

Technical and Bibliographic Notes / Notes techniques et bibliographiques

The Institute has attempted to obtain the best original copy available for filming. Features of this copy which may be bibliographically unique, which may alter any of the images in the reproduction, or which may significantly change the usual method of filming, are checked below.

L'Institut a microfilmé le meilleur exemplaire qu'il lui a été possible de se procurer. Les détails de cet exemplaire qui sont peut-être uniques du point de vue bibliographique, qui peuvent modifier une image reproduite, ou qui peuvent exiger une modification dans la méthode normale de filmage sont indiqués ci-dessous.

Coloured covers/
Couverture de couleur

Covers damaged/
Couverture endommagée

Covers restored and/or laminated/
Couverture restaurée et/ou pelliculée

Cover title missing/
Le titre de couverture manque

Coloured maps/
Cartes géographiques en couleur

Coloured ink (i.e. other than blue or black)/
Encre de couleur (i.e. autre que bleue ou noire)

Coloured plates and/or illustrations/
Planches et/ou illustrations en couleur

Bound with other material/
Relié avec d'autres documents

Tight binding may cause shadows or distortion along interior margin/
La reliure serrée peut causer de l'ombre ou de la distorsion le long de la marge intérieure

Blank leaves added during restoration may appear within the text. Whenever possible, these have been omitted from filming/
Il se peut que certaines pages blanches ajoutées lors d'une restauration apparaissent dans le texte, mais, lorsque cela était possible, ces pages n'ont pas été filmées.

Additional comments: / Various pagings.
Commentaires supplémentaires:

Coloured pages/
Pages de couleur

Pages damaged/
Pages endommagées

Pages restored and/or laminated/
Pages restaurées et/ou pelliculées

Pages discoloured, stained or foxed/
Pages décolorées, tachetées ou piquées

Pages detached/
Pages détachées

Showthrough/
Transparence

Quality of print varies/
Qualité inégale de l'impression

Continuous pagination/
Pagination continue

Includes index(es)/
Comprend un (des) index

Title on header taken from: /
Le titre de l'en-tête provient:

Title page of issue/
Page de titre de la livraison

Caption of issue/
Titre de départ de la livraison

Masthead/
Générique (périodiques) de la livraison

This item is filmed at the reduction ratio checked below/
Ce document est filmé au taux de réduction indiqué ci-dessous.

10X	14X	18X	22X	26X	30X
<input type="checkbox"/>	<input type="checkbox"/>	<input type="checkbox"/>	<input type="checkbox"/>	<input checked="" type="checkbox"/>	<input type="checkbox"/>
12X	16X	20X	24X	28X	32X

The Canadian Patent Office

RECORD



Vol. VI.—No. 8.

AUGUST, 1878.

{ Price in Canada \$2.00 per An.
United States - \$2.30 "

CONTENTS.

INVENTIONS PATENTED.....	115
INDEX OF INVENTIONS.....	CXXV
INDEX OF PATENTEEES.....	CXXVI
ILLUSTRATIONS.....	127

INVENTIONS PATENTED.

No. 8948. Improvements on Oil Cans. (*Perfectionnements aux bidons à huile.*)

John A. Frey, New York, U.S., 25th June, 1878, for 5 years.
Claim.—1st. A glass reservoir inclosed within a metal casing which is provided at one side with a vertical opening, that is spanned by horizontal metal bars to indicate the height within said reservoir of any predetermined quantity of liquid. 2nd. An oil can composed of a glass containing vessel, and the sheet metal casing. 3rd. The corrugated sheet metal casing for protecting glass vessels.

No. 8949. Method of Transmitting Power. (*Méthode de transmission de la puissance.*)

Mitchell Henry, Kilmore Castle, Ireland, (Assignee of Henry C. Spalding, Bloomfield, N.J., U. S.), 25th June, 1878, for 15 years.
Claim.—1st. The arrangement and combination of apparatus, composed of a prime mover with an engine for producing electric currents, a conductor and an electric motor engine. 2nd. The method of transmitting power from the place where it is developed, to the place where it is to be used for actuating machinery by means of electrical currents.

No. 8950. Improvements on Blind Hinges. (*Perfectionnements aux peulures des piscines.*)

Ellswood Smart, Brockville, Ont., 25th June, 1878, for 5 years.
Claim.—1st. The female portion constructed with the knuckle J, within the area of its plate H; 2nd. Forming the plate H, with a recess M.

No. 8951. Combined Candle-holder, Match-safe and Nail File. (*Bougeoir, porte-allumettes et lime à ongles combinés.*)

Samuel Fuld, New York, U. S., 25th June, 1878, for 5 years.
Claim.—A tube A with spring G, pin a5, the sleeve H with slots h h1 cap, horizontal tube B with circular file C, and match lighter D, caps E E1 and chains J J.

No. 8952. Improvements on Washboards. (*Perfectionnements aux planches à laver.*)

Joseph Murphin and Alfred B. Richman, Malaga, N. J., U. S., 26th June, 1878, for 5 years.
Claim.—In combination with a washboard, having the longitudinally corrugated rollers B, and the grooves i, at each side of the said rollers of the plate C adapted to be shifted from one side to the other of the board.

No. 8953. Improvements on Mops. (*Perfectionnements aux torchons.*)

Dexter Greenwood, (Assignee of William H. Thayer,) Nashua, N. H., U. S., 7th June, 1878, for 5 years.
Claim.—1st. The combination of a mop head A, having either the concave-converging flanges D, or central projection E, or both, and endless mop web F, and a wringer having a foot rest H, body I, inclinedly supported by hook K, having an arm L terminating in a ring M over the part, 2nd. The mop head A, cast in one or more pieces having either the concave portion or converging flanges D, or central projection E, or either for the purpose set forth. 3rd. The combination of a mop head A having a skeleton socket, a handle B and an inserted wedge or key c, for securing the same; 4th. A mop wringer having strip H curved body I, hook K, and an arm L terminating in a ring M, or its equivalent.

No. 8954. Heating Apparatus. (*Appareil de chauffage.*)

John Cowan, Dramore Kimmare, Ireland, 27th June, 1878, (Extension of Patent No. 2508,) for 5 years.

No. 8955. Improvements on Door Knobs. (*Perfectionnements aux boutons des portes.*)

Charles Egner, Hamilton, Ont., 27th June, 1878, for 5 years.
Claim.—1st. A metallic knob or handle having the shank A attached to it by welding the projecting part d of the said shank down, on the inside of the bottom part B of the said knob. 2nd. The knob constructed in two sections B and C, so that the shank A can be welded thereto on the inside.

No. 8956. Wearing Apparel. (*Vêtement.*)

Israel Crane, New York, U.S., 27th June, 1878, for 5 years.
Claim.—1st. The combination of the outer garment A or A', the waist B and the neck or shoulder fastening b. 2nd. As an improved article of manufacture, a suit of clothing in which a waist B is attached by a neck or shoulder fastening b, within the outer garment A or A'.

No. 8957. Improvements on Baby Walkers. (*Perfectionnements aux charriots d'enfants.*)

John LeButler, Allison C. Johnson, Elias Touret and Philip Thoreau, Osceola, Iowa, U.S., 27th June, 1878, for 5 years.
Claim.—In combination with the rim A and its supporting legs C C, the folding seat E having aperture n, slide m and sliding cushion G.

No. 8958. Fire and Water Alarm. (*Alarme d'incendie et d'eau.*)

Aristide Gerard, New Orleans, La., U. S., 27th June, 1878, for 5 years.
Claim.—1st. In a thermoscope or fire alarm indicator, the vessel A and tube A' containing confined air, tube B containing mercury, rod E, tubes C C', and adjustable needles c c'. 2nd. In an auto pneumatic water indicator, the cylinder G4, air-tight tube g5, mercury tube I4, wire c6, tube D3, adjustable needle c3 and screw c4, in combination with an electric alarm. 3rd. In an annunciator, the movable plate D9, hinged as shown, in combination with the switch D5 and spring a7. 4th. In an annunciator the plate D9, springs a7 switch D5, switch buttons 1 2 3, &c., posts L5 E6 e6 e7 e8, wires e8 e9 e9, magnets B5, armature C7, gong C5 and chapper c6.

No. 8959. Bed Stone Support. (*Support de meule de dessous.*)

Peter T. Elting, Boston, Mass., U. S., 27th June, 1878, for 5 years.
Claim.—1st. A bed-stone and liquid support therefor, to operate as described; 2nd. A bed-stone liquid holding vessels, and followers sustained by the pressure of the liquid below the followers. 3rd. The combination with a bed-stone liquid holding vessels and followers, of pipes to connect the vessels; 4th. The combination with a bed stone liquid-holding vessels, followers and pipes to connect the vessels, of pressure gauges; 5th. The combination with liquid holding vessels, followers and bed-stone, of a leveling plate and screws to adjust or level it. 6th. The bed-stone and liquid-holding vessels and pipes to supply them with liquid, combined with the valves to open or close the communication between such pipes.

No. 8960. Bedstead Fastening. (*Fasture de couchette.*)

Alexis Chevigny, Montreal, Que., 27th June, 1878, for 5 years.
Résumé.—L'épaulement ou petite équerre de la languette désignée par les lettres e f g ainsi que la coulisse correspondante, et c. en combinaison avec les autres parties de l'invention.

No. 8961. Process for Painting Houses. (*Procédé de peinture en bâtiments.*)

Louis Améris and Joseph Buessard, Quebec, Que., 27th June, 1878, for 5 years.
Résumé.—D un composé d'oxyde de zinc, d'eau étendue de chlorure de zinc, et de silicate de potasse, le tout mélangé dans les proportions décrites.

No. 8962. Improvement on Lamps.*(Perfectionnement aux lampes.)*

Charles F. Spencer, Rochester, N.Y., U. S., 27th June, 1878, for 5 years.

Claim.—A parlor stand A, provided with a fountain top C, or a hollow C, having one or more pipes D leading therefrom, with fixtures for the attachment of lamps.

No. 8963. Improvements on Air Guns.*(Perfectionnements aux fusils à air.)*

Asa Pettengill, Keene, and Frank H. Colony, Harrisville, N. H., U. S., 27th June, 1878, for 5 years.

Claim.—1st. The barrel as composed of the two concentric tubes *a b*, and their uniting rings *c d*; 2nd. The barrel provided with the locking stud *e*, in combination with the stock provided with the socket *g*, grooved and notched as set forth; 3rd. The barrel provided with the stud *e*, in combination with the stock A, provided with the socket *g*, having the groove *k* and notch *i*, as set forth, and with the perforated abutment *f*, and the air chamber and its plug piston operative spring or springs, catch lever and its spring and trigger; 4th. The barrel socket constructed with or having the opening *h*, the groove *k* and notch *i*, arranged in it to receive the barrel provided with the stud *e*.

No. 8964. Manufacture of Gas. (Fabrication du gaz.)

Silas C. Salisbury, New York, U. S., 3rd July, 1878, for 10 years.

Claim.—1st. In one or more boilers A, with the furnaces B combined with the bench C, of retorts for heating the blast, and superheating the steam, the blast injector D and blast pipe E L, extending from said retort in front of the furnace B; 2nd. The benches of ordinary retorts combined with an injector D, and pipe *p* extending nearly to the inner ends of the several retorts and pipe *q*, and connecting pipes for manufacturing fixed gas from liquid hydro-carbon in ordinary gas retorts; 3rd. A liquid or semi-liquid fuel compound, consisting of a mixture of coal tar, and the tar residuum from the distillation of petroleum, shale or rosin and in proportion as set forth.

No. 8965. Railway Rail Chair. (Coussinet de rail de railroute.)

John W. Close, St. Thomas, Ont., 4th July, 1878, (Extension of Patent No. 2514.) for 5 years.

No. 8966. Automatic Air Carburetter.*(Carburettur automatique à air.)*

Charles A. Howard, Pontiac, Mich., U. S., 6th July, 1878, for 5 years.

Claim.—1st. A chamber packed with alternate layers of cotton, wool and excelsior wood shavings, or other suitable materials, saturated with gasoline or other suitable carburetter, which chamber is provided with inlet and exit openings for air and elevated above the level of the burners in such manner that air entering at the top and passing through the carburetting chamber will increase in specific gravity by the absorption of the carburetting material and thus flow naturally down to, and supply the burners with an illuminant; 2nd. The cylinder A, with carburetting chamber F, packed with alternate layers of cotton, wool and excelsior wood shavings saturated with gasoline and having inlet and exit openings for the passage of air; 3rd. The combination of the perforated conductor C, with the packed carburetting chamber; 4th. The air and other openings into and from the carburetting chamber, covered with wire cloth for the purpose of preventing the passage of flame with said carburetting chamber; 5th. The receiving chamber E, in combination with the carburetting chamber F, and divided therefrom by the intermediate head B, having the connecting opening covered with wire cloth; 6th. A packing and absorbent for the carburetting chamber of air and gas carburetting machines, consisting of alternate layers of cotton, wool and excelsior or thread wood shavings.

No. 8967. Air Carburetter. (Carburettur à air.)

Charles A. Howard, Pontiac, Mich., U. S., 6th July, 1878, for 5 years.

Claim.—1st. A carburetting chamber divided into two sections by a partition at the bottom or lower part of which one or more openings are made from one section into the other for the purpose of causing the liquid carburetter necessary to supply combustion to be drawn from the bottom of the chamber; 2nd. The hinged or flexible section F of the air pipe provided with a float, and so arranged that the mouth of the air pipe is sustained below the surface of the carburetting liquid at all levels so as to form a seal; 3rd. The hollow cross-head G provided with a perforated drooping edge, in combination with the flexible or hinged and buoyed section F; 4th. The combination and arrangement of the filling pipe C, gas main D with the carburetting chamber A.

No. 8968. Velvet and Plush Mats and Robes.*(Nattes et robes de voitures en velours et en peluche.)*

Elam F. Austin, Rochester, N.Y., U. S., 6th July, 1878, (Extension of Patent No. 2510.) for 5 years.

No. 8969. Refrigerator Car. (Wagon frigorifique.)

Joel Tiffany, Chicago, Ill., U. S., 6th July, 1878, for 5 years.

Claim.—1st. A car having insulated air spaces *b* at the sides, top and bottom, an exterior jacket *a* covering the vertical sides and top, the intermediate space divided into air passages *a*, each having a door at the ends, to admit and stop circulation of air, to adapt the car for winter or summer use; 2nd. The ventilating passages E, connecting the chamber of the car with the air spaces *a* in the roof; 3rd. The perforated air flues E, passing horizontally through the car; 4th. The elevated ice chamber, located near the ceiling, supported on joists M and fed through doors in the roof; 5th. The ice chamber, composed of slats S at the sides, irregularly laid floor pipes X, floor N, inclines *t*, gutter *n* and waste pipes P.

No. 8970. Washing Machine. (Laveuse mécanique.)

Albert H. Randall and Edward Foster, Leamington, Ont., 6th July, 1878, for 5 years.

Claim.—1st. A rotating cylinder B, within which clothes are placed to be washed, in combination with a clothes boiler; 2nd. The rotating cylinder

B, consisting of the heads C C, provided with inwardly projecting cones E and connected together at or near their periphery by a series of cupped bars D, arranged with open intervals between; 3rd. The cylinder B, provided with the trunnions F and wheel G, in combination with boiler A, provided with suitable trunnion bearings and the detachable cover A, provided with the pinion G, by which the cylinder may be rotated; 4th. The detachable cover A, and attachments, in combination with the boiler and attachment and the cylinder B.

No. 8971. Broom Sewing Machine. (Machine à coudre les balais.)

Charles E. Lipe, Syracuse, Edward D. Bronson, Amsterdam, and Alphonso Walrath, Fort Blain, N.Y., U. S., 6th July, 1878, for 5 years.

Claim.—1st. A rocking broom-holding vise provided with alternating ratchet teeth on its sides, in combination with vertically and horizontally movable pawls; 2nd. A broom-holding vise, in combination with devices whereby the oscillation of said vise causes the same to climb upward, step by step; 3rd. A moving broom-holding vise, in combination with gear shifting mechanism, whereby, when the sewing is completed, the driving wheel is thrown out of gear; 4th. A broom-holding vise, in combination with a clutch shifting lever, having a pivoted pawl or arm; 5th. A shaft having two rotary take-up arms that operate alternately on each side of the broom; 6th. The combination of two needle drivers with a double pointed needle, each of said needle drivers being provided with a spur that catches into a perforation in said needle; 7th. The combination of a needle guide way and needle; 8th. The combination of a needle guide way, having an oblique stop-slot, and a needle driver provided with a suitable projection to engage with said slot; 9th. The combination of a sliding vibrating needle driver, and an operating yoke moved by the driving shaft; 10th. The combination of spring operated feed-pawls with the carriage moving lever C; 11th. The combination of a cam *c*, or its equivalent, with a lever and broom carriage, whereby an intermittent forward and backward motion is given to the broom; 12th. The combination of a broom carriage with a control *n* lever, either end of which may be made the fulcrum at will; 13th. A rocking broom vise, in combination with a sliding broom carriage; 14th. A broom holding vise, in combination with a broom rocker, an operating cam and suitable connection; 15th. A broom rocking device which automatically varies the angle of the broom with the sewing mechanism, on the different bands of stitching; 16th. In combination with a broom holding vise, a pair of pivoted levers, in combination with a treadle, whereby said vise can be closed at will; 17th. In a broom pressing vise, a pair of pressing levers which may be connected and disconnected at will; 18th. A broom holding vise, in combination with one or more band supporting bars; 19th. A broom vise, in combination with clasps for holding together its two parts or jaws when released from the pressure of the closing levers; 20th. In a broom sewing machine, a broom holding vise, in combination with the carriage, the two being connected by a universal joint; 21st. Devices for laying the stitches in consecutive bands on alternating radial lines; 22nd. A double pointed needle, provided with an inserted tension spring; 23rd. The combination of a driving shaft with a take-up shaft at right angles thereto, the two being connected by suitable gearing; 24th. The combination of a connecting yoke with two needle drivers, which alternately seize and release the needle; 25th. The combination of a connecting yoke with two needle drivers which are alternately moved inward and outward thereby; 26th. The combination of a broom carriage and controlling lever with a shifting plate provided with devices in the nature of inclined planes for shifting the position of the broom; 27th. The combination of a broom holding vise with two needle drivers and a needle; 27th. The combination of a shifting plate and feeding mechanism, whereby the broom and feed are quickly changed from the stopping to the starting point; 29th. The combination of an operating treadle with a system of slides and levers, for simultaneously shifting the broom and opening the tension for threading the needle.

No. 8972. Furniture Castor. (Roulette de meuble.)

William H. Tucker, Robert S. Dorsey, Indianapolis, Ind., Christian H. Sohn and George A. Rentschler, Hamilton, Ohio, (Assignees of Alexander C. Martin, Hamilton, Ohio.) U. S., 6th July, 1878, for 5 years.

Claim.—Floor wheels E E, anti-friction pivot-wheel F, housing B, elliptical-housing opening, or its mechanical equivalent, and rocker-formed collar-bearing, or its mechanical equivalent, all combined so as to allow the floor wheel axis to oscillate horizontally.

No. 8973. Machine for Manufacturing Floor, Oil and Leather Cloth and Paper.*(Machine à fabriquer le préart-cuir et le carton-cuir pour les parquets.)*

William A. Scott, London, Ont., 6th July, 1878, for 5 years.

Claim.—1st. The apparatus for feeding the material to the machine and carrying the same through the machine composed of travelling stand J, having flanged wheels *d*, check roller J, spreader rollers K L, brush M, upper rollers N O, endless rubber band P, polishing roller *b* and turning off roller or drum H, operated by means of cog-wheels E F, to which motion is communicated by pinion D on end of driving shaft; 2nd. The devices for painting the cloth or paper, composed of the knife G and carrying block R, standards S S, screw rod T, regulator bevel wheel V and pinton U, connected by shaft X and adjusted by wheel W; 3rd. The apparatus for printing the cloth, &c., with various patterns composed of standards Y Y, paint distributing rollers Z Z, and pattern roller Z.

No. 8974. Plotting Instrument. (Rapporteur.)

Daniel F. Hitt, Ottawa, Ill., U. S., 6th July, 1878, for 5 years.

Claim.—The combination of the square frame A having guide slots *b*, in parallel sides with hypotenuse scale C and a sliding lateral scale D, both having verniers at the ends and fastening clamp screw.

No. 8975. Lightning Rod. (Paratonnerre.)

Thomas C. Hewitt, Brantford, Ont., (Assignee of Charles H. Smith, Chicago, Ill., U. S.,) 6th July, 1878, for 5 years.

Claim.—A glass ornament for lightning rods or weathervanes, having exterior or interior reflecting surfaces.

No. 8976. Furniture Castor. (*Roulette de meuble.*)

Charles A. Parent, (Assignee of Joseph J. Adgate,) New York, U.S., 10th July, 1878, for 5 years.

Claim.—1st. The glass ball A and holder having the arms D, the swells or projections a, of solder or other soft metal attached to the inner sides of the arms; 2nd. A glass ball A and a metallic holder, an ivory tip or point b inserted in the holder for forming the top bearing for the ball; 3rd. The combination of the ball A, plate B, with stern C and ivory tip b, and the arms D with inner projections d.

No. 8877. Clothes Wringer. (*Essoreuse à linge.*)

Richard P. Street, Hamilton, Ont., (Assignee of Cornelius E. Haynes, Boston, Mass., U. S., 10th July, 1878, for 5 years.

Claim.—1st. In combination with a clothes wringer of the spring levers B B; 2nd. In combination with a wringer, of the rod G and eccentrics H H for securing the machine to a tub; 3rd. In combination with a wringer of the clothes guards F F; 4th. In combination with a wringer, of the springs E, constructed as shown, secured to the lower end of the lever B and lower end of frame A, and held by projections a a in lever and frame, and holes b b in springs.

No. 8978. Improved Shoe. (*Soulier perfectionné.*)

Jesse W. Hatch, Rochester, N. Y., U. S., 10th July, 1878, for 5 years.

Claim.—1st. The combination of a permanent inner sole, an upper and an outer sole extended beyond the toe of the upper far enough to serve as a protecting edge for the upper, the upper and the shoe outside the end of the inner sole, whereby the toe of the upper is so held as not to be cut over the edge of the inner sole; 2nd. A permanent inner sole made narrower and shorter than the outer sole from its shank forward, in combination with an upper and outer sole sewed together by stitches passing only into the upper and outer sole, outside of the edge of the inner sole, in front of the shank; 3rd. A permanent inner sole, reduced in width and length in front of the shank in combination with an outer sole and an upper united together in front of the shank by stitches passing only into the upper and outside the edge of the inner sole and at the shank, and backwards by stitches passing through the outside, upper and inner sole; 4th. The described method of manufacturing an extension edge upper protecting shoe, provided with a permanent inner sole, consisting in stitching the upper to the outer sole outside the edge of the permanent inner sole forward of the shank.

No. 8979. Anti-Friction Devices. (*Machines à anti-friction.*)

William Tucker, East Brookfield, and John G. Avery, Spencer, Mass., U.S., 10th July, 1878, for 5 years.

Claim.—1st. The combination with a shaft or its equivalent, and a journal box or its equivalent, of equi-distant cylindrical facings of hardened metal, and one or more circumferential series of solid journalers, friction rollers of like hardened metal interposed between said facings, and in solid contact therewith, as a substitute for lubrication; 2nd. The combination with a cylindrical shaft of a sleeve of hardened steel or its equivalent, having conical enlargements in its ends a pair of split wedging rings fitted to said enlargements, and a pair of clamping nuts for driving and retaining said wedging rings for providing such shaft with a concentric hardened surface; 3rd. The combination of parallel or equi-distant surfaces, short journaler rollers in solid contact with both said surfaces, and a carrier having a socket or cell for each roller, and supported out of contact with said coating surfaces by said rollers; 4th. The combination of several parallel series of short journalers friction rollers, and a carrier having a socket or cell for each roller, said cells being so arranged that the axes of no two rollers are in line with each other longitudinally; 5th. The combination of several rings, each having separate sockets or cells, for a circumferential series of short journalers friction rollers, and forming together a carrier sleeve of any required dimension, containing parallel series of said rollers; 6th. The combination of several rings, each having separate sockets or cells for a circumferential series of short journalers friction rollers, and forming together a carrier sleeve, containing several parallel series of said rollers with the axes of no two rollers in line with each other longitudinally; 7th. The combination of a shaft, or its equivalent, and a bearing or its equivalent, having parallel or equi distant surfaces or facings of hardened metal, and an interposed carrier sleeve having separate sockets or cells for a large number of short journaler rollers of like hardened metal, arranged in several circumferential series with the axes of no two rollers in line with each other longitudinally.

No. 8980. Machine for Cutting Nails. (*Machine à couper le clou.*)

William N. Severance, Lima, Ohio, U. S. 10th July, 1878, for 5 years.

Claim.—1st. The cutter stocks H and K, each carrying two series of cutters which are brought alternately into action on the nail plate in lines at, or nearly at right angles to the plane of the sheet; 2nd. The cutter stock H, having an oscillating and also a reciprocating vertical movement by which latter it is brought down upon the sheet in making the cut; 3rd. In combination with the cutter stock H, supported in sliding boxes, the stationary ways adapted to guide the outer stock in its vertical movements; 4th. In combination with the cutter stock H, the yoke l and 2, and the sliding boxes in which said cutter stock rests; 5th. The combination of the cutter stock H, the toggle levers G G, connecting rod F, walking beam E and mechanism for moving the same; 6th. In combination with the cutter stock A, the intermediate feed mechanism; 7th. In combination with the frame and cutter stocks H and K, the stationary guides V, arranged in relation thereto; 8th. In combination with the stationary guides N N, the adjustable gibs; 9th. In combination with stationary guides and recesses therein, the reciprocating cutter stock and adjustable guides O O; 10th. In combination with the cutter stocks having inclined recesses, the guides O O, set screws and wedges for adjusting said guides at an inclination to the radial line; 11th. In combination with the adjustable cutters and set screws, the metallic packing strips interposed between them, for the purpose of preserving a space between the cutter and at the same time holding them rigidly in place; 12th. In combination with the reciprocating cutter stock H, and feed rollers, the lever Q, pawl Q₂, and ratchet C₂, for communicating motion to the feed rollers with the rise and fall of the cutter stock; 13th. In combination with the oscillating cutter stock K, the oscillating and reciprocating cutter stock H and interlocking guides O O, for preserving the

relations of the cutters; 14th. In combination with the outer stock feed lever Q and jaws Q₃ for regulating the movement of the feed; 15th. The combination of the cutter stocks, and the opposite interlocking guides O O₂ and O₃; 16th. The connecting rod I, having upon the inner surfaces of the end thereof, upon which the cams work, blocks of metal and elastic cushions, the blocks being held in place and made adjustable with set screws.

No. 8981. Improvements on Pianos and Organs. (*Perfectionnements aux pianos et aux orgues.*)

Edward K. Millikin, Portland, Me., U.S., 10th July, 1878, for 5 years.

Claim.—1st. The method of transposition of the scale on musical instruments having key boards, which consists in the movement of the key board up and down the trackers, or the supplementary trackers of the same, and so guiding the said keys into fixed relations to the valves or hammers that any given key may be made to play in different scales; 2nd. The joint and section between the keys and ordinary trackers; 3rd. The sliding bed a, in combination with the k-y's and trackers; 4th. The sliding bed a, keys and pins, and the joint and section; 5th. The sliding bed a, when so constructed as to be capable of being lifted and depressed, or moved inwardly or outwardly; 6th. The combination of the keys, supplemental trackers c, and the arrangement of the pivots w.

No. 8982. Spring Bed Bottom. (*Fond de lit à ressorts.*)

Susan B. Walker, (Administratrix of the goods of G. S. Walker,) Erie, Pa., U.S., 10th July, 1878, for 5 years.

Claim.—1st. The combination within a bed bottom of the slats B B B, &c., elastic separating pieces K K K, &c., and the binding cord I; 2nd. An improved device for sustaining and suspending a slatted bed bottom in the eye bolts F, rods H D and springs E; 3rd. The combination within a bed bottom of the slats B, separating pieces K, cords I, eye bolts F, rods H and D, and springs G.

No. 8983. Process of Curing and Packing Meats. (*Procédé de salage et d'empaquetage des viandes.*)

Thomas Wallace, Hamilton, Ont., 10th July, 1878, for 5 years.

Claim.—1st. In curing the meat in a brine made of salt, saltpetre, sugar, Jamaica rum and the essence of Jamaica pepper, in or about the proportions specified; 2nd. Curing meats and packing in a wooden box lined with tin, hermetically sealed, and provided with or without an exhaust air tube.

No. 8984. Device for Ventilating Millstones. (*Appareil pour rafraichir les meules.*)

George Moech, Rushville, Ill., U. S., 10th July, 1878, for 5 years.

Claim.—1st. The combination with a grinding mill and its casing, of an exhaust pipe communicating with the interior of the casing for the purpose of carrying off hot and damp air; 2nd. The exhaust pipe C communicating with the interior of the hoops or casing of a grinding mill and provided at its upper end with a sack distended by a suitable frame; 3rd. The combination with the casing of a mill stone of the ventilating pipe C, extending below said casing and communicating directly or indirectly therewith, and the sack D upon the upper end of the said pipe, and distended by a suitable frame.

No. 8985. Improvement in Knitting Machines. (*Perfectionnement dans les machines à tricoter.*)

William T. Lemon, Detroit, Mich., U. S., 10th July, 1878, for 5 years.

Claim.—1st. In a registering attachment, the bifurcated arm N, the pivoted lever M and pawl O in combination with the ratchet wheel H, and pawl P provided with the spring Q; 2nd. The bifurcated arm N, carrying the pawl O, in combination with the pivoted lever M and ratchet wheel H; 3rd. The bifurcated arm N, the pawl O, the pivoted lever M, and the ratchet wheel H, in combination with pivot screw d; 4th. In a registering attachment, the bifurcated arm N, pivoted lever M, pawls O and P, and ratchet wheel H, in combination with the double pawl T; 5th. In a registering attachment the main plate H provided with the rim G and slots F, in combination with the bed C, provided with the adjusting screws D; 6th. The double pawl T, provided with the arms a a and a diamond pointed head, in combination with the plate U, guide rod V and spring W; 7th. The ratchet wheel H, with its knob K and operating mechanism, in combination with the toothed wheel L; 8th. The ratchet wheel H, with its knob K and operating mechanism, in combination with the wheel L and stop e.

No. 8986. Process of Treating Vegetable Oils. (*Procédé de traitement des huiles végétales.*)

Henry A. Clark, Boston, Mass., U.S., 10th July, 1878, for 5 years.

Claim.—Heating the oil, in contact with sulphur to that degree at which the sulphur is vaporized, in which condition the sulphur reacts upon the oil to vulcanise it, and then treating it with benzine and benzole or their equivalents; 2nd. The treatment of vegetable oils which have been reduced to a gummy condition, first with benzine for extracting grease, and then with benzole.

No. 8987. Carpet Stretcher. (*Étireur de tapisserie.*)

Daniel W. Beadle, (Assignee of Theodore H. Brumfield,) Geddes, N. Y., U.S., 10th July, 1878, for 5 years.

Claim.—1st. The combination of the toothed head A, ratchet bar B, with slotted projections t t, and the screw cams or eccentrics h h; 2nd. The slotted bar C, with spike c, pawl D and bail E, in combination with the ratchet bar B, toothed and perforated head A, with notch and operating lever.

No. 8988. Process for Treating Feathers for Dusters. (*Procédé de traitement des plumes à plumetoux.*)

Clarence W. Nicholls, Chicago, Ill., U.S., 10th July, 1878, for 5 years.

Claim.—1st. In passing the feathers between heated surfaces; 2nd. In passing the feathers between rollers corrugated or fluted; 3rd. In removing

the inner portion of the stems and passing them between heated fluted rollers; 4th Splitting the stem and removing the inner portion, and then subjecting the stem to a rasping or grinding process to remove all or nearly all of the pith; 5th Splitting the stem, removing the inner portion, rasping or grinding the stem to remove the pith, and then subjecting it to feather to the notion of crushing rollers or surfaces either fluted or otherwise, either with or without the action of heat.

No. 8939. Mangling and Wringing Machine.
(*Machine à calandrier et essorer.*)

James C. Harrison, Brockville, Ont., 10th July, 1878, for 5 years.

Claim.—The arrangement of the rollers H H, and the pressure roller H, having an equilibrating spring A imposed on its movable bearings regulated by screw B, and geared together to operate in unison within the frame D.

No. 8990. Sliding Door. (*Porte en coulisse.*)

George R. Kildler, Annada, Meb., U. S., 10th July, 1878, for 5 years.

Claim.—1st. In a sliding door or gate, the combination of the hangers B B with the door or gate A, pulleys C C and elevated platform A; 2nd. The combination of the door or gate A, platform A, hangers B B, pulleys C C and bent or angular bar D, provided with a friction roller d.

No. 8991. Camp Bedstead. (*Lit de camp.*)

William Shoobred, (Assignee of Thomas Steers, Jr.) Ottawa, Ont., 10th July, 1878, for 5 years.

Claim.—A camp bedstead constructed of rails A A and C C, telescoping together and hinged to cross legs E E F F D D, said legs formed with a zig-zag pivot joint at their intersection to fold compactly as set forth.

No. 8992. Machine for Crushing Withe. (*Machine pour écraser Vosier.*)

William Lesslie, Jr., Kingston, Ont., 10th July, 1878, for 5 years.

Claim.—The rollers A B having the tapered surface and the spiral groove *d e f*, and the parallel grooves *g h k*, for crushing wites.

No. 8993. Washing Machine. (*Machine à laver.*)

Leonard C. Snyder and Hiram E. Bates, Essex Junction, Vt., U. S., 10th July, 1878, for 5 years.

Claim.—1st. In combination with a plain rubber roller B, journaled in the standards A A of a washing machine, in an ordinary manner, a roller c having longitudinal grooves F, 2nd. The combination with the wringer standard A A, of the locking block G and segmental bar H.

No. 8994. Improvement in Scrubbing Machines.
(*Perfectionnement dans les machines à frotter les parquets.*)

August F. Stockley, Bishop Creek, Cal., U. S. 10th July, 1878, for 5 years.

Claim.—1st. The arrangement of devices for giving a reciprocating movement to the brush, composed of the wheel M, with a sunken gear in its outer periphery pinion, cranks and shaft K, horizontal arms L and fixed upright standards H; 2nd. The combination with the tank A, of the sprinkler R, valve S, and its operating mechanism composed of the vertical rod T and arm and adjustable nuts V.

No. 8995. Improvements in Ironing Boards.
(*Perfectionnements dans les tables à repasser.*)

Louis Duval, Longueuil, Que., 10th July, 1878, for 5 years.

Claim.—The combination with the board A of supports B and C, pivoted respectively to lugs *b* and *d* (the former having slots B formed therein,) and the connecting rod D, with heads or nuts D,

No. 8996. Improvements on Carriage Springs.
(*Perfectionnements aux ressorts des voitures.*)

William Bambridge, Oshawa, Ont., 10th July, 1878, for 5 years.

Claim.—The combination of an elastic cushion or separator A, with springs B B, clips C, follower C¹ and rivets D.

No. 8997. Art of Draughting and Cutting Garments.
(*Art de tracer et tailler les hardes.*)

Neil McMillan, Mount Forest, Ont., 10th July, 1878, for 5 years.

Claim.—1st. The combination of scales G F P T B and W B, 2nd. The combination of scales S P H and F

No. 8998. Improvements in Gates. (*Perfectionnements dans les barrières.*)

Jacob S. Lounsbury, Sandwich East, Ont., 10th July, 1878, for 5 years.

Claim.—1st. The curved double lever F F F, with the hinged double pulley H; 2nd. The wheels L L with their attachments, acting in combination with curved double lever F F F; 3rd. The spring lever M M with their attachments, acting in combination with latch guards D D; 4th. The swinging leaf A, at the lower side of the gate with its bolt; 5th. The combination of the curved double lever F F F and its adjuncts H and G, with wheels L L, and their attachments I I I I, and with spring levers M M and their attachments, with swinging leaf A.

No. 8999. Improvements on Gas Governors.
(*Perfectionnements aux régulateurs à gaz.*)

Frank B. Scovell, Waterford, Ont., 10th July, 1878, for 5 years.

Claim.—1st. The outer vessel or can A, vertical pipe B, float E and rod F, having universal joint G, collar K, set screw L and weights M, in combination with valve chamber C, check valve H, outlet I, and connection J, 2nd. As a means of regulating the flow of gas from the main pipe to the burners, in a vessel A, partially filled with water D and having a space N between said fluid and a float E, operating the valve H or equivalent devices.

No. 9000. Improvement in Rein-holders.
(*Perfectionnements aux accroche guides.*)

John M. Taylor and John MacKoy, Fredericton, N.B., 10th July, 1878, for 5 years.

Claim.—The device G, made with two recesses C¹ C², to adapt it to be attached to the hip straps of a harness for holding the reins.

No. 9001. Improvement on Cooking Stoves.
(*Perfectionnement aux poêles de cuisine.*)

John M. Taylor and John Mackey, Fredericton, N.B., 10th July, 1878, for 5 years.

Claim.—The device E, so made as to adapt it to be secured to the fuel chamber of cooking stoves.

No. 9002. Apparatus for Utilizing Steam in Heating.
(*Appareil pour utiliser la vapeur dans le chauffage.*)

Birdsall Holly, Lockport, N. Y., U. S., 10th July, 1878, for 5 years.

Claim.—1st. An underground steam street main in combination with steam-supplying apparatus, and with a meter constructed to control the pressure of steam in a building, and also record the consumption of steam from such main; 2nd. Underground street mains, connected with steam supplying apparatus and with junction boxes which permit expansion and contraction of the mains longitudinally, and with heat radiators in building contiguous to streets where the mains are laid; 3rd. In combination with steam conveying-pipes of a building, for conveying steam to heat the building and for other purposes, a steam meter constructed to control the pressure of steam in such pipes and also to record the consumption of steam in the building; 4th. An underground steam street main in combination with steam supplying apparatus, and with a heat radiator of a building and with a meter; 5th. Underground street mains connected with steam supplying apparatus and with a heat radiator, and with a steam trap; 6th. Underground street mains connected with steam supplying apparatus and with a heat radiator, and with a steam trap which answers the double purpose of a reheater and a steam-trap; 7th. An underground steam street main in connection with steam supplying apparatus, and with a heater of building and with a water hydrant; 8th. An underground steam street main connected with steam supplying apparatus, and with a heater of a building and with a street steam hydrant; 9th. An underground street mains connected with steam supplying apparatus and with a heat radiator, and with an automatic steam regulator or governor; 10th. Underground steam street mains connected with a steam supplying apparatus and with a heat radiator of a building and with underground snow and ice reservoirs, having open ended or perforated steam pipes in said reservoirs for the escape of steam therein; 11th. A steam street main expansion-chamber F⁸; 12th. An adjustable hood *g*, in combination with steam main F¹, service pipe *a*, and expansion chamber which serves as a steam chamber; 13th. The combination of the expansion chamber F⁸, the street main F¹, screw threaded as at *f*₃, the adjustable ring G₂, and the follower *e*; 14th. The wall of the expansion chamber F⁸ of the junction box F¹, made to support the inner end of a section of the steam main, and the outer covering *m*₂ of the steam main; 15th. The section *f*₂ of the steam main, made of nickel plated metal; 16th. The combination of the convex ring *g*₁ of the steam main F¹, the wall of the expansion chamber tube G and eyebolts *g*₃; 17th. Steam street mains, insulated as described, drained by tiles as at *z*; 18th. The meter cylinder *c*, having inlet *m*₃ and outlet *m*₄ and an annular diaphragm *c*, in combination with a longitudinally adjustable valve *e*₄, a laterally travelling pencil finger *z*; clock movement M and ribbon M¹; 19th. One or more than one radiator heated by steam supplied through the passage of the cone valve *e*₄, in combination with the regulator K, whereby the same determined the pressure of the steam is practically maintained either in one radiator or in more than one radiator, whether only one radiator or more than one radiator is in use at the same time; 20th. The spring *h*, in combination with the bar *h*, the pencil finger *z*, clutch *u*, and valve stem *e*₅; 21st. The combination of the conducting pipe *n*₁ and steam pipe *n*₂ having a coil *h* and the trap *l*, having connected chambers *e*₂ *e*₃ and pipe *m*₁; 22nd. The suspended trap *h*₂ provided with a tube *l*, of less height than the depth of the chamber of the float, in combination with the pipe *m*₁, pipe *m*₂, cock *o*₂ and pipe *w*₃; 23rd. A reheater interposed between radiators which are heated by steam from the source of supply, and radiators which are heated by water of condensation from the same steam; 24th. The reheater pipe *n*, in combination with the trap *l*; 25th. A street steam hydrant connected with the street main F¹ and located in close contiguity to a water hydrant, which is warmed by a pipe *n* connected to said main F¹, whereby steam and water may at all times be simultaneously supplied from the same locality to an engine for extinguishing fires; 26th. The casing *m*₃ for the service pipes, said casing serving for preventing the major portion of the service pipes from becoming impacted by earth, and for permitting them to expand and contract freely; 27th. A contrivance or contrivances for supplying steam for warming districts of dwellings in cities and towns, and for driving machinery and for other purposes in said districts, consisting of steam supplying apparatus, street mains having expansion junction service boxes, service pipes having connecting pipes and meters.

No. 9003. Apparatus for the Extraction of Gold from Auriferous Gravel.
(*Appareil pour l'extraction de l'or du gravier aurifère.*)

Phillip Cadell, Victoria, B.C., 11th July, 1878, (Extension of Patent No 3489) for 5 years.

No. 9004. Improved Tape Measure. (*Ruban-mesure perfectionné.*)

Asahel F. Ward, Philadelphia, Pa., U. S., 11th July, 1878, for 5 years

Claim.—A non-elastic tape measure, composed of a fabric impregnated and coated with rubber, and having figures and graduation marks printed on its rubber surface.

No. 9005. Inking Roller Composition for Printers. (*Composé pour les rouleaux d'encre d'imprimeries.*)

Andrew Van Bibber, Cincolanati, Ohio, U. S., 11th July, 1878, for 5 years.

Claim.—A compounded glue, as a merchantable commodity convertible into printers' inking roller composition, by the admixture of saccharine matter.

No. 9006. Improvements on Bottle Stoppers. (*Perfectionnements aux bouchons des bouteilles.*)

John M. Lewin, Lockport, N.Y., U. S., 11th July, 1878, for 5 years.

Claim.—1st. A fastening composed essentially of the circular ring F, having on its perimeter the aperture f and handle H, and the bail D secured to the bottle, &c., within the recesses b, 2nd. The combination with the cover B, having the concaved rise E, ribs E' and projection G of the cam ring F; provided with the aperture f and handle H, and the bail D secured to the bottle in the manner stated.

No. 9007. Combined Cane and Camp Stool. (*Bâton et siège de camp combinés.*)

Water L. French, Brockton, Mass., (Assignee of David B. Reynolds, New York.) U. S. 11th July, 1878, for 5 years.

Claim.—1st. A cane provided with a head, and having its body made in three sections of about equal lengths coupled together end to end, and adapted to be readily disconnected and coupled to the cane head to form a tripod; 2nd. In combination with the body of a cane made in three sections of equal length, coupled together end to end and adapted to be readily disconnected, a cane-head provided with means for coupling said section thereto to form a tripod, and also provided with three or more sockets to receive radial arms to support a flexible seat; 3rd. The combination of the sections A, A' and A'' adapted to be coupled together end to end to form a cane and to the cane-head D to form a tripod, three or more arms CC adapted to be set in sockets in the head D, in inclined radial position, and provided with shoulders i, near their outer ends, and a flexible seat B provided with the metal sockets C G adapted to engage with said shoulders i; 4th. A cane body made in three sections of equal lengths coupled together end to end, and adapted to be readily disconnected and coupled to the cane head to form a tripod, in combination with the chamber b, formed in one of said sections and adapted to receive the flexible seat and its supporting arms, one or both; 5th. As a means of coupling two or more sections of a cane body together or to the cane head, the cylindrical socket or bushing d provided with the lips e e, in combination with the shank f, provided with the shoulders g g, adapted to engage with the inner sides of the lips e e.

No. 9008. Improvements on Sleigh Shoes. (*Perfectionnements aux patins des traîneaux.*)

Benjamin F. Sweet, Fond-du-Lac, Wis., U. S., 11th July, 1878, for 5 years.

Claim.—A sleigh shoe, the underside of which for a portion of its length from the rear forward, is provided with a groove diminishing in depth as it approaches the longitudinal center of the shoe.

No. 9009. Draught Attachment for Ploughs. (*Avant-train de charrues.*)

Milo Harris, Jamestown, N.Y., U. S., 11th July, 1878, for 15 years.

Claim.—1st. The truck E the perforated and laterally adjustable standard A and vertically adjustable pole B; 2nd. The combination of truck E, standard A, pole B, brace D and plough beam C.

No. 9010. Improvements on Fences. (*Perfectionnements aux clôtures.*)

James Garrett, Pembroke, N.Y., U. S., 11th July, 1878, for 5 years.

Claim.—1st. The combination of one or more uprights A, A' braced by the wires E and kept F with or without the blocks a, the seat or shoe B, wire links C and panels D; 2nd. The method of bracing and holding a fence by the wires E, being attached at or near the lower ends of posts F F' which are driven into the ground transversely to the uprights A, the other ends of the wires being connected to the fence posts in any suitable manner.

No. 9011. Process for the Manufacture of Hydraulic Cement. (*Procédé de fabrication du ciment hydraulique.*)

Cleveland F. Dunderdale, Kingston, N. Y., U. S., 11th July, 1878, for 5 years.

Claim.—1st. The combination of a refractory clay rich in alumina, and a fusible clay rich in silicic acid, with lime or its carbonate; 2nd. The artificial admixture of a marl (calcareous clay) with a silicate of alumina and a marl rich in silicate, with one rich in alumina with lime or the carbonate thereof; 3rd. The artificial admixture of infusorial silica and a silicate of alumina, with lime or the carbonate thereof.

No. 9012. Improvements on Railway Switches. (*Perfectionnements aux aiguilles de railroads.*)

James Briody, Detroit, Mich., U. S., 11th July, 1878, for 5 years.

Claim.—In combination with the main line and switch of a railway, the guard rails D and bearing rails E.

No. 9013. Improvements on Horse Collars. (*Perfectionnements aux colliers de cheval.*)

John N. Schmitz, Kilburo, Wis., U. S., 11th July, 1878, for 10 years.

Claim.—1st. The combination of a leather bow E, plates F F and hames A A, said plates and hames being attached as set forth; 2nd. In hame A, provided cross-perforations arranged in series, a vertical slot in its inner face and protecting plates G G H; 3rd. The combination of the leather strips J, bars K K, castings L L, and thongs K' K'; 4th. In the construction of horse collars, the wooden blank R, having notch m cut from its inner side near the lower end and adapted to be closed, when said blank is steamed and bent in the manner shown.

No. 9014. Improvements in Waggon Springs. (*Perfectionnements dans les ressorts des wagons.*)

Alexander W. McKown, Kilmoo, Pa., U. S., 11th July, 1878, for 5 years.

Claim.—1st. The combination of shackle or bracket z, projecting inward from the axle or bolster, a yielding packing under its forward end, and a link hung between the axle or bolster and such packing; 2nd. In combination with an auxiliary waggon spring and with a device for connecting and disconnecting the same, a bearing 5, constructed with a notch and stop; 3rd. The bearing 5, adapted for application to an auxiliary spring, and constructed with a yoke revolving guide c' notch G, and a portion at the rear of the notch, to serve as a stop or detent; 4th. In combination with the auxiliary springs and the described bearing thereon, connecting device arranged to be swung down, and provided with a fork or yoke at their lower ends adapted to strike such bearings and to engage therewith; 5th. The combination with the yoke bar and its arm or handle 10, a jointed part or its equivalent, for operating the same and passing through a slot in an upright part of the seat or body.

No. 9015. Improvement in Sandbands and Caps. (*Perfectionnement dans les moyens des roues.*)

Edward H. Miller, Hollowell, Ont., 11th July, 1878, for 5 years.

Claim.—The cap D, in combination with the sand band C, of their respective forms shown in the drawings.

No. 9016. Improvement on Hoop Machines. (*Perfectionnement aux machines à cercles.*)

Russell H. Nogar, Carleton, Mich., U. S., 11th July, 1878, for 5 years.

Claim.—1st. The vertically rotating hoop cutters provided with driving cutting spurs for the purpose of finishing three sides of a series of hoops; 2nd. In combination with a hoop machine designed to cut hoops in series from the face of a log, rotating planers for the purpose of bevelling the ends of said hoops; 3rd. In combination with the frame carrying the vertically rotating hoop cutters, the pressure bar and guide plate K; 4th. The combination of vertically rotating hoop cutters by means of which the f of a log is divided into hoops, finished upon three of their sides with a circular saw by means of which the fourth or remaining side is finished; 5th. In combination with the bed plate D, the frame E adjustably secured thereto, and the vertical cutter bar t, 6th. In combination with the frame E, the frame I, pivoted thereto and provided with a vertically rotating planer head; 7th. In combination with the hinged or swinging frame I, the spring arm h and bevelled sides i, of the carriage, for the purpose of controlling the action of the planer knives J; 8th. A hoop cutting machine wherein the four sides of the hoops are finished with one handling, and cut from the side of a log in series; 9th. A hoop cutting machine whereby a series of finished hoops, with their ends bevelled, are cut from the face of a log.

No. 9017. Improvements on Flat Brushes. (*Perfectionnements aux pinceaux plats.*)

John L. Whiting, Boston, Mass., U. S., 11th July, 1878, for 5 years.

Claim.—1st. A flat brush in which the head is provided with an interior groove or recess d, 2nd. In a flat brush, the combination with the head a, having the internal groove or recess d, of the clinched nails or rivets f f f, for the purpose of securing the ferrule and bristle to the head; 3rd. The combination with a grooved or channelled brush-head a d, of the detachable clinching or riveting plate e.

No. 9018. Machine for Registering the Sale of Retail Liquors. (*Machine pour contrôler la vente en détail des liqueurs.*)

William L. Thompson, Montreal, Que., 15th July, 1878, for 5 years.

Claim.—1st. In a dial for registration, divided into one hundred parts and numbered as described, the combination of the pointers or index hands M N O; 2nd. The cog wheels A B C, connected respectively with the index hands M N and O, and moved by the pawl K, and the compound levers D and E, and the ratchets F, and the spring V connected therewith and attached to the ratchets F, the spring and hammer W furnished with the bell B, the set screws G G and pivoted to the stud U combined with the dial Q; 3rd. In combination with the cog-wheels A B and C, the manual I, pivoted to the dial Q, and connected with the spring V, the pawl K and springs V; 4th. In combination with the dial Q, the index hands M N O, the cog wheels A B C, the pawl K and the compound levers D E, and the ratchets F, the springs V, and the spring and hammer attached thereto W furnished with the bell B.

No. 9019. Inhaler. (*Inhalateur.*)

Clifton D. Hunter and Ernest S. Woods, Marlborough, Mass., U. S., 15th July, 1878, (Extension of Patent No. 2531,) for 5 years.

No. 9020. Improvements on Gates. (*Perfectionnements aux barrières.*)

Lorenzo Dickerson, Trenton, Mich., U. S., 15th July, 1878, for 5 years.

Claim.—In combination with post A, and gate B, the spring C, pull cord D, hinge E and latch F.

No. 9021. Spring Bed Bottom. (*Fond de lit à ressorts.*)

Charles Miller, Walkerton, O., 15th July, 1878, for 5 years.

Claim.—1st. A bed bottom composed of the longitudinal slats G, bearing in transverse slots E E supported near their ends upon S-shaped springs F, bearing on slats C C; 2nd. The S-shaped springs F.

No. 9022. Improvements on Hand Trucks.

(*Perfectionnements aux chariots à bras.*)

George P. Clark, Windsor Locks, Ct., U.S., 15th July, 1878, for 5 years.

Claim.—1st. A wheel composed of two compressing discs, each of which is provided with a peripheral flange, an annular shoulder, and a section of hub, in combination with an annular rim of vulcanized rubber or other non-sounding material; 2nd. The combination with an annular compressible rim, of two metallic discs, each of which has an annular shoulder for supporting the rim, and an annular flange, which is bevelled inward from its periphery to said shoulder.

No. 9023. Improvements in Lift Pumps.

(*Perfectionnements dans les pompes aspirantes.*)

Emory Barnes, Mount Pleasant, Mich., U.S., 15th July, 1878, for 15 years.

Claim.—In combination with the submerged pump cylinder having a perforated or open bottom and with a piston C, having valves a, rod D and valve d.

No. 9024. Improvements on Car-Couplings.

(*Perfectionnements aux attelages de wagons.*)

Jacob N. Best, Denver, Colorado, U.S., 15th July, 1878, for 5 years.

Claim.—1st. The form of the cavity in the draw-head; 2nd. The coupling pin having a flange wrought on its side by which it is strengthened, in combination with the bar D, lifting rod E and dog F.

No. 9025. Improvements on Harvester Reels.

(*Perfectionnements aux réateurs des moissonneuses.*)

John J. Dewey, Lake, Minn., U.S., 15th July, 1878, for 5 years.

Claim.—The Y-shaped metal bar L, having journal bearings *l* *l*, V-shaped brace M and crank shaft O in combination with the vertically vibrating reel and its operating mechanism.

No. 9026. Non-Conducting Covering for Steam Boilers.

(*Couverture non-conductrice pour les chaudières à vapeur.*)

Benjamin F. Smith and Charles J. Lewis, New Orleans, La., U. S., 15th July, 1878, for 5 years.

Claim.—A covering composed of the hulls of either cotton seed or rice seed, or a mixture of both confined in a fixed condition.

No. 9027. Window Cleaning Step Chair.

(*Chaise-marche-pied pour le lavage des fenêtres.*)

Anna Dormitzer, New York, U.S., 15th July, 1878, for 5 years.

Claim.—1st. A step-chair having a folding back, a folding brace and a folding front support; 2nd. The combination of the levelling screws *f* with the plate arm A; 3rd. The combination of the standard *n* with the platform A; 4th. The combination of the hinged brace E, chains F, screw d and travelling nut G, with the platform A; 5th. The combination of the auxiliary step *h* with the support H and platform A; 6th. The combination of the springs *l* and eccentric *m*, with the support H.

No. 9028. Improvements on Grate-bars.

(*Perfectionnements aux barres de grilles.*)

Thomas Murphy, Detroit, Mich., U.S., 15th July, 1878, for 5 years.

Claim.—1st. The combination of two sets of alternating and inclined bars D D', with a supporting frame A, and a feathered rock shaft C, adapted to vibrate the bars D' of each set; 2nd. The combination of the toothed cylinder B with the frame A; 3rd. The combination of the toothed cylinder B with the frame A and stationary and vibrating bars D D'; 4th. In combination with the frames A of the triangular grate frames E E', in an alternating series, the said frames E' being susceptible of a lateral vibration from the rock shaft C, hung in the frames E; 5th. The arrangement of the two sets of transverse grate bars, inclined from the sides of the fire-box towards each other; 6th. The combination of two sets of transverse grate-bars, inclined from the sides of the fire-box towards each other, and revolving toothed cylinders.

No. 9029. Improvements in Reaping Machines.

(*Perfectionnements dans les moissonneuses.*)

Matthew Garvin, New Castle, Ont., 15th July, 1878, for 5 years.

Claim.—1st. The gear jack F constructed in a single casting and provided with lugs, bearings and brackets to receive the several connecting parts of a reaping machine; 2nd. The gear jack F, in combination with the frame D and operating parts of a reaping machine; 3rd. The lifting lever J, pin J₂, gear jack F with upwardly projecting ratchet-plate and lugs *f* *f*, quadrant plate J₃ and chain J₃, in combination with the table of a reaping machine, and the guide and supporting standard G; 4th. The lifting lever J pivoted on the frame at a point in rear of the driving wheel axle and extending forwardly, upwardly and towards the driving wheel, to a point within convenient reach of the operator; 5th. The shifting lever H working within an inflected slot *i*, in combination with the sliding pinion B and driving shaft C; 6th. The casing I provided with inflected slot *i* for lever H, and extended to form a protecting cover for the toothed gearing A' B C C'; 7th. The combination and arrangement of the tilting lever K with the angle rod K₁, rod E, frame and connections of a reaping machine; 8th. The rake brackets N with pivoted spring, lifting and locking latch N₁, in combination with and pivoted upon the rake arm levers M, which arms are provided with a curved slot to allow of a limited rolling movement by the rakes, and are also provided with a latch locking notch; 9th. The rake arm brackets with spring locking latch and the rake arm lever with curved slot and locking notch, in combination with the tripping roller O; 10th. The rake arm brackets provided with the projection N₂, in combination with the bearing plate P provided with the shoulder P₁ for reversing the position of rakes, and mounted in such a manner that it is sufficiently flexible to allow the rake arm brackets, when the rakes are operating, to slip over the shoulder P₁; 11th. The loosely mounted tripping roller O mounted in such manner that it will trip the rake bracket latches, or may be drawn out of the way

to allow the rakes to operate; 12th. The foot lever Q₁ with rod or rope and bell crank connection, in combination with the tripping roller O, which roller is held in and returned to position by a spring; 13th. The combination of the tripping roller O, flexible bearing plate P with shoulder P₁, with the rake arm levers and rake arm brackets of a reaping machine; 14th. A second tripping roller O₁ with corresponding shoulder on the plate P, arranged in combination with rolling rake arms for the purpose of reversing the position of the rakes, at or about the termination of the cutting table; 15th. The seat S and spring standard S₁ mounted on the frame of machine, in such manner that it is adjustable in height to suit the requirements of different operators; 16th. The rake arm levers provided with a loose friction roller R.

No. 9030. Improvements on Self-creamers.

(*Perfectionnements aux boîtes à lait.*)

George A. Evans, Kingsley, Que., 15th July, 1878, for 5 years.

Claim.—1st. The combination of the cream gatherer B, with milk vessel A; 2nd. The combination of the movable stopper or bottom E; 3rd. The combination of vessels A and B, faucet D, movable stopper E, with the thumb screw F, neck J and socket K.

No. 9031. Mode of Transmitting, Receiving and Recording Telegraphic Despatches.

(*Mode de transmettre, recevoir et enregistrer les dépêches télégraphiques.*)

G. Boucher de Bouoherville, Quebec, 18th July, 1878, for 5 years.

Résumé.—L'emploi de signes négatifs prolongés, dont le nombre d'espaces typiques contenu en locux, mesurés sur le signe positif qui est le trait typique ou l'unité de mesure, indique le nombre ou la lettre télégraphié, et pour la transmission, réception, enregistrement et vérification de tels traits typiques et espaces typiques, le clavier à espaces typiques et à décharge A, le commutateur B, les boutons C et D, l'indicateur E et le repère F, le manipulateur G, la tige T et les boutons P et Q, l'essieu H avec son bras X X', la rainure R et la vis J, la traverse de support K, les ressorts L fixés sur le cercle métallique N, et les ressorts M fixés sur le cercle métallique O, la bande graduée B', le vérificateur typique A B P B' A', tous combinés tel que décrit.

No. 9032. Improvements in Paper Boxes.

(*Perfectionnements dans les boîtes en papier.*)

Peleg Clarke, Dundas, Ont., 18th July, 1878, for 5 years.

Claim.—1st. A paper box constructed as specified, and composed of the strips A and B, folded as shown, to make the inner form as described, also the outer form C cut and constructed with the folds e *f*, as shown, and with the additional folds or projections a a b as shown; 2nd. The combination of the strips A and B, of the inner form, and the outer form C, and so combining them that the contents of the box is held by means of the levelled lip *g*, of the strip A, being pressed down at one end of the box between the inner and outer forms; 3rd. The strip A cut at the line *x* *x*, folded at the dotted lines, and used in combination with the strip B, making two sizes so that, when combined one within the other, a modification of the inner form will be in telescopic shape and enclosed in the outer form.

No. 9033. Improvements on a Steam Boiler.

(*Perfectionnements à une chaudière à vapeur.*)

Dana N. Allen, Concord, N.H., U.S., 18th July, 1878, for 5 years.

Claim.—1st. The water jacket H wholly enclosed within the combustion chamber; 2nd. The water jacket H connected with the outer boiler by bent water pipes a, thimbles c, and vertical water tubes b, in combination with the outer casing C and water and steam spaces above the fire pot traversed by the tubes *i*; 3rd. The boiler provided with an outer smoke jacket C, an auxiliary combustion chamber F, annular fuse *f* and the outlet pipes J and K, one of which connects directly with the auxiliary combustion chamber and the other with the smoke jacket; 4th. The bed plate B provided with the rings *g* and *h*, in combination with the water jacket H, outer boiler and smoke jacket C; 5th. A steam boiler composed of the several parts described and shown, combined and arranged for joint operation in the manner specified.

No. 9034. Improvements on Triturating Machines.

(*Perfectionnements aux machines à triturer.*)

John R. Alsing, Stockholm, Sweden, 18th July, 1878, for 10 years.

Claim.—1st. A triturating cylinder C, in which the corner slabs C₁ are concaved in the end of the diagonal, opposite to the corner, to form a curved junction C₂ between the inner cylindrical and end surfaces; 2nd. A triturating cylinder A formed by the combination of the outer iron cylinder A₁, the intermediate wooden cylinder B and the inner glass or porcelain cylinder C, the latter being made of blocks c c' cemented by plaster of Paris and glue to the wooden cylinder; 3rd. A triturating cylinder A curved at C₂ in the junction between its inner cylindrical and end surfaces, and in which an inner cylinder C is made of glass or porcelain by cementing corrugated glass or porcelain slabs or blocks c c' by plaster of Paris and glue upon the wooden lining B of the iron cylinder A₁; 4th. The combination of the triturating cylinder A, consisting of the iron cylinder A₁, the wooden cylinder B and the glass or porcelain cylinder C, with the hopper E, the axial inlet and outlet pipes F G, the fan H, and the caavass bin K provided with the incline K₁, and the bottom receptacle or hopper L; 5th. The combination of the caavass bin K having the incline K₁, hopper L and spout *l*, with the vibrating tube N, the tub O, the revolving upright shaft k, having radial arms *r*, the water pipe P, and the conveying discharge pipe Q; 6th. The combination of the triturating cylinder A, hopper E, axial inlet and outlet pipes F G, fan H, caavass bin K having incline *k* and hopper L, vibrating tube N tub O, stirring shaft R, water pipe P and conveying discharge pipe Q, and their several regulating valves and dampers.

No. 9035. Hoop and Moulding Machine. (*Machine à cercles et à moulage.*)

Matthew Bostwick, Painaville, Ohio, U. S., 18th July, 1878, for 5 years.

Claim.—The combination with the horizontal driving shaft B and circular saw D secured thereto, of the vertical driving shaft C provided with a series of stripping saws E and cutters of forming knives G, said cutters consisting of flat knives detachably secured to collars placed between the saws, the cutters being arranged specially about the shaft.

No. 9036. Improvements on Locomotives. (*Perfectionnements aux locomotives.*)

Adolphus Davis, Montreal, Que., 18th July, 1878, for 5 years.

Claim.—1st. The combination of the petticoat A and D working in connection with the exhaust B B and C C; 2nd. The combination with the wire cloth attachment, both in and out of petticoat in smoke box F F, in connection with petticoat A A and exhaust B B.

No. 9037. Machine for Housing Stairs. (*Machine à encastrer les escaliers.*)

William F. Morell, Millbrook, Ont., 18th July, 1878, for 5 years.

Claim.—1st. The plate A, socket B and the manner in which the knife D is held in position in the slot; 2nd. the saw blade H and the manner in which it is held in position by set screws and guards.

No. 9038. Improvements on Lightning Rods. (*Perfectionnements aux paratonnerres.*)

Henry Cooley, Toronto, Ont., 18th July, 1878, for 5 years.

Claim.—A corrugated sheet metal electric fluid conductor for houses and structures, constructed and arranged as shown.

No. 9039. Machine for Gleaning and Binding Grain. (*Machine à glaner et lier le grain.*)

The Grain Binder Association, (Assignees of Moses G. Hubbard and Josiah D. Hubner,) Norristown, Pa., U. S., 18th July, 1878, for 5 years.

Claim.—1st. The combination of a pair of toothed cylinders revolving in opposite directions for gleaning and taking up the grain; 2nd. The yielding vertical grain receptacle E E; 3rd. The frame A, located and constructed as specified; 4th. A driver's seat located both over the drive wheel and on the front of the machine; 5th. The combination of the vertical carrying scrolls E E, and the vertical grain compressors F F; 6th. A self sustaining raising lever, in combination with the gleaning device; 7th. The arm S, or its equivalent for starting the binder arm automatically, by the action of the gavel; 8th. The two carrying rollers Y Y; 9th. The track clearer P, or its equivalent, in combination with a gleaner and binder for turning the gavels lengthwise; 10. The teeth of the elevating and gleaning cylinders, curved at their ends; 11th. The stationery tubes in combination with the gleaner shaft.

No. 9040. Improvements in Railway Spikes. (*Perfectionnements aux chevillettes de rail-
routes.*)

David Servis, Charles F. Sturtevant, and Corydon H. Merriman, New York, U. S., 18th July, 1878, for 5 years.

Claim.—1st. A spike provided with a ridge of upwardly tending notches and a groove on each side of the said notches; 2nd. A spike provided with a ridge of notches and a groove on each side of such notches, said grooves widening gradually in a downward direction; 3rd. The body A of a spike having head a and bevelled point b, and provided with notches B and grooves c c.

No. 9041. Process of Tanning Leather. (*Procédé de tannage des peaux.*)

Charles J. Tinnerholm, Brooklyn, N. Y., U. S., Carl Smith and Simon A. R. Nicond, Saint John, N. B., 18th July, 1878, for 5 years.

Claim.—A compound of Peruvian bark, catechu, glaubers salt, salt of tartar, oxide of zinc, alum and soda ash, compounded with tan bark liquor.

No. 9042. Improvements on Washing Machines. (*Perfectionnements aux machines à laver.*)

Ransom G. Baldwin, Andrew J. Parkhurst, Reuben K. Parkhurst and Alfred Eddy, Oskaloosa, Iowa, U. S., 18th July, 1878, for 5 years.

Claim.—The combination of the standards C C having slots c c, slides D D adjustable by thumb screws G, shaft E having its bearings in slides D D, drive wheel F adjustable upon shaft E, and a vertical shaft J having two or more conical pinions J K of different sizes in the tub A, cover B, standards C C, vertically adjustable shaft E having laterally adjustable cog wheel F, casting I having collar H, shaft J having two or more pinions j k, disc K having collar N and lugs m m, and cross frame L having pegs l l.

No. 9043. Improvements in Refrigerators. (*Perfectionnements dans les garde-manger.*)

Allen M. Murphy, Fond-du-Lac, Wis., U. S., and Allen Trebilcock, Toronto, Ont., 18th July, 1878, for 5 years.

Claim.—1st. The perforated or open soffit C of the roof caves forming passages, which connect with the attic chamber and open windows and cupola; 2nd. The attic chambers provided with openings to allow of a free circulation of air over the ice chamber; 3rd. The flues H leading from the underside of ceiling of cooling room, and connecting with the attic chamber, for the purpose of allowing the heated and foul air and gases of cooling apartment to escape; 4th. The cold air flues G leading from the top or near the ceiling of ice chamber to the top of cooling room; 5th. The ceilings of cooling room pitched upwardly to the centre; 6th. The

circulating warm air flues I leading from the cooling room, at a point commencing below the level of the inlet mouths of the flues H for the purpose of allowing the warm air to pass upward to the ice chamber to be cooled and returned again; 7th. The air passages formed under the metal floor lining by the strips D₁, which air passages lead to the flue E to the cooling chamber; 8th. The open rack D₂ placed on the metal floor lining as a support for the ice, the interstices in which rack form passages, by which air is circulated under the body of ice, thus giving a large area of extra cooling surface; 9th. The cooling room ceiling rack K formed by a series of parallel bars K₁, stretching from side to side of building over whole area of apartment, and provided with detachable hooks upon which the matter to be preserved is hung.

No. 9044. Improvements on Straw Cutters. (*Perfectionnements aux coupe-paille.*)

Thomas E. Marable and Peter T. Young, Petersburg, Virginia, U. S., 18th July, 1878, for 5 years.

Claim.—1st. A knife adapted for hay and straw cutting machines, having a wide thin blade with one side flat and serrated, and the other side bevelled and smooth, and provided with means for attaching it at both ends to operating arms or levers; 2nd. The combination of the knife and operating arm b with the stiff rod or bar d, arranged outside of the knife-blade; 3rd. The combination of the knife supported and operated by two levers, articulated to its upper and lower ends, with the gauge g supported and operated by said levers; 4th. The combination of the knife, levers b and c, and stiff bar d; 5th. The combination of the levers b and c, the knife, the bar d and gauge g, arranged between the bar d and the knife.

No. 9045. Repeating Gun. (*Fusil à répétition.*)

The Evans Rifle Manufacturing Company, Mechanics' Falls, Me., (Assignees of Warren R. Evans, Lynn, Mass.,) U. S., 22nd July, 1878, (Extension of Patent, No. 2534), for 5 years.

No. 9046. Repeating Gun. (*Fusil à répétition.*)

The Evans Rifle Manufacturing Company, Mechanics' Falls, Me., (Assignees of Warren R. Evans, Lynn, Mass.,) U. S., 23d July, 1878, (Extension of Patent, No. 2534), for 5 years.

No. 9047. Improvements on Cocks and Valves. (*Perfectionnements aux robinets et aux valves.*)

William Barry, Montreal, Que., 23rd July, 1878, (Extension of Patent, No. 2565), for 5 years.

No. 9048. Horse Shoe Sharpener. (*Rémouleur de fer à cheval.*)

John Little, Newburg, N. Y., U. S., 23rd July, 1878, (Extension of Patent, No. 2568), for 5 years.

No. 9049. Improvements on Butter Workers. (*Perfectionnements aux battes à beurre.*)

Henry A. Clow, Des Moines, and Richard A. Rhoads, Newton, Iowa, U. S., 30th July, 1878, for 5 years.

Claim.—1st. The roller A having the enlargement b, short journals d, annular cavities C, in combination with the bent bearers g and the hinged arms m; 2nd. The movable carriage P having runners r to engage the tracks t on the outside of the tray, and hinged arms m carrying the bent bearers g inside of the tray, and the roller A having enlarged ends b fitted against the inside faces of the vertical tray sides H.

No. 9050. Process of Preventing the Dissolution of the Metal of Vessels containing Food. (*Procédé pour prévenir la dissolution du métal des vases contenant des aliments.*)

Samuel B. Dunning and Robert A. Dunning, Brunswick, Me., U. S., 30th July, 1878, for 5 years.

Claim.—The application to the surfaces of vessels used to contain articles of food and hermetically sealed goods, of a compound of gum copal, chloroform and alcohol.

No. 9051. Improvement in Cutting Tools. (*Perfectionnements dans les instruments tranchants.*)

Jesse King, Oswego, N. Y., U. S., 30th July, 1878, for 5 years.

Claim.—1st. A cutting tool implement, or other article, with one or more of its surfaces case hardened to produce a hard and sharp cutting edge or edges; 2nd. Adapting the edge of a case hardened surface with a softer metal body or backing as a cutting edge, and by the gradual wearing away producing a continuously self-sharpening edge; 3rd. Adapting the edge of the case hardened surface as a cutting edge to any and all tools, implements, or articles where the cutting edge is usually made sharp by grinding or other process, from the one side only; 4th. Adapting one or more case hardened surfaces as hard, sharp, or cutting edges where hard, sharp or cutting edges or sides are usually made sharp by grinding or other process, such edges square or flat or nearly so.

No. 9052. Improvements on Harrows. (*Perfectionnements aux herbes.*)

Archibald McPherson, Westminster, Ont., 30th July, 1878, for 5 years.

Claim.—1st. A harrow constructed of a series of separate bars A A of wood or iron, arranged parallel to one another, bolts B and connecting rods C, and bolts and nuts D; 2nd. In combination with the bars A, the teeth E F projecting on upper and lower sides, so as to constitute a reversible harrow; 3rd. In combination with the double tree composed of three pieces C C C₂ and series of hooks, or chains and hooks H H.

No. 9053. Improvements on Spring Carriages.

(*Perfectionnements aux voitures à ressorts.*)

Thomas J. Magner and Charles L. Thomas, Hornellsville, N.Y., U.S., 27th July, 1878, for 5 years.

Claim.—1st. The combination of the side springs C C pivoted above the rear axle and to the bolster, the lower springs F G, crossing each other in advance of the centre pivoted below the axles and the cross-bars N O P connected to the side springs and to the cross springs, at the rear of the crossing point. 2nd. The yoke E provided with lateral projecting arms forming a cross piece I, to the ends of which the cross-springs F G are secured.

No. 9054. Improvements on Churn Dashers.

(*Perfectionnements aux batte-beurre.*)

David N. Ellsworth, London, Ont., 30th July, 1878, for 5 years

Claim.—1st. The combination of staple H, rod F and plate E. 2nd. The combination of the holes G through air-lumber A, and bells B and C, and joints I.

No. 9055. Improvements in Telephones.

(*Perfectionnements dans les telephones.*)

Henry S. Pole, Halifax, N.S., 30th July, 1878, for 5 years.

Claim.—1st. The combination, in a telephone, of a tubular magnet, a soft iron diaphragm placed in contact with one of the poles of the tubular magnet, and a central soft iron armature provided with a helix. 2nd. The combination of a tubular magnet with a central soft iron armature hollow and used as a speaking tube for conducting sounds. 3rd. In a speaking telephone, a permanent magnet with a helix within the pole of the magnet.

No. 9056. Varnishing Machine.

(*Machine à vernir.*)

Daniel Gunn, George N. Bliss, Thomas B. Dooley and Joseph Curtis, Boston, Mass., U.S., 30th July, 1878, for 5 years.

Claim.—1st. In a machine for spreading varnish, glue, or similar substances, over sheets of cloth or paper, the combination with the rotating drum and its supporting standards, of a suitable fountain with a feed roller for the liquid, and an elastic varnishing roller adapted to apply the varnish directly to the paper sheet; 2nd. The combination of the rotating drum and its supporting standards, with the varnish tank and rollers and the adjustable pins; 3rd. The combination of the rotating drum, the varnish tank and the supporting standards, with a varnishing roller arranged to alternately approach and recede from the drum; 4th. The combination of supporting standards and a rotary drum having one or more removable slats, with a varnish tank and a pair of varnishing rollers; 5th. The combination of the drum, the fountain and the varnishing rollers, with the hinged extension N of the feed table and the mechanism for operating the same.

No. 9057. Improvements on Axles.

(*Perfectionnements aux essieux.*)

Robert R. Moore, Lewisville, Ark., U.S., 30th July, 1878, for 5 years.

Claim.—1st. The skein D provided with the lug d, in combination with the axle A, bolster C and the bolts E E. 2nd. The bolt F and recessed nut F, in combination with the axle A and skein D; 3rd. The oil reservoir G, arranged as described, in combination with the skein D, axle A and bolster C. 4th. The recess or oil chamber H, formed in the upper surface of the axle journal, in combination with the skein D, cap or cover D₂ and valves I I; 5th. The tube g and cylinder K, in combination with the oil reservoir G and oil chamber H; 6th. The combination of the cylinder K, having the perforations K, the piston or valve J working in said perforated cylinder or valve seat, the connecting tube g, the oil chamber H and the valves I I; 7th. The combination and arrangement of the rod or pin M and its springs n, the levers L L, piston or valve J, cylinder K, tube g, oil chamber H and valves I I and the springs i i.

No. 9058. Apparatus for Supplying Locomotive Tenders with Water.

(*Appareil pour fournir l'eau aux fourgons des locomotives.*)

Joseph Haggas, Uxbridge, and William Gooderham, Jr., Toronto, Ont., 2nd August, 1878, for 5 years.

Claim.—1st. The injector B permanently fixed in connection with a sunken water tank or other suitable water reservoir, and provided with a permanent water discharge pipe and steam pipe connection, and arranged to be supplied with steam from the boilers of locomotives by a flexible adjustable pipe connecting the injector with the locomotive; 2nd. The combination of appliances, whereby the steam from a locomotive boiler is utilized for the purpose of elevating water from a tank or reservoir, by means of the permanently fixed injector B and connections.

No. 9059. Improvements in Waggon Tops.

(*Perfectionnements dans les soufflets des voitures.*)

Robert W. Thompson, Cleveland, Ohio, U.S., 5th August, 1878, for 5 years.

Claim.—1st. In combination with the detachable bow B and bows G and H, the diagonal braces E, hinged or pivoted to each other. 2nd. In combination with the bows B G and H and diagonal braces E, the intermediate bows I and J and stretcher K arranged to operate in relation to each other. 3rd. One or more rigid stretchers A, in combination with the sections of frame when arranged in respect to each other and attached to a waggon body or box. 4th. In combination with a waggon or other vehicle, the frame consisting of the bows B G H, diagonal braces E, bows I and J pivoted to each other, and stretcher.

No. 9060. Improvements on Kneading Machines.

(*Perfectionnements aux pétrins mécaniques.*)

Louis Durand, Quebec, Que., 5th August, 1878, for 5 years.

Claim.—The combination of a revolving ring shaped trough having tapering body with one or more kneaders or mixers, revolving in opposite direction to trough, and having straight opposite sides corresponding to inclination of sides of trough, and curved intermediate sides.

No. 9061. Steam Water Elevator.

(*Pompe à vapeur.*)

William B. Doty, Chillicothe, Ohio, U.S., 5th August, 1878, for 5 years

Claim.—The combination of the large globe or chamber A with water inlet G the smaller globe or chamber B, the neck C connecting the two globes, steam pipe D with nozzle a, and the branch steam pipe D' with valve F and nozzle b.

No. 9062. Improvements on Roofs.

(*Perfectionnements aux toitures.*)

Nathan H. Brown, Detroit, Mich., U.S., 5th August, 1878, for 5 years.

Claim.—1st. The metallic batten strip C made in sections arranged end to end, the wedge-formed sides d of the end of one section being interlocked with the upturned sides of the end of the next section. 2nd. The combination with the roofing boards A having shoulder b, of the batten-strip C made in sections adapted to lock together.

No. 9063. Improvement in the Manufacture of Bells.

(*Perfectionnement dans la fabrication des clochettes.*)

George W. Tucker, Waterbury, Ct., U.S., 5th August, 1878, for 5 years

Claim.—The mode of making bells, that is to say, forming a blank with two or more wings of the character described, drawing or stamping the centre of the blank to form the body of the bell, and then without cutting bending in the wings to form resonant tongues with parallel edges.

No. 9064. Improvements on Washing Machines.

(*Perfectionnements aux lavuses mécaniques.*)

John W. Gawthrop, Walkerton, Ont., 5th August, 1878, for 5 years.

Claim.—The arrangement of the bearings B and B' outside of the up rights A and A', 2nd. The arrangement of the springs D and D' with the bearings B and B'.

No. 9065. Improvements in Snatch Blocks.

(*Perfectionnements dans les poulies coupées.*)

Alexander McDonald, Halifax, N.S., 5th August, 1878, for 5 years.

Claim.—1st. The locking hook. 2nd. The locking hook combined with the swivel hook; 3rd. The locking and swivel hooks, in combination with the long end of the strap, 4th. The slot to receive the locking hook on the short end of the strap.

No. 9066. Improvements on Fire-escapes.

(*Perfectionnements aux sautoirs d'incendie.*)

Patrick Mack, John Sullivan and Horace J. Beemer, Montreal, Que., 5th August, 1878, for 5 years.

Claim.—1st. The combination of the pump I with the telescopic tubes provided with ladders, 2nd. The combination of the pump I, telescopic tubes, with the guys H' and car I; 3rd. The combination of the telescopic tubes with the hollow shaft C, and pump I, 4th. The combination of the portable frame A, pump I, shaft C, having telescopic tubes, rack C', having windlasses D' E' and guys H, and safety-car I.

No. 9067. Improvement in Hydraulic Presses.

(*Perfectionnement dans les presses hydrauliques.*)

John W. Hyatt and Thomas S. Crane, Newark, N.J., U.S., 5th August, 1878, for 5 years.

Claim.—1st. The method of cumulating hydraulic pressure by combining or arranging two or more flexible pistons (operating by a flow of water under pressure) to concentrate their forces upon a single object or platen. 2nd. A hydraulic press, constructed with one or more diaphragms or bags and operated by steam from a boiler, in connection with an intermediate tank or its equivalent. 3rd. The arrangement of a steam boiler, a hydrostatic press of any form of construction, and an intermediate tank in which the steam pressure is converted into water pressure. 4th. The compound hydraulic press, constructed by arranging two or more diaphragms or bags in a hydrostatic press, so that their forces may be concentrated on the platen of the press or its equivalent. 5th. In a compound hydraulic press, the pressure plates P P, constructed with projections e e' and operating in combination with the pressure chambers contained in the diaphragms m m or bags G G, upon the platen D. In a compound hydraulic press, the pressure plates P P, furnished with studs i i, for transmitting and adding the press e e' of one to the other through or passed the intervening supporting plate B. 6th. The hydraulic press consisting of a bag constructed as described and operating in combination with the plate B, pressure plate P, or platen D, cap H or K, and connections g g, or their equivalent, from plate A to cap H or K; 8th. In combination with a compound hydraulic press, the pipe connective to bag G, formed by compressing the sides of the bag or a connection thereto against a perforated washer S; 9th. Curving the supporting plates B and pressure plates P, in a compound hydraulic press. 10th. The combination of a screw or screws with the head of a hydraulic press, to lessen the movement of the platen D and hydraulic appliances. 11th. The combination and arrangement of the auxiliary cylinder A and piston B, with the platen D of a hydraulic press, for advancing the same to its work at each stroke, before applying the hydraulic pressure. 12th. In combination with a hydraulic press or equivalent pressing mechanism, the vacuum box J, constructed and operated in the manner described.

No. 9068. Improvements in Telephones.

(*Perfectionnements dans les telephones.*)

Abner M. Roseburg, Toronto, Ont., 5th August, 1878, for 5 years.

Claim.—A phonetic telephone formed by a diaphragm B, placed between elastic supports C, in a casing A having a mouth piece h, in combination with a card f, connecting the diaphragm B to a corresponding one in a similar instrument.

No. 9069. Improvements in Telephony.*(Perfectionnements dans la téléphonie.)*

Abner M. Roseburgh, Toronto, Ont., 5th August, 1878, for 5 years.

Claim.—1st. A resistance medium B of such material and construction that it will offer high resistance to the galvanic current and comparatively little resistance to the secondary or induced current; 2nd. A self-acting shunting switch formed by the mouth piece K, hinged to the telephone A and connected to the galvanic circuit, in such a manner that, immediately the operator ceases to use the telephone, the galvanic circuit is automatically closed; 3rd. In combination with the high resistance medium, a shunting switch R pivoted between two contact points S T and arranged in connection with a telephone, for the purpose of enabling the operator to ground the telephone at pleasure, without interfering with the action of the galvanic current used in the same line; 4th. In telephony, a glass tube a filled with glycerine and water, or other suitable liquid, and provided with air tight fitting caps b b connected with platinum points d d, forming a high resistance medium, capable of offering high resistance to the galvanic current, and comparatively little resistance to the induced current applied as specified; 5th. In telephony, a graphite pencil having a section g of the wood or graphite cut away, as described, and provided with wires b₁ b₂ suitably connected to the terminal ends of the graphite applied as specified; 6th. In telephony, a resistance medium of German silver, or other insulated wires, constructed and applied as specified; 7th. In telephony, a resistance medium B located on the ground wire ll of a branch line of any closed galvanic current, for the purpose of forming a secondary current circuit, without interfering with the action of the galvanic current; 8th. In telephony, a resistance medium B connecting the wires of two independent closed galvanic circuits, without interrupting the action of the galvanic currents.

No. 9070. Improvements on Washing Machines.*(Perfectionnements aux laveuses mécaniques.)*

Caleb Guyer and Asbury W. Guyer, Tyrone, Pa., U.S., 5th August, 1878, for 5 years.

Claim.—The box A having the slatted false bottom B, supported yieldingly therein by means of spiral springs combined with the reciprocating slotted washer E suspended by the links l, from the vertically moving perforated board C.

No. 9071. Improvement in Lubricating Oil.*(Perfectionnement dans l'huile lubrifiante.)*

Henry Fink and Catharine Fink, Baltimore, Md., U.S., 5th August, 1878, for 5 years.

Claim.—1st. The mixture composed of pulverized lime, pulverized French chalk, carbonate of potash, castor oil and water; 2nd. The composition or mixture described and mixed with oil.

No. 9072. Improvements on Hose Couplings.*(Perfectionnements aux joints de boyaux.)*

John Galvin, Detroit, Mich., U.S., 5th August, 1878, for 5 years.

Claim.—The combination of the hose A, internal metallic coupling neck D, external collar B and the packing strip or cord E, wound upon the hose, and underneath or inside of the collar B; 2nd. In combination with the hose and the internal coupling neck D, having the external teeth or ribs, the external collar B provided with the opening F, and the metallic band E wound within the collar, upon the exterior of the hose; 3rd. The combination of a neck or tube to enter the hose, and a collar B to encircle the same, provided with an opening F, through which to insert a fastening band; 4th. The combination with the hose A, the coupling neck D provided with the screw thread G, and the collar B, provided with corresponding screw thread and the fastening band E; 5th. The combination of the neck D provided with screw thread G, with the loose thread d collar or sleeve C, and the collar B provided with screw thread, both applied thereto as shown; 6th. In combination with the hose and the coupling constructed as shown, the metallic band or strip E, provided with the teeth or corrugations at its end to engage with the hose.

No. 9073. Process and Apparatus for Preserving Eggs and Fruits.*(Procédé et appareil pour la conservation des œufs et des fruits.)*

William Inglis, Bolton, Eng., and James Inglis, Montreal, Que., 5th August, 1878, for 5 years.

Claim.—1st. Keeping the eggs and fruits covered with water which is kept at a temperature as low as 32 degrees Fahrenheit, or nearly so, by means of ice immersed in such water; 2nd. In the combination with a tank or vessel to contain water and eggs or fruits immersed in such water for the purpose of preservation, of one or more grids to support ice, such grids dipping below the water level and allowing ice to descend into such water in proportion as it melts therein.

No. 9074. Improvements in Stove Shelves.*(Perfectionnements aux tablettes de poêles.)*

Ezek Bussey, Troy, N. Y., U.S., 5th August, 1878, for 5 years.

Claim.—1st. The exterior stove-shelf D, which is raised to the plane of the oven-bottom by opening the oven-door and by closing said door is lowered to a plane below the oven, always retaining a position parallel, or nearly parallel to the oven-bottom; 2nd. The horizontally sliding shelf D, on the outside of the stove, combined therewith and with the oven door C having pin C.

No. 9075. Process for Making Paper Pulp.*(Procédé de fabrication de la pâte à papier.)*

Moore R. Fletcher, Concord, N.H., U.S., 5th August, 1878, for 5 years.

Claim.—1st. The bed plate Et, of the pulping engine, provided with corrugations, grooves or elevations of zig-zag form; 2nd. The revolving drum E of the pulping engine having blades E₂ set obliquely backwards, in com-

ination with the concave corrugated bed plate Et; 3rd. The blades E₂, in their laminar construction of plates E₅ and E₆; 4th. In the manufacture of pulp or paper stock, the disintegrating of the material as done by the disintegrating machine D, after being digested, and prior to its introduction to the pulping engine; 5th. The novel combination of the cutting, crushing, disintegrating and pulping machines; 6th. In the manufacture of paper pulp or stock from wood slices or cuttings, the crushing of the material, as done by the crusher B, before the material is digested; 7th. In the manufacture of paper pulp or stock, cooking with weak alkali without pressure; 8th. In the manufacture of paper pulp or stock, cooking with a weak alkali at a low temperature; 9th. In the manufacture of pulp or paper stock from wood, the wood cut in diagonal slices.

No. 9076. Improvements on Railway Ties.*(Perfectionnements aux traverses des railroites.)*

Gideon W. Cottingham, Denison, Texas, U.S., 5th August, 1878, for 5 years.

Claim.—1st. A railroad tie made of metal, in several parts, and united together by clamps; 2nd. A railroad tie made of metal in several parts, and united together by the same clamps which fasten the rails to the tie; 3rd. A bisected clamp with wedge key for scouring the rail to a metallic tie made of several parts, and said parts united by the same clamp; 4th. A bisected clamp having its upper portion extended to form fish bars in combination with the rails and a wedge-key; 5th. The combination of the metallic railroad tie made in several parts, the rails, bisected clamps and wedge keys; 6th. A metallic railroad tie, constructed to form a pillar or four inclined feet at each end.

No. 9077. Improvements on Blind Hinges.*(Perfectionnements aux pentures des persiennes.)*

William Jones, Oshawa, Ont., 5th August, 1878, for 5 years.

Claim.—1st. The removable handle J, provided with the groove K, in combination with the shaft H and socket I, having the projection M and recess L, and the key O and thumb screw N; 2nd. The movable washer P, on the top of the spindle F, which can be turned around and lifted over the catch on the spindle E, thus allowing the shutter to be taken off; 3rd. The combination of the removable handle J, having groove K, socket I having projection M, recess L, key O and thumb screw N, and the shaft H carrying gear wheel G, with the portion C carrying spindle F, and the portion D having gear wheel F.

No. 9078. Improvements in Washing Machines.*(Perfectionnements dans les laveuses mécaniques.)*

Thomas Forfar, Waterdown, and Llewellyn A. Morrison, Toronto, Ont., 8th August, 1878, for 5 years.

Claim.—1st. The bracket G, working on its centre or hinge screw H, and having projections O on the back, equidistant from the centre H; 2nd. The combination of the moveable corrugated feed roller E, under pressure, the under rollers F F operating in the oscillating brackets G G, stationary at centre point H, and the upright bottom B fitting closely up to the underside of under rollers, with the extension rod attachment C D I K.

No. 9079. Improvements in Waggon.*(Perfectionnements dans les voitures.)*

Clarence F. Whipple and Effinger E. Whipple, Racine, Wis., U.S., 5th August, 1878, for 5 years.

Claim.—1st. The draw bar described, composed of the body B, arms a a and hook H, formed in a single piece; 2nd. The combination of the chains R R, draw bar A, having loose evener bolt E, head L and bolt P; 3rd. In combination with the tongue of a waggon, a slotted rotating bolt head L, and a draw bar fitted to slide therein; 4th. The combination in a draft attachment for waggons, of a fixed hammer strap hook H and tilting evener bolt E; 5th. The combined clamp and hook constructed and adapted to be applied, as set forth.

No. 9080. Improvements on Sash Balances.*(Perfectionnements aux contre-poids des croisées.)*

William Milner, Strathroy, Ont., 5th August, 1878, for 5 years.

Claim.—1st. The two cog wheels or circular boxes A B, enclosing coil springs c c, having separate horizontal axles or journals C D, with supplementary cog wheel G, journal F, grooved flange H, clutch I and handle J, by means of which the two wheels or circular boxes A B can be attached or detached, causing the upper and lower window sash to act simultaneously or separately; 2nd. The ratchets N O and pawls P Q, in combination with the circular boxes A B and axles C D, used singly or together; 3rd. The winding axles C D, to give tension to the springs c c, and in combination with the springs; 4th. The two cog wheels or circular boxes A B, enclosing coil springs c c, having separate horizontal axles C D, one of these axles being stationary, and the other having a horizontal movement carrying with it the wheel or circular box by means of which the two wheels A B can be attached or detached, and engaging with each other by means of cogs c d, or straps or cords connecting the said boxes with sashes, causing the upper and lower window sash to act simultaneously or singly; 5th. The arrangement where one regulator with strap and cord only is used, of attaching said regulator to bottom corner of the sash K₁, whereby the opposite top corner constitutes a frictional counterpoise; 6th. The axles C D, of the circular boxes A B, the wedge-shaped notch a; 7th. The circular boxes A B, constructed as shown, with internal projections f f, to support the cover of said boxes and stud g, to attach outer ends of springs to.

No. 9081. Mop and Wringer combined.*(Torchon-essoreuse.)*

William P. Sampson and James L. Sandford, Binghamton, N.Y., U.S., 5th August, 1878, for 5 years.

Claim.—1st. The supplementary rollers B working within the mop roller A; 2nd. The combination of the mop roller A and supplementary roller B, wringing roller C, crank D, stop pin E and latch F.

List of Patents issued up to 21st August, 1878, but not yet Officially published in the Patent Office Record.

- No. 9082. W. Burke and T. Horrigan, Syracuse, N. Y., U. S. A., "Adjustable Draft Bar," 5th August, 1878.
- No. 9083. P. Miles, New York, U.S.A., "Shield Pin," 5th August, 1878.
- No. 9084. H. T. Chamberlin, Brockport, N. Y., U. S. A., "Vaginal Syringes," 5th August, 1878.
- No. 9085. C. F. Hunt, Chicago, Ill., U. S. A., "Steam Boiler Furnace," 5th August, 1878.
- No. 9086. Jas. Sharman, Stratford, Ont., "Clutch Block for Rock Drilling Machines," 5th August, 1878.
- No. 9087. Jos. Bailey, Dawn Mill, Ont., "Water and Fire Proof Coating for Preserving Wood, &c., &c.," 5th August, 1878.
- No. 9088. F. Morningster, Bertie, Ont., "Plough Pole and Wheel Attachment Combined," 5th August, 1878.
- No. 9089. L. H. Montross, Simcoe, Ont., "Car Axle Box," 5th August, 1878.
- No. 9090. C. J. Holman, Toledo, Ohio, and G. C. Griffith, Oshkosh, Wis., U.S.A., "Wagon Spring," 6th August, 1878.
- No. 9091. R. Beun, Hudson, Mich., U.S.A., "Pump," 6th August, 1878.
- No. 9092. R. Bayers, Halifax, N. S., "Radiator for Warming Buildings by Hot Water," 6th August, 1878.
- No. 9093. W. T. Neate, Georgetown, Ont., "Griddle Pan," 6th August, 1878.
- No. 9094. F. Hopkins, Helena, Montana, U. S. A., "Whip," 6th August, 1878.
- No. 9095. P. Pierce, Brooklyn, N. Y., (Assignee of C. Comstock, New Canaan, Ct.) U.S.A., "Metallic Shingles," 6th August, 1878.
- No. 9096. G. Hart, Detroit, Mich., U.S.A., "Emery Wheel," 6th August, 1878.
- No. 9097. B. Wetherbie, St. Eleonor's, P.E.I., "Improved Casting Chilled Harrow Shares," 6th August, 1878.
- No. 9098. M. Merrick, (Assignee of L. Meeker,) Oswego, N.Y., U.S.A., "Lifting Jack," 6th August, 1878.
- No. 9099. G. H. Crosby, Rome, Ohio, U. S. A., "Sled," (Extension of Patent No. 2692,) 7th August, 1878.
- No. 9100. O. St. Amant and J. Woodley, Quebec, Que., "Sewing Machine," (Extension of Patent No. 2641,) 12th August, 1878.
- No. 9101. J. Cowan, Philadelphia, Pa., U. S. A., "Saw Tooth Swage," (Extension of Patent No. 2336,) 12th August, 1878.
- No. 9102. G. N. Stearns, Syracuse, N.Y., U.S.A., "Hollow Auger," 12th August, 1878.
- No. 9103. A. Gordon, Williamsport, Pa., U.S.A., "Spring Bed Bottom," 12th August, 1878.
- No. 9104. D. C. Reed, Kalamazoo, Mich., U.S.A., "Harrow," 12th August, 1878.
- No. 9105. A. H. Dixon, Toronto, Ont., "Show Card," (Extension of Patent No. 2647,) 13th August, 1878.
- No. 9106. Jas. Stewart, Hamilton, Ont., "Oven Stove," 15th August, 1878.
- No. 9107. W. J. Dickson, Truro, N.S., "Washing Machine," (Extension of Patent No. 2655,) 16th August, 1878.
- No. 9108. J. & R. Hollen, Alleghans, Penn., U.S.A., "Railroad Switch," (Extension of Patent No. 2664,) 16th August, 1878.
- No. 9109. J. Pike, Montreal, Q., "Mowing and Reaping Knife Grinder," 17th August, 1878.
- No. 9110. D. A. Fiske, Hudson, Wis., (Assignee of R. F. Miller, River Falls, Wis.) U. S. A., "Churn," 19th August, 1878.
- No. 9111. H. Pollock, Frederickton, N.B., "Thread Cutter for Sewing Machines," 19th August, 1878.
- No. 9112. A. Newbury, (Assignee of B. F. Eaton, Cox Sackie, N.Y.) U.S.A., "Paper Holding Case," 19th August, 1878.
- No. 9113. A. H. Vitt and W. Leiser, Union, Mass., U.S.A., "Piston Rod Packing," 19th August, 1878.
- No. 9114. A. T. Hill, Detroit, Mich., U.S.A., "Nut Lock," 19th August, 1878.
- No. 9115. N. J. Alexander, Austin, Texas, U.S.A., "Paper Bag," 19th August, 1878.
- No. 9116. J. A. Forden, Bay City, and J. E. Thomas, West Bay City, Mich., U.S.A., "Waggon Top Adjuster," 19th August, 1878.
- No. 9117. J. S. Murray and B. Shantz, (Assignees of C. E. Drake, Avoca, Iowa, U.S.A., "Grain Distributor," 19th August, 1878.
- No. 9119. W. Hankin, Sr., Seelyville, Penn., U.S.A., "Saw Frame," 21st August, 1878.
- No. 9120. T. Sills, Fort Erie, Ont., "Grain Door," 21st August, 1878.
- No. 9121. D. A. Hopkins, Park Bridge, New Jersey, U.S.A., "Device for Lining Journal Boxes," 21st August, 1878.
- No. 9122. A. E. Kenyon, Providence, Rhode Island, U.S.A., "Button Fastener," 21st August, 1878.
- No. 9123. W. W. Austin, Lowell, Mass., U.S.A., "Naphtha Gas Lamp," 21st August, 1878.
- No. 9124. J. Kritch, Cleveland, Ohio, U.S.A., "Carriage Wheel Hub," 21st August, 1878.
- No. 9125. C. P. S. Wardwell, Lake Village, New Hampshire, U.S.A., "Corn Sheller," 21st August, 1878.
- No. 9126. A. Adams, Cleveland, Ohio, and B. B. Taggart, Watertown, N. Y., U.S.A., (Assignees of C. B. Stilwell, Worcester, Mass., U.S.A.) "Paper Bag Machinery," 21st August, 1878.
- No. 9127. M. R. B. Cowan, Windsor, Ont., "Selfacting Fans," 21st August, 1878.
- No. 9128. N. R. Allen and Chs. W. Woodford, Montreal, Que., "Ice Tongs," 21st August, 1878.

INDEX OF INVENTIONS.

Alarm, fire, A. Gerard	8958
Anti-friction devices, W. Tucker et al.	8979
Axles, R. A. Moore	9057
Baby walkers, J. Le Butler et al.	8957
Bed bottom, spring, C. Miller	9021
" " " S. B. Walker	8982
" stead, camp, W. Shoobred	8991
" fastening, A. Chevigny	8960
Bells, G. W. Tucker	9063
Blocks, snitch, A. McDonald	9065
Boards, ironing, L. Duval	8995
Boiler covering, B. F. Smith et al.	9026
" steam, D. N. Allen	9033
Bottle stoppers, J. M. Lewin	9006
Boxes, paper, B. Clarke	9052
Broom sewing machine, C. E. Lipe et al.	8971
Brushes, flat, J. L. Whiting	9017
Butter workers, H. A. Clow et al.	9049
Candle holders, S. Fuld	8951
Cane and camp stool, W. L. French	9007
Can, milk, G. A. Evans	9030
" oil, J. A. Frey	8948
Caps and sandbands, E. H. Miller	9015
Carburettor, air, C. A. Howard	8966
Carpet stretcher, D. W. Beadle	8987
Car coupling, J. N. Best	9024
" refrigerator, J. Tiffany	8969
Carriage, spring, T. J. Magner et al.	9053
Castor, furniture, C. A. Parent	8976
" W. H. Tucker et al.	8972
Cement, hydraulic, C. F. Dunderdale	9011
Chair, step, A. Dormitzer	9027
Churn dashers, D. N. Edsworth	9054
Cloth, oil and leather, W. A. Scott	8973
Cocks and valves, W. Berry	9047
Collars, horse, J. N. Schmitz	9013
Creamers, self, G. A. Evans	9030
Devices, anti-friction, W. Tucker et al.	8979
Door, sliding, G. R. Kidder	8990
Dusters, feather for, C. W. Nicholls	8988
Egg preserving, W. & I. Ingils	9073
Elevator, steam water, W. B. Doty	9061
Feathers, treating, C. W. Nicholls	8988
Fences, J. Garrett	9010
File, nail, S. Fuld	8951
Fire alarm, A. Gerard	8958
" escapes, P. Mack et al.	9066
Friction devices, anti, W. Tucker et al.	8979
Fruit preserving, W. & I. Ingils	9073
Furniture castor, C. A. Parent	8976
" W. H. Tucker et al.	8972
Garments, cutting, N. McMillan	8997
Gas, carburettor, C. A. Howard	8966
" governors, T. B. Scovell	8999
" manufacture, S. C. Salisbury	8964
Gates, J. S. Lounsbury	8998
" L. Dickerson	9020
Gold extraction, P. Cadell	9003
Grain blinding, The Grain Binder Association	9039
Grate bars, T. Murphy	9028
Guns, air, C. F. Spencer	8963
" repeating, The Evans Rifle Manufacturing Co.	9045
Harrows, A. McPherson	9052
Harvester reels, J. J. Dewey	9025
Heating apparatus, J. Cowan	8954
" steam, B. Holly	9002
Hinges, blind, E. Smart	8950
" " W. Jones	9077
Hoop machine, M. Bostwick	9025
" " R. H. Nogar	9016
Horse shoe sharpener, J. Little	9048
Hose couplings, J. Galvin	9072
Houses, painting, L. Almérás et al.	8961
Inhaler, C. D. Hunter et al.	9019
Inking composition roller, A. Van Bibber	9005
Ironing boards, L. Duval	8995
Kneading machine, L. Durand	9060
Knitting machine, W. T. Lemon	8985
Knobs, door, C. Egner	8955
Lamps, C. F. Spencer	8962
Leather tanning, C. J. Tinnerholm et al.	9041
Lighting rods, H. Cooley	9038
" rod, T. C. Hewitt	8975
Liquors, registering the sale of, W. L. Thompson	9018
Locomotives, A. Davis	9036
" supplying water to, J. Haggas et al.	9058

Mangling machine, J. C. Harrison	8989
Match safe, S. Fuld	8951
Mats and robes, E. F. Austin	8968
Measure, tape, A. F. Ward	9001
Meat curing, T. Wallace	8983
Mops, D. Greenwood	8953
Mop and wringer, W. P. Sampson et al.	9081
Moulding machine, M. Bostwick	9035
Nail cutting machine, W. N. Severance	8980
Oil, lubricating, H. and C. Fink	9071
" treating, vegetable, H. A. Clark	8986
Organs and pianos, E. K. Milklin	8981
Painting houses, L. Almérás et al.	8961
Paper, oil and leather, W. A. Scott	8973
" pulp, M. R. Fletcher	9075
Pianos and organs, E. K. Milklin	8981
Plotting instrument, D. F. Hill	8974
Plough attachment, M. Harris	9009
Power transmitting, M. Henry	8949
Pumps, lift, E. Barnes	9023
Pump, steam, W. B. Doby	9061
Presses, hydraulic, J. W. Hyatt et al.	9067
Rail, chair, W. Close	8965
Reaping machines, M. Garvin	9029
Reels, harve, r, J. J. Dewey	9025
Refrigerators, A. M. Murphy et al.	9043
" car, J. Tiffany	8969
Rein-holders, J. M. Taylor et al.	9000
Robes and mats, E. F. Austin	8968
Roller composition, inking, A. Van Bibber	9005
Roofs, N. H. Brown	9062
Sandbands and caps, E. H. Miller	9015
Sash balances, W. Miller	9080
Scrubbing machines, A. F. Stockley	8991
Sewing machine, broom, C. E. Lipe et al.	8971
Shoe, J. W. Hatch	8978
Sleigh shoes, B. F. Sweet	9008
Spikes, railway, D. Servis et al.	9040
Springs, carriage, W. Bambridge	8996
" waggon, A. W. McKown	9014
Stairs, housing, W. F. Morell	9037
Steam utilizing, B. Holly	9002
Stone support, bed, P. T. Elting	8959
Stones, ventilating mill, G. Moench	8984
Stool, cane and camp, W. L. French	9007
Stoppers, bottle, J. M. Lewin	9006
Stove, cooking, J. M. Taylor et al.	9001
" shelves, E. Bussey	9074
Straw-cutters, T. E. Marable et al.	9041
Switches, railway, J. Briody	9012
Tanning leather, C. J. Tinnerholm et al.	9041
Telegraphic despatches, G. B. de Boucherville	9031
Telephones, A. M. Rosebragh	9068
" H. S. Pole	9055
Tiers, railway, G. W. Cottingham	9076
Tools, cutting, J. King	9051
Triturating machines, J. R. Alsing	9034
Trough, kneading, L. Durand	9060
Trucks, hand, G. P. Clark	9022
Valves and cocks, W. Berry	9047
Varnishing machine, D. Gunn et al.	9056
Ventilating millstones, G. Moench	8984
Vessels, food, S. B. and R. A. Dunning	9050
Waggon, C. F. and E. E. Whipple	9079
" tops, R. W. Thompson	9059
Wash boards, J. Murphy et al.	8952
Washing machine, A. H. Randall et al.	8970
" " C. and A. W. Guyer	9070
" " J. W. Gawthrop	9064
" " L. C. Snyder et al.	8983
" " R. G. Baldwin et al.	9012
" " T. Forfar et al.	9078
Water alarm, A. Gerard	8958
Wearing apparel, I. Crane	8956
Window cleaning, A. Dormitzer	9027
Withe crushing, W. Leslie, Jr.	8992
Wringer and mop, W. P. Sampson et al.	9081
" clothes, R. P. Street	8977
Wringing machine, J. C. Harrison	8989

INDEX TO PATENTEES.

Adgate, J. J., furniture castor	8976
Allen, D. N., steam boiler	9033
Almérás, L., et al., painting houses	8961
Alsing, J. R., triturating machines	9034
Austin, E. F., mats and robes	8968

Avery, J. G., et al., anti-friction devices.....	9079	Lewis, C. J., boiler covering.....	9026
Baldwin, R. G., et al., washing machines.....	9012	Lipe, C. E., et al., broom sewing machine.....	8971
Bambridge, W., carriage springs.....	8996	Little, J., horse shoe sharpener.....	9018
Barnes, E., lift pumps.....	9023	Lounsbury, J. S., gates.....	8998
Bates, H. E., et al., washing machines.....	8993	McDonald, A., smatch blocks.....	9065
Beagle, D. W., carpet stretcher.....	8987	McKown, A. W., waggon springs.....	9014
Beemer, H. J., et al., fire-escapes.....	9066	McMillan, N., cutting garments.....	8997
Berry, W., cocks and valves.....	9047	McPherson, A., barrows.....	9052
Best, J. N., car-couplings.....	9021	Mack, P., et al., fire escapes.....	9066
Bliss, G. N., et al., varnishing machine.....	9050	Mackey, J., et al., cooking stoves.....	9001
Bostwick, M., hoop machine.....	9035	Mackey, J., et al., rein-holders.....	9000
Boucherolle, G. B. de, telegraphique despatches.....	9031	Magner, T. J., et al., spring carriage.....	9053
Bridoy, J., railway switches.....	9012	Marable, T. E., et al., straw-cutters.....	9044
Bronson, E. D., et al., broom sewing machine.....	8971	Martin, A. C., furniture caster.....	8972
Brown, N. H., roofs.....	9062	Merriman, C. H., et al., railway spikes.....	9010
Brownfield, T. H., carpet stretcher.....	8987	Milkin, E. K., pianos and organs.....	8981
Busssey, E., stove shelves.....	9071	Miller, C., spring bed bottom.....	9021
Butler, J. L., baby walkers.....	8957	“ E. H., sandbands and caps.....	9015
Cadell, P., extraction of gold.....	9003	Milner, W., sash balances.....	9080
Chevigny, A., bid-stead fastening.....	8960	Moench, G., ventilating millstones.....	8984
Clark, G. P., hand trucks.....	9022	Moore, R. A., axles.....	9057
“ H. A., treating vegetable oils.....	8986	Morell, W. F., housing stairs.....	9037
“ P., paper boxes.....	9032	Morrison, L. A., et al., washing machines.....	9078
Close, J. W., rail chair.....	8963	Murphy, J., et al., wash boards.....	8972
Clow, H. A., et al., butter workers.....	9049	Murphy, A. M., et al., refrigerators.....	9043
Cooley, H., lightning rods.....	9018	“ T., grate bars.....	9028
Cottingham, G. W., railway ties.....	9076	Nicholls, C. W., feathers for dusters.....	8988
Cowan, J., heating apparatus.....	8951	Nicom, S. A. R., et al., tanning leather.....	9041
Crane, I., wearing apparel.....	8956	Nogar, R. H., hoop machines.....	9016
“ T. S., et al., hydraulic presses.....	9067	Parent, C. A., furniture caster.....	8976
Curtis, J., et al., varnishing machine.....	9056	Parkhurst, A. G. and R. K., et al., washing machines.....	9042
Davis, A., locomotives.....	9036	Pole, H. S., telephones.....	9055
Dewey, J. J., harvester rears.....	9025	Randall, A. H., et al., washing machine.....	8970
Dickerson, L., gates.....	9020	Reynolds, D. B., cane and camp stool.....	9007
Dooley, G. B., et al., varnishing machine.....	9056	Reutschler, G. H., et al., furniture caster.....	8972
Dornitzer, A., step chair.....	9027	Rhoads, R. A., et al., butter workers.....	9049
Dorsey, R. S., et al., furniture caster.....	8972	Richman, A. B., et al., wash boards.....	8952
Doty, W. B., steam water elevator.....	9061	Rosebrugh, A. M., telephones.....	9068
Dunderdale, C. F., hydraulic cement.....	9011	“ “ “ telephony.....	9069
Dumling, S. B. & R. A., food vessels.....	9053	Salisbury, S. C., gas manufacture.....	8964
Durand, L., kneading machines.....	9060	Sampson, W. P., et al., mop and wringer.....	9081
Duval, L., ironing boards.....	8995	Sandford, J. L., “ “.....	9081
Eddy, A., et al., washing machines.....	9042	Schmidt, J. N., horse collars.....	9013
Egebor, C., door knobs.....	8955	Scott, W. A., floor cloth and paper.....	8973
Edsworth, D. N., churn dashers.....	9054	Seovell, F. B., gas governors.....	8999
Eding, P. L., bed stone support.....	8959	Servis, D., et al., railway spikes.....	9040
Egan, G. A., self-creamers.....	9030	Severance, W. N., mill cutting machine.....	8980
“ W. R., repeating gun.....	9045	Shoolbred, W., camp bedstead.....	8991
“ Rude Manufacturing Co., repeating gun.....	9045	Smart, E., blind hinges.....	8950
Fink, H. and C., lubricating oil.....	9071	Smith, B. F., et al., boiler covering.....	9026
Fletcher, M. R., paper pulp.....	9075	“ C., et al., tanning leather.....	9011
Forfar, T., et al., washing machines.....	9078	“ C. H., lightning rods.....	8975
Foster, E., et al., washing machine.....	8970	Snyder, L. C., et al., washing machine.....	8993
French, W. L., cane and camp stool.....	9007	Sohn, C. H., et al., furniture caster.....	8972
Frey, J. A., oil cans.....	8918	Spading, H. C., power transmitting.....	8919
Fuld, S., muffle.....	8951	Spencer, C. F., air guns.....	8963
Garrett, J., fences.....	9010	“ “ “ lamps.....	8962
Galving, J., hose couplings.....	9072	Steers, T., Jr., camp bedstead.....	8991
Garvin, M., reaping machines.....	9020	Stockley, A. F., scrubbing machine.....	8991
Gawthrop, J. W., washing machines.....	9064	Street, R. P., clothes wringer.....	8977
Gerard, A., fire alarm.....	8958	Sturtevant, C. F., et al., railway spikes.....	9010
Grain Binder Association, grain binding.....	9039	Sullivan, J., et al., fire-escapes.....	9068
Greewood, D., mops.....	8953	Sweet, B. F., sleigh shoes.....	9008
Gunn, D., et al., varnishing machine.....	9056	Taylor, J. M., et al., cooking stoves.....	9001
Guyer, C. and A. W., washing machines.....	9070	“ “ “ rein holders.....	9000
Haggas, J., et al., supplying water to locomotives.....	9058	Thayer, W. H., mops.....	8953
Harris, M., plough attachment.....	9009	Thomas, C. L., et al., spring carriage.....	9053
Harrison, J. C., mangling machine.....	8989	Thompson, R. W., waggon tops.....	9059
Hatch, J. W., shoe.....	8978	“ W. L., registering the sale of liquors.....	9015
Haynes, C. E., clothes wringer.....	8977	Thoreau, P., et al., baby walkers.....	8957
Henry, M., power transmitting.....	8949	Tiffany, J., refrigerator car.....	8969
Hewitt, T. C., lightning rod.....	8975	Timmer-olm, C. J., et al., tanning leather.....	9011
Hitt, D. F., plotting instrument.....	8971	Touet, E., et al., baby walkers.....	8957
Holly, B., millizing steam.....	9002	Treblcock, A., et al., refrigerators.....	9043
Howard, C. A., air carburetor.....	8966	Tucker, G. W., bells.....	9063
Hubbard, M. G., et al., grain binding.....	9039	“ W., et al., anti-friction devices.....	8979
Hubner, J. D., et al., grain binding.....	9039	“ W. H., et al., furniture caster.....	8972
Hunter, C. D., et al., tubular.....	9019	Van Bibber, A., inking roller composition.....	9005
Hyatt, J. W., et al., hydraulic presses.....	9067	Walker, S. B., spring bed bottom.....	8982
Inglis, W. and J., egg preserving.....	9073	Wallace, T., meat curling.....	8943
Jones, W., blind hinges.....	9077	Walrath, A., et al., broom sewing machine.....	8971
Johnson, A. C., et al., baby walkers.....	8957	Ward, A. F., tape measure.....	9004
Kibler, G. R., sliding door.....	8900	Whipple, C. F. and E. E., waggons.....	9070
King, J., cutting tools.....	9051	Whiting, J. L., flat brushes.....	9017
LeBuller, J., et al., baby walkers.....	8957	Woods, E. S., et al., inhaler.....	9019
Lenon, W. T., knitting machines.....	8985	Young, P. T., et al., straw-cutters.....	9011
Leslie, W., Jr., crushing mill.....	8992		
Lewin, J. M., bottle stoppers.....	9006		

THE
CANADIAN PATENT OFFICE RECORD.

ILLUSTRATIONS.

Vol. VI

AUGUST, 1878.

No. 8

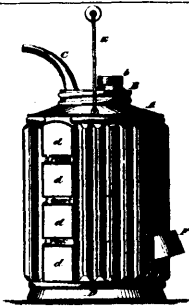

8948 Frey's Improvements on Oil Cans.

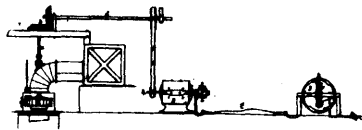

8949 Spalding's Method of Transmitting Power.

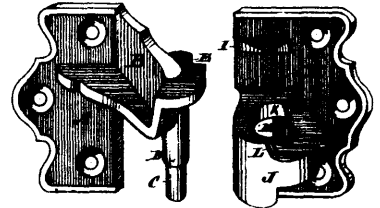

8950 Smart's Improvements on Blind Hinges.

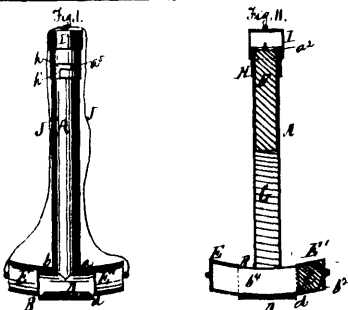

8951 Fuld's Combined Candle-holder, Match-safe and Nail File.

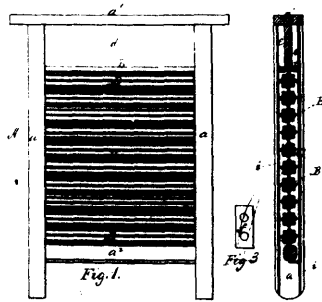

8952 Murphin & Richman's Improvements on Washboards.

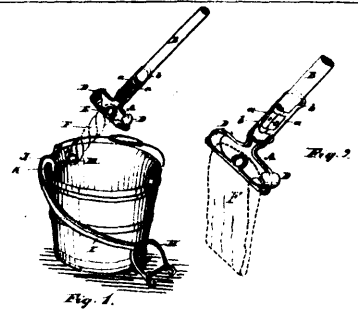

8953 Thayer's Improvements on Mops.

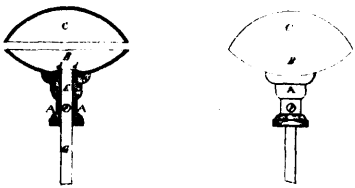

8955 Egenger's Improvements on Door Knobs.

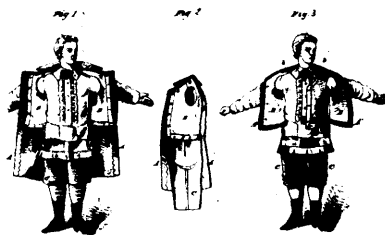

8956 Crane's Wearing Apparel.

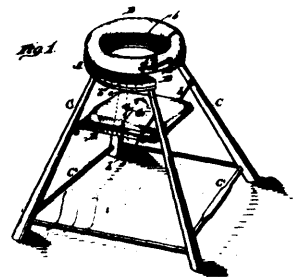

8957 LeButler, Johnson, Touet & Thoreau's Improvements on Baby Walkers.

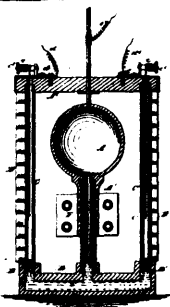

8958 Gerard's Fire and Water Alarm.

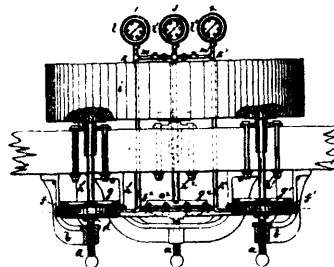

8959 Elting's Bed Stone Support.

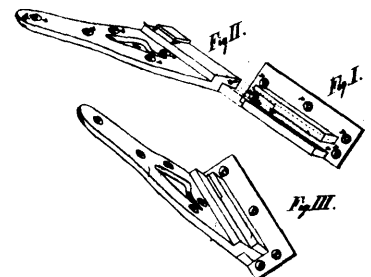

8960 Chevigny's Bedstead Fastening.

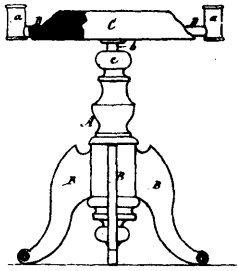

8962 Spencer's Improvements on Lamps.

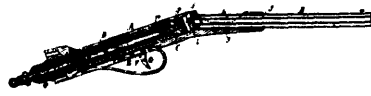

8963 Pettengill & Colony's Improvements on Air Guns.

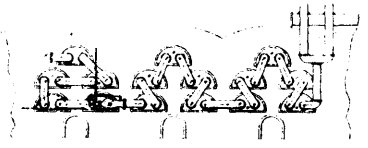

8964 Salisbury's Manufacture of Gas.

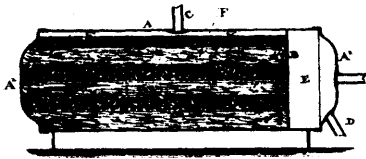

8966 Howard's Automatic Air Carburetter.

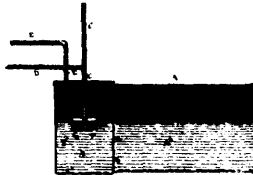

8967 Howard's Air Carburetter.

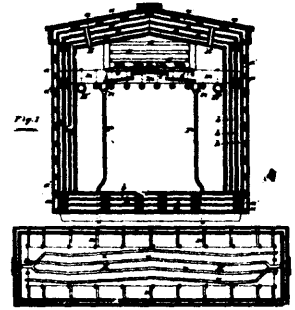

8969 Tiffany's Refrigerator Car.

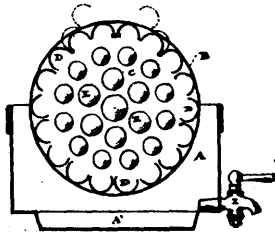

8970 Randall & Foster's Washing Machine.

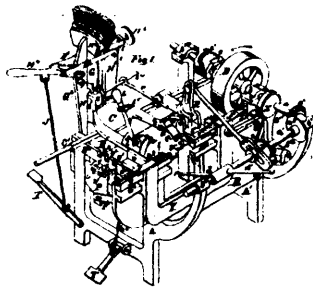

8971 Lipe, Bronson & Walrath's Broom Sewing Machine.

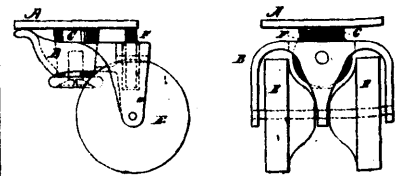

8972 Martin's Furniture Caster.

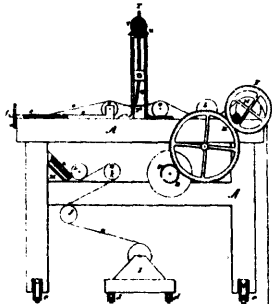

8973 Scott's Machine for Manufacturing Floor, Oil and Leather Cloth and Paper.

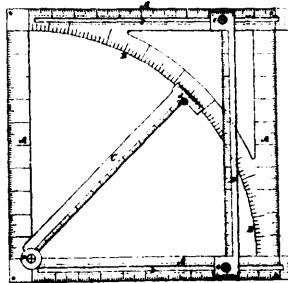

8974 Hitt's Plotting Instrument.

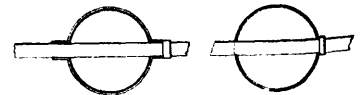

8975 Smith's Lightning Rod.

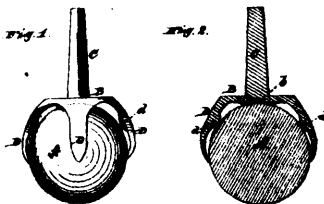

8976 Adgate's Furniture Caster.

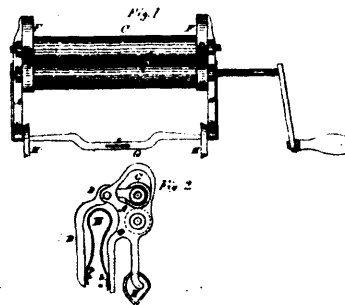

8977 Haynes' Clothes Wringer.



8978 Hatch's Improved Shoe.

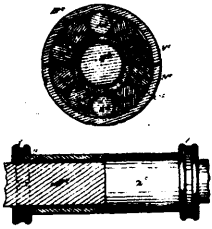

8979 Tucker & Avery's Anti-Friction Devices.

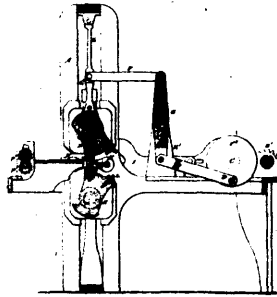

8980 Severance's Machine for Cutting Nails.

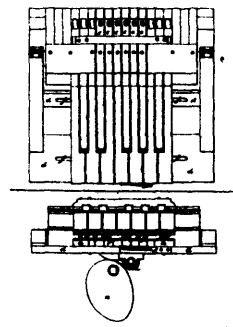

8981 Milkin's Improvements on Pianos and Organs.

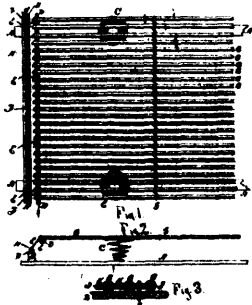

8982 Walker's Spring Bed Bottom.

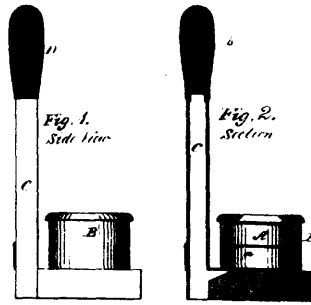

8984 Moench's Device for Ventilating Millstones.

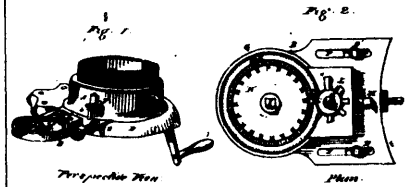

8985 Lemon's Improvement in Knitting Machines.

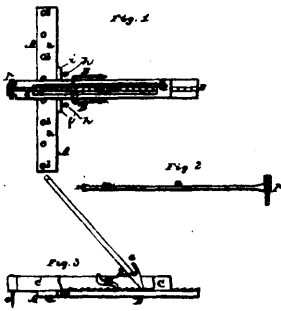

8987 Brumfield's Carpet Stretcher.

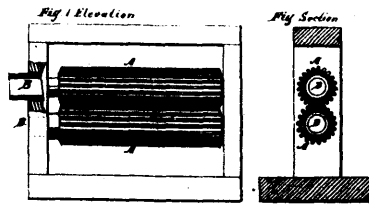

8988 Nicholls' Process for Treating Feathers for Dusters.

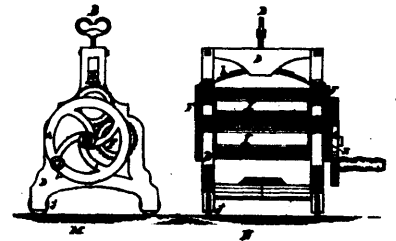

8989 Harrison's Mangling and Wringing Machine.

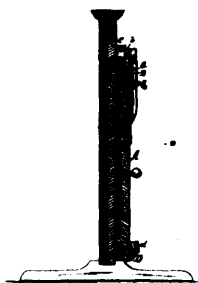

8990 Kidder's Sliding Door.

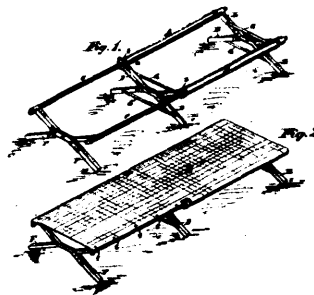

8991 Steers' Camp Bedstead.

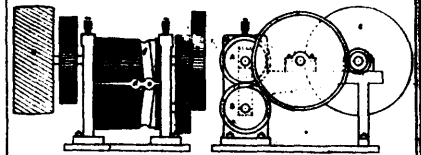

8992 Lesalle's Machine for Crushing Withs.

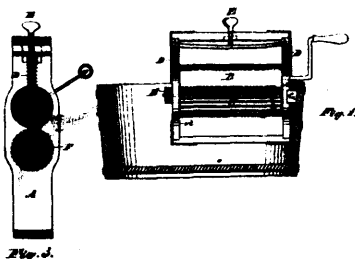

8993 Snyder & Bates' Washing Machine.

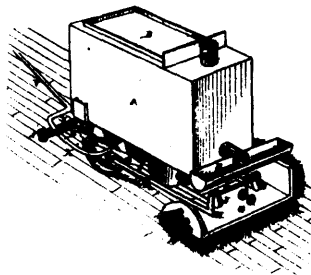

8994 Stockley's Improvement in Scrubbing Machines.

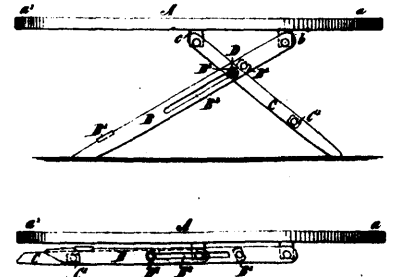

8995 Duval's Improvements in Ironing Boards.



8996 Bambridge's Improvements on Carriage Springs.

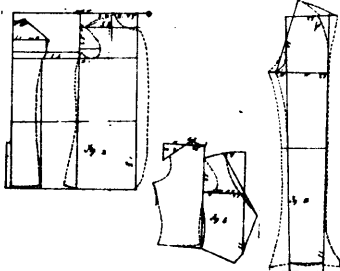

8997 McMillan's Art of Decorating and Cutting Garments.

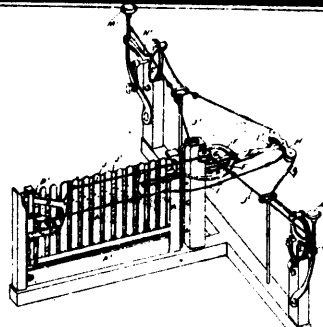

8998 Lounsberry's Improvements in Gates.

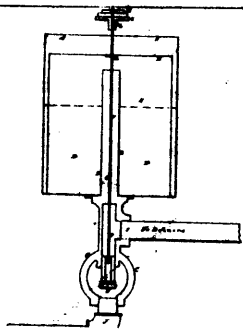

8999 Scovell's Improvements on Gas Governo:rs.

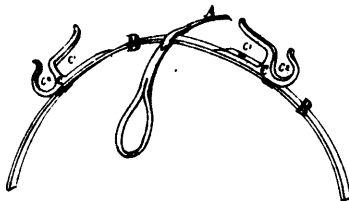

9000 Taylor & MacKey's Improvement in Rein-holders.

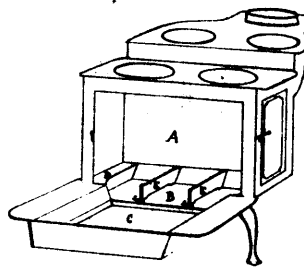

9001 Taylor & MacKey's Improvement on Cooking Stoves.

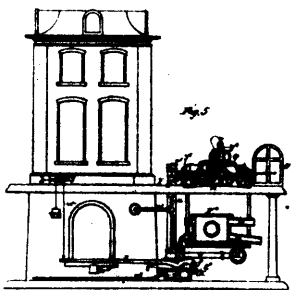

9002 Holly's Apparatus for Utilizing Steam in Heating.

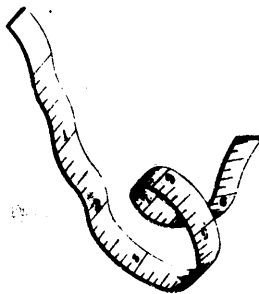

9004 Ward's Improved Tape Measure.

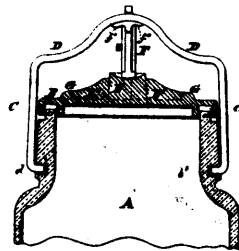

9006 Lewin's Improvements on Bottle Stoppers.

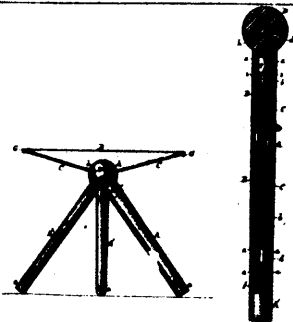

9007 Reynolds' Combined Cane and Camp Stool.

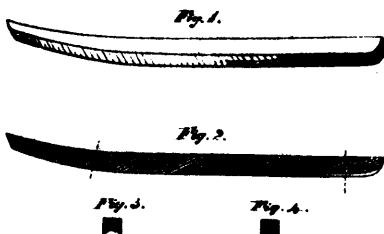

9008 Sweet's Improvements on Sleigh Shoes.

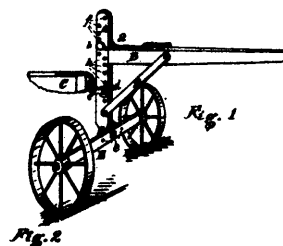

9009 Harris' Draught Attachment for Ploughs.

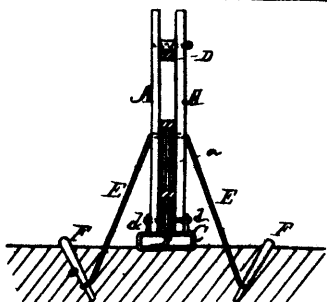

9010 Garrett's Improvements on Fences.

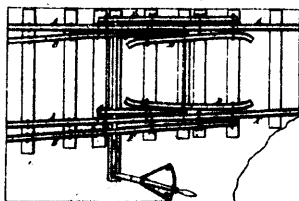

9012 Briedy's Improvements on Railway Switches.

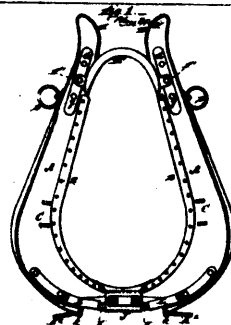

9013 Schmitz's Improvements on Horse Collars.

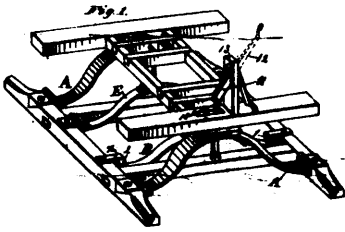

9014 McKown's Improvements on Waggon Springs.

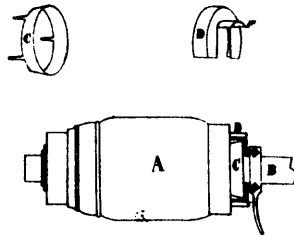

9015 Miller's Improvement in Sandbands and Caps.

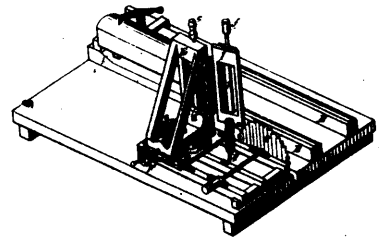

9016 Nogar's Improvement on Hoop Machines.

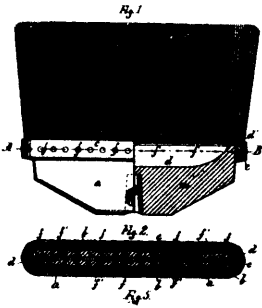

9017 Whiting's Improvements on Flat Brushes.

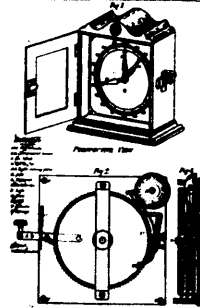

9018 Thompson's Machine for Registering the Sale of Retail Liquors.

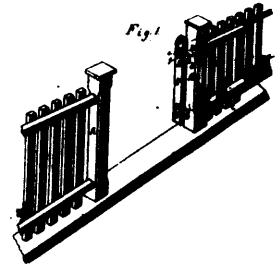

9020 Dickerson's Improvements on Gates.

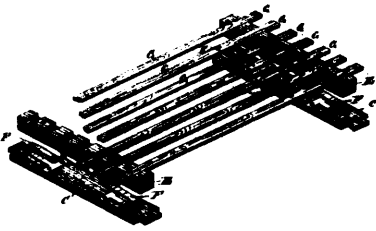

9021 Miller's Spring Bed Bottom.

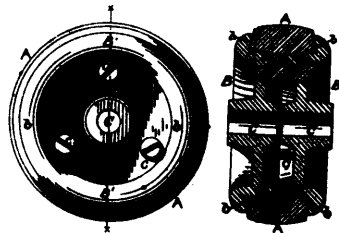

9022 Clark's Improvements on Hard Trucks.

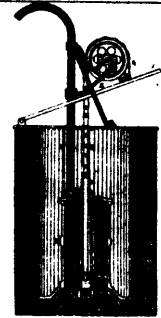

9023 Barnes' Improvements in Lift Pumps.

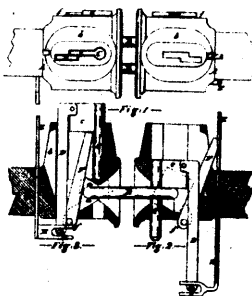

9024 Best's Improvements on Car-Couplings.

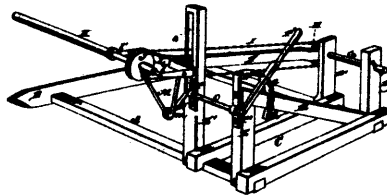

9025 Dewey's Improvements on Harvester Reels.

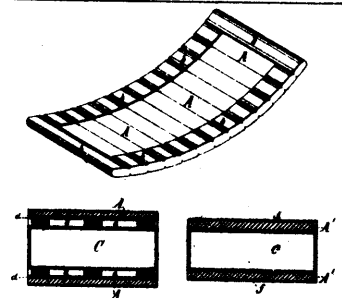

9026 Smith & Lewis' Non-Conducting Covering for Steam Boilers.

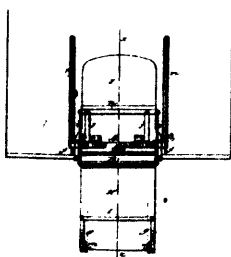

9027 Dormitzer's Window Cleaning Step Chair

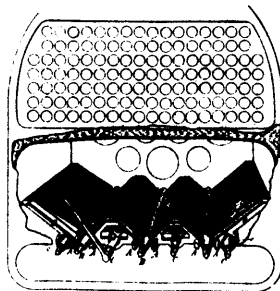

9028 Murphy's Improvements on Grate-bars.

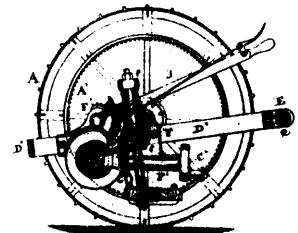

9029 Garvin's Improvements in Reaping Machines.

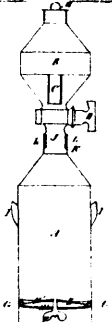

9030 Evans' Improvements on Self-creamers.

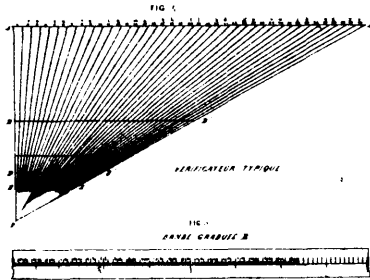

9031 Boucher de Houcherville's Mode of Transmitting, Receiving and Recording Tele-graphic Despatches.

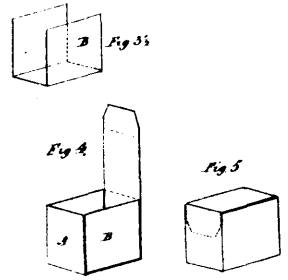

9032 Clarke's Improvements in Paper Boxes.

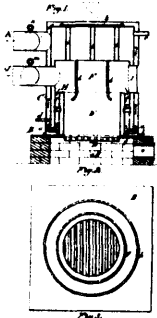

9033 Allen's Improvements on a Steam Boiler.

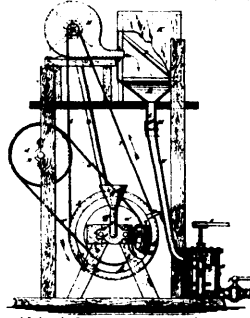

9034 Alsing's Improvements on Triturating Machines.

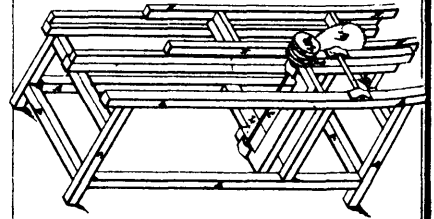

9035 Bostwick's Hoop and Moulding Machine.

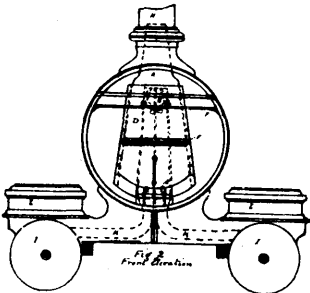

9036 Davis' Improvements on Locomotives.

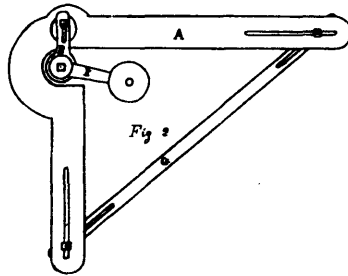

9037 Morell's Machine for Housing Stairs.

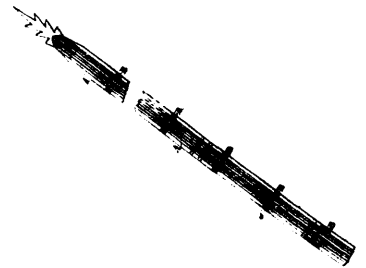

9038 Cooley's Improvements on Lightning Rods.

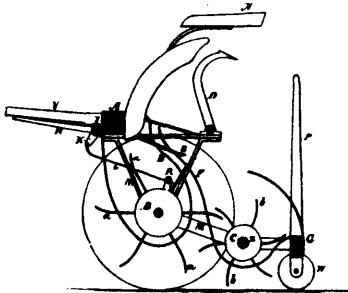

9039 Hubbard & Hutner's Machine for Cleaning and Binding Grain.



9040 Servis, Sturtevant & Merriman's Improvements in Railway Spikes.

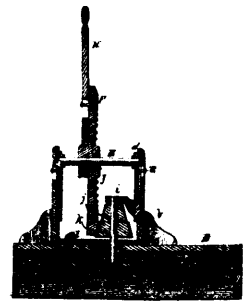

9042 Baldwin, Parkhurst & Eddy's Improvements on Washing Machines

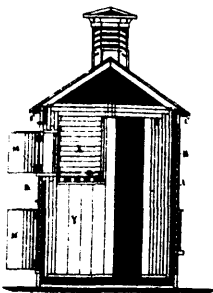

9043 Murphy & Tr. bilcock's Improvements in Refrigerators.

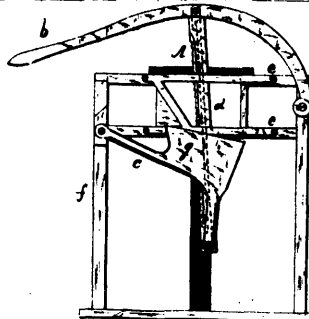

9044 Marable & Young's Improvements on Straw Cutters.

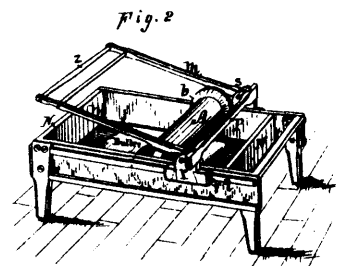

9049 Clow & Rhoads' Improvements on Butter Workers.

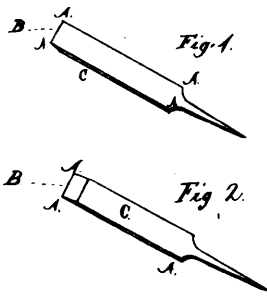

9051 King's Improvement in Cutting Tools.

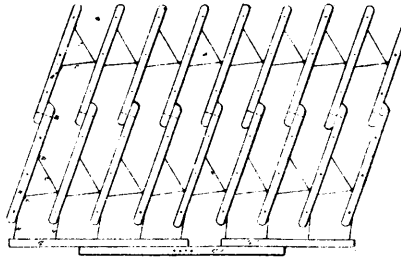

9052 McPherson's Improvements on Harrows.

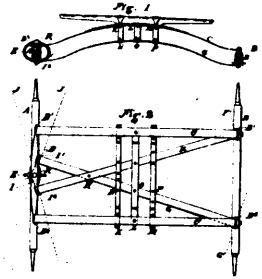

9053 Magner & Thomas' Improvements on Spring Carriages.

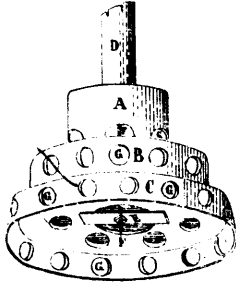

9054 Ellsworth's Improvements on Churn Dashers.

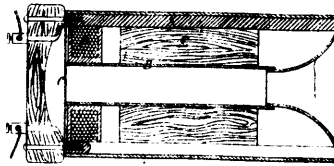

9055 Pole's Improvements in Telephones.

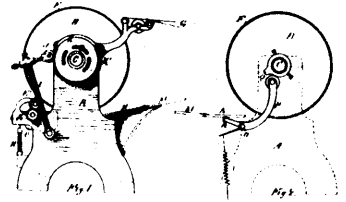

9056 Gunn, Bliss, Dooley & Curtis' Varnishing Machine.

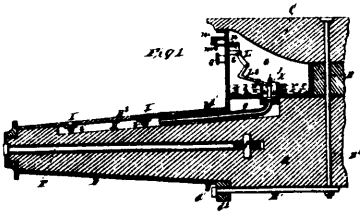

9057 Moore's Improvements on Axles.

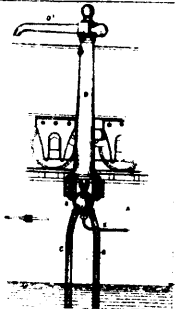

9058 Haggas & Gooderham's Apparatus for Supplying Locomotive Tenders with Water.

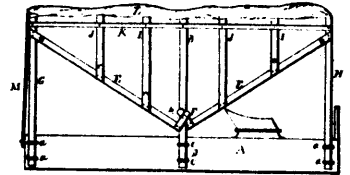

9059 Thompson's Improvements in Waggon Tops.

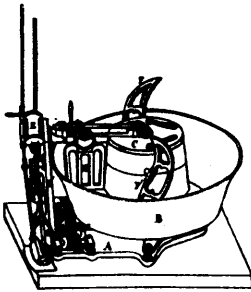

9060 Durand's Improvements on Kneading Machines.

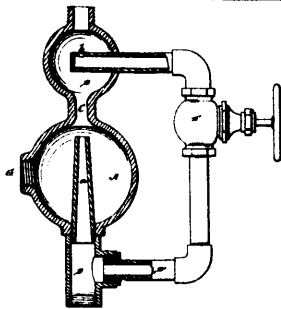

9061 Doty's Steam Water Elevator.

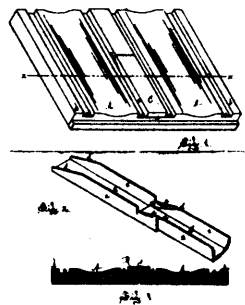

9062 Brown's Improvements on Roofs.

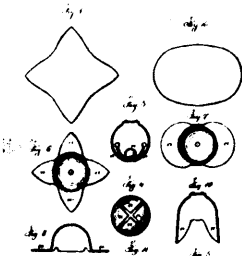

9063 Tucker's Improvement in the Manufacture of Bells.

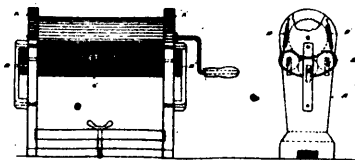

9064 Gawthrop's Improvements on Washing Machines.

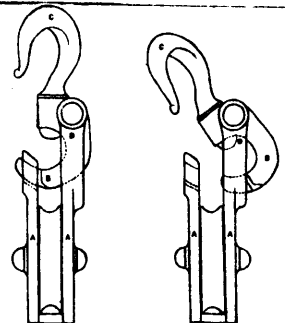

9065 McDonald's Improvements in Snatch Blocks.

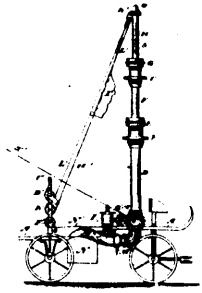

9066 Mack, Sullivan & Steniet's Improvements on Fire-escapes.

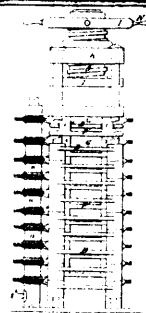

9067 Hyatt & Crane's Improvement in Hydraulic Presses.

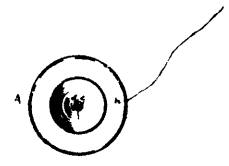

9068 Rosebrugh's Improvements in Telephones.

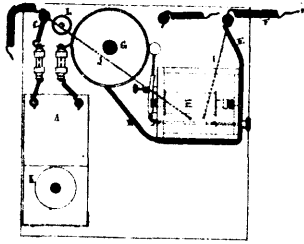

9069 Rosebrugh's Improvements in Telephony.

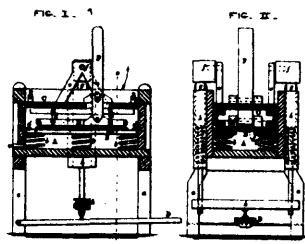

9070 Guyer's Improvements on Washing Machines.

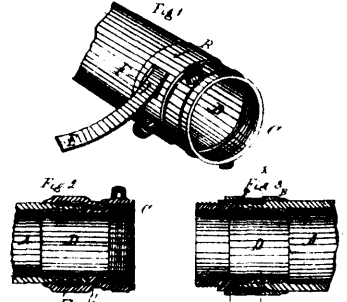

9072 Galvin's Improvements on Hose Couplings.

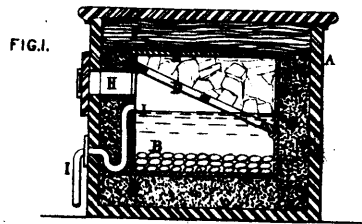

9073 Inglis' Process and Apparatus for Preserving Eggs and Fruit.

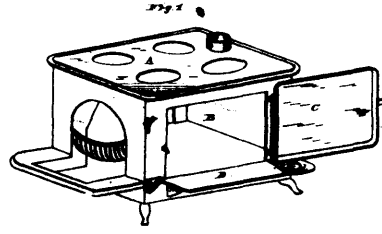

9074 Bussey's Improvements in Stove Shelves.

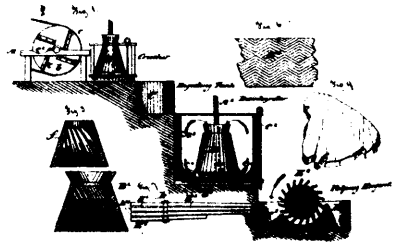

9075 Fletcher's Process for Making Paper Pulp.

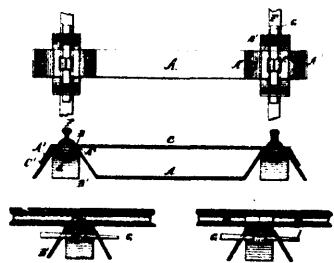

9076 Cottingham's Improvements on Railway Ties.

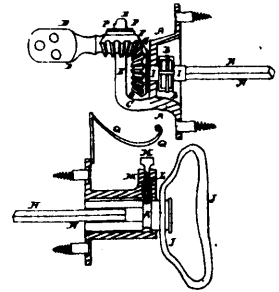

9077 Jones' Improvements on Blind Hinges.

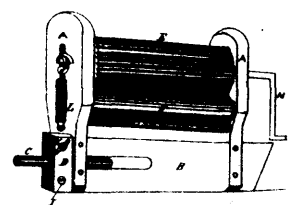

9078 Forfar & Morrison's Improvements in Washing Machines.

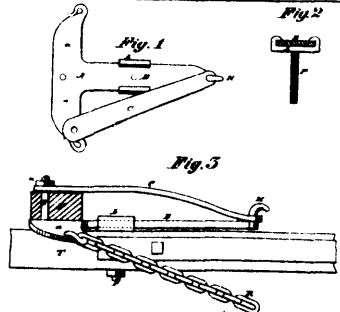

9079 Whipple's Improvements in Waggon.

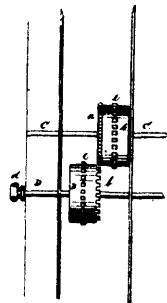

9080 Milner's Improvements on Sash Balances.

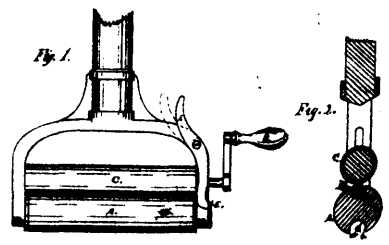

9081 Sampson & Sandford's Mop and Wringer combined.