

Technical and Bibliographic Notes / Notes techniques et bibliographiques

The Institute has attempted to obtain the best original copy available for scanning. Features of this copy which may be bibliographically unique, which may alter any of the images in the reproduction, or which may significantly change the usual method of scanning are checked below.

L'Institut a numérisé le meilleur exemplaire qu'il lui a été possible de se procurer. Les détails de cet exemplaire qui sont peut-être uniques du point de vue bibliographique, qui peuvent modifier une image reproduite, ou qui peuvent exiger une modification dans la méthode normale de numérisation sont indiqués ci-dessous.

- Coloured covers /
Couverture de couleur
- Covers damaged /
Couverture endommagée
- Covers restored and/or laminated /
Couverture restaurée et/ou pelliculée
- Cover title missing /
Le titre de couverture manque
- Coloured maps /
Cartes géographiques en couleur
- Coloured ink (i.e. other than blue or black) /
Encre de couleur (i.e. autre que bleue ou noire)
- Coloured plates and/or illustrations /
Planches et/ou illustrations en couleur
- Bound with other material /
Relié avec d'autres documents
- Only edition available /
Seule édition disponible
- Tight binding may cause shadows or distortion
along interior margin / La reliure serrée peut
causer de l'ombre ou de la distorsion le long de la
marge intérieure.
- Additional comments /
Commentaires supplémentaires:

Continuous pagination.

- Coloured pages / Pages de couleur
- Pages damaged / Pages endommagées
- Pages restored and/or laminated /
Pages restaurées et/ou pelliculées
- Pages discoloured, stained or foxed/
Pages décolorées, tachetées ou piquées
- Pages detached / Pages détachées
- Showthrough / Transparence
- Quality of print varies /
Qualité inégale de l'impression
- Includes supplementary materials /
Comprend du matériel supplémentaire
- Blank leaves added during restorations may
appear within the text. Whenever possible, these
have been omitted from scanning / Il se peut que
certaines pages blanches ajoutées lors d'une
restauration apparaissent dans le texte, mais,
lorsque cela était possible, ces pages n'ont pas
été numérisées.

The Canadian Patent Office

RECORD

Vol. XIII.—No. 7.

JULY, 1885.

Price in Canada \$2.50 per An.
United States - \$2.50

CONTENTS.

INVENTIONS PATENTED.....	267
ILLUSTRATIONS.....	287
INDEX OF INVENTIONS.....	I
INDEX OF PATENTEES.....	II

INVENTIONS PATENTED.

NOTE—Patents are granted for 15 years. The term of years for which the fees have been paid, is given after the date of the patent.

No. 21,796. Medicinal Compound.

(Composition Médicinale.)

Daniel Haerberle, Springfield, (Assignee of Peter Haerberle, Brookline,) Mo., U.S., 3rd June, 1885; 5 years.

Claim.—The combination, in a medicine of balsam of fir, glycerine, balsam of Peru, calamus root, juniper berries, blossoms of yarrow and alcohol, in the proportions and for the purposes specified.

No. 21,797. Horse Power. (Mauège.)

George B. Ellis, (Assignee of John Ellis,) East Coventry, Pa., U.S., 3rd June, 1885; 5 years.

Claim.—1st. The combination of bearing-wheels E, on the frame of the horse-power, with endless chains, the links of which have flanges a projecting beyond the ends of the lugs, so as to form a supporting track for the chain on its return, as set forth. 2nd. The links having inner flanges a, with guide ribs a₁, as set forth. 3rd. The combination of the links having inner flanges, with ribs a₁, the guide-wheels E₁ carried by shafts a₂, and means for confining said shafts laterally to the frame of the power, as set forth. 4th. The combination of the shaft or spindle M and the centrally-grooved anti-friction rollers b₂, with a wheel-hub open at both ends, internally chilled, and having a central rib b, as set forth. 5th. The combination of the sprocket-wheel, idler pulley and chains of a horse-power, with the frame having brackets H with guides d, the boxes d carrying the shaft of the idler-pulley, and set-screws d₂ for adjusting said boxes, as set forth. 6th. The combination of a friction brake-strap and operating-lever therefor, with a sprocket-wheel having a flange for the action of said brake-strap, as set forth. 7th. The combination of the sprocket-wheel and its flange, the friction-strap, the bracket c₁, the rock-shaft L, with arms I and the operating-lever l, as set forth. 8th. The combination of the idler-pulley having a circular periphery, with a socket s, with the chain composed of connected links, each having a concave recess a₃, as set forth. 9th. The links G, having at each end a vertically-projecting lug h forming an end bearing, as set forth. 10th. The links G, each having at one end a hook g₁ and at the opposite end lugs g₂ carrying a hollow pin f, as set forth. 11th. A metallic lag for the treat of a horse-power, said lag comprising longitudinal ribs and transverse connecting-bars, as set forth. 12th. A metallic lag F comprising hollow longitudinal ribs m, and transverse braces n extending between and across said ribs, as set forth. 13th. A metallic lag F comprising longitudinal ribs m, tapered from the center toward each end and having a top flange m₁, in combination with connecting plates and braces for said ribs, as set forth. 14th. The combination of a link G having a tubular projection i, with a metallic lag F having end plates with openings i₂, as set forth. 15th. The combination of the lags F, with the links G, each having inclined projections n₂ forming the bearings for the lag, as set forth.

No. 21,798. Water Heater.

(Calorifère à Eau.)

Eugène S. Manny, Montreal, Que., 5th June, 1885; 5 years.

Réclame. 1o. La combinaison de la bouilloire à double parois A, avec le couvercle double D, à l'aide des tuyaux de communication E, E, tel que décrit. 2o. La combinaison des tuyaux B, avec la bouilloire

A, tel que décrit. 3o. La combinaison des tuyaux M, M, reliant le couvercle double D aux tuyaux d'eau chaude H, H, tel que décrit et pour les fins indiquées.

No. 21,799. Lubricator. (Boîte à Graisse.)

Clarence B. Hodges and Elijah McCoy, Detroit, Mich., U.S., 5th June, 1885; 5 years.

Claim.—1st. In a lubricator, an equalizing steam conduit embraced fully or partially within the body of the lubricator itself, substantially as described. 2nd. The combination of the oil reservoir, the visible feed tube through which the oil rises, and the oil exit connected by a passage with the upper end of the visible feed tube with a steam conduit at the top of the reservoir, for discharging steam into the oil-exit between the latter and the upper end of the visible feed tube, substantially as described. 3rd. The combination of the oil-reservoir, the condenser, the visible feed tube through which the oil rises and the oil-exit connected by a passage with the upper end of the visible feed tube, with the steam conduit formed in the top wall of the oil-reservoir for discharging steam into the oil-exit between the latter and the passage which connects the visible feed tube with the oil-exit, substantially as described. 4th. The combination of the oil-reservoir having the neck F at its upper end, and the visible feed tube through which the oil rises, with the oil-exit connected through the said neck with the upper end of the visible feed tube, and the steam-conduit in the top portion of the reservoir for delivering steam into the oil-exit between the latter and the upper end of the visible feed tube, substantially as described. 5th. The combination of the oil-reservoir, the visible feed tubes at the sides thereof through which the oil rises, and the necks at the top of the reservoir having oil-exits connecting by passages with the visible feed tubes, with the condenser and the two steam conduits in the top wall of the reservoir, for delivering steam into the exit between the latter and the passages connecting said oil-exits with the upper end of the visible feed tubes, substantially as described. 6th. The combination of the oil-reservoir, the visible feed tubes through which the oil rises, and the neck F at the top of the reservoir, having a space o, and the oil-exit with the steam-conduit in the top wall of the reservoir, for delivering steam to the oil-exit, between the latter and the upper end of the visible feed tube, and the throttling valve governing the oil-exit and the flow of oil and steam from the said space in the neck, substantially as described. 7th. The combination of the oil-reservoir having neck F provided with an oil-exit, and the visible sight feed tube through which the oil rises to the oil-exit, with the valve H arranged in the neck to govern the oil-exit, and having an orifice through its stem, and an oil cup at its top, and a valve extending through the cup, and governing the orifice in the valve stem, whereby it may be fed from the said cup if the visible feed tube be broken, substantially as described.

No. 21,800. Matrix Making and Printing Machine. (Machines à Faire et Imprimer les Matrices.)

Ottmar Mergenthaler, Baltimore, Md., U.S., 5th June, 1885; 5 years.

Claim.—1st. The combination of a type wheel provided with fixed peripheral type, a cylinder concentric therewith, and a series of longitudinal sliding rolls mounted in said cylinder, and arranged to be extended endwise therefrom opposite the respective type. 2nd. The combination, substantially as described and shown, of a rotary type-wheel, rotary presser devices to sustain the paper against the type, and supporting and operating means, substantially as described, to carry the presser devices during their action in a path parallel with that of the type. 3rd. The combination of a rotary wheel and type sustained by said wheel and facing radially, a presser device opposed to the face of the type, and operating mechanism, substantially as described, which permits the type and presser devices to move in parallel concentric paths. 4th. The combination of a rotary wheel provided with fixed type, a rotary cylinder or carrier concentric with and rotating in unison with the wheel, radially movable presser devices, substantially as described, carried by the cylinder and opposed to the faces of the type, and means, substantially as described, for forcing the presser devices toward the type during the rotary motion, whereby the presser devices are caused to advance with the type while holding the paper thereon. 5th. In combination,

with mechanism, substantially as described, for supporting and operating the same, a rotary wheel having fixed type, and pressor devices, substantially as described, opposite to the faces of the type, and having both a rotating movement about the axis of the wheel, and a movement to and from the faces of the type during such rotation. 6th. In combination with the rotary cylinder, the slides arranged to protrude endwise therefrom, the keys operating directly on the slides to project the same, and the cam plate located at the front of the cylinder, and acting to push the slides inward. 7th. The combination of the type-wheel and the cylinder provided with the endwise moving slides, and a toothed pressure-wheel arranged to force the slides upon the type, substantially as set forth. 8th. The combination of the type-wheel, the cylinder B, the sliding and radially-moving rods, the dog I and the toothed wheel J. 9th. In a printing or indenting machine, the combination of the rotary type wheel, one rings, substantially as and for the purpose described. 10th. In combination with the type-wheel provided with fixed type, the cylinder B, slides C and pressure devices arranged to act upon said slides, the pressure device N and a device, substantially as shown, arranged to raise said pressure device from the strip previous to each impression or indentation. 11th. In combination with the type-wheel and an intermediate pressure device, substantially as shown, a pressure-wheel J having teeth c, inclined or bevelled, substantially as and for the purpose described. 12th. In combination with the wheel having fixed type, a cylinder concentric therewith and slides mounted in the cylinder, and each capable of moving both endwise and radially in relation to the cylinder, in order to co-operate in conjunction with the faces of the type, substantially as described and shown. 13th. The combination of the rotary cylinder, the movable rods therein, the finger keys to advance the rods, the wheel with fixed type and a pressure device to move the extended rods toward the type. 14th. In combination with the cylinder, its slides or rods and the finger keys to actuate the slides, the laterally movable wheel provided with two or more circumferential lines of type, and a cam-wheel or pressure device also movable laterally. 15th. The combination, with mechanism for presenting the paper, of a laterally movable type-wheel, a laterally movable feed or pressure wheel, and mechanism common to the two wheels for effecting their simultaneous adjustment. 16th. The combination, in a printing or indenting machine, of an impression device acting upon or against the type, and a wheel to operate said device, provided with teeth having concentric extremities but of different lengths on the circumference. 17th. In combination with a wheel, provided with a series of fixed type, means, substantially as described, for sustain the paper against the type, and a pressure-wheel to cause the impression having teeth with concentric extremities but of varying length on the circumference. 18th. The combined pressure and feed wheel having the teeth with concentric ends, but of varying widths and inclinations on the circumference. 19th. In combination with the cylinder, its rods or slides and the finger keys, a locking device common to all the keys, and means, substantially as described, for moving the same to and fro. 20th. The cylinder, its rods or slides, the finger keys, a locking bar common to all the keys, a spring to advance the bar for engagement, and a cam or like device to cause its positive retraction.

No. 21,801. Metallic Ceiling.

(Plafond Metallique.)

Albert Northrop, Pittsburg, Pa., U.S., 5th June, 1885; 5 years.

Claim.—1st. The cap or molding A, the edges B of which are provided with corrugations or crimps C, in combination with a sheet of metal having corrugations or crimps, substantially as hereinbefore described and for the purpose set forth. 2nd. In a metallic ceiling, a cap having corrugated edges, said edges being provided with openings for the reception of nails, in combination with a corrugated plate provided on its edge with openings adapted to register with the openings in the corrugated cap, said plate and cap openings being larger than the nails, whereby the parts may expand and contract without displacing the nails, substantially as described and for the purposes set forth.

No. 21,802. Moulds for Casting Slugs and Leads for Printers' Use. (Moules pour Couler les Interlignes et les Blancs d'Imprimerie.)

George W. Surguy, Columbus, Ohio, U.S., 5th June, 1885; 5 years.

Claim.—1st. A mould for casting slugs or leads, provided with inner strips of wood, or of similar non-conducting material, substantially as and for the purpose herein described. 2nd. A mould for casting slugs or leads, comprising two plates lined with a non-conducting substance, in combination, strips of wood, or similar non-conducting material, substantially as described.

No. 21,803. Farm Harness. (Harnais de Travail.)

Melvin W. Huffman, London (Assignee of Isaac Ireland, Mount Forest.) Ont., 5th June, 1885; 5 years.

Claim.—1st. The evener E, provided with an arch A, adapted to pass over the tongue T to enable this harness to be used with a wagon or other vehicle provided with a tongue, substantially as shown and described. 2nd. The evener E, provided with an arch A and curves C, adapted to fit the horse so that, when harnessed and working this evener will not chafe or strike against the horses, substantially as set forth. 3rd. The evener provided with an arch A and curves C, C, in combination with the tongue T, hooks H, H, chains G, G, grooved pulleys J, J, and chains I, I, I, substantially as shown and described and for the purpose specified.

No. 21,804. Water Purifying Apparatus.

(Appareil à Purifier l'Eau.)

Pascal B. Charbonneau and William H. Southworth, Bay City, Mich., U.S., 5th June, 1885; 5 years.

Claim.—1st. In a water purifying apparatus, the combination of an evaporating chamber and condensing chamber placed directly over the said separating chamber, and provided with means, as described, for conducting vapour from the said evaporating chamber to the condensing chamber, and a cold water reservoir above the said condensing chamber, substantially as and for the purpose set forth. 2nd. In a water purifying apparatus, the combination of an evaporating chamber and a condensing chamber located directly over the said evaporating chamber, and provided with means of conducting vapour from the said lower chamber to the condensing chamber, and a cold water reservoir located directly over the said condensing chamber, with a supply pipe for conducting the water from the said cold water reservoir to the said evaporating chamber, and means, as described, of regulating the flow of water through the said pipe, substantially as specified. 3rd. In a water purifying apparatus, an evaporating chamber A and a condensing chamber B located directly above the said chamber A, and a pipe N connecting the said chambers with the deflecting plate E attached to the top of the said chamber B, and the deflecting plate F attached to the outsides of the said chamber and provided with the central opening G, and the opening H on its outer edge, substantially as set forth and shown. 4th. In a water purifying apparatus, the combination of an evaporating chamber A and a condensing chamber B located directly over the said chamber A, and a pipe N connecting the said chambers with an air chamber L located between the said chambers A and B, and provided with the holes M in the sides thereof, substantially as and for the purpose set forth.

No. 21,805. Compound of Herbs to be used as a Blood Purifier for the Relief and Cure of Rheumatism, Dyspepsia, etc. (Composition d'Herbes servant à Purifier le Sang pour le Traitement et la Guérison du Rhumatisme, de la Dyspepsie, etc.)

Luther L. Moore, Victoria, B.C., 5th June, 1885; 5 years.

Claim.—A compound of the following herbs: barberry bark, the moss of the bark of the salmon berry, and wild licorice, substantially in the proportions and for the purposes set forth.

21,806. Manufacture of Horse Collars from Leather Scraps. (Fabrication des Colliers de Cheval avec des Morceaux de Cuir.)

James Stanley and Theodore F. Lemassena, Newark, N.J., U.S., 5th June, 1885; 5 years.

Claim.—1st. As a new article of manufacture, a horse collar formed of scraps of leather united by suitable cement, and having a recess formed in the front side, and provided with means, substantially as described, for securing a pad in such recess, as and for the purpose set forth. 2nd. As a new article of manufacture, a horse collar formed of scraps of leather united by suitable cement, and having a recess formed in the front side and covered by flaps integral with the back of the collar. 3rd. The process of forming a hollow collar consisting in, first, pressing or moulding the collar with flaps at the sides of the intended hollow, then pasting down the flaps to cover the hollow, and then drying, and finally pressing the pasted flaps to the finished or desired form. 4th. The combination, with a collar moulded of scraps of leather, as described, of a strip or strips of raw hide inserted in the bottom of the collar, substantially as and for the purpose set forth.

No. 21,807. Saw Set. (Fer à Contourner)

Wilhelm Kopf, Santa Rosa, Cal., U.S., 5th June, 1885; 5 years.

Claim.—1st. In a saw-set having a suitable die, and a hammer between which the teeth of the saw are fitted to be set, an oscillating rest or bench, upon which the blade of the saw is supported, said rest or bench being adapted to be moved by an oscillating nut and screw to or from the plane of the die and hammer, to accommodate different widths of blade, and up or down to support the blade at a suitable angle with the horizontal plane of the die, substantially as herein described. 2nd. In a saw set, the frame A having transverse recess or groove a, with the die B and the hammer C, in combination with the bench or rest E parallel with the recess or groove a, and an oscillating screw and threaded bolt by which said bench or rest may be raised or lowered, to support the saw blade at an angle with the horizontal plane of the groove or recess, substantially as herein described. 3rd. In a saw set, the frame A having transverse recess or groove a in its face with a die B and the hammer C, in combination with the bench or rest E, parallel with the recess or groove, and a means by which said bench or rest may be adjusted to or from said recess or groove, consisting of a screw F passing through the bench and through a suitable nut in the frame A, substantially as herein described. 4th. In a saw set, the frame A having transverse recess or groove a, with a die B and the hammer C, in combination with the bench or rest E, and the means by which said bench or rest is adjusted up to support the saw blade at an angle with the horizontal plane of the groove or recess, consisting of the arms H and the oscillating pin or bolt I through which the arms loosely pass, substantially as herein described. 5th. In a saw set, the frame A having transverse recess or groove a in its face, with a die B and the hammer C, in combination with the bench or rest E and the means by which said bench or rest is adjusted to or from the recess and up or down, consisting of the screw F passing through the bench, the oscillating pin or bolt G with its nut g through which the screw F passes, arms H and the oscillating pin or bolt I through which said arms loosely pass, substantially as herein described. 6th. In a saw set, the frame A having transverse groove or recess a in its face, with the die B and the hammer C, in combination with the bench or rest E, and the means by which said bench or rest is adjusted to or from the recess or groove and up or down, consisting of the screw F, the oscillating pin or bolt G, having nut g, through which the screw passes, arms H and oscillating pin or bolt I, through which the arms

loosely pass, and the means by which said bench or rest is fixed in any desired position, consisting of the vertically adjustable plate J mounted upon the screw F and having an elongated slot *ji*, and the set screw K passing through said slot, substantially as herein described.

No. 21,808. Nut Lock. (*Arrête-Ecrou.*)

George B. Smith, Fort William, Ont., 5th June, 1885; 5 years.

Claim.—1st. The combination of the plate E having holes or notches E₁, and provided with button F, and plate H having a slot H₁, applied as described for the purpose set forth. 2nd. The combination of plate E having holes or notches E₁, provided with button F, offset by washer G, and plate H having slots H₁ and off sets H₂, as set forth for the purpose described. 3rd. The combination of the plate E having offsets E₂, holes or notches E₁, button F, washer G and plate H having slot H₁, offsets H₂ and notched at the ends to lock the nut of a bolt when applied, as set forth.

No. 21,809. Ventilating Stove.

(*Poêle à Ventilation*)

Hornee C. Snow, Winnipeg, Man., 5th June, 1885; 5 years.

Claim.—1st. The straight air-tube D passing through the centre of the bottom and top of the stove, and through the grating and fire chamber, as set forth. 2nd. The smoke outlets L, L₁ in the top of the stove, in combination with a central tube D, as set forth. 3rd. The combination of the grate shaker sections E, E₁, coincidingly perforated for the purpose set forth. 4th. The combination of the grate shaker sections E, E₁ correspondingly perforated, the upper one provided with prongs H, for the purpose set forth. 5th. The perforated annular rim damper C, in combination with a perforated inlet to the ash pit, as set forth. 6th. In combination with a stove having a ventilating tube D, the water reservoir O attached to the exterior of the stove, and having a pipe O₁ to discharge vapor in said tube above the level of the reservoir, as set forth.

No. 21,810. Combined Derrick and Carrier.

(*Treuil Locomobile.*)

John N. Fisk, Saint James, N.B., 5th June, 1885; 5 years.

Claim.—1st. The combination, with the running gear A, having side bars and platforms A₁, as described, the derrick frame, the block and tackle and the operating cranks arranged on a transverse shaft, as set forth. 2nd. In a derrick and carrier, as described, the combination, with the block and tackle, the drum and gear and the shaft F having provisions for throwing its pinions out of mesh, of the brake lever M arranged to apply friction to the drum and allow the load to be lowered at will, as specified. 3rd. In a machine, as described, the combination, with the derrick frame B, B₂, having its braces *g*, *g*₃ arranged to provide for gear mechanism, of the transverse drum and shaft F having collars I, the tackle, the pinion J, gear E and the latch H, all arranged and adapted to serve with the running frame having platforms A₁, as and for the purposes set forth.

No. 21,811. Lifting Jack. (*Cric.*)

James Chase, Rochester, N.Y., U.S., 5th June, 1885; 5 years.

Claim.—1st. The combination, with the lifting bar of a jack, of a spring sustaining the car under the weight of the object to be raised, substantially as described. 2nd. The combination of a supporting stand, a screw to act on the weight or load, and a spring sustaining the screw under the weight of the object to be raised, substantially as described. 3rd. The combination of a supporting stand, a screw having a cap piece at one end to bear against the weight or load, and a spring sustaining the screw under the weight of the object to be raised, substantially as described. 4th. The combination of a supporting stand, a screw to act on the weight or load, a spring sustaining the screw, a scale and an indicator, substantially as described. 5th. The combination of a supporting stand, a screw having a loosely supported cap piece at one end to bear against the weight or load, a spring sustaining the screw, a scale and an indicator, substantially as described. 6th. The combination of a tubular stand, a spring therein, a tube supported by the spring, a screw nut on the tube, a screw in the nut, a head by which to rotate the screw and a cap piece loose on the end of the screw, substantially as described. 7th. The combination of a tubular stand, a spring therein, a tube supported by the spring, a screw nut on the tube, a screw in the nut, a scale and an indicator, substantially as described. 8th. The combination of a tubular stand, a spring therein, a tube supported by the spring, a screw nut on the tube, a screw in the nut, a scale and an indicator, substantially as described. 9th. The combination of a tubular stand, a spring therein, a tube supported by the spring, a screw nut on the tube, a loose cap piece on the screw, a scale and an indicator, substantially as described. 10th. The combination of a tubular stand, a spring therein, a tube supported by the spring, a screw nut on the tube, a screw in the nut, and a scale on the outside of the tubes, substantially as described.

No. 21,812. Boots and Shoes. (*Chaussures.*)

Howard T. Marshall, Brockton, Mass., U.S., 6th June, 1885; 5 years.

Claim.—As an improved article of manufacture, a boot or shoe made with a slitted opening in its vamp or upper, arranged to be connected by a lacing cord or cords, for adjusting the boot to fit the instep and around the ankle of the wearer, and having an elastic goring, or gorings, and formed, all substantially as set forth, so that the boot can be adjusted to the foot, and taken off and put on without disturbing the fastenings.

No. 21,813. Reed Organ. (*Orgue.*)

George W. Scribner, Chatham, Ont., 6th June, 1885; 5 years.

Claim.—1st. In combination with a reed organ having the usual

keys and metallic reeds and exhaust bellows, a set band or series of reeds or vibrators placed back of the keys and over the wind chest at a convenient distance apart, with openings H in the reed board G over the reeds, for the admission of air and the emission of tone, substantially as and for the purposes hereinbefore set forth. 2nd. In combination with a reed organ, having an exhaust bellows and a set or series of metallic reeds placed back of the keys and over the wind chest, a set series of qualifying tubes or resonant pipes I, made of wood or metal separately or in compartments open or stopped, placed perpendicularly with the lower ends or foot immediately over the openings H, and reeds or vibrators for the purposes specified. 3rd. In combination with a reed organ, having an exhaust bellows, metallic reeds and qualifying tubes or resonant pipes placed back of the keys over the wind chest, a set or series of valves S and springs R₁ placed under the added reeds and qualifying tubes or resonant pipes I, substantially as and for the purposes hereinbefore set forth.

No. 21,814. Pavement and Sidewalk and Facing Block. (*Bloc de Pavé et Trottoir et Parement.*)

Henry G. Fiske, San Francisco, Cal., U.S., 6th June, 1885; 5 years.

Claim.—1st. A paving or sidewalk block composed of alternate transverse strips of wood laid close together, with a binding and filling of asphaltum, either with or without an exterior coating of cement or concrete, substantially as herein described. 2nd. A paving block composed of gravel, broken rock or other material, and asphaltum and coal tar, mastic cement, or other plastic material, capable of being set and hardened when cool or dry, together with a wooden frame-work within which the material of the block is contained, substantially as herein described. 3rd. A mould for constructing paving blocks consisting of an exterior bottomless frame having lining plates at the sides, and a level surface or bed upon which it is supported, said mould being adapted to receive the wooden frame of the block which is afterwards filled with broken rock or gravel and asphaltum and coal tar, or other plastic material, substantially as herein described. 4th. A sidewalk or paving block composed of an exterior surface or coating of stone concrete, and an interior wooden frame work, and a filling of broken rock or gravel and asphaltum and coal tar or other plastic binding material, substantially as herein described. 5th. A facing block composed of a series of parallel longitudinal and transverse strips fastened together, and a filling of concrete or artificial stone, in which one or more sides of the frame are imbedded, substantially as herein described.

No. 21,815. Button or Knob. (*Bouton.*)

William F. Ware, New York, N.Y., U.S., 6th June, 1885; 5 years.

Claim.—As a new article of manufacture, the herein-described button or knob having the elongated head wedge-shaped towards the end, which end is similarly rounded on the upper and lower surfaces, and the shank connected with said head, substantially as shown and described.

No. 21,816. Lamp. (*Lampe.*)

Leonard Henkle, Rochester, N.Y., U.S., 6th June, 1885; 5 years.

Claim.—1st. In the Argand lamp, the combination, with the center air-tube and a guide-tube outside the center tube, of a circular holder embracing the wick, and a handle attached thereto extending up through the lamp, as set forth. 2nd. In an Argand lamp, a wick-holder and adjuster consisting of a clamp attached to the wick, and a handle attached to the clamp, arranged to operate in the manner and for the purpose specified. 3rd. In an Argand lamp, the combination, with a clamp attached to the wick, and a handle attached to the clamp of a slitted bearing or guide on top of the lamp through which the handle passes, as shown and described and for the purpose specified. 4th. A device for adjusting wicks consisting of a clamp attached to the wick, a handle attached to the clamp and provided with a screw thread, and a nut screwing thereon, as herein shown and described.

No. 21,817. Machine for Chamfering Shin-gles. (*Machine à Chanfrener le Bardeau.*)

Guillaume Adam, Cookshire, Que., 6th June, 1885; 5 years.

Réclame.—1o. Dans une machine à chanfrener le bardeau, la table A munie des rigoles C, des lames-ressorts G et J, du guide I et du plan incliné d, en combinaison avec la scie circulaire inclinée F, les chaînes métalliques D, pourvues de projections a, et les tambours hexagonaux E, E, tel que ci-dessus décrit et pour les fins sus-mentionnées. 2o. Dans une machine à chanfrener le bardeau, les chaînes métalliques D munies d'un nombre convenable, de paires de projections a, en combinaison avec les tambours hexagonaux E, E, les rigoles C et la table A, tel que ci-dessus décrit et pour les fins sus-mentionnées. 3o. Dans une machine à chanfrener le bardeau, la combinaison du mécanisme R, S, T, Q, Q₂, V, g, i, N, avec les tambours hexagonaux E, E, les chaînes métalliques D pourvues de projections a, la table A, la scie F et la batte E B, le tout tel que ci-dessus décrit et pour les fins sus-mentionnées.

No. 21,818. Combined Seed Drill and Broadcast Scatterer. (*Sémoir en Ligne et à la Volée.*)

John Larsen, Oshawa, Ont., 6th June, 1885; 5 years.

Claim.—1st. In a combined seed drill and broadcast scatterer, a double discharge spout B D rigidly fastened to the distributor, in combination with an adjustable gate, substantially as and for the purpose specified. 2nd. A tube-shaped conductor pivoted to the discharge spout of the scatterer, in combination with the drill tube pivoted on the end of the tube-shaped conductor, substantially as and for the purpose specified.

No. 21,819. Composition Paving Block.*(Bloc de Pavé Aggloméré.)*

David G. Conger, Ottawa, Ont., 6th June, 1885; 5 years.

Claim.—As an improved manufacture, a paving block made up of two compositions, the first asphaltum, sand cement, gypsum and gravel, the second coal tar pitch, sand cement, field plaster and broken stone, moulded as set forth.

No. 21,820. Duplex Horse Shoe.*(Fer à Cheval double.)*

Arnold C. Hawes, Noroton, Ct., U.S., 6th June, 1885; 5 years.

Claim.—1st. In a duplex horse shoe, the base plate having flanges at its outer edges at the widest portion of the shoe, said flanges being raised above the surface of the base plate and having grooves and nail holes, in combination with an outer plate having cut-away portions corresponding with said flanges and fitting snugly thereto, and screws passing through the outer plate and into the base plate for securing the plates together. 2nd. The base plate having raised flanges at its opposite outer edges, in which are nail holes and grooves for heads and screw holes surrounded by raised bosses, in combination with an outer plate having cut-away portions at opposite sides which register with the flanges on the base plate, and sockets corresponding with the bosses and means, as screws E, for securing the two plates together. 3rd. The base plate having grooves A, bosses A₂, and flanges B in which are the nail holes, in combination with the outer plate having grooves C₁, sockets C₂, calks D and cut-away portions C₃ which register with the flanges and screws or bolts for securing the plates together.

No. 21,821. Pipe Coupling. (Joint de Tuyau.)

William Martin, Dunkirk, N.Y., U.S., 6th June, 1885; 5 years.

Claim.—1st. In a pipe coupling, a pipe A provided with a hemispherical shell B, a pipe D provided with a ball C, combined with an incasing shell having a screw-threaded extension c and nut G, as set forth. 2nd. In a pipe coupling, a pipe A provided with a shoulder or offset d, and shell B, combined with a nut G, and an incasing shell and pipe D provided with a ball C, as set forth. 3rd. In a pipe coupling, the hemispherical shell B, ball C and external casing, provided with the screw-threaded extension c, combined with the pipe A and screw nut G, as set forth. 4th. In a ball and socket pipe coupling, the external casing provided with a screw-threaded extension c, combined with the nut G, pipe A and shoulder d, as set forth. 5th. The hemispherical shell B, provided with a groove f for packing material, combined with the outer casing and the ball C, as set forth.

No. 21,822. Pug Mill. (Pétrin de Briqueterie.)

Stephen K. Fletcher and Robert Thomas, Indianapolis, Ind., U.S., 6th June, 1885; 5 years.

Claim.—1st. The combination, with a machine for producing clay manufactures, of a pug mill for mixing and pulverizing the clay and delivering it to said machine, said pug mill consisting essentially of a casing, a shaft extending horizontally through said casing and wings mounted on said shaft, said casing having an orifice at or near one end through which the clay can be discharged into the machine, and said wings being partly screw-shaped and partly straight in relation to the shaft, and thus adapted to pulverize said clay and force it through said orifice. 2nd. The combination, with a brick machine A, of a horizontal pug-mill B arranged to discharge into said brick-machine near the top, being provided with an orifice b for that purpose, said pug-mill having a horizontal shaft C, provided with screw-shaped pulverizing and conveying wings c and discharging wings c₂ straight in relation to the shaft, but curved in the direction of their own length, all substantially as shown and specified. 3rd. The combination of the brick machine A, the pug-mill B, its shaft C, said shaft being provided with wings c and c₂, the counter-shaft D and water supply pipe E, said several parts being constructed, arranged and operating substantially as shown and described, and for the purposes specified.

No. 21,823. Apparatus for Raising and Lowering the Windows of Railway and other Carriages. (Appareil pour Lever et Baisser les Croisées des Voitures de Chemins de Fer et autres.)

Walter Frost, Harry E. Winter and Jean L. Merigot, London, Eng., 6th June, 1885; 5 years.

Claim.—1st. In apparatus for raising and lowering the windows of railway and other carriages, the combination of a radiating lever jointed at one end to the frame of the door or window, and having its other end sliding in a slot in the sash frame, with a link and crank, substantially as and for the purposes hereinbefore described. 2nd. In apparatus for raising and lowering the windows of railway and other carriages, the combination of a radiating lever jointed at one end to the frame of the door or window, and having its other end sliding in a slot in the sash frame, with a link and crank rigidly fixed on the spindle of a handle working in the frame of the carriage door or window, and a counter-balancing spring (or a weight), all arranged substantially as and for the purposes hereinbefore described and represented in Figs. 1, 2 and 3 of the accompanying drawings. 3rd. In apparatus for raising and lowering the windows of railway and other carriages, the combination of the aforesaid arrangement of radiating lever, slot link and crank, with a ratchet mechanism and handle, substantially as and for the purposes hereinbefore described and represented in Figs. 4 to 9 of the accompanying drawings. 4th. In apparatus for raising and lowering the windows of railway and other carriages, the combination of the aforesaid arrangement of radiating lever, slot, link, crank ratchet mechanism and handle with a counterbalancing spring, substantially as and for the purposes hereinbefore described and represented in Figs. 4 to 9 of the accom-

panying drawings. 5th. The improved apparatus for raising and lowering the windows of railway and other carriages, as hereinbefore described and represented in the various Figs. of the accompanying drawings.

No. 21,824. Electrical Cable or Conductor.*(Câble ou Conducteur Electrique.)*

Anson C. Tichener, San Francisco, Cal., and George Marston, Hampstead, N.H., U.S., 6th June, 1885; 5 years.

Claim.—A cable or conductor for electrical purposes, consisting of a wire or metallic strip surrounded and enveloped by pulverized carbon, encased by one or more flexible wrappings, each of which wrappings is saturated or coated with a protective compound, substantially as described.

No. 21,825. Apparatus for Washing and Storing Dishes. (Appareil pour Laver et Serrer la Vaisselle.)

James S. Stevens and C. J. Kephart, Avalton, Mo., U. S., 6th June, 1885; 5 years.

Claim.—1st. The combination of a cupboard in which dishes may be stored, and dish cleaning mechanism that is made a part thereof, substantially as herein set forth. 2nd. The combination of the cupboard, the dish-cleaning mechanism made a part thereof, and the folding board attached to the cupboard, substantially as and for the purpose hereinbefore set forth. 3rd. In combination with the cupboard having a folding top B₄, the dish supporting screen B, a F, substantially as herein set forth. 4th. The combination of the cupboard having the folding top B₄, the dish supporting screens B, a F, the sheath y secured to one of the screws, and the coiled spring z, also secured to a screen, substantially as herein set forth. 5th. In combination with the cupboard A, the gear wheel e, the pinion x, the shaft C carrying the paddles and the screens B, a, F, and K, K₂, substantially as herein set forth.

No. 21,826. Lifting Jack. (Cric.)

The Railway Speed Recorder Company, Kent (Assignee of J. Wesley Hawkins, Galion), Ohio, U.S., 6th June, 1885; 5 years.

Claim.—1st. In a ratchet lifting jack, the combination, with a tumbler arranged to engage simultaneously or alternately the lifting and holding pawls, of a weighted lever mounted on the spindle of the tumbler with the arrangement of parts such that, with the weighted lever turned in one direction, the tumbler will force both pawls from the ratchet, and, when turned in the opposite direction, the tumbler will engage the pawls alternately and reverse their action on the ratchet, and cause the lifting-bar to descend, substantially as set forth. 2nd. In a ratchet lifting jack, the combination, with the tumbler H provided with the arm h, the shoulder m and the sliding rod I, of the pin c₁ and the weighted lever J, substantially as set forth. 3rd. In a ratchet lifting jack, the combination, with the tumbler and connected spindle and depending lug, of a weighted lever mounted on the spindle, and the recess J₂, substantially as set forth. 4th. In a ratchet lifting jack, the combination, with lever J, cam-groove J₃ and prongs i, of the slot a₂, roller G and lug g, substantially as set forth.

No. 21,827. Weir and Sluice. (Barrage et Ecluse.)

Mitar D. Ezoetkovic, Edmund Horbaczewski and Wilhelm Von Kopal, Vienna, Austria, 6th June, 1885; 5 years.

Claim.—1st. The arrangement of the hatches A, gearing together and pivoted at C, for the purpose described and substantially as described. 2nd. The combination of the hatches A, with the arrangement serving for automatically lowering the same, and consisting of the passage H, water-wheel J and rope or chain K, substantially as described. 3rd. The combination of the hatches A, with the arrangement L, M, H, J, K, for automatically lowering the same in the case of a flood, substantially as described. 4th. The combination of the hatches A, with the floating grate E, substantially as described. 5th. The arrangement of fastening the hatch 2 and leaving the lowest hatch 1 loose, for the purpose of allowing water to pass out below the hatches, and to carry sand and gravel with it, substantially as described.

No. 21,828. Combined Flue and Ventilator.*(Tuyau de Cheminée Ventilateur.)*

Allen S. Jackson and John S. Tarkington, Kokomo, Ind., U. S., 6th June, 1885; 5 years.

Claim.—The casing B, provided with the covering hood C, the enlargement B₁ and annular register D, in combination with the stove pipe A, constructed and arranged substantially as set forth.

No. 21,829. Adjustable Cultivator Shovel.*(Pelle Mobile de Cultivateur.)*

Myron A. Twitchell and Samuel T. Perin, Kingsley, Iowa, U. S., 6th June, 1885; 5 years.

Claim.—1st The combination, with a trapezium-shaped plough blade sharpened at its four edges, concave and centrally perforated, of a cylindrical standard E, a shank F having a socket therefor, and a set-screw m, and a bolt securing the shank reversibly to the centre of the said blade, substantially as described, whereby a plough blade hung to present any side or corner forward may be turned around the standard to any angle with the line of travel, for the purpose set forth. 2nd. The combination, with the many-edged blade J, of the bevelled serrated wheel C pivoted thereon, the shank F secured to the wheel C and provided with a standard socket, and the buttons H and I having serrated edges, and slots L and the bolts K, substantially as shown and described.

No. 21,830. Roofing and Siding Board.*(Planche de Toiture et de Revêtement.)*

James W. Crable, Brooklyn, N.Y., U.S., 6th June, 1885; 5 years.

Claim.—1st. A roofing or siding board, formed with counterpart single-faced, inwardly-inclined rabbets C, C, upon both its lateral edges, substantially in the manner and for the purpose herein set forth. 2nd. The combination, with each other, of two or more board, each having single counterpart inwardly-inclined rabbets formed upon both edges thereof and superimposed, so that the rabbet of the one shall overlap the corresponding rabbet of the other, substantially in the manner and for the purpose herein set forth.

No. 21,831. Blackboard. (Tableau Noir.)

William H. Whittemore, Cape Elizabeth, Me., U.S., 6th June, 1885; 5 years.

Claim.—As a new article of manufacture, a glass writing tablet, having one side painted, or otherwise covered, with a black, or other coloured substance, and the other side made suitably smooth, by grinding and treating in the manner above set forth.

No. 21,832. Composition of Matters for the Cure of Internal and External Diseases. (Composition de Matières pour guérir les Maladies Internes et Externes.)

Désiré Langis, Ste. Marie Magdelein, Que., 8th June, 1885; 5 years.

Reclame.—Un composé de matières consistant de camphre et d'ammoniaque forte, de jus de mousse d'Irlande, de gingembre, de la gomme d'épinette rouge, de la gomme de sapin, de la graisse et du soda à pâte, le tout mélangé dans de l'alcool dans les proportions et pour les fins décrites.

No. 21,833. Reservoir Attachment for Whitewash and other Brushes. (Réservoir pour les Pinceaux à Blanchir ou autres.)

Marcella A. Parmelee, Ottawa, Ont., 8th June, 1885; 5 years.

Claim.—The combination of the reservoir C, D attached to a whitewashing or other brush, as shown and described for the purposes set forth.

No. 21,834. Regulating the Tension Band for Machines for Spinning and Twisting Fibrous Materials. (Manière de Régler la Bande de Tension des Machines à Filer et Retordre les Matières Fibreuses.)

John Reid, Almonte, Ont., 8th June, 1885; 5 years.

Claim.—1st. The combination, with the spindle A and its driving band C, of the oscillating arm F and double grooved pulley E, fitted to bear on the band for taking up the slack, substantially as described. 2nd. The combination, with the driving band C, of spinning and twisting machines, the arms oscillating on shaft or axle F, and having weighted arm I and pulley arm F, substantially arranged and for the purpose hereinbefore set forth. 3rd. The combination in a spinning frame provided with double grooved tension pulley E, the spindle A provided with shoulder H, substantially as and for the purpose hereinbefore set forth.

No. 21,835. Machine for Drying, Cooling, or Cleaning Grain, etc. (Machine pour Sécher, Refroidir ou Nettoyer les Grains, etc.)

Edward H. Sawin, West Gardner, Mass., U.S., 9th June, 1885; 5 years.

Claim.—1st. An air-box, as R, adjustable sidewise and endwise in relation to cylinder A, at any desired angle, and having the perforated surface B B, B₁ B₁, substantially as described and for the purposes specified. 2nd. An air-box, as R, adjustable sidewise and endwise in relation to the cylinder A at any desired angle, with the upper surface B B, B₁ B₁ broken, as at a, a₁, more or less, perforated substantially as described and for the purposes specified. 3rd. A revolving cylinder, as A A₁, in combination with an adjustable air-box, as B, substantially as described. 4th. The cylinder A A₁, with the shelves K, rings H, H₁ and trucks F, F, in combination with the air-box R, inlet C and also at the end opposite C, and the perforated surface B B, B₁ B₁, adjusted with a partition for the use of different kinds of air at the same time, substantially as described and for the purposes specified. 5th. The cylinder A A₁, rings H, H₁, trucks F, F, shelves K and the perforated spaces between the straight pieces N, N, in combination with the air-box R, surface B B, B₁ B₁, shaft D, inlet C and also at the end opposite C, and the mechanism whereby the end supported by the shaft D is raised or lowered, substantially as described.

No. 21,836. Potato Planter. (Semoir à Patates.)

William F. Newbold, Cedar, Iowa, U.S., 9th June, 1885; 5 years.

Claim.—1st. The combination, with the hopper and the carrying-belt moving there through, of the presser-board arranged in the hopper having a tension toward, and adapted to force the potatoes against the belt, substantially as set forth. 2nd. The combination, with the conveyer, the vertical adjustable guide pulley, the operating pulley and the hopper, of the belt passed around the operating and guide pulleys and through the hopper, and a presser board arranged to said hopper having a tension toward, and adapted to force, the potatoes against the carrying belt, substantially as set forth. 3rd. The combination, with the hopper having openings E₁, and provided

with presser-boards F pivoted at its lower end, the belt moving upward through the hopper, and a spring F₂ engaging the rear upper end of the presser F, whereby said presser is given a tension toward the belt, substantially as set forth.

No. 21,837. Boot. (Botte.)

George Leclerc, Valleyfield, Que., 9th June, 1885; 5 years.

Claim.—1st. In a legged boot, the stiffening rod C placed in the leg of the boot extending down its rear side and across the side at the ankle toward the instep, as shown and described. 2nd. The combination, in a legged boot, of the leg A, with the lining piece B having the channel b formed in it, and its margins a cemented to the boot leg and the stiffening rod C, substantially as shown and for the purpose set forth.

No. 21,838. Corset. (Corset.)

Susan T. Burkhead, New Berne, N.C., U.S., 9th June, 1885; 5 years.

Claim.—As a new article of manufacture, the within described corset, united by lacings a which are located just behind the arms and are covered by the cloth shield or fly f, stitched along one side and free at the other, whereby a dress-protecting corset is produced and the necessity of a corset cover obviated, all as described and set forth.

No. 21,839. Rubber Overshoe. (Claque.)

James S. Hopkins, South Framingham, Mass., U.S., 9th June, 1885; 5 years.

Claim.—1st. An overshoe having an external coating of rubber, and within it a lining cut in a single piece, said shoe being provided with an elongated water proof tongue secured at one end within the shoe, substantially as set forth. 2nd. An overshoe having an external coating of rubber, and an internal lining of fibrous material, and provided with a tongue formed of material similar to the lining, with a film of rubber on its upper surface, substantially as set forth.

No. 21,840. Electro-Medical Battery. (Batterie Electro-Médicale.)

Silas Verney, Toronto, Ont., 9th June 1885; 5 years.

Claim.—1st. A battery jar having its bottom curved on a quadrant line, substantially as herein shown and described. 2nd. A battery jar having a quadrant bottom, whereby the closed end is adjacent to the neck, combined with a stopper in the neck, and with elements secured on the stopper and projecting down into the jar, substantially as herein shown and described. 3rd. The combination, with the box or cabinet A, of the partitions D and E, the latter forming the compartments G and H, the battery jar and of the drawer F, substantially as herein shown and described. 4th. The combination, with the box or cabinet A, of a battery in the same, a helix in the box, which helix is connected with the battery, a sliding tube for covering the helix, and a series of surtches connected with the helix, substantially as herein shown and described. 5th. The combination, with the box or cabinet A having the horizontal partition D, provided with the slot T, the helix R, the sliding tube S having a handle piece S₁ passed up through the slot T, and of a series of switches connected with the helix, substantially as herein shown and described.

No. 21,841. Method of, and Means for the Quantitative Estimation of Haemoglobin in the Blood. (Méthode et Moyens d'Estimation Quantitative de l'Hémoglobine dans le sang.)

Ernst F. Von Marxow, Vienna, Austria, 9th June, 1885; 5 years.

Claim.—1st. For the purpose of estimating, in a colorimetric way, the amount of haemoglobin contained in blood, the use of wedge-shaped plates of glass stained in red, and the diminution of the relative intensity of the violet rays in the light caused to be transmitted by the glass and the blood solution. 2nd. An apparatus for estimating, in a colorimetric way, the amount of haemoglobin contained in blood, said apparatus essentially consisting of a cylindrical vessel having a transparent bottom, and being divided by means of a vertical partition into two chambers, one containing water and the other an aqueous solution of the blood to be examined, and of a graduated wedge of red glass movable beneath the compartment filled with water, said wedge being displaced until its portion, having the same absorbing power as the blood solution, comes to stand below the water filled compartment. 3rd. Making the standard-wedge by grinding a plate of so called true ruby glass in the shape of a wedge, marking the portion which transmits light poor in violet rays with the same intensity as a solution of a given quantity of normal blood, and finally graduating the portion between said mark and the edge.

No. 21,842. Car-Coupler. (Accouplage de Chars.)

Betsy A. Maxey, Knoxville, Ill., U.S., 9th June, 1885; 5 years.

Claim.—1st. In a car-coupler, and as an improved article of manufacture, an elongated link having a handle bar projected from one of its arms, midway its ends, and at right angles to the direction of elongation of the link, substantially as set forth. 2nd. In a car-coupler, the draw-head provided with mortises A, A, open at the end side of the draw-head and closed at the top and bottom, said mortises being separated by an intermediate partition, and pin-holes being formed through the top and bottom walls of each of the mortises, substantially as set forth. 3rd. In combination, with the draw-head provided with mortises open at the end and side, closed at the top and bottom, separated by an intermediate partition, and having pin-holes formed through their top and bottom walls, links movable laterally into and out of said mortises and provided with right-angled arms, substantially as set forth.

No. 21,843. Cutting Apparatus for Mowers and Reapers. (*Lames de Faucheuses Moissonneuses.*)

Henry T. Sanford, Albany, (Assignee of Erasmus J. Sanford, Lawrence) N.Y., U.S., 9th June, 1885; 5 years.

Claim.—1st. In a cutting apparatus for mowers and reapers, the finger guard bar A formed by the combination of the bar *a*, guard fingers *a1*, *a2*, provided each with a horizontal slot *a3* having its lower side *x* above the plane of the upper side surface of bar *a*, and the shoulders *s* at the front edge of said bar, keepers *d*, *d* provided with shoulders or lips *s1* and shoulders *s2*, and plate D fixed to the heel end of said bar, and provided with locking tongue *a4*, substantially as and for the purposes set forth. 2nd. In a cutting apparatus for mowers and reapers, the combination, with finger guard bar A having bar *a*, guard fingers *a1*, provided with horizontal slot surfaces *x* and shoulders *s*, and keepers *d* provided with shoulder lips *s1* and shoulders *s2*, and plate D having locking tongue *a4*, the removable stationary cutter bar B formed by bar *b* provided with holding notch *b2*, adapted to engage with said holding tongue *a4*, and the V shaped knives *b1* screwed to bar *b*, substantially as and for the purposes set forth. 3rd. In a cutting apparatus for mowers or reapers, the combination of the fingers guard bar A, constructed in its several parts as above described, removable stationary cutter bar B, constructed in its parts as above described, of the reciprocating bar C above described, all arranged substantially as set forth for the purposes specified.

No. 21,844. Weather Strip. (*Bourellet de Porte.*)

William J. Devers, Providence, Pa., U.S., 9th June, 1885; 5 years.

Claim.—The combination of the hinged door A, having the strip E1 at the hinged edge formed with a tongue *e1* projecting in a plane parallel with the plane of the door, and strip D secured to the opposite edge of the door, and having a groove *d* in a plane at right angles to the tongue *e1* and the plane of the door, with the grooved and tongued strips D1, *d1*, E1, *e1* on the door casing, for engaging respectively the tongue *e1* and the groove *d*, as herein shown and described.

No. 21,845. Button Hole Attachment for Sewing Machine. (*Machine à Coudre faisant les Boutonnieres.*)

John K. Harris, Springfield, Ohio, U.S., 9th June, 1885; 5 years.

Claim.—1st. In a button-hole attachment for sewing machines, the combination, with the feed bar and the cloth clamp, of a continuous rack having rounded end, an intermittingly rotated pinion and a guide for retaining the latter in gear with said rack, substantially as hereinbefore set forth. 2nd. In a button-hole attachment for sewing machines, the combination, with a cloth clamp, of a feed plate or bar therefore, provided with a continuous adjustable or extensible rack having semi-circular or rounded ends, an intermittingly rotating pinion, and an adjustable or extensible guide for retaining the latter in gear with the said rack, substantially as hereinbefore set forth. 3rd. In a button-hole attachment for sewing machines, the combination, with an oscillating and longitudinally movable feed bar carrying a cloth clamp at its forward end, and provided at its rear end with a continuous adjustable or extensible rack having rounded ends, an intermittingly rotated pinion and an adjustable or extensible guide for the pinion stud, whereby fabrics may be automatically moved to entirely work different sized button-holes, without turning the goods or cloth clamp bodily around the vertically line in which the needle reciprocates, substantially as hereinbefore set forth.

No. 21,846. Brick Machine. (*Machine à Brique.*)

Joel Tiffany, Hinsdale, Ill., U.S., 9th June, 1885; 5 years.

Claim.—1st. In a brick-machine, the combination, with the mould, of horizontally-reciprocating plungers constituting the sides thereof, a main pressure lever for operating both of said plungers, connecting rods and an intermediate lever connecting said main lever with said plungers, and a cam for operating said main lever, substantially as described. 2nd. In a brick-machine, the combination, with the mould, of horizontally-reciprocating plungers constituting the sides thereof, and a sliding plate constituting the top thereof, substantially as set forth. 3rd. In a brick-machine, the combination, with the mould, of horizontally-reciprocating plungers constituting the sides thereof, a main pressure-lever for operating both of said plungers, connecting-rods and an intermediate lever connecting said main lever with said plungers, a cam for operating said main lever, and an adjustable stop for regulating the drop of the main lever, substantially as described. 4th. In a brick-machine, the combination, with the mould, of horizontally-reciprocating plungers constituting the sides thereof, a sliding top frame provided with two openings respectively for the feeding of the clay and discharge of the brick, and with an intermediate plate between said openings, which constitutes the top of the mould, and cams for reciprocating said frame intermediately to bring the feed-opening, the plate and the discharge-opening successively into position over the mould, substantially as set forth. 5th. In a brick-machine, the combination of the side plates covering the ends of the mould and constituting a part of the supporting-frame, angle-bars connecting said plates provided with attaching webs at their ends, and bolts uniting said plates and webs, substantially as described. 6th. In a brick-machine, the combination of the side plates constituting the ends of the mould, the angle-bars connecting said side plates, said bars being each composed of a transverse horizontal and a transverse vertical web connected at their ends by vertically-reciprocating plungers which constitute attaching plates, the horizontally-reciprocating plungers sliding on said horizontal transverse webs, the vertically-reciprocating plunger playing between said transverse vertical webs, and a reciprocating top frame, substantially as described. 7th. In a brick machine, the combination, with the mould, of the horizontally-reciprocating plungers C, C1, the lever K, the connecting-rod L connecting said lever with the plunger C1, the up-

right lever N, the connecting-rod M, connecting plunger C with said lever N, and the lever O connecting said lever N with said lever K, substantially as described. 8th. In a brick-machine, the combination of the side plates A, A, the sliding top frame E, the plates *d*, *d*, the horizontally-reciprocating plungers C, C1, the lever K, the connecting-rod L connecting said lever with the plunger C1, the upright lever N, the connecting-rod M connecting said plunger C with said lever N, and the rod O connecting said lever N with said lever K, substantially as described. 9th. In a brick-machine, the combination of the side plates A, A, the sliding top frame E, the plates *d*, *d*, the horizontally-reciprocating plungers C, C1, the lever K, the connecting-rod L connecting said lever with the plunger C1, the upright lever N, the connecting-rod M connecting plunger C with said lever N, the rod O connecting with lever N with said lever K, the vertically-reciprocating plunger D, the lever P and the cams for actuating said lever, substantially as described. 10th. In a brick-machine, the combination, with the mould, of the horizontally-reciprocating plungers C, C1, the lever K, the connecting-rod L connecting said lever with the plunger C1, the upright lever N, the connecting-rod M connecting plunger C with said lever N, the lever O connecting said lever N with said lever K, and the adjustable stop S for regulating the drop of lever K, substantially as described. 11th. In a brick-machine, the combination, with the mould, of the sliding top frame E provided with openings *h*, *i*, and having horizontal arms E1, vertical arms E2, E3, dependent from said horizontal arms, and a horizontal arm E4 having a dependent lug E5, a shaft and disks on said shaft provided with pins, which engage said dependent arms and lugs, substantially as described. 12th. In a brick-machine, the combination, with the mould, of the horizontally-reciprocating plungers C, C1, the vertically-reciprocating plunger D, the main lever K, the connecting-rods and intermediate lever connecting said horizontally-reciprocating plungers with said main lever, the sliding top frame provided with arms E1, E2, E3, E4 and lug E5, the lever P, the driving shaft Q and cam disks on said driving-shaft, for actuating both levers K, P, and said top frame, substantially as described.

No. 21,847. School Slate. (*Ardoise d'Ecole.*)

Thomas A. M. Moore, Chatham, Ont., 10th June, 1885; 5 years.

Claim.—1st. In combination with a school slate, the hinged covers D, D, for the prevention of obliteration of exercised in writing or figures, which it is desirable to preserve upon the slate, substantially as described. 2nd. In combination with a school slate, the hinged covers D, D, provided with printed, written, stamped, or engraved exercises in writing, arithmetic, tables, or other suitable subjects for the study and education of the pupil, substantially as set forth. 3rd. The combination, in a school slate, of the slate A, the frames B, B, B1, B2, the hinge pin C, the cover or covers D, D, provided with hinges E, substantially as and for the purposes hereinbefore set forth.

No. 21,848. Explosive Compound.

(*Composition Explosible.*)

Touissant Pkey and Oscar Fallentein, Daron, Germany, (Assignees of Herman Lisch, Fünfkirchen, Austria.) 10th June, 1885; 10 years.

Claim.—1st. The process of making explosive compounds, which consists in mixing the other substances of the said compound with a solution of gun-cotton in nitro-compound of the aromatic group of coal-tar derivatives, substantially as hereinbefore described. 2nd. The explosive compound composed of chlorate or chlorates and sulphur, sulphide or sulphides, admixed with a solution of gun-cotton in nitro-compound of the aromatic group of coal-tar derivatives, in the proportions substantially as herein set forth. 3rd. The explosive compound composed of chlorate or chlorates, nitrate or nitrates, and sulphur, sulphide or sulphides admixed with a solution of gun-cotton in nitro-compound of the aromatic group of coal-tar derivatives, in the proportions, substantially as herein mentioned.

No. 21,849. Sole Sewing Machine.

(*Machine à Coudre les Semelles.*)

The Goodyear Shoe Sewing Machine Association, (Assignee of Zachary T. French,) Boston, Mass., U.S., 10th June, 1885; 5 years.

Claim.—1st. The needle segment, its attached curved needle and the needle guide provided with a pin 6 and a toe or projection 5, combined with the block *b* and with the independently movable guide moving lever to operate the needle guide, substantially as described. 2nd. The link *g2*, the needle segment with which it is connected, the stud to support the said segment, and the needle guide mounted loosely on the said stud and provided with a pin 6, combined with the guide moving lever *g*, and spring connected with the guide moving lever, to operate substantially as described. 3rd. The needle segment, needle, needle guide and link *g2*, combined with the lever *e2*, with which the said link is adjustably connected, to alter the length of the loop drawn by the needle, substantially as described. 4th. In a sole sewing machine, the welt guide and the welt guide slide, combined with means, substantially as described, to operate the said slide positively in both directions. 5th. The welt guide slide provided with the screw nut *ds*, the lever *ds*, slotted link *ds* and the adjustable block to vary the extent of the positive throw of the said welt guide slide and its attached welt guide, substantially as described. 6th. In a sole sewing machine, the sticker bar provided with teeth and offset, as described, combined with the gear *h1* and the rock shaft *ds*, and means to move it, substantially as described.

No. 21,850. Sole Sewing Machine.

(*Machine à Coudre les Semelles.*)

The Goodyear Shoe Sewing Machine Association, (Assignee of Zachary T. French,) Boston, Mass., U.S., 10th June, 1885; 5 years.

Claim.—1st. The table or work support and its connected slide provided with teeth, combined with a lever and a pawl to engage the

said teeth, substantially as described. 2nd. The table or work support and its connected slide provided with teeth, as described, combined with the two pawls having their points one back of the other, to operate substantially as described.

No. 21,851. Journal Bearing for Railways, etc. (*Coussinet de Tourillon pour Chemins de Fer., etc.*)

Edward Copley, Justus F. Seldomridge and George De la Vergne, Colorado Springs, Col., U.S., 10th June, 1885; 5 years.

Claim.—A journal-bearing section formed with the passage *c*, shoulders *d*, end recesses *e* and end shoulders *f*, in combination with a filling of papier-maché or leatherette, substantially as described.

No. 21,852. Creamer Gate Faucet. (*Robinet de Garde-Lait*)

John M. Gill. (Assignee of John C. McEwan), Brockville, Ont., 11th June, 1885; 5 years.

Claim.—1st. The stem *A* having a lug *B* provided with an enlarged sleeve portion *B3*, in combination with a lever *D*, having a correspondingly enlarged portion *D1* provided with a fulcrum pin *D2* entering said sleeve *B3*, whereby the fulcrum and bearing are solidified, and a secondary bearing dispensed with, as set forth. 2nd. The lever *D* having an enlarged portion *D1*, provided with a fulcrum pin *D2*, central portion provided with screw *F*, free end *D5*, flattened horizontally, and rib *D6* extending from end to end, whereby the lever is adapted to resist breakage. 3rd. The stem *A* provided with a button *H*, to lock down the lever *D* when closed, as set forth.

No. 21,853. Vehicle Hub Cap. (*Cuiller de Moyeu de Roue.*)

The Cleveland Carriage Goods Company, Cleveland (Assignee of John G. Eberhard, Akron), Ohio, U.S., 11th June, 1885; 5 years.

Claim.—1st. A glass or porcelain front piece, shaped to conform to the inner circumference of, and in combination with the point band *n* of a vehicle hub, substantially as described. 2nd. A glass or porcelain front piece, formed with a circumferential groove containing a cushion, in combination with a vehicle hub, substantially as described.

No. 21,854. Machine for Glueing and Putting together Dovetailed, Lock Joint, Fingered and other Boxes. (*Machine à Coller et Assembler les Boîtes à Joints en Queue d'Aronde et autres.*)

George P. Sherman and Henry Shackell, Jr., Milwaukee, Wis., U.S., 11th June, 1885; 5 years.

Claim.—1st. In a machine for manufacturing boxes, the table *A*, angular lever *B*, *B*, cross-heads *C*, *C* and cross-head *U*, with their connections, substantially as and for the purposes set forth. 2nd. In a box machine, the table *D* adapted to take the bottoms of the boxes from below and raise the same to a level with table *A*, and table *A*, substantially as and for the purposes set forth. 3rd. The combination, in a box machine, of the table *D*, cam *L*, lever *R* and their connections, substantially as and for the purposes set forth. 4th. The combination, in a box machine, of the table *A*, chute *G*, swinging arm *B1* and rising and falling table *D*, together with suitable mechanism for operating the same, substantially as and for the purposes set forth. 5th. In a box machine, the combination of table *D*, chute *G*, swinging arm *B1* provided with fingers *r1*, *r1*, *r1*, and rack *C1*, substantially as and for the purposes set forth. 6th. In a box machine, the table *D* adapted to be moved up and down on ways *m1*, *m1*, by means of cam *L1*, lever *M1* provided with the roll *p1* and rod *q1*, pivoted to the standard of table *D*, substantially as and for the purposes set forth. 7th. In a box machine, the table *D* raised upon the standard *G1*, vertical ways *m1*, *m1* cam *L1*, lever *M1*, and connecting rod *q1* pivoted to standard *G1*, and provided with the adjusting screws *s1*, substantially as and for the purposes set forth. 8th. The combination, in a box machine, of the swinging arm *B1* provided with counterbalanced adjustable fingers *r1*, *r1*, angular levers *B*, *B*, rod *D1* connecting said arm with one of said levers, curved chute *G* and rack *C1*, substantially as and for the purposes set forth. 9th. In a box machine, the arm *B1* adapted to feed the bottoms to the machine one by one, together with suitable connections, substantially as and for the purposes set forth. 10th. In a box machine, the arm *E1* adapted to remove the boxes as they are made from table *D*, and table *D*, substantially as and for the purposes set forth. 11th. In a box machine, the rack *C1* in combination with gauges or adjustable guides *d1* and *i1*, for holding the bottoms to be fed to the machine, substantially as and for the purposes set forth. 12th. In a box machine, the curved chute composed of bars *j1*, *j1*, in combination with rack *C1* and swinging arm *B1*, provided with the counterbalanced fingers *r1*, *r1*, substantially as and for the purposes set forth. 13th. In a box machine, the levers *B*, *B*, pivoted to base *T*, in combination with the shaft *Y*, driving wheel *W*, cross-head *U*, connecting bars *N1*, *N1* and *O1*, pitman *X* and slotted standard *V*, substantially as and for the purposes set forth. 14th. The combination, in a box machine, of the two levers *B*, *B*, one of which is connected with cross-head *U* by bar *O1*, the pivoted bars *P1*, *P1* joining their ends so that both levers shall have precisely the same movement, bar *Q1* pivoted to bar *O1*, and the apex formed by bars *P1*, *P1*, together with side levers *B*, *B*, connected with said cross-head *U* by bars *N1*, *N1*, and the cross-head *U*, substantially as and for the purposes set forth. 15th. In a box machine, fixed ways *H*, *H*, in combination with cross-head *C*, *C*, adapted to travel thereon between central opening in table *A* and racks *N*, *N*, table *A* and racks *N*, *N*, substantially as and for the purposes set forth. 16th. The combination, in a box machine, of the adjustable ways *H1*, *H1* and cross-heads *C*, *C*, adapted to travel back and forth thereon, substantially as and for the purposes set forth. 17th. The combination of the adjustable ways *H1*, *H1* provided with tongues or flanges *q1*, *q1*, table *A* slotted to receive said flanges *q1*, *q1*, hand screws *v*, *v*, eyed blocks *w*, *w* and set screws *z*, *z*, sub-

stantially as and for the purposes set forth. 18th. In a box machine, the corners *E*, *E1*, *E1* and *E1*, substantially as and for the purposes set forth. 19th. In a box machine, the combination of fixed corner *E*, corners *E1*, *E1*, each adjustable in a single direction, and corner *E1* adjustable in two directions, substantially as and for the purposes set forth. 20th. In a box machine, the corner *E1*, bar *K*, right angled plate *L*, hand-screws *I* and *m*, clamp *f* and set screw *n*, in combination with the fixed corner *E* and corners *E1*, *E1*, each adjustable in a single direction, substantially as and for the purposes set forth. 21st. The combination, in a box machine, of adjustable ways *H1*, *H1*, cross-heads *C*, *C*, travelling thereon, levers *B*, *B*, with which said cross-heads are adjustably connected by means of threaded bars *J1*, *J1*, collars *I*, *I* and hand-screws *Z*, *Z*, substantially as and for the purposes set forth. 22nd. In a box machine, the adjustable racks *N*, *N*, provided with guides *u*, *u*, fixed thereto, support *g*, the laterally sliding arms *O*, *O*, provided with guides *c*, *c*, and support *d* adjustable therewith, and gauges *e*, *e*, substantially as and for the purposes set forth. 23rd. In a box machine, a cross-head *C* composed of a channelled block, adapted to slide upon dovetailed way *H* and provided with fixed standard *h*, adjustable standard *h1* raised upon transversely sliding block *P*, pivoted arms *k*, *k1*, crank *s* and shaft *p*, substantially as and for the purposes set forth. 24th. In a box machine, the cross-heads *C*, *C*, provided with fixed standards *h*, *h*, adjustable standards *h1*, *h1*, pivoted adjustable arms *k*, *k1* and cranks *s*, *s*, in combination with ways *H*, *H* and tracks *F*, *F*, substantially as and for the purposes set forth. 25th. The combination, in a box machine, of the cross-heads *C*, *C*, provided with standards *h*, *h1*, adjustable arms *k*, *k1* and cranks *s*, *s*, with ways *H*, *H* and tracks *F*, *F*, provided with sliding hooks *f1*, *f1* and retracting springs *h1*, *h1*, substantially as and for the purposes set forth. 26th. In a box machine, the arms *k*, *k1*, adapted to take the sides and ends from racks *N*, *N*, and carry them to a perpendicular position at the center of the machine, substantially as and for the purposes set forth. 27th. The cross-heads *C*, *C*, provided with arms *k*, *k1*, which have sliding feet *r1*, *r1*, adjustable blocks *t*, *t*, containing dogs or spring catches *z1*, *z1*, small tripping levers *u1*, *u1*, rods *b1*, *b1*, connecting said levers with feet *r1*, *r1*, retracting spring *c1*, *c1* and terminal hooks *e1*, *e1*, substantially as and for the purposes set forth. 28th. In a box machine, the gluing rollers *R*, *R*, provided with dog teeth *o1*, *o1*, fountains *S*, *S*, sustained and adapted to slide vertically upon brackets *U*, *U*, glue pot *T* and their connections, substantially as and for the purposes set forth. 29th. In a box machine, the gluing rollers *R*, *R*, adapted to pass over the fingered ends of the pieces of which the boxes are made, and glue the same, substantially as and for the purposes set forth. 30th. A machine for putting boxes together, consisting of the table *A* with central rectangular opening table *D*, adapted to receive the bottoms from below and raise them to position; and fill the opening in table *A*, cross-heads *C*, *C*, ways *H*, *H*, racks *N*, *N* and *C1*, levers *B*, *B*, arms *B1*, cross-head *U*, driving gear *W*, pinion *r*, balance wheel *S* and pulleys *t*, *t*, substantially as and for the purposes set forth. 31st. A machine for glueing and putting boxes together, consisting of table *A*, rising and falling table *D*, arm *B*, rack *C1*, chute *G*, cross-heads *C*, *C*, levers *B*, *B*, gear *W*, cross-head *U*, racks *N*, *N*, glueing rollers *R*, *R* and their connections, substantially as and for the purposes set forth. 32nd. In a box machine, the combination of the pivoted rods *t*, *t* and the retracting springs *u*, *u*, substantially as and for the purposes set forth.

No. 21,855. Dry Closet. (*Latrines.*)

Isaac D. Smead, Toledo, Ohio, U.S., 12th June, 1885; 5 years.

Claim.—1st. The combination and arrangement of one or more ducts for the removal of the foul air from a room, or rooms of a building, a vault for receiving and retaining the fecal deposits connected with said duct, or ducts, and a ventilating, or exit shaft, connected with said vault, whereby the warm air from within the building is made to desiccate or dry the deposit in the vault and remove all odours therefrom to the outer air, as set forth. 2nd. The combination, in a building, of a series of foul air ducts *B*, a gathering room *C*, a vault *D* and a ventilating or exit shaft *E*, with means, substantially as described, for creating a draft through the same, substantially as and for the purpose set forth. 3rd. A dry closet arranged in relation to the ducts which convey the air from the room or rooms in a building, and the ventilating, or exit shaft, substantially as shown and described, whereby foul and warm air from the room or rooms is made to pass through said dry closet, and thence out through the ventilating shaft, as and for the purpose set forth. 4th. In combination with the ventilating shaft *E*, of the drain pipe *V* having one or more urinals *U* connected thereto, and the pipes *W* and *X*, arranged to operate substantially as shown and described. 5th. The urinal *U*, composed of sheet metal cut and formed substantially as shown in Figs. 6 and 7, as herein described.

No. 21,856. Telephone Transmitter. (*Transmetteur Téléphonique.*)

Joseph S. Witmer, Suspension Bridge, N.Y., U.S., 12th June, 1885; 5 years.

Claim.—1st. In a telephone transmitter, the combination of the elastic tube *i*, *i*, the adjusting screw *g* and the weight *B*, substantially as and for the purpose hereinbefore set forth. 2nd. In a telephone transmitter, the elastic supports *e*, *e*, in combination with the weight *B*, the elastic tube *i*, *i*, and the diaphragm *D*, substantially as and for the purpose hereinbefore set forth.

No. 21,857. Diaphragm for Telephones. (*Diaphragme pour Téléphones.*)

Daniel G. Barnard, Winslow, N.J., U.S., 12th June, 1885; 5 years.

Claim.—1st. A metal diaphragm for telephones, firmly secured a its rim to a metal frame, and drawn to a high state of tension, substantially as herein shown and described. 2nd. The combination, with a diaphragm, of a metal frame secured to the same and expanded after it has been secured firmly to the diaphragm, whereby the diaphragm is brought to a high state of tension, substantially as herein shown and described.

No. 21,858. Snap Pulley for Hay Elevators and Carriers. (*Poulie pour Monte-Poin.*)

Edwin Harrington, Port Perry, Ont., 12th June, 1885; 5 years.

Claim.—1st. In a snap pulley, the pulley arms A and latch arm B, joined or formed together so as to form a bend or angle at their junction, substantially as shown and described. 2nd. A snap pulley having the pulley arms A and latch arm B, formed together relatively as shown, in combination with the latch C fulcrumed in the arm B, the hook D pivoted in the arm B, and bell-crank F also fulcrumed in the arm B, and spring e, substantially as shown and for the purpose set forth. 3rd. The combination, in a snap pulley composed partly of the pulley arms A and latch arm B, of the latch C pivoted in said latch arm, and having the notch d, the hook D, rope E having the loop c, bell-crank F fulcrumed in said arm B and latch line G, substantially as herein shown and described and for the purpose set forth.

No. 21,859. Chair. (*Fauteuil.*)

Frank H. Plummer, Leominster, Mass., U.S., 12th June, 1885; 5 years.

Claim.—1st. In a reclining chair, the combination of the side rails forming the seat frame, the crossed legs arranged in pairs transversely under the seat frame, and having their upper ends attached to the seat rails, and the central pivoting bar connecting the said legs, substantially as set forth. 2nd. In a reclining chair, the combination of the seat rails, the back frame, and leg-rest frame hinged, or pivoted, respectively at the rear and front ends of the same, and the crossed legs arranged in pairs transversely under the seat, having their upper ends attached to the front and rear ends of the seat rails and connected by the central pivoting bar, the rear legs being set in a rearwardly-inclined position so as to brace the chair, substantially as set forth. 3rd. The combination of the seat frame, the leg or supports, the back frame hinged at the rear end of the seat rails, the leg rest frame hinged at the front ends of the same, and the arm rests, the rear ends of which are pivoted to the sides of the back frame, and the lower edges of which at a distance from their front ends are connected pivotally with lever arms extending forwardly and upwardly from the sides of the leg rest frame, substantially as set forth. 4th. The combination of the seat frame, the legs or supports, the hinged back frame, the leg rest frame hinged at the front ends of the seat rails, sockets secured at the upper ends of the side rails of the leg rest frame and having forwardly and upwardly curved lever arms, and the arm rest having forwardly and downwardly extending scrolls or brackets connected pivotally with the said lever arms, while the rear ends of the said arm rests are pivoted to the side rails of the back frame, whereby the tops of the arm rests being approximately horizontal, the distance between the pivoting points A and Z is less than the distance between the points B and C, substantially as set forth. 5th. The combination of the seat frame, the legs or supports, the hinged back frame, the leg rest frame hinged at the front ends of the seat rails and having sockets provided with forwardly and upwardly curved lever arms, the arm rests connecting the latter pivotally with the sides of the back frame, the extension frame arranged to slide on cleats upon the inner sides of the side rails of the leg rest frame proper, and cords connecting the lower corners of the said extension frame with the upper front ends of the arm rests, substantially as set forth. 6th. In a reclining chair, substantially as described, the leg rest frame consisting of side rails connected by cross-bars or braces, having cleats upon their inner sides and curved with flexible or textile material, in combination with the extension frame covered with flexible material arranged to slide upon the cleats and under the covering of the main frame, and having a foot rest hinged to its lower edge, and adapted to be retained at right angles to the frame by means of hasps and the operating cords, all arranged and operated substantially as set forth. 7th. In a reclining chair, the combination, with the back frame, of a head rest consisting of a bow, the ends of the legs of which are pivoted to the side rails of said back frame, and the upper portion of which is covered with flexible or textile material, and braces pivoted to the sides of the head rest frame and having curved and notched outer ends sliding in staples or keepers upon the side rails of the back frame, substantially as and for the purpose set forth. 8th. The combination of the seat frame, the legs or supports, the hinged back frame, the hinged leg rest frame having forwardly and upwardly extending lever arms, the arm rests connecting the latter pivotally with the back frame, perforated lugs pivoted to the sides of the arm rests, and curved rods pivoted at the rear ends of the seat rails, extending through said perforated lugs and provided with adjustable stop collars, substantially as and for the purpose set forth. 9th. The combination, with a reclining chair, constructed, substantially as described, and provided with lugs extending downwardly from the front ends of the seat rails, of a cross-bar having perforations to receive said lugs, and provided near its center with pivoted diagonally rearwardly extending bars extending under and beyond the seat rails in front of the hinged back frame, and suspending ropes or cords attached to the projecting ends of the transverse and diagonal bars, the former of which also serves to space the side rails of the seat and prevent any tendency in the latter to collapse, substantially as and for the purpose set forth.

No. 21,860. Chair. (*Fauteuil.*)

Frank H. Plummer, Leominster, Mass., U.S., 12th June, 1885; 5 years.

Claim.—1st. In a reclining chair, the combination of the seat frame, the back hinged or pivoted to the same, the hinged leg-rest having upwardly and forwardly extending curved lever arms and the arm rests, the rear ends of which are pivoted to the side rails of the back frame, and the front ends of which are provided with longitudinal sliding adjustable rods connected pivotally with the lever arms of the leg-rest, substantially as set forth. 2nd. In a reclining chair, the combination of the seat frame, the back hinged or pivoted to the same, the hinged leg-rest having upwardly and forwardly extending curved lever arms, the arm-rests pivoted to the side rails of the back

frame and having forwardly and downwardly extending scrolls on their undersides, sleeves upon the inner sides of the said scrolls in an inclined position with relation to the tops of the arm-rests, rods sliding in the said sleeves secured and connected pivotally at their front ends to the lever arms of the leg-rest, and means for retaining the said rods in any position to which they may be adjusted substantially as set forth. 3rd. The combination of the seat rails having slots at their front ends, the back hinged at the rear ends of the said seat rails, the leg-rest frame sockets at the upper ends of the side rails of the latter, having laterally extending studs journaled in the slots of the seat rails and provided with upwardly and forwardly extending curved lever arms, and the arm-rests pivoted to the side rails of the back frame and provided with longitudinally sliding adjustable rods, the front ends of which have laterally extending studs journaled in the upper ends of the lever arms, substantially as set forth. 4th. The combination of the seat-frame, consisting of side rails connected by metallic straps, the seat resting upon the said straps, and having transverse cleats on its underside to prevent its displacement, the hinged back frame and leg-rest frame and the arm-rests forming pivotal connection for the said frame, substantially as set forth. 5th. The combination, with the chair body constructed substantially as described, and the seat rails of which are provided with downwardly extending stud bolts, of the rocker-frame, the top rails of which are provided with perforations to receive the said studs and bolts, and thumb nut fitting the said bolts for securing the chair body detachably upon the rocker frame, substantially as set forth. 6th. The combination, with the rocker frame, of the detachable chair body, consisting essentially of the seat frame, the hinged back and leg-rest frames, the arm-rests forming pivotal connections for the same, and curved rods pivoted at the rear end of the seat rails and extending through eye-bolts arranged transversely in the arm-rests, or having tightening-nuts, or equivalent tightening or clamping devices, whereby the arm-rests may be connected rigidly, with the said curved rods, so as to retain the back and the leg-rests in any position to which they may have been adjusted. 7th. The combination, with the rocker frame, of the chair body having hinged leg-rest and suitable catches or latches, for connecting the said leg-rest frame temporarily with the rocker frame, substantially as set forth. 8th. The combination, with the chair body, constructed substantially as herein described, and mounted detachably upon a rocker frame, the seat rails of the said chair body being provided with downwardly extending studs and bolts, of a pair of longitudinal bars having perforations to receive the said studs and bolts, cross-bars connecting the said longitudinal bars and having suspended ropes or cords connected to their projecting ends, and the thumb nuts fitted to the said bolts, substantially as set forth. 9th. A head rest for reclining chairs, consisting of a suitable cushion having a central transverse tube of cloth rubber, or other suitable material or combinations of materials, and cords passing in opposite directions through the said tube, and having their upper ends attached to the top of the chair back frame, and provided at their lower projecting ends with stops or tassels, substantially as set forth.

No. 21,861. Fire Alarm Telegraph System.

(*Système de Télégraphe Avertisseur d'Incendie.*)

Lewis H. McCullough, Richmond, Ind., U.S., 12th June, 1885; 5 years.

Claim.—1st. In combination with electric circuit conductors, one running from each pole of a generator back to the same pole, two or more circuit closers in multiple arc relation between the said conductors, and receiving apparatus at one or more stations for receiving the signal when any one of the circuit closers is operated, substantially as set forth. 2nd. In combination with a loop or loops connected at each end with one pole of a generator, a loop connected at each end to the opposite pole thereof, circuit-closers arranged in multiple arc between loops which are connected to opposite poles, and apparatus at one or more stations for receiving the signal when any one of the circuit closers is operated, substantially as set forth. 3rd. In a signalling system, an open metallic circuit, two or more circuit closers in the same, each connected in two directions with each pole of the generator, and receiving apparatus at one or more stations for receiving the signal when any one of the circuit closers is operated, substantially as set forth. 4th. In a signalling system, an open metallic circuit, two or more signal boxes in the same, each connected in two directions with each pole of the battery, and one or more gongs for receiving the box signals, substantially as set forth. 5th. In combination with electric circuit wires, one running from each pole of the battery back to the same pole, two or more boxes arranged in multiple arc relation between the said wires, and one or more gongs or bells for receiving the box signals, substantially as set forth. 6th. In combination with a loop or loops connected at each end with one pole of a battery, a loop connected at each end to the opposite pole of the battery, signal boxes arranged in multiple arc relation between loops which are connected to opposite poles, and one or more gongs or bells for receiving the box signals, substantially as set forth.

No. 21,862. Non-Interfering Fire-Alarm Telegraph System. (*Système de Télégraphe Avertisseur d'Incendie de Sûreté.*)

Lewis H. McCullough, Richmond, Ind., U.S., 12th June, 1885; 5 years.

Claim.—1st. The combination, with two electric circuit conductors, one running from one pole of a generator back to the same pole, and the other running out from the opposite pole, of two or more circuit closers in multiple arc relation between the said conductors, and receiving apparatus at one or more stations, for receiving the signal when any one of the circuit closers is operated, substantially as set forth. 2nd. The combination, with two electric circuit conductors, one running from one pole of a generator back to the same pole, and the other running out from the opposite pole, of two or more circuit closers in multiple arc relation between the said conductors, and apparatus at a central station actuated by the operation of any circuit closer, whereby every other circuit closer is cut out of the cir-

cuit, substantially as set forth. 3rd. The combination, with two electric circuit conductors, one running from one pole of a generator back to the same pole, and the other running out from the opposite pole through one or more gong or bell magnets to a hand at a central station, of a series of conductors including signal boxes running from the hand to the first named conductor, and apparatus at the central station whereby, on the operation of any signal-box, the hand will be released and form a new circuit to the exclusion of the rest of the series, substantially as set forth. 4th. The combination, with two electric circuit conductors, one running from one pole of a generator back to the same pole, and the other running out from the opposite pole through receiving apparatus located at one or more stations to a hand at a central station, of a series of conductors including circuit closers running from the hand to the first named conductor, and apparatus at a central station whereby, on the operation of any circuit closer, the hand will be released and form a new circuit to the exclusion of the rest of the series, substantially as set forth. 5th. The combination, with two electric circuit conductors, one running from one pole of a generator back to the same pole, and the other running out from the opposite pole, of two or more signal-boxes in multiple arc relation between the said conductors, and receiving apparatus at one or more stations for receiving the signal when any one of the signal-boxes is operated, substantially as set forth. 6th. The combination, with two electric circuit conductors, one running from one pole of a generator back to the same pole, and the other running out from the opposite pole, of two or more signal boxes in multiple arc relation between the said conductors and apparatus at a central station actuated by the operation of any signal box, whereby every other signal box is cut out of the circuit, substantially as set forth. 7th. In combination with a conductor running from one pole of a battery through gong or bell magnets, a series of conductors, including signal boxes, branching from the said conductor, and connected in two directions with the opposite pole of the battery, substantially as set forth. 8th. In combination with a conductor running from one pole of a battery back to the same pole, a series of conductors running from the said conductor to the opposite pole of the battery, each of the series including a signal-box and all including common bell or gong magnets, substantially as set forth. 9th. In combination with a conductor, running from one pole of a battery back to the same pole, a conductor running from the opposite pole through gong or bell magnets to a travelling conducting hand or pointer in a central office, and a series of conductors, including signal boxes, running from the conducting stop of the said hand or pointer to the first named conductor, substantially as set forth. 10th. In combination with a conductor, running from one pole of a battery back to the same pole, a conductor running from the opposite pole through gong or bell magnets to a travelling conducting hand or pointer in a central office, and a series of conductors including signal boxes running from the conducting stop of the said hand or pointer to the first named conductor through a common releasing magnet, and through a series of magnets, each adapted, when operated, to move its armature lever out into the path of the conducting hand or pointer, substantially as specified. 11th. In combination with a conductor running from one pole of a battery back to the same pole, a conductor running from the opposite pole through gong or bell magnets to a travelling conducting hand or pointer in a central office, and a series of conductors, including signal-boxes, running from the conducting stop of the said hand or pointer to the first named conductor, through a common releasing magnet and through a series of magnets and their respective armature levers, each magnet being adapted, when operated, to move its armature lever out into the path of the hand or pointer, and means connected with the hand or pointer for breaking the original circuit and forming a new one when it comes into contact with any armature lever, whereby, on the operation of any signal-box, its circuit is first completed through its own magnet, and common releasing magnet, and afterwards those magnets are cut out together with all the other box magnets, substantially as specified. 12th. In combination with a series of open metallic circuits, including signal boxes and suitable receiving apparatus, an apparatus located at a central station composed of the following parts: a travelling conducting hand or pointer, a stop for holding the same normally at rest, a releasing magnet for the said stop common to all the box circuits, and a series of magnets, each in the circuit, of a different signal box and adapted, on the closure of the circuit to throw its armature lever into the path of the hand or pointer, substantially as set forth.

No. 21,863. Road Cart. (*Cabrouet*.)

Isaac Dolsen, Beemerville, N.J., U.S., 13th June, 1885; 5 years.

Claim.—The combination of the body C, the loop or supporting bar D, which is applied to the under side of the body C, which said loop D has its ends turned upwards and then horizontally outwards, with the springs B, which are supported upon the axle A, the saddles F which are secured upon the tops of the springs B, and through which the bearings E of the supporting looper rod D pass, and the springs H, substantially as and for the purpose hereinbefore set forth.

No. 21,864. Running Gear of Toy Waggon.

(*Train de Wagons-Jouets*.)

Charles T. Brandon, Toronto, Ont., 13th June, 1885; 5 years.

Claim.—A wooden axle A having its bottom edge grooved to receive the axle E, and its top notched to receive the flat draw-piece B, in combination with the bolster C, secured in position by the king-bolt D.

No. 21,865. Draft Equalizer. (*Régulateur des Tirages*.)

George C. Roth, Big Springs, Ks., U.S., 13th June 1885; 5 years.

Claim.—The combination, with the frame and tongue of a harvesting machine, of the oblique brace secured to the tongue and to the frame, the laterally-projecting perforated bars, the sheave journalled adjustably between the said bars, the sheave journalled upon the tongue to the rear of the former sheave, the perforated transverse bar at the rear portion of the machine frame, and the rope or chain

having the double-tree at one end and the clip and bolt at the other end and passing over opposite sides of the pulleys, as and for the purpose set forth and shown.

No. 21,866. Neck Yoke Centre.

(*Volée d'Avant de Voiture*.)

Philip J. Heilman, Emporia, Ks., U.S., 13th June, 1885; 5 years.

Claim.—1st. A neck yoke center, composed of leather or other suitable material, having its upper or band portion which encircles the yoke, divided substantially as shown and described, in combination with a clamp attached thereto by which it may be adjustably connected with said yoke. 2nd. In a flexible neck yoke center, a detachable device, in combination therewith by means of which the upper portion of the center is secured to the yoke-bar, and its tension thereabout regulated as required, said device consisting of the plate C C securely fastened to said center, and provided with the ears D, D, D, with the adjusting screw-bolts E, E passing through said ears, for the purpose set forth.

No. 21,867. Dry System of Disposing of Sewage or Refuse, Organic Matter in Dwellings, etc. (*Système à la Terre Sèche pour déposer des Immondices ou Vidanges dans les Maisons*, Eng.)

Thomas Hawksley, M. D., of Brighton, Eng., 13th June, 1885; 5 years.

Claim.—1st. A dry earth closet consisting of a pan *a e e t* formed in two parts, the lower or conical part being constructed in halves *e* and *e t*, and so arranged that the said halves may be quickly moved away from one another by a suitable mechanism, for the discharge of any matter deposited in the pan into a receiver beneath, as hereinbefore described. 2nd. The use, with a closet such as that hereinbefore described and claimed, of a loose lining or bag *t* of suitable material, provided with a portion of any suitable deodorizing medium *f*, such as dry earth, as and for the purpose substantially as described. 3rd. The improved closet consisting of a cylinder *a* and vertically divided conical part *e e t* suspended from the part *a* by the bars *a t*, and operated so as to move the halves *e* and *e t* away from one another, by the levers or arms *b t* actuated by the pull handle *g*, in the manner hereinbefore described and represented in figures 1, 2, 3 and 5 of the accompanying drawing. 4th. The modified construction of closet, in which the conical part *e* of the pan is formed in one part hinged to the upper part *a*, and is operated by the pull handle *g*, in the manner described and brought back to its closed position by the counterweight *h*, as hereinbefore described and represented in figure 4 of the accompanying drawing. 5th. The combination, with closets such as those described, of a shaft or shafts *l* leading perpendicularly from the closet or closets *m* to a suitable receiver *n* placed beneath, and provided with an air shaft *o*, as and for the purposes hereinbefore described and represented in figure 5 of the accompanying drawing.

No. 21,868. Machine for Making Wire Tacks.

(*Machine à faire les Broquettes en Fil de Fer*.)

Thomas Harris, Seymour, Ct., U.S., 13th June, 1885; 5 years.

Claim.—1st. In a machine for making tacks from wire, the combination of the dies L, M, one stationary the other arranged for oscillatory movement toward and from the first, the adjacent faces of the two constructed with a cavity *e*, the two cavities corresponding to the wire blank from which the tack is to be produced, a cutter in each of said dies arranged to sever the blank midway of its length into two parts and thereby form the points, two hammers arranged in line with the cavities in the dies L, M, each of said hammers arranged to move toward and from respective sides of said dies L, M, L, M, and the mechanism, substantially as described, to impart reciprocating movement to said movable dies and hammers, substantially as described. 2nd. The combination of the two dies L, M, each having a corresponding cavity *e* across its face, the cutters *f*, *g*, one arranged in each of said dies, the cutting edge of each cutter being diagonally across the cavity *e* and corresponding to each other, the mechanism, substantially as described, to cause said dies L, M and in line with the cavity *e*, and the mechanism, substantially as described, to impart reciprocating movement to said hammers, substantially as specified. 3rd. The combination of the dies L, M, the face of each constructed with a corresponding cavity *e*, the cutters *f*, *g*, one in each of said dies, the cutting edge of said cutters being diagonally across the said cavity, the holders *h*, *i*, one in each of said dies, and movable therein to grasp the blank, two hammers arranged one each side of said dies L, M and in line with the cavity therein, and the mechanism, substantially as described, to cause said dies and impart reciprocating movement to said hammers, substantially as specified.

No. 21,869. Belt Shifting and Replacing Device. (*Appareil d'Embrayage*.)

Philip Diehl, Elizabeth, N. J. U.S., 13th June 1885; 5 years.

Claim.—1st. The combination, with a pulley-wheel, of a belt-shifter placed adjacent thereto and having an opening for the passage of the belt, and a spring connected with said shifter and adapted to hold the same in position for the belt to run on the said pulley, and to return or retract said shifter to such position after it has been moved to shift the belt from the pulley, substantially as set forth. 2nd. A spring retracted belt-shifter, having an enclosed opening for the passage of the belt, substantially as set forth. 3rd. The combination, with a sewing-machine, of a spring retracted belt-shifter, substantially as set forth. 4th. The combination, with the dress-guard of a sewing-machine stand, of a belt shifting lever pivoted thereto, substantially as set forth. 5th. The combination, with the dress-guard of a sewing-machine stand, of a spring-retracted belt-shifter pivoted to the top thereof, substantially as set forth. 6th. The combination, with a pulley provided with a belt replacer, of

a spring-retracted belt-shifter, substantially as set forth. 7th. The combination, with the main or lower driving-pulley and the belt-shifter, of a belt-guard for covering the upper pulley, substantially as set forth. 8th. The combination, with the stand, the belt-shifter placed at the front side thereof, and the main driving-pulley, of a belt-guide on the rear side of said stand, substantially as set forth.

No. 21,870. Shoe. (*Soulier.*)

Charles B. Godfrey, Milford, Mass., U.S., 13 June, 1885: 5 years.

Claim.—In a shoe, the vamps A, quarters B, tongue C, ankle-piece H and sole a, constructed, combined and arranged substantially as set forth.

No. 21,871. Apparatus for Supplying Locomotive or Stationary Engine Boilers with Water. (*Appareil pour Fournir l'Eau aux Chaudières des Locomotives ou des Machines Fixes.*)

William H. Rushforth, Camden, N.J., U.S., 13th June, 1885: 5 years.

Claim.—1st. In a locomotive or other engine, in combination with a water tank and boiler, a water feed pipe or feed pipes, a portion of which passes, or pass, through and is, or are, located within the smoke box, for the purposes specified. 2nd. In a locomotive or other engine, in combination with a water tank and boiler, a water feed pipe or feed pipes, a portion of which passes, or pass, through and is, or are, located within the smoke box, said feed pipe or pipes, communicating with the boiler below the water line at points near the top and bottom thereof respectively, as and for the purposes specified. 3rd. In a locomotive, or other engine, in combination with a water feed pipe or feed pipes, leading from the water tank to, or terminating in, a water drum or coil located in a smoke box, two or more pipes leading from said coil or drum to, an emptying into, the boiler below the water line, and at points at or near the top and bottom thereof respectively.

No. 21,872. Hay Elevator. (*Monte-Foin.*)

The Ney Manufacturing Company, (Assignee of Jacob Ney,) Canton, Ohio, U.S., 13th June, 1885: 5 years.

Claim.—1st. The pivoted lever E having the projection or arms c and F and frame C, in combination with the slide H and dog d, substantially as specified. 2nd. The combination of the detent L having the cross-head N, with the arch P having the groove O, and provided in its inside with a straight surface, the slide H, the frame B and the frame C, substantially as described. 3rd. The combination of the frame C, with the frame B, the lever E, dog d, and slide H with the detent L and arch P, constructed and operating substantially as set forth. 4th. The frame C having end supports, and the guide mouth D with the travelling frame B, arch or cam block P, detent L, slide H, lever E, dog d, head I having the pin a, point K and rope J, all constructed and operating substantially as specified. 5th. The combination of the frame C, provided with the bell-shaped guide D, with the pin a, point K with the locking and releasing lever E and the dog d, substantially as described.

No. 21,873. Manufacture of Aerated Water.

(*Fabrication de l'Eau Gazeuse.*)

Alexander Esilman, Bradford, and Abner Haqsal, Kin's Cross, Eng., 13th June, 1885: 5 years.

Claim.—The employment of phosphoric acid, or phosphoric acid mixed with a small quantity of citric acid, or of tartaric acid, or admixtures of phosphoric acid with citric and tartaric acid, as the acidifying principle or agent in the manufacture of mineral or aerated waters, substantially as set forth.

No. 21,874. Guard Rail Lock for Railroads.

(*Arrête-Contre-Rail pour Chemin de Fer.*)

Fayette H. Oroutt, Worcester, Mass., U.S., 13th June, 1885: 5 years.

Claim.—1st. The plate C for supporting and locking a guard rail A, in connection with the main rail B, constructed as shown, with a flat base having the rail seats a, b, the central double lipped tapering flange f, the shoulders c, at the outer limits of the rail-seats a, b, and the holes e, e, substantially as and for the purpose hereinbefore set forth. 2nd. The combination, with the main rail B and the guard rail A having its ends curved, as shown, of the locking plate C provided with the double-lipped flange f and shoulders c, c, adapted for supporting and embracing the base flanges of said rails in the manner shown, substantially as and for the purpose hereinbefore set forth.

No. 21,875. Signalling mainly applicable to Railways and apparatus therefor. (*Système de Signaux Spécialement applicable aux Chemins de Fer et Appareil pour cet objet.*)

The Electric Signalling Company, (Assignee of James Enright,) London, Eng., 13th June, 1885: 5 years.

Claim.—1st. The combination of a receiving instrument, or receiving instruments, a battery or electric source, a telegraphic line and contact posts at distances apart on the line, making earth connections during the passage of trains, substantially as herein described. 2nd. The combination of a battery or electric source and keys, a telegraphic line, contact posts at distances apart on the line, making earth connections during the passage of trains, and vacuum tubes, or bulbs, or it may be other indicators, substantially as described. 3rd. The combination of a Wheatstone bridge arrangement, a telegraphic line, a battery or electric source, and contact posts at distances apart on the line and with artificial resistances between them, such contact posts serving to make earth connections and

the-by complete the circuit during the passage of trains, substantially as described. 4th. The combination of a Wheatstone bridge arrangement varied telegraphic line, a battery or electric source, and resistances which are successively short circuited, or placed in circuit by the movement of a mercury column or other body, substantially as described. 5th. The receiving instrument, in which is combined ordinary step mechanism, and bells or sounders operated thereby, substantially as described. 6th. The recording instrument, with cylinder driven by a clock and with rock propellant to traverse the pencil or marker, substantially as described. 7th. The method herein described of automatic "blocking" by breaking and making the circuit through which the signals pass, by the combination of keys and levers connected together and operated by the passing trains, substantially as described.

No. 21,876. Mechanical Lamp.

(*Lampe Mécanique.*)

T. Elwood May, New York, (Assignee of George H. Chinnoek, Brooklyn,) N. Y., U.S., 13th June, 1885: 5 years.

Claim.—1st. The combination, with a frame, of a shaft journaled therein, and springs serving to rotate the shaft and adapted to be removed without disturbing the frame, substantially as specified. 2nd. The combination, with a frame having side pieces, of a driving shaft shorter than the distance between said side pieces, two or more springs coiled about the said shaft, and removable interlocking bearings for the said shaft arranged outside said springs and journaled in said side pieces, substantially as specified. 3rd. The combination of a frame having side pieces, the shaft C shorter than the distance between said side pieces, and the removable interlocking bearings b, b', substantially as specified.

No. 21,877. Roller Skate. (*Patin à Roulettes.*)

Jairns H. Hull, Markdale, (Assignee of Alfred J. Peerless,) Toronto, Ont., 13th June, 1885: 5 years.

Claim.—1st. A roller bracket B, shaped substantially as shown, in combination with the bracket C secured to the bottom of the foot-piece D and arranged to receive the bracket B, so that the weight on the rollers shall be directed into the socket a. 2nd. The roller-bracket B, pivoted in the bracket C, as described, in combination with the flat spring E secured to the bottom of the foot-piece D, and acting against the bottom surface of the bracket B, substantially as and for the purpose specified.

No. 21,878. Lamp. (*Lampe.*)

Holmes, Booth & Haydens, (Assignees of Hiram W. Hayden,) Waterbury, Ct., U.S., 13th June, 1885: 5 years.

Claim.—1st. In a lamp, the combination of a wick-tube, closed at the bottom and open at the top, and a button-shaped deflector extending over the top of the wick tube and removably connected to its support, substantially as specified. 2nd. In a lamp, the combination of a vertical annular wick-tube, closed at the bottom and open at the top, of a button-shaped deflector, and a vertically-movable support enabling the deflector to serve as an extinguisher, the deflector being removably connected to said support, substantially as specified. 3rd. In a lamp, the combination of a vertical wick-tube, a detachable button-shaped deflector, a rod serving to support the deflector and bent around the bottom of wick-tube and extended out to the exterior of the lamp, a spring for elevating the deflector and its rod, and a stop for limiting the upward movement of the deflector and rod, substantially as specified. 4th. In a lamp, the combination of a vertical wick-tube, an air-chamber outside and surrounding the wick-tube, a button-shaped deflector, a rod serving to support the deflector and bent around the bottom of the wick-tube, and up through the air-chamber, a spring for elevating the extinguisher and its rod and a stop for limiting the upward movement of the deflector and rod, substantially as specified. 5th. In an Argand lamp, the combination of an annular vertical wick-tube, a flame and air deflector R, arranged to project above the top of the wick-tube, a button-shaped flame and air deflector S, diametrically large enough to cover the open top of the wick-tube, and small enough to descend below the top of the deflector R, a vertically movable support for the deflector S extending down through a central air tube and terminating outside the lamp, where it may be reached for the purpose of lowering the deflector S below the top of the deflector R, and upon the top of the wick-tube, substantially as and for the purpose, described. 6th. In a lamp, the combination of an annular wick-tube and air space or duct within the wick-tube, an annular reservoir, an air chamber arranged between the wick-tube and the reservoir and provided with openings at the top and bottom, a base piece and an air inlet, arranged intermediately of the base piece and reservoir, for supplying air to the space or duct, which is within the wick-tube, and the air chamber which is between the wick-tube and the reservoir, substantially as specified. 7th. In a lamp, the combination of a burner tube, an annular reservoir and air chamber, arranged between the burner tube and the reservoir, and an air distributor at the lower end of the air tube and above the base piece, substantially as specified. 8th. In a lamp, the combination of a burner tube and annular reservoir, an air-chamber arranged between the burner tube and the reservoir, an imperforate base piece, an air distributor intermediate of the base piece and reservoir, and a drip cup below the base tube, substantially as specified. 9th. In a lamp, a wick-carrier composed of an outer and inner tube arranged to receive and clamp a wick in tubular position between them, the inner tube being provided at its lower end with teeth to penetrate the lower inner fiber of the wick, and at its other end with resilient arms to facilitate its entrance in the wick and in the outer tube, and the outer tube provided with holes, recesses, or perforations, to engage with the teeth of a pinion wheel or wheels, substantially as and for the purpose described. 10th. In a lamp, a wick-carrier and support consisting of an outer and inner tube, constructed and arranged to hold the wick between them, as described, in combination with pinion wheels or wheel, mounted on a shaft journaled in the upper outside wall of the wick-tube, as and for the purposes described. 11th. In a lamp, the perforated air distributor Q having

central resilient arms or springs 3, arranged to clasp and hold the distributor in position upon the upper outside wall or the wick-tube, substantially as described. 12th. The combination, in a lamp, of the air deflector Q, its central resilient arms or springs 3, the chimney holding springs or clamps 5, and the air deflector R, substantially as and for the purposes described.

No. 21,879. Caliper and Divider.

(*Compas d'Epaisseur et Compas à Diviser.*)

Oscar Stoddard, Detroit, Mich., U.S., 13th June, 1885; 5 years.

Claim.—1st. In combination with the legs of calipers and dividers, the adjusting-arms pivotally attached to said legs by means of the metal yokes D, having arms *t*, *t* and set screws, as specified, said adjusting-arms secured at their upper end by a set screw, as and for the purposes specified. 2nd. In combination with the hollow-legs A, A, of calipers, the adjusting-arms pivoted thereto, said arms united and adjustably held by the set screw *p*, the extension legs B, B, adjustably secured within the hollow legs, and the pivoted arm C having the internally screw-threaded portion *r* adapted to receive a pencil or point *a*, as and for the purpose specified. 3rd. In combination with the leg of calipers and dividers, having the recess *s*, the arm C provided with the web *n*, pivotally attached within said recess and adjustably held by the set screw *a*, said arm provided with the internally screw-threaded portion *r* for holding a point or pencil, as and for the purposes set forth.

No. 21,880. Picket Pointing Machine.

(*Machine à Tailler les Piquets.*)

Ottomer Schmachtenberger, Marshall, Ill., U.S., 15th June, 1885; 5 years.

Claim.—1st. In a machine for pointing fence pickets, the combination, with a bed or table having a pivoted cutter, and a spring bearing against the same, of a longitudinally movable slide, or pair of sliding plates carrying a pivoted arm, provided with an angular recess to receive and hold the pickets for operation, and a stop block or plate for the said swinging arm, substantially as and for the purpose set forth. 2nd. In a machine for pointing fence pickets, the combination with a bed or table having a pivoted cutter and a spring bearing against the same, of a longitudinally adjustable slide or pair of sliding plates, carrying a pivoted recessed arm, and a cam plate or angular block, two of the sides of which form stops for the said swinging arm, substantially as and for the purpose herein set forth. 3rd. The combination of the bed plate, having recesses in its upper and lower sides connected by a longitudinal slot, a pair of plates arranged to slide in the said recesses, bolts connecting the said plates, an arm having an angular recess mounted pivotally on one of said bolts, a cam plate or angular block mounted securely on the other bolt and having two sides that form stops for the pivoted arm, a pivoted cutter, the pivoting bolt of which is adjustable in a slot in the bed plate, and a spring arranged to bear against the said cutter, substantially as and for the purpose set forth.

No. 21,881. Head Rest for Chairs and Car Seats. (*Appui-Tête pour Fauteuils et Banquettes de Chars*)

Henry E. Doren, Grand Rapids, Mich., U.S., 15th June, 1885; 5 years.

Claim.—In a head rest, the cushioned portions B, C, hinged to each other, the inner side of one of the hinged portions being provided with clamps G having set-screws *g*, and a wall D with cut-away portion H, in combination with the rods F and clamps E, the parts being organized substantially as and for the purpose set forth.

No. 21,882. Machine for Hoing Corn and Roots. (*Machine à Houer le Blé d'Inde et les Légumes.*)

George Patterson, Kalamazoo, Mich., U.S., 15th June, 1885; 5 years.

Claim.—The combination of hoes, shovels D and E, attached to the bars B and C, with beam A and handles H and I, substantially as and for the purposes hereinbefore set forth.

No. 21,883. Apparatus for Carbonizing Saw Dust, Bagasse, etc. (*Appareil pour Carboniser la Sciure, la Bagasse, etc.*)

Jean A. Mathieu, Detroit, Mich., U.S., 15th June, 1885; 5 years.

Claim.—1st. A retort for carbonizing wood, saw-dust, or similar substances, having in its top a flue communicating through apertures with the interior of the retort, a combustion chamber communicating with said flue and air pipe, and a gas pipe leading into said combustion chamber, and a gas pipe leading into said retort near its top, substantially as described. 2nd. In the carbonization of wood, a retort within which the wood is supported, in combination with a box located in the bottom of the retort for containing pyroligneous acid, and a pipe V leading from the bottom of the box or retort upwardly to the level of the acid in said box or retort, for drawing off the tar accumulating in the bottom of the retort, substantially as described. 3rd. In combination with the retort M, the toothed bars *p*, *p*, provided with push rods *s*, *s*, substantially as shown and described. 4th. The combination of a retort having a pipe at or near its top, for entry of hot vapour, with mechanism for introducing the substance to be distilled at the bottom of the retort, and forcing the same upwards as the distilled solid material is removed from said retort, whereby distillation is effected from above upon a mass of material raised up within the retort to the source of heat. 5th. The herein described method of partially condensing the vapours resulting from carbonizing the upper portion of a mass of material contained in a retort, consisting in passing such vapours through the uncarbonized portion of the material in said retort. 6th. The combination of the screw *t*, retort M, trunks *g*, *h*, and screws *d*, *h*, substantially as and for the pur-

poses set forth. 7th. The combination of the jacket *u*, and trunk *h*, with the exit pipe *t* of the retort, whereby a preliminary distillation of the material is effected by the hot vapours issuing from the retort. 8th. The combination of the jacketed trunk *h*, hopper *a*, trunk *g* and screw *d*, substantially as shown and described. 9th. In combination with the retort, the safety-box F having the swinging discharge pipe *f*, and connected by the pipe G with a condenser, substantially as shown and described. 10th. The condenser, herein described, having vessel H, with pipes G, R, and vessel I having the drain pipe and faucet *o*, and pipe U, said vessels being connected by pipes P, substantially as shown and described. 11th. The herein-described process of condensing a portion of the vapour arising from the distillation of wood, consisting in bringing said vapour in contact with a spray of cold pyroligneous acid, whereby condensation is effected by the chemical affinity of the acid and vapour, as well as by reducing the temperature of said vapour.

No. 21,884. Machine for Gathering Stones.

(*Machine à Ramasser les Pierres.*)

Brayton A. Weatherbee, Warren, N. Y., U.S., 15th June, 1885; 5 years.

Claim.—1st. In a stone-gathering machine, the pickers 7 placed forward of the stone propelling apparatus, for loosening the stones, and having independent hinge-connection at their forward ends with the frame, in combination with the revolving propeller arranged in rear thereof, substantially as described. 2nd. In a stone-gathering machine, a revolving propelling device having spring teeth or beaters attached to horizontal bars, each tooth being attached at its inner end to a bar, and being passed around said bar, substantially as and for the purposes described. 3rd. A revolving stone propelling device, having heads 22, and provided with removable bars holding spring teeth adapted for striking and propelling the stones, substantially as shown and described. 4th. The revolving stone propelling device, having the heads 22, provided with teeth 24, removable bars 25, with grooves 27, and the teeth 26 severally passing around said bars, being secured thereto, as shown, in combination with suitable operating mechanism, substantially as set forth. 5th. In combination with a revolving device on a shaft, the arms 30 having a pivotal connection with the machine carriage, and provided with openings 39 and adjustable journal boxes 40 within said openings, having lateral arms 41 entering sockets in the arm 30, substantially as and for the purposes set forth. 6th. In combination with the arms 30 carrying the shaft of a revolving propelling device, a transverse shaft 43 having arms 44 attached thereto, and the rods 45 with end slots 47 connecting said arms 30 and 44, substantially as and for the purposes set forth. 7th. In a stone gathering machine, the combination, with the revolving propeller, of the inclined sectional drag apron, each section being loosely coupled to the lower part of the machine, and forward of the propelling device, substantially as and for the purpose set forth. 8th. In a stone-gathering machine, the combination, with a revolving propelling device and a receptacle for stones, the inclined drag apron arranged in front of the propeller and formed of teeth, each being severally coupled at its forward end to the machine, and means for raising the apron, substantially as described. 9th. In a stone gathering machine, the guides 19 suspended to the frame work of the machine to swing endwise, and provided with fixed guards 21, in combination with a stone-propelling device, substantially as set forth. 10th. In a stone-gathering machine, the combination, with a stone receptacle, of ribs or corrugations formed upon the bottom thereof, transversely to the line of motion of the machine, substantially as described. 11th. In a stone-gathering machine, the combination, with a stone receptacle, of hoisting drums of different diameters, whereby one end of said receptacle is elevated more rapidly than the other, substantially as described. 12th. In a stone-gathering machine, the combination, with a stone receptacle which is hoisted to dump the load, of a hinged end wall having an angular extension or apron covering a portion of the rear wall, and means, substantially as described, for supporting the hinged end when thrown down to form a chute, as set forth. 13th. In a stone gathering machine, the combination, with a stone receptacle, which is hoisted to dump the load, of a hinged end wall, an angular extension thereof covering a portion of the front wall, and a strip pivoted at one end upon said extension, and having a pin upon its other end running in a slot in the front wall, substantially as described. 14th. In a stone-gathering machine, the combination, with a stone receptacle having a hinged end wall 94, provided with an extension or apron 96, of cords attached to the four corners of said receptacle, and leading at one end to a large drum 101, and at the other end to a small drum 109, substantially as described. 15th. In a stone gathering machine, the combination, with a stone receptacle having a hinged end wall 94, an apron 96 and a strip 97 pivoted at one end to the apron, and having a pin upon the other end running in a slot 99, of hoisting mechanism, whereby the receptacle is raised into an inclined position and the weight of the load thrown partly against the hinged end wall, substantially as described.

No. 21,885. Dental Separating Wedge.

(*Coin pour Séparer les Dents.*)

David Genese, Baltimore, Md., U.S., 15th June, 1885; 5 years.

Claim.—A tooth separator for dentists, consisting of a moulded and vulcanized rubber wedge, substantially as and for the purposes described.

No. 21,886. Construction of Railway and other Wheels. (*Fabrication des Roues de Chemins de Fer et autres.*)

Walter Eyre, Sheffield, Eng., 15th June, 1885; 15 years.

Claim.—1st. The production of a forged weldless wheel, in which the boss forms part of the wheel itself, by means of suitable swage tools or dies, substantially as described. 2nd. The production of a forged and weldless centre part of a wheel and boss, by means of suitable swage tools or dies, substantially as described.

No. 21,887. Lubricator for Railway Car Axles. (*Boîte à Graisse pour Essieux de Chars de Chemins de Fer.*)

Isaie Fréchette and Charles L. Girard, St. Hyacinthe, Que., 15th June, 1885; 5 years.

Claim.—1st. The combination of the axle C, roller L having groove M, arms G, axis F having groove H, chain O, operating spring B connected with arms G and frame A, the whole constructed and arranged substantially as and for the purposes set forth. 2nd. The combination of the pivoted and swinging arms G, roller L having groove M, pin I, spring arm F, chair O and spring B arranged to operate the said arms G, the whole constructed and arranged substantially as and for the purposes set forth.

No. 21,888. Chimney Cowl.

(*Chapeau de Chiminée.*)

Thomas Edwards, Amherst, N.S., 15th June, 1885; 5 years.

Claim.—A chimney cowl composed of an open base A to fit the top of a chimney, arched plate *c* having an opening through the top, and arched plate D over said openings, both plates secured together transversely, whereby the due passages will cruciformly intersect, as set forth.

No. 21,889. Oil Stove. (*Poêle à Huile.*)

Charles T. Ham, Rochester, N.Y., U.S., 15th June, 1885; 5 years

Claim.—1st. In an oil or lamp stove, a detachable oven, constructed at its rear side with a diving-flue having its lower portion projecting downwardly and rearwardly beyond the oven, and adapted to close the passage in the oil-stove leading from the flame-chamber to the outlet for the products of combustion, and to engage under the top plate of the stove, thereby securing the oven on the stove, substantially as set forth. 2nd. In an oil or lamp stove, a detachable oven adapted to receive bottom plates, having openings of different shapes, whereby the oven can be placed over the elongated opening in the front of the stove-top, or over the circular opening in the rear of the same, and its bottom opening made to coincide with either, substantially as set forth. 3rd. In an oil or lamp stove, a detachable oven provided with a catch K, adapted to engage under the top of the oven, substantially as set forth. 4th. The combination, with the base of the stove, and a flame-chamber provided with a top extending rearwardly over the base, and resting loosely on the base, so as to be capable of being tilted backward to expose the wicks, of a toggle joint supporting in its extended upright position the overhanging rear portion of the top on the base, and permitting the rear portion of the top to be lowered and the front portion of the flame-chamber to be raised upon being folded together, substantially as set forth. 5th. The combination, with the base A and a flame-chamber resting loosely on the base and provided with a rearwardly overhanging top D, of the toggle links *m* connecting the overhanging rear portion of the top with the base, and provided with square contact faces *o*, which engage against each other and support the top in a horizontal position when the links *m* are arranged perpendicularly, substantially as set forth.

No. 21,890. Key Lock for Doors, etc.

(*Serrure à Clé pour Portes, etc.*)

Washington I. Ludlow, Cleveland, Ohio, U.S., 16th June, 1885; 5 years.

Claim.—1st. A lock-case or shell having at one end a flange to serve as escutcheon or face plate, and threaded at the other end for receiving a nut, whereby the case or shell can be securely confined in its seat without other fastening devices, substantially as described. 2nd. In combination with the case carrying the key-barrel and locking mechanism of a lock, a screw-threaded extension on the case or barrel to receive a nut for confining it in its seat, and a lock-bolt entering the case or barrel at right angles thereto, and bolt being actuated by the key-barrel and locking mechanism and operating key, substantially as described. 3rd. The combination of a lock-case having at its outer end a flange serving as an escutcheon, a key-barrel arranged in the case, a lock-bolt arranged at right angles to, and entering the rear end portion of, the case behind the escutcheon plate, and connected with the key-barrel at a point between the escutcheon plate and the rear end of the case, and locking mechanism operated by the key-barrel, substantially as described. 4th. The combination of a locking-bolt having a flattened rear portion, a seat for a wrist-pin and a flaring opening contracted at the inter-section with the seat for the wrist-pin with the lock-case, and the key barrel having a wrist or eccentric pin, substantially as described. 5th. The combination of the bifurcated spring-tumbler, having an opening for a fastening screw, and the key-barrel provided with an annular groove in which the spring-tumbler is fitted with the lock-case having an opening for the locking bolt, and a hole for the passage of the tumbler fastening screw, substantially as described. 6th. The combination of the key-barrel having a key-way, an annular groove and a spline, or transverse rib, arranged in said groove, with a lock-case having a bifurcated spring-tumbler, around which the spring-barrel can rotate, and a key for operating said barrel, substantially as described. 7th. The combination of the key-barrel having a key-way, an annular groove and a stop arranged in said groove at one side of or out of, line with the key-way, with a lock-case having a tumbler or stop adapted to engage with the stop of the key-barrel and a key for operating said barrel and serving as a pull when the bolt is unlocked, substantially as described. 8th. The combination of the key-barrel having a diametric key-way, an annular groove and a stop or spline arranged in said groove, with a lock-case provided with a stop adapted to engage with the stop of the key-barrel, and limiting the movement of the latter, substantially as described. 9th. In combination with a lock-case, having at one end a flange to serve as an escutcheon, and at its other end a screw-threaded stem to serve as a nut, a lock-bolt entering the case at right angles thereto, capable of being locked and unlocked by the key-barrel, and locking mechanism housed within the case or barrel, substantially as described.

No. 21,891. Horse Power. (*Manège.*)

Zotique Durocher, Iberville, Que., 16th June, 1885; 5 years.

Claim.—1st. In combination with the frame of a horse-power-rollers carried in links, raised and lowered by means of levers pivoted to the frame, and serving when down to carry the machine, all substantially as herein set forth. 2nd. The combination, with the planks forming the travelling deck, of the metal strips K having eyes formed in them for the reception of the axle, and their ends turned in between the strip and the plank, as and for the purposes set forth. 3rd. The combination, with the planks D, of the hook-bearings N, as and for the purposes described. 4th. In a horse-power, the combination, with the main shaft M, of a shaft P driven by gear wheels O, O, (contained within the frame) and carrying driving pulley, all as herein set forth.

No. 21,892. Vehicle Axle Box.

(*Boîte à Graisse de Voiture.*)

William H. Doty, Hebron, N.S., 16th June, 1885; 5 years.

Claim.—1st. The axle box C, provided with the holding collar B and end cap D fitted into the end portions of the axle box, and held therein by a screw-thread, substantially as shown and described. 2nd. The holding collar B, fitted on the axle of a vehicle, chambered to reach over the fixed collar *b*, and screwed into the axle box C, as shown and for the purpose set forth. 3rd. The end cap D, screwed into the axle box, and having the oil opening *f* formed in its neck portion, as shown and described. 4th. The combination of the axle journal A provided with the groove *a* and fixed collar *b*, with the axle box C having fitted into its end portions, the holding collar B and end cap D, substantially as herein shown and described.

No. 21,893. Machine for Dressing Flour.

(*Blutoir.*)

Andrew Hunter, Chicago, Ill., U.S., 16th June, 1885; 5 years.

Claim.—1st. The combination, in a flour-dressing machine, of the sliding valve P, vertical cam U, reciprocating bar *o* and pins C, substantially as described. 2nd. The combination, in a flour-dressing machine, of the conveyor C, sliding valve P, vertical cam U, reciprocating bar *o* and pins I, substantially as described. 3rd. In a flour-dressing machine, the combination of hopper B, conveyor C, air discharge openings N, N, beaters G, G, and stationary cylinder I, substantially as described. 4th. In a flour-dressing machine, the combination of a longitudinal feed device, stationary cylinder I having a longitudinal feed opening in the top, and discharge opening H and rotary beaters G, G, substantially as described. 5th. In a flour-dressing machine, the combination of rotary shaft R, radial arms G, G, and lifting convex beaters G, G, substantially as described. 6th. In a flour-dressing machine, the combination of rotary shaft R, radial arms G, G, and lifting convex beaters G, G, with their rear sides flat, substantially as described. 7th. The combination of revolving beaters G, G, stationary cylinder I covered with suitable cloth *e*, in combination with rotary beaters G, G, substantially as described. 8th. In a flour-dressing machine, frames Y, Y, clothed with loose unstretched bolting cloth *e*, in combination with rotary beaters G, G, substantially as described. 9th. In a flour-dressing machine, the combination of frames Y, Y, clothed with loose unstretched cloth *e*, and ribs *d*, *d*, with rotary beaters G, G, substantially as described.

No. 21,894. Household Furniture.

(*Meuble de Ménage.*)

Adam Herig, Cleveland, Ohio, U.S., 16th June, 1885; 5 years.

Claim.—1st. The combination, in a piece of furniture having drawers, of a safe located in one of the divisions thereof, one of the drawer fronts having a prolongation to overlap the safe, whereby its exact location is hidden from sight, substantially as described and for the purpose specified. 2nd. In a piece of furniture having divisions of drawers, the combination therewith of a metallic lining located in one of said divisions, said lining having one end open and provided with hinge-lugs, to which is attached a door provided with a lock and key which are hidden by the overlapping drawer-front, substantially as described and for the purpose specified.

No. 21,895. Manufacture of Starch, Glucose, etc. (*Fabrication de l'Amidon, Glucose, etc.*)

Davenport Glucose Manufacturing Company, (Assignee of Paul Radenhausen,) Davenport, Iowa, U.S., 16th June, 1885; 5 years.

Claim.—1st. The process of arresting ammoniacal putrefaction in the starch milk after it has been separated, and precipitating the solid matter more quickly and effectually, which consists in adding to the ground-up grain or starch liquor, sulphuric acid, substantially in the manner and for the purposes described. 2nd. The process, herein described, of manufacturing starch, glucose and other starch products from corn and other grain, which consists in first passing the crushed grain and water through separators, then precipitating the separated starch milk with sulphuric acid, then drawing off the acid water and soluble constituents of the grain contained in it and stirring up the residue in dilute sulphuric acid, and afterwards passing the liquid thus obtained over the starch depositors, substantially as and for the purposes specified.

No. 21,896. Grain Car Door.

(*Porte de Char à Grain.*)

William McGuire and Frank Jager, Chicago, Ill., U.S., 16th June, 1885; 5 years.

Claim.—1st. A door having on each end a guide or loop, in combination with retaining hooks or supports, the main or body portion of which is bent or curved to throw the guide or loop into the holding portion thereof, and a catch for maintaining the door in an elevated

position, substantially as and for the purpose specified. 2nd. A door having on each end a guide or loop, in combination with guide-ways or rods and retaining hooks or supports, the main or body portion of which is bent or curved to throw the guide or loop into the holding portion thereof for hanging up the door, substantially as specified.

No. 21,897. Thrashing Machine.

(Machine à Battre.)

Lovell A. Richards, Grayson, Cal., U.S., 16th June, 1885; 5 years.

Claim.—On a grain separator, the stream carrier D, opened out as shown, and the return-board G, over which its lower side scrapes in returning, in combination with the fan E within and between the upper and lower sides of the straw-carrier, and the wind-board F, substantially as herein described.

No. 21,898. Brush for Flour Bolting Machines. (Brosse de Blutoir.)

Arthur L. Battson, Morrisburg, Ont., 16th June, 1885; 5 years.

Claim.—1st. In combination with a polygonal reel-bolt A, the shaft E parallel thereto, provided with a brush or brushes, F, successively sweeping the flat section of the bolt cloth, and alternately allowing the ridges of the reel to pass without contact with the brush, as set forth. 2nd. In combination with a polygonal reel-bolt A, the shaft E parallel thereto, provided with brush F having the fibres diametrically opposite and geared to spindle U of the reel, by sprocket wheel G, chain H and sprocket wheel I, and timed whereby the axially revolving brush will be flatwise to allow the rib of the reel to pass without frictional contact, and subsequently be endwise presented to sweep the open flat surface of the cloth, as and for the purpose set forth.

No. 21,899. Carpet Stretcher.

(Tendeur de Tapis.)

Fred W. Burns, Lemars, Iowa, U.S., 16th June, 1885; 5 years.

Claim.—1st. In an extensible carpet stretcher, the guide *a*, the yoke *b* having the cam or eccentric device E, with a suitable handle or hand lever *c*, to guide and clamp or lock the extensible bars C and D firmly together when adjusted to any length required, substantially as and for the purpose hereinbefore set forth. 2nd. In an extensible carpet stretcher, the combination, with the extending bars C and D, of the guide *a* and the yoke *b*, and the cam or eccentric device E having the hand lever *c*, substantially as and for the purpose hereinbefore set forth.

No. 21,900. Harvester Binder.

(Moissonneuse-Lieuse.)

John H. Groat and Sylvester Oakley, Grimsby, Ont., 16th June, 1885; 5 years.

Claim.—1st. In a harvester and binder, hinging the binder attachment C to the front post *d* of the harvester, by which the said binder attachment can be thrown forward over the tongue, to diminish the width of the machine so as to pass easily through ordinary gates, bars, etc., substantially as specified. 2nd. In a harvester and binder, the peculiar form of the hinge rod *d* and brace combined, as shown at Fig. 3, the lower end terminating in an eye *e* and hinged to the hinge eye *f* which is secured to the post *b*, and the upper bent end made to enter the open end of a gas pipe *h*, which forms part of the binder frame, substantially as and for the purpose specified. 3rd. In a harvester and binder, the combination of the combined hinge and brace *d*, eye hinge *f*, gas-pipe *h*, or its equivalent, post *b*, binder attachment C, hinge *e* and brace *k*, all arranged and constructed substantially as specified.

No. 21,901. Piano Forte. (Piano.)

Luigi Caldera, Turin, Italy, 16th June, 1885; 5 years.

Claim.—1st. The arrangement of the said additional hammers in such a manner that their line of percussion is further from the bridge than that of the main hammers, as and for the purpose above specified. 2nd. The connection of the additional hammers with the main hammers, or with a fixed support, in such a manner that each of the said additional hammers will be held away from its string, except when the corresponding key is depressed, substantially as and for the purpose set forth. 3rd. The improved device, consisting essentially of the eccentrically journalled shaft, arranged to be actuated by the performer, to press upon bands or straps connected with one or more of the dampers, or with one or more of the keys, substantially as and for the purposes set forth. 4th. The improved means, substantially as described and shown in Fig. 5, of the drawing, for the facilitating the repetition of a note, as above specified. 5th. The improved motor consisting of the parts, constructed and combined substantially as described, with reference to the accompanying drawing (with or without the brake K²), and arranged to be operated as and for the purpose specified.

No. 21,902. Centrifugal Reel. (Blutoir Centrifuge.)

George T. Smith, Jackson, Mich., U.S., 16th June, 1885; 5 years.

Claim.—1st. In a flour bolt, the combination of the hollow trunnion provided with the feeding blades, the shell surrounding the feeding blades and having a chute below the feeding blades, and the reel head having a stationary ring provided with a throat to receive material from the chute, substantially as set forth. 2nd. In a flour bolt, a reel head having an outer rotating flange, an inner rotating flange or plate, spokes connecting the inner plate with the outer flange, and intermediate stationary ring, substantially as set forth. 3rd. In a flour bolt, the combination, with the reel head, at the tail end of the bolt, having the outer flange and open spaces between the flange and the axis of the reel, of the flanged plates, one secured to the inner sides of the spokes, and the other secured to the outer sides of the

spokes, substantially as set forth. 4th. In a flour bolt, the combination, with the reel head at the tail end of the bolt having an outer flange and open spaces between the flange and the axis of the reel of a plate attached to the reel head, and having a flange projecting toward the bolting cloth and also towards the opposite end of the reel, substantially as set forth. 5th. The combination, in a flour bolt, with the reel head at the tail end of the bolt, having an outer flange and open spaces between the flange and the axis of the reel, of a plate attached to the reel head and having a flange projecting rearwardly towards the tail end casing, and outwardly from the axis of the reel, substantially as set forth. 6th. The combination, in a flour bolt, of a reel head at the tail end of the bolt, having an outer flange, a plate which surrounds the axis of the reel and extends nearly to the outer flange having a throat between the central plate and the outer flange for the passage of the tailings, and a series of revolving beaters having their ends arranged in close proximity to the throat through which the tailings pass, substantially as set forth. 7th. The combination, in a flour bolt, of a reel head having a throat near its outer edge for the passage of the tailings, and a series of revolving adjustable beaters, substantially as set forth. 8th. The combination, in a flour bolt, of a reel head having near its periphery a rearwardly projecting flange, and a vertical portion a short distance inside the tail end casing, and provided with an opening to receive the projecting flange, whereby a chamber is formed to receive the tailings, substantially as set forth. 9th. In a flour bolt, the combination, with the hopper-bottomed tailings chamber, the conveyor shaft, the rotating blades and an enclosing shell having circular walls, substantially as set forth. 10th. In a flour bolt, the cast metal shell surrounding the discharging blades and formed with shoulders, to receive the other boards of the tailings hopper, substantially as set forth. 11th. The combination of the conveyors having sprocket wheels upon the projecting ends of their shafts, the driving chain and means for moving one of the sprocket wheels and its conveyor shaft sideways for tightening the chain, substantially as set forth. 12th. The combination, with the driving chain, sprocket wheels and conveyor shafts, one being mounted in the sliding plate, the screw-threaded bolt and the plate attached to the conveyor box for tightening the chain, substantially as set forth. 13th. In a flour bolt, the combination, with the longitudinal bars, cloth-supporting rings and the cloth of the two-part carrier adapted upon the inner side to rest upon the longitudinal bar, and at its outer side to receive the cloth-supporting ring, substantially as set forth. 14th. In a flour bolt, the combination, with the longitudinal bars, the cloth-supporting rings and the cloth of the two-part carriers, consisting of the loops surrounding the bars, and the saddles secured to the rings and the loops, substantially as set forth. 15th. In a flour bolt, the combination, with the reel head provided with sockets to receive the nuts on the longitudinal bars of a bolting cloth extending lengthwise of the reel, and having one end turned over the reel head towards its axis, and means for drawing the turned over end of the cloth towards the axis of the reel, substantially as set forth. 16th. In a flour bolt, the combination, with the reel head provided with the projecting lugs upon the outer face of the bolt cloth extending lengthwise of the reel, and having its end turned over the reel head and toward its axis, of the circular tightener, the threaded hooks and the nuts, which connect the hooks with the lugs of the reel head, substantially as set forth. 17th. In a flour bolt, the combination of the reel head having an inner flange, an outer flange connected to the inner one by spokes, an intermediate stationary ring provided with a feeding throat below the axis of the reel, a series of outer beater blades, a series of inner beater blades attached to the central shaft, and a screen interposed between the outer and inner series of beater blades and attached to, and carried by the outer flange of the reel head, substantially as set forth. 18th. In a flour bolt, the combination, with the spiners 26 having throats 95, 96, of the beater blades 27 and the wedges 97, substantially as set forth. 19th. In a flour bolt, the combination of the reel head at the head end of the machine, having the hollow trunnion 16 provided with the feeder blades, and the boxing adapted to receive the outer end of the hollow trunnion, substantially as set forth. 20th. In a flour bolt, the combination, with the hollow trunnion 16 projecting beyond the shell of the feeder, and the beater shaft arranged within the hollow trunnion, of the sleeve provided with the spherical enlargement, and the metal boxing adapted to receive and support both the hollow trunnion and the sleeve, substantially as set forth. 21st. In a flour bolt, the combination, with the hollow trunnion 16, having its outer end of reduced diameter, of the shell of the feeder having the shoulder 59, whereby there is formed an annular recess 93 adapted to receive a packing, substantially as set forth. 22nd. In a flour bolt, the reel head provided with the concave plate 17, and the cogged ring 28, in combination with the hollow trunnion 88 and the bearing 87, arranged within the concave plate and the toothed gearing, and the shield 83, 84, substantially as set forth. 23rd. In a flour bolt, the combination, with the beater shaft and the reel head having the cogged rim 28, of the pinion 12 secured to the beater shaft, the spur gear 29 and the pinion 71 arranged outside the tail and casing, and suitable bearings for the beater shaft and the hollow trunnion, substantially as set forth. 24th. In a flour bolt, the combination, with the cogged gear arranged in the tailings chamber, between the tail and casing 6 and the partition 7, of the shield 83, 84, arranged above the gearing, substantially as set forth. 25th. In a flour bolt, the combination, with the hollow trunnion 88, of the reel head and the beater shaft, of the bed plate 85, 86, having a central opening to receive the pinion 12, substantially as set forth. 25th. In a flour bolt, the combination of the reel head having the concave plate 17, the toothed rim or flange 28 and the hollow trunnion 88 cast in one piece of the beater shaft, of the bed plate 85, 86, the bearing 87 and the sleeve 9 having the spherical enlargement, and the bearing 10 at the tail end of the reel, substantially as set forth. 27th. In a flour bolt, the combination of the reel head, the beater shaft, the pinion 12 secured to the beater shaft, the spur gear 29 and pinion 71 provided with hub 80, the short shaft 30, the sprocket wheel 29, the sprocket wheels on the conveyor shafts, and the chain 31 for driving the conveyors, substantially as set forth. 28th. The combination, with the boxings permanently secured to the girts 3 and 4, of the pinion 12, the reel heads, the hollow trunnions and the longitudinal bars 20, and the nuts at the ends of the bars, substantially as set forth. 29th. In a flour bolt, the combination of a beater shaft mounted at its ends in sleeves having spherical enlarge-

ments, a pinion mounted at the tail end of the machine, upon the beater shaft and inside the casing, a reel surrounding the beater shaft and supported upon hollow trunnions surrounding the beater shaft, a hub or collar attached to the beater shaft, at the outer end of the hollow trunnion of the tail end reel head, and means for adjusting the reel heads towards and from each other, substantially as set forth.

No. 21,903. Steam Boiler for Heating Purposes. (*Chaudière de Calorifère à Vapeur.*)

Frank H. Pulsifer, Auburn, N. Y., 16th June, 1885; 5 years.

Claim.—1st. In a cast iron heating furnace, the combination of the horizontal sections C, D, E, each section formed of concentric rings connected by hollow arms, and the inner rings located one above the other, to form a central magazine for coal, substantially as shown and described. 2nd. The combination of the horizontal section A forming the fire pot of a furnace, with horizontal section C formed of concentric rings connected by hollow arms, and drop tubes M projecting inwardly over the fire pot from the outer ring of said section C, substantially as and for the purpose described. 3rd. The combination of the horizontal sections C, D, E, with the upper section H provided with pockets L and arched flues h, substantially as and for the purpose described. 4th. The combination of horizontal sections D, E, forming a portion of a central magazine for coal, with top section H constructed to form the upper portion of the magazine, and located above the section E in such a manner as to form a horizontal passage h₂ in the upper portion of the magazine, substantially as and for the purpose described. 5th. The combination of a series of horizontal sections composed of concentric hollow rings united by hollow arms, with the fire pot section A having its upper portion wider than its lower portion, and provided with recesses f₁ in the walls thereof, corresponding with the flues f₂ of the upper sections, substantially as and for the purpose set forth.

No. 21,904. Carriage Spring. (*Ressort de Voiture.*)

Christopher C. Bradley, Syracuse, N. Y., U. S., 16th June, 1885; 5 years.

Claim. 1st. The combination, with a bolster, of a trunnion projecting from the end of the bolster, and a socket or flange whereby the trunnion is secured to the bolster, substantially as set forth. 2nd. The combination, with side springs B provided with trunnions e, of a rigid bolster provided with trunnions f and couplings H, whereby the adjacent trunnions of the springs and bolsters are connected, substantially as set forth. 3rd. The combination, with side springs B provided with trunnions e, of rigid bolsters C and D, provided with trunnions f and couplings H, each provided with two openings arranged at right angles to each other, one above the other, in which the adjacent trunnions of a side spring and a bolster are seated, so as to be capable of turning therein, substantially as set forth.

No. 21,905. Door Check. (*Arrête-Porte.*)

Otis P. Vanderburgh, Toledo, Ohio, U. S., 16th June, 1885; 5 years.

Claim.—1st. A door check consisting of a tubular portion C, having outwardly projecting flanges a, a, for its attachment to the door A, and the rubber cushion b secured between said tubular portion C and the door A, and said tubular portion C having an outer annular flange Cr, to partly enclose the tubular space C, and a plate D provided with a stem or post E, having a headed portion G, and an elastic cushion c located between said plate D and the baseboard H, all substantially as and for the purpose hereinbefore set forth. 2nd. In a door check, the combination, with the tubular portion C having the flanges a, a, and the annular flange Cr, of the elastic rubber cushion b and the plate D, with the stem or post E and ball head G, and the elastic rubber cushion c interposed between said plate D and the baseboard H, substantially as and for the purpose hereinbefore set forth. 3rd. In a door-check, a stem or post E having a headed portion G and a plate D for its attachment, and an elastic cushion c interposed between said plate D and the baseboard H, and means carried by the door A for receiving said headed portion G of the stem, substantially as and for the purpose hereinbefore set forth. 4th. A door check, comprising a tubular portion C with flanges a, a, and recesses a₁, a₁, and perforations for fastening the said portion to the door, said portion clamping and binding the elastic rubber cushion on the door, with a post or stem E with a ball head G and plate D integral therewith, and the rubber cushion c, substantially as and for the purpose hereinbefore set forth.

No. 21,906. Evaporator. (*Appareil Evaporatoire.*)

Edward L. Wallace, Toronto, Ont., 16th June, 1885; 5 years.

Claim.—1st. As an evaporator, the chamber B having an interior metallic can at a distance from it of about two inches more or less, in combination with the stoves or heater A. 2nd. In an evaporator, as aforesaid, the chamber B having an interior chamber C with metallic partitions alternately arranged as shown, in combination with the smoke flue I, as shown and for the purpose specified.

No. 21,907. Canal and Navigation of the Same. (*Canal et Navigation des Canaux.*)

Jean Nougues fils Ainé, Agen, France, 16th June, 1885; 5 years.

Claim.—1st. A system of canal construction and navigation comprising an axial divisional wall or dam D in each reach or level, and a tubular conduit or connecting pipe E E₁ through each lock, to convey the water from one reach into the other. 2nd. An axial divisional dam D, in a level or reach of a canal or navigable artificial water way constructed with locks. 3rd. The tubular conduits E, E₁, connecting two reaches of a navigable water-way constructed with locks, all substantially as described and set forth.

No. 21,908. Life Boat. (*Bateau de Sauvetage.*)

David P. Dobbins, Buffalo, N. Y., U. S., 16th June, 1885; 5 years.

Claim.—1st. In a life-boat, the combination, with the combined

keel and keelson made of one piece of material, of a rider keelson or strong back reaching from the keelson to, and supporting the deck, and running the whole length of the boat, and dividing the hold into two longitudinal compartments, the whole being secured together by bolts, substantially as described. 2nd. The combination, with the combined keel and keelson formed in one piece and provided with a series of perforations or mortises, of the ribs or frames of the boat adapted to pass through the mortises, and be secured substantially as described. 3rd. A life-boat provided with a detachable iron keel-shoe secured by bolts passing through the deck, strong back keel and keelson and into the keel-shoe, and having a line secured to one end of the keel-shoe and to the stern of the boat, whereby the keel-shoe may be released from the deck and be used as a drag, substantially as described. 4th. In a life-boat, the combination, with the combined keel and keelson formed in one piece of a strong back, and a deck-frame secured to the strong back, the several parts being united together and to the stem and stern posts by edge bolt, substantially as described. 5th. A life-boat, the hold of which is filled with cork, having air cases above the deck, provided with man-holes and spring hinged scuppers, and having spring-hinged scuppers arranged in each side of the boat, whereby the boat is rendered unsummergeable and the water shipped will be discharged through the scuppers, substantially as described. 6th. A life-boat, the hold of which is filled with sheet cork, secured together and to the hull of the boat by dowels and bolts, the said cork being rendered water-proof by paraffine, whereby the boat is rendered tight and strong, is properly ballasted, and the hold is impervious to air and water, substantially as described. 7th. A life-boat, having the hold divided into two longitudinal compartments, substantially as specified, and filled solid with water-proofed cork in the form of sheets or boards set up edgewise and strongly bolted or secured together to the deck, the strong back and to the body of the boat, so as to make the hold solid, impervious to air and water and unsummergeable, substantially as and for the purpose described. 8th. In a life-boat having a combined keel and keelson provided with a long narrow vertical opening, a strong back having a corresponding opening reaching from the bottom up to and through the deck, in combination with a pivoted slip-keel and spring hinged scuppers, in the upper part of the slip-keel case, substantially as and for the purposes described. 9th. In a life-boat, a rider-keelson or strong back edge bolted to the perforated combined keel and keelson and to the deck of the boat, and provided with a slip-keel case, substantially as and for the purposes described. 10th. In a life-boat, the combination therewith of the end air-cases lined with heavy canvas, substantially as specified, and provided with man-holes for the ingress and egress of invalid passengers or for other purposes, and with automatic acting spring hinged scuppers and bulls-eyes, for the admission of light and ventilation for the purposes within, substantially as described.

No. 21,909. Mould for Casting Ingots of Alternating Layers of Metal. (*Moule pour Couler les Lingots à Couches de Metal Alternatives.*)

John Illingworth, Newark, N. Y., U. S., 16th June, 1885; 5 years.

Claim.—1st. In a mould for casting ingots of alternating layers of metal, a plate receptacle having inclines f and wedge-shaped guide g, substantially as and for the purpose set forth and shown. 2nd. In combination, the base having passages therein, the funnel, the receptacle d and foundation piece e provided with wedge-shaped projections, all said parts being arranged and operating, substantially as set forth. 3rd. In combination, the base a, the funnel and one or more plate receptacles, each consisting of a foundation piece provided with means for spacing and supporting one or more metal plates, and a hollow upright A₁, said base having therein passages b leading from said funnel to said receptacle or receptacles, substantially as and for the purposes set forth. 4th. The combination of a funnel, one or more ingot moulds, one or more metal plates in each mould, and a passage extending from the funnel to each mould or plate receptacle, and to a position under the plate or plates therein, whereby the metal passes beneath and upwardly on both sides of the plate or plates, as and for the purposes set forth. 5th. In a mould for casting ingots of alternating layers of metal, a plate receptacle having ledges j, inclines f and guides g, arranged and operating substantially as and for the purposes set forth.

No. 21,910. Boat. (*Bateau.*)

John W. Rough, New Rochelle, N. Y., U. S., 16th June, 1885; 5 years.

Claim.—1st. The shoe adapted to fit the under surface of the boat, and carrying a center-board combined with straps, by which the shoe may be attached to the boat, or detached therefrom at will, substantially as set forth. 2nd. The shoe adapted to fit the under surface of the boat and carrying a center-board, combined with a rudder attached at the heel of the center-board, cords or wires for operating the rudder, and straps by which the shoe may be applied to the boat, substantially as set forth. 3rd. The shoe D carrying the center-board B, combined with the straps F and the hooks H and buckles J secured to the boat, substantially as set forth. 4th. The shoe D carrying the center-board B, in combination with the rudder secured at the heel of the center-board, the cords or wires O and eyes or boxes P, substantially as set forth. 5th. An attachment for a boat, consisting of the elongated shoe D and center-board B, with means of attachment to the boat, substantially as shown and described.

No. 21,911. Spring Catch or Fastening for Coffins, etc. (*Fermeture à Ressort pour Cercueils, etc.*)

John D. Ripson and Robert Watson, Toronto, Ont., 16th June, 1885; 5 years.

Claim.—1st. The spring plate C, bent as indicated and having inwardly projecting lips d formed on its ends, in combination with the plate A to which the said spring is rivetted, substantially as and for the purpose specified. 2nd. The U-shaped spring C, having lips d on its ends, and projections b to secure it with the plate A, in combination

with the separator B, arranged substantially as and for the purpose specified. 3rd. A plate A fadged so as to form a support a for the shank E of the separator B, in combination with the U-shaped spring C, substantially as and for the purpose specified.

No. 21,912. Seeding Machine.

(*Semoir Mécanique.*)

William T. Dingle, (Assignee of John Bartlett,) Oshawa, Ont., 17th June, 1885; 5 years.

Claim.—1st. In a seeding machine, an angle iron frame C having the horizontal web notched out at the corners, the vertical web bent rectangularly to form three sides and the mitre edges welded together, as set forth. 2nd. The combination, with the angle iron frame C and fixed rail N, of the swinging rail M, lever C₃, bar C₂ and arm C₁ for throwing the drag-bars out of rank, as set forth. 3rd. In a seeding machine, the lifting bar D₁, supported by brackets E₂, sleeved on axle J, and provided with cap F₁ having stop H₂ and handle G for pulling to lift the drag-bar A₂, as set forth. 4th. In a seeding machine, the combination, with shaft R₁ of the saddle cup T, cam S, shaft Z, pointer W, thumb-nut Z₂, bolt Z₁ and slotted plate V, to regulate the discharge of seed to be sown, as set forth. 5th. In a seeding machine, the tilting lever I provided with loose gear wheel L and tulerumed on a pin, projecting from a driving gear wheel M₁ fixed to the wheel hub, said lever I having a projection K, to engage with a bracket projection O on the end of bar D₁, whereby the lifting of bar D₁ will raise lever I and throw wheels L, N₁ out of mesh, and stop the action of the grain distributors, as set forth. 6th. In a seeding machine, the combination of a support-board P, tube-holders 5 and scattering tubes O₂, frictionally clamped thereto, to permit the tubes to yield to obstructions and be returned to their normal position, as set forth. 7th. In a seeding machine, the combination of the support board P, slotted sliding-board P₁ and nutted bolts P₂, for changing the adjustment to sow in drills or broad cast, as set forth.

No. 21,913. Sewing Machine.

(*Machine à Coudre.*)

The Union Bag Machine Company, Chicago, Ill., (Assignee of Lorenz Muther, Chicago, Ill., and Charles A. Dearborn, New York, N. Y., U. S.,) 17th June, 1885; 5 years.

Claim.—1st. The combination, with the needle and the feeding mechanism of a pivoted looper-frame whose axis of oscillation is substantially at right angles to the line of feed, a looper pivoted to said frame and having an axis of oscillation, substantially at right angles to the axis of the frame, and means for oscillating said frame and said looper respectively, the whole operating substantially in the manner specified. 2nd. In a sewing-machine having an eye-pointed needle, the combination, with said needle, of the oscillating looper-frame A₂, the looper pivoted thereto upon an axis of right angles to the axis of the frame, and the pirman A₁ connected with the looper by means of a ball-and-socket joint, whereby the oscillation of the looper-frame at right angles to the movement of the pirman is permitted. 3rd. The combination of the rocking frame having the feed dog mounted thereon, the driving shaft provided with a lifting-cam beneath said feed-dog, and also provided on its outer end with a radially-adjustable crank-pin, and the freely pivoted link connecting said crank-pin and said frame, whereby the length of feed may be altered without varying the time of feed movement, substantially as set forth.

No. 21,914. Sewing Machine.

(*Machine à Coudre.*)

The Union Bag Machine Company, Chicago, (Assignee of Lorenz Muther, Chicago, and Russell G. Woodward, Waukegan,) Ill., U. S., 17th June, 1885; 5 years.

Claim.—1st. In a double-chain stitch sewing-machine, the combination, with the stitch-forming mechanism, of a tension device acting upon the upper thread, and an intermittently-operating stop and take-up acting upon the lower thread, substantially as specified. 2nd. As an improvement in take-up devices for sewing-machines, the combination of a cam disk, arranged with its periphery in contact with the thread mechanism, whereby said cam is rotated in proper relation to the action of the stitch-forming mechanism, and a throw-off arm extending within the line of rotation of the cam's periphery, the whole operating substantially as set forth. 3rd. As an improvement in take-up devices for sewing-machines, the combination of a cam-disk and mechanism for rotating the same, with thread-guides arranged on each side of said cam and having eyes for the passage of the thread, said eyes being located within the outer periphery of the cam, substantially as and for the purposes set forth.

No. 21,915. Consecutive Numbering Machine. (*Machine à Numéroter Consecutivement.*)

James H. Reinhard, (Co-inventor with Charles S. Ellis,) and George Schmalzried, Memphis, Tenn., U. S., 17th June, 1885; 5 years.

Claim.—1st. The combination, with the numbering device, consisting of a series of wheels having mechanism, substantially as described, for effecting consecutive changes in their positions, of a spring-actuated plunger whose movement actuates said mechanism, so that the changes may be effected automatically by the pressure against the plunger of the platen of a printing press, as it moves against the type of the wheels, to obtain an imprint therefrom, substantially in the manner herein set forth. 2nd. The combination, with the case A having two compartments with a slotted partition between, of a set of numbering wheels, an axial shaft and a swinging pawl-frame arranged in one compartment, and a vertically-sliding spring-seated plunger C arranged in the other compartment, having a pin C₁ projecting therefrom through the partition, to engage and move the swinging pawl-frame and thereby actuate the wheels, substantially in the manner and for the purposes herein set forth. 3rd. The com-

ination, with the fixed center shaft having a flat face or recess on one side of the same, of a numbering wheel having the type section bearing the cipher made radially-adjustable and adapted, as described, to drop into said channel or ride upon the shaft, substantially in the manner and for the purpose herein set forth. 4th. The numbering wheel, having a radially-sliding type-section, with a spring T and offset W, as and for the purpose specified.

No. 21,916. Fire Ladder. (*Sauveteur d'Incendie.*)

Ramon de Elorriago-y-Rivas, Belbas, Spain, 17th June, 1885; 5 years.

Claim.—A fire ladder, such as hereinbefore described and shown, consisting of three sections, the lowermost fixed on an adjustable frame hinged to a truck, the other two being extended or opened by sliding on the first, and operated by drums or winches, and provided with fixed hose for the water supply, the lower section steadied by extensible braces E, and the ladder provided with platforms D and E, substantially as shown and described and for the purpose set forth.

No. 21,917. Carriage Seat. (*Siege de Voiture.*)

Joseph Pariseau, jr., St Jean Baptiste, Que., 17th June, 1885; 5 years.

Claim.—1st. In a carriage-seat, the combination of the stationary section A and the movable section B and connecting hinges C, D and W, substantially as described, whereby the movable section B is permitted, firstly, to rise a certain height, secondly, to revolve back, and thirdly, to rise open, as set forth. 2nd. In a carriage-seat, the combination of the stationary section A, the rising, revolving and opening section B and a locking device X, substantially as shown, with which the movable section engages by a vertical motion. 3rd. In a carriage-seat, the combination of the movable section B, with the mechanism O, P, p, S, V, as described and shown, whereby the curtain is automatically folded against the bottom of said movable section B when opened. 4th. In combination with the movable section B of the carriage-seat, the spring N and curtain mechanism O, P, p, S, V, as and for the purpose described.

No. 21,918. Machine for Producing Stereotype Matrices, etc. (*Machine pour Produire les Matrices, etc., Stéréotypes.*)

Ottmar Mergenthaler, Baltimore, Md., U. S., 17th June, 1885; 5 years.

Claim.—1st. A metal bar, tapered continuously from end to end, and provided with characters or letter in its tapered edge. 2nd. A series of independently-reciprocating parallel bars, each consisting of a single piece of metal, tapered continuously from end to end, and provided at its edge with a series of single characters in position to be read transversely of the bar. 3rd. The type-bar having the series of letters or characters on its edge, and the automatic spacing device on its side. 4th. The type-bar, as described, provided with the line of single characters at its edge, and the spring J at its side. 5th. The continuous type-bar having the characters formed on its edge, and the reduced portion or neck; near one end. 6th. A series of parallel independent bars movable independently in the direction of their length, and each provided with a series of letters or characters, in combination with stop devices, substantially as described, arranged in rows in front of the respective bars, whereby the various bars may be stopped at different points to bring different letters in line. 7th. The reciprocating type-bar provided with type at its edge, combined with a series of stop-pins acting directly to arrest the bar at different points, adjusting-pins to set the stop-pins, the finger-keys to actuate the adjusting-pins, substantially as described. 8th. The series of type-bars, the stop-pins arranged in rows adjacent to the respective bars, the adjusting-pins, and a laterally movable support for the latter, combined substantially as described, whereby the adjusting-pins may be placed in position to actuate the stop-pins of the different printing-bars in succession. 9th. The type-bars, the stop-pins acting directly upon the bars, the adjusting-pins, the rock-shafts to actuate the adjusting-pins, and the finger-keys to actuate the respective shafts, combined substantially as described and shown. 10th. The type-bars, the stop-pins, and the frame to carry said pins, movable in a forward and backward direction, combined substantially as described, whereby the projected pins may be restored to their normal positions and disconnected from the bars. 11th. In combination with a guide or support therefor, a type-bar or carrier, a series of independent stops to arrest the motion of the bar at different points, and a dog or detent movable with the bar, to hold the same after the stop is disengaged. 12th. In combination with a movable type-bar, a series of stop-pins arranged to slide to and from the same in a fixed support, and a dog or detent movable with the bar and arranged to engage a fixed plate, whereby the bar may be maintained in the position in which it is stopped after the stop-pin ceases to act thereon. 13th. In combination with the independent type-bar, the stop-pins, the adjusting-pins, the frame sustaining the stop-pins, and mechanism, substantially as described, to impart three motions to the pin-frame, viz: first, a backward movement to the place the previously-projected pins in position to stop the bar; second, a further backward motion to restore all the pins to their normal positions in the frame; and, third, a forward motion to disengage the pins from the bars and place them in position to begin operations. 14th. The series of independently-reciprocating parallel type-bars with type at their edges, combined with clamps acting laterally to bind them together, and mechanism substantially as described, for actuating the clamps. 15th. A series of parallel independently reciprocating bar or carriers, each having a series of type on its edge, in combination with two clamps extending across the edges of the series, and mechanism, substantially as described, to approximate said clamps, whereby they are caused to confine the dies and bring the type to a common plane. 16th. In combination with the independently-movable type-bars or carriers, the clamp extending across the back of the series, the two clamps extending across the front of the series, and operating devices, substantially as described, for approximating the front and rear clamps. 17th. The series of independently-movable type-bars

or carriers, each provided with a series of type at the edge, in combination with the front clamps, to engage the upper and lower edges of the selected and aligned characters, and mechanism, substantially as described, to close the clamps upon the type and also urge them toward the edges of the bars. 18th. In combination with the movable type-bars or carriers, the clamps C1, C2, constructed as described, to act on the front edges of the bars above and below the line of characters, and to expose the faces of the characters between them. 19th. In combination with the longitudinally-movable type-bars and their suspending devices, substantially as described, means substantially as described, to hold the bars edgewise out of line, whereby the projecting characters in the edges of the respective bars are prevented from encountering each other. 20th. In combination with the guiding-plates *a, a1*, the series of type-bars and the spring-actuated pins mounted in the lower ends of the bars, and arranged to throw the bars edgewise out of line. 21st. In combination with the body portion of the type-bars, or bar proper, the suspending-links, the heads attached to said links, and the grooved guiding-plate in which the heads slide, 22nd. In combination with the guide-plates, and the vertically-sliding heads therein, the type-bars suspended from the heads, as described, to hang with their adjacent edges out of line. 23rd. In combination with the type-bars or carriers, a beater to force the blanks thereon, and operating mechanism, substantially as described, to cause rapidly-succeeding actions of said beater, whereby the blanks is gradually adapted to the surface of the type. 24th. In combination with a series of type-bars, the two beaters, and mechanism, substantially as described, to actuate them alternately. 25th. In a machine for taking impressions from type, and in combination with a series of movable type-bars, a beater of soft material, a beater of hard material, and mechanism, substantially as described, to actuate said beaters successively. 26th. In combination with the type-bars or carriers, the swinging-beater *F1* and the pitman and crank connected with, and driven by, the operative parts, of the machine, substantially as described and shown. 27th. In combination with the type-bars, the beater *F1*, the arm *r3* connected therewith, the spring *e3* and the notched wheel *t3*. 28th. In combination with the type-bar having the reduced ends or necks, a lateral clamp having a forked or divided end, to straddle the neck of these bars which are not in action, as described. 29th. In combination with the type-bars and the lateral clamps, the actuating levers with jointed yielding ends, and the cam for operating said levers. 30th. The type-bars, the lateral clamp, the arm to actuate the clamp, and the adjustable connection between the arm and clamp, whereby the clamp may be adjusted to move inward a greater or less distance, according to the length of the lines to be printed. 31st. The combination of the type and space-bars, the finger-keys, the intermediate mechanism, substantially as described, to align the designated characters, and the indicating mechanism, substantially as described, actuated by the finger-keys, to indicate the aggregate width of the designated characters in advance of their assemblage, whereby the attendant is enabled to determine upon the necessary designation of the spaces. 32nd. The combination, substantially as hereinbefore set forth, of the type-bars, the stop-pins, the adjusting-pins, and the indicating mechanism, substantially as described, actuated by the adjusting-pins. 33rd. In combination with the series of type-bars, the indicating mechanism, substantially as described, the stop-pins and the adjusting-pins, to cause the stop-page of the bars at different points, each pin representing a letter or character, and provided with an inclined surface proportioned to the width of the character to actuate the indicating mechanism. 34th. In combination with a series of independently movable type-bars, diminishing in width from one end toward the other, a series of finger-keys, intermediate mechanism, substantially as described, whereby the keys are caused to stop the bars at different points, and thus present their designated character in a common line, and the indicating mechanism, substantially as described, to show the aggregate width of the bars at the points where the designated characters are carried thereon. 35th. In combination with the type-bars and the lateral clamp, the guide therefor, the adjustable stop to limit the motion of the clamp toward the bars, the yielding arm to actuate the clamp. 36th. The pendent type bars having the heads thereon, in combination with the locking-dogs in said heads, and the notched guide-plate to receive and hold the dogs, whereby the bars may be sustained at different elevations. 37th. The series of type bars arranged to slide independently in a longitudinal direction, and provided with heads, in combination with the vertically movable frame adapted to act beneath the heads, whereby the bars may be raised and lowered in unison and permitted to stop independently in their descent at different points. 38th. The independently movable type-bars and the locking-dogs, or detents carried thereby, in combination with the guide *a, a1*, provided with shoulders or notches to engage the dogs, and a vertically-movable head or yoke *C*, whereby the bars are raised and lowered and their dogs automatically actuated, as described, whereby the respective bars are permitted to stop, and are automatically suspended at different points when descending with the head, but lifted to a common elevation as the head ascends. 39th. The sliding pins having inclines thereon, in combination with the bar *Y*, the indicator rod, the intermediate lifting dog *Z*, and the locking-dog *z*. 40th. The combination, substantially as described and shown, of the finger keys representing characters of different widths, the indicator connected therewith to show the aggregate width of the designated characters, and the alarm mechanism having its trip *oz* arranged to be actuated by the indicator rod *e2*, whereby said rod is caused to serve a double purpose. 41st. In combination with the finger keys representing characters of different widths, the smooth indicator-rod, the friction dogs co-operating therewith, and devices, substantially such as shown, for imparting variable movements to one of said dogs from the respective keys, whereby characters of any width may be employed, and the aggregate width of the designated characters accurately indicated. 42nd. In combination with the type-bars and stop-pins and the adjusting pin frame movable laterally from one bar to another, the indicator or counting device *p2, q2*, to show the number of bars called into action. 43rd. In combination with the type-bars, the stop-pins, the adjusting-pins, the laterally movable frame supporting the adjusting-pin, the escapement to control the lateral movement of said frame, the finger keys, and connections, substantially as described, connecting the respective keys with the corresponding adjusting pins and the entire series of keys with

the escapement, whereby each key is enabled to designate a particular character and also cause the action of the escapement. 44th. In a machine for producing matrices from type or dies assembled temporarily in line, the combination of the independent type-bars or carriers, each bearing a plurality of characters, the finger-keys representing the respective characters, the stop devices to arrest the movement of the respective bars at proper points, connections, substantially as described, between the keys and stop devices, and a reciprocating suspending head *C*, substantially as described, to advance the type bars simultaneously after the adjustment of the stop devices. 45th. The series of upright gravitating independent type bars, each bearing a number of characters, the series of stop pins arranged in line with the bars to engage the individual bars and stop them at different heights, and the lifting-head whereby the bars are raised and lowered simultaneously, but permitted to stop individually in their descent at different points. 46th. The combination, substantially as described and shown, of a longitudinally reciprocating type bar or carrier bearing a series of characters, with a series of stops corresponding with the respective characters, arranged to engage the bar, one at a time, and arrest the same with the desired character at the printing point. 47th. In an automatic machine for producing an impression from a line of temporarily-assembled types, the combination of the following elements: the independent type bars, each bearing a number of characters, the corresponding finger keys, the intermediate stop mechanism and connections, substantially as described, the mechanism, substantially as described for advancing the type bars to the stops, the clamps to confine the bars, the beater to force the blank material against the aligned characters, and the actuating mechanism, substantially as described, for causing the successive and automatic action of the several parts, as described. 48th. The combination, substantially as hereinbefore described and shown, of the type-bars and the clamps acting thereon, the beater, and the driving mechanism acting to automatically close the clamps and subsequently actuate the beater. 49th. The finger keys, the adjusting pins *R* actuated thereby, the stop pins *S2*, the reciprocating type bars and the reciprocating lifting-head *C*, bearing beneath the heads or shoulders of the bars, said parts combined and arranged to operate as described. 50th. In a machine for securing impressions from independently movable bars, each provided with a series of letters or characters, and in combination with said bars, a series of finger keys representing the respective characters, stop devices and connections, substantially as described, actuated by the respective keys, to arrest the motion of the bars at suitable points to bring the designated characters into line, secondary locking devices, substantially as described, to hold the bars in the position in which they are arrested by the stop devices, and automatic means, substantially as described, whereby the stop pins are disconnected from the bars and restored to their normal positions, whereby the operator is enabled to actuate the keys and designate the characters for a second line, during the time that an impression is being taken from the first line. 51st. In a machine for producing impressions from type-bars or carriers, each bearing a number of characters, the combination of the said bars, the series of finger keys, the stop devices and connections, substantially as described, actuated by said keys, to arrest the bars at different points, and thereby align the designated characters, the suspending devices, substantially as described, to retain the bars in their adjusted positions after the disconnection of the stop devices, the beating mechanism, substantially as described, to force the blank material against the aligned type, the mechanism, substantially as described, to restore the stop devices to their original position previous to the restoration of the bars, and the mechanism, substantially as described, to restore the bars after the action of the beater, said members being organized and arranged for joint operation, as set forth, whereby the operation of the keys to designate the characters for one line is permitted during the taking of the impression from the preceding line. 52nd. In combination with a series of independent type bars arranged to advance in unison, as described, and each bearing a series of characters, a series of finger keys representing the different characters, intermediate connections and stop devices, substantially as described, acting to arrest the motion of the bars at different points, and automatic mechanism, substantially as described, acting to disconnect the stop devices from the various bars at one operation and restore them to their normal positions. 53rd. In a machine for producing impressions from type, the combination of a series of parallel bars movable independently in a longitudinal direction, each bar provided on its edge with a series of characters or type, and also provided at a suitable point in its length, with a laterally-acting spring or equivalent spacing device, whereby every bar in the series is adapted for use in indenting, or for spacing between the bars which are used to indent, as the operator may elect.

No. 21,919. Step Ladder. (*Echelle à Queue.*)

Charles T. Brandon, Toronto, Ont., 17th June, 1885; 5 years.

Claim.—1st. A step-ladder, in which the legs *C* are rigidly fastened by two or more bolts *D* to brackets *B*, which are fastened on the bottom of the top step *A*, as specified, in combination with the rod *F*, secured to, and supported by the brackets *B*, and forming a pivot-point for the legs *E*, substantially as and for the purpose specified. 2nd. A shelf, formed as described, and having notches *a* cut in its sides to fit over the rod *G*, in combination with a strip *I*, secured to the bottom of the step opposite to the rod *D*, substantially as and for the purpose specified. 3rd. The side bars *J* connected together by a series of rungs *K*, and having notches *a* cut in them, in combination with pivoted clasps *L*, arranged and fastened substantially as and for the purpose specified.

No. 21,920. Veneer, and Method of Applying the Same. (*Feuille de Placage et Mode de l'Appliquer.*)

Ann of Mantua and Montferriat and Charles of Mantua and Montferriat, London, Eng., 17th January, 1885; 5 years.

Claim.—1st. Applying and securing to a backing of plaster, wood, cloth, paper, mill-board, straw board, wood pulp board, sheet metal, or other suitable material, with waterproof cement, a sheet of wood veneer, substantially and for the purposes set forth. 2nd. As a new

article of manufacture, wood veneer applied and secured to cloth, paper, mill-board, sheet metal, and other suitable flexible material, with waterproof cement, substantially as set forth. 3rd. The method of applying and securing wood veneer to plaster, or plaster walls, consisting in treating the plaster surface with a weak silicious solution, and then with a weak solution of chloride of calcium, and then coating with a waterproof cement and pressing the veneer into it, substantially as set forth.

No. 21,921. Collar Button and Neck-Tie Holder Combined. (*Bouton de Col et de Cravate.*)

John W. Burtis, Saratoga Springs (assignee of Willard J. Burtis, Troy), N.Y., U.S., 17th June, 1885; 5 years.

Claim.—1st. A collar button and neck-tie holder combined, formed of two holding plates, connected by a post formed from a single piece of metal, one end of the post being fixed to one plate, the other end of the post terminating in points or spurs, and the intermediate portion of the post being provided with a hinge connection, substantially as described, adapted to form a hinge joint with the other plate, which is perforated to receive the terminal points of the post, substantially as described and for the purposes set forth. 2nd. In a collar button and neck-tie holder combined, the combination of plate A, post C having hinge connection *d* and points D integral therewith, perforated plate B and hinge-plate *b*, substantially as and for the purposes set forth.

No. 21,922. Manufacture of Grape Sugar and Glucose. (*Fabrication du Sucre de Raisin et de la Glucose.*)

William T. Jebb, Buffalo (Assignee of John C. Schuman, Akron), N.Y., U.S., 17th June, 1885; 5 years.

Claim.—1st. The herein-described process of manufacturing grape sugar or glucose from Indian corn or maize, which consists in steeping the corn, then detaching the hulls and germs from the starchy portions of the kernels by whipping or beating without additional water, then separating the hulls and germs from the crude starch by sifting, and then converting the separated crude starch into grape sugar or glucose, substantially as set forth. 2nd. The herein-described process of manufacturing grape sugar or glucose from Indian corn or maize, which consists in steeping the corn, then detaching the hulls and germs from the starchy portions of the kernels by whipping or beating without additional water, then separating the hulls and germs from the crude starch by sifting, then acidulating the crude starch and converting it into grape sugar, or glucose, under pressure, substantially as set forth.

No. 21,923. Manufacture of Starch.

(*Fabrication de l'Amidon.*)

William T. Jebb, Buffalo, (Assignee of John C. Schuman, Akron), N.Y., U.S., 17th June, 1885; 5 years.

Claim.—1st. The herein described process of manufacturing refined starch from indian-corn, which consists in steeping the corn, then detaching the hulls and germs from the starchy portions of the kernels by whipping or beating without additional water, then separating the hulls and germs from the crude starch by sifting, and then refining the separated crude starch, substantially as set forth. 2nd. The herein described process of manufacturing refined starch from indian-corn, which consists in steeping the corn, then detaching the hulls and germs from the starching portions of the kernels by whipping or beating without additional water, then separating the hulls and germs from the crude starch by sifting, then grinding the separated crude starch with water, and then refining the ground starch, substantially as set forth. 3rd. The herein described process of manufacturing refined starch from Indian-corn, which consists in steeping the corn, then detaching the hull and germs from the starchy portions of the kernels by whipping or beating without additional water, then separating the hulls and germs from the crude starch by sifting, then separating the hulls and germs from the crude starch by sifting, then grinding the separated crude starch with water, then separating the remaining fibrous matter or offal from the starch by sifting, then treating the separated starch with caustic alkali and depositing the starch, substantially as set forth. 4th. The herein described process of manufacturing refined starch from Indian-corn, which consists in steeping the corn, then detaching the hulls and germs from the starchy portions and the kernels by whipping or beating without additional water, then separating the hulls and germs from the crude starch with water, then separating the remaining fibrous matter or offal from the starch by sifting, then treating the separated starch with caustic alkali, and then removing the remaining traces of impurities by repeatedly depositing and washing the starch, substantially as set forth.

No. 21,924. Pill Counter. (*Compteur de Pillules.*)

David B. Moore, Saint Louis, Mo., U.S., 19th June, 1885; 5 years.

Claim.—1st. In a pill counter, the combination, with the perforated strip A, of the trough C, suspended from the same and adapted to serve both as a bottom and discharge spout, as set forth. 2nd. In a pill counter, the perforated strip A, having its end bevelled and provided with the handle B, in combination with the sliding cover D, substantially as herein shown and described. 3rd. The combination, with the strip A provided with a series of pill counting holes *a*, of the numbered plates *a*, as specified. 4th. The combination, in a pill counter, of the strip A provided with holes *a*, the swinging spring acted trough C and a sliding cover D, as specified. 5th. The combination, in a pill counter, of a strip A provided with a handle B, a trough C, stirrups *b*, *c* and spring *f*, as specified. 6th. The combination, in a pill counter, of the perforated strip A provided with a handle B, the trough C, stirrups *b*, *c*, spring *f* and sliding cover D, as described.

No. 21,925. Folding Table. (*Table de Camp.*)

William E. Eldred, Brooklyn, N.Y., U.S., 19th June, 1885; 5 years.

Claim.—In a folding table, the combination, with the top C transverse bar D recessed at G, to form a shoulder G₁, legs A pivoted to said bar, cross-piece B connecting the legs and a bevelled transverse cleat E, on the underside of the top, and parallel with cross-piece D, of the bottom F, pivoted to the cross-piece D, near the shoulder G₁, and to the cleat E, as shown, the edge of the bottom, next to the said bevelled cleat, being also bevelled, whereby the bottom will bind between the cross-piece B and cleat E, to hold the legs in place and be prevented from swinging too far back by the said shoulder, substantially as set forth.

No. 21,926. Car Axle Box. (*Boîte à Graisse.*)

Robert Hunter, Detroit, Mich., U.S., 19th June, 1885; 5 years.

Claim.—1st. A car axle box having channelled ribs on either side of the opening, and extending above the top plane of the box, in combination with a ledge formed by an enlargement of the channels in the ribs, as a means for securing the cover, substantially as described. 2nd. A car axle box having channelled ribs on either side of the end opening therein, and having ears projecting from the inner edges of such ribs, as a means for securing the cover, substantially as described. 3rd. A car axle box having wedge-shaped channels formed in ribs upon either side of the mouth or opening into the end of such box, in combination with a cover having wedge-shaped side edges and means, as described, for compelling the cover to firmly seat itself in said channels as set forth. 4th. A car axle box and cover thereof, constructed substantially as described, said cover having a set screw by means of which said cover is prevented from accidental displacement, as specified. 5th. A car axle box having the presentation of the front edge of the wall, which forms the top of said box, upon two different planes, the first being vertical as a rest against which the rear face of the cover will remain, when standing upon its ledges, and the other and upper plane being inclined upon the plane of the channels in the ribs, as described.

No. 21,927. Retort and Seal therefor.

(*Cornue et Fermeture de Cornue.*)

Deming Jarves, Detroit, Mich., U.S., 19th June, 1885; 5 years.

Claim.—1st. A retort having means for supporting it upon the floor of a kiln, and for supporting the roof of said kiln, centrally contracted to form a discharge-mouth at its lower end, eccentrically contracted at its upper end, and having a vertical discharge pipe by the side of the contracted upper end, substantially as and for the purpose described. 2nd. A retort having an opening in its side wall, communicating with a rectangular open ended box, and having an interior lug or ledge, in combination with a slide gate, a handle for operating said slide gate, and means, as described, for closing the outer end of such slide inclosing box against escaping gas, substantially as and for the purposes specified. 3rd. In a gas proof expansion joint, for the purposes described, a packing or seal of viscid tar, of the nature specified, substantially as set forth. 4th. In a gas-proof expansion joint, for the purposes described, an annular cup formed around the lower section of the discharge pipe, in combination with the pipe joint described, the upper section of the discharge pipe forming a dividing diaphragm in the upper portion of said cup, and of the packing or seal, in the annular cup, consisting of tar boiled down to a viscid consistency, all arranged and operating substantially as and for the purpose specified.

No. 21,928 Carpet-Sewing Machine.

(*Machine à Coudre les Tapis.*)

Alphonso B. Smith, San Francisco, Cal., U.S., 19th June, 1885; 5 years.

Claim.—1st. In a carpet-sewing machine, a frame or carriage adapted to rest astride of, and more at the edges of the material, and composed of the plates A, K, carrying all the mechanism, and having a steady handle on one side, and the crank handle connected with the driving mechanism to operate the same on the opposite side, the feeding lever D₁, actuating cam *c*, and means, substantially as herein described, whereby the upper end of the lever is held at the time of the outward movement of its lower end, substantially as described, all combined for operation as set forth. 2nd. In a carpet-sewing machine, the frame or carriage adapted to rest astride of, and move over the edges of the material, composed of plates A, K, of which one is movable and adjustable in position with reference to the other plate, to give different width of space between them, and means of fixing them in position when set, the double set of carrying rollers *g*, *g*, Q, Q₁, the feed lever D₁, the actuating cam *c* and interchangeable devices adapted for attachment to the upper end of the feed-lever, for operation as described, all in combination substantially as set forth. 3rd. The combination, with the frame or carriage adapted to travel astride of the edges of material, and having traction wheels or rollers, of a stationary work-supporting bench with a fixed track, the work-clamping device and a steady-bar with traction roller, for operation with a fixed track on the bench, substantially as herein described. 4th. The combination, with the frame or carriage of a carpet-sewing machine, adapted to travel over the edges of the material to be stitched, of a steady-bar, substantially as described, applied for operation as set forth. 5th. The combination, with the carrying-frame or carriage of a carpet-sewing machine, of the steady-bar P having a crutch piece on one end, substantially as described for operation as set forth. 6th. In a carpet-sewing machine, the combination, with the travelling frame adapted to carry all the stitch-forming mechanism, and to move over the edges of the material to be stitched, of the nipper jaws S, S, upon opposite sides of the frame, having dogs S₁, S₁, to engage with and grasp between them the material to be stitched, the wedge piece *r*, and mechanism, substantially as described, whereby the outer ends of said jaws are spread apart, and their inner ends pressed together, to grasp the material and thereby form a resistance point, by which progression of

the frame is produced step by step, at each grip of said jaws in the material, substantially as set forth. 7th. The combination, with the travelling frame having horizontally reciprocating needle carrier and vibrating looper, of the feed-lever with the wedge piece *r*, the fixed loop *as* on the frame, the brackets *st*, the nipper jaws supported by said brackets, and the openings in the plates *A, K*, substantially as set forth. 8th. The combination, with the travelling frame or carriage having horizontally reciprocating needle carrier and looper, of the brackets *S, S*, dogs *st*, pivoted on said bars, the binding screws *t*, wedge piece *r*, actuating lever *DI* and cam for operating said lever, substantially as set forth. 9th. The combination, with the stationary bench *W*, of the track-notched plate *ic* and clamp-bar having movable clamps, substantially as described. 10th. The combination of the plates *A, K*, one having the needle bar box *A* and carrying all the mechanism, and the other secured to the said box by means that permit of its parallel movement and adjustment, and provided with a steadying and guarding handle *M*, substantially as described.

No. 21,929. Harrow. (*Hersse.*)

William Dougherty and Edward M. Ball, Barnston, Que., 19th June, 1885; 5 years.

Claim.—1st. The clamp in connection with tooth and wedge, as hereinbefore set forth. 2nd. The V-sections of harrow connected together by links, substantially as and for the purposes hereinbefore set forth.

No. 21,930. Waterproof Garment.

(*Vêtement Imperméable.*)

Loretto Cory, Shelbyville, Ind, U.S., 19th June, 1885; 5 years.

Claim.—The herein-described water-proof skirt consisting of the circular *A*, provided with a band *a* near its lower end, and the protector *B* detachably connected to said band and to a band *c*, supported by a series of straps *d* from a waist-band *e*.

No. 21,931. Belt Tightener.

(*Tendeur de Courroie.*)

John H. Whiting, Detroit, Mich., U.S., 19th June, 1885; 5 years.

Claim.—In a tightener for cable and belts, a block having laterally projecting hooks, eyes or guides secured to its frame, in combination with two parallel bars secured to a fixed support at right angles to the cable, all arranged and operating substantially as described.

No. 21,932. Machine for Ornamenting Wood.

(*Machine pour Orner le Bois.*)

John P. Jamison, Cambridgeport, Mass., U.S., 19th June, 1885; 5 years.

Claim.—1st. In a machine for embossing designs upon wood, in imitation of carving, two die-rolls connected together by gears and arranged to revolve in unison and to act upon the surface to be ornamented in succession, and provided, the one with cutting knives to outline the design by cutting the fibres of the wood, and the other with projecting surfaces adapted to depress certain portions of the wood bounded by said outlines, substantially as described. 2nd. In combination with a moving table or bed carrying the stock to be ornamented, the die-roll *M*, provided with the cutting-knives *h* adapted to cut the fibres of the wood to outline thereon the design, and the die-roll *M'*, provided with the projecting surfaces *i* and *j*, all arranged and adapted to operate substantially as and for the purposes described. 3rd. The combination of the die-rolls *M* or *M'*, adjustable around the shaft *L* or *L'*, provided with the groove *m*, the collar *T*, provided with the index fingers *u* and *o* and the set screw *l*, and the block *N* provided with the line *p*, all arranged and adapted to operate substantially as described.

No. 21,933. Scuffler. (*Scarificateur d'Agriculture.*)

Benjamin Wagner, Kinsale, Ont., 21st June, 1885; 5 years.

Claim.—1st. Side scuffing blades attached to parallel bars on opposite sides of the beam of the machine, and pivotally connected to cross-bars pivoted upon the said beam, in combination with mechanism arranged to adjust the angle of the pivoted cross-bars, for the purpose of altering the distance between the scuffler blades, substantially as and for the purpose specified. 2nd. In a scuffler, an iron beam composed of two plates *A* set on edge and bolted together a short distance apart, so as to admit the plough shank and other attachments, in combination with the handle *C* braced by the rods *D* and *E*, substantially as and for the purpose specified. 3rd. The bars *H* pivoted to the beam of the machine, and pivotally connected to the hand-lever *F* pivoted to the beam of the machine, and provided with an ordinary spring catch and notched quadrant *G*, the said hand-lever being connected to one of the bars *I* by the rod *J*, the whole specified. 4th. The curved shanks *K* rigidly attached to the bars *H*, in combination with a scuffler blade or mould board, provided with a grooved head having lips *b* formed on them, to lap over the edges of the shanks *K*.

No. 21,934. Transfer Truck. (*Chariot de Fonderie.*)

John H. Whiting, Detroit, Mich., U.S., 21st June, 1885; 5 years.

Claim.—1st. In a car wheel truck, a circular support provided with trunnions supported by the truck frame, and having a handle or equivalent device for turning the ring support upon its trunnions, substantially as described. 2nd. In a car wheel truck, a four wheel truck having a circular support supported near one end thereof, said support being provided with trunnions, and a device such as a handle for turning it upon its trunnions, substantially as set forth. 3rd. In a car wheel truck, a circular support supported upon trunnions by the frame of the truck and having a handle projecting rearwardly from said support, in combination with suitable devices such as the

forked rest *G* and dog *H* for locking the handle to the truck frame, substantially as described. 4th. In a car wheel truck, the combination of the following parts: a four wheeled truck, a circular support pivotally secured upon trunnions near the front end of the truck, a handle for dumping the said support, a locking device for locking the handle to the truck frame, and a brake provided with a brake lever projecting in proximity to the handle, all arranged substantially as and for the purpose set forth. 5th. In a car wheel truck, the combination of the truck frame, the circular support pivotally supported upon trunnions, the handle *F* for operating the said support with the self-operating locking device consisting of the bifurcated rest *G* and gravity dog *H*, all arranged substantially as described.

No. 21,935. Chill for Casting Car Wheels.

(*Coquille pour Couler les Roues des Chars.*)

John H. Whiting, Detroit, Mich., U.S., 21st June, 1885; 5 years.

Claim.—In combination with a chill for casting car wheels, the wrought-iron band or ring externally or internally concealed within said chill, substantially as and for the purposes described.

No. 21,936. Harness. (*Harnais.*)

Charles Allen and William E. Dubbs, Peru., Ind., U.S., 21st June, 1885; 5 years.

Claim.—1st. The girth or belly-band provided near its ends with the buckles, having loops extended in advance of the points of the tongues, and having the thill loops secured at one end in the extended loops of said buckles, substantially as and for the purpose specified. 2nd. The combination of the girth, the buckles secured near the opposite end of same, and provided with loops extended in advance of the bearing-points of the tongues, the thill-loops secured at one end in said extended loops, the back-band or saddle and the connecting straps secured at one end to the back-band, having their opposite ends held by the buckles on the girth, substantially as set forth.

No. 21,937. Device for Detachably Connecting the Hoes of Seeding Machines to the Drag Bars. (*Appareil pour Ajuster à Volonté les Dents des Semoirs aux Sommier.*)

Peter Hamilton, Peterborough, Ont., 21st June, 1885; 5 years.

Claim.—1st. The drag-bar head *A*, formed substantially as specified, and secured to the drag-bar *B* by the bolt *C*, arranged to receive the notch *d* formed on the end of the shank of the hoe *D*, a notch *a* arranged to receive the pin *b* on the hoe, in combination with the hooked end *e* of the brace *E*, arranged substantially as and for the purpose specified. 2nd. The brace *E*, having the hooked end to fit over the pin *b* on the hoe *D*, and its other end extending beyond the bolt *F*, in combination with the adjustable block *H*, arranged substantially as and for the purpose specified. 3rd. The brace *E* provided with a hooked end *e*, secured by the bolt *J* passing through a slot in the body of the hooked end *e*, as specified.

No. 21,938. Automatic Cut-off Valve for Steam, Gas and other Engines. (*Souppape de Déteinte Automatique pour Machines à Vapour, à Gaz et autres.*)

James H. Man, Denver, Col., U.S., 21st June, 1885; 5 years.

Claim.—1st. The method of automatically actuating cut-off valves, herein described, which consists in first opening the valve by a defined limited force, and then closing the same against the operation of such force by differential pressures on opposite sides of said valve, as specified. 2nd. An automatic cut-off valve, provided with means for normally holding the same open, such valve being so arranged with relation to the passages that it is automatically closed by the fluid current induced by the difference of pressure on opposite sides thereof caused by the piston movement, substantially as described. 3rd. In combination, a valve actuated in one direction by differential pressures on its opposite sides, and means for adjusting the valve and thereby regulating the area of the steam passages with relation to the speed of the engine, and varying the point of cut-off, substantially as specified. 4th. In combination, a valve actuated in one direction by differential pressures on its opposite sides, and an adjustable stop operated by suitable means for effecting an automatic regulation of speed, as set forth. 5th. A valve, consisting of a hollow stem having two flaring right-angled projections forming two parallel disks of different diameters, the stem being adapted to receive a spindle or bar which supports and guides the said valve, and which in turn is firmly supported so as to bear a fixed position relative to the valve seat, the whole being arranged to operate to cut off the steam in its passage from the steam chest to the cylinder, substantially as and for the purpose set forth.

No. 21,939. Wagon Pole Iron.

(*Crochet de Tîmon de Voiture.*)

Nelson E. Springsteen, Detroit, Mich., U.S., 21st June, 1885; 5 years.

Claim.—1st. A tip-iron for wagon poles, provided with a dog, one end of which is pivotally secured in such tip-iron, while its free end is arranged to engage with the hold back, substantially as and for the purposes set forth. 2nd. A wagon pole tip, consisting of the tip-iron *B*, arranged to embrace the upper and lower faces of the pole point, a hold-back consisting of a brace *C* and pin *D*, and a dog *E*, when constructed, arranged and operating substantially in the manner and for the purposes described.

No. 21,940. Machine for Sowing Grass Seed, Turnip Seed, etc. (*Semoir pour la Graine d'Herbe, de Navets, etc.*)

John Whelan, Woodhouse, Ont., 21st June, 1885; 5 years.

Claim.—The combination, in a machine of a broadcast sower and seed drill, interchangeable boxes worked by the combination of levers A, A and wheels B, B acted on by spokes C, with rod F and cord G passing through seed-box, together with a regulating pin D, substantially as and for the purpose herein set forth.

No. 21,941. Rail Joint. (*Joint de Rail.*)

Joseph Kellow, Pen Argyll, Penn., U.S., 21st June, 1885; 5 years.

Claim.—The rails having slots or openings and recesses *b*, in combination with a fish-plate having flanges provided with holes or openings, a rib on the fish plate to fit the recesses *b*, wedges having inverted flanges, and keys to fit the openings in said wedges, as set forth.

No. 21,942. Waggon. (*Wagon.*)

Lorenzo D. Hurd, Wellsville, Nelson Upper, Buffalo, N. Y., U.S., and George Upper, St. Thomas, Ont., 23rd June, 1885; 5 years.

Claim.—1st. The combination, with the tongue and front axles pivoted separately to a supporting frame and provided with actuating arms, of a cross-piece moving laterally with the tongue in turning the same, and connected with said actuating arms by a shifting connection, whereby the operative length of the arms is made unequal in turning the tongue, thereby causing one axle to be turned more than the other by the same movement of the tongue, substantially as set forth. 2nd. The combination, with the axle frame A and pivoted axles *a*, provided with arms J having slots *i* and *k*, of the tongue C, cross-bars L, L, and bolts *l*, *l*, connecting the cross-bars with the slotted arms J, substantially as set forth. 3rd. The combination, with the axle frame *a* and braces *e*₂, of the axles *a* provided with spindles E, bearings *e*₁, and connecting bolt *f*, substantially as set forth. 4th. The combination, with the axle frame A, of the frame G pivoted to the frame A by a vertical bolt *g*, tongue C pivoted to the frame G by a horizontal bolt *g*₁ and guide segment *h*, substantially as set forth. 5th. The combination, with the axle frame A and pivoted axles *a*, provided with slotted arms J, of the tongue C, frame I surrounding the tongue, frame G supporting the frame I, and cross-bars L, L pivoted to the frame I and connecting with the slotted arms J, substantially as set forth. 6th. The combination, with the rear axle N and reach D, of the cross-piece P secured to the reach, brackets *p* secured to said cross-piece, and braces *m* secured with rear ends to the axle and adjustably attached with their front ends to the brackets *p*, substantially as set forth.

No. 21,943. Velocipede. (*Vélocipède.*)

Henry C. Willis and Norman W. Stearns, (Assignee of Luther Hall,) Boston, Mass., U.S., 22nd June, 1885; 5 years.

Claim.—1st. The following co-acting elements, viz: The driving wheels B, B, of a velocipede, provided with long hubs *k*, *k* extending inwardly toward each other, and having secured thereto, or formed integral therewith, the notched portions H, H, sleeves I, I, surrounding the same, balls or rolls *k*, *k*, interposed between the sleeves or notched portions, a pair of connecting-rods L, L, and a pair of working levers G, G, combined to operate substantially as and for the purpose described. 2nd. In combination with the upright levers G₂, G₂, the connection *m* extending between them and around the axle of the driving wheels, as and for the purpose set forth.

No. 21,944. Condenser. (*Condensateur.*)

The Cushing Process Company, Boston, (Assignee of Ira B. Cushing,) Brookline, Mass., U.S., 23rd June, 1885; 5 years.

Claim.—1st. In an apparatus for purifying and maturing liquors, a condenser composed of an outer vessel A, a closed vessel or cylinder B containing an open bottomed vessel or cylinder G, in communication with the eduction pipe and arranged with an annular space *t* between them, in combination with the central induction pipe C, opening into the space *t* between the upper ends of the cylinders B, G, whereby the air and alcoholic vapours are caused to pass at first from the centre of the condenser to its periphery, and thence return from the periphery to the centre before escaping into the eduction pipe, substantially as and for the purpose set forth. 2nd. In an apparatus for purifying and maturing liquors, the combination, with the closed vessel or cylinder B and the open bottomed vessel or cylinder G, in communication with the eduction pipe and arranged with an annular space *t* between them, of the central induction pipe C opening into the space *t*, between the upper ends of the cylinder B, G, and provided with apertures for the return of the condensed liquid to the spirit tank by means of the pipe C, all constructed to operate in the manner and for the purpose described. 3rd. In an apparatus for purifying and maturing liquors, the combination of the outer vessel A, the closed vessel or cylinder B and the open bottomed vessel or cylinder G, arranged with an annular space *t* between them, the vessel or cylinder H arranged within the cylinder G, and having a central open bottomed tube *m*, extending down from its top, the central induction pipe C, extending from the spirit tank D up through the cylinders A, B, G, H, and tube *m*, and opening into the space *t*, and having apertures *g*, *r*, at or near the level of the bottoms of the cylinders B, H, whereby the condensed liquid in both of the cylinders B, H, is returned to the spirit-tank through the same pipe by which the vapours pass to the condenser, and the eduction pipe P, leading from the cylinder H through the cylinders G, B, A, all constructed and arranged to operate substantially in the manner and for the purpose set forth.

*CERTIFICATES OF THE PAYMENT OF FEES FOR FURTHER TERMS HAVE BEEN ATTACHED TO
THE FOLLOWING PATENTS.*

- | | |
|----------------------------------------------------------------------------------------------------------------------------------------------------------------------------------------------------------------------------------------------------------------------------------------------------------------------------------------------------------------------------------------------------------------------------------------------------------------------------------------------------------------------------------------------------------------------------------------------------------------------------------------------------------------------------------------------------------------------------------------------------------------------------------------------------------------------------------------------------------------------------------------------------------------------------------------------------------------------------------------------------------------------------------------------------------------------------------------------------------------------------------------------------------------------------------------------------------------------------------------------------------------------------------------------------------------------------------------------------------------------------------------------------------------------------------------------------------------------------------------------------------------------------------------------------------------------------------------------------------------------------------------------------------------------------------------------------------------------------------------------------------------------------------------------------------------|----------------------------------------------------------------------------------------------------------------------------------------------------------------------------------------------------------------------------------------------------------------------------------------------------------------------------------------------------------------------------------------------------------------------------------------------------------------------------------------------------------------------------------------------------------------------------------------------------------------------------------------------------------------------------------------------------------------------------------------------------------------------------------------------------------------------------------------------------------------------------------------------------------------------------------------------------------------------------------------------------------------------------------------------------------------------------------------------------------------------------------------------------------------------------------------------------------------------------------------------------------------------------------------------------------------------------------------------------------------------------------------------------------------------------------------------------------------------------------------------------------------------------------------------------------------------------------------------------------------------------------------------------------------------------------------------------------------------------------------------------------------------------------------------------------------------------------------------------------------------------------------------------------------------------------------------------------------|
| <p>384. C. M. LEE, 2nd 5 years of No. 11,327, from the 5th day of June, 1885. Improvements on Shoes, 2nd June, 1885.</p> <p>385. S. W. LUDLOW, 2nd 5 years of No. 11,364, from the 11th day of June, 1885. Improvements on Combined Springs and Axles for Vehicles, 2nd June, 1885.</p> <p>386. L. MALTUS, 3rd 5 years of No. 4,814, from the 5th day of June, 1885. Improvements on Fare Boxes for Street Cars, etc., 5th June, 1885.</p> <p>387. I. MILLS, 2nd 5 years of No. 11,318, from the 5th day of June, 1885. Combined Mattrass and Bed Bottom and Device for securing the same in the place when in use, 5th June, 1885.</p> <p>388. W. BUCK, and J. W. BUCK, 3rd 5 years of No. 4,810, from the 5th day of June, 1885. Improvements on Heating-Stoves, 5th June, 1885.</p> <p>389. A. BRIDGEMAN, J. L. PERRY and C. A. MATHER, 2nd 5 years of No. 11,399, from the 19th day of June, 1885. Improvements on Wood-Polishing Machines, 1885.</p> <p>390. C. W. GLIDDEN, 2nd 5 years of No. 11,408, from the 19th day of June, 1885. Improvements in Heel Trimming Machines, 5th June, 1885.</p> <p>391. THE UNITED STATES STEAM STOKING CO., (Assignees), 2nd 5 years of No. 11,403, from the 19th day of June, 1885. Improvements on Machines for Discharging Coal Gas Retorts of the Spent Coke, 8th June, 1885.</p> <p>392. J. L. STURDY, 2nd 5 years of No. 12,442, from the 1st day of March, 1886. Improvements on Snow Ploughs 8th June, 1885.</p> <p>393. J. G. WALKER, 2nd 5 years of No. 11,381, from the 14th day of June, 1885. Improvements on Washing Machines, 1885.</p> <p>394. J. A. OSGOOD and E. P. MONROE, 2nd 5 years of No. 11,368, from the 11th day of June, 1885. Improvements in Supports for the Valve or other Rods of Steam, Air and Water Engines, 11th June, 1885.</p> | <p>395. G. BOIVIN, 2nd 5 years of No. 11,389, from the 15th day of June, 1885. Improvements in Shoes for Playing Lacrosse, 11th June, 1885.</p> <p>396. W. A. KIRBY, 2nd 5 years of No. 11,502, from the 15th day of July, 1885. Improvements on Grain Binding Machines, 11th June, 1885.</p> <p>397. Q. E. PACKARD, 2nd and 3rd 5 years of No. 11,496, from the 15th day of July, 1885. Improvements on Rivets, 12th June, 1885.</p> <p>398. G. W. PRENTICE, 2nd and 3rd 5 years of No. 12,475, from the 9th day of March, 1886. Improvements on Instruments for Attaching Buttons to Wearing Apparel, 12th June, 1885.</p> <p>399. G. W. PRENTICE, 2nd and 3rd 5 years of No. 12,789, from the 13th day of May, 1886. Improvements on Button Fasteners, 12th June, 1885.</p> <p>400. F. MOSES and G. CLARKE, 2nd 5 years of No. 11,423, from the 20th day of June, 1885. Improvements on Stoves for Burning Coal or Wood, 17th June, 1885.</p> <p>401. J. T. WARING, 2nd 5 years of No. 11,411, from the 19th day of June, 1885. Improvements on Machinery for Felting Hat Bodies and other articles, 17th June, 1885.</p> <p>402. E. FISHER and J. WATSON, 2nd 5 years of No. 11,426, from the 21st day of June, 1885. Improvements on Metallic Horse Collar Fastening, 20th June, 1885.</p> <p>403. G. F. SWIFT, (Assignee), 2nd 5 years of No. 11,536, from the 24th day of July, 1885. Improvements on Refrigerating Apparatus, 22nd June, 1885.</p> <p>404. G. WALKER, 2nd and 3rd 5 years of No. 19,970, from the 15th day of August, 1889. Improvements in Apparatus for Producing Gas from Saw Dust, 24th June, 1885.</p> <p>405. G. D. WHITCOMB and O. BUTLER, 2nd 5 years of No. 11,344, from the 23th day of June, 1885. Improvements on Mining Machines, 27th June, 1885.</p> <p>406. THE SHAW STOCKING CO., (Assignees) 2nd 5 years of No. 11,506, from the 15th day of July, 1885. Improvements on Machines for Knitting, 27th June, 1885.</p> |
|----------------------------------------------------------------------------------------------------------------------------------------------------------------------------------------------------------------------------------------------------------------------------------------------------------------------------------------------------------------------------------------------------------------------------------------------------------------------------------------------------------------------------------------------------------------------------------------------------------------------------------------------------------------------------------------------------------------------------------------------------------------------------------------------------------------------------------------------------------------------------------------------------------------------------------------------------------------------------------------------------------------------------------------------------------------------------------------------------------------------------------------------------------------------------------------------------------------------------------------------------------------------------------------------------------------------------------------------------------------------------------------------------------------------------------------------------------------------------------------------------------------------------------------------------------------------------------------------------------------------------------------------------------------------------------------------------------------------------------------------------------------------------------------------------------------|----------------------------------------------------------------------------------------------------------------------------------------------------------------------------------------------------------------------------------------------------------------------------------------------------------------------------------------------------------------------------------------------------------------------------------------------------------------------------------------------------------------------------------------------------------------------------------------------------------------------------------------------------------------------------------------------------------------------------------------------------------------------------------------------------------------------------------------------------------------------------------------------------------------------------------------------------------------------------------------------------------------------------------------------------------------------------------------------------------------------------------------------------------------------------------------------------------------------------------------------------------------------------------------------------------------------------------------------------------------------------------------------------------------------------------------------------------------------------------------------------------------------------------------------------------------------------------------------------------------------------------------------------------------------------------------------------------------------------------------------------------------------------------------------------------------------------------------------------------------------------------------------------------------------------------------------------------------|

THE
CANADIAN PATENT OFFICE RECORD

ILLUSTRATIONS.

Vol. XIII.

JULY, 1885.

No. 7.

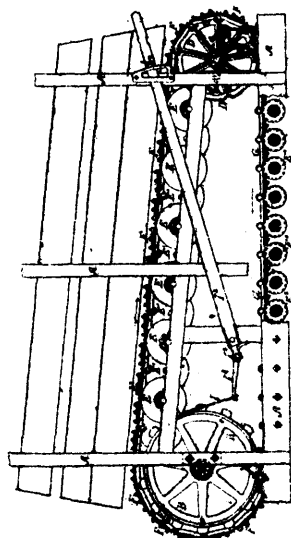

21797 Ellis' Horse Power.

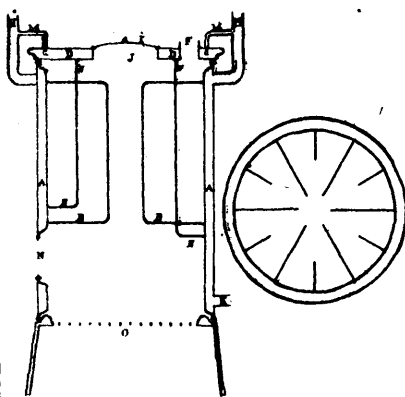

21798 Manny's Water Heater.

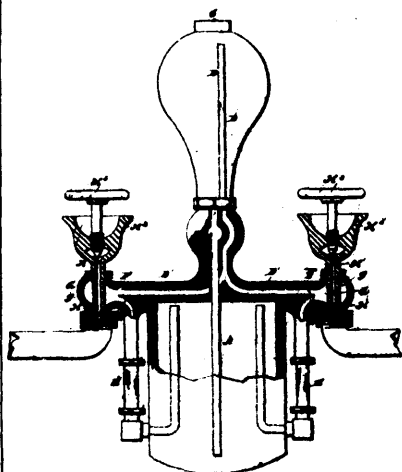

21799 Hodges & McCoy's Lubricator.

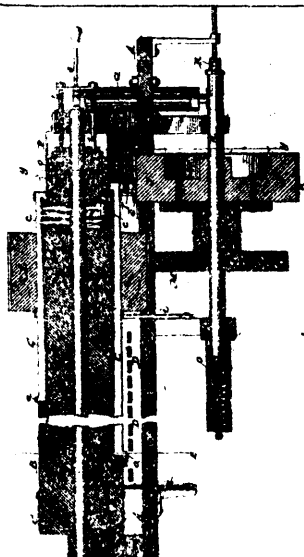

21800 Mergenthaler's Matrix Making and Printing Machine.

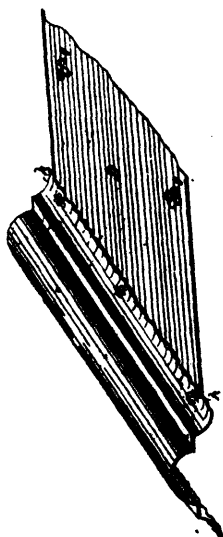

21801 Northrop's Metallic Ceiling.

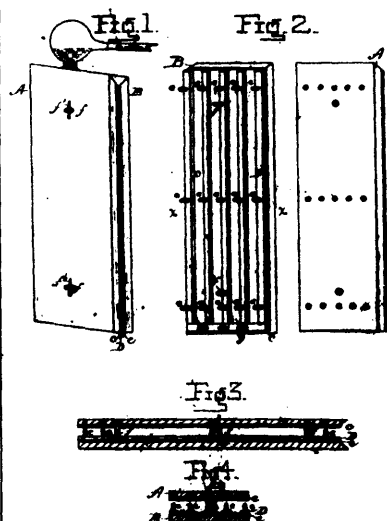

21802 Surguy's Mould for Casting Slugs and Leads for Printer's Use.

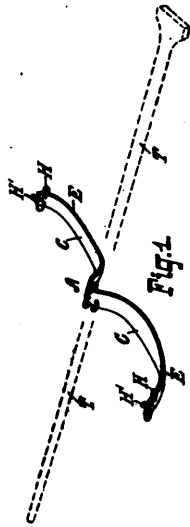

21803 Hoffman's Farm Harness.

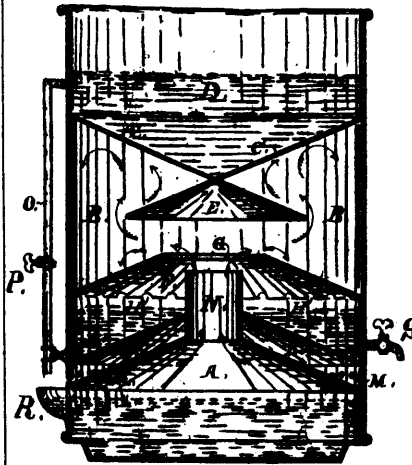

21804 Charbonneau's Water Purifying Apparatus.

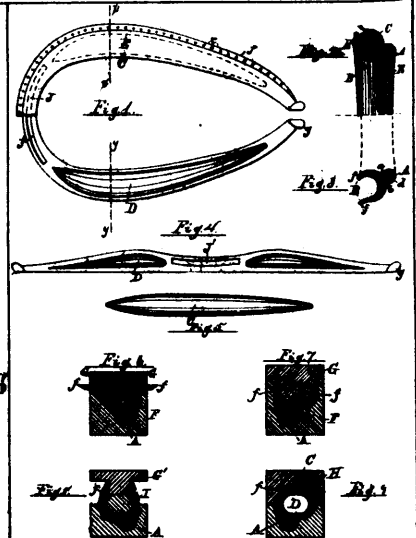

21806 Stanley & Lemassena's Horse Collar.

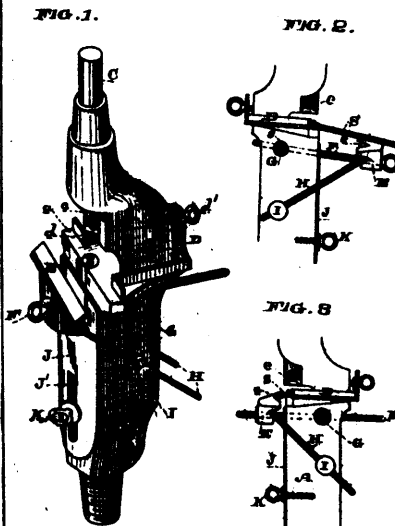

21807 Kopf's Saw Set.

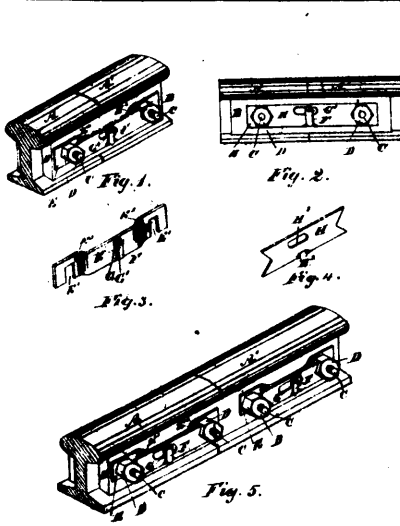

21808 Smith's Nut Lock.

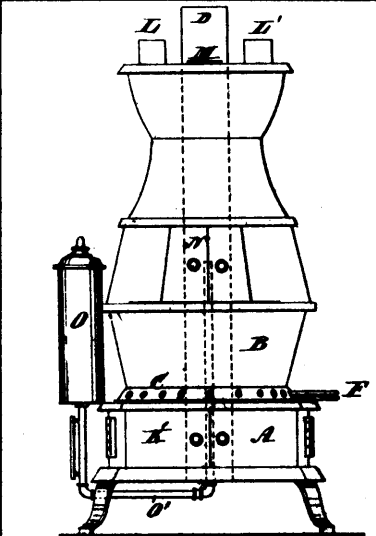

21809 Snow's Ventilating Stove.

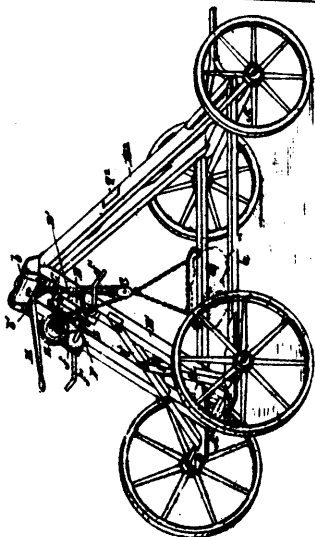

21810 Fisk's Derrick and Carrier.

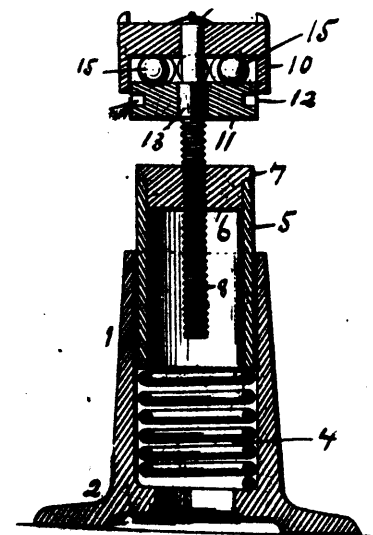

21811 Chase's Lifting Jack.

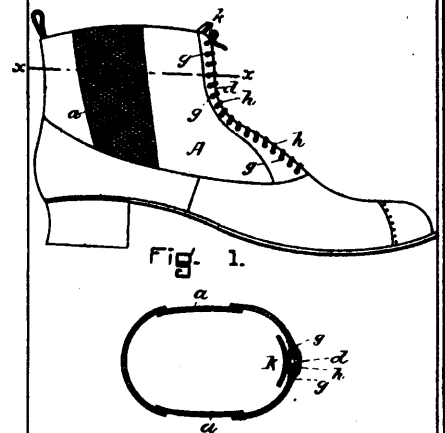

21812 Marshall's Boot and Shoe.

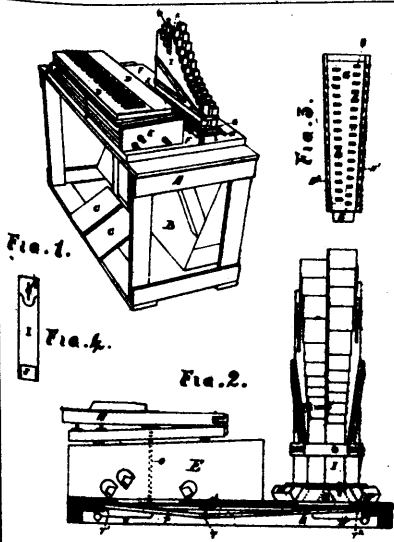

21813 Scribner's Reed Organ.

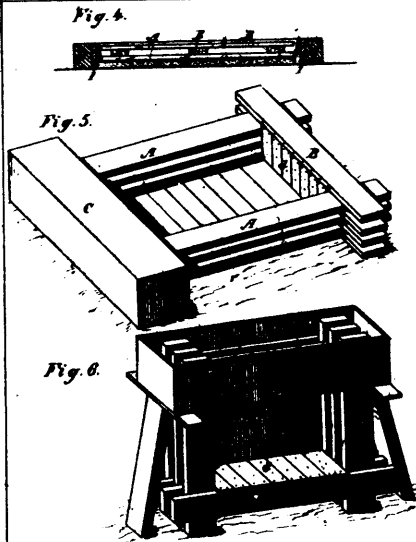

21814 Fiske's Pavement and Sidewalk and Facing Blocks.

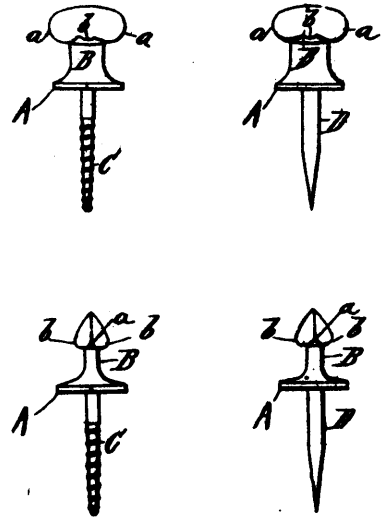

21815 Ware's Button or Knob.

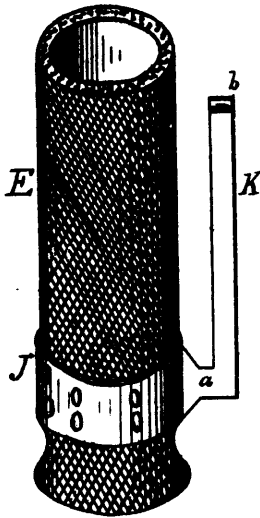

21816 Henkle's Lamp.

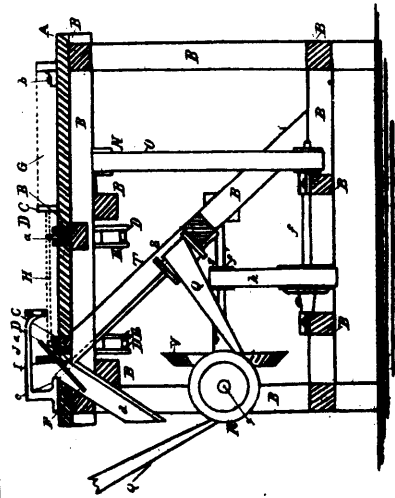

21817 Adam's Machine for Chamfering Shingles.

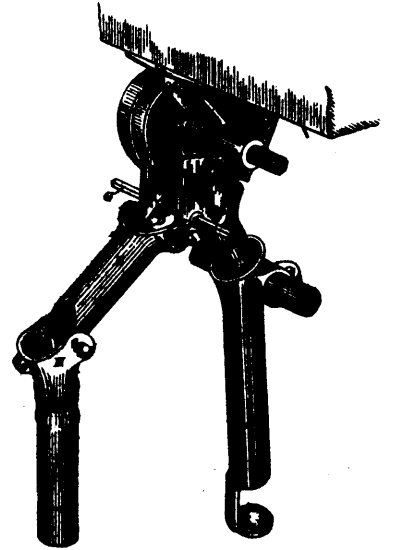

21818 Larsen's Seed Drill and Broadcast Scatterer.

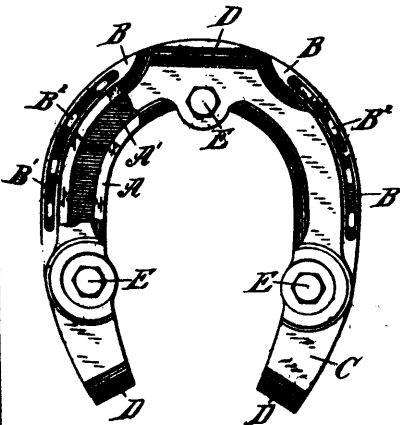

21820 Hawes' Duplex Horse Shoe.

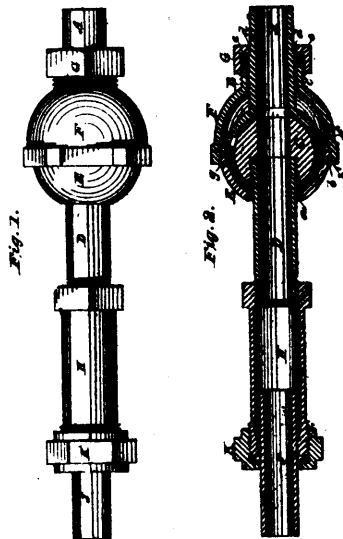

21821 Martin's Pipe Coupling.

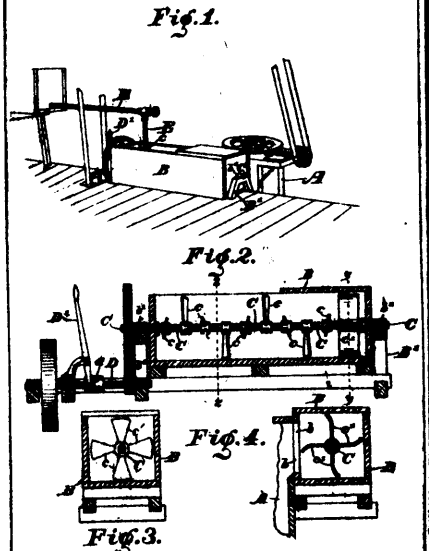

21822 Fletcher & Thomas' Pug Mill.

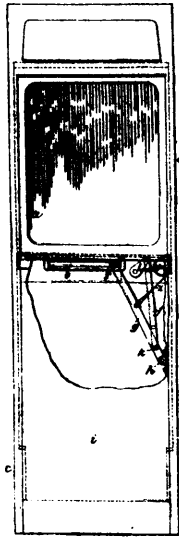

21823 Frost's Apparatus for Raising and Lowering the Windows of Railway and other Carriages.

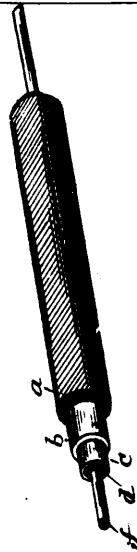

21824 Tichenor's Electric Cable or Conductor.

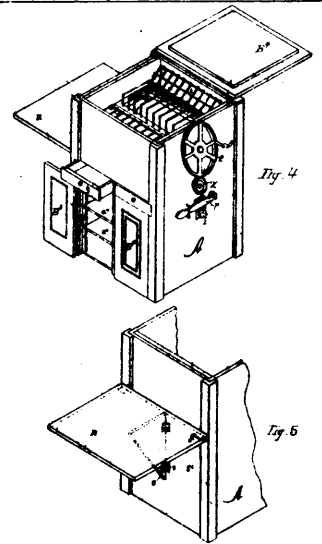

21825 Stevens' Apparatus for Washing and Storing Dishes.

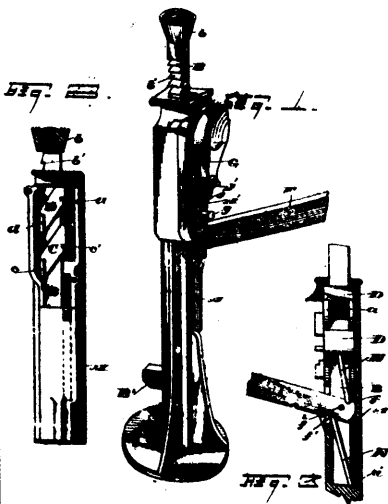

21826 Hawkins' Lifting Jack.

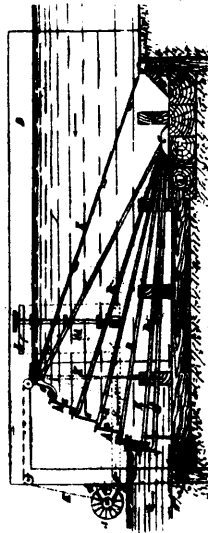

21827 Czoetkovics' Weir and Sluice.

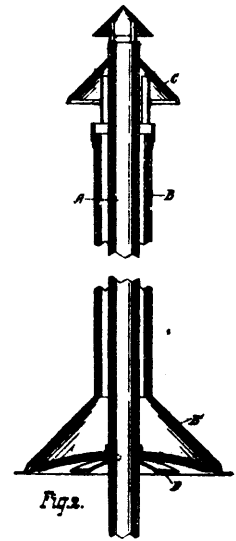

21828 Jackson's Flue and Ventilator.

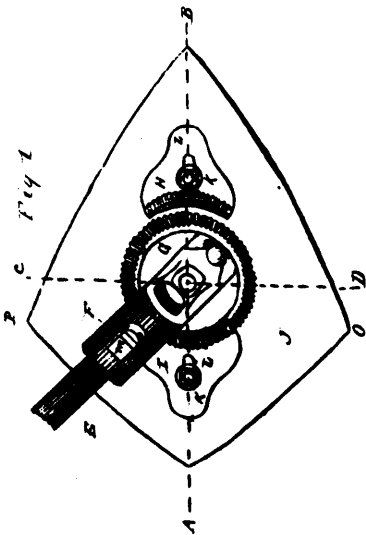

21829 Twitchell's Adjustable Cultivator Shovel.

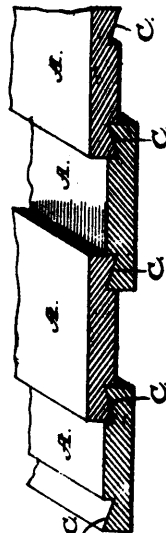

21830 Crable's Roofing and Siding Board.

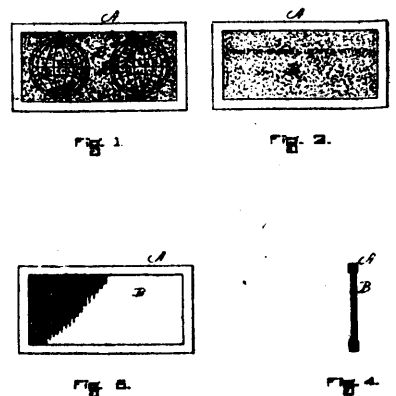

21831 Whittemore's Blackboard.



Figure 2

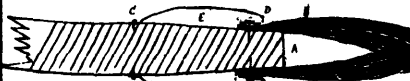

21833 Parneice's Reservoir Attachment for Whitewash and other Brushes.

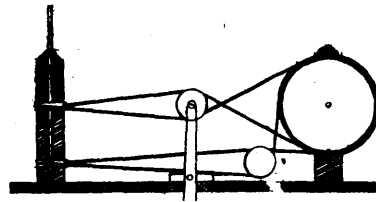
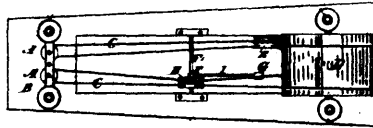

21834 Reid's Improvement for Regulating the Tension Band for Machines used in Spinning and Twisting Fibrous Material.

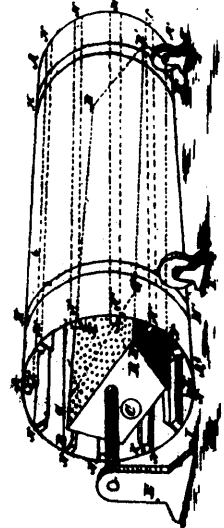

21835 Sawin's Machine for Drying, Cooling, or Cleaning Grain, etc.

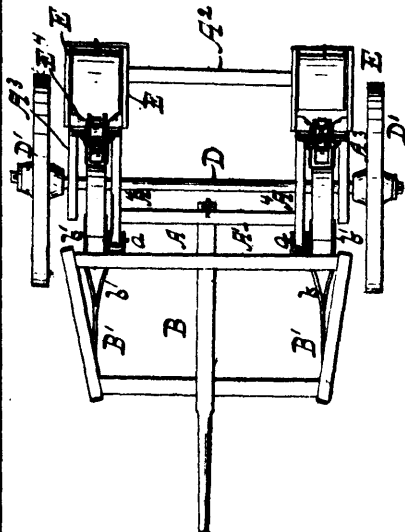

21836 Newbold's Potato Planter.



Fig. 2

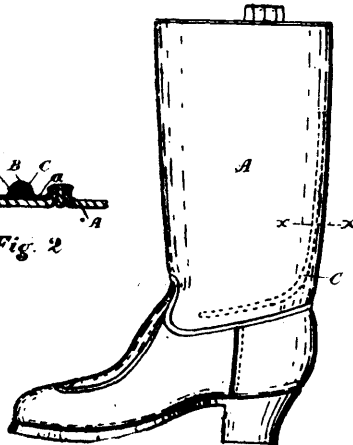

Fig. 1

21837 Leclerc's Boot.

Fig. 1.

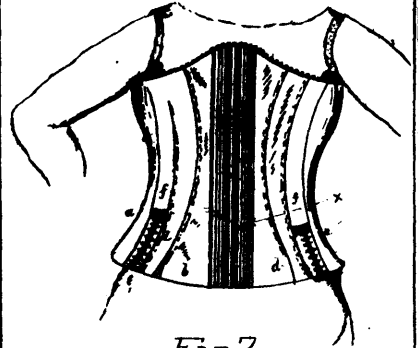
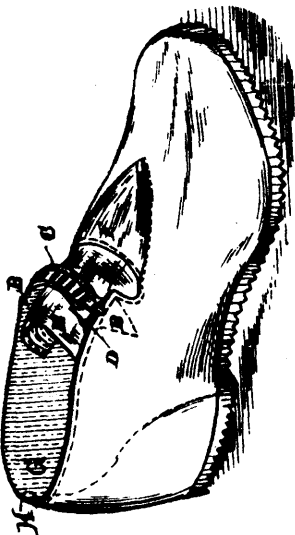

Fig. 2.



21838 Burkhead's Corset.



21839 Hopkins' Rubber Overshoe

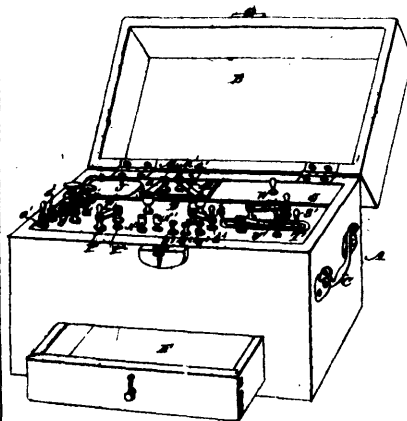

21840 Vernoy's Electro-Medical Battery.

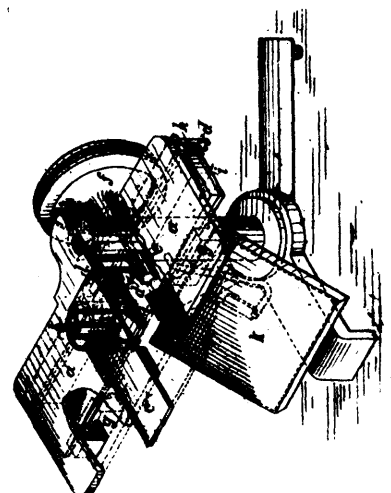

21841 Von Marzow's Means for the Quantitative Estimation of Haemoglobin in the Blood.

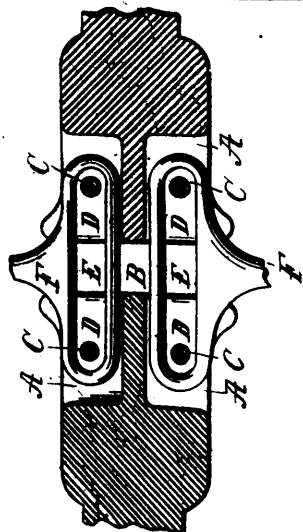

21842 Maxey's Car-Coupler.

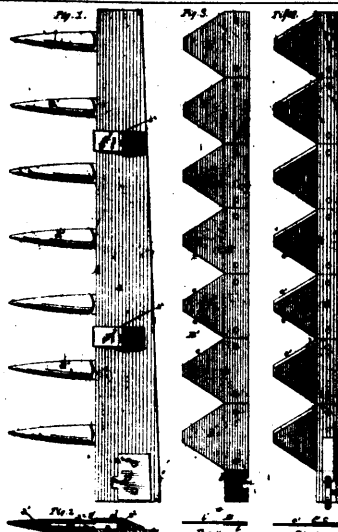

21843 Sanford's Cutting Apparatus for Mowers and Reapers.

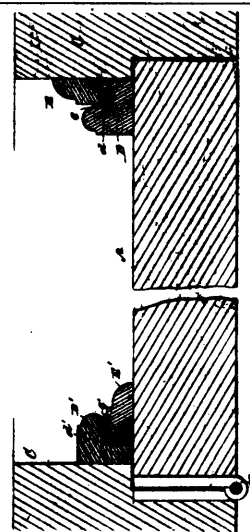

21844 Devers' Weather Strip.

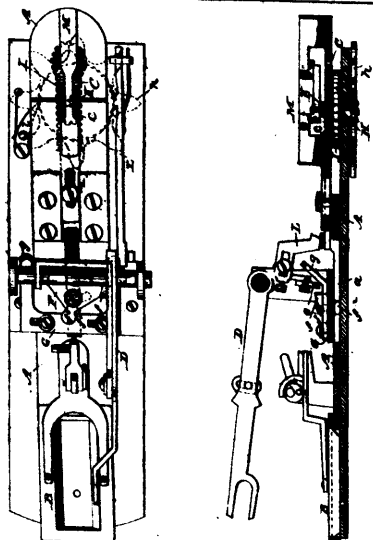

21845 Harris' Button Hole Attachment for Sewing Machines.

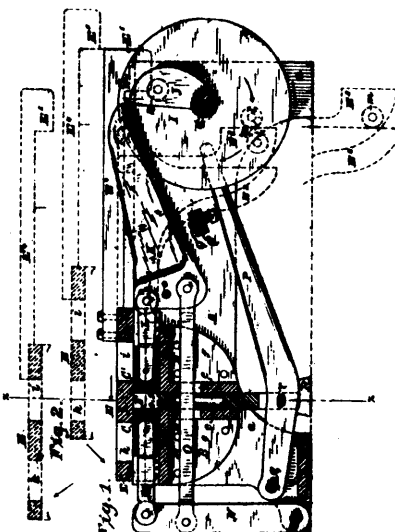

21846 Tiffany's Brick Machine.

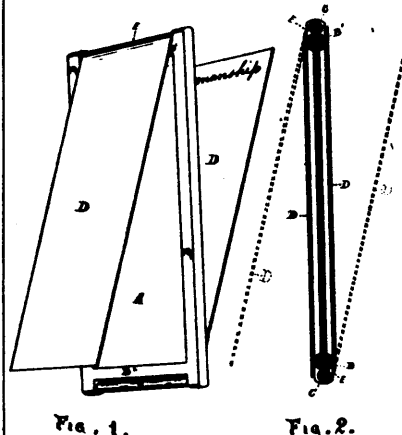

21847 Moore's School Slate.

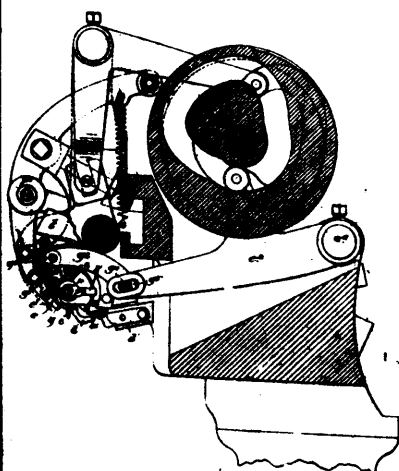

21849 French's Sole Sewing Machine.

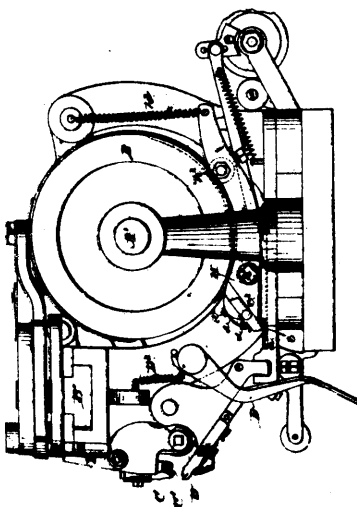

21850 French's Sole Sewing Machine.

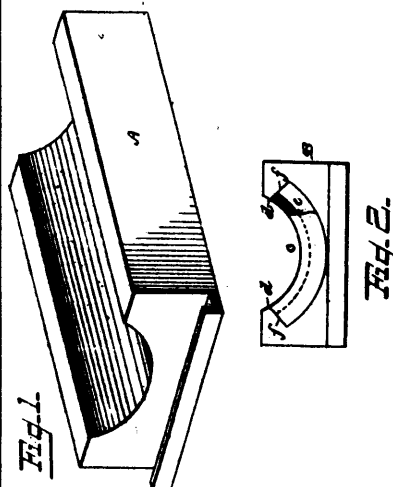

21851 Copley, Seldomridge and De la Vergne's Journal Bearing.

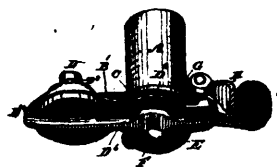

Fig. 1

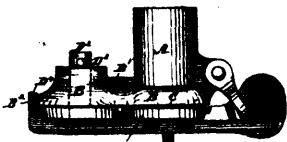

Fig. 2

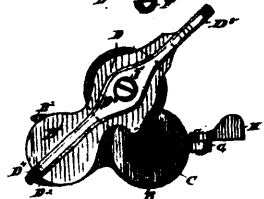

Fig. 3

21852 McEwan's Creamer Gate Faucet.

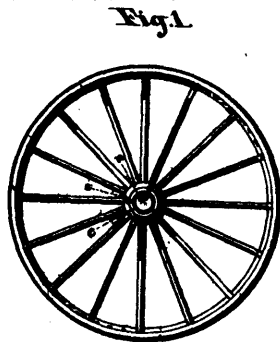

Fig. 1

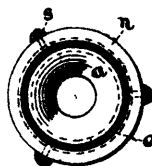
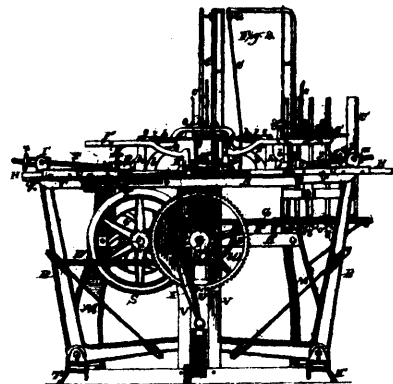
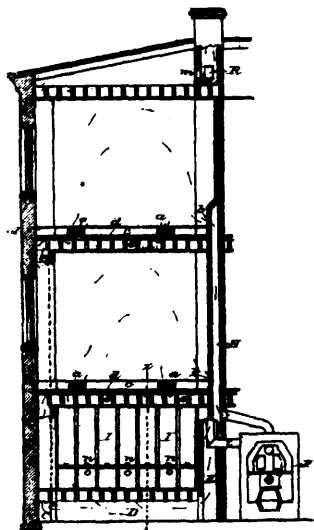

Fig. 2.

21853 Eberhard's Vehicle Hub Cap.



21854 Sherman's Machine for Glueing and Putting Together Dovetailed and other Boxes.



21855 Smead's Dry Closet.

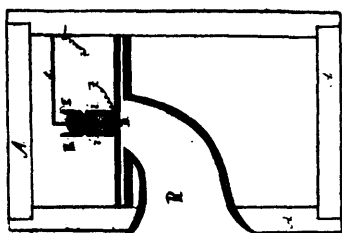

Fig. 1



Fig. 2

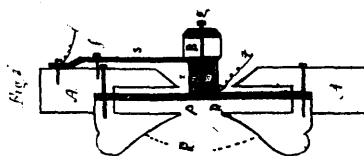

Fig. 3

21856 Witmer's Telephone Transmitter.

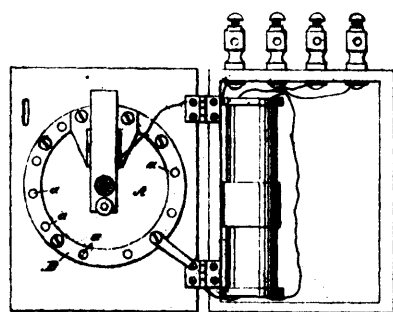

Fig. 1

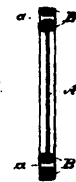

Fig. 2

21857 Barnard's Diaphragm for Telephones.

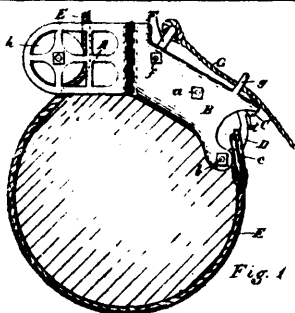

Fig. 1

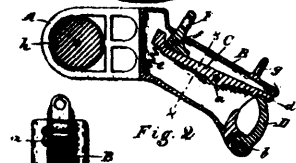

Fig. 2

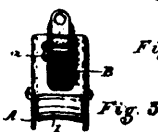
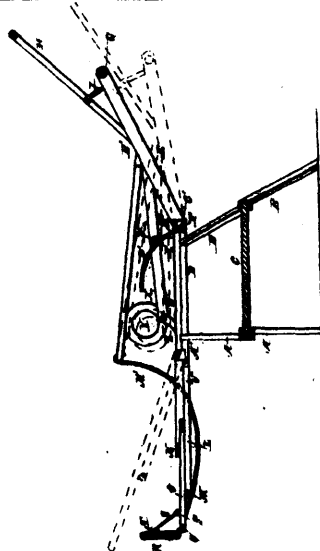
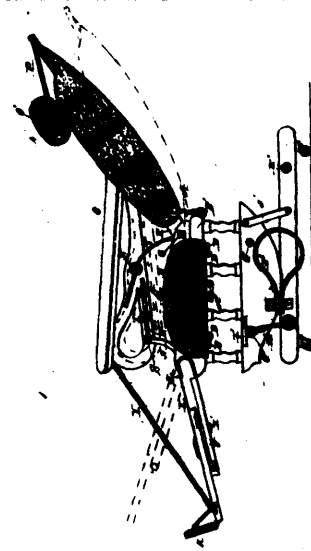

Fig. 3

21858 Harrington's Snap Pulley for Elevators.



21859 Plummer's Chair.



21860 Plummer's Chair.

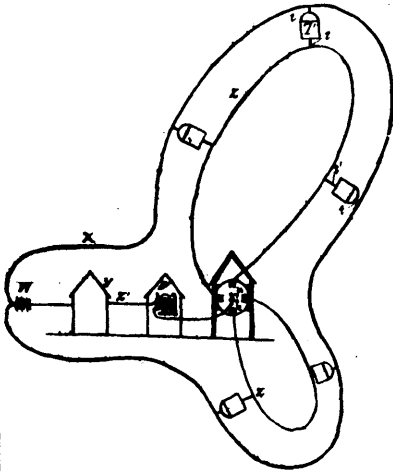

21861 McCullough's Fire Alarm Telegraph System.

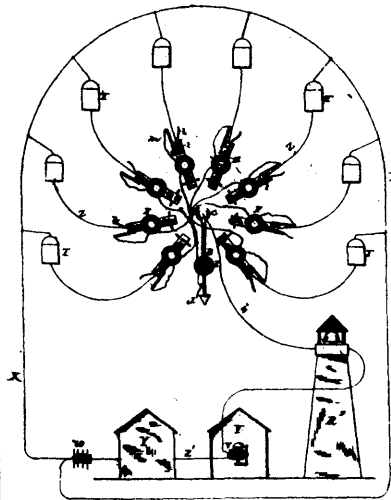

21862 McCullough's Non-Interfering Fire Alarm Telegraph System.

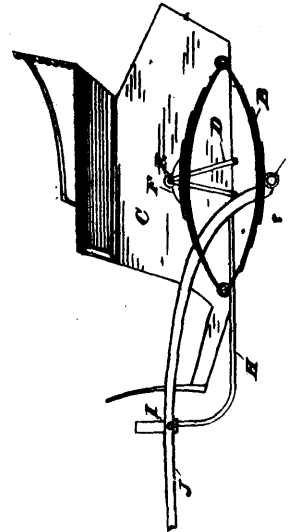

21863 Dolsen's Road Cart.

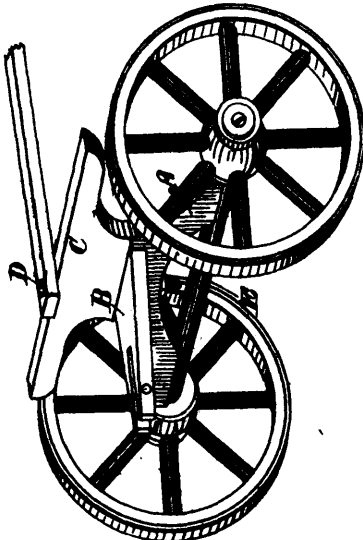

21864 Brandon's Running Gear for Toy Waggon.

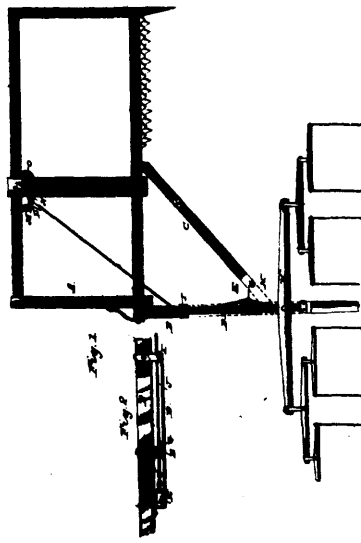

21865 Roth's Draft Equaliser.

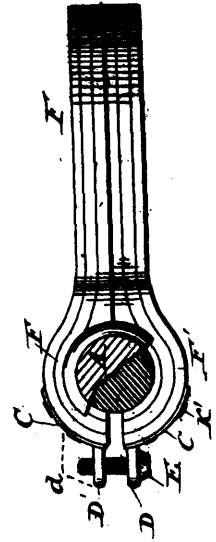

21866 Hellman's Neck Yoke Centre.

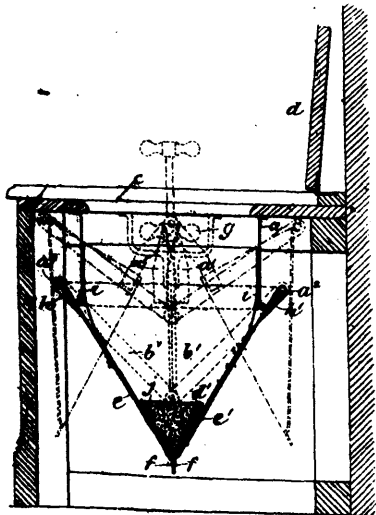

21867 Hawkey's System of Disposing of Sewage etc.

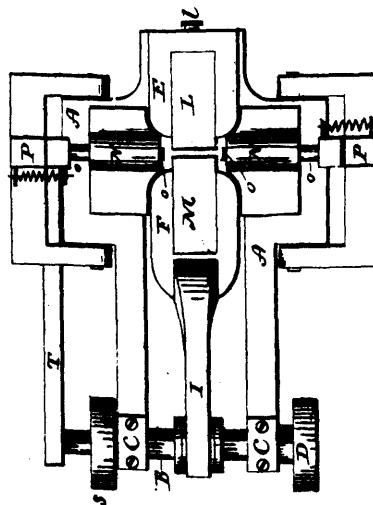

21868 Harris' Machine for Making Wire Tacks.

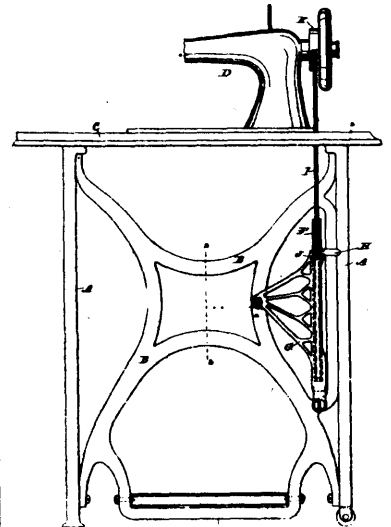

21869 Diehl's Belt Shifting and Replacing Device.

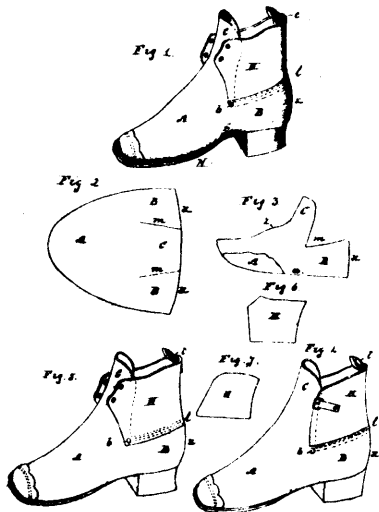

21870 Godfrey's Shoe.

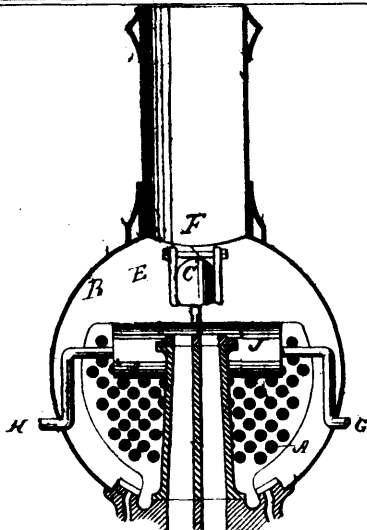

21871 Bushforth's Apparatus for Supplying Locomotive or Stationary Engine Boilers with Water.

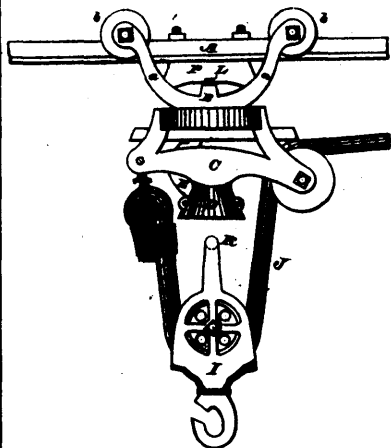

21872 Ney's Hay Elevator.

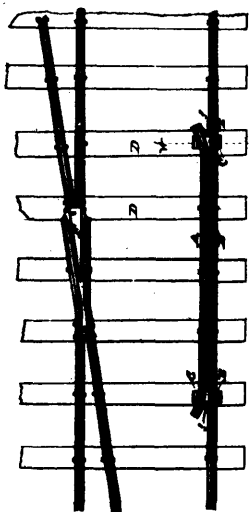

21874 Orcutt's Guard Rail Lock for Railroads.

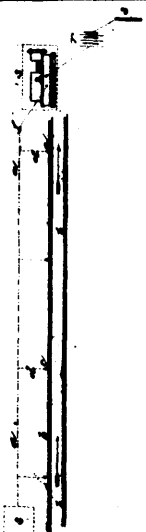

21875 Enright's Signalling Apparatus for Railways, etc.

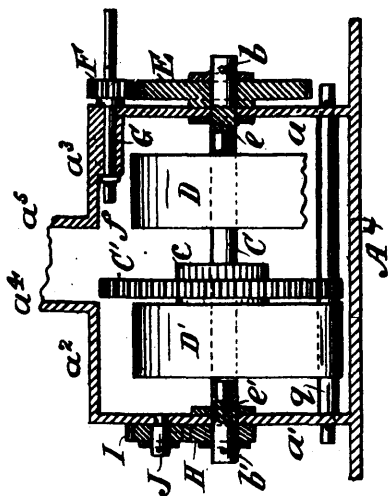

21876 Chitnook's Mechanical Lamp.

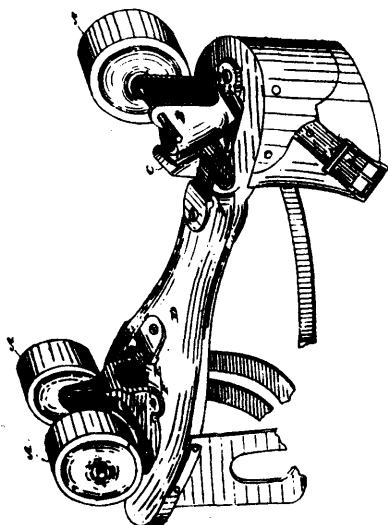

21877 Peerless' Roller Skate.

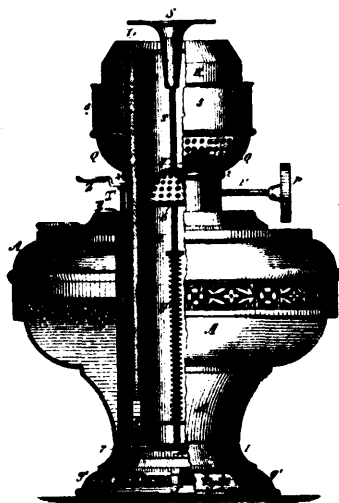

21878 Hayden's Lamp.

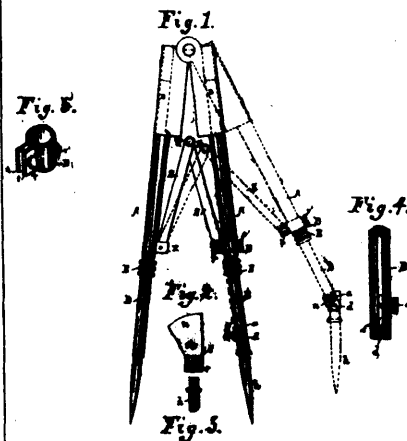

21879 Stoddard's Calliper and Divider.

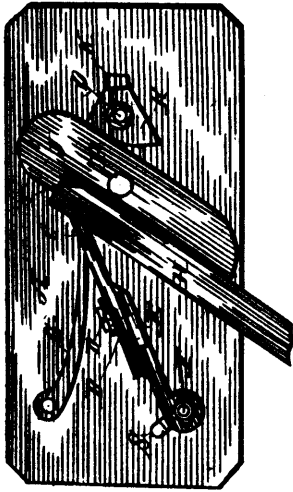

21880 Schmachtenberger's Picket Pointing Machine.

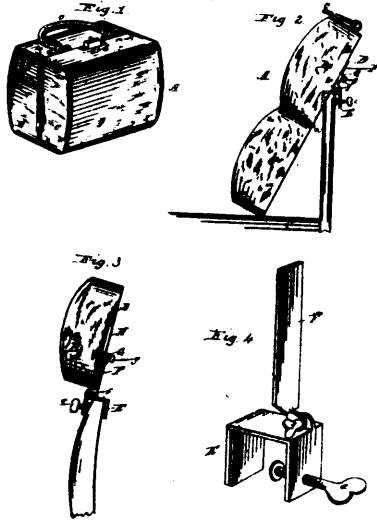

21881 Doren's Head Rest for Chairs and Car Seats.

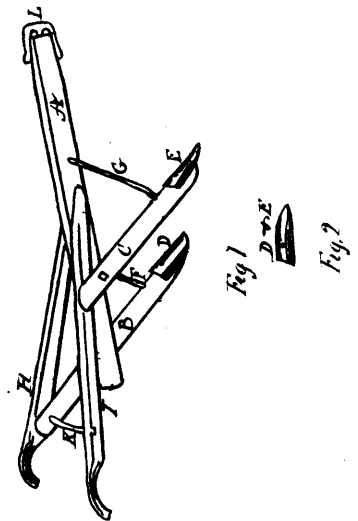

21882 Patterson's Machine for Hoeing Corn and Boots.

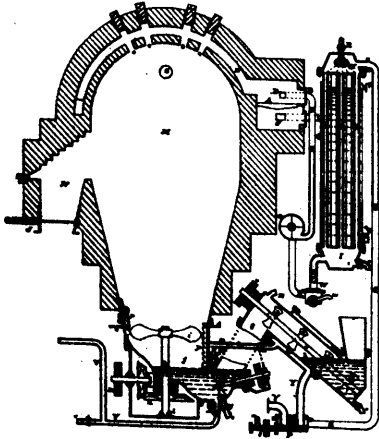

21883 Mathieu's Apparatus for Carbonizing Saw Dust, etc.

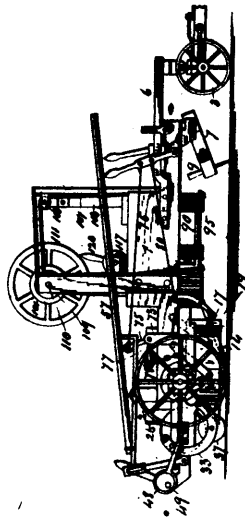

21884 Weatherbee's Machine for Gathering Stones.

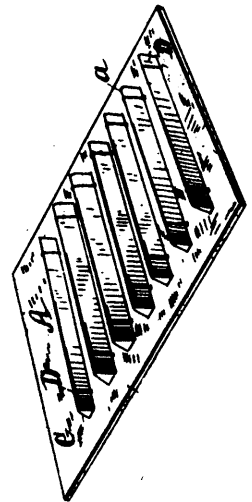

21885 Genese's Dental Separating Wedge.

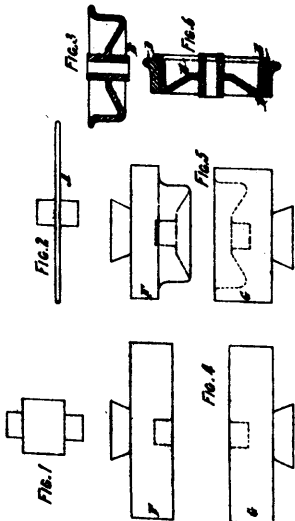

21886 Eyre's Construction of Railway and other Wheels.

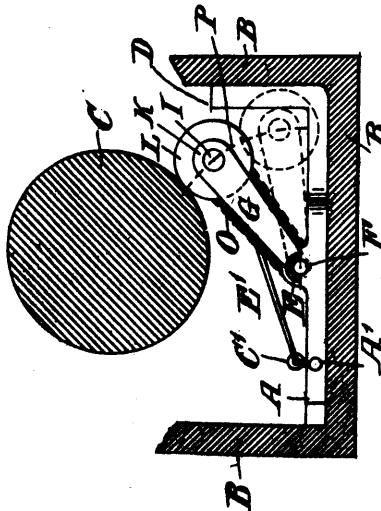

21887 Frechette and Girard's Lubricator for Railway Car Axles.

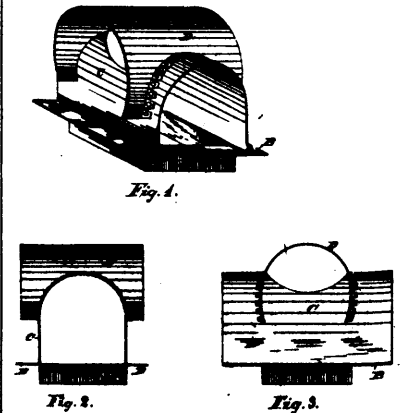

21888 Edwards' Chimney Cowl.

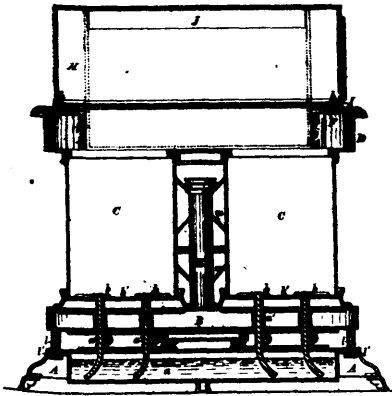

21889 Ham's Oil Stove.

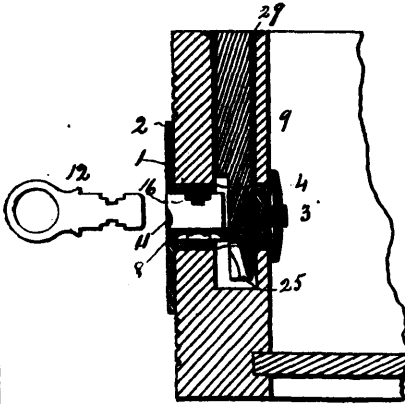

21890 Lindlow's Key Locks for Doors, etc.

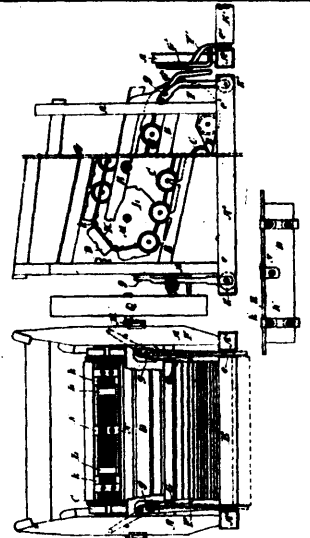

21891 Durocher's Horse Power.

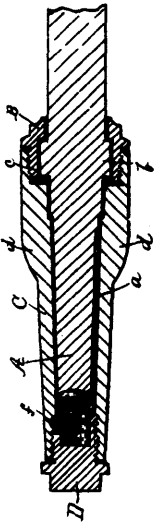

21892 Doty's Vehicle Axle Box.

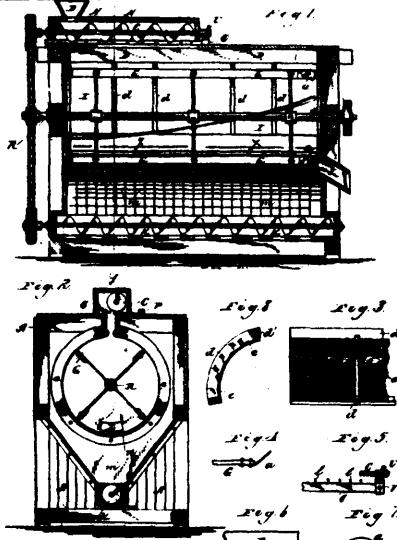

21893 Hunter's Machine for Dressing Flour.

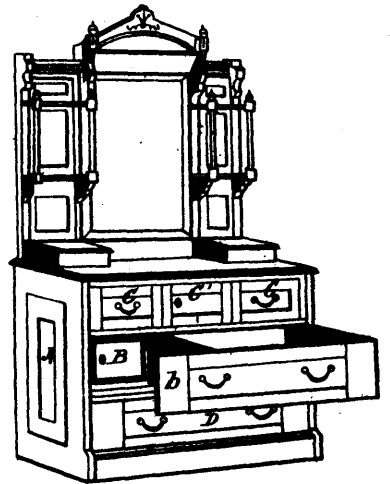

21894 Herig's Household Furniture.

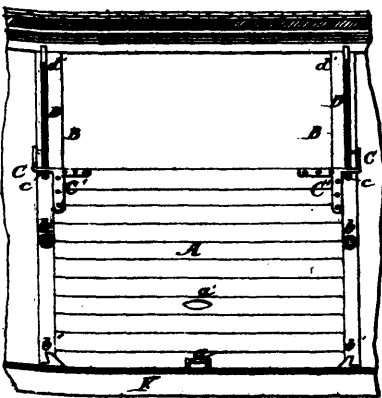

21896 McGuire's Grain Car Door.

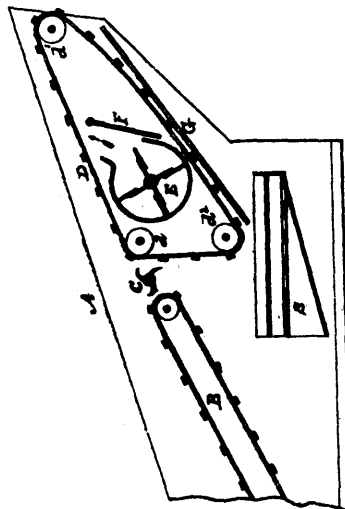

21897 Richards' Threshing Machine.

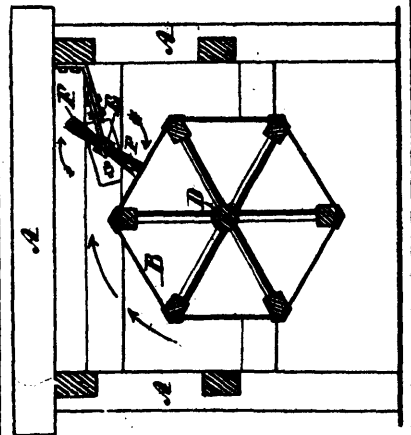

21898 Battson's Brush for Flour Bolting Machines.

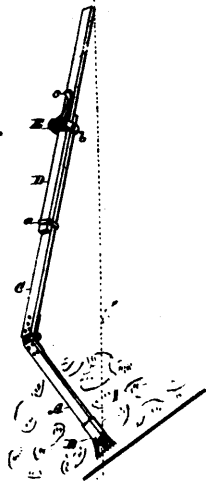

21899 Burns' Carpet Stretcher.

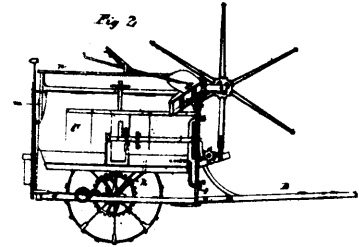
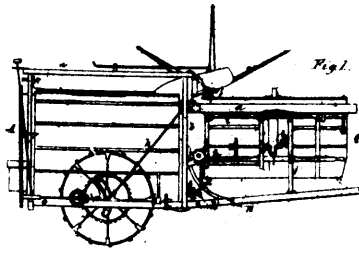

21900 Grout & Oakley's Harvester Binder.

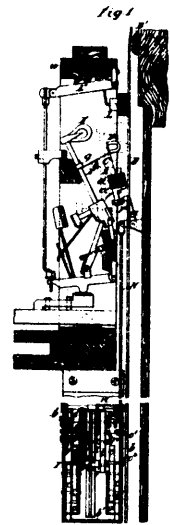

21901 Caldera's Pianoforte.

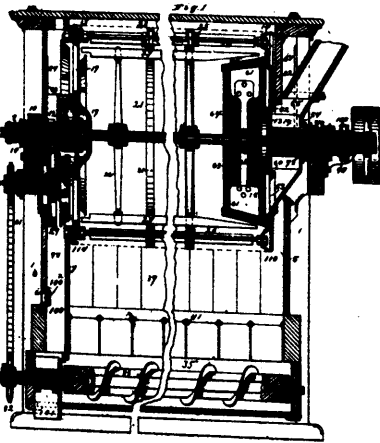

21902 Smith's Centrifugal Reel.

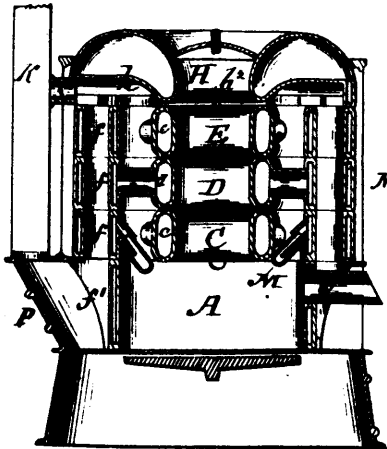

21903 Pulsifer's Boiler for Heating Purposes.

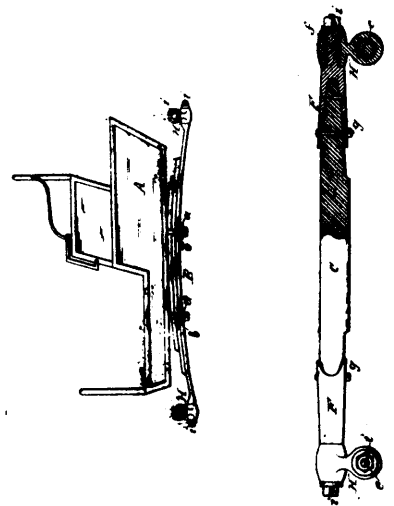

21904 Bradley's Carriage Spring.

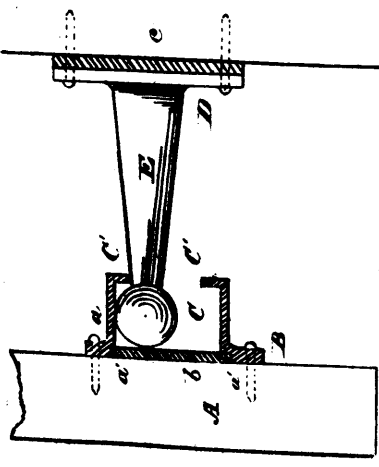

21905 Vandeburgh's Door Check.

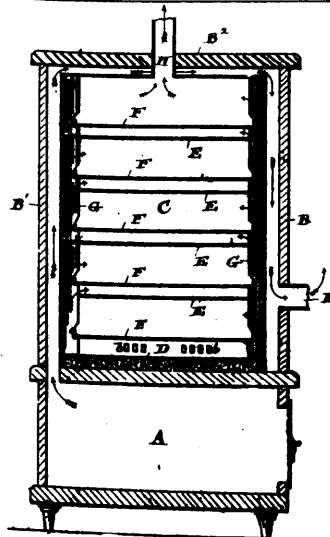

21906 Wallace's Evaporator.

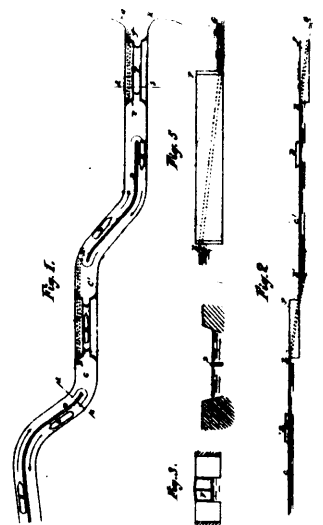

21907 Nougues' Canal and Navigation of the same.

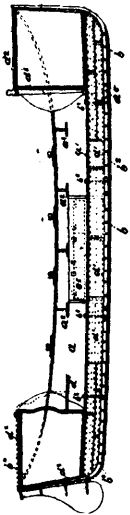

21908 Dobbins' Life Boat.

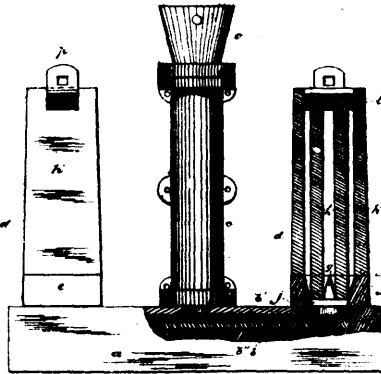

21909 Illingworth's Mould for Casting Ingots.



21910 Bough's Boat.

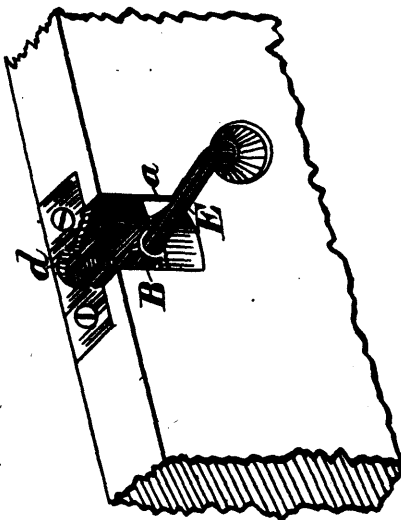

21911 Ripson & Watson's Fastening for Coffins, etc.

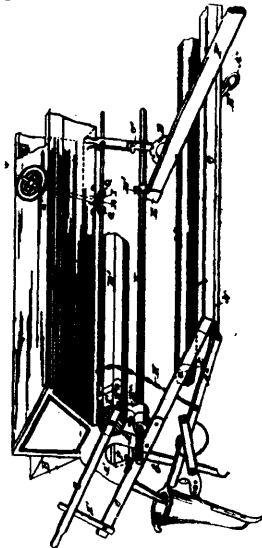

21912 Bartlett's Seeding Machine.

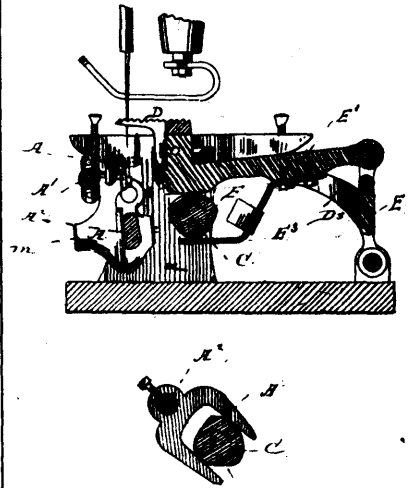

21913 Muther and Dearborn's Sewing Machine.

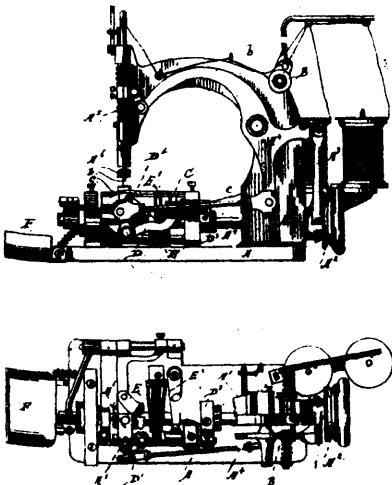

21914 Muther & Woodward's Sewing Machine.

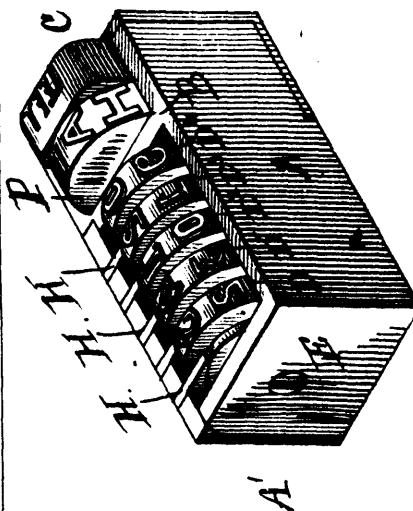

21915 Beinhardt & Ellis' Consecutive Numbering Machine.

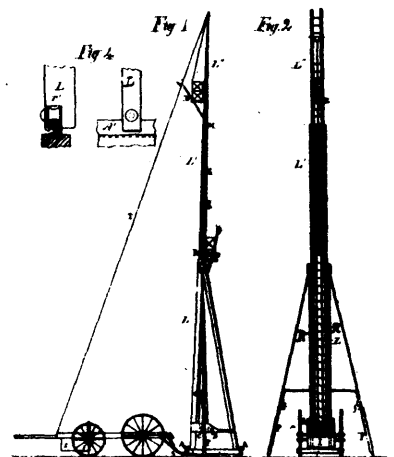

21916 De Elorriaga-Y-Rivas' Fire Ladder.

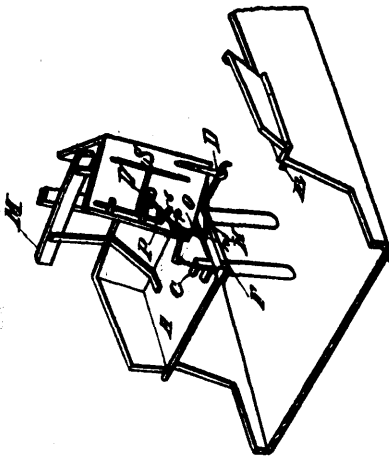

21917 Pariseau's Carriage Seat.

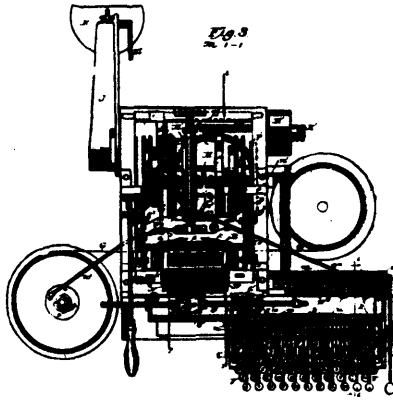

21918 Mergenthaler's Machine for Producing Stereotype Matrices, etc.

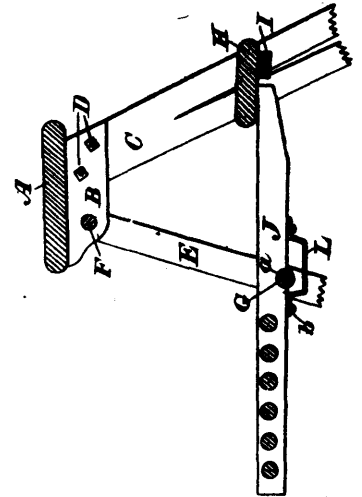

21919 Brandon's Step Ladder.

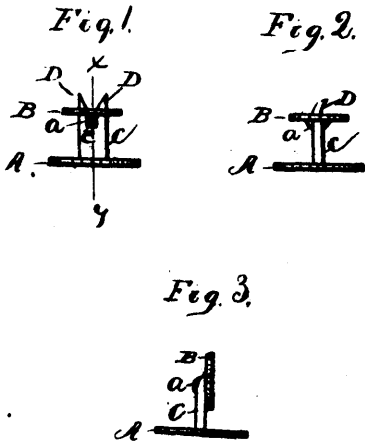

21921 Burtis' Collar Button and Necktie Holder.

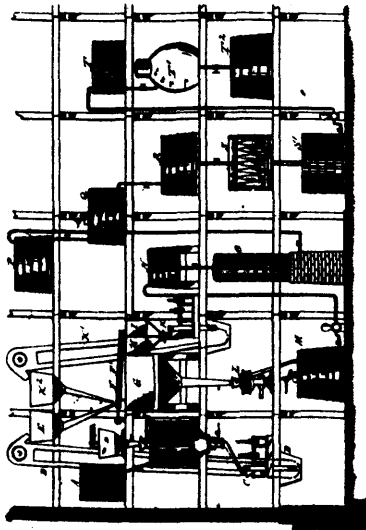

21922 Schuman's Manufacture of Grape Sugar and Glucose.

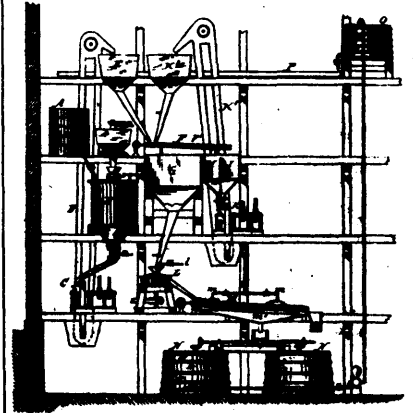

21923 Schuman's Manufacture of Starch.

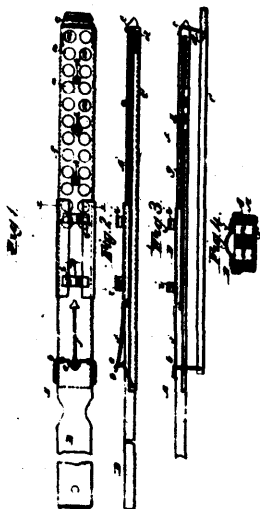

21924 Moore's Pill Counter.

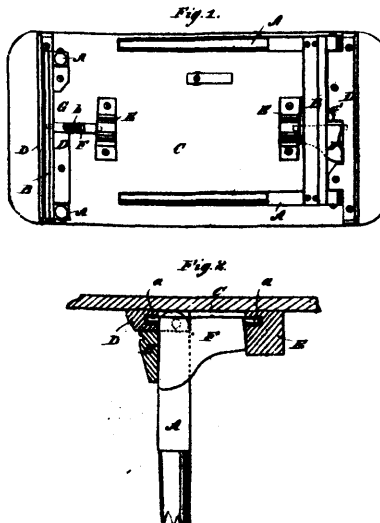

21925 Eldred's Folding Table.

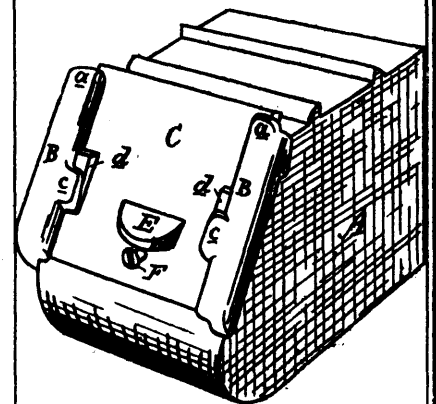

21926 Hunter's Car Axle Box.

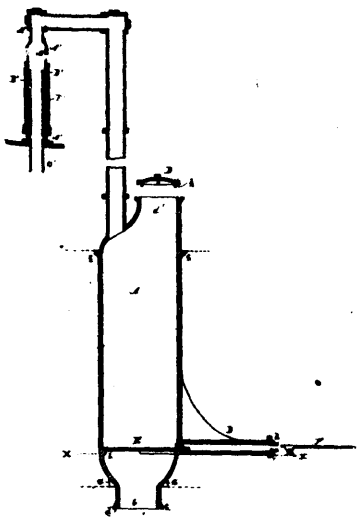

21927 Jarves' Retort and Seal therefor.

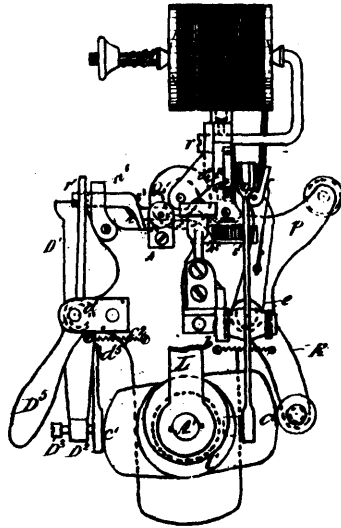

21928 Smith's Carpet Sewing Machine.

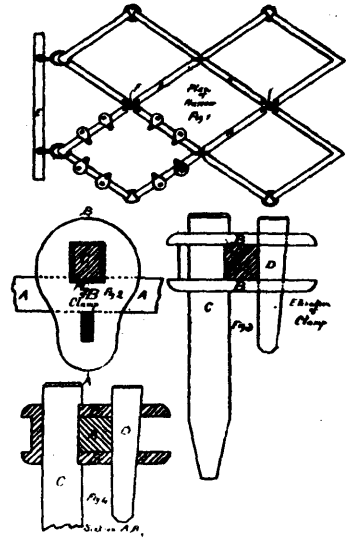

21929 Dougherty & Ball's Harrow.



21930 Cory's Waterproof Garment.

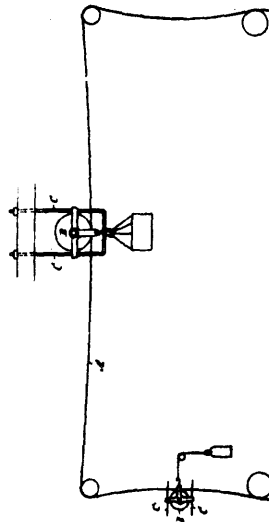

21931 Whiting's Belt Tightener.

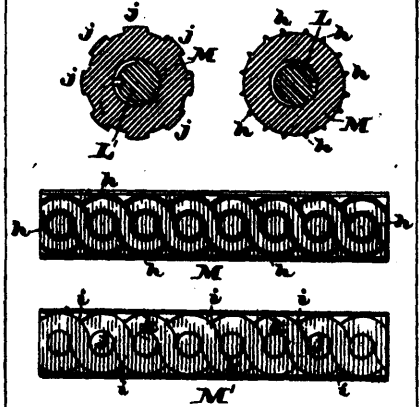

21932 Jamison's Machine for Ornamenting Wood.

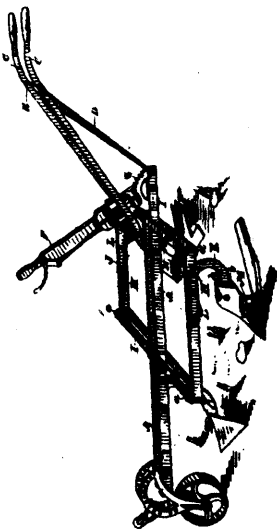

21933 Wagner's Souffler.

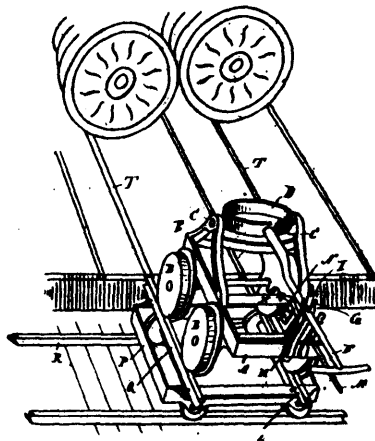

21934 Whiting's Transfer Truck.

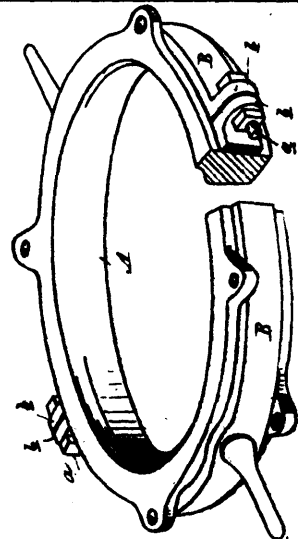

21935 Whiting's Chill for Casting Car Wheels.

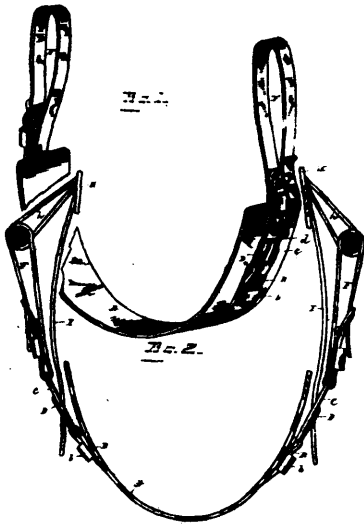

21936 Allen & Dubbe' Harness.

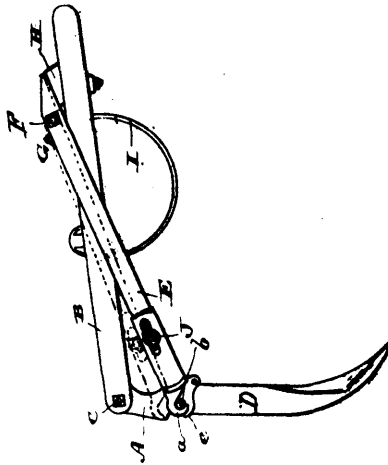

21937 Hamilton's Device for Detachably Connecting the Hoes of Seeding Machines to the Drag Bar.

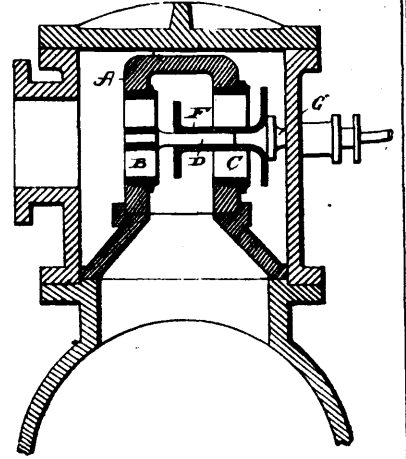

21938 Mann's Automatic Cut-off Valve for Steam, Gas, or other Engines.

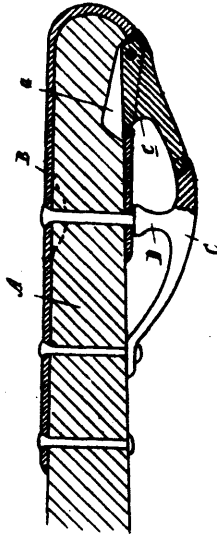

21939 Springsteen's Wagon Pole Iron.

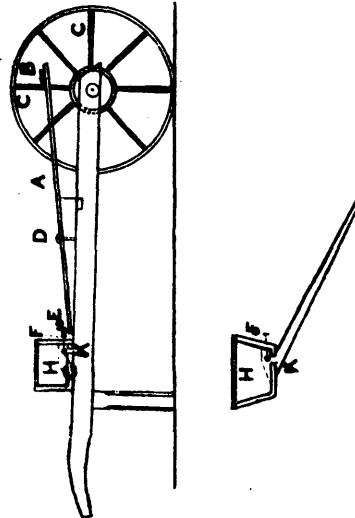

21940 Whelan's Machine for Sowing Grass Seed, etc.

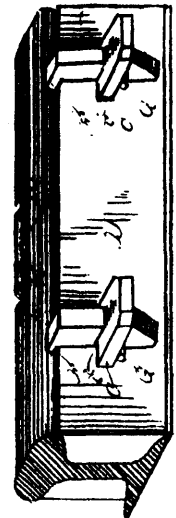

21941 Kellow's Rail Joint.

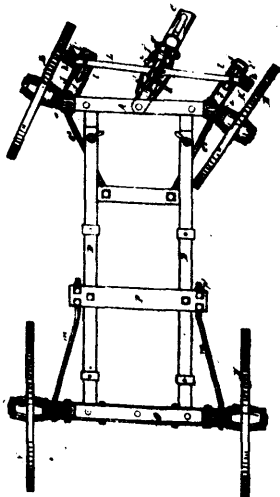

21942 Hurd's Wagon.

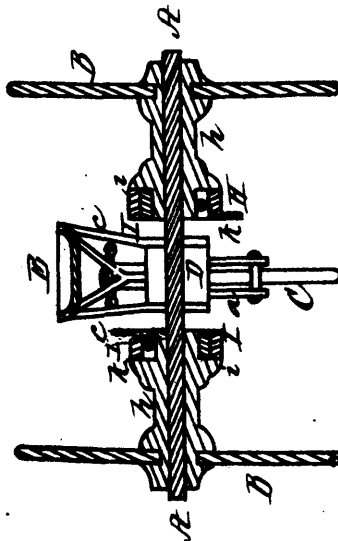

21943 Hall's Velocipede.

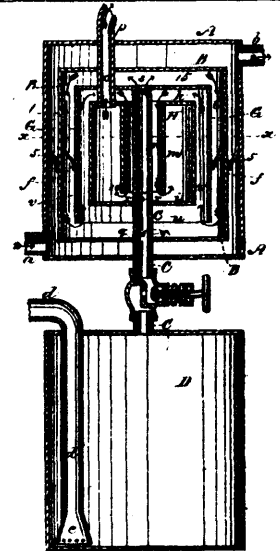

21944 Cushing's Condenser.

INDEX OF INVENTIONS.

Aerated water, A. Esilman, et al.....	21,873
Axle box, car, R. Hunter.....	21,926
“ “ vehicle, W. H. Doty.....	21,892
“ lubricator, railway car, I. Fréchet et al.....	21,887
Belt shifter and replacer, P. Diehl.....	21,869
“ tightener, J. H. Whiting.....	21,931
Blackboard, W. H. Whittemore.....	21,831
Boat, J. W. Rough.....	21,910
Boller, apparatus for supplying water to, W. H. Rushforth.....	21,871
Boot and shoe, H. T. Marshall.....	21,812
Boots, G. Leclerc.....	21,837
Brick machine, J. Tiffany.....	21,846
Brushes, reservoir for, M. A. Parmalee.....	21,833
Button and neck tie holder, collar, J. W. Burtis.....	21,921
“ “ or knob, W. F. Ware.....	21,815
Cable or conductor, electrical A. C. Tichenor et al.....	21,824
Caliper or divider, O. Stoddard.....	21,879
Canals, navigation of, J. Mongues.....	21,907
Car coupler, B. A. Maxey.....	21,842
“ door, grain, W. McGuire.....	21,896
“ seat, head rest, H. E. Doren.....	21,881
“ wheel, chills for casting, J. H. Whiting.....	21,935
Carbonizing saw dust, bagasse, etc., J. A. Mathieu.....	21,833
Carpet stretcher, F. W. Burns.....	21,899
Cart, road, I. Dolsen.....	21,863
Carriage seat, J. Pariseau.....	21,917
“ spring, C. C. Bradley.....	21,904
Catch spring, J. D. Ripson et al.....	21,911
Ceiling, metallic, A. Northrop.....	21,801
Centrifugal reel, G. T. Smith.....	21,902
Chair, F. H. Plummer.....	21,859
Chamfering machine, shingle, G. Adam.....	21,817
Chimney cowl, T. Edwards.....	21,888
Condenser, J. B. Cushing.....	21,944
Corn and roots, machine for hoeing, G. Patterson.....	21,882
Corset, S. T. Burkhead.....	21,838
Cultivator shovel, adjustable, M. A. Twitchell et al.....	21,829
Cut-off valve, steam engine, J. H. Man.....	21,938
Derrick, J. N. Flisk.....	21,810
Dishes, apparatus for washing and storing, J. S. Stevens et al.....	21,825
Door check, O. P. Vandeburgh.....	21,905
Doors, drawers, etc., key locks for, W. I. Ludlow.....	21,890
Draft equalizer, G. C. Roth.....	21,865
Dry closet, I. D. Smead.....	21,855
Evaporator, E. L. Wallace.....	21,906
Explosive compound, T. Petry, et al.....	21,848
Faucet creamer, gate, J. M. Gill.....	21,852
Flour bolt, brushes for, A. L. Battson.....	21,898
“ dresser, W. H. Doty.....	21,893
Flue and ventilator, A. S. Jackson et al.....	21,828
Folding table, W. E. Eldred.....	21,925
Furniture, household, A. Herig.....	21,894
Garment, waterproof, L. Cory.....	21,930
Grain, sugar, etc., drying, cooling, etc., E. H. Sawin.....	21,855
Guard, rail lock for railways, F. H. Orcutt.....	21,874
Haemoglobin, means for the quantitative estimation of, E. F. Van Marscow.....	21,841
Heating apparatus, hot water, E. S. Manny.....	21,798
Harness, C. Allen et al.....	21,936
“ I. Ireland.....	21,803
Harrow, W. Dougherty et al.....	21,929
Harvester binder, J. H. Grout.....	21,908
Hay elevator, J. Ney.....	21,872
“ “ and carrier, snap pulley for, E. Harrington.....	21,858
Horse collars from leather scraps, manufacture of, J. Stanley et al.....	21,906
“ power, G. B. Ellis.....	21,797
“ “ Z. Durocher.....	21,891
“ shoe, duplex, A. C. Howes.....	21,820
Hub-cap, vehicle, J. G. Eberhard.....	21,853
Ingots, moulds for casting, J. Illingworth.....	21,909
Journal bearing, E. Copley et al.....	21,851
Ladder, fire, R. de E. T. Rivas.....	21,916
“ step, construction of, C. F. Brandon.....	21,919
Lamp, Holmes, Booth & Haydin.....	21,878
“ L. Henkle.....	21,816
“ mechanical, F. E. May.....	21,876
Life boat, D. P. Dobbins.....	21,908
Lifting jack, J. Chase.....	21,811
“ “ J. W. Hawkins.....	21,826
Lock joints, machine for gluing and putting together, dove tailed, G. P. Sherman.....	21,854

Lubricator, C. B. Hodges.....	21,799
Medical battery, electro, S. Vernoy.....	21,840
Medicinal compound, D. Haerberle.....	21,796
“ “ “ D. Langis.....	21,832
“ “ “ L. L. Moore.....	21,805
Mowers and reapers, cutting apparatus for, H. T. Sawford.....	21,843
Numbering machine, consecutive, J. H. Reihardt et al.....	21,915
Nut lock, G. B. Smith.....	21,808
Organ reed, G. W. Scribner.....	21,813
Overshoe, rubber, J. S. Hopkins.....	21,839
Pavement, side walk and facing block, H. G. Fliske.....	21,814
Paving block composition, D. G. Conger.....	21,819
Piano forte, L. Caldera.....	21,901
Picket pointing machine, O. Schmachtenberger.....	21,880
Pill counter, D. B. Moore.....	21,924
Pipe coupling, W. Martin.....	21,821
Potato planter, W. F. Newbold.....	21,836
Printers' moulds for casting slugs and leads, G. W. Surguy.....	21,802
Printing machine and matrix making, O. Mengenthaler.....	21,800
Pug mill, S. K. Fletcher et al.....	21,822
Rail joint, J. Kallow.....	21,941
Railway signal, J. Enright.....	21,875
Retort and seal, D. Jarves.....	21,927
Roofing and sliding board, J. W. Crable.....	21,850
Running gear for toy waggons, C. T. Brandon.....	21,864
Saw set, W. Koff et al.....	21,807
School slate, T. A. M. Moore.....	21,847
Scuffer, B. Wagner.....	21,933
Seed drill and broadcast scatterer, J. Larsen.....	21,818
Seeding machine, J. Whelan.....	21,940
“ “ W. T. Dingle.....	21,912
“ “ device for connecting the hoes of, P. Hamilton.....	21,937
Sewage, dry system of disposing of, T. Hawksley.....	21,867
Sewing machine, L. Muther et al.....	21,913
“ “ carpet, A. B. Smith.....	21,928
“ “ button hole attachment, J. H. Harris.....	21,845
“ “ sole, Z. T. French.....	21,849
Shoe, C. B. Godfrey.....	21,870
Skate, roller, J. H. Hull.....	21,877
Starch, Manufacture of, W. J. Jebb.....	21,923
“ and glucose manufacture of, P. Radenhausen.....	21,877
Steam boiler for heating purposes, F. H. Pulsifer.....	21,903
Stereotype matrices etc., machine for producing, O. Mergenthaler.....	21,918
Stone gatherer, B. A. Weatherbee.....	21,884
Stove oil, C. T. Ham.....	21,889
“ ventilating, H. C. Snow.....	21,809
Sugar and glucose, grape, manufacture of, W. T. Jebb.....	21,922
Telegraph fire alarm, L. H. McCullough.....	21,861
“ “ non interfering, L. H. McCullough.....	21,862
Telephone, diaphragm for, D. G. Barnard.....	21,857
“ transmitter, J. S. Witner.....	21,856
Thrashing machine, L. A. Richards.....	21,897
Truck, transfer, J. H. Whiting.....	21,934
Velocipede, L. Hall.....	21,943
Veneer, A. and C. Montferrat.....	21,920
Wagon, L. D. Hurd.....	21,942
“ pole iron, N. E. Springsteen.....	21,939
Water purifier apparatus, P. B. Charboneau.....	21,804
Weather strip, W. J. Devers.....	21,844
Wedge, dental separating, D. Genese.....	21,865
Weir and sluice, M. D. Czoetkovic et al.....	21,827
Wheels, construction of, W. Eyre.....	21,886
Windows of carriages, apparatus for raising and lowering, W. Frost et al.....	21,823
Wire tacks, machine for making, T. Harris.....	21,868
Wood ornamenting machine, J. P. Jamison.....	21,932

INDEX OF PATENTEES.

Adam, G., shingle and chamfering machine.....	21,816
Allen, C., et al., harness.....	21,939
Ball, E. M., et al., barrow.....	21,927
Barnard, D. G., diaphragms for telephones.....	21,857
Bartlett, J., seeding machine.....	21,912
Battson, A. L., brushes for flour bolting machines.....	21,899
Bradley, C. C., carriage spring.....	21,908
Brandon, C. T., construction of step ladder.....	21,914
“ “ running gear of toy waggons.....	21,864
Burkhead, S. T., corset.....	21,838

Burns, F. W., carpet stretcher.....	21,899	Koff, W., saw set.....	21,807
Burtis, J. W., collar button and necktie holder.....	21,921	Langis, D., medicinal compound.....	21,832
Caldera, L., improvements in and relating to pianofortes.....	21,901	Larsen, J., seed drill and broadcast scatterer.....	21,818
Charboneau, P. B., et al., water purifying apparatus.....	21,804	Leclerc, G., boots.....	21,837
Chase, J., lifting jack.....	21,811	Lemassena, T. F., et al., manufacture of horse collar from leather scraps.....	21,806
Chimock, G. H., mechanical lamp.....	21,876	Litsch, H., et al., explosive compound.....	21,848
Cleveland Carriage Goods Co., vehicle hub caps.....	21,853	Ludlow, W. I., key locks for doors, drawers, etc.....	21,890
Conger, D. G., composition paving block.....	21,819	McCoy, E., et al., lubricator.....	21,799
Copley, E., et al., journal bearing.....	21,851	McCullough, L. H., fire alarm telegraph.....	21,861
Cory, L., waterproof garments.....	21,930	" " non-interfering fire alarm telegraph.....	21,862
Crabbe, J. W., roofing and siding boards.....	21,830	McEwan, J. C., creamer gate faucet.....	21,852
Cushing, I. B., condenser.....	21,944	McGuire, W., et al., grain car door.....	21,896
" Process Co., condenser.....	21,944	Man, J. H., automatic cut-off valve for steam, gas, or other engines.....	21,938
Czoatkovics, M. D., et al., weirs and sluices.....	21,827	Manny, E. S., hot water heating apparatus.....	21,798
Davenport Glucose Man'g. Co., manufacture of starch and glucose.....	21,895	Marshall, H. T., boot and shoe.....	21,812
Dearbon, C. A., et al., sewing machine.....	21,913	Marston, G., et al., electrical cables or conductors.....	21,824
De La Vergne, G., et al., journal bearing.....	21,851	Martin, W., pipe coupling.....	21,821
Devers, W. J., weather strip.....	21,844	Mathieu, J. A., apparatus for carbonizing saw dust, vasse, etc.....	21,883
Diebe, P., belt shifting and replacing devices.....	21,869	Maxey, B. A., car coupler.....	21,842
Dingle, W. T., seeding machine.....	21,912	May, F. E., mechanical lamp.....	21,876
Dobbins, D. P., life boat.....	21,908	Mergenthaler, O., machine for producing stereotype matrices, etc.....	21,918
Dolsen, I., road cart.....	21,863	Mergenthaler, O., matrix making and printing machine.....	21,900
Doren, H. E., head rests for chairs and car seats.....	21,881	Merlot, J. L., et al., apparatus for raising and lowering the windows of railway and other carriages.....	21,823
Doty, W. H., vehicle axle box.....	21,892	Montferat, A. & C., veneer.....	21,920
Dubbs, W. E., et al., harness.....	21,936	Moore, D. B., pill counter.....	21,924
Durocher, Z., horse power.....	21,891	" L. L., medicinal compound.....	21,805
Eberhard, J. G., vehicle hub cap.....	21,853	" T. A. M., school plate.....	21,847
Edwards, T., chimney cowl.....	21,888	Muther, L., et al., sewing machine.....	21,913
Eldred, W. E., folding valve.....	21,925	Newbold, W. F., potato planter.....	21,836
Electric Signal Co., railway signalling apparatus.....	21,875	Ney, J., hay elevator.....	21,872
Ellis, G. B. & J., horse power.....	21,797	Ney Man'g. Co., hay elevator.....	21,872
Enright, J., railway signalling apparatus.....	21,875	Northrop, A., metallic ceiling.....	21,801
Esilman, A., et al., aerated water.....	21,873	Nongues J., canals and the navigation of same.....	21,907
Eyre, W., construction of wheels.....	21,886	Oakley, S., et al., harvester binder.....	21,900
Fallenstein, O., et al., explosive compound.....	21,848	Orcutt, F. H., guard-rail lock for railways.....	21,874
Fisk, J. N., derrick and carrier.....	21,810	Pariseau, J., carriage seat.....	21,917
Fiske, H. G., sidewalk and facing block for pavements.....	21,814	Parmelee, M. A., reservoir attachment for whitewash and other brushes.....	21,833
Fletcher, S. K., et al., pug mill.....	21,822	Patterson, G., machine for hoeing corn and roots.....	21,882
Fréchette, I., et al., lubricators for railway car axles.....	21,887	Peelless, A. J., roller skate.....	21,877
French, Z. T., sole sewing machine.....	21,849	Perin, S. T., et al., adjustable cultivator shovel.....	21,829
Frost, W., et al., apparatus for lowering the windows of railway and other carriages.....	21,823	Petry, T., et al., explosive compound.....	21,848
Genese, D., dental separating wedges.....	21,885	Plummer, F. H., chair.....	21,860
Gill, J. M., creamer gate faucet.....	21,852	Pulsifer, F. H., steam boiler for heating purposes.....	21,903
Girard, C. L., et al., lubricators for railway car axles.....	21,887	Radenhausen, P., manufacture of starch and glucose.....	21,895
Godfrey, C. B., shoe.....	21,870	Railway Speed Record Co., lifting jack.....	21,826
Grout, J. H., et al., harvester binder.....	21,900	Reid, J., regulating the tension band for machines used in spinning and twisting fibrous materials.....	21,834
Haeberle, D., medicinal compound.....	21,796	Reinhardt, J. H., et al., consecutive numbering machine.....	21,915
" P., " " ".....	21,796	Richards, L. A., thrashing machine.....	21,897
Ham, C. T., oil stove.....	21,889	Ripson, J. D., et al., spring catch or fastening, more especially adapted for coffins and caskets.....	21,911
Hamilton, P., device for connecting the hoes of seeding machines.....	21,937	Rivas, R. de E. T., fire ladder.....	21,916
Harrington, E., snap pulley for hay elevators and carriers.....	21,858	Roth, G. C., draft equalizer.....	21,865
Harris, J. K., button hole attachment for sewing machines.....	21,845	Rough, J. W., boat.....	21,910
Harris, T., machine for making wire tacks.....	21,868	Rushforth, W. H., apparatus for supplying locomotives or stationary engine boilers with water.....	21,871
Hassall, A., et al., aerated water.....	21,873	Sanford, H. T., apparatus for mowers and reapers.....	21,843
Hawes, A. C., duplex horse shoe.....	21,820	" " cutting apparatus for mowers and reapers.....	21,843
Hawkins, G. W., lifting jack.....	21,826	Sawin, E. H., drying, cooling, or cleaning grain, sugar, etc.....	21,835
Hawksley, T., dry system of disposing of sewage.....	21,867	Schmachtenverger, O., picket pointing machine.....	21,880
Hayden, H. W., et al., lamp.....	21,878	Schmalzried, G., consecutive numbering.....	21,915
Hellman, P. J., neck yoke centres.....	21,866	Schuman, J. C., manufacture of grape sugar and glucose.....	21,922
Henkle, L., lamp.....	21,816	Schuman, J. C., manufacture of starch.....	21,923
Hereg, A., household furniture.....	21,894	Scribner, G. W., reed organ.....	21,813
Hodges, C. B., et al., lubricator.....	21,799	Seldomidge, J. F., et al., journal bearing.....	21,851
Hopkins, J. S., rubber overshoe.....	21,839	Shackell, H., et al., machine for glueing and putting together dovetailed lock joint, fingered and other boxes.....	21,854
Horbaczewski, E., et al., weirs and sluices.....	21,829	Sherman, G. P., et al., machine for glueing and putting together dovetailed lock joint, fingered and other boxes.....	21,854
Huffman, M. W., farm harness.....	21,803	Smead, I. D., dry closet.....	21,855
Hull, J. H., roller skate.....	21,877	Smith, A. B., carpet sewing machine.....	21,928
Hunter, A., machine for dressing flour.....	21,893	" G. B., nut lock.....	21,808
" R., car axle box.....	21,926	" G. T., centrifugal reel.....	21,902
Hurd, L. D., wagon.....	21,942	Snow, H. C., ventilating stove.....	21,809
Illingworth, J., moulds for casting ingots of alternating layers of metal.....	21,909	Southworth, W. H., et al., water purifying apparatus.....	21,804
Ireland, I., farm harness.....	21,803		
Jackson, A. S., et al., fue and ventilator.....	21,828		
Jager, F., et al., grain car door.....	21,896		
Jamison, J. F., machine for ornamenting wood.....	21,932		
Jarves, D., retort and seal therefor.....	21,927		
Jebb, W. T., manufacture of grape sugar and glucose.....	21,922		
" " " starch.....	21,923		
Jenkins, N., et al., lamp.....	21,878		
Kellow, J., rail joint.....	21,941		
Kephart, C. J., et al., apparatus for washing and storing dishes.....	21,825		

Springsteen, N. D., waggon pole irons.....	21,939	Von Marscow, E. F., method of and means for the quantitative estimation of haemoglobin in the blood.....	21,841
Stanley, J., et al., manufacture of horse collars from leather scraps.....	21,806	Wagner, B., scuffer.....	21,933
Stearns, N. W., et al., velocipede.....	21,913	Wallace, E. L., evaporator.....	21,906
Stevens, J. S., et al., apparatus for washing and storing dishes.....	21,825	Ware, W. F., buttons or knobs.....	21,815
Stoddard, O., caliper and divider.....	21,879	Watson, R., et al., spring catch or fastening, more especially adapted for coffins and caskets.....	21,911
Surguy, G. W., moulds for casting slugs and leads for printer's use.....	21,802	Weatherbee, B. A., machine for gathering stones.....	21,884
Tarkington, J. S., et al., flue and ventilator.....	21,823	Whelan, J., seed sowing machine.....	21,940
Thomas, R., et al., pug mill.....	21,822	Whiting, J. H., belt tightener.....	21,931
Tickener, A. C., et al., electrical cable or conductor.....	21,824	" " chills for casting car wheels.....	21,935
Tiffany, J., brick machine.....	21,846	" " transfer truck.....	21,934
Twitchell, M. A., et al., adjustable cultivator shovel.....	21,829	Whittemore, W. H., blackboard.....	21,831
Union Bag Machine Co. sewing machine.....	21,913	Willis, H. C., et al., velocipede.....	21,943
Upper, N. & G., waggon.....	21,942	Winter, H. E., et al., apparatus for raising and lowering the windows of railways and other carriages.....	21,823
Vandeburgh, O. P., door check.....	21,905	Witmer, J. S., telephone transmitter.....	21,856
Verno, S., electro medical battery.....	21,840	Woodward, R. G., et al., sewing machine.....	21,914
Von Kopal, W., et al., weirs and sluices.....	21,827		