

Technical and Bibliographic Notes / Notes techniques et bibliographiques

The Institute has attempted to obtain the best original copy available for filming. Features of this copy which may be bibliographically unique, which may alter any of the images in the reproduction, or which may significantly change the usual method of filming, are checked below.

L'Institut a microfilmé le meilleur exemplaire qu'il lui a été possible de se procurer. Les détails de cet exemplaire qui sont peut-être uniques du point de vue bibliographique, qui peuvent modifier une image reproduite, ou qui peuvent exiger une modification dans la méthode normale de filmage sont indiqués ci-dessous.

Coloured covers/
Couverture de couleur

Coloured pages/
Pages de couleur

Covers damaged/
Couverture endommagée

Pages damaged/
Pages endommagées

Covers restored and/or laminated/
Couverture restaurée et/ou pelliculée

Pages restored and/or laminated/
Pages restaurées et/ou pelliculées

Cover title missing/
Le titre de couverture manque

Pages discoloured, stained or foxed/
Pages décolorées, tachetées ou piquées

Coloured maps/
Cartes géographiques en couleur

Pages detached/
Pages détachées

Coloured ink (i.e. other than blue or black)/
Encre de couleur (i.e. autre que bleue ou noire)

Showthrough/
Transparence

Coloured plates and/or illustrations/
Planches et/ou illustrations en couleur

Quality of print varies/
Qualité inégale de l'impression

Bound with other material/
Relié avec d'autres documents

Continuous pagination/
Pagination continue

Tight binding may cause shadows or distortion along interior margin/
La reliure serrée peut causer de l'ombre ou de la distorsion le long de la marge intérieure

Includes index(es)/
Comprend un (des) index

Title on header taken from:/
Le titre de l'en-tête provient:

Blank leaves added during restoration may appear within the text. Whenever possible, these have been omitted from filming/
Il se peut que certaines pages blanches ajoutées lors d'une restauration apparaissent dans le texte, mais, lorsque cela était possible, ces pages n'ont pas été filmées.

Title page of issue/
Page de titre de la livraison

Caption of issue/
Titre de départ de la livraison

Masthead/
Générique (périodiques) de la livraison

Additional comments:/ Various pagings.
Commentaires supplémentaires:

This item is filmed at the reduction ratio checked below/
Ce document est filmé au taux de réduction indiqué ci-dessous.

10X	14X	18X	22X	26X	30X
<input type="checkbox"/>	<input type="checkbox"/>	<input type="checkbox"/>	<input type="checkbox"/>	<input checked="" type="checkbox"/>	<input type="checkbox"/>
12X	16X	20X	24X	28X	32X

THE
CANADIAN PATENT OFFICE
RECORD.

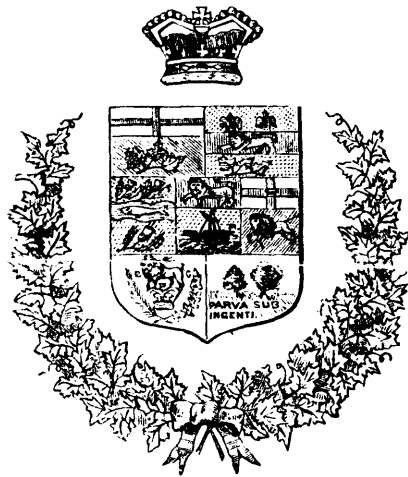

VOLUME X.

OTTAWA:
PUBLISHED BY AUTHORITY.

1882.

The Canadian Patent Office

RECORD

VOLUME X, 1882.—INDEX.

INDEX OF INVENTIONS.

Ageing and treating liquors, C. W. Ramsay.....	15,377	Bands, hub, W. I. Atwood.....	14,140
Air compressing apparatus, J. M. Bois.....	15,245	Basins, wash, A. Edwards.....	11,018
Alarma apparatus, electric, S. S. Applegate.....	14,761	Batteries for storing electricity, J. W. Swan.....	15,069
" low water, G. Wilson.....	14,075	" galvanic, J. and A. J. Higgin.....	14,651
Alarms, burglar, G. G. Schwanz.....	14,374	Batting machin., cotton, T. F. Dunn.....	14,779
" M. H. Kernie.....	14,518	Barbs, fence, W. P. Chisholm.....	14,059
" R. M. Patchin.....	14,590	" for fences, W. W. Butler.....	13,907
" door knob, W. F. Cook.....	14,402	Bark preparing, tan, W. H. Smith.....	15,562
Aikalles, apparatus for recovering, J. A. Fisher.....	15,292	" spent, process for treating, W. Guest et al.....	14,526
Alumina, J. Webster.....	14,317	Barrel covers, F. M. James et al.....	15,177
Amalgamating apparatus, C. Taylor.....	14,251	" heads, The American Paper Barrel Co'y.....	14,759
" machines, T. A. Readwin.....	14,457	" rollers and guides, B. H. Schonhoff.....	15,658
Amalgamators, ore, W. L. Imlay.....	15,551	Barrels, F. S. Olmsted et al.....	14,725
Ammonia, H. Y. and E. B. Costner.....	15,343	" coal oil, J. W. Cuthbertson et al.....	15,477
Animal restraining device, H. M. Harvey et al.....	15,471	" fruit, C. E. Bartram.....	14,107
Animals to loads, manner of attaching, H. McNally.....	14,299	Barrows, wheel, T. Brewer.....	15,170
Anti-slipping materials, C. A. Maxfield et al.....	14,897	Bars, fire, J. G. Galley.....	15,266
Apple parers, J. Clark.....	14,414	" grate, J. C. Knoepfel.....	14,749
" paring and coring machines, A. J. Rice.....	15,149	Bearding machines, barley, F. W. Brenton.....	14,029
" slicers, A. J. Rice.....	14,111	Bearings, anti-friction, E. Salomon et al.....	15,209
Arithmetical frames, J. Gould.....	14,015	" " T. F. Hemmich.....	14,754
Armatures, J. J. Wright.....	15,133	" " T. R. Ferrall.....	13,905 14,301
" dynamo electric, E. A. Sperry.....	15,564	" axle, A. Kasson.....	13,915
" electrical, J. J. Wool.....	15,510	" Journal, G. J. and S. J. Shiner.....	15,499
Arms, magazine fire, A. Schneider.....	14,737	" " G. W. Fairman et al.....	15,857
" sights for fire, T. Gilbert.....	15,378	" " J. H. Lagley.....	14,845
Arresters, spark, J. K. Taylor.....	14,174	" " T. V. Le Roy.....	15,761
Ash pans, locomotive, J. Ritchie et al.....	15,428	Beaters, egg, C. Des.....	14,518
" sifters, C. G. C. Simpson.....	15,189	" " T. W. Brown.....	13,842
Attaching, manner of, animals to loads, H. McNally.....	14,299	Bed bottoms, C. I. Mauley.....	15,120
Augers, P. A. Gladwin.....	13,784	" " D. Knowlton.....	15,609
" earth, C. D. Pierce.....	14,985	" " H. J. Beemer et al.....	14,063
Axle nuts, E. P. Holly.....	15,698	" " spring, E. T. Slayton.....	13,864
" rolls, car, E. Hallett et al.....	15,253	" " J. Bowen.....	15,426
Axles, C. Cook.....	14,703	" " O. L. Haich.....	15,120
" carriage, L. Provancher et al.....	14,516	" " S. Pariseau.....	15,613
" machines for dressing, J. N. Smith.....	15,248	" " T. Burdick.....	15,720
" vehicle, A. E. Smith.....	15,736	" folding, E. S. Griffith.....	15,117
" " J. B. Armstrong.....	15,766	" " F. B. and W. A. Williams.....	14,731
Backs, stove, W. Schenck.....	14,279	" invalid, J. D. Johnson.....	15,610
Bag, broom, V. E. Fuller.....	14,848	" sofa, C. Scofield.....	15,139
" fasteners, grain, W. Hunter.....	15,658	" " H. R. Plympton.....	15,566
" fastenings, nail, J. H. Bartlett et al.....	15,643	" spring, J. Chisholme.....	15,951
" holder, E. Collins.....	14,536	" " L. Wildermuth.....	15,705
" machine, paper, D. Macmillan.....	15,579	Bee hives, H. Bailey.....	15,801
" machines, paper, W. C. Cross.....	14,204	" " S. Petet.....	15,392
Bagging machines, V. Arnold et al.....	14,285	Beer cooling and drawing machines, C. Gordon.....	15,750
Bags, mail, A. F. Martell.....	13,871	Belt replacing devices, G. P. McConnell et al.....	15,172
" " S. Smith et al.....	14,745	" " H. C. Hartley et al.....	15,010
" paper, J. C. Wilson.....	15,370	" shifters, E. C. Durand.....	15,728
" " R. and J. Kilgour.....	13,863	" shippers, B. H. Hadley.....	13,791
Balls, trolling spoon, S. Allcock et al.....	14,088	" splice, T. Clohecy.....	13,870
Baking powder, A. Glesceck.....	14,803	Belts, chain, J. M. Dodge.....	14,282
Balances, F. A. Roeder et al.....	15,346	Bench, chair and wash, D. L. Richards.....	13,945
" door, W. F. Sexton, Sr. and Jr.....	15,812	Benches and wringers, I. R. Laux et al.....	14,149
" sash, C. E. Bogle et al.....	15,870	" church, C. Potter.....	14,357
Baling hay, machines for, P. K. Dederick.....	15,599	Bending machines, sheet iron, C. Roach.....	15,473
Ball and socket joints, O. C. White.....	15,056	" springs, machines for, J. Fowler.....	15,836
Balloons, aerial, Ct. A. Apraxine.....	13,781	Berths, self-levelling, J. H. Porter.....	13,874
		" " The Brunswick Ships Berth Co'y.....	14,740
		" ships, A. A. Young.....	14,855
		Beton, repairing structures with, J. C. Goodridge.....	13,365

Beverages, process for making, C. Van Outrive Carlier et al.....	14,582		
Beverages, tonic, C. Parrish.....	14,433		
Bicycles, W. Kenyon.....	15,223		
Binders, The Toronto Reaper and Mower Co'y.....	14,945		
“ and gleaners, J. F. Mahon.....	13,969		
“ and harvesters, G. Draper.....	14,932		
“ “ The Toronto Reaper and Mower Co'y.....	14,970		
“ grain, L. Miller.....	14,772		
“ “ P. Wallace.....	14,794		
“ “ S. Johnston.....	14,192		
“ “ The McCormick Harvesting Machine Co'y.....	14,944		
Binding, book, W. R. Blackhall.....	15,521		
“ machines, The Toronto Reaper and Mower Co'y.....	15,012		
“ “ Whiteley, Fassler and Kelly.....	14,588		
Bits, bridle, J. H. Jones.....	15,594		
Blanket fasteners, E. E. Brown et al.....	15,070		
Blankets, bed, C. D. Murdoch et al.....	14,272		
Blanks, horse shoe, D. Wilcox.....	14,389	14,390	
Bleaching machine, F. A. Hooker et al.....	15,637		
Blinds, window, A. C. and W. W. Gibson.....	14,863	14,864	
“ “ A. Delone.....	14,286		
“ “ E. W. Bowslaugh.....	14,837		
Blinkers, bridle, A. Hosack et al.....	13,885		
Block press, lever collar, E. L. Brazenor.....	15,416		
Blocks, head, W. J. F. Liddell.....	13,844		
“ pulley, J. W. Norcross.....	14,859	14,861	
“ treating wood, J. B. Blythe.....	14,856		
Blotters and covers, J. W. Payson et al.....	15,218		
Blowers, W. D. Smith.....	14,112		
Blueing packages, E. W. Gillett.....	14,822		
Boards, bulletin, A. D. Marble.....	14,108		
“ instruction, T. Paecer.....	14,734		
“ splash, L. E. McKinnon.....	13,840		
“ stove, G. F. Sterne.....	15,104		
“ “ R. M. Bidelman et al.....	14,273		
“ wash, A. W. Geisel.....	15,537		
“ “ P. T. Gates.....	14,464		
Boats, C. L. and C. W. King.....	14,592		
“ D. Urch.....	13,830		
“ E. G. Durand.....	15,800		
“ ferry, W. Farquhar.....	14,640		
“ life, J. H. Hatton.....	14,467		
“ sliding seats for, G. Warin.....	15,676		
“ tow, A. McDougald.....	14,650	14,644	
Bobbin winders, C. B. Thompson.....	14,187		
“ “ J. C. Goodwin et al.....	14,918		
Boller cleaners, steam, C. Reiser.....	13,922		
“ cleaning, S. R. M. Parker.....	14,217		
“ coverings, T. Sparham.....	15,261		
“ furnaces, G. H. Watson.....	14,343		
“ “ D. Orvis.....	14,252		
Boilers, cooking, W. Castle.....	14,302		
“ heating, W. J. Carshore.....	15,013		
“ levelling engine, T. F. and A. L. Wilson.....	15,608		
“ sectional, W. King.....	15,188		
“ steam, A. S. Fisher.....	14,074		
“ “ D. Hanna.....	15,272		
“ “ G. Hill.....	15,493		
“ “ G. H. Rheutan.....	14,967		
“ “ G. Wilson.....	14,075		
“ “ H. Kolker.....	14,121		
“ “ N. Chute.....	15,681		
“ “ P. Fitzgibbons.....	15,344		
“ “ R. L. Walker.....	15,105		
“ “ S. Fox.....	15,580	15,583	
“ “ The Ames Iron Works.....	15,691		
“ “ The Babcock and Wilcox Co'y.....	15,792		
“ “ T. Sharp.....	13,839		
“ “ U. Beaupré.....	15,591		
“ wash, A. Holmes.....	14,995		
“ “ J. Roberts.....	14,292		
“ “ W. Barton.....	14,622		
Bolt and rivet cutter, C. W. Levalley.....	14,982		
“ fastener, M. Thibault.....	14,755		
“ threading machines, W. A. Price.....	14,064		
Bolts, door, R. M. Patchin.....	14,590		
“ keys for, G. B. Taylor et al.....	13,779		
“ machines for making, G. H. Waring et al.....	15,244		
“ window, P. Houle.....	13,799		
Bone black, H. Y. and E. B. Castner.....	15,343		
“ “ R. A. Cheesebrough.....	14,099		
Book binding rollers, E. L. Miller et al.....	14,321		
“ cases, D. M. Schell.....	15,131		
Book racks, T. Gillilan.....	15,862		
Books, check, A. Gardner.....	14,978		
“ “ H. B. Butterfield.....	15,107		
“ “ cheque, J. R. Carter.....	14,182		
Boot trees, H. Kranz et al.....	14,528		
Boots, R. Thompson et al.....	15,838		
“ “ T. T. Marshall.....	14,186		
“ and shoes, A. O. Lemay.....	14,757		
“ “ C. J. Blakely.....	15,145		
“ “ E. C. C. Henderson et al.....	14,094		
“ “ E. Fisher.....	13,800		
“ “ E. L. Spragne.....	14,990		
“ “ E. Lanthier.....	15,275		
“ “ F. Rivard.....	15,460		
“ “ G. H. P. Flagg.....	14,648		
“ “ G. W. Copeland.....	14,218		
“ “ J. H. Stevens.....	14,055		
“ “ J. Kelsey.....	14,095	15,549	
“ “ J. Kleffer.....	14,044		
“ “ J. L. Pelletier.....	15,785		
“ “ J. L. Thompson.....	15,022		
“ “ L. Côté.....	15,492		
“ “ M. Bray.....	14,874	14,875	
“ “ O. E. Lewis.....	14,211		
“ “ O. W. Ketchum.....	14,020		
“ “ S. K. Hindley.....	15,176		
“ “ T. Laurin.....	13,862		
“ “ W. Comey.....	13,966		
“ “ W. F. Hutchinson.....	13,899		
“ “ W. S. Childs.....	15,382		
“ “ Z. Beaudry.....	15,251		
“ “ D. Whitlock.....	13,771		
“ “ F. Richardson.....	14,679		
“ long leg, R. Church.....	14,379		
“ seamless, T. P. Marshall.....	15,380		
Borers, hub, E. Caswell.....	14,275		
Boring fellos, machine for, H. J. Miller.....	14,808		
“ machines, N. Saunders.....	15,731		
Bottles and jars, J. M. Thorpe et al.....	14,638		
“ apparatus for cleansing tubes of feed, T. Marshall.....	15,079		
“ securing corks in, O. R. Chaplin et al.....	15,026		
“ regulators for nursing, W. C. Carpenter.....	15,213		
Bows, carriage, W. L. Fay et al.....	14,311		
“ manufacture of, N. McCormick.....	14,341		
Box, fire, C. K. Vilas.....	15,420		
Boxes, ammunition, E. G. Parkhurst.....	14,195		
“ bread, J. Fournier.....	14,962		
“ candy, J. Henderson.....	14,391	14,392	
“ car axle, G. E. Yost.....	14,549		
“ “ J. N. Smith.....	14,612		
“ “ W. W. Whitaker.....	14,774		
“ fire, R. L. Walker.....	15,105		
“ fireproof, J. H. Nolin et al.....	15,067		
“ for berries, The Smith Mfg Co'y.....	15,707		
“ journal, C. E. Sampson.....	14,775		
“ “ T. S. Phillips et al.....	15,534		
“ “ W. E. Wilcox et al.....	15,442		
“ lining axle, I. Joseph.....	15,791		
“ packing, J. W. M. Shattuck.....	14,497		
“ service, R. Mitchell.....	14,146		
“ shipping, W. H. Harrison.....	15,542		
“ show, J. J. Langlis.....	14,490		
“ taking up the wear in axle, E. Brulé.....	15,462		
“ wooden, J. Womersley.....	13,882		
Braces and corsets, shoulder, C. A. Williamson.....	15,171		
Brackets, roof, H. M. Hoerner.....	14,049		
Brakes, car, A. Benoit.....	13,879		
“ “ A. F. Martel.....	14,482		
“ “ A. H. Marden.....	15,151	15,746	
“ “ J. G. Schiller et al.....	14,601		
“ “ J. K. Tremain.....	15,805		
“ “ J. W. Cloud.....	15,288		
“ “ P. Lord et al.....	15,352		
“ “ S. Halladay.....	15,711		
“ “ W. B. Guernsey.....	15,796		
“ “ A. F. Gue et al.....	15,517		
“ railway, C. F. Sinn et al.....	13,983		
“ “ G. O. S. Conway et al.....	14,788		
“ “ J. F. Mallinckrodt.....	14,806		
“ steam, C. E. Kendall.....	14,485		
“ wagon, C. J. Le Roy et al.....	15,036		
Bread, raising, C. E. Avery.....	13,925		
Breaking machines, iron, T. A. Blake.....	14,330		
Breeching hooks, W. L. Gilchrist.....	13,897		
Bretzel machines, W. Lampert et al.....	15,241		
Brewing malt liquors, art of, J. F. Gent.....	15,371		
Brick machines, D. Davis.....	15,255		

Brick machines, I. Cullen.....	14,530	Cargoes, apparatus for stowing, M. C. Walsh.....	15,436
“ L. B. Kennedy.....	14,078	“ means of securing, E. H. Farrar.....	15,086
“ P. H. A. and J. M. Kells.....	15,091	Carriage bows, H. F. Wilson et al.....	14,311
Bricks, G. Yon.....	14,561	“ seat rail, D. Conboy.....	13,916
“ J. A. Dupuis.....	14,818	“ tops, D. Conboy.....	14,574
“ manufacture of, L. Promoti et al.....	14,260	“ “ E. Miller.....	15,445
“ sheds for drying, J. Evans.....	15,652	Carriages, D. W. Baird.....	15,569
Bridle bits, J. H. Jones.....	15,594	“ G. R. McCrea.....	14,261
Bridles, rosettes for, R. Sloat.....	15,331	“ J. Y. Gurney et al.....	14,441
Bronze, manufacture of, H. H. Vivian.....	13,878	“ adjustable seats for, J. Moon.....	14,560
Broom holder, H. M. Wells et al.....	15,268	“ process for treating the wood work of, P. O'Brien.....	14,671
Brush holders, W. N. Miles.....	15,710	“ railway, W. Robinson.....	15,136
“ machines, J. H. Dodds.....	14,263	Carriers, eash, W. S. Lamson.....	15,135
Brushes, J. F. Bartlett.....	15,803	“ egg and fruit, J. J. McIntire... 14,308 15,002	15,005
Brushing gold leaf, J. B. Waterson et al.....	13,967	“ stove, G. Dee.....	14,325
Buckets, holsting, G. W. Calkins.....	15,757	“ trace, W. H. Main.....	15,302
Buckle attachments, La. F. Hartson.....	15,664	Carrying apparatus, egg, J. Halley et al.....	13,984
Buckles, harness, D. C. Bassett.....	13,767	“ devices, fruit, G. A. Cochran..... 14,506	14,507
“ hoop, J. M. Williams.....	15,284	Cars, dumping, T. P. Cordrey.....	15,437
“ tug, M. T. Shaddock.....	14,832	“ freight, J. Dalgman.....	15,096
Buffer, shoe sole, F. Winslow.....	14,799	“ preserving and freight, O. G. Davis.....	14,370
Buffing machines, G. H. P. Flagg.....	14,213	“ railway, D. F. Van Liew.....	15,480
“ J. H. Stevens.....	14,055	“ “ The La Mothe Mnf'g Co'y.....	14,045
Buggies, running gears of, J. Field et al.....	15,834	“ “ T. L. Wilson et al.....	14,232
Buggy tops, T. Smith.....	14,278	“ sleeping, G. Leve et al.....	15,581
“ W. Hodge.....	14,870	“ “ P. M. Melick.....	15,649
Building materials, A. Pelletier et al.....	14,768	“ “ and drawing room, W. L. Lowell.....	15,629
“ construction of, J. M. Peck.....	14,559	“ stock, A. C. Mather.....	14,618
“ fabrics for, J. S. Brooks.....	14,300	“ “ G. D. Burton.....	15,557
“ temporary, J. Westman.....	15,851	“ “ H. C. Hicks.....	14,678
Bungs and bushes, W. W. Jackson.....	15,354	“ “ J. H. and S. A. Shellabarger et al.....	14,948
Buoyant devices, F. W. Brewster.....	14,867	“ “ J. R. McPherson.....	14,871
Buoys, signal, F. Barr.....	14,282	“ “ L. Hay.....	15,329
Bureau, G. F. Richardson et al.....	15,867	“ uncoupling, B. Hickok.....	15,661
Burglar Alarms, G. G. Schwanz.....	14,374	Carts, road, J. P. Callan.....	14,662
Burners, hydro-carbon, E. A. Edwards.....	15,747	Case fasteners, W. A. Firstbrook.....	14,913
“ incandescent, W. M. Jackson.....	13,904	Cases, ammunition, E. G. Parkhurst.....	14,989
“ vapour, A. H. Watkins.....	15,740	“ burial, The Ontario Burial Case Co'y..... 15,028	15,029
Burning apparatus, fuel, J. Wolstenholme.....	13,817	“ “ W. H. Harrison.....	15,542
“ process, lime, F. B. Livingston.....	14,726	“ watch, R. J. Gingley.....	14,307
“ soft coal, H. R. Ives.....	13,837	“ writing, S. Wheeler.....	14,227
Burnishers, heel, Z. beaudry.....	15,251	Casings, button hole, T. Daun.....	14,688
Burnishing knives, L. Faber.....	14,844	Casks, steaming, etc., W. Ellis.....	14,659
“ machines, C. J. Blakely.....	15,145	Casters, J. K. Ross.....	15,182
“ heel, W. F. Hutchinson.....	13,899	“ furniture, R. J. Jordan et al... 15,696 15,703	15,704
Bushes and bungs, W. W. Jackson.....	15,354	Casting machines, L. B. Benton.....	15,051
Buttons, spring, I. J. Saunders.....	13,769	Catarrh, compound for, M. A. Reaves.....	13,797
Bushes, roller, P. Brownley et al.....	15,679	“ remedy for, H. Dierliam et al.....	15,279
Bustles, J. Stewart.....	14,743	“ “ J. Murray.....	14,952
Butchering apparatus, G. F. Dickinson.....	15,526	Catcher, bird insect, W. S. Burn et al.....	13,825
Butter artificial, G. Cosine.....	14,912	Ceilings and walls, T. J. McGeary et al.....	15,814
“ compound to be used in place of, S. H. Cochran.....	15,239	“ glass, J. Budd.....	15,020
“ keeping, J. F. Ferguson.....	14,556	Cells, secondary, J. W. Swan.....	15,069
“ workers, E. E. Sully.....	15,367	Cement, R. G. Fraser.....	13,955
“ “ G. A. Blanchard.....	14,504	Cements, hydraulic, W. H. Hughan.....	14,545
Butting apparatus, W. H. Knight.....	14,104	Centrifugal machines, The Burmister and Wains Mac- kin and Skebsygerl.....	14,421
Button fastenings, G. S. Schneller.....	15,670	Chain belts, J. M. Dodge.....	13,945
“ hole casings, T. Dann.....	14,633	Chains, drive, F. M. Lechner.....	15,227
Buttons, method of attaching, F. H. Farnsworth et al.....	15,465	“ “ J. H. Elward.....	15,504
Cabinets and tables, The Manhattan Cabinet Mnf'g Co.....	13,780	“ driving and carrying, C. W. Levalley.....	15,379
“ paper, J. S. Norris.....	14,886	“ log, J. W. Raymond et al.....	15,875
Cables, electric, P. B. Delany..... 15,057	15,204	Chairs, C. H. Gilpin.....	14,135
“ insulated, H. A. Clark.....	14,994	“ J. S. Anthes.....	14,067
Caddies, tobacco, G. T. Tuckett.....	13,985	“ and cots, E. Hatch.....	15,034
Calculators, R. T. Martin.....	14,981	“ and wash bench, D. L. Richards.....	13,822
Calendars, perpetual, T. H. Hovenden.....	14,860	“ barber and dental, G. W. Archer.....	14,126
“ time-piece, G. E. Sanford et al.....	14,769	“ folding, A. G. Cole.....	14,477
Calks, toe, P. Routledge.....	13,937	“ “ E. C. Flint.....	14,685
Can filling apparatus, W. West.....	15,013	“ invalid, A. S. Evans.....	14,768
Cancellors, stamps, H. F. Gaines.....	14,322	“ rail, M. R. Perkins.....	14,101
Candies, R. F. W. Loper et al.....	13,959	“ “ W. A. Cooper et al.....	14,173
Cane shredding machines, G. A. Bezé et al.....	15,467	“ rocking, E. Kriehoff et al.....	14,240
“ weaving, J. S. Ford et al.....	14,558	“ “ J. Biersdorf et al.....	15,068
Cans, milk, A. Huff.....	14,161	“ “ S. A. McCaffrey et al.....	15,191
“ “ W. M. Haney.....	15,739	“ tilling, J. W. Kenna.....	14,280
“ oil, W. G. Durham.....	15,366	“ window cleaning, A. Dormitzer.....	15,878
“ packing, J. W. M. Shattuck.....	14,497	Chalk holders, A. N. Rouch.....	15,454
“ paint, F. R. Grout.....	14,474	Chambers, preserving, C. Ross.....	14,710
Cant dogs, E. Mansfield.....	15,621	Chandellers, electric, T. A. Edison.....	15,642
“ hooks, A. Stuford.....	15,772	Charcoal, manufacture of, H. M. Pierce.....	14,805
Caoutchoue, H. Kurth et al.....	14,237	Checks, baggage, J. M. Lyons.....	14,911
Caps, flanging, J. A. Chadwick.....	14,352	“ door, The Norton Door Check and Spring Co'y.....	13,934
Carburetters, A. Wigginn.....	14,605	Cheese hoop followers, D. H. Burrell et al.....	14,573
“ metrical, W. M. Jackson.....	15,865	“ machines, W. Cooley.....	14,776
Card teeth, T. Kershaw et al.....	14,494	“ manufacture, J. Naylor.....	14,968
Carding engines, J. F. Gebhart.....	15,813	Chills for castings, W. Hazelhurst.....	14,928
“ “ feeders for, W. C. Bramwell.....	15,247		

Chimneys, glass, F. M. James et al.....	15,182	Connections on trams, electric, J. B. and F. S. Lowe...	15,387
Choppers, meat, M. L. Edwards.....	14,347	Consumers, smoke, J. Elliott.....	13,772
Chronographs, W. H. Douglas.....	15,663	" " The Tobey Furniture Co'y.....	14,690
Chucks, planer's, J. H. Greenwood.....	14,719	Consuming, " H. R. Ives.....	13,837
Churn and cream pail, J. F. Grobb.....	14,571	Conveyors, flour mill, The George T. Smith Middlings	
" powers, A. J. Morrow.....	15,485	Purifier Co'y.....	15,431
" " T. W. Hogsett.....	14,544	Cooking boilers, W. Castle.....	14,302
Churning apparatus, B. F. Moore et al.....	15,024	" stoves, E. Peerless.....	14,199
Churns, A. W. Burke.....	15,150	" " G. F. Filley 13,852 13,855 13,853 13,858	14,480
" A. W. Wright.....	14,705	" " The American Stove Mfg Co'y.....	14,245
" E. S. Gibbs.....	14,398	Cooler, milk, W. Cooley.....	13,808
" F. Aldred.....	13,816	" " A. and F. Allaire.....	13,977
" G. Morehouse.....	15,224	" " D. M. Macpherson.....	14,336
" H. B. Gates.....	13,953	Cooling apparatus, H. Mestern.....	14,954
" H. Van DeWater et al.....	13,957	" " J. E. Culver.....	14,097
" J. Bennet.....	14,552	" " machines, air, J. P. and O. G. Burnham.....	14,232
" O. Haley et al.....	14,666	" " process, beer, D. W. Davis.....	15,093
" W. W. Kitchen.....	15,360	Coops for fowls, J. M. Householder.....	15,623
" rotary, J. Burbank et al.....	15,304	Copper, treating, A. Getchell.....	15,409
Cigar bunching machines, A. Gordon.....	15,098	Cores, whip, V. B. Barstow.....	15,535
" machines, O. Hammerstein.....	14,954	Coring and paring machines, apple, A. J. Rice.....	15,149
" protectors, L. Abrahams.....	15,475	Cork screws, means of attaching, H. W. Simms.....	15,809
Cigarette machines, P. P. Pratt et al.....	14,532	Corn cutting machines, W. Sprague.....	14,630
Cigarettes, Kinney Tobacco Co'y.....	14,643	" shellers, A. T. Kugan.....	15,198
" L. Ginter.....	14,361	Corset forming apparatus, J. A. House.....	14,910
Circuits, electric, F. Blake.....	13,917	" stays, M. P. Bray.....	15,495
Clamps, bench, J. Murphy.....	14,980	Corsets, B. Baldwin.....	15,243
" tassel, H. V. Wells et al.....	14,063	" F. Compton.....	14,758
" wood working, A. M. Colt.....	14,284	" S. and H. M. Vermilyea.....	14,927
Cleaners, grain, W. L. Taber.....	14,076	" and braces, C. A. Williamson.....	15,171
" steam boiler, C. Reiser.....	13,922	" nursing, C. N. Chadwick.....	15,481
" track, A. Day.....	13,773	Cots and chairs, E. Hatch.....	15,034
" tube, J. Harley.....	14,550	" folding, T. W. B. Murray et al.....	13,766
Cleaning compound, Sir M. Parker.....	14,217	Cotton fabrics, finishing, F. B. Wilkins.....	15,325
" machines, grain, J. Miller.....	14,333	" twisting machines, A. Yates.....	14,138
Cleersers, snow, J. Coxen.....	14,096	Counters, heel, M. Hynes.....	14,943
Clips, hame, E. D. Cole.....	15,364	" machines for making, L. Cote.....	15,492
" pole, G. W. Hunter.....	15,349	Couplers, car, A. Zettel.....	13,992
" wear, J. H. Philpott et al.....	15,819	" " C. E. Mark.....	15,391
" whiffletree, H. McCoy.....	15,432	" " D. E. Southwick.....	15,194
Cloaks, reversible, H. F. Bindsell et al.....	15,064	" " G. O. S. Conway et al.....	14,789
Clocks, W. N. Miller.....	14,026	" " H. Gladwin.....	14,576
" self winding, A. Dardeune.....	15,810	" " H. Mitchell.....	14,802
Closets, earth, J. H. McNairn.....	14,081	" " J. A. Gowans et al.....	15,296
" water, A. Edwards.....	14,046	" " M. C. Dixon.....	14,926
" " G. C. Phillips.....	15,590	" " W. Hunter.....	14,778
" " J. E. Boyle.....	15,015	" " car pole, S. R. Otis.....	14,351
" " R. Reach.....	14,511	" " shaft and pole, C. H. Titus et al.....	14,348
Cloth, art of weaving, T. Isherwood.....	14,979	Coupling for shafting, W. Johnston.....	15,666
Coal, breaking down, C. S. Smith et al.....	13,925	Couplings, belt, V. Rice.....	14,519
" burning soft, H. R. Ives.....	13,837	" " car, A. Benoit.....	15,745
" mining, J. Du Bois.....	15,798	" " A. Leyden.....	14,787
Coating metallic articles, W. Garrity et al.....	15,160	" " B. W. Arnold.....	15,293
" metals, process for, H. Roberts.....	14,616	" " D. H. Sherman et al.....	14,707 14,889
" process, wire, L. L. Smith.....	14,714	" " D. Kunkel.....	13,841
Coats, N. Malmar.....	14,580	" " D. McKinnon.....	15,853
Cockeyes and sockets, M. Miller.....	14,840	" " D. P. Prescott.....	14,120
Cocks and valves, D. R. Ashton et al.....	15,282	" " D. S. Walrath et al.....	15,607
Codes, cypher, R. T. Oney.....	15,721	" " G. W. Vunk et al.....	15,341
Coffee, A. and M. Conroy.....	13,938	" " F. Cordrey.....	15,726
Cofferdams, H. P. Kirkham.....	14,826	" " F. M. Hazleton.....	15,786
Coffins, metallic, W. D. McGloaghton.....	13,976	" " F. Tarble.....	14,256
Coke, manufacture of, J. Jameson.....	15,804	" " G. F. Bond.....	14,566
Collars and cuffs, F. B. Ide et al.....	14,148	" " H. G. H. Reed.....	15,453
" horse, C. Roehl et al.....	15,359	" " J. A. Burns et al.....	14,287
" " G. W. Daly et al.....	14,295	" " J. B. Parent.....	15,483
" " J. Whitney.....	14,153	" " J. C. Mitchell et al.....	15,316
" " L. Guinnip.....	14,440	" " J. E. Barrett.....	14,514
" " S. Peace.....	14,111	" " J. E. Smith.....	13,931
" stuffing horse, J. Newton.....	13,949	" " J. F. Lewallen et al.....	13,952
Collecting machines, mill dust, S. L. Beau.....	14,034	" " J. H. Hunt et al.....	14,540
Collectors, sediment, D. Hanna.....	15,272	" " J. H. Putnam.....	14,086
Colouring process, H. M. Vaughn.....	14,829	" " J. H. Quackenbush et al.....	15,388
Combustion in furnaces, G. H. Patterson et al.....	15,466	" " J. McCree.....	15,864
Comforts, bed, C. D. Murdock et al.....	14,202	" " J. Terry.....	14,684
Commode, wash stands, W. T. Egbert.....	14,362	" " L. P. Bayliff et al.....	15,289
Commutators, E. Thomson.....	15,072	" " M. R. Hubbell.....	14,475
" " J. J. Wright.....	15,133	" " M. R. Thurber.....	14,419
Compressors, air, B. T. Babbitt.....	15,741	" " P. E. Mignault.....	15,484
Compressing apparatus, air, J. M. Bois.....	15,245	" " S. A. V. Hartwell.....	15,193
" " machine, heel, E. Fisher.....	13,800	" " The Athwood R'y Wheels Co'y.....	15,192
Concentrators, ore, E. Warne.....	14,811	" " W. C. Kelly.....	14,115
" " W. L. Imlay.....	15,551	" " W. E. Thompson.....	14,780
Condensers, petroleum, M. J. Woodward.....	14,993	" " W. V. Perry.....	14,175
Conductors, carbon, T. A. Edison.....	13,886	" " commutator, J. J. Wood.....	15,541
" " telegraph, W. O. Callender.....	15,395	" " electric, E. D. Parker.....	15,569
" " underground, T. A. Edison.....	15,830	" " harness and trace, G. W. Hunter.....	15,349
Conduits, " C. H. Goebel et al.....	15,689		

Couplings, shaft, C. Barber.....	14,386	Distributing apparatus, W. Hadden.....	14,152
" strap, A. VanLuven.....	13,789	Distribution systems, electrical, T. A. Edison.....	15,831
" thill, A. Kasson.....	13,914	Distributors, fertilizer, J. M. Westcott.....	14,296
" " C. L. Ferguson.....	15,789	" " S. B. Hart.....	14,181
" " H. T. Perram.....	13,971	Ditchers, J. Clement.....	15,861
" " O. Tower.....	15,214	Ditching machines, F. Plumb.....	15,207
" " The Guelph Carriage Goods Co'y.....	15,281	" " F. W. Hales.....	14,694
" tubing, E. C. Converse.....	15,045	" " J. L. House.....	14,375
" wagon, T. C. Waller.....	14,834	Docks and pontoons, J. L. Clarke et al.....	14,453
Coverings, boiler, T. Sparham.....	15,261	Dogs, cant, H. Peavey.....	14,396
" roof, W. H. Kershaw.....	14,872	Door balances, W. F. Sexton sr., and jr.....	15,812
Covers and blotters, J. W. Payson et al.....	15,218	" fasteners, J. W. Krepps.....	15,185
" barrel, F. M. James.....	15,177	" " car, R. H. Briggs et al.....	14,543
" pot, W. F. Willmot.....	14,393	" fastenings, C. A. Crongeyer et al.....	14,332
Cream keeping, J. F. Ferguson.....	14,558	" hangers, W. F. Berry.....	14,226
Creamers, W. E. Parmenter.....	14,196	" knob alarms, W. F. Cook.....	14,402
Creepers, ice, H. Bland.....	13,908	" securers, J. Lockwood.....	14,257
Crimping machines, T. P. Marshall.....	15,614	Doors, freight car, H. H. Hewitt et al.....	14,538
Crocheting machines, H. M. Paynter.....	14,849	" stove, D. K. Alden.....	15,633
Crocks, flower, A. D. Polsgrove et al.....	13,933	Doubling machines, cotton, A. Yates.....	14,138
Croup, remedy for, H. Dierlamm et al.....	15,279	Draft adjusting devices for harness, J. Huggin.....	14,531
Cruppers, machine for making, J. Schaffer.....	14,373	" apparatus for stoves, F. Beaumont, jr.....	14,921
Crushers, R. McCully.....	15,279	" equalizers, S. and W. T. Marvin.....	15,356
" stone and ore, S. L. Marsden.....	15,368	Draft mechanism, J. P. Coulter et al.....	15,834
Crushing machines, ore, G. Dalton.....	15,626	Drainers, liquid, J. C. Harlackner et al.....	15,744
Crystallizing, grape sugar, H. Williams.....	13,861	Drains and sewers, F. X. Rousseau.....	15,385
Cuffs and collars, F. B. Ide et al.....	14,118	Drawers and tights, R. M. Appleton.....	15,025
Culinary vessels, J. W. Fisher et al.....	15,641	Dredges, vacuum, A. C. Whittier.....	13,932
Cultivator teeth, G. Bettschen.....	15,238	" " J. F. Sanders.....	13,768
Cultivators, D. O. Everest.....	14,546	Dredging machines, A. C. Both.....	15,622
" J. W. Thomas.....	15,755	" " R. R. Osgood et al.....	14,411
" " et al.....	15,743	" " W. Morrison.....	15,719
" G. Bettschen.....	14,565	Dressing apparatus, W. H. Knight.....	14,104
" J. E. Weller.....	14,637	" machines, millstone, D. Vaughan.....	14,201
" and sowers, W. S. Wisner.....	15,452	Drill ploughs, J. Ley.....	13,790
" spring tooth, H. Springer et al.....	14,854	Drills and broadcast sowers, J. Fraser.....	14,852
Cups, lubricating, J. L. Winslow.....	14,692	" " T. Galloway.....	15,730
Curing rubber coated fabrics, H. W. Burr.....	14,555	" grain, J. and T. H. Noxon.....	13,916
Curtain fixtures, C. Buckley.....	14,727	" rock, A. J. Mershon.....	11,949
Curtains, window, H. M. Wells et al.....	14,063	" " J. E. Booth.....	15,780
Cushion protectors, J. M. Thorpe et al.....	14,638	" " The Rand Drill Co'y.....	13,920
Cuspadores, W. Westlake et al.....	14,965	Drivers, first and intermediate, J. Westman.....	13,814
Cutter, bolt and rivet, C. W. Levalley.....	14,982	" millstone, W. E. Sergeant.....	13,860
Cutters, cork, R. J. Noyes.....	14,664	Dryers, fruit, D. M. Donald.....	14,610
" meat, J. Zimmermann et al.....	14,933	" " H. M. Dake.....	13,960
" rotary, E. Salomon et al.....	15,144	" " J. A. and H. Bartholomew.....	15,065
" straw, C. Sheppardson.....	13,926	" " L. E. Woodruff et al.....	14,087
" swell body, C. R. Wilson.....	15,560	" lumber, A. F. Barron.....	14,877
Cutting machines, W. Sprague.....	14,680	" " G. W. Read.....	14,091
" " file, F. Outram.....	15,048	" salt, The North American Co'y.....	15,470
" " hoop, F. L. Wilson.....	15,817	Drying and pulverizing oil, apparatus for, J. F. Gub- bins.....	15,335
" " ice, C. A. Sager.....	15,511	Drying apparatus, wall paper, H. Hilbero.....	14,999
" " F. L. D. Pearson.....	13,990	" " wood, D. F. Noyes.....	14,742
" " leather, J. I. and H. Pellerin.....	14,798	" dye wood, H. C. F. Stormer.....	14,435
" " oat, F. M. Kremer et al.....	13,849	" kilns, lumber, R. J. Rundell.....	13,851
" " veneer, H. S. Smith et al.....	14,177	Dust pans, S. M. Perry.....	15,668
" pills, machine for, T. Daniels.....	14,106	Dye wood distilling apparatus, H. C. F. Stormer.....	14,435
" tenons, machine for, H. J. Miller.....	14,808	Dynamometers, The Transmitting Dynamometer Co'y.....	14,092
Cylinders and pistons, W. Hanna.....	15,222	Ear mufflers, C. Greenwood.....	14,547
" for gang saws, G. W. Nichols.....	14,599	Edges, machine for setting, G. H. P. Flagg.....	14,648
" tools for dressing, J. N. Smith.....	15,230	Egg and fruit carriers, J. J. McIntire.....	15,002
Damper regulators, D. C. Kellen.....	13,898	" beaters, C. Deis.....	14,548
" reverting, S. G. and W. H. Scaright.....	14,420	" carriers, J. J. McIntire.....	14,308
" stovepipe, W. F. Green.....	13,827	" carrying apparatus, J. Halley et al.....	13,984
Dash and foot rails, F. C. Ayer.....	15,106	" desiccating, L. J. Caldwell.....	14,183
Dash-boards, vehicle, The Guelph Carriage Goods Co'y.....	15,717	" preservers, D. Smith.....	14,193
Dashes, carriage, L. E. McKinnon.....	13,840	" preserving, A. M. Bailey et al.....	15,782
" vehicle, W. F. Elliott et al.....	15,709	Ejectors, oil, G. F. Miller.....	15,290
Daters, stamp, H. F. Gaines.....	14,322	Electric armatures, dynamo, E. A. Sperry.....	15,564
Decks, log, P. Musser.....	15,217	" connections of trains, J. B. and F. S. Lowe.....	15,387
Decorticators, grain, W. Ager.....	14,873	" insulation, J. A. Fleming.....	14,465
Decoys, C. T. Cochel.....	15,732	" lights, T. A. Edison.....	15,093
Derrick machines, R. R. Osgood et al.....	14,411	Electric machine, dynamo, E. A. Sperry.....	15,567
Desiccating eggs, L. J. Caldwell.....	14,183	" " E. Thomson.....	15,072
Despatches, telegraphic, A. F. and F. B. Johnson.....	14,400	" " H. B. Sheridan.....	15,019
Detachers, horse, J. T. Walker.....	15,500	" " J. J. Wright.....	15,133
Dextrine, nitro, G. S. Dean.....	15,565	" " T. A. Edison, 13,836, 15,843.....	15,848
Dials, lock, G. M. Hathaway.....	14,339	" " 15,846, 15,817 and.....	14,380
Dies for springs, E. Spaulding.....	15,396	" " T. L. Willson.....	14,235
Digger, horse, W. H. Rhodes.....	14,145	" " The European Electric Co'y.....	14,380
Digging devices, W. H. H. Davis.....	15,855	" wires, H. A. Clark.....	14,258
" machines, J. Parker.....	14,502	Electrical apparatus, W. C. Shaffer.....	14,338
Diphtheria, remedy for, H. Dierlamm et al.....	15,279	" distribution systems, T. A. Edison.....	15,831
Dishes, grocers, C. Ingersoll.....	14,670	" power, C. V. Boys.....	14,865
Disks, pulverizer, S. P. M. Tasker.....	14,594	Electrometers, T. A. Edison.....	13,906
Distilling apparatus, G. Race.....	14,836	Elevating machines, V. Arnold, et al.....	14,286
" T. A. and W. T. Jebb.....	14,297	Elevator safety apparatus, J. McCarroll.....	14,221
" dye wood, H. C. F. Stormer.....	14,435		

Elevators, G. C. Tewksbury.....	15,173	Fasteners door, J. W. Krepps.....	15,185
“ floating, J. Nolan.....	15,519	“ “ J. Savole.....	14,661
“ for hatchways, P. J. Singer.....	15,129	“ carpet, D. N. Baldwin.....	15,348
“ hay, J. Dain.....	14,488	“ “ S. J. Spltter.....	15,080
“ “ W. H. Wortman.....	15,768	“ case, W. A. Firstbrook.....	14,913
“ hyd aulic, E. Thayer.....	15,087	“ glove, E. Horsepool.....	14,139
“ water, E. W. Vanduzen.....	13,900	“ hame, W. W. Bell.....	15,123
“ “ J. H. Beers, et al.....	15,229	“ sash cord, T. Morton.....	14,045
“ “ L. C. Warner.....	15,532	“ snath, A. J. Schultze, et al.....	15,143
“ “ W. A. Bickford.....	14,695	“ window light, T. Tanner.....	14,144
Embroidering machines, rug, E. Ross.....	14,334	Fastenings, door, C. A. Crongeyer, et al.....	14,332
Engine boilers, levelling, T. F. and A. L. Wilson.....	15,808	“ for laces, T. Green.....	15,078
Engines, apparatus for actuating the followers of wood		“ knob spindle, F. Lattimer, et al.....	15,068
pulping, W. Jones.....	15,203	“ ship, H. Squier.....	14,170
Engines, caloric, J. Bucket.....	15,313	“ stirrup, W. H. Kirby.....	14,553
“ carding, J. F. Gebhart.....	15,813	“ wire, O. R. Chaplin, et al.....	15,028
“ doctor, G. J. Fritz.....	14,292	Fatty matters, subdividing, A. Marix.....	15,628
“ electric motive, D. T. Plot.....	15,811	Fats, apparatus for rendering and bleaching, G. Cosine	14,901
“ feeders for carding, W. C. Bramwell.....	15,247	“ treatment of, W. Green.....	14,150
“ fire, B. J. C. Howe, et al.....	13,912	Faucets, G. W. Hilliards.....	13,843
“ gas, R. T. Jeffery.....	14,542	“ J. Winckler.....	15,536
“ gas motor, A. Fiddes.....	13,944	Feather renovating apparatus, M. Rose.....	14,903
“ “ N. A. Otto, et al.....	15,611	Feather renovators, E. B. Dufort et al.....	14,119
“ heaters for steam, C. Hollands.....	15,332	Feed mechanism, J. H. Elward.....	15,505
“ locomotive, H. Waterman.....	15,627	“ “ J. H. Hermance.....	14,712
“ portable, T. McGreg r.....	14,082	Feeders, automatic, C. E. Sage.....	13,832
“ rotary, A. C. Gibson, et al.....	15,767	“ for carding engines, W. C. Bramwell.....	15,247
“ rotatory, R. Hodson.....	14,815	Feeding apparatus, L. M. Senécal, et al.....	15,277
“ “ G. W. Dudley.....	14,335	“ devices, J. F. Gebhart.....	15,813
“ steam, A. Morton.....	15,651	“ “ stock, A. D. Tingley.....	14,267
“ “ H. and W. Monk.....	14,537	Felloes, machine for boring, H. J. Miller.....	14,808
“ “ J. Scott.....	14,431	Felt, roofing, O. A. Smith, et al.....	15,311
“ “ R. Morrison.....	15,824	Felting machines, J. and C. Rubl.....	15,615
“ “ W. J. Boland.....	14,236	Fence bars, W. P. Chisholm.....	14,059
“ “ W. Johnson.....	15,390	“ posts, E. J. Major.....	14,916 15,586
“ swinging lever, J. Von Zäch.....	14,630	“ “ J. Frazier.....	14,987
“ traction, J. Nixon.....	15,393	“ “ iron, J. S. Fox.....	14,051
“ transportable, C. Sorensen.....	15,520	“ strips, barbed, T. C. Hewitt.....	14,744
Engraving machines, J. Earle.....	15,082	“ wire machine, The Washburn and Moen Manf'g	
Engraving script, method of, J. Earle.....	15,088	Co'y.....	15,548
Entrenching tools, N. W. Wallace.....	15,835	“ “ stretchers, S. M. Stevens.....	14,629
Envelope machines, H. J. Wickham.....	13,776	Fences, J. Corman.....	14,443
Envelopes, G. Cox.....	14,524	“ J. DuBois.....	14,858
Equalizers, draught, S. and W. T. Marvin.....	15,356	“ J. M. Rowe.....	14,234
Evaporating apparatus, D. H. Gowing.....	14,748	“ L. McNall.....	14,368
Evaporators, J. C. Gunn.....	14,425	“ and posts, L. Dow.....	15,507
“ fruit, H. C. Grover.....	15,474	“ barbed, E. M. Crandal.....	15,506
“ “ J. A. and H. Bartholomew.....	15,065	“ “ J. Carpenter, et al.....	15,673
“ “ J. M. Teasdale.....	14,907	“ “ J. W. Harbaugh, et al.....	14,971
“ “ M. Hill.....	14,229	“ “ T. McCosh.....	14,642
“ “ The Steam Heat Evaporating Co'y.....	15,692	“ “ M. S. Chapman.....	15,408
“ sap, P. S. Ewins.....	14,735	“ farm, C. Laufer, et al.....	15,788
Eveners, tension, A. Atwood.....	15,538	“ gates and latches, S. W. Martin.....	15,058
Excavating machines, F. Plumb.....	15,207	“ iron, J. G. German.....	14,093
“ “ earth, S. T. Gerow.....	14,596	“ “ S. W. Martin.....	15,037
Exhibitor, cloth, H. Mitchell.....	14,676	“ metallic, J. F. Walmsley.....	14,172
Explosive compound, E. Judson.....	14,125	“ “ T. C. Hewitt.....	14,188
“ “ E. Turpin.....	14,631	“ “ barbed, T. C. Hewitt.....	15,425
“ powder, L. Robert.....	13,972	“ posts for, H. R. Ives.....	14,895
Explosives, manufacture of, W. F. Reid.....	14,413	“ tags for, J. J. La Fleur et al.....	14,271
Extinguishers, fire, F. Grinnel.....	14,691	“ wire, A. Wesson.....	15,059
“ “ L. C. Desloovere.....	15,753	“ worm rail, G. A. Horn.....	15,530
“ “ M. Walker.....	15,823	Fencing, barbed, J. F. Walmsley.....	13,846
“ s'ack, I. Deyell.....	14,677	“ “ T. C. Hewitt.....	14,654
Extinguishing apparatus, gas, G. P. Ganster.....	14,620	“ “ The Washburn and Moen Mnf'g Co'y.....	13,956
“ fires in kilns, H. M. Pierce.....	14,304	Fenders, car, J. G. Schiller et al.....	14,601
“ fires, means of, R. C. Blackall, et al.....	15,574	Fertilizer distributors, J. M. Westcott.....	14,296
Extractors, fish hook, J. W. Foard.....	14,627	“ “ S. B. Hart.....	14,181
Fabrics, curing rubber cated, H. W. Burr.....	14,555	Fertilizing compounds, E. J. Houser.....	14,595
“ elastic, T. Taylor, et al.....	14,824	Fibre, manufacture of, J. G. Stevens.....	14,652
“ fibrous, E. M. Doubleday.....	14,827	“ treating vegetable, J. B. Blythe.....	14,856
“ finishing cotton F. B. Wilkins.....	15,325	Fibres, separating, G. M. and A. L. Rice.....	13,828 13,838
“ fire proof, J. S. Brooks.....	14,300	“ machine for obtaining, The Sanford Universal	
“ fur-coated, E. M. Doubleday.....	14,791	Fibre Co'y.....	15,638 15,639
“ kni, J. Penman.....	13,968	Fibrous materials, H. M. Vaughn.....	14,829 14,830
“ ornamented, W. H. R. Toye.....	14,158	“ “ treating, The Society for the Manu-	
“ woven, S. W. Martin.....	14,575	facture of Wood Pulp.....	14,437
Fanning mills, C. C. Eddy, et al.....	15,266	Fibrous substances, C. D. Ekman.....	15,771
“ “ J. Costin.....	15,461	Fifth-wheels, E. P. Carter.....	15,324
“ “ J. W. Russell.....	15,303	“ “ G. Dynes.....	14,782
“ “ R. J. Horton.....	14,709	File cutting machine, F. Outram.....	15,048
“ “ T. Wilson.....	15,386	Files, G. V. Nanerth.....	14,567
Fastener, b I, T. Clohocy.....	14,282	“ sharpening, M. A. Richardson.....	14,178 14,179
“ bolt, M. Thibault.....	14,755	Fillers, lamp, J. W. Cuthbertson.....	15,148
Fasteners and stoppers, bottle, A. E. Rica.....	15,751	Filling apparatus, can, W. West.....	15,043
“ blanket, E. E. Brown, et al.....	15,070	Filtering apparatus, The Newark Filtering Co'y.....	14,984
“ “ O. Sweet.....	15,130	“ “ The Sinclair Rectifying Co'y.....	15,827
“ car door, R. H. Briggs, et al.....	14,543	Filters, H. C. Rice.....	14,823

Filters liquid, T. Cushing.....	14,038	G. s. apparatus, D. H. Martin.....	15,595
Filtration process, The Newark Filtering Co'y.....	14,935	" " G. Ramsdell.....	15,665
Finger bars, harvester, W. N. Whiteley.....	14,937	" " W. Duffield et al.....	14,851
Fire arms, magazine, A. Schneider.....	14,737	" carbonic oxide, W. Duffield.....	15,733
" sights for, T. Gilbert.....	15,378	" coal, J. McDonald.....	13,940
" bars, J. G. Galley.....	15,265	" lamps, lighting, G. P. Ganster.....	14,620
" bottom for stoves, J. S. Symmonds.....	14,517	" lighters, W. D. Schooley.....	15,146
" box, C. K. Villas.....	15,420	" lighting, C. L. Clarke et al.....	14,563
" escape ladders, J. H. Allen.....	15,907	" machines, J. H. Bryne.....	14,520
" " O. Sherwood et al.....	14,250	" manufacture of, L. W. Serrell.....	15,137
" engines, B. J. C. Howe et al.....	13,912	" purification of, T. N. Kirkham et al.....	15,232
" escapes, A. Dormitzer.....	15,375	Gate hangings, W. G. Alexander.....	14,724
" " D. S. Thomas.....	15,250	Gates, A. P. Campton.....	14,966
" " J. Davy.....	15,472	" I. S. Sherwin.....	14,956
" " W. E. and J. Dean.....	15,758	" L. Flagg.....	15,113
" " and guards, J. O'Neill.....	15,258	" farm, J. E. Strong.....	15,515
" extinguishers, F. Grinnell.....	14,691	" fences and latches, S. W. Martin.....	15,058
" " L. C. Desloovere.....	15,753	" hanging lock, T. B. Townsend.....	14,429
" " M. Walker.....	15,823	" railroad, B. Hempstead.....	15,558
Fireman's protecting apparatus, W. Murray.....	15,009	" railway, P. Mayrand.....	15,630
Fireplaces and stoves, J. B. Pette'r.....	15,482	Gathering machines, The Toronto Reaper and Mower Co'y.....	14,711
Fireproof compositions, C. C. Gilman.....	13,941	Gauge and guide spoke, J. McCloskey.....	14,953
" material, J. H. Nolan et al.....	15,067	" tools, wood turning and, S. Washburn.....	15,531
" solution, F. W., R. J., S. S. and A. S. Boxer.....	15,092	" tubes, L. M. Fleet.....	14,959
Fires in kilns, extinguishing, H. M. Pierce.....	14,304	Gauges, saw jointers, and, R. E. Poindexter.....	15,283
" means of " R. C. Blackall et al.....	15,574	Gear, carriage, G. E. Bartholomew et al.....	15,671
Firing and tamping devices, J. E. Gallagher.....	15,486	" set, H. Gawley.....	14,066
Fish freezing, S. L. Kelly.....	14,072	" valve, F. B. Rice.....	14,973
" preserved, C. Allen.....	13,895	Gearings, T. T. Leacox.....	14,436
Fishing apparatus, H. E. Willard.....	14,675	Gears of buggies, J. Field et al.....	14,958
Filters, stovepipe, W. Volk.....	14,672	" valve, J. Scott.....	14,431
Fixtures, curtain, C. Bockley.....	14,727	" " W. Johnson.....	15,390
Floats, fishing line, C. M. Smith.....	14,366	" vehicle, J. L. and H. M. Clark.....	15,124
Floors, tiling for, J. J. Williams.....	14,473	" " The Herbrand Co'y.....	14,655
Flower stands, C. A. Storey.....	14,313	" " running, R. McLaughlin.....	14,628
Flues, radiating, F. B. Nichols et al.....	15,522 15,722	" waggon, W. T. Shaver.....	15,381
Fluids, apparatus for separating, G. De Laval.....	14,597	Gelatinizing apparatus, grain, E. Luck.....	14,430
" transmitting heat to, A. M. B. Fraser.....	14,947	Generators, electric, J. J. Wood.....	15,539
Fluting machines, A. F. Zimmerling.....	15,494	" gas, J. Flannery.....	11,423
Fog horns, O. C. Hansen.....	14,862	" steam, D. Hess.....	15,674
Followers, cheese hoop D. H. Burrell et al.....	14,573	" " E. R. Whitney et al.....	13,807
" of wood pulping engines, apparatus for actuating, W. Jones.....	15,203	" " G. H. Watson.....	14,814
Foot and leg protectors, W. Beattie.....	14,198	" " M. M. Mosanto et al.....	15,523
Forage, preserving, C. H. Roberts.....	14,500	Gibs for bolts, G. B. Taylor et al.....	13,779
Forges, mechanical, P. Learn.....	15,158	Girths, saddle, W. McNaught jr.....	13,962
Forging hammers, art of, D. Maydole.....	14,346	Glass, machines for transferring the grains of wood upon, J. Budd.....	15,030
Forks, hor-e, J. H. Lux.....	14,228	Glass, ornamenting, J. Budd.....	14,294
Frames, arithmetical, J. Gould.....	14,015	Glasses, port-hole, The Sanitary Mnf'g Co'y.....	13,828
" photograph, J. Dewe.....	14,264	Gleaners and binders, J. F. Mahon.....	13,969
" photographic printing, G. S. Street et al.....	14,355	Globes, glass, F. M. James et al.....	15,182
" saw, E. M. Madten.....	15,234	Gloves and mitts, E. J. Ewens.....	14,197
Freezers, C. Boss.....	14,105	Glucose, manufacture of, H. A. Weber et al.....	14,509
Freezing fish, S. L. Kelly.....	14,072	Gold, amalgamating, C. Taylor.....	14,251
Freight transfers, A. E. McDonald.....	13,970	" extracting, R. Barker.....	15,797
Frogs, railway, F. C. Weir.....	15,294	" leaf brushing, J. B. Waberstou et al.....	13,967
" " J. S. Trites.....	14,230	Governors, J. Judson.....	15,211
Frost, apparatus for preventing, C. J. Anthony et al.....	15,411	" engine, F. H. Ball.....	15,842
Fruit and egg carriers, J. J. McIntire.....	15,002	" " P. Armington.....	11,667
" carriers, J. J. McIntire.....	14,308	" gas, J. C. Flisk et al.....	15,866
" carrying devices, G. R. Cochran.....	14,507	Graders and separators, H. P. Edmunds.....	14,203
" pickers, A. J. Ferris.....	15,032	Grain decorticator, W. Ager.....	14,873
Fuel burning apparatus, J. Wolstenholm.....	13,817	" gelatinizing apparatus, E. Luck.....	14,430
" compressed, G. Walker et al.....	14,533	" reducing process, F. Taggart.....	15,702
" saving apparatus, J. Cunningham.....	15,041	Grate bars, J. C. Knoeppel.....	14,749
Fumes, apparatus for collecting, G. S. Lewis.....	14,899	Grates, fire, A. C. Enzert.....	14,033
Fur sticking to bats, E. A. and C. A. Mallory.....	14,479	" fire bottom for, J. S. Symmonds.....	14,517
Furnaces, J. W. F. Sole.....	14,603	" for furnaces, H. and J. H. Rogers.....	14,220
" O. Charland.....	14,584	" furnace, F. Sturdy.....	15,535
" R. L. Walker.....	14,484	" " G. E. Palmer et al.....	13,867
" boiler, G. H. Watson.....	14,343	" Grease, process for extracting, C. B. Davy.....	14,446
" " O. D. Orvis.....	14,252	Grinding machines, ore, T. A. Readwin.....	14,457
" combustion in, G. H. Patterson et al.....	15,466	" " sickle, W. S. Ingrabam.....	14,380
" fire bottom for, J. S. Symmonds.....	14,517	" " mills, F. J. L. and J. E. Wilson.....	15,252
" gas consuming, K. M. Jarvis.....	14,035	" " J. Elliott.....	14,816
" hydro-carbon, J. Mundell et al.....	15,779	" wood, S. M. Allan.....	15,216
" oven, E. A. Cullerton.....	14,253	Grooving machine, V. E. Fuller.....	15,742
" smoke consuming, C. Smith.....	14,639	Guards, saw, R. W. Taylor.....	13,982
" steam, M. M. Mosanto et al.....	15,523	Guide and gauge, spoke, J. McCloskey.....	14,953
" " boiler, G. E. Palmer.....	13,868	Guides, saw, J. P. Hall.....	14,591
" water, A. N. and L. M. A. Aubin.....	13,831	Gun cleaners, J. F. Davis.....	15,620
Furniture, O. S. Garretson.....	14,422	Guns, machine, W. G. rdnor.....	15,543
" camp, P. Latour.....	15,694	" multicharge, J. R. Haskell.....	13,823
" extension, A. F. Potts.....	15,351	Halters, C. S. Upton et al.....	14,729
Galleys, printers, W. J. G. McAndrew et al.....	13,872	" L. B. Stowell.....	14,472
Garments, R. H. Anderson.....	15,760	Hame tugs, T. A. Simmons.....	15,806
" sample, H. Lelser.....	14,238	Hames, adjustable, E. D. Cole.....	15,268
Gas, apparatus, A. Wilson.....	14,344		

Hammers, art of forging, D. Maydole	14,346	Heating apparatus, J. E. Culver.....	14,097
" stone dressing, A. Macdonald.....	14,039	" " J. F. Pease et al.....	15,708
Handles, cane, M. A. Gilman.....	14,583	" " car, M. Harly.....	14,702
" coffin, The Meriden Britannic Co'y.....	15,755	" " water, J. Pye.....	13,927
Handles, saw, C. W. Knapp.....	15,752	" boilers, W. J. Carshore.....	15,013
" " R. H. Smith.....	14,085	" stoves, G. G. Thomas.....	15,435
" " The Montreal Saw Works.....	15,219	Heeling machines, D. Whitlock	13,771
" shovel, W. H. Johnson.....	14,613	Heels, boot and shoe, J. Kelsey.....	15,550
Hands, artificial, J. B. Bowers	14,455	" " " J. Kleffer.....	14,044
Hangers, door, S. Ide.....	14,110	" " " W. S. Childs.....	15,382
" " W. F. Berry.....	14,226	Hemorrhoides, remedy for, J. Murray.....	14,952
" eaves trough, W. F. Stoetzel.....	15,735	Hinges and rollers, gate, S. B. Pratt.....	14,031
" for shafting, P. Cramer.....	13,794	" blind, F. Menard.....	14,100
" pocket, T. McDonald.....	14,415	" " H. Stubbendorff.....	15,748
Hanging lock gates, T. B. Townsend.....	14,429	" manufacture of, E. Salomon et al	15,512
Hangings, gate, F. J. Sheldon.....	15,415	Hoes, F. A. Tryon.....	14,878
" " W. G. Alexander.....	14,551	" spring, J. and T. H. Noxon.....	13,916
Harness, C. E. Berry.....	13,796	" " J. O. and W. S. Wisner.....	13,806
" J. B. Dewey et al.....	15,401	Hog catching device, O. Ewing.....	13,961
" draft adjusting devices for, J. Hugill.....	14,531	Hogs, machine for singeing, W. Morgan.....	14,857
" irons, J. H. Philpott et al.....	15,819	Hoisting machines, A. Dobbie.....	15,469
" loops, A. J. Dennis.....	15,228	" " A. Leitch et al.....	13,783
Harrows, A. Campbell.....	14,452	" buckets, G. W. Calkins.....	15,757
" A. F. McLean.....	13,834	" machines, T. Mann.....	15,402
" A. J. Nellis.....	14,688	Holdbacks, C. J. Calvert.....	15,339
" B. F. Rix et al.....	15,345	" M. Miller.....	14,853
" J. H. Smale.....	14,004	" W. L. Gilchrist.....	13,897
" J. Maunder et al.....	15,436	Holder and ruler, head line, E. W. Blackball.....	14,291
" E. E. Whipple.....	14,771	Hook extractors, fish, J. W. Foard.....	14,627
" P. and A. S. Patterson.....	15,829	Hooks, bench-dog, W. M. and J. E. Howland	15,042
" T. H. Davis et al.....	14,444	" breeching, W. L. Gilchrist.....	13,897
" W. J. Lane.....	14,130	" cant, A. Sanford.....	15,772
" W. Kelly.....	15,355	" lacing, M. Bray.....	14,632
" iron, J. Maunder.....	14,184	" snap, C. I. Calvert.....	15,339
" rotary, H. H. Monroe.....	15,525	" trace, W. K. Rairigh.....	15,546
" spring tooth, H. Springer et al.....	14,854	" trolling, C. R. Buck.....	15,300
" " O. J. Panches.....	14,032	Hoop buckles, J. M. Williams.....	15,284
" sulky, C. La Dow.....	14,770	" cutting machine, D. F. Holston.....	15,577
" wheel, F. Bramer.....	14,166	" " F. L. Wilson.....	15,871
Harvester attachments, L. Spitzig.....	15,567	" followers, cheese, D. H. Burrell et al.....	14,573
Harvester finger bars, W. N. Whiteley.....	14,937	" planing machines, H. F. Campbell	14,728
Harvesters, A. Harris et al.....	13,909	" splint.....	14,738
" D. Maxwell.....	15,011	Hoops, barrel, W. Bowker.....	14,835
" D. Patterson.....	14,795	Horse detachers, J. T. Walker.....	15,500
" J. Harris.....	13,887	Horse shoe blanks, D. Wilcox.....	14,389
" J. K. Kepner.....	14,868	" " rolls for, T. S. Very.....	15,312
" J. P. Manny.....	14,242 14,243	" machinery, F. A. Roe.....	15,725
" L. D. Sawyer et al.....	14,381	" shoes, T. K. Flower.....	13,200
" P. Flock.....	15,700	" " J. D. Billings.....	14,329
" S. P. Graham.....	15,242	" " P. Routledge.....	13,937
" The Toronto Reaper and Mower Co'y.....	14,915	" " T. S. Very.....	14,028 14,617 15,617
" Whiteley, Fassler and Kelly.....	14,483	" " T. M. Marshall.....	15,850
Harvesters and binders, G. Draper.....	14,932	Hose and socks, shape for, W. B. Pollock.....	13,896
Harvesters and binders, The Toronto Reaper and Mower Co'y.....	14,970	" manufacture, W. B. Pollock.....	13,973
Harvesters, grain, J. H. Elward.....	15,616	" pipe nozzles, J. E. Prunty.....	15,319
" rakes for, W. H. Knapp.....	15,178	" pipes, T. S. Nowell.....	15,180
Harvesting machines, A. C. Miller et al.....	15,820	Houses, ice, J. E. Baril.....	15,237
" C. D. Dewey.....	15,604	" malt, L. C. Huck.....	15,018
" " C. W. Levalley.....	14,904	" portable, J. Rielly.....	14,733 15,404
" " D. Maxwell.....	14,972	Hub bands, W. I. Atwood.....	14,140
" " G. Sweet et al.....	14,103	" manufacture, G. W. Bentley.....	13,991
" " J. Watson.....	14,157 14,468	Hubs, wheel, J. Lajeunesse et al.....	15,168
" " W. Deering.....	14,174	" " M. L. Smith et al.....	14,850
" " Whiteley, Fassler and Kelly.....	14,589	Hullers, clover, A. R. Appleman.....	15,074
" " W. N. Whiteley.....	14,938	Hydrants, W. Dodd et al.....	15,269
Hatbodies, felt, E. A. and C. A. Mallory.....	14,479	" W. H. Law.....	15,418
Hats, napped, W. A. Baglin et al.....	15,154	Ice cutting machines, C. A. Sager.....	15,514
" shaking cotton from, W. A. Baglin et al.....	15,163	" " F. L. D. Pearson.....	13,990
Hay cutting machine, D. W. Carpenter et al.....	15,570	" houses, J. E. Baril.....	15,237
" stackers, J. H. Bean.....	15,286	" tools, J. B. Fischer, et al.....	14,239
" unloaders, J. M. Hendricks.....	15,397	India rubber, H. A. Clark.....	14,259
Head blocks, W. J. F. Liddell.....	13,814	Indicator, pipe junction and boundary line, S. North.....	15,445
Heads, barrel, The American Paper Barrel Co'y.....	14,759	Indices, J. H. Wagstaff.....	14,750
Heat, apparatus for transmitting, A. M. B. Fraser.....	14,947	Induction in telegraphic and telephonic systems, apparatus for preventing, F. Van Ripselberghe.....	15,333
Heaters, E. E. Spencer.....	14,708	Incrustations, removal of, H. Kolker.....	14,121
" J. Johnson.....	13,793	Inhaling apparatus, A. J. Leslie.....	14,520
" and ventilators, W. F. Condon.....	13,801	Illuminating tiles, The Sanitary M'g Co'y.....	13,826
" car, B. Chamberlain et al.....	15,430	Injectors, L. Shuttle.....	14,316
" " J. A. Salmon.....	15,226	" The Hancock Inspirator Co'y.....	13,958
" " M. C. Root.....	14,016	" W. E. McDonald.....	13,939
" feed water, G. H. Watson.....	14,814	" steam boiler, C. H. Stewart, et al.....	15,337
" " J. H. Turner.....	14,739	Iron, S. R. Foster.....	14,564
" for steam engines, C. Hollands.....	15,332	" bending machines, sheet, C. Roach.....	15,473
" water, P. Smith.....	14,647	" breaking machines, T. A. Blake.....	14,330
Heating and ventilating, L. A. Spaulding.....	14,206	" manufacturing, G. Beals.....	14,061
Heating apparatus, E. F. Osborne.....	14,014	" removing, C. Lamper, et al.....	13,919
		" surfaces, F. S. Barff, et al.....	14,442

Irons, harness, J. H. Philpott, et al.....	15,819	Lasts, darning, G. A. Cochran.....	15,102
Insulating materials, wire, W. O. Callender.....	15,395	Latches, door, L. B. Spencer.....	15,121
" telegraph wires, W. E. Banta, et al.....	15,259	" gates and fences, S. W. Martin.....	15,058
Insulation, electric, J. A. Fleming.....	14,466	Lathes, S. Welte.....	14,154
Jacks, M. C. Walsh.....	15,439	Leaching apparatus, S. Strunz.....	15,456
" lifting, G. A. Harvie.....	15,187	Lead pigments, white, G. T. Lewis, et al.....	14,879
" " H. R. Terris.....	15,770	Leads, printers, L. B. Benton.....	15,051
" " J. Stewart.....	15,141	Leather, belting, J. A. J. Shultz.....	14,931
" " W. N. Higgins.....	14,825	" cutting machines, J. I. and H. Pellerin.....	14,798
Jars and bottles, J. M. Thorpe, et al.....	14,638	" skiving machine, M. A. Holton.....	13,816
" fruit, J. A. Chadwick.....	14,352	Leg and foot protectors, W. Beattie.....	14,198
Jewelry, manufacture of, O. C. Devereux.....	15,017	Life-boats, J. H. Hatton.....	14,467
Jointers and gauges, saw, R. E. Poindexters.....	15,283	Life preservers, B. J. Willard.....	15,061
" saw, G. Walsh.....	15,054	Lifters, lid, W. Volk.....	14,672
Joining and sharpening machines, saw, W. R. Parsons.....	15,334	" transom, M. E. Drayton.....	15,168
Joints, ball and socket, O. C. White.....	15,056	Lifting devices, A. Arnot, et al.....	14,578
" folding, P. Latour.....	15,694	" machine, R. Kirkpatrick.....	14,842
" well, tubing, J. A. Beverly.....	13,847	Lighters, gas, W. D. Schooley.....	15,146
Journals, machines for dressing, J. N. Smith.....	15,248	" towing, H. Ressel.....	15,680
Keys for bolts, G. B. Taylor, et al.....	13,779	Lighting apparatus, W. Wheeler.....	13,948
Kettles, F. Ménard.....	15,321	" " gas, C. L. Clarke, et al.....	14,563
" tea, H. L. Palmer.....	14,281	" " " G. P. Gauster.....	14,820
Kilns, brick, S. J. Plant.....	15,153	" electric, T. A. Edison.....	13,875
" drying, E. M. Flaherty.....	15,215	" mechanism, J. M. Rose.....	14,807
" extinguishing fires in, H. M. Pierce.....	14,304	Lightning arresters, C. T. Fitch, et al.....	14,655
" for drying lumber, R. J. Rundell.....	13,851	Lights locomotive, J. A. Williams.....	13,923
Kindling wood, W. A. Allen.....	14,314	Lime burning process, F. B. Livingston.....	14,726
Knees, sleigh, P. Fillman.....	14,041	Lining axle boxes, J. Joseph.....	15,791
Knife, garden, D. Fletcher.....	15,697	" devices, W. H. H. Davis.....	15,855
Knives burnishing, L. Faber.....	14,844	Links, connecting and disconnecting, J. Walker.....	14,523
" mower, A. J. Ramsay.....	14,687	" horse-power, B. L. Olds.....	14,024
Knit fabrics, J. Penman.....	13,968	" machine for welding, H. C. Szink, et al.....	14,487
Knitting machinery, H. A. Fruit.....	15,659	Liquids, dispensing, L. Bergin.....	15,645
" machines, C. Callahan.....	14,955	" filtering, The Sinclair Rectifying Co'y.....	15,827
" " H. C. Shaw.....	14,846	" treating and preserving, C. W. Ramsay.....	15,376
" " H. P. Ballou.....	15,039	Liquors, art of brewing malt, J. F. Gent.....	15,371
" " H. W. Murdock.....	14,950	" treating and ageing, C. W. Ramsay.....	15,377
" " J. Bradley.....	13,786	Loaders and rakes, T. F. Flynn.....	15,287
" " R. I. and R. Creelman.....	14,496	Lock dials, G. M. Hathaway.....	14,339
" " S. Peberdy, et al.....	14,084	Locks, H. Lemmon.....	14,563
" " The Shaw Glove Co'y.....	14,732	" car door, J. H. Fisher.....	15,513
" " The Universal Knitting Machine Co'y.....	15,427	" " J. W. Krepps.....	15,196
" " W. Esty.....	14,409	" door, J. Mathisen.....	15,695
Knob alarms, door, W. F. Cook.....	14,402	" hasp, J. E. Youngs.....	15,869
" attachments, O. M. Hidden.....	15,190	" " J. G. Krichbanm.....	14,663
" spindle fastenings, F. Lattimer, et al.....	15,068	" mortise, L. B. Spencer.....	15,121
Knobs, door, G. M. Hathaway.....	13,929	" permutation, G. M. Hathaway.....	14,403
" G. Price.....	14,214	" time, H. F. Newbury.....	15,306 15,307 15,308
Label-holders, C. J. Slaughter.....	14,609	Locomotive engines, H. Waterman.....	15,627
" " J. F. Burgdorf.....	14,831	Locomotives, J. M. Taylor.....	14,367
Lactates, C. E. Avery.....	14,048	Looms, A. Smith, et al.....	15,713
Ladders, extension, J. Davy.....	15,472	" G. Keighley.....	13,999
" fire-escape, J. H. Allen.....	15,007	" stop motions for, F. O. Tucker.....	15,323
" " O. Sherwood, et al.....	14,250	Loops, harness, A. J. Dennis.....	15,228
" step, H. P. Spencer.....	15,576	Lowlands, apparatus for reclaiming, G. Howell.....	14,050
Lamp fillers, J. W. Cuthbertson.....	15,148	Lubricators, E. McCoy.....	14,270
" fixtures, electric, T. A. Edison.....	15,654	" G. F. Godley.....	14,290
Lamps, S. S. Newton.....	13,950	" G. W. Baker.....	14,700
" apparatus for lighting, G. P. Gauster.....	14,620	" O. H. Jewell, et al.....	13,911
" electric, A. G. Waterhouse.....	14,767	" R. J. Hoffman.....	15,338
" " E. M. Fox.....	14,225	" T. Holland.....	14,698
" " E. Thomson.....	15,183	" W. K. Rhodes.....	14,525
" " J. Best, et al.....	13,778	" H. R. A. Boys.....	13,877
" " J. Fyfe.....	15,774	Lubricating compounds, G. H. Merrill.....	15,407
" " J. Jamison.....	14,721	" " E. Smalley, et al.....	15,854
" " J. J. Wood.....	15,552 15,553	" cups, J. L. Winslow.....	14,692
" " J. Olmsted.....	14,456	" oil, H. and C. Fink.....	15,256
" " P. Jablochkoff.....	15,544	" steam machinery, G. F. Miller.....	15,290
" " T. A. Edison.....	13,835 13,886 15,844	Lumber machine, A. C. Campbell, et al.....	14,686
" " T. E. Gatehouse.....	14,636	" sorters, E. T. Davies.....	14,372
" " T. L. Kay.....	14,463	Malt-houses, L. C. Huck.....	15,018
" " T. L. Willson.....	14,180	Mandrels, expanding, W. H. Nicholson.....	14,634
" " W. Crookes.....	15,826	Mangles and wringers, clothes, C. Gentesse.....	15,625
" " W. M. Thomas, et al.....	14,458	" clothes, ".....	14,889
" gas, J. M. Rose.....	14,807	Marble, artificial, J. W. McKnight.....	13,811
" oil, F. J. Hamilton.....	14,011	Marbling, process of, W. B. Blackhall.....	15,521
" self-extinguishing, W. Scott.....	14,839	Mattresses, spring, E. L. Bushnell.....	15,521
" signals, S. Coxon.....	14,508	Measuring apparatus, C. V. Boys.....	14,865
" stove, B. F. Lancaster, et al.....	15,747	Meat choppers, M. L. Edwards.....	14,347
Lanterns, C. F. Anderson.....	15,060	" cutters, J. Zimmerman, et al.....	14,933
" J. B. Stetson, et al.....	14,920	Mechanical power, C. V. Boys.....	14,865
" tubular, J. H. Stone.....	14,977	Medicinal compound, C. E. Williams.....	14,312
" signals, J. J. Robinson.....	14,764	" " T. C. Fields.....	14,215
Lard, compound to be used in place of, S. H. Cochran.....	15,239	Medical compounds, J. R. H. and L. L. Davis.....	14,593
Lasting machines, G. W. Copeland.....	14,218	Metallic articles, coating, W. Garrity, et al.....	15,160
" " S. B. Ellithorp.....	13,994	Metals process for coating, H. Roberts.....	14,916
		" treating, H. R. Cassel.....	15,448 15,516
		Meters, electric, C. V. Boys.....	14,866

Meters, electric, T. A. Edison.....	13,906	Netting machines, E. Keeler.....	15,108	15,109
Microphones, The Canadian Telephone Co'y.....	14,164	Nipper, universal, M. and A. Brazeau.....	15,199	15,199
“ means of operating, F. Van Rysselberghe	15,305	Nitro-dextrine, G. S. Dean.....	15,565	15,565
Middlings purifiers, C. E. Sage.....	13,832	Nozzles, hose pipe, J. E. Prunty.....	15,319	15,319
“ “ H. J. Livergood.....	15,496	“ spray, L. C. Desloovere.....	15,753	15,753
“ “ N. Weber.....	14,328	Nut locks, A. F. McDonald.....	14,254	14,254
Milk, keeping, J. F. Ferguson.....	14,556	“ “ D. E. Jones.....	14,408	14,408
“ preserving process, H. W. L. O. Van Roden.....	14,887	“ “ J. A. Soley.....	13,946	13,946
Mill conveyors, flour, (The George T. Smith Middlings		“ “ J. B. Doray et al.....	13,802	13,802
Purifier Co'y.....	15,431	“ “ J. H. Burrows et al.....	15,257	15,257
Mildrust collecting machines, S. L. Bean.....	14,034	“ “ S. Gissinger.....	14,894	14,894
Millstone dressing machines, D. Vaughan.....	14,201	“ “ S. S. Smith.....	14,001	14,001
“ drivers, W. E. Sergenut.....	13,860	“ “ W. H. Paige.....	11,460	11,460
Mill-stones, A. Gardel.....	15,200	Nuts, axle, E. P. Holly.....	15,698	15,698
“ A. St. Denis et al.....	15,260	Oat cutting machine, F. M. Kremer et al.....	13,849	13,849
Mills, attrition, T. F. Rowland.....	15,773	Oatmeal machines, L. G. Thorp et al.....	14,689	14,689
“ corn, A. E. F. Chattaway.....	13,321	Offal, apparatus for drying, &c., J. F. Gubbins.....	15,335	15,335
“ disintegrating, L. J. Bennett.....	13,963	“ drier and cooler, M. Tamm.....	15,648	15,648
“ grinding, F., J. L. and J. E. Wilson.....	15,252	Oil, lubricating, H. and C. Fink.....	15,256	15,256
“ “ J. Elliott.....	14,816	“ white, C. E. Williams.....	14,312	14,312
“ fanning, C. C. Eddy et al.....	15,266	Oils, treatment of, H. Frasch.....	15,110	15,111
“ “ H. Keller.....	14,129	“ “ W. Green.....	14,150	14,150
“ “ J. Costin.....	15,461	Ore crusher and reducer, G. Dalton.....	15,626	15,626
“ “ J. W. Russell.....	15,303	“ grinding machines, T. A. Readwin.....	14,457	14,457
“ “ R. J. Horton.....	14,709	Ores, amalgamating, W. H. Howland.....	15,593	15,593
“ “ T. Wilson.....	15,386	“ composition for smelting, W. A. Mastin.....	14,811	14,811
“ “ W. E. Howarth.....	13,978	“ concentrators for, E. Warne.....	14,811	14,811
“ pulverizing, C. Ross, jr.....	14,762	Organic substances, preservation of, F. S. Barff.....	14,503	14,503
“ “ R. McCully.....	15,297	Organs, E. Brown.....	15,197	15,197
“ reduction, H. J. and G. A. Gilbert.....	15,672	“ E. L. Mundy.....	15,357	15,357
“ saw, H. Gawley.....	14,066	“ and pianos, C. N. Andrews.....	14,131	14,131
“ “ T. Moore.....	14,058	“ cabinet, O. C. Whitney.....	15,122	15,122
“ wind, C. J. Hamilton et al.....	14,007	“ reed, A. H. Hammond.....	14,509	14,510
“ “ J. E. Jones.....	15,323	“ “ A. Newell.....	14,665	14,665
“ “ L. Carrler.....	14,298	Ornamentation, general, W. B. Blackhall.....	15,521	15,521
Mineral substances, pulverizing, L. F. Holman.....	13,869	Ornamenting glass, J. Budd.....	14,294	14,294
Minerals, breaking down, C. S. Smith et al.....	13,928	“ machines, rug, E. Ross.....	14,334	14,334
Mining machines, F. M. Lechner et al.....	14,042	“ walls, etc., J. McGeary et al.....	15,314	15,314
Mittens, J. Nelson et al.....	14,796	Ottomans and registers, J. A. Graham et al.....	14,756	14,756
Mitts, J. Thurman.....	15,285	Ovens, stove and range, G. F. Filley.....	13,856	13,857
“ and gloves, E. J. Ewens.....	14,197	Overalls, A. Feder et al.....	14,557	14,557
Moccasins, G. Bolvin.....	14,783	“ G. Frank et al.....	14,434	14,434
“ G. Boulter.....	15,006	Ox shoes, A. Sanford.....	14,785	14,785
Mop holders, J. H. Omo.....	15,563	Ozone Machines, H. Milson.....	14,147	14,147
Mortar and plaster, W. Arronguler et al.....	14,786	Packages, blueing, E. W. Gillett.....	14,822	14,822
Mosaics, G. Stanley.....	14,699	“ butter, C. Blacktin.....	13,894	13,894
Motion converting, F. Etling.....	15,644	“ “ J. T. Ferres et al.....	14,501	14,501
“ “ device, A. G. Smyth et al.....	14,984	“ metal, J. F. Ross.....	14,988	14,988
“ “ machines, W. B. Munger.....	15,749	Packing, axle box, The Non-Combustible Lubrica-		
“ imparting mechanism, J. McDougall.....	14,379	ting Packing Co'y.....	14,456	14,456
“ rotary, J. J. Read.....	13,936	Packing boxes, J. W. M. Shattuck.....	14,497	14,497
“ engine, electric, D. T. Plot.....	15,811	“ metallic, E. P. Monroe.....	15,155	15,330
Motors, A. and A. Iske.....	14,289	“ piston, J. Seeberger.....	14,491	14,491
“ J. Sutliff.....	14,813	“ “ M. W. Woodruff.....	15,040	15,040
“ electric, T. A. Edison.....	15,816	“ self-lubricating, R. Morrison.....	15,824	15,824
“ electro-magnetic, T. A. Edison.....	15,822	“ rings, T. S. Nowell.....	15,181	15,181
“ hydraulic, F. W. Tuerk.....	15,852	“ valve stem, A. N. Matthews.....	15,754	15,754
“ “ N. Yagn.....	15,712	Pail, C. Kinney.....	14,804	14,804
“ rotary, W. J. Gurd.....	14,470	“ and churn, cream, J. F. Grobb.....	14,571	14,571
“ sewing machine, A. E. Rouff.....	15,606	“ sap, C. C. Post.....	15,575	15,575
Moulding machines, F. Hanson.....	14,318	Paint, A. Buzolick et al.....	15,634	15,634
“ “ W. H. Law.....	15,417	“ composition, A. W. Burke.....	13,935	13,935
“ “ sand, J. B. McCune et al.....	14,693	“ compound, “.....	15,175	15,175
“ pottery, machinery, W. H. Parsons.....	14,448	“ compounds, C. Miller.....	14,394	14,395
Moulds, car wheel, J. Thierry.....	14,792	“ fire-proof, J. Butler.....	13,798	13,798
“ screw pattern, W. A. Ingalls.....	13,993	“ “ W. L. Maltby.....	14,888	14,888
Movements, mechanical, W. F. Cochran.....	14,079	“ roof, S. Phelps.....	14,231	14,231
Mowers and reapers, A. G. Ramsay.....	14,687	Panel raisers, E. N. Gore.....	15,632	15,632
“ “ J. C. Meyors et al.....	14,019	Pans, drip, C. E. Laverty.....	13,818	13,818
“ lawn, E. G. Passmore.....	13,803	“ locomotive ash, J. Ritchie et al.....	15,428	15,428
Mowing machines, A. Gordon et al.....	14,734	“ milk, B. C. Bort.....	15,503	15,503
“ “ C. J. F. Wilkins.....	14,109	“ “ W. Cooley.....	13,808	13,808
“ “ C. W. Levalley.....	14,222	“ vacuum, C. Wahl.....	15,833	15,833
“ “ F. J. Hazard.....	14,554	Pantaloons, A. Feder et al.....	14,557	14,557
“ “ G. W. Freeman.....	14,615	“ G. Frank et al.....	14,434	14,434
Mucous diseases, compounds for, M. A. Reaves.....	13,797	Paper drying apparatus, wall, H. Hilbers.....	14,999	14,999
Mufflers, ear, C. Greenwood.....	14,547	“ machines, C. Bremaker.....	15,317	15,317
Musical instruments, F. Stone.....	15,598	“ making, C. D. Ekman.....	14,963	14,963
“ “ G. W. Ingalls.....	15,818	“ manufacture of, W. Guest et al.....	14,526	14,526
“ “ W. F. Abbott.....	15,815	Paraffine, freezing, E. Kells et al.....	15,568	15,568
Nail cutting machine, L. M. Sénécal et al.....	15,277	Parers, apple, J. Clark.....	14,414	14,414
“ machines, J. A. Pillow et al.....	14,359	Paring and coring machines, apple, A. J. Rice.....	15,149	15,149
Nailing machines, A. Knowlton.....	15,089	Patterns, screw, W. A. Ingalls.....	13,993	13,993
Nails, cut, D. J., J. P. and S. Farmer.....	14,969	Pavements, A. Pelletier et al.....	14,010	14,010
“ horse shoe, J. M. Laughlin.....	15,076	“ “ J. B. A. Brouillet.....	13,777	13,777
“ screw, C. D. Rogers.....	15,849	Paving materials, A. Pelletier et al.....	14,768	14,768
“ wire fence, C. W. Dean et al.....	15,293	Pegging machines, T. Laurin.....	13,862	13,862
Needles, knitting, S. Peberdy et al.....	14,084			

Pen holders, J. Palmer.....	14,077	Pottery moulding machinery, W. H. Parsons.....	14,448
Percolators, tea or coffee, J. C. Mackey.....	15,479	Powder, baking, A. Giesecke.....	14,803
Petroleum products, apparatus for separating, J. Cole	14,122	" explosives, L. Robert.....	18,972
Petroleum rectifying apparatus, L. Daul.....	15,073	Power links, horse, B. L. Olds.....	14,024
Phosphorescent compositions, M. B. Sherwood.....	15,326	" measuring apparatus, C. V. Boys.....	14,865
Photographic printing frames, G. S. Street et al.....	14,355	" regulators, horse, B. L. Olds.....	14,025
Photographs, mode of exhibiting, J. Dewe.....	14,264	" steam, E. F. Osborne.....	14,014
Piano-fortes, G. W. Dettman.....	15,468	" transmitting, A. Jarolimek et al.....	14,069
" T. A. Heintzman.....	14,021	" treadle motive, W. Cooper.....	14,841
Pianos and organs, C. N. Andrews.....	14,131	" animal, J. Tackaberry.....	15,487
" upright, C. E. and W. Bourne.....	14,212	" churn, A. J. Morrow.....	15,485
" " G. Heintzman.....	15,246	" " T. W. Hoggsett.....	14,544
" " W. A. Lorenz.....	14,384	" " horse, A. Muir.....	13,889
Pickers, fruit, A. J. Ferris.....	15,032	" " J. Smire.....	14,635
" universal, M. and A. Brazeau.....	15,199	Preservation of organic substances, F. S. Barff.....	14,503
Picking machines, stone, S. T. Gerow.....	14,596	Preservers, egg, D. Smith.....	14,193
Pictures, coloring and finishing, C. H. Meyers.....	15,588	Preserving and treating liquids, C. W. Ramsay.....	15,376
Pigments, J. B. Orr.....	14,047	" apparatus, milk, H. W. L. O. Von Roden.....	15,320
" W. Johnson.....	15,318	" chambers, C. Ross.....	14,710
" white lead, G. T. Lewis et al.....	14,879	" forage, C. H. Roberts.....	14,500
Pile drivers, H. T. Stock.....	15,686	" process, milk, H. W. L. O. Von Roden.....	14,887
Piles, machines for driving, A. L. and H. N. Gilbert....	15,340	Presses, H. M. Smith.....	15,655
Pills, machine for cutting, T. Daniels.....	14,106	" J. H. Brinkop.....	14,116
Pipe machines, glass, E. B. McIntosh.....	14,476	" chromatic, J. Rotbins.....	15,501
Pipes and machines, sheet metal, W. Austin.....	15,597	" baling, N. W. Herring.....	14,825
" compound for sewer, D. H. Dorset.....	14,128	" " " et al.....	15,498
" flexible, M. C. Walsh.....	15,440	" fruit, F. F. N. Marais.....	15,231
" hose, T. S. Nowell.....	15,180	" glass, R. Hermingray.....	14,579
" metallic, D. A. Ritchie.....	14,160	" hay, J. E. Trenholme.....	14,658
Pistons and cylinders, W. Hanna.....	15,222	" " P. K. Dederick.....	14,645
Pivots, transom, M. E. Dayton.....	14,459	" lever collar block, E. L. Brazenor.....	15,416
Planers' chucks, J. H. Greenwood.....	14,719	" printing, E. Prouty.....	14,809
Planes, bench, A. Fales.....	15,327	" " G. L. Adams et al.....	15,278
Planing machines, hoop, H. F. Campbell.....	14,728	" " The Gilman Vertical Press Co'y.....	14,716
" " V. E. Fuller.....	15,742	" " W. Heckert.....	15,084
" " W. S. Holland.....	15,135	Pressing machine, R. Kirkpatrick.....	14,842
Planters, hand corn, A. Hoag.....	15,502	Printing machines, H. P. Feister.....	14,793
" " T. Horton.....	15,443	" " plate, H. Lee.....	14,173
" seed, J. A. Houser.....	15,444	Projectiles, M. Gruson et al.....	14,017
" " W. Nevins.....	15,860	Protecting apparatus, fireman's, W. Murray.....	15,009
Plaster and mortar, W. Arrouquier et al.....	14,786	Projecting telegraph wires, W. E. Banta et al.....	15,259
" of paris, J. M. Reid.....	13,876	Protectors, cigar, L. Abrahams.....	15,475
Plasters, voltaic, W. B. Patter.....	14,065	" cushion, J. M. Thorpe et al.....	14,638
Plastering compound, R. L. M. de Prandieres.....	13,954	" for telegraphic instruments, C. T. Howard,	15,383
" walls, etc., J. McGeary et al.....	15,314	Protectors, leg and foot, W. Beattie.....	14,198
Plastic material, M. B. Church.....	14,800	" pantaloons, J. L. Thomson.....	15,022
" " articles from, J. Naylor.....	14,009	Pulley blocks, J. W. Norcross.....	14,859 14,861
Plates, dental, J. A. Robinson.....	15,508	Pulleys, wood rim, W. W. Carey.....	13,845
" electric accumulators, T. S. Sarney et al.....	15,414	" belt, P. Medart.....	15,208
" roofing, L. Lane et al.....	14,498	" loose, W. H. Essery et al.....	14,406
" screw, W. H. Price.....	14,089	Pulp apparatus, paper, M. L. Keen.....	14,619
" wear, D. Sennis.....	15,840	" machine, F. M. Ball.....	14,961
Platforms, stove, E. W. L. Rice.....	15,062	" manufacturing, M. V. Elcheberger.....	14,265
Ploughs, F. Simonds.....	14,005	" paper, S. M. Allen.....	15,216
" J. I. Carter.....	14,365	Pulping engines, W. Jones.....	15,203
" J. S. Felt.....	15,863	Pulverizer disks, S. P. M. Tasker.....	14,594
" W. Sanderson.....	13,986	" " dry, ".....	14,717
" double furrow, G. McSherry.....	14,541	Pulverizing machines, M. Golding.....	15,455
" drill, J. Ley.....	13,790	" " S. P. M. Tasker.....	15,513
" gang, C. Grattan.....	14,309	" mills, C. Ross, jr.....	14,762
" " L. F. Bungay et al.....	15,828	" " R. McCully.....	15,297
" " W. H. Rowe.....	15,406	" mineral substances, L. F. Holman	13,869
" snow, A. P. Farrar.....	14,930	" offal, apparatus for drying and, J. F. Gub-	
" " H. T. Stock.....	15,184	" " bins.....	15,335
" " J. H. Ayres.....	15,132	Pumps, F. Ahrens.....	15,763
" " J. Wood.....	14,268	" J. A. McMartin.....	14,349
Plugs for electrical switch boards, H. W. Leland.....	15,225	" J. B. Drake.....	14,342
Points, railway, H. Whitehead et al.....	14,143	" J. Sanders.....	15,764
Pole attachments, car, S. A. Otis.....	14,351	" M. Lescaubeau.....	15,008
" clips, G. W. Hunter.....	15,349	" M. Walker.....	13,363
Polishing machines, A. F. Zimmerling.....	15,494	" P. E. Jay.....	15,636
" " G. H. P. Flagg.....	14,213	" chain, M. D. Temple.....	14,224
" " grain, D. M. Richardson.....	15,740	" force, J. A. Dewell.....	14,909
" " wood, J. L. Perry et al.....	14,581	" " J. Harris.....	14,401
Pontoons and docks, J. L. Clark et al.....	14,453	" " J. Sanders.....	14,080
Posts and fences, L. Dow.....	15,507	" " W. A. Bickford.....	15,859
" fence, A. K. Stiles.....	15,527	" rotary, L. B. Villebonnet.....	14,319
" " C. Kinney.....	15,097	" ship, A. F. Ellis et al.....	14,604
" " E. J. Major.....	14,916 15,586	" suction and force, A. J. Hopkins.....	14,871
" " J. Frazier.....	14,987	" swivels for adjusting, H. Cairns.....	14,428
" " S. Heaton.....	15,394	Punching machines, heel, E. Fisher.....	13,800
" " T. S. Peck.....	15,511	Purifiers, middlings, C. E. Sage.....	13,832
" iron fence, J. S. Fox.....	14,051	" " H. J. Livergood.....	15,496
" wire " H. R. Ives.....	14,895	" " N. W. La Porte.....	14,328
Pot covers, W. F. Willmot.....	14,393	Purifying apparatus, water, S. E. Collins.....	14,669
Potato separating machines, W. Penniston.....	14,845	Quarrying machines, A. R. Reese et al.....	15,400
" sprouts, removing, E. Payne.....	15,600	Racks, book, T. Gilfillan.....	15,862

Racks, clothes, H. F. Gray.....	15,350	Rollers field, A. R. Moore.....	14,704
“ for storing and ageing whiskey, C. M. Johnson.....	15,164	“ window shade, E. R. O'Brien.....	14,056
“ hay, A. G. Barton et al.....	15,795	Rolls, car axle, F. Hallett et al.....	15,253
“ wagon, A. McCallum et al.....	15,585	“ for horse shoe blanks, T. S. Very.....	15,312
Radiators, W. J. Carshore.....	14,843	Roof coverings, W. H. Kershaw.....	14,872
“ steam, L. C. Rodier.....	14,462	“ tiling, J. J. Williams.....	14,473
Rail, carriage seat, D. Conboy.....	13,918	Roofing compound, F. W., R. J., S. S. and A. S. Boxer.....	15,092
“ cutting machine, F. C. Weir.....	13,424	“ compositions, J. W. Paterson.....	15,035
“ joints, railroad, F. Lightfoot.....	15,658	“ plates, L. Lane et al.....	14,498
Railroads, cable, W. Haddock et al.....	14,657	Root cutters, H. W. Fleury.....	15,784
Railway points, H. Whitehead et al.....	14,143	Rope attachments, wire, W. P. Healey.....	15,423
“ trails, electric connections on, J. B. and F. S. Lowe.....	15,387	“ serving machines, J. H. Nute et al.....	15,429
Rakes, O. Bergstrom.....	15,457	Rosettes for bridles, R. Sloat.....	15,331
“ and loaders, T. F. Flynn.....	15,267	Routing machines, R. T. White.....	14,364
“ garden, W. Chaplin.....	14,377	Rowlocks, S. Irwin.....	14,819
“ harvester, W. H. Kuapp.....	15,178	Rubber coated fabrics, curing, H. W. Burr.....	14,555
“ hay, E. L. Gould et al.....	15,001	Rug embroidering machines, E. Ross.....	14,334
“ H. Hitchcock.....	14,781	Rugs, bed, C. D. Murdock et al.....	14,272
“ horse, A. A. Noyes.....	15,434	Ruler and holder, head line, E. W. Blackball.....	14,291
“ G. M. and N. Cossitt.....	15,778	Saddle trees, W. H. and S. Taylor.....	14,159
“ J. Watson.....	14,241	Safes, fireproof, J. H. Nolan et al.....	15,067
“ W. H. Field.....	14,036 15,127	“ paper, E. H. Crandell.....	14,450
“ wheel, W. H. Patten et al.....	15,027	“ provision, L. G. Osborne et al.....	14,936
Rams, hydraulic, G. Yellott.....	14,070	Sample garment, H. Leiser.....	14,288
Ranges, G. F. Filley.....	13,854 13,884	Sash balances, C. E. Bogle et al.....	15,870
“ and stoves, G. F. Filley.....	13,853 13,856	“ cord fasteners, T. Morton.....	14,045
	13,857	Saw dressing tools, G. Walsh.....	15,053
Ranges and stoves, M. A. Nicholson.....	15,090	“ dust drying apparatus, H. C. F. Stormer.....	14,435
Reaper tables, W. Russell.....	14,606	“ frames, E. M. Madden.....	15,234
Reapers and mowers, A. G. Ramsay.....	14,687	“ guides, J. P. Hall.....	14,591
“ “ J. C. Meyors et al.....	14,019	“ handles, C. W. Knapp.....	15,752
Reaping and mowing machines, F. J. Hazard et al.....	14,554	“ “ The Montreal Saw Works.....	15,219
“ machines, C. J. F. Wilkins.....	14,109	“ jointers, G. Walsh.....	15,054
“ “ G. W. Freeman.....	14,615	“ “ and gauges, R. E. Poindexter.....	15,283
Receivers, telephone, C. F. Livermore.....	14,354	“ mills, C. A. Hege.....	15,212
Receiving instruments, telegraph, G. Smith.....	15,140	“ “ C. E. Lewis.....	15,596
Recorders, continuous, J. B. Moscrop.....	14,356	“ “ D. C. Prescott.....	15,685
Reducing machines, ore, G. Dalton.....	15,626	“ “ G. H. Millen et al.....	15,687
“ process, grain, F. Taggart.....	15,702	“ “ H. Gawley.....	14,066
Reeds, fisherman's, F. R. Smith et al.....	14,521	“ “ P. Musser.....	15,217
“ yarn, T. H. Burrows.....	14,522	“ “ T. Moore.....	11,058
Reflector attachments, W. Wheeler.....	15,115	“ “ W. J. F. Liddell.....	13,844
Reflectors, W. Wheeler.....	14,929	Sawing machinery, W. Bowker.....	14,835
Refrigerating apparatus, J. T. Reed.....	15,031	“ “ hoop, W. Bowker.....	14,752
Refrigeration system, J. J. Bites.....	15,619	“ machines, D. and D. G. Jesseman.....	15,174
Refrigerator waggon, J. T. Gurney et al.....	13,813	“ “ F. X. Bertrand.....	14,892
Refrigerators, A. S. Haslam.....	14,219	“ “ J. Campbell.....	11,723
“ D. W. Davis et al.....	15,005	“ “ J. H. Hermance.....	14,712
“ G. H. Aird.....	14,585	“ “ R. Smart.....	13,820
“ J. T. Gurney et al.....	16,287	“ “ W. Hamilton.....	14,011
“ W. C. Kewn.....	14,383	“ wood, W. A. Allen.....	14,315
“ lager beer, J. Alexander.....	15,044	Saws, circular, F. Genin.....	14,155
Registers and ottomans, J. A. Graham et al.....	15,419	“ cross-cut, H. Westphal.....	14,399
Regulators, automatic, A. M. Kerr.....	14,756	“ “ J. C. Dietrich.....	14,168
“ current, T. A. Edison.....	14,002	“ devices for jointing, E. Preston.....	14,906
“ damper, D. C. Kellem.....	15,843	“ gang, S. and S. Adams.....	15,421
“ electric machine, T. A. Edison.....	13,898	“ gig, W. Cooper.....	14,841
“ “ “.....	15,847	“ machines for jointing and sharpening, W. R. Parsons.....	15,334
“ electric current, E. Thomson.....	15,186	“ open back, L. Lawson.....	13,987
“ “ light, The Union Electric Mfg Co.....	15,205	Scaffolds, G. W. Smith.....	15,573
“ for nursing bottles, W. C. Carpenter.....	15,213	Scarfs, manufacture of, N. McCormick.....	14,341
“ gas, G. S. Lacey et al.....	14,946	Scouring machines, grain, D. M. Richardson.....	15,740
“ speed, B. L. Olds.....	14,025	Scrapers, drag, J. Cosgrove, et al.....	15,116
“ watch, J. A. Awalt.....	14,337	“ earth, A. R. Byrket.....	13,903
Rein and whip holders, F. C. Ayer.....	15,790	“ road, G. Gregory, et al.....	15,459
“ holders, C. L. Granis et al.....	15,033	“ “ J. D. Smith, et al.....	14,810
Reins, check, F. L. Jones.....	13,850	“ steel, G. Wilkinson.....	15,534
“ “ H. T. Harding.....	15,463	“ vehicle wheel, F. C. Mercer.....	14,568
Renovating apparatus, feather, M. Rose.....	14,903	Screens, window and door, The Otter Sweeper Co'y.....	15,464
Renovators, feather, E. B. Dufort et al.....	14,119	Screw balls, C. D. Rogers.....	15,849
Replacers, car, J. Parker.....	13,815	“ patterns, W. A. Ingalls.....	13,993
Replacing device, belt, H. C. Hartley et al.....	15,010	“ plates, W. H. Price.....	14,089
Restraining device, animal, H. M. Harvey et al.....	15,471	Screws, C. D. Rogers.....	14,801
Reversing mechanism, V. W. Mason.....	14,269	Scuffers, E. Moore.....	14,697
Rings, finger and scarf, R. J. LaGrange.....	14,623	Searching for submerged bodies, apparatus for, C. A. McEvoy.....	15,315
“ neckyoke, C. Shuman.....	14,751	Seats adjustable, carriage, J. Moon.....	14,560
“ packing, T. B. Nowell.....	15,181	“ beach, S. Tarant.....	14,489
Rivet and bolt cutter, C. W. Levalley.....	14,982	“ buggy, W. A. Eddy.....	15,737
Rivets, machines for making, G. H. Waring et al.....	15,244	“ car, E. L. Bushnell.....	15,433
Roads, system of constructing, W. B. Henning et al.....	15,578	“ “ J. M. Van Wagner.....	14,992
Roasters, coffee, G. A. Beldler.....	13,880	“ carriage, J. M. Perkins.....	14,961
Rods, lightning, J. H. Schoonmaker et al.....	15,117	“ “ J. W. Anderson.....	15,276
“ metallic, S. W. Skinner et al.....	13,866	“ “ P. A. Larivière.....	15,000
Rollers and hinges, gate, S. R. Pratt.....	14,031	“ folding, J. L. Kapple.....	15,718
“ book binding, E. L. Miller et al.....	14,321	“ for boats, sliding, G. Warin.....	15,676
“ curtain, H. Farley.....	14,008	“ vehicle, F. Oppenheim.....	14,283
“ “ W. B. Noyes.....	15,077		

Securers, door, J. Lockwood.....	14,257	Signal apparatus, telephone, J. F. Kettell.....	14,905
Seed planters, J. A. Houser.....	15,860	" buoys, F. Barr.....	14,262
" " W. Nevins.....	14,306	" lamps, S. Coxon.....	14,608
Seeding machines, J. M. Westcott.....	14,221	" lanterns, J. J. Robinson.....	14,764
" " J. W. Mann.....	13,833	" whistles, R. F. Crowther.....	15,310
" " J. W. Thomas, et al.....	15,743	Signalling apparatus, A. C. Brown, et al.....	14,577
Selecting devices, J. E. Munsen.....	15,447	" " O. Grasset.....	15,161
Separators, J. Paradis, et al.....	15,729	" " railway, H. Morris.....	14,997
" " and thrashers, J. Fisher.....	14,713	" " electric, T. D. Lockwood.....	15,825
" " The McDonald Mnf'g Co'y.....	14,246	" " mechanism, A. and E. F. Webster.....	15,167
" " gold, E. S. Bennett.....	14,784	Signals and switches, J. A. Bonnell.....	15,187
" " grain, C. E. McNeal, et al.....	15,533	" " electric, C. D. Tisdale, et al.....	15,254
" " H. P. Edmunds.....	14,203	" " railway, B. Hempstead.....	15,558
" " V. Arnold, et al.....	14,285	" " W. W. McLellan.....	15,021
" " ore, C. D. Buchanan.....	13,989	" " telegraph and railway, J. S. Trites.....	15,142
" " E. Warne.....	14,811	Silk doubling machines, A. Atwood.....	15,538
Separating fluids, apparatus for, G. de Laval.....	14,597	Silver extracting, R. Barker.....	15,797
" " machines, potato, W. Penniston.....	14,845	Singeing logs machine for, W. Morgan.....	14,857
Serving machine, rope, J. H. Nute, et al.....	15,429	Sinks, J. A. Talpey.....	15,660
Setters, box, E. Caswell.....	14,275	" " J. Kilbourne.....	14,612
Setting edges, machine for, G. H. P. Flagg.....	14,648	Sirup and sugar, H. A. Weber, et al.....	15,510
" " machines, edge, W. F. Hutchinson.....	13,899	" " and mineral waters, H. L. Bowker.....	15,270
Sewer traps, T. Guerin.....	15,050	Seizing tubes, method of, S. R. M. Tasker.....	14,766
Sewers and drains, F. X. Rousseau.....	15,385	Skates, E. G. Macomber.....	13,829
Sewing apparatus, S. Borton, et al.....	14,598	" " W. A. Sutton.....	15,647
" " machine table, The Gerald Sewing Machine Co'y.....	15,411	" " H. Bezer.....	14,003
" " machines, motors, A. E. Rouif.....	15,606	" " J. Bartlett.....	15,374
" " A. M. Leslie.....	14,833	" " The Starr Manuf'g Co'y.....	14,013
" " C. R. Thompson.....	14,187	" " roller, C. M. Raymond.....	14,624
" " C. Lockman.....	14,071	" " J. K. Ross.....	15,162
" " D. Mills.....	14,505	Skiffs, shooting, G. Warin.....	15,602
" " E. Bruncker.....	15,165	Skin diseases, compound for, M. A. Reaves.....	13,797
" " E. Stern.....	15,787	Skirt adjuster, N. C. Greene.....	13,974
" " G. Doolittle, et al.....	14,432	Skiving machine, leather, M. A. Holton.....	13,819
" " J. C. Goodwin, et al.....	14,918	Skif-lights, A. C. Dunlevy, et al.....	14,883
" " button, J. H. Morley.....	14,053	Slabs bricks and stones, L. Promoti, et al.....	14,260
" " J. I. and H. Pellerin.....	14,798	Slate quarrying, A. R. Reese, et al.....	15,400
" " J. Mathison.....	13,788	Slates, J. D. McDade.....	15,688
" " J. M. Fair.....	15,075	Sleds, C. M. Hinman.....	15,839
" " S. J. Baird.....	14,978	" " J. T. Gurney et al.....	14,223
" " T. Clohecy.....	14,282	" " R. R. Haldeman.....	15,362
" " T. Stevens.....	14,134	Sleepers, treating, J. B. Blythe.....	14,856
" " W. T. Cook.....	14,621	Sleighs, D. M. Kirkpatrick.....	15,336
" " W. Y. Allen.....	15,756	" " J. C. F. Pagel.....	15,582
" " The Empress Embroiderer Co'y.....	15,678	" " saw log, J. M. Stanley, et al.....	15,489
" " The Garretson Ruffler Co'y.....	15,369	Slicers, apple, A. J. Rice.....	14,141
" " The Manhattan Cabinet Mnf'g Co'y.....	13,780	Smelting, composition for, W. A. Mastin.....	14,611
" " The Williams Mnf'g Co'y.....	15,762	" " fumes from, G. T. Lewis.....	14,899
" " broom, G. F. McCombs, et al.....	14,303	Smoke consumers, J. Elliott.....	13,772
" " " The Hand Stitch Broom Sewing Machine Co'y.....	14,608	" " The Tobey Furniture Co'y.....	14,690
" " button hole, J. Reece.....	14,682	" " H. R. Ives.....	13,837
Shaft coupling, W. Johnson.....	15,068	" " consuming furnaces, C. Smith.....	14,639
Shafting hangers for, P. Cramer.....	13,794	Smoothing machines, A. F. Zimmer Ing.....	15,494
Shafting, steps for vertical, W. Crowe.....	14,974	Snath fasteners, A. J. Schultze, et al.....	15,143
Shafts, flexible, F. A. Cortis.....	15,299	Snow clearers, J. Coxen.....	14,096
Shapes for hose and socks, W. B. Pollock.....	13,896	Soap, manufacture of, W. Green.....	14,150
Sharpeners, saw, W. H. Halladay.....	15,491	" " process, C. S. Higgins.....	13,995
Sharpening and jointing machines, saw, W. R. Parsons.....	15,334	Sockets and cockages, M. Miller.....	14,840
Sharpening files, M. A. Richardson.....	14,179	" " spoke, E. Kallam.....	15,450
Sheds for drying bricks, J. Evans.....	15,652	Socks and hose shapes for, W. B. Pollock.....	13,896
Shells, corn, A. T. Keegan.....	15,198	Soda, perfumed caustic, G. T. Lewis.....	14,817
Shifters, belt, E. C. Durand.....	15,728	Sofa beds, C. Scofield.....	15,139
Shingle machine, F. X. Bertrand.....	14,892	" " H. R. Pimpton.....	15,566
" " machines, J. Fréchalte.....	15,856	Sofas, R. W. Anderson.....	14,207
" " J. A. Munford.....	15,413	Sole buffing machines, J. H. Stevens.....	14,055
" " W. J. Perkins.....	14,118	Sorters lumber, E. T. Davies.....	14,372
Ship fastenings, H. Squier.....	14,170	Soup compounds, J. D. Warren.....	13,988
Shippers, belt, B. H. Hadley.....	13,791	" " broad cast, J. C. Waddell.....	15,452
" " belt, W. Gray.....	13,870	" " " J. Dickleson.....	14,680
Ships, air, C. W. Peterson.....	14,218	" " drills and broad cast, J. Fraser.....	15,099
Shirts, I. Schmeer.....	14,722	" " " T. Galloway.....	14,852
Shoe sole buffer, F. Winslow.....	14,799	Spark arresters, D. June.....	15,236
Shoes, F. E. Farwell.....	15,631	" " J. J. Hewitt.....	13,795
" " A. W. Burr.....	13,770	" " J. K. Taylor.....	14,114
" " J. L. Joyce.....	15,529	" " extinguishers, I. Deyell.....	14,677
" " ox, A. Sanford.....	14,785	Spike machines, G. H. Waring, et al.....	15,244
" " sleigh, E. D. Cannon.....	14,777	" " H. W. Fowler.....	14,715
Shovels, H. W. Shephard.....	14,760	" " W. A. D. Bowman, et al.....	14,648
" " snow, H. W. Searle.....	14,040	Spirals railway, J. B. Barnes, et al.....	14,255
Show boxes, J. J. Langles.....	14,490	Spirits, apparatus for maturing, E. Luck.....	14,412
Sifters, ash, C. G. C. Simpson.....	15,189	Spirometer, M. Souvielle.....	14,427 14,586
" " E. G. Schultz, et al.....	14,876	Splash boards, L. E. McKinnon.....	13,840
" " cinder, J. T. Wilson, et al.....	15,682	Splice, belt, T. Clohecy.....	14,282
" " coal, J. F. Andrews.....	13,888	Splitting machines, C. E. Grandy, et al.....	44,495
Sight for fire-arms, T. Gilbert.....	15,378	Spoke guide and gauge, J. McCoskey.....	14,953
Signal apparatus, E. Dunlop.....	15,094	Spokes, machine for cutting, H. J. Miller.....	14,808
		Spoon baits, trolling, S. Allcock et al.....	15,088

Spout, pall, etc., sap, C. C. Post.....	15,575	Stoves, gasoline, F. A. Lyman.....	14,022
Spouts, sap, G. J. Alford	14,083	" heating, A. H. Herington	15,684
Springs, bed, A. Haller	15,101	" " G. G. Thomas	15,435
" buggy, G. Pennoyer	15,490	" hot water, E. Bellavance	14,000
" car, C. T. Schoen et al.....	14,746	" magazine, J. and F. A. Magee.....	14,957
" " G. F. Godley	14,773	" oil, L. C. Heckman	13,891
" carriage, A. J. L. Jantz.....	15,799	" " The Boston Petroleum Heating Co'y.....	14,917
" " The Guelph Carriage Goods Co'y.	13,965	" self-feeding, F. J. Gould.....	14,940
" devices for banding, J. Hale.....	14,037	Stowing cargoes, apparatus for, M. C. Walsh.....	15,438
" dies for, E. Spaulding	14,527	Straw carrier, chain, A. Kline.....	15,769
" elliptic, E. Cliff et al.....	15,396	" cutters, C. Sheppardson	13,926
" machine for bending, J. Fowler.....	14,117	" cutting machine, D. W. Carpenter et al	15,570
" vehicle, H. S. Clark	15,836	Stretchers, fence wire, S. M. Stevens.....	14,629
" " J. H. Moran.....	14,741	" wire, R. Elwood.....	15,202
" " N. Nilson.....	14,898	Strips, barbed fence, T. C. Hewitt.....	14,744
" " P. J. Kern.....	14,896	Structures with beton, methods of repairing, J. C. Goodridge	15,365
" " S. A. Bailey.....	15,055	Stud, lacing, M. Bray	14,874 14,875
" " The Spiral Spring Buggy Co'y.....	14,478	Stuffing horse collars, J. Newton.....	14,942
" " W. Davison	15,195	Sugar and syrup, H. A. Weber et al	13,949
" " W. W. Grier.....	14,983	" apparatus, T. A. and W. T. Jebb.....	15,510
" waggon, J. L. and H. M. Clark	14,922	" crystallizing, grape, H. Williams	14,326
Squares, L. Low.....	14,492	" grape, W. T. Jebb	13,861
Squeezers, lemon, W. B. Dean.....	14,142	" manufacture of, M. Heinrich.....	15,403
Stackers, hay, J. Dain.....	14,572	" manufacturing, E. Fleisher	15,667
" " J. H. Bean	14,488	" refining process, G. A. Drummond.....	14,062
Stacks, smoke, G. S. Strong.....	15,286	Supports, valve rod, E. P. Monroe.....	15,330
Staffs, millstone, W. Lehman.....	13,996	" " waggon tongue, M. Conrad	15,714
Stamp cancellers, H. F. Gaines.....	15,085	Suspenders, trousers, J. Cohen	13,883
" cancelling, L. Tilton.....	14,322	Swags, saw, N. Johnson.....	14,797
Staples, C. W. Dean	13,943	Sweepers, carpet, C. L. Travis	15,052
" hasp, G. Smith.....	14,619	Switch boards, plugs for electrical, H. W. Leland	15,225
" wire, P. Dunn et al.....	14,397	Switches and signals, J. A. Bonnell.....	15,137
Starch apparatus, T. A. and W. T. Jebb.....	15,669	" railway, C. H. Logan et al.....	14,382
" " for treating the refuse of, W. T. Jebb.	14,326	" " F. S. Scheffer	14,828
" manufacture of, A. Atkinson.....	15,322	" " L. N. Bruner.....	14,360
Starching machines, D. and C. G. Rowley	15,821	" " R. F. Crowther.....	15,310
Starters, car, G. A. and H. T. Evans.....	15,262	" " T. Solte.....	13,821
Staves, barrel, E. M. Jewett.....	15,347	Swivels for adjusting pumps, H. Cairns	14,428
Stays, corset, M. P. Bray.....	14,966	Syringes, vaginal, F. Wilhoft.....	13,951
Steam apparatus, E. F. Osbone.....	15,495	Syrup and sugar, H. A. Weber et al.....	15,510
" apparatus for preventing the accumulation of,	14,014	Tables, J. Plenkharp.....	14,626
" C. J. Anthony et al.....	15,441	" and cabinets, The Manhattan Cabinet Mfg Co.	13,780
Steam superheating apparatus, A. Estrade	13,890	" extension, C. Beall.....	14,156
" vessels, L. P. Fairbanks.....	13,792	" " W. B. Crich.....	14,052
Steel, S. R. Foster.....	14,561	" laundry, W. Dicer.....	15,271
" surfaces, F. S. Barff et al.....	14,442	" reaper, W. Russell	14,606
Steps for vertical shafting, W. Crowe.....	14,974	" sewing machine, The Gerald Sewing Machine Co	15,411
Sticks, walking, J. Draper.....	14,736	" writing, J. A. Harriman.....	14,882
Stirrers, tan, and vats, C. Flohr.....	14,437	T. blots, information, E. S. Boynton.....	14,902
Stirrups fastenings, W. H. Kirby.....	14,553	" writing, J. H. Hodder.....	14,137
Stock feeding device, A. D. Tingley.....	14,267	Tacking machines, G. W. Copeland.....	14,218
" rolling, A. Estrade	13,947	Tags for fences, J. J. LaFleur et al	14,271
Stockings, R. M. Appleton	15,081	" paper, W. C. Wildman.....	14,0 0
" manufacture of, W. Esty.....	14,461	Tall, se-fregistering, J. W. Elliott.....	14,975
" waterproofing, J. B. Mackinnon.....	15,014	Tamping and firing devices, J. E. Gallagher.....	15,486
Stone, artificial, D. W. Weems.....	15,095	Tan bark, preparing, W. H. Smith	15,562
" " J. W. McKnight.....	13,811	" process for treating, W. Guest et al	14,626
" dressing machines, A. McDonald	14,914	Tanks, oil, J. D. Arnold et al.....	14,194
" paving, L. Promoti et al.....	14,260	Tanning machinery, J. W. Janson.....	14,136
Stop motions for looms, F. O. Tucker.....	15,328	" process, J. Head et al.....	15,690
Stoppers and fasteners, bottle, A. E. Rich.....	15,751	" " R. F. Dobson	13,930
" bottle, F. Will	14,820	" " W. Harris	15,775
" " J. McGuire et al.....	15,841	Taper machine, J. B. Lanier.....	14,653
" " N. Thompson	14,424	Ta-sel clamps, H. M. Wells et al.....	14,063
" can, W. H. Rodden	14,127	Tedders, hay, H. Hitchcock	14,781
Stopping apparatus, train, W. C. Shaffer.....	14,438	Teeth, card, T. Kershaw et al.....	14,494
Stove backs, W. Schenck	14,279	" cultivator, G. Bettschen.....	15,238
" boards, R. M. Bidelman et al	14,273	Telegraphic apparatus, F. Van Ryselberghe	15,363
" carriers, G. Dee.....	14,325	" despatches, A. F. and F. B. Johnson.....	14,400
" doors, D. K. Alden.....	15,633	" instruments, protectors for, C. T. Howard.....	14,908
" lamps, B. F. Lancaster et al.....	15,747	" systems, apparatus for preventing induction in, F. Van Ryselberghe.....	15,333
" ornaments, H. A. Matthews.....	14,765	Telegraphic transmitters, A. F. and F. B. Johnson.....	14,404
" platforms, E. W. L. Rice	15,062	Telegraph conductors, W. O. Callender	15,395
" pipe fitters, W. Volk	14,672	" electric, A. F. and F. B. Johnson	14,407
Stoves, J. D. Pierce	14,202	" receiving apparatus, J. W. Fuller.....	14,133
" and fire places, J. R. Petter.....	15,482	" " instruments, G. Smith.....	15,140
" and ranges, G. F. Filley.....	13,852 13,853 13,856	" wires, insulating, W. E. Banta et al.....	15,259
" " M. A. Nicholson.....	14,480	Telegraphs, B. Smith.....	14,331
" and ventilators, W. F. Condon	15,090	" Sir J. Anderson et al.....	14,331
" coal, C. Rathbone.....	15,389	" T. A. Edison et al.....	13,774
" " J. W. Elliott.....	15,398	" train, E. D. Parker.....	15,569
" cooking, E. Peerless.....	14,345	Telephone exchange, E. T. Guimby.....	15,134
" " G. F. Filley.....	14,199	" lines, T. D. Lockwood	15,825
" " The American Stove Mfg Co'y.....	13,855 13,858 13,859	" receivers, C. F. Livermore	14,354
" draft apparatus for, F. Beaumont, Jr.....	14,245	" signal apparatus, J. F. Kettell	14,905
" fire bottom for, J. S. Symmonds.....	14,921	" transmitters, C. F. Livermore.....	14,353
	14,517		

Telephones, A. E. Dolbear	14,098	Treating metals, H. R. Cassel.....	15,448	15,516	15,517
" A. W. Rose	15,650	Trees, boot, H. Kranz, et al.....			14,528
" C. V. Stafford et al.....	15,802	Trees, saddle, W. H. and S. Taylor.....			14,159
" E. T. Gilliland.....	14,151	Trestles, D. E. Teal.....			15,868
" H. C. Strong et al.....	14,023	Tricycles, J. A. McKenzie.....			14,847
" J. A. Lakin.....	14,416	Trimming apparatus, S. Barton, et al.....			14,598
" J. R. Bennett.....	15,249	Trough hangers, eaves, W. F. Stoetzel.....			15,785
" L. Beecher.....	14,924	Trough, eaves, W. F. Moulton.....			14,451
" The Canadian Telephone Co'y.....	14,190	Trough machines, eaves, W. B. Chambers.....			15,264
" W. Hubbard.....	14,191 14,209 14,210	Trucks, J. Esch.....			14,471
" W. J. Dudley.....	14,320	" barrel, J. J. Swain.....			15,301
Telephonic apparatus, F. Van Rysselberghe.....	13,785	" car, J. N. Smith.....			14,570
systems, apparatus for preventing induction in, F. Van Rysselberghe.....	15,363	Trunks, F. H. Ransom.....			13,997
Telephony, electric, The Canadian Telephone Co'y.....	13,810	" J. Hurst.....			14,706
Tenons, machine for cutting, H. J. Miller.....	14,808	Trusses, J. R. Alexander.....			14,417
Thill lugs, N. T. Folsom.....	15,801	" N. Herrick.....			14,821
Thrashers and separators, J. Fisher.....	14,713	Tube cleaners, J. Harley.....			14,550
" " The McDonald Mnf'g Co'y.....	14,246	Tubes, gauge, L. M. Fleet.....			14,959
Thrashing machines, A. Klim.....	14,769	" glass, F. M. James, et al.....			15,182
" " J. A. Beam.....	14,893	" of feed bottles, apparatus for cleansing, T. Marshall.....			15,079
" " J. McCloskey.....	15,699	" paint, F. R. Groat.....			14,474
" " J. Miller.....	14,333	" welding and sizing, S. P. M. Tasker.....			14,766
" " J. Paradis et al.....	15,729	Tubing joints, well, J. A. Beverly.....			13,847
" " M. Griffin.....	15,083	Tugs, game, T. A. Simmons.....			15,806
" " R. Mowry.....	15,125	Turbine wheels, J. L. Rodgers.....			15,488
" " W. R. Allen.....	13,805	Turbines, water, W. B. Farrar.....			14,405
" flax, L. W. Robards.....	15,794	Turning machines, treenail, F. Lightbody.....			14,030
Threading machines, bolt, W. H. Price.....	14,064	Tuyeres, O. P. Clayton.....			14,426
Threads on cylinders, forming, J. F. Brower.....	14,991	" W. M. and A. A. Riggis.....			14,730
Ticket-holders, price, E. Whyte.....	15,727	Twisting machines, cotton, A. Yates.....			14,138
Tickets, coupon, J. M. Lyons.....	14,911	Umbrellas, J. Feldman.....			15,715
Ties, bag, J. L. Vandemark.....	13,881	Undercarriages, T. C. Waller.....			14,834
" bale, E. S. Lenox.....	14,162	Undergarments, F. B. Farrington.....			15,571
" cattle, H. M. Robbins.....	14,928	Undershirts, R. M. Appleton.....			14,696
" railroad, D. Sennis.....	15,840	Unloaders, hay, J. M. Hendricks.....			15,397
Tights and drawers, R. M. Appleton.....	15,025	Upholstery, fibre for, J. G. Stevens.....			14,652
Tile, marble and stone, J. W. McKnight.....	13,811	Upsetters, tire, F. K. Collier, et al.....			14,276
Tiles, illuminating, The Sanitary Mnf'g Co'y.....	13,826	Upsetting machines, tire, A. Womack, et al.....			15,497
Tiling for floors, J. J. Williams.....	14,473	Utensils, F. Ménard.....			15,321
" roofs, etc., J. J. Williams.....	14,473	Valve gear, F. R. Rice.....			14,973
Tills, B. W. Webb.....	15,118	" J. Scott.....			14,481
Timber dressing, W. H. Knight.....	14,104	" gears, W. Johnson.....			15,390
Time-piece calendars, G. E. Sanford, et al.....	14,769	" rods, E. P. Monroe.....			15,330
Tire machines, G. B. Libby.....	14,539	" safety, G. Wilson.....			14,075
" shrinkers, F. K. Collier, et al.....	14,276	" stem, piston and cylinder, A. N. Mathews, et al.....			13,804
" upsetting machines, A. Womack, et al.....	15,497	" and cocks, D. R. Ashton, et al.....			15,282
Tobacco, J. Lindsley, et al.....	14,057	" ball, A. G. Alexander.....			15,528
Toe pieces, J. L. Thomson.....	15,022	" balance slide, T. Poore, et al.....			14,481
Tongue supports, waggon, M. Conrad.....	15,714	" slide, H. H. Beach.....			15,119
Tools, cylinder dressing, J. N. Smith.....	15,230	" steam, J. Neff.....			14,753
" entrenching, N. W. Wallace.....	15,835	" P. Armington.....			14,701
" ice, J. B. Fischer, et al.....	14,259	" The Pratt and Cady Co'y.....			14,891
" saw dressing, G. Walsh.....	15,053	" W. S. Phelps.....			15,342
" wood turning and gauge, S. Washburn.....	15,531	Vats for heating and saturating hoops, D. H. Burrell, et al.....			15,071
Tops, buggy, T. Smith.....	14,278	" and stirrers tan, C. Flohr.....			14,447
" W. Hodge.....	14,870	Vaults, grave, G. W. Boyd.....			14,790
" carriage, D. Convoys.....	13,918	Vehicles, spring, G. Delker.....			15,814
" E. Miller.....	14,445	" two-wheel, O. Heber t.....			15,449
" W. Hodge.....	14,185	Velocipedes, J. R. Smith.....			15,610
Torpedo operation, apparatus for, C. A. McEvoy.....	15,315	Veneer cutting machines, H. L. Smith, et al.....			14,177
" tamping and firing device for, J. E. Gallagher.....	15,486	Veneering, B. Morton, et al.....			15,458
Toy whips, M. A. Gilman.....	14,523	Ventilating and heating, L. A. Spaulding.....			14,206
Toys, mechanical, W. A. Webber.....	14,718	" apparatus, H. Mestern.....			14,954
Trace carriers, W. H. Main.....	15,203	" windows, S. Hart.....			15,274
Traces and neck yokes, M. Miller.....	14,840	Ventilation system, J. J. Bates.....	13,812		13,813
Train, stopping apparatus, W. C. Shaffer.....	14,338	Ventilators and heaters, W. F. Condon.....	13,801		15,389
Trains, electrical connections on railway, J. B. and F. S. Lowe.....	15,387	" and traps, F. X. Rousseau.....			15,385
Transfers, freight, A. E. McDonald.....	13,970	" rotary, L. B. Villebonnet.....			14,319
Transmitters, telegraphic, A. F. and F. B. Johnson.....	14,404	Vermin and water repelling compound, D. M. Lamb.....			15,662
" telephone, C. F. Livermore.....	14,353	Vessels, aerial, A. L. Blackman.....			15,047
" J. Olmsted.....	14,681	" construction of, C. H. H. C. de Winter.....			14,327
Transmitting messages, system of, A. F. and F. B. Johnson.....	14,407	" sheet metal, J. Hale.....			14,385
Transom lifters, M. E. Dayton.....	15,169	" steam, L. P. Fairbanks.....			13,792
" pivots.....	14,459	Vices, A. Hendry.....			15,263
Trap and ventilator, F. X. Rousseau.....	15,385	Vinegar, manufacture of, B. E. Charlton.....			14,438
" bird insect, W. S. Burn, et al.....	13,825	Waggon, J. Cruickshank.....			13,975
Traps, animal, J. H. and T. D. Morris.....	13,964	" J. T. Gurney, et al.....			14,376
" ball, G. N. Sidney.....	14,998	" dumping, H. Leggett.....			15,478
" sewer, T. Guerin.....	15,050	" refrigerator, J. T. Gurney, et al.....			14,249
" steam, J. Pender.....	14,310	" spring, L. M. Fitch, et al.....			13,848
" water, W. J. English, et al.....	15,777	Walling, stone, J. Heard.....			15,112
Treadle motive power, W. Cooper.....	14,841	Walls and ceilings, T. J. McGeary, et al.....			15,314
Treads of wheels, machines for dressing, J. N. Smith.....	15,248	Warp dressing machines, W. Titmas.....			15,210
		Warming apparatus, H. Mestern.....			14,954
		Wash, apparatus for acetifying alcoholic, E. Luck.....			14,412
		" basins, A. Edwards.....			14,018

Wash bench, chair and, D. L. Richards.....	13,822	Windows, bay, W. S. Garrison	14,324
" boards, A. W. Geisel.....	15,537	" locomotive, J. M. Taylor	14,274
" " P. T. Gates.....	14,464	" store, C. J. Anthony et al.....	15,441
" boilers, A. Holms.....	14,925	" ventilating, S. Hart.....	15,274
" " J. Roberts.....	14,292	Wind wheels, B. J. Palmer.....	14,900
" " W. Barton.....	14,622	Wire, barbed, O. P. Briggs	15,186
" stands, S. K. Amherst.....	14,323	" " The Worcester Barb Fence Co'y.....	14,919
" " commode, W. T. Egbert.....	14,362	" " fence, S. S. Chisholm et al	15,605
Washing machines, A. W. Burke.....	14,369	" coating process, L. L. Smith.....	14,714
" " C. A. Conover	14,915	" colling machines, G. Gale	15,410
" " G. B. Dowswell.....	14,388	" " L. Wildermuth	15,422
" " G. S. Morphy.....	14,102	" electric, H. A. Clark.....	14,258
" " H. J. Skinner.....	14,884	" machine, fence, The Washburn and Moen Mnf'g Co'y	15,548
" " H. S. McLean.....	14,499	Wire machine for barbing, D. G. Wells	15,837
" " J. Dougherty.....	14,720	" manufacture of covered, H. A. Clark	14,994
" " J. H. Atwater.....	14,663	" machinery for covering, H. A. Clark.....	14,995
" " L. C. Egbert.....	14,238	" stretchers, R. Elwood	15,202
" " M. W. Robinson.....	15,635	Wood, method of treating, C. D. Ekman	14,963
" " O. Harris.....	14,113	" moulding, F. Hanson.....	14,381
" " R. H. Cornett.....	15,589	" upon glass, machines for transferring the grains of, J. Budd.....	15,030
" " R. S. Forbes.....	14,439	Wood working machinery, W. H. Essery.....	15,738
" " R. S. Morse	15,781	" " machines, F. Hanson.....	14,078
" " coal, C. Sheppard	14,939	Workers, butter, E. E. Sully.....	15,367
Watch cases, R. J. Quigley.....	14,307	" " G. A. Blanchard.....	14,504
" regulators, J. A. Awalt.....	14,337	Wrappers, bottle, M. V. Kacer	14,614
Water and vermin repelling compound, D. M. Lamb.....	10,562	Wrenches, G. W. Hight et al.....	15,724
" closets, G. C. Phillips.....	15,590	" " H. A. Thompson.....	13,865
" purifying, S. E. Collins.....	14,669	" pipe, T. D. Mernan et al	13,998
" " T. Sharp.....	13,839	Wringers and benches, I. R. Laux et al	14,149
" removing impurities from, A. S. Fisher.....	14,074	" and mangles, clothes, C. Gentesse.....	15,625
Water works, G. E. Beach	14,266	" clothes, " "	14,869
Watering device, stock, A. D. Tingley.....	14,267	" " D. F. Babb	14,027
Waterproof articles, W. O. Callender	15,372	" mop, H. Taylor.....	14,673
Waters and syrups, mineral, H. L. Bowker.....	15,270	Wringing machines, J. S. Fox	15,114
Wear in axle boxes, taking up the, E. Brulé.....	15,462	" " The Hamilton Industrial Works Co	15,518
Weaving, cane, J. S. Ford et al.....	14,558	Writing cases, S. Wheeler.....	14,227
" cloth, art of, T. Isherwood.....	14,979	" machines, type, A. G. Shannon.....	15,783
Weighing devices, A. Arnot et al	14,578	Yeast, preparation of, S. Levy.....	15,240
" machines, R. Kirkpatrick.....	14,842	Yoke rings, neck, C. Shuman	14,751
" " V. Arnold et al	14,285	Yokes and traces, neck, M. Miller.....	14,840
Welding links, for machine, H. C. Szink et al.....	14,487	" neck, C. I. Calvert	15,339
" tubes, method of, S. P. M. Tasker.....	14,766	" G. W. Hunter.....	15,349
Wells, devices for digging, W. H. H. Davis.....	15,855		
Wheat separating and scouring machine, H. J. Livergood	15,353		
Wheel barrows, T. Brewer	15,170		
" scrapers, vehicle, F. C. Mercer.....	14,568		
Wheels, R. Gowans.....	14,006		
" car, G. W. Fairman et al.....	15,857		
" " G. W. Miltimore	15,592		
" " J. K. Sax.....	15,688		
" " J. Reese et al.....	14,602		
" " L. W. Washburn	14,674		
" " The Sheffield Velocipede Car Co.....	15,877		
" carriage, O. C. Ross.....	14,277		
" current, A. D. Clark.....	13,981		
" fifth, E. P. Carter.....	15,324		
" " G. Dynes.....	14,782		
" machines for dressing treads of, J. N. Smith.....	15,248		
" moulds for, J. Thiery	14,792		
" paddle, W. C. Thompson.....	14,535		
" sprocket, F. M. Lechner.....	15,100		
" steering, S. B. Greacen	15,776		
" turbine, J. L. Rogers	15,488		
" vehicles, D. Johnson	15,412		
" " J. Gobb.....	15,759		
" waggon, W. Downham	15,049		
" water, A. Edwards.....	14,683		
" " C. R. Cowley	14,132		
" " G. Yellot	14,070		
Whip and rein holders, F. C. Ayer.....	15,790		
" cores, V. B. Barstow	15,555		
" toy, M. A. Gillman.....	14,583		
Whippletree clips, H. McCoy.....	15,446		
Whiskey, racks for storing and ageing, C. M. Johnson.....	15,164		
Whistles, signal, R. F. Crowther	15,310		
Whitenings and trimmings, C. B. Davey.....	14,446		
Wicks, lamp, G. Beck	15,103		
Winders, bobbin, C. B. Thompson.....	14,187		
" " J. C. Goodwin et al.....	14,918		
Windmills, B. Chamberlain et al.....	15,572		
" " C. J. Hamilton	14,007		
" " " et al.....	15,361		
" " F. J. Lee.....	13,913		
" " F. J. Lee et al.....	15,179		
" " J. E. Jones.....	15,323		
" " W. Forbes.....	13,873		
Window light fasteners, T. Tanner.....	14,144		

INDEX TO PATENTEES.

Abbot, W. F., musical instruments.....	15,815
Abrahams, L., cigar protectors.....	15,475
Adams, G., mortise locks.....	15,121
" G. L., et al., printing presses.....	15,278
" S. and S., gang saws.....	15,421
Adams and Westlake (The) Mnf'g Co'y., et al., cuspa-dors.....	14,965
Ager, W., grain Decorticators.....	14,873
Ahrens, F., pumps.....	15,763
Allaire, A. and F., milk coolers.....	13,977
Alcock, S., et al., trolling spoon baits.....	14,088
Alden, C., preserved fish.....	13,895
" D. K., stove doors.....	15,833
Aldred, F., churns.....	13,815
Aletter, H., et al., boot trees.....	14,528
Alexander, A. G., ball valves.....	15,528
" J., lager beer refrigerators.....	15,419
" J. R., trusses.....	14,417
" W. G., gate hangings.....	14,551
Alford, G. J., sap spouts.....	14,083
" W. D., et al., meat cutters.....	14,933
Allen, A. B., railway cars.....	15,480
" I. H., fire-escape ladders.....	15,007
" S. M., grinding wood.....	15,216
" W. A., bundling kindling wood.....	14,314
" W. A., sawing kindling wood	14,315
" W. O., et al., wind mills.....	15,361
" W. R., thrashing machines	14,805
" W. Y., sewing machines.....	15,756
Almgoist, A. W., et al., machines for making spikes.....	14,646
Alprovidence, J. M., et al., plates for electric accumula-tors.....	15,414
American (The) Paper barrel Co'y., barrel heads.....	14,759
" (The) Stove Mnf'g Co'y., cooking stoves.....	14,245
Ames, J., et al., harvesters.....	14,381
" (The) Iron Works, steam boiler.....	15,691
Amherst, S. K., washstand.....	14,323
Anderson, A. T., netting machines.....	15,108

Anderson, C. F., lanterns.....	15,060	Baril, J. E., ice houses.....	15,237
" E. W., et al., walls and ceilings.....	15,314	Barker, R., gold extracting.....	15,797
" J., (Sir) et al., telegraphs.....	14,331	" R., et al., mowers and reapers.....	14,019
" J. D., et al., metallic barrels.....	15,477	Barnes, A. J., et al., method of attaching buttons.....	15,465
" J. W., carriage seats.....	15,276	" G., et al., shaft and pole couplers.....	14,348
" R. H., garments.....	15,780	" J. B., et al., railway spikes.....	14,255
" R. W., sofas.....	14,207	Barnum, W. S., et al., fishermen's reels.....	14,521
" W. C., et al., nut locks.....	15,257	Barr, A., et al., egg carrying apparatus.....	13,984
Andrews, C. N., pianos and organs.....	14,131	" F., signal buoys.....	14,262
" J. F., coal sifters.....	13,888	Barrett, J. E., car-couplings.....	14,514
" S. C., et al., hydrants.....	15,289	" T. et al., mortar and plaster.....	14,786
Anthes, J. S., chairs.....	14,067	Barron, A. F., lumber dryers.....	14,877
Anthony, C. J., et al., apparatus for preventing the accumulation of steam and frost.....	15,441	Bartholomew, J. A. and H., fruit evaporators.....	15,065
Applegate, S. S., electric alarm apparatus.....	14,761	" G. E., et al., carriage gear.....	15,671
Appleman, A. R., clover hullers.....	15,074	Bartlett, C. O., et al., oatmeal machines.....	14,089
Appleton, R. M., under shirts.....	14,696	" E. O., et al., white lead pigments.....	14,879
" R. M., drawers and tights.....	15,025	" H. R., fire-escape ladders.....	11,250
" R. M., stockings.....	15,081	" J., skates.....	15,374
Apraxine, Ct. A., aerial balloons.....	13,781	" J. F., brushes.....	15,803
Armant, E., et al., rotary cutters.....	15,144	" J. H., et al., mail bag fastenings.....	15,643
" et al., wheel hubs.....	15,168	" S. H., et al., telephone transmitters.....	14,353
" et al., anti-friction bearings.....	15,209	" S. H., et al., telephone receivers.....	14,354
" et al., manufacture of hinges.....	15,512	Barton, A. G. et al., hay racks.....	15,795
" et al., carriage gear.....	15,671	" W., wash boilers.....	14,622
" et al., rotary engines.....	15,767	Bartram, C. E., fruit barrels.....	14,107
Armington, P., engine governors.....	14,667	Barstow, V. B., whip cores.....	15,555
" P., steam valves.....	14,701	Byrne, J. H., gas machines.....	14,529
Armstrong, J. B., vehicle dash boards.....	15,717	Byrnes, M., et al., steam engines.....	14,236
" J. B., vehicle axles.....	15,766	Bassett, D. C., harness buckles.....	13,767
" T., preserving chambers.....	14,710	Batchelder, H. J., horse shoe machines.....	14,617
Archer, G. W., barber and dental chairs.....	14,126	Bates, J. J., ventilation, etc.....	13,812
Arms, E. H., et al., watch cases.....	14,307	" W. H., et al., knob spindle fastenings.....	15,068
Arnold, B. W., car couplings.....	15,293	Bayley, W., et al., harvesters and binders.....	14,588 14,589
" J. D., et al., oil tanks.....	14,194	Bayliff, L. P., et al., car-couplings.....	15,289
" V., et al., grain separators.....	14,285	Beach, G. E., water works.....	14,266
" W. E., cooking boilers.....	14,302	" H. H., slide valves.....	15,119
Arnot, A., et al., weighing and lifting devices.....	14,578	Beall, C., extension tables.....	14,156
Arrouquer, W., et al., mortar and plaster.....	14,786	Beals, G., iron manufacturing.....	14,061
Ashton, D. R., et al., cocks and valves.....	15,282	Beam, J. A., thrashing machines.....	14,593
Askins, J., burial cases.....	15,029	Beam, J. H., hay stackers.....	15,286
Atkinson, A., manufacture of starch.....	15,821	" S. L., mill dust collecting machines.....	14,084
Atwater, J. E., elevators for hatchways.....	15,129	Beattie, W., leg and foot protectors.....	14,198
Atwood, A., tension eveners.....	15,538	Beatty, C. F., et al., provision safes.....	14,936
" W. J., hub bands.....	14,140	Beaudry, Z., heel burnishers.....	15,251
" (The R'y Wheel Co'y., car couplings.....	15,192	Beaumont, F., draft apparatus for stoves.....	14,921
Aubin, A. N. and L. N. A., water furnaces.....	13,831	Beaupré, U., steam boilers.....	15,911
Austin, G., et al., road scrapers.....	15,459	Beck, G., lamp wicks.....	15,103
" W., sheet metal pipes and machines.....	15,597	" J. O., refrigerators.....	15,287
" W. R., et al., car wheels.....	15,857	Beecher, L., telephones.....	14,924
Avery, C. E., bread raising.....	13,925	Beemer, H. J., et al., bed bottoms.....	14,068
" C. E., lactates.....	14,048	Beers, J. H., et al., water elevators.....	15,229
" J. G., et al., power transmitting.....	14,069	Beiersdorf, J., et al., rocking chairs.....	15,063
" N., et al., coating metallic articles.....	15,160	Beidler, G. A., coffee roasters.....	13,980
Awalt, J. A., watch regulators.....	14,337	Belcher, F. S., et al., fruit evaporator.....	15,692
Ayer, F. C., dash and foot rails.....	15,106	Bell, J. A., et al., electric lamps.....	13,778
" F. C., rein and whip holders.....	15,790	" W. W., hame fasteners.....	15,123
Ayres, J. H., snow ploughs.....	15,132	Bellevance, E., hot water stoves.....	14,000
Babb, D. F., clothes wringers.....	14,027	Belloli, J. A., et al., cushion protectors.....	14,638
Babbitt, B. T., air compressors.....	15,741	Bennett, E. H., et al., steam boilers.....	15,792
Babcock, G. H., et al., steam boilers.....	15,793	" E. S., gold separators.....	14,784
" S. B., et al., fire engines.....	13,912	" J., churns.....	14,552
" and Wilcox (The Co'y., steam boilers.....	15,793	" J. B., telephones.....	15,249
Badger, O. W., wheel harrows.....	14,166	" L. J., disintegrating mills.....	13,968
Badlam, E., spoke sockets.....	15,450	Bemroe, J., wash basins.....	14,018
Baglin, W. A., et al., napped hats.....	15,154	Benoit, A., car brakes.....	13,879
" W. A., et al., shaking cotton from hats.....	15,163	" A., car-couplings.....	15,745
Bailey, A. M., et al., egg preserving.....	15,782	Bennor, G. W., manufacture of hubs.....	13,991
" D. H., et al., wrenches.....	15,724	Benton, L. B., printers' leads.....	15,051
" H., bee hives.....	15,801	Bergen, L., dispensing liquids.....	15,645
" S. A., vehicle springs.....	14,478	Bergstrom, O., rakes.....	15,457
" W., et al., harvesters.....	14,483	Berry, C. E., harness.....	13,796
Baird, D. W., carriages.....	15,559	" W. F., door hangers.....	14,226
" S., sewing machines.....	14,978	Bertolette, C. B., et al., wash balances.....	15,870
Baker, C. J., et al., folding cots.....	13,766	Bertrand, F. X., shingle machine.....	14,892
" G. W., lubricators.....	14,700	Best, J., et al., electric lamps.....	13,778
" W. R., grain binders.....	14,944	Bettschen, G., cultivators.....	14,565
Baldwin, B., corsets.....	15,243	Bettachen, G., cultivator teeth.....	15,238
" D. N., carpet fasteners.....	15,348	Beverly, J. A., well tubing joints.....	13,847
Ball, E. M., paper pulp machine.....	14,961	Bezé, G. A., et al., cane shredding machines.....	15,467
" F. H., engine governors.....	15,842	Bezer, H., skates.....	14,008
Ballou, H. P., knitting machines.....	15,039	Bickell, J., jr., knitting machines.....	15,427
Bancroft, H. N., et al., wheel hubs.....	14,850	Bickford, W. A., force pumps.....	15,858
Banta, W. E., et al., insulating telegraph wires.....	15,259	" W. A., water elevators.....	14,695
Barber, C., shaft couplings.....	14,986	Bidelman, R. M., et al., stove boards.....	14,278
Bare, W. and M., et al., tee tools.....	14,239	Billings, J. D., horse shoes.....	14,829
Barff, F. S., preservation of organic substances.....	14,503	Bindsell, H. F., et al., reversible cloaks.....	15,064
" F. S., et al., iron and steel surfaces.....	14,442	Bird, G. E., et al., blanket fasteners.....	15,070
		Bishop, J., car-couplings.....	14,707 14,889 14,890

Bismann, J., extension tables	14,156	Buck, C. R., trolling hooks	15,300
Blanchard, G. A., butter workers.....	14,504	" D. S., fences.....	14,443
Black, R. W., et al., stove lamps.....	15,747	" G. C., et al., harness irons	15,819
Blackhall, E. W., head line ruler and holder.....	14,291	Bucket J., calorific engines.....	15,313
" R. C., et al., means for extinguishing fires...	15,574	Buckland, E., et al., photographic printing frames.....	14,355
" W. B., process of marbling.....	15,521	Buckley, C., curtain fixtures.....	14,727
Blackman, A. L., aerial vessels.....	15,047	Budd, J., glass ceilings.....	15,020
Blacktin, C., butter packages.....	13,894	" machines for transferring the grains of wood upon glass.....	15,030
Blake, F., electric circuits.....	13,917	Bungay, L. F., et al., gang plough.....	15,828
" T. A., breaking machines.....	14,330	Bunker, W. J., et al., rocking chairs.....	15,063
Blakely, C. J., burnishing machines.....	15,145	Burbank, J., et al., rotary churns.....	15,304
Bland, H., ice creepers.....	13,901	Burdick, T., bed bottoms.....	15,720
Blythe, J. B., treating sleepers, etc.....	14,856	Burgess, G. W., sewing machines.....	13,780
Bogle, C. E., et al., sash balances.....	15,870	Burgdorf, J. F., label-holders.....	14,831
Bois, J. M., air compressing apparatus.....	15,245	Burk, J. J., barrel staves.....	14,966
" N. A., et al., thrashing machines.....	15,729	Burke, A. W., churns.....	15,150
Boivin, G., moccasins.....	14,783	" A. W., paint composition.....	13,935
Boland, W. J., et al., steam engines.....	14,236	" A. W., washing machines.....	14,369
Bond, G. F., car-couplings.....	14,566	Burmister (The) and Wain Maskin and Skibsyggeri centrifugal machines.....	14,421
Bonnell, J. A., signals and switches.....	15,137	Burn, W. S., et al., bird insect catcher.....	13,825
Bonnett, E. J., et al., book racks.....	15,862	Burnham, A. S., bed bottoms.....	15,120
Bonney, E. G., et al., time-piece calendars.....	14,769	" J. P. and O. G., air cooling and compressing machines.....	14,232
Booth, J. E., rock drills.....	15,780	Burns, J. A., et al., car-couplings.....	14,287
Bort, B. C., milk pans.....	15,503	Burland, W. H., et al., car wheels.....	14,602
Berton, S., et al., sewing and trimming apparatus.....	14,598	Burr, H. W., curing rubber coated fabrics.....	14,555
Boss, C., freezers.....	14,105	" H. W., shoes.....	13,770
" C., preserving chambers.....	14,710	Burrell, D. H., et al., cheese hoop followers.....	14,573
Bossé, C. L., et al., steam generator.....	13,807	" D. H., vats for heating and saturating hoops.....	15,071
Boston (The) Petroleum Heating Co'., oil stoves.....	14,917	Burrows, J. H., et al., nut locks.....	15,257
Both, A. C., dredging machines.....	15,622	" T. H., yarn reels.....	14,522
Boulter, G., moccasins.....	15,008	Burton, G. D., stock cars.....	15,557
Bourne, C. E. and W., upright pianos.....	14,212	Bush, G. W., et al., door fastenings.....	14,332
Bowen, J., bed bottoms.....	15,426	Bushnell, E. L., car seats.....	15,433
Bower, G., et al., iron and steel surfaces.....	14,442	" E. L., spring mattresses.....	15,524
Bowes, J. B., artificial hands.....	14,455	Butler, J., fireproof paint.....	13,798
Bowker, H. L., syrups and mineral waters.....	15,270	" T. H., et al., pretzel machines.....	15,241
" W., sawing machinery.....	14,752	" W. W., barbs for fences.....	13,907
Bowman, W. A. D., et al., machines for making spikes.....	14,646	Butterfield, H. B., check books.....	15,107
Bowslaugh, E. W., window blinds.....	14,837	Buzolich, A., et al., paint.....	15,634
Boxer, F. N., F. W., R. J., S. S. and A. S., roofing compound.....	15,092	Byrket, A. R., earth scrapers.....	13,903
Boyd, G. W., grave vaults.....	14,790	Cabell, M. S., et al., oil ejectors.....	15,290
Boyle, J. E., water closets.....	15,015	Cairns, H., swivels for adjusting pumps.....	14,428
Boynton, E. S., information tablets.....	14,902	Caissé, M., et al., rotary churns.....	15,304
Boys, C. V., electric meters.....	14,866	Caldwell, L. J., desiccating eggs.....	14,183
" C. V., power measuring apparatus.....	14,865	Calkins, A. H., washing machines.....	14,102
" H. R. A., engine lubricators.....	13,877	" G. W., hoisting buckets.....	15,757
Bradley, J., knitting machines.....	13,786	Callahan, C., knitting machines.....	14,955
" W. J., et al., sewing machines.....	14,432	Callan, J. P., road carts.....	14,662
Bramer, F., wheel harrows.....	14,169	Callender, W. O., telegraph conductors.....	15,395
Bramwell, W. C., feeders for carding engines.....	15,247	" W. O., waterproof articles.....	15,372
Brandon, C. T., et al., planing machines.....	15,742	Calvert, C. I., neck yokes, etc.....	15,339
Bratton, G. W., et al., underground conduits.....	15,689	Campbell, A., harrows.....	14,452
Bray, M., lacing stud.....	14,874	" A. C., et al., lumber machines.....	14,686
" M., hooks.....	14,632	" F. M., et al., sky-lights.....	14,833
" P., corset stays.....	15,495	" H. F., hoop planing machines.....	14,728
Brayton, R., et al., spark arrester.....	15,236	" H. F., hoop splint machines.....	14,738
Brazeau, M. and A., universal picker.....	15,199	" J., sawing machines.....	24,723
Brazenor, E. L., lever collar block press.....	15,416	" A. A., et al., combustion in furnaces.....	15,466
Bremaker, C., paper machines.....	15,817	Campton, R. P., gates.....	14,724
Brenton, F. W., barley bearding machines.....	14,029	Canadian (The) Telephone Co'., electric telephones.....	23,809 23,810
Brewer, T., wheel-barrows.....	15,170	" " " " microphones.....	14,164 14,165
Brewster, F. W., buoyant devices.....	14,867	" " " " telegraphs.....	13,774 13,775
Brien, T. N., et al., carriage axles.....	14,516	" " " " telephones.....	14,190 14,191 14,209 14,210
Briggs, G. D., et al., car journal boxes.....	14,584	Cannon, E. D., sleigh shoes.....	14,777
" J., nail machines.....	14,359	Carey, W. W., wood rim pulleys.....	13,845
" O. P., barbed wire.....	15,188	Carpenter, D. W., et al., hay and straw cutter.....	15,570
" R. H., et al., car door fasteners.....	14,543	" J., et al., barbed fences.....	15,673
Brinkhop, J. H., presses.....	14,116	" W. C., regulator for nursing bottles.....	15,213
Brock, M., et al., boots and shoes.....	14,218	Carrier, L., wind mills.....	14,298
Bronson, E. D., broom bag.....	14,848	Carshore, W. J., heating boilers.....	15,013
Brooks, J. S., fire-proof fabrics.....	14,300	" W. J., radiators.....	14,843
" R. M., car couplers.....	14,926	Carter, E. P., fifth-wheels.....	15,324
Broinlet, J. B. A., pavement.....	13,777	" J. I., ploughs.....	14,365
Brower, J. F., forming threads on cylinders.....	14,991	" J. B., cheque books.....	14,182
Brown, A. and W. E., pantaloons waist band.....	15,220	Casebeer, J. B., et al., system of constructing roads.....	15,578
" A. C., et al., signalling apparatus.....	14,577	Cass, J. F., et al., wagon racks.....	15,685
" E., et al., organs.....	15,197	Cassel, H. R., treating metals.....	15,448 15,516
" E., et al., blanket fasteners.....	15,070	Castle, G., cheese hoop followers.....	14,573
" O. L., et al., evaporating apparatus.....	14,748	" W., cooking boilers.....	14,302
" S., et al., car-couplings.....	15,853	Castner, H. Y. and E. B., bone black.....	15,343
" T. W., et al., egg beaters.....	13,842	Caswell, E., hub borers.....	14,275
Brownley, P., et al., roller bushes.....	15,679	Cawood, J., et al., grain separators.....	14,285
Brulé, E., taking up the wear in axle boxes.....	15,462	Chadwick, C. N., nursing corsets.....	13,481
Bruner, L. N., railway switches.....	14,360		
Bruncker, E., sewing machines.....	15,165		
Brunswick (The) Ships Berth Co'., self-levelling berth.....	14,340		
Buchanan, C. D., ore separators.....	13,989		

Chadwick, J. A., fruit jars.....	15,352	Corman, I., fences.....	14,448
Chamberlain, B., car heaters.....	15,480	Cornell, S., et al., manufacture of gas.....	15,157
" B., et al., wind mills.....	14,572	Cornett, R. H., washing machines.....	15,589
Chambers, W. B., eaves trough machines.....	15,284	Cortis, F. A., flexible shafts.....	15,299
Chandler, S. and J., et al., purification of gas.....	15,233	Cosgrove, J., et al., drag scrapers.....	15,116
Chaplin, O. R., et al., wire fastenings.....	15,026	Cosine, G., apparatus for rendering and bleaching fats.....	14,901
" W., garden rakes.....	14,377	" artificial butter.....	14,912
Chapman, M. S., barbed fences.....	15,408	Cossitt, G. M. and N., horse rake.....	15,778
Charland, O., furnaces.....	14,584	Costin, J., fanning mills.....	15,461
Charlton, B. E., manufacture of vinegar.....	14,438	Coté, L., machines for making counters.....	15,492
Chase, I. H., musical instruments.....	15,815	Coulter, J. P., et al., draft mechanism.....	15,834
" L. L., car-couplings.....	14,256	Coulthard, W., spring hoes.....	18,806
Chattaway, A. E. F., corn mills.....	13,921	Cour, J., et al., car-couplings.....	15,289
Cheesebrough, R. A., bone black.....	14,099	Court, C., et al., process for treating bark.....	14,526
Childs, W. S., boot and shoe heels.....	15,382	Courtman, J., fanning mills.....	15,808
Chilton, F. H., sewing machine.....	15,678	Cowdery, W. H., garden rakes.....	14,877
Chisholm, J., spring beds.....	14,957	Cowlis, S. H., et al., lightning arresters.....	14,655
" S. S., et al., barbed fence wire.....	15,605	Cowley, C. R., water wheels.....	14,132
" W. P., fence barbs.....	14,059	Cox, G., envelopes.....	14,524
Christie, R., harvesters.....	14,381	Coxen, J., snow clearers.....	14,096
Church, H. L., et al., freezing paraffine.....	15,568	Coxon, S., signal lamps.....	14,508
" M. A., plastic material.....	14,800	Craig, J. A. J., et al., steam generator.....	18,807
" R., long leg boots.....	14,378	Cramer, P., hangers for shafting.....	18,794
Chute, N., steam boilers.....	15,681	Crandal, E. M., barbed fences.....	15,506
Clark, A. D., current wheels.....	13,981	Crandell, E. H., paper safes.....	14,450
" A. D., et al., spring waggons.....	13,848	Crawford, W. M., et al., bretzel machines.....	15,241
" B. S., et al., elliptic springs.....	14,117	Creelman, R. I. and R., knitting machines.....	14,496
" B. S., et al., keys for bolts.....	13,779	Crich, W. B., extension tables.....	14,052
" H. A., electric wires.....	14,258	Cridler, D. F., et al., tanning process.....	15,690
" H. A., India rubber.....	14,259	Crisp, J. E., et al., boots and shoes.....	14,218
" H. A., manufacture of covered wire.....	14,994	Crongeyer, C. A., et al., door fastenings.....	14,382
" H. S., vehicle springs.....	14,741	Crooker, L. J., et al., stove lamps.....	15,747
" J., apple parers.....	14,414	Crookes, W., electric lamps.....	15,828
" J. L. and H. M., vehicle gears.....	15,124	Cross, W. C., paper bag machines.....	14,204
" J. L. and H. M., wagon springs.....	14,492	Crossley, F. W. and W. J., et al., gas motor engines.....	15,611
" J. L., et al., docks and pontoons.....	14,453		
" M., et al., valve stem.....	13,804	Crothers, A. M., et al., insulating telegraph wires.....	15,259
" P., filtering apparatus.....	14,934	Crowe, W., steps for vertical shafting.....	14,974
Clarke, C. L., et al., gas lighting apparatus.....	14,563	Crowther, R. F., railway switches.....	15,310
" T., sleeping and drawing-room cars.....	15,629	Cruikshank, G., et al., churning apparatus.....	15,024
Clary, T. E., et al., valve stem.....	13,804	" J., waggons.....	13,975
Clement, O. P., tuyeres.....	14,426	Cullen, I., brick machines.....	14,530
Clement, J., ditchers.....	15,861	Cullerton, E. A., oven furnaces.....	14,253
" C. W., et al., boots.....	15,838	Culver, D. E., et al., car-coupling.....	14,287
Cliff, E., et al., elliptic springs.....	14,117	" J. E., heating and cooling.....	14,097
Clohecy, T., belt fasteners.....	14,282	Cunningham, H. E., et al., card teeth.....	14,494
Cloud, J. W., car brakes.....	15,288	" J., et al., fuel saving apparatus.....	15,041
Coates, C. E., et al., halters.....	14,729	Cuppla, H. A., cigarettes.....	14,648
Coburn, H. P., et al., harvesters.....	14,381	Cushing, T., liquid filters.....	14,038
Cocheb, C. T., decoys.....	15,732	Cuthbertson, J. W., lamp fillers.....	15,148
Cochran, S. H., butter and lard.....	15,239	" J. W., et al., metallic barrels.....	15,477
Cochrane, G. A., darning lasts.....	15,101	Daigneau, J., freight cars.....	15,096
" G. A., fruit carrying devices.....	14,507	Dain, J., hay elevators.....	14,488
" W. F., mechanical movements.....	14,079	Dake, H. M., fruit driers.....	13,960
Cohen, J., trouser suspenders.....	18,883	Dalton, G., ore crusher and reducer.....	15,626
Cole, A. G., folding chairs.....	14,477	Daly, G. W., et al., horse collars.....	14,295
" E. D., adjustable hames.....	15,298	Daniels, T., machine for cutting pills.....	14,106
" E. D., hame clips.....	15,364	Dann, T., button hole casings.....	14,633
" J., separating petroleum products.....	14,124	Dardenne, A., self-winding clocks.....	15,810
Coleman, A. B., harness.....	15,401	Daul, L., petroleum rectifying apparatus.....	15,073
Collier, F. K., et al., tire upsetters.....	14,276	Davey, C. B., process for extracting grease.....	14,448
Collins, E., bag-holder.....	14,586	Davies, E. T., lumber sorters.....	14,372
" S. E., water purifying apparatus.....	14,669	" T. H., et al., harrows.....	14,444
Colt, A. M., wood working clamps.....	14,284	Davis, A., et al., sleeping cars.....	15,581
Comey, W., boots and shoes.....	13,966	" B. R., et al., flower crocks.....	13,933
Compton, F., corsets.....	14,758	" D., brick machines.....	15,255
Conboy, D., carriage seat rail.....	13,918	" D. W., beer cooling process.....	15,098
" D., carriage tops.....	14,574	" D. W., et al., refrigerators.....	14,585
Condon, W. F., stoves and ventilators.....	13,801	" E. H., et al., railway cars.....	14,232
Conover, C. A., washing machines.....	14,915	" J. A., sewing machines.....	14,621
Conrad, M., wagon tongue supports.....	15,714	" J. F., gun cleaners.....	15,630
Conroy, A. and M., coffee.....	13,938	" J. R. H. and L. L., medical compounds.....	14,598
Conway, G. O. S., et al., car-couplers.....	14,789	" O. G., preserving and freight cars.....	14,370
" G. O. S., et al., railway brakes.....	14,788	" W. H. H., devices for digging wells.....	15,855
Converse, E. C., tubing couplings.....	15,045	Davison, W., vehicle springs.....	14,983
Cook, C., axles.....	14,703	Davy, J., fire-escapes.....	15,472
" J. T., et al., barbed fence wire.....	15,605	Dawes, A., lacing stud.....	14,874
" W. F., door knob alarms.....	14,402	Day, A., track cleaner.....	13,778
" W. T., sewing machines.....	14,621	Dayton, M. E., transom pivots.....	14,459
Cooley, W., cheese machines.....	14,776	" M. E., transom lifters.....	15,169
" W., milk cooler.....	13,808	Dean, C. W., staples.....	14,649
Cooper, J., et al., car-couplers.....	14,789	" C. W., et al., wire fence nails.....	15,295
" J., et al., railway brakes.....	14,788	" W. B., lemon squeezers.....	14,572
" W., treadle motive power.....	14,841	" W. H. and J., fire-escapes.....	15,758
" W. A., et al., rail chairs.....	14,178	" W. E. and J. C., scaffolds.....	15,573
Copeland, G. W., boots and shoes.....	14,218	Dederick, P. K., hay presses.....	14,045
Cordery, F., car-couplings.....	15,726	" P. K., machine for baling hay.....	15,599
" T. P., dumping cars.....	15,437	Dee, G., stove carriers.....	14,335

Deering, W., harvesting machines.....	14,174	Edison, T. A., electric lighting.....	13,875
Deis, C., egg beaters.....	14,548	“ T. A., electric lamp fixtures.....	15,446 15,654
DeGarno, D., et al., mowing machines.....	14,734	“ T. A., electric machines.....	13,836
Delaney, P. B., electric cables.....	15,057 15,204	“ T. A., electric motors.....	15,816
De Laval, G., apparatus for separating fluids.....	14,597	“ T. A., electric-magnetic motors.....	15,822
Delker, G., spring vehicles.....	15,814	“ T. A., electrical distribution systems.....	15,831
Delone, A., window blinds.....	14,286	“ T. A., electro meters.....	13,906
Denning, A. B., et al., gas regulators.....	14,946	“ T. A., telegraphs.....	13,774
Dennis, A. J., harness loops.....	15,228	“ T. A., telephones.....	14,190 14,191 14,209
Desjardins, G., saw log sleighs.....	15,489	“ T. A., underground conductors.....	15,830
Desloovere, L. C., fire-extinguishers.....	15,753	Edmunds, H. P., graters and separators.....	14,203
Dettman, G. W., piano-fortes.....	15,468	Edwards, A., wash basins.....	14,018
Detwiller, J. J., et al., quarrying machines.....	15,400	“ A., water closets.....	14,046
Devereau, O. C., manufacture of jewelry.....	15,017	“ A., water wheels.....	14,683
DeWater, H. Van, et al., churns.....	13,957	“ E. A., hydro-carbon burners.....	14,747
Dewe, J., mode of exhibiting photographs.....	14,264	“ M. L., meat choppers.....	14,347
Dewell, J. A., force pumps.....	14,909	Eddy, C. C., et al., fanning mills.....	15,266
Dewey, C. D., harvesting machines.....	15,604	“ W. A., buggy seats.....	15,737
Dewey, J. B., et al., harness.....	15,401	Eggert, L. C., washing machines.....	14,238
De Winter, C. A. H. C., construction of vessels.....	14,327	Egbert, W. P., commode wash-stands.....	14,362
Dezell, J., spark extinguishers.....	14,677	Eichelberger, M. V., pulp manufacturing.....	14,265
Dicer, W., laundry tables.....	15,271	Ekman, C. D., fibrous substances.....	15,771
Dickieson, J., broad cast sowers.....	15,099	“ C. D., method of treating wood.....	14,963
Dickinson, G. F., butchering apparatus.....	15,526	Elbing, F., converting motion.....	15,614
“ H., water elevators.....	15,532	Elliott, A. W., et al., process for making beverages.....	14,582
Dierlamm, H., et al., remedy for diphtheria.....	15,279	“ J., grinding mills.....	14,816
Dietrich, J. C., et al., saw frames.....	15,235	“ J., smoke consumers.....	13,772
“ J. C., cross-cut saws.....	14,168 14,171	“ J. W., coal stoves.....	14,345
Dixon, J. W., recovering alkalies.....	15,291 15,292	“ J., self-registering tally.....	14,975
“ M. C., car-couplers.....	14,926	“ W. F., et al., vehicle dashes.....	15,709
Dobbe, A., hoisting machines.....	15,469	Ellis, W., steaming, etc., casks.....	14,659
Dobson, R. F., tanning process.....	13,930	Ellithorp, S. B., lasting machines.....	13,994
Dodd, J. M., et al., insulating telegraph wires.....	15,259	Ells, A. F., et al., ship pumps.....	14,604
“ T., et al., railway points.....	14,143	Ellsworth, J. C., printing presses.....	15,278
“ W., et al., hydrants.....	15,269	Elward, J. H., drive chains.....	15,504
Dodds, J. H., brush machines.....	14,263	“ J. H., feed mechanism.....	15,505
Dodge, J. M., chain belts.....	13,945	“ J. H., grain harvesters.....	15,616
“ W. H., window and door screws.....	15,464	Elwood, R., wire stretchers.....	15,202
Dolbear, A. E., telephones.....	14,098	Emerson, R., et al., mittens.....	14,796
Donald, D. M., fruit dryers.....	14,610	Empress (The) Embroiderer Co., sewing machine.....	15,678
Doolittle, G., et al., sewing machines.....	14,432	Engert, A. C., fire grates.....	14,033
Doray, J. B. and S., et al., nut locks.....	13,802	Engle, J. L., et al., mail bags.....	14,745
Dormitzer, A., chairs and fire-escapes.....	15,375	English, P., et al., gas apparatus.....	14,851
Dorset, D. H., compound for sewer pipes.....	14,128	“ W. J., et al., water traps.....	15,777
Doubleday, E. M., and W. E., fibrous fabrics.....	14,827	Esch, J., trucks.....	14,471
“ E. M., fur coated fabrics.....	14,791	Essery, W. H., wood working machinery.....	15,738
Dougherty, J. H., et al., car door fasteners.....	14,543	“ W. H., et al., loose pulleys.....	14,406
“ J., washing machines.....	14,720	Estrade, A., rolling stock.....	13,947
Douglas, W. H., chronographs.....	15,663	“ A., steam super-heating apparatus.....	13,890
Daw, G. W., shipping boxes.....	15,542	Esty, W., knitting machines.....	14,408
“ L., posts and fences.....	15,507	“ W., manufacture of stockings.....	14,461
Downham, W., waggon wheels.....	15,049	European (The) Electric Co., dynamo-electric machines.....	14,380
Downsell, G. B., washing machines.....	14,388	Evans, A. S., invalid chairs.....	14,763
Drake, J. B., pumps.....	14,342	“ E., remedy for diphtheria.....	15,279
Draper, G., harvesters and binders.....	14,932	“ G. A. and H. T., car starters.....	15,347
“ J., walking sticks.....	14,736	“ J., sheds for drying bricks.....	15,652
Drummond, G. A., sugar refining process.....	14,805	Everest, D. O., cultivators.....	14,546
DuBois, J., coal mining.....	15,798	Ewens, E. J., gloves and mitts.....	14,197
“ J., fences.....	14,858	Ewing, O., hog catching device.....	13,961
Duc, H. A., attrition mills.....	15,773	Ewins, P. S., sap evaporators.....	14,735
Dudley, G. W., rotatory engines.....	14,335	Faber, L., burnishing knives.....	14,844
“ W. J., telephones.....	13,785	Fabberg, C., et al., iron removing.....	13,919
Duffield, W., carbonic oxide gas.....	15,733	Fahs, J. F., et al., oat cutting machines.....	13,849
“ W., et al., gas apparatus.....	14,851	Fair, J. M., sewing machines.....	15,075
Dufort, E. B., et al., leather renovator.....	14,119	Fairbanks, L. P., steam vessels.....	13,792
Duffy, T. W., heat transmitting apparatus.....	14,947	Fairman, F., et al., car-couplers.....	14,789
Dunlevy, A. C., et al., sky-lights.....	14,883	“ F., et al., railway brakes.....	14,788
Dunlop, E., signal apparatus.....	15,094	“ G. W., et al., car wheels.....	15,857
Dunn, P., et al., wire staples.....	13,941 15,669	Fales, A., bench planes.....	15,327
“ T. F., cotton batting machine.....	14,779	Farley, H., curtain rollers.....	14,008
Dupuis, J. A., bricks.....	14,818	Farmer, D. J. J. P. and S., cut nails.....	14,969
Durand, E. C., belt shifters.....	15,728	Farnsworth, F. H., et al., method of attaching buttons.....	15,465
Durant, E. G., boats.....	15,800	Farquhar, J., ferry boats.....	14,640
Durham, W. G., oil cans.....	15,366	Farrar, A. P., snow ploughs.....	14,930
Duvall, J. S., et al., knitting machines.....	14,084	“ E. H., means of securing cargo.....	15,086
Dynes, G., fifth-wheels.....	14,782	“ W. R., water turbines.....	14,405
Earnhart, G. W., et al., bretzel machines.....	15,241	Farrington, T. B., undergarments.....	15,571
Earle, J., engraving machines.....	15,082	Farwell, F. E., shoes.....	15,631
“ J., method of engraving script.....	15,088	Fay, W. L., et al., carriage bows.....	14,311
Eastwood, J., et al., printer's galleys.....	13,872	Fearns, J. W., et al., glass chimneys.....	15,182
Eaton, D. L. C., et al., car-couplings.....	15,388	Feder, A. and S., et al., overalls.....	14,557
Eddridge, H., et al., leather renovator.....	14,119	Feister, H. P., printing machines.....	14,793
Edison, T. A., carbon conductors.....	13,886	Feldman, J., umbrellas.....	15,715
“ T. A., dynamo electric machines.....	15,843	Feldmann, A. B., pulverizing machines.....	14,513
“ T. A., electric lamps.....	13,835 15,847 15,848	Felt, J. S., ploughs.....	15,863
“ T. A., electric chandeliers.....	15,642	Ferguson, C. L., thill couplings.....	15,789
“ T. A., electric lights.....	15,693	“ J. T., keeping milk, cream and butter.....	14,556
“ T. A., electric lights.....	15,693	Ferris, A. J., fruit pickers.....	15,032

Ferris, J. P., et al., butter package.....	14,501	Galligan, J., et al., overalls, etc.....	14,434	
Ferrall, P. R., anti-frictional bearings...13,905	14,301	14,493	Galloway, T., drills and broadcast sowers	15,730
Fiddes, A., gas motor engines.....	13,944	13,944	Gardel, A., millstones	15,200
Field, G. F., et al., railway brakes	15,547	15,547	Gardner, A., check books.....	14,976
" J., et al., running gears of buggies.....	14,958	14,958	" W., machine guns.....	15,543
" R., root-cutters.....	15,784	15,784	Garretson, O. S., furniture.....	14,422
" W. H., horse rakes.....15,127	15,128	15,128	" T. B., sewing machines.....	15,369
" W. H., et al., horse rakes.....	14,036	14,036	" (The) Ruffler Co'., sewing machines.....	15,369
Fields, T. C., medicinal compound.....	14,215	14,215	Garrison, W. S., bay windows.....	14,324
Filley, G. F., cooking stoves.....13,855	13,858	13,859	Garrity, W., et al., coating metallic articles.....	15,160
" G. F., ranges.....13,854	13,884	13,910	Garsed, R. P., railway switches.....	14,360
" G. F., stoves and ranges...13,852	13,853	13,856	Gatehouse, T. E., electric lamps	14,636
	13,857	14,480	Gates, H. B., churns	13,953
Filman, P., sleigh knees.....	14,041	14,041	" T. T., wash-boards.....	14,464
Finch, J. M., flour mill conveyors.....	15,431	15,431	Gault, N. C., et al., lightning rods.....	15,117
Fink, H. and C., lubricating oil.....	15,256	15,256	Gauster, G. T., apparatus for lighting lamps	14,620
Firstbrook, W. A., case fasteners.....	14,913	14,913	Gawley, H., set gear	14,066
Fischer, J. B., et al., ice tools.....	14,239	14,239	Gebhardt, J. F., carding engines.....	15,813
Fisher, A. S., removing impurities from water.....	14,074	14,074	Geisel, A. U., wash-boards.....	15,537
" E., heel compressing and punching.....	13,800	13,800	Genin, F., circular saws.....	14,155
" J., thrashers and separators.....	14,713	14,713	Gent, J. F., art of brewing malt liquors	15,371
" J. A., recovering alkalies.....	15,292	15,292	Genesse, C., clothes wringers and mangles. 14,869	
" J. H., car door locks.....	15,513	15,513		15,624
" J. W., et al., culinary vessels.....	15,641	15,641	George T. Smith (The) Middlings Purifier Co'., con-	
Flisk, J. C., et al., gas governors.....	15,866	15,866	veyors for flour mills	15,431
Fitch, C. T., et al., lightning arresters.....	14,655	14,655	Gerald (The) Sewing Machine Co'., sewing machine	
" L. M., et al., spring waggons.....	13,848	13,848	" tables	15,411
Fitts, L., et al., barbed fences.....	15,673	15,673	German, J. G., iron fences.....	14,093
Fitzgerald, A., sewing machine tables.....	15,411	15,411	Gerow, S. T., picking stones and excavating earth.....	14,596
Fitzgibbons, P., steam boilers.....	15,344	15,344	Getchell, A., copper treating.....	15,409
Flags, G. H. P., boots and shoes.....	14,648	14,648	Gibbs, E. S., churns.....	14,398
" G. H. P., polishing machines.....	14,213	14,213	Gibson, A. C. and W. W., window blinds.....	14,864
" L., gates.....	15,066	15,113	" A. C., et al., rotary engines	15,767
Flaherty, E. M., drying kilns.....	15,215	15,215	Glebecke, A., baking powder	14,803
Flanders, A. W., et al., book racks.....	15,862	15,862	Gilbert, A. L. and H. N., machine for driving piles.....	15,340
Flannery, J., gas generators.....	14,423	14,423	" H. J. and G. A., reduction mills	15,672
Fleet, L. M., gauge tubes.....	14,959	14,959	" T., sights for fire-arms.....	15,378
Fleisher, E., sugar manufacturing.....	14,062	14,062	Gilchrist, W. L., breeching hooks.....	13,897
Fleming, J. A., electric insulation.....	14,465	14,466	Giles, J., burglar alarms.....	14,374
Fletcher, D., garden knife.....	15,697	15,697	Gillilan, T., book racks.....	15,862
Fleury, H. W., root-cutters.....	15,784	15,784	Gillet, E. W., bluing packages	14,822
Flint, E. C., folding chairs.....	14,685	14,685	Gilliland, E. T., tele. bones	14,151
Flock, P., harvesters.....	15,700	15,700	Gilman, C. C., fire-proof compositions.....	18,941
Flohr, C., tan vats and stirrers.....	14,447	14,447	" M. A., toy whips and cane handles	14,583
Flower, G. K., horse shoes.....	14,200	14,200	" (The) Vertical Press Co'., printing presses....	14,716
Flynn, T. F., rakes and loaders.....	15,267	15,267	Gilpin, C. H., chairs	14,135
Foard, J. W., fish hook extractors.....	14,627	14,627	Ginter, L., cigarettes.....	14,361
Foley, J., liquid filters	14,038	14,038	Gissinger, S., nut locks.....	14,894
Folsom, H. E., et al., splitting machines.....	14,495	14,495	Githens, J. C., rock drills	13,920
" N. T., thill lugs	15,601	15,601	Gladwin, H., car-couplers.....	14,576
Forbes, R. S., washing machines.....	14,439	14,439	" T. A., augers	13,784
" W., windmills.....	13,873	13,873	Goble, J., vehicle wheels.....	15,759
Ford, J. S., H. H., S. W. and M. E., et al., machinery		14,558	Godley, G. F., car springs	14,773
" for weaving cane.....	14,558	14,558	" lubricators.....	14,290
Forsyth, W., et al., thrashing machines.....	15,125	15,125	Goebel, C. H., et al., underground conduits.....	15,689
Foster, S. R., process for preparing iron and steel.....	14,564	14,564	Golding, M., pulverizing machines.....	15,455
Fournier, J., bread boxes.....	14,962	14,962	Goodridge, J. C., methods of repairing structures with	
Fowler, H. W., spike machines.....	14,715	14,715	" beton	15,365
" J., machines for bending springs.....	15,836	15,836	Goodwin, J. C., et al., bobbin winders.....	14,918
Fox, E. M., electric lamps.....	14,225	14,225	Goold, E. L., et al., hay rakes	15,001
" J. S., iron fence post.....	14,051	14,051	Gore, E. N., panel raisers.....	15,632
" J. S., wringing machines.....	15,114	15,114	Gordon, A., cigar bunching machines	15,098
" S., steam boilers.....15,580	15,583	15,584	" A., et al., mowing machines.....	14,734
Frank, G., et al., overalls, etc.....	14,434	14,434	" C., beer cooling and drawing machines.....	15,750
" J. and I., et al., cable railroads.....	14,641	14,657	" W. J., et al., hydro-carbon furnaces.....	15,779
Frasch, H., treatment of oils.....	15,110	15,111	Gould, F. J., self-feeding stoves.....	14,940
Fraser, A. M. B., heat transmitting apparatus.....	14,947	14,947	" J., arithmetical frames	14,015
" J., drill and broadcast sowers.....	14,852	14,852	" J. D., et al., electric signals.....	15,254
" R. G., cement.....	13,955	13,955	Gowans, J. A., et al., car-couplers.....	15,296
Frazier, J., fence posts.....	14,937	14,937	" R., wheels.....	14,006
Frécheté, J., shingle machines	15,856	15,856	Gowing, D. H., evaporating apparatus.....	14,748
Freeman, G. W., mowing and reaping machines.....	14,615	14,615	Grattan, C., gang plough	14,309
French, O. F., et al., spark arrester	15,236	15,236	Graham, J. A. and A. L., et al., registers and ottomans.	14,756
Fritz, G. J., doctor engines.....	14,292	14,292	" S. P., harvesters.....	15,242
Fruitt, H. A., knitting machinery.....	15,259	15,259	Grandy, C. E. and L. C., et al., splitting machines	14,495
Fullarton, G. A., boots and shoes.....	14,848	14,848	Grannis, C. L., et al., rein-holders	15,083
Fuller, J. W., telegraph receiving apparatus.....	14,133	14,133	Grassett, O., signalling apparatus	15,161
" T., et al., reaping and mowing machines.....	14,554	14,554	Graves, J., shovels	14,760
" T. R., et al., broom-holder.....	15,268	15,268	Gray, H. F., clothes racks.....	15,350
" T. R., et al., planing machine.....	15,742	15,742	" W., belt shippers.....	13,870
" T. R., et al., tassel clamps.....	14,064	14,064	" W. H., et al., car wheels.....	15,857
" V. E., broom bag.....	14,848	14,848	Greacen, S. B., steering wheels	15,776
" V. E., planing machine	15,742	15,742	Green, T., fastenings for laces.....	15,078
Fyfe, J., electric lamps	15,774	15,774	" W., manufacture of soap.....	14,150
Gale, G., wire coiling machines.....	15,410	15,410	" W. F., stovepipe dampers.....	12,827
Gaines, H. F., stamp cancellers and daters.....	14,322	14,322	Greene, N. C., skirt adjuster.....	12,974
Gallagher, J. E., tamping and firing devices.....	15,486	15,486	Greenwood, C., ear muffers.....	14,547
Galley, J. G., fire bars	15,265	15,265	" J. H., planer's chucks	14,719

Gregory, G., et al., road scrapers	15,459	Hartley, H. C., et al., belt replacing device	15,010
Grier, W. W., vehicle springs	14,922	Hartwell, S. A. V., car-couplings	15,193 15,556
Griffith, E. S., folding beds	15,147	Harvie, G. A., lifting jacks	15,187
Griffiths, T., pigments	15,318	Harvey, H. M., et al., animal restraining device.....	15,471
Grinnell, F., fire-extinguishers	14,691	Haskell, J. R., multicharge guns	13,823
Grobb, J. F., churn and cream pail.....	14,571	Haskins, C. D., electric light regulators	15,205
Grout, F. K., cans and tubes	14,774	Haslam, A. S., refrigerators.....	13,902 15,004 15,005
Grover, H. C., fruit evaporators.....	15,474	Hatch, E., chairs and cots	15,034
Gruson, M., et al., projectiles.....	14,017	" O. L. and W. R., bed-bottoms.....	15,126
Guard, C. H., manufacture of hubs.....	13,991	Hathaway, G. M., door knobs	13,929
Gubbins, J. F., apparatus for drying and pulverizing ofgal	15,335	" G. M., lock dials	14,339
Gue, A. F., et al., railway brakes.....	15,547	" G. M., permutation locks	14,403
Guelph (The) Carriage Goods Co'y., carriage springs.	13,965 14,037	Hatton, J. H., life-boats.....	14,467
Guelph (The) Carriage Goods Co'y., thill couplings	15,280	Havitt, H. H., et al., freight car doors.....	14,538
Guelph (The) Carriage Goods Co'y., vehicle dash boards.	15,717	Hay, L., stock cars	15,329
Guérin, T., sewer traps	15,050	Hazard, F. J., et al., reaping and mowing machines...	14,554
Guernsey, W. B., car brakes.....	15,796	Hazelhurst, W., chills for castings.....	14,923
Guest, W., et al., process for breaking bark.....	14,526	Hazelton, F. M., car-couplings	15,786
Guinnip, L., horse collars.....	14,440	Head, J., et al., tanning process.....	15,690
Gunn, J. C., evaporators.....	14,425	Healey, W. P., wire-rope attachments.....	15,423
Gunsaulis, B., et al., benches and wringers.....	14,149	Heard, J., stone walling	15,112
Gurd, W. J., rotary motors.....	14,515	Hearington, A. H., heating stoves.....	15,684
Gurney, J. T., et al., carriages.....	14,441	Heaton, S., fence posts	15,394
" J. T., et al., refrigerators	14,248 14,383	Hebert, O., two-wheeled vehicles.....	15,449
" J. T., et al., refrigerator waggons.....	14,249	Heckman, L. C., oil stoves.....	13,891
" J. T., et al., sleds.....	14,223	Hege, C. A., saw-mills.....	15,212
" J. T., et al., waggons	14,376	Heinrich, M., manufacture of sugar.....	15,667
Hadden, W., distributing apparatus.....	14,152	Heintzman, G., upright pianos.....	15,246
Haddock, W., et al., cable railways.....	14,641 14,657	" P. A., piano fortes.....	14,021
Hadley, B. H., belt shippers.....	13,791	Hellhoff, A., et al., projectiles.....	14,017
Hahn, J. H., et al., hay racks.....	15,795	Hemingray, R., glass presses.....	14,579
Halbmayer, J., et al., projectiles.....	14,017	Hemlich, T. F., anti-friction bearings	14,754
Haldeman, R. A., sleds	15,362	Hempstead, B., railroad signals and gates.....	15,558
Hale, J., devices for banding springs.....	14,527	Henderson, J., candy boxes	14,391 14,392
" J., sheet metal vessels	14,385	" E. C. C., et al., boots and shoes.....	14,094
Hales, F. W., ditching machines.....	14,694	Hendricks, J. M., hay unloaders.....	15,397
Haley, O., et al., churns.....	14,666	Hendry, A., vices.....	15,263
Hall, J. P., saw guides.....	14,591	Henning, W. B., et al., system of constructing roads...	15,578
Halladay, S., car brakes.....	15,711	Henson, J. W., et al., wagon brakes.....	15,036
" W. H., saw sharpeners.....	15,491	Herbrand, J., vehicle gears.....	14,655
Hallarn, W. J., et al., cinder sifters.....	15,682	" (The) Co'y., vehicle gears.....	14,655
Haller, A., bed springs.....	15,101	Hernance, J. H., sawing machines	14,712
Hallett, E., et al., car axle rolls.....	15,253	Herrick, N., trusses.....	14,821
Halley, J., et al., egg carrying apparatus.....	13,984	Herring, N. W., baling presses	14,825
Hamilton, C. J., wind mills.....	14,007	" N. W., et al., baling presses.....	15,498
" C. J., et al., wind mills.....	15,361	Hersey, R., et al., nail machines	14,358 14,359
" F. J., oil lamps	14,012	Hess, D., steam generators	15,674
" W., sawing machines.....	14,011	Hewitt, J. J., spark-arresters.....	13,795
Hamilton (The) Industrial Works Co'y., wringing ma-		" T. C., barbed fencing.....	14,664
chines	15,518	" T. C., barbed fence strips	14,744
Hamlin, C. A., coal stoves.....	15,398	" T. C., metallic barbed fences.....	14,188 14,189 15,425
Hamma, M. W., et al., culinary vessels.....	15,641	Hibbert, T., et al., draft mechanism	15,834
Hammelman, C., mechanical forges.....	15,159	Hickert, W., printing presses	15,084
Hammerstein, O., cigar machines.....	14,054	Hickok, B., uncoupling cars.....	15,661
Hammill, R. E., et al., running gears of buggies	14,958	Hicks, H. C., stock cars.....	14,678
Hammond, C. D., et al., means for extinguishing fires.	15,574	Hidden, O. M., knob attachments.....	15,190
" A. H., reed organs.....	14,509 14,510	Hight, G. W., et al., wrenches.....	15,724
Hancock, J. T., injectors.....	13,958 13,979	Higgin, J. and A. J., galvanic batteries	14,651
" (The) Inspector Co'y., injectors.....	13,958 13,979	Higgins, C. S., soap, process.....	13,995
Hand (The) Stitch Broom Sewing Machine, broom		" W. N., lifting jacks	14,625
sewing machines.....	14,607 14,608	Hilbers, H., wall paper drying apparatus.....	14,909
Haney, W. M., milk cans	15,739	Hill, G., steam boilers	15,493
Hanna, D., sediment collectors.....	15,272	" M., fruit evaporators.....	14,229
" W., cylinders and pistons.....	15,222	Hillards, G. W., faucets.....	13,843
Hansen, O. C., fog horns	14,862	Hindlay, S. K., boots and shoes.....	15,176
Hanson, F., moulding machines.....	14,318	Hinman, C. M., sleds	15,839
" F., wood working machines.....	14,078	Hitchcock, H., tadders and rakes.....	14,781
Harbaugh, J. W., et al., barbed fences	14,971	" H. O., et al., barrows	15,345
Hardgrave, H., thrashers and separators	14,246	" R. A., et al., machinery for weaving cane.....	14,558
Harding, H. T., check reins.....	15,463	Hoag, A., hand corn planters.....	15,502
Hardwicke, H. G., et al., pipe wrenches.....	13,998	Hodder, J. H., writing tablets.....	14,137
Harlacker, J. C., et al., liquid drainers.....	15,744	Hodge, W., buggy tops.....	14,870
Harley, J., tube cleaners	14,550	" W., carriage tops	14,165
Harriman, J. A., writing tables.....	14,882	Hodson, R., rotary engines.....	14,815
Harris, A. and J., et al., harvesters	13,909	Hoerner, H. M., roof brackets	14,049
" A. and J., et al., force pumps.....	14,401	Hoffman, R. J., lubricators.....	15,338
" J., harvesters	13,887	Hogsett, P. W., churn powers.....	14,544
" O., washing machine.....	14,113	Holden, H. H., treadle motive power.....	14,841
" T., et al., wire staple.....	15,669	Holland, B., hose pipes.....	15,180
" W., tanning process.....	15,775	" B., packing rings	15,181
Harrison, J. M., et al., bridle blinkers.....	13,385	" P., lubricators.....	14,698
" W. H., shipping boxes.....	15,542	" W. S., planing machines.....	15,135
Hart, S. B., fertilizer distributors	14,181	Hollands, C., heaters for steam engines	15,332
" S. and H., ventilating windows.....	15,274	Holly, E. P., axle nuts	15,698
Hartnoll, J., stone dressing hammers.....	14,039	Holman, L. F., pulverizing apparatus.....	13,869
Hartson, La F., buckle attachments	15,664	Holmes, A., wash boilers.....	14,925
		Holmes, D. F., hoop cutting machine.....	15,577
		Holton, M. A., leather skiving machine.....	13,819

Hooker, F. A., fruit evaporator.....	15,692	Johnson, D., vehicle wheels.....	15,412
" et al., bleaching machine.....	15,637	" H. W., et al., machinery for weaving cane...	14,558
Hopkins, A. J., suction and force pumps.....	14,371	" I. D., invalid beds.....	15,640
Horn, G. A., worm rail fences.....	15,530	" J., heaters.....	13,783
Horsepool, E., glove fasteners.....	14,139	" N., saw swages.....	14,797
Horton, R. J., fanning mills.....	14,709	" W., pigments.....	15,318
" T., hand corn planters.....	15,444	" W., valve gears.....	15,390
Hosack, A., et al., bridle blinkers.....	13,885	" W. H., handles for shovels.....	14,613
Hotop, W., bobbin winders.....	14,918	" S., grain binders.....	14,192
Houle, P., window bolts.....	13,799	Johnston, W., coupling for shafting.....	15,666
House, J. A., corset forming apparatus.....	14,910	Jones, D. E., nut locks.....	14,408
" J. L., ditching machines.....	14,375	" F. L., check reins.....	13,850
Householder, J. M., coops for fowls.....	15,623	" F. W., et al., car-couplings.....	14,540
Houser, E. J., fertilizing compounds.....	14,595	" E. J., wind mills.....	15,323
" J. A., seed planters.....	15,860	" J. H., bridle bits.....	15,584
Hovenden, T. H., perpetual calendars.....	14,860	" W., apparatus for actuating the followers of wood pulpung engines.....	15,203
Howard, C. T., protectors for telegraphic instruments.....	14,908 15,383	Jordan, R. G. et al., furniture castors.....	15,703
Howarth, W. E., fanning mills.....	13,978	Joseph, I., lining axle-boxes.....	15,791
Howe, B. J. C., et al., fire engines.....	13,912	Joyce, J. L., shoes.....	15,529
Howell, G., apparatus for reclaiming lowlands.....	14,050	Judson, E., explosive compound.....	14,123
Howland, W. H., amalgamating ores.....	15,593	" J., governors.....	15,211
" W. M. and J. E., bench-dog-hooks.....	15,042	June, D., spark-arrester.....	15,236
Hubbard, W., telephones.....	14,320	Kaer, M. V., bottle wrappers.....	14,614
Hubbell, M. R., car-couplings.....	14,475	Kains, W. K., et al., rocking chairs.....	14,240
Huber, H., et al., bretteau machines.....	15,241	Kane, F. L., et al., roofing felt.....	15,311
Huck, L. C., malt houses.....	15,018	Kapple, J. L., folding seats.....	15,718
Huebner, S., et al., bricks, slabs and stones.....	14,260	Karch, C., et al., fuel saving apparatus.....	15,041
Huff, A., milk cans.....	14,161	Kasson, A., axle bearings.....	13,915
Huffman, G., et al., barrels.....	14,725	" A., thill couplings.....	13,914
Hughan, W. H., hydraulic cements.....	14,545	Kay, A., et al., knitting machines.....	14,496
Hugill, J., draft adjusting devices for harness.....	14,531	" P. L., electric lamps.....	14,463
Hulett, D., et al., purification of gas.....	15,233	Keegan, A. T., corn shellers.....	15,198
Humphries, G. P., et al., gates.....	15,068	Keeler, E., netting machines.....	15,109
Hunt, J. H., et al., car-couplings.....	14,540	Keen, M. L., paper pulp apparatus.....	14,819
Hunter, G. W., harness and trace couplings.....	15,349	Keeney, F. B., et al., baling presses.....	15,498
" W., car-couplers.....	14,778	Keighley, G., looms.....	13,999
" W., grain-bag fasteners.....	15,658	Kelke, J., bird insect catcher.....	13,825
Huntington, S., et al., means for extinguishing fires.....	25,574	Kellern, D. C., damper regulators.....	13,898
Huntley, B. E., et al., car-couplings.....	15,341	Keller, H., fanning mills.....	14,129
Hury, M., car heating apparatus.....	14,702	Kellogg, H., fur-coated fabrics.....	14,791
Hurst, J., trunks.....	14,706	Kells, E., et al., freezing paraffine.....	15,568
Hussey, C. A., dynamo-electric machines.....	14,380	" P. H., A. and J. M., brick machines.....	15,091
Hutchinson, W. F., boots and shoes.....	13,899	Kelly, S. L., freezing fish.....	11,072
Hyatt, J. W., filtration apparatus.....	14,935	" W., harrows.....	15,355
Hyde, H., et al., knob spindle fastenings.....	15,068	" W. C., car-couplings.....	14,115
Hynes, M., heel counters.....	14,943	Kelsey, J., boot and shoe heels.....	14,095 15,549
Ide, F. B., et al., collars and cuffs.....	14,148	" L. A., et al., journal box.....	15,442
" S., door hangers.....	14,110	Kendall, C. E., steam brakes.....	14,485
Iellinek, E., et al., over-alls.....	14,557	Kenna, J. W., tilting chairs.....	14,280
Imlay, W. L., ore-concentrators.....	15,551	Kennedy, L. B., brick machines.....	14,073
Ingalls, G. W., musical instruments.....	15,818	" R., et al., printers' galleys.....	13,872
" W. A., screw-patterns.....	13,993	Kennyson, W., bicycles.....	15,223
Ingersoll, C., grocers dishes.....	14,670	Kepper, J. K., harvesters.....	14,868
Ingraham, W. S., sickle grinding machines.....	14,880	Kern, P. J., vehicle springs.....	15,055
Irwin, S., row-locks.....	14,819	Kerner, M. H., burglar alarms.....	14,518
Isherwood, T., art of weaving cloth.....	14,979	Kerr, A. M., automatic regulators.....	14,002
Iske, A. and A., motors.....	14,289	Kershaw, T., et al., card teeth.....	14,494
Ives, G. L., et al., harrows or cultivators.....	14,854	" W. T., roof coverings.....	14,872
" H. R., burning soft coal.....	13,837	Ketchum, O. W., boots and shoes.....	14,020
" H. R., wire fence posts.....	14,895	Kettell, J. F., telephone signal apparatus.....	14,905
Jablochhoff, P., electric lamps.....	15,545	Kewn, W. C., refrigerators.....	15,044
Jackson, W. W., bush and bungs.....	15,354	Kieffer, J., boot and shoe heels.....	14,044
" W. M., incandescent burners.....	13,904	Kilbourne, J., sinks.....	14,512
" W. M., metrical carbureters.....	15,865	Kilgour, R. and J., paper bags.....	13,863
James, F. M., et al., barrel covers.....	15,177	King, C. L. and C. W., boats.....	14,592
" F. M., et al., glass chimneys.....	15,182	" W., sectional boilers.....	15,188
Jameson, J., electric lamps.....	14,838	Kinleyside, J., et al., wringing machines.....	15,518
" J., manufacture of coke.....	15,804	Kinney, C., fence posts.....	15,097
Janson, J. W., tanning machinery.....	14,136	" C., pails.....	14,804
Jantz, A. J. L., carriage springs.....	15,799	" Tobacco Co's, cigarettes.....	14,643
Jarolimiek, A., et al., power transmitting.....	14,069	Kirby, W. H., stirrup fastenings.....	14,553
Jarvis, K. M., gas consuming furnaces.....	14,035	Kirkham, H. P., cofferdams.....	14,826
Jay, P. E., pumps.....	15,636	" P. N., et al., purification of gas.....	15,232
Jebb, T. A. and W. T., distilling apparatus.....	14,297	Kirkpatrick, D. M., sleighs.....	15,386
" T. A. and W. T., grape sugar.....	15,403	" R., lifting machine.....	14,842
" T. A. and W. T., starch apparatus.....	14,326	Kitchen, W. W., churns.....	15,360
" W. T., apparatus for treating the refuse of starch.....	15,322	Kitts, P., et al., car-couplings.....	15,807
Jeffery, R. P., gas engines.....	14,542	Klenze, C. F., et al., horse collars.....	15,359
Jeffry, J. A., et al., mining machines.....	14,042	Klimsch, J. O., treating fibrous material.....	14,437
Jesseman, C., sawing machines.....	15,174	Kline, A., chain straw carrier.....	15,769
" D. and D. G., sawing machines.....	15,174	Knapp, C. W., saw handles.....	15,752
Jewell, O. H., et al., lubricators.....	13,911	" W. H., rakes for harvesters.....	15,178
Jewett, E. M., barrel staves.....	14,966	Knapp, C. W., saw handles.....	14,104
Johnson, A. F. and F. B., electric telegraph.....	14,407	" W. H., timber butting.....	14,749
" A. F. and F. B., telegraphic despatches.....	14,400	Knoepfel, J. C., grate bars.....	15,089
" A. F. and F. B., telegraphic transmitters.....	14,404	Knowlton, A., nailing machines.....	15,609
" C. M., racks for storing and ageing whiskey..	15,164	" D., bed bottoms.....	15,609
		" D. C., et al., wire fastening.....	15,026

Kolker, H., removal of incrustations.....	14,121	Ley, J., drill ploughs.....	13,790
Kranz, H., et al., boot trees.....	14,528	Leyden, A., car-couplings.....	14,787
Kremer, F. M. and J. C., et al., oat cutting machines.....	13,849	Libby, G. B., tire machines.....	14,539
Krepps, J. W., door fasteners.....	15,196	Liddell, W. J. F., head blocks.....	13,844
Kreichbaum, J. G., hasp locks.....	14,868	Light, B. E., et al., nut locks.....	15,257
Krieghoff, E., et al., rocking chairs.....	14,240	Lightbody, F., tree nail turning machines.....	14,030
Kunkel, D., car-couplings.....	13,841	Lightfoot, F., railway rail joints.....	15,656
Kurth, H., et al., treating caoutchouc.....	14,237	Lincoln, E., et al., railway spikes.....	14,255
Lacey, G. S., et al., gas regulators.....	14,946	Lindemann, F., et al., ash-sifters.....	14,876
Ladd, A. P., thill couplings.....	15,280	Lindsley, J., et al., tobacco.....	14,057
La Dow, C., sulky harrows.....	14,208	Linge, J., et al., remedy for diphtheria.....	15,279
La Fleur, J. J., et al., tags for fences.....	14,271	Little, S., et al., carriages.....	14,441
La Grange, R. J., finger and scarf rings.....	14,623	" S., et al., refrigerators.....	14,333
Laight, C., et al., trolling spoon baits.....	14,088	" S., et al., refrigerator waggons.....	14,249
La Jeunesse, J., et al., wheel hubs.....	15,168	Livergood, H. J., middlings purifiers.....	15,496
Lakin, J. A., telephones.....	14,416	" H. J., wheat scouring.....	15,353
Lamb, D. M., water and vermin repelling compounds.....	15,662	Livermore, C. F., transmitters for telephones.....	14,353
" J. M., et al., nut locks.....	15,257	" C. F., telephone receivers.....	14,354
" R., et al., car heaters.....	15,430	Livingston, F. B., lime burning process.....	14,726
" R., et al., windmills.....	15,572	Lloyd, L. H., et al., telephones.....	14,023
Lanier, J. B., taper machine.....	14,653	Lockman, C., sewing machines.....	14,071
La Mothe, B. J., railway cars.....	14,043	Lockwood, J., door securers.....	14,257
La Mothe (The) Mufg Co'y, railways cars.....	14,043	" T. D., electric signalling.....	15,825
Lampert, W., et al., bretzel machines.....	15,241	" W., vehicle gears.....	15,701
Lamson, W. S., cash carriers.....	15,138	Logan, C. H., et al., railway switches.....	14,382
Lancaster, B. F., et al., stove lamps.....	15,747	Loiseau, E., et al., combustion in furnaces.....	15,666
Lance, S. D., et al., vehicle dashes.....	15,709	Loper, R. F. W., et al., candles.....	13,959
Lane, L., et al., roofing plates.....	14,498	Lord, P., et al., car brakes.....	15,352
" W. J., harrows.....	14,130	Lorenz, W. A., upright pianos.....	14,384
" W. J., horse rakes.....	14,036	Loud, S. C., et al., ships' pumps.....	14,604
Langille, J. L., et al., tags for barbed fences.....	14,271	Lovejoy, A. J., et al., tire upsetters.....	14,276
Langtes, J. J., show boxes.....	14,490	Low, L., squares.....	14,142
Langley, J. H., journal bearings.....	14,885	Lowe, J. B. and F. S., electric connection on railway trains.....	15,387
Langlois, J. T., et al., nut locks.....	13,802	" R. W., et al., roller bushes.....	15,679
Lansing, L. D., et al., tire upsetters.....	14,276	" W. T. J., trolling spoon baits.....	14,088
Lanthier, E., boots and shoes.....	15,275	Lowell, S. W., et al., bleaching machines.....	15,637
Laraway, G. W., et al., barrel heads.....	14,759	" W. L., sleeping and drawing-room cars.....	15,629
Larivière, P. A., carriage seats.....	15,000	Luck, E., apparatus for acetifying alcoholic wash.....	14,412
Lash, J. F., clocks.....	14,026	" E., grain gelatinizing apparatus.....	14,430
Latour, P., folding joints for camp furniture.....	15,694	Luckenbach, F. A., et al., pulverizing apparatus.....	13,869
Lattimer, F., et al., knob spindle fastenings.....	15,068	Ludlaw, A. R., et al., cultivators.....	15,743
Lauffer, C., et al., farm fences.....	15,758	Luna, F., et al., pavements.....	14,010
Laughlin, J. M., horse shoe nails.....	15,076	Lunas, T., et al., building materials.....	14,768
Laurin, P., pegging machines.....	13,862	Lux, J. H., horse forks.....	14,228
Laux, I. R., et al., benches and wringers.....	14,149	Lyman, F. A., gasoline stoves.....	14,022
Laverty, C. E., drip pans.....	13,818	Lyons, J. M., baggage checks.....	14,911
Law, W. H., hydrants.....	15,418	McAndrew, W. J. G., et al., printers' galleys.....	13,872
" W. H., moulding machines.....	15,417	McCaffry, S. A., et al., rocking chairs.....	15,191
Lawson, L., open back saws.....	13,987	McCallum, A., et al., wagon racks.....	15,585
Lawton, W. E., et al., manufacture of gas.....	15,157	McCannon, G., et al., thrashing machines.....	15,125
Leacox, P. P., gearings.....	14,436	McCarroll, J., elevator safety apparatus.....	15,221
Learn, P., mechanical forges.....	15,159	McCarty, W. F. C., subdividing fatty matters.....	15,628
Lechner, F. M., drive chains.....	15,227	McCloskey, J., spoke guide and gauge.....	14,953
" F. M., sprocket wheels.....	15,100	" J., thrashing machine.....	15,699
" F. M., et al., mining machines.....	14,042	McCombs, G. F., et al., broom sewing machines.....	14,303
Lee, A. H., et al., balance slide valves.....	14,481	McCormick, N., manufacture of scarfs.....	14,341
" F. J., windmills.....	13,913	" (The) Harvesting Machine Co'y, grain binders.....	14,944
" H., plate printing machine.....	15,179	McCosh, P., barbed fences.....	14,642
Leggett, H., dumping waggons.....	15,478	McCoy, E., lubricators.....	14,270
Lehmann, W., millstone staffs.....	15,085	" H., whiffletree clips.....	15,432
Leigh, J., et al., lighting gas.....	14,563	McCrea, G. R., carriages.....	14,261
Leinbach, F. W., et al., paper bags.....	13,863	McCree, J., car-couplings.....	15,864
Leiser, H., garment samples.....	14,288	McCully, R., crushers.....	15,297
Leitch, A., et al., hoisting machines.....	13,783	" W., et al., knob spindle fastenings.....	15,068
Leland, H. W., plugs for electrical switch boards.....	15,225	McCune, J. B., et al., sand moulding machine.....	14,693
Lemay, A. O., boots and shoes.....	14,757	McDade, J. D., slates.....	15,683
Lemmon, H., safe combination locks.....	14,562	McDonald, A., stone dressing hammers.....	14,039
Lenox, E. S., bale ties.....	14,162	" A., stone dressing machines.....	14,914
Leonard, C. M., et al., rocking chairs.....	15,191	" A. E., freight transfers.....	13,970
Le Roy, C. J., et al., wagon brakes.....	15,036	" T., pocket hangers.....	14,415
" T. V., journal bearings.....	15,761	" T. A., et al., boots and shoes.....	14,094
Lescarbeau, M., pumps.....	15,008	" W. E., injectors.....	12,939
Leslie, A. J., inhaling apparatus.....	14,520	" (The) Mufg Co'y., thrashers and separators.....	14,246
" A. M., sewing machines.....	14,833	McDougall, A., tow boats.....	14,650
Levalley, C. W., bolt and rivet cutter.....	14,982	" C., motion imparting mechanism.....	14,379
" C. W., driving chains.....	15,379	McEvoy, C. A., apparatus used in torpedo operations.....	15,815
" C. W., harvesting machines.....	14,904	McFarlane, M., et al., mill stones.....	15,260
" C. W., mowing machines.....	14,222	McGerry, J., et al., walls and ceilings.....	15,314
Levan, A. A., et al., fanning mills.....	15,266	McGhehan, I. S., car-couplings.....	15,192
Leve, G., et al., sleeping cars.....	15,581	McGuire, J., et al., bottle stoppers.....	15,841
Levy, S., preparation of yeast.....	15,240	McGloblon, W. D., metallic coffins.....	13,976
" S., et al., snath fasteners.....	15,143	McGregor, T., portable engines.....	14,082
Lewallen, J. F., et al., car-couplings.....	13,952	McIntire, J. J., egg carriers.....	14,308
Lewis, C. E., saw mills.....	13,596		
" G. T., apparatus for collecting fumes.....	14,899		
" G. T., perfumed caustic soda.....	14,817		
" G. T., et al., white lead pigments.....	14,879		
" O. E., boots and shoes.....	14,211		

McIntire, J. J., egg and fruit carriers.....	15,002	15,003	Matthews, H. A., stove ornaments.....	14,765
McIntosh, E. B., glass pipe machines.....		14,476	Maunder, J., et al., harrow.....	15,436
McIntyre, P. D., et al., mail bag fastenings.....		15,643	" J., iron harrows.....	14,184
McKenzie, A. L., et al., knob spindle fastenings.....		15,068	Maxfield, C. A., et al., anti-slipping materials.....	14,897
" J. A., tricycles.....		14,847	Maxwell, D., harvesting machines.....	14,972
McKeone, C., et al., candles.....		13,959	Maydole, D., art of forging hammers.....	14,346
McKinnon, D., car-couplings.....		15,853	Mayrand, P., railway gates.....	15,630
" L. E., splash-boards.....		13,849	Medart, P., belt pulleys.....	15,208
McKnight, J. W., artificial marble.....		13,811	Meehan, D. C., et al., furniture casters 15,696	15,703
McLaughlin, R., vehicle running gears.....		14,628	Melick, P. M., sleeping cars.....	15,619
McLean, A. F., harrows.....		13,834	Ménard, F., blind hinges.....	14,100
" H. S., washing machines.....		14,499	" F., kettles.....	15,321
McLellan, W. W., railway signals.....		15,021	Mercer, F. C., vehicle wheel scrapers.....	14,568
McLeod, J. E., et al., rail chairs.....		14,173	Meriden (The) Britannic Co'., coffin handles.....	15,765
McMartin, J. A., pumps.....	14,349	14,350	Mernan, T. D., et al., pipe wrenches.....	13,998
McMurray, J. S., et al., planing machine.....		15,742	Merrill, G. H., lubricating compounds.....	15,407
McNairn, J. H., earth closets.....		14,081	" M., et al., fire proof boxes.....	15,067
McNall, L., fences.....		14,368	Merritt, E. D., et al., lubricating compounds.....	15,854
McNally, H., manner of attaching animals to loads.....		14,299	" T., et al., gang plough.....	15,828
McNaught, W. J., saddle girths.....		13,962	Mershon, A. J., rock drills.....	14,949
McNaughton, J., et al., dredging machines.....	14,410	14,411	Messinger, W. T., steam boiler injector.....	15,337
McNeal, C. E., et al., grain separators.....		15,533	Mestern, H., apparatus for ventilating, etc.....	15,954
McPherson, J. R., stock cars.....		14,871	Meyer, L., et al., railway switches.....	14,382
McSherry, G., double furrow ploughs.....		14,541	Meyors, J. C., et al., mowers and reapers.....	14,019
McWilliam, C., et al., combustion in furnaces.....		15,466	Mighener, W. R., steam boilers.....	15,691
Macdonald, A. F., nut locks.....		14,254	Mignault, P. E., car-couplings.....	15,484
" J., coal gas.....		13,940	Miles, W. H., brush holders.....	15,710
Mackey, J. C., tea or coffee percolators.....		15,479	Millen, G. H., et al., saw mills.....	15,687
Mackinnon, J. B., waterproofing stockings.....		15,014	Miller, A., clover hullers.....	15,074
Macleod, W. A., et al., wire fastening.....		15,026	" A. C., et al., harvesting machines.....	15,820
Macmillan, D., paper bag machine.....		15,579	" C., paint compounds.....	14,394
MacMillan, J., et al., car couplers.....		15,296	" C., et al., bolts, spikes and rivets.....	15,244
Macomber, E. G., skates.....		13,829	" E., carriage tops.....	14,445
" Aacpherson, D. M., milk coolers.....		14,336	" E. L., book-binding rollers.....	14,321
Madden, E. M., saw-frames.....	15,234	15,235	" G. F., oil ejectors.....	15,290
Maddox, J. E. Q., et al., gates.....		15,066	" H. J., machine for boring feloes.....	14,808
Magee, J. and F. A., magazine stoves.....		14,957	" J., thrashing machines.....	14,333
Mahon, J. F., gleaners and binders.....		13,969	" L., grain binders.....	14,772
Main, W. H., trace carriers.....		15,302	" M., holdbacks.....	14,853
Major, E. J., fence posts.....	14,916	15,586	" M., neck yokes and traces.....	14,840
Mallinckrott, J. F., railway brakes.....		14,806	" W. F., et al., car journal boxes.....	14,584
Mallon, F. T., corn shellers.....		15,198	" W. N., clocks.....	14,026
Mallory, E. A. and C. A., felt hat bodies.....		14,479	Mills, D., sewing machines.....	14,505
" G. W., et al., windmills.....		15,179	Milsum, H., ozone machines.....	14,147
Malmer, N., coats.....		14,580	Milumore, G. W., car wheels.....	15,592
Maltby, W. L., fireproof paint.....		14,888	Minaker, D. H., et al., harness.....	15,401
Manhattan (The) Cabinet Mnf'g Co'., tables and cabinets.....		13,780	Mitchell, H., car-couplers.....	14,802
Manheim, J., et al., apparatus for preventing the accumulation of steam and frost.....		15,441	" H., cloth exhibitor.....	14,676
Manley, C. T., bed bottoms.....		15,120	" J. C., et al., car-couplings.....	15,316
Mann, J. W., seeding machines.....		13,833	" R., service boxes.....	14,146
" T., hoisting machines.....		15,402	Monk, H. and W., steam engines.....	14,537
Manny, J. P., harvesters.....	14,242	14,243	Monroe, E. P., metallic packing.....	15,155
Mansfield, E., cant dogs.....		15,621	" E. P., valve rods.....	15,380
Marais, F. F. N., fruit presses.....		15,231	" H. H., rotary harrows.....	15,525
Marble, A. D., bulletin boards.....		14,108	Montreal (The) Saw Works, saw handles.....	15,219
Marden, A. H., car brakes.....	15,151	15,746	Moodie, W. J., et al., sash balances.....	15,870
Marix, A., subdividing fatty matters.....		15,628	Moon, J., adjustable seats for carriages.....	14,560
Mark, C. E., car-couplers.....		15,391	Moore, A. R., field rollers.....	14,704
Marsden, S. L., stone and ore crushers.....		15,368	" B. F., et al., churning apparatus.....	15,024
Marshall, T., apparatus for cleansing tubes of feed bottles.....		15,079	" E., scufflers.....	14,697
" P. M., horse shoes.....		15,850	" T., sawmills.....	14,058
" T. T., crimping machines.....		15,614	Moran, J. H., vehicle springs.....	14,898
" T. T., boots.....		14,186	Morehouse, G., churns.....	15,224
" T. T., seamless boots.....		15,880	Morgan, W., machine for singeing hogs.....	14,857
Martel, A. F., car brakes.....		14,482	Morley, J. H., button sewing machines.....	14,063
" A. F., mail bags.....		18,871	Murphy, G. S., washing machines.....	14,102
Martin, D. H., gas apparatus.....		15,595	Morris, H., railway signalling apparatus.....	14,997
" J. M., et al., tire upsetting machine.....		15,497	" J. H. and T. D., animal traps.....	13,964
" R. T., calculators.....		14,981	Morrison, R., self-lubricating packing.....	15,824
" S. W., fences, gates and latches.....		15,058	" W., dredging machines.....	15,719
" S. W., iron fences.....		15,037	" W. A., heaters.....	14,708
" S. W., woven fabrics.....		14,575	Morrow, A. J., churn powers.....	15,485
" S. and W. T., draught equalizers.....		15,356	" J., et al., hay elevators.....	15,708
Mason, J., heating boilers.....		15,013	Morse, H. D., et al., lightning rods.....	15,117
" J., radiators.....		14,843	" R. S., washing machines.....	15,781
" V. W., reversing mechanism.....		14,269	Morton, A., steam engines.....	15,651
Mastlin, W. Q., composition for smelting.....		14,611	" B., et al., veneering.....	15,458
Mather, A. C., stock cars.....		14,618	" T., sash cord fasteners.....	14,045
" C. A., et al., wood polishing machines.....		14,681	Mosanto, M. M., et al., steam generators.....	15,523
Matheny, T. G., et al., system of constructing roads.....		15,578	Moscrop, J. B., continuous recorders.....	14,356
Mathias, D., bale ties.....	14,162	14,163	Moulton, W. F., eaves troughs.....	14,451
Mathisen, J., door locks.....		15,695	Mourhes, J. F., et al., tanning process.....	15,690
Mathison, J., sewing machines.....		13,788	Mousseau, E., et al., sawmills.....	15,687
Mathews, A. N., valve stem packing.....		18,754	Mowry, R., thrashing machines.....	15,125
" A. N., et al., valve stem.....		13,804	Muir, A., horse powers.....	18,889

Munger, W. B., motion converting machine.....	15,749	Palmer, B. J., wind wheels	14,900
Munsell, J. E., selecting devices.....	15,447	" G. E., steam boiler furnaces	13,868
Murdock, C. D., et al., bed comforts.....	14,272	" G. E., et al., furnace grates	13,867
" H. W., knitting machines.....	14,950	" G. H. and H. E., et al., windmills.....	15,572
Murphy, J., bench clamps.....	14,980	" H. C., et al., lightening arresters.....	14,665
Murray, J., remedy for catarrh.....	14,952	" H. S., tea kettles	14,281
" T. W. B., et al., folding cots.....	13,766	" J., pen-holders	14,077
" W., fireman's protecting apparatus.....	15,009	" W. E. and G. H., et al., car heaters.....	15,430
Musser, B., sawmills.....	15,217	Paradis, J., et al., thrashing machine.....	15,729
Myers, C. H., colouring and finishing pictures.....	15,588	Parent, J. B., car-couplings.....	15,483
Naneth, G. V., paper files.....	14,567	Pariseault, S., bed bottoms.....	15,813
Nation, D. H., cooking stoves.....	14,090	Parks, D., self levelling berths	14,340
" D. H., ranges.....	13,910	Parker, E. D., electric couplings.....	15,569
Naylor, J., cheese manufacture	14,968	" J., car replacers	13,815
" J., articles from plastic material.....	14,009	" J., digging machines.....	14,502
Neff, J., steam valves.....	14,573	" Sir M., boiler cleaning	14,217
Negley, J. S., et al., car-couplings	14,287	Parkhurst, E. G., ammunition boxes	14,195
Nellis, A. J., barrows.....	14,688	" E. G., ammunition cases.....	14,989
Nelson, J., knit fabrics.....	13,968	Parmenter, W. E., cleaners.....	14,196
" J., et al., mittens.....	14,766	Parrish, C., tonic beverages.....	14,433
Nevins, W., seed planters	14,306	Parsons, W. R., machines for jointing and sharpening saws	15,334
Newark (The) Filtering Co'y, filtering apparatus.....	14,935	" W. H., pottery moulding machinery.....	14,448
Newbury, H. F., time locks.....	15,306 15,307 15,308	Passenore, E. G., lawn mowers.....	13,824
Newell, A., reed organs.....	14,665	Patchin, R. M., burglar alarms and door bolts ..	14,500
Newth, W. H. D., et al., locomotive ash pans.....	15,428	Patterson, J. W., roofing compositions.....	15,035
Newton, J., stuffing machines	13,949	Patten, E. K., et al., bureaux.....	15,867
" S. S., lamps	13,950	" W. H., et al., wheel rake.....	15,027
Nichols, C. B., et al., churns.....	13,957	Patterson, D., harvesters.....	14,795
" F. B., et al., radiating flues.....	15,522 15,722	" G. H., et al., combustion in furnaces.....	15,466
" G. W., compression cylinders for gang saws	14,599	" P. and A. S., harrows.....	15,829
Nicholson, M. A., stoves and ranges.....	15,090	" W. J., et al., barbed fences	14,971
" W. H., expanding mandrels	14,634	Paulding, W. H., sleeping and drawing-room cars.....	15,629
Nielsen, L. C., et al., centrifugal machines.....	14,421	Payne, E., removing potato sprouts.....	15,600
Nilson, N., vehicle springs.....	14,387	Paynter, H. M., crocheting machines.....	14,849
Nixon, J., traction engines.....	15,393	Payson, J. W., et al., blotters and covers.....	15,218
Nolan, J., floating elevators.....	15,519	Peace, S., horse collars.....	14,111
" J. H., et al., fire proof boxes.....	15,067	Pearson, F. L. D., ice cutting machines.....	13,990
Non combustible (The) Lubricating Packing Co'y, axle box packings.....	14,486	" J., et al., fruit driers.....	14,087
Norcross, J. W., pulley blocks.....	14,859 14,861	Pease, J. F., et al., heating apparatus.....	15,708
Norris, J. S., paper cabinets.....	14,886	Peavey, H., cant dogs.....	14,396
North American (The) Chemical Co'y, salt dryers	15,470	Peberdy, S., et al., knitting machines.....	14,084
North, S., pipe junction and boundary line indicator.....	15,445	Peck, J. M., construction of buildings	14,559
Norton, L. C., door checks	13,934	" T. S., fence posts.....	15,511
Norton (The) Door Check and Spring Co'y, door checks	13,934	Pederson, O., furniture casters.....	15,704
Nowell, T. S., hose pipes.....	15,180	Peerless, E., cooking stoves	14,199
" T. S., packing rings.....	15,181	Pellerin, J. I. and H., leather cutting machines.....	14,798
Noxon, J. and T. H., grain drills.....	13,916	Pelletier, A., pavement	13,777
Noyes, A. A., horse rakes.....	15,434	" A., et al., building materials	14,768
" D. F., wood drying apparatus.....	14,742	" A., et al., pavements.....	14,010
" R. S., cork cutters.....	14,664	" J. L., boots and shoes.....	15,785
" W. B., curtain rollers.....	15,077	Penman, J., knit fabrics.....	13,968
Nute, J. H., et al., rope serving machines.....	15,429	Peniston, W., potato separating machine.....	14,845
O'Brien, E. R., window shade rollers.....	14,056	Pennoyer, G., buggy springs.....	15,490
" P., process for treating the wood work of car- riages.....	14,671	Perkins, E. L., et al., saw mills	15,687
Odio, B., et al., cane shredding machines.....	15,467	" I. M., carriage seats	14,964
" B., et al., steam generators.....	15,523	" M. R., rail chairs.....	14,101
Olds, B. L., horse power links.....	14,024	" W. J., shingle machines.....	14,118
" B. L., speed regulators.....	14,025	Perozo, F., et al., cane shredding machines.....	15,467
Olmsted, F. S., et al., barrels	14,725	" F., et al., steam generators.....	15,523
" J., electric lamps.....	14,456	Perram, H. T., thill couplings.....	13,971
" J., telephone transmitters.....	14,681	Perry, J. L., et al., wood polishing machines.....	14,581
Olson, C., smoke consumers	14,690	" S. M., dust pans.....	15,668
Omo, J. H., mop holders.....	15,563	" W. V., car-couplings	14,175
Omoheandro, L. J., et al., bed comforts.....	14,272	Petersen, C., et al., centrifugal machines	14,421
O'Neill, J., fires guards and escapes	15,268	Peterson, C. W., air ships.....	14,216
Oney, R. T., cypher codes.....	15,721	Petier, S., bee hives.....	15,392
Ontario (The) Burial Case Co'y, burial cases.....	15,029	Petter, J. B., stoves and fire places	15,482
Oppenheim, F., vehicle seats.....	14,283	Pfeffer, J., lumber dryers.....	14,091
Orr, J. B., pigments.....	14,047	Phelps, S., roof paint.....	14,231
Orvis, O. D., boiler furnaces.....	14,252	" W. S., steam valves.....	15,342
Osborne, A., provision safes.....	14,936	Phillips, F. V., transom lifters	15,168
" D. M., et al., harvesting machines.....	15,820	" F. V., transom pivots.....	14,459
" E. F., steam apparatus.....	14,014	" G. C., water closets.....	15,590
" J. K., et al., harvesters	13,909	" T. S., et al., car journal boxes.....	14,534
" L. G., et al., provision safes.....	14,936	Pbilpott, J. H., et al., harness irons	15,819
Osgood, R. R., et al., dredging machines.....	14,411	Pierce, C. D., earth augers.....	14,985
Otis, S. A., car pole attachments.....	14,351	" H. M., extinguishing fires in kilns.....	14,304
Otter (The) Sweeper Co'y, window and door screens	15,464	" H. M., manufacture of charcoal.....	14,305
Otto, N. A., et al., gas motor engine	15,612	" J. D., stoves	14,202
Outram, F., pile cutting machines	15,048	Pierson, H. M., et al., manufacture of gas.....	15,157
Owen, W. J., wrenches.....	15,724	Pillow, J. A., et al., nail machines	14,359
Oyster, S. W., et al., liquid drainers	15,744	Pinney, E. D., et al., horse collars.....	14,295
Packer, T., instruction boards.....	15,734	Piot, D. T., electric motive engine	15,811
Pagel, J. C. F., sleighs.....	15,582	Plant, S. J., brick kilns	15,152
Paige, W. H., nut locks.....	14,460	Plenkharp, J., tables	14,626
		Plumb, F., ditching machines.....	15,207
		Plympton, H. R., sofa beds	15,566

Poindexter, R. E., saw jointers and gauges.....	15,283	Ridge, J., water elevators.....	15,229
Pollock, W. B., hose manufacture	13,973	Rielly, J., portable houses	14,733 15,404 15,405
Polsgrove, A. D., et al., flower crocks.....	13,933	Riggin, G. W., A. A. and W. M., tuyeres.....	14,780
Ponder, J., steam traps.....	14,310	Ritchie, A., et al., anti-slipping materials	14,897
Poore, T., et al., balance slide valves	14,481	" A., et al., lumber machine.....	14,686
Poppewell, W. W., et al., elastic fabrics.....	14,824	" D. A., metallic pipes.....	14,160
Porter, J. H., self-levelling berths	13,874	" J., et al., locomotive ash-pans.....	15,428
Post, C. C., sap spout, pall, etc.....	15,575	Rivard, F., boots and shoes	15,480
Pothiere, W., coffin handles.....	15,765	Rix, B. F., et al., harrows	15,845
Potter, C., church benches.....	14,357	Roach, C., sheet iron bending machines.....	15,473
" W. B., voltaic plasters.....	14,065	Robards, L. W., flax thrashing machines	15,794
Potts, A. F., extension furniture.....	15,351	Robbins, H. M., cattle ties	14,928
Powell, E. R., fence posts.....	15,511	" I., chromatic presses.....	15,501
Prandières, R. L. M. de, plastering compounds.....	13,954	Robert, L., explosive powder.....	13,972
Pratt (The) and Cady Co'y, steam valves.....	14,891	Roberts, C. H., forage preserving.....	14,500
" N. W., et al., steam boilers.....	15,793	" H., coating metals.....	14,616
" P. P., et al., cigarette machines.....	14,532	" J., wash boilers.....	14,292
" S. B., gate hinges and rollers.....	14,031	Robinson, E., et al., wire fence nails.....	15,295
Prescott, D. C., saw mills.....	15,685	" J. A., dental plates.....	15,508
" D. F., car-couplings.....	14,120	" J. J., signal lanterns.....	14,764
Preston, C. W., car door locks.....	15,196	" M. W., washing machine.....	15,635
" E., devices for jointing saws.....	14,906	" W., railway carriages	15,136
Price, G., door knobs	14,214	Rodden, W. H., can-stoppers	14,127
" G. D., et al., log chains	15,675	Rodgers, J. L., turbine wheels	15,488
" W. H., bolt threading machines	14,064	Rodier, L. C., steam radiators.....	14,462
" W. H., screw plates.....	14,089	Roe, F. A., horse-shoe machinery	15,725
Promoti, L., et al., bricks, slabs and stones	14,260	Roeder, F. A., et al., balances.....	15,346
Prouty, E., printing presses	14,809	Roehl, C., et al., horse collars.....	15,359
Provancher, L., et al., carriage axles.....	14,516	Rogers, C. D., screw nails.....	15,849
Prunty, J. E., hose pipe nozzles.....	15,319	" C. D., screws.....	14,801
Punches, O. J., spring tooth harrows	14,032	Rogers, C., et al., broom sewing machines.....	14,303 14,607 14,608
Putnam, A. W., fence wire machine	15,548	" E., et al., harrow.....	15,486
" J. H., car-couplings.....	14,086	" H. and J. H., grates for furnaces.....	14,219 14,220
Pye, J., water heating apparatus.....	13,927	" J., et al., bottle stoppers.....	15,841
Quackenbush, J. H., et al., car-couplings.....	15,388	" J. L., et al., belt replacing device.....	15,010
Quesnel, E. A., et al., cooking-stoves	14,245	Root, M. C., car-beaters.....	14,016
Quigley, R. J., et al., watch cases	14,307	Rorebeck, H., halters.....	14,729
Quimby, E. T., telephone exchange	15,134	Rose, A. W., telephones	15,650
Race, G., distilling apparatus.....	14,836	" I. M., lighting mechanism.....	14,807
Rae, R. R., et al., telephones.....	15,802	" M., feather renovating apparatus	14,903
Raffington, M. G., et al., cigarette machines.....	14,532	Ross, C., jr., pulverizing mills.....	14,762
Rairigh, W. K., trace hooks	15,546	" E., rug embroidering machines.....	14,334
Ramsay, A. G., mower knives.....	14,687	" J. F., metal packages	14,988
" C. W., treating and ageing liquors	15,377	" J. K., roller skates.....	15,162
" C. W., treating and preserving liquids.....	15,376	" O. C., carriage wheels.....	14,277
Ramsdell, G., gas apparatus.....	15,655	Rouch, A. N., chalk-holders.....	15,454
Rand (The) Drill Co'y, rock drills	13,920	Rouif, A. E., sewing machine motors.....	15,606
Ranney, P., et al., harrows	15,345	Rousseau, F. X., trap and ventilator.....	15,385
Ransom, F. H., trunks	13,997	Routledge, P., horse shoes.....	13,937
Rathbone, C., coal stoves	15,393	Rowe, J. M., fences.....	14,234
Rathbun, E. W., compressed fuel	14,533	" W. H., gang ploughs.....	15,406
Ransch, E. C., et al., registers and ottomans	14,756	Rowell, G. A., et al., furnace grates.....	13,867
Raymond, C. M., roller skates	14,624	Rowland, P. F., attrition mills	15,773
" J. W., et al., log chains.....	15,675	Rowley, D. and C. G., starching machines	15,262
Reach, R., water closets.....	14,611	Roy, J. L., blind hinges.....	15,748
Read, G. W., lumber dryers.....	14,091	Ruddick, H., registering dynamometers	14,092
" J. J., rotary motion.....	13,936	Ruhl, J. and C., felting machine.....	15,615
Reaves, M. A., compound for catarrh.....	13,797	Rundell, R. J., lumber drying kilns.....	13,851
Reece, J., button hole sewing machines.....	14,682	Russell, J. W., fanning mills.....	15,303
Reed, D. C. and H. C., & Co., harrows	15,829	" W., reaper tables	14,606
" H. G. H., car-couplings	15,453	Sage, C. E., middlings purifiers.....	13,832
" J. T., refrigerating apparatus	15,619	Sager, C. A., ice cutting machines.....	15,514
Reese, A. R., et al., quarrying machines.....	15,400	Salmon, I. A., car heaters	15,226
" J., et al., car-wheels.....	14,602	Salomon, E., et al., anti-friction bearings.....	15,209
Reid, J. M., plaster of Paris.....	13,876	" E., et al., manufacture of hinges.....	15,512
" W. F., manufacture of explosives.....	14,413	" E., et al., rotatory cutters.....	15,144
Reiser, C., steam boiler cleaners.....	13,922	Sampson, C. E., journal boxes.....	14,775
Renil, G., sleeping and drawing-room cars	15,629	Sanders, J., pumps	14,080 15,764
Ressel, H., towing lighters.....	15,980	" J. F., vacuum dredges.....	13,768
Rheutan, G. H., steam boilers.....	14,967	Sandersen, W., ploughs.....	13,986
Rhoder, T. R., paper bag machine.....	15,579	Sanford, A., cant-hooks.....	15,772
Rhodes, W. H., hole digger	14,145	" A., ox shoes.....	14,785
" W. K., lubricators	14,525	" G., machine for obtaining fibres.....	15,638 15,639
Rice, A. J., apple paring machines.....	15,149	" G. E., et al., time-piece calendars.....	14,769
" A. J., apple slicers.....	14,141	Sanford (The) Universal Fibre Co., machine for ob- taining fibres	15,639
" E. W. L., stove platforms	15,062	Sarney (The) Mnf'g Co'y, illuminating tiles.....	13,826
" F. B., valve gear.....	14,973	Santry, T. S., et al., plates for electric accumulators	15,414
" G., salt dryers.....	15,470	Saunders, H. A. C., et al., signalling apparatus	14,577
" G. M. and A. L., separating fibres.....	13,838	" I. J., spring buttons.....	13,769
" H. C., filters.....	14,823	" N., boring machines.....	15,731
" V., belt couplings.....	14,519	Savoye, J., door fasteners.....	14,661
Rich, A. E., bottle stoppers and fasteners	15,751	Sawyer, L. D., et al., harvesters.....	14,381
Richards, D. L., chair and wash bench.....	13,822	Sax, J. K., car wheels.....	15,668
" F. H., printing presses.....	14,716	Scheffer, F. S., railway switches.....	14,828
Richardson, D. M., polishing machines.....	15,740	Schell, D. M., book cases.....	15,131
" F., rubber boots and shoes.....	14,679	Schenck, W., stove backs.....	14,279
" G. F., et al., bureaus.....	15,887		
" M. A., sharpening files.....	14,178		

Schiller, J. G., et al., car brakes and fenders.....	14,601	Smith, A. E., vehicle axles.....	15,736
Schneider, A., magazine fire-arms.....	14,737	" B., et al., telegraphs.....	14,331
Schneer, I., shirts.....	14,722	" C., smoke consuming furnaces.....	14,639
Schneller, G. O., button fastenings.....	15,670	" C. H., et al., drag scrapers.....	15,116
Schoen, C. T., et al., car springs.....	14,746	" C. M., fishing line floats.....	14,366
Schofield, S., et al., tobacco.....	14,057	" C. S., et al., breaking down coal.....	13,928
Schonhoff, B. H., barrel rollers and guides.....	15,653	" D., egg preservers.....	14,193
Schooley, W. D., gas lighters.....	15,146	" F. R., et al., fishermen's reels.....	14,521
Schoonmaker, J. C., et al., wringing machines.....	15,518	" G., hasp staples.....	14,397
" J. H., et al., lightning rods.....	15,117	" G., telegraph receiving instruments.....	15,140
Schultz, E. G., et al., ash-sifters.....	14,876	" G., vehicle springs.....	15,195
Schultze, A. J., et al., snath fasteners.....	15,148	" G. K., grinding mills.....	14,816
Schwanz, G. G., burglar alarms.....	14,374	" G. W., fire-escapes.....	15,758
Scott, C., sofa beds.....	15,139	" G. W., scaffolds.....	15,573
Scott, C., et al., car springs.....	14,746	" H. M., presses.....	15,655
" J., water gears.....	14,434	" H. S., et al., veneer cutting machines.....	14,177
" W., self-extinguishing lamps.....	14,839	" J., et al., motion converting device.....	15,273
Scovell, M. A., et al., manufacture of glucose.....	15,509	" J. A., et al., car-couplings.....	15,316
" M. A., et al., sugar and syrup.....	15,510	" J. C., et al., walls and ceilings.....	15,314
Scribner, J. M., et al., animal restraining device.....	15,471	" J. D., et al., road scrapers.....	14,810
" W. M., et al., covers and blotters.....	15,218	" J. E., car-couplings.....	13,931
Searlight, S. G. and W. H., reverting dampers.....	14,420	" J. N., axle-journals and treads of wheels.....	15,248
Searle, H. W., snow shovels.....	14,040	" J. N., car axle boxes.....	14,612
Seeberger, J., piston packing.....	14,491	" J. N., car trucks.....	14,570
Semper, C., et al., iron removing.....	13,919	" J. N., cylinder dressing tools.....	15,230
Sénécal, L. M., et al., nail cutting machines.....	15,277	" J. R., velocipedes.....	15,610
Sennis, D., wear plates.....	15,840	" J. W., et al., car brakes and fenders.....	14,601
Sergeant, W. E., millstone drivers.....	13,860	" L. L., wire coating process.....	14,714
Serrell, L. W., manufacture of gas.....	15,157	(The) Man'g Co'y, boxes for berries.....	15,707
Sexton, W. F., sr. and jr., door balances.....	15,812	" M. L., et al., wheel hubs.....	14,850
Shaddock, M. P., tug bucklers.....	14,832	" O. A., et al., roofing felt.....	15,311
Shaffer, J., machine for making cruppers.....	14,373	" P., water heaters.....	14,647
" W. C., train stopping apparatus.....	14,338	" R. H., saw handles.....	14,085
Shannon, A. G., type writing machines.....	15,783	" S., et al., mail bags.....	14,745
Sharp, T., steam boilers.....	13,889	" S. H., boxes for berries.....	15,707
Shattuck, J. W. M., packing boxes.....	14,497	" S. S., nut locks.....	14,001
Shaver, W. T., waggon gears.....	15,381	" T., buggy tops.....	14,278
Shaw, E., et al., hay and straw cutter.....	15,570	" S. K., et al., paint.....	15,634
" H. C., knitting machines.....	14,732	" W. D., blowers.....	14,112
" (The) Glove Co'y, knitting machines.....	14,732	" W. D., et al., waggons.....	14,376
Sheard, T., et al., car-couplings.....	15,607	" W. H., preparing tan bark.....	15,562
Sheffield, G. S., car wheels.....	15,677	Smyth, A. G., devices for converting motion.....	14,984
Sheffield (The) Velocipede Car Co'y., car wheels.....	15,677	" A. G., et al., motion converting device.....	15,273
Sheldon, R. B., cultivators and sowers.....	15,452	Snider, L. P., et al., belt replacing devices.....	15,172
" R. B., hay rakes.....	15,001	Society (The) for the Manufacture of Wood Pulp, treat- ing fibrous material.....	14,437
Shellabarger, J. H. and S. A., stock cars.....	14,948	Sole, J. W. F., furnaces.....	14,603
Shepard, H. W., shovels.....	14,760	Soley, J. A., nut locks.....	13,946
Sheppard, C., coal washing machines.....	14,939	Solomon, E., heel counters.....	14,948
Sheppardson, C., straw-cutters.....	13,926	Solte, F., railway switches.....	13,821
Sheridan, H. B., dynamo-electric machines.....	15,019	Sorensen, C., transportable engine.....	15,520
Sherman, D. H., et al., car couplings.....	14,707 14,889	Southwick, D. E., car-couplers.....	15,194
Sherwin, I. S., gates.....	14,956	Southworth, W. H., et al., oil tanks.....	14,194
Sherwood, M. B., phosphorescent compositions.....	15,326	Souvielle, M., spirometer.....	14,427 14,586
" O., et al., fire-escape ladders.....	14,250	Sparkham, T., boiler coverings.....	15,261
Shimer, G. J. and S. J., journal bearings.....	15,499	" T., fireproof paint.....	14,888
Shinn, M. C., barbed fences.....	14,642	Spaulding, A. H., et al., grain separators.....	15,533
Shipman, H. W., et al., veneer cutting machines.....	14,177	" E., dies for springs.....	15,396
Shippee, C. W., boots and shoes.....	15,176	" L. A., heating and ventilating.....	14,206
Shultz, J. A. J., belting leather.....	14,931	" N. H., et al., steam boiler injector.....	15,337
Shuman, C., neck-yoke rings.....	14,751	Spencer, A., sectional boilers.....	15,168
Shurly, C. J., et al., saw frames.....	15,235	" E. E., heaters.....	14,708
Shutte, L., injectors.....	14,316	" H. P., step-ladders.....	15,576
Sidney, G. N., ball traps.....	14,998	" L. B., mortise locks.....	15,121
Simmons, T. A., hame tugs.....	15,806	Sperry, E. A., dynamo-electric armatures.....	15,564
Simms, H. W., means of attaching corkscrews.....	15,809	" E. A., dynamo-electric machine.....	15,567
Simonds, F., ploughs.....	14,005	Sperry, J. N., et al., cocks and valves.....	15,282
Simons, J. L., windmills.....	15,179	Spiral (The) Spring Buggy Co., vehicle springs.....	15,195
Simpson, C. G. C., ash-sifters.....	15,189	Spitler, S. J., carpet fasteners.....	15,080
Sims, A. H., et al., collars and cuffs.....	14,148	Spitzig, L., harvester attachments.....	15,657
Stclair (The) Rectifying Co'y, filtering apparatus.....	15,827	Sprague, E. L., boots and shoes.....	14,990
" T. R., filtering apparatus.....	15,827	" W., corn cutting machines.....	14,680
Singer, P. J., elevators for hatchways.....	15,129	Springer, A., et al., balances.....	15,346
Sinn, C. F., et al., railway brakes.....	13,983	" A. C., car brakes.....	15,711
Skinner, C. L., et al., machines for welding links.....	14,487	" H., et al., harrows or cultivators.....	14,854
" H., et al., looms.....	15,713	Sprong, J. W., et al., means for extinguishing fires.....	15,574
" H. J., washing machines.....	14,884	Squier, H., ship fastenings.....	14,170
" S. W., et al., electric lamps.....	15,399	Stafford, C. V., et al., telephones.....	15,802
Skinner, S. W., metallic rods.....	13,866	Standfield, J., et al., docks and pontoons.....	14,453
Slaffer, C. J., car label holders.....	14,609	Stanley, G., mosaics.....	14,699
Slate, D., et al., barrel heads.....	14,759	" J. M., et al., saw-log sleighs.....	15,489
Slayton, E. T., spring bed bottoms.....	13,864	Stannard, G. A., et al., lubricators.....	13,911 15,046
Sloan, A., saw handles.....	15,219	Starr (The) Man'g Co'y, skates.....	14,013
Sloat, R., rosettes for bridles.....	15,331	St. Denis, A., et al., mill stones.....	15,260
Smale, J. H., harrows.....	14,004	Steam (The) Heat Evaporating Co., fruit evaporator.....	15,692
Smalley, E., et al., lubricating compounds.....	15,854	Stearns, H. A., gates.....	15,113
Smart, R., sawing machines.....	13,820	Stern, E., sewing machines.....	15,787
Smirl, J., horse powers.....	14,635	Sterne, G. F., stove-boards.....	15,104
Smith, A., et al., looms.....	15,713		

Stetson, J. B., et al., lanterns.....	14,920	Thompson, R., et al., boots.....	15,838
Stevens, J. G., vegetable fibre.....	14,652	" R., et al., car-axle-rolls.....	15,253
" J. H., sole buffing machines.....	14,055	" R. H., et al., treating caoutchouc.....	14,237
" S. M., fence wire stretchers.....	14,629	" W. C., paddle wheels.....	14,535
" T., sewing machines.....	14,134	" W. E., car-couplings.....	14,780
Stewart, C. H., steam boiler injector.....	15,337	Thomson, C., et al., radiating flues.....	15,522 15,722
" J., bustles.....	14,743	" E., commutators.....	15,072
" J., lifting jacks.....	15,141	" E., dynamo-electric machines.....	15,206
" J. F., harvesting machines.....	14,174	" E., electric lamps.....	15,183
Stiles, A. K., fence posts.....	15,527	Thomson, E., regulators for electric currents.....	15,166
Stock, H. T., pile drivers.....	15,686	" J. L., boots and shoes.....	15,022
" H. T., snow ploughs.....	15,184	" J. L., et al., rein-holders.....	15,033
Stockstill, D. W., et al., walls and ceilings.....	15,314	" R., et al., harvesting machine.....	15,603
Stockwell, L. W., bolt treading machines.....	14,064	Thorpe, J. M., et al., cushion protectors.....	14,638
" L. W., screw plates.....	14,089	" L. G., et al., catmeal machines.....	14,689
Stoetzel, W. F., eaves trough hangers.....	15,735	Thurmer, M. R., car-couplings.....	14,419
Stone, F., mechanical musical instruments.....	15,598	Thurman, J., milts.....	15,285
" J. H., tubular lanterns.....	14,977	Tilley, A., et al., veneering.....	15,458
" J. H., et al., bird insect catcher.....	13,825	Tilton, L., cancelling stamps.....	13,943
Storey, C. A., flower stands.....	14,313	Tingley, A. D., stock-feeding device.....	14,267
Stormer, H. C. F., apparatus for drying, etc.....	14,435	Tinkham, A. R., et al., car-couplings.....	15,316
Stover, D. C., barbed fencing.....	13,956	Tisdale, C. D., et al., electric signals.....	15,254
Stowell, L. B., halters.....	14,472	Titmas, W., warp-dressing machines.....	15,210
Street, G. S., et al., photographic printing frames.....	14,355	Titus, C. H., et al., shaft and pole couplers.....	14,348
Strong, F. M., et al., road scrapers.....	14,810	" C. M., horse rake.....	15,778
" G. S., smoke stacks.....	13,996	Tobey (The) Furniture Co'y, smoke consumers.....	14,690
" H. C., et al., telephones.....	14,023	Toronto (The) Reaper and Mower Co'y, gathering machines.....	14,711
" J. E., farm gates.....	15,515	" " " " harvesters.....	14,945
" M. H., et al., manufacture of gas.....	15,157	" " " " harvesters and binders.....	14,970
Strunz, S., leaching apparatus.....	15,456	" " " " binding machines.....	15,012
Stuart, J. de G., et al., nail cutting machines.....	15,277	Tower, O., thill couplings.....	15,214
Stubbendorff, H., blind hinges.....	15,748	Townsend, T. B., hanging lock gates.....	14,429
Studer, W., et al., railway brakes.....	13,983	Toye, W. H. R., ornamental fabrics.....	14,158
Sturdy, F., furnace grates.....	15,535	Transmitting (The) Dynamometer Co'y, dynamometers.....	14,092
Sullivan, J., et al., bed bottoms.....	14,068	Travis, C. L., carpet sweepers.....	15,052
Sully, E. E., butter workers.....	15,367	Tremain, J. K., car brakes.....	15,805
Sumner, J. D., horse shoe nails.....	15,076	Trenholm, J. E., hay presses.....	14,658
Sutliff, J., motors.....	14,813	Trites, J. S., railway frogs.....	14,230
Sutton, W. A., skates.....	15,647	" J. S., telegraph and railway signals.....	15,142
Swain, J. J., barrel trucks.....	15,801	Tryon, F. A., hoes.....	14,873
Swan, J. W., batteries for storing electricity.....	15,069	Tucker, F. O., stop motions for looms.....	15,328
Sweet, G., et al., harvesting machines.....	14,103	Tucket, G. T., tobacco caddies.....	13,985
" O., blanket fasteners.....	15,130	Tuerk, F. W., hydraulic motors.....	15,852
Symmonds, J. S., fire bottom for stoves.....	14,517	Turnbull, M., et al., holting machines.....	13,783
Zink, H. C., et al., machines for welding links.....	14,487	Turner, J. H., feed water heaters.....	14,739
Tackaberry, J., animal powers.....	15,487	Turpin, E., explosive compounds.....	14,631
Taggart, F., grain reducing process.....	15,702	Tylander, H. E., et al., machinery for weaving cane.....	14,558
Talcott, W. A., et al., mittens.....	14,796	Union (The) Electric Mnf'g Co'y, electric light regulators.....	15,205
Talpey, J. A., sinks.....	15,600	Universal (The) Knitting Machine Co'y, knitting machines.....	15,427
Tamm, M., offal drier and cooler.....	15,648	Upton, A. F., et al., gas consuming furnaces.....	14,035
Tanner, T., window light fasteners.....	14,144	" C. S., et al., halters.....	14,729
Tarante, S., beach seats.....	14,489	Uroh, D., boats.....	13,380
Tarble, F., car-couplings.....	14,266	Vandermark, J. L., bag ties.....	13,881
Tasker, S. P. M., pulverizing machines.....	14,513 14,569	Van De Water, H., et al., churns.....	13,957
" S. P. M., welding and sizing tubes.....	14,717	Vanduzen, E. W., water elevators.....	13,900
Taylor, C., gold amalgamating.....	14,251	Van Ensley, M., bee hives.....	15,801
" G. B., et al., gibs for bolts.....	13,779	Van Liew, D. F., railway cars.....	15,480
" H., mop wringers.....	14,673	Van Luven, A., strap couplings.....	13,789
" J. K., spark-arresters.....	14,114	Van Meter, A. C., et al., knob spindle fastenings.....	15,068
" J. M., locomotives.....	14,367	Van Outrive-Carlier, G., et al., processes for making beverages.....	14,582
" J. M., locomotive windows.....	14,274	Van Rysselbergher, F., apparatus for preventing induction in telegraphic and telephonic systems.....	15,338
" R. W., saw guards.....	13,982	" F., means of operating micro-phones.....	15,805
" T. P., corsets.....	14,758	" F., telegraphic and telephonic apparatus.....	15,363
" T., et al., elastic fabrics.....	14,824	Van Wagner, J. M., car seats.....	14,992
" W. H. and S., saddle trees.....	14,159	Vaughan, D., millstone dressing machines.....	14,200
Teakles, M., et al., churns.....	14,666	" H. M., colouring process.....	14,829
Teal, D. E., trestles.....	15,868	Vermilyea, S. and H. M., corsets.....	14,927
Teasdale, J. M., fruit evaporators.....	14,907	Verniaud, C., et al., oil injectors.....	15,290
Tees, J., chairs.....	14,067	Very, T. S., horse shoes.....	14,028 15,617
Temple, M. D., chain pumps.....	14,224	" T. S., horse shoe machines.....	14,617
Terris, H. R., lifting jacks.....	15,770	" T. S., rolls for horse shoe blanks.....	15,812
Terry, J., car-couplings.....	14,684	Vilas, C. K., fire-box.....	15,420
Teter, W. S., grain-cleaners.....	14,076	Villebonnet, L. B., rotary pumps.....	14,819
Tewksbury, G. C., elevators.....	15,173	Vinet, J. B. and A. S., et al., car brakes.....	15,352
Thayer, E., hydraulic elevators.....	15,087	Vining, W. N., et al., cooking stoves.....	14,245
Thibault, M., bolt fastener.....	14,755	Vivian, H. H., manufacture of bronze.....	13,878
Thierry, J., moulds for car wheels.....	14,792	Voigt, E. W., et al., refrigerators.....	14,585
Thomas, D. S., fire-escapes.....	15,250		
" E. T., sewing machines.....	15,762		
" G. G., heating stoves.....	15,435		
" J. W., seedling machines.....	15,755		
" J. W., et al., cultivators.....	15,743		
" W. M., et al., electric lamps.....	14,458		
" W. M., et al., metallic rods.....	13,866		
Thompson, C. B., sewing machines.....	14,187		
" H. A., wrenches.....	13,866		
" N., bottle stoppers.....	14,424		

Volk, W., stovepipe fitters	14,672	Wheeler, H. B., et al, fruit driers.....	14,087
Von Roden, H. W. I. O., milk preserving process	14,887	" S., writing cases.....	14,227
Vou Zach, J., swinging lever engines.....	14,630	" W., lighting apparatus.....	13,948
Vunk, G. W., et al., car-couplings	15,340	" W., reflectors	14,929
Waddell, J. C., broad cast sowers	14,660	" W., reflector attachments.....	15,115
Wagstaff, J., bag holder.....	14,536	Whitaker, D. W., spring beds.....	14,951
" J. H., indices.....	14,750	" W. W., car axle box	14,774
Wahl, C., vacuum pans.....	15,833	White, O. C., ball and socket joints.....	15,056
Waite, H. E., et al., telephone receivers.....	14,354	" R. T., routing machines.....	14,864
" H. E., et al., transmitters for telephones.....	14,353	Whitehead, H., et al., railway points	14,143
Walker, B. F., well tubing joints.....	13,847	Whiteley, Fasseler and Kelly, harvesters.....	14,483
" G., et al., compressed fuel.....	14,538	"	14,588
" J., connecting and disconnecting links.....	14,523	" W., binding machines.....	15,012
" J. T., horse detachers.....	15,500	" W., et al., harvesters.....	14,483
" M., fire-extinguishers.....	15,823	" W. N., gathering machines.....	14,711
" M., pumps.....	14,363	" W. N., harvesters and binders.....	14,945
" R. L., fire boxes	15,105	" W. N., harvester finger bars	14,937
" B. L., furnaces.....	14,484	" W. N., harvesting machines.....	14,938
Wallace, M., nut locks	14,408	" W. N., et al., harvesters and binders.....	14,588
" N. W., entrenching tools.....	15,835	"	14,589
" P., grain binders.....	14,794	Whitlock, D., heeling machines	18,771
Waller, T. C., waggon-couplings.....	14,834	Whitman, W. W., et al., vats for heating and saturating hoops	15,071
Walmsley, J. F., barbed fencing.....	13,846	" W. W., et al., cheese hoop followers.....	14,573
" J. F., metallic fences.....	14,172	Whitney, E. R., et al., steam generator.....	13,807
Walrath, D. S., et al., car-couplings.....	15,807	" J., horse collars.....	14,153
Walsh, G., saw-dressing tools.....	15,053	" O. C., cabinet organs	15,122
" saw jointers.....	15,054	Whittier, A. C., vacuum dredges.....	13,932
" M. C. and M. J., apparatus for stowing cargoes.....	15,438	Whipple, E. E., harrows.....	14,771
" M. C. and M. G., flexible pipes.....	15,440	Whyte, E., price ticket holders.....	15,727
" M. C. and M. G., jacks.....	15,439	Wickham, H. J., envelope machines	13,776
Walton, B. W., gang plough.....	15,828	Wiggin, A., carbureters	14,605
Wanzer, R. M., et al., sand moulding machine.....	14,693	Wilcox, C. H., et al., sewing and trimming apparatus.....	14,598
Ward, F., et al., hay elevators.....	15,768	" D., horse shoe blanks.....	14,389
Warden, A., journal boxes.....	14,775	" F. N., et al., oatmeal machines.....	14,689
Warin, G., shooting skills.....	15,802	" S., et al., steam boilers.....	15,792
" G., sliding seats for boats.....	15,676	" W. E., et al., journal box	15,442
Waring, G. H., et al., bolts, spikes and rivets	15,244	Wildner, R. S., et al., harrows.....	14,444
Warne, E., concentrators and separators for ores.....	14,812	Wildermuth, L., spring beds.....	15,705
Warner, L. C., water elevators.....	15,532	" L., wire coiling machines	15,422
" L. S. and L. A., et al., overalls.....	14,567	Wildman, W. C., paper tags.....	14,060
Warren, J. D., soap compounds.....	13,988	Wilbort, F., vaginal syringes.....	13,951
Washburn and Moen (The) Mnf'g Co'y, fence wire machine	15,548	Wilkins, C. J. F., reaping machines	14,109
"	13,958	" F. B., finishing cotton fabrics.....	15,325
"	13,958	Wilkinson, G., steel scrapers.....	15,584
Washburn, L. W., car wheels.....	14,674	Will, F., bottle stoppers.....	14,820
" S., wood turning and gauge tools.....	15,531	Willard, B. J., life preservers.....	15,061
Waterhouse, A. G., electric lamps.....	14,787	" H. E., fishing apparatus	14,675
Waterman, H., locomotive engines.....	15,827	Williams, A. B. and C. G., egg preserving.....	15,782
Waterston, J. B., et al., brushing gold leaf.....	13,967	" A. R., et al., harvesting machines.....	15,603
Watkins, A. H., vapour burners.....	14,740	" C. E., medicinal compound.....	14,312
" W. C., wire stretchers.....	15,202	" C., jr., microphones.....	14,165
Watson, G. H., boiler furnaces.....	14,343	" F. B. and W. A., folding beds.....	14,731
" G. H., steam generators	14,814	" H., grape sugar crystallizing	13,861
" J., harvesting machines.....	14,103	" I. A., locomotive lights	13,923
"	14,468	" J. J., tiling for floors, etc.....	14,473
" J., horse rakes	14,241	" J. M., hoop buckles.....	15,284
" T. A., telephones.....	14,454	" (The) Mnf'g Co'y, sewing machines.....	15,762
Weaver, T., carriage seats.....	15,276	Williamson, C. A., corsets and shoulder braces.....	15,171
Webber, W. A., mechanical toys.....	14,718	Willmot, W. F., pot covers.....	14,393
Webb, R. W., tills.....	15,118	Willson, A. J., horse rakes.....	14,241
Weber, H. A., et al., manufacture of glucose.....	15,509	" H. F., et al., carriage bows	14,311
" H. A., et al., sugar and syrup.....	15,510	" T. L., dynamo-electric machines.....	14,235
" N., middlings purifiers.....	14,328	" T. L., et ceteric lamps	14,180
Webster, A. and E. F., signalling mechanism.....	15,167	Willmot, J. A., carpet fasteners.....	15,348
" J., alumina.....	14,317	Wilson, A., gas apparatus.....	14,344
" O., et al., stove boards.....	14,273	" A. D., et al., lanterns.....	14,920
" S., et al., loose pulleys.....	14,406	" C. R., swell body cutters.....	15,560
Weems, D. W., artificial stone.....	15,095	" F. J. L. and J. E., grinding mills.....	15,373
Weil, L., et al., reversible cloaks.....	15,064	" F. L., hoop cutting machines.....	15,817
Weir, F. C., machine for cutting rails.....	15,424	" G., low-water indicator.....	14,075
" F. C., railway frogs.....	15,294	" J. C., paper bags.....	15,370
Welch, S. F., et al., drag scrapers.....	15,116	" J. H., et al., car heaters.....	15,430
Weller, J. E., cultivators.....	14,637	" J. T., et al., cider sifter	15,632
Wells, D. G., machines for barbing wires.....	15,837	" J. H., et al., windmills.....	15,572
" H. M., et al., broom-holder.....	15,268	" T., fanning mill.....	15,386
" H. M., et al., tassel clamps.....	14,063	" T. F. and A. L., levelling engine boilers.....	15,608
Welte, S., lathes.....	14,154	" T. L., et al., railway cars	14,232
Wesson, A., wire fences	15,059	" W. S., harvesting machines.....	14,157
West, E. K., et al., heating apparatus.....	15,708	"	14,468
" W., can filling apparatus.....	15,043	Winckler, J., faucets	15,536
Westcott, J. M., fertilizer distributors.....	14,296	Winslow, F., shoe sole buffer.....	14,799
" J. M., seeding machines	14,221	" J. L., lubricating cups.....	14,692
Westlake, W., et al., cuspadors.....	14,965	" J. M., et al., valve stem.....	13,804
Westman, J., temporary buildings	15,857	Winterstein, W., weighing and lifting devices.....	14,578
" J. and W. D., drivers.....	13,814	Wisner, J. O. and W. L., et al., hay rakes.....	15,001
Westphal, H., cross cut saws.....	14,399	" J. O. and W. L., spring hoes.....	13,806
Westwood, B., et al., trolling spoon baits	14,088	" W. S., cultivators and sowers.....	15,452
		Wolfe, C. A., et al., paper bags.....	13,863

Wolfender, J., et al., pulverizing apparatus.....	13,869	Worthington, A., et al., furnace grates.....	13,867
Wolstenholme, J., fuel burning apparatus.....	13,817	Wortman, W. H., bay elevators.....	15,768
Womack, A., et al., tire upsetting machines.....	15,497	Wright, A. W., churns.....	14,705
Womersley, J., wooden boxes.....	13,882	" J. J., dynamo-electric machines.....	15,133
Wood, J., snow ploughs.....	14,268	Yagn, M., hydraulic motors.....	15,712
" J., et al., keys for bolts.....	13,779	Yates, A., cotton twisting machines.....	14,138
" J. J., commutator couplings.....	15,541	Yellott, G., water wheels.....	14,070
" J. J., electrical armatures.....	15,540	Yon, G., bricks.....	14,561
" J. J., electric generators.....	15,539	Yost, G. E., car axle boxes.....	14,549
" J. J., electric lamps..... 15,552 15,553	15,554	Young, A. A., ships' berths.....	14,855
" W., et al., water traps.....	15,777	" C., crocheting machines.....	14,849
Woodhill, J., hoisting buckets.....	15,757	" S. P. and C. D., et al., wheel rake.....	15,027
Woodruff, G. S., et al., gas governors.....	15,866	Youngs, J. E., hasp locks.....	15,869
" L. E., et al., fruit driers.....	14,087	Yule, G., et al., napped hats.....	15,154
" M. W., piston packings.....	15,040	" G., et al., shaking cotton from hats.....	15,163
Woods, A., et al., car-couplings.....	13,952	Zettel, A., car-couplers.....	13,992
Woodward, E., et al., boots and shoes.....	14,218	Zimmer, C. H., et al., farm fences.....	15,788
" M. J., petroleum condensers.....	14,993	Zimmerling, A. F. smoothing machines.....	15,494
Woodworth, L. D., et al., roofing plates.....	14,198	Zimmerman, J., et al., maten tteres.....	14,933
Worcester (The) Barb Fence Co'y, barbed wire.....	14,919	" W., et al., brushing gold leaf.....	13,679

The Canadian Patent Office

RECORD

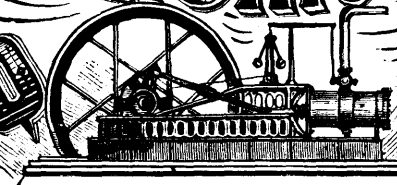
Vol. X.—No. 1.

JANUARY, 1882.

Price in Canada \$2.00 per An.
United States - \$2.50

CONTENTS.

INVENTIONS PATENTED.....	1
INDEX OF INVENTIONS.....	XVI
INDEX OF PATENTEES.....	XVII
ILLUSTRATIONS.....	21

INVENTIONS PATENTED.

No. 13,766. Improvements on Folding Cots.

(Perfectionnements aux lits de camp)

Thomas W. B. Murray and Caleb J. Baker, Chicago, Ill., U. S., 1st. December, 1881; for 5 years.

Claim.—1st. The angle irons or hinge plates D D having diagonal sections D₂ extending in opposite directions, to bring the pivoting points of the legs C, which they connect to the side rails of such cot in the same axis. 2nd. The hinge plates D bent at E, to afford room between the legs and side rails for the braces F. 3rd. The angle irons or hinge plates D having diagonal sections D₂ bent at E, for securing the legs to the side rails. 4th. The combination of the side rails A, flexible cover B, legs C, angle irons D bent at E, and the jointed braces F. 5th. In having a flexible cover as shown, the head rest consisting of rods G G, pivoted standards H H, bars I I, and the flexible strips J secured to the bars I I and having its front corners secured permanently, and its rear corners detachably to the side rails of the cot.

No. 13,767. Improvements in Harness Buckles.

(Perfectionnements aux boucles des harnais.)

Dewitt C. Bassett, Cambria Mills, Mich., U. S., 1st. December, 1881; for 5 years.

Claim.—1st. A buckle frame constructed with a solid flat end plate B having lateral extensions or lugs C and the main portion of the frame A wider than the body of said plate, and forming shoulders or offsets b, in combination with the loose draft loop or bail D adapted to fit between said lugs and offsets and the rigid tongue H. 2nd. A buckle frame constructed with a flat front plate B provided with notches in its outer sides, in combination with the sliding draft loop or bail fitted and guided in the notches of said plate.

No. 13,768. Improvements on Vacuum Dredges.

(Perfectionnements aux dragueurs à vide.)

John F. Sanders, Ogden, Utah, U. S., 1st. December, 1881; for 5 years.

Claim.—1st. The vacuum dredge composed of the vacuum pan A which is provided with a hinged bottom, for the discharge of its contents, and with steam and water supply pipes, in combination with the gravel supply pipe E which reaches higher than the pan A. 2nd. The combination of the vacuum pan A having steam and water supply pipes, with the swinging bottom G having weighted extension a, all arranged so that said bottom will be closed under the influence of the weight a, and opened when the pan is properly filled and the vacuum therein destroyed. 3rd. The combination of the vacuum pan A and its supply pipe E, with the downwardly extending posts a and with the supporting pivots b, said pivots being lower than the pan. 4th. The vacuum pan A provided with the dredge pipe F and combined with the annular turn table B, and with the supports b, which turn on a plane below that of the pan. 5th. The combination of the E, with the frame F erected on said turn table, and with the tackle a₂ for controlling the inclination of the pan A and pipe E. 6th. The vacuum pan A having steam inlet pipe K, and air outlet pipe or opening q and valve p thereon.

No. 13,769. Improvements on Spring Buttons.

(Perfectionnements aux boutons à ressort.)

Ira J. Saunders, Union City, Mich., U. S., 1st. December, 1881; for 5 years.

Claim.—A button head a having a shoulder c and bent parts b b₁, for securing such spring button in place in a shoe.

No. 13,770. Improvements on Shoes.

(Perfectionnements aux souliers.)

Henry W. Burr, Cambridgeport, Mass., U. S., 1st. December, 1881; for 5 years.

Claim.—1st. A shoe having quarters separable at the head and provided at their extremities with suitable fastening devices, in combination with a flexible heel section, to which the quarters are stayed at points in rear of the breast of the heel.

No. 13,771. Improvements on Machines for Heeling Boots and Shoes.

(Perfectionnements aux machines à poser les talons des chaussures.)

Daniel Whitlock, Newark, N. J., U. S., 1st. December, 1881; for 5 years.

Claim.—1st. The combination, with a nailing mechanism mounted upon a suitable support, of a bracket H, sliding carriage G, last standard K and an adjustable stop P. 2nd. The combination, with a sliding carriage G, of a transversely adjustable bed F provided with a means of adjustment f and formed with an extension for supporting the sliding carriage, when drawn from under the nail driver. 3rd. In combination with the sliding carriage G, the screw shaft I and nut J, for raising the last standard by hand when desired. 4th. In combination with a sliding carriage carrying a movable spindle L and last standard K, a supporting bed H or F, a screw shaft I, a nut b and mechanism adapted to operate the nut for raising and lowering the screw shaft. 5th. The combination, with the screw shaft I and its nut, of a frictional device operated under a regulated pressure and arranged to turn the nut for clamping the shoe between the last standard and nail die. 6th. The combination, with the nut and gear b operating the screw shaft I, of the driving shaft B, gears c c₁ provided with friction rings e e₁ and cone a, driven by a feather upon the shaft in the manner described, and operated by shifter t, to raise and lower the screw shaft. 7th. The means for regulating the rotations of the screw-nut b when driven by the double cone and friction ring on gears c c₁ consisting of the shipper t, the shipper X operated by screw thread upon the hub of gears c₁, and the adjustable weight W suitably connected to the shipper t, and cone a. 8th. In combination with the shipper t, arranged to operate the double cone a, the lever W, handle Y fitted to notched segment Y, the weight W, and the treadle U suitably connected to the lever W. 9th. In combination with the socket J formed in the screw shaft or spindle L, the last standard K provided with stud K₁ adapted to fit and support ordinary wooden lasts. 10th. In combination with a nailing mechanism mounted upon a suitable support, a nail die or die-holder as m adjustably secured to the same support and provided with means for adjusting to and from the nail driver as screw K. 11th. The combination, with a nail die provided with a series of holes for nails as o, of a movable loader N having a sliding bottom O operating in combination with a stop q to automatically move the slide, when the holes in the latter and the nail die coincide. 12th. In combination with the spindle L arranged in the sliding carriage and raised by the screw shaft I, the nut L for adjusting and limiting the descent of the spindle. 13th. The tongue for centering the heel sections beneath the nail die, consisting of the jaws Q pivoted upon the plate R, the latter being provided with a handle and with a hand lever R₁ and sliding spring wedge r for operating the jaws. 14th. The combination of the tongue with the grinding ribs s upon the die-holder, and with the stop o₁ for setting the heel in the desired position.

No. 13,772. Improvements in Smoke Consumers.

(Perfectionnements aux foyers fumivores.)

James Elliot, Montreal, Que., 1st. December, 1881; (Re-issue of Patent No. 12,750.)

Claim.—1st. In a boiler furnace or steam generator, a pipe or pipes arranged to receive air and the smoke and gases which escape from the fire, and discharge same over the grate mingled with and by means of jets of steam. 2nd. In an apparatus for consuming smoke, the arrangement inside the brick work, of pipes and nozzles and the sides of the fire chamber. 3rd. In a furnace for generating steam or

other purposes, a flue or passage made in two divisions, one above the other, and connected by passages near the back, the upper flue or division receiving cold air from outside the furnace, and the lower flue discharging same in a heated condition underneath the grate. 4th. A furnace door enclosing a pipe or coil or pipes to which steam is admitted from the boiler, and from which jets are directed over the fire. 5th. A furnace door made hollow, receiving a coil of steam pipes and provided with openings on its outer face for the admission of cold air, and similar openings on its inner side for the discharge of said air in a heated condition over the fire. 6th. In combination with a hollow furnace door, receiving air from outside and discharging same over the fire, a jet or jets of steam discharged simultaneously in the same direction, the supply being controlled by a self-acting cock or tap, placed at the hinge of the door.

No. 13,773. Railway Track Cleaner. (*Nettoyeur de voie de fer.*)

Augustus Day, Detroit, Mich., U. S., 1st. December, 1881: (Extension of Patent No. 6893.)

No. 13,774. Improvements in Speaking Telegraphs. (*Perfectionnements dans les télégraphes parlants.*)

The Canadian Telephone Company, Montreal, Que., (Representative of Thomas A. Edison, Menlo Park, N. J., U. S.,) 1st. December, 1881: (Extension of Patent No. 8026.)

No. 13,775. Improvements in Speaking Telegraphs. (*Perfectionnements dans les télégraphes parlants.*)

The Canadian Telephone Company, Montreal, Que., (Representative of Thomas A. Edison, Menlo Park, N. J., U. S.,) 2nd. December, 1881: (Extension of Patent No. 8026.)

No. 13,776. Improvements on Envelope Machines. (*Perfectionnements aux machines à enveloppes.*)

Horace J. Wickham, Hartford, Ct., U. S., 2nd. December, 1881: (Extension of Patent No. 6897.)

No. 13,777. Improvements on Street Pavements. (*Perfectionnements au pavage des rues.*)

John B. A. Brouillet, (Assignee of Antonio Pelletier,) Washington, D. C., U. S., 2nd. December, 1881: (Extension of Patent No. 6834.)

No. 13,778. Improvements in Electric Lamps. (*Perfectionnements aux lampes électriques.*)

Joseph Best and Joshua A. Bell, Montreal, Que., 2nd December, 1881; for 5 years.

Claim.—1st. In an electric lamp in which the carbons are placed vertically, the combination, with such carbons, an electro-magnet and armature, of pulleys or drawers, and cords attached to said drums, and the carbon-holders for the purpose of separating the carbons. 2nd. In combination with the blocks *figs.* carbons *1, 2,* box *A* and standard *F,* the slides *g, h.* 3rd. In combination with the shaft *E* disk or wheel *D,* armature and electro-magnet *B,* the pulleys *F, G.* 4th. A key for turning an electric current off and on, formed by insulating the core of said key from the wire and directing the current at will, through the metal of the key to another wire, by the operation of a cam.

No. 13,779. Improvements on Gibs or Keys for Bolts &c. (*Perfectionnements aux clavettes ou clés pour les boulons, &c.*)

George B. Taylor, New Brunswick, Joseph Wood, Red Bank, N. J., and Benjamin S. Clark, New York, N. Y., U. S., 2nd December, 1881; for 5 years.

Claim.—1st. A bolt gib or key *D* so constructed and made as to have recess *d,* projections *h, h,* in combination with a bolt and spring. 2nd. A bolt gib or key, in combination with a bolt and spring.

NO. 13,780. Improvements on Tables and Cabinets for Sewing and Other Machines. (*Perfectionnements aux tables et aux cabinets, pour les machines à coudre et autres.*)

The Manhattan Cabinet Manufacturing Company, New York, N. Y., (Assignee of George W. Burgess, Boston, Mass.,) U. S., 2nd December, 1881: for 5 years.

Claim.—1st. The combination, in a table or cabinet having a top composed of an outer frame or rail, provided with a hole or opening, of a body portion having a sewing or other machine or instrument mounted on one side, and pivoted within the said hole or opening, so that it may be turned to bring uppermost either the side upon which the machine or instrument is mounted or the other side, so as to conceal the machine or instrument and present the appearance of an ordinary table or cabinet. 2nd. The combination, in a table or cabinet having a top consisting of an outer frame or rail and a pivoted body portion on which is mounted a machine or instrument, and which comprises an aperture for the passage of a belt for driving said machine or instrument, of a hinged flap, for closing said aperture when the body portion is turned to conceal the machine or instrument. 3rd. The combination, in a table or cabinet having a top consisting of an outer frame or rail, a body portion pivoted within the same so that it may be turned upside down, of an aperture formed by cutting away one end of the body portion,

a flap for closing said aperture, and a pin or projection extending from said frame of rail, and with which the said flap engages as the said body portion is turned in one direction, whereby said aperture is automatically opened. 4th. The combination of the frame or rail *A,* the pivoted body portion *C* adapted to be turned upside down and having one end cut away to form an aperture *l,* a hinged flap *H* upon said body portion, the pin *n* for holding said flap to open said aperture, and the pin *o* for holding said flap to close said aperture. 5th. The combination of the frame or rail *A,* the pivoted body portion *C* adapted to be turned upside down and having one end cut away to form an aperture *l,* a hinged flap *H,* a pin *n* for acting upon said flap to open said aperture, and a spring for actuating the flap to close said aperture. 6th. The combination, in a table or cabinet having a top consisting of a frame or rail, and a pivoted body portion adapted to be turned upside down, of a sewing machine attached to said body portion, a driving wheel below said body portion, a belt passing through an aperture in said body portion, and a forked or slotted guard for retaining said belt upon the driving wheel, or in position to be applied thereto.

No. 13,781. Improvements in Aerial Balloons. (*Perfectionnements dans les ballons.*)

Count Antoine Apraxine, St. Petersburg, Russia, 2nd December, 1881; for 5 years.

Claim.—1st. A captive or limited ascent aerostat composed of at least two balloons *a, c* separable at will, the one *a* being heavier than air, and the other *c* having power sufficient to determine its ascension, and to support the weight of a cable *g.* 2nd. A captive or stationary aerostat composed of the same elements but in which the lower balloon *a* is rendered lighter than air so as to ascend along the cable *g* without the air of the upper balloon. 3rd. A free aerostat composed of a main balloon *a* and of at least two auxiliary balloons *c, c,* the latter provided with moderating and controlling appliances. In form of parachutes or their equivalents. 4th. A free aerostat composed of a main balloon *a* and of at least two auxiliary balloons of biconvex or lenticular form, as in *c, c,* the said auxiliary balloons acting as the parachutes or moderating appliances. 5th. An aerostat composed of a main balloon *a* and of at least two auxiliary balloons *c, c,* working in combination with a cord set on vertical supports.

No. 13,782. Improvements in Aerial Balloons. (*Perfectionnements dans les ballons.*)

Count Antoine Apraxine, St. Petersburg, Russia, 2nd December, 1881; for 5 years.

Claim.—1st. An aerostat composed of a balloon in combination with two suspended parachutes. 2nd. An aerostat composed of a balloon in combination with two suspended parachutes and two counterpoises. 3rd. An aerostat composed of a main balloon and of two auxiliary balloons surmounting and in combination with two parachutes. 4th. An aerostat composed of a balloon in combination with horizontal frames provided with valves. 5th. An aerostat composed of a balloon in combination with two archimedean screws.

No. 13,783. Improvements in Hoisting Machines. (*Perfectionnements aux machines à hisser.*)

Andrew Leitch and Michael Turnbull, Hamilton, Ont., 2nd December, 1881; for 5 years.

Claim.—1st. An automatic safety device operated by the resistance or lateral tension of the hoisting rope or cable, so that said device is brought into action whenever the strain on the hoisting cable ceases. 2nd. In combination with a hoisting mechanism or gear, a spring operated frame having a pulley in frictional contact with, and resisting the lateral tension of the hoisting rope, whereby the frame is retained motionless, and moved by the springs when the down strain of the rope is slackened or broken, said frame then releasing a trigger in engagement with an arm on a rock shaft connected to the belt shifter, by which the belt is automatically shifted to stop the hoisting gear. 3rd. The endless sliding rods *I, I* provided with springs *5* at one end, the opposite ends connected by a shaft *2* having a pulley *3* in frictional contact with the hoisting rope *4,* one of said rods carrying a trigger *6,* in combination with a weighted trigger arm *7* sleeved on shaft *1,* provided with stop pin *8,* whereby the trigger and trigger arm are kept in engagement by the down tension of the hoisting rope and released when the rope becomes slack. 4th. The combination of the sliding rods *I, I* having a trigger *6,* shaft *L* having a weighted trigger arm *7* and stop pin *8,* and the governor *9* driven by the hoisting gear, whereby the trigger and trigger arm are released by the governor rising, thereby rocking shaft *L* and shifting the driving belt automatically.

No. 13,784. Improvement on Augers.

(*Perfectionnement des tarières.*)

Peter A. Gladwin, Boston, Mass., U. S., 4th December, 1881; for 5 years.

Claim.—In an auger or similar boring tool having a gimlet point and a spiral shank-channel provided with the groove or channel *C,* extending from the lower end of the shank-channel downward across the thread of the screw *B* and following the general direction of said shank-channel, toward the gimlet point of said screw *B.*

No. 13,785. Improvements in Telephones.

(*Perfectionnements dans les téléphones.*)

Walter J. Dudley, Boston, Mass., U. S., 4th December, 1881: for 5 years.

Claim.—1st. In an individual signalling instrument, an actuating electro-magnet and polarized armature therefor, and a switching device actuated with a step-by-step movement by the said armature,

combined with a signal operating electro-magnet, normally in an open circuit, which is adapted to be switched into the main circuit by the said switching device, at the end of one of its step movements, the signal being actuated by currents of the opposite polarity to those by which the switching device is moved. 2nd. A signal controlling device and actuating mechanism therefor, combined with a telephone or communicating instrument, and controlling switch therefor adapted to be engaged and actuated by the said actuating mechanism or disconnected therefrom. 3rd. The signal controlling device and its actuating mechanism combined with a telephone, a movable support and controlling switch therefor, and intermediate mechanism between the said switch and the said actuating mechanism, and the telephone support whereby, when the telephone remains on its support, the said switch is engaged with, and actuated by the said actuating mechanism, but when the said telephone is removed from its support, the said switch may be disengaged from the said mechanism. 4th. In an individual signalling apparatus, the signal controlling switch consisting of a drum forming part of the main circuit, and two contact springs resting thereon, one connected with the main circuit directly and the other through a signal operating magnet, the said drum being provided with insulating material, whereby during a definite portion of its rotation, the former spring is insulated therefrom and the latter not, the main circuit being then through the said magnet, and during the remainder of its rotation the latter spring is insulated and the former not, the said magnet being then removed from the main circuit. 5th. The combination of the electro-magnet, pivoted armature lever and polarized armature thereon, and a ratchet mechanism actuated by the said lever with another independent armature oppositely polarized to the first, whereby either of the said armatures may be operated independently of the other by currents of opposite polarity in the same circuit. 6th. In a transmitting instrument for operating an independent signal, four contact springs, two connected with the ground and the other two with the line, one through a break-circuit key and the other through a rotating interruptor, combined with two contact pieces for the said springs, one connected with each pole of the battery, and an actuating cam whereby either one of the grounded and one of the line springs may be pressed into contact with the said anvil pieces respectively, or the other grounded, and the other line spring pressed into contact with the opposite anvil pieces and a current of one polarity is sent to line through the key, and of the other polarity through the interruptor. 7th. In a transmitting instrument, the battery pole reversing springs and cam to actuate them combined with a contact spring connected with the line, and a grounded anvil piece therefor, the said spring being operated by the said cam and arranged relatively to the other springs, whereby it is forced into contact with its anvil piece, and the line thereby grounded when the said pole reversing springs and battery are disconnected from the line.

No. 13,786. Improvements on Knitting Machines. (*Perfectionnements aux machines à tricoter.*)

John Bradley, Lowell, Mass., U.S., 4th December, 1881; for 15 years.

Claim.—1st. The combination of a series of needles arranged to revolve about a common centre, two or more yarn guides carrying yarn of different colours, a push-back, a fixed cutter blade, and a movable cutter blade, both mounted upon and supported by said push back, a leaf spring mounted upon one of said cutter blades, and mechanism for intermittently vibrating said movable cutter blade. 2nd. The combination of a circular series of barbed or spring needles, a stitch wheel co-operating therewith, two or more vibrating yarn guides, a cam or cams arranged to operate said yarn guides and to carry the yarns above the stitch wheel to throw them out of action, a fixed cutter blade, a movable cutter-blade mechanism for intermittently vibrating said movable cutter-blade, and a leaf spring secured by one end to one of said cutter-blades.

No. 13,787. Improvements on Knitting Machines. (*Perfectionnements aux machines à tricoter.*)

John Bradley, Lowell, Mass., U.S., 4th December, 1881; for 5 years.

Claim.—1st. In combination with the needle thread and working wheels of a spring needle circular knitting machine provided with two or more yarn guides and yarn severing and holding devices, the cam W, lever V, pawls U U' carried by the lever V, the ratchet wheel T adapted to move at different speeds, and the cams X Y. 2nd. The combination of two or more yarn guiding levers, yarn severing and holding devices, a pattern cam, mechanism connecting said cam T T' A', cams X Y q and mechanism for imparting to said ratchet wheels and cams intermittent rotary motions. 3rd. The combination of two or more yarn guides, a severing device, a yarn holding device, a pattern cam, mechanism connecting said cam with the yarn guides, and the severing device with the ratchet wheels T T', the pawls U U' therefor provided with the pin p, the cam y secured to, and rotating with the wheel T, the lever V and the cam W. 4th. The combination of two or more yarn guides, a severing device, a yarn holding device, a pattern cam, mechanism connecting said cam with the yarn guides and the severing device, the ratchet wheels T T', the pawls U U', the former provided with the pin p, the cam y secured to, and rotating with the wheel T, the lever V and cam W, and a removable segment Y' secured to said cam Y. 5th. In combination with the ratchet wheel T, the pawl U and mechanism for reciprocating said pawl, the ratchet wheels A', mechanism for imparting to said wheel A' an intermittent rotary motion, one or more cams secured upon the wheel A', and mechanism connecting said cams with the pawl U and adapted to disengage said pawl from engagement with the wheel T. 6th. The combination of the ratchet wheels T T', the pawls U W, means for reciprocating said pawls through strokes of different lengths, the pin t set in the under side of the wheel T, the lever C' having secured thereon the pawls u, the ratchet wheel A', one or more cams secured upon the wheel A' and the elbow lever r. 7th. The yarn guard plate b provided with the shelf h, the spring c and curved finger h'. 8th. The combination, in a circular knitting machine, of the ratchet wheel T having secured thereon the cam X, the wheel T' carrying the cam Y and provided with the pin t, lever C' carrying the

pawl u, ratchet wheel A', cam q, lever r and means of imparting to the wheels T T' intermittent rotary motions about their axes at different speeds.

No. 13,788. Improvements on Machines for Sewing Buttons. (*Perfectionnements aux machines à coudre les boutons.*)

Joseph Mathison, Lynn, Mass., U.S., 4th December, 1881; for 5 years.

Claim.—1st. The mode of attaching a button to cloth or other material, such consisting in, first drawing a thread in the form of a loop up through the material, next passing such loop through the eye of the button, next drawing or forcing the loop down through the material, and finally passing the thread through the loop. 2nd. The combination for automatically effecting the stitch as explained, such combination consisting of the needle, presser, thread guide and shuttle, and their operating mechanism. 3rd. The combination for automatically delivering buttons to, and sewing them to a piece of work or material as explained, such consisting of the button feeder, the needle presser, thread guide and shuttle and their operative mechanisms. 4th. The combination of the springs p q with the button feeding chute, provided with the discharge port o, and the button eye-guide slot m.

No. 13,789. Improvements on Strap Couplings. (*Perfectionnements aux joints des courroies.*)

Alpheus Van Luyen, Yarker, Ont., 4th December, 1881; for 5 years.

Claim.—1st. As a new article of manufacture, a strap-binding tongue or coupler D, the end portions extending outward in a parallel direction from an oblique central portion. 2nd. The combination, with straps A B having holes C, of the tongue or coupler D having oblique central portion seated in the holes, with outwardly extending ends to press against the straps. 3rd. The coupler or tongue D, in combination with the sheath F and straps A B.

No. 13,790. Improvements on Drill Ploughs. (*Perfectionnements aux charrues tracé-lignes.*)

James Ley, Toronto, Ont., 4th December, 1881; for 5 years.

Claim.—1st. In a drill plough provided with flexible mould boards A, plough beam C extending behind the mould boards and braced to the handles D by the rods E, in combination with the perforated bars F hinged to the flexible mould boards and arranged to hook upon the pin J projecting from the plough beam. 2nd. A drill plough provided with a marker attached to the plough beam by a hinged bar placed by steading chains H, a casting a grooved to fit the angle of the rectangular bar G and rivetted to the marker I, in combination with an eye bolt b provided with a thumb-screw d.

No. 13,791. Improvements in Belt Shippers. (*Perfectionnements aux embrayeurs.*)

Benjamin H. Hadley, Providence, R. I., U.S., 4th December, 1881; for 5 years.

Claim.—1st. The shipper rod provided with a belt fork, an operating rod provided with a handle by which it can be turned, a crank connected with the operating rod, and by means of a link with the shipper-rod, constructed to ship the belt from one pulley to the other, by turning the operating rod. 2nd. The combination, with the rod r, of the adjustable sleeve g constructed to support the rod in the desired position. 3rd. The combination, with the counter-shaft and shipper device, of the plate a and bracket b, constructed to support the counter-shaft and shipper and adjust the same. 4th. The combination, with the plate a and bracket b, of the adjustable bracket c and the sleeve g constructed to be secured to the bracket C, and adjusted to the desired height. 5th. The combination, with the belt shipper device, of the rod f and one or more laterally projecting operating handles f' constructed to operate the shipper.

No. 13,792. Improvements on Steam Vessels. (*Perfectionnements aux vaisseaux à vapeur.*)

Lewis P. Fairbanks, Dartmouth, N.S., 4th December, 1881; for 5 years.

Claim.—1st. A pontoon or pontoons B carrying a propeller shaft C having screw propellers E and attached to the outside of the bottom of a vessel by screw bolts G or other means. 2nd. A longitudinal propelling shaft or shafts C, which may be set at any desired angle, provided with a screw propeller or propellers E at one or both ends of each shaft, below the bottom of the vessel A. 3rd. A shipping and unshipping propeller shaft placed under and supported from the bottom of the vessel, and provided with a propelling screw or screws E. 4th. A rudder M having a drop section N.

No. 13,793. Improvements on Heaters. (*Perfectionnements aux calorifères.*)

Jonathan Johnson, Lowell, Mass., U.S., 4th December, 1881; for 5 years.

Claim.—1st. In hot water heater, a stove provided with a fire pot consisting of pipes a in close proximity, and upper and lower water chambers F G communicating with the outlet and inlet branches of the radiating and circulating system. 2nd. The combination of the circulating and radiating system and a stove provided with a fire pot consisting of tubes a, an upper and lower casings arranged and constructed to permit a free straight upward flow of the water through the entire mass of pipes from one chamber to the other, and from the bottom to the top of the fire. 3rd. The combination, of the stove circulating and radiating pipes, casing c open at the top and arranged in the line of circulation, and gauge r. 4th. The combination, with the water heating and circulating system of a railway car, of a condenser communicating freely with the circulating chambers. 5th. The combination, with the stove and circulating pipes, of a reservoir

E and cock *d*. 6th. The combination, in the stove base, of the outer and inner doors and intervening tortuous air passage. 7th. The combination of the outer and inner doors connected to slide together, one of the outer doors provided with an apron. 8th. A car stove provided with spring catches formed of a material which will not lose its resiliency by heat. 9th. The stove provided with a crown plate perforated except opposite the feed door. 10th. The combination of the crown plate having lugs, a cap and a handle connected to the cap and having a bearing against the door *a*. 11th. The combination, with the stove casing and grate, of the hollow water rings and connecting pipes. 12th. The rings connected by pipes having reverse threads. 13th. The radiating pipe combined with a cross chamber, containing non-conducting material.

No. 13,794. Improvements in Hangers for Shafting. (*Perfectionnements aux ajustages des arbres de couche.*)

Philip Cramer, Montreal, Que., 4th December, 1881; for 5 years.

Claim.—The combination of a hanger frame with box and rocking shaft.

No. 13,795. Improvements on Spark-Arresters. (*Perfectionnements aux arrête-flammèches.*)

John J. Hewitt, Markham, Ont., 4th December, 1881; for 5 years.

Claim.—In connection with the smoke stack of a steam boiler, a cylindrical casing attached to the smoke box end of the boiler at the opening where the smoke escapes therefrom, in combination with a revolving spindle passing longitudinally through the said casing and having attached to it an agitator, or agitators, arranged to beat the smoke down into water contained within the lower half of the casing.

No. 13,796. Improvements on Harness.

(*Perfectionnements dans les harnais.*)

Charles E. Berry, Cambridge, Mass., U. S., 4th December, 1881; for 5 years.

Claim.—1st. The hame parts pivoted together at top by the single pivot *a* and provided, one part with a recess *b* and face *c*, and the other part with a tongue *b* to enter the said recess, a catch to engage the tongue, and a face *c* to abut against the face *c*, the said two faces being between the ends of the collar, combined with the collar separated only at its bottom, and to which collar the hame parts are secured. 2nd. The collar having a connected flexible top, combined with the hinged hames, having their lower ends provided with a recess and tongue, the said lower end of the hames being made adjustable with relation to the upper hinged portions of the hames to adapt the hames to collars of different sizes and lengths. 3rd. The horse collar, open only at its bottom, and the hames *a* at *b* hinged together at the top of the collar, connected with the collar and provided with a tongue and catch, to hold the collar and hame parts together, combined with the loose ring *x* connected with the lower end of one of the hame parts.

No. 13,797. Compound for Catarrh, Mucous and Skin Diseases. (*Composé pour le catarrhe, les maladies muqueuses et cutanées.*)

Mary A. Reaves, Snelling, Cal., U. S., 4th December, 1881; for 5 years.

Claim.—A compound composed of an infusion of tobacco leaves mixed with an infusion of the leaves of wild mallard.

No. 13,798. Fire and Water-proof Paint.

(*Peinture réfractaire et hydrofuge.*)

James Butler, Walsingham, Ont., 4th December, 1881; for 5 years.

Claim.—The process for the manufacture of waterproof paint, consisting in mixing with petroleum tar, ground alum, in the proportion of about six pounds of alum to forty gallons of petroleum tar, the same being mixed together in a cold state, but heated when required for use.

No. 13,799. Improvements in Window Bolts.

(*Perfectionnements aux targettes des fenêtres.*)

Pierre Houle, Montreal, Que., 5th December, 1881; for 5 years.

Resumé.—La combinaison de la targette A avec un arrêt *a*, les crampes B B' et le ressort *b*.

No. 13,800. Machine for Compressing and Punching Heels for Boots and Shoes. (*Machine à comprimer et découper les talons des chaussures.*)

Edwin Fisher, Worcester, Mass., U. S., 5th December, 1881; for 5 years.

Claim.—1st. In a machine for preparing heels, the combination, with a supporting bed and reciprocating pressing plunger E and plate B, adapted to first press the heels vertically, of an independently acting plunger provided with a gang of awls, and working within said pressing plunger. 2nd. In an organized machine for pressing heels, the following instrumentalities, viz: the heel supporting bed reciprocating pressing plunger and perforated pressing plate, adapted to compress the heel vertically, the punching follower provided with a gang of awls which are projected through the perforations of the said pressing plate, and an operating shaft provided with cams adapted to actuate the pressing plate and punching plunger independently. 3rd. The heel support combined with the movable concave side pressing dies C, which are closed a suitable time upon the heel

side, to embrace the sides of, compress the heel laterally, and outline the shape of the heel. 4th. In a machine for preparing heels, the top pressing plate and follower and heel supporting bed, combined with the horizontally movable side press or dies C, adapted to compress and shape the heel laterally by direct action against the edges of the lifts. 5th. The heel supporting bed perforated top pressing plate and plunger, and connected projecting die face combined with the punching plunger, working within the side pressing plunger and its gang of awls, and with laterally moving side presses or dies C. 6th. In a machine for pressing and punching heels, the combination of the heel supporting bed, the pressing plunger and plate and die face to compress the heel vertically, the punching plunger and its gang of awls, the rotating shaft D and connected parts to actuate the said pressing and punching plunger at the proper time, and clutching mechanism automatically actuated to release the driving gear and permit it to run loosely on the said shaft, at the completion of each rotation of the said shaft or the completion of each heel. 7th. The supporting bed, the side presses or dies to compress and outline the heel laterally and means to close them upon the sides of the heels, combined with the pressing plate and plunger, and means to operate the said plunger and hold or retain the pressing down upon the compressed heel sufficiently long to set the leather. 8th. The combination, with the side pressing die or dies C, of the die carrier C', the inclined follower C' and actuating cam D'. 9th. The combination, with the die-carrier C' and yielding supporting bed B, of the loosely connected side pressing die C, whereby the side pressing die is permitted to move vertically with, or follow the movement of the yielding supporting bed. 10th. In a heel nailing machine, in combination, the pressing and punching mechanism, the operating shaft combined with cams for actuating the same, the driving gear K, the clutch M with locking pin *p*, and tripping lever P, the slide piece R R' and starting lever V. 11th. The combination, with the pressing plunger and plate, and the cams for giving pressure to the same, of the lifters and rolls C, or E, 12th. The pressing plate E, provided with dowel pins and side grooves, and the retaining springs *c*, in combination with the plunger E. 13th. The swinging arm G provided with detachable breast block *n* and the locking bar G', in combination with the side pressing dies and heel supporting bed. 14th. The combination and relative arrangement of the table A, standards *a*, plungers or followers E H, operating shaft D, cams D', eccentric D', and yoke H'.

No. 13,801. Improvements on Stoves or Heaters and Ventilators. (*Perfectionnements aux calorifères et aux ventilateurs.*)

William F. Condon, East Saginaw, Mich., U. S., 5th December, 1881; for 5 years.

Claim.—1st. The combination of a stove or heater, one or more pipes leading to and from the heater, and an automatic blast apparatus for forcing the air into and out of the heater, and impelling it through the pipes to the point desired. 2nd. The combination of a stove or heater, a chamber in connection with the fire pot wherein air may be heated, one or more pipes for conducting air to and from said heating chamber, and an automatic blast for drawing and impelling air into and through said chamber and pipes. 3rd. The combination of a stove and fire pot with an air heating chamber around the same, pipes for conducting air to and from said heating chamber, and an automatic blast apparatus for forcing air into and through said chamber and pipes. 4th. A fire pot provided with a jacket around its exterior forming a chamber between the pot and jacket, in combination with pipes leading to and from said chamber and a blast apparatus for impelling air to and through said chambers and pipes. 5th. In a stove or heater, the combination, with the fire pot and fuel magazine, of a grate to the pot provided with a rod extending into the magazine and adapted to agitate the fuel therein. 6th. A fire pot for a stove and heater provided with two grates, one above the other, the top one being adapted to hold the fire while the ashes may be discharged through the other one. 7th. A fire pot provided with a perforated or slotted flange and a detachable plate resting on said flange, so as to cover the opening therein, and adapted to fall from over the same when the pot is overturned. 8th. A fire pot provided with a perforated or slotted flange, and a sectional detachable plate resting on said flange, so as to cover the openings therein, and adapted to fold and uncover the openings in the flange when the pot is overturned. 9th. A tank for holding water located in the lower part of the stove and made separate therefrom so as to be removable from the stove. 10th. A water tank located in the lower part thereof and provided with a float adapted to rise and fall with the water, so as to indicate the height of water in the tank. 11th. The combination of a fire pot and a section fuel magazine, one section of the magazine being adjustable on the other and adapted to separate therefrom. 12th. The smoke flue Q provided with a loose valve and a lug forming a seat, on which the valve may catch and rest, when moved from one part of the flue to the other. 13th. The smoke flue Q provided with a loose valve and a lug forming a seat, on which the valve may catch and rest, when moved from one part of the flue to the other. 13th. The conoidal or egg-shaped flue provided with lugs *n*, in combination with loose valve. 14th. The lid to the stove or heater provided with the two pivoted dogs adapted to grasp by their lower ends a lug on the stove, so as to hold the lid closed and to release their grasp thereon, when the upper ends are drawn together, so as to permit the lid to be raised. 15th. The combination of a stove or heater lid, of the two dogs O provided with hooked lower ends and fulcrumed so that their upper ends will be thrown outward, and their lower ends inward. 16th. The combination, with a side door of a stove or heater, of two dogs, one being pivoted to the door and the other to the body of the stove, one of the dogs being adapted to engage with a shoulder on the other, and the latter with a lug or catch on the stove. 17th. The combination, with a stove and its side door, of the dogs *n* provided with a hooked end pivoted to the stove, and the dog *n* provided with a shoulder or hook on its top and bottom and pivoted to the stove door, the two being adapted to operate as set forth. 18th. The cylinder C made in one piece and provided, within its interior, with a fire pot J and water tank D connected by pipe T, and having air chamber *f* between the two. 19th. The combination of the cylinder C and jacket A, both provided with doors, each door having a shut-off admitting of vertical

and side adjustment. 20th. The combination of the water tank D and air chamber *f*, the air chamber having perforations in its sides. 21st. The combination of water tank D, fire pot J and connecting pipes F. 22nd. The combination of water tank D, fire pot J, pipes F, and air chamber *f*. 23rd. The combination of outer jacket A and cylinder C, both provided with doors having self-closing shut-offs, water tanks D, fire pot J, pipes F and chamber *f*. 24th. The fire pot J provided with depending sockets, having perforations above. 25th. The fire pot J, in combination with water tank D, the two connected by pipe F constructed to prevent water splashing into fire pot.

No. 13,802. Improvements on Nut Locks.
(*Perfectionnements aux arrête-écrous.*)

Jean B. Doray, Samuel Doray and Joseph T. Langlois, Sutton, Que., 5th December, 1881; for 5 years.

Claim.—1st. An elastic plate notched at its end or ends provided with a hole to receive an independent retaining bolt, and with a seat or depression to receive the head of the said retaining bolt, whereby the retaining bolt is held normally against turning, but is permitted to be turned upon the application of a moderate pressure thereto without moving the plate. 2nd. The combination, with a nut or nuts, a plate placed behind the same, tapped to receive a retaining bolt or screw, and provided with spurs to engage with the body behind, and a spring plate adapted to engage with the nut or nuts, perforated to receive the retaining bolt or screw, and provided with a seat or cavity to receive the head of the bolt or screw and hold it against turning. 3rd. In combination with the elastic locking plate and its retaining bolt, the plate G formed with the tubular neck threaded on its interior.

No. 13,803. Improvements on Lawn Mowers.
(*Perfectionnements aux faucheuses à bras.*)

Everett G. Passmore, Philadelphia, Penn., U.S., 5th December, 1881. for 5 years.

Claim.—1st. The combination, with the pivoted bail, of a reversible collector or gathering box supported by the bail, so as to prevent disturbance of the equilibrium of the cutting apparatus. 2nd. The combination, with the collector and the bail, of the toes *b*. 3rd. The combination, with the rotary cutting apparatus and its supporting and driving mechanism, of a reversible collector in front and a receiver in rear of the cutting apparatus. 4th. The combination, with the rotary cutting apparatus, of the collector, the receiver and the shield interposed between the cutting apparatus and the receiver. 5th. The combination of a pivoted bail, a castor frame, and a bellows or a telescope receiver connecting said bail and castor frame. 6th. The combination, of a rotary cutting apparatus, a pivoted bail, a reversible collector, a castor frame and a flexible receiver connecting the bail and castor frame.

No. 13,804. Combined Valve Stem, Piston and Cylinder. (*Tige, piston et cylindre de soupape combinés*)

Abram N. Matthews, John M. Winslow, Thomas E. Clary, Norwood, and Milton Clark, Boston, Mass., U.S., 5th December, 1881; for 5 years.

Claim.—1st. The combination, with a steam chest A, of a cylinder D in which is arranged a piston and valve stem. 2nd. The combination of the piston and piston packing with the valve stem C, yoke B and cylinder D. 3rd. The ferrule K in combination with the piston E, yoke B and valve stem C.

No. 13,805. Improvements in Thrashing Machines (*Perfectionnements aux machines à battre.*)

William R. Allen, Clark, Ont., 5th December, 1881; for 5 years.

Claim.—1st. In connection with a thrashing machine, in a revolving auxiliary thrashing cylinder C contained within a casing B, provided with a hopper A and a discharge spout F, in combination with a concave E.

No. 13,806 Improvements on Spring Hoes.
(*Perfectionnements aux hoes élastiques.*)

Jesse G. Wisner, and Wareham S. Wisner, Brantford, Ont., (Assignees of Walter Coulthard, Oshawa), Ont., 5th December, 1881; for 5 years.

Claim.—1st. A spring hoe having a bifurcated drag bar, a socket E located at the crotch of the drag bar on its bottom side, and arranged to support one end of the spindle D, the other end of which is notched to fit on to the pin *a* inserted at one end of the locking stud B, which stud is connected to the hoe by the link C, in combination with the spiral spring F arranged to operate the locking stud. 2nd. A bifurcated drag bar, a socket E cast in two parts and forming a block to fit with the drag bar at its bifurcated end, in combination with the spiral spring F, one end of which presses against the socket E and other against the collar *b* formed upon the spindle *d*, which passes through the said spring and is supported at one end by the socket E, and at the other by the locking stud B.

No. 13,807. Electric Steam Generator.
(*Générateur électrique de vapeur*)

Edwin R. Whitney, Charles L. Bossé and Joseph A. J. Craig, Montreal, Que., 5th December 1881; for 5 years.

Claim.—1st. An apparatus for heating water by means of electricity, consisting of the chamber for containing the water to be heated, adapted to form one of the electrodes, in combination with a carbon point, or other suitable electrode, and line connections. 2nd. In an apparatus for utilizing the heat generated by electricity, a chamber to contain water adapted to act as one of the electrodes and to move reciprocally or by rotation, in combination with a carbon, or other point forming the other electrode.

No. 13,808. Milk Pan and Cooler.

(*Boîte garde-lait.*)

William Cooley, Waterbury, Washington, Vt., U.S., 5th December, 1881; (Extension of Patent No. 7,330.)

No. 13,809. Improvements in Electric Telephony. (*Perfectionnements dans la téléphonie électrique.*)

The Canadian Telephone Company, Montreal, Que., (Representative of Alexander G. Bell, Boston, Mass., U.S.,) 5th December 1881; (Extension of Patent No. 7,789.)

No. 13,810. Improvements in Electric Telephony. (*Perfectionnements dans la téléphonie électrique.*)

The Canadian Telephone Company, Montreal, Que., (Representative of Alexander G. Bell, Boston, Mass., U.S.,) 5th December 1881; (Extension of Patent No. 7,789.)

No. 13,811. Improvements on Artificial Stone, Tile and Marble. (*Perfectionnements dans la pierre et le marbre artificiels et la tuile.*)

John W. McKnight, Washington, D. C., U.S., 12th December, 1881; for 5 years.

Claim.—1st. A composition for artificial stone, composed of sand or gravel and Portland or other cement, combined with the liquid compound. 2nd. The compound for coating artificial stone or other bodies in imitation of marble, the same consisting of Keen's, or other similar cement combined with the liquid compound and suitable pigments. 3rd. The method of imitating marble, the same consisting in scoring the surface of the slab while in a plastic state and filling the indented lines or scores with the compound cement suitably colored. 4th. The method of producing designs in imitation of marble, the same consisting in tracing or placing such designs with the compound cement upon a sheet of glass, casting the slab thereon, and when sufficiently set, removing the glass therefrom. 5th. The method of preparing an artificial marble pigment or paint, the same consisting in disintegrating gypsum or sulphate of alumina by means of the fluid or liquid compound, drawing off the liquid portion, and drying and pulverizing the residuum. 6th. The concrete surface consisting of the moulded blocks having recess at their edges, the strips secured in said recesses and extending from block to block and the filling set in the intermediate spaces.

No. 13,812. System of Ventilation, Refrigeration, etc. (*Système de ventilation, réfrigération, etc.*)

John J. Bates, Brooklyn, N.Y., U.S., 12th December, 1881; (Extension of Patent No. 6,938.)

No. 13,813. System of Ventilation, Refrigeration, etc. (*Système de ventilation, réfrigération, etc.*)

John J. Bates, Brooklyn, N.Y., U.S., 13th December, 1881; (Extension of Patent No. 6,938.)

No. 13,814. Improvements in First and intermediate Drivers. (*Perfectionnements aux conducteurs-moteurs initiaux et intermédiaires.*)

Joseph Westman, (Assignee of William D. Westman), Toronto, Ont., 13th December, 1881; (Extension of Patent No. 6,943.)

No. 13,815. Improvements in Car Replacers.
(*Perfectionnements aux charioteurs des chars.*)

Joseph Parker, Reading, Penn., U.S., 14th December, 1881; for 5 years.

Claim.—1st. The combination of a rail A, a clamp B adapted thereto, a bridge rail E pivoted to the clamp B and an elastic wedge bolt D, whereby the clamp is secured to the thread of the rail. 2nd. The elastic wedge bolt consisting of a bar of iron or steel bent at its opposite ends, so as to form a long leg *h* and a short leg *h'*. 3rd. The combination of a rail A, a clamping wedge D, and a clamp B having a straight flange adapted to embrace one side of the rail tread, and an inclined flange *a* adapted for the reception of the wedge D which bears on the opposite side of said thread. 4th. The combination of the rail A, the rail clamp B and the bridge rail E pivoted to said clamp B and having bevelled edges *i* on its under side, whereby it is adapted to overlap and fit closely to the rail A. 5th. The combination of the rail clamp B, the wedge bolt D and the retaining pin *j*.

No. 13,816. Improvements on Churns.
(*Perfectionnements aux barattes.*)

Fred Aldred, Glencoe, Ont., 14th December 1881; for 5 years.

Claim.—1st. In a swinging churn, the springs F attached to the ends of the churn body A above the central line, whereby the churn body is supported and allowed to vibrate. 2nd. The cast iron sockets G in combination with the spring F provided with pins or bolts H, whereby the springs F are allowed to vibrate freely in the sockets G. 3rd. The combination, with the churn body A, of the supporting springs F provided with cross pins N, and the hook sockets E, whereby the churn body A is allowed to vibrate freely. 4th. The cross bars L in combination with the bars or fingers M forming the dashers.

No. 13,817. Improvements on Apparatus for Burning Fuel. (*Perfectionnements aux calorifères.*)

James Wolstenholme, Buffalo, N. Y., U. S., 14th December, 1881; for 5 years.

Claim.—1st. In a furnace or other heating device having the usual chimney for producing the necessary draft, an air-tight door, and the usual open grate for admitting air to the fuel, in combination with a tube or coil having its inlet opening in the outer air, and its outlet end terminate in a long narrow opening adapted for conducting the heated air across the path of the gases in their course to the chimney.

No. 13,818. Improvements on Drip Pans for Oil Barrels. (*Perfectionnements aux cuillers pour les barils d'huile.*)

Charles E. Laverty, Gladeville, W. V., U. S., 14th December, 1881; for 5 years.

Claim.—1st. The combination, with the barrel having a pump B of a drip pan A. 2nd. A drip pan adapted to be applied to the top of oil barrel, having a flaring flange *a* to adapt it to different sizes of barrels. 3rd. A drip pan for oil barrels, consisting of a disk-shaped pan adjustable to different sizes of barrels by a flange *a* of the grooves *c* and the tube provided with perforations.

No. 13,819. Improvements in Leather Skiving Machines. (*Perfectionnements aux machines à refendre les cuirs.*)

Merritt A. Holton, Hittchburg, Mass., U. S., 14th December, 1881; for 5 years.

Claim.—1st. In a leather skiving machine, a vertically adjusting knife rest, in combination with the slotted frame and endless screw. 2nd. The knife rest of a skiving machine, in combination with the semi-cylindrical inserted block adjustable in the arc of a circle. 3rd. The presser arms in combination with the coiled springs and connecting plates provided with cross bars or trunnions at their ends. 4th. A spiral spring in combination with a head R having an interior thread of a dimension, and pitch corresponding to the dimension and pitch of the wire coil. 5th. The feed plate in combination with the reciprocating head provided with adjusting screws at right angles to each other. 6th. The adjustable double rib *t* in combination with gib *r*, grooved plate *d* and adjusting devices. 7th. The swinging guide plate in combination with the double rib attachment T, screw hinges *d* and supporting frame, provided with slots *v* &c. 8th. The impression roll provided with a die or stamp, for stamping the work at the same operation with the skiving.

No. 13,820. Improvements on Sawing Machines. (*Perfectionnements aux scieries.*)

Roderick Smart, Martintown, Ont., 14th December, 1881; for 5 years.

Claim.—1st. The combination, with the body A standing upon front and rear legs, of the tilting bar G pivoted to post F and provided with saddle H, links I I attached to foot bars J J or provided with stirrups K K, and saw lever N having a projecting arm M, whereby bar G will be tilted by the operator straddling the saddle transferring his weight from the saddle to the stirrups alternately to reciprocate the saw attached to the lower end of lever N. 2nd. The tiltings, saddle bar G mounted on a standing frame and connected to saw lever N by stirrup links I I and arm M, for reciprocating the saw.

No. 13,821. Improvements on Railway Switches. (*Perfectionnements aux aiguilles des railoutes.*)

Thomas Solte, Rockport, Penn., U. S., 14th December, 1881; for 5 years.

Claim.—1st. The combination of the stationary and switch rails, the binders, and head and tail shoes, said shoes extending entirely across the track and outside of the binders, and having rigidly secured thereto the stationary rail ends, the binders and the fixed ends of the switch rails. 2nd. In combination with the switch, the ribs arranged upon the head and tail shoes, and adapted to hold the stationary rail ends against lateral displacement.

No. 13,822. Combination Chair and Wash Bench. (*Chaise et banc à laver combinés.*)

David L. Richards, Saint John, N. B., 14th December, 1881; for 5 years.

Claim.—1st. The combination of A and B respectively by hinges C. 2nd. The spring latch D and bar E.

No. 13,823. Improvements in Multicharge Guns. (*Perfectionnements aux canons à multicharge.*)

James R. Haskell, Passaic, N. J., U. S., 14th December, 1881, for 5 years.

Claim.—1st. In combination, with the breech of a gun, a screw-breech cap having a hole in its centre and a breech plug fitted and secured therein, said breech plug to be so arranged upon an arm and pivot that, when said cap is screwed forward, said plug will automatically take its seat into the bore of the gun, and over the hole in the cap and so that, when said cap is screwed back, said plug will fall into its side, clear of the hole in the centre and of the bore of the gun, that the gun may be loaded and the plug replaced without removing the cap. 2nd. In a multicharge gun, the supplemental charge chambers made wholly of separate pieces of steel or other suitable metal, and combined with the bore of the gun. 3rd. In combination with a multicharge gun, a priming plug consisting of a tubular screw bushing fitted with a tubular key, containing and shielding or protecting a solid central screw-pin. 4th. The supplemental charge chambers

fitted with a smooth taper pin or plug held and removed by a cap screwed on the breech of the chamber by which the chamber can be cleaned and the dirty water withdrawn without getting in the thread of the screw that secures the cap and pin. 5th. In a multicharge gun having one or more supplemental charge chambers, the combination of a bushing or facing of steel or other tough strong metal, in the bore of the gun, with a supplemental charge chamber made wholly of steel or with an entire steel lining, the two being united to form a continuous facing of steel or other tough strong metal in the bore and chambers of the gun. 6th. In a facing of tough strong metal over the entire surface of the bore and chambers of a multicharge gun from the main breech of the gun, to and including the last supplemental charge chamber, the body of the gun being composed of cast iron or gun metal. 7th. A gas cheek wad for a multicharge gun, composed of leather (or any known substitute for leather), protected by an armor of soft metal and having its length greater than the diameter of the throats of the charge chambers, the leather being to extinguish the windage and clean the gun, the armor being to protect the leather against the fire of the powder, and the length, with reference to the diameter of the throats of the chambers, being to keep the fire from cutting around the wad and firing the charge in advance of the shot. 8th. A gas cheek wad for a multicharge gun combined with, and made part of the shot. 9th. In combination with a multicharge gun, an indestructible gas cheek wad made to resist the destructive effects of the powder, extinguish the windage and prevent the flame from cutting around or past it, to fire the powder in advance of the shot or wad.

No. 13,824. Improvements on Lawn Mowers. (*Perfectionnements aux faucheuses à bras.*)

Everett G. Passmore, Philadelphia, Pa., U. S., 14th December, 1881; for 5 years.

Claim.—1st. The combination, in a lawn mower, of a rotary spiral outer having hollow end journals, and a driving shaft passing freely through said journals and imparting motion to the rotary spiral cutter, by a ratchet device mounted upon the shaft between the ends of the rotary spiral cutter. 2nd. The combination of a disk supported by and turning upon a hollow journal cast upon one of its sides and having a ratcheted rim upon its opposite side, a shaft passing freely through said journal, a plate secured upon said shaft fitting freely within the rim of the disk and pawls pivoted to said plate. 3rd. The combination of a rotary spiral cutter, a fixed straight cutter, a roller supporting said fixed cutter, and the clearing strip F carried by the fixed cutter. 4th. A two part shaft with pinions on the ends, in combination with the tubular journals of the rotary cutter and pawls that connect said shaft and cutter.

No. 13,825. Bird Insect Catcher and Trap. (*Piège à parasites des oiseaux.*)

Walter S. Burn and John H. Stone, (Assignees of James Kelk.) Hamilton, Ont., 14th December, 1881; for 5 years.

Claim.—A bird insect trap composed of the cylinder B surrounding the perch A, the ring C secured to said cylinder, forming a recess D in front, for any substance obnoxious to insects, the cap E forming the entrance *a*, and trap recess *a*.

No. 13,826. Improvements in Tiles for Illuminating Purposes. (*Perfectionnements aux terres des hublots.*)

The Sanitary Manufacturing Company, (Assignee of James G. Peirneyouik.) Boston, Mass., U. S., 14th December, 1881; for 5 years.

Claim.—1st. The semi-prism B raised at the centre and provided with radial grooves, and bevelled sides *b*, whereby the radiating surface is augmented and protected from abrasion. 2nd. The central spur *c* projecting up above said face, in combination with projections *d* on the lens frame. 3rd. The semi-prism B having its downwardly extending tongues inclined on the back face *f*.

No. 13,827. Improvements on Stovepipe Dampers. (*Perfectionnements aux clés des tuyaux de poêles.*)

William F. Green, (Assignee of John H. Goodfellow.) Troy, N. Y., U. S., 14th December, 1881; for 5 years.

Claim.—1st. The journal B composed of parts *b b* and the spring C, combined. 2nd. The journal composed of parts *b b* and the spring C, combined and made of the same material and in one piece with the body of the damper. 3rd. The body A formed in two parts *a a*, each part having a part of the divided journal B thereon, and a spring C connecting the parts *a a*. 4th. The body A, two part journal B, spring C for separating the parts *b b* of such journal, and the finger hole E. 5th. The journal B composed of parts *b b* and provided with a notch or crease *f* therein, and a spring C.

No. 13,828. Improvement on the Process of Separating Animal Fibres from Vegetable Fibres. (*Perfectionnement du procédé pour séparer les fibres animales des fibres végétales.*)

George M. Rice and Alfred L. Rice, Worcester, Mass., U. S., 14th December, 1881; for 5 years.

Claim.—1st. In the art of separating animal fibres from vegetable fibres, the process of treating the mixed fibrous materials, which consists in distributing throughout the mass of material in granulated pulverized form a chemical substance of solid nature from which gaseous hydrochloric acid, chlorine or chloric compounds can be liberated, and the subsequent liberations of the said gaseous product in contact with the material by the elevation of temperature. 2nd. The process of treating mixed fibres for separation, consisting in exposing the mixed fibrous material, in combination with a granulated solid chemical agent or agents, within a close receiver to the action of

heat at a temperature sufficient to liberate disintegrating gas or gases from said solid chemicals. 3rd. The process of separating animal fibres from vegetable fibres, consisting in mixing with the mixed fibrous material, dry bleaching powder or chloride of lime exposing the mass within a close receiver to the action of heat, and subsequently removing the chemical fumes and vapour by a blast of air passed through the receiver.

No. 13,829. Improvements in Skates.

(*Perfectionnements dans les patins.*)

Ellwood G. Maconber. Portsmouth, R. I., U. S., 14th December, 1881; for 5 years.

Claim.—1st. An ankle support for skates constructed with the forward edge of the heel plate provided with a socket in which is secured the bent lower end of an upright rod, to the upper end of which is attached a divided leg band, one leaf or section of which is closed by the pressure of a spiral spring that is carried on the upright rod, the degree of pressure of which is made adjustable. 2nd. The combination, with the spiral spring J and the upright rod E carrying the stationary half band H and the hinged half band I, of the collar K and the set screw L, whereby the tension of the said spring can be readily adjusted. 3rd. The heel plate B made with an open socket at its forward edge to receive the bent lower end of the upright rod.

No. 13,830. Improvements on Boats.

(*Perfectionnements aux bateaux.*)

David Ureh, Portsmouth, N. H., U. S., 14th December, 1881; for 5 years.

Claim.—1st. A marine propeller which comprises in its construction two shallow draft boats or floats set apart but united, a submerged propeller placed between the two boats or floats, mechanism for rotating the propeller, and a steering rudder. 2nd. An inclined plank or platform between the two boats or floats, supported on cross bars and having, mounted upon it, mechanism for operating a propeller, and a support for either a buggy-like seat or a saddle. 3rd. A submerged screw propeller provided with a hinged vertically and laterally bracing stay, for holding it to its work beneath the water and for raising it out of the water, in combination with two boats having a draft of water much less than the diameter of the propellers, and with mechanism for driving the propeller. 4th. The two boats A A', a submerged screw propeller G, hinged supporting device F having a lever arm *g*, and the sliding tube *e*, in combination with the jointed shaft and operating mechanism. 5th. A transversely divided saddle support having a saddle applied to it, and one-half of which is permanently fixed and the other removable, and stationary buggy-like seat supports which are provided with a removable buggy-like seat, in combination with two boats or floats, a screw propeller and treadle mechanism for operating the propeller. 6th. The boats A A' constructed with partition blocks *b*, in combination with the cross bars *a a' a'' a'''* and bolts which fasten the bars to the boat. 7th. In combination with two boats or floats and a platform, the front quadrant portion of a arch-shaped laterally braced saddle support and a mast, the latter (the mast) being extended from the platform and fastened to the said portion of the saddle support. 8th. In combination with two side floats or boats, a platform and a mast, a sail support fitted loosely on the mast, and a sail fitted loosely upon the support and provided with means whereby it can be kept unfurled, be furled, and also adjusted to a horizontal position to serve as a canopy, and vertically and obliquely to serve as an ordinary sail. 9th. The rudder I pivoted either to the cross bar *a* of the boat, A A' or to converging inner branch beams of said bar, in combination with the cords *p*, *q*, yoke *k* and upright rod *l* with handles *h* B, said rod being mounted or pivoted on the platform, and arranged in relation to the saddle support or buggy-like seat, and to the treadles. 10th. The combination of the removable grass collecting forks or guard *l* to lift and remove grass and like substances, submerged screw-propeller and the two shallow draft boats A A'. 11th. The supporting bracing and raising and lowering device F having a hinge connecting means at its upper end, and a tube *e* joined to its lower end combined with an adjustable propeller shaft. 12th. The bearing plate B₂ having bearing boxes *b*, *h* which are on the arms of the plate, and also having bearing boxes *d*, *h'*, in combination with the propeller shaft and treadle shaft, and with the bevel wheels *m* applied within the said plate. 13th. The mode of fastening the propeller blades to their shaft.

No. 13,831. Improvements on Water Furnaces.

(*Perfectionnements aux calorifères à eau*)

Amé N. Aubin and Louis M. A. Aubin, Montreal, Que., 14th December, 1881; for 5 years.

Claim.—1st. The section *e d e'* having the water spaces *W w*, and the smoke flues *H h* so disposed as to compel the water whilst it is heating to move in a contrary direction to the currents of heat. 2nd. The combination of independent sections *e d e'* and *f* with a fire box *b*, grate bars *b'* and ash pit *a*. 3rd. The combination, with sections *e d e'* and *f*, of fire box *b*, grate bars *b'*, of the regulator R, air space *r*, diaphragm S, lever C, rod *r'*, dampers *a* and *a'*. 4th. The combination, with sections *e d e'* and *f*, of cooking ranges, coal or gas burners regulator R and its accessories.

No. 13,832. Improvements in Automatic Feeders for Middlings Purifiers.

(*Perfectionnements aux alimentateurs automatiques pour les épurateurs des gruaux.*)

Carlton E. Sage, Elkhart, Ind., U. S., 14th December, 1881; for 5 years.

Claim.—1st. In an automatic feeder for middlings purifiers, smutlers and crushers, the combination, with the pivoted register A, and the pressure board H pivoted within the hopper. 2nd. The combination, with the pivoted register or valve A and the pressure board H

pivoted within the hopper N, of the connecting rod or rods D and set screws *f*, and one or more tension springs E arranged to automatically close the register aperture *m*. 3rd. In an automatic feeder, the combination, with a pressure board H pivoted within the hopper, of the flexible strips S₁ S₂ secured to the ends, and at the joint of the pressure board, to prevent the stock from filling in beneath the said board H.

No. 13,833. Improvements on Seeding Machines.

(*Perfectionnements aux semoirs.*)

James W. Mann, Brockville, Ont., 14th December, 1881; for 5 years.

Claim.—1st. The internal bottom of the hopper A composed of sectional castings B having inclined sides longitudinal with the hopper, and semi-circular sides transversely thereto around the discharge apertures and fitting endwise together. 2nd. The sectional castings B composing the bottom of the hopper A cast with a semi-circular eye *c* and a corresponding recess below the same for holding the seed agitator shaft. 3rd. The external bottom of the hopper A composed of castings G provided with a sliding plate K, to which to secure the seed tubes and an intermediate filling of blocks I. 4th. The castings B provided with lugs F, and castings G having notched ribs J J, for holding the intermediate sliding bar *o* in position.

No. 13,834. Improvements on Harrows.

(*Perfectionnements aux hersees.*)

Alexander F. McLean, Moncton, N.B., 14th December, 1881; for 5 years.

Claim.—1st. The combination of levers *a b*. 2nd. The combination of levers *a b* in connection with the claims *h i*, the stand C and guide *d*, the drag and guide irons *e f* and the roller *g*.

No. 13,835. Improvements on Electric Lamps.

(*Perfectionnements aux lampes électriques.*)

Thomas A. Edison, Menlo Park, N.J., U.S., 14th December, 1881; for 15 years.

Claim.—1st. In an incandescent electric lamp, the collar, moulded upon the neck of the lamp to which is secured the two electrodes of the lamp. 2nd. In an incandescent electric lamp, the collar having metal rings in different horizontal planes, said collar being moulded upon the neck of the lamp and into said rings at the same time. 3rd. In an incandescent electric lamp having a moulded collar provided with metal rings, the wire of the lamp being secured together and imbedded in the moulded collar. 4th. The mould having seats for the collar rings, in combination with a holder for retaining the lamp in its proper position in the mould. 5th. In an incandescent electric lamp, the tubular wire support having the knob or enlargement on its lower end, in combination with the perforated stopper and the globe. 6th. In an incandescent electric lamp, the globe having a long neck with tapering end, in combination with the tapering rubber stopper and the long tubular glass wire support having an enlarged lower end. 7th. In an incandescent electric lamp, the globe and wire support provided with metal rings sealed thereto which are soldered together before the globe is exhausted. 8th. In an incandescent electric lamp, the globe provided with platinum rings D, sealed to its lower end, in combination with the glass wire support B, having the platinum ring E sealed thereto, such rings fitting one inside of the other and being soldered together before the globe is exhausted. 9th. The method of uniting the carbon filament and the leading in wires of an incandescent electric lamp consisting in first attaching short wires to the ends of the carbon filament, and then securing such short wires to the leading in wires of the lamp. 10th. The method of uniting the carbon filament and leading in wires of an incandescent electric lamp consisting in, first attaching short wires mechanically to the carbon filament, then electro-plating such joints, and then fusing or soldering these short wires to the leading in wires of the lamp. 11th. An incandescent electric lamp having the leading in wires sealed directly in the lower end of the exhausted glass bulb. 12th. In an incandescent electric lamp, the exhausted glass bulb compressed or melted upon the leading in wires at its lower end for securing the same directly therein. 13th. In an incandescent electric lamp, the glass bulb A having open lower end with enlarged walls *a*, in combination with leading in wires secured directly in the lower end of said bulb by the compression of the walls *a* thereon. 14th. An incandescent electric lamp or lamp chandelier, the leading in wires of which are connected removably with the conducting wires by hooks or hooks and eyes. 15th. An incandescent electric lamp or lamp chandelier, the leading in wires of which are connected removably with the conducting wires by hooks or hooks and eyes, such lamp or chandelier being provided with an extra weight to produce good contact. 16th. An incandescent electric lamp, the leading in wires of which are connected removably with the conducting wires, the connections being submerged in water. 17th. An incandescent electric lamp, the leading in wires of which are connected by hooks or hooks and eyes with the conducting wires, such hooks or hooks and eyes being submerged in water, and the wires being insulated except at the points of contact with a coating impression to water.

No. 13,836. Improvements on Dynamo or Magneto Electric Machines.

(*Perfectionnements aux machines électro-magnétiques ou dynamiques.*)

Thomas A. Edison, Menlo Park, N.Y., U.S., 14th December 1881; for 15 years.

Claim.—1st. The inductive bars broadened at their ends for connection with the disks. 2nd. The combination of the disks having a double spiral line of projecting ears, with the inductive bars connected with such ears, the alternate bars being curved outwardly to avoid the first line of ears. 3rd. The combination of the inductive bars and cross connecting disks, having their contacts plated or amalgamated. 4th. In a machine having cross connecting disks, the outside rods

connecting the disks with the commutator. 5th. The combination of the inductive bars and the disks having projecting ears, with the outside rods extending from alternate ears to the commutator bars. 6th. The cross connecting disks located outside the magnetic field. 7th. The combination, with the armature core, of the cross-connecting disks separated from the ends of such core leaving air spaces and removing disks from magnetic field. 8th. The cross-connecting disks having bevelled edges, in combination with intermediate insulation. 9th. The copper inductive bars wrapped with parchment paper or its equivalent. 10th. The copper inductive bars having an insulation of mica held by an exterior wrapping. 11th. The copper inductive bars having an insulation of mica and parchment paper or its equivalent. 12th. An air blower situated outside of the machine and forcing air through the space around the armature. 13th. The air blower driven by the armature shaft and forcing currents of air through the space between the armature and the polar extensions of the exciting magnet or magnets. 14th. Polar extensions of the exciting magnet or magnets connected at their side edges so as to form a chamber surrounding the armature and open only at the ends of such armature, in combination with a lower forcing air through said chamber. 15th. The inductive bars supported off of the armature core and separated from each other, leaving spaces entirely around said bars. 16th. The combination of the inductive bars supported off of the armature and separated from each other, with a blower for forcing air into the space between the armature, and the polar extension of the exciting magnet or magnets. 17th. The method of reducing the resistance of moving surface contacts consisting in amalgamating the contacting surfaces. 18th. The method of reducing the spark at the commutator of a dynamo or magneto electric machine consisting in amalgamating the contacting surfaces of commutator and the brushes, strips, wheels or other collectors. 19th. The combination of a commutator and its brushes, strips, wheels or other collectors having amalgamated contacting surfaces.

No. 13,837. Improvements on the Art of Burning Soft Coal and Consuming Smoke, with Apparatus therefor. (*Perfectionnements dans l'art de brûler la houille et consumer la fumée, et appareil pour cet objet.*)

Hubert R. Ives, Montreal, Que., 15th December, 1881; (Extension of Patent No. 1299.)

No. 13,838. Improvements on the Process of Separating Animal from Vegetable Fibres. (*Perfectionnements au procédé pour séparer les fibres animales des végétales.*)

George M. Rice, and Alfred L. Rice, Worcester, Mass., U.S., 16th December 1881; for 5 years.

Claim.—1st. The art of separating mixed animal and vegetable fibres by means of chemical disintegrating agents, the process of rendering said chemical agents temporarily inactive during distribution, which consists in absorbing the chemicals with a suitable comminuted or finely granulated substance, and then distributing the same in a comparatively dry or mealy condition among the mixed fibrous material. 2nd. In the art of separating animal fibres from vegetable fibres, the process consisting in mixing with the material to be treated, in a comparatively dry condition, a comminuted or finely granulated inert substance saturated or impregnated with hydrated acid or other chemical disintegrating agent, and then subjecting the mass to the action of heat.

No. 13,839. Improvements in Apparatus for Cleansing and Purifying Water in Steam Boilers. (*Perfectionnements aux appareils à nettoyer et épurer l'eau dans les chaudières à vapeur.*)

Thomas Sharp, Salem, Ohio, U.S., 16th December 1881; for 5 years.

Claim.—1st. In a boiler-cleaning apparatus, the combination of a steam boiler with pipe E and exterior pipes B and D and reservoir C. 2nd. The combination of a steam boiler with pipe E, exterior pipe B, reservoir C, partition plate b.

No. 13,840. Improvements on Carriage Dashes, (Splash Boards.) (*Perfectionnements aux garde-crottes.*)

Laethlan E. McKinnon, St. Catharines, Ont., 16th December, 1881; for 5 years.

Claim.—1st. The shaping of the lower rail A with a groove or channel in the outer side, for the purpose of receiving the heads C of the bolts C. 2nd. The bolts C with oblong heads C. 3rd. The feet B with square or angular holes E.

No. 13,841. Improvements on Car-Couplings. (*Perfectionnements aux accoupleurs des chars.*)

Daniel Kunkel, Sr., Oregon, Mo., U.S., 16th December 1881; for 5 years.

Claim.—1st. The coupling heads A having vertical partitions A, the hinged bolts B, hinged coupling hooks C, coupling bolts D, inclined slider E and curved arms G, for raising the hooks in coupling, the locking blocks I held forward by springs m and carrying the swinging bars K and lifting blocks L, for raising the hooks in uncoupling, the bolts J having cross bars attached to their ends, and the lever cams o and stops P. 2nd. The combination, with the coupling-heads A and the hinged coupling hooks C, of the curved arms G and the inclines H, whereby the coupling hooks C are raised into contact with the slides E when the cars are run together. 3rd. The combination, with the coupling heads A and the hinged coupling hooks C, of the

swinging locking blocks I, their suspending bolts J having cross bars N and the springs M, whereby the coupling hooks C are locked against accidental uncoupling. 4th. The combination, with the coupling heads A, the hinged coupling hook C and the swinging locking blocks I, of the hinged arms K and the swinging lifting blocks L, whereby the coupling hooks are raised to uncouple the cars by swinging back the locking blocks I. 5th. The combination with the coupling heads A, and the cross bars N attached to the bolts J that suspend a d operate the locking blocks I, of the lever cams o and their stops P, whereby the locking blocks can be adjusted and locked in either position.

No. 13,842. Improvements on Egg-Beaters.

(*Perfectionnements aux verges à œufs.*)

Thomas W. Brown, Belmont, Mass., U.S., 16th December, 1881; for 5 years.

Claim.—1st. The combination of the fixed parts k k k k k and spindle B, with the revolving beater H h h h h divided and curved as shown. 2nd. The direct combination of the beater H H and the pinion D with the eyelet E.

No. 13,843. Improvement in Faucets.

(*Perfectionnement dans les robinets.*)

George W. Hilliard, Brighton, Ill., U.S., 16th December 1881; for 5 years.

Claim.—1st. The combination, with the pipe A having only a direct passage, of the key B having the slot D between the flow openings CC.

No. 13,844. Improvements in Head-Blocks for Saw-Mills. (*Perfectionnements aux poupées des scieries.*)

Walter J. F. Liddell, Charlotte, N.C., U.S., 16th December, 1881; for 5 years.

Claim.—1st. In a head-block for saw-mills, the through shaft D provided with the pinion d and the sliding clutch collar F, in combination with the wheel E, secured to a sleeve on said shaft carrying the pinion d and provided with a clutch engaging the clutch collar, and through shaft for operating the knees. 2nd. The combination, with the through shaft and sleeve carrying the pinions actuating the knees, of the ratchet wheel E and the double pawl connected with the pivoted base plate on the lever, for actuating said wheel and pinions. 3rd. The combination, in a head-block, of the double pawl I, its pivoted base h and shifting lever K, with the lever H vibrating around the through shaft as a centre, for actuating the wheel through which motion is imparted to the pinions operating the knees.

No. 13,845. Improvements on Wood Rim (Shell) Pulleys. (*Perfectionnements aux poulies à chape de bois.*)

Wilson W. Carey, Lowell, Mass., U.S., 16th December, 1881; for 5 years.

Claim.—1st. The spider having radial arms d d terminating in perforated eyes e e, the middle fellow a a secured to each of said eyes by means of a single radial screw-bolt f f and having side rims b b.

No. 13,846. Improvements on Barbed Fencing. (*Perfectionnements aux clôtures barbelées.*)

Joseph F. Walmsley, London, Ont., 16th December, 1881; for 5 years.

Claim.—The part stripe or band of iron or other metal A stamped so as to prevent a series of barbs B B on both sides.

No. 13,847. Improvements in Well Tubing Joints. (*Perfectionnements aux joints des tuyaux de puits.*)

James A. Beverly, Bradford, (Assignee of Benjamin F. Walker, Derick City), Pa., U.S., 16th December, 1881; for 5 years.

Claim.—1st. A clasp packer for well tubing joints, consisting of the two semi-cylindrical parts C D hinged to each other at one side E, edge, and fastened at the other side edge by a hook E and pin F, and provided with packings I J, and the discharge hose L. 2nd. The combination, with the coupling B and tubing A, of the packer made in two parts C D hinged to each other at one side edge and fastened together at the other side edges by a hook E and pin F, and provided with packings I J, and hose L, whereby the oil from the disconnected section of tubing will be discharged into a receiver. 3rd. The combination, with the parts C D of the packer, of a stop plate M, whereby the oil from a flowing well will be kept from flowing out at the upper end of the packer and made to pass through the hose L to a receiver. 4th. The combination, with the parts C D of the packer, of the hooks O, to hook upon the elevator and prevent the packer from being forced off by the pressure of flowing oil.

No. 13,848. Improvements in Platform Spring Waggon. (*Perfectionnements aux wagons plateformes à ressorts.*)

Lauren M. Fitch and Archibald D. Clark, Rome, N. Y., U.S., 16th December, 1881; for 5 years.

Claim.—1st. The diagonal bars B B, central bar D, bearing block C, transverse bar E, in combination with the lateral springs H H, rear spring G, diagonal side springs S S, having their converging ends turned inward and connected midway between transverse bar E and bearings block C, and brace h, whereby the platform is firmly braced at the point of greatest strain. 2nd. The combination, with the reach L and the axle K, of the clips b and coupling a, provided with lugs c and knuckle b.

No. 13,849. Improvements on Machines for Cutting Oats. (*Perfectionnements aux machines à concasser l'avoine.*)

Franklin W. Kremer, John C. Kremer, Wadsworth, and Joseph F. Fahs, Akron, Ohio, U.S., 16th December, 1881; for 5 years.

Claim.—1st. The combination of a rotary shaft feeder disks keyed thereon, and knives or cutters fitting closely between and aiding in separating such disks. 2nd. In an oatmeal machine, the combination of a rotary shaft feeder disks keyed thereon, fixed adjustable knives extending in closely between the disks to aid in separating them, and horizontal reciprocating levelling fingers arranged above and overlying the disks, to insure the proper feeding of the grain. 3rd. The combination, with a grooved feeder, of a reciprocating bar having horizontal levelling fingers arranged above and overlying the feeder, to insure the proper feeding of the grain lengthwise into the grooves of said feeder. 4th. The knives of an oatmeal cutter supported in an open back adjustable frame. 5th. In an open back frame, the knives arranged therein and a bar or brace combined therewith at the back of the knives. 6th. A knife carrying frame adjustable toward the feeder cylinder to compensate for the wear of the knives combined with a brace for the backs of such knives adjustable harmoniously with the frame. 7th. The feeder cylinder combined with a knife overlying its grooves between the hopper and the knives. 8th. The feeder cylinder and the separating fingers held in clamps combined as described.

No. 13,850. Improvements on Check Reins. (*Perfectionnement aux foucses-réins.*)

Frederick L. Jones, Fentonville, Mich., U. S., 17th December, 1881; for 10 years.

Claim.—1st. A metallic strap G having loops at the extremities and supported from a base B, or frame E, whereby the ends will be free to move flexibly. 2nd. A base B, an arm or arms F established thereon, and supporting a metallic strap G having loops at the extremities, whereby the ends will be free to yield. 3rd. The combination of base B, a detachable from E and strap G, the ends having a yielding movement. 4th. Two locking parts, one carrying a strap G with flexible ends, said parts consisting of a base B, having a post C passing through the base of the other part E pivotally, said posts provided with side lugs to lock over the upper face of the part E.

No. 13,851. Improvements in Kilns for Drying Lumber (*Perfectionnements dans les fours des sécherics à bois.*)

Richard J. Rundell, Chicago, Ill., U. S., 17th December, 1881; for 5 years.

Claim.—A drying kiln provided with a double or duplicated system of air passages or inlets, arranged so as to be reversible in order to face the currents of wind when blowing from opposite directions.

No. 13,852. Improvements on Cooking Stoves and Ranges. (*Perfectionnements aux fourneaux et aux landiers de cuisine.*)

Giles F. Filley, St. Louis, Mo., 20th December, 1881; for 5 years.

Claim.—A cooking stove or range having an opening or openings between the oven door and side of the stove or range.

No. 13,853. Improvements on Cooking Stoves and Ranges. (*Perfectionnements aux landiers et aux fourneaux de cuisine.*)

Giles F. Filley, St. Louis, Mo., U.S., 20th December, 1881; for 5 years.

Claim.—A cooking stove or range oven door consisting of a finely perforated plate A, the perforations B being formed directly in the plate c.

No. 13,854. Improvements on Ranges. (*Perfectionnements aux landiers.*)

Giles F. Filley, St. Louis, Mo., U.S., 20th December, 1881; for 5 years.

Claim.—1st. The combination of the flues C H N, said flues C H being separated by the strip K, and said strip being arranged, extended and perforated, all out away as described. 2nd. The combination, in the range A, of the flues C D D E E F G H N, and the damper M, said flues C H being separated by the strip K, and said strip being arranged, extended and perforated or cut away.

No. 13,855. Improvements on Cooking Stoves. (*Perfectionnements aux fournaux de cuisine.*)

Giles F. Filley, St. Louis, Mo., U.S., 20th December, 1881; for 5 years.

Claim.—1st. The combination of the flues C H, said flues C H being separated by the strip K, and said strip being arranged, extended and cut away or perforated, and the flue H having the escape N arranged at the end of the stove. 2nd. The combination of the flues C D D E E F G H and damper M, said flues C H being separated by the strip K, and said strip being arranged extended and cut away, and said flue H having the escape N arranged at the end of the stove.

No. 13,856. Improvements on Stove and Range Ovens. (*Perfectionnements aux fourneaux des poêles et des landiers.*)

Giles F. Filley, St. Louis, Mo., U.S., 20th December, 1881; for 5 years.

Claim.—1st. A cooking stove or range oven having one or both doors provided with a register or registers, arranged in the upper part of

the door or doors and with a register or registers arranged in the lower part of the door or doors and without a diaphragm arranged horizontally in the oven between the upper and lower registers, and extending throughout the principal portion of the oven. 2nd. A cooking stove or range oven door having series of registers C C C' D D D', the openings of said registers having the gauge E.

No. 13,857. Improvements on Stove and Range Ovens (*Perfectionnements aux fourneaux des poêles et les landiers.*)

Giles F. Filley, St. Louis, Mo., U.S., 20th December, 1881; for 5 years.

Claim.—1st. A cooking stove or range oven door or doors having a register arranged and extended throughout the main portion of the door. 2nd. A cooking stove or range oven door or doors having the register B and gauge C, said register being arranged and extended as set forth. 3rd. The combination of the door A and register B, said register having a larger opening in its upper than in its lower half. 4th. A cooking stove or range oven door or doors having a register B and the register D in combination.

No. 13,858. Improvements on Cooking Stoves. (*Perfectionnements aux fourneaux de cuisine.*)

Giles F. Filley, St. Louis, Mo., U. S., 20th December, 1881; for 5 years.

Claim.—1st. The combination, in the stove A, of the flues C D D E E F G H and the dampers M M', said flues C H being separated by the strip K, said ascending flue G being extended at g, and the flue H having the escape N arranged at the rear end of the stove.

No. 13,859. Improvements on Cooking Stoves. (*Perfectionnements aux fourneaux de cuisine.*)

Giles F. Filley, St. Louis, Mo., U. S., 20th December, 1881; for 5 years.

Claim.—1st. The combination of the flues C D D and H, said flues C H being separated by the strip K, and said strip being extended and cut away at K K, and the flue H having the escape N arranged at the ends of the stove. 2nd. The combination of the flues C D D E E F G H and damper M M', said flues C H being separated by the strip K, and said strip being arranged, extended, and cut away at K K, and the flue H having the escape N arranged at the end of the stove.

No. 13,860. Improvements on Millstone Drivers. (*Perfectionnements aux chassoires des meules.*)

Wells E. Sergeant, Minneapolis, Minn., U. S., 20th December, 1881; for 5 years.

Claim.—1st. The combination of a driving member, a driven member connected thereto by joints which permit the parts to rock in one direction with relation to each other, and to slide in relation to each other in a direction at right angles to the first. 2nd. In combination with the driving collar A, the driven member B connected thereto by horizontal rocking and sliding joints. 3rd. In combination with the collar A having seats in its upper side, the part B provided with the horizontal journals or bearings b. 4th. The combination of the part A and the part B provided with inwardly extending lugs e, the two parts being connected. 5th. In combination with a driving collar A, a driven member B provided with an open centre and connected to the part A, by means of a horizontal joint consisting of circular open sided seats, and corresponding journals arranged to rock and also slide endwise within the seats. 6th. The combination, with the part A, of the part B connected thereto and curved downward past the sides of the part A. 7th. In a mill driver the combination of two parts, one having a rocking motion upon the other and a spring or springs, whereby the rocking member is maintained normally in a horizontal position.

No. 13,861. Improvement on the Process and Apparatus for Crystallizing Grape Sugar. (*Perfectionnement dans les procédés et les appareils à cristalliser le sucre de raisin.*)

Horace Williams, Buffalo, N. Y., U.S., 20th December, 1881; for 5 years.

Claim.—1st. The process of obtaining a thorough crystallization of uniform fineness through the entire mass and of saving time in cooling, avoiding loss by leakage and liability of fermentation, consisting of artificially cooling and agitating the syrup after it leaves the vacuum pan. 2nd. The process of inducing and aiding the crystallization of the syrup consisting of adding a creamy solution of grape sugar and water during the agitation of the syrup, while exposed to a cooling surface. 3rd. Treating the concentrated syrup for the purpose of cooling and crystallizing it, and apparatus consisting of a tank fitted with an agitator to thoroughly agitate the syrup, and with cooling pipes or surfaces to carry off the heat and aid in cooling it.

No. 13,862. Improvements in Machines for Pegging Boots and Shoes. (*Perfectionnements aux machines à cheviller les chaussures.*)

Théophile Laurin, Montreal, Que., (Co-inventor with Charles P. Cameron, Colborne, Ont.) 20th December, 1881; for 5 years.

Claim.—In combination with the sliding plate A and spindle B, the supplemental roller or disk H.

No. 13,863. Improvements in Paper Bags.*(Perfectionnements aux sacs en papier.)*

Robert Kilgour and Joseph Kilgour, Toronto, Ont., (Assignees of Felix W. Lanbach and Clarence A. Wolle, Bethlehem, Penn., U. S.), 20th December, 1881; for 5 years.

Claim.—1st. The mode for cutting a tube of paper without waste into bag blanks, the primary folds of which will have edges overlapping in the centre and separated on the flaps, said mode consisting in severing the tube on lines curved or inclined in reverse directions from the centre to the opposite edges of the tube. 2nd. A bag blank having its opposite ends curved or inclined in reverse directions, from the centre to opposite edges, the bottom end being the reverse of the mouth end.

No. 13,864. Improvements on Spring Bed Bottoms.*(Perfectionnements aux sommiers élastiques.)*

Edward T. Slayton, St. Paul, Minn., U. S., 20th December, 1881; for 5 years.

Claim.—1st. The bands D d interwoven with the springs C and with each other, in combination with said springs and the take-up springs c in connection with the abutments A. 2nd. In a frame with longitudinal slats, the twin springs and connection with the abutments of the framing at head and foot. 3rd. The twin springs having the top connections a and below the same, the supporting links b, 4th. The combination, with the twin springs having the top connections c and the supporting links below the same, of the connecting links Z. 5th. The bed bottom constructed with two or more lateral sections independent of each other or provided with yielding connections.

No. 13,865. Improvements on Wrenches.*(Perfectionnements aux clés à écrous.)*

Henry A. Thompson, Farmington, Me., U. S., 20th December, 1881; for 5 years.

Claim.—The combination, of the bar A, provided with the jaw B, at one end, and the screw threaded shank C, at the other, and the bar E provided with the jaw F, rectangular opening G and aperture H, and the lever D provided with the screw threaded aperture.

No. 13,866. Improvements on Metallic Rods.*(Perfectionnements aux tiges métalliques.)*

Samuel W. Skinner and William M. Thomas, Cincinnati, Ohio, U. S., 20th December, 1881; for 5 years.

Claim.—1st. In charging with granulated iridium a cup-formed carbon positive electrode and bringing the same while under the action of galvanic discharge into repeated contact with the tip of a rod of other metal. 2nd. Charging with granulated hydrogen a cup-formed carbon positive electrode and bringing the same while under the action of galvanic discharge into repeated contact with the tip of a rod of other metal, the rod proper being then enveloped with a reinforce of the same or different metal. 3rd. The combination, with a lower negative electrode, of carbon, the upper carbon positive electrode of tubular form for the purpose designated.

No. 13,867. Improvement on Furnace Grates.*(Perfectionnement des grilles de fourneaux.)*

George E. Palmer, Amasa Worthington, Chicago, Ill., and George A. Rowell, Brooklyn, N. Y., U. S., 20th December, 1881; for 5 years.

Claim.—1st. An inclined grate having transverse bars lying nearly or quite flatwise a portion being mounted stationary and another set mounted in spaces between being movable horizontally. 2nd. The bottom grate P, with its front lead plate P₁ in combination with a separate inclined grate with means for moving a portion of the latter forward and backward. 3rd. In combination with an inclined grate with provisions for shaking the same, the adjustable connection X leading from a uniformly moving part W to a lever L. 4th. The combination of an inclined grate I J with provisions for shaking apart, a feeding hopper M for supplying fuel thereto, and a horizontal grate P for burning the residue, and a hanging bridge R arranged to induce a mixture and complete combinations of the gases.

No. 13,868. Improvements on Steam Boiler Furnaces.*(Perfectionnements aux foyers des chaudières à vapeur.)*

George E. Palmer, Chicago, Ill., U. S., 20th December, 1881; for 15 years.

Claim.—1st. The hanging bridge R and lower platform R₁ in combination with the back masonry F, partition T and upper platform T₁, and with the boiler A, inclined tubes B and connections C D. 2nd. The case a having provisions for receiving and distributing air arranged at the front of the furnace and receiving air in adjustable quantities from the side or sides, in combination with a hopper and with an inclined grate. 3rd. A furnace formed in two partially separated chambers, the first lined with non-conducting material on all sides and above, and the second similarly lined on all sides, an inclined grate with provisions for feeding fuel slowly down thereon, a hanging bridge and a transverse pipe G having connections g₁ g₂ to a steam boiler A, combined and arranged to serve as specified. 4th. The method of exposing bituminous fuel to the distillation of its volatile matter and to a partial combustion of its solid matter in one chamber, subjecting the solid residue to complete combustion with an excess of air, so that the resulting gases therefrom contain much free oxygen at a high temperature in another chamber, and finally mingling the two kinds of heated gases in the upper portion of the second chamber, so as to induce complete combustion.

No. 13,869. Method of Pulverizing Mineral and Other Substances, and Apparatus Therefor.*(Méthode et appareil pour pulvériser les substances minérales.)*

Lyman F. Holman, (Assignee of Frederick A. Lukenbach and John Wolfenden,) New York, U. S., 21st December, 1881; for 5 years.

Claim.—1st. The aforesaid method of pulverizing substances by introducing them into opposing currents by means of which two or more streams of material are brought into collision and pulverized by concussion. 2nd. The combination of the chamber FG, pipes B B₁, hoppers H, chambers A.

No. 13,870. Improvements on Belt Shippers.*(Perfectionnements aux embrayeurs.)*

William Gray and Amos Whitney, Hartford, Ct., U. S., 21st December, 1881; for 5 years.

Claim.—1st. The frame D G H adapted to carry the rollers J K L in combination with said rollers and a supporting pole. 2nd. The combination of a frame arranged on three sides of a rectangle, with the rollers J K L. 3rd. The combination of the frame D G H provided with rollers J K L arranged as described, the shank B and the clamping device E F.

No. 13,871. Improvements on Mail Bags.*(Perfectionnements aux valises à lettres.)*

Adélaré F. Martel, Montreal, Que., 21st December, 1881; for 5 years.

Claim.—1st. A mouth frame for mail bags composed of two parallel ends or side sections connected by intermediate jointed sections adapted to fold inward between them, the joints being furnished with stops whereby they are prevented from coming into line with each other. 2nd. In combination with a folding mouth frame, a lock provided with a seal passage, and a tongue secured to the mouth frame, and adapted to close said passage when the frame is folded.

No. 13,872. Improvements in Printers' Gallies.*(Perfectionnements aux galeries d'imprimerie.)*

William J. G. McAndrew, John Eastwood and Richard Kennedy, Hamilton, Ont., 21st December, 1881; for 5 years.

Claim.—1st. In combination with a printer's galley of the metal side stick E, provided with the wedge projections a b, and the screw c of the same passing through slot e in the frame for attaching it to the frame. 2nd. In combination with a printer's galley, the recesses f f, the slots j j, d, the wedges G T secured to the frame by screws moving in slots j j, or the equivalent thereof. 3rd. In combination with a printer's galley, the recesses a g, the same corresponding with the level of the outer ones f f. 4th. In a printer's galley, the combination of the adjustable wedges G T and wedge-shaped projections a b on the side stick E.

No. 13,873. Improvements on Wind-Mills.*(Perfectionnements aux moulins à vent.)*

William Forbes, Plainwell, Mich., U. S., 21st December, 1881; for 5 years.

Claim.—1st. In a wind-mill, the combination of the vertical sail described adapted to make a complete revolution on its axis independently of the movement of the wheel provided with the crank I below the arm C, and the sail cord and weight. 2nd. In a wind-mill, the combination, with the sail cord thereof having a perforated plate or ring at its lower end, of the weight strap provided with a hook at its upper end and a stud for holding the weight in place slotted and secured to the vertical shaft of the mill. 3rd. In a wind-mill, the sliding bar having a fork at its upper angle secured to the derrick post and partially encircling the vertical shaft beneath the sliding collar on the same, in combination with the sliding collar and the slotted and weighted weight strap secured to the end of the sail cords. 4th. In a windmill, the slotted and bent lever X provided with the adjustable plate carrying the friction roller c and adapted to be connected at one end to the pump rod, in combination with the inclined collar on the vertical shaft B, and the perforated arm guide and the set screw on the derrick post.

No. 13,874. Improvements on Self-Levelling Berths for Vessels.*(Perfectionnements aux lits suspendus des vaisseaux.)*

James H. Porter, Boston, Mass., U. S., 21st December, 1881; for 5 years.

Claim.—1st. The combination of a beam pivoted centrally to a suitable support and offset, or extended outwardly or laterally at its ends from said support, a berth or its equivalent pivoted to said extended ends and thereby offset from the support of the beam and provided with an unobstructed space overhead and friction rollers arranged to prevent the beam from binding on its bearings in consequence of the leverage exerted by the offset berth. 2nd. The combination of the beam composed of the central socketed section I pivoted to a suitable support, the adjustable offset or outwardly extended arms 2 2, and a berth or its equivalent pivoted to said arms. 3rd. The combination of the pivoted beam, the berth or its equivalent pivoted to the ends of the beam, and friction rollers arranged to prevent friction of the pivoted berth on its bearings. 4th. The combination of the beam having in its opposite ends pivots or bearings K K, the berth having enlarged journals and the parallelled friction rollers c interposed between said journals and pivots. 5th. The combination of the beam having in its opposite ends pivots or bearings K₁, the berth having bearings adapted to turn upon said pivots, and springs interposed between said bearing and the surrounding portions of the berth frame.

6th. The beam composed of the pivoted socketed section I having a pinion K and the part 2 supporting the berth and provided with rack teeth engaging with said pinion. 7th. The combination of the berth, the pivoted beam composed of two parts, one pivoted to a support and the other adapted to be moved independently, to vary the position of the berth with relation to the pivot, and wall plate adapted to be moved laterally to compensate for changes in the position of the berth. 8th. The combination, with the pivoted beam, of the brackets 9 pivoted to the wall and provided with projections adapted to make both the beam and berth immovable.

No. 13,875. Improvements in Electric Lighting. (*Perfectionnements dans l'éclairage électrique.*)

Thomas A. Edison, Menlo Park, N.J., U.S., 21st December 1881: for 15 years.

Claim.—1st. A system of electric lighting in which a constant and uniform pressure of current is maintained, the combination of lamps varying in radiating surface and resistance. 2nd. The method of varying the light producing power of electric lights for use in one system, consisting in diminishing the radiating surface and increasing the resistance in proportion as they are to vary from the standard lamp.

No. 13,876. Improvements in the Manufacture of Plaster of Paris. (*Perfectionnements dans la fabrication du plâtre fin.*)

John M. Reid, Montreal, Que., 21st December, 1881; (Extension of Patent No 6,891).

No. 13,877. Improvements on Steam Engine Lubricators. (*Perfectionnements aux graisseurs des machines à vapeur.*)

Henry R. A. Boys, Barrie, Ont., 23rd December 1881; for 5 years.

Claim.—1st. The combination of the air exit tube between a lubricator and the steam pipe, the lower part of the connecting pipe being shaped so as to force the steam in, and the air out of the condensing cylinder. 2nd. The combination of the condensing cylinder and regulating condensing plug. 3rd. The combination of the supplementary condenser. 4th. The combination and arrangement of tubes, passages and parts.

No. 13,878. Improvements in the Manufacture of Bronze. (*Perfectionnements dans la fabrication du bronze.*)

Henry H. Vivian, Park Wern, Swansea, Wales, 23rd December, 1881; for 15 years.

Claim.—1st. In bronze composed of copper, 93 to 96 per cent, tin, 7 to 4 per cent, and antimony, one third to one fifth per cent. 2nd. In bearing bronze composed of copper, 82 to 88 per cent, tin, 16 to 20, and antimony, 1 to 2 per cent.

No. 13,879. Improvements in Car Brakes. (*Perfectionnements aux freins des chars.*)

Autoine Benoit, Dunham, Que., 23rd December 1881: for 5 years.

Claim.—1st. A railway engine tender wheel having formed on, or attached to it the studs *a*. 2nd. The axles A having slots formed in them in the reception of the wheel locks B, and the cross levers C. 3rd. The upright arms K formed on, or attached to the axles A, and the brake rods L as connecting the upright arms K with the braking appliances of any car or cars. 4th. The arrangement and combination of the studs *a*, wheel locks B, cross levers C, links *f*, upright levers D, horizontal levers F G and hand levers H I J.

No. 13,880. Improvements on Coffee Roasters. (*Perfectionnements aux torréfacteurs à café.*)

George A. Beidler, Middletown, Pa., U.S., 23rd December 1881; for 5 years.

Claim.—1st. The combination of the roasting vessel A, the cranked stirring rod B, its loose tube *f* and the flanged base support D constructed with slot *i*. 2nd. The combination of the two part roasting vessel A provided with a door C and a cranked stirring rod B, also with a double circular flanged base support D. 3rd. The combination, with the cranked rod B, of the roasting vessel A and the dipping cup E. 4th. The reversible base support D consisting of the parts *g* *h* of different diameters, a flange *h* and slots *i*. 5th. The combination of the flanged reversible base D, the slot *i* in the flange thereof, the cranked rod B, the roasting vessel A and the tubular bearing *f* loosely applied on the cranked rod B.

No. 13,881. Improvements on Bag Ties.

(*Perfectionnements aux attache-sacs.*)

John S. Vandermark, Wilkesbarre, Pa., U.S., 23rd December, 1881: for 5 years.

Claim.—1st. The detachable bag, bale, bundle, sack or sail tie composed of the cord A with a fixed loop at one end, the other end being free to pass through the disks or buttons B B and fasten. 2nd. A detachable tie for the above named purposes having disks or buttons B B with oblong holes *a* made through them for the passage of the cord A. 3rd. A detachable tie for the above named purposes, having disks or buttons B B with circular cord holes *a* therein, of which those in the inner disk are placed at a greater distance apart than the cord holes in the outer disk.

No. 13,882. Improvements on Wooden Boxes and on Machinery and Process for Manufacturing the same.

(*Perfectionnements aux boîtes de bois, et aux appareils et procédés pour les fabriquer.*)

Joshua Womersley, Norwich, England, 23rd December, 1881: for 15 years.

Claim.—1st. Cutting the grooves of such a form that the fibres of the wood at the bottom of the groove can assume, when bent, a rounded form instead of an angular form. 2nd. The arrangement of the cutters for forming the groove. 3rd. Softening the wood by fluid or steam at the bottom of the groove. 4th. The arrangement of machinery in softening the wood at the bottom of the groove.

No. 13,883. Improvements in Trouser Suspenders. (*Perfectionnements aux bretelles des pantalons.*)

Jacob Cohen, Montreal, Que., 23rd December, 1881; for 5 years.

Claim.—1st. In trouser suspenders, the combination of the shoulder straps A with the continuous cord F extending from one side to the other across the back, and provided with the button loops *d d*. 2nd. The combination of the shoulder straps A, back strap D and sockets C E with the shields or covers *e*. 3rd. The arrangement and combination of the shoulder straps A, web B, sockets C E, with the pulleys *a* and *c* respectively, the back strap D with its button loop *b b*, the shields *e* and cord F with its button loops *d d*.

No. 13,884. Improvements on Ranges.

(*Perfectionnements aux landiers.*)

Giles F. Filley, St. Louis, Mo., U.S., 23rd December 1881: for 5 years.

Claim.—1st. In a range A, the combination of the flues C D D H N said flues C and H being separated by the strip K, and said strip being arranged, extended and cut away at K K. 2nd. The combination, with the range A, of the flues C D D E F G H N and the damper M M, said flues C and H being separated by the strip K, and said strip being arranged, extended and cut away at K K.

No. 13,885. Improvements in Bridle Blinkers. (*Perfectionnements aux veillers des brides.*)

Alfred Hosack and James M. Harrison, Columbia City, Ind., U.S., 23rd December, 1881: for 5 years.

Claim.—1st. In a bridle or headstall, the combination, with the blinkers E E, of the stay or stays B bent midway to form the loop *h* secured adjustably in the socketed plate C. 2nd. The combination of the blinkers E E, stay or stays B B having middle bent part or loop *h h*, socketed plate C and clamp screw D.

No. 13,886. Improvements in the Manufacture of Carbon Conductors for Incandescent Electric Lamps.

(*Perfectionnements dans la fabrication des conducteurs de carbons pour les lampes électriques incandescentes.*)

Thomas A. Edison, Menlo Park, U.S., 26th December 1881: for 15 years.

Claim.—1st. The method of manufacturing incandescing conductors of the materials set forth, consisting in pressing the material into sheets and then cutting or stamping the conductors therefrom. 2nd. The method of manufacturing incandescing conductors, consisting in pressing the materials named into sheets, and then treating with hydrocarbon and heat and then cutting or stamping the conductors therefrom. 3rd. An incandescing flexible and high resistance conductor for electric lamps formed of the materials noted and by the method described. 4th. An incandescing conductor for electric lamps formed of Graphite, Plumbago or Graphitoidal Silicon, Boron or Zirconium subjected to pressure and the action of hydrocarbon and heat. 5th. The method of varying the resistance of carbons formed of Graphite, Plumbago or Graphitoidal Silicon, Boron or Zirconium by incorporating therewith a proper percentage of powdered carbon or charcoal. 6th. An incandescing conductor formed of the materials and in the manner described, and having enlarged ends for clamping, integral therewith.

No. 13,887. Improvements on Harvesters.

(*Perfectionnements aux moissonneuses.*)

John Harris, Brantford, Ont., 26th December, 1881: for 5 years.

Claim.—1st. A rake arm having cast with it a hollow spindle upon which the rake head is pivoted, a friction roller on the rake arm, and a similar roller on the rake head, in combination with a cam track having a projecting ledge shaped for the purpose of adjusting the rake heads as they descend to the table. 2nd. A rolling rake head provided with a downwardly projecting arm having a friction roller, in combination with a throat arranged in connection with a sloping cam track, for the purpose of gradually withdrawing the teeth from the grain as the arms are elevated. 3rd. A rake jack, in which the rake frame cam track and bearings, for the horizontal spindle, are cast in one piece. 4th. In combination with a rake jack, in which the rakes are elevated independently of each other, a rolling rake head having an arm projecting from its inner end with a friction roller pivoted on a stud fastened to the said arm, in combination with a projecting ledge on the cam track. 5th. A rake frame, provided with an arm extending below the tripping gate. 6th. A rake arm provided with a hollow spindle, in combination with a rake head fitting the said arm, and operated by coming in contact with the cam track, and its attachments. 7th. A rake jack, in which the rake arms are indi-

vidually raised and lowered by a cam track independently of each other, an inner cam plate formed to support and steady the rake arms as they assume a vertical position and descend to the grain table.

No. 13,888. Improvements on Coal Sifters.

(*Perfectionnements aux cribles à charbon.*)

Joseph V. Andrews, Nashua, N.H., U.S., 26th December 1881; for 5 years.

Claim.—1st. The combination, with the inclined screen E, of an inwardly projecting shelf F and a loosely suspended flap F¹, the shelf and flap being arranged beneath the trap or lid B. 2nd. The combination of the case A, the inclined screens E and E¹¹, the flap Fr, chutes E¹ G, partition H and coal and ash chambers, or receptacles D C. 3rd. The combination, with the screens E E¹¹, of the chutes E G and the draught partition H. 4th. The upright case A, the inclined screens E E¹¹, the chutes E¹ G, the draft partition H, perforated wall I and coal and ash chambers D C.

No. 13,889. Improvements in Horse Powers.

(*Perfectionnements aux manèges.*)

Andrew Muir, East Garafraxa, Ont., 26th December, 1881; for 5 years.

Claim.—1st. The long arm A secured to the rim D of the main wheel, by any suitable means therefor, the long brace rod E¹ connecting the extremity of the said long arm A to the next long arm A or at a point in the said next arm A, wherein the hook I¹ is placed both meeting at the same point. 2nd. The short arm B connecting the long arm A with the centre piece C, the short brace rod F connecting the arm A to the next short arm B. 3rd. In combination, the rim D, clevis G with the long arm A and hooked bar G¹, short arm B, long brace E, short brace F, hooks H H¹ I I¹ and ring J.

No. 13,890. Improvements in Apparatus for Superheating Steam.

(*Perfectionnements dans les appareils à surchauffer la vapeur.*)

Auguste Estrade, Perpignan, France, 26th December, 1881; for 5 years.

Claim.—1st. In apparatus for superheating steam, steam generators consisting of an extension of the steam pipe into the fire box or furnace of the boiler, such extension being surrounded by a tubular water jacket through which the water of the boiler is made to circulate. 2nd. In combination with a water jacketed extension of the steam tube of steam generators into the fire box or furnace, wire gauze or perforated metal disks within such extension.

No. 13,891. Improvements on Oil Stoves

(*Perfectionnements aux poêles à huile.*)

Louis C. Heckman, Cleveland, Ohio, U.S., 26th December, 1881; for 5 years.

Claim.—1st. In a drum adapted for use in coal oil stoves, a casing made in two or more parts, each part so hinged that it is adapted to move independently of the other. 2nd. In a drum adapted for use in coal oil stoves, the combination, with a casing made in two parts, each part adapted to move independently of the other, of a chimney so constructed that it may be removed or placed in position without disturbing the upper or lower plates. 3rd. In a drum adapted for use in coal oil stoves, a wick cone A¹ provided with stop a and chimney C. 4th. In a drum adapted for use in coal oil stoves, the combination, with the lower plate, of a chimney adapted to move laterally over the wick cone. 5th. The combination of a wick cone and a chimney adapted to be moved laterally over said cone.

No. 13,892. Improvements on Joints for Lead Pipes.

(*Perfectionnements aux joints des tuyaux de plomb.*)

Amaza Kasson, Milwaukee, Wis., U.S., 26th December, 1881; for 5 years.

Claim.—A joint in lead water pipes formed by reaming out the ends of the pipe to be joined and inserting therein a short tinned brass tube which is thereafter soldered in place fast to the joined ends of the pipe.

No. 13,893. Improvements in Extension Steps for Cars and other Vehicles.

(*Perfectionnements à la marche-pieds à röllage pour les chars et les voitures.*)

Nelson G. Northup, Eaton Rapids, Mich., U.S., 26th December, 1881; for 5 years.

Claim.—1st. The combination, with the steps C and the hangers F of the step G, of the plate D, and the semi-tubular guides E secured to the steps over the said plate. 2nd. The combination, with the car steps C, of the guides D E, hangers F, racks H, step G and shaft and pinions K L, whereby said steps may be extended or shortened. 3rd. The combination, with steps C, the guides D E, the pinion K, of the hangers F of the auxiliary step G provided with the rack H, and the stop e.

No. 13,894. Improvements on Butter Packages.

(*Perfectionnements aux emballages à beurre.*)

Charles Blacktin, St Stephen, N.B., 26th December, 1881; for 10 years.

Claim.—A package having a lining consisting of an inserted bottom B, inserted sides B held together by notches b and projections a¹, and cemented to the inside of the package, and provided with a cover D having a lining D¹ cemented thereto.

No. 13,895. Improvements on Preserved Fish and Means of Manufacturing the Same.

(*Perfectionnements au poisson en conserve, et aux moyens de le préparer.*)

Charles Alden, Gloucester, Mass., U.S., 26th December, 1881; for 15 years.

Claim.—1st. The process or method of preparing and preserving fresh fish for food in a dry state or condition without the aid of salt, condiments, or any preserving agencies other than disintegrating the fibril of the fresh fish meat, entirely removing the bones and evaporating the free moisture (without cooking) by keeping the mass of fresh fish meat in rapid motion in an evaporating pan, and the application of steam, heat and air currents for expanding and separating completely the fish fibre, and carrying off its free moisture. 2nd. The mechanical means employed for preserving and fibrilizing fresh fish meat, namely, in combination, an evaporating pan, a heating coil, steam chamber or steam jacket, an air fan or blower and a movable set of blades revolving on the inside of the evaporating pan so adjusted as to entirely prevent the fish meat from adhering to the bottom or sides of the pan, and at the same time keep it in a rolling or revolving motion. 3rd. The resulting product of treating fresh fish meat as before described, being fresh fish finely fibrilized and evaporated so as to form a nearly water free substance, as a new article of food manufacture and commerce.

No. 13,896. Improvements in Shapes for Hose and Socks.

(*Perfectionnements aux formes pour les bas et les chaussettes.*)

William B. Pollock, Montreal, Que., 26th December, 1881; for 5 years.

Claim.—A hose or sock divided shape.

No. 13,897. Improvements on Holdbacks (Breaching Hooks).

(*Perfectionnements aux ragots des limonnières.*)

William S. Gilchrist, Franklin, N.H., U.S., 26th December, 1881; for 5 years.

Claim.—1st. A guard spring attached to or in the rear of a breast hook, or post, which is flexible in its entire length from its fastenings at said points, to the point where it bears against the thrill in front of said hook or post. 2nd. A guard spring in holdbacks capable of deflection in the rear of the hook or post. 3rd. In a holdback for carriages, the combination of the hook H having an extension plate, and brace B, the curved guard spring S secured to said extension passing over and resting upon the hooks and terminating at a suitable distance in front of the latter.

No. 13,898. Improvements on Damper Regulators for Furnaces.

(*Perfectionnements aux régulateurs des registres de fourneaux.*)

Daniel C. Kellen, Detroit, Mich., U.S., 26th December, 1881; for 5 years.

Claim.—1st. In a damper regulator, a steam cylinder and piston, one of which is connected with the damper and has a relative motion with respect to the other, said cylinder and piston located at the top of an upright steam conducting stem, in combination with a valve located in a valve chamber in said stem, a weighted lever passed through said stem, and bearing upon the valve, and steam port or ports leading upward through the stem at the sides of the lever to the cylinder and piston. 2nd. The combination, with a valve chamber and valve located therein, the construction being such that, when the valve is raised, steam flows to the valve actuating mechanism, of a valve lever for regulating the load on the valve, and a steam port or passage located in the solid end of the hollow piston and on the side of the valve lever, and forming a steam conduit between the upper portion of the valve chamber and the chamber of the damper actuating mechanism. 3rd. The combination, with an outer cylinder and inner hollow piston, of a guide rod connected with the outer cylinder, and extending downwardly into said piston, and guided within the upper end thereof. 4th. In a damper regulating device, a pipe communicating with a steam generator, and provided with a valve and hollow piston A having ports b affording communication for the steam to pass into the hollow piston A, the movement of said valve being controlled by the weighted lever E. 5th. In combination with a damper regulating device, the hollow piston A into which steam is admitted, and with a cylinder I and cap H, chamber K, the ports c through which steam is admitted from the hollow piston into the chamber K. 6th. The cap H of cylinder I, the guide rod K passing through the tube extension G of the cap F of the hollow piston A. 7th. The outer cylinder L, in combination with the cylinder I, and its cap H, and the hollow piston A. 8th. The hollow piston A, pipe B, chamber a inclosing a valve C, the ports b, the ring D provided with lugs or ears e, the lever E fulcrumed thereto, the caps E, tubular extension G, cylinder I, chamber K, ports i, guide rod K and incasing cylinder L.

No. 13,899. Improvements on Machines for Setting Edges and Burnishing Heels of Boots and Shoes.

(*Perfectionnements aux machines à polir la tranche et brûner les talons des chaussures.*)

William F. Hutchinson, Lynn, Mass., U.S., 26th December, 1881; for 5 years.

Claim.—1st. In a machine for burnishing the sole edges of boots and shoes, the combination of a head carrying the reciprocating tool and pivoted in the arm supporting said head, said head being pivoted upon an oscillating frame, a shaft in said frame driven by suitable mechanism, and connected with the reciprocating tool in the head, by means of suitable rod and wrist pin, whereby reciprocating move-

ment is imparted to said tool, said head arm and frame being constructed to permit the ordinary movements. 2nd. The combination of the shaft *f*, pivoted arm B, frame K K, pivoted head D, the sliding block F and the connecting rod. 3rd. In an edge setting and burnishing machine, the combination of the reciprocating block, the reciprocating rod, bars *t* and their swivel connections with block and rod. 4th. The combination of the head D, the cross bar *h* having perforated disk *m*, and handle *n*. 5th. The combination in a jack, of the axle, the sleeve 2 held upon the said axle by a pin and slot, and the hub connected to said sleeve by a pin and set screw, whereby lateral adjustment is obtained. 6th. The combination of the pivoted arm, the driving frame, the head pivoted in the arm, the reciprocating block carrying the tool, and the treadle and connecting rod attached directly to the parts which carry the reciprocating block.

No. 13,900. Improvements on Steam Water Elevators. (*Perfectionnements aux Elevateurs d'eau à vapeur.*)

Ezra M. Vanduzen, Newport, Ky., U.S., 26th December, 1881: for 5 years.

Claim.—1st. A steam blow pump composed of the flattened shell A, constructed with a discharge throat at the top, and a steam supply at the extreme lower edge, so as to carry the steam to the bottom of the pump and having a short upturned jet. 2nd. The flattened shell A having a recessed lower edge, a top discharge throat and a steam nozzle entering horizontally at the bottom in line with the extreme lower edge, the whole comprising one casting. 3rd. The combination, with the flattened shell A constructed with a steam supply at the extreme lower edge so as to carry the steam to the bottom of the pump and having a short upturned jet, of one or more supplemental discharge nozzles, in the throat of the shell. 4th. The combination, with the flattened shell A constructed with a steam supply at the extreme lower edge so as to carry the steam to the bottom of the pump, of one or more short upturned steam jets. 5th. The combination, with the flattened shell A constructed with a steam supply at the extreme lower edge, so as to carry the steam to the bottom of the pump, of two or more short upturned steam jets and two sets of separate discharge nozzles, each set being equal in number to the steam jets. 6th. The combination, with the flattened shell A constructed with a steam supply at its extreme lower edge, of two or more separate short upturned steam jets and two or more discharge nozzles in the throat of the shell registering with the steam jets.

No. 13,901. Appliance to be attached to Boots and Shoes to prevent Persons from Slipping. (*Appareil à ajuster aux chaussures pour empêcher de glisser.*)

Henry Bland, Luton, Eng., 26th December, 1881: for 5 years.

Claim.—1st. The peculiar construction and arrangement of removable expanding and contracting appliance specially designed to be fitted to the soles of boots and shoes, in order to afford a better foothold and to prevent slipping, and the mode of holding or securing the said appliance in position by means of hooked clamps. 2nd. The combination of spike jointed links or strips of metal or other suitable material and hooked clamps.

No. 13,902. Improvements in Refrigerators. (*Perfectionnements aux réfrigérateurs.*)

Alfred S. Haslam, Derby, Eng., 26th December 1881: for 5 years.

Claim.—1st. In a refrigerator in which the air to be cooled passes first into a compressor A cooled externally by water flowing around its spirally channelled cylinder, and around the valves in its covers; secondly into or through two or more sets of tubes in a condenser B situated immediately beneath the said compressor A, within which the moisture in the air is condensed by the action of the water flowing around them; thirdly to an air reservoir such as C, the greater part of which is situated immediately beneath the said condenser B, and serves also as a bed plate for the engine F; fourthly into and through the tubes of a collector and separator D, the space within the said collector and around the said tubes being connected by pipes A, with the air expansion cylinder E, the cold room and the compressor A; fifthly into an air expansion cylinder E, situated midway of the shaft of the refrigerating apparatus and vertically beneath the crank level with the motive power engine F, which engine is arranged on a level with the compressor A and above the condenser B and air reservoir C. 2nd. The combination of the compressor A, condenser B, separator D, expansion cylinder E and engine F. 3rd. An air compressor having spiral channels around its cylinder for the circulation of the water, whereby it is cooled, and channels in its end covers around the inlet and outlet valves of the compressor, whereby they may be cooled by the said water. 4th. In an air compressor, an inlet valve consisting of a valve disk having a central stem (preferably made hollow for strength and lightness) working within a fixed sleeve and connected by means of a buffed cap piece and a rod or its equivalent, with a spiral spring contained within a casting situated in the outside of the cylinder cover. 5th. In an air compressor, an air outlet valve consisting of a valve disk having a hollow stem working within a fixed sleeve, fitted in the cylinder cover and accessible from the outside thereof, in combination with a rod situated within the hollow stem, one end of the said rod bearing against a spiral spring or an equivalent elastic medium placed around the rod situated centrally within said sleeve, whereby shock to the working parts is prevented. 6th. In a refrigerating machine, an expansion cylinder valve made adjustable in the manner described and on the opposite or an adjacent side or face, with an exhaust valve which allows the expanded air to pass off through short straight ports, the said exhaust valve being capable of adjustment in the manner shown and readily accessible from the snow base which is fitted with a cover of wood or other light non-conducting material. 7th. In combination with a toothed fly wheel of a refrigerator, the safety starting device consist-

ing of a lever *g*2, in combination with a short arm or rocking piece *a* carrying a pawl *a*, and a spring *a*3.

No. 13,903. Improvements on Earth Scrapers. (*Perfec ionnements aux bœufs.*)

Ahijah R. Byrckett, Troy, Ohio, U.S., 26th December, 1881: for 5 years.

Claim.—1st. In a scrop for earth scrapers constructed of two pieces of metal A B swaged in suitable dies and lapped together at or about the centre. 2nd. An earth scrop having runners C, each consisting of a strip of metal, and blocks D bolted or rivetted to the bottom of the scrop, and within the runners. 3rd. An earth scraper consisting of the following elements, to wit: a scrop formed of two pieces of metal A B lapped and rivetted together at or about the centre runners C C, of sheet metal blocks D D resting within the runners and secured thereto and to the scrop bail E, handle F, cross bar G, pivoted hook spring for engaging same, and catch I. 4th. The combination, with the scrop of an earth scraper, of the handle F having both holes *a*, and cross bar G having slotted arms *r* *r*. 5th. The combination, with the scrop of an earth scraper, of bail E pivoted at its lower ends to the scrop body, and the handle F pivoted to said bail, either immediately above, or in advance of the pivoted connection of the bail to the scrop. 6th. The combination of scrop A B, bail E, handle F, cross bar G, and a suitable device for retaining said cross bar in position. 7th. A bail for a scraper having twisted corners *s*. 8th. The die J having groove *u*. 9th. The combination of the die J and pivoted tongs *p*. 10th. In a cross bar adapted to rest at its narrowest part upon the scrop body and capable of adjustment there along. 11th. The combination of the plate H having outwardly and upwardly extending ears *h*, hook I, spring I and catch I. 12th. The method of forming bails for earth scrapers consisting of swaging a flat bar in dies to a semi-circular form, and then twisting the curved corners. 13th. An earth scraper having the bowl constructed in two pieces.

No. 13,904. Improvements on Incandescent Burners. (*Perfec ionnements aux becs incandescents.*)

Walter M. Jackson, Providence, R.I., U.S., 26th December 1881: for 5 years.

Claim.—1st. The method of producing illumination by rendering incandescent any suitable substance by heating it to a proper temperature by means of burning gases or vapors. 2nd. The device described for producing illumination by the incandescence of a highly heated substance, the said substance being suitably supported in the flames of burning gases or vapors. 3rd. In combination with a hollow shell A provided with a narrow opening or slot B at the top, for the escape of the gas or vapor to be burned, and with a suitable induction for such gas or vapor, the dividing bar or tie E, and the standard F for supporting the substance to be rendered incandescent. 4th. In combination with the hollow casing A and its gas escape opening B, the tapering grooved standards F and the wires wrapped and arranged around the same in such manner as to gradually approach each other towards the top and extended through the outer portion of the hollow flame so as to be rendered thoroughly incandescent. 5th. In combination with the hollow shell A, and the standards F and wires attached thereto, the perforated extension C a d perforated sleeve, and the gas or vapor jets D projecting into said extension, whereby a current of air may be commingled with the gases or vapors to be burned. 6th. In combination with the hollow casing A having a narrow opening B at the top and suitable seats at each side, the removable cross bar E and standards F, for supporting the wires to be rendered incandescent, whereby the parts are adapted to be separated for the purpose of repairs.

No. 13,905 Improvements on Anti-frictional Bearings. (*Perfectionnements aux coussinets à anti-friction.*)

Thomas A. Ferrall, Boston, Mass., U. S., 26th December, 1881: for 5 years.

Claim.—1st: In an anti-frictional bearing, the box *a* with its annular groove *a* and flanges *a*1 *a*2, the solid cylindrical rollers *c* *c* and regulators *b* with its notches *b* *b*1, and intermediate projections *b* *b*1. 2nd. In an anti-frictional bearing, the combination of the box *a*, its annular groove *a* and flanges *a*1 *a*2, the solid cylindrical rollers *c* *c*, notched regulator *b* *b*1 *b*2 and central bearing sleeve *f* having flanges *f* *f*1.

No. 13,906. Improvements in Meters for Measuring Electric Currents. (*Perfectionnements aux électro-mètres.*)

Thomas A. Edison, Menlo Park, N. J., U. S., 26th December, 1881; for 5 years.

Claim.—1st. In an electric meter, an electro depositing cell provided with amalgamated metallic electrodes. 2nd. In an electric meter, an electro depositing cell having amalgamated zinc electrodes. 3rd. The combination, with an electric circuit having a definite and known resistance, of a shunt circuit around such resistance containing one or more electro depositing cells provided with amalgamated metallic electrodes for determining the current in the main circuit. 4th. The combination, with an electric circuit having a definite and known resistance, of a shunt circuit around such resistance containing one or more electro depositing cells provided with amalgamated zinc electrodes for determining the current in the main circuit. 5th. A meter for measuring the current in any electric circuit consisting of a known resistance in such circuit, around which is a shunt circuit containing one or more electro depositing cells with amalgamated metallic electrodes and resistances for compensating for the effect of changes of temperature on the resistance of such cells. 6th. The combination with electro depositing cell acting as a meter of a circuit closer and breaker arranged to break the meter circuit, when no translating devices are in operation and to close such meter circuit when a single translating device is put into operation. 7th. The combination, with an electro circuit having a definite and known resistance, of one or

more electro depositing cells arranged in shunt around such resistance, and an electro magnet in the main circuit or in a shunt or multiple arc circuit therefrom operating to open and close the meter shunt. 8th. In an electrolytic cell voltmeter, a carbon or other resistance heated by an electric current and arranged in proximity to the cell or cells, for maintaining the temperature of the solution above the freezing point. 9th. In an electrolytic cell voltmeter, the combination of a carbon or other resistance arranged in proximity to the cell or cells, and an automatic thermo-circuit regulator for making and breaking the circuit of the resistance. 10th. In an electrolytic cell voltmeter, the combination of a carbon or other resistance arranged in proximity to the cell or cells, and an automatic thermo-circuit regulator composed of a spring and contact lever for making and breaking the circuit of the carbon or other resistance. 11th. In an electrolytic cell voltmeter, the plates of the cell retained a definite distance apart by means of non-conducting blocks or strips and removably clamped upon such blocks or strips. 12th. In an electrolytic cell for voltmeters composed of a copper vessel and a removable copper cylinder placed in such vessel and insulated therefrom, the connection being made with such vessel and cylinder. 13th. The method of maintaining the solution of an electrolytic cell above the freezing point consisting in heating the same from a carbon or other resistance, the circuit of which is made or broken automatically by the fall and rise of the temperature.

No. 13,907. Improvements on Barbs for Fences. (*Perfectionnements aux pointes des clôtures.*)

William W. Butler, Boise City, Idaho, U. S., 26th December, 1881: for 5 years.

Claim.—1st. A barb for fences adapted to yield to pressure applied in any direction. 2nd. A barb for fences adapted to yield to pressure applied in any direction and to resume its normal position by its own elasticity. 3rd. A barb for wire fences consisting of a coil of wire having its ends bent within the coil and then outward, to form the needle points or barbs. 4th. A barb wire for fences consisting of a coil of wire in the form of an elongated ellipse provided with the shoulders *d* and having its ends bent within the coil, and then outward, to form the needle points or barbs *b*. 5th. The combination, with coil provided with shoulders *d* and the needle points *b*, of the buttons *c*. 6th. The combination, with coiled wire *a* and the fence wires *b*, of the V-shaped clasp *A*.

No. 13,908. Appliance to be Attached to the Shoes of Animals to Afford a Better Foothold. (*Appareil à attacher aux fers des animaux pour mieux prendre pied.*)

Henry Bland, Luton, Eng., 26th December, 1881: for 5 years.

Claim.—The peculiar construction of roughs or cogs, and mode of securing the same in the shoes of animals.

No. 13,909. Improvements on Harvesters. (*Perfectionnements aux moissonneurs.*)

Alanson Harris, John Harris and James R. Osborne, (Assignees of John C. McLachlan,) Brantford, Ont., 28th December, 1881: for 5 years.

Claim.—1st. In harvesting machines, a tilting lever rigidly connected to the hinged pole or tongue of the machine, in combination with the grain wheel adjusting chain so arranged that, in tilting the machine, the movement of the tilting lever imparts simultaneously a vertical adjustment on the grain wheel side of the machine. 2nd. In combination with a grain wheel, adjusting lever pivoted on the tilting lever and so connected to the grain wheel that a vertical adjustment can be imparted to the grain wheel side of the machine without affecting the inside. 3rd. A ratchet sheaf pivoted to the tilting lever and having attached to it the grain wheel adjusting chain, in combination with a ratchet pawl pivoted to the tilting lever and operated by the grain wheel adjusting lever. 4th. In a harvesting machine having a lever seat arranged to adjust the inside of the machine, a tilting lever rigidly fastened to the hinged tongue or pole of the machine, in combination with a rack bar connected to the main frame of the machine and a chain connecting the tilting lever to the grain wheel, by means of which either side or both sides of the table may be raised or lowered by the one tilting lever. 5th. In a harvesting machine having the finger beam bolted rigidly to and adjusted with the main frame of the machine of the combination of a diagonal brace extending from the finger beam to the hinged pole or tongue of the machine. 6th. In a harvesting machine, a chain *N* attached to the grain wheel arm *R* and passing over the grooved pulley *P* located at the base of the rake jack stand and grooved pulley *O* on the pitman head cover, in combination with the ratchet sheaf *I* pivoted on the tilting lever *E* and operated by the lever *J*. 7th. A diagonal brace extending from the hinged tongue or pole of the machine, in combination with a triangular washer bolted to the finger beam and table and forming a flexible connection for the said brace. 8th. The combination, with the cutter bar, of a wedge-shaped shield extending over the outside end of the cutter bar and forming a grain divider. 9th. The combination, with the pole *B*, of a pole block *C*, forming one member of the hinge *D*, connecting the pole to the main frame *A* and shaped to receive the tilting lever *E*, which is bolted to it as specified. 10th. In a grain wheel, adjusting chain *X* connected to the grain wheel arm *R* by an eye pin entering from the top side of the arm and secured by the clamp *T*. 11th. A pawl *H* pivoted to the tilting lever *E* and having a slotted passage way *h* cut in it, in combination with the lifting rod *i* connected to the lever *J* and operated for the purpose of throwing the pawl in and out of gear. 12th. A grain wheel adjusting chain *N* connected to the ratchet sheaf *I* pivoted on the tilting lever *E* and prevented from revolving in one direction by the slotted pawl *H* with blocks *M* on the face of the said sheaf, in combination with lever *J* pivoted to the tilting lever *E* on the same centre as the sheaf *I*, and provided with a lifting rod *i* passing through a

slot *h* in the pawl *H*, and secured to the lever *J*. 13th. The table *B* having notched stringers *u*, in combination with the spring truss *X* and bolt *u* arranged as specified.

No. 13,910. Improvements on Ranges. (*Perfectionnements aux ardoisiers.*)

Giles F. Filley, (Assignee of David A. Nation,) St. Louis, Mo., U. S., 28th December, 1881: for 5 years.

Claim.—1st. In a range *A*, the combination of the flues *C H N*, said flues *C H* being partly separated by the strips *K K* arranged and located between the sides *a a* respectively and leaving an opening at the top between the inner ends of the strips at the centre of the range. 2nd. In a range *A*, the combination of the flues *C D D E E F F G H N*, and the centre damper *M* and strips *K K*, said strips extending respectively from the sides *a a* and forming an opening at the centre of said range to be closed by said damper.

No. 13,911. Improvements on Lubricators. (*Perfectionnements aux graisseurs.*)

Omar H. Jewell and George A. Stannard, Chicago, Ill., U. S., 28th December, 1881: for 5 years.

Claim.—1st. The combination, with the valve rod *F*, arm *G*, operating rod *H* and spring *I*, of the bevelled lift plate or projection *O* located on the revolving part of a machine and striking the lower end of the operating rod, so as to lift the same directly. 2nd. In a moving lubricator the diaphragm *E* dividing off the chamber *E* in the cap from the body of the lubricator, in combination with an air vent entering said chamber. 3rd. In a moving crank pin lubricator, the combination, with the cup of the diaphragm *E* forming the chamber *E* in top of the cup, the working valve rod *F* passing through such diaphragm and the top of the cup, the stuffing box *d* and opening *L*.

No. 13,912. Improvements on Fire Engines. (*Perfectionnements aux pompes à feu.*)

Benjamin J. C. Howe, Syracuse, and Silas B. Babcock, Geddes, N. Y., U. S., 28th December, 1881: for 5 years.

Claim.—1st. A horse power fire engine composed of two or more double acting force pumps grouped at the centre of a horizontal driving wheel and connected with said wheel by suitable actuating mechanism, all mounted on a suitable vehicle and having extended from the driving wheel a lever adapted for the connection thereto of the animal power required for operating the said driving wheel and pumps connected therewith. 2nd. The combination, with pumps *P P P*, of the frames *F and F* extended respectively from opposite ends of the pumps and supported at their free ends by the two axles of a vehicle, the cranks *C C C* journaled on the frames *F F* and connected each with one of the piston rods, and provided above the aforesaid frames with the pinion *D*, the spur wheel *E* mounted centrally over the pumps and engaging the respective pinions and provided with the lever *L*. 3rd. In combination with the pump cylinder *P P P* arranged side by side, the valve chambers *b b* extended respectively across opposite ends of the several pump cylinders, the water induction and water eduction chambers *B B* and *B B* arranged respectively above and below the valve chambers, and extended the length thereof, the ducts *G G* connecting respectively the two induction chambers and the two eduction chambers, and provided, the one with the suction pipe *H* and the other with the discharge pipe *I*. 4th. The combination of the pumps *P P P* connected at their ends by the valve chambers *b b*, the water induction chambers *B B G* arranged underneath the valve chambers, the eduction chambers *B B G* placed above the valve chambers, the air chamber *K* connected with the eduction chamber by the neck *u*, the driving wheel *E* pivoted on said neck, the pinions *D D D* attached to the cranks *C C C*, and the piston rods connected with said cranks. 5th. In combination with the pumps *P P P* carried on a vehicle, the driving wheel *E* mounted horizontally on said pumps and provided with hounds *N* having boxes *e e*, with set screw *s*, and the lever *L* adapted to slide endwise in said boxes and clamped by the set screw.

No. 13,913. Improvements in Wind-Mills. (*Perfectionnements aux moulins à vent.*)

Frederick J. Lee, Mallorytown, Ont., 29th December, 1881: for 5 years.

Claim.—1st. The combination of a driving wheel carrying an adjustable sail on each spoke, a frame *E* reciprocated in the vane frame *C* and operating the sails by intermediate levers, a pivotal staff *F* having flag board *R* to move the frame *E* in one direction by pressure of wind on the flag board, and a weighted arm *X* to reciprocate it in an opposite direction when the wind falls to cause the sails to be automatically feathered and set broadside to the wind. 2nd. A driving wheel having spokes, each spoke carrying a feathering sail, the sails connected in two sets by links *M* and operated by a reciprocating frame *E* and levers. 3rd. The combination, with the vane frame *C* of a wind-mill, of a reciprocating frame *E*, pivotal staff *F* having flag board *R* and a weighted arm *X* for closing and opening the sails. 4th. The weighted arm *X* connected by levers to the reciprocating frame *E*, rope *N* and pulley posts *N N* for feathering the sails by manual power.

No. 13,914. Improvements on Thill Couplings. (*Perfectionnements aux armons des limonnières.*)

Amasa Kasson, Milwaukee, Wis., U. S., 29th December, 1881: for 5 years.

Claim.—1st. The thill coupling composed of two segments fitted together with grooves and projections, and provided with the grooved oil reservoir *C* and oil wells *b b b b*. 2nd. The thimble or pocket *Cat* attached to the thill strap *A*. 3rd. In combination with the thills of a wagon or buggy, the straps *A* and *B* provided with the projections and recesses intermeshing together, with the oil groove *c* and oil wells *b b b b* and orifice *X*.

No. 13,915. Improvements on Axle Bearings. (*Perfectionnements aux coussinets des essieux.*)

Amasa Kasson, Milwaukee, Wis., U. S., 29th December, 1881: for 5 years.

Claim.—1st. The combination of the box B provided with the two conically shaped bearings at the ends; the axle A provided with the interior cone E and the conically shaped washer C. 2nd. The combination of the axle H provided with the conically shaped shoulder E, the box B conically tapered at both ends, and the conically shaped washer C provided with the wear washer D.

No. 13,916. Improvements on Spring Hoes and Grain Drills. (*Perfectionnements aux hoes et aux semoirs-traveurs elastiques.*)

James Noxon and Thomas H. Noxon, Ingersoll, Ont., 29th December, 1881: for 5 years.

Claim.—1st. In a grain drill, the combination, with the hoe B and drag bars A A, of a rocking cylinder H axially journaled between the drag bars, spring J wound spirally around said cylinder the free end secured to a lug I of the cylinder, the other end attached to a fixture, links F F pivotted to a lug G of the cylinder, and to a plate D or pin C of the hoe above the pivot point of its connection with the drag bars, and eccentric O forming a stop for an arm N of cylinder H, whereby the primary resistance of the hoe to an obstruction can be

weakened or strengthened by throwing the pivotal end of links F F more or less out of line with the axis of cylinder H, by the adjustment of the eccentric O raising or lowering the arm N, the spring J re-acting to retract the hoe to a normal position, after yielding to, and passing over an obstruction. 2nd. The combination with a hoe and drag bars pivoted thereto, of a cylinder H rocked by links F F, and yielding hoe, and re-acted by the expansion of a spiral J wound around said cylinder. 3rd. The drag bars A A pivoted at the end to a plate D or to a fin C of the hoe, links F F pivoted to said plate or fin above the drag bars, rocking cylinder H journaled between said drag bars, in advance of their pivotal connection with the hoe, said cylinder having an arm G pivoted to the lower end of the links, and a stop arm N, whereby the arm is retained retentively. 4th. In combination with a cylinder H journaled between the drag bars of a grain drill and spring J wound spirally around said cylinder, the cylinder L axially secured between the drag bars by a clamping bolt, and provided with interlocking faces. 5th. In combination with spring J wound around a cylinder H journaled between the drag bars A A pivoted to the hoes B or plate D and connected to the hoes by links F F, the cylinder L axially secured between the bars A A and having a flange M and projection K to secure the end of spring J fixedly. 6th. The combination of cylinder H journaled between drag bars A A pivoted to the hoe links F F jointedly connected to the cylinder, and spring J wound spirally around said cylinder, the free end of the spring connected thereto, and the other end to a fixture, whereby, when the hoe yields to an obstruction, the cylinder rocks and winds the spring thereon for re-action, to retract the hoe to its normal position.



INDEX OF INVENTIONS.

Augers, P. A. Gladwin..... 13,784
 Bags, mail, A. F. Martel..... 13,871
 " paper, R and J. Kilgour..... 13,863
 Balloons, aerial, C. A. Apraxine..... 13,782
 Barbs for fences, W. W. Butler..... 13,907
 Bearings, anti-frictional, T. R. Ferrall..... 13,905
 " axle, A. Kasson..... 13,915
 Beaters, egg, T. W. Brown..... 13,842
 Bed bottoms, spring, E. T. Slayton..... 13,864
 Bench, chair and wash, D. L. Richards..... 13,822
 Berths, self levelling, J. H. Porter..... 13,874
 Blinkers, bridle, A. Hosack et al..... 13,885
 Blocks, head, W. J. F. Liddell..... 13,844
 Boards, splash, L. E. McKinnon..... 13,840
 Boats, D. Urch..... 13,830
 Bolts, keys for, G. B. Taylor et al..... 13,779
 " window, P. Houle..... 13,799
 Boilers, steam, T. Sharp..... 13,839
 Boots and shoes, E. Fisher..... 13,800
 " " T. Laurin..... 13,862
 " " W. F. Hutchinson..... 13,899
 " " heeling, D. Whitlock..... 13,771
 Boxes, wooden, J. Womersley..... 13,882
 Brakes, car, A. Benoit..... 13,879
 Breaching hooks, W. L. Gilchrist..... 13,897
 Bronze, manufacture of, H. H. Vivian..... 13,878
 Buckles, harness, D. C. Bassett..... 13,767
 Burners, incandescent, W. M. Jackson..... 13,904
 Burning apparatus, fuel, J. Wolstenholme..... 13,817
 " " soft coal, H. R. Ives..... 13,837
 Burnishing machine, heel, W. F. Hutchinson..... 13,899
 Buttons, spring, I. J. Saunders..... 13,769
 Cabinets and tables, The Manhattan Cabinet Mnf'g Co..... 13,780
 Catarrh, compound for, M. A. Reaves..... 13,797
 Catcher, bird insect, W. S. Burn et al..... 13,825
 Chair and wash bench, D. L. Richards..... 13,822
 Churns, F. Aldred..... 13,816
 Cleaner, track, A. Day..... 13,773
 Coal, burning soft, H. R. Ives..... 13,837
 Compressing machines, heel, E. Fisher..... 13,800
 Conductors, carbon, T. A. Edison..... 13,886
 Consumers, smoke, J. Elliott..... 13,772
 Consuming, smoke, H. R. Ives..... 13,837
 Cooking stoves, G. F. Filley 13,852, 13,853, 13,855, 13,858
 Cooler, milk, W. Cooley..... 13,808
 Cots, folding, T. W. B. Murray et al..... 13,766
 Couplings, car, D. Kunkel..... 13,841
 " strap, A. Van Luven..... 13,789
 " thill, A. Kasson..... 13,914
 Creepers, ice, H. Bland..... 13,901
 Crystallizing, grape sugar, H. Williams..... 13,861
 Cutting machines, oat, F. M. Kremer et al..... 13,849
 Damper regulators, D. C. Kelleman..... 13,898
 " stove pipe, W. F. Green..... 13,827
 Dashes, carriage, L. E. McKinnon..... 13,840
 Dredges, vacuum, J. F. Sanders..... 13,768
 Drills, grain, J. and T. H. Noxon..... 13,916
 " ploughs, J. Ley..... 13,790
 Drivers, first and intermediate, J. Westman..... 13,814
 " millstone, W. E. Sergeant..... 13,860
 Drying kilns, lumber, R. J. Rundell..... 13,851
 Electric machines, T. A. Edison..... 13,836
 Elevators, water, E. W. Vanduzen..... 13,900
 Engines, fire, B. J. C. Howe et al..... 13,912
 Envelope machines, H. J. Wickham..... 13,776
 Faucets, G. W. Hilliards..... 13,843
 Feeders, automatic, C. E. Sage..... 13,832
 Fencing, barbed, J. F. Walmsley..... 13,846
 Fibres, separating, G. M. and A. L. Rice..... 13,838
 Fire engines, B. J. C. Howe et al..... 13,912
 Fish, preserved, C. Alden..... 13,895
 Fuel burning apparatus, J. Wolstenholme..... 13,817
 Furnaces, steam boiler, G. E. Palmer..... 13,868
 " water, A. N. and L. M. A. Aubin..... 13,831
 Galleys, printers', W. J. G. McAndrew et al..... 13,872
 Generator, steam, E. R. Whitney et al..... 13,807
 Gibs for bolts, G. B. Taylor et al..... 13,779
 Grates, furnace, G. E. Palmer et al..... 13,867
 Guns, multicharge, J. R. Haskell..... 13,823
 Hangers for shafting, P. Cramer..... 13,794
 Harness, C. E. Berry..... 13,796
 Harrows, A. F. McLean..... 13,834
 Harvesters, A. Harris et al..... 13,909
 " J. Harris..... 13,887
 Head blocks, W. J. F. Liddell..... 13,844

Heaters, J. Johnson..... 13,793
 " and ventilators, W. F. Condon..... 13,801
 Heeling machines, D. Whitlock..... 13,771
 Hoes, spring, J. and T. H. Noxon..... 13,916
 " J. O. and W. S. Wisner..... 13,806
 Hoisting machines, A. Leitch et al..... 13,783
 Holdbacks, W. L. Gilchrist..... 13,897
 Hooks, breeching, W. L. Gilchrist..... 13,897
 Hose and socks, shapes for, W. B. Pollock..... 13,896
 Illuminating tiles, The Sanitary Mnf'g Co'y..... 13,826
 Joints, well tubing, J. A. Beverly..... 13,847
 Keys for bolts, G. B. Taylor et al..... 13,779
 Kilns for drying lumber, R. J. Rundell..... 13,851
 Knitting machines, J. Bradley..... 13,786
 Lamps, electric, J. Best et al..... 13,778
 " " T. A. Edison..... 13,835
 Leather skiving machine, M. A. Holton..... 13,819
 Lighting, electric, T. A. Edison..... 13,875
 Lubricators, O. H. Jewell et al..... 13,911
 " " engine, H. R. A. Boys..... 13,877
 Marble, artificial, J. W. McKnight..... 13,811
 Meters, electro, T. A. Edison..... 13,906
 Middlings, purifiers, C. E. Sage..... 13,832
 Millstone drivers, W. E. Sergeant..... 13,860
 Mineral substances, pulverizing, L. F. Holman..... 13,869
 Mowers, lawn, E. G. Passmore..... 13,803
 Mucous diseases, compound for, M. A. Reaves..... 13,824
 Nut lock, J. B. Doray et al..... 13,797
 Oat cutting machine, F. M. Kremer et al..... 13,802
 Ovens, stove and range, G. F. Filley..... 13,857
 Packages, butter, C. Blacktin..... 13,894
 Paint, fire-proof, J. Butler..... 13,798
 Pans, drip, C. E. Laverty..... 13,818
 " milk, W. Cooley..... 13,808
 Pavement, J. B. A. Brouillet..... 13,777
 Pegging machines, T. Laurin..... 13,862
 Plaster of Paris, J. M. Reid..... 13,876
 Ploughs, drill, J. Ley..... 13,790
 Powers, horse, A. Muir..... 13,889
 Pulleys, wood rim, W. W. Carey..... 13,845
 Pulverizing mineral substances, L. F. Holman..... 13,869
 Punching machines, heel, E. Fisher..... 13,800
 Purifiers, middlings, C. E. Sage..... 13,832
 Ranges, G. F. Filley..... 13,854, 13,884
 " and stoves, G. F. Filley..... 13,852, 13,853, 13,856
 Refrigeration system, J. J. Bates..... 13,812
 Refrigerators, A. S. Haslam..... 13,813
 Regulators, damper, D. C. Kelleman..... 13,902
 Reins check, F. L. Jones..... 13,898
 Replaces, car, J. Parker..... 13,850
 Roasters, coffee, G. A. Beidler..... 13,815
 Rods, metallic, S. W. Skinner et al..... 13,800
 Sawing machines, R. Smart et al..... 13,866
 Saw mills, W. J. F. Liddell..... 13,820
 Scrapers, earth, A. R. Byrckett..... 13,844
 Seeding machines, J. W. Mann..... 13,903
 Setting machines, edge, W. F. Hutchinson..... 13,833
 Sewing machines, J. Mathison..... 13,899
 " " The Manhattan Cabinet Mnf'g Co'y..... 13,788
 " " "..... 13,780
 Shafting, hangers for, P. Cramer..... 13,794
 Shapes for hose and socks, W. B. Pollock..... 13,896
 Shippers, belt, B. H. Hadley..... 13,791
 " belt, W. Gray..... 13,870
 Shoes, H. W. Burr..... 13,770
 Sifters, coal, J. F. Andrews..... 13,838
 Skates, E. G. Macomber..... 13,829
 Skin diseases, compound for, M. A. Reaves..... 13,797
 Skiving machine, leather, M. A. Holton..... 13,819
 Smoke consumers, J. Elliott..... 13,772
 " consuming, H. R. Ives..... 13,837
 Socks and hose, shapes for, W. B. Pollock..... 13,896
 Spark arresters, J. J. Hewitt..... 13,896
 Splash boards, L. E. McKinnon..... 13,840
 Steam superheating apparatus, A. Estrade..... 13,890
 Steam vessels, L. P. Fairbanks..... 13,792
 Stone, artificial, J. W. McKnight..... 13,811
 Stoves and ranges, G. F. Filley..... 13,852, 13,853, 13,856
 " cooking, G. F. Filley..... 13,855, 13,858
 " oil, L. C. Heckman..... 13,857
 Sugar crystallizing, grape, H. Williams..... 13,861
 Suspenders, trousers, J. Cohen..... 13,883
 Switches, railway, T. Solte..... 13,821
 Tables and cabinets, The Manhattan Mnf'g Co'y..... 13,780
 Telegraphs, T. A. Edison..... 13,775
 Telephones, W. J. Dudley..... 13,785
 Telephony, electric, The Canadian Telephone Co 13,809
 Thrashing machines, W. R. Allen..... 13,810
 Ties, bag, J. L. Vandermark..... 13,805
 "..... 13,881

Tiles, illuminating, The Sanitary Mnf'g Co'y.....	13,826
" marble and stone, J. W. McKnight.....	13,811
Trap, bird insect, W. S. Burn et al.....	13,825
Tubing joints, well, J. A. Beverly.....	13,847
Valve stem, piston and cylinder, A. N. Matthews et al.....	13,804
Ventilation system, J. J. Bates.....	13,813
Ventilators and heaters, W. F. Condon.....	13,801
Vessels, steam, L. P. Fairbanks.....	13,792
Waggons, spring, L. M. Fitch et al.....	13,848
Wash bench, chair and, D. L. Richards.....	13,822
Water purifying, T. Sharp.....	13,839
Windmills, F. J. Lee.....	13,913
" W. Forbes.....	13,873
Wrenches, H. A. Thompson.....	13,865

INDEX OF PATENTEES.

Alden C., preserved fish.....	13,895
Alfred F., churns.....	13,815
Allen, W. R., thrashing machines.....	13,805
Andrews, J. F., coal sifters.....	13,888
Apraxine, Ct. A., aerial balloons.....	13,781
Aubin, A. N. and L. M. A., water furnaces.....	13,831
Babcock, J. B., et al., fire engines.....	13,912
Baker, C. J., et al., folding cots.....	13,766
Bassett, D. C., harness buckles.....	13,767
Bates, J. J., ventilation, etc.....	13,813
Beldler, G. A., coffee roasters.....	13,880
Bell, J. A., et al., electric lamps.....	13,778
Benoit, A., car brakes.....	13,879
Berry, C. E., harness.....	13,796
Best, J., et al., electric lamps.....	13,778
Beverly, J. A., well tubing joints.....	13,847
Blacktin, C., butter packages.....	13,894
Bland, H., ice creepers.....	13,901
Bossi, C. L., et al., steam generator.....	13,807
Boys, H. R. A., et al., engine lubricators.....	13,877
Bradley, J., knitting machines.....	13,786
Brouillet, J. B. A., pavement.....	13,777
Brown, T. W., egg beaters.....	13,842
Burn, W. S., et al., bird insect catcher.....	13,825
Burr, H. W., shoes.....	13,779
Butler, J., fire-proof paint.....	13,798
Butler, W. W., bars for fences.....	13,907
Byrkett, A. R., earth scrapers.....	13,903
Canadian Telephone Co. The, electric telephony.....	13,809
Canadian Telephone Co'y. The, telegraphs.....	13,774
Carey, W. W., wood rim pulleys.....	13,845
Clark, A. D., et al., spring waggons.....	13,848
" B. S., et al., keys for bolts.....	13,779
" M., et al., valve stem.....	13,804
Clary, T. E., et al., valve stem.....	13,804
Cohen, J., trouser suspenders.....	13,883
Condon, W. F., stoves and ventilators.....	13,801
Cooley, W., milk cooler.....	13,808
Coulthard, W., spring hoes.....	13,806
Craig, J. A. J., et al., steam generator.....	13,807
Cramer, P., hangers for shafting.....	13,794
Day, A., track cleaner.....	13,773
Doray, J. B., and S., et al., nut locks.....	13,802
Dudley, W. J., telephones.....	13,785
Eastwood, J., et al., printers' galleys.....	13,872
Edison, T. A., carbon conductors.....	13,886
Edison, T. A., electric lamps.....	13,835
Edison, T. A., electric lighting.....	13,875
Edison, T. A., electric machines.....	13,836
Edison, T. A., electro-meters.....	13,906
Edison, T. A., telegraphs.....	13,775
Elliott, J., smoke consumers.....	13,772
Estrade, A., steam superheating apparatus.....	13,890
Fahs, J. F., et al., oat cutting machines.....	13,849
Fairbanks, L. P., steam vessels.....	13,792
Ferrall, T. R., anti-frictional bearings.....	13,905
Filley, G. F., cooking stoves.....	13,855, 13,858
Filley, G. F., ranges.....	13,854, 13,884
Filley, G. F., stoves and ranges.....	13,852, 13,853, 13,856
Fisher, E., heel compressing and punching.....	13,800
Fitch, L. M., et al., spring waggons.....	13,848
Forbes, W., windmills.....	13,873
Gilchrist, W. L., breeching hooks.....	13,897
Gladwin, P. A., augers.....	13,784
Gray, W., belt shippers.....	13,870
Green, W. F., stove pipe dampers.....	13,827
Hadley, B. H., belt shippers.....	13,791
Harris, A., and J., et al., harvesters.....	13,909
" J., ".....	13,887
Harrison, J. M., et al., bridle blinkers.....	13,885

Haskell, J. R., multicharge guns.....	13,823
Haslam, A. S., refrigerators.....	13,902
Hackman, L. C., oil stoves.....	13,891
Hewitt, J. J., spark arresters.....	13,795
Hilliards, G. W., faucets.....	13,843
Holman, L. F., pulverizing apparatus.....	13,869
Holton, M. A., leather skiving machine.....	13,819
Hosack, A., et al., bridle blinkers.....	13,885
Houle, P. window bolts.....	13,799
Howe, B. J. C., et al., fire engines.....	13,912
Hutchinson, W. F., boots and shoes.....	13,899
Ives, H. R., burning soft coal.....	13,837
Jackson, W. M., incandescent burners.....	13,904
Jewell, O. H., et al., lubricators.....	13,911
Johnson, J., heaters.....	13,793
Jones, F. L., check rims.....	13,850
Kasson, A., axle bearings.....	13,915
" " thill couplings.....	13,914
Kelk, J., bird insect catcher.....	13,825
Kellem, D. C., damper regulators.....	13,898
Kennedy, R., et al., printers' galleys.....	13,872
Kilgour, R. and J., paper bags.....	13,863
Kremer, F. M., and J. C., et al., oat cutting machines.....	13,849
Kunkel, D., car couplings.....	13,841
Langlois, J. T., et al., nut locks.....	13,802
Laurin, T., pegging machines.....	13,862
Lavery, C. E., drip pans.....	13,818
Lee, F. J., windmills.....	13,913
Lindback, F. W., et al., paper bags.....	13,863
Leitch, A., et al., hoisting machines.....	13,783
Ley, J., drill ploughs.....	13,790
Liddell, W. J. F., head blocks.....	13,844
Luckenbach, F. A., et al., pulverizing apparatus.....	13,869
McAndrew, W. J. G., et al., printers' galleys.....	13,872
McKinnon, L. E., splash boards.....	13,840
McKnight, J. W., artificial marble.....	13,811
McLean, A. F., barrows.....	13,834
Macomber, E. G., skates.....	13,829
Manhattan Cabinet Mnf'g. Co. The, tables and cabinets.....	13,780
Mann, J. W., seeding machines.....	13,833
Martel, A. F., mail bags.....	13,871
Mathison, J., sewing machines.....	13,788
Matthews, A. N., et al., valve stem.....	13,804
Muir, A., horse power.....	13,889
Murray, T. W. B., et al., folding cots.....	13,766
Nation, D. H., ranges.....	13,910
Noxon, J., and T. H., grain drills.....	13,916
Osborne, J. K., et al., harvesters.....	13,909
Palmer, G. E., steam boiler furnaces.....	13,868
" " et al., furnace grates.....	13,867
Parker, J., car replacers.....	13,815
Pasmore, E. G., lawn mowers.....	13,803
Pelletier, A., pavement.....	13,777
Porter, J. H., self-levelling berths.....	13,874
Reaves, M. A., compound for catarrh.....	13,797
Reid, J. M., plaster of Paris.....	13,876
Rice, G. M. and A. L., separating fibres.....	13,828
Richards, D. L., chair and wash bench.....	13,822
Rowell, G. A., et al., furnace grates.....	13,867
Rundell, R. J., lumber drying kilns.....	13,851
Sage, C. E., middlings purifiers.....	13,832
Saunders, J. F., vacuum dredges.....	13,768
Sanitary Mnf'g Co'y. The, illuminating tiles.....	13,826
Sanders, I. J., spring buttons.....	13,769
Sergeant, W. E., millstone drivers.....	13,860
Sharp, T., steam boilers.....	13,839
Skinner, S. W., et al., metallic rods.....	13,866
Slayton, E. T., spring bed bottoms.....	13,864
Smart, R., sawing machines.....	13,820
Solte, I., railway switches.....	13,821
Stannard, G. A., et al., lubricators.....	13,911
Stone, J. H., et al., bird insect catcher.....	13,825
Taylor, G. B., et al., gibs for bolts.....	13,779
Thomas, W. M., et al., metallic rods.....	13,866
Thompson, H. A., wrenches.....	13,865
Turnbull, M., et al., hoisting machines.....	13,783
Urch, D., boats.....	13,830
Vandermark, J. L., bag ties.....	13,881
Vanduzen, E. W., water elevators.....	13,900
Van Luven, A., strap couplings.....	13,789
Vivian, H. H., manufacture of bronze.....	13,878
Walker, B. F., well tubing joints.....	13,847
Walmsley, J. F., barbed fencing.....	13,846
Westman, J. and W. D., drivers.....	13,814
Witlock, D., heeling machines.....	13,771
Whitney, E. R., et al., steam generator.....	13,807
Wickham, H. J., envelope machines.....	13,776
Williams, H., grape sugar crystallizing.....	13,861

Winslow, J. M., et al., valve stem.....	13,804	Wolstenholme, J., fuel burning apparatus.....	13,817
Wisner, J. O. and W. S., spring ho s.....	13,806	Wood, J., et al., keys for bolts.....	13,779
Wolfender, J., et al., pulverizing apparatus.....	13,869	Womersley, J., wooden boxes.....	13,882
Wolle, C. A., et al., paper bags.....	13,863	Worthington, A., et al., furnace grates.....	13,867

Patents issued up to 8th February, 1882, Claims and Drawings of which will appear in a subsequent number of the Patent Record.

No. 13,917. F. Blake, Weston, Mass. "Switch Board," Patented January 2nd, 1882.
 No. 13,918. D. Conboy, Uxbridge, Ont. "Seat Rails for Carriage Tops" (Re-issue of Patent No. 10,150.) Jan. 2nd, 1882.
 No. 13,919. C. Semper, and C. Fahlberg's Phil. "Method of removing Iron from Ferruginous Aluminous Solutions," Jan. 2nd, 1882.
 No. 13,920. The Rand Drill Company, New York. (Assignees of J. C. Githens.) "Steam Rock Drill," Jan. 2nd, 1882.
 No. 13,921. A. E. F. Challaway, Wixford, England. "Corn Mills," Jan. 2nd, 1882.
 No. 13,922. C. Kaiser, Prairie du Chien, Wis. "Steam Boiler Cleaner," Jan. 2nd, 1882.
 No. 13,923. I. A. Williams, Utica, N.Y. "Head Lights for Locomotives," Jan. 2nd, 1882.
 No. 13,924. I. A. Williams, Utica, N.Y. "Head Lights for Locomotives," Jan. 2nd, 1882.
 No. 13,925. C. E. Avery, Boston, Mass. "Raising Bread," Jan. 2nd, 1882.
 No. 13,926. C. Shepardson, Cazenovia, N.Y. "Straw Cutter," Jan. 2nd, 1882.
 No. 13,927. J. Pye, Quebec, "Heating Apparatus," Jan. 2nd, 1882.
 No. 13,928. C. S. Smith, County of Leicester, and T. Moora, County Derby, England. "Steam Generating Incombustible Cartridge," Jan. 2nd, 1882.
 No. 13,929. F. M. Hathaway, Jersey, N.J. "Knobs," Jan. 2nd, 1882.
 No. 13,930. R. F. Dobson, Darlington, Wis. I. Dobson, Lincoln, Nebraska. "Hides," Jan. 2nd, 1882.
 No. 13,931. J. E. Smith, Wilkesbarre, Penn. "Car Couplings," Jan. 2nd, 1882.
 No. 13,932. A. C. Whittier, Boston, Mass. "Dredges," Jan. 2nd, 1882.
 No. 13,933. A. D. Polsgrove, B. R. Davis, Catawisa, Penn. "Flower Crook," Jan. 2nd, 1882.
 No. 13,934. The Norton Door Check and Spring Company, Portland, Maine, (Assignee of L. C. Norton, Boston, Maine.) "Door Check and Spring," Jan. 2nd, 1882.
 No. 13,935. A. W. Burke, Stayner, Ont. "Paint," Jan. 2nd, 1882.
 No. 13,936. J. J. Read, Dublin, Ireland. "Rotary Motion," Jan. 2nd, 1882.
 No. 13,937. P. Routhledge, Township of King, Ont. "Toe Cork," Jan. 2nd, 1882.
 No. 13,938. A. Conroy, M. Conroy, Liverpool, Eng. "Malt Coffee," Jan. 2nd, 1882.
 No. 13,939. W. E. MacDonald, Borough of Sandy Lake, Penn. "Injector," Jan. 2nd, 1882.
 No. 13,940. J. MacDonald, London, Eng. "Gas," Jan. 2nd, 1882.
 No. 13,941. J. Patrick Dunn, Thomas Harris, Côte St. Paul, Que. "Wire Staple," Jan. 2nd, 1882.
 No. 13,942. C. C. Gilman, Hardin City, Iowa. "Fire Proof Composition," Jan. 2nd, 1882.
 No. 13,943. L. Tilton, Brooklyn, New York. "Cancelling Stamp," Jan. 2nd, 1882.
 No. 13,944. A. Fiddes, Bristol, England. "Gas Motor Engines," Jan. 2nd, 1882.
 No. 13,945. J. M. Dodge, Chicago, Ill. "Chain Belt," Jan. 2nd, 1882.
 No. 13,946. J. A. Soley, Winnipeg, Manitoba. "Nut Locks," Jan. 2nd, 1882.
 No. 13,947. A. Estrade, Perpignan, France. "Rolling Stock," Jan. 2nd, 1882.
 No. 13,948. W. Wheeler, Concord, Mass. "Lighting Apparatus," Jan. 2nd, 1882.
 No. 13,949. J. Newton, Ottawa, Ont. "Horse Collar Stuffing Machine," Jan. 9th, 1882.
 No. 13,950. S. S. Newton, Binghampton, N.Y. "Lamps," Jan. 9th, 1882.
 No. 13,951. F. Wilhoft, N. Y. "Springs," Jan. 9th, 1882.
 No. 13,952. J. P. Lewallen, A. Woods, Nicholasville, Kentucky. "Car Couplings," Jan. 9th, 1882.
 No. 13,953. H. B. Gates, Stantead, Que. "Churns," January 9th, 1882.
 No. 13,954. R. L. M. de Prandieres, Lyons, France. "Fabrication de Agglomeres," January 9th, 1882.
 No. 13,955. R. G. Fraser, Halifax, N.S. "Cement," (Extension of Patent No. 6946.) Jan. 9th, 1882.
 No. 13,956. The Washburn and Moen Manufacturing Company, Worcester, Mass. (Assignees of Daniel C. Stover, Freeport, Ill.) "Barbed Metallic Strand Fencing," Jan. 9th, 1882.
 No. 13,957. H. V. DeWater, C. B. Nichols, Auburn, N.Y. "Churns," Jan. 9th, 1882.
 No. 13,958. The Hancock Inspirator Company, (Assignees of John Theobald Hancock,) Boston, Mass. "Inspirator," (Extension of Patent No. 7011.) Jan. 9th, 1882.
 No. 13,959. R. F. W. Loper, C. McKeone, Philadelphia, Penn. "Candle," Jan. 9th, 1882.
 No. 13,960. H. M. Dake, Nymda, N.Y. "Fruit Drier," Jan. 9th, 1882.
 No. 13,961. G. Ewing, Decatur, Ill. "Device for Catching and Holding Hogs," Jan. 9th, 1882.
 No. 13,962. W. McNaught, jr., Cartersville, Georgia. "Side Saddle Girth," Jan. 9th, 1882.
 No. 13,963. L. J. Bennett, Buffalo, N.Y. "Disintegrating Mill," Jan. 9th, 1882.
 No. 13,964. J. Hutchison Morris, T. Daniel Morris, Seward, Nebraska. "Animal Trap," Jan. 9th, 1882.
 No. 13,965. J. B. Armstrong, Guelph, "Spring," (Extension of Patent No. 7012.) Jan. 9th, 1882.
 No. 13,966. Wm. Coney, Westboro, "Boots and Shoes," Jan. 9th, 1882.
 No. 13,967. J. B. Waterston, and W. Zimmerman, Chicago, "Gold Brushing Machine," Jan. 9th, 1882.
 No. 13,968. J. Nelson, Rockford, "Knit Fabric," Jan. 9th, 1882.
 No. 13,969. J. F. Mahon, London, "Sulky Binder," Jan. 9th, 1882.
 No. 13,970. A. E. McDonald, Brooklyn, "Freight Transfer," Jan. 9th, 1882.
 No. 13,971. H. T. Perram, Stamford, "Thill Coupling," Jan. 9th, 1882.

No. 13,972. L. A. M. C. S. Robert, Paris. "Turfurine," Jan. 11th, 1882.
 No. 13,973. W. B. Pollock, Montreal. "Hose," Jan. 11th, 1882.
 No. 13,974. N. C. Green, South Brooklyn. "Skirt Adjuster," Jan. 11th, 1882.
 No. 13,975. J. Cruikshank, Weston. "Attachment for Waggon," Jan. 11th, 1882.
 No. 13,976. Wm. D. McGlochlou, London. "Coffin," Jan. 11th, 1882.
 No. 13,977. A. Allaire, et F. Allaire, St. Lin, Que. "Réfrigérateurs," Jan. 11th, 1882.
 No. 13,978. Wm. E. Howarth, St. Thomas. "Combined Fanning Mill and Grain Separator," Jan. 11th, 1882.
 No. 13,979. J. T. Hancock, Jamaica Plains, "Inspirator," (Extension of Patent No. 7011.) Jan. 16th, 1882.
 No. 13,980. C. H. Guard, Dayton, "Hubs," Jan. 16th, 1882.
 No. 13,981. A. D. Clarke, Omaha. "Current Wheels and Floats," Jan. 16th, 1882.
 No. 13,982. R. W. Taylor, Bury St. Edmunds. "Saw Guard," Jan. 16th, 1882.
 No. 13,983. C. F. Simm, and Wm. Studer, Montreal. "Railway Brake," Jan. 16th, 1882.
 No. 13,984. J. Halley, and A. Barr, Glasgow. "Halley and Barr's Oxifer," Jan. 16th, 1882.
 No. 13,985. G. T. Tuckett, Hamilton. "Tobacco Caddy," Jan. 16th, 1882.
 No. 13,986. Wm. Sanderson, Township of Eramosa, Ont. "Plough or Shear Point," Jan. 16th, 1882.
 No. 13,987. L. Lawson, New York. "Open Back Saws," Jan. 16th, 1882.
 No. 13,988. J. D. Warren, Lyndonville, N.Y. "Vegetable Soup," Jan. 16th, 1882.
 No. 13,989. C. G. Buchanan, Brooklyn. "Electro-Magnetic Ore Separator," Jan. 16th, 1882.
 No. 13,990. F. L. D. Pierson, Montreal, Que. "Ice Cutting Machine," Jan. 16th, 1882.
 No. 13,991. C. H. Guard, Dayton, Ohio. "Hubs," Jan. 16th, 1882.
 No. 13,992. A. Yetted, Formosa, Ont. "Self Car Coupler," Jan. 16th, 1882.
 No. 13,993. Wm. A. Ingalls, Providence, R.I. "Device for Drawing Screw Patterns from the Mould," Jan. 16th, 1882.
 No. 13,994. S. B. Ellithorpe, Rochester, N.Y. "Lasting Machine," Jan. 16th, 1882.
 No. 13,995. C. S. Higgins, Brooklyn. "Soap Process," Jan. 16th, 1882.
 No. 13,996. G. S. Strong, Philadelphia, Penn. "Smoke Stack," Jan. 16th, 1882.
 No. 13,997. F. H. Ransom, Buffalo, N.Y. "Trunk," Jan. 16th, 1882.
 No. 13,998. T. D. Merman and A. Hyde, Buffalo, N.Y. "Pipe Wrench," Jan. 16th, 1882.
 No. 13,999. C. Keighley, Burnley, Eng. "Looms," Jan. 16th, 1882.
 No. 14,000. E. Bellarance, Montreal, Que. "Appareil de Chauffage à l'eau chaude," Jan. 16th, 1882.
 No. 14,001. S. S. Smith, Bryan, Ohio. "Nut Locks," Jan. 16th, 1882.
 No. 14,002. A. M. Kerr, Westminster, Ont. "Automatic Regulator," Jan. 16th, 1882.
 No. 14,003. H. Bever, London, Eng. "Skates," Jan. 16th, 1882.
 No. 14,004. J. H. Smale, St. Thomas, Ont. "Harrows," Jan. 16th, 1882.
 No. 14,005. F. Simonds, Grand Island, N.Y. "Plows," Jan. 16th, 1882.
 No. 13,006. R. Govens, Scarborough, Ont. "Wheels," Jan. 16th, 1882.
 No. 14,007. C. J. Hamilton, Plymouth, Mich. "Wind Mills," Jan. 16th, 1882.
 No. 14,008. H. Forley, Philadelphia, Penn. "Rollers," Jan. 16th, 1882.
 No. 14,009. J. Naylor, Sterling, N.J. "Articles from Plastic Material," Jan. 16th, 1882.
 No. 14,010. A. Pelletier, Washington, D. C. "Pavements," Jan. 16th, 1882.
 No. 14,011. Wm. Hamilton, Peterborough, Ont. "Machine for Sawing Lumber," Jan. 16th, 1882.
 No. 14,012. F. J. Hamilton, Orilla, Ont. "Lamps," January 16th, 1882.
 No. 14,013. The Starr Manufacturing Company, (Representing John Forbes,) Halifax, N.S. "Skates," (Extension of Patent No. 1344.) Jan. 16th, 1882.
 No. 14,014. E. F. Osborne, St. Paul, Minn. "Steam Heat and Power Supply," Jan. 19th, 1882.
 No. 14,015. J. Gould, Chatham, N. J. "Arithmetical Frame," Jan. 19th, 1882.
 No. 14,016. M. C. Root, Toledo, Ohio. "Heater," Jan. 19th, 1882.
 No. 14,017. H. Gruson, Bueckhnm, Prussia, A. Helkoff, Mayence, German Empire, J. Halbmayr, Marienback, Austrian Empire, "Gruson's Projectiles," Jan. 19th, 1882.
 No. 14,018. A. Edwards, Philadelphia, Penn. "Bennor's Basins," Jan. 19th, 1882.
 No. 14,019. J. C. Meyors and R. Barker, Bayfield, Ont. "Hanlan Reaper and Mower," Jan. 19th, 1882.
 No. 14,020. O. W. Ketchum, Toronto, Ont. "Adjustable Strap Boot," Jan. 19th, 1882.
 No. 14,021. T. A. Heintzman, Toronto, Ont. "Double Bearing Bridge for Upright Pianos," Jan. 19th, 1882.
 No. 14,022. F. A. Lyman, Cleveland, Ohio. "Gazoline Stove," Jan. 19th, 1882.
 No. 14,023. H. C. Strong and L. H. Lloyd, Chicago, Ill. "Strong's Relay Telephone," Jan. 19th, 1882.
 No. 14,024. B. L. Olds, St. Albans, Vermont. "Link for Horse Powers," Jan. 19th, 1882.
 No. 14,025. B. L. Olds, St. Albans, Vermont. "Speed Regulators," Jan. 19th, 1882.
 No. 14,026. W. N. Miller, Toronto, Ont. (Assignee of J. F. Lash, Hamilton, Ont.) "Clocks," Jan. 19th, 1882.
 No. 14,027. D. F. Babb, Kingsville, Ont. "Clothes Wringers," Jan. 16th, 1882.
 No. 14,028. T. S. Very, Boston, Mass. "Horse Shoes," Jan. 19th, 1882.

- No. 14,029. F. W. Brenton, Foxboro, Ont., "Barley Bearder," Jan. 19th, 1882.
- No. 14,030. F. Lightbody, Bath, Maine. "Tree Nail Burning Machine," Jan. 19th, 1882.
- No. 14,031. S. B. Pratt, Canandaigua, N.Y., "Gate Hinge and Roller," Jan. 19th, 1882.
- No. 14,032. O. J. Pinches, Plymouth, Mich., "Spring Tooth Harrows," Jan. 19th, 1882.
- No. 14,033. A. C. Engert, Middlesex, Eng., "Grate," Jan. 19th, 1882.
- No. 14,034. S. L. Bean, Washington, Columbia, "Dust Collectors for Flour Mills,"
- No. 14,035. K. M. Jarvis, Peabody, Mass., A. F. Upton, Boston, Mass., "Gas Furnace," (Extension of Patent No. 6984,) Jan. 19th, 1882.
- No. 14,036. W. H. Field, Portchester, (Assignee of W. J. Lane, Milbrook, N.Y., (Extension of Patent No. 6976,) Jan. 19th, 1882.
- No. 14,037. The G. C. G. Co., Guelph, Ont., (Extension of Patent No. 7012,) Jan. 19th, 1882.
- No. 14,038. T. Cushing, Montreal, Que., (Assignee of J. Foley, et al., Montreal, Que.,) "Filter," (Extension of Patent No. 6967,) January 19th 1882.
- No. 14,039. A. McDonald, Belmont, Mass., "Hammer," (Extension of Patent) January 19th 1882.
- No. 14,040. H. W. Searie, Hamilton, Ont., "Shovel," (Extension of Patent No. 7001,) January 19th, 1882.
- No. 14,041. P. Filman, Barton, Ont., "Sleigh Knee," (Extension of Patent No. 6996,) January 19th, 1882.
- No. 14,042. F. M. Lechner, Waynesburg, J. A. Jeffry, Colorado, Ohio, (Extension of Patent No. 12,557,) January 21st 1882.
- No. 14,043. The La Motte Manufacturing Company, (Assignees of Bernard Joachim La Motte) New York, "Iron Car," (Extension of Patent No. 7000,) January 21st, 1882.
- No. 14,044. J. Kieffer, Montreal, Que., "Heels," January 25th, 1882.
- No. 14,045. T. Morion, New York, "Sash Cord Fasteners," January 25th, 1882.
- No. 14,046. A. Edwards, Philadelphia, Penn., "Water Closets," January 25th, 1882.
- No. 14,047. J. B. Orr, London, Eng., "Pigment," January 25th, 1882.
- No. 14,048. C. E. Avery, Boston, Mass., "Lactates," January 25th, 1882.
- No. 14,050. H. M. Hoerner, Fowler, Mich., "Roof Bracket," January 25th, 1882.
- No. 14,051. J. S. Fox, Port Hope, Ont., "Device," January 25th 1882.
- No. 14,052. W. B. Crick, Clinton, Ont., "Table Slides," January 25th, 1882.
- No. 14,053. The Morley Sewing Machine Company, (Assignees of J. H. Morley,) Holyoke, Mass., "Button Sewing Machine," January 25th, 1882.
- No. 14,054. O. Hammerstein, New York, "Cigar Machine," January 25th, 1882.
- No. 14,055. J. H. Stevens, Lynn, Mass., "Buffing Machine," January 25th, 1882.
- No. 14,056. E. K. O'Brien, Toronto, Ont., "Window Shade Rollers," January 25th, 1882.
- No. 14,057. I. Lindsley, Pautucket, S. Schofield, Providence, Rhode Island, "Compressed Tobacco," January 25th, 1882.
- No. 14,058. T. Moore, St. Thomas, Ont., "Saw Mills," January 25th, 1882.
- No. 14,059. W. P. Chisholm, Chicago, Ill., "Wire Fence Barbs," January 25th, 1882.
- No. 14,060. W. C. Wildman (Assignee of Charles Moore Richardson,) Bridgeport, Conn., "Tag Machine," January 25th, 1882.
- No. 14,061. G. Beals, Buffalo, N. Y., "Manufacture of Iron from Ore," January 25th, 1882.
- No. 14,062. E. Fleischer, Dresden, Germany, "Sugar," January 25th, 1882.
- No. 14,063. H. M. Wells, Toronto, Ont., T. R. Fuller, "Window Shade Fasteners," January 25th, 1882.
- No. 14,064. W. H. Price, (Assignee of L. W. Stockwell,) Cleveland, Ohio, "Loom Threading Machine," January 25th, 1882.
- No. 14,065. W. B. Potter, Boston, Mass., "Plasters," (Extension of Patent No. 7034,) January 26th, 1882.
- No. 14,066. H. Gawley, Maidstone, Ont., "Gear," (Extension of Patent No. 7041,) January 26th, 1882.
- No. 14,067. J. S. Anthes, Berlin, Ont., "Chair," (Extension of Patent No. 7044,) January 26th, 1882.
- No. 14,068. H. J. Beemer, J. Sullivan, Montreal, Que., "Mattress," (Extension of Patent No. 7070,) January 26th, 1882.
- No. 14,069. A. Jarolimek, Danube, Austria, J. G. Avery, Spencer, Mass., "Elastic Steel Bands," January 26th, 1882.
- No. 14,070. G. Yellott, Tausen, Maryland, "Water Wheel," January 26th, 1882.
- No. 14,071. C. Lockman, Hamilton, Ont., "Sewing Machine," January 26th, 1882.
- No. 14,072. S. L. Kelly, Victoria, B. C., "Preparing and Preserving Fresh Fish," January 26th, 1882.
- No. 14,073. L. B. Kennedy, Keokuk, Iowa, "Brick Machine," January 26th, 1882.
- No. 14,074. A. S. Fisher, Clinton, Ont., "Boiler Cleaner," January 26th, 1882.
- No. 14,075. G. Wilson, Old Kent Road, London, Eng., "Valve," January 26th, 1882.
- No. 14,076. W. L. Peter, Philadelphia, Penn., "Grain Cleaner," January 26th, 1882.
- No. 14,077. J. Palmer, Point Edward, Ont., "Pen Holder," January 26th, 1882.
- No. 14,078. F. Hanson, Hollis, Maine, "Wood Working Machine," January 26th, 1882.
- No. 14,079. W. F. Cochrane, Indianapolis, Indiana, "Mechanical Movement," January 26th, 1882.
- No. 14,080. J. Sanders, Toronto, Ont., "Force Pumps," January 26th, 1882.
- No. 14,081. J. H. McNairn, Toronto, Ont., "Earth Closets," January 26th, 1882.
- No. 14,082. T. McGregor, Dayton, Ont., "Engines," January 26th, 1882.
- No. 14,083. G. J. Alford, Bastard, Ont., "Sap Spout," January 26th, 1882.
- No. 14,084. S. Peberly, J. S. Duvall, Philadelphia, Penn., "Needles for Knitting Machines," January 26th, 1882.
- No. 14,085. R. H. Smith, St Catharines, Ont., "Saw Handle," January 26th, 1882.
- No. 14,086. J. Havens, Putnam Tiago, Penn., "Car-Coupling Device," January 26th, 1882.
- No. 14,087. L. E. Woodruff, H. Phil. Wheeler, J. Pearson, Howell, Mich., "Fruit Drier," January 26th, 1882.
- No. 14,088. S. Alcock, C. Laight, B. Westwood, Toronto, Ont., (Assignees of W. T. J. Lowe, Buffalo, N. Y.,) "Bait," January 25th, 1882.
- No. 14,089. W. H. Price, Cleveland, Ohio, (Assignee of L. W. Stockwell,) "Screw Plates," January 28th, 1882.
- No. 14,090. G. F. Filley, St. Louis, (Assignee of D. H. Nation, St. Thomas, Missouri,) "Stove," January 28th, 1882.
- No. 14,091. G. W. Reid, New York, "Lumber Drier," (Extension of Patent No. 7047,) January 30th, 1882.
- No. 14,092. The Transmitting Dynamometer Company, New York, (Assignees of Hamiton Ruddick, Brooklyn) N. Y., "Registering Dynamometer," January 30th, 1882.
- No. 14,093. J. G. German, St. Mary, Ont., "Fences," January 30th, 1882.
- No. 14,094. E. C. Cramer Henderson, Pictou, T. A. McDonald, Durham, N. S., "Shoe Lace Fastening," January 30th, 1882.
- No. 14,095. J. Keisey, Montreal, Que., "Heels," January 30th, 1882.
- No. 14,096. J. Coxen, San Francisco, California, "Track Clearer," January 30th, 1882.
- No. 14,097. J. E. Culver, New Jersey, "Heating and Cooling Apparatus," January 30th, 1882.
- No. 14,098. A. E. Dobbear, Somerville, Mass., "Telephone," January 30th, 1882.
- No. 14,099. R. A. Chesebrough, New York, "Apparatus for Making Bone Black," Jan. 30th, 1882.
- No. 14,100. F. Menard, Montreal, Que., "Couplet de Jalousie," Jan. 30th, 1882.
- No. 14,101. M. R. Perkins, Portsmouth, N. H., "Railroad Chairs," Jan. 30th, 1882.
- No. 14,102. G. S. Murphy, Toronto, Ont., "Calkin's Novelty Washer," (Extension of Patent No. 7,035,) Jan. 30th, 1882.
- No. 14,103. G. Sweet, Dansville, N. Y., J. Watson Ayr, Waterloo, Ont., "Keels and Lakes," (Extension of Patent No. 7,000,) Jan. 30th, 1882.
- No. 14,104. W. H. Knight, Que., "Floating Timber Dressing Machine," (Extension of Patent No. 7,140,) Jan. 31st, 1882.
- No. 14,105. C. Boss, Bathurst, N. B., "Freezer," (Extension of Patent No. 7,334,) Jan. 31st, 1882.
- No. 14,106. T. Daniels, Toledo, Ohio "Pills," Jan. 31st, 1882.
- No. 14,107. C. E. Bartram, Fredonia, N. Y., "Fruit Barrel," Jan. 31st, 1882.
- No. 14,108. A. D. Marble, Scandia, Kansas. "Bulletin Boards," Jan. 31st, 1882.
- No. 14,109. C. J. F. Wilkins, Windsor, N. S., "Guards," Jan. 31st, 1882.
- No. 14,110. S. Ide, Medina, N. Y., "Door Hanger," Jan. 31st, 1882.
- No. 14,111. S. Peace, London, Ont., "Collar," Jan. 31st, 1882.
- No. 14,112. W. D. Smith, Detroit, Mich., "Blowers," Jan. 31st, 1882.
- No. 14,113. O. Harris, Kingsville, Ont., "Washing Machine," Jan. 31st, 1882.
- No. 14,114. J. K. Taylor, Boston, Mass., "Spark Arrester," Jan. 31st, 1882.
- No. 14,115. W. C. Kelley, Hastings, Mich., "Car Coupling," Jan. 31st, 1882.
- No. 14,116. J. H. Brinkop, Quincy, Ill., "Press," Jan. 31st, 1882.
- No. 14,117. E. Cuff, Newark, N. J., and B. S. Clarke, New York, "Spring," Feb. 2nd, 1882.
- No. 14,118. W. J. Perkins, Grand Rapids, Mich., "Shingle Machine," Feb. 6th, 1882.
- No. 14,119. E. B. Dufort, Toronto, H. Eldridge, Township of Clark, Ont., "Feather Renovators," Feb. 6th, 1882.
- No. 14,120. D. P. Prescott, Vernon, Vermont, "Car Coupling," Feb. 6th, 1882.
- No. 14,121. H. Kolker, Breslan, Germany, "Composition Preventing Incrustations in Steam Boilers," Feb. 6th, 1882.
- No. 14,122. J. Cole, Cleveland, Ohio, "Petroleum Separator," (Extension of Patent No. 7,155,) Feb. 6th, 1882.
- No. 14,123. E. Judson, San Francisco, Cal., "Explosive Compound," (Extension of Patent No. 7,148,) Feb. 6th, 1882.
- No. 14,124. J. Cole, Cleveland, Cuyahoga, Ohio, "Petroleum Separator," (Extension of Patent No. 7,154,) Feb. 7th, 1882.
- No. 14,125. E. Judson, San Francisco, California, "Explosive Compound," (Extension of Patent No. 7,148,) Feb. 7th, 1882.
- No. 14,126. G. W. Archer, Rochester, N. Y., "Inn Barber and Dental Chair," (Extension of Patent No. 7,292,) Feb. 7th, 1882.
- No. 14,127. W. H. Rodden, Toronto, Ont., "Stopper for Cans," Feb. 7th, 1882.
- No. 14,128. D. H. Dorsett, Clinton, Iowa, "Pipes," Feb. 7th, 1882.
- No. 14,129. H. Keller, Lank Centre, Minn., "Fanning Mills," Feb. 7th, 1882.
- No. 14,130. W. J. Lane, Milbrook, N. Y., "Harrow," Feb. 7th, 1882.
- No. 14,131. C. M. Andrews, San Francisco, Cal., "Electrical Piano and Organ Player," Feb. 7th, 1882.
- No. 14,132. C. R. Cowley, Wyoming, N. Y., "Water Wheel," Feb. 7th, 1882.
- No. 14,133. J. W. Fuller, London, Eng., "Telegraph," Feb. 7th, 1882.
- No. 14,134. T. Stephens, Hamilton, Ont., "Sewing Machines," Feb. 8th, 1882.
- No. 14,135. C. H. Gilpin, Uxbridge, Ont., "Attachments to Chairs," Feb. 8th, 1882.
- No. 14,136. J. W. Janson, London, Eng., "Machine for Breaking Hides," Feb. 8th, 1882.
- No. 14,137. J. H. Hodder, Aurora, Ill., "Writing Tablets," (Extension of Patent No. 7,049,) Feb. 8th, 1882.
- No. 14,138. A. Yates, Yisington, Derby, Eng., "Twisting and Doubling Machine," Feb. 8th, 1882.
- No. 14,139. E. Horsepool, London, Eng., "Glove Fastener," Feb. 8th, 1882.
- No. 14,140. W. L. Aurod, Amesbury, Mass., "Hub Bands," Feb. 8th, 1882.

THE CANADIAN PATENT OFFICE RECORD.

ILLUSTRATIONS.

Vol. X.

JANUARY, 1882.

No. 1.



13786 Murray & Baker's Improvements on Folding Cots.

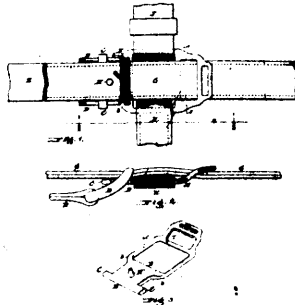

13767 Bassett's Improvements in Harness Buckles.

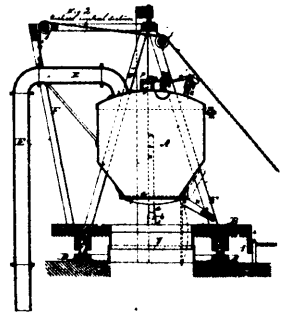

13768 Sanders's Improvements on Vacuum Dredges.

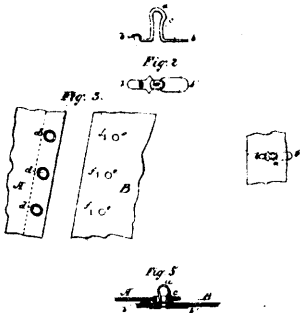

13786 Murray & Baker's Improvements on Folding Cots.

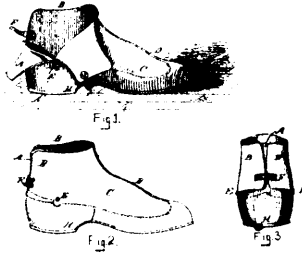

13770 Burr's Improvements on Shoes.

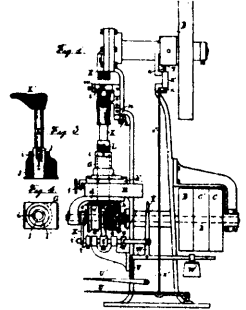

13771 Whitlock's Improvements on Machines for Heeling Boots and Shoes.

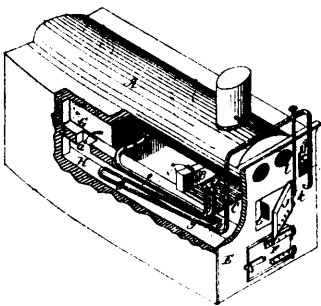

13772 Elliot's Improvements in Smoke Consumers.

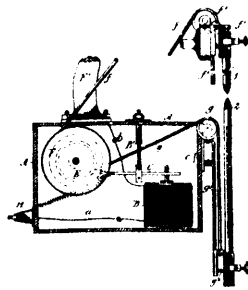

13778 Best's Improvements in Electric Lamps.

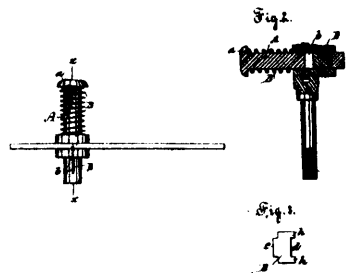

13779 Taylor's Improvements on Gibs or Keys for Bolts, &c.

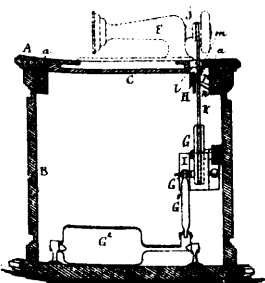

13780 Burgess's Improvements on Tables and Cabinets for Sewing and other Machines.

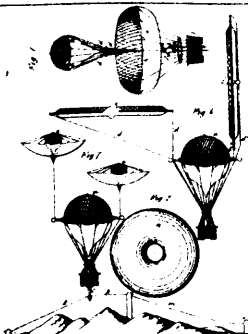

13781 Apraxine's Improvements in Aerial Balloons.

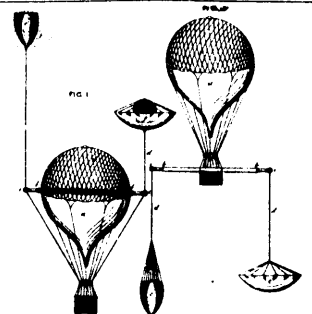

13782 Apraxine's Improvements in Aerial Balloons.

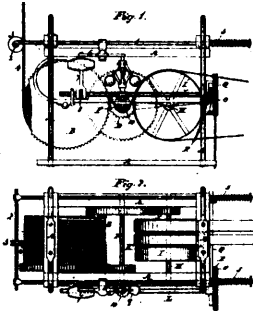

13783 Leitch & Turnbull's Improvements in Hoisting Machines.

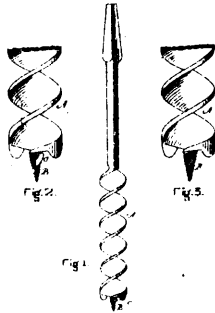

13784 Gladwin's Improvement on Augers.

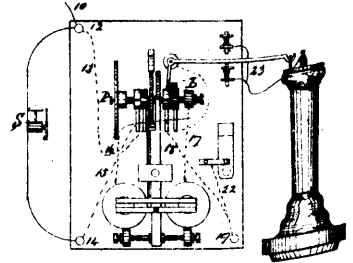

13785 Dudley's Improvements in Telephones.

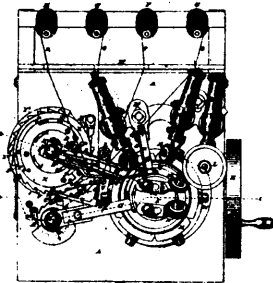

13786 Bradley's Improvements on Knitting Machines.

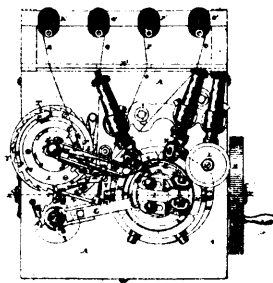

13787 Bradley's Improvements on Knitting Machines.

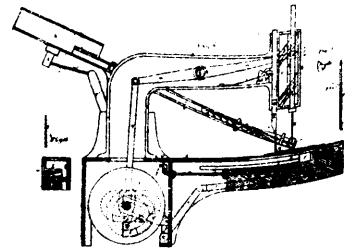

13788 Mathison's Improvement in Machines for Sewing Buttons.

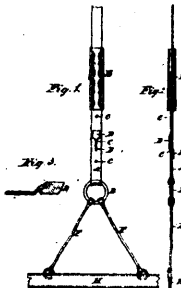

13789 Van Luven's Improvements on Strap Couplings.

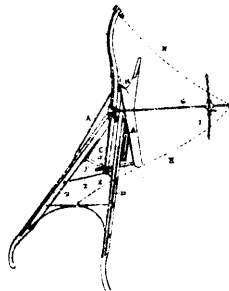

13790 Ley's Improvements on Drill Ploughs.

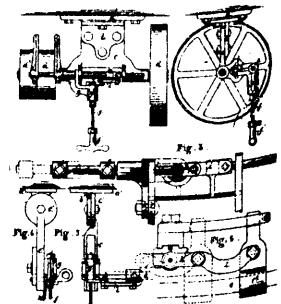

13791 Hadley's Improvements in Belt Shippers.

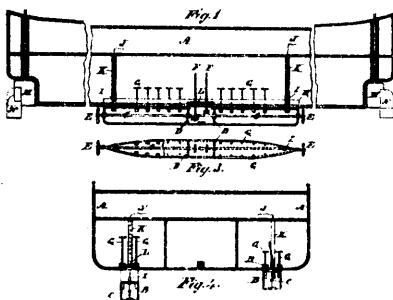

13792 Fairbanks's Improvements on Steam Vessels.

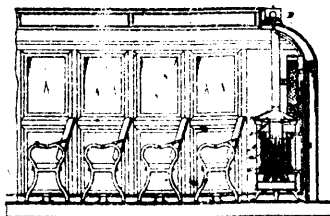

13793 Johnson's Improvements on Heaters.

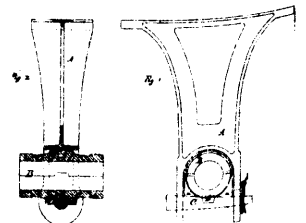

13794 Cramer's Improvements in Hangers for Shafting.

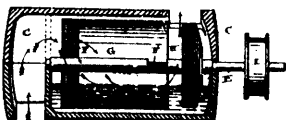

13795 Hewitt's Improvements on Spark Arresters.

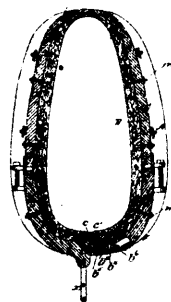

13796 Berry's Improvements on Harness.

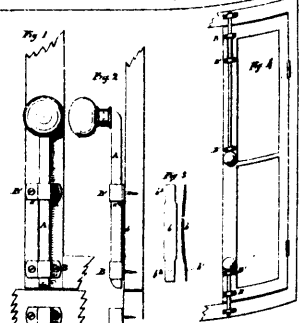

13799 Houle's Improvements in Window Bolts.

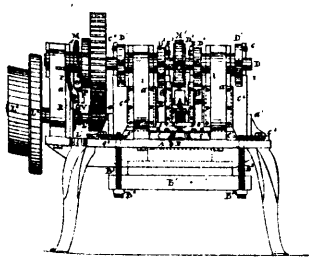

13800 Fisher's Machine for Compressing and Punching Heels for Boute and Shoes.

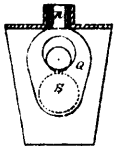
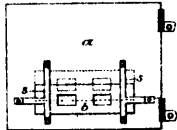

Fig. 7.



13801 Condon's Improvements on Stoves or Heaters and Ventilators.

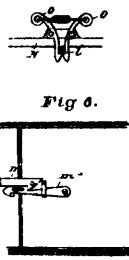

Fig. 6.

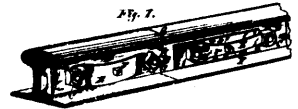

Fig. 7.

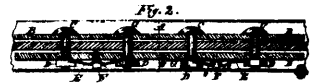

Fig. 2.

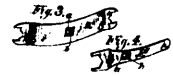
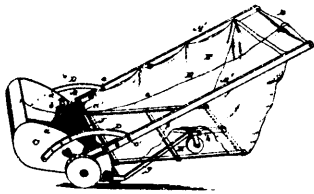

Fig. 3.



Fig. 4.

13802 Doray's Improvements on Nut Locks.



13803 Passmore's Improvements on Lawn Mowers.

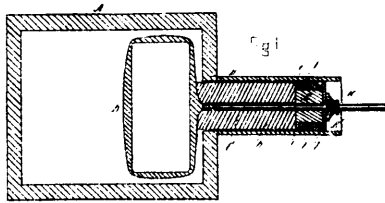

Fig. 4.

Fig. 5.

Fig. 5.

Fig. 2.



13804 Matthews's Combined Valve Stem, Piston and Cylinder.

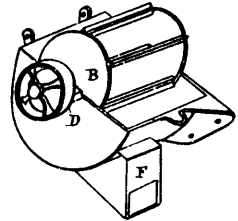

13805 Allen's Improvements in Thrashing Machines.

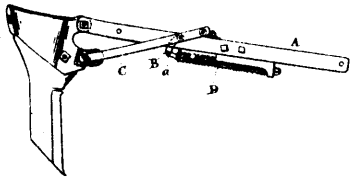

13806 Coulthart's Improvements on Spring Hoes.

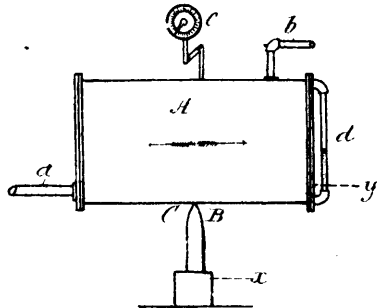

13807 Whitney's Electric Steam Generator.

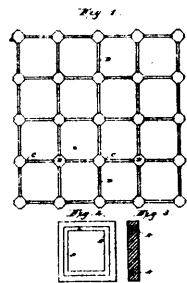
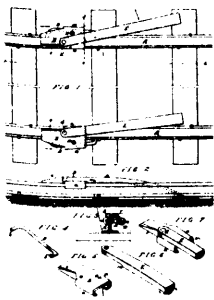
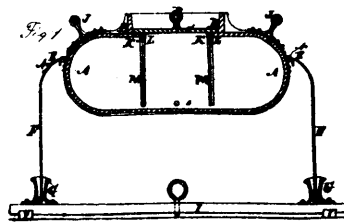

Fig. 1.

13811 McKnight's Improvements on Artificial Stone, Tile and Marble.



13815 Parker's Improvements in Car Replacers.



13816 Aldred's Improvements on Churns.

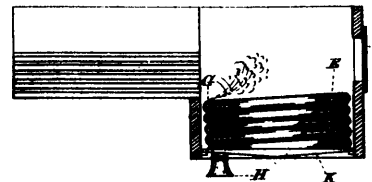

13817 Wolstenholme's Improvements on Apparatus for Burning Fuel.



13818 Laverty's Improvements on Drip Pans for Oil Barrels.

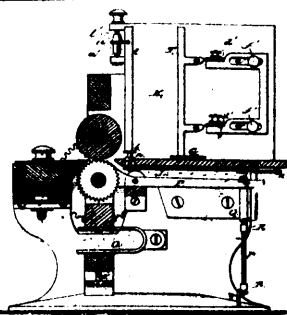

13819 Holton's Improvements in Leather Skiving Machines.

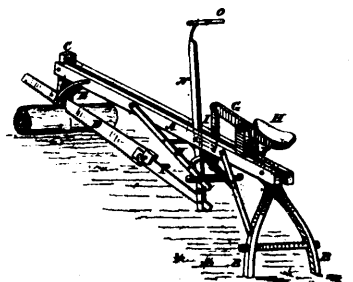

13820 Smart's Improvements on Sawing Machines.

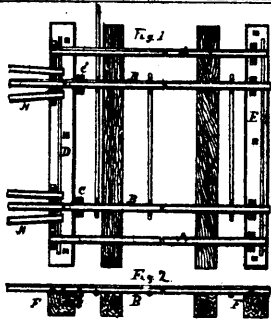

13821 Solt's Improvements on Railway Switches.

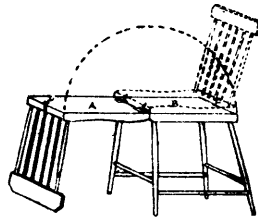

13822 Richards's Combination Chair and Wash Bench.

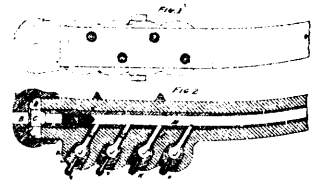

13823 Haskell's Improvements in Multicharge Guns.

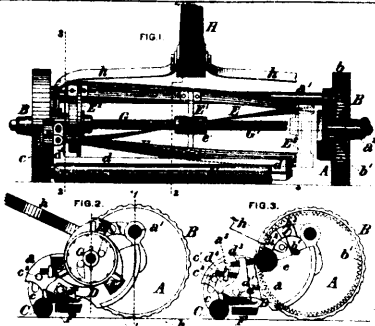

13824 Passmore's Improvements on Lawn Mowers.

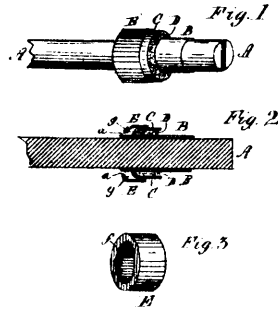

13825 Kelk's Bird Insect Catcher and Trap.

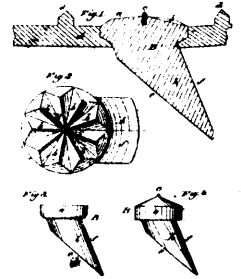

13826 Pennycuik's Improvements in Tiles for Illuminating Purposes.

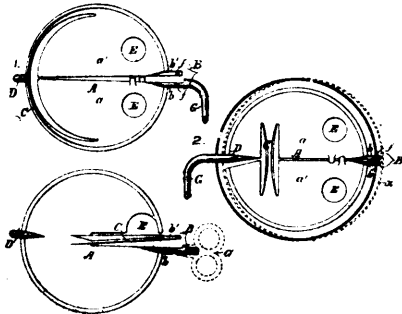

13827 Goodfellow's Improvements on Stovepipe Dampers.

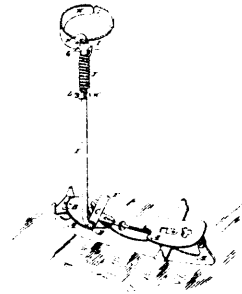

13829 Macomber's Improvements in Skates.



13830 Urch's Improvements on Boats.

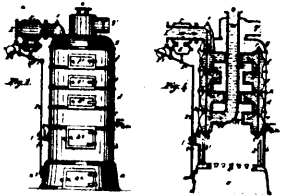

13831 Aubin's Improvements on Water Furnaces.

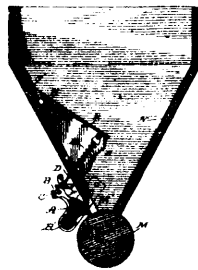

13832 Sage's Improvements in Automatic Feeders for Middlings Purifiers.

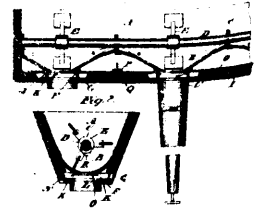

13833 Mann's Improvements on Seeding Machines.

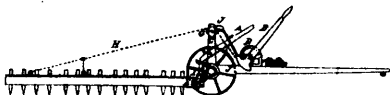

13834 McLean's Improvements on Harrows.

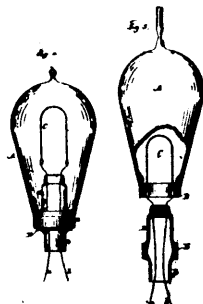

13835 Edison's Improvements on Electric Lamps.

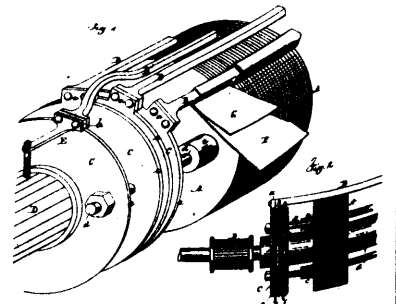

13836 Edison's Improvements on Dynamo or Magneto Electric Machines.

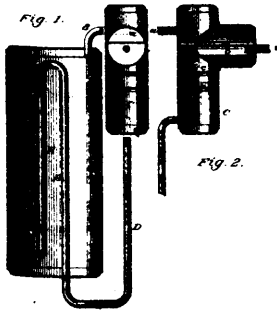

13839 Sharp's Improvements in Apparatus for Cleansing and Purifying Water in Steam Boilers.

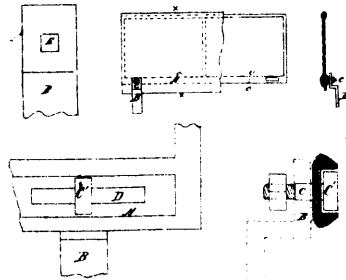

13840 McKinnon's Improvements on Carriage Dashes, (Splash Boards.)

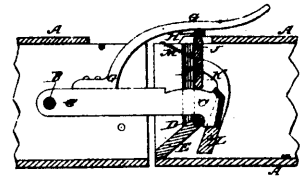

13841 Kunkel's Improvements on Car-couplings.

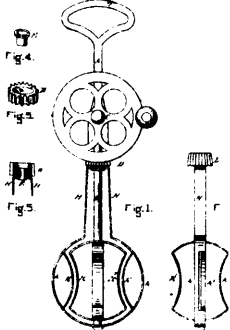

13842 Brown's Improvements on Egg-beaters.

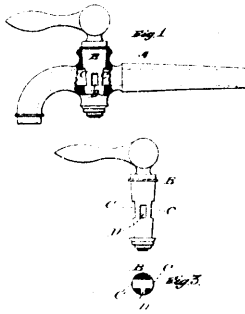

13843 Hilliard's Improvements in Faucets.

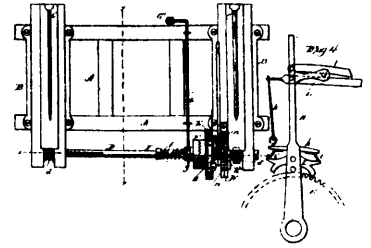

13844 Liddell's Improvements in Head blocks, for Saw Mills.

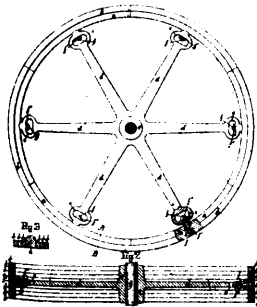

13845 Carey's Improvements on Wood Rim Pulleys.

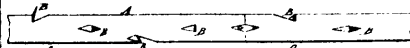

13846 Walmley's Improvements on Barbed Fencing.

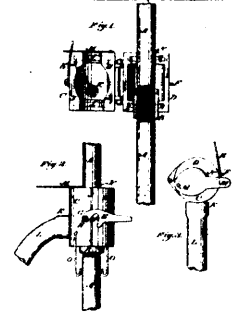

13847 Walker's Improvements in Well Tubing Joints.

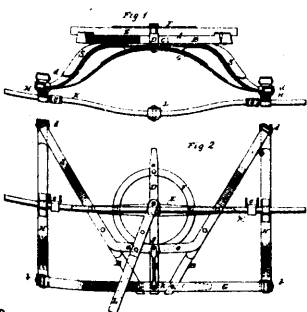

13848 Fitch's Improvements in Platform Spring Waggon.

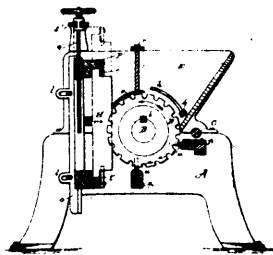

13849 Kremer & Fahs's Improvements on Machines for Cutting Oats.

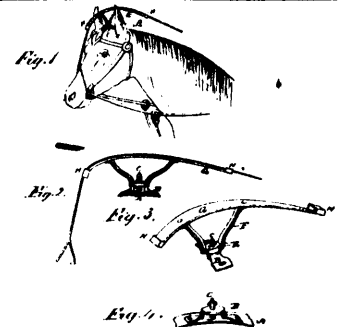

13850 Jones's Improvements on Check Reins.

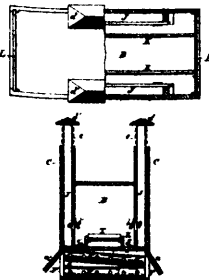

13851 Rundell's Improvements in Kilns for Drying Lumber.

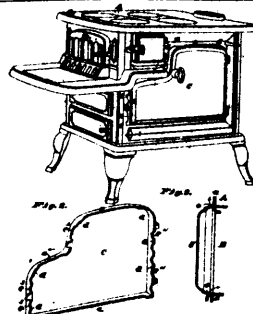

13852 Filley's Improvements on Cooking Stoves and Ranges.

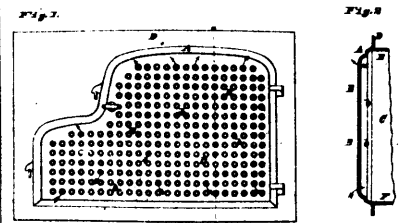

13853 Filley's Improvements on Coking Stoves and Ranges.

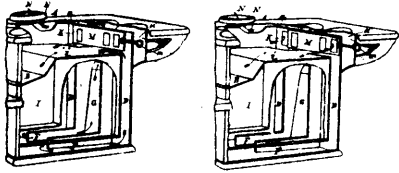

13854 Filley's Improvements on Ranges.

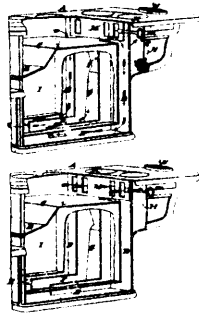

13855 Filley's Improvements on Cooking Stoves.

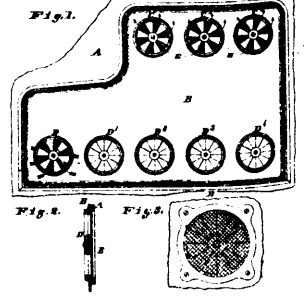

13856 Filley's Improvements on Stove and Range Ovens.

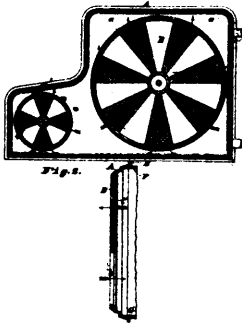

13857 Filley's Improvements on Stove and Range Ovens.

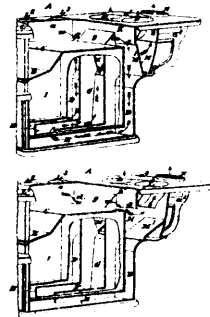

13858 Filley's Improvements on Cooking Stoves.

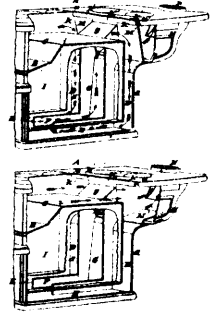

13859 Filley's Improvements on Cooking Stoves.

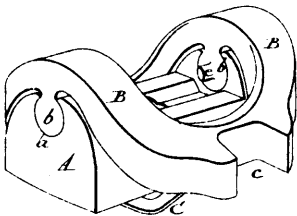

13860 Sergeant's Improvements on Millstone Drivers.

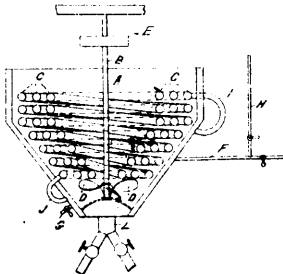

13861 Williams's Improvements on the Process and Apparatus for Crystallizing Grape Sugar.

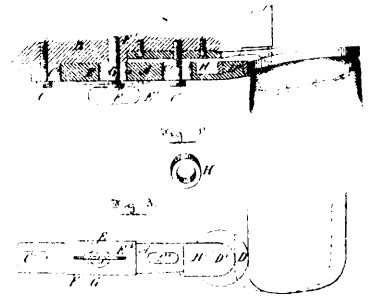

13862 Laurin's Improvements in Machines for Pegging Boots and Shoes.

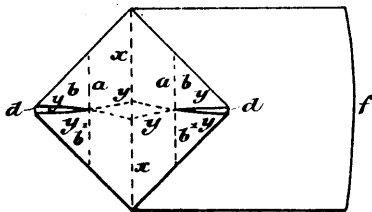

13863 Lanbach & Wolle's Improvements in Paper Bags.

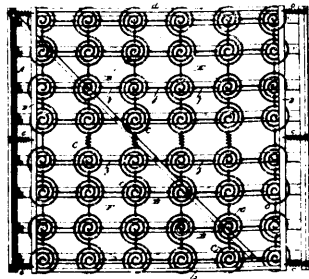

13864 Slayton's Improvements on Spring Bed Bottoms.

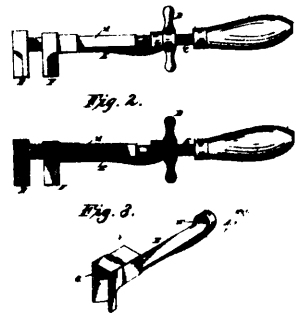

13865 Thompson's Improvements on Wrenches.

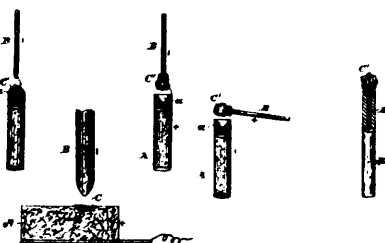

13866 Skinner & Thomas's Improvements on Metallic Rods.

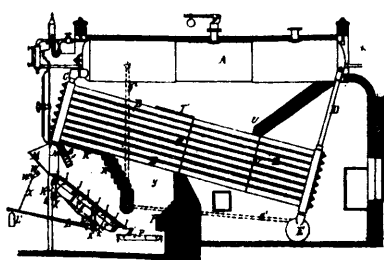

13867 Palmer, Worthington & Rowell's Improvements on Furnace Grates.

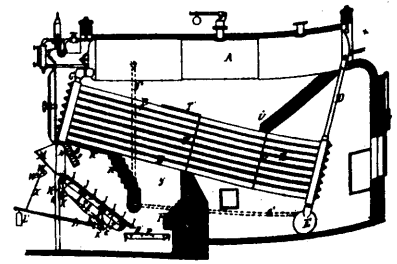

13868 Palmer's Improvements on Steam Boiler Furnaces.

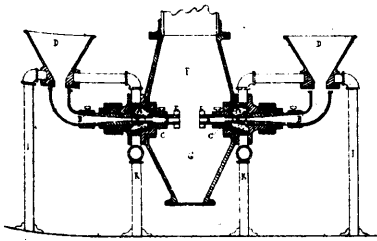

13869 Luckenbach & Wolfenden's Method of Pulverizing Mineral and other Substances and Apparatus therefor.

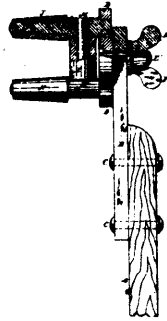

13870 Gray's Improvements on Belt Shifters (Shippers).

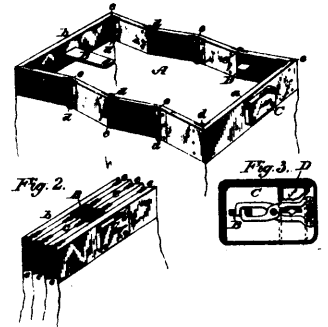

13871 Martel's Improvements on Mail Bags.

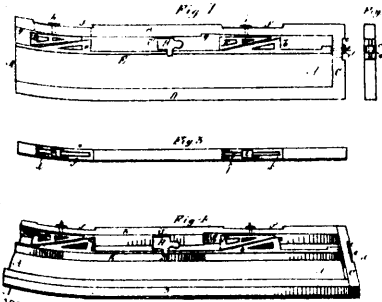

13872 McAndrew's Improvements in Printers' Gallies.

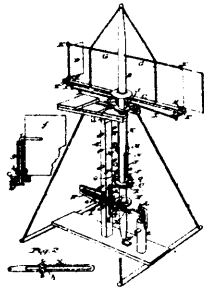

13873 Forbes's Improvements on Wind Mills

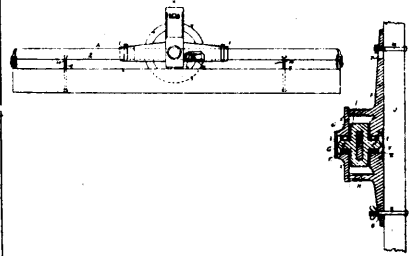

13874 Porter's Improvements on Self Levelling Berths for Vessels

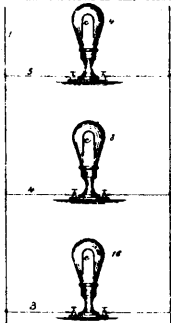

13875 Edison's Improvements in Electric Lighting.

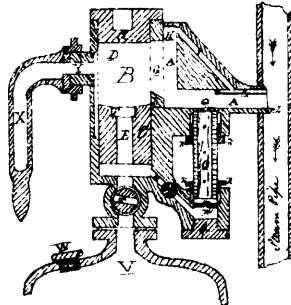

13877 Boys's Improvements on Steam Engine Lubricators.

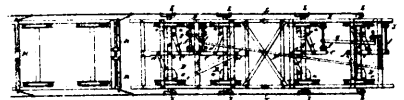

13879 Benoit's Improvements in Car Brakes.

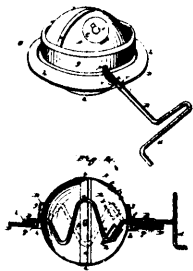

13880 Beidler's Improvements on Coffee Roasters.



13881 Vandermark's Improvements on Bag Ties.

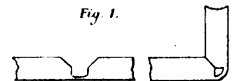

13882 Womersley's Improvements on Wooden Boxes and on Machinery and Process for Manufacturing the same.

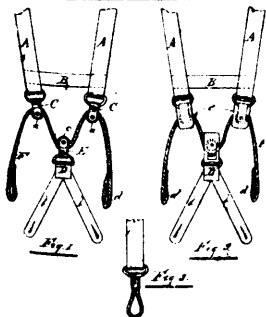

13883 Cohen's Improvements in Trousor Suspenders.

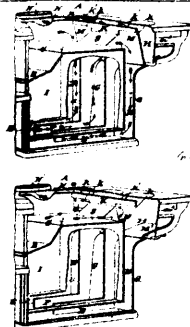

13884 Filley's Improvements on Ranges.

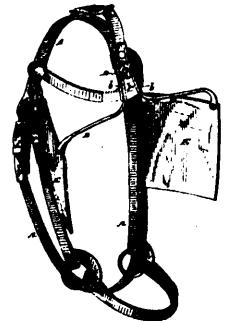

13885 Hosack's Improvements in Bridle Blinkers.

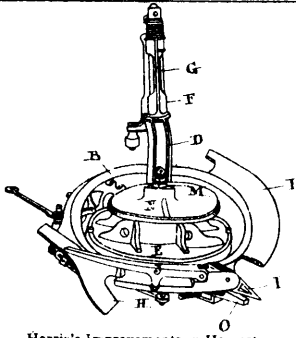

13887 Harris's Improvements on Harvesters.

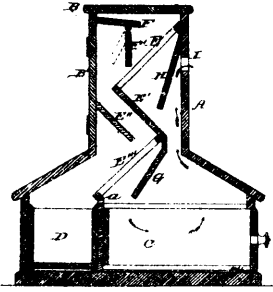

13888 Andrews's Improvements on Coal Sitters.

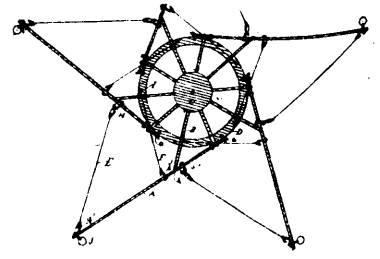

13889 Muir's Improvements in Horse Powers.

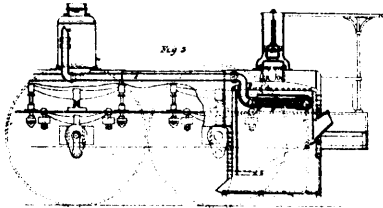

13890 Estrade's Improvements in Apparatus for Superheating Steam.

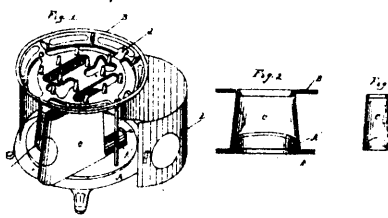

13891 Heckman's Improvements on Oil Stoves.

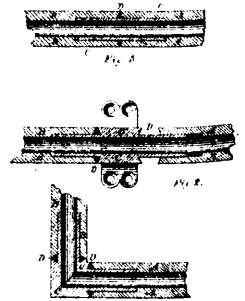

13892 Kasson's Improvements on Joints for Lead Pipes.

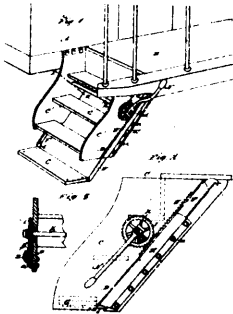

13893 Northup's Improvements in Extension Steps for Cars and other Vehicles.

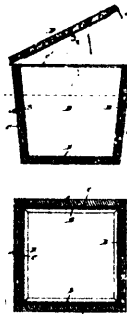

13894 Blacktin's Improvements on Butter Packages.

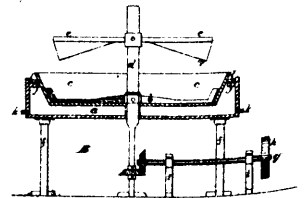

13895 Alden's Improvements on Preserved Fish and Means of Manufacturing the same.

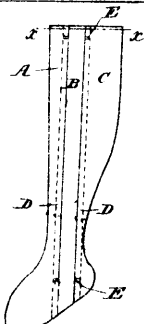

13896 Pollock's Improvements in Shapes for Hose and nocks.

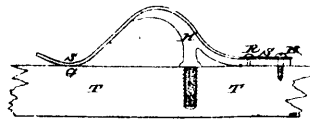

13897 Gilchrist's Improvements on Holdbacks (Breeching Hooks).

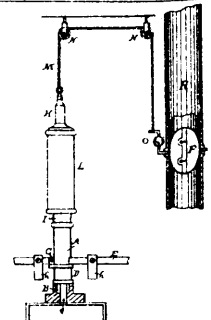

13898 Kellen's Improvements on Damper Regulators for Furnaces.

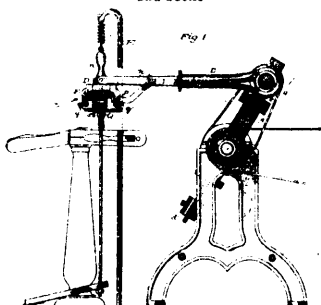

13899 Hutchinson's Improvements on Machines for Setting Edges and Burnishing Heels of Boots and Shoes.

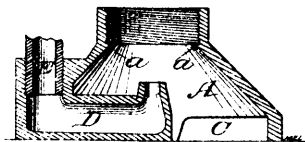

13900 Vanduzen's Improvements on Steam Water Elevators.

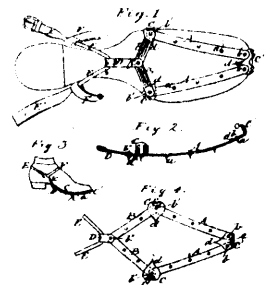

13901 Bland's Appliance to be Worn on a Boot or Shoe to Prevent Persons Slipping.

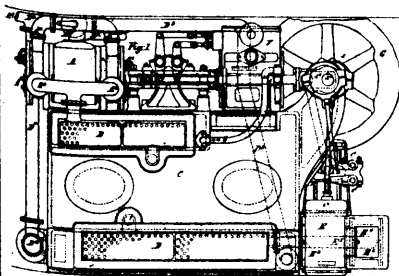

13902 Haslam's Improvements in Refrigerators.

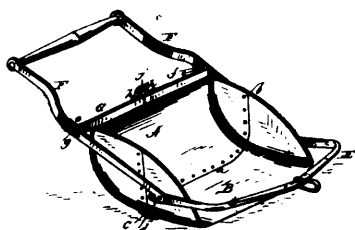

13903 Byrnett's Improvements on Earth Scrapers.

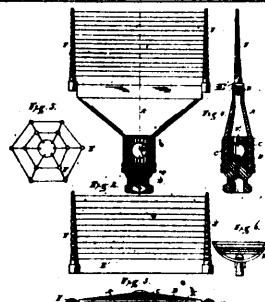

13904 Jackson's Improvements on Incandescent Burners.

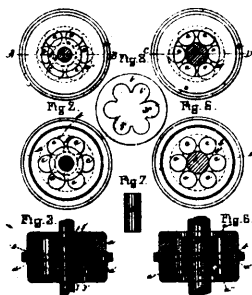

13905 Ferrali's Improvements on Anti-friction Bearings.

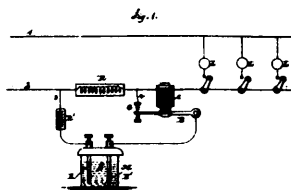

13906 Edison's Improvements in Meters for Measuring Electric Currents.



13907 Butler's Improvements in Barbs for Fences.

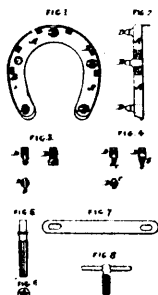

13908 Bland's Appliance to be Attached to the Shoes or Plates of Animals to Afford a better Foothold.

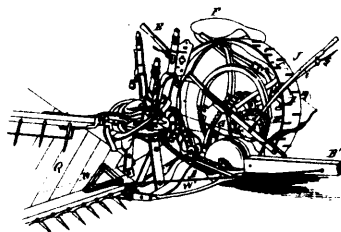

13909 McLachlan's Improvements on Harvesters.

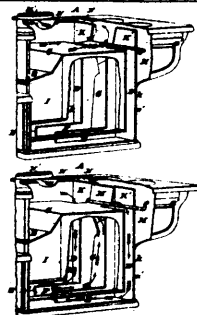

13910 Filley's Improvements on Ranges.

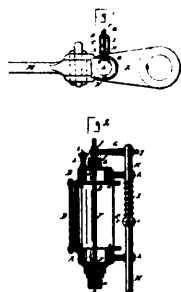

13911 Jewell's Improvements on Lubricators.

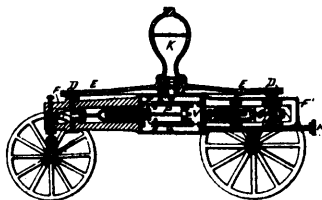

13912 Howe's Improvements on Fire Engines.

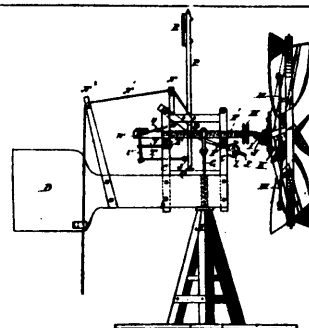

13913 Lee's Improvements in Windmills.

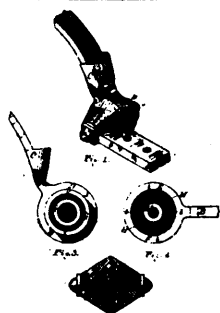

13914 Kasson's Improvements on Thill Couplings.



Fig. 1.



13915 Kasson's Improvements on Axle Bearings.

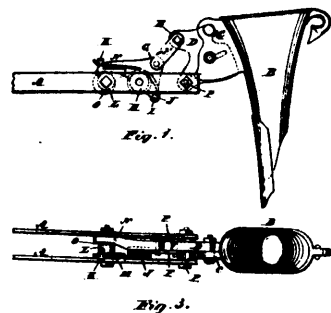

Fig. 3.

13916 Noxon's Improvements on Spring Hoes and Grain Drills.