

Technical and Bibliographic Notes / Notes techniques et bibliographiques

The Institute has attempted to obtain the best original copy available for filming. Features of this copy which may be bibliographically unique, which may alter any of the images in the reproduction, or which may significantly change the usual method of filming, are checked below.

L'Institut a microfilmé le meilleur exemplaire qu'il lui a été possible de se procurer. Les détails de cet exemplaire qui sont peut-être uniques du point de vue bibliographique, qui peuvent modifier une image reproduite, ou qui peuvent exiger une modification dans la méthode normale de filmage sont indiqués ci-dessous.

- Coloured covers/
Couverture de couleur
- Covers damaged/
Couverture endommagée
- Covers restored and/or laminated/
Couverture restaurée et/ou pelliculée
- Cover title missing/
Le titre de couverture manque
- Coloured maps/
Cartes géographiques en couleur
- Coloured ink (i.e. other than blue or black)/
Encre de couleur (i.e. autre que bleue ou noire)
- Coloured plates and/or illustrations/
Planches et/ou illustrations en couleur
- Bound with other material/
Relié avec d'autres documents
- Tight binding may cause shadows or distortion
along interior margin/
La reliure serrée peut causer de l'ombre ou de la
distorsion le long de la marge intérieure
- Blank leaves added during restoration may appear
within the text. Whenever possible, these have
been omitted from filming/
Il se peut que certaines pages blanches ajoutées
lors d'une restauration apparaissent dans le texte,
mais, lorsque cela était possible, ces pages n'ont
pas été filmées.
- Additional comments:/
Commentaires supplémentaires:

- Coloured pages/
Pages de couleur
- Pages damaged/
Pages endommagées
- Pages restored and/or laminated/
Pages restaurées et/ou pelliculées
- Pages discoloured, stained or foxed/
Pages décolorées, tachetées ou piquées
- Pages detached/
Pages détachées
- Showthrough/
Transparence
- Quality of print varies/
Qualité inégale de l'impression
- Continuous pagination/
Pagination continue
- Includes index(es)/
Comprend un (des) index
- Title on header taken from: /
Le titre de l'en-tête provient:
- Title page of issue/
Page de titre de la livraison
- Caption of issue/
Titre de départ de la livraison
- Masthead/
Générique (périodiques) de la livraison

This item is filmed at the reduction ratio checked below/
Ce document est filmé au taux de réduction indiqué ci-dessous.

10X	12X	14X	16X	18X	20X	22X	24X	26X	28X	30X	32X
<input type="checkbox"/>	<input type="checkbox"/>	<input type="checkbox"/>	<input type="checkbox"/>	<input type="checkbox"/>	<input type="checkbox"/>	<input type="checkbox"/>	<input checked="" type="checkbox"/>	<input type="checkbox"/>	<input type="checkbox"/>	<input type="checkbox"/>	<input type="checkbox"/>

FARMING

SEPTEMBER

1895

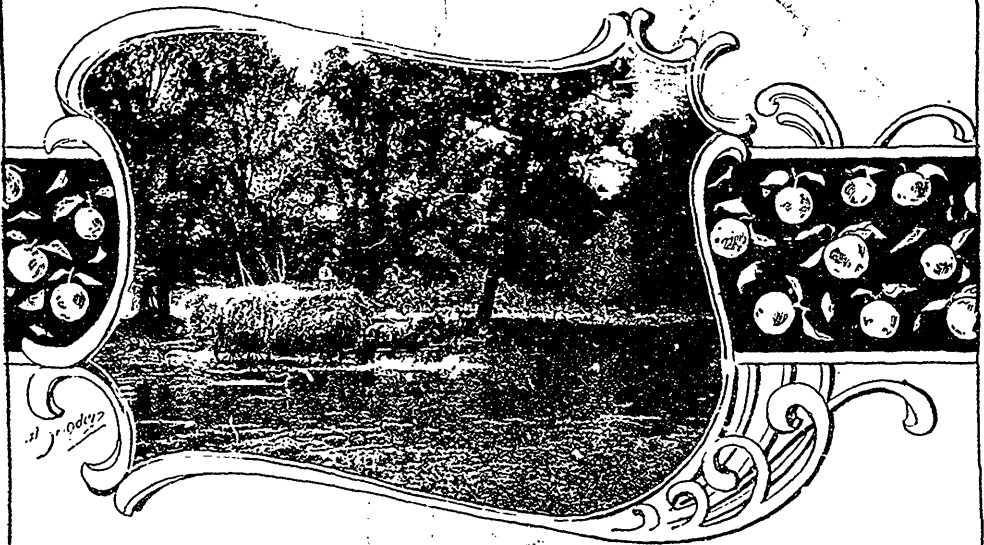

Too 1 N6 CO

SUCCESSFUL FARMERS

USE

Freeman's HIGH-GRADE BONE Fertilizers

They produce large crops of wheat of superior quality.

Try our Fertilizer for Fall Wheat, which is especially manufactured for that class of crop.

TERMS EASY. PRICES LOW.

"Having used your Sure-Growth Fertilizer for the past three seasons, it is with pleasure I recommend its use to others. I commenced with one ton the first season, and two years ago purchased from you two tons, and last season two and one-half tons. Always used it on fall wheat at the rate of about two hundred pounds per acre, and am fully convinced I had at least one-third larger yield and finer sample than where no fertilizer was used. Thanking you for your prompt delivery, I remain,

(Signed) RICHARD SELDON, Township Clerks, NORTH OXFORD."

The W. A. FREEMAN CO., Ltd., - Hamilton, Ont.

209

The Bain Holley Patent Low-Down Wagon

The Latest Invention and Greatest Success in Wagon Building

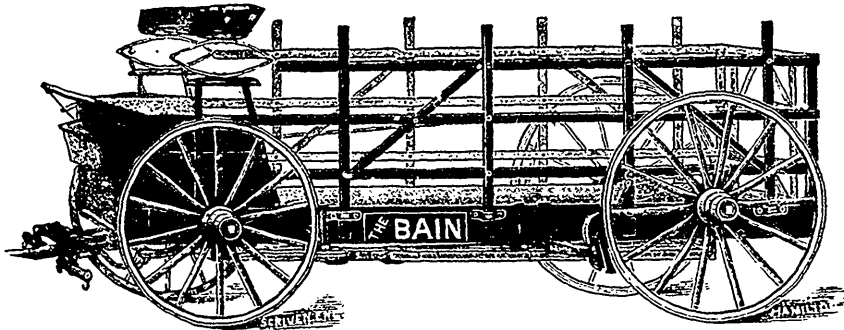

Especially suitable for handling LIVE STOCK, FRUIT, DAIRY PRODUCTS, HEAVY MATERIAL. No slatting of pole—BODY HANGS LOW—therefore no high lifting in loading. Will be on exhibition at principal fairs. Call and see it. Further particulars and prices cheerfully furnished on application.

276 BAIN BROS. MFG. CO. (LTD.) - - BRANTFORD, ONT.

Rain

Does not dissolve it away when out in pasture. Cattle get all the salt they want, whenever they want it.

Rock Salt

Is all this, and cheaper to use than loose salt. We have an exhibit at Toronto Fair, and want you to leave us an order 400 lbs., or over, at 50 cents per 100 lbs.

(Cash with the order.)

TORONTO SALT WORKS,
128 Adelaide Street East, - Toronto

271

DAIRYING

FOR PROFIT . . .

Is read by all good dairymen. Given for one new subscriber to FARMING.

HOLLOWAY'S

Pills and Ointment

THE PILLS

Purify the Blood, correct all disorders of the LIVER, STOMACH, KIDNEYS & BOWELS,

And are invaluable in all complaints incidental to females of all ages.

THE OINTMENT

Is the only reliable remedy for Bad Legs, Sores, Ulcers, and Old Wounds.

FOR BRONCHITIS, SORE THROATS, COUGHS, COLDS, GOUT, RHEUMATISM,

Glandular Swellings, and all Skin Diseases, it has no equal.

Manufactured only at 78 NEW OXFORD, STREET, late 533 OXFORD STREET, LONDON.

And sold by all Medicine Vendors throughout the World.

BREEDERS' DIRECTORY

Cards under this head inserted for one year at the rate of \$1.50 per line when not exceeding five lines. No card accepted under two lines, nor for less than six months.

HORSES.

DANIEL BRIMS, Athelstan, Que., Breeder of purebred Clydesdales, Shorthorns, and Shropshire Sheep. Stock for sale. 183

SPRUCEDALE FARM, Owen Sound, John Harrison, Prop., Breeder of English Thoroughbred Horses (Registered in English Stud Book) and Shropshire Sheep. Stock for sale. 295

SHORTHORNS

ALEX. BURNS, Maple Lodge Farm, Rockwood, Ont., Breeder of Shorthorn Cattle. Young stock for sale. 422

WM. DONALDSON, Huntingford, South Zorra P.O., Ont., Breeder of Shorthorns and Shropshire Down Sheep. 294

WM. DOUGLAS, Caledonia, Ont., Breeder of Short horn Cattle. Young stock for sale at all times. 374

WM. TEMPLER, Breeder of purebred Shorthorn Cattle and Berkshire Pigs, Wood Lawn Farm, Jerseyville P.O., Ont. Telegraph Office and R. R. Station, Copetown, G.T.R. Young stock for sale. 199

HENRY SMYTH & SONS, Chatham, Ont., Breeder of pure Shorthorn Cattle. Young stock for sale. 204

H. K. FAIRBAIRN, Rose Cottage, Thedford, Ont., Breeder of Scotch Shorthorn Cattle. Stock for sale. 407

GALLOWAYS.

A. M. & R. SHAW Brantford, Ont., Breeders of Galloway Cattle. Choice young animals for sale. 360

DAVID McCRAE, Janefield, Guelph, Canada, Importer and Breeder of Galloway Cattle, Clydesdale Horses, and Cotswold sheep. Choice animals for sale. 251

AYRSHIRES.

T. GUY, Sydenham Farm, Oshawa, Ont., Breeder of Ayrshire Cattle, Southdown and Leicester Sheep. 398

J. McCORMACK, Rockton, Ont., Breeder of Ayrshire J. Cattle, Toulouse Geese, and Colored and Silver-Grey Dorkings. 252

W. M. & J. C. SMITH, Fairfield Plains, Ont., Breeders of World's Fair prize-winning Ayrshires, Merino Sheep, Poland-China Pigs, and Poultry. Stock for sale. 180

J. YUILL & SONS, Carleton Place, Ont., Breeder of Ayrshire J. Cattle, Shropshire Sheep, and Berkshire Swine. 249

W. F. & J. A. STEPHEN, Brook Hill Farm, Trout River, Que., Breeders of Ayrshire Cattle and Yorkshire Pigs. Young stock for sale at reasonable prices. 243

THOMAS IRVING, Montreal, Importer and Breeder of Ayrshire Cattle and Clydesdale Horses. Choice young Ayrshire bulls and heifers bred from Chicago winners for sale. Write and get prices and other particulars. 296

WALTER NICHOL, Plattsville, Ont., Breeder of Ayrshire Cattle and Leicester Sheep. Choice young stock for sale. 190

JERSEYS.

WM. ROLPH, Glen Rouge Farm, Markham, Ont., Breeder of Jersey Cattle. Herd nearly all pure St. Lambert. Young stock always for sale at reasonable prices. 338

H. HAIG BROS., Menie, Breeders of Jersey Cattle of the best prize-winning strains. Farm close to Hoard Station, G.T.R. 225

D. H. KITCHESON, Menie, Ont., Breeder of A. J. C. C. Jerseys, Shropshire Sheep, and Berkshire Pigs. Stock for sale. Hoard's Station (G.T.R.). 368

ROBT. REESOR, Locust Hill, Ont., Breeder of Jersey Cattle and Shetland Ponies. Young stock for sale at reasonable prices. Locust Hill is 20 miles from Toronto on the C.P.R. 361

J. H. SMITH & SON, Willow Grove Farm, Highfield, Ont., Breeder of St. Lambert and St. Helen's Cattle. Prize herd at the last Industrial. Young stock for sale. 297

DEVONS.

W. J. RUDD, Eden Mills, Ont., Breeder of Devon Cattle, Cotswold and Suffolk Sheep, Berkshire Pigs, Plymouth Rock Fowls, and White Turkeys. 380

SWINE.

WM. SINCLAIR, Varna, Ont., Breeder of Poland-China Swine. Stock for sale. Write or call. 451

FOR the finest Tamworth Swine correspond with **H. FEARMAN**, Hamilton, Ont. 266

M. H. PARLEE, Sussex, N.B., Breeder of Large Yorkshire and Berkshire Pigs, Light Brahmas, Silver Laced Wyandottes, and Black Plymouth Rocks. Choice stock for sale. Write for prices. 359

W. H. O'DELL, Belmont, Ont., Breeder of Registered Tamworth Pigs. Stock for sale. 374

TAMWORTH Swine, Oxford Sheep, Collie Dogs, Bronze Turkeys, Toulouse Geese, Pekin Ducks, and Buff Leghorns. **A. ELLIOTT**, Pond Mills, Ont. 406

SHEEP.

JAS. P. PHIN, The Grange, Hespeler, Ont., breeding and importing Shropshire Sheep a specialty. 363

A. TELFER & SONS, Paris, Ont., Breeders and Importers of registered Southdown Sheep. Stock for sale. 241

JNO. A. MCGILLIVRAY, Q.C., Jerseyville Farm, Uxbridge, Ont., Breeder and Importer of Dorset Horned Sheep, Jersey Cattle, and Tamworth Pigs. 494

JOHN JACKSON & SONS, Abingdon. Southdown J. Sheep. Champion flock at World's Fair. Awarded 20 prizes—10 firsts. 253

S. P. GOUDEY, Yarmouth, Nova Scotia, Importer and Breeder of Leicester and Shropshire Sheep, Jersey Cattle, and Chester White Swine. All registered. 495

WM. E. WRIGHT, Glanworth, Ont., Breeder of Shropshire Sheep and Chester White Swine. 196

DEALER IN Established 1868.

GRAIN AND PRODUCE

James Kerr

239 Wellington St., Montreal.

Shippers' Headquarters for Live Stock Supplies. Pressed Hay a Specialty.

BRITISH ADVERTISEMENTS.

Secretary to the National Sheep Breeders' Association of England and the Southdown Sheep Breeders' Association; Hon. Secretary Kent Sheep Breeders' Association.

W. W. CHAPMAN,

PEDIGREE LIVE STOCK AGENT AND EXPORTER.

All kinds of Registered Stock, Horses, Cattle, Sheep, and Pigs supplied on Commission.

References—JOHN JACKSON & SON, Abingdon, Ont.; N. CLAYTON, Selsey, Chichester, Eng.

Offices:

Fitzalan House, Arundel St., Strand, London, England.

Registered address for cables—"Sheepcote, London."

H. PENFOLD, Selsey, Chichester, Eng.

REGISTERED SOUTHDOWN, No 4.

Established over a century. One of the best and purest of Southdown Flocks in England. Many prizes have been won for the last 30 years. Rams and Ewes always for sale; full pedigrees kept.

Edwin Buss, Elphicks, Horsmonden, Kent, Eng.

Breeder of Pedigree Large White Yorkshire and Berkshire Pigs. Highest awards at Royal Shows. Boars, Yelts, and in-pig Sows of either breed always for sale. Yorkshire boar in use, Holywell Bath (1799), winner of 10 firsts, 4 seconds, 2 reserves.

A few pedigree Bates-bred Shorthorns kept.

KENT OR ROMNEY MARSH SHEEP.

The Walmer Court Flock, established in 1852, duly registered and recorded in "The Flock Book of the Kent or Romney Marsh Sheep-Breeders' Association," has long been considered a leading flock, and has won over \$2,500 at the R.A.S.E., and other leading shows. Inspection and enquiries invited. Apply to the owner,

H. PAGE, Walmer Court, WALMER, KENT, ENGLAND.

JAMES LAWRENCE, Stall Pitts' Farm, Shrivenham, Bucks., England

BREEDER OF . . .

Registered Berkshire Pigs, from stock unsurpassed for true characteristics, size, and quality. One of the oldest established herds in England.

Enquiries Solicited. - - Prices Moderate.

F. N. HOBGEN, F.S.I.

T. C. HOBGEN, F.S.I.

HOBGEN BROS.

Auctioneers and Cattle Commission Agents,

CHICHESTER, SUSSEX, ENGLAND.

Appointed Auctioneers to the Southdown Sheep-Breeders' Association.

H. T. LOCKE-KING, Brooklands, Weybridge, England.

Registered Southdown Flocks, 10 and 11.

Ewes individually numbered and full individual pedigrees of every sheep recorded in private flockbook. Rams and ewes always for sale, descended from all the best and purest blood. Shire horses also kept, bred from noted prize-winners.

MUTTON SHEEP.

PUREBRED SUFFOLK SHEEP, from registered flocks, for exhibition or exportation. Full particulars may be obtained upon application to the Secretary of the Suffolk Sheep Society. Address

ERNEST PRENTICE,

Auctioneer and Commission Agent,
Stowmarket, England.

SIR THOS. BARRETT LENNARD, Woodingdean, Rottingdean, Brighton, England.

Registered Southdown Flocks 7 and 8 at Belhus in Essex and Woodingdean in Sussex. Winner of many prizes, including the gold medal given by the Emperor of the French at Poissy; first prize, Fat Stock Show, Lewes, 1892; and commended at Chichester, 1892. Full pedigrees kept, and all ewes numbered.

PAGHAM HARBOUR CO.,

Selsey, Chichester, England.

Flock of 1,000 ewes, winners Southdown Challenge Cup in 1893-4, 1st prize Wool; Jubilee, Royal, and Royal Prize Ram Lambs in 1892-93-94.

SUSSEX CATTLE.

Pedigree Sussex cattle descended from the oldest and best strains of blood (first prize for bull and also for cow at County Show, 1894), also registered Southdown sheep (Flock No. 25 S.D.F.B.), for sale at reasonable prices. Apply to the owner

T. BANNISTER, Limehurst,

Hayward Heath, Sussex, England.

SIR THOS. BARRETT LENNARD, Woodingdean, Rottingdean, Brighton, England.

Large White pigs of prize-taking blood, bred entirely from the stock of Sanders Spencer, Walker Jones, and Duckering, and Berkshire pigs from the stock of Benjafield. Boars, yelts, and sows always for sale at very moderate prices.

KIDNER EDWIN,

LICENSED VALUER AND SALESMAN, breeder of Registered Dorset Horn Sheep, Shropshire Sheep, and Devon Cattle. All commissions personally executed. Address: MANOR FARM, Cothelstone, Taunton, Somerset, England.

Messrs. J. R. & R. R. KIRKHAM . . .

Own a flock of about 2000 Lincoln sheep, having always rams and ewes for sale. Individual pedigrees recorded, and given with every animal. Enquiries and inspection solicited. Address:

Biscathorpe House, Lincoln, England

REGISTERED SOUTHDOWN, S,

Flock No. 6, Southdown Flock Book.

Property of F. N. Hobgen, Appledram, Chichester, Sussex, England.

Sheep always for sale. Inspection invited. The best only are kept. Specialty, good wool and mutton combined.

Registered Red Poll Cattle.

Property of LORD HASTINGS, Melton Constable, NORFOLK, ENGLAND.

Bulls, cows and heifers always for sale. Messrs. Miller's, of Nebraska, celebrated cow RUPERTA came from this herd. Pedigree Tamworth pigs also for sale. Inspection invited. Quotations given. Apply Estate Office, Melton Constable, Norfolk, England.

POULTRY.

DUFF'S - - -

White and Black Minorcas
Barred Plymouth Rocks

My birds have won highest honors at the largest exhibitions in the United States and Canada. To farmers who desire to increase the laying qualities of their flock, I hereby offer to supply them with Cockerels of any of the above varieties for \$1.50 each. These will not be exhibition birds, but will be of the same blood as my winners, and quite as serviceable for laying qualities of your flock. 518

THOMAS A. DUFF, Toronto, Canada.

YOU SHOULD EXAMINE THE

"Toronto" Incubator and Brooder

AT THE

INDUSTRIAL EXHIBITION, Sept. 2nd-14th, 1895

This machine is fully up-to-date. Hot-air system, positive regulation of temperature, substantially built, and handsomely finished. For further information address the manufacturer,

T. A. WILLIAMS,

542 Manning Avenue, - 513 - TORONTO, Ont.

WHEN IN WANT OF

Brown Plymouth Rocks, Silver Grey Dorkings, Black Spanish, White Leghorns, Pekin Ducks, and Bronze Turkeys of the HIGHEST quality, at the LOWEST figure, write

J. L. CORCORAN

"Web-Foot Villa" Poultry Yards

1380 QUEEN STREET EAST

TORONTO

N.B.—Now is your chance for Pekin Ducks. Your pick of a thousand cheap. 518

THEY MUST GO.

The breeding season being over, and as we have raised a large number of very promising chicks we offer all this year's breeders for sale, which include several prize-winning and

VALUABLE BIRDS.

We have also a choice lot of early chicks that will make winners at the fall fairs.

If you want anything in W. S., and G. Wyandottes, or B.P. Rocks, send for catalogue and particulars. Prices, \$1.00 to \$1.50. If you want the celebrated

WEBSTER & HANNUM

BONE-CUTTER write me.

JOHN J. LENTON,

Park Farm, - - OSHTAWA, Ont.

311

SWINE.

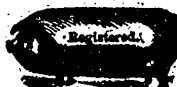

S. W. SMITH, Cochranville, Chester Co., Pa.

Berkshire, Chester White, Jersey Red & Poland China Pigs, Jersey, Guernsey & Holstein Cattle, Thoroughbred Sheep, Fancy Poultry, Hunting and House Dogs. Catalogue.

LARGE ENGLISH BERKSHIRES FOR SALE.

Three sows in pig, also young stock, both sexes. Address

R. J. DIXON,
Glendon, Ontario.

273

PLEASANT VIEW HERD

of REGISTERED TAMWORTHS



For sale, a few yearling sows, young sows ready to be served, two young boars fit for service, and one imported boar, Birmingham Hero. Very low prices. Write for particulars.

412

E. R. KOLB, Berlin, Ont.

OHIO IMPROVED CHESTER WHITES AND ENGLISH BERKSHIRES.

My stock of Ohio Improved Chester Whites are imported from the celebrated herd of L. B. Silver & Co., Cleveland, Ohio. I also have a choice stock of registered Berkshires.



504

GIDEON SNYDER, Jarvis, Ont.

MAPLE LEAF STOCK FARM...

Improved Yorkshire Pigs

of the best strains of breeding.

Large English Berkshires



Large thrifty pigs are my type, that is the way I breed them. All ages now on hand.

503

THOMAS WATSON, Springvale, Ont.

LARGE ENGLISH BERKSHIRES

Choice boars one year old, good for show. Some choice sows under one year, to farrow in Sept. and Oct. Boars and sows six weeks to five months old. Registered pedigrees. Satisfaction guaranteed. Come and see stock, or write for prices.



G. R. DECKER,
Chesterfield P.O., Ont.
2 1/2 miles from Bright Station, 298 G.T.R. Please mention FARMING.

POLAND-CHINAS FOR SALE CHEAP

1 Aug. 20th, 1894, boar. 6
Sept. 20th, 1894, boars. 1 Dec.
20th, 1894, boar. 1 March 20th,
1895, boar. 2 April 30th, 1895,
Boars, imported in dam. I give a registered pedigree, and guarantee every pig to be as represented.



463 R. B. McMULLEN, Goldsmith P.O., Ont.

BERKSHIRES FOR SALE.

Two Registered Sows, 2 and 3 years old good breeders. Two litters of pigs now ready to ship. All eligible to register. Will exchange for Poland-Chinas. Correspondence cheerfully answered.

C. J. WRIGHT,
P.O. Box 114, DIXVILLE, P.O.

385

YORKSHIRES

Six weeks old for \$8.00.
For full particulars write
F. RUSSELL,
MOUNT FOREST, ONT.

201

PUREBRED TAMWORTHS.

A choice lot of spring pigs, farrowed last of February, now in grand shape to ship. Have also a limited number of young sows bred to farrow in July and August. I am making a speciality of this class of swine and keep no other.



LEVI MASTER, Haysville, Ont.

TAMWORTHS FOR SALE.

1 boar 10 months old,
2 boars 7 months old,
6 boars 3 months old,
4 sows 7 months old,
bred to Woodland's
Duke;
9 sows 3 months old.

Drop me a card for all information. Stock guaranteed.

410 J. L. REVELL, - - Putnam, Ont.

RED TAMWORTHS.

My breeding herd is almost all imported. The noted English herds are represented. Boars and sows old enough for mating, also some good spring litters all ready for shipment. Correspondence solicited.

ANDREW DUNN, - - Ingersoll Ont.
411

BERKSHIRES FOR SALE

My Berkshires secured a large number of the most important prizes at Toronto, Montreal, and London exhibitions; also several prizes at the Fat Stock Show in Guelph, including sweepstakes for best purebred sow of any age or breed.

A choice lot of all ages for sale.

Please mention FARMING.

GEO. GREEN, Fairview, Ont.
Stratford Station and Telegraph Office. 263

POLAND CHINAS

My herd is composed of the most popular strains of prize-winning blood from imported stock. A choice lot of spring pigs from imp. Black Joe ready to ship. Also a 12 months old sow due to farrow in August (a show sow).

OLIVER DEURY,
Fargo, Ont.

345

Tamworths, Polands, Chesters.

Some choice Tamworth boars fit for service, and sows bred to farrow in September. Chesters from 10 to 14 weeks old. Polands 3 to 3½ mos. Tamworths 4 months. A post card will bring you all information.

HERRON & DAFOE,
AVON, ONT.

231

POLAND CHINAS at Williscroft.

ARE THE RIGHT KIND.

Brood sows for sale. Boars ready for service. Young sows ready to breed. Lots of pigs two to three months old; good long pigs with heavy bone. Prices right. Mention FARMING.



493

R. WILLIS, Jr., Glen Meyer, Ont.

IT PLEASUS US

To have folks come to see our stock, or to write about them. There is always pleasure and satisfaction in handling Poland Chinas and Chester Whites when they are really well bred. The prices, too, will surprise you.

DANIEL DeCOURCEY,
Bornholm, Ont.

147

**E. D. GEORGE**
PUTNAM, ONT.

Importer and Breeder of
Ohio Improved Chester White Swine

The largest and oldest established registered herd in Canada. I make this breed a speciality and furnish a good pig at a fair price. Write for prices. 293

CANADA WILKES

A first-class specimen of the most fashionable strain of Poland Chinas in the world at head of herd.



Send for illustrated catalogue of

POLAND CHINAS,
POULTRY,
and RASPBERRY PLANTS
(In season)

Correspondence solicited, and personal inspection invited. Address,

CAPT. A. W. YOUNG,
Tupperville, Ont.

399

TAMWORTHS

Some extra fine

EXHIBITION PIGS

Pairs not akin. Also September, 1894, boar, fit to head any herd. Satisfaction guaranteed. 278

JOHN C. NICHOL - - Hubrey, Ont.

Make Money . . .

By investing in some good TAMWORTHS. Let us know what you are in need of. Some fine stock now for sale, including boars fit for service. Sows due to farrow in August and later. Grand lot of young pigs. Pairs not akin. Also Ayrshire Bull ready for service, and some fine cows and heifers.

Caldwell Bros., Orchard, Ont.

For the Finest Strains

of **LONG**

ENGLISH
BERKSHIRE
PIGS

Apply

Bow Park

Co. (Ltd.)

BRANTFORD Canada.

THOMAS DOLLIN & SON, Chatham, Ont.

IMPORTERS and Breeders of Ohio Improved Chester White Swine. Young stock of above always for sale. Satisfaction guaranteed, and prices to suit the times. Pedigrees furnished with all sales, and nothing but first-class stock shipped. Four choice brood sows for sale, registered. Correspondence solicited. 205



GOLD MEDAL HERD OF BERKSHIRES

Young boars and sows of spring litters, bred straight from imported stock. Sires weigh from 650 to 840 lbs. Size and quality combined. Orders booked for September and October pigs at eight weeks old, and for sows bred to imported boars.

J. O. SNELL - Edmonton, Ont.

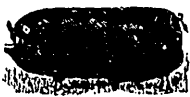

Chester Whites

A large number of sows bred for fall orders. Send in your orders. Now is the time to secure special prices.

JOS. CAIRNS, Camlachie, Ont.

375

IMPROVED LARGE YORKSHIRES.

The winners of twenty first prizes at the World's Fair.

A number of young Boars and Sows for sale.

ALL CHOICE STOCK.

JOSEPH FEATHERSTON,

PINE GROVE FARM. 336

STREETSVILLE, P.O. and Telegraph, Ont.



Some of the Best

Yorkshires in the country are to be found at the Woodroffe Stock Farm.

I have them for sale, cheap, from three months to two years of age. Both sexes. Young sows to farrow in October.

J. G. CLARK, OTTAWA, ONT.

289

H. J. DAVIS, WOODSTOCK, ONT.



Improved Large Yorkshire Boars, very fine, fit for service. Also young pigs supplied not akin. Berkshire Boars of good breeding, fit for service, and young pigs ready to ship; also Shorthorn Bulls and Shropshire Rams from imported stock for sale at moderate prices. 195

It is No Trouble

To make money in breeding Tamworths if you can get the best blood to start with. Let me hear from you if you want something good. I have them at all ages, both sexes, and lowest prices. Also a few Yorkshires.



J. F. Master, New Dundee, Ont. 461

63 CHESTER WHITE SWINE REGISTERED STOCK.

Toulouse Geese, Pekin Ducks, Bronze Turkeys, eggs \$1 50 per 11. Partridge and Buff Cochins, Plymouth Rocks, Silver Gray Dorkings, Golden, Silver, and White Wyandottes, Brown and White Leghorns, Black Hamburgs, American Dominiques, Black-Red and Black Sumatras, and Indian and Pit Games; eggs, \$1 per 13. Will mix sittings if desired; also a few pairs of Wild Turkeys for sale. G. BENNETT & PARDO, Charing Cross, Ont.



469

MAPLE LEAF FARM. IMPROVED LARGE YORKSHIRES

Markham Baron, the sweep, stakes barrow over all breeds at Fat Stock Show at Guelph in 1892, was bred by us. A choice lot of young sows old enough for mating. Also young boars. Pairs furnished not akin. Only first-class stock shipped.



JOHN PIKE & SON, 202 Locust Hill P.O., O.P.R., Markham G.T.R.

LARGE ENGLISH BERKSHIRES



Of the best recently imported families from which I now have a choice selection of fall and spring pigs. Pairs furnished not akin.

Also a few superior Yorkshires of the best strains. Dennis Hawkins, - Woodville, Ont.

433

Yorkshires

For Sale. One of the best herds in the province.

Also CARRIAGE HORSES from Standard-bred and Hackney stallions



J. M. HURLEY & SON, Belleville, Ont. Box 442. Kingston Road Stock Farm. 392

HAVE YOU ANY FINE SHOW PIGS ?



If not, I would like to hear from you. I have for sale an excellent lot of Tamworths under six months.

W.M. ROW, 358 AVON P.O. Ont.

BERKSHIRES

Choice pigs, by Baron Lee 4th, weight 602 lbs. at 13 months, and the following prize-winners at Toronto exhibition: Star One (imp.), 858 lbs.; Regalia, 540 lbs. at 12 mos., and Lord Ross. We have the best boars and sows in the history of the herd. Also choice Jerseys for milk, and in calf. Brampton Stn. 455



J.G. SNELL & BRO., Edmonton, Ont

POLAND CHINAS AT REDUCED PRICES.



1 boar 2 years old; boar 10 months old; 1 sow 1 year old, with pig; 1 sow 10 months old. The above are all first-class, and registered. Write for particulars.

WESLEY W. FISHER, 221 Benmiller, Ont.; Goderich Station.

LARGE ENGLISH BERKSHIRES

Bright Prince, a never-beaten winner, assisted by Banner Boy. Grand young boars and sows now for sale, also choice Shropshires.

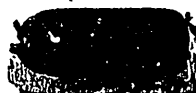

453 T. A. COX, Stock Farm, Brantford, Ont.

YOU ARE INVITED . . .

To come and see our stock or to write to us for prices and particulars. We have for sale 85 head of Chester White and Tamworth pigs from six to ten weeks old, from imported and prize-winning stock. Best quality. Lowest prices.

H. GEORGE & SONS, Crampton, Ont.

3 95

Meet Me at the Industrial, Toronto

I have again decided to make a representation of Holstein-Friesians. Stock only in breeding condition. Remember the old reliable Spring Brook Stock Farm, where you get the choicest stock for the least money. Great choice in Tamworths of all ages.

A. C. HALLMAN,

Waterloo Co. 171 New Dundee. Ont.

BERKSHIRES.

A CHOICE lot of sows for sale, bred to farrow in February and March, and some to breed yet. A few boars fit for service. Young pigs of various ages. Call and see stock, or write for prices and description.

J. H. SIEFFERT,

95 NORTH BRUCE, ONT.

If you want Improved Chester White Swine or Dorset Horn Sheep of first-class quality at rock-bottom prices, write to

R. H. HARDING, Breeder and Importer,

222 MAPLEVIEW FARM, Thorndale, Ont.

KEEP YOUR EYE ON THIS SPACE

CHOICE BERKSHIRES—A litter just farrowed. Dam has a record of six 1st and two 2nd prizes for 1894. Some fine young boars fit to ship, and other pigs of different ages. Sires and dams of all imported. Also Cotswold shearing rams, ram and ewe lambs fit for any flock. All stock guaranteed as described. Visitors welcome.

247

O. T. GARBUTT, Claremont, Ont.

LARGE ENGLISH BERKSHIRES

My breeding stock has been selected from the best English herd. Two imported boars, and eight imported sows all breeding. Pigs of all ages to select from.

230

ISRAEL GRESSMAN, New Dundee, Ont.

Polands

BEST HERD IN CANADA.

ALL STOCK GUARANTEED.

March pigs nearly all gone. Some excellent April and May pigs ready to ship.

Address,



W. & H. JONES,

160

MT. ELGIN, Ont., Oxford Co.

**Ashton Grange Farm****Improved Yorkshire and Berkshire Swine**

Young stock from prize winners at leading shows or pairs of either breed now ready for shipment.

WM. TAIT,

St. Laurent, Quebec.
Near Montreal.

178

YORKSHIRES

A specialty made of breeding purebred Yorkshires of the most desirable type. A large herd of different ages on hand. Prices moderate, and quality of stock guaranteed to be as described.

J. E. BRETHOUR,
Burford, Ont.

214

SHEEP.**SHROPSHIRE RAMS**

AND

YOUNG SHORTHORN BULLS

FOR SALE.

ALSO A FEW FEMALES.

All of the finest breeding. Write for particulars and prices, or come and see our stock. Visitors always welcome.

C. H. IRVING,

Newmarket, Ont.

424

Oxford Downs.

We can suit you. Drop us a card for prices and particulars



Turner & Jull,

448 Burford, Ont.

SHROPSHIRE

Our flock, the oldest Shropshire flock in Canada, was founded in 1881. Importations made from time to time, selected in person from best English flocks. This season's lambs are a strong lot, dropped in January and February. Orders can now be taken for pick.

J. COOPER & SON,
Kippoon, Ont.

157

**Hillhurst Farm**

Oldest Stud of Hackneys in America.

1864.



1895.

Shorthorn and Aberdeen-Angus Cattle.

Dorset Horn and Shropshire Sheep.

Ram and ewe lambs of the best blood and quality.

M. H. COCHRANE,

Hillhurst Station, P. O.

154

SHEEP.

GOOD LEICESTERS

you your case is hopeless. We have shearling ewes; ewe and ram lambs; yearling, two-year-old, and aged rams. Let us furnish you with all particulars.

E. Archer & Sons, Warwick, Ont.

We have some of the best Leicesters to be found in the country, and if we cannot please you, we have shearling ewes; ewe and ram lambs; yearling, two-year-old, and aged rams. Let us furnish you with all particulars.

LINDEN OXFORDS.

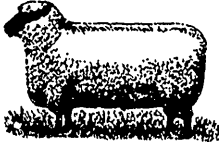

Do you want a ram lamb sired by the Royal winning rams Royal Warwick 3rd, or Bath and West? If so, write, or come and see us. Also some fine young Yorkshires.

R. J. HINE, Dutton P.O.
K. FINLAYSON,
Campbellton P.O.
Stations—Dutton, M.C.R.
Glencoe, G.T.R.

OXFORD DOWNS

FOR SALE.—Six shearling ewes and a few imported ewes, 3 and 4 years old, also 25 ram and ewe lambs. Prices reasonable.

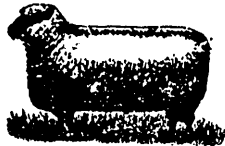

SMITH EVANS,
156 GOUROCK, ONT.
BREEDER and IMPORTER

WHITESIDE BROS.

The Glen, Innerkip,
Oxford Co., Ont.

Shropshires—Yearlings and lambs. Berkshires—Breeding stock, both sexes. Also Ayrshires

In writing mention this journal.
188



THEY ARE FINE!

Fairview's Shropshires

Were never in better shape to supply fine animals. Best breeding, all ages, both sexes. Come or write, to secure the pick.

JOHN CAMPBELL,
Woodville, Ont.

238

MONTROSE STOCK FARM

Breeder of Shorthorns (Waterloo Booth strains), Shropshires, Berkshires, Bronze Turkeys, and Fancy Plymouth Rocks. I make a specialty of raising Swede Turnip Seed, warranted fresh and 1/2 lb. sufficient per acre. The best quality of turnips grown. Write for prices.

HORACE CHISHOLM,
Paris, Ont.

218



T. W. HECTOR

The Cottage,
Springfield-on-the-Credit, Ont.

Breeder and Importer of

DORSET HORN SHEEP

And dealer in
Saddle and Carriage HORSES.

Stations: Springfield, C.P.R., and Port Credit, G.T.R.

The Largest and most Noteworthy Flock of SOUTH DOWNS

In the Dominion.

Bred from Royal and World's Fair Winners. Awarded 20 Premiums at World's Fair, Chicago. Show sheep and flock sheep of all ages and both sexes for sale at prices away down. Specimens will be exhibited at Toronto Show. Address,

JOHN JACKSON & SONS, Abingdon, Ont.

A CHOICE LOT TO PECK FROM.

Consisting of ram and ewe lambs, and ewes in lamb. The finest lot of Shropshire Lambs we ever bred, and you cannot object to the prices we ask. Let us hear from you.

ALLEN McPHERSON,
Forest, Ont.



OXFORDS.

Fine rams, shearling and 2 shears, and ram lambs. Yorkshire sows due to farrow in a few weeks. Also Plymouth Rocks. We can suit you. Send card for particulars and prices.

JOHN COUSINS & SONS,
Harriston, Ont.



OXFORDS :

FOR SALE: One 4-year-old imp. ram, first-prize ram when shearing at the Bath and West of England show. One two-year imp. ram. 15 homebred shearling rams, ram lambs, also ewes of all ages, at prices to suit the times. Also first-class Bronze Turkeys.

462

JAS. TOLTON, Walkerton, Ont.

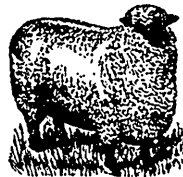
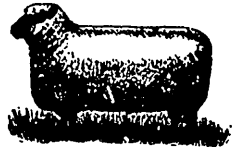

Minnie Miles.

Twice Winner Over all Breeds.

200 OXFORD DOWN SHEEP

for sale, all ages and both sexes. Won many prize at World's Fair. Prices reasonable.

HENRY ARKELL, Arkell P.O.

Guelph—G.T.R.

Telegraph—Guelph.

403

Arkell—C.P.R.

Telephone—Arkell.

LINCOLNS.

The Largest Flock in Canada!

Our breeding ewes, 150 in all, are from the best English flocks. Our last importation was made from the flock of Mr. Henry Dudding, and were all personally selected. If you want a ram or a few ewes, send along your order. If you want shearlings or lambs of either sex, we can supply you with the very best.

J. F. GIBSON, Denfield, Ont.
W. WALKER, Ilderton, Ont.

SHROPSHIRE RAMS

To show, and head the best flocks. Ewes of equal quality, and good show lambs of both sexes will be sold at lowest prices for the next sixty days. Will show at Toronto, Montreal, and Ottawa.

JOHN MILLER & SONS,

Brougham, Ont.

HOLSTEINS.

FOR PRICES ON
HOLSTEINS

WRITE TO

F. A. FOLGER,
393 RIDEAU STOCK FARM
BOX 577 KINGSTON, ONT.

HOLSTEIN-FRIESIANS

H. BOLLERT, Cassel, Ont.

I now offer for sale several very choice bulls fit for service; they are of rare breeding, with great milk and butter records to back them. Also females of all ages and A1 breeding at prices that are right. Remember the best are the cheapest. Come and see them, or write for prices and full particulars. 339

REGISTERED HOLSTEINS

FOR SALE BY

ELLIS BROTHERS,
BEDFORD PARK P.O., ONT.

3 miles north of Toronto, on Yonge Street. Electric cars bring you to our gate.

Inspection invited and Correspondence solicited,
306

**FAIRVIEW FARM****E. PANNABECKER**

Breeder of Grand Milking
Registered Holstein Cattle.
A specialty in females of all
ages at present.

244 **HESPELER, ONT.****CHOICE
HOLSTEIN-
FRIESIANS.**

My herd is all descended from
the first pair I purchased, which
were imported from Holland. From
these I have choice heifers and
bulls for sale.

502 **S. K. BECK, S. Cayuga.**

Meadow Brook Fruit and Stock Farm, St. David's,
Niagara Township, Lincoln Co., Ont.

**CHOICE
HOLSTEIN-FRIESIANS**

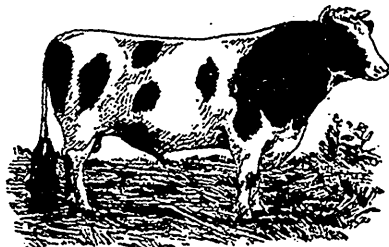

Count Mink Mercedes at the head of herd. He is choicely bred and a superb individual. The cows are from the highest producing families and directly descended stock imported from Holland. Choice young bulls from dams with large milk records now on hand.

SAMUEL & W H COLLINSON,
236 Sherbourne Street, TORONTO.

457

MEET US AT THE GREAT FAIRS

We will again exhibit at the large fairs a carload of **HOLSTEIN CATTLE**, and promise to show you something that will please any lover of good milkers. Parties desiring young stock from the great Holstein families will kindly write or ask for records, etc., which we shall be pleased to supply. We keep no culls.

A. & G. RICE,

490

Brookbank Stock Farm,
Currie's Crossing, Ont.

HELBON STOCK FARM

Holstein-Friesians of the
highest producing strains,
founded on the best imported
families of NORTH HOLLAND.

A few grand young bulls on
hand at reasonable prices and easy
terms. Also Improved Large
Yorkshires of Sanders Spencer
and Walker Jones' breeding. Also
choice Oxford Down rams.

J. W. LEE, 430 Simcoe, Ont.**HOLSTEIN-FRIESIANS.**

Richly bred. None but the best kept.
Young bulls and heifers of the Netherland,
Peel, Johanna, and Moore strains.

519

JNO. MCGREGOR, Constance, Ont**AYRSHIRES.****Glengarry Stock Yards**

My **AYRSHIRE HERD** comprises the best
business strains. Bull and heifer calves descended
from the importations of the late Thomas Brown.
One very fine bull calf by Saladin and Glenrose suit-
able for fall exhibitions. Drop a card for particulars.
478 **JOHN A. McDONALD, Jr. - Williamstown, Ont.**

DOMINION PRIZE HERD**PUREBRED****AYRSHIRE CATTLE**

RECORD FOR 1893

54 Prizes 54**37 FIRST II SECOND**

WITH

Gold, Silver and Bronze Medals**MONTREAL, TORONTO, LONDON AND OTTAWA.**

This herd has always taken the lead; they are
of large size, and of good milking strains.

JAMES DRUMMOND & SON,

292

Petite Cote, Montreal, P. Q.

AYRSHIRES

A few fine young stock bulls for sale.
One by the same dam as the Columbian winner
(Tom Brown).

Also some good young females.

197 Come and inspect our stock. Prices to suit the times.
ROBERTSON & NESS - Howick, Que.

MAPLE GROVE AYRSHIRE STOCK FARM

R. G. STEAOX - Importer and Breeder - LYN, ONT.

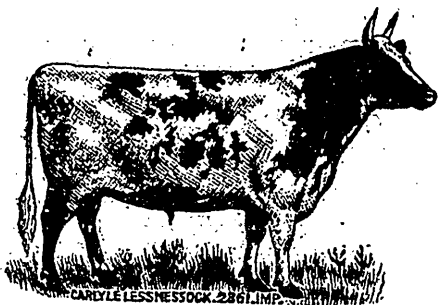

CARLYLE LESSNESSOCK 2261 IMP.

Largest importers in United States and Canada of the most noted Milk, Butter, and Prize record Ayrshires procurable in Scotland. Head of herd is Carlyle Lessnessock, whose grand dam was never defeated in a milking contest in England and Scotland, competing against all other dairy herds for years in succession, and awarded more prizes in gold medals, cups, and money, than any Ayrshire ever exhibited with the imported females of noted individual records. I am in a position to offer none but performers at reasonable prices. Do not fail seeing my stock at all leading exhibitions this fall.

Registered rough-coated Scotch collies from imported stock.

ALEX. HUME,

Burnbrae P.O., Ont.,

Importer and Breeder of

AYRSHIRE CATTLE AND YORKSHIRE PIGS

has for sale a few large aged cows, two yearling heifers (not yet served), a few fine calves, one two-year-old bull of heavy milking strain, one one-year-old (imp. in dam) of the best strain of Scotland's Ayrshires, and choice dairy cows and heifers of several crosses from the best of dairy stock. Also spring pigs from four months old down and two sows under two-year-old class, one boar and two sows under one-year-old class. Show animals.

Telephone, Hoard's Station, G.T.R.

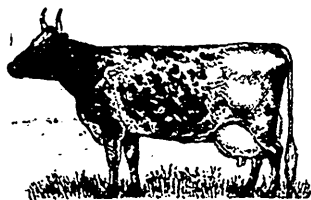

40

AYRSHIRES

None but the best kept. Some fine bulls, also calves of both sexes for sale. Send a card for full particulars.

F. W. TAYLOR,
Wellman's Corner,
228 Ontario.



SALE OF AYRSHIRES.

At the sale to be held on Mr. J. N. Greenshields' farm, in September (date to be announced later), we will offer twenty head of purebred Ayrshires, of different ages and both sexes. There are no inferior animals among them. It will be a great chance to get a start with this breed. Catalogues will be sent free to any one sending a post card.

A. McCALLUM & SON,

Spruce Hill Dairy Farm. DANVILLE, QUE. 198

Ayrshires and Shorthorns



Of the finest breeding. A number of bull calves sired by Dominion Chief; dams, Amy, Ella, etc. A beautiful light colored yearling bull from Amy, and several Shorthorn heifer calves sired by Gibson Duke. Send all particulars and prices.

JOHN H. DOUGLAS,
Breeder and Importer, 222 Warkworth, Ont.

JAMES COTTINGHAM, Riverside Farm,

Ormslow, Que.

Breeder of

AYRSHIRE CATTLE.

My herd is headed by the prize-winning bull, Sir James (5057); sire, Rob Roy (3577). Stock of both sexes for sale at all times, including some choice young bulls and heifers.



Menie Stock Yard



AME LAVER 1096

Breeder of Ayrshire Cattle and Berkshire Pigs. First-class pedigree stock always on hand and for sale. First-class milking stock a specialty.

Wm. Stewart, Jr.
Menie, Ont.
Hoard's Station,
G.T.R. 184

Ayrshire Cattle.

DAVID BENNING, Glenhurst,
Williamstown, Summersdown Station, G.T.R.,

BREEDER OF

Ayrshire Cattle, Leicester Sheeps, and Berkshire Pigs. The Bull, Tom Brown and heifer, White Floss, winners of sweepstakes at World's Fair, were bred from this herd. Young stock always for sale. 340

NEIDPATH STOCK FARM

THOS. BALLANTYNE, Stratford, Ont.

Breeder of Purebred Ayrshire Cattle. Herd consists of the imported bull, Beauty Style of Auchinbrain, and ten imported cows of the highest milking strains and their progeny, by imported bulls. 355

GREENHOUSE STOCK FARM

W. B. COCKBURN, Nassagaweya, Ontario.

Breeder of Ayrshire Cattle, Oxford Sheep and Berkshire Pigs.

I have several choice bull calves from imported cows for sale, at prices to suit the times; also a nice lot of shearing Oxford ewes, and some very promising Berkshire pigs. Write for prices and particulars. 171

Choice Ayrshires.

My stock bull is Imported SILVER KING; a dam of Silver King is Nelly Osborne (Imported), who took 1st as milk cow and champion medal at World's Fair, and his sire is Traveller, the champion Ayrshire bull of Scotland. Young stock of both sexes for sale, sired by this famous young bull.

Please address D. McLAUGHLIN,
Petite Cote, P.Q.

GUERNSEYS.

EASTVIEW GUERNSEYS

A few choice yearling bulls of the richest breeding. All registered. Write for particulars and prices.

E. R. BROW,
Eastview Farm, Charlottetown, P.E.I.

GUERNSEYS

THE GRANDEST OF ALL DAIRY BREEDS.
FOR SALE—Two choice bull calves, also some good
IMPROVED YORKSHIRE

boar pigs fit for service, showing stock pedigrees. Prices right. Come and see, or write.

W. H. & C. H. McNish,
Elm Grove Farm, 511 - LYN, ONT.

JERSEYS.

FOR SALE A J. C. C. JERSEY BULL CALF

Dropped Nov. 12th, 1894. Solid color, black points. Combines close up to blood of Ida's Rioter of St. L., 19 tested daughters; Stoke Pogis, 27 tested daughters; Tormentor, 33 tested daughters; Ida's Stoke Pogis, 23 tested daughters; Pedro, 21 tested daughters. Ida of St. L. tests 30 lbs. 2 oz. Allie of St. L. tests 26 lbs. 12 oz. Oonan of St. L. tests 22 lbs. 2 oz. Eurotas of St. L. tests 22 lbs. 7 oz.
For particulars and prices, write

223 H FRALEIGH, St. Marys, Ont.

JERSEY COWS AND HEIFERS.

The highest testing strains.
Rich breeding and good colors.
ALSO TAMWORTH PIGS.

454 JOHN PULFER, - Brampton, Ont.

JERSEY BULL FOR SALE.

Calved July 26th, 1894, sired by Exciter 33620, dam Matrina of St. Lambert 87304, granum Lisgara; average test, 5.19. Great grandam, Lisgar's Rose; average test, 4.7. This record is taken from Ontario Agricultural College Report for 1894, p. 151. Also some FINE REGISTERED BERKSHIRE PIGS
234 WILLIAM CLARK, Meyersburg, Ont

HEREFORDS.

BEST ALWAYS CHEAPEST

INGLESIDE
HEREFORDS

THE UP-TO-DATE
HERD OF CANADA

A few choice young bulls for sale. Satisfaction guaranteed.

H. D. SMITH,
Ingleside Farm, - COMPTON, QUE.
G.T.R. Station 2½ miles. 181

TO STOCKMEN AND BREEDERS

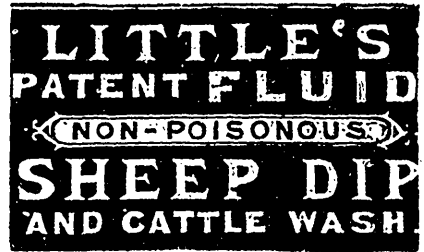

For the destruction of Ticks, Lice, Mange, and all Insects upon Sheep, Horses, Cattle, Pigs, Dogs, etc.
Superior to Carbolic Acid for Ulcers, Wounds, Sores, etc.
Removes Scurf, Roughness and Irritation of the Skin, making the coat soft, glossy, and healthy.

The following letters from the Hon. John Dryden, Minister of Agriculture, and other prominent stockmen, should be read and carefully noted by all persons interested in Live Stock:

"MAPLE SHADE" HERDS AND FLOCKS.

BROOKLIN, ONT., Sept. 4th, 1890.
DEAR SIR,—I cannot afford to be without your "Little" Sheep Dip and Cattle Wash." It is not merely useful for Sheep, but it is invaluable as a wash for Cattle, etc. It has proved the surest destroyer of lice, with which so many of our stables are infested, I have ever tried; it is also an effectual remedy for foul in the feet of Cattle. I can heartily recommend it to all farmers and breeders.

JOHN DRYDEN.

17 Gold, Silver, and other Prize Medals have been awarded to "Little's Patent Fluid Dip" in all parts of the world. Sold in Large Tins at \$1.00. Special terms to Breeders, Ranchmen, and others, requiring large quantities. Ask your nearest druggist to obtain it for you; or write for it, with pamphlets, etc., to

ROBERT WIGHTMAN, Druggist, Owen Sound.

333 Sole Agent for the Dominion.

Jottings.

Oxford Down Flock Book.—We have received from Mr. R. Henry Rew, secretary of the English Oxford Down Sheep Breeders' Association, Volume 7 of the flock book.

Pennsylvania State College.—Our thanks are due to Director Armsby for a copy of the annual report of the Pennsylvania State College for 1894.

Hay Trade Journal.—If you have hay to buy or sell, or are in any way interested, send postal-card request for sample copy of *The Hay Trade Journal*, Canajoharie, N.Y. It will save you money.

Toronto Salt Works.—When we know of a good thing, we like to let our readers know of it too. The Windsor salt, which is the only salt for domestic purposes handled by the Toronto Salt Works, is a really first-class salt, and we can highly recommend it. This company also sell "surf" sea salt for use in baths, for which purpose it is said to be very refreshing and serviceable.

North American Review.—A timely and important paper on "The Turning of the Tide," by Worthington C. Ford, Chief of the Bureau of Statistics at Washington, appears in the August number of the *North American Review*, Mr. Ford showing conclusively that the commercial and financial depression of the United States is at an end, and that the tide is turning toward renewed prosperity.

"Toronto" Incubator and Brooder.—The attention of farmers and others interested in incubators and brooders is called to the advertisement of the "Toronto" Incubator and Brooder which appears elsewhere. These machines will be in full running order at the Industrial Exhibition, and those contemplating buying should, before purchasing elsewhere, look thoroughly into their construction and working. They will bear inspection.

POLLED ANGUS.

The beef of the
POLLED ANGUS

commands the highest price in the British market.
Drop us a card and get full particulars of our herd.

Wm. STEWART & SON,

182 WILLOW GROVE FARM,
Lambton Co., Lucasville P.O., Ont.

SHORTHORNS.

Shorthorns.

Some fine young heifers and bulls.
Also a choice lot of Leicester
shearing rams.
Drop us a card for full particulars.

256 **H. & W. D. SMITH,**
Half mile from Exeter Stn. Hay, Ont.

"THE BRIARS"

SUTTON WEST, ONT.

84 Head of Registered Shorthorns.

Including bulls of various ages, incorporating the best blood of the Scotch and English Herds. Also HORSES AND PIGS. Inspection invited.

F. C. SIBBALD.
J. CARSON, Agent, Yorkton, Assa.



249

H. I. ELLIOTT

Breeder of Scotch Shorthorns and Southdown Sheep
Imported King James at the head of herd.

335 **Riverview Farm, Danville, Que.**

**SCOTCH SHORTHORNS
AND BERKSHIRE PIGS**

For Sale—Choice young cattle of both sexes of the most select breeding. Also young Berkshire pigs from sows selected from the herd of J. C. Snell, Edmonton, Ont. Write for prices. **W. WARD,**
Birchton, Quebec.

Farm one-half mile from station, C.P.R.



246

Shorthorns For Sale

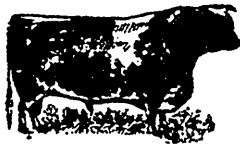

YOUNG BULLS AND HEIFERS

Write for particulars, or come and see stock. Prices reasonable.

JOHN MILLER,
Markham, Ont.

Farm three miles from Locust Hill, C.P.R., and four miles from Markham, G.T.R. 227

AMPLE SHADE STOCK FARM,

In Shorthorns and Leicesters we have some excellent showyard timber, sure winners, coming forward for the fall fairs. Inspection invited.

E. GAUNT & SONS,
ST. HELENS, ONT.

445

Jottings—Continued.

Ontario Veterinary College.—The annual announcement of the Ontario Veterinary College, session 1895-96, has just been forwarded to us. In the exercises at the close of the last session we notice a large list of prize and honor men, and see by the questions that were submitted to the students at the last spring examinations that the college fully maintains its well-known reputation for sound scientific as well as practical work. The session will commence this year on Wednesday, October 16th.

Grasses of Ontario.—Messrs. F. C. Harrison, B.S.A., and G. E. Day, B.S.A., of the Ontario Agricultural College, have prepared a sixty-six-page bulletin, in which twenty-six varieties of Ontario grasses are fully described and their value indicated. A full-page illustration of each variety accompanies the text. This bulletin is certainly one of the most important of the ninety-nine publications of this kind that have been issued from the Department of Agriculture. The grasses are among the most useful plants grown on the farm, and an exact and thoroughly practical knowledge of those which are suited to different uses, soils, and localities will prove of great value. The bulletin should become a standard text-book on this subject.

Newlands Buffalo Robes.—Among farmers, doctors, and business men, who all have much driving to do, a good lap robe is a necessity, while those who drive out as a pastime will find that a warm robe means the difference between comfortable enjoyment and absolute discomfort. We can speak personally as to the value of the Hudson Bay buffalo robes manufactured by Messrs. Newlands & Co., Galt, which are quite equal to the natural buffalo skin which they so admirably imitate, and yet surpass them in some particulars. They afford an absolutely waterproof covering, while any outside wet is readily dried out. They are light, and, through their elasticity, they cling to the figure, and, therefore, are easily kept in position. Messrs. Newlands & Co. will have a large exhibit in the carriage building at the Industrial Fair, Toronto, and in the main building, Ottawa, where these goods may be examined.

Montreal Exhibition.—The Provincial Exhibition which is advertised to take place in Montreal from the 12th to 21st September next, and which is to be opened to the world, promises to be one of the most successful fairs that has been witnessed in the metropolis of Canada for many years past. The entries are coming rapidly, and the various committees organized are now at work. The buildings have been materially improved and extended. They are receiving a new coat of paint, while each portion of them will be tastefully decorated. Handsome prizes, such as medals, as well as prizes in cash value, will be given for the best exhibits. Among the special prizes offered in the sheep department for Oxfords are, for the best pen of four lambs of either sex, \$25, \$15, and \$10; for the best yearling ram, \$15 and \$10; for the best pair of yearling ewes, \$15 and \$10. These prizes are given by the American Oxford Down Sheep Record Association. In the swine department, a special prize by the American Berkshire Association will be given for Berkshires. It will consist of the first ten volumes of the "American Berkshire Record" and is valued at \$50. These prizes are offered for the best breeding pen of Berkshires, registered in the "Berkshire Record," to consist of a boar and four sows, over one year old, owned by a resident of the Province of Quebec. The Horse Committee has considerably improved its department this year, and has built some one hundred new stalls. Several new features have likewise been introduced. New stalls have been built for the cattle department, while the sheep and swine pens have been enlarged and considerably improved. The Percheron Studbook of Canada are offering a special prize, consisting of a silver medal, for the best Percheron stallion exhibited. A gold medal is offered for the best Hackney exhibit, while a prize, consisting of \$50, is offered for the best pair of matched carriage horses 15½ to 16 hands high (no cross allowed), to be driven by owner in a gentleman's carriage. A gold medal is also offered for the best road turnout, also a gold, a silver, and bronze medals offered in the high jumping contest. In section 8, fat cattle for export, an additional prize of a medal is offered to the winner of the first prize. In the poultry department new coops are being added, while the building is being extended.

Toronto Industrial Exhibition.—The annual recurrence of the Toronto Industrial Exhibition is eagerly anticipated by an increasing number of people, who look forward to it as the great holiday outing. It provides opportunities for sight-seeing, instruction, and recreation for all classes such as cannot be placed within their reach in any other way for so small a sum. The seventeenth annual exhibition will be opened on the 2nd of September, continuing until the 14th, and promises to be by far the best yet held. As an indication of the popularity of the fair with exhibitors, we need only refer to the fact that owing to the crush of exhibits in the department of manufactured goods the buildings, spacious as they are, were found entirely inadequate to accommodate the exhibits offered, and the management were compelled to erect tents on the ground

W. C. EDWARDS & CO., Breeders and Importers.

ELMHURST STOCK AND DAIRY FARM

Clarence, Ont.

Shorthorns of milking families with imported Grandeur at the head of our herd. Our Shropshires are all imported from the best flocks in England. Berkshire Pigs. Young stock for sale. Post office and telegraph office, Clarence, Ont. Railway station and steamboat landing Thurso, P.Q., on the C.P.R.

334 HENRY SMITH, Manager.

PINE GROVE STOCK FARM

Rockland, Ont.



Special bargains on young bulls of superior merit and select Scotch breeding. Also thick young heifers at the right prices.

Post Office, Telegraph Office, and Steamboat Landing, Rock-

land, Ont., on the C.P.R.

JOS. W. BARNETT, Manager.

LAURENTIAN STOCK AND DAIRY FARM

North Nation Mills, P.Q.

Ayrshires, imported and homebred; here headed by imported Emperor of Dromore 5434 C.A.H.R. and 1868 S.A.H.B. Jerseys, all of the celebrated St. Lambert family; herd headed by Liegar Fogis of St. Anne's 25704, A.J.C.C. Berkshire Pigs. Young stock of all the above breeds for sale.

Post Office, Telegraph Office, and Railway Station, North Nation Mills, P.Q., on the C.P.R.

GEORGE CARSON, Manager.

H. CARGILL & SON, Cargill, Ont.

BREEDERS OF

Shorthorn Cattle and Trotting Bred Horses



444

The herd was founded on the best animals attainable, both as to pedigree and individual merit, and no expense was spared to procure the choicest specimens of the breed, comprising the well-known Kose of Strathallan, Ury Queen, Duchess of Kent, and Isabella families. Imported Golden Drop bull Albert Victor =6315= (55250), and Imported Saladin, by Vice-Chancellor (56681), now at the head of herd. A few choice young bulls and heifers for sale. For particulars, address

H. CARGILL & SON,
Cargill, Ont.



UNMATCHED OF ELMHURST 622-71134

Would you like to have the best SHORTHORNS

in the country?

If so, let me have your name. A fine lot now for sale, including two young cows with bull calves at foot, and an excellent lot of heifers.

489

W. J. BIGGINS, Clinton, Ont.

GLENBURN STOCK FARM.



SHORTHORNS AND BERKSHIRES

A few choice bull calves for sale; also a splendid lot of young pigs by (imp.) Randolph, and out of choice, well bred sows. Prices reasonable.

JOHN RACEY, Jr.,
Lennoxville, Que.

SHORTHORNS



ELMHURST 18423

I have for sale two nice yearling heifers, red, and red and little white, good ones. Also two bull calves, well bred, and well grown. All are from first-class stock, and at reasonable prices.

D. ALEXANDER,
Brigden,
446 Lambton County, Ont.

Jottings.—Continued.

to enable them to receive the overflow. The entries of live stock exhibits are far in advance of those of any previous year, and the display of horses and cattle will be the finest ever witnessed. The choicer grades are especially well represented. In horses there will be a very fine showing of Thoroughbreds, Standard-bred trotters, roadsters, Clydesdales, hunters, saddle and carriage horses, most of the noted stables in the Dominion being represented, as well as several in the United States. In the cattle department the Jerseys, Holsteins, and Ayrshires will be a very full and representative display, and there will also be a splendid show of Shorthorns. Sheep exhibitors have shown their appreciation of the improved facilities of the new sheep building by a very large increase in the volume of their exhibits. The parade of valuable animals in the ring this year will be a spectacle long to be remembered, as it will undoubtedly be the best and most complete illustration of the resources of Canada as a stock-raising country ever presented. The programme of special attractions this year is in keeping with the superior excellence of the staple departments. All tastes and requirements have been abundantly catered for. The novel and unique pageant never before shown on this continent, the water fête and aquatic exhibition, will embrace a number of performances by artistic specialists of continental renown, and a series of beautiful symbolic tableaux and floats got up upon a lavish scale of magnificence. Every evening there will be presented the great historical, military, and pyrotechnic representation, "The Relief of Lucknow," illustrating a thrilling episode of the Indian mutiny, and concluding with a brilliant display of fireworks. The number of visitors is likely to be greatly in excess of any previous season. The American railroads have made liberal arrangements with regard to fares, and will run many cheap excursions. The Canadian lines grant round trip tickets for single fare, in addition to running special excursion trains, so that a very large influx of visitors from a distance is anticipated. Fortunately, the display is one which will be calculated to enhance the reputation of the country in the eyes of visitors, and send them home with a highly favorable impression of the position of Canada as a progressive and enterprising community.

Central Canada Exhibition.—The best evidence of the growing prosperity and increasing popularity of the Central Canada Exhibition, Ottawa, is the increased prize list this year; \$24,000 are offered in prizes, besides thirty-five specials (including twenty-five gold medals), silver and bronze medals, silver cups, and special cash prizes. It is certain to be the best exhibition ever held in the capital city, and all who can should visit it.

SIMMONS & QUIRIE

Shorthorns and Berkshires.

The herd is headed by the Matchless bull, Royal Saxon =10537=, by Excelsior (imp.) =2697=(5123), with Barmpton M. =18240=, sired by Barmpton Hero=324= as reserve. Among the females are representatives of the Strathallans, Minas, Golden Drops, Mysies, Elviras. They are Bates, with Scotch crosses. The herd of Berkshires includes many prize-winners, and are an exceedingly choice lot. Farm 7 miles from Ilderton Station, G.T.R. Stock of all kinds for sale. Apply to

C. M. SIMMONS, Ivan P.O., Ont., or
JAMES QUIRIE, Delaware, Ont.

ARTHUR JOHNSTON, Greenwood, Ont.



Offers at moderate prices a splendid lot of young Shorthorn bulls sired by Indian Chief, also a very superior lot of young cows and heifers. BERKSHIRES of both sexes now ready to ship. Orders by letter for either SHORTHORNS or BERKSHIRES filled with care. Send for 1895 catalogue. "No Business, No Harm." is our motto.

CLAREMONT STATION, C.P.R., or
PICKERING STATION, G.T.R.
Greenwood Telegraph and P.O.

HORSES.

IMPORTED CLYDESDALE STALLIONS.

I have three imported Clydesdale stallions bred from the most popular lines, guaranteed to be sound, sure, and excellent getters, that I wish to sell at reasonable prices. Drop a card for particulars.

G. S. Stewart, Howick, Que.

ROBERT NESS

IMPORTER AND BREEDER OF

CLYDESDALES

From the best studs in Scotland. English and French Carriage Horses, Shetland Ponies, and Ayrshire Cattle.

WOODSIDE FARM,

HOWICK P.O., Que.

THORNCLIFFE STOCK FARM.

I have on hand the best young Clydesdale Horses and Mares on this continent. Bred from the well-known sires, Prince of Wales, Darnley, Macgregor, Energy, Lord Montrose, The Ruler, Carruchan Stamp, Knight Errant, and other celebrities.

SHROPSHIRE.

Orders can now be booked for Shearling Rams, Ram Lambs and Ewes, sired by the celebrated prize-winning English ram, Bar None. Also rams and ewes of this year's importation.

SHORTHORNS.

Choice young Heifers and Bulls by the celebrated Cruickshank bulls, Northern Light and Vice-Consul.

My stock in the above lines were very successful at all the large shows last year. Call and examine stock before purchasing elsewhere. Terms reasonable.



ROBT. DAVIES, PROP.; P.O., TORONTO.

Stock Notes

Horses.

MESSRS. JOHN MILLER & SONS, Brougham, Ont., have recently purchased in England nine beautiful mare ponies, which were specially selected for cross-ing with Canadian-bred pony stallions. They are nearly all bright bays in color, and are highly spoken of by those who have seen them.

Cattle.

MR. H. K. FAIRBAIRN, Thedford, Ont., writes that he will exhibit at Toronto and London exhibitions some fine bull and heifer calves. They are the get of Great Chief, own brother to Mr. C. M. Simmons' Mina Chief, which are both by Mr. A. Johnston's celebrated stock bull, Indian Chief.

MESSRS. F. BIRDSALL & SON, Birdsall, Ont., write: We have recently put at the head of our Jersey herd a pure St. Lambert bull, bought from Mrs. E. M. Jones, of Brockville. We are very well pleased with him, and his breeding is second to none in the province, as he is a son of Canada's Sir George, and his dam is Muriel of St. Lambert. Our Jerseys have done remarkably well this summer, considering the very dry weather. Our Shorthorn calves are far above the average and doing nicely. Feed will be very scarce this coming winter, as the hay crop was nearly a complete failure.

DR. F. C. SIBBALD, Sutton West, writes us that the recent abundant rain has much improved the farmer's prospects in his section. He has nothing to complain of so far, excepting that a few acres of clover were dried up. The timothy was very good. The grain crops on old land were rather light, but those on new land (sandy loam) are very heavy. The turnips promise well, owing to early sowing; they were in by the 23rd of May. His stock are looking well, owing to a large range of good pasture, plenty of shade, and easy access to water, having a water frontage of over three miles. He intends sending five animals to the Toronto exhibition—one bull and four heifers. The bull is three years old, and traces, on the sire's side, to Fourth Duke of Clarence, the celebrated Bow Park bull; and the heifers trace, on their sire's side, to Royal Barmpton, an imported Cruickshank bull. This and last year's get by the above, Mazurka Duke roth, are the best even and finest lot he has ever seen. He still believes in the beef breed, till the English become vegetarians, feeling certain that it must prevail, especially as milking and sending milk to the factory is such an arduous undertaking.

Swine

CAPT. A. W. Young, Tupperville, Ont., writes that young Poland-Chinas are beginning to put in an appearance again. He has a number of sows and boars on hand at present. He has recently sold a sow to Messrs. L. W. Bates & Son, Brighton, Ont., and a boar to Mr. J. J. Wallace, Stratsburg, Ont.

MR. A. C. HALLMAN, New Dundee, Ont., writes: I have again at the last hour decided to make an exhibit at Toronto. I shall show mostly young animals of rich breeding. I trust again to meet my old friends and many new ones. My stock are not especially fitted up, and anybody buying can see what he buys. I have a great choice in Tamworths of excellent breeding.

MR. E. BUSS, Elphicks, Horsmonden, Kent, England, whose celebrated herd of pigs at Canterbury show once more took all before them, winning all the first prizes, and whose truly grand sow, Elphicks Matchless, won two championship-prizes, besides several first prizes in the class for sows under eighteen months, not having been beaten this year by any Berkshire, has been purchased by Messrs. Metcalfe, of New York, at a very high figure.

Clydesdales For Sale

A grand pair of mares by Lord Rollo (imp.), dam Nellie (imp.), by the Monarch of the Glen. One a sweepstake mare at Montreal in 1893, and has a fine yearling filly. Also choice Ayrshires of all ages.

440

THOMAS CAIRNS,

Athelstan, Que.

SANDY - BAY - STOCK - FARM

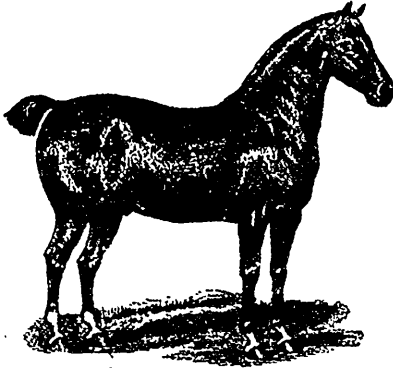

The above stud, though only commenced in 1890, has achieved greater success than any of the same age and kind in Canada. During the five years of its existence it has taken over seventy prizes at first-class shows, including Halifax, London, and Doncaster in England; Chicago World's Fair and Philadelphia in the States; Canadian Horse Show, Montreal Exhibition, and Western Fair, London, in Canada. Shires and Hackneys always on hand for sale.

HORACE N. CROSSLEY,

Sandy Bay Stock Farm Rosseau, Muskoka.

Two Fillies

2 and 3 years old, for sale, registered in American Clydesdale Stud Book, fine colors and good animals in every way. The 3-year-old is bred. Let me hear from you early, if you want a bargain.

JOHN DAVIDSON,

332

ASHBURN, ONT.

FOR SALE.

AYRSHIRES

Always for sale. Some choice young bulls and heifers bred from the Glenhurst herd.

John Sandilands, Williamstown, Ont.

AYRSHIRE BULLS FOR SALE.

One yearling bull, one two-year-old bull, heifer and bull calves. All from choice milking stock. Prices reasonable. 287 Address, WM. KIDD, Petite Cote, Que.

WM. CLARK, North Wiltshire, P.E.I., offers for sale, at moderate prices, a very choice lot of Leicester ram lambs from prize-winning ewes, and sired by his noted stock ram, McNeil 190. He also breeds Improved Large Yorkshire pigs, and Plymouth Rock poultry.

FOR SALE

Choice Ayrshire bull calf, sire Glencairn 3rd (imp.), dam Nellie Osborne (imp.). All young stock sired by imported bulls.

187

DANIEL DRUMMOND, Petite Cote, P.Q.

FOR SALE

Shorthorn bull, with pedigree. Seventeen months old.

H. POWELL,
180 Gladstone Ave., Toronto

For Sale

27 vols. "Coate's Herd Book," Short-horn Society of Great Britain and Ireland. Also 4 vols. Canada Short-horn Herd Book. Apply
E. C. ATTRILL,
Ridgewood Park, Goderich

Stock Notes—Continued.

MR. JOHN RACEY, JR., Lennoxville, Que., writes: Our Shorthorns and Berkshires are looking well, especially the latter, and we never had a finer lot of pigs to offer than we have at present. They are by the imported boar, Randolph who is proving an excellent stock-getter. Litters sired by him are remarkably large, strong, even, and of fine quality. We have a very promising September bull calf for sale, by Strathroy 9305, dam from one of the old milking families. Grain promises well in this section, but is very much lodged. Hay was rather below the average, owing to the dry weather. Corn and roots = very good.

MR. C. R. DECKER, Chesterfield, Ont., reports: I have now a large stock of the largest and best Berkshires that I have had in thirteen years, direct from imported stock. They are in good condition and doing well, and I find the demand for good, lengthy, well-proportioned hogs good. The following are a number of my recent sales: To Mr. James Lillico, Ayr, one boar; to Mr. J. W. Huntley, Newmarket, one sow in farrow; to Mr. R. J. Logan, North Gleanord, one sow in farrow and one boar; to Mr. Wm. Robertson, Chesterfield, one sow in farrow; to Mr. Robert Jameson, Freelon, one sow in farrow; to Mr. G. Smith, Bright, two boars; to Mr. Louis Kauffman, Hickson, one boar; to Mr. Jas. Brown, Chesterfield, one sow in farrow; to Mr. R. C. Nixon, Esquesing, one boar; to Mr. James Warnock, Galt, one boar; to Mr. L. F. Goodwin, Munro, one sow; to Mr. B. Haist, Cassel, one sow in farrow; to Mr. Christian Zehr, Tavistock, one sow in farrow; to Mr. E. MacMillan, Rodney, one sow in farrow; to Mr. Geo. Murray, Walmer, one sow in farrow; to Mr. S. H. Walton, Peterboro, one boar; to Mr. A. Hastings, Chesterfield, one sow in farrow; to Mr. Wm. Malcolm, Innerkip, one boar; to Mr. D. A. Graham, one aged sow and boar; to Mr. John E. Bickell, one boar; to Mr. Adam Decker, Mills, Mich., one boar; to Mr. Andrew Hall, Ayr, one sow in farrow.

Poultry.

CAPT. A. W. YOUNG, Tupperville, Ont., writes: I enclose you a result of some eight yards of poultry, as to the number of eggs laid during a period of seventy days, between March 23rd and June 10th. The non-sitting varieties are shown to excel. The White Leghorns win in their average over the Spangled Hamburgs by one. The Light Brahmas were handicapped in two ways. In breaking them up from sitting they lost time, and about May 1st one of the three hens died, which lowers the average. The Dorkings were handicapped, during the last half of the season, by six out of the ten hens being allowed to sit, as were four of the Brown Leghorns and one Spanish. The results of this test, as I read it, are as follows: For laying qualities—1st, Spangled Hamburgs; 2nd, White Leghorns; 3rd, Light Brahmas; 4th, Silver Gray Dorkings; 5th, Black Spanish; 6th, Partridge Cochins; 7th, Brown Leghorns; 8th, Silver Wyandottes.

Varieties.	No. of Hens.	Days.	Eggs.	Average.	Position considering circumstances.
S. G. Dorkings.....	10	70	368	36.80	4th
Brown Leghorns.....	11	70	289	26.27	7th
Black Spanish.....	6	70	171	28.43	5th
Partridge Cochins.....	2	70	61	30.50	6th
White Leghorns.....	1	70	50	50.	2nd
Silver Hamburgs.....	2	70	98	49.	1st
Silver Wyandottes.....	1	70	22	22.	8th
Light Brahmas.....	3	70	105	35.	3rd
Total.....	36	70	1164	32.33	

I put Hamburgs ahead of White Leghorns because I consider forty-nine eggs is a better average for two hens than fifty for one, and I put the Light Brahmas ahead of the Dorkings for the same reason, although there is a doubt in my mind whether the six hens sitting in the Dorkings might not be a greater drain on the Dorking average than the death of the one hen in the pen of Light Brahmas. Some of our Agricultural College graduates might try the problem.

Sheep.

LORDS A. and L. CECIL, Orchardmains, Tunbridge, England, at the recent Royal Counties Show at Bournemouth and at Canterbury, took the leading position as principal prize-winners in Clydesdale horses.

MR. W. TOOP, Aldingbourne, Chichester, England, won first for shearing ewes (Southdowns) both at the Royal and at the Royal Counties, besides prizes for ram and ewe lambs in very strong competition.

THE Fagham Harbor Co., Selsey, England, report an excellent demand for Southdowns. This flock has been particularly successful this year in the leading English shows, among its winnings being first prize for ram lambs at the recent Royal Show.

BIG SALE

At Isaleigh Grange Farm, Danville, Que., will be held in October one of the greatest stock sales that have ever taken place in this country. Mr. J. N. Greenshields, proprietor of Isaleigh Grange Farm, and Mr. A. McCallum, of Spruce Hill Dairy Farm, have decided to hold a joint sale on Mr. Greenshields' farm (which comprises over 800 acres) in October (date to be announced later), when they will offer an immense herd of purebred Ayrshire and Guernsey cattle, Shropshire sheep, and Yorkshire swine, of all ages and both sexes. It will be a grand opportunity for breeders to secure first-class animals of the above breeds at their own prices. The stock contains no culls.

It is proposed to make the sale an annual event, and to conduct it in such a manner as to merit the fullest confidence and support. The date has not yet been decided on, but will be fixed either before or immediately following the Montreal Exposition.

Catalogues containing full particulars of stock are now ready and a copy will be sent free to any one applying to

T. D. McCALLUM, Manager,
Danville, Que.

185

Dispersion Sale

WE will sell by public auction about the last of October next (date fixed in October number) our entire herd of Shorthorn cattle, consisting of thirty-five females and ten young bulls; also eighty Southdown and Leicester sheep, and a number of Berkshire pigs.

Catalogues ready by 10th of September, and sent free on application.

Our herd is of very choice breeding, having used only "Campbell" or "Lord Polwarth" bulls for the last fifteen years.

Sale to commence immediately after lunch at 12 o'clock.

TERMS—Eleven months' credit on approved notes.

E. JEFFS & SONS - Grange Park - BOND HEAD

FOR SALE

Four extra good bull calves (Ayrshire) and a few fine heifer calves, out of such bulls as Prince of Byron and Norman of Robertsland. Also some very fine Berkshire pigs, of different ages, sired by Knowlton. All direct from imported prize-winning stock, and all registered.

226

A. TERRILL, Wooler, Ont.

FOR SALE.

3 - YOUNG SHORTHORN BULLS - 3

From 8 to 24 months old, at prices and terms to suit the times. Come and see stock, or write.

389 **DAVID MILNE, Ethel, Ont.**

Stock Notes.—Continued.

- MESSRS. JOHN MILLER & SONS, Brougham, Ont., write: Our importation of sheep, comprising many of the most successful prize-winners in England the past season, came home in good form, and representatives will be seen in nearly every important showyard between Montreal, New York, and the Mississippi. We were never better prepared to supply first-class sheep at moderate prices. Every visitor has bought, so far, and every order filled has given entire satisfaction. We shall show Shropshires and Cotswolds at Toronto, Montreal, and Ottawa.

MR. JOHN CAMPBELL, Woodville, Ont., writes: The yearling Shropshire ram, Fairview Stamp 77778, sired by Newton Lord 30983, and out of Campbell's 345, 30980, has grown into a sheep of great merit and best type. Though a very late lamb, and only in good growing condition, yet he is rounding out into capital form, and is now thought to be the best ram bred at Fairview. It is claimed that the sire and dam won more first premiums at the World's Fair than any two sheep shown there by one person, as they carried off nine firsts, representing cash to the amount of \$700, and a silver cup. Campbell's 540, the winner of the grand sweepstakes at Guelph, and the sweepstakes at London, in 1894, has, with her mate, Campbell's 544, grown well, kept her form, and they now are as much alike as two peas. These, with others, will be seen at the leading fairs this month, all being well, and purchasers wanting good things will have the privilege of inspecting the Fairview representatives. The trade in real choice Shropshires was not as good any time during the past twelve years as

it has been so far this season. There is a specially brisk demand for extra good rams to head standard flocks. Breeders from Ohio, Wisconsin, and Indiana have been paying Fairview Farm visits, and others are coming shortly. The shearing ram, True Type 68733, has gone on fully as well as was expected of him by many admirers. He is of good size, very fine in quality, well covered, and has a beautiful fleece, with thick flesh all over. He is well worthy of his name.

MR. ALFRED MANSELL (Mansell & Co., Shrewsbury) conducted the annual sale at Harrington Hall, near Shifnal, Eng., of forty-five purebred Shropshire rams and forty-five ewes. For many years past Harrington has been the home of purebred Shropshire sheep, whose merits have gained for its past and present owners the proudest reputation it has ever been possible to obtain as breeders of the far-famed Shropshires. At all the leading showyards in the kingdom the Harrington flock is represented, and from each of them the sheep have brought unqualified success. Everything connected with the sale was remarkable, and it was undoubtedly the most successful ever held of any class of sheep. The spirited bidding was a noticeable feature of the sale. Even after the first twelve—all handsome winners—were disposed of, the bidding continued brisk, and at the close it was found that the unparalleled average of £41 16s. 6d. for forty-five rams had been made. The animal purchased for 230gs. rose in one bound from 50gs. to 100gs., and the price rapidly rose by ten-guinea bids to 180gs., and then to 200gs. It quickly reached 225gs., and became the property of Mr. Mills at the figure above named. A large number of the animals were retained in Shropshire, and several were sold for exportation. Prices: *Shearing Rams*.—Mr. Graham (let), 105gs.; Mr. Parton, 45gs.; Mr. T. Jones, 55gs.; Mr. M. Williams, 70gs.; Mr. P. Everall, 63gs.; Mr. Inge, 75gs.; Messrs. Evans, 65gs.; Captain Townsend, 74gs.; Mr. Mills, 230gs.; Lord Strathmore, 335gs.; Lord Falmouth, 409gs.; Mr. Davies (Canada), 52gs.; Mr. Mason, 309gs.; Earl of Lisbourne, 52gs.; Mr. C. Coxon, 412gs.; Mr. Saunders, 135gs.; Mr. White (Ireland), 309gs.; Mr. Griffiths, 162gs.; Mr. Fenn, 209gs.; Earl of Dartmouth, 162gs.; Mr. C. E. Wilkinson, 109gs.; Mr. J. Harding, 209gs.; Mr. P. A. Muntz M.P., 49gs.; Mr. Buttar (let), 109gs.; Mr. Bann (let), 209gs.; Messrs. Evans (let), 152gs.; Mr. G. Meredith, 109gs.; Mr. Dixon (Ireland), 155gs.; Mr. Dickin, 275gs.; Mr. F. W. Pugh, 155gs.; Mr. Arkwright, 169gs.; Mr. Hill, 219gs.; Mr. Plant, 125gs.; Mr. R. Meredith, 69gs.; Mr. Cordon, 445gs.; Mr. Parr, 8½gs.; Mr. H. Williams, 275gs.; Mr. Sing, 75gs.; Colonel Lovett, 319gs.; Mr. J. Jones, 109gs.; Mr. Parr, 185gs.; Colonel Kenyon-Slaney, M.P., 75gs.; Major Heber Percy, 69gs.; Mr. Plant, 155gs.; Mr. Whitfield, 219gs. The ewes made 7½gs., 6gs., 5gs., 4½gs. etc., and averaged £5 2s. 9d.

CONTENTS.

GENERAL—	PAGE		PAGE
A big corn crop.....	1	Swine as money makers.....	28
A Newfoundlander on the silo.....	9	Testimony to the value of farming.....	33
Barnyard manure.....	8	FARM—	
Change in the Clydesdale Horse Society's regulations.....	2	“Agricola” to the farmers.....	34
Cold storage for fruit for Great Britain.....	1	Agricultural fairs.....	35
Death of Col. Moberley.....	3	A pair of collies.....	39
Death of Mr. Robert Marsh.....	3	A wagon-box for roots.....	37
Farming notes from Great Britain.....	6	Corn fodder.....	38
Frozen rabbits for England.....	1	Do farmers need recreation?.....	39
Horse racing at exhibitions.....	3	Eradicating the ox-eye daisy.....	41
Manitoba is progressing.....	1	Fall plowing.....	36, 41
Our live stock records.....	2	Sowing seed corn.....	37
Secretary Morton winds up a humbug.....	2	Soils for rape.....	41
Provincial Dairy Show.....	5	To the boys.....	35
The Highland Society's show.....	7	Winter wheat.....	41
The price of farm products.....	4	DAIRY—	
The show season.....	4	A herd of dairy cattle.....	44
The Winnipeg show.....	5	Cutting corn and filling the silo.....	46
HORSES—		Dairy jottings.....	44
Clydesdale notes.....	12	Making fall cheese.....	47
Clydes at Dumfries.....	14	Ripening and churning temperatures.....	49
Horse items.....	10-12	The outlook for creamery butter.....	43
Live stock records.....	13	The “Thistle” milking machine.....	43
Purity of blood.....	15	To dairymen.....	42
Scottish vs. American Clydes.....	12	Winter dairying.....	44
Hackneys.....	14	HORTICULTURE—	
CATTLE—		An interesting insect.....	52
A group of Pine Grove Shorthorns.....	18	Crimson clover.....	51
An odious regulation.....	17	Farmers, attention.....	50
Belgium removes the embargo.....	18	Grapes in cold latitudes.....	53
Black leg in cattle.....	21	The cultivation of orchard soil.....	50
Fattening cattle on potatoes.....	18	The evaporating of fruit.....	51
Fixing a type.....	19	To horticulturists.....	50
Give the boys a chance.....	20	POULTRY—	
Short items.....	16-17	A comfortable poultry house.....	54
Scottish feeders want our store cattle.....	17	Analysis of hen manure.....	59
The horn-fly.....	21	Care of eggs.....	56
SHEEP—		Feeding for winter eggs.....	58
A flock of sheep.....	26	How to get the best results from farm poultry.....	57
Breeding ewes at the mating season.....	22	Minorcas.....	55
Care of the rams.....	23	Poultry at the fall fairs.....	56
Devote more land to sheep.....	24	Suggestions for September.....	54
Dipping sheep.....	27	To all poultrymen.....	54
Grub in the head.....	27	APIARY—	
Important to exporters of sheep to the U.S.....	22	Shaking bees off the comb.....	61
Pasturing rape.....	26	The honey bee.....	60
Sheep as scavengers.....	22	RECENT INVESTIGATIONS—	
The class of ewes to select.....	26	A grass bulletin.....	64
SWINE—		A milking machine.....	62
A noted Berkshire sow.....	31	Exterminating chinch bugs.....	64
Cross-breeding.....	28	Feeding hens.....	64
Feeding wheat to pigs.....	29	Fixation of free nitrogen.....	62
Marketing hogs.....	33	Loss of nitrogen in drainage waters.....	64
Selection in breeding.....	32	PUBLISHERS' DESK.....	65-66
Some scraps of hog history.....	29		

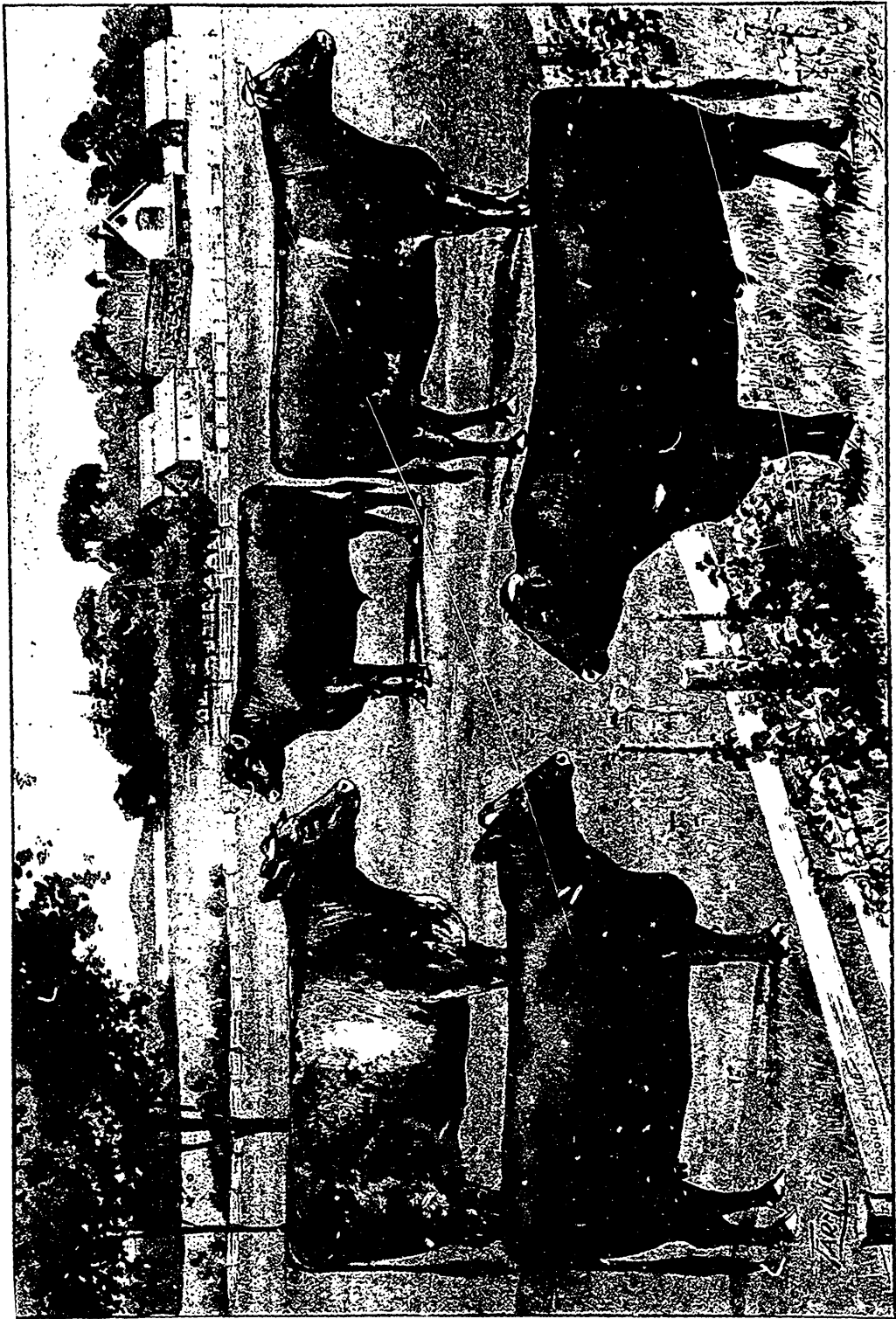

A GROUP OF CHOICE SHORTHORN CATTLE

FARMING

Vol. XIII.

SEPTEMBER, 1895.

No. 1.

A Big Corn Crop.

The corn crop in the Western States this year promises to be the biggest one on record by several million bushels. Feeders in those parts will have plenty of feed for their stock during the winter, and there should, therefore, be a large number of choice fat steers forward next spring in Chicago and other markets.

In portions of Western Ontario, and in some parts of the United States, feed will be scarce (in some few cases very scarce), and in these districts no stock can be carried through the winter except such as are absolutely necessary. Those feeders, therefore, who have plenty of feed and to spare are likely to get remunerative prices for their fat cattle in the spring, provided that they buy them cheap enough this fall, and that should not be a hard matter to do under present circumstances.

Manitoba is Progressing.

An important feature in the export cattle trade from Canada this season is the increased number of fine fat cattle that Manitoba is sending to the old country. Last year a few hundred were exported, but this year the shipments from Manitoba alone are expected to be in the neighborhood of 20,000. Messrs. Gordon and Ironsides, who are the principal shippers, have made arrangements with the C.P.R. whereby the stock trains make fast time to Montreal, the running time being much the same as that of the express trains. The cattle are fed and watered at Winnipeg and Schreiber, and go through in good condition.

The great wheat crop that will be handled this year in Manitoba will certainly give that province a great impetus. Before this reaches our readers' hands, cutting will be all over, and, judging by the first-cut samples, the grain will be magnificent. The first sample to reach Winnipeg weighed 64 pounds to the bushel. Hail and wet weather has done some damage in a few places, but not sufficient to

affect the total yield more than one per cent. Other grains, too, promise well. Manitoba has a great future before it. All it wants is settlers.

Cold Storage for Fruit for Great Britain.

The Dominion Government have agreed to provide cold storage chambers on board steamships for two trial shipments of fruit to Great Britain, the shipments to be not less than one carload each, and not more than two carloads each. The temperature on board the steamships will be kept between 34° and 40° F. Shippers will pay the usual freight charges of about 20s. per ton of 75 cubic feet from Montreal to the port of entry in Great Britain. Professor Craig will act in conjunction with fruit-growers and arrange for the preparation of the shipments.

Frozen Rabbits for England.

Australia is making a practical use of what has so long been a pest, viz., the millions of rabbits that have overrun the country. From the last number of the *Australasian* to hand, we learn that by the steamer *Nineveh*, which left Melbourne for London on July 11th, the Department of Agriculture for Victoria shipped 125 tons of frozen poultry, game, and rabbits. The quantity of rabbits is about 100,000, most of which are already sold to English buyers, the shipments being made in execution of orders.

"It is not three months," says the *Australasian*, "since the news that three shipments were afloat from Melbourne caused the most dismal forebodings of a collapsing market in the minds of London salesmen, whereas now orders are being received at a faster rate almost than they can be executed. As examples of the orders in hand, it may be mentioned that one firm has lately received an order for shipment at the rate of 300 crates per week, and another firm at the rate of 200 crates per

week ; and as supplies from the districts in which the trappers were at work a few months ago have fallen off, the concurrence of an increased demand with a diminished supply recently caused the Melbourne market to advance from 3s. 6d. to 6s. per dozen. The method of forwarding the dead rabbits from the country to the Melbourne Refrigerating Works has been improved by the adoption on the part of dealers of the form of crate used by the Department of Agriculture for ocean carriage, but of a heavier make, in order to be available for repeated railway journeys. The crate allows the free circulation of air. In addition to the shipments to London by the *Nineveh*, a good-sized shipment of game and rabbits is being sent to Cape Town by this vessel. A trial shipment of rabbits was recently sent to Japan."

Secretary Morton Winds up a Humbug.

Secretary Morton, of the United States Department of Agriculture, has abolished that ancient humbug, free seed distribution. Unable to get Congress at its last session to consent to the lopping off of this useless branch, he consulted Attorney-General Olney, who gave it as his opinion that under the law the Secretary of the Agricultural Department was authorized to purchase only such seeds as were rare, and uncommon to the country, or such as could be made more profitable by frequent change from one part of the country to the other.

Armed with his opinion, when the bids for furnishing seeds to the department were opened, Secretary Morton decided that none of the seeds came up to the requirements of the law, and rejected them all. He has thus saved the country a large sum of money which was being uselessly expended, as the only use made of this distribution was by congressmen, who utilized the seeds for the purpose of ingratiating themselves with their constituents, and the seeds were of old-time varieties which could be purchased anywhere. The whole thing long ago became a farce, and Secretary Morton is to be congratulated on abolishing that branch of his department. It will be regretted only by the congressmen, and those seedsmen who made money by furnishing the seeds to the Agricultural Department.

Change in the Clydesdale Horse Society's Regulations.

The decision of the Scottish Clydesdale Horse Society, at their meeting held at the time of the Highland Society's show at Dumfries, to rescind by-law 39, which read that "no horses shall be entered in the studbook unless bred in the United Kingdom," is a wise one. American Clydesdale breeders have for some time been trying to get this rule altered so that they could, if they wished, enter in the Scottish Clydesdale Studbook Clydesdales bred in America on the same footing as Scottish-bred Clydesdales are entered in the American Clydesdale Studbook. The change in the rule is thus in the nature of a reciprocity arrangement.

It is not likely that many American-bred stallions or mares will be entered and brought over to Scotland, but it gives Clydesdale breeders in the latter country the opportunity of securing for the improvement of the breed any very superior animals that may be bred in America. It is a proof of the breaking down of that exclusiveness which has always characterized the Scottish Clydesdale Horse Society that the motion to repeal the by-law stood in the name of Mr. Martin, Auchendennan, who has hitherto been an advocate of restrictive measures in regard to registration.

Our Live Stock Records.

In this issue Mr. D. McCrae, Guelph, editor of our Horse Department, has an article on the vexed question of our live-stock records, which, in a few concise words, gives, without comment, the views of the two opposing parties as to the best method of conducting these records in the future.

We have in a previous issue given our opinion on this question. We believe in keeping our Canadian records in Canadian hands in all cases where the breeder is not put to too great expense by so doing. In this, we are confident we have the support of a large majority of the breeders of this country. These now have it in their power to make much more advantageous arrangements than formerly for the recording of their stock, and the delegates from the various associations who will meet in this city during the Industrial Exhibition to confer with the Hon. John Dryden on this question will have themselves to

blame if they do not bring matters to a satisfactory solution. Discuss this question, gentlemen, and settle it once for all.

Death of Mr. Robert Marsh.

We regret to announce the death of Mr. Robert Marsh, Richmond Hill, which took place on August 1st, at the age of 71 years. Deceased was one of the pioneer importers and breeders of Southdown sheep in this country, having established a flock in 1857. He commenced exhibiting ten years later, and soon won a high reputation for breeding first-class sheep. At the Centennial in Philadelphia he carried off many first prizes, as he did also at New Orleans, and during later years at Buffalo, Toronto, and other large exhibitions. Sheep from his flock, or their descendants, can be found all over Canada, and in many of the states of the Union. He frequently acted as judge of sheep and cattle at Toronto and other large shows.

Deceased was born in the year 1824, within a few yards of his late residence, and lived on the homestead until his death. He had suffered from inflammatory rheumatism for some years, and of late had been confined to his bed. He was very highly respected, not only in the section of country in which he resided, but by all with whom he came in contact, being of a very kindly disposition, and at shows his familiar form was always looked for by his numerous friends. He leaves a widow, five sons, and four daughters, to mourn his loss.

Death of Col. Moberley.

The death of Col. T. S. Moberley, Richmond, Ky., on August 7th, removes from the midst of American Shorthorn breeders a prominent and active figure. Col. Moberley had been staying at Virginia Beach for the benefit of his health, which had not been good for some time. In company with his two children he was bathing in the surf, when his little daughter got beyond her depth, and, in trying to save her, he got exhausted, and sank before assistance could reach him. The daughter was rescued by another.

Col. Moberley was born with an innate love for cattle, especially for Shorthorns. Among some of the earlier cattle bought by him were representatives of the celebrated Marys and Rose of Sharons, which he always

held in great esteem. He was of late no advocate of sticking to "line breeding," but purchased the best wherever found. His purchase of Young Abbottsburn and the wonderful success that attended the Forest Grove herd is well-known history to all Shorthorn breeders. He will be greatly missed by all his fellow-breeders.

Horse Racing at Exhibitions.

As is well known, the Ontario Legislature at its last session passed an Act for the regulation of all agricultural societies that receive grants of money from the Ontario Department of Agriculture. This Act forbids horse racing other than trials of speed at exhibitions held by such associations on their grounds, or within five miles thereof.

Some doubts having arisen on the part of various agricultural societies as to the interpretation of the section forbidding horse racing, the Hon. John Dryden, Minister of Agriculture for Ontario, has issued a circular clearly defining the intent of the Act. After showing that the object of such societies, as regards live stock, is confined to the purchase or importation of animals for the improvement of the breeds, and to awarding premiums for excellence in the raising of stock, and that the expenditure of moneys for any other purpose is inconsistent with the above, he points out that, in awarding premiums for light horses, form, soundness, and style should be considered, as well as speed, and that no horse should be placed first for speed alone. As regards trials of speed, it is expressly stated that such may be allowed, if in the judgment of the officers or judges it is deemed desirable to test the speed of the contesting horses, but the prizes must, in every case, be awarded for general excellence. No purses are to be offered by owners of contesting horses, and all prizes must be offered in the ordinary way.

This view of the purpose of an agricultural show, as defined by Mr. Dryden, must commend itself to all who wish to keep our county and township shows purely agricultural shows, excluding everything in the race and circus line. For those who wish to race their horses there are plenty of race tracks in the country, where they can race to their fill. We are not opposed to racing when properly conducted, but the interests of our agricultural shows and racing are totally distinct, and should be kept so.

The Show Season.

September is to farmers in a great many parts of this continent a very important month in many ways. It is a sort of half-way house between the summer and fall, giving the farmer a little breathing time after the continuous labor of harvest, before he has once more to harvest the fall crops and make preparations for another season's crops. For this reason, as well as because at this season of the year fruits and vegetables are generally at their best, September has been chosen in many places as the month in which to inaugurate the long list of fall fairs that will be in full swing for some weeks to come.

That these exhibitions, from the smallest to the largest, if only they are properly conducted, can be productive of much good to the farmer and his family goes without saying. Besides the information that can be obtained by the enquirer concerning the various breeds of live stock and the newest varieties of fruit, grain, and vegetables, he has the great advantage of a complete rest from farming toils, and the opportunity of social enjoyment with many friends, whom he otherwise would not be able to see. This last feature, of course, would be relatively greater at the larger exhibitions. Change of scene, once in a while, tends to keep those who can manage to obtain it in better health and spirits. The old proverb that "All work and no play makes Jack a dull boy" is just as true now as ever, but is oftentimes too little considered by the farmer in reference to his wife and family. On many farms it is to be feared that the lot of these is little less than slavery, from one year's end to another. No wonder, then, that the young people hasten to get away from homes where such is the case, or that the wife, in some instances, dies, while comparatively young, solely from overwork.

This must be changed. There should be certain days in every year set aside as holidays for the farmer and his family, in which only such work as is absolutely necessary should be done; or it could be arranged that so many members of the family could take a day off at one time, and so many at another. The idea is the same, to have certain holidays in the year. These will be looked forward to with joyful interest, especially by the younger members of the family, and the daily routine of work will seem lighter with the prospects ahead of a day to themselves in the near future. Where this is done, the work will be

better done, and there will not be the same haste to leave the farm for the city that is so pronounced a feature at the present time.

Try this plan, then, those who have not already brought it into use. Reserve certain days for holidays for yourselves and families during the year, and, where possible, visit one of the exhibitions going on during the fall, even if it be only the small township one held in your neighborhood. The opportunities for improving the mind are, however, naturally greater at the large exhibitions, and, therefore, if one of these can be visited, the results are likely to be so much the better.

The Price of Farm Products.

To the inhabitants of an agricultural country, such as a large portion of North America must ever be, the question of the price of farm products must always be a most important one. When the farmer does well here, the beneficial results are felt all over the land; but, when the opposite is the case, the result is a great restriction of business. The last-named state of affairs has been the case for some time past, but now better times seem to be at hand.

The great increase in the products of the farm of late years, and the consequent decrease in prices, arose from various causes, which have been discussed at length in the daily press. Some of these causes are the opening up of new countries and the extension of agriculture there, and in old settled ones as well; the introduction of improvements in machinery and implements, whereby the farmer is enabled to reap his crops more easily, and thus to extend his operations over a larger quantity of land; the improved methods of farming, by which a farmer gets more off the same quantity of land, etc. There are many persons who hold that farmers will never get as good prices again for what they have to sell as were obtained in past years, and these are never tired of pointing out the possibilities of agriculture in South America, Africa, and other places, when those countries get more thickly settled, and improved methods of agriculture come into use there.

All these causes named will certainly have considerable bearing on the question of the prices of farm products in the future, but we do not think that they will have such an effect in keeping down prices as some expect. We believe that agricultural products will bring remunerative prices for all ages, but that these

prices will vary from time to time, as they have in the past. The increase in the population of the world, which is going on by leaps and bounds, will require a constantly increasing supply of food, and, as settlement progresses, the land available for agricultural purposes will become smaller and smaller. In fact, it is only a question of time when it will all be taken up.

Another curious feature which will also tend to maintain prices for farm products is the gradually diminishing proportion of the population that is turning its attention to farming. We will take the United States as an example. In that country, in 1870, farmers formed forty-seven per cent. of the population. In 1880 the proportion had dropped to forty-four per cent., while the census of 1890 revealed a still further drop to forty per cent.

These figures tell a tale. They show that the population of the towns and cities is being built up more rapidly than that of the country, and the same is the case in many parts of Canada, and in other countries as well. All this will have an important bearing on the question of future prices for farm products.

Provincial Dairy Show.

The dairy show to be held at Gananoque, Ont., on October 1st, 2nd, and 3rd, is the first purely dairy show to be held in the Dominion of Canada. The dates that have been selected for the show, following, as it does, the big exhibitions, are very convenient, and should attract a large entry, especially as liberal prizes are offered for all dairy breeds, as well as one class for beef breeds that may wish to compete together in milk. The entries close on September 15th, the fees for cattle being, for those over one year, \$1; for those under one year, 50 cents; for butter, cheese, dairy appliances, etc., 25 cents. Entries should be made to Mr. Henry Wade, Toronto.

The following judges have been appointed: For cheese and butter, Prof. Robertson, Dairy Commissioner, Ottawa, and Prof. Ruddick, Ottawa; for dairy utensils, John H. Croil, 614 St. Paul street, Montreal; for dairy cattle, Ayrshires, John Douglas, Warkworth; Jerseys, J. C. Snell, Edmonton; Holsteins, J. M. Cook, Aultsville. The awards for cattle will all be made by the scale of points adopted by the British Dairy Farmers' Association.

The Winnipeg Show.

While not favored with the best of weather during the continuance of the show, yet the directors of this exhibition must be congratulated on the success that attended their efforts, although the receipts were not up to last year's total.

Horses were present in fair numbers. In the Clydesdale class, J. E. Smith, Brandon, was a strong competitor, winning many of the chief prizes for both stallions and mares. For the first place in the Thoroughbred class, Dr. Rutherford's Kilburn was a strong favorite, but the judge preferred G. Campbell's Wellgate.

The show of Shorthorns numbered some seventy head, and most of them were of high merit. Mr. James Russell, Richmond Hill, tied the ribbons. P. Thompson's Hilliary obtained first place in the aged bull class, followed by J. G. Barron's Topsman, W. S. Lister's Gravesend's Heir 2nd only winning third position. The two-year-old bull class had two sons of Mr. Arthur Johnston's Indian Chief at the head, Indian Warrior, owned by J. Lawrence & Son, standing first, and A. Graham's Manitoba Chief second. A son of Mr. Biggins' Royal Don, Sir Victor, shown by A. & G. Chadburn, was first in the yearling class. P. Thompson's Hilliary was the winner of the champion prize for bulls.

Messrs. Lawrence's white Village Lily worthily headed the aged cow class, and a second entry of the same exhibitor, Wimple of Ialton, came second. To the former also went the sweepstakes for cows. Messrs. Lawrence also won first in the three-year-old and two-year-old classes, as well as the herd prizes, both the open one and that restricted to exhibitors from Manitoba and the Northwest Territories. The sweepstakes for herd open to all breeds also fell to these exhibitors, as well as the specials given by the Manitoba Cattle Breeders' Association for the best cow over three years, open to all beef breeds.

The prizes in the Polled Angus class were pretty well divided among the four competitors, Messrs. Barrett, Stewart, Clifford, and Traquar. The herd prize went to Mr. Stewart, while the Hon. W. Clifford took three firsts and three seconds. All the prizes for Galloways went to Wm. Martin's well-known herd, and those for Herefords to W. Sharman, Souris. A number of good grade cattle, both for beef and dairy purposes, were shown, prizes being offered for both classes,

and there was a good turnout of fat cattle.

Holsteins were a bigger class than last year, there being nine exhibitors. Here, too, the prizes were pretty well divided, but James Glennie won the largest number of firsts, including the herd prize. R. McKenzie, High Bluff, however, secured the sweepstakes for bulls. James Bray, Portage la Prairie, won the majority of the prizes in the class for Jerseys and Guernseys, including the sweepstakes for bulls and the herd prizes.

The Ayrshire class was made more interesting by the presence of W. M. & J. C. Smith, Fairfield Plains, Ont., who had several animals entered. They secured the herd prize, four first prizes for females, and one for bull calves. Steele Bros., Glenboro', won the sweepstakes for bulls with their yearling bull, What Care I, and were also first for three-year-old cows. The dairy classes were judged by Mr. J. C. Snell, Edmonton, Ont.

Most of the sheep classes were filled; the accommodation provided was none too large for the entries. The judge was Mr. D. G. Hanmer, Mount Vernon, Ont. S. Coxworth, Whitby, Ont., had it pretty much all his own way with Cotswolds, as had J. Murray, Lyleton, with Leicesters. Lincolns and Southdowns were only medium. Shropshires were good, as were Oxford Downs. In the former class A. J. Macmillan was a leading prize-winner, capturing the American Shropshire Association's prizes, as well as other first premiums. In Oxford Downs, P. McLaren, Menzies Bros., and James Bray were the prize-winners. Merinos and Dorset Horns were shown by W. M. & J. C. Smith and E. Vance, Emerson.

The swine classes were very well filled. S. Coxworth was a strong exhibitor of Berkshires, and won the lion's share of the prizes. R. McKenzie, High Bluff, however, won two firsts and several seconds. W. Kitson, R. L. Lang, and other exhibitors, secured a share of the winnings.

Yorkshires were well shown by J. Brighton, James Bray, A. B. Potter, and others. The first named won the sweepstakes for boars, and Mr. Bray for sows. A fair entry of Chester Whites, Tamworths, and Duroc-Jerseys were made, while, for Poland Chinas, W. M. & J. C. Smith and D. Fraser & Sons divided the honors. The pig classes were judged by Messrs. D. G. Hanmer, Mount Vernon, and James Elder, Virden, Man.

Farming Notes from Great Britain.

The past month has been one of warmth and growing showers, just what was wanted in the south of England, for, although the rain has come too late for the swede and mangel crops, it will enable the farmer to get in a large acreage of rape, thousand-headed kale, and white-fleshed, green-top, and purple-top turnips, all of which are excellent feed, and will stand a fair amount of frost. The thousand-headed kale will stand any extremes of cold we get in this country, and it is a most valuable green food for early spring. The grain crops are very varied as regards quantity, and, while we have some grand crops, we have many that are very poor indeed. The following table, compiled from about six hundred reports from all over this country, gives a very fair idea of what is the case here:

	Wheat.	Barley.	Oats.	Beans.	Peas.
Over average..	12	52	26	12	19
Average	118	189	127	69	102
Under average	398	302	479	225	200
	528	543	632	336	321

PERCENTAGES.

Over average...	2.3	9.6	4.1	3.6	5.9
Average.....	22.3	34.8	20.1	20.5	31.8
Under average	75.4	55.6	75.8	75.9	62.3
	100	100	100	100	100

	Hay.	Potatoes.	Turnips.	Mangels.
Over average..	3	138	24	30
Average.....	51	279	134	128
Under average	582	154	440	349
	636	571	598	507

PERCENTAGES.

Over average..	0.5	24.1	4.0	5.9
Average.....	8.0	48.9	22.4	25.3
Under average..	91.5	27.0	73.6	68.8
	100	100	100	100

From this table it does not appear that our English grain farmer is likely to have a very grand year.

DAIRY.

At the recent Tunbridge Wells show the Jersey Society carried out a butter test competition. There was an entry of sixteen cows, and the average yield of milk of the sixteen cows was, for twenty-four hours, 33 lb. 5 oz., and the butter 2 lb. 1 1/4 oz., the ratio of pounds of milk to butter being 15.90.

The particulars of the first and second prize cows were:

First prize, St. Brelade's Lady; born March 18th, 1890; calved March 22nd, 1895;

sixty-four days in milk; yielded 35 lb. 8 oz. of milk, 3 lb. 4 oz. of butter, ratio of pounds of milk to butter being 10.92.

Second prize, Greek Maid 6th; born May, 1891; calved February, 1895; one hundred and sixty-nine days in milk; yielded 35 lb. of milk, 2 lb. 15¼ oz. of butter, ratio being 11.85.

The great value of these kinds of tests is daily becoming more and more apparent; hence, although one, perhaps, ought not to say definitely it ought to be, one is greatly inclined to say that no cow should be awarded a prize unless it passes a certain standard.

All farmers on your side of the water, as well as on this, ought, therefore, to make it a rule that no cow in a butter dairy shall be retained therein unless she produces a certain fair quantity of butter. Refer back to these two cows, or take the whole sixteen tested ones, and we find that here are sixteen cows which produce, per day, butter worth from 60 to 70 cents, or \$4.20 to \$4.90 per week for butter alone.

Moral: Test every cow, and keep only heifers for cows that are descended from bulls and cows whose parents are tested ones.

The Highland Society's Show.

(By Our Own Correspondent.)

The sixty-eighth annual show of the above society was held at Dumfries, commencing on Tuesday, July 23rd. Generally speaking, it was a good one in all respects. Cattle entries numbered 269, horses 333, sheep 226. Briefly summarizing the show, we give a few short notes on the various sections.

Shorthorns came first in order, and the champions were: Best Shorthorn, Lord Polwarth's Nonsuch. Best Shorthorn bull, the same owner and animal; the reserve number going to G. Harrison's Champion Cup. Best Shorthorn female, A. W. Law's Graceful 3rd; reserve going to Lord Polwarth's Heroine.

The old bull class only numbered five, but they were good ones. In this class was Lord Polwarth's bull, Nonsuch, and thus, in addition to the honors mentioned above, he took the first prize in this class. He is a massive, well-ribbed bull of grand carriage and build, and of great substance, with splendid quarters. This bull recently won champion honors at Darlington, R. A. S. E.

Two-year-old bulls were a grand class, and worthily headed by that splendid, level, mellow,

and symmetrical bull, Champion Cup, owned now by Mr. G. Harrison, but bred by J. Deane Willis.

The yearling bulls were a very nice lot. First and second prizes went to two bulls of Mr. Duthie's breeding, Watchword and Bridegroom, now owned respectively by Messrs. J. D. Fletcher and J. Gilmour.

The cows were of excellent merit and well shown.

Aberdeen-Angus, with an entry of 73, may be said to have been well shown in every respect, and it certainly was a very high honor that fell to Sir G. M. Grant when it was found that all the three prize bulls in the old class were bred by him, this breeder also winning champion for the best Aberdeen-Angus, with Prince Inca, and for best Aberdeen-Angus stallion with Equestrian.

The other bull classes were of quite average merit, whilst those for cows and heifers were excellent in every respect, Mr. Smith's Witch of Endor being made champion female of her breed.

Galloways were, as was expected, excellent in every way. The old bull class was well headed by Crown Jewel 2nd (Mr. Dudgeon), sired by that famous bull, Harden. This bull is a very massive, heavy-fleshed animal, and has been a conspicuous prize-taker. To him also went the cup for the best Galloway bull. The two-year-old bulls were but five in number, and the fight was between Messrs. Wilson's bull, Sir Duncan, and Mr. C. Graham's Glenlivet, Sir Duncan having beaten Glenlivet in the spring. At Darlington the decision went the other way, whilst here Sir Duncan again won. The cow section was a very grand one, whilst the yearling heifers were a feature.

Highland cattle were well shown, and the general merit was good, notwithstanding the numbers of entries were but about half the average number. Ayrshires were, both as regards number and quality, such a section that the Dumfries show will be for a long time remembered by the breeders of these cattle as a red-letter day. The old bulls found a worthy leader in the Royal champion bull, Royal Kyle (Mr. R. W. Reid's). In the two-year-olds, we found but three bulls present, but they were, and are, perhaps, the three best bulls of the breed in Scotland at the present time. Mr. A. Mitchell's Son of a Gun went first; he was second at the Royal, as well as at Ayr. Mr. R. Montgomery's Royal Macgregor, which, as a yearling, was unbeaten, and was

first at Kilmarnock and third at Ayr, took the second place; whilst Sir M. J. Stewart's First Choice, which was first at Ayr and the Royal, went to the third place.

The exhibit of Clydesdale horses was somewhat short in numbers, but, as regards quality, was certainly above the average, and the various classes, which were the best shown in 1895, were very keenly contested. The following are the winners of champion and first-class prizes: Best Clydesdale stallion, the Marquis of Londonderry (Holyrood). Best mare or filly, J. Gilmour (Moss Rose). Stallions foaled before 1892 (Holyrood). Entire colts foaled in 1892, J. D. Fletcher (MacEachran). Entire colts foaled in 1893, W. Curr (Knight of Cowal). Entire colts foaled 1894, M. Marshall (Capt. Alexander). Mares with foal, W. Graham (Royal Rose). Yeld mares foaled before 1892, J. J. Mowbray (Lady Bute). Fillies foaled in 1862, J. D. Fletcher (Fuchsia). Fillies foaled in 1893, W. Graham (May Queen). Fillies foaled in 1894, W. Hood (Lady Diana).

There were very good classes for hunters, while the Hackneys were not as strong as we should have expected.

The pony classes are always one of the features at these shows, and there was no exception to the rule here, as the entries were both strong and good, and the competition very keen. The Shetland ponies were a disappointing class, which was to be regretted.

The sheep sections were all well filled with excellent entries of very fine, and in most cases typical, specimens of their various breeds.

Blackfaced sheep were well shown, and Mr. C. Howatson, R. & J. Cadzow, and D. T. Martin were the principal winners.

Cheviots made a fine exhibit. Messrs. J. Elliot and Jacob and John Robson were the winners of the leading pens.

Border Leicesters were well shown. Messrs. A. Smith, T. Clark, the Duke of Buccleuch, and Right Hon. A. J. Balfour were the leading winners.

During July we have, perhaps, had somewhere between twenty-five and forty country and district shows, some being for one or two days, at the whole of which plenty of interest has been shown, and it is perfectly evident that the live-stock breeding department of farming is one to which a very great deal of attention is being devoted. One dare not attempt to deal with these shows in detail, but we shall content ourselves with saying that in nearly every instance success has been attained by them.

Barnyard Manure.

To the Editor of FARMING:

Sir,—Having noticed, in the August issue, an article on barnyard manure, I thought that my experience with it might be of some service to others. The kind of manure to which I have devoted most attention is horse manure, which, in my opinion, requires to be rightly handled and protected. It has been my practice to bed horses well day and night, so that there may be no loss of the urine for want of something to absorb it. The straw or bedding, I find, becomes well saturated with it, and, when thrown out with the dung into the yard or receptacle, soon makes a first-class manure when it has heated to some extent. Care must, however, be taken that it does not heat too much, and get fire-fanged and mouldy.

This can be done by scattering it well when it is thrown out, and another method of prevention is to let pigs or cattle tramp it well. For the preservation of horse manure a shed of some kind is necessary. Although it was never necessary in my small business as a farmer, I had a stable and driving shed built, 45 x 30 feet, it being the time when threshing machines were driven by horse power. The horse stable runs the whole length of the building, and takes up half the width. In it there are nine stalls, with a passageway between the fifth and sixth stalls. The ground beneath the building is inclined, having a fall of two feet or more, the horses' heads being towards the centre of the building. I have three doors behind them, opening into a lean-to, 45 x 15 feet, the roof of which is a continuation of the horse stable roof. About two and a half feet from the floor of the stable is a floor, above which is the straw mow, and, below, the receptacle for the manure, so that the straw passes through the door one way and the manure goes out the other. Under that shed I kept my manure the whole of the past year. About three weeks ago I had it hauled out by a man as gray as myself, who has had an experience in farming of between thirty and forty years, and he spoke strongly as to its good quality. I believe that protected manure is far in advance of unprotected.

About 1827, when I was fourteen years old, I discovered an old newspaper which gave an account of the preparation of forty acres of land for potatoes by some Irish lord. One-half was manured with manure that had been protected, and the rest with manure that had

lain outside. The result was in favor of the former, in the ratio of 26 to 19.

With regard to barnyard manure, I favor having the yard as small as possible, consistent with convenience. Keep a good bottom of straw or some other absorbent under the pile, and allow no rain from the buildings to run on to it, as rain will cause it to lose many of its best manurial properties.

WM. CHANTLER.

Newton Robinson.

A Newfoundlander on the Silo.

To the Editor of FARMING :

SIR,—I have been a subscriber to your paper for many years, and always find the perusal of it both pleasurable and profitable. As the years pass, its usefulness to me increases. It is one of the journals that continue to improve, so many of the articles being original and most helpful to practical farmers. Subjects such as ensilage are very interesting to me. This method of storing food was quite a problem some ten years ago, and such a thing as sweet ensilage was unknown. Many of the highest agricultural authorities even doubted its utility. Since then, people's ideas have changed, and there are now no doubts whatever about the value of ensilage. The question of cost is the primary consideration in these days of poor prices for agricultural produce generally.

If you will allow me, I will give you my views upon the building of a silo, which are based on practical experience. Air-tight silos are, to me, a myth. My first experience was with a partially underground one, built with stone, and set in mortar and cement, the silage being tramped and packed down with a very great deal of labor and time. This silo was a failure. The second year's trial was also unsuccessful. I then built a new one on the surface, and studded and cased it inside and outside with matched boards. This was an improvement, but by no means satisfactory, and, after two seasons, I found that the wood lining was considerably decayed. The following year I decided that what was wanted was to exclude the air from the silage itself, irrespective of the building, and found that all that was necessary was a frame to keep the ensilage in shape and to exclude the air by compression. For the last two years (after the silo has been thoroughly filled) I have simply forced the

air out by weighting the mass at the rate of eighty or one hundred pounds of stone per foot: After three or four days I removed the weights and refilled the silo. I do this four times. It is astonishing the quantity a silo will contain when the ensilage is thus compressed into the solidity of tobacco. Notwithstanding this, on examination I found the silage contracted on the sides, and I could, without any difficulty, pass a half-inch rod all round it. This was further proof, to me, of the folly of attempting to build an *air-tight* silo.

I am so well satisfied with the results from the last-built silo that I intend to build an additional one, twenty-five feet long, fifteen feet wide, and twenty-five feet deep. I shall use 6-inch scantling as a frame, lined inside with 1½-inch plain spruce boards, not tongued and grooved. If the joints are left a little open, all the better. This prevents rotting. The silage I use is pretty well matured hay, natural grasses of all sorts, and oats cut in their milky state, filled in without any cutting, and then weighted with stone, as before mentioned. The silage, after six months' keeping, is all that can be desired, and the cattle eat it with the greatest avidity. I fill the silo from the top, but have a door at one end, with movable boards extending the whole depth of the silo. When we begin to use the silage, I move the weights from off about eighteen inches of the surface, and throw them further back. Then, with an axe, I make a cut about ten inches wide and a foot deep right across the silo. This gives a good meal to about twenty head of cattle. When this strip is used to the bottom I remove more weights off and repeat the process, always leaving the weights on the rest of the silage till it is all used up. The silage retains its heat, about eighty degrees, all winter. The chief point, in my opinion, is, as soon as the silo is filled, to weight it at once, and, when the contents have thoroughly settled, to remove the weights and refill.

I have written this for the information of some who may be thinking of building a silo, in order to prevent them going to unnecessary expense, as I did. I am convinced that a rough, cheap frame is as good, and will last twice as long, as an expensive would-be air-tight building, and is as good as stone for twenty years. I must apologize for the length of this letter.

G. MAKINSON.

Cochrane Dale, Newfoundland.

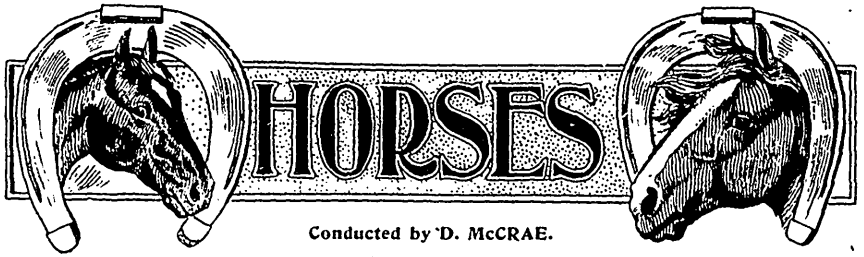

Conducted by D. McCRAE.

Horse Items.

Alix trotted recently at Detroit the last half of a mile in 1.00½, and the third quarter was covered in 28½ seconds.

New Castle trotted the last half of a mile at Tiffin, Ohio, in 1.02¾.

Benzetta promises to be the best four-year-old trotter of the year. Her record is 2.06¾.

Joe Patchen has now a pacing record of 2.04¼.

Fidol, the Iowa stallion, 2.04½, may be heard from again.

The following are the best trotting records for mares, stallions, and geldings: Alix, 2.03¾; Directum, 2.05¼; Azote, 2.06½.

Robert J. hold, the pacing record at 2.01½.

Rosebery and Filemaker made the two best high jumps on record, being a tie at 7 ft. 3½ in.

Mr. Alex. Galbraith, Janesville, Wisconsin, will judge the Clydes and Shires at the Toronto Industrial this month.

Heavy Hunters.—One of the best heavy hunting horses in Britain is the Duke of Portland's great hunting horse, Trappist. He is a crossbred animal, his sire being a Thoroughbred, and his dam a Clydesdale mare. He has speed, weight, and splendid heavy-boned legs, with fine style, and can carry the heaviest hunting gentleman with ease.

Packing Horse Flesh.—There has very recently been established at Linnton, some twenty-five miles from Portland, Oregon, a firm known as the Western Packing and Fertilizing Co., who are buying and slaughtering range horses, and packing their meat for human food. The flesh of the horse is darker than that of good beef. There is very little kidney fat, and it is of a yellow color. The firm are at present packing "hams" for export to France and Belgium. They expect to do a large and profitable trade, and hope soon to be able to place their goods with advantage on the home market.

Brood Mares.—The present is a good time to secure a good type of brood mares. Prices have been, and are still, low for even good animals, and the wise breeder will take the opportunity to get the best of the breed that he fancies that his means will permit. It costs no more to raise a foal from a really good animal than from a scrub, and the result both in pleasure and profit to the owner is all on the side of the good dam.

Watering horses when heated is advocated by an English veterinary surgeon, who has seen service in India. He says a horse then needs a drink just as much as a man does, and in moderation it always does good. He says: "All the trainers in India give their racehorses about half a bucket of cold water to drink immediately after a gallop, and with the best results as regards their appetite and health. I have not only never seen, but have never heard of any harm to a horse from drinking cold water when he was heated."

Geldings.—There is a good demand, both in Britain and in the large cities of the United States, for good heavy geldings. But to bring the top price they must have weight. It is true that there is also a demand for good vanners, active, strong horses that can run off with a load at a good trot, but these never bring the price that is given for the strong-boned, heavy draught animal, weighing from eighteen hundred to a ton. For the traffic of the larger cities, such an animal is always in good demand.

Shying.—In driving a young horse, it is often a capital plan to let an animal see for himself the object that caused the shying. Do this quietly, and with an encouraging word. If the horse be led up to the startling object and allowed to look at, examine, and sniff at it, he will usually go away satisfied, and be less likely to repeat the shying. It is the mysterious something that causes fear in horses. Instinct prompts the horse to give a wide berth to the strange, startling object. It may have hidden powers of mischief behind it, and the thought of that is enough. Care and sen-

sible driving will give the horse confidence, and this is the best antidote against the habit of shying.

Walking is the ordinary gait of the farm horse. Plowing, reaping, and all the ordinary work of the farm is done at a walk. The steady three and a half miles an hour is the gait that gets over the ground. If a four-mile-an-hour team can be got, so much the more work will be done by them. The walk is the pace that should be cultivated and improved. It is a well-known fact that many of our fast trotting horses are very slow walkers. On the other hand, some heavy draught horses have a good brisk walk. See to it that your farm horses learn to walk at a good fair pace.

An Old Mare.—The celebrated trotting mare, Little Queen, 27 years old, is nursing a black filly foal. She is by King Herod, and her mate, Little Mink, by the same horse, a year older, is also breeding regularly.

Park driving is ordinarily done at about six miles an hour. A horse for this work must have bold style and good action, above all else. He must go to be seen, and have plenty of knee action. A fast pace is not required, and would be decidedly out of place. The feet must be picked up with a snap, and hocks and knees work like clockwork. Style is everything here.

Hackneys.—Hackneys were first brought out as an established breed in Norfolk, England, about the middle of the eighteenth century. One of the first recorded sires was Original Shales, by a famous Thoroughbred named Blaze, he by the great Flying Childers. The dam of Shales was a Hackney mare foaled before 1750. This blood was much famed in Norfolk, and about 1800 the Yorkshiremen took it up through Fireaway, a descendant of Shales, who was taken to Yorkshire. The type developed in Yorkshire stands higher, and is heavier than that of Norfolk. Many of our Canadian breeders would like more size in the Hackney; the best specimens seldom reach sixteen hands.

Shires.—Of the many grand Shires which were shown at the Royal English Show, at Darlington, this year, quite three-fourths of the prize-winners were of Lincolnshire Lad blood. Several of the winners claimed Harold for both sire and grandsire. The first-prize brood mare was by Lincolnshire Boy,

as was also the dam of the first-prize yearling filly. In the three-year-old filly class, the winners were both by Bury Victor Chief.

The Morgan Horse.—The true origin of the Morgan horse has been a subject of lively discussion among New England horsemen for half a century. Recently *The Horse World* has obtained evidence about the matter from Mr. Hiram Turner, who, in his early days, was well acquainted with the section where Justin Morgan the breeder and original owner of the famous horse that bore his name, lived. Mr. Turner drove, when a boy, behind Gifford Morgan, a grandson of the original Justin; and, although he never saw the old horse, he lived for many years among men who had known him well. Mr. Turner is firmly of opinion that Justin Morgan was a Canadian horse, small in size, not more than 900 or 950 pounds. He was a good sire, all his colts having a striking resemblance in shape, and all bigger than himself. All were splendid roadsters, and fine-looking animals, and so the family was founded from a Canadian sire.

Standard-bred trotters have not been in the past famed for their good looks, but in recent years there has been a decided improvement in this respect. Ten to fifteen years ago it was rare to find in a big bunch of starters a really handsome animal. Many were long, lean, and lanky, with ewe necks and bandy legs booted out of shape. At meetings nowadays many animals may be seen which are good ones to look at, and also rare ones to go. The type of the trotter is improving, while the speed is increasing. Much may yet be done in this direction by careful breeding. More care, more thought, and better judgment are being put into the business, and the result will be more fixity of type, and that type a better one than we have had in the past.

Coach Horses.—The coach horse should have a clean-cut head, a broad forehead showing intelligence, a slim, smooth, arched neck of good length, oblique shoulders, deep chest, well-rounded body, stout back, well-sprung ribs, full and rather long quarters, tail set high up, almost on a level with the backbone, and well carried. He should have well-developed muscles, good clean bone, sound open feet, and good hoofs. He should have bold, free action, handling his legs and feet well, should be of good color, smooth form, and, above everything, have plenty of style. Appearance

counts for much in the coach horse, and he should be stylish and attractive to charm the eye and bring a big price.

Trotting Dams.—The trotting mares of the present day that get records of 2.30 or better are the ones that will be in evidence as the great dams of the future. The days when a lot of mares could be seen on a stock farm kept for breeding, because not fast enough to sell well for racing, are away in the past. It is now a recognized fact among the best breeders that you must have speed to get speed, and that it is an advantage to give the breeding mare a turn of speed now and then. Developed sires and dams are those that are now producing the best of trotters.

Trotting.—Trotting records have been wonderfully lowered this season, and, by looking back to the old records, it will be seen that the Standard-bred trotter has very much improved in speed in recent years. Previous to 1860, the best time as recorded by the American Racing Calendar was:

Mile heats—Flora Temple, b.m.—Kalamazoo, Oct. 15, 1859, 2.19¾. Ethan Allen, stallion—Union, L.I., Oct. 28, 1858, 2.28.

Two miles—Flora Temple—Long Island, Aug. 16, 1859, 4.50½. Lady Franklin—Long Island, July 30, 1858, 5.11.

Flora Temple was a little bay mare with black points, standing fourteen hands two inches, with long sloping shoulders and a very short back. Her head was light and fine as that of an Arab, and she was said to have a good deal of that blood. Before being raced she was used two years in a New York livery.

Percherons.—These are the leading draught horses of France. The following are features of the breed: Color, black or dapple gray; forehead broad and slightly convex between the eyes: face long, with slightly Roman nose; nostrils open and movable; lips, thick; mouth, large; cheeks, round; ears, long, but erect; eye quick, eyelids heavy. Neck and shoulders strong and mane bushy; chest broad, withers high and thick; shoulders long and sloping; breast broad and deep; tail set high and bushy. Legs strong and solid; cannon bone strong and clean, without hair; pasterns short, knees broad and strong.

Pacing.—The pacing record for mares has, during the past month, been lowered from 2.08¼, no less than three having beaten it. These are Angie D., 2.07; Vera Capell,

2.07½; and Aileen, 2.07½. It is expected that before the season ends this record may be again lowered, and some predict that it will be down by that time to 2.05.

Hackneys.—Hackneys were out in great force at the recent Yorkshire show held at Halifax, England. It was much the best section in the horse department of the show. The judges disagreed on the horse to put first in the aged class, and a third was called in, the well-known Mr. Tom Mitchell, of Bradford. He put Hedon Squire, by Rufus, first. This horse, owned by Sir Walter Gilbey, was going in splendid form, and moves with great freedom. M.P., the champion at the London show, was placed second. Clifton II., by Danegelt, out of Lightsome, and the winner at the Royal show this year, was third. In two-year-olds The Conqueror, by Ganymede, was first. This colt has great quality and style, and is expected to make a future champion. The brood mares were a grand lot, well brought out. Lady Keyingham was first. Many thought her the best Hackney in the show. Second prize went to Frisk, the twelve-year-old sister of Donal Grant. In three-year-olds the roan filly, Titania, winner at London and Darlington, was again first. The chestnut, Bonwick Belle, a very fine mare and a great mover, came second. Marguerite, by Danegelt, headed the two-year-old fillies, and Moss Rose, by Chocolate Junior, out of Primrose, did the same in the yearling class. In the saddle class Sir Gilbert Greenall's great roan horse, Amazement, by Wildfire, came first, and in the lighter class Orange Blossom, by Rufus, the London champion, got first prize.

Clydesdale Notes.

Prices and prospects for some time have been "away down," but it would seem that the change has come, and already many of the more knowing among the farmers and breeders are picking up likely young mares at present low prices. Quite recently an eastern breeder, hearing that prices in the west were low for good young Clyde mares, and that some of the big dealers had more than enough of good ones, and would sell at low prices, concluded to go west and pick up a few. In fact, it was said they would hardly refuse good money if offered. This buyer knows quality when he sees it, and concluded he would not go more than \$500 for any one animal, but

would secure half a dozen at that figure if they were really first-class. He went, and saw some very choice young things that would suit him, but he could not get them for the price he offered, so he returned without them. If Clyde breeders could always raise good ones, there would be a fair margin in selling half a dozen young fillies at \$500 each in these hard times.

Scottish vs. American Clydes.

Last fall a prominent breeder of Clydes, Wm. Montgomery, of Banks, Kirkcudbright, Scotland, paid a visit to some of the American breeders, and while here he purchased from Col. Holloway, of Alexis, Illinois, the Clyde stallion, Prince of Quality 2173, who stood second to the champion at the World's Fair, Chicago. Mr. Montgomery bought the horse because he thought him good enough to take to Scotland for service there. Coming through to Toronto Exhibition, he thought it would be well to cable to Glasgow to Mr. Macneilage, the secretary of the Clydesdale Horse Society, asking if the pedigree would be accepted and registered in the Scotch studbook. The answer was that it would be contrary to the rules of the Scotch society, which says that no animal may be entered in the studbook unless bred in the United Kingdom. The result was that Prince of Quality was purchased by Mr. Robert Davies, of Todmorden Stock Farm, and, remaining in Canada, was exhibited at the spring stock show in the drill shed, Toronto, where many of our readers will remember seeing him. The matter of registration has been before the Scotch society ever since. During the recent show at Dumfries, a meeting was held there to consider this matter. A notice of motion made at a previous meeting by John M. Martin, of Auchendennan, was considered: "That By-law 35, to wit, 'No horses shall be entered in the studbook unless bred in the United Kingdom,' is hereby rescinded." This was carried on a division after considerable discussion, during which, as reported by a local paper, "The chairman moved the previous question, on the ground that the present was not an opportune time to introduce any further difficulty in the way of the breeders in this country. Agricultural affairs were not in a very satisfactory condition, and he did not think it would be right to impose further burdens upon the breeders, owners, and users of the stallion by handicapping him with foreign

competition. It went without saying that they had in this country a sufficient stock animals for their breeding purposes, and they did not require animals from America." Comment is unnecessary.

Live Stock Records.

Our live-stock records are a very important matter to the farmers and stockbreeders of Canada. The keeping of stock is a necessity to every farmer. Some may manage with very little stock. Others, and they are a steadily increasing number, make the keeping of stock, and the marketing of stock and their products, the chief part of their farming, and the part from which they expect the bulk of their returns. It is not too much to say that in recent years farming has only been profitable when in close connection with stock. Speaking generally, the best stock pay the best. And our best improved breeds of stock are now recorded. It is necessary that these records should be carefully and correctly kept. These improved breeds of live stock are largely of British origin. The developing and building up of these breeds to their present measure of perfection has been a process of gradual development. Now and then a master hand appeared who, taking hold of a breed, would, in his lifetime, push it forward with rapid strides; but this was the exception rather than the rule, and the process was usually a slow and tedious one. The records of this work were sometimes kept in private hands, but more frequently the details of the work done were known only to those immediately concerned in the doing of it. Since the breeds have become fixed in type, the necessity was felt for records to help in keeping the type pure.

While Britain has been the home of the breeds, America has been the place where the demand for records has been especially strong. Not in all breeds, but in very many, the demand for recorded stock was the strong reason for establishing British records. Here in Canada the public records kept have been under the management of the Agriculture and Arts Association. By an Act passed at last session of the legislature, this association becomes obsolete at the end of the present year, and the keeping of the records in the future will be turned over to the care of the different stock associations. During September a meeting of representatives has been called to discuss and determine what shall be

done under the changed conditions. The breeders themselves are the ones most interested, and they should carefully review the situation, and, in deciding what they think best, let their views be known to the representatives of their favorite breed. Already the question has been discussed in the press. Two views have been taken. One strongly favors the keeping of Canadian records for all Canadian purebred stock; the other favors the keeping on of Canadian associations, but the publishing of the records in conjunction with the United States associations on a fair and equitable basis—local organization with continental publication. The former point out that we have now in Canada a large number of purebred stock of the different breeds, that these are in most cases steadily increasing, and that our records should be kept under our own control. The other side say that already, with our Canadian records, a large amount of money is sent each year to record animals in the United States; that this money is practically lost to Canada; that arrangements might be made by which we should have our fair proportion of this returned, with, at the same time, representatives on the various boards of management in the United States. And, finally, that it is to the advantage of Canadians to have close relations with United States breeders, and, when sales are made, to have our stock go free of duty to American purchasers. Now is the time for action, and the matter should be settled in the way that will best help the purity of the breeds and the profit of the breeders.

Hackneys.

The Hackney type of horse is now very popular for fancy city driving, and good animals of the breed with fair action command good prices. For the Canadian breeder, one of the most profitable light horses to raise is the cross of a Hackney sire with a half-bred mare. This type of animal is useful on the farm, and brings a good price when fit for the market. It is the type that most of our prominent horse-buyers are now after. A Hackney should be a short-legged, powerful horse. Most of them are not large, few reaching 16 hands or over, but most standing from 15.2 to 15.3 hands. Sometimes Hackney classes are divided by the 15 hands limit, those below ranking in the pony class, and those above in the true Hackney. The neck should be well

sprung from the shoulder; head a fair size not too small, neat, and fairly broad between the eyes; eyes full and bright; ears very active, but not long; neck light and fine as it nears the head—not too long, as this gives a "blood" look; shoulders deep and well sloped. Short, straight shoulders are very objectionable in a Hackney. Back short; ribs well rounded, and spring out from backbone with well-developed muscles, forming a hollow along backbone; hind quarters broad and muscular, but not too long; thighs well let down, with a gentle droop; tail should not come out straight from back like a Thoroughbred. The droop gives a graceful general outline and helps the muscles of the thighs. Tail well carried, raised when walking or trotting, showing nerve force. Legs short and powerful, large hocks, and broad knees, with plenty of muscle force above, and all the broad, flat bone below the knee that can be got.

The cannon bone should always be short in the true Hackney. Pastern joints large and deep set; pasterns not very long, but strong, broad, and well set back; hoof medium size, deep, not large, broad, or flat; hair and hide not over-fine, showing more vigor and toughness than sensitive delicacy. In going, the Hackney must be quick and alert, showing nerve force; must go straight, no turning in toes or winding one leg over another; with high action before and especially behind, bringing hind feet well under him; high knee action and the clever throw-out before putting down the foot, so graceful and characteristic of true Hackney style, is most desirable; high lifting and straight pounding are very objectionable; color dark bay or chestnut, the latter now predominating, and promising to become the standard color of Hackney. A Hackney always must have plenty of go—electric force, nerve force. Look out for this; it is a most valuable quality.

Clydes at Dumfries.

The leading event in Scottish Clyde circles is the Highland Society's Show. This year it was held in Dumfries, which is very convenient for the breeders of the south and west of Scotland. Trade for heavy horses has not been very good of late years. The American buyers who formerly were out in force at the Highland show, and were not averse to giving a rattling good price for the animals that pleased them, have been very few, and their bids miserably small. As a consequence,

there was a falling off in the number of animals shown, there being only 181 entries in classes, against 239 at the last Dumfries show in 1886. The quality was good, however, and in the filly classes there was a capital lot. There was a big class both of yearling and two-year-old fillies, and scarcely an inferior animal in the whole lot. There were a great many animals of the Macgregor blood, and some of these showed up well in the prize list. This was to be expected, so near the home of Macgregor, and with the chance he has had with a lot of the very best breeding mares to be found in Galloway, or anywhere else for that matter. The Macgregor type is well known in Canada, and many good ones of his get have been winners in our local shows. It is, therefore, of interest to all Canadian breeders to see the place that animals of this blood are taking in the showyards of Scotland. The champion stallion was Lord Londonderry's Holyrood (9546), a fine dark-brown horse by Gallant Prince, dam, Jeanie Darnley. This was the third time he won first place at the Highland show, having before been placed first as a two-year-old at Edinburgh and first as a three-year-old at Aberdeen. He won for his owner the medal for best Clydesdale stallion, the champion cup for best male animal on the ground, and the breeders' prize for best animal of any age.

Second place went to Prince Albert (9357), by Prince of Albion, dam, Alice Gray, a Springhill Darnley mare. In three-year-olds, MacEachran (9792), a son of Macgregor, was a popular winner. He was first in his class at the last Highland show, and also at the Royal this year. Another Macgregor colt took second place, and some very promising youngsters of the same breeding won in the yearling class. The two-year-old colt, Knight o' Cowal, by Gallant Prince, out of Bell 2nd, a Top Gallant mare, was first. He is a big horse, thick and good. He has been making the rounds of the shows, steadily improving as he went, and winning wherever shown.

The champion female was the fourteen-year-old mare, Moss Rose, by Prince Charlie, a very well-known mare, and still an easy winner. She gained for her owner, Mr. Gilmour, Montrave, the Cawdor Challenge Cup, worth \$250. The winning mare, with foal by her side, was Royal Rose, by Macgregor, dam by Top Gallant. She is a four-year-old, winning in the three-year class last year, and at the Royal this year. She has good, clean bone, fine feather, and moves well, with a

stylish carriage. The winner in the three-year-old mare class was Fuchsia, a get of William-wood, out of a Prince Lawrence mare. She is a newcomer into show rings, but proved the best of the lot. She was bred by Wm. McTurk, Barlae. A Macgregor filly from Penrith took second place. In the two-year-old filly class there were seventeen out, and not a poor one in the lot. The judges had a difficult task in placing the winners. Ultimately they followed the lead of the Royal show, and placed May Queen, a Macgregor, first. She is not large, but has good bone, perfect action, and is sweet, if not bulky. A Prince Alexander filly was second, and third place fell to a Top Royal filly, which has been a prominent winner in the shows of the west of Scotland. There were a great many yearling fillies out. That veteran breeder, Wm. Hood, Chapelton, Borgue, captured the first place with Lady Diana, out of Robina, by Prince Romeo. Second and third places fell to Macgregors. The classes for geldings were well filled, and the President's medal for best gelding in the show fell to Wm. Clark, Netherlee, for Topsman. Altogether, the Clyde breeders of Scotland were well pleased with the exhibit made.

Purity of Blood.

In writing on this subject, "Stonehenge" says: It is not to be supposed that there is any real difference between the blood of the Thoroughbred horse, and that of the half-bred animal; the term "blood" is here used for "breed," and by purity of blood is meant purity in the breeding of the animal; that is to say, that the horse which is entirely bred from one source is pure from any mixture with any other, and may be a pure Suffolk Punch or a pure Clydesdale, or a pure Thoroughbred horse. But all these terms are comparative, since there is no such animal as a perfectly purely bred horse of any breed. All have been produced by an admixture of other kinds; and though now kept as pure as possible, yet they were originally compounded from varying elements; and thus the racehorse of 1700 was obtained from a mixture of Turks, Arabs, and Barbs. Even the best and purest Thoroughbreds are stained with some slight cross with the old English or Spanish horse, and therefore it is only by comparison that the word pure is applicable to them or any others.



Pasture.—This year has been a bad one for stock farmers who had to depend on pasture for the feeding of their stock. The severe frosts in the middle of May, followed by several weeks of dry weather, so injured the pastures that they have not yet recovered. Early dry land suffered the most. Low-lying and swampy land was but little injured. The grasses on these had not grown to any extent. In damp lands they had barely started growth, and these escaped and have furnished the best grazing of the year. Farmers who had arranged for other crops for soiling or field feeding have been fortunate. These have generally done very well. Corn came early and promises well, and has been largely used for summer feed. Rape, where early sown, has also been of great use. Recently a field of seven acres was seen by the writer with thirty-three head knee deep on it. They had been put upon it early in August with the run of an adjoining pasture field, which served as sleeping quarters, and the cattle were doing well. The showery days had kept the rape in good growing condition, and it promised to see the stock well into September.

A *Galloway grade* fed in Roxburghshire, Scotland, and marketed at two years and eleven months, weighed 2,016 lbs. live weight, and had never been fed anything but grass in summer and turnips and straw in winter. He was a first cross between a Galloway and a Shorthorn. At the last test of different breeds at the Agricultural College, Guelph, the Galloway grade proved by far the most profitable animal fed, the Shorthorn taking second place in one instance and the Hereford in another. The cost of all the food used was carefully calculated in the test.

Milk Fever.—It is unfortunate that the heaviest milking cow on the farm is the one that is oftentimes the victim of this fatal disease. Many and various remedies have been suggested. Some put great faith in aconite, and others recommend an active purge by the use of two pounds of Epsom salts. Others believe in putting ice to the back of the head

and cold packs on the body, while others recommend hot fomentations, blisters on the loins, and copious bleeding. Prevention is one of the best ways out of the difficulty. The big milkers should be carefully treated about the time of calving. The food should be of a laxative character. Before calving, it is a good plan to give a moderate dose of Epsom salts, say, one to two pounds, twelve to twenty-four hours before calving is due. If calving has occurred, lose no time in giving the purgative if danger be apprehended. If the udder be very full, it may be milked several days before, and three times a day or oftener after. Daily exercise is also a preventive. Open air is good, and an open shed in the shade of trees is much better than a stuffy stall. Rich pasture must be avoided. Dry straw or hay, with plenty of salt and water, is better. Cows attacked in the first two days after calving are in much greater danger than those attacked later. After a week most cases recover. There are two types of the disease, the *congestive* and the *torpid*. In the former case the head should be kept well up above the level of the body. It may even be desirable to tie it up to prevent injury by the animal dashing it from side to side. Frequent rubbing of the udder and drawing off of the milk is good. Cases sometimes recover very quickly. A cow is up and eating that was down and insensible a few hours before. Others require careful, restricted feeding and a daily dose of saltpetre and nux vomica for several days.

Summer Shade.—Cattle need shade in our hot summer season in Ontario. Most farmers see that there is shade of some sort, but many give little thought to it. Shade trees are best where there is room enough about them. Where they are absent a rough shed should be provided with boards, and ample enough to let the stock all into the shade. This is better without closed sides or ends. The cost will be repaid by the comfort to the cattle. As regards dairy cows the cost will be repaid in the extra flow of milk, and all classes of stock will be benefited.

Watering Cattle.—Fortunate are the farmers who have in these dry seasons a running stream in their pastures. The watering place in pastures is too often a mud hole. If this be a spring, it should not be left open for the cattle to tramp in it. Cover the spring, and provide a pipe and trough where the cattle can get a clean drink. Where the supply is from wells in the field, let it be some one's duty to see that water is pumped often and regularly. In the hot summer days it is cruelty to keep stock without water even for a few hours. No amount of feed will ensure stock doing well unless they have at all times plenty of water.

Heavy Steers.—The day of the heavy steer has gone past. Years ago the fat stock shows had many that were truly mountains of beef and fat. In those good old days, when some of the big ones went far over a ton in weight, the price was also heavy. Fifteen cents per pound live weight was for many years the price for the champion at the Guelph show. Then a York shilling was the ruling rate, but now they could not be sold at any price. Reports this year from Chicago say that the 1600-pound steer will soon be a thing of the past. About 1,200 pounds is now the best weight, thirty months the age, and the greatest quantity of rich juicy meat, merchantable and palatable, the result.

Stockers.—There has been a good demand for stockers from the Calgary district of the Northwest, and a number have been purchased from the county of Grey and adjoining townships. Prices paid have been miserably small, but in that section many farmers have not feed of any kind to carry them over and had to sell at any price. Several buyers have been picking up round lots, one shipment of 800 head of yearling and two-year-old steers having been made.

Range Cattle.—The ranchmen of the Canadian Northwest have had a good season. The past winter was a good one, and the pastures have been such as to turn off the stock this year in excellent conditions. The ordinary price at Calgary has been \$40 per head for fat steers, and some prime lots are reported to have brought more money. The shipments have been the largest since the trade began, and the stock have gone straight through to the British markets.

Regularity in Milking.—It is an important point in milking to have regular hours, and to keep to them. If cows are not milked regularly, they will fall off in milk.

Scottish Feeders Want Our Store Cattle.

Testimony to the feeding qualities of Canadian cattle is furnished by the continued attempts of Scottish feeders to get the British Government to relax its restrictions and admit Canadian cattle for feeding purposes. The new President of the Board of Agriculture was recently approached by a deputation on this subject, but, in view of the reported discovery of contagious pleuro-pneumonia among some cattle landed at Deptford from the *Hurona* on July 10th, it is not likely that anything will be done to relax the restrictions.

It is a little singular, to say the least about it, that this reported discovery of "pleuro" should have taken place on the advent of a new head to the Agricultural Department of the government. It seems as if it was necessary for him to have a good reason ready why he could not open the inland markets to Canadian cattle. Belgium had consented to open her ports to give our cattle a trial, and strong pressure was to be brought to bear on the government by feeders in North Britain to get them to do the same. The reported discovery will, therefore, be hailed with satisfaction by British breeders, who are in favor of keeping our live cattle out.

A very unsatisfactory part of the proceedings is that our commissioner was not notified of the discovery till some time after, and, therefore, no independent examination of the lungs of the condemned animals on his behalf was possible. Had there been, it would probably have been found that the animals were only suffering from what is known as "corn-stalk disease," a non-contagious disease, the results of colds contracted on the voyage over.

An Odious Regulation.

Perhaps no greater injustice exists in our live stock regulations than the restriction that necessitates an application of the tuberculin test upon all cattle imported from Europe while they are at the quarantine station.

Verily our Veterinary Association are carrying things with a high hand when they can bring sufficient influence to bear upon the government to have such an enactment brought into force. The order is doubtless proving sufficiently aggressive in that we may hope for no further importations of cattle while it is in force.

Leaving out of the question the bungling absurdity of the test whereby healthy cattle are liable to be condemned and slaughtered, many of the most eminent medical authorities claim that the injection of tuberculin of itself into the veins of a healthy animal is harmful enough to condemn its use.

Surely the class of men that are and have been importing improved stock into the country are sufficiently capable of judging as to the health of the animals they are likely to select.

Canadian stock interests are worthy of being assisted, and not obstructed, and the removal of this odious regulation would stimulate the further importation of several breeds of cattle.

The fall exhibitions would afford a fitting opportunity for passing round a petition to have the order rescinded.

Belgium Removes the Embargo.

The Belgian government have shown a spirit of fairness towards Canada in temporarily removing the embargo against Canadian cattle, so as to allow experimental shipments to be made during the months of October, November, and December next. If no cases of pleuro-pneumonia are found, during that period, in any of the cattle imported into Belgium, the embargo will be permanently removed.

Fattening Cattle on Potatoes.

The probabilities of a very large crop of potatoes, not only on this continent, but in some of the countries of the old world as well, will result in low prices for that commodity.

In view of this, and of the poorness of some of the grain crops in places, the coming winter will afford an excellent opportunity for feeders to experiment with cooked potatoes as part of the ration for fattening cattle. As will be remembered, in our last issue we gave an account of the successful results obtained by M. Girard, a French feeder, in his experiment with cooked potatoes as a feed for fattening both cattle and sheep. In the ration which he fed, no grain was used at all, only potatoes and hay and a little salt, the proportions per head, per day, for cattle being, potatoes 55 lbs. 1 $\frac{3}{4}$ oz., chopped hay 6 lbs. 9 $\frac{3}{4}$ oz., long hay 13 lbs. 3 $\frac{1}{2}$ oz. The preparation of

the feed was done by spreading successive layers of hay and potatoes sufficient for the whole lot of cattle for one day, mixing them with a shovel, and allowing the mixture to remain in a heap. A slight fermentation was thus created, and the animals eat it greedily. The long hay was fed by itself.

The gains made by the cattle were surprising, when we consider that no grain at all was fed. The experiment lasted from the beginning of November, 1894, till January 16th, 1895, and the increases of weight per animal ranged from 172 lbs. to 280 lbs., while the percentage of carcase to live weight averaged from 56.92 per cent. in the case of three of the cattle to 61.94 in the case of three others. The sheep, too, gave excellent returns. The carcasses of these averaged from 52.87, in the case of two sheep, to 55.12 per cent. in the case of two others.

Another feature was the excellence of the meat, which for quality was considered equal to the best grass-fed beef, and gave a large percentage of lean. It must be borne in mind that the potatoes were cooked for the cattle, and that far poorer results were obtained when raw potatoes were fed by M. Girard to a pen of sheep during the period of this experiment.

The results obtained are certainly very encouraging, and feeders who have potatoes to spare, or who can buy them cheaply, should try this ration on a small scale this winter. Those doing so will confer a benefit on us if they will report the results.

A Group of Pine Grove Shorthorns.

The group of Shorthorns which our artist has admirably depicted upon our plate page for this issue is not only likely to play an important part in the exhibition rings during the autumn campaign, but the herd at Rockland, from which these specimens have been selected, are destined to prove of incalculable benefit to Canadian Shorthorn breeding interests.

No less than five of the most noted Scottish Shorthorn herds find representatives in the five individuals which form the subject of our sketch, and an analysis of the breeding lines shows conclusively how Sittyton blood has been the fountain-head from which all Aberdeenshire breeders have drawn their best supplies.

Justly deserving precedence in this brief description is the red four-year-old bull, Knight of St. John, bred by Mr. William Duthie, Collynie, of the Sittyton Clipper family. The red cow is Rose Bloom, bred at Kinellar, and of that herd's Rosebud family. The roan three-year-old cow, Missie 142nd, was bred by Mr. W. S. Marr, Upper Mill, and is of his Missie family. The roan two-year-old standing in the right background is Lady Fame, by Challenge, dam Roan Betty, by Baron Lenton, grandam imported Roan Betty, from Kinellar, while the red bull calf is by Knight of St. John, dam Rose Bloom (imp.) above. For further description look up the breeding of the animals of which the Pine Grove herd is composed, in the stock reviews for this issue.

Fixing a Type.

To become famous in the breed of cattle that he has chosen should be the aim of each one who has taken up the breeding problem, hoping to solve it to his own satisfaction.

Perhaps no factor has contributed more to the advancement of each variety of improved stock than our exhibitions, great and small, for the healthy emulation that ribbon-winning excites has done much to stimulate care in mating, and its twin sister, care in feeding, while the judging ring affords an opportunity for making comparisons, the educational advantage of which cannot be overestimated.

At the same time, those who have climbed highest on the ladder of fame are those breeders who formed an ideal of their own and followed it persistently until they had produced the type which had been so long fixed in their minds' eye. It was so with the early improvers. How well Robert Bakewell succeeded, Leicester sheep men are still fond of telling.

Who had a greater following than Thomas Bates, who decided that only such cattle were worth reproducing which, in addition to their handsome beefing form, would yield a large quantity of milk and butter weekly? And who was it that stamped so indelibly upon his strain of Shorthorns the type that carried that thick natural flesh which others have in use of in improving this trait in their cattle? It was Booth who remarked when pointing to the broad backs of his favorites, "That is worth a few pints of milk."

Amos Cruickshank and William McCombie on one day and at one date took their cue

from a Booth heifer that won at the "Royal." This was the type each determined to reproduce, this was their ideal which they toiled a lifetime to copy.

It is true that, in the case of the latter, the figure was worked in black, in which graceful curves predominate, while in the red and white and roan of the former straight lines appear, yet in the shortness of the leg, and in the wealth of natural flesh, both copies are equal to the original.

Each breed of cattle has been brought to its present stage of perfection for some definite purpose. If that breed does not fill the bill, or, rather, if it does not prove suitable to the surroundings, it quickly passes out. It may have fitted perfectly a niche in its native soil, but with a change of situation conditions are changed, and the breed that appeared exactly suited to a certain purpose does not nearly fulfil all requirements under the altered circumstances.

If a breed is to continue to flourish, it must have an abundance of useful points, and a certain type that will give the best results under existing conditions. Then, if the champions of a breed hope for ultimate success, they should agree as to what is wanted; "a house divided against itself will surely fall."

Once more we are about to commence a chain of exhibitions. The judges of each class have been selected. Not only should they adjudicate upon the merits of the animals brought before them, but they should consider themselves the instructors of the moment, if they are to prove themselves "good men and true," and their decisions should be made according to one ideal.

If he who has been chosen to judge is honest to himself, and honest to the breed on which he is placing the awards, he should see to it that he follows one type, and that one which is likely to benefit that breed, and on such base his awards. No personal friendship, no petty self-interest, will carry any weight in an honest mind which feels that there is a higher motive in view, a more important position to fill.

If the judges are to be the teachers of the class they represent, they should respect their office sufficiently to study the subject before presenting their views to the public.

The English Shropshire breeders were farsighted enough to trust the fixing of the type of their breed of sheep to certain breeders who were appointed, not for one year, but for ten successive years. By this means, not one,

but every exhibitor knew the type and quality that would win, and fitted and bred to this ideal. And see the result! No other breed has become so uniform; no other breed has become so popular in so short a time; no breed has spread over so large an area in the last ten years. But what should the ideal form be? Some one will say there are principles that apply to all alike—such as width of the floor of the chest, a fullness at the elbow, that there may be room for the play of the organs. But here the paths separate. The best beef grows on the back down to the middle rib. Then the form most suitable for beef production requires a well-sprung rib with a thick covering of natural flesh. Milk is produced underneath. Then there cannot be too much room for the play of the organs, nor for the food supply; hence, for milk, the chest should be wide, the barrel capacious, and plenty of length to the rib, which should be nicely sprung at the centre, but not from the backbone.

It is said that the blacksmith's arm grows stronger by use, but the arm should be properly developed, or it will not stand the strain. So the beast that is intended for a definite purpose should show development for that purpose, or it will make a sorry showing when it comes to a trial.

When Shorthorn cattle are called into the ring, let the judges see to it that constitution, natural flesh, scale, and quality, are all considered, but let a uniformity of type, a decided character, carry full weight. In dairy cattle don't let judges give it all for a handsome form in one class, and all for milking qualities in the next.

Let the judges decide which are the most important points; substance and constitution, handsome form, and performing powers must receive due consideration, but the value of breeding and character should count high up in the scale of points.

The judge should prove equal to weighing each point at an established value, or the on-lookers will decide that he is but a student only a short distance on the road to knowledge, instead of the master mind which should dictate to the class which are the essential points.

In the one case, he must not grumble if his inconsistent decisions are severely criticized; while, in the other, he will have the satisfaction of having faithfully filled a most important and honorable position, and of having given younger breeders an ideal after which they can strive.

Give the Boys a Chance.

Already it may be too late to make entries for some of the larger exhibitions, but there are few sections of the country where county and township shows will not find a place in the thoughts of those who intend to take part in exhibiting some animals or farm product at one or more of these.

It has fallen to the lot of many a boy to do chores, to feed and care for some of the animals on the farm, when other work has been pressing, and the stronger hands have been needed at the heavier work.

Only a few of our larger breeding establishments afford a herdsman whose sole business it is to take charge of the stock and prepare the cattle for the exhibitions. Many a bright boy has been employed in this position, and has taken pains in his work, and those calves or other young things have done wonders under his care, and he has been looking forward with eager expectation to the day at the township show, or possibly the county exhibition, where one or more days will be occupied with the stock.

But, perhaps, at home, time is considered too precious; the work has fallen behind, and the boy who has faithfully performed his part is disappointed at the last moment. His charges are hardly considered fit enough, and, while he has strong hopes of winning, it is decreed that the stock will not be shown this season. Calculations are made that there are not enough winnings in sight to warrant going out, and the boy is badly discouraged.

It is for this class of boys that we would plead. We were once boys ourselves, and it is the boys of this generation that will make the future men, and just how good men depends much upon how they are led, and how they have been encouraged in laudable work. The boy cannot learn it all at home. His elders may never have had any decided fancy for stock, while he has already shown a preference for them, and must need go abroad to learn how his pets should be brought out.

He has yet to learn of the one hundred and one things in detail which are required to bring them out in good form; that a liberal washing with soap and water, plenty of brushing, and a little oil, will make the coats of those handsome young things shine like silk; that horns need a little touching up with sandpaper and an oiled cloth; and, again, there is much in training his charges how to stand that they may show to the best advan-

tage. Then there are pointers to be had about feeding—how somebody else developed so much weight and size in so short a time—and although the boy has done wonderfully well, as far as he knows, it is by rubbing up against those who have spent years in their work that this bright, wishful boy can learn. How he will seek out each competitor to find what chances there may be for his charges winning; how he will learn to compare points, and long before judging time is reached it is settled where the prizes should be placed!

He will learn that size is but one point; that in the beefing sorts full crops, ribs sprung right from the backbone, well-laid shoulders, thick loins, meaty middle ribs, flanks well let down, and mossy coats, together with a smooth, even finish, are points that will win. And again, in that dairy heifer, fine shoulders, a sharp chine, ribs deep but not so well sprung, a long and fine neck, a vessel that already gives promise of large development, and in all cases a wide floor to the chest is a point of paramount importance in either a beef or milk producer. Depend upon it, even if no prize is won, that boy will take home with him a store of information that he will never forget, and the value of which would be difficult to estimate. Our country needs more stock, more stockmen, better stock, and better methods; cattle for beefing purposes, cattle for dairying. Without cattle our country would fare badly. Our greatest hope is in beef-making and pushing our dairy products. Other countries are in the race. It is a case of the survival of the fittest.

The cheapest means of production will prevail. Quality will always count. Cheaper lands may produce cheaper beef, but we must produce the quality that will bring the higher price.

We must look to our dairy products. Much will depend upon the cows that will turn to good account the food they consume, and we must study to breed the type that excels in this.

The exhibitions are schools where all who will may take lessons. Who so apt as that boy whom his father may have taken to help him? The boy takes in the biggest share; his ideas are not biased, his judgment is not yet warped. It is he who has asked the most questions, and none are so readily or kindly answered; none have heart to deceive a boy who is so wishful to learn. As to the cow that has won the prize for the best production of milk and butter fat, will not that boy find

out how she was treated, how she was fed; yes, and how to select the cow that will produce the greatest quantity of each, the type that produces at the least cost? Yes, all this is required on the road to successful competition in the world's markets. On this point hinges the future prospect of our agricultural wealth.

He will learn that a certain steer has gained so many hundred pounds in a given time; he will learn that it made a daily gain of so many pounds; how much it cost to feed it; that it cost more to put on the last four hundred than the previous six hundred; that this steer cost so much per day to feed, and that the steady gain cost less than if it had been allowed to lose occasionally; that it never would have won if it had lost any time in gaining weight, and that this steer is probably worth seven or eight cents per pound, while the common steer will hardly bring half the price.

It is a practical illustration like this that makes men determined to strive to learn better methods. Then let us reiterate what we said at the first. Let the coming exhibitions be factors through which many helpful lessons may be learned, many young tastes directed, and we shall hear fewer grumbling about hard times.

The Horn Fly.

To the Editor of FARMING:

SIR,—I notice in the August issue of THE JOURNAL a subscriber asks for a remedy for the horn-fly. I can recommend Rogers' Mexican horn-fly paste as a good preventive.

ANOTHER SUBSCRIBER.

Black Leg in Cattle.

Colonel W. A. Harris, of Linfield, Kansas, sends to the *Breeder's Gazette* the following remedy, which he maintains is a certain preventive of black leg: "The mixture for prevention of black leg consists of ten pounds sulphur, six pounds copperas, three pounds saltpetre, and three pounds air-slaked lime. Pulverize and mix, and use in the salt trough in the proportion of a pint of the mixture to a gallon of salt. In the spring and fall, for a month or six weeks, I use it and find it effective. It is also excellent for hogs."



Conducted by "JASON."

Important to Exporters of Sheep to the United States.

In a circular recently issued Secretary Morton announces that sheep and lambs intended for immediate slaughter may be admitted to the United States from Canada when accompanied by certificates as specified as follows, instead of those provided for in section 3 of the regulations of the Department of Agriculture, dated February 11th, 1895 :

(1) A certificate from the official veterinary inspector of the port of export, or the province, or district, in which the sheep or lambs were raised or fed, stating that no contagious disease affecting sheep has existed in said province or district during the past three months.

(2) An affidavit from the owner or importer, that the sheep or lambs offered for importation are from the district covered by the certificate above mentioned, that they were not outside of that district during a period of three months preceding shipment, and that when not driven they have been shipped direct from said district to the port of import in clean and disinfected cars.

Sheep as Scavengers.

Sheep stand at the head of the list of farm scavengers. No animals kept on the farm will compare with them in this respect. They love variety in food, and they are constantly on the look out for it. They move rapidly over fields, and then come back over them again and again ; hence no plants growing in the pastures escape their notice. And there is no weed, perhaps, which they will not eat if allowed to get at it while it is young and tender. They are especially fond of weed seeds while yet growing in the head. When turned into a stubble field, for instance, in which such weeds as lamb's-quarter and ragweed are maturing their seeds, they will soon turn a lot of these into mutton. Every farmer, therefore, should have a flock of sheep to enable him to turn weeds into mutton. Their

presence will soon manifest itself in the greater cleanness that it will bring to the farms on which they are kept. Let the sheep have free range, therefore, in the nooks and corners. Allow them access to the stubble fields before the plow is to follow them, and many weed seeds will be placed by them beyond the reach of harm. It has been well said that the sheep has a golden hoof. It may be said with equal propriety that it carries a scavenger's broom.

Breeding Ewes at the Mating Season.

The opinion has long prevailed among flockmasters that if the ewes are given extra food a short time before the mating season, a larger and a more vigorous crop of lambs will be secured. In other words, it is considered a good plan to have the ewes in what is termed a rising condition when the season for mating has arrived. The correctness of this view has been challenged. That it does not universally prevail, and that practically it is not believed by a considerable proportion of those engaged in sheep husbandry, is apparent from the answers recently given by the same to questions bearing on the point, propounded by Alfred Mansell, of Shrewsbury, England. Mr. Mansell is the secretary of the Shropshire Breeders' Association of England. The following question bearing upon this feature of sheep husbandry was put by Mr. Mansell to twenty-one flockmasters : " Do you make any alteration in the keep at the time of putting the ewes to the ram ; if so, what are your reasons ? " Of the answers returned, seven breeders, or one-third of the whole, made no change at that season in the keep of the ewes. The other breeders, that is to say, two-thirds of the entire number, planned to increase the food of the ewes at that time. The reasons assigned by the latter varied, but, in substance, they claimed, first, that the ewes came sooner in heat ; second, that they produced a larger crop of lambs ; and, third, that they brought forth stronger lambs, and larger. The laws which govern fecundity certainly favor the view

of the majority as above expressed. There is an intimate relation between nutrition and the breeding impulse, and between nutrition and the feeding of the fœtus. When females are lean and low in flesh, the procreative powers are certainly less active than when they are vigorous, as the result of good condition. Self-preservation is a law of animal life, and one of its first laws; hence, when there is a conflict between the ordinary life process, as such, and the tendency to procreate, the procreative powers suffer.

But, it may be asked, how can nutrition given before conception aid the development of the fœtus after conception? It can easily do so. Liberal feeding before conception enables the animal to store up in the system what may be termed a reserve supply of food. After conception, if food is still plentifully supplied, this reserve store is not drawn upon. But if there is any shortage in food supplies, it is drawn upon to some extent to sustain and develop the fœtus. And after the birth of the young animal, the danger is yet greater that it will be more and more drawn upon during the milk period. This explains, in part at least, the fact that it is more difficult to maintain a condition of good flesh during the period of pregnancy or of milk production than at other times. And during those periods the difficulty of increasing the flesh of the dam is still greater than in simply maintaining it, as has been frequently noticed.

It would seem to be a wise plan, therefore, to bring ewes into a good condition of flesh at the approach of the mating season. With that end in view, the aim should be to have a considerable interval between the weaning of the lambs and the breeding of the ewes. During the whole of this interval, it would seem to be good practice to have the ewes on good keep. When the mating season is near at hand, rich food, as rape, or grain, or barley, will be found to hasten the mating time.

Care of the Rams.

We frequently hear that pampered, overfed rams are not the best sires. They are not sure breeders, we hear some one say. But, probably, the man that makes that statement never used a highly-fed ram. It is certain that the poor ones are seldom fed for exhibition, for the simple reason that they would never carry off a prize, no matter how highly they were fitted. We have used rams of all

ages, and in the highest show form, with the best results. Granted that it takes a little care to handle them during the mating season, yet that care will pay. How often has a lean ram disappointed the flockmaster who did not take enough trouble in seeing after him while he was running with the ewes! We have heard of dozens of cases where it never was found out, until after the mating season was past and lambs expected, that the whole flock had turned out barren; hence the necessity of watching the flock constantly.

It should be known to stockmen that only such sires as will attend to their work and beget offspring while in high flesh are likely to improve the flesh-forming habit. Again, those that carry natural flesh must be distinguished from those that are forced into high form with stimulating food. In the one case it is a natural and in the other it is an unnatural state, and the habit may be developed just as can any other trait. It is this that so many improvers of stock have labored to develop, and it was from the fact that "like produced like" in all its bearings that the improved form and aptitude to carry flesh was brought out.

If the ram is properly handled, he will more easily serve double the number of ewes than when he is allowed to run with them constantly, an important point in high-priced rams. Our plan is to keep him up and feed him by himself twelve hours out of the twenty-four. By this means his condition is kept up, he remains vigorous to the end of the season, and strong, healthy lambs are the consequence.

The ewe stays in heat thirty-six hours, and in order to save the ram she should be taken away after service, particularly as some rams will follow one ewe persistently, and neglect all others.

The ewe returns in heat in seventeen days, and, if she passes this period, may generally be counted safe in lamb, and she and others of this class may be placed by themselves, which will curtail the size of the flock still to be served.

Much difference of opinion exists as to the best age for the ram to be used, although many claim that a ram lamb is not as satisfactory as an older buck. Doubtless much depends on the individual, though a ram lamb cannot, on the whole, be considered as desirable as an older sheep. Whatever the age or condition of the ram, however, he must be generously fed if he is to give good results, for

a sheep run down in condition is weak, and not the vigorous sire that he otherwise should be.

Many Canadian flocks are kept up by frequent importations from those of the British breeders, and, doubtless, this plan makes it easier to keep up a high standard, but we question if it does not keep breeders of some of the varieties from becoming more self-reliant. The fact that so many are constantly importing and selling rather than aiming to build up a flock of high excellence smacks more of the dealer than the breeder. For while money may enable a man to buy good show sheep or get a high-class breeding flock, it requires skill to breed the best and maintain a high standard of excellence.

The selection of a sire that will blend or nick well with the ewes is a problem that is not easily solved, and while the same difficulty arises in herds of purebred cattle, yet the life of the ewe flock, being so short, adds materially to the trouble, as a couple of bad crosses will almost occasion the ruin of the whole flock. This shows the necessity of a careful selection.

It is here that the benefit of purchasing a ram from the ram breeder who has a high-class flock comes in. In this case not only are a high class of sheep produced, but they are so uniform in type that a certain quality is insured. As it has been the aim of such a breeder for many years to keep certain objects in view, a ram bred in a flock of this character is almost certain to reproduce himself in his offspring.

Devote More Land to Sheep.

No country appears to be naturally better adapted to sheep production than Canada, which fact is borne out by the admirable flocks of purebred sheep that are to be found in the hands of what may be styled the professional breeders.

This class of breeders have devoted much of their time and attention to producing most of the modern breeds of sheep in their purity, and have established a name by which Canadian breeders are most favorably known throughout our own Dominion, and also among the sheep breeders of the United States. Consequently, rams and ewes bred in these Canadian flocks have been purchased to improve their respective breeds, and have furnished stock from which are bred the rams that supply the mutton flocks on the farm and the ranch.

The success that has been attained in breeding purebred sheep proves how very suitable our soil and climate are for producing sheep for the block, and it is difficult to conceive why our farmers have never turned their attention to this branch of farming. Here is a field that offers many inducements, among which we may cite the following: No stock requires so little work, and that work, too, is done at a season when the farm itself demands but little attention. There is not the slavery in tending sheep that we find in other branches of stock, no rising hours before daylight to look after the sheep, no necessity for attention twice daily, Sunday and Saturday. The flock feeds itself, and requires very little work during the busy season. This may be put off until winter storms prevent work in the fields.

Lambing season comes on when man and beast are away from the fields, and may be arranged to come at a time when no outside work is feasible. Then the attention that sheep require is of the lightest description, as compared with that about other stock, and it will quickly become a source of pleasure if proper methods are adopted, for in the flock, as in all other departments, interest quickly subsides when profits are not attached to the undertaking. That dollar at the other end of the row is what gives the proper stimulus. But are not the before-mentioned professional breeders much in fault? Are they not to blame for the lack of interest taken in the work? Why do they not show by example the profit that is attached to breeding for mutton? Precept in this is all very well, but example would carry more weight. Farmers want the fact properly illustrated to them, and they will quickly fall into line. The professional breeder heretofore has taken no direct interest in feeding sheep for the block. His ram lambs are expected to be sold to other breeders, or, if not good enough, they are expected to be sold to do duty in the ranch flocks. If, however, the same trouble and expense were spent on shearing wethers, these would bring as much money, and would show what could be done in this line.

Much of the lack of thrift in the ordinary flocks of the country arises through no special provision having been made for feeding; pastures dry up, and there is only enough feed left to keep the sheep alive. Consequently, lambs are stunted at weaning time, and the ewes are so thin in condition for the approaching mating season that but small increase

must be looked for another lambing time. Thus the flock quickly deteriorates in value, and, in a fit of disgust, the business is sold out and the farmer tries something else which it will be hoped may turn out more favorably.

How different this picture from one that we call to mind where a little special attention gave very different results! A prominent flockmaster (now dead) began his flock year with September, at which time he purchased his flock of ewes for the next year's operations, as it was his plan to sell out and each year buy a fresh lot of sheep, finding a profit both through the increase in lambs and the ad-

yeaning season, while the lambs were stronger, with far less losses to be chronicled. A ram of one of the Down varieties was always used, as the cross appeared to give more growth and substance, while the lambs matured faster. The ewes began dropping their lambs in February, and, with both ewes and lambs on full feed, there were plenty of fat early lambs, all of which were generally away in good time. Then the ewes were dried up and fattened off and sold. All found a ready sale at satisfactory prices. Although he was handling his flock in this manner for many years, and before prices ranged as high as they have at



From a Photo by F. Brigden.

A FLOCK OF COUNTRY SHEEP.

vanced value of the ewes. He selected such young lean ewes as would suit his purpose best, taking especial care that they were sound, with teats and udders all right. They were generally long-woolled grades of good size. On getting them home he would place them on good feed, a few early-sown turnips and rape, with a field of good after-grass near at hand. Three or four weeks' feed worked wonders for them, and by mating time they were in good shape for breeding, as he always concluded that a flock of ewes in fresh condition produced a larger proportion of twins next

tained since, he sold his lambs at \$4.00, and made a dollar in advance on the ewes.

The ewes were estimated to average $1\frac{1}{2}$ lambs each, so that the financial aspect was something as follows :

Lambs, $1\frac{1}{2}$ to each ewe.....	\$6 00
Increase in the value of the ewe...	1 00
Wool.....	80
	<hr/>
	\$7 80

Not a bad showing, yet this man did this kind of business for years. His farm must have been favorable, says one. So it was, but

there are hundreds, yes, thousands, just as good for the purpose. On his farm there were forty acres of hilly pasture that was of little use for any other purpose, but he took care to give his sheep a change of pasture occasionally into some rich lower land. Consequently, the sheep were continually gaining in flesh. If this could be done on one farm, why not make the practice more general?

Nothing has paid the Canadian shippers like sheep during the last year. Through them they made up losses incurred in shipping cattle. Sheep have been selling at high prices in England for the last eighteen months, yet we have not sufficient of the proper class to send over there. Baggy ewes, old rams, anything but good wethers, are generally all that can be secured for shipping.

But if sheep are to be made profitable, method must be put into the work, and such crops grown as will insure plenty of feed at all seasons.

Early-sown turnips and rape will bridge over July and August drouths and keep the sheep thriving. If lambs are to make good shearlings, they must be pushed forward while suckling, and have choice feed after weaning. If they are to be extra well pushed, let them be shorn before the weather gets cold in the fall. They will grow far faster without their wool. They may be shorn again if they are not shipped until May. A proper system is what is required. Provide the feed, provide the care, put a little brains in the work, and success is assured.

The Class of Ewes to Select.

There is such a difference of opinion as to the most approved type among several of the breeds that the young flockmaster may easily be led astray. It would, therefore, be wise for him to employ assistance in making his selections rather than to rely entirely upon his own judgment.

His first consideration should be to conclude which type is likely to meet the demand, for on this point breeders of the several varieties differ materially. Some prefer size, others make the fleece the first desideratum, while a third decide that character is of the most consequence, and make this the chief essential.

But whatever is decided upon, the flock should be uniform in appearance. Nothing looks so out of place in a purebred flock as a

lot of sheep of nondescript type, whereas a nicely-matched flock always shows to the best advantage.

But where, our reader asks, are these to be had, and will they not cost more than I can afford? The answer is easy. There are plenty of breeders who make a business of breeding just such sheep as you require. That they will sell them at mutton prices no reasonable man can expect. Yet they will sell at a price at which their produce will pay far better than ordinary stock would, and in any case it will pay to buy the best. Good individuals among purebred flocks do not come by chance. It has taken years of careful work, good judgment in selection, and experience in feeding to bring them to the present pitch of perfection. Then, surely, you would not expect to obtain sheep produced with such skill at the same price as you could get those intended for block purposes.

Again, it is at the top of the list where the profits will be greatest. Those breeders who have been most careful invariably make the greatest success. The aim should be to buy the best individuals obtainable.

A Flock of Sheep.

A very large proportion of the ordinary farm sheep of this country have a greater or less proportion of Leicester blood in them. This can be seen by driving along our country roads in the summer, where we so often see flocks of them grazing on the roadside in defiance of the township by-laws. In the accompanying half-tone, taken directly from a photograph, the artist has very happily "caught" a flock of these half-bred Leicester sheep in a pasture.

Pasturing Rape.

Editor Sheep Department, FARMING:

Subscriber, Renfrew, asks: Do you consider it safe to pasture valuable purebred sheep on rape? How should this class of sheep be managed when they are getting rape?

ANS.—There is always some risk in pasturing rape, though we have never lost any sheep because of any trouble that could be traced directly to this cause. We have always had a small piece of pasture adjoining the rape field, and the sheep had free access to it at all times. We use hurdles, so that only a small piece of rape is given the sheep at any time.

It is the practice of a number of feeders of purebred sheep to give their lambs unlimited range over the rape field. All things considered, if our correspondent has a fresh piece of pasture near the field, I should advise cutting the rape, and throwing it to them. Especially should this be followed if the animals to get it are sheep, and not lambs. By cutting the rape and feeding it, there is no risk whatever of bloating, and then there is a saving in the rape. Last season we cut one piece twice, and had a return at the rate of 36 tons of green food per acre. It was cut about four inches from the ground, and fed to the sheep in an adjoining pasture.

At this time we are feeding our rape—in the midst of the greatest drouth this section has ever had—to our breeding flock in the manner indicated. It will be advisable to feed some oats to the sheep that are getting the rape, especially if it is desirable to get as great gains as possible.

JOHN A. CRAIG.

Wisconsin Experiment Station,
Madison, Wis.

Grub in the Head.

The following reaches me from a correspondent signing himself "Inquirer," Clinton: "Now and then we lose sheep with what the veterinarians call 'grub in the head.' Is there any remedy for it, and, if not, is there any means of preventing it?"

The disease known as grub in the head is caused by the sheep gadfly (*Æstrus ovis*), which lays its eggs in the nostrils of the sheep during the summer season. The egg hatches, and the larva, or grub, passes up the nasal channels into the head. It is the irritation of the lining membrane of the nostril caused by the worm which gives rise to the discharge which comes from the nose. The best method of prevention consists in smearing the noses of the sheep with pine tar two or three times during the summer. When the fly is bothering the sheep, they will be seen running from one part of the field to another with their heads close to the ground. More thorough treatment can be given by smearing the noses of the sheep directly, than by any method of doing it indirectly, by putting tar in the feeding or salting places. The best remedy I know for treating the disease when there is a discharge from the nose is to inject into the nostril by means of a bulb syringe an equal mixture of olive oil and turpentine.

Mr. Wm. Watson has had the most experience of any one that I know of in combating this disease, and this is the remedy he has used with the best success. About a teaspoonful is enough to inject. I would advise our correspondent to smear the noses of all his sheep at this season. There is another trouble in sheep which is sometimes called grub in the head which is parasitic in nature. The sheep merely acts as a host. The larva encysts itself in the brain cavity, and death soon results. There is no discharge from the nose in such instances. The disease which results from the attacks of the gadfly is the most common, though it is not fatal so often as that which is parasitic.

JOHN A. CRAIG.

Dipping Sheep.

Editor Sheep Department, FARMING :

A., Aurora, writes: I would like to get information regarding the dipping of sheep. (1) Which dip do you consider the best; (2) What is your opinion of kerosene emulsion for this purpose? How should it be used, if at all?

ANS.—(1) My experience with sheep dips includes trials with McDougal's, Cooper's, and the tobacco and sulphur solution. These are all effective in their action. It is more agreeable and easier to use the prepared dips. McDougal's dip is in fluid condition, and Cooper's is in the form of a powder. We have been using Cooper's for several years, and find it very satisfactory. Tobacco fluid and sulphur makes a good dip, but is some trouble to make and mix it properly. (2) I have never tried kerosene emulsion. Some of those that have tried it speak favorably of it. I have no doubt but that it would be effective in killing the ticks and their eggs, but I do not think its influence on the wool would be as beneficial as that of Cooper's or McDougal's. I should not advise its usage for the sole reason that I cannot do so from personal experience, as I have not tried it. If any of the readers of FARMING have had experience with kerosene emulsion, it would be of general interest to report it.

JOHN A. CRAIG.

To Sheep Breeders.

All questions on sheep matters will be answered by Prof. John A. Craig, Madison, Wis., to whom all such correspondence should be sent.

SWINE

Swine as Money Makers.

We are great believers in farmers giving swine an important place in the departments of the live stock on the farm. Irishmen rightly give them the attribute of being the "gentlemen that pay the rent," for that is what they can and will do if properly managed and looked after. English and Scottish farmers (especially the latter) do not pay as much attention to the raising of pork as they should do, and, in consequence, the British market is largely supplied from Denmark and other European countries, as well as from Canada and the United States, in all of which countries swine breeding and feeding is very largely followed.

In Canada most of our farmers, as a rule, very rightly keep more or less pigs on their farms, and we could point out many a prosperous one who is not ashamed to tell you that he owes his prosperity to pigs alone. There is, and always has been, money in pork, even when prices were low, provided that the feeder fed and managed his pigs on intelligent principles.

Some people keep a pig or two solely because they are useful to clean up scraps and prevent waste, not for the money to be made out of them. In the absence of any higher aim, this is an excellent reason; but, at the same time, if these persons looked into the matter, they would soon find that there was money in keeping pigs, and they would largely extend their operations.

As an adjunct to the dairy, swine fill a most important position, and enable us to utilize what would otherwise be waste products. In fact, without swine much of the profits of dairying would be lost. An important point, however, is to keep the kind of pig that is in demand for the time being for the packer's trade.

As an example of how much money can be realized by the sale of bacon, in an interview with a representative of the *Cable*, Mr. Peter, the agent of Lord Fitzhardinge, Berkeley Castle, Gloucestershire, stated that he kept about 200 to 300 head of pigs in the styes, and

sold about 40 head weekly, the amount realized last year from bacon sold off the farm being between \$10,000 and \$15,000. These pigs are kept in connection with a milk factory, and are long, lean pigs of the sort that bacon-curers desire. Mr. Peter acknowledged that the British farmer felt the competition of Danish bacon severely, but still advocated breeding pigs, as there was money in them.

Cross-Breeding.

A discussion upon the best methods of cross-breeding swine might be profitably undertaken in these columns. The packer asks the farmer to feed the long, lean hog, but many farmers believe that such hogs require more food per pound of gain than some of our more compact varieties. It is true that packers pay somewhat more for the leaner pork, but the average buyer makes very little difference in the price. To compromise matters, a cross between the two extremes is proposed, and there is no doubt that many of these crosses are superior animals, producing pork cheaply, and at the same time furnishing a product of high market value.

The question, therefore, arises, How shall we cross? Shall we use the short boar and the long sow, or *vice versa*? The former method, at first sight, seems to be the more reasonable, because we thus secure the prolific dam, who will likely raise a large litter, and raise them well. But there is another side to the question. It is claimed by some that the progeny of the short boar and long sow lack in uniformity, some resembling the sire and some resembling the dam, while others, possibly, do not resemble either. This is a serious objection, since uniformity of type is a great aid in making an advantageous sale. On the other hand, we hear it stated that the progeny of the long boar and short sow are much more uniform in type, and that they seem to be a genuine compromise between the two extremes.

The experience of those who have made a business of cross-breeding hogs would certainly be interesting and valuable, and it is to be hoped that some one will make himself heard on this question.

Feeding Wheat to Pigs.

The question of feeding wheat to pigs and other animals of the farm received a very great deal of consideration from the various experiment stations in the Western States last winter. Farmers in wheat-growing countries also gave the same much attention. Many articles appeared in the agricultural papers, giving the results that had been obtained from feeding it, some of which were so large as to lead to the suspicion that there was something wrong about the computation. The results obtained from the experiment stations were always of a temperate character, although they clearly demonstrated the profit that could be obtained from feeding wheat when the market value was low. The profit, of course, has been dependent, to a considerable extent, on the quality of the stock. But it has been demonstrated very clearly that the feeding value of wheat stands high when compared, pound for pound, with that of other kinds of grain.

While the knowledge thus obtained is valuable, and will serve as a guide to the feeders of the future, it does not seem probable that wheat will ever become a staple article of food for live stock. As soon as the price advances from the neighborhood of, say, fifty cents in the west, and sixty cents in the east, it becomes, at least, problematical as to whether the average farmer should then feed it to live stock. It has already gone beyond those figures east and west; hence it is not probable that any good wheat will be fed to live stock the coming season.

We were never particularly enthusiastic over the feeding of wheat to live stock. In any case, the by-products—viz., the bran and shorts—are used for feed, and the flour seemed too valuable as a human food to feed it to the human family, as it were, indirectly, and through the medium of some kind of meat.

Even when wheat has sold as cheaply, pound for pound, as other grain, it was never clear to us that it would prove as profitable to grow it for that purpose. The yields are less, relatively, than from other kinds of grain. Wheat also needs a good soil to grow it in

good form, and it is even more liable to injury from various causes than other cereals. While it will always be necessary to grow wheat where it can be grown in good form, just as soon as it drops down to what may be called stock-feeding value, then we should consider the advisability of sowing less wheat and more of some other kind of grain that can be more easily raised.

A bulletin has recently been issued by Mr. Geo. C. Watson, of Cornell University, N.Y. From the conclusions of the same we glean the following, viz.: That cornmeal and gluten gave a greater growth and produced cheaper pork than ground wheat, and that cornmeal alone made a less growth than wheat and than cornmeal and gluten when fed together. The object of feeding the gluten with the cornmeal was to make a ration with a nutritive ratio about the same as that of wheat. The outcome would tend to prove that variety in feeding is advantageous, even though the foods fed should have the same nutritive ratio, and should therefore be on a par, viewed from the standpoint of chemical analysis.

While this bulletin may close the long list issued during the present year which have touched upon the feeding value of wheat, the work of experimentation in feeding other food-stuffs should go on. Many problems in feeding are yet unsolved, or only partially solved. Better work cannot be undertaken by our experiment stations. It is a fact, nevertheless, that but little relatively has been done in this line. Bulletin after bulletin has been issued on chemical and kindred subjects, and also on horticulture, but it is only now and then that we get a really good bulletin on the feeding of live stock.

Some Scraps of Hog History.

The Large White hogs, or, as we call them, Improved Yorkshires, constitute one of the leading breeds of English hogs. There is no telling just where they came from, or how they originated. White pigs, of various names, have existed in England for centuries, and, no doubt, the modern Improved Yorkshire contains the blood of more than one of these strains. The breed first became famous in 1851, when Joseph Tuley, a weaver of Keighley, in Yorkshire, exhibited some white pigs at the Exhibition of the Royal Agricultural Society, which filled the spectators with wonder and admiration. No doubt Mr. Tuley was a

skillful breeder, and his famous strain of hogs were the progenitors of the Improved Yorkshires of to-day. Two of his most noted animals were the sow Matchless and the boar Sampson, to which animals some of our Yorkshires may still be traced. Two other men stand out prominently in the improvement of this breed, namely, Mr. Wainman, of Carhead, Yorkshire, and his manager, Mr. John Fisher. Mr. Wainman purchased animals of the Tuley strain, and became the most celebrated breeder and exhibitor in the kingdom, sending animals to all parts of the world.

Directly the opposite of the Large White in all its characteristics is the Small White, or Small York. Fisher traces them back to 1818, when they were bred by Charles Mason and Robert Colling, of Shorthorn fame. There is little doubt that Chinese blood was used in the formation of this breed, as it possesses many of the Chinese characteristics. It is more of a fancy breed than anything else, though perhaps no other pig can be fattened upon less feed. It was also more or less used in improving the fattening qualities of the common hogs of the country. The Small White is a small animal, with a very wide, deep body, and extremely short legs and snout, being anything but the type of the packer's hog, which we hear so much about to-day.

By combining the Large and Small Whites, the Middle White, or Middle York, was produced. As might be expected, this breed is intermediate between the two extremes, and, though the breed is little known in this country, there seems to be reason to believe that they have occasionally been brought here under the name of Improved Yorkshires.

As a matter of history, it is interesting to note a breed that was once more or less known in this country. It was known as the Windsor breed, and was formed by the Prince Consort by clever selections from the herds of the principal breeders. Though once very fashionable among amateur breeders, it has practically lost its identity.

When we come to speak of Suffolk hogs, considerable confusion arises, for it is not easy to decide what a Suffolk is. It is true that we have a small white breed which we call Suffolks, but some very good authorities claim that they have been improperly so called, and that they are nothing more or less than the Small Whites, previously mentioned. Though certain English white pigs

have been called Suffolks, the English Suffolk proper is a black hog.

We are also in the dark regarding the extraction of the Black Suffolk, but Long believes it to have been produced by one or two crosses upon the original Essex pig, and there is little reason to doubt the correctness of his belief.

Standing at the head of English black breeds, and stubbornly contesting the ground with all comers, black or white, English or American, is the Berkshire. The original Berkshire was much larger than the modern animal, and frequently was quite freely marked with sandy-colored spots.

The breed was improved, between the years 1820 and 1830, by Lord Barrington and other breeders, whose methods of crossing are not known. It is claimed by many that Neapolitan blood was used, but the Berkshire possesses some qualities so different from the Neapolitan that other good authorities are led to doubt that this cross was ever introduced. The Hon. A. B. Allen, who has devoted much time to the subject, believes that the original cross in the improvement of the old Berkshire was with the Siamese. These Siamese hogs varied in color between a black, a dark slate, and a rich plum. Two or three of the feet were generally white, but the white did not extend to any other part of the body. The body was tolerably long, the loins broad, the hams deep and thick, the face decidedly dished, and the ears erect, and closely resembling those of the Berkshire. Taking everything into consideration, it seems probable that there is some ground for Mr. Allen's belief.

The original breed of the county of Essex was entirely different from the animals now named after that county. The breed was first improved by Lord Western, who, somewhere about 1830, brought over from Italy a boar and sow of the Black Neapolitan breed, which were afterwards used in crossing with some well selected Essex county pigs. The result was an entirely black hog, known as the Essex Neapolitan. Fisher Hobbes, a tenant of Lord Western's, then took up the work and still further improved the breed, calling it the Improved Essex. Sidney states that Hobbes used the Berkshire in improving this breed.

In common with the other small English breeds, such as the Small Whites and Black Suffolks, they are noted for their early-matur-

ing and fattening qualities. They are somewhat larger than the Small Whites, and have proved useful in improving the common hogs of the country.

The Tamworth seems to be nearer to the native hog of Europe than any other breed. As far back as it can be traced, the breed seems to have possessed its characteristic red color, though the modern Tamworth is very different from the long-legged, coarse-boned, razor-backed potato diggers of half a century

Chester White, and Duroc-Jersey. Besides these there are the Victorias and Cheshires, which are, no doubt, closely connected with the white hogs of Great Britain. As space is limited, no attempt will be made to trace the history of the American breeds. The proverbial perversity of the hog seems, in this case, to have got mixed up with its history (or its historians), and it is impossible to decide which of the many explanations is the correct one. After all, it matters very little what



THE BERKSHIRE SOW, ELPHICKS MATCHLESS,
 Winner of champion prizes at the Royal and other shows.

ago. Though many of its extreme characteristics have disappeared, it still retains sufficient of its old-time vigor and fecundity, connected with the ability to produce lean meat, to make it a very valuable breed.

Though America possesses no native pigs, it has, nevertheless, given to the world some noted and valuable breeds, formed by careful selection and cross-breeding. The three leading American breeds are the Poland-China,

were the exact crosses used, so long as the animals prove themselves of superior merit.

A Noted Berkshire Sow.

The sow Matchless, depicted in the illustration on this page, is one that has had a remarkable show career in England this season. She was shown by Mr. Edwin Buss, Horsmonden,

Kent, a well-known Berkshire breeder, and has never been beaten wherever shown. She also won the championship prize for the breed at the Royal, Royal Counties, and other leading shows, and is said to be the best Berkshire that has been exhibited for years. She has lately been purchased by Messrs. Metcalfe, New York State, for a high figure, and is now in that country.

Selection in Breeding.

Extract from an address delivered by the HON. JOHN DRYDEN.

The young beginner should first decide what particular breed is best suited to his circumstances, but it is not enough for him to select the breed, nor is it enough for him to determine that these should be registered in some herd or flock book. There is often nearly as much distinction between individual specimens of the same breed as there is between average types of different breeds. He who is to be a successful breeder should have in his own mind the particular form, as well as the particular breed, he desires to produce. If this be understood, he will naturally, when selecting foundation stock, secure that which is nearest the ideal. Doubtless, it will be impossible for him absolutely to reach it. We have not yet been able to find perfection in any of these animals. His skill will, therefore, be seen in his ability to build up and perpetuate the good, and, at the same time, eliminate, as far as possible, whatever imperfection his keen eye may discern.

There are some qualities, common to all animals, that must not be unnoticed by the beginner. Good health, robust constitution, with the ability to produce at the lowest cost, should be requisites in every case. A weakly, puny cow, pig, or sheep, is just as likely to bring its owner success as that a race of warriors should spring from consumptive parents. These weaklings should be weeded from any herd or flock, much less should they be chosen as foundation stock by any beginner. I am a strong believer in judicious selection in order to increase superior production. It is true in vegetable and plant life, and is just as true and more easily discerned in the animal world.

In founding a herd or flock, the females should be selected as near the ideal as possible. I should want to do this first. Having selected the females, then you are better prepared to select a male animal that will be cal-

culated to fix the ideal type, or to correct the imperfections that may be observed in the herd.

No matter how careful the selection, it will sometimes happen, for what reason I am unable to tell, that the produce does not show that accuracy of form and type that the owner was warranted in expecting. Such animals should always be discarded as breeders, and sent to the butcher at the earliest opportunity, and only those be retained that come the closest to the ideal set before the breeder. As years go by, if the skill of the breeder is sufficient, the herd will improve in uniformity, and conform more closely to the design he has in his mind. On the other hand, it is a very easy thing, after you have selected a choice herd of females, to destroy the type altogether by the use, for a few years, of an improper sire. This is especially the case with sheep and swine, because the animals will need to be replaced by young ones within a few years.

It is sometimes said that the male is half the herd; in some cases the breeder proves that he is more than half, because, if he be an improper sire, he will destroy the type altogether. It is, therefore, true that the young beginner, and the old breeder as well, will always find the greatest difficulty in the selection of a suitable male animal. If the animals that comprise the herd are seen to have any specially weak point, the selection of the male should not be such as to perpetuate it, because, when it is once set, it becomes a characteristic of the herd, and is extremely difficult to breed out. He should, therefore, be selected, bearing in mind the characteristics of the individual animals comprising the herd. This principle, if acted upon, means that an animal which might be useful to one breeder would not necessarily meet the requirements of another. I should be delighted if the day would ever come in this country when the man who goes to purchase would go having his own individual ideas of what he wants for himself, and be prepared to act upon them without regard whatever to the opinions of others. Who has not seen men refuse to bid at an auction sale because their neighbor was not doing so? or who, on the other hand, has not seen a man bidding on an animal, simply because he saw a prominent breeder doing the same? It might be wise for the prominent breeder to bid, but very unwise for the man who is copying, and trying to follow in his footsteps. Every man should be his own judge, and be prepared to follow the good

example of breeders in Great Britain, who formed their own opinions, and acted independently of every one else.

The power to select exactly what is needed, without mistakes, is one that may well be coveted by the wisest men. It is a power that may add to the perfections of an animal, or subtract and take from them those already there. It is a subject well worthy of study, and I am glad to know that, in these days, our young men are not left entirely to their own experience in the matter, but that we have schools and colleges where these questions are discussed, and where a boy commences, even in his school days, his observations, and receives constant aid and assistance to enable him to accomplish the desired result. We have not commenced this work too soon, and we cannot give it too much of our sympathy.

Marketing Hogs.

A correspondent asks us: When is the best time to market hogs? What is the best kind of hog to feed, and at what age should they be fit for the market?

In answer, we would say that the best time to market hogs is when they are ready for market, irrespective of the time of year. At the present time, the best demand is for hogs ranging from 150 to 200 pounds, when dressed, and for these weights the packers will give better prices, provided that the pigs are of the long, lean kind, and not too fat. Some of the country buyers and shippers, it is true, do not discriminate between this class of pigs and others, but pay the same price for all they purchase, and they take care that the prices paid are on the basis of those paid by packers for hogs less suited for their business; that is to say, they pay lower prices than they should for the style of pig so much in demand.

Hogs should be ready for market when they are from six to ten months old, if they have been properly fed and pushed on. It is easy to get them to the required weights at those ages if the right kind of pigs are kept. After that time, and when those weights have been exceeded, more feed will be required in order to secure the same amount of increase of flesh that had previously been made on less food, and, therefore, our correspondent will see that there will be more profit made by marketing his hogs before the period of the increased feeding required arrives. A few years ago some feeders made a good deal of money by

fattening pigs for marketing during the months of July, August, and September, when the supply of hogs was light, and when, in consequence, prices were considerably higher than later in the year, when larger supplies come in. Now, however, owing to the increased number of cheese factories and creameries in the country, and the large number of hogs kept by them and by private individuals, in order to consume the whey and skim-milk during the summer, prices do not range as high as formerly in comparison with those paid at other seasons of the year, although considerable money is yet made by those who follow this course.

The best advice that we can give to feeders is to market their hogs whenever they are ready for market, and not to hold on to them too long after that period, in the hope that prices will take an upward turn, as they are oftentimes quite as likely to go down.

Testimony to the Value of "Farming."

Editor Swine Department, FARMING:

I have been intending for some time to write and let you know how much I think of your paper, which every intelligent farmer should take and read. I have learned more from it in three years than I gained in my fifteen years' experience of farming. I am much interested in swine. The spring before last I had a good litter of pigs, four of which were sows. I determined to winter these, and treat them after the manner recommended in your columns. Last spring they presented me with forty-three young pigs. One was born dead, but the other forty-two were alive, and are doing very well wherever I sold them. The sows in question were fed on boiled turnips and a little oats, wheat, and barley.

I have also learned from FARMING how to save my barnyard manure, and how to apply it with advantage. When, too, my cows come home at night, I am ready to supply their wants with a good feed of corn fodder. This they never got before I read your paper. I could give you plenty more instances in which I derived great help from your columns.

Fox Creek, N.B.

D. D. LEGER.

[Our correspondent's kind words are a great encouragement to us in our mission of assisting farmers in their work, by bringing before them new, improved, and reliable methods of farming in all its branches.—ED.]



Conducted by "AGRICOLA."

"Agricola" to the Farmers.

"Agricola" has promised to conduct the farm department of FARMING, that is, if it should turn out that his brain power is sufficient. Farmers, he wants every one of you to read his articles carefully, and if they are not worth reading tell him so, and he will try to make them better. But before you tell him that, be sure you are right, or you may get into a tangle with "Agricola." And don't condemn his methods until you have tried them, or until you know of some one else who has.

"Agricola" has spent a good many years upon the farm. He may be all the bigger fool on that account, but, in the meantime, he has gathered a few ideas on farming, and he wants you farmer readers to go to work and prove them false. But he is satisfied it will keep you all busy if you do. There will be no time left for standing around the corner grocery, or for going to town on Saturday afternoons to discuss politics.

"Agricola" has great faith in the value of keeping up the fertility of the soil, where farming is to be made profitable. He wants every man who doesn't take the same view to go west as quickly as possible, since, if he were to remain, he would be a public nuisance. He wants him to go beyond the Rocky Mountains, and, when he gets there, to go right on to Vancouver, and from Vancouver right on to China, where he will find suitable companions.

"Agricola" has great faith in clean farming. He believes that weeds live upon the same kind of food as crops, and that, when weeds take the food, there is that much less left for the plants. He is satisfied that weeds injure plants by crowding and by their shade, and that they drink up moisture in the soil that should go to the plants. He is quite sure that farmers could keep their farms tolerably free from weeds if they would try, but he is equally sure that many of them don't try very hard. And he wants them all to try.

"Agricola" believes every farmer should have a garden, and he intends to make considerable noise until those who haven't gardens now get them. The farmer who has a garden has broken his marriage vow, for, when she promised to leave the world for him, he promised to love her, and that includes providing her with a garden and lots of vegetables, so that she can cook dinners for him at which he will not growl. If he is without a garden, and has, therefore, broken this vow "Agricola" thinks the first thing that he should do is to set to work to mend it by planting a garden.

"Agricola" is convinced that the farmer should use lots of fertilizers on his farm. Without them the farmer will not get on well unless he lives on a very rich farm. And while "Agricola" is of the opinion that commercial fertilizers are sometimes good, he is not of the opinion that farmers should drink in everything which the fertilizer man tells them. He believes that there is no way of getting fertilizers so cheaply as by keeping lots of good stock, and that there is no way of getting them so dearly as by keeping lots of inferior stock.

"Agricola" has lots of faith in the rotation of crops, but not in that kind of rotation that is like the track of the fox chased by the hounds, who goes again over the course he left. Such a rotation is rather crooked for a farmer to follow. He believes in a straight rotation, as straight as a bee line, unless bad seasons interfere. And he believes in a short rotation. He has no admiration for those long rotations, begun by the father and finished by the son after the father has died.

"Agricola" has every confidence in keeping lots of plant food in the soil. He does not mean plant food put into it by allowing grain to waste and go back again into the soil by shelling in the field, but plant food sown for plowing under, and lots of grass, more especially clover, turned under at short intervals. He is sure that, when this is done, soils will stand moisture better, they will cultivate

easier, the processes of absorption, aeration, and capillarity will be more perfect in these, and, consequently, they will be more productive.

And "Agricola" has unbounded faith in the education of farmers' boys. He has no sympathy with that class of farmers who can't be taught anything because they have already mastered everything. "Agricola" is an observing fellow, and he has observed that farmers of that class have nothing to learn and very little to forget. He has great faith in some agricultural schools, including ours at Guelph. He believes that agricultural text-books should be introduced into common schools, and that, if the teachers in these are either unable or disinclined to teach from the same, they should be relieved of their duties, and some one else appointed to them who can and will teach agriculture.

Now, farmers, these are some of "Agricola's" sentiments. How do you like them? Let him know in the next number of FARMING. Don't say you never wrote an article to an agricultural paper in your life. Whose fault is it if you didn't?

If any farmer has hit upon any good thing in farming, he should send it at once to "Agricola" to give to the people. He should not try to hide it; anybody can do that. The most selfish churl in the world can try to enjoy a good thing all alone. There is no glory in imitating a churl and a niggard.

Now, farmers, rain in your questions. "Agricola" has arranged with Prof. Shaw to answer them in this department. Do not refrain from sending in questions because you do not want to let other readers of FARMING know that you are not posted on certain points. Your name need not appear, unless you wish it. Then fire them in, and get the worth of your money. Everybody is invited to do this.

Agricultural Fairs.

The season of fairs is upon us, and we should try to take in one or more of these. But we must not go too far in this direction. There is much work crowding even in the autumn, which should be completed before winter. Nay, it must be completed before that season, if it is to be done at all. Keep the fair business well under control. More especially is the caution thus given applicable to young men whose leanings are in the direction of fast horses. Fast horses and pro-

gressive farming do not go very well together. They have their place, and it is an important one, but they are given a place frequently which should never have been assigned to them, and that place is on the average arable farm. Young men should go to fairs, and they should eagerly take in everything that is likely to prove helpful to them in their work, but they should not go to too many fairs in one season. It is greatly important that the work of the farm should be well ahead for the coming season, if that coming season is to produce crops such as we like to get. And it is well to remember that only close application will bring it into this condition. While fairs are to be attended, therefore, let them be kept in their place. A taste of their benefits will prove a relish, but unrestrained indulgence in attending them will lead to physical, mental, and moral dissipation.

To the Boys.

Now, boys, what books are you going to read the coming winter? You know the squirrel and the chipmunk lay up nuts in the autumn to supply themselves with food through the winter. Wouldn't it be a good plan, boys, for you to lay up some books in readiness for the long winter evenings which are coming? "Agricola" has great faith in the help that books can bring to boys on the farm, especially books of the right kind. Dime novels are not meant, nor even that better class of tales which are sometimes read to rest the weary mind of scholars and literary men. The reference is rather to good agricultural books, such as Stewart's "Feeding Animals," "The Crops of the Farm," by Scott and Morton, and "The First Principles of Agriculture," taught in our own schools. If it is not taught in all our country schools, it ought to be, for it is a little work which contains very much useful information. And it is information which every farm boy should master. Then, boys, get hold of one or two of those books, and when the evenings get long devour their contents. Before you read far you will relish them more than Johnny cake, or pie, or dumplings. It's a fact, boys. "Agricola" knows what he is talking about. Save your dimes, then, and get the books. When you go past the lemonade stands, and the orange pyramids, and the grape baskets, shut your eyes till you get past. Gather the dimes, and buy agricultural books.

Fall Plowing.

In some countries fall plowing is a luxury which cannot be indulged in. The rainfall in winter so runs the soil together when it is thus plowed that its last condition is worse than the first. It is very seldom, however, that these conditions apply to Ontario, or even to any of the provinces of the Dominion; hence, with us, it is almost always in order to plow in the fall.

The benefits from autumn plowing are many. They include the deepening of the cultivable area, the improvement of the seed bed, the liberation of plant food, the accomplishment of labor in the fall that would otherwise have to be done in the spring, and, in some instances, the more complete destruction of weeds.

Fall plowing aids in deepening the soil. When the work is done in the fall, the land may be plowed more deeply than if done in the spring, because the raw soil thus brought up is exposed to reducing agencies from fall until spring. These agencies tend to liberate plant food, as will be more fully described below. If such deep plowing were done in the spring, there would not be time for those reducing agencies to do their work properly; hence, in stiff soils more especially, the plants might literally starve through the growing season, yet plant food may abound, but in non-liberated forms. Nor is there sufficient time to secure that fine pulverization which would be the outcome of fall plowing.

Fall plowing improves the seed bed. It improves it mechanically. Suppose a stiff clay were plowed in the autumn, and that it turned up more or less cloddy. The action of the rain and frost and other influences would cause these clods to crumble. When the harrow or cultivator is passed over such soils in the spring as soon as they are dry, they readily crumble; hence, a good tilth may usually be secured upon them. If not plowed until spring, they are much prone to turn up more or less adhesive from below; hence, much labor is required to put them in a fine condition mechanically for receiving the seed.

Fall plowing tends to the liberation of plant food. The agencies of nature, the sun, the rain, frost and snow, act upon upturned soils more or less from the time that they are plowed in the fall until they are sown in the spring. This action is not only mechanical, but it is also chemical. Plant food, there-

fore, is continually being liberated; that is to say, it is being changed from an inert into an active form. When inert, the plants cannot feed upon it because it is not accessible to them; but when transferred to the active or soluble form, the roots of growing plants find it and appropriate it to their own uses. Where the soil is not upturned until within a short time before sowing the seed, the time is insufficient for the agencies of nature to effect very much in thus liberating plant food. And when the soil is stirred on the surface as soon as it is dry enough, nitrification becomes more active as the air can more freely penetrate it. The soil also becomes warm near the surface through the influence of sunshine and warm rain washing down through a warm atmosphere. Vegetation, therefore, under such conditions, cannot be otherwise than vigorous when the weather is at all favorable.

Labor is facilitated by autumn plowing. Early sowing with nearly all kinds of spring grain is greatly important. But early sowing would only be possible to a limited extent if all the plowing had to be done in the spring. The autumn gives more leisure; hence, the more of the work of the following season that can be done then, the less there will be to do in spring, which is always a time of hurry and rush with those who are going to keep up with their work. This argument in itself would be of sufficient importance to justify plowing to the greatest extent possible in the autumn, in the absence of any arguments to the contrary.

Fall plowing is of great service in destroying weeds, at least in many instances. We may imagine some few conditions under which fall plowing would rather encourage the growth of weeds than tend to destroy them. This would be the case with some kinds of perennials, as, for instance, Canada thistles, when the grain is sown early in the spring. But with annuals, and even with perennials, fall plowing may be made to help to destroy them greatly with crops planted late, as, for instance, crops of corn and field roots. By stirring the fall-plowed surfaces occasionally from the opening of the spring until the planting of the crop, one generation after another of the seeds of annuals may be sprouted and, in turn, destroyed, and by running a cutting implement just below the surface of the soil Canada thistles and other perennials would be cut off, and thus materially checked in their growth.

A Wagon Box for Roots.

The root crop is a heavy one to handle where grown extensively, and any device that will lessen the labor of handling should be hailed with delight by all who grow this most productive of cattle-feeding crops to any extent.

While at Mr. Rennie's, Wick, we were shown a wagon box, a plan of which we give in the accompanying cut, and which is well worth adding to the list of useful labor-saving implements.

Any one about the farm that is handy with tools can easily make a couple of these at small cost, and save the heaviest part of the labor, that of shovelling the roots into the cellar. Another good point that commends itself is that the slatted bottom allows the

an angle from *E* to *D*. The reach is cut at *DD*, and bolted to the cross-bed pieces, leaving the centre compartment *B* bottomless and free for the action of the trap *G*, which also serves as a chute to conduct the roots to the cellar. The trap is also slatted at the bottom, and is hung with chains *KKKK* on each side, which hang on points *HH*, which are placed in a lever made in the form of a *T* inverted, made of inch and a half gas-pipe, of which *I* is the handle. The lever is held in its place by a ring, which passes over the handle, which, on being released, turns down and allows the chains to slip off, letting down one end of the trap, which allows the roots to roll out. The trap is six feet long, with sides eight inches deep, and fits in between the cross-bed pieces under the box. The box will hold about fifty bushels, and can be made of any size by placing it on shelving sides

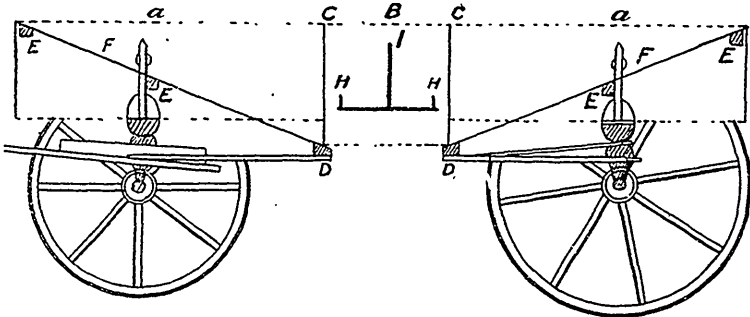

Saving Seed Corn.

loose dirt to fall through, whereby the roots are got into the cellar clean, while it also saves carrying a load of useless earth back and forward from the field at each load. In building, the side pieces, shown in the dotted lines in the cut, are 12 feet long by 20 inches wide, but are cut down at each end *A-A* to 16 inches deep, leaving the centre *B* 30 inches long and 20 inches deep. Strong iron straps $\frac{1}{2}$ inch by $1\frac{1}{2}$ inches are bolted to the sides at *CC*, and run down through the cross-bed pieces *DD*, as in the ordinary box. Cross-bed pieces are also run through at *EEEE* to support the slatted bottom *F*, which runs at

We do not propose to go into the question of carrying seed corn through the winter, but simply want to submit a few thoughts with reference to selecting the seed. It is unquestionably a good plan to make the selections in the field, and while the corn is still standing. The first ripe ears can then be easily detected, and this means a great deal in the long run; for, if the first ripe ears are thus chosen from year to year, there can be no question but that the early-maturing properties of the corn will be enhanced. Practical men have in this way advanced the average period for maturing certain varieties of corn by at least two or three weeks. In fact, where this mode of selection has been long practiced in any one locality, it is somewhat doubtful if much advantage will arise from the effort to introduce earlier varieties from abroad, although, of course, it would not do to press this idea too far.

In making these selections, the first ripe ears may easily be told by the yellowness of the covering, as compared with that of other ears that are only approaching ripeness. The size of the corn should also be considered. We refer here to the growth of the stalk and of the cob. In some parts of the field the corn will probably be stronger than in other parts, and there will also be a corresponding increase in the size of the ear. It is from these parts, of course, that the ears should be chosen.

While the size of the cob should have a good deal to do with the selection, size alone is not the only consideration. Of course, small ears should be passed by. But it will frequently be found that large ears will have some defect. A little practice, however, will soon enable the individual to choose seed corn with no little certainty, even without making an examination of each cob before it is broken off. The appearance of the top end of the cob is something of an index of what may be expected from the whole cob.

The work may be done somewhat as follows: The gleaner may furnish himself with a basket, into which he puts the ripe ears as he goes along. At the farther end he empties the basket into a sack, which has been previously provided. He goes back again similarly between the next two rows and again empties his basket, when he returns to the end from which he started. He proceeds thus until enough of corn has been secured for seed. When we say enough, we mean about twice the quantity that will really be wanted, for in husking it will be found that many ears will have to be rejected, because of one flaw or another, and it is always a good plan to have a plentiful supply of seed on hand. Many growers save enough one year to furnish a two years' supply, so that when any mishap comes to the corn through early frost or adverse weather, which hinders the growth of a good sample, they can still fall back on the reliable home-saved seed, and can also make an honest penny by supplying their neighbors with reliable seed corn.

It may seem like taking a good deal of trouble to thus select corn from year to year for seed, but it is trouble that will bring a rich return. Such a mode of working might not answer where corn is to be saved in a wholesale way, but it should be eminently practicable on ordinary farms, where the farmer wishes to grow a crop of matured ears which are to be husked for the grain.

Corn Fodder.

Without any doubt, in nearly all parts of Ontario corn fodder is the surest fodder that we can raise for our live stock. In a wet season we can grow it in abundance, and in a dry year we can get at least a fair crop of corn fodder when all other fodder crops are a partial failure. Of course, we cannot keep our cattle on corn alone, but we can do so to a very large extent. While corn is exhaustive to the soil in a degree, it is not more so than other crops. The roots go down deeply in congenial soils, and bring up a part of their food from a great distance from beneath the surface; hence, if land gets fair treatment, corn can be grown on it for a long time, but not, of course, in successive years.

The controversy still goes on as to the respective merits of curing the fodder in the field or in the silo. The smoke of battle on this question, however, is subsiding. Controversialists seem to be inclined to concur in the following: (1) That where corn fodder is fed in very large quantities, it is the better plan to put it into the silo; (2) that in the dry sections of the west it is more advantageous, relatively, to cure corn in the shock than in the east, where precipitation is greater; and (3) that in any case where a silo has been properly located, it is more convenient to feed from it than from the corn shock or stack.

When, however, a silo not at hand, the only resource is to cure the fodder in the field. Many ways have been adopted of doing this, but the following has met with much favor in some sections: Cut the fodder with a narvester with a self-rake attachment. In this way it is laid off in sheaves. It is then allowed to wilt for some time if the weather is dry, and tied up in sheaves. These are put into large shocks, and there they remain until they are wanted for food.

The amount of stock that can be kept upon a farm where much corn fodder is raised is relatively very large. Those who have grown it know its value so well that they are almost certain to enlarge from time to time the area of the corn crop. And yet there are very many farmers who have never grown a single stalk of corn.

The process of growing it is very, very simple. We repeat it again. Plow the ground in the fall. If clover sod, it may be plowed in the spring. Work on the surface in the spring until the ground is fair in tilth and moist. Plant the seed with the grain drill. Put the

rows about three and a half feet apart, and use about twelve quarts of seed. Harrow with a harrow with slanting teeth before the corn is up, and also after it is up, at least twice. Then cultivate it frequently till it gets too high. You are then sure of a crop, your land is cleaned, and it is in a good condition to grow a grain crop next year.

It is very important to cut this crop before it gets too ripe. If overripe, then palatability of the fodder is, in a great measure, lost; hence the stock do not relish it so well. Its feeding value is lessened; hence they do not make such good gains when it is fed to them. The proper time to cut the corn, even for fodder, is when the grain has reached the glazed stage. Very much promptness should be shown in this matter, or there may be considerable loss.

A Pair of Collies.

Very closely connected with improved farm stock is the handsome and intelligent collie. The beautiful pair that are depicted in the accompanying illustration are specimens of a sort that has become as fashionable as a lady's companion in the drawing room as it is popular among the shepherds on the hillside.

The intelligence of the collie has been developed as carefully as the speed of the race horse, the high action of the Hackney, the useful traits of our improved bovine herds, or the various good qualities of the flocks of high-bred sheep that it has been this dog's vocation to assist in tending. We are indebted to Mr. R. G. Steacy, Lyn, who is breeding some good ones, for the photo from which our picture is taken.



A PAIR OF COLLIE DOGS.

The property of Mr. R. G. Steacy, Lyn, Ont.

The corn crop on this continent is an enormous one. It has been computed that if the crop grown in a single year were loaded on freight cars, putting 500 bushels on each car, it would load 3,200,000 cars; that is to say, it would make three solid freight trains from San Francisco to Boston. These figures are taken from an essay by John Gould, delivered at a Wisconsin farmers' institute. Let us make the most of this wonderful gift to man. The agriculture of this continent could not get on without this product. Notwithstanding the attention that is being given to it in Canada during recent years, it does not yet receive a tithe of the notice of which its high merit as a fodder plant is deserving. Much corn means much good fodder. Much good fodder means much meat and milk, and much meat and milk mean much money.

Do Farmers Need Recreation ?

On this question opinions differ greatly. Some persons' say yes, and some say no. And this difference of opinion exists among farmers themselves. In answering it, we should want to know, with some degree of precision, what is meant by recreation, and attention will now be given to the definition of the term.

Recreation does not mean simply rest or cessation of physical labor, although that is the idea many have regarding it. Rest is an element in recreation in many instances, but it is not recreation itself. Some forms of recreation consist very largely of physical activities, as will be shown below. Nor does it consist simply of change, although change is also one of its accompaniments. Nor does it consist solely of an unbending or relaxing

from the severer labors or duties of life, although relaxing is also one of its accompaniments. It may be defined, therefore, as that condition which enables us to relax from the heavy strain of normal duties, to secure the benefits of a change in the line of our activities, and to secure a satisfaction in the new condition which for the time being sweetens life. It gives fresh tone to the system, and fresh nerve to the energies. The office of recreation is to renew and freshen, and, through such renewing and freshening, to give fresh impulse to all the energies of life.

From the above definition it will be apparent that recreation will not only be found in varied forms, but in conditions that are very opposite. The student and the professional man of sedentary habits will find recreation in the activities and the hard physical exertion of the gymnasium. To the tired farmer such exercise would bring pain. The merchant finds recreation in the solitude of the summer grove by the lake or the river, where, for the time being, the rumbling of the wheels of business cannot reach him. The farmer finds recreation amid the sights and bustle of the city. The child whose task is done gets it in the romp and the games on the village green. And the man whose brain is tired and weary from prolonged and severe thought gets recreation in reading some smooth-running, well-written tale. The nature of the relaxation, therefore, that will be beneficial is dependent upon the conditions of the present and of the recent past. It should usually be sought in a direction that may be termed the opposite of that in which the person has been journeying.

The necessity for relaxation is so great and constant that it would seem to be a law of our being. Men who do not relax wear out prematurely if their labors are arduous, and this remark applies to every line of life. Life is well worth living; hence we should do our best to try to prolong it to the utmost. The quality of labor is also hindered when we do not relax sufficiently. Because of this we frequently find men who at one period of life will accomplish more in ten hours than they can overtake in twelve hours at another time. The energies of the system in the first instance are fresh and vigorous, and in the second instance they are fatigued. They are being plied without the lubricating influences of sufficient relaxation. And without relaxation life cannot be found at its best. Work that may be pleasant in itself for a time, if too constantly and too continuously pursued will

become a long and irksome task; whereas the same work, if tempered with sufficient relaxation, would be a continuously flowing well-spring of satisfaction. And the severer the strain, the greater the necessity for the relaxation. One man must relax much, or he will soon wear out. Another man needs but little relaxation, since, in the first place, his duties may not be such as are termed arduous, and, in the second, they may be of a character which associates them with frequent change.

It is evident, therefore, that the farmer needs relaxation. His labors are, at least physically, severe. And the form of relaxation which will prove most helpful to him will consist largely of cessation for the time being from severe and prolonged physical labor. The more of monotony and sameness in his work, the greater the necessity for relaxation. And it should be remembered that the more of enjoyment the farmer gets in his work, the less the consequent wear, and hence the less the need for recreation.

And here it may be mentioned that recreation, though in itself a good thing, can be easily abused. If sought as an end in itself, and not as a means to greater future helpfulness, it will soon become labor, and labor of the most unsatisfying and exhaustive character. He, of all men, is a fit subject for commiseration who is found going about seeking in vain for that enjoyment of life which can only be found in faithful service tempered by relaxation.

The tillers of the soil should, therefore, seek relaxation when wearied and worn. Of course, they should exercise judgment as to when they shall seek it. All times are not equally opportune. Some seasons may be inopportune because they are so busy. But when the wheels have run wearily for a long time, or even for a shorter time, they should be oiled with the lubricants of rest and change.

And the inmates of our farm homes should not be forgotten. Who has more cares than a farmer's wife, with a family growing up around her? Who, therefore, is more in need of relaxation? And who so seldom gets it? Answer, ye husbands of those women, weary, patient, worn. Our children also must have recreation. It is trying when a matured person is put upon the treadmill of incessant labors. To put a child or one immature, or even mature, but with the whole being bounding with the fiery pulsations of youth, upon the same footing is simply intolerable. Young people should labor, but the labor should be tempered with sufficient relaxation. Deny all relaxation

to the young people of our farm homes, and we shall accomplish one of two things. Either we shall cause them to snap the cord of parental authority as they set off in search of what we have denied them, or we shall crush out of their young hearts all those aspirations that impel them on to higher heights.

Eradicating the Ox-Eye Daisy.

Editor Farm Department, FARMING :

Subscriber, Danville, Que. : I would like to know how to eradicate the ox-eye daisy. Is there any means of exterminating it ?

ANS.—By Prof. Shaw : Several methods of fighting it are given in "Weeds, and How to Eradicate Them." Of these the following is probably the most effective : Grow two hoed or cultivated crops in succession. Give every care to make sure that these crops are kept perfectly clean. Follow with a crop of spring grain sown with grass seeds. If any stray plants appear in the meadow, remove them with the spud when they first come into blossom. Where they are found growing very numerous in pastures and meadows, these should be broken up and managed as described above.

Fall Plowing.

Editor Farm Department, FARMING :

J. W., London : What are the advantages of fall plowing over spring plowing, if any ?

ANS.—By Prof. Shaw : First, the work of plowing is done at a time when there is more leisure to do it than if deferred until the busy season of spring. This in itself would be a great gain. Second, the seed can be sown earlier, as a rule, on fall-plowed land, and this, in nearly all instances, means that a better crop can be grown from early as compared with later sowing. Third, the mechanical condition of stiff soils is improved by the exposure of the up-turned surface of fall-plowed lands to such influences as sun, rain, and frost. These influences produce disintegration in stiff soils, and light sands and prairie soils have time to settle down to their normal density, so that they hold moisture better. Fourth, fall-plowed soils are warmer. Rain falling in the spring warms the surface of the soil before it becomes warm below. If land is plowed in the spring, the warm surface is turned down and a colder

surface brought up, which is less favorable to a quick growth of the seed. And, fifth, there is more available fertility in fall-plowed land. The weather agencies that have just been named tend to liberate fertility which heretofore the plants may have been unable to utilize. The advantages of fall plowing will be greater, however, in a dry season than in a wet one, in stiff soils than in those of easy texture, and in light, spongy soils as compared with those of more density.

Winter Wheat.

Editor Farm Department, FARMING :

Subscriber, Wyoming : Will you give me your opinion as to the advisability of sowing winter wheat in this time of low prices ?

ANS.—By Prof. Shaw : Some winter wheat should be sown every year on every farm well adapted to its growth. It should be so grown because the work of sowing and harvesting can be done at a time which does not seriously interfere with other work on the farm ; because it can be advantageously fed to live stock when the price falls below the cost of production ; because it furnishes a good nurse crop for grass seeds ; and because the bulky straw which it produces is wanted for litter for live stock. Of course in periods of depression the acreage should be reduced.

Soils for Rape.

Editor Farm Department, FARMING :

J. S., Compton, Que. : I notice a growing interest is being manifested in the culture of the rape plant. A few years ago one would never see anything about it in the papers. Now it is being talked of in almost every number. What kind or kinds of stock is it good for ?

ANS.—By Prof. Shaw : It is good for every class of live stock that will eat it, and I don't know of any class of domestic animals kept on the farm that will not eat it. But it is particularly adapted to furnishing pasture for sheep. Sheep fatten quickly when feeding upon it. It is also excellent for fattening cattle, but cattle destroy more of it by treading it down. It is good to cut and feed to milch cows, but when so fed it should be given to the cows after they have been milked. It is, *par excellence*, a sheep food.



Conducted by "DAIRYMAN."

To Dairymen.

Dairying is now fully recognized as one of our most important Canadian industries. It is entitled to this distinction for two important reasons. First, because of the value of its exports, and the large amount of hard cash it is annually the means of bringing into the country to be distributed among a large share of our population; secondly, because of the large number of our people who are directly engaged in the production of dairy products.

The value of our cheese exports in 1894 amounted to over \$15,000,000. The value of the butter exports, though something less than \$1,000,000 for the same year, seems to be increasing and showing signs of further development. There are estimated to be over 2,000 cheese factories in Canada, of which about 1,000 are situated in the Province of Ontario.

We find, from the annual report of the secretary of the Western Ontario Dairymen's Association, that there are estimated to be an average of over 70 patrons and over 460 cows to every cheese factory in the district looked after by that association. These estimates may, perhaps, be too high for the whole Dominion. But if we say 60 patrons and 400 cows to each cheese factory, the estimate will not be very far astray. This would give a total of 120,000 patrons who supply the milk of 800,000 cows to the cheese factories of Canada.

We have no very reliable figures to show the extent of the creamery business in Canada. But we may safely estimate the number of creameries to be at least 200, and, allowing the same number of patrons and cows to each creamery as to each cheese factory, there would be, in addition to the above, 12,000 patrons who supply the milk of 80,000 cows to the co-operative creameries in Canada.

Besides, it may be safely estimated that there are 5,000 persons employed in the cheese factories and creameries of Canada, in the manufacturing of butter and cheese.

These, together with the persons employed to haul milk to the factories, would make a total of 15,000 more who are directly interested in the dairy business, not to mention those who devote their time to buying the product and transporting it to the consumer in Great Britain.

It is estimated that seven-tenths of the population of Canada are engaged in the business of farming. Now, every farmer keeps a greater or lesser number of cows, whether he be supplying milk to a cheese or butter factory or not. So that, in addition to the estimated 147,000 individuals who are directly connected with our factory system, and are making more or less a business of dairying, we have as many more who are interested in dairying to the extent that they keep and feed cows, and utilize their product for their own benefit.

It is to this large constituency that the columns of this dairy department are devoted. We desire to cater to the wants and interests of the various branches of this constituency by keeping these columns filled with the latest thought and information regarding the best practices in modern dairying. It will be our earnest effort to cater to the interests of the patron of the cheese and butter factory, and the man who keeps cows, by supplying them with the latest information regarding the best practices in the rearing, breeding, feeding, and caring for dairy cows, and in caring for their product so as to make the finest quality of cheese and butter; to the interests of the manufacturer and maker of cheese and butter by supplying the latest information regarding the best methods of making a fine quality of cheese and butter; and to the interests of every one connected with the dairy industry by furnishing the latest news on all matters pertaining to its development and progress.

To accomplish this successfully, it is necessary to have the co-operation of those directly connected with the trade, and to this end we desire and solicit correspondence from practi-

cal dairymen in different parts of the country. Anything of value in connection with the actual experience of those who are keeping cows, or are engaged in the manufacturing of cheese and butter, will be given due prominence in these columns.

One very necessary and important feature in connection with the dairy branch of any paper is the questions and answers department. We desire to make this a special feature of our work, and trust that dairymen everywhere who desire information on any special feature of their work will feel free to send their questions to the Dairy Department of this journal. We shall endeavor to have these questions answered by a practical man, who is a specialist in his own department.

We would especially urge upon subscribers to FARMING to let us have their experiences in breeding, feeding, and caring for dairy stock, and in handling and manufacturing dairy products, for publication in these columns, and also strongly urge upon them to use these columns for receiving answers to all questions that may arise in their dairy practice.

The Thistle Milking Machine.

In the June issue we called the attention of our readers to a new milking machine, called the "Thistle," which has been operated successfully in Scotland.

The milking machine is now being tested at the Ontario Agricultural College, Guelph. We have not had particulars as to the results, but, as far as we can learn, the machine at the college is a bulky and expensive affair, and, unless a smaller, more convenient, and less expensive size can be made, indications are that it will not be of much benefit to the average dairyman of this country.

We understand, however, that where it has been tried the machine does its work well. At large dairies where eighty or a hundred cows are kept it would, no doubt, be a profitable investment, that would save considerable labor and time; but we are of the opinion that it will be a considerable time before the average Canadian dairyman will be in a position to utilize or invest in such a bulky and expensive piece of machinery.

He will prefer to utilize the "fore paws" of his hired man for a while longer in extracting the lacteal fluid from the cows' store-house every night and morning. Such a

machine will doubtless prove a boon to the young man who is prevented from visiting his best girl on Sunday afternoons because his share of the cows will go un milked.

But, seriously speaking, a suitable, convenient, and cheap milking machine, that could be depended upon to do its work well, would indeed be a boon to the dairy business. If the one under discussion turns out to be such a one, its originators will have proved themselves to be benefactors to their race.

The Outlook for Creamery Butter.

The cold storage facilities provided by the Dominion Government for the transportation of butter to the British market seems to be having a stimulating effect upon that branch of dairying. The prices for creamery butter have not advanced very materially, but during the past few weeks a firmer demand for fine goods has sprung up that has put new life into the butter business.

The cold storage facilities provided are ample, and whether our export trade in fine butter is to be materially increased or not will depend largely upon the manufacturer and dealer in that commodity. If the creamery men are unwilling to sell at summer prices, and have their products go forward into consumption in a fresh condition, the butter industry will be in about the same position as it was in last fall. Instead of having the market free for the winter creamery butter, there will be a lot of summer creamery held over for the higher prices of the fall and winter. The result will be a "glutted" market, with a lot of old stock on hand that will have to be sacrificed at less than cost prices.

We are of the opinion, however, that such will not be the case this year. The creamery men have profited considerably by their experience of the last year or two in holding summer butter for a higher market. As far as we can learn, the bulk of the butter made during the present season is going into immediate consumption.

To have the butter go forward a couple of days after it is made, in a fresh condition, and disposed of at current market prices, is the only way of building up our export butter trade. The British consumer is not willing to pay a good price for butter several months old from Canada, when he can get what he wants in a fresh condition elsewhere.

The creamery man may have to take a lower price during the summer, till the quality of his goods is known, and their reputation established. But when that is accomplished, and there is the same demand and inquiry for Canadian butter as for Canadian cheese, then more profitable prices will be obtained.

Winter Dairying.

Winter dairying has obtained a strong foothold in some districts in Ontario, and has been carried on with considerable profit to those engaged in it. Last winter the prices obtained were not quite as high as during other seasons, yet many factories report very favorably regarding their last winter's experience. Nearly all our winter creameries are run in connection with the cheese factories, and are chiefly in those sections where farmers have made a specialty of cheesemaking. These farmers have adapted themselves largely to these new conditions, and have a number of cows in milk during the winter; therefore these winter creameries will be run in many places, even if the prices are not very high.

In some respects, the prospects for the winter creamery this season are brighter than they were last season. As has been mentioned, there is not likely to be as large a supply of summer butter on hand at the beginning of the winter as there was last year. This will leave the market freer for the fresh winter goods. Besides, the local demand for creamery butter is increasing in our towns and cities, so that if it will not be profitable to make butter for export during the winter, the bulk of the product can be disposed of in the local markets at remunerative prices.

One drawback to winter buttermaking will be the scarcity of winter feed reported from many sections where winter dairying has been carried on. This fact will, however, tend to decrease the output in some places, which will leave the market freer for those who are more favorably situated in regard to a supply of winter's fodder.

Many farmers make butter during the fall and early spring, before the cheese factories open. Why not make it on the co-operative plan during the winter, as well as make cheese on that system during the summer? A more uniform and finer product will be secured at no greater cost.

Dairy Jottings.

Patrons of cheese factories require to give as much care and attention to the milk during September and October as during July and August. Whether the nights are hot or cold, all milk for cheesemaking should be thoroughly *aired*. Unless this is done, the flavor will not be perfect.

It will pay dairymen to have their cows put in the stable as soon as the cold nights begin. A cow is so constituted that a chilling of the body or a lowering of her normal temperature will lessen her supply of milk, and make it necessary for her to devote more of the food she takes to keeping up the heat which her body requires.

Every cheese and butter factory should have in it a Babcock milk tester, whether the milk delivered is paid for by the percentage of butter fat or not. Nothing will be more efficacious in keeping up the quality of the milk.

No buttermaker should attempt to make butter without a reliable thermometer. To do so is about the same as trying to guide a vessel without a compass. You may possibly pull through all right, but you are never certain of the direction in which you are going, and where you are going to land.

The bitter flavor in butter is often caused by impure foods, or from holding the cream too long before churning. Twenty-four hours should be sufficient to prepare cream for churning. Until this preparation begins, the cream should be kept cool and sweet.

Never mix ripe cream with fresh. There is always a waste when this is done, as the butter from the green, thin cream will not separate as soon as it will from mature cream. The cream of the first or second lot intended for churning should be kept in a cold temperature where it will not change until it is put in the ripener.

A cheese or butter maker's skill is largely shown in the way he finishes his product. An unclean and untidy cheese or package of butter always indicates an unclean or untidy cheese or butter maker.

A Herd of Dairy Cattle.

In the plate on the opposite page, we give our readers a view of the fine herd of Guernsey cows kept by Mr. E. Rigg Brow, Charlottetown, P.E.I., who owns the Eastview Farm, situated about four miles from that city.

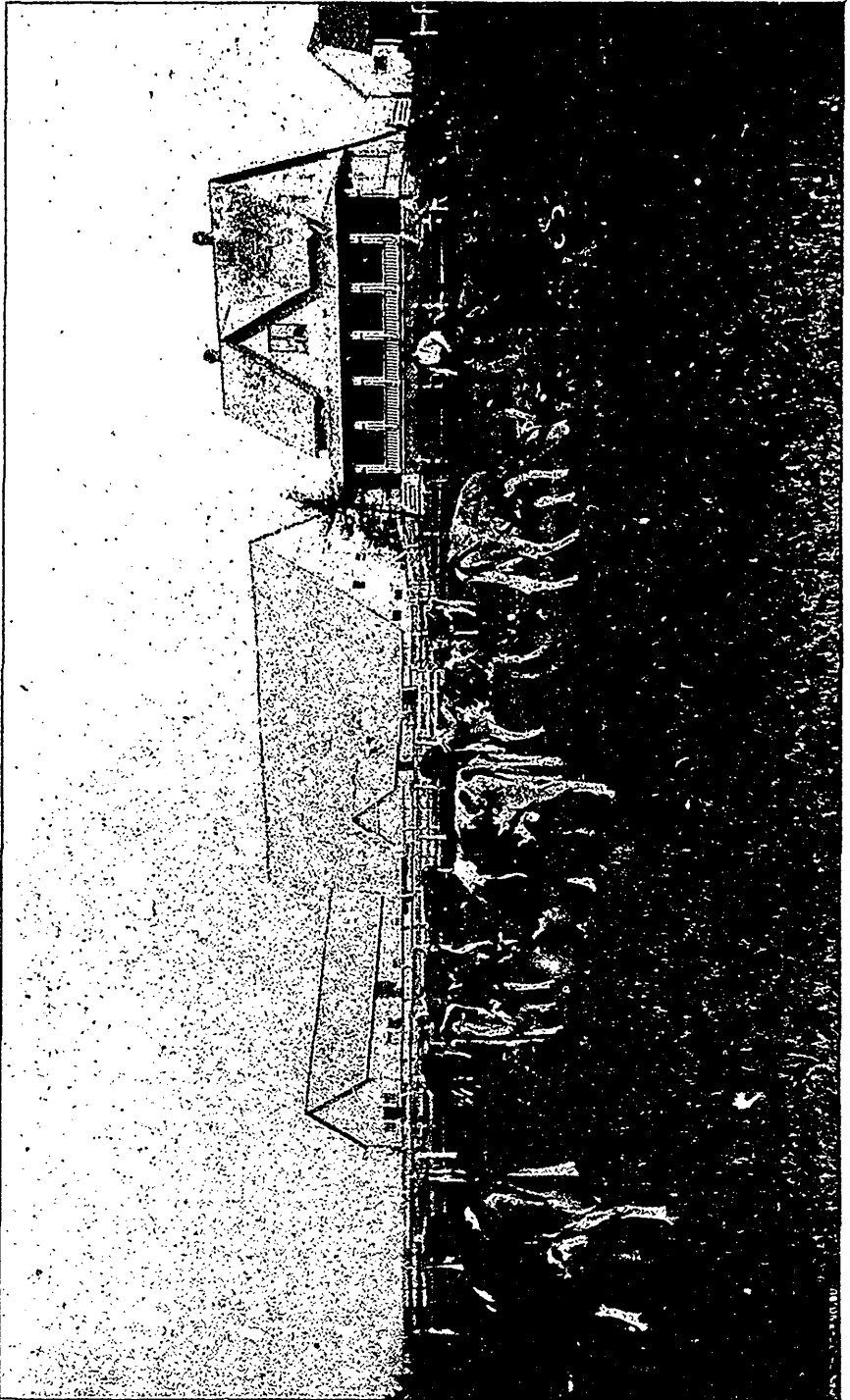

A GROUP OF GUERNSEY COWS.
Owned by Mr. E. Rigg Brov, Charlottetown, P.E.I.

Mr. Brow commenced dairying in 1886, since which time he has collected and bred as fine a herd of Guernseys as can be found in the Maritime Provinces. Twelve of these cows, when tested in July of last year on pasture alone, gave the following percentages of butter fat :

No. 1 gave 5.2 ; No. 2, 5.0½ ; No. 3, 5.4 ; No. 4, 5.1½ ; No. 5, 5.0 ; No. 6, 5.4 ; No. 7, 5.1 ; No. 8, 5.3½ ; No. 9, 6.1½ ; No. 10, 6.3 ; No. 11, 5.4 ; No. 12, 5.2.

These returns are most satisfactory, and show the high standard of the cows kept at the Eastview Farm. Mr. Brow believes in keeping his cattle in a hardy, natural condition, and no pampering is allowed.

The farm is run throughout on business principles, and everything is done to save labor. The barn, with that necessity of modern dairying, the silo, is exceedingly well arranged, and thus fewer hands are required than where the opposite is the case. On page 47 will be found a half-tone of the dairy house built by Mr. Brow, which, like the other buildings, is neat and compact.

Cutting Corn and Filling the Silo.

During the next few weeks farmers will be cutting their corn and preparing it for winter's feeding. The silo is strongly recommended as the best and most economical method of preserving corn in a suitable condition for feeding all kinds of stock.

In many districts the severe drouth of June and early July has caused a shortage in the hay crop and other rough feeds that farmers depend upon for their winter's supply of fodder. As a rule, in many of these sections, the prospects for a good corn crop are very favorable. Farmers who have a few acres of corn growing should prepare to handle and preserve it in the best way.

If you have not a silo, there is still time to get one in shape that will serve the purpose for a year or two. Last fall, a gentleman in one of the northern counties had a few acres of corn and desired to preserve it in a silo. He was not in a position to build a regular one, but he improvised one after this fashion : He purchased a number of two-inch plank, twelve or fourteen feet long, and with them he made an air-tight compartment in the form of a large cistern. He cut his corn up and put it into this novel silo, and had very good results. So pleased was he with the experi-

ment that he intends using the same arrangement this season.

A silo is not a difficult thing to construct. The essential thing required is an air-tight compartment. A silo 16 feet square and 20 feet high will hold about 100 tons. One square foot of space will hold from 45 to 50 lbs. of ensilage. It will pay farmers who have corn growing this year to have it preserved for winter's feeding in the form of ensilage.

We quote below part of an address delivered by John Gould, of Ohio, at the Eastern Ontario Dairymen's Convention last January, who is a recognized authority on the silo and the cutting and handling of corn for winter's feeding :

"The silo should be built of sound lumber. Build it round or square, or any other shape, so long as it is air-tight. Make it of two thicknesses of good lumber, lined with tar paper. I prefer the best flooring, free of knots, and put up by an experienced maker. I believe that the day of the stone silo is gone, and also the day of the stone foundation. I would never have stone in connection with my silo. For foundation build a trench ten inches deep, and put in a stick of timber well tarred ; put in some cement around it, and that will give you as good service as a stone foundation costing \$50. My timber foundation is just as sound as it was six years ago, and is doing as good work as my stone foundation. I built the first wooden silo east of the Alleghany mountains. That silo has been filled nine times, and we have never had a board taken off, nor has it cost anything for repairs. The inside corner of the silo is just as safe as along the walls. I find that silos with acute or right angles are just as easily filled as any, and there does not seem to be any more waste. Trouble in moulding in corners and sides is caused by too much tramping, and it dries out and moulds. Since I have abandoned tramping my silage and merely kept it level, this trouble has disappeared.

"Now, as to how the silo should be filled. I formerly had sixteen men to do the work, but last year I only had six, and these six men did more work than the sixteen used to do. They are never in each other's way. I have flung aside all the machinery for cutting the standing corn, and now have the crop hand-cut. I get it cut for about 80 cents an acre and the board of one man. A corn harvester costs \$130, and will not last more than eight

years, and \$18 interest on money and wear of the machine yearly will cut my corn by hand twice over each year. A man cutting by hand can take three rows at a time, and a good man can cut three acres a day, if he works alone. Never allow corn when cut to be dropped into the furrows. Let it be put crosswise of the rows, so that the man who comes along to take it up can do so without using his finger-nails for a rake. In picking up the corn we do not use a low wagon, but an ordinary high one, and one man loads and unloads his own wagon. We have four men in the field: the cutter, a loader, and two

now. In filling a silo, you should always aim to keep the highest portion near the walls. We place a sort of table or small platform over the centre of the silo, run the ensilage on to it, making a pyramid, then the corn must fall towards the walls, and not to the centre. Now and then it may take five minutes' work with the fork to make things even, and level up. Do not cover your silo. Ten pails of water evenly distributed over the top when the corn is all in and the top well tramped is best of all. The moisture on the top of the silo will quickly develop a fine mould, which is better than anything else by way of preserv-



A DAIRY HOUSE.

'pick-me-ups.' A great deal depends upon careful loading. Get the driver to load his wagon seven bundles high, and keep it there until the wagon is loaded. Formerly in operating the cutting machine, we had two men to feed it and one man to boss the job. Now we have one man to feed the machine, and no one to boss him. He must simply keep feeding the machine or get buried. We used to put two men in the silo when filling; now we find one man can attend to that part of the work, look after the engine, and do odd jobs. A load of corn weighs more than a man, and that is why we do not do any tramping

ing that which is beneath. You will lose only about ten bushels of ensilage by the moulding, and that costs less than would a day's work making an artificial covering."

Making Fall Cheese.

—
Cheese made during September and October are intended for consumption during the winter and early spring. In fact, they should be made so as to keep for an almost indefinite period, if need be. Every fall cheese should have a firm body, a flaky texture, and a clean

and pure flavor before it can be said to have the qualities of a good "keeper."

To secure these qualities in his product, the cheesemaker should use his best skill and judgment in handling the milk and manipulating the curd as the process of making it into cheese advances. The following are some instructions and rules issued by the Dairy Department of the Ontario Agricultural College on the making of fall cheese :

Milk in the fall is usually sweeter and in better condition than in summer, so that the heat may be applied sooner, or when it is being received into the vat ; care being taken to have it stirred carefully all the while the steam is going on. Heat to 86°, then apply the rennet test to ascertain the condition of milk, and if found too sweet for the application of rennet use some clean-flavored starter. Set vats at that stage of ripeness which will insure thorough cooking of the curd before the removal of the whey, which takes ordinarily three hours from the time the rennet is added until it is all removed and curd showing one-quarter inch acid. Enough rennet should be used to cause perfect coagulation in from forty to forty-five minutes.

When ready for cutting, start by using the horizontal knife first, and cut continuously until completed.

After the cutting is completed, the curd should be stirred very carefully for ten or fifteen minutes before any heat is applied, then raise the temperature gradually to 98°, taking about forty-five minutes to do so.

Stir the curd carefully all the while steam is going on, and for some time after the desired temperature has been reached, to prevent matting, and to insure a more uniform and thorough cooking.

Remove the whey when the curd shows one-quarter inch acid. Drain well by hand, stirring before allowing to mat, and when matted sufficiently cut or break into convenient strips, and turn them over occasionally, reversing the position of the curd each time. Piling may be allowed at this stage, two or three deep, but never allow any whey to gather in pools on or around the curd. If this is noticed at any time, the curd should be opened out at once and whey allowed to escape. Keep up the temperature to not less than 94° until grinding. When curd feels mellow and will pull apart in flakes, or show one and a quarter to one and a half inches of acid, it should be put through the curd mill. Stir and air well immediately after milling, and

at intervals, to keep it from matting until ready for the salt.

When the curd is well matured, and has a velvety feel and a buttery appearance, the salt may be applied. Use at the rate of $2\frac{3}{4}$ to $3\frac{1}{4}$ lbs. per 1,000 lbs. milk, varying the quantity to the amount of moisture in the curd. The temperature at this stage should be about 86°. The curd may be hooped and put to press in from 15 to 20 minutes after the salting is done. Apply the pressure very slowly at first, or until the whey begins to run somewhat clear, when all the pressure can be safely applied.

Allow the cheese to remain in the press not less than 45 minutes before taking out to dress.

See that the dressing is done neatly. Do not allow any wrinkles to remain in the bandage, but have it drawn up smoothly and laid over each end about $\frac{3}{4}$ in. Use clean, sweet cap-cloths, one on each end of the cheese, and have them laid on smoothly. Only pure, warm water should be used in bandaging.

Turn the cheese in the hoops every morning, and never allow a cheese to be placed in the curing room without a perfect finish. The temperature of the curing room should be maintained as near as possible to from 60° to 65°F. Cheese, when taken to the curing room, should be placed on the top shelves, and removed to the lower ones when room is required, as by doing so there will be more uniformity in curing.

When coloring, pour the coloring into a dipper of warm milk from the vat, then draw the dipper quickly along under the surface of the milk from one end of the vat to the other, then stir well, and there will be no danger of streaks in the curd. Have a dipper with a long handle for the purpose.

Rennet should be diluted to one gallon of pure water for each vat, and the milk should be well stirred for at least five minutes after the rennet has been added. In case the milk is very ripe, two minutes will be ample time to stir after adding the rennet.

Everything in and about the factory should be kept scrupulously clean. The cheesemaker who fails to do this need not grumble if his patrons follow his example.

All strainers, sink-cloths, etc., should be well washed, then scalded and thoroughly aired each time they have been used.

The vats, pails, curd-sinks, etc., should be scalded with boiling hot water after washing, and if the water can run out readily they will

dry off in a few minutes without wiping. Do not use a dish-cloth, as it usually leaves an unpleasant flavor.

It will pay every cheesemaker or factory manager at this season of the year to go over the making-room and have all cracks and chinks in the walls closed up and the windows and doors fixed, so that the temperature of the room can be controlled while making the fall cheese. There should be a stove in every making-room for use in the fall. A great many fall cheese are faulty because the curd has got cold during the process of making.

Ripening and Churning Temperatures.

—
By H. B. GURLEK.

(From an address before the National Butter and Cheesemakers' Association.)

The subject of temperature is an important one in all creamery work, from cooling after milking and receiving the milk at the weigh-can to the delivery of the butter at its destination. Its importance in ripening cream is greater than is generally supposed. I do not think it is practicable to make a rule to fit all cases, as we must take into consideration the condition of the milk when received, the temperature of the room in which it is to be ripened, and the time that is to be allowed for ripening. I think most buttermakers churn the following day, when the cream is ripening. This gives, when the separator is used, from eighteen to twenty-four hours for the ripening process; with gathered cream work it may be a longer or shorter period, depending on the time the cream is delivered and the time the churning is done. When we wish to churn the following day, giving about twenty hours for the ripening process, we may use a temperature of from 55° to 68°. If the milk has been properly cared for and delivered at the creamery in first-class condition, the cream may be ripened at 65° to 68°, depending on the season of the year or the outside temperature. I believe 70° is as high as it is advisable to ripen cream. I once ripened a vat of cream in the winter season, at a temperature of 80°. The butter from this cream was shipped, with the balance of the week's butter, to the regular customer who was receiving the goods, and he was asked to report on this day's make, it having been marked so we could describe it to him. He reported that

this day's make had no flavor, and that he could not put it out to his trade who were taking the regular make of this creamery. †

I recently met a man who was, a short time before, sent to discover what was the trouble with a separator, the operator of which claimed it was not doing good work, and that his yield of butter was too small. This man first tested the separator, and found it doing satisfactory work. He then continued to hunt for the cause of the loss, and found the buttermaker was churning every other day, holding the first day's cream at a temperature to cause it to ripen, and the second day putting the cream from the separator into the same vat and churning as soon as the temperature was right. This kind of work left six per cent. of fat in the buttermilk. It is surprising that a buttermaker would do such work in this age.

Some good buttermakers hold their cream over until the second day before churning. I am confident that there are conditions, at times, that make it desirable to hold the cream more than twenty-four hours for ripening it, holding the temperature lower than when it is to be churned the following day. I know I have been able to ripen cream at a low temperature, taking two days' time, and make butter that would pass inspection, when I could not when it was ripened at a high temperature and only one day's time taken to ripen it. Why this was so I have never been fully satisfied. If we have cream from milk that has absorbed bad odors, or that has been contaminated by unsound feed, I believe a temperature that will cause a proper degree of acid at forty-four hours, with a pure atmosphere surrounding and frequent agitation, is desirable. This kind of cream might be improved for buttermaking by pasteurizing. When cream is to be held until the second day before churning, the temperature should be between 55° and 60°. This temperature will develop sufficient acid. The condition of the milk when received at the creamery will have such influence on the development of acid, both in quality and quantity, so much, in fact, that an ironclad rule cannot be made safely. Judgment must be used, and experience is valuable in this work.

If three-tenths of one per cent. of fat is left in the skim-milk, instead of two-tenths, in a separator creamery receiving 1000 pounds of milk a day, there will be a loss of about 340 pounds of butter for the whole year.—*Woll.*



HORTICULTURE

Conducted by E. J. McINTYRE.

Farmers, Attention.

The aim of this department of FARMING will be to assist the farmer in maintaining a good orchard and garden. A farmhouse does not look natural unless it is surrounded with trees and plants and flowers, beautiful as well as useful and profitable. The orchard and the garden can be made to contribute materially to the farmer's resources, as they undoubtedly can to the comforts that render farm life attractive. It is much to be regretted that often this part of the farm is the least cared for. It requires what is called intense culture, and the farmer has no time or desire to turn his hand to it. One acre of garden ground will need more work and care devoted to it than ten acres of field crop. But agriculture is steadily becoming more and more like horticulture in its methods. Farms are admittedly too large.

The orchard and the garden require watchful and constant care. Trees have to be selected, planted, and cultivated with due attention to many conditions. The vegetables and fruits have to be marketed or used to best advantage, and every step in the process must be taken with circumspection. But there is no doubt that the farmer will be amply repaid for the care he may give, or may cause to be given, to his orchard and garden.

The editor wishes to be as serviceable as possible to the readers of these columns, and to keep in touch with them. Questions are freely invited, and no reasonable pains will be spared in solving difficulties that may be presented. Specimens of fruit, or plants, or insects will be gladly considered, and all the facilities at the disposal of the editor will be cheerfully exercised on behalf of any subscriber.

The Cultivation of Orchard Soil.

Why is it that so many orchards are unprofitable? The story of the barren fig tree still finds its application. Apple trees, pear

trees, and plum trees persist in yielding no fruit, till one is tempted to uproot them as cumberers of the ground. There is one cause that operates more than any other, and that is, lack of proper cultivation of the soil.

Nurserymen tell us that a second crop of trees cannot be taken, even from a fertile field, immediately after the first crop. Why is this? It is not because the plant food in the soil is exhausted. An elaborate experiment on this line showed that such a crop of three-year-old trees contained 21 lbs. of phosphoric acid and 27 lbs. of potash per acre, and of these substances there are, in an acre of common soil, two or three tons available for ready use. Nor is there any material depletion of nitrogen. When, however, a nursery crop is taken off, there is nothing of the plant left in the soil. All the roots are carefully removed. The land settles down, packs, and deadens. There is no humus restored, as there is after a grain crop. The land, in fact, becomes mechanically unfit for another crop of trees, or grain, or anything else, although its inherent fertility is but little impaired.

The care of the soil varies, according to many conditions. The season, the crop, the climate, the country, even the portion of the farm, has to be taken into consideration. But careful cultivation is indispensable. Orchard lands, if left uncultivated, become not unlike this dead nursery land after the crop has been removed. They are mechanically unfit for the purpose for which they are reserved. When a soil is kept crumbly, it holds moisture better, it allows better aeration, and a greater surface is presented to the rootlets to absorb their food material. Tillage is manure. Experience is showing with convincing certainty that the best farming is that which sustains itself.

There are three materials that have to be returned to the soil for food for the plants. They are phosphoric acid, potash, and nitrogen. Of these, phosphoric acid and potash alone need be supplied from outside; and, if the soil is well tilled, a much less quantity is

required. As for nitrogen, it is best obtained from plowing down a crop of clover.

It is recommended, therefore, and urged, that the soil of the apple orchard should receive mechanical attention, if the trees are unproductive. It should be plowed in the spring and cultivated, or harrowed, weekly till July, then fertilized and sown with some suitable grain or clover crop, to be plowed under in the fall, or in the following spring. The growth of the tree will take place, as it should, early in the year, and the temporary cessation of cultivation will allow the wood to harden so as to stand the rigor of winter.

Accordingly, if you have a barren orchard tree, follow the example of the dresser of the vineyard in the parable, and the tree, one may reasonably expect, will no longer cumber the ground.

Crimson Clover.

If this variety of clover is all that its admirers claim it to be, we shall soon have a plant that will make an ideal orchard crop. It is a well-known fact that a crop of clover increases the fertility of the land upon which it is grown. The fact has long been known, but the cause has only recently been found out. Indeed, much of the matter is still obscure, but scientific investigation has shown that on each clover rootlet are colonies of bacteria which have the property of abstracting nitrogen from the air. The nitrogen remains in the soil, and forms one of the necessary elements of plant food.

This new variety of clover, it is said, is a better nitrogen catcher than any other. It is, moreover, an annual. Reports differ with regard to the success attending its cultivation. But, as it is a new variety, the conditions of its life and growth are not yet determined. Experiments so far in the United States go to show that it is best to sow it about the middle of August. Before the winter comes, it has obtained a luxuriant growth, and early in spring (the earlier the better) it can be plowed under. Not only will the soil be enriched by the nitrogen that the bacteria have collected, and by the plant material that will be restored to it, but its mechanical condition will be greatly benefited. Success, in some cases, has followed sowing early in September.

Crimson clover is well worth a trial. Even if it should fail to catch once in a while, that

should not discourage further attempts. Other varieties are not uniformly successful. The seed is much larger than that of red clover. There are false varieties that have been imposed on buyers, and care must be taken to get the right kind. From twelve to fifteen pounds is the proper quantity to sow to the acre. It costs about \$5 a bushel here. We shall be glad to hear the results of trials of crimson clover.

The Evaporating of Fruit.

We are altogether too much at the mercy of the market in realizing on our fruit. In a year like the present, when fruit is quite scarce, we do not notice it so much, but, in a year of plenty, fruit-growers find that they often have scant returns for much labor. A very plentiful year is dreaded almost as much as a year of scarcity. Not only is the fruit unremunerative, but the trees are exhausted. Then, again, with the extensive setting out of orchards, we must prepare for a time when the market may be glutted with an ordinary yield of fruit. Last year peaches went a-begging. It was a common story to hear how money had to be sent to help pay the freight on a consignment of fruit. Had we evaporated three-fourths of the crop, we could have realized good prices for the dessert article, and the rest of the year we might be selling the evaporated. We must not forget that fruit is eaten, and has to be obtained in some form or other, all the year round; whereas we ship almost all our fruit when it is most perishable.

The remedy for this unsatisfactory state of affairs lies in having recourse to evaporators. With an evaporator one is independent of the market, the commission man, and the transportation company. In New York State farmers are ahead of us in this regard. In Wayne county there are 2,200 evaporators in private use. The fruit that is mainly evaporated is, of course, the apple. But of raspberries alone in that county no less a quantity than 1,000 tons was last year treated in this manner. I am not sure which kind of evaporator is the best and most in use, but in the next issue of *FARMING* I shall recommend in greater detail. The price of one need not be more than \$25 or \$30 at the most, and may be much less.

Another refuge to the fruit-grower from a surcharged market is the canning factory. When fruit reaches a certain price, great

quantities are canned at profitable prices to the grower and manufacturer. In Wayne county, the canning industry also is in a flourishing condition. Varieties of fruit, like the Prince Albert currant, that are very prolific, and not attractive for dessert, are in demand for canning. Sour cherries are kept up to a very respectable price by their excellent canning qualities, sometimes commanding an average price of six cents per quart. We, too, have many canning factories that are doing valuable work for the fruit-grower and general farmer; and these factories are deserving of encouragement.

An Interesting Insect.

Farmers' children should all be naturalists. What a host of insects and plants lie before them, full of interesting ways and curious habits of growth and life! No more welcome present could be given them than a magnifying glass; without such a helper a naturalist is well-nigh blind. It is a pity that the study of insects and plants has not a place in our public schools, and that every school child is not equipped with a microscope, as a necessary part of a school outfit, cherished as much as any of the other occupants of the well-worn school bag. What interesting lessons could be taught! what rivalry in collecting and watching specimens! Surely entomology is no harder, and as surely it is no less interesting than etymology. Even as it is, nothing prevents an ambitious boy or girl from making a collection of insects, and becoming possessed of a microscope. To see an insect assume formidable proportions and to watch its motions on a grand scale have all the pleasure associated with watching a great, fierce beast in a menagerie, powerless to harm us behind the bars of its cage. Yet this field of easy and very interesting study is scarcely ever entered. How many could tell the codling moth or the plum curculio, if they were to see them? or the flea beetle, the squash bug, the cankerworm, the cutworm, or many others equally common? These insects, especially the first two, are very hurtful to fruit and to vegetation. They inflict many millions of dollars' worth of damage upon the farmer every year. They are, moreover, very difficult to fight, and to fight them successfully one must know their habits. It has been remarked that, wherever they are most carefully observed and studied, they are least injurious, and wherever

people are ignorant of their ways and careless about studying them they are most hurtful. Thus there are economical as well as educational reasons for the study of entomology.

In this article I wish to describe some of the habits of the plum curculio. It competes with the codling moth for the bad eminence of being the most destructive pest that the fruit-grower has to contend with. Of the two, I think the curculio is the more obnoxious. Its havoc is more general; its instincts are more cunning.

It is a small beetle, about the size of a quarter of a pea, with long legs bunched under its body. When you touch it, it shams death. It may be seen at this time of the year as well as in the spring, but the mischief that it accomplishes is over for the season.

The life history of the curculio is very interesting. It spends the winter in the forest, ensconced warmly under a piece of bark or leaf, and there it fasts till spring. It comes out of its winter fast very hungry, and eats ravenously any green leaf that it can find. It has a long mouth, which looks something like a nose. When the fruit of the plum, cherry, peach, or apricot, is of the size of a pea, the female is ready to lay her egg. She pierces the skin of the fruit with her sharp mouth, and penetrates underneath as far as she can reach; then, when the place is prepared, she deposits the egg, very carefully, for it is soft and easily crushed. All this occupies several minutes, and the curculio seems to take great pains to have everything comfortable for the egg. This does not finish the work, either. She bites away a crescent trench under the egg, so that the egg lies, as it were, in a flap of the fruit. Naturalists are not sure for what purpose she makes this crescent cut. It is probably to secure the egg from being crushed by the rapidly growing fruit. At all events, the flap in which the egg lies does not grow as much as the rest of the fruit. In a week or so the egg hatches into a worm, which is so unpleasantly familiar to lovers of stone fruits. As a rule, the plum and the peach drop immature, but the cherry, ripening earlier, keeps the worm until it drops naturally. The worm enters the ground, becomes what they call a pupa, a soft, harmless object which very soon becomes the beetle. There is only one brood a year. The late ones do no special harm, for they lay no eggs till spring. The female lays about fifty eggs, one in each fruit she attacks. The nectarine and apricot are her favorite fruits.

When stone fruits are scarce, the curculio will lay its egg in the apple and pear. Its mark has been found even on the gooseberry. The egg laid in these does not develop, but the fruits are hopelessly blemished. The side stung does not grow evenly with the other. One sees sometimes an apple with the stem and flower end close together on one side, and a great hump on the other. This is the effect of the curculio's mischief. Any unsightly dimples that may be found on the apple or pear are, in all probability, due to the same cause. If you look closely, you will see the curculio's brand, a crescent overarching a dark spot, the whole perhaps somewhat modified by the growth of the fruit. Sometimes one may find five or six of such blemishes on one fruit.

One may suppose that so cunning an insect is difficult to fight. Such is indeed the case. There is no insect enemy of the fruit-grower that baffles him so persistently. I remember when it was recommended to scatter chips about the base of the tree; they would take refuge under them, it was said, and could be caught. Some would hang red rags in the trees with the object of frightening away the insect. Others, acting on the curculio's sense of smell rather than that of sight, suspended in the branches of the trees corn-cobs coated with tar. Others, again, recommended coating the trunks of the trees with some substance that would prevent the insect from reaching the branches, as if the curculio were not an active flyer.

All these methods were recommended by sage fruit-growers. But now two methods, more rational than the ones above, are used in fighting the curculio. After it comes from the forest in the spring, it feeds greedily on the tender leaves of the orchard trees, waiting for the fruit to become large enough to be a receptacle for its egg. If the orchard is sprayed with Paris green at this time, the curculio runs the risk of being poisoned. Many fruit-growers have tried this method, with success, and have grown luscious stone fruits quite free from the ravages of the pest. But one can easily see that the insects do not confine themselves to the trees that may be sprayed. Any tree may afford them a refuge. Indeed, it has often been observed that they are most numerous near a forest, or where the orchard is thickest. It is, therefore, not to be wondered at that many unfavorable reports are heard of unsuccessful results of spraying for the curculio. The other method is gener-

ally considered more satisfactory. It consists in jarring the trees and catching the beetle in a large canvas umbrella inverted, constructed especially for this purpose. The curculio is very active during the day, but towards evening it becomes sluggish, and does not recover its sprightliness till the next forenoon. It is not enough to shake the tree. The curculio is used to that when the wind blows. But if the tree receives a sharp shock in the morning or evening (and, indeed, it would not be amiss to continue the hunt in some seasons all night), the curculio contracts itself, falls to the ground or into the umbrella, and so is caught.

But the curculio can do no more harm this year. In the spring we shall have a good deal more to say about fighting this cunning and tenacious enemy.

Grapes in Cold Latitudes.

Grapes can be grown in cold latitudes with entire success. They may be easily grown as far north as 46°, or even further north. But they must be covered in winter. When the grapes are planted, put them in aslant at an angle of 45°, and in the same direction as the trellis will stand. Train the vine so that it will run only in one direction, and extend until it comes near where the next vine has been planted. The canes can be made to extend upward from this vine at proper distances. Every autumn these upward laterals are cut back, leaving only a couple of buds or so of that year's growth. Then lay the vine down on the ground and put a little earth on it to hold it down. Then put some marsh hay or straw on and add some more earth. In the spring remove the earth and tie up the main stem again to the bottom wire of the trellis. The litter used in covering may be put around the roots of the soil as a mulch. By handling grapes in this way they may be grown quite far north. They may thus be profitably grown for the market, but these directions are rather intended for those who grow home supplies. In warmer latitudes, tender varieties may be grown in the same way. Some of the best varieties for northerly latitudes are Delaware, Brighton, Moore's Early, and Concord.

Look out for borers in your apple and pear trees. You will find their holes and the sawdust from them near the ground, or a little below the surface. A sharp wire poked into the holes will kill these pests.

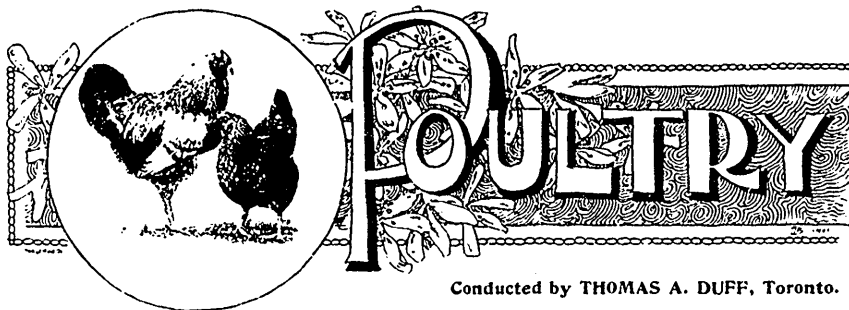

Conducted by THOMAS A. DUFF, Toronto.

To All Poultrymen.

The publishers of FARMING, recognizing the important position which poultry raising has reached in this country, have decided to devote the same space to the subject as is given to the various other branches of agriculture, and have engaged my services as editor of the department. It seems, therefore, that a few words as to what my aims will be would not be amiss.

I shall, in all my articles, write nothing but what I know, or believe, to be the facts, and the result of actual tests, so that readers may be able to safely rely upon each article. It will be my aim to make this department interesting and instructive, and I can assure one and all that poultry properly fed, housed, and cared for, will prove the best paying investment on the farm, when the amount of capital invested is considered.

It will afford me pleasure to reply to any and all inquiries which may be made relative to the care, housing, feeding, and diseases of fowl, and I invite all who experience any trouble, or desire any information, to write to me. I shall be happy to answer their queries to the best of my ability in our "Questions and Answers" columns.

I shall also be delighted to receive any interesting items of news from various parts of the country, and to have results of experiments, etc.

THOMAS A. DUFF.

Toronto, August 15th, 1895.

Suggestions for September.

Farmers and others who keep poultry should, if they have not done so before, now clean out thoroughly their houses, and make them comfortable for the winter. It is not a bit too early to start. Do not leave it until the snow and winds find ready entrance through the cracks. This is one cause of disease, and the preventive is always better than the cure.

If your poultry house has an earth floor, clean it all out, and put in fresh, dry sand; take out all the roosts, and thoroughly saturate them with coal oil; then thoroughly whitewash the entire inside of the building with good hot lime, to which might be added two tablespoonfuls of strong carbolic acid for every gallon of the wash. This will clear out all vermin, and you will have good comfortable quarters for your fowl. A clean and warm house goes a long way towards obtaining eggs in winter. If this be done, and the fowl fed as elsewhere directed, you will find that there is more profit in poultry, considering the amount of capital expended, than in any other class of stock kept on a farm.

I would suggest that the above be given a trial, and an accurate account be kept of the food consumed, and of the value of eggs laid; and I will guarantee that all who try it, and who do as I have directed, will be able to demonstrate for themselves the profit there is in fowl.

A Comfortable Poultry House.

A very good poultry house can be constructed on the south side of a barn. I would recommend it to be double-boarded. My idea is, first of all, to run tarred paper across the uprights (2 x 4 scantling) on the outside, then put on the boards. Put tarred paper again on the inside of the uprights and boards. This will leave an air space of four inches, which will undoubtedly add much to the comfort of the building. I would either shingle the roof or cover it with some warm waterproof paper. Have most of the windows facing the south; one small window to every six feet of run I consider sufficient. A large window admits more heat and light during the day, but it radiates the heat rapidly at night. One of the most essential requirements in a poultry house is light, as the hens will abandon a darkened house during the day, no matter how warm it is. Instead of using very large

windows, there should be small windows in front and at the ends, so as to render the house light and cheerful in every part. Another advantage of using a number of small windows is that they are cheaper singly than large ones, and the cost is increased but little. They also admit the sunlight from all quarters during the day, and aid in more rapidly drying the floor, should it be damp. Be sure to locate the house on a dry spot. I prefer an earth floor, as it can be so much more readily cleaned out, and fresh, dry sand put in. I would divide the house off into sections, keeping not more than twenty or twenty-five fowl in each section. At least six square feet of floor space should be allowed for each fowl. A house constructed as above should be warm enough for any variety.

Another good plan would be to have the sleeping apartment on the inside of the barn and a shed to run in on the south side. If this were done, single boards would be sufficient for the shed.

I would recommend that the roosts be at least eighteen inches from the wall, so that no part

of the fowl would come in contact with the building. Provide dropping boards (three feet wide) under the roosts, so that the manure can be readily scraped off with a hoe.

A poultry house should be kept scrupulously clean. The oftener it is cleaned the better, but it should never be left for more than a week at a time without being thoroughly cleaned out and coal oil put on the roosts. I would strongly recommend that the manure be taken and put on the land at once before it loses its strength. It would be found of great value for garden produce or asparagus.

Minorcas.

The quality upon which the Minorca has founded its world-wide reputation is that of

being a splendid layer. They are the largest non-setting breed in existence, being fully one-third larger than the Leghorn, and equal to them as egg-producers, laying, however, a much larger egg. Eggs from matured hens will often run six to the pound.

There is a general impression abroad that Minorcas are not winter layers. This is incorrect. If warmly housed, well fed, and sheltered from cold and wet, they may be depended upon at all seasons for eggs. They are, as a rule, small eaters. Another good trait in them is their suitability for close confinement. If well fed, and their wants are properly attended to, they will do almost as well in a small run, or a back yard in a crowded town, as if upon a grass run in the country. This can be vouched for from actual

experience. This, together with their splendid laying qualities, has done more to popularize the breed than almost anything else.

The following is a description of what a Minorca ought to be:

The Male.

— His beak should be fairly strong and stout, not too straight. The

head should be of medium length, and broad enough to carry a good base of comb. The comb must be single, fairly large, evenly and deeply serrated, with five to seven spikes. The spikes should be about equal in depth to the blade of the comb. The comb should be broad at the base, or wedge-shape, straight in front, and free from any twist, thumb marks, or hollows at the side. The carriage of the comb at the back is important; for, whilst it is desirable that it should reach well down the neck, it should not go so far as to touch the feathers. The comb, face, and wattles should be bright red. No trace of white must appear on the face, not even a spot or a line under the eye. Lobes should be white and almond-shape. The body should be broad at shoulder, square and compact, with fairly long back. The bird

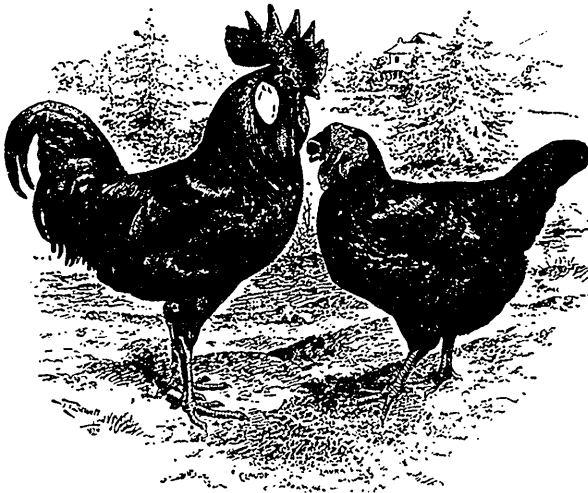

BLACK MINORCAS.

Cockerel 1st and special, Pullet 1st, New York, 1895. Owned by Thomas A. Duff, Toronto, Canada.

should stand on legs of medium length. Tail fairly large, well arched, and carried well back. Weight $6\frac{1}{2}$ to 9 pounds.

The Female.—Her comb should be fairly large, evenly and deeply serrated. It should form a nice loop in front so as not to obstruct the sight. Lobes fairly large and pure white. She should be full in body, breast well rounded, with medium length of leg. Her back should be long. Tail carried well back. Weight $5\frac{1}{2}$ to 7 pounds.

The Blacks are a little larger than the Whites, but there is little between them in the matter of egg-production.

It seems a great pity that White Minorcas are not bred more extensively than they are. They are no harder to keep clean, and are quite as pretty as the White Leghorn, laying fully as many eggs, which are, of course, much larger than those laid by the Leghorn. While not yet as large a bird as the Black Minorca, they are very much in advance of the Leghorn, and this is of importance, as they mature early, and make much better broilers.

Poultry at the Fall Fairs.

“Fair time” is now at hand, and the rush of work is over with most of the farmers. The farmer who has given a little of his spare time to thoroughbred poultry can gather in a few dollars by exhibiting them. Almost every township has a fair, and in some cases very liberal prizes are offered for poultry. This is as good to the farmer as to the city “pot-hunter,” who hires a wagon, or perhaps borrows one, loads it up with a lot of birds, some of which may be his own, but the majority are borrowed, and goes out to one of these exhibitions and scoops in a nice little pile of money. This should go to the farmer, and, if the farmer would look after his interests, he could get the money that now goes to the “pot-hunter.” Bestir yourselves from this on, and see when you are showing your cattle, horses, sheep, swine, grain, butter, etc., that you also take along some of your fowls, and help to swell the amount of prize money to which you are so justly entitled. The directors of these exhibitions should see that competent judges are appointed, so as to ensure fair play.

My suggestion to the directors would be to look well after those who borrow birds, and apply the rule strictly to such characters.

Care of Eggs.

A serious mistake the farmers make is not gathering their eggs regularly. They are allowed to remain for days, sometimes for a week, in a filthy house. The shell of an egg is porous, and is very susceptible to smell. Eggs should be gathered every day in order to be of a first-class quality, and none should be sent to market unless perfectly clean. It would pay a farmer to market his eggs every week instead of packing them, as I believe better results would be obtained.

From letters received from large egg dealers, the following are quotations: One says: “We may say that we are very glad to know that you are taking up this matter of the production of fresh eggs in Canada during the winter. If the trade and public generally could depend upon obtaining absolutely fresh eggs during the winter, the consumption of them would be enormously increased. At present what are sold as fresh are not fresh, and every one knows it. . . . On the whole subject of the egg trade of Canada, permit me to call your attention to the following, which we think you cannot too strongly urge upon the farmers and country egg dealers, and that is the importance of selling their goods and getting them into the market while fresh. The greatest difficulty that we experience is this. Between the farmers and the country storekeepers holding and waiting for an advance, the eggs get old and stale before they reach us.”

Another says: “We have made several attempts to induce farmers to give special attention to this business. We believe that there is no business that offers such returns on money invested. We believe that special attention should be given to the breed of fowls, etc., and, above everything, farmers should not hold their eggs longer than a week before marketing.”

One of the very largest dealers writes as follows:

“November, December, January, February, and part of March are the most difficult months to secure new-laid eggs; in fact, sometimes we get so disheartened at the complaints of our customers saying that they get stale eggs among stock we sell for ‘new laid’ that we feel inclined to tell them that it is impossible to get a reliable article. We have written to our shippers, times out of number, trying to impress upon them the necessity of not mixing the ‘held’ eggs with the ‘new laid,’ but all

our efforts prove fruitless. We paid last season during the months above mentioned, for 'so-called' new-laid eggs (we cannot use a better term), 25 cents per dozen, and 30 cents for something extra choice. We have not the least doubt that the consumption would be considerably increased if a genuine article were obtainable. . . . We are of opinion that both the farmer and country storekeeper are to blame. So many farmers have got the bad habit of trying to preserve when they are low to get higher prices, and the majority will not hesitate to mix them among their fresh-gathered, and sell them as such, which is really a fraud. The storekeeper takes them,

How to Get the Best Results from Farm Poultry.

Prize Essay by DAVID STEWART, Upper Kent, N.B.

This is a question that should interest every farmer, and is worthy of far more attention than it receives from farmers generally, for this reason: The farmer can, if he is systematic, and has his henhouse near the stables, or sheep pens, care for one hundred fowls with little extra labor. Besides, poultry, when given good care, give better results for the amount of food consumed than any other kind of stock on the farm.

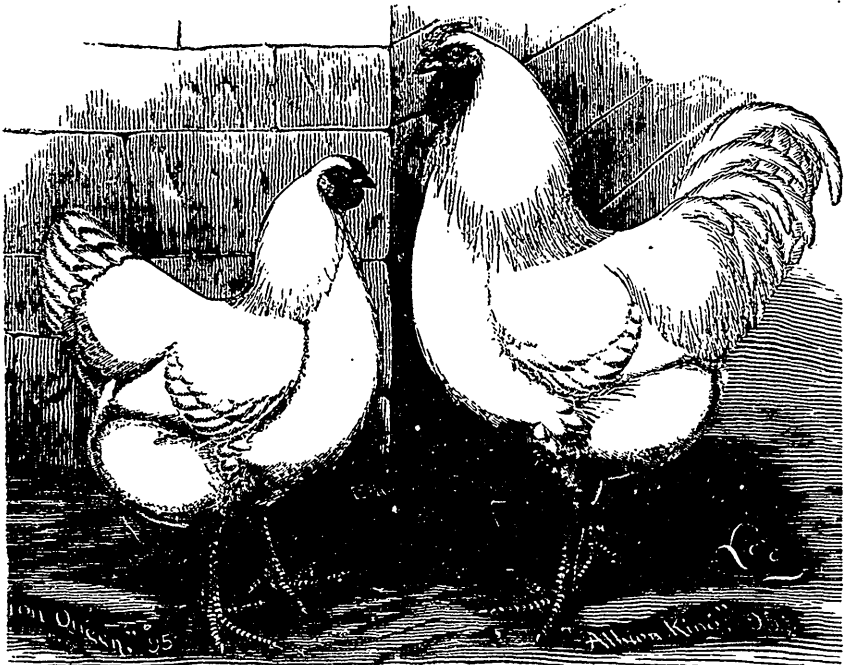

WHITE WYANDOTTES.

and perhaps he knows they are not what the farmer represents them to be; but, owing to competition, and being afraid of offending his customer, he takes them. Another evil is the bad packages used for shipping. The fillers are used time after time; eggs break in them, perhaps they are left in a musty place, never cleaned out, but have eggs filled in which perhaps stand for a week. Is it any wonder, therefore, that 'new-laid' eggs get a musty taste?"

If the consumer only gained confidence in the producer, a much larger quantity of eggs would be used.

On the other hand, if they are neglected, as too many are, they cannot pay. Take, for example, the farmer whose fowls are left to roost in any out-of-the-way place they can find, and are only fed when some one happens to think of it, their only supply of water the snow that has drifted in through the cracks or around the doors of the buildings. The result cannot be otherwise than disappointing. However, if the farmer wishes returns that will change his opinion of poultry, the first and most important step is to improve the breed. If he is wide-awake and subscribes for a good agricultural paper, he will find adver-

tisements of all leading varieties in its columns, reliable, and at reasonable figures. Some farmers, no doubt, will say, "What! \$2 for a setting of eggs, when we only get twelve or fifteen cents per dozen for ours?" Yes, it will certainly pay to give \$2 for a setting of eggs from any of the leading varieties of poultry to improve your flocks. I do not advise farmers to try to keep purebred flocks of poultry (that is better left to the professional breeder), but by bringing in new blood every other year they can, in a few years, have poultry that will equal the purebred, save in the show-room. This has been my practice for a good many years, and I have not been disappointed in any importation. As to which breed is best suited for the farm, every farmer must decide for himself. This much is certain: if the farmer will invest in any of the pure breeds of poultry, and give them proper care, the results, when compared with the old style, will be on a different scale from what they have been.

Having decided which breed he will select to improve his flock, the next thing is the care of the chicks. An improvement on the old plan of letting the hen wander all over the fields with her brood is to provide coops without bottoms. When the chicks are a few days old, the hen may be put in the coop, and the chicks can go out or in at will. Place the coops in the orchard, or, better still, on the edge of the vegetable garden, as the chicks will find lots of insects, and grow faster, than if allowed to roam through the wet grass. In this way, the farmer, or any member of his family, can tend one or even two hundred chickens in a few minutes every day.

With liberal feeding, the pullets of an early-maturing breed, as the White Leghorn, will, if hatched early in May, begin laying by October 1st. This is the time when farmers should be on the alert, preparing for winter, repairing old buildings, or erecting new, as they think best. Having got the house ready, the next question is, How to feed for profit. The farmer should give this, as well as other branches of his business, personal supervision, and not trust too much to his boy. Those who think it is only boys' work to manage the poultry on the farm will have to be content with boys' pay for their trouble. This, then, is my advice to farmers to get the best results from farm poultry: Keep only young fowls; study their habits; be leisurely in your movements while amongst them. Feed and water judiciously and regularly. Give a variety of

food. The morning ration, of warm mash, should always be given as soon as the fowls can see to eat it. At noon, two quarts of wheat scattered in the litter is sufficient for fifty fowls. Feed grain liberally at night. Give them comfortable quarters near the stables or sheep pens, that they may have the run of the pens, or scratch in the manure pile, as this prevents egg-eating and other bad habits. Poultry will not pay if confined, even in frost-proof houses. Clean out the house and apply fresh litter—either chaff or cut straw—to the floor every other day, at least. Place a shallow box, full of ashes, in a sunny position, for the fowls to dust in. Supply fine gravel and lime, also green food in the form of cabbage, or raw turnips, and use every means to keep them laying from September to April, when eggs are worth twice as much as in summer. Some people may think all this too much trouble, but it is attention to the minutest details that increases the profits. Last, but most important of all, introduce new blood from some reliable breeder every other year. Subscribe for a good agricultural paper, and keep posted in all matters relating to the poultry calling. If farmers would try this plan of caring for their poultry, instead of tolerating them as a necessary evil, as many do, the result would be a handsome profit.

Feeding for Winter Eggs.

—

Editor Poultry Department, FARMING :

For some time past I have kept quite a number of Barred Plymouth Rocks, and, believing that they have paid me well, I should like to have your advice as to the proper method of feeding them during the winter season. I admit that I have not had them any too comfortably housed, but intend to make everything snug for this winter. As eggs are higher in price in winter, I should be much obliged if you would give me your method of feeding.

J.L.

Malvern, Ont.

ANS.—Do not feed too much or too little. Fowls require a change. It is absurd to suppose that a continuous supply of wheat, without change of variety, will do. For egg-production I would recommend the following: In the morning I would give a milk-warm feed, composed of shorts, bran, and oat chop, having first thoroughly scalded it. A few boiled turnips or potatoes, or some clover, mixed with this, would be much relished by the fowls, and increase the egg output. I

would recommend this to be fed in a trough about two inches deep, placed against the wall, so that the fowl could not get their feet into it. Do not allow them to gorge themselves, as it makes them lazy. A hen should be active—always busy. Such are the best layers.

I cannot too strongly comment upon the feeding of green bone. In my opinion it is, *par excellence*, the greatest boon the poultry world has had in years. I would give a little of this at noon each day, allowing about one ounce to each bird. At night, feed grain, all that the fowl will eat up clean. This should be scattered in the pens, so that the birds have to scratch for it. A cabbage should be placed in each pen. The best method of doing this, I think, is to tie it by the root, just high enough to have the fowl jump for it, which will give them exercise. If cabbage is not plentiful, I would recommend cutting a turnip in two and putting it in the pen. My experience has been that fowls are very fond of turnips. A mangel would answer the same purpose. A good vegetable food is clover. This should be steamed, and mixed with the morning food. An eminent writer has this to say of the value of green bone and clover, in an article on "Aids to Egg-Production":

"There are two articles of food, at least, that are not so generally used by poultry keepers, to stimulate laying in the winter season, as they should be. I refer to fresh, raw meat and clover. Animal and vegetable food is furnished by this combination in the very best possible shape. The meat, being raw and full of nutritious juice, promotes vigor and egg-production much more perfectly than cooked meat, that loses considerable of its virtue by the process of cooking. To be sure, if the soup that boils out of meat is well utilized, much of the loss through stewing is saved. Nevertheless, we prefer the raw article to anything else in the meat line. Of course, it should be fed in moderate quantities, only two or three times a week. Never go to extremes and overdo a matter. Hens that were meat-hungry would, doubtless, engorge themselves if allowed flesh without restriction, to the serious derangement of their digestive organs. But we have found raw meat, reasonably fed, to set the egg-producing machinery to work better than any other one food substance. The clover is grand for food for many reasons. It is bulky. It contains the nitrogenous elements and the carbohydrates in excellent proportions for the

nourishment of the animal. It is rich in mineral constituents. Compounds of lime are abundant, such as are required for shell formation. The poultry relish it at all seasons. It is especially appetizing to them in winter, when there is a dearth of green food. Chop it finely, steam, and feed it mixed with ground wheat, bran, and cornmeal."

A bone-mill can easily be procured, and will, in a very short time, more than pay for itself. Most farmers have a horse-power, or windmill, and by this means enough bone could be cut up in a few minutes to feed a large flock of fowl. Bones and rough meat are easily obtained for little or nothing, and a week's supply can be laid in during the cold months.

The fowls should be supplied with grit, as an aid to digestion, and plenty of fresh water should always be before them. Should it, however, freeze in winter, a good idea is to add enough warm water to take off the chill, and, after the fowls have drunk sufficient for their wants, to throw the water out.

Analysis of Hen Manure.

Chemists assert that hen manure analyzed is as follows: Phosphoric acid, 3.43 per cent.; potash, 2.26 per cent.; nitrogen as ammonia, an organic matter, 3.25 per cent. The manure of birds is valuable from the fact that it contains the urates and other highly nitrogenous substances, which in other animals pass away with the urine. Hen manure is superior to ordinary barnyard manure, as the following shows, giving the number of pounds of the three most valuable elements in a ton of hen manure, and a ton of well-rotted barn manure:

	Barn.	Hen.
Phosphoric acid.....	6	48.00
Potash.....	10	41.00
Nitrogen.....	11	67.00

Thus it will be seen that four hundred pounds of pure hen manure contain nearly as much nitrogen as is contained in a ton of common barnyard manure.—*Wisconsin Farmer*.

It is claimed by writers in the East that it costs one cent to produce an egg. On the farm in the West, it is not believed that it costs more than half as much, which would afford a profit at the lowest market figures.—*Poultry Herald*.

APIARY



Conducted by R. F. HOLTERMANN, Brantford.

The Honey Bee.

By R. F. HOLTERMANN, Brantford.

In my closing remarks in the June issue I said that a second swarm can generally be recognized by a young queen, or several young queens, being with the swarm. There are, however, exceptions to this rule. Suppose a colony is strong, and almost ready for the swarming impulse, and, for some reason, accidental or otherwise, it loses its queen. The bees, of course, begin to build queen cells, and, under such conditions, when the first of the cells hatch the hive may cast a swarm, and, of course, in such a case it will be accompanied with one or more young queens. After-swarms, with several queens, can often be distinguished by the way in which they light. Instead of one compact cluster, there may be several semi-detached clusters as they settle. The reason of this is that in the regular first swarm there is only one queen, and there is only one attraction. In the other there are generally several young queens, and they may not settle in exactly the same spot.

SWARMS.

When it comes to handling swarms there are many ways of doing this, and here let me say that I know of no beekeeper in Canada or in the United States who practises regularly what is known as *artificial swarming*. By artificial swarming we mean that before the bees swarm, or are likely even to swarm, the bees and combs are divided more or less equally, and, from the one, two separate colonies are established, one of which has to rear a queen, or be supplied from some other source. The great objection to this is that we are recognizing that generally it is best to prevent swarming, and go in for the production of honey. When swarming by artificial means, we must divide many colonies which may possibly swarm, but which, if left alone, would not. So universally is this practice considered that we can accept the verdict without hesitation. When it comes to natural swarming, let me say that it is simply the natural method of increase of the bee. The honey season comes on, and the bees build up more or less rapidly, according to their strength, in the first place, when leaving

winter quarters; according to the queen, the disposition of the bees, the season, and the flowers in the vicinity.

Next, if the bees get the swarming impulse when the hive gets to be uncomfortably crowded, the size of the hive must have something to do with it. Colonies which have wintered badly are not likely to build up soon, if at all, for swarming, and we also know that they are not likely to give any surplus. The right way to manage is this. As soon as the bees begin to be a little crowded in the body of the hive, which by many is called the lower story, the brood chamber, or even the hive, supers should be put on as soon as the bees begin to whiten the comb along the top bar, unless we know that the honey season is sure to slacken off, say, fruit bloom is over, and there will be nothing for some weeks until clover comes in. If, however, one is not sure about this, he will do no great harm in warm weather with the super added. It will be understood that this important addition to the home of the colony will prevent the feeling of overcrowding which is likely to shortly follow the condition given previously, and keeps the working forces of the colony united. If, however, the swarming impulse has already been reached, the bees, as before stated, start queen cells. These cells in time hatch young queens, one of which becomes, in the natural course of events, the mother of the colony in existence; the old bees and the old queen, after filling themselves with stores to the capacity of their honey sack, leave all to their offspring and venture out into the cold world, in faith that Providence will provide for them. The honey in the sack of the worker bee answers several useful purposes. First of all, should several days of rain follow, and the bees be unable to gather honey, they have with them sufficient to tide through this. Next, if the bees do not use the honey for this purpose (and during the swarming season they rarely do), then they use this honey for the secretion of wax. The worker bees have upon the lower side of the abdomen glands for the secretion of wax, the bees hang in festoons and gradually digest the honey, producing a fatty substance, which, as oil, is lighter than water. It is remarkable that quietness and darkness is the best condition for producing wax, just as they are supposed to be the best condition for fattening stock.

The wax is secreted in scales, and from these scales the comb is built. But the honey in the sack of the bee answers another purpose. The bees can always be better handled with their honey sacks full, and that is one reason why a swarm of bees can be handled without much danger to the operator.

In swarming, the queen is rarely the first to leave the hive. In fact, she very often does not issue from the hive until half the bees are on the wing. Should the bees start a new colony without the queen, she being the mother of the hive, the colony would be exterminated, no young bees being there to replace the old. For this reason, bees never throw a normal swarm without a queen, and, should anything happen to separate the queen and the worker bees, the bees will return to the hive from whence they came. This principle is taken advantage of by the beekeeper in many ways. Some clip the wing of the queen soon after she begins laying, or every spring, when there are less bees in the hive and she can be found more readily. It consists simply of clipping the wings on one side of the queen, and prevents her flying. I like to do this by catching the wings by means of a fine pair of tweezers, and then, with a fine and sharp pair of scissors, cutting the larger portion of the wing away. My object in doing it in this way is this: As long as the queen can reach the comb with her legs, she will keep them on the comb; as soon as she is lifted from the comb and you have hold of the wing, either by means of the pinchers or your fingers, she plants her feet against whatever holds the wings, and, in her efforts to free herself, one is very liable to cut a leg or two with the wing. By clipping the wing the queen cannot take wing with the swarm, and, if you are there when the swarm issues, all you require is a cage in your hand, and, as Mrs. Queen attempts to fly in front at the entrance, you slip this cage over her, quickly remove the old hive to a new stand, and put the new hive on the old stand. The swarm, missing the queen, will return to the old location, which now has the new hive. The queen, in her cage, you can put on top of the frames, and the bees will soon return. In a future article I shall take up what may happen if the beekeeper is not present.

Shaking Bees off the Comb.

In changing combs in the apiary, says G. M. Doolittle, in *Gleanings in Bee Culture*, I

always shake the bees off, or the majority of them; and with hybrids and the blacks every bee can be shaken off, providing the combs are built in the frames as they should be, so that they fill the frames full and are in a straight and even line with the frame, thus giving the bees no little holes or open space along between the bottom bar of the frame and the comb, into which they can crowd in such shape that they cannot be dislodged so long as they stay there.

After having the combs built out as above, and desiring to take a comb away from the bees, I place the projecting ends of the frame on the ends of the two middle fingers of each hand; and then with a quick upward stroke throw the ends of the frame against the ball or thick part of the hand at the base of the thumb. As the frame strikes the hand, let the hands give a sudden downward motion, which makes the shock still greater. As the frame strikes the fingers, it is again thrown back against the hand, and so on until all, or nearly all, of the bees are off.

The principle is that the bee is on its guard all the while to keep from falling off, thus holding on tenaciously so as not to be easily shaken off by any motion which tends to throw it down. By a sudden stopping of the upward and a quick downward motion, the bees are thrown off their guard and dislodged from their comb in an upward direction.

I do not remember ever having broken a comb by shaking it as above described, although some claim that they cannot shake bees off their combs without breaking the combs more or less. In this way I have no trouble in shaking off black bees and hybrids. And if we disturb the Italians, causing them to fill themselves with honey, they can be shaken from their combs about as easily as black bees. But even if we cannot afford to wait until they are filled with honey, four-fifths of them can be shaken off.

To get off the remainder, one of the different bee brushes, now to be had of supply dealers, will finish the job very quickly; or, instead of the bee brush, you can use a turkey or goose quill to fully as good advantage by trimming off about one-half of the wide side, so that the feather part will not irritate the bees. Of course, this will appear a little awkward at first, but will soon be found easy enough.

In working for extracted honey, I adopt the same plan to rid the combs of bees.

RECENT INVESTIGATIONS

Conducted by "ENQUIRER."

A Milking Machine.

An engine placed outside a dairy barn for the purpose of milking cows is a somewhat novel sight, and the idea of milking cows by machinery may cause some of the knowing ones to smile. Be that as it may, the Thistle Mechanical Milking Machine, invented by Dr. Alexander Shiels, of Glasgow, underwent a pretty thorough test at the Ontario Agricultural College a short time ago, and, to all appearances, performed its work in a most satisfactory and business-like manner.

The milking is accomplished by creating a vacuum varying from five to fifteen inches of mercury, and causing an external pressure of from two and a half to seven and a half pounds. Pulsating rubber teat cups are attached to the cow's udder, and are held in position by the atmospheric pressure mentioned above. The teat cups are connected by rubber tubes to an air-tight pail, which, in turn, is attached by a rubber tube to an iron pipe leading from the large air-pump which creates the vacuum.

In starting the machine, there is first created in a reservoir a vacuum of nineteen inches (of mercury), or any pressure above what is required for milking. The air is then withdrawn from the teat cups until there is a vacuum of fifteen inches, the pressure being prevented from going above this by means of a reducing valve attached to the machine. While the air is being withdrawn from the teat cups they begin to collapse, first at the top, then gradually towards the bottom, extracting all the milk from the teats. There is, then, air admitted to the cups until the vacuum is reduced to five inches. This allows the cups to expand, and releases the teat until it is filled, when it is emptied again, as described above. The motion resembles that of a calf sucking, or the beat of the heart. The pail which receives the milk is fitted with a glass top, which shows when the cow is dry, and, everything being perfectly air-tight, all dirt, is excluded from the milk. A three horse-power engine is sufficient to milk ten cows at once, and the milk is removed from a cow in from four to six minutes.

A question arises as to how many cows a dairyman should have in order to make such a machine profitable. No doubt that in the future it will be manufactured more cheaply

than is possible at present, but as yet it is out of the reach of any but the more extensive dairymen. To say the least, it certainly looks as if the problem of milking cows by machinery were nearing a solution. The invention is apparently safe as well as scientific, and approaches more closely to nature's plan than anything of the kind before offered to the public.

Fixation of Free Nitrogen.

For more than half a century, investigators have been at work upon the question: Can plants assimilate the free nitrogen of the atmosphere? And, though it has been proved that some plants, under certain conditions, possess this power, there are still many things to learn regarding the matter.

When we recollect that nearly four-fifths of the atmosphere is composed of nitrogen, while, at the same time, nitrogen is the most easily exhausted element of plant food in the soil, as well as the most expensive fertilizer to purchase, we can realize the importance to agriculturists of this question of the fixation of free nitrogen by plants. We see one class of plants perishing, or, at best, producing a very inferior crop, from want of nitrogen, though they are surrounded by an atmosphere containing an unlimited quantity of this important element. On the other hand, we see another class of plants growing upon the same kind of soil flourishing, and producing more nitrogenous material than is produced by the class of plants previously mentioned. This being the case, the question naturally arises, Why does one plant starve from want of nitrogen, while another, under the same conditions, apparently has enough and to spare? Investigators started work upon this question many years ago, and the answer given is: One plant can make use of the free nitrogen of the atmosphere, and the other can not. But another and more difficult question follows: Why, and how, can one plant assimilate free nitrogen, while another can not? This question has received the attention of the ablest investigators of our day, and, as yet, it is only partially answered.

It may be well to mention just here that the term "uncombined nitrogen" means the

same as "free nitrogen"—that is, nitrogen not combined with any other substance. The term "combined nitrogen" means nitrogen combined with some other substance or substances. For example, potassium nitrate (saltpetre) is made up of potassium, nitrogen, and oxygen, and, therefore, the nitrogen of saltpetre is called "combined nitrogen" because it is combined with potassium and oxygen.

Now, so far as we know at present, plants in general take up their supplies of nitrogen as combined nitrogen (principally as nitrates), through the medium of their roots. But leguminous plants, that is, those which bear their seed in pods, such as beans, peas, clover, etc., possess the power of taking hold of the uncombined, or free, nitrogen of the atmosphere, and of manufacturing it into food for themselves.

If you pull up a white or Dutch clover plant, and examine the roots carefully, you will find, here and there, attached to the roots, minute rounded or oval-shaped bodies, called tubercles, or nodules. By experimenting with different kinds of leguminous plants, it was found that, under certain conditions, these nodules were formed abundantly, while under other conditions none were produced; and it was further noted, in connection with these plants, that those which produced nodules grew much more luxuriantly than those which did not. This fact led to the conclusion that the root nodules were in some way associated with the assimilation of free nitrogen by the plant. It was also discovered that certain forms of microbes, or bacteria, are always found in connection with these nodules, and, therefore, it is only reasonable to believe that the microbes in question are the agents which enable leguminous plants to feed upon the free nitrogen of the atmosphere. How the microbes thus assist the plant is not yet known. Three explanations have been offered:

(1) That, owing to the presence of these bacteria, the plant is able to fix the free nitrogen of the atmosphere, by its leaves; (2) that the nodule organisms (bacteria) become distributed within the soil, and there fix the free nitrogen, the resulting nitrogenous compounds becoming available as a source of nitrogen to the roots of the higher plant; (3) that free nitrogen is fixed in the course of the development of the organisms within the nodules, and that the resulting nitrogenous compounds are absorbed and utilized by the plant. The last

explanation seems the most reasonable, and is the one most generally accepted. According to this view, the root nodules are, as it were, the laboratories in which the bacteria work; and in which they manufacture the free nitrogen into compounds upon which the plant can feed.

An interesting point in this investigation was brought out by growing leguminous crops on soils that had been treated in different manners. On a soil which contained no nitrogenous material beyond what was contained in the seed sown, there were no root nodules formed, and the plants were very weak. On a similar soil that had been treated with a solution containing bacteria obtained from a fertile soil many root nodules were formed, and the plant growth was remarkably vigorous. Nodules were also formed when the plants were grown upon a fertile garden soil which contained an abundance of nitrogenous material. Thus it seems that a soil practically destitute of nitrogenous material may be made to grow leguminous crops successfully, by simply supplying or infecting it with the right kind of bacteria, which at once go to work to collect nitrogen for the plants. Why these bacteria refuse to perform the same kindly offices for other than leguminous plants is not known.

There is still another curious fact in connection with this matter. Different kinds of bacteria are found associated with different kinds of leguminous crops. Sir Joseph Gilbert, the noted investigator of Rothamstead, England, sums up as follows: The experimental results which have been brought forward clearly establish that there is a great gain of nitrogen under some conditions. It has also been clearly shown that due infection of the soil and of the plant is an essential to success. The evidence at the same time points to the conclusion that the soil may be duly infected for the growth of one description or some descriptions of leguminous plants, but not for some other descriptions. The field experiments on such plants at Rothamstead have further shown that land which is, so to speak, quite exhausted, so far as the growth of one leguminous crop is concerned, may still grow very luxuriant crops of another description of the same order, but of different habits of growth, and especially of different character and range of roots. This result, though undoubtedly more or less due to other causes also, is, nevertheless, in some cases doubtless dependent on the existence, the distribution,

and the condition of the appropriate microbes for the due infection of the different descriptions of plant.

Loss of Nitrogen in Drainage Water.

According to the experiments of P. P. Dehérain, the drainage water from soils bearing a poor crop is much richer in nitrogen than that from soils bearing a good crop. In fact, the total nitrogen removed from the soil, by the drainage water and crop combined, was greater in the case of the poor crop than in that of the good crop. Further experiments go to show that fallow soils lose much more nitrogen in the drainage than those covered with crops, and, therefore, autumn catch crops are deemed important.

T. Schlossing, however, maintains that the methods employed in determining the loss of nitrogen in drainage water have denoted a much larger loss than really occurs; and analyses of river water indicate that the losses are not nearly so serious as has been supposed.

A Grass Bulletin.

Messrs. F. C. Harrison, B.S.A., and G. F. Day, B.S.A., of the Ontario Agricultural College, have just issued a bulletin on some of the grasses found in Ontario. Some twenty-six grasses are noticed, including those weeds which belong to the grass family. Complete botanical descriptions of the grasses are given, together with notes on their agricultural importance, cultivation, etc. Perhaps the most important feature of the bulletin is the cuts of the different grasses, which greatly assist in their identification.

The old form of bulletin has been abandoned, and the pages are much larger than those of the bulletins heretofore published by the department. This is certainly a great improvement.

Feeding Hens.

Bulletin 90, new series, of the Geneva Experiment Station, reports an experiment in feeding laying hens on whole grain versus ground grain, part of the latter being moistened with water before feeding.

The test was made in duplicate, White Leghorns and Buff Cochins being used. The results are somewhat contradictory, as will be seen from the following summary:

(1) Two lots of laying hens, of large and small breeds respectively, having their grain food only dry and whole, ate more food at greater cost per fowl and for the live weight, than did two similar lots having about thirty-seven per cent. of their grain ground and moistened.

(2) A pen of Leghorns, which had for the year thirty-seven per cent. of their food ground and moistened grain, produced eggs at a greater profit than did an exactly similar pen fed whole grain.

(3) Of two like pens of Cochins, the one fed whole grain produced eggs at much less cost than did the pen having ground grain, which result is attributed partly to the exercise assured in feeding whole grain.

It is also stated that, with the kinds of grain usually available, it is not possible to supply the hens with sufficient nitrogenous matter when feeding whole grain alone; but by using some highly nitrogenous by-product with ground grain this difficulty may be overcome without feeding an excessive amount of meat.

The experiment also indicates that when the egg product from the large and small breeds is the same, and when the cost of raising and the ultimate poultry value of the hens are taken into consideration, the profits will be, if anything, in favor of the larger hens.

The contradictory results indicate the necessity of care in drawing conclusions in connection with experimental work in general. One experiment will not settle any feeding problem, but satisfactory conclusions can be drawn only after a large number of experiments have been carefully conducted. It will, no doubt, require a great many more experiments before the question mentioned above can be settled, though at first sight it may appear to be a very simple one.

Exterminating Chinch Bugs.

One of the destructive pests of the Western States is the chinch bug, which, during some seasons, does great damage to the grain crops. Till lately there had been discovered no means of combating them, but now it has been found that there is a certain fungous growth which, when applied to the bugs, kills them. At the present time, experiment with this fungous growth are being carried on at the Minnesota State Experiment Station, to see what success is likely to attend the spreading of this disease among the healthy bugs. So far, the results have been most satisfactory.



Publishers Desk

FARMING

SUCCESSOR "THE LIVE STOCK JOURNAL."
An Illustrated Monthly Magazine devoted to farming
in all its branches.

Published on the first of each month by
THE BRYANT PRESS,
20 BAY STREET - - - TORONTO, CANADA.

EDITOR-IN-CHIEF, - - - G. W. GREEN.
STOCK EDITOR, - - - F. R. SHORE.
BUSINESS MANAGER, - - - S. S. BOND.

Subscriptions

Canada and the United States, \$1.00 per annum in advance.

Great Britain and other foreign countries in the Postal Union, \$1.50 per annum in advance.

Single copies 10 cents.

All subscriptions are received on the understanding that we be notified when the subscriber wishes to discontinue. FARMING will be sent to all subscribers until a notice to discontinue is received and all arrears are paid up.

The date opposite the name on the Address Label indicates the time to which a subscription is paid, and the changing of this date is sufficient acknowledgment of payment of subscription. We should be notified when this change is not made promptly.

Returning a paper is not a notice to discontinue. A subscriber wishing to discontinue must notify us by postal card, or see that the postmaster gives us the proper notification. We cannot find a name on our books unless the post-office address is given. In ordering change of address, be sure to give the old address as well as the new.

Advertisements

Ten cents per line per insertion.

Special guaranteed positions, 15 per cent. extra.

DISCOUNTS.

250 lines used within one year.	15 per cent.
500 " " " " " "	20 " "
750 " " " " " "	25 " "
1000 " " " " " "	30 " "

For Breeders' Card rates see Breeders' page.

Nonpareil measurement (12 lines to the inch).

No advertisement inserted for less than One Dollar. Send for advertising rate card, which gives all particulars.

Communications

All business communications should be addressed to "FARMING, 20 Bay Street, Toronto, Canada."

Communications for the Editor-in-Chief should be addressed to "The Editorial Department," FARMING, 20 Bay Street, Toronto, Canada."

Communications for any particular editorial department should be sent to the address given under the heading of that department.

Matter of any kind for publication must reach us by the 15th of the month preceding date of publication.

W. W. CHAPMAN, Representative for Great Britain and Ireland,
Fitzalan House, Arundel St., Strand, London, Eng.

Introductory.

We are inclined to think that the subscribers of THE CANADIAN LIVE STOCK AND FARM JOURNAL will scarcely recognize their old friend in this issue. In order, therefore, to prevent any embarrassment, we will introduce to you THE JOURNAL in its new form and

with its new name, FARMING. No doubt its friends will be somewhat startled by so sudden and complete a change, but we trust that they will soon recover from the shock it has given them, and become, if possible, more friendly than they have ever been in the past. When subscribers have looked carefully over this first number of FARMING, examined closely all its new and attractive features, and made comparisons with THE JOURNAL, we expect that few will ask, "Why is such a radical change been made?"

The conditions of agriculture, as of everything else, are constantly changing, and when a publication devoted to this industry has not adapted itself to the existing conditions, and is not keeping abreast of the times, it has fallen short of its mission, and its day of usefulness has passed away.

Although THE JOURNAL has always been considered one of the foremost publications of its class, and wherever presented has met with much favor, the publishers have been conscious that there was room for improvement, and that more might be done in the interest of those engaged in agriculture. With subscribers the change may seem sudden, but with the publishers it has been a burning question for some time, and the change is the outcome of much serious thought and careful study.

Our policy is that FARMING shall be devoted to farming in all its branches, that the authority of its writers shall be of the highest, and that all that is written shall be presented to its readers in as attractive a form as possible. For the present we have divided the reading matter into the following departments: Horses, Cattle, Sheep, Swine, Poultry, The Apiary, Horticulture, The Farm, The Dairy, and Recent Investigations, with space for general matter which cannot be classed under any of these heads. In charge of each of these departments we have placed an editor who is actively engaged in the work, and who is also a recognized authority on the branch of which he has charge. We shall give each department the amount of space and the attention that its importance demands, and nothing that is in any way connected with the interests of farmers will be lost sight of.

Our principal reason for the change in the

form of the journal is that the new form is much more convenient to handle, and will make a more attractive volume when bound.

We have sometimes been asked why *THE JOURNAL* was not issued more frequently. In answer to this, we would say that it is not our ambition to publish a mere newspaper. Nearly every farmer can get all the news through his local weekly newspaper. What we shall try to do is to publish only such ideas as tend to the development of agriculture, to give only the soundest information bearing directly on the subject, and to present it in such a practical way that it can be readily made use of it. If each number contains as much of such matter as farmers have time to read and make use of, few will look for a more frequent issue.

It will be our aim to make the typographical appearance of *FARMING* as attractive as possible. Not even the profoundest student cares to wade through page after page of solid matter unrelieved by artistic type or illustration, and when ideas are presented in this style, no matter how convincing or valuable they may be, their effect is often lost because of the uninviting style in which it appears. Aside, too, from the pleasure that is always gained from seeing a good illustration, there is often more to be learned by a glance at one than by reading a whole column of matter.

Owing to lack of time and other causes, we have not been able to complete arrangements in every particular, but before many months have gone by we expect to have everything in complete running order. Although this first issue falls considerably short of our ideal, we confess that we take some pride in pressing it. It is the result of some serious thinking and a considerable expenditure of money. We have done our best, and will leave it now with our readers to judge of the work. We invite free criticism, but we hope there will be few who will not find in it at least something suited to their needs, and some possibly who will have to offer some words of commendation.

WE want correspondents in every locality to report on crops, and to furnish items of interest generally. We should like to hear from any of our subscribers whenever they have anything to report which would be interesting to our readers. Our aim is to publish a magazine that will meet the requirements of every branch of farming, and we recognize the fact that, in order to do this, we

shall require all the assistance we can get. The field is large, and there is any amount of work in it; but we feel that if we can get our subscribers to help us, if each one will contribute his share, and we can work together, and profit by each other's successes and failures, we shall make some progress, and the work will not be altogether uninteresting. If, therefore, you are interested in "dairying," and you think our dairy editor is not quite correct on certain points, do not be slow to let him hear from you. He will always be thankful for any pointers, and ready to thresh things out with you, or to furnish you with any information he can. If it be one of the other departments that you are most interested in, and in your work you come across something that will help the editor, and interest the subscribers, send it along. No matter how clever a writer, or how well informed an editor may be, he will fall far short of success if he is compelled to work in the dark. We have now an editor for each department in *FARMING*, and would like to see them all succeed; but we are conscious that this can only be done through having the sympathy and assistance of our subscribers.

* * * *

IT has always been the policy of *THE JOURNAL* to accept none but the most reliable advertising for its pages, and now *FARMING* intends to be, if possible, even more careful. No advertising will be inserted but what we believe to be perfectly reliable and worthy of our best recommendation. If, however, after inserting an advertisement, we find it unreliable, we shall discontinue it at once. We desire to protect the interests of our subscribers and so merit their confidence, and will consider it a favor if they will report to us any cases of fraud on the part of our advertisers.

* * * *

THE amount of time and labor required to produce this first number of *FARMING* has been considerable, and, consequently, it is somewhat late in appearing. We trust, however, that our subscribers will overlook the delay when we promise them that in the future we shall endeavor to have it in their hands by the first of the month. In order to accomplish this, we shall be obliged to close down on all copy on the 15th of the month preceding the date of publication. Therefore, will advertisers and subscribers please bear this in mind, and let us have matter for publication as early in the month as possible, and not later than the 15th?

MISCELLANEOUS.

NOW

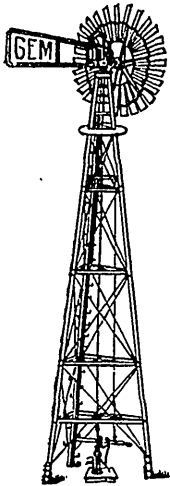

Is the time when dealers should make their selections of good paying and good selling articles for 1895-96. If you want excellent returns write for particulars of our . . .

- Gem Steel Windmills
- Gem Steel Towers
- Canadian (Steel) Air Motors
- Halladay Standard Windmills
- Haying Tools
- Iron and Wood Pumps
- Dust Collectors
- Saw Tables, etc.

We manufacture a full line of both Pumping and Geared Windmills and the greatest variety of Pumps of any firm in Canada. Our Haymaker car and patent Steel track is leading them all, and our prices are made to suit the times.

ONTARIO WIND ENGINE and PUMP CO.

367 Spadina Avenue - Toronto, Ont.

141

It is not Paradise,

But—

If you have some cash to spare and are willing to work, financial independence cannot be more surely secured than by buying a few acres of irrigated land in Salt River Valley.

This valley is in Southern Arizona, and is noted for its fine semi-tropical fruits and superior climate. Horticulturists say that greater profits can be realized here from oranges and grapes than in Florida or California. Physicians assert that the warm, dry, bracing climate excels in healing qualities Italy's balmy airs. The great blizzard of 1895 did not blight the tenderest leaf in this protected spot.

To get there, take Santa Fe Route to Phoenix, A. T., via Prescott and the new line, S. F., P. & P. Ry. Address F. T. Hendry, 63 Griswold Street, Detroit, Mich., for illustrated folders. They tersely tell the story of a remarkable country. Actual returns are given—no guesswork or hearsay.

**It is the
Salt River Valley.**

**THE KEYSTONE
DEHORNER**

© Cuts clean on all sides—does not crush. The most humane, rapid and durable knife made, fully warranted. Highest World's Fair Award. Descriptive Circulars Free.

A. C. BROSIUS, Cochranville, Pa.



STAMMERING

Stuttering, and all other impediments

PERMANENTLY CURED
to a distinct articulation.

OUR SYSTEM IS STRICTLY EDUCATIONAL

No Advance Fees. Write for Circulars.

THE ONTARIO INSTITUTE,

65 SHUTER ST., TORONTO.

Formerly the Linton Institute.

American and Canadian Horses

EXPORT TRADE TO SCOTLAND.

GLASGOW, as a centre for the disposal of American and Canadian horses, has proved by far the best market in Britain during the past season, and it is likely to continue so, as from its central position it commands buyers from all parts of Scotland and England.

Messrs. MACDONALD, FRASER & CO., Limited, Live-Stock Salesmen, Glasgow, have sold this season, either by private bargain or by public auction, several thousand American and Canadian horses, consigned by all the leading exporters from the States and Canada. From their wide connection among buyers, and the central position of their stables and sale-yard, they are in a position to make the best market value for all horses entrusted to their care.

Canadian and States Cattle and Sheep.

Macdonald, Fraser & Co., Limited, also handle carcasses, and have done so for many years past, large number of Canadian and States cattle and sheep.

Postal address: MACDONALD, FRASER & CO.,

Limited, 63 Bellgrove St., Glasgow.

Cable Address: "Frasersco," Glasgow.

Special Stock Reviews.

Shorthorns at Pine Grove.

Of the three breeding establishments owned by Messrs. W. C. Edwards & Co. at Rockland, Ont., North Nation Mills, P. Q., and Clarence, Ont., that at the former place is devoted to Shorthorn breeding, and is under the supervision of Mr. Joseph W. Barnett, who has for a lifetime been associated with Shorthorns of the highest excellence, and who has successfully prepared many a prize-winner in the past.

Although it is generally known that there have been a number of superior individuals imported in recent years, still Shorthorn breeders have no conception of the extent of the herd, nor can any idea be formed of the large number of uniformly good cattle that the herd contains, without paying a personal visit to the farm.

In Knight of St. John the herd has the advantage of claiming one of the best bulls that has been imported for many years. Not only is he individually good, but his breeding is superb. He is sired by Cap-a-pié, whose sire and grandsire were both bred at Sittyton, while his dam, Clarissa, is of the best branch of Mr. Cruickshank's famous Clipper tribe. Crocus, by Pride of the Isles, and her dam, Princess Royal, by Champion of England, names which appear on his dam's side, were considered by competent judges to be among the best cows of their day at Sittyton. Knight of St. John is a deep red; long, low, level, and handsome in finish, and carries any amount of natural flesh, while his grand Shorthorn character and large scale proclaim him to be a bull second to none, either individually or from a breeder's standpoint. The fact that twelve of

CHAMPION EVAPORATOR

For MAPLE, SORGHUM, CIDER, and FRUIT JELLIES. Has a corrugated pan over firebox, doubling boiling capacity; small interchangeable strap pans (connected by siphons), easily handled for cleaning and storing; and a perfect automatic regulator. The Champion is as great an improvement over the Cook pan as the letter was over the old iron kettle hung on a fence rail.



Catalogue Free.

THE G. H. GRIMM MFG. CO.,
HUDSON, Ohio, & MONTREAL, Quebec.

FARMERS

are you **BUILDING**

A roof, or does your old one need repairs? Send for prices and samples of our new

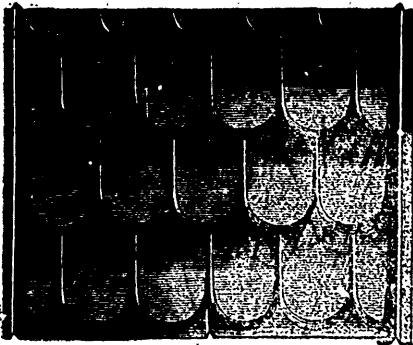

SPRING LOCK SHINGLE

Made of steel, painted red or slate color, also galvanized iron. Fire and waterproof.

COLLINS MFG. COMPANY,

66 Esplanade St. West - - - - - TORONTO,
AGENT'S WANTED.

The Manitoba Washer

The Best Machine in the United States or Canada.

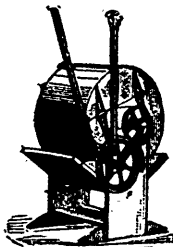

This Machine takes Less Soap Less Water Less Labor

And washes more clothes at one time than any other machine. Write for prices and terms to

Dowswell Bros. & Co.
Hamilton, Ont.

Manufacturers of Washers, Wringers, Churns, Mangles, etc.

469 FIRST-CLASS AGENTS WANTED.

his calves made the largest average in the Collynie bull sale of 1893 prove his value as a sire.

His assistant is Knight of Lancaster (imp.), a smoothly-finished three-year-old red, son of the grand bull, Scottish Archer, still in use at Collynie. His dam is Lady Lancaster Sixth, by Gravesend, a good cow of the Mary Anne of Lancaster family, with scale and quality that should insure her value in the breeding herd. She was selected with the ten others that were purchased by Mr. Edward's agent in 1892. Her bull, now two years old, imported in dam, is also, by Scottish Archer, and very much resembles in appearance his brother mentioned above.

The herd numbers nearly eighty head, the cows of which embrace many of the most desirable families, the breeding of which is along the most popular lines, while the great scale and easy feeding qualities are such as should meet the demand of the requirements of the day.

Four Sittyton families are represented among the recently imported cows. One of these is Sittyton Verona, by Collingwood, with such good ones as Pride of the Isles and Champion of England following next in reading the pedigree, which ends in one of the good old families bred by Mr. Rennie, of Phantassie. Lady Lancaster 6th, of the Mary Anne of Lancaster family before mentioned, and Rose of Autumn Third, by Gravesend, are two others of the old sorts, while Sittyton Clipper 2nd, by William of Orange, represents the Clipper tribe, which Mr. Cruickshank valued so highly. From Kinellar came Rose Bloom, by the Sittyton-bred Royal James, and Alpine Rose, her daughter, by Clan Alpine. Heather Bloom, topped out with bulls from Stryton, was bred by Mr. William Norrie, Cairn-hill, Ayrshire. There are several capital things of North Country extraction bred on this side of the ocean, including a Kinellar Bessie, appropriately christened Lady Fame, for a beautiful heifer she is, with style, beauty of form, natural flesh, and all the quality that any one could desire. She was sired by Challenge, and her dam is by imported Baton Lenton. The Kinellar Minas are represented by Minnie 2nd, by Minnie Chief. She has turned out a beauty, while a half-sister from the Strathallan family is close after her. A fine good three-year-old of the same family, by imported Northern Light, is also worth mentioning. Nor are the Booth families neglected. The highly-prized Manitoba and Fame sorts, carefully bred, have found a place here, as also other families, not so well known, yet possessing the best of this blood. No less than ten of the good old Syme sort, topped out with the best bred individuals of their day, and perhaps nearer the type of this useful sort as we remember them when first introduced than any we have yet seen, are here to be found. There are also several nicely bred young Marys, a sort that have always commanded attention where big figures have been paid at United States Shorthorn sales. In fact, a perusal of the breeding of the numerous families at once impresses the student in Shorthorn history with the fact that there has been no lack of care in getting together the material of which the herd is comprised, neither has there been lack of money, or plainer cattle, and plainer breeding would have had to have sufficed.

Again, the scale and flesh that these cattle possess when they have been bred for two generations on the farm show that the management and surroundings are suitable to development in the highest degree.

The presence of such a herd is of vast advantage to Canadian Shorthorn interests, and will prove a source from which breeders may draw choice animals to head their herds.

Windsor Salt

Purchasers of Windsor, Dairy, or Cheese Salt should examine the labels on the barrels to make sure that ordinary fine salt has not been sold them instead of special Dairy or Cheese Salt respectively.

All Dairy and Cheese Salt Barrels are Paper Lined

8

To Exhibitors

of

Stock at the Fall Fairs

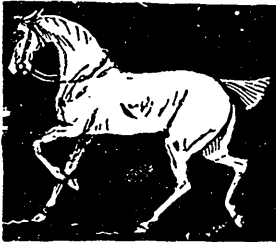

If you would secure **first prize**, you must have your animal in the finest condition, his coat must be smooth and glossy, and he must be in good spirits so as to "show off" well. **DICK'S BLOOD PURIFIER** is the best Condition Powder known for horses and cattle. It tones up the whole system, regulates the bowels and kidneys, strengthens the digestion, turns a rough coat into a smooth and glossy one. It gives horses "good life," making them appear to the best possible advantage.

Get **DICK'S** from your druggist or grocer, or address

DICK & CO. P. O. BOX 482, MONTREAL.



364

Wanted . .

A large number of one-year-old Pullets. Name, breed, number for sale, and lowest cash price.

The W. A. Freeman Co., Ltd., Hamilton, Ont.

Hillhurst Stud, Herd, and Flocks.

Overlooking, as it does, a stretch of scenery of surpassing beauty, Hillhurst has for twenty-seven years held much the same exalted position as regards its varied departments of fine stock breeding. And whether we call to mind the extravagant prices that a Scottish earl chose to pay for Duchess heifers bred here, or the extensive importations of the most popular strains of Aberdeen-Angus, or the Hereford legions, led by Cassio, it is evident that Senator Cochrane aimed high in selecting any sort he chose to associate with Hillhurst.

It was a rich treat that Mr. James Cochrane afforded us that July evening as he drove us over the farm, and we would fain attempt a description of the productive grass fields, the grand stretches of pasture lands, the luxuriant root and corn fields, or the promising horse beans, all of which speak of attentive cultivation and richest fertile fields. Or, again, we might dwell upon the two excellent flocks, one of Shropshires and the other of Dorset Horns, both of which deserve mention, would space permit.

Hillhurst has returned to its first love in the recently established herd of thick-fleshed Shorthorns that once more roam over its pastures. At their head stands the capital three-year-old roan bull, Riverside Hero 2nd, sired by the Sittyton bull, Sultan Selim, his dam being the handsome imported show cow, Bracelet 2nd.

The cows are mostly of Aberdeenshire lineage, and have scale, flesh, and finish to recommend them.

But it is the stud of Hackneys that reigns supreme at Hillhurst now, a stud that may justly claim precedence in its establishment upon North American soil, and which has grown to such dimensions that over fifty head eligible for the Hackney book are to be found there.

The Denmark horse, Fordham, was away at the time of our visit, but right well is he supported by those that were at home.

The big bay horse, Hayton Shales, by Pioneer, is a combination of such good old sorts as Phenomenon, Fireaway, and Shales. A great harness horse is Hayton Shales. His sensational action is shown to the best advantage in this capacity, while his extra bone, high, handsome crest, and beautiful color proclaim him to be a horse of great value in the stud. But it was the two-year-old horse, Barthorpe Performer, that took our eye. He is by Gaston Duke of Connaught, rich in the blood of Denmark, while through his dam, by Prince Alfred, comes the much-coveted Fireaway blood. Barthorpe Performer was imported last season, and has not yet appeared in public. He is a handsome dark chestnut that will easily top 15.3 hands when he is finished. Such a handsome, breezy head and neck one rarely sees, and he carries his good points further, as a grand back, good ribs and barrel attest. His legs are clean and as cordy as a Thoroughbred's, and he can use them, too, with that even, all-round action, brilliant and neat, which combines pace sufficient to insure road qualities.

Princess Dagmat produced a colt foal last season that should do justice to both parents. He has limbs and size that should claim attention for stud purposes. But it is Miss Baker's yearling colt, by Agility, that bears the palm among the youngsters, so easily can he put up an exhibition of true Hackney action that shows how truly he takes after his brilliant parentage. And as for the way his dam, Miss Baker, went that afternoon on the halter, we have yet to see anything approaching it. Her harness manners have always been faultless in public, but, as her groom remarked,

she is too modest when competing on the line. Then there is the sweepstakes mare, Princess Dagmar, and the Matchless mare, Charwoman—what a harness pair they make! All are driven at Hillhurst; even the stallions are mannerly, and what a chance there is to horse any vehicle a gentleman might fancy!

But there is a dark side to every picture. We counted no less than ten purebred Hackney yearling geldings. Mr. James Cochrane informed us that he would rather trust to the liberality of city purchasers than keep them entire with the hope of selling them for breeding. For the same reason a number of the mares had not been stunted this season.

When will our horse-breeders learn wisdom? Here is the best Hackney blood, beautiful conformation, combined with the type that commands the highest figures, in greater demand for actual harness work than breeding purposes, and yet farmers continue to breed weeds whose sale will not pay for a year's keep.

There is a grand crop of foals in the pastures this season. Miss Baker's foal, which was adopted by a nurse mare, and another from the Great Shot mare, Miss Lynn, are beauties that can show their paces already, and there are others, some fourteen in all, and gems among them. Why not have a few distributed through the country? The prices at Hillhurst are not extravagant.

Ingleside Herefords.

The unsurpassed grazing qualities of the white faces are too well established to require any comment at our hands, and where could a more favorable location be found than in the eastern townships, where the great essentials for cattle production have been so bountifully supplied by nature? Grass, water, and shade for summer, and hay and roots for winter feeding, are easily supplied, and, with markets convenient, there is no reason why feeding cattle for beef should not engage the attention of such landowners as choose to adopt this profitable branch of farm management. It is in this district that the Ingleside herd of Herefords, owned by Mr. H. D. Smith, Compton, has been established, a herd that may justly lay claim to be first in order of merit of any of the breed in Canada.

At the head of the herd is Amos of Ingleside, sired by Wildeye 15th, dam by Rudolph 2nd, second dam Anxiety, a combination of good breeding that should insure the best results, especially as Amos of Ingleside is, without doubt, the greatest yearling of the breed that has ever been shown here, and is a model of what a beefing bull of the age should be. In fact, we hardly know which to admire most, his great scale, easy feeding quality, or capital breeding character.

As an assistant at Ingleside they have the two-year-old bull, Young Pinkham, sired by that great show bull, Young Tushingham, dam Pink, by Lord Tushingham, the latter being a son of the great Cassio.

The cows at Ingleside are such as are calculated to keep up the reputation of this grand beefing sort. Lady Tushingham, by Lord Tushingham, dam Lady Wintercote 2nd (imp.), and Spot, whose dam is Anxiety 4th, will attract attention at coming shows, while the three-year-old heifer, Josephine 2nd, and the two-year-old Sylvan of Ingleside, will be apt to play an important part.

Three yearlings, that carry wonderful flesh, testify to the early-maturing qualities of Hereford blood.

Bull calves are a particularly promising lot, and such of them as are not required in the Hereford herds should do good service in crossing for beef production.

Improved Yorkshires and Tamworths are also included in the breeding operations. Oak Lodge Duke,

of Mr. J. E. Brethour's breeding, is by Model Duke, dam Oak Lodge Maid, a daughter of Marion (imp.). Several sows have been purchased at Isaleigh Grange, which are chiefly of Sanders Spencer's breeding.

The Tamworths have been purchased from Mr. John Bell, Amber, and are chiefly bred from the herds of Mr. Norman, of Cliff House, and Mr. W. Philip, of Cole Hill. Besides breeding both sorts pure, Mr. Smith is crossing the different kinds for the block, and he finds that the crosses mature quickest.

Spruce Hill Ayrshires.

The dairy farm of Mr. A. McCallum lies close to Danville, P. Q. Here a herd of Ayrshire cattle is the chief attraction. As Mr. McCallum has been for a number of years operating a creamery at Danville, it goes without saying that his farm would be devoted to this branch of farm work, and that a herd of Ayrshire cattle would fit nicely into the arrangement.

The first purchases were made from those families that were descended from the earlier importations, with other good ones added from time to time as occasion offered, while due care has been exercised in choosing such bulls as would keep the herd up to a high standard, and the result proves that there has been no lack of judgment displayed.

In looking over the pedigrees which, by the by, are just about to be published in a sale catalogue, it will be found that the herd is comprised of a large number of families in which there is quite a variety of breeding, and yet, on inspecting the cattle, there will be found a great uniformity of type in the make-up of the herd.

The advantage of this is apparent, for by this means there is no difficulty in furnishing fresh blood to such customers who may have previously purchased bulls to head their herds, and, as every stockman is aware that one old patron is worth two new ones, the point is easily seen. In looking up our notes, we find the following names of cows as we saw them in their pastures the afternoon of our visit:

Hatty 5th, by Solomon, dam Hatty, by Sir Roger (imp.), tracing to Miss Pinner (imp.); Maud Spotty, by Earl of Plantagenet, tracing to Snowdrop (imp.); Sybil 5th, by Royal Charley, tracing to Susan (imp.); Moss Rose, by Hanlan of Hawick, tracing to imp. Jane; Rosebud, by Earl of Plantagenet, tracing to Ayrshire Mary (imp.); and Derby of Petite Côte (imp.), by the noted bull, Traveller.

Each of the foregoing may be credited with more than one or two daughters, while several of these families have quite a number of representatives.

The herd is a large one, comprising nearly eighty head, and the cows are large in size, are particularly handsome in type, and unmistakably promising as milk producers.

The last bull in service was Baron Renfrew (imp.), a bull that Mr. McCallum selected in person from the herd of Mr. R. Wilson, of Manseraes, Scotland, by whom are many of the young things in the herd, while the present stock bull is by Silver King, dam Derby of Petite Côte (imp.), by Traveller. As this herd has altogether outgrown the capacity of the farm, they are all to be offered by auction at a date which will be announced in Mr. McCallum's advertisement.

Isaleigh Grange.

The three miles of road leading from Danville to the estate of Mr. J. N. Greenshields winds up an easy incline from the river below, affording a view of hills and valleys, forest and farm, charming in its diversity. When Isaleigh Grange is reached, we find fields with gentle declines, level surfaces, and a depth of soil that

gives the idea that it can produce abundance of feed for herd or flock. The farm is under the supervision of Mr. T. D. McCallum, who early found that poor land gives but meagre returns. In the future we may, therefore, expect to find the producing powers of this farm, with its broad acres, kept at a high standard.

The flourishing condition of the breeding operations would lead one to suppose that this department will claim the same attention, and that there will be no lack of handsome young things in either herd or flock.

Especially fine are the Guernsey calves by Adventurer (imp.), and wonderfully well has he nicked with the cows, or they would not be so uniformly good as they are. Adventurer, it will be remembered, was the sweepstakes bull at all the shows of 1893, and also won twenty-nine first prizes previous to his importation, both on the island and at English shows.

Ontario's Pride is also in use, and has carried his share of winnings, to which he will probably add somewhat during the coming season.

A right good youngster is Isaleigh May Boy, by Adventurer, dam May Queen 6th. Isaleigh Conjuror, by the same bull, out of Little May Queen, may also be expected to show himself.

Among the cows, Eliza 6th, an eight-year-old cow, by Young Duke 2nd, has never yet been beaten, although Little May Queen, a six-year-old cow, by Barney, may make her look to her laurels.

May Queen 6th is another eight-year-old which has won many prizes, and a right good one she is.

We counted twelve Guernseys in milk, and their handsome appearance and goodly size should insure them further popularity. There were also fifty neat yearling heifers. A very promising lot they are, and we shall hope to see a goodly herd, of which we shall have favorable reports, at the coming shows.

A herd of very good Ayrshires, with Duke of Monmouth, by Golden Guinea, at its head, is the most recent addition to the stock department. The cows have every appearance of being able to furnish their quota to the supply of milk at the creamery, and o being equally good in the breeding herd.

We had expected to see an extra fine lot of Improved Yorkshire pigs, knowing the source from which the herd had sprung and the care that was exercised in their selection, and we were in no way disappointed.

Four or five boars are in service. One of these is Holywell Minor, which won first at the Royal, at Warwick, in 1892, before his importation, since which time he has carried first at Montreal, London, and Ottawa. That he has done good service in the breeding herd a grand lot of young things by him testify. And so has Holywell Prince (imp.), also of Sanders Spencer's breeding. However, it is Maxim that will have to do battle at the shows this season; but he is equal to the task, for, although not in high flesh, he is among the very best specimens we have yet seen. Such length, such scale, such character, and, withal, such depth and thickness! And, better still, we have yet to see such three-months-old pigs as we saw from him. That, however, we might expect from his breeding. He was bred by Mr. J. E. Brethour, and sired by Diamond, dam Millie III., a daughter of that grand sow, Marion.

That capital sow, Holywell Mite, by Kinicroft, that won first in her class and the family prize at Toronto, was looking well, as was her pen companion, Matchless Beauty, that won first at the leading English shows of 1892.

One hundred pigs had been sold during the first six months of this year, and yet there was plenty of choice.

The Shropshires will also take a hand in the coming

exhibitions. This flock, it will be remembered, was founded upon an importation of eighty ewes imported in 1892 and twenty-five ewes in 1893. The rams used during the last two seasons are Coming Blue Blood, bred by Wm. Thomas; Rayton Swell, bred by Richard Brown; Warwick Hero, bred by Geo. Thompson; and St. Leger, bred by Richard Brown. The mating is done with a view to producing a uniform flock of good lambs, which should be expected from the high character of the original selection.

Roadmaking.

The following special bulletin, prepared by the Ontario Good Roads Association for the use of pathmasters, has been issued by the Ontario Department of Agriculture:

Requisites for Permanency.—In order to make and maintain a permanent roadway, two rules must be followed:

- (1) Take the water out.
- (2) Keep the water out.

Underdraining.—Where a road is to be constructed on a wet and retentive soil, a perfect system of underdraining must be provided. This is best done by cutting ditches diagonally across the roadbed, with discharge into side-ditches. These diagonal ditches should have a good fall and good outlet, and should be from eighteen inches to two feet deep, and about one foot wide at the bottom, with a slight slope outward. In these should be laid coarse, broken stone, broken bricks, or other material suitable to form a drain, filling them up to the level of the sub-grade.

Surface Draining.—Open ditches should be cut on each side of the roadbed, at a distance of about twelve feet from the outsides of the metalling. They should be deep enough to drain the foundation; at least eighteen inches below the sub-grade.

Tile Preferable.—Where tile is cheap, and a good outlet obtainable, tile side drains are preferable to open ditches. Shallow gutters should be made over the tiles to catch the surface water, and conduct it to catch-basins placed at convenient distances apart. The catch-basins should be made of durable materials of sufficient size to be freely cleaned, and should be covered with iron gratings. The basins should extend at least two feet below the bottom of the tile to provide space for the deposit, and they should be cleaned at least twice a year.

The Roadsides.—The strips of ground between the metalled road and the open ditch should be properly graded to conform with the crown and grade of the metalling, and should be seeded and kept in sod. This will always be pleasing to the eye, is cheap and very largely useful in preventing the carrying

of mud on to the metalling. Moreover, the uniformity of the grade facilitates the passing of meeting teams.

Location of Sub-drains.—In a soil that is gravelly and pervious to water, the open ditches on each side of the road, even of a 66-foot wide road, are sufficient for draining the roadbed. If there be any springs under the road, a sub-drain leading directly to the side ditch will be required. Should the road be on a side hill, a deep open ditch on its upper side, to arrest the flow from the adjacent land, may be sufficient, the water being at intervals conducted across and under the road by an ordinary stone culvert.

Outlets.—Mistakes are often made by giving insufficient outfalls to the drains. Under the Ditches and Watercourses Act, a municipality has the same power as an individual to enforce the natural outlet for the drainage water of the land. But municipal officers are apt to shrink from forcing an outlet through private lands, and to leave their road drains with insufficient outlets rather than incur the ill-will of possibly influential constituents. This should not be so. Municipalities should insist upon their rights, and the owners of lands interfered with should pay the same proportion of the cost of the work as if only private individuals were concerned.

Bad Drainage and Frost.—Imperfect drainage is the cause of the badness of our roads in nearly all cases. The inexperienced are not apt to appreciate the paramount necessity for the maintenance of a perfectly dry foundation of earth for their surface of broken stone, gravel, etc., to lie upon. A protracted rain will soften an undrained road, and, on the passing of a heavy load, injurious ruts are the consequence. In these latitudes the soil water freezes, and the consequent expansions and contractions quickly ruin a roadbed.

Destructiveness of Ruts.—It matters not whether a road be earth or macadam if attention is not given to the preservation of the finished crown. If ruts are allowed to form, water is admitted. Every depression is a centre of destruction. The power of resistance to the water becomes less and less until the roadway becomes actually impassable.

Road Machines.—In constructing earth roads a plow should not be used except where actually necessary, because a plowed surface is only with great difficulty made hard and smooth, and the plow is likely to cut too deeply into the earth. A good road machine should be procured, if possible, for by the use of a machine the natural foundation of the ground is not disturbed in rounding up the road, as is done with common plows and

scrapers. Every municipality should own a road machine, and should have a man especially instructed and constantly in charge of it. With a road machine in skilled hands, there will be no question raised as to the economy of construction and repairs, and the efficiency of the work done.

Width of Roadway.—The roadway should be twenty-six feet between the ditches and the metalling for ordinary roads eight feet wide; where more than a single line of travel is required the metalling should be sixteen feet wide.

Height of Crown.—A roadway of this width should have a crown of at least ten inches, and should always be maintained in this shape.

Rolling.—After the road machine has completed its work, the whole grade should be rolled with a roller weighing about five tons. Rolling is essential in making the foundation and surfacing to form permanent or gravel roads. The roller should follow closely upon the grader or scraper, so that the loose earth may be consolidated while it is still moist. The roller should pass many times over the softer portions of the road, and, where the road is very dry and not inclined to pack, it may be slightly moistened to facilitate the consolidation of the earth. The rolling should begin at the sides of the road, and proceed gradually towards the centre; that is, the roller should be passed from end to end along the side of the road, and then in the second passage the roller should slightly lap the first passage until the centre of the road is reached.

Metalling.—After the formation of the road and the draining are completed, the mass of broken stone or gravel which is to form its wearing surface should be laid, packed, and so consolidated that it will be practically water-tight. Such a road will be durable and easily maintained. It will shed water readily. Its hardness will prevent the formation of ruts, which is the first stage of destruction.

Width of Tires.—If all wagons used on country roads could be provided with tires four inches wide, they would roll the surface more smoothly and more quickly, and the road would be in fairly good condition all the year round.

Noxious Weeds.—Chapter 202, R.S.O., 1887.

Section 9: "It shall be the duty of the overseers of highways in any municipality to see that the provisions of this act relating to noxious weeds are carried out within their respective highway divisions, by cutting down or destroying, or causing to be cut down or destroyed at the proper times, to prevent the

ripening of their seed, all the noxious weeds growing on the highways or road allowances within their respective divisions, such works to be performed as part of the ordinary statute labor, or to be paid for at a reasonable rate by the treasurer of the municipality, as the council of the municipality may direct."

Section 10, subsection 4: "Every overseer of highways who refuses or neglects to discharge the duties imposed upon him by this act shall, upon conviction, be liable to a fine of not less than \$10, or more than \$20."

Noxious weeds include Canada thistles, ox-eye daisy, wild oats, ragweed, and burdock.

FOR FARMING.

Complete Manures.

The term "complete manure" is used to name such a combination of fertilizing materials as will supply all the elements necessary to normal plant growth. As the principal ingredients needed to support fertility in ordinary farming operations are practically limited to nitrogen, potash, and phosphoric acid, a manure containing these three may be understood to be, in fact, a complete manure. The simple fact that a manure contains these elements is not enough; it must contain them in certain definite proportions. A manure may contain sufficient nitrogen, for example, to produce a yield of thirty bushels of wheat per acre; sufficient phosphoric acid for twenty-five bushels, and potash for twenty bushels only. Such manure will have an agricultural efficiency of twenty bushels, and the excess of nitrogen and phosphoric acid will, so far as that particular crop is concerned, be wholly useless. Not only useless, but largely lost; as, unless the catch crop method is practised, the fertilizing elements not assimilated either take unavailable forms, or are dissipated by drainage and other causes. Even catch crops are but slightly efficacious; the soil, already exhausted of available potash by the wheat, is unable to supply materials needed, and, though the catch crop may require relatively less potash than the wheat, this difference between crops is so small that little economy is possible.

The lesson indicated is: the crop-producing value of a manure is measured by its lowest fertilizing ingredient. It is true that some soils contain naturally varying stores of plant food in an available form. It is also true that these stores are rarely or never balanced economically. If such supplies were easily measurable, a fertilizer could well be compounded to profit from the same, but such stores of plant food are subject to constant

change and dissipation; a method of culture giving results one season may prove disastrous the season next following.

It must be understood that these remarks apply more particularly to the farms of the northern and eastern parts of this continent, which have been so systematically exhausted by diversified cropping that the elements of plant food in an available form are almost uniformly deficient. In the west and parts of the south, cropping has been as yet less searching, either owing to the period under cultivation having been shorter, or to the absence of a wide diversification of crops grown. In this latter territory instances are frequent in which incomplete manures have been used for many years with some success, but the principle remains the same; the plant must have the chief elements of fertility in certain proportions, at a particular time, and in an available form. By trusting to chance in these proportions, the average of agricultural production has been brought to a very low ebb indeed.

The farms of the east and north have been practically exhausted of their natural supplies of plant food in such form as to have a specific crop-producing value. The constant use of farm-made manures has contributed no little to this exhaustion. The nitrogen of manures is always supplemented by nitrifying organisms in the soil, nitrates in rain water, and other sources. Farm-made manures usually contain an excess of nitrogen, as compared with the other elements. The formula (under actual growing conditions) in fertilizer language is practically as follows:

Ammonia.....	10
Potash.....	6
Phosphoric acid.....	3

With many staple crops this is not a properly balanced manure. The proportions for wheat are: ammonia, 10; potash, 4; and phosphoric acid, 3. The minerals are deficient here as compared with the manure, but the discrepancy is not on the wrong side. With corn, however, the conditions are very different; the proportions become: ammonia, 10; potash, 10; phosphoric acid, 4. Taking into consideration the quantity of ammonia obtainable from other sources than the manure itself, this crop seems fairly well adapted for home-made manures. But how is it with potatoes? The proportion in this case is: ammonia, 10; potash, 14; phosphoric acid, 5; the potash is deficient. Clover is one of the most important crops to the farm—rather, the most important one. The proportions for clover are: potash, 17; phosphoric acid, 5. Clover, being a leguminous plant, accumulate

the larger part of its nitrogen from the atmosphere. By the continued use of farm manures, the natural supplies of soil minerals have been exhausted. It is well understood that farm manures contain an excess of nitrogen, relatively. Grain lodges badly if they are used continuously without the addition of potash and phosphate. Potatoes produce a diminished crop, or go to vines and produce little or nothing; on every hand are evidences of deficient minerals, particularly in the case of potash.

It follows that the farmers of the north and east should pay especial attention to the minerals in their manures. Potash is the weak point almost invariably, and measures the crop possibilities—fixes the limit of production, so to speak. Incorporate potash with the home-made manures, and also a small portion of phosphate, and the full value of the manure may be obtained; otherwise, the greater portion of the expensive ammonia must surely suffer loss.

P.

Fall Fairs.

Toronto.....	Sept.	2-14
Sherbrooke, Que.....	"	2-7
Kingston.....	"	2-7
St. Thomas.....	"	9-12
Montreal.....	"	12-21
London.....	"	12-21
Cornwall.....	"	13-14
Cobourg.....	"	17-18
Owen Sound.....	"	17-19
Brockville.....	"	17-19
Guelph.....	"	17-19
Perth.....	"	17-19
Whitby.....	"	17-19
Belleville.....	"	17-20
Bowmanville.....	"	20-21
Ottawa.....	"	20-28
Ilderton.....	"	23
Exeter.....	"	23-24
Peterborough.....	"	23-25
St. Catharines.....	"	23-25
Strathroy.....	"	23-25
Uxbridge.....	"	24-25
Paisley.....	"	24-25
Cayuga.....	"	24-25
Berlin.....	"	24-25
Wingham.....	"	24-25
Mitchell.....	"	24-25
Sarnia.....	"	24-25
Prescott.....	"	24-26
Chatham.....	"	24-26
Orillia.....	"	24-26
Collingwood.....	"	24-27
St. John, N.B.....	Sept. 24-Oct. 4	
Woodstock.....	Sept. 25-26	
St. Marys.....	"	25-26
Clinton.....	"	25-26
Leamington.....	"	25-27
Lindsay.....	"	25-27
Brantford.....	"	26-27
Stratford.....	"	26-27
Glencoe.....	"	26-27

Welland.....	Sept.	26-27
Brampton.....	"	26-27
Ailsa Craig.....	"	26-27
Dundas.....	"	26-27
Seaforth.....	"	26-27
Norwich.....	"	27-28
Orangeville.....	Oct.	1-2
Thamesville.....	"	1-2
Paris.....	"	1-2
Cookstown.....	"	1-2
Walkerton.....	"	1-3
Goderich.....	"	1-3
Hamilton.....	"	1-3
Ganaoquo.....	"	1-3
Essex.....	"	1-3
Wallaceburg.....	"	2-3
Kirkton.....	"	2-3
Picton.....	"	2-3
Stayner.....	"	2-4
Markham.....	"	2-4
Almonte.....	"	2-4
Elora.....	"	3-4
Fergus.....	"	3-4
Gait.....	"	3-4
Ridgetown.....	"	7-9
Tilsonburg.....	"	8-9
Rockton.....	"	8-9
Milton.....	"	8-9
Woodville.....	"	8-9
Burford.....	"	10-11
Caledonia.....	"	10-11
Theford.....	"	11
Dunnville.....	"	14-15
Woodbridge.....	"	15-16
Simcoe.....	"	15-16
Hightate.....	"	17-18
Bradford.....	"	17-18

For Sale

(without reserve)

STALLIONS

3 French Coach

3 Glydesdale

15 Percherons

All purebred and registered. Every one guaranteed as a sure foal-getter.

The balance unsold, if any, after November 1st, will be sent to the United States.

For particulars apply to

THE HARAS NATIONAL CO.,
 30 St. James Street,
MONTREAL.

Buffalo Markets.

Under date of August 29th, Messrs. Eirick Bros., Live Stock Commission Agents, East Buffalo, N.Y., report the cattle market generally lower. Good cattle 10c. to 15c. per hundred lower. Calves were a trifle stronger, with good kinds selling readily. The sheep market was depressed, choice lambs fetching from \$4.00 to \$5.10. Values of swine were also lower.

Quotations are as follows :

Prime Steers.....	\$5.45 to \$5.70
Prime heifers.....	\$4.25 to \$4.50
Prime veal calves.....	\$7.00 to \$7.25
Export wethers.....	\$3.60 to \$3.75
Prime lambs.....	\$4.50 to \$5.10
Prime hogs.....	\$4.70 to \$4.75

A Cure that Cures

Is the kind most people desire. Such a cure is Ripans Tabules, but not a cure for everything. They are for liver and stomach disorders, and one tabule gives relief.

Ripans Tabules may be obtained through your nearest druggist. Price 50 cents a box.

302

Have you read "Dairying for Profit," by Mrs. E.M. Jones, Judge of Butter at World's Fair, Chicago? If not, you miss a treat, which would save you hundreds of dollars. Only 50c. by mail. ROBT. BROWN, Agent, Box 324, Brockville, Ont., Can.

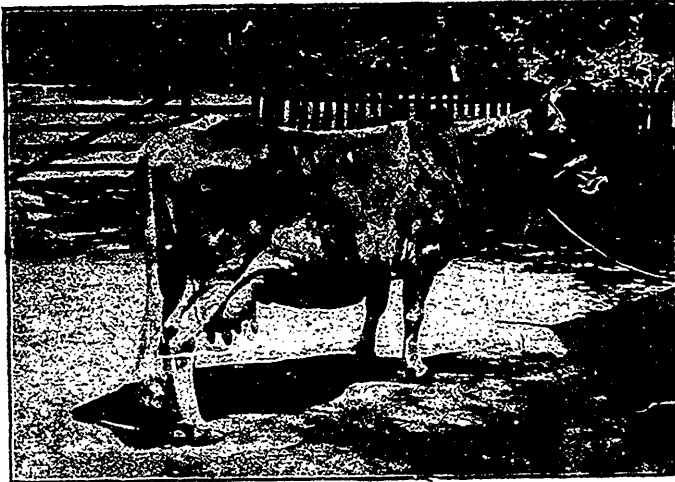

Jersey Cow, Massena

The property of Mrs. E. M. JONES, Brockville, Ont. Can.

8,000 lbs. Milk, which made 654 lbs. Splendid Butter, all within her sixteenth year.

My herd has won thirty medals — gold, silver, and bronze; over 400 cash prizes, besides diplomas, etc. Solid Silver Cup, value \$340, given at the Kellogg sale in New York for highest price on animals sold there; also Silver Tea Set at London, Ont. for three best Dairy Cows of any kind. Grandsons and granddaughters of this great cow for sale; also from Canada's Sir George, whose dam made 2634 lbs. butter a week, and gave 57 lbs. milk a day; also from my Signal bull, whose dam made 20 lbs. 6 oz. butter a week on second calf. Chicago tests have proved the Jersey to be the farmer's best paying cow

MRS. E. M. JONES,
331 Brockville, Ont., Can.

331

Stock Raisers!

We manufacture a full line of

Root Pulpers and Slicers

(Single or Combined, and for Hand or Power.)

SEND FOR DESCRIPTION

SEE OUR DISK HARROW

DAVID MAXWELL & SONS

ST. MARYS, ONTARIO

Mention FARMING.

Agents wanted in all unoccupied territory.

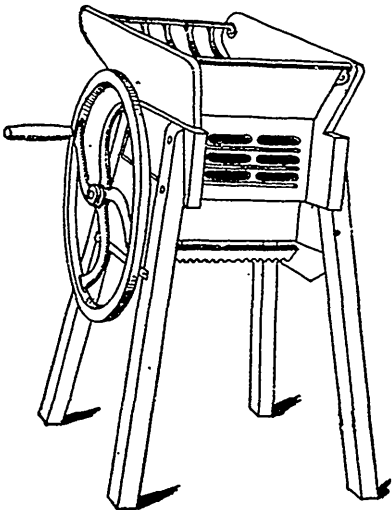

WESTERN FAIR

CANADA'S FAVORITE Live - Stock Exhibition

Sept. 12th to 21st, 1895.

LONDON, - ONTARIO

The Prize Lists are ready—and distributed to all known exhibitors. Several important additions and alterations in the Live Stock, Dairy, and Agricultural classes.

Send post-card if you have been overlooked. Stalls and space allotted on receipt of entry. Be early and get your choice.

ENTRIES CLOSE SEPTEMBER 12

Cheap railway and express rates on all lines. The greatest, strongest, and best collection of special attractions ever offered a Canadian public are being secured. Everything indicates a most successful Fair. Electric and steam cars, best hotel accommodation in Canada. Everything at reasonable rates.

Capt. A.W. Porte,
President.

Thos. A. Browne,
Secretary.

475

467

The Match that always lights

Costs no more
than the match
that doesn't al-
ways light.

E. B. EDDY'S

Matches always light.

ESTABLISHED 1884.

75,000 IN USE.

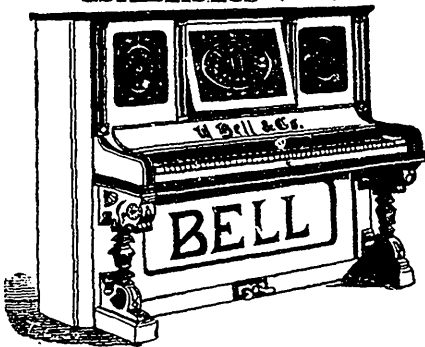

BELL PIANOS AND ORGANS

Recommended by leading musicians as superior in tone and touch. Elegant in finish and durable.

Send for catalogues and copies of testimonials to

THE BELL ORGAN & PIANO CO. (LIMITED)

GUELPH, ONTARIO.

Branch Warerooms at Toronto, Hamilton, London, Etc.

421

Mention this paper.

Seed Wheat

Selected clean stock of the following varieties :

- WHITE LEADER.....\$1.20 per bus.
- DAWSON'S GOLDEN CHAFF.....\$1.20 per bus.
- EARLY RED CLAWSON (true to name) 85 per bus.
- JONES' WINTER FYFE.....\$1.15 per bus.
- SURPRISE..... 90 per bus.
- GENESEE GIANT (Early).....\$1.20 per bus.

Cotton bags, 17 cents each. Prices above are for quantities to suit your wants. Send orders with cash enclosed by registered letter.

Timothy, Clover, and Grass
Seeds a specialty.

SEND FOR PRICES

J. A. SIMMERS

147, 149, 151 KING STREET EAST

Toronto, Ont.

BOYS FOR FARM HELP

THE Managers of Dr. Barnardo's Homes desire to obtain good situations with farmers throughout the country for bright, healthy little boys from ten to twelve years of age, who will be arriving from the London Homes in several parties during the present season. There are at present nearly 5,000 in these Homes receiving an industrial training and education to fit them for positions of usefulness in life, and those who are sent to Canada will be selected with the utmost care with a view to their moral and physical suitability for Canadian farm life. Farmers requiring such help are invited to apply to

MR. ALFRED B. OWEN,
 Agent Dr. Barnardo's Homes,
 397 214 Farley Avenue, TORONTO.

PATENTS, TRADE MARKS, CAVEATS, COPYRIGHTS.

Can I Obtain a Patent? For a prompt answer and an honest opinion write to **Munn & Co.**, who have had nearly fifty years' experience in the patent business. Communications strictly confidential. A Handbook of information concerning Patents and how to obtain them sent free. Also a catalogue of mechanical and scientific books sent free.

Patents taken through Munn & Co. receive special notice in the *Scientific American*, and thus are brought widely before the public without cost to the inventor. This splendid paper, issued weekly, elegantly illustrated, has by far the largest circulation of any scientific work in the world. \$3 a year. Sample copies sent free.

Building Edition, monthly, \$2.50 a year. Single copies 25 cents. Every number contains beautiful plates, in colors, and photographs of new houses, with plans, enabling builders to show the latest designs and secure contracts. Address

MUNN & CO.,
 361 Broadway, NEW YORK.

New Ideas in Dress

Ladies of taste, however fastidious, can always find something to please them at our establishment. We never remember a season so full of variety in style and material. We have combinations of material and color to suit all complexions and sizes of purse. Tailor-made gowns, in tweed or cloth, to order, from \$15, including material.

Send or call for samples and estimates.

The **Misses Shanly**, ROOM 8, AVENUE CHAMBERS, Northwest corner of Spadina and College, TORONTO. Belt Line and College Street cars pass every few minutes.

FIRST ANNUAL . . . Provincial Dairy Show

UNDER THE JOINT AUSPICES OF

The Agriculture and Arts Association of Ontario

AND

The Gananoque Horticultural Society

To be held on the Fair Grounds in the town of

GANANOQUE, CANADA

On Tuesday, Wednesday, and Thursday,
 October 1st, 2nd, and 3rd, 1895.

PRIZES FOR DAIRY CATTLE, PRODUCTS, AND APPLIANCES.

Entries close on Saturday, Sept. 14th, 1895, in time for Catalogue, and should be addressed to **HENRY WADE**, Secretary, Toronto.

Secretary: **HENRY WADE,**
 Toronto, Canada

THE MODEL SCUFFLER

LIGHT AND STRONG

QUICKLY ADJUSTED.

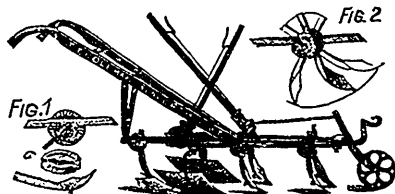

WE aim to make an implement which will adjust itself to all the varying conditions of the soil in the quickest possible manner, and with the least manipulation. We accomplish this by our new patented shank fastener or clamp. The change is made by loosening one nut half a turn, by which operation the point can be shifted to any conceivable position. This Scuffler is what many of our customers have already termed it—"a world beater." It is strong, durable, and of the best material and workmanship.

If your local agency does not supply you, write direct to

THE ESTATE OF T. T. COLEMAN
 SEAFORTH, ONTARIO.



**IRON FENCING
COMMUNION RAILING**
and all kinds of
IRON AND WIRE WORK

**TORONTO FENCE AND
ORNAMENTAL WORKS,**
437 37 Adelaide St. W. JOSEPH LEE, Manager

ONTARIO VETERINARY COLLEGE

Temperance St., Toronto, Can.

Patrons: Governor-General of Canada and Lieutenant-Governor of Ontario. The most successful Veterinary Institution in America. All experienced teachers. Classes begin on Wednesday, Oct. 17th. Fees, \$65 per session. Apply to the Principal, PROF. SMITH, V.S. EDINBURGH, TORONTO, CANADA.

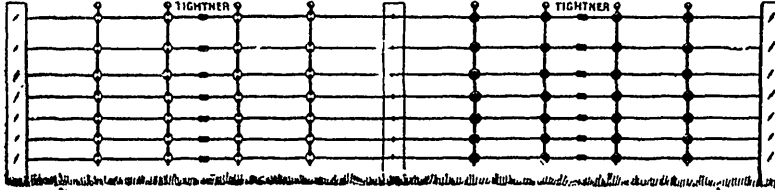

No better wire fence built than the Casey Diamond Grip, Pat. Just the thing for farmers—neat, strong, and durable. Will last a lifetime, barring accidents. Uses only straight wires, with so little depression as not to cause the galvanize to crack or peel. If there is a dealer who wants something better to handle than he's



had, try it. We also supply the Double Lock Wire Fence, which is claimed by some to be second to none, the lateral wire of which, as well as the upright stay, being crimped at joints. Our agents build either on premises. Agents wanted everywhere in Canada, to whom sole territory will be allotted. County and township rights for sale. Our Gas Pipe Frame Gate takes the lead. No better or cheaper place in the city to get plain or fancy turning done. Call on, or address,

CANADA FENCE CO. Cor. Bathurst and Clarence Sts. **LONDON ONT.**

THE GREAT LIVE STOCK AND AGRICULTURAL SHOW OF THE DOMINION

CANADA'S

Great Industrial Fair

TORONTO, September 2-14, 1895

Increased Prizes and Improved Accommodation

Greater and better attractions than ever before

There is more to see at the **Great Toronto Fair** than all others put together, and it is within easy reach of all.

**CHEAP
EXCURSIONS
on all
RAILWAYS.**

If you wish to keep posted in your business, you should attend one of the great fairs every year, and it will pay you to go to the best.

Make this the occasion of your annual holiday, and take in the **TORONTO FAIR.**

Visitors are coming from all parts of the Continent

JOHN J. WITHROW,

President.

TORONTO.

H. J. HILL,

Manager

Fertilizers for Fall Crops

should contain a high percentage of Potash to insure the largest yield and a permanent enrichment of the soil.

Write for our "Farmers' Guide," a 142-page illustrated book. It is brim full of useful information for farmers. It will be sent free, and will make and save you money. Address,

GERMAN KALI WORKS, 93 Nassau Street, New York.



BRANTFORD

Steel

Wind Mills

GALVANIZED.

Patent Roller and Ball Bearings

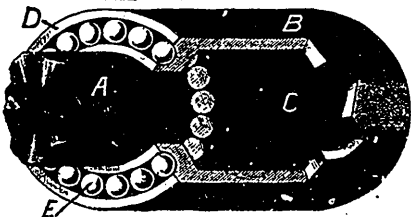

GALVANIZED STEEL TOWERS AND WHEELS

The Best in America.

Ideal Spray Pumps, Iron Pumps, Water Tanks, Piping, etc.

The Ideal Solid Power Mill, with Roller and Ball Bearings, is a wonder. Send for Circular, and mention this paper.

See exhibits at Toronto and London.



BRANTFORD CAN.

MONTREAL EXPOSITION COMPANY

THE GREATEST EXHIBITION

In the Province of Quebec

WILL BE HELD IN MONTREAL

September
12th to 21st, 1895

Grand Shows of
Live Stock, Agricultural and Dairy Products

BENCH SHOW OF DOGS

Horticultural Display Historical Museum
Ladies' Art Work Children's Work
H.M. Warships in Harbor.

Splendid attractions. Reduced rates on all railways.

S. C. STEVENSON, Manager and Secretary,
456 76 St. Gabriel St., MONTREAL

MOST PRACTICAL EDUCATION

Nimmo & Harrison

Business College

Cor. Yonge and College Sts., Toronto.

Excels all others for a thorough instruction in Bookkeeping, Shorthand, etc. Students enter any time. Catalogue sent free.

NIMMO & HARRISON, Principal.

400 ACRES. FRUIT AND ORNAMENTAL TREES

Grape Vines and Berry Plants.

Planters will find it to their interest to patronize a Canadian Nursery.

Varieties are offered most suitable to our climate; useless sorts discarded. My stock is graded with scrupulous exactness, and is true to name. Everything new and old in the nursery line deemed worthy of distribution. Having one hundred acres in fruit here, from which scions, buds, and cuttings are taken, I can offer stock that I know is true to name.

Agents wanted in every township.

Helderleigh Fruit Farms and Nursery,

400 ACRES IN EXTENT.

E. D. SMITH, Prop., WINONA, ONT.

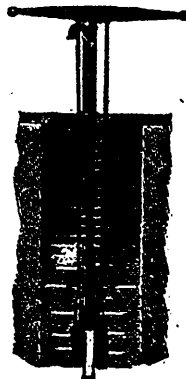

Will deliver water anywhere required, from one well.

ANDERSON'S Double-Acting FORCE PUMPS.

No suckers—will last a lifetime—never freezes—works very easy at any depth. We will send a pump direct to any responsible person, on trial. We guarantee satisfaction or no sale. Do not buy until you hear from us. Catalogue free.

J. W. ANDERSON
AYLMER WEST,
458 Ont.

The Locked- Wire Fence Company, INGERSOLL, ONT.

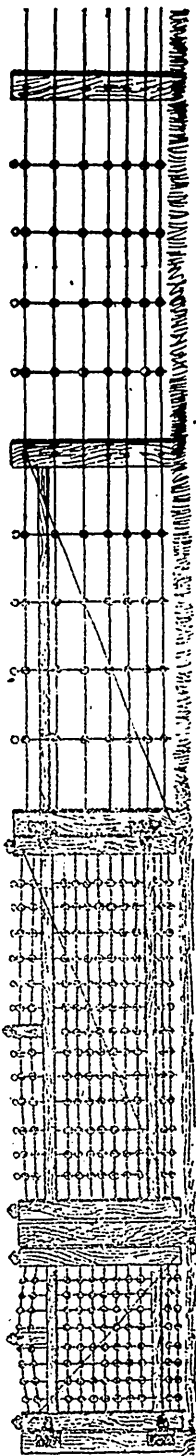

The accompanying cut represents five panels of fence and gate of the **LOCKED-WIRE FENCE**, which is now built with improved corrugated hardened steel stay and Bessemer steel clamp, a combination which is proof against the most manly stock or designing men. The crimp in the wire, in combination with steel clamp, when locked, acts as a spring, adjusting the fence to heat or cold.

**Perfectly Safe,
Stronger,
Better,
and Cheaper**

than any other fence,
and without doubt
the best fence on the
American continent.

All persons having wire fences erected in the past should use the stays and steel clamps of the Locked-Wire Fence Co. on them. The crimp consumes all the slack, makes the fence tight, and adds over 100 per cent. to its value, at a very small cost.

We desire to inform the farmers and public generally that we are prepared to supply the material or erect this fence throughout the Dominion of Canada.

Recollect, we are the only firm that is furnishing the genuine material in the form of the corrugated hardened steel stay and Bessemer steel clamp.

THE BEST FENCE MADE FOR FARMS AND RAILROADS.

AGENTS WANTED in every township.
Send for circulars and particulars.

ADDRESS—

**THE
Locked-Wire Fence Co.
INGERSOLL, ONT.**

408

THE LEMIRE STONE and STUMP EXTRACTOR

UNIQUE OF ITS KIND

Patented 1894.

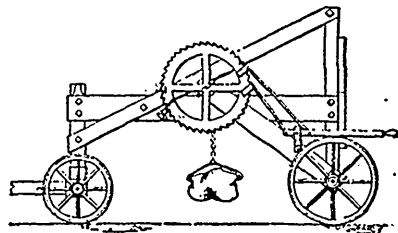

Lifts a stone of 18,000 lbs.

Can raise, carry off, and put in a fence 4 to 5 feet high, the stones extracted. By buying this strong and durable machine you can build your fence with your large stones instead of buying barbed wire for fencing. You will also clear your land for your mower and binder. In order to raise a stone, use the lever, and the hooks will hold the stone as it rises. You can let it down in the same way, or you can let it fall at once by touching a ring that is in the wheel. The axle-trees of this machine are made of wood, and we will sell it without the wheels to those who have wheels with tires 3 to 4 inches in width. Several farmers can combine and buy one.

PRICE - \$120

Patent for sale. For full information address;

AZARIE LEMIRE, Wotton, Que.

THE IMPROVED FAMILY KNITTER

Will knit 15 pairs of socks a day. Will do all knitting required in a family, home-spun or factory yarn.

Simplest Knitter on the Market

A child can operate it. We guarantee every machine to do good work. We can furnish ribbing attachments. Agents wanted. Write for particulars.

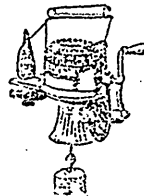

PRICE. \$8 DUNDAS KNITTING MACHINE CO.

Mention this paper.

Dundas, Ont.

Dairying for Profit

Is read by all good Dairy-men. Given for one new subscriber to FARMING.

USE
Queenston
Cement . . FOR BUILDING
 CONCRETE OR OTHER WALLS, CISTERNS, STABLE FLOORS,
 HOG TROUGHS, ETC.

Write for prices and particulars. When parties use our goods, when necessary, we will send a skilled man, at our own cost, to give instructions how to build. Farmers can thus build their walls and save half the cost.

ISAAC USHER & SONS, - 459 - **Thorold, Ont.**

THE LATEST AND BEST IS
Tolton's No. 1 Double Root Cutter

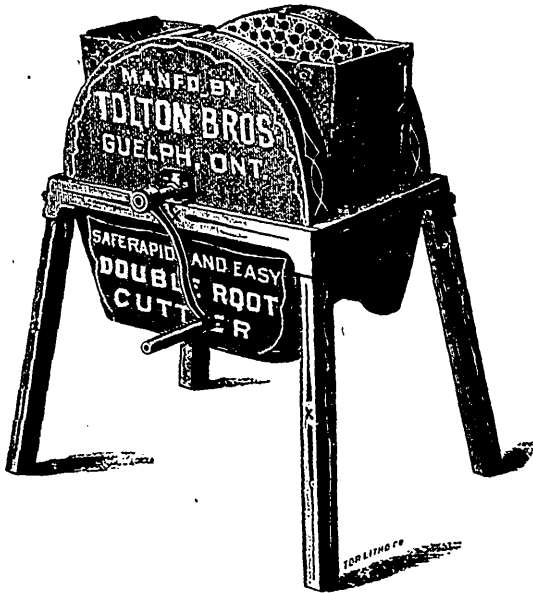

Patented September 6, 1894.

285 DO NOT FAIL TO SEE OUR EXHIBIT AT TORONTO FAIR

Being the only Double Root Cutter manufactured, and is noted for being a Safe, Rapid, and Easy Machine, and one which sells at sight after a careful inspection, as it will either pulp coarse or fine, or slice by simply turning over the centre grate and turning crank the reverse way. It is considered in either capacity superior to any single machines, and has taken first prize at every fair where exhibited, where prizes were given.

POINTS OF MERIT

- 1st.—To change from pulping to slicing is but the work of a moment, which can be done at the one feeding, with no loss of time and no trouble.
- 2nd.—There are two separate wheels, one for pulping and the other for slicing. Each one is specially adapted for the work it has to do, with the best of knives placed in their respective wheels in a manner to obtain the very best results possible (three for slicing and six for pulping).
- 3rd.—The united force of both wheels is always used in doing the work in either capacity. This accounts for it being a steady, easy-running, and rapid root cutter.
- 4th.—The Hopper being between the wheels, and having large lower pockets, prevents choking, and with the knife-wheels both internally shielded makes it perfectly safe and prevents the roots from acting as a break on the wheels, and also from jostling them about, so common in all other combined machines.
- 5th.—Hence the Latest and Best, and, what has been long looked for, a safe, rapid, and easy Double Root Cutter.

Soliciting your orders for same, we are, yours truly,

TOLTON BROS.
GUELPH, ONT.

Agricultural College

The Ontario Agricultural College will reopen on October 1st.

Full courses of Lectures, with practical instruction in Agriculture, Horticulture, Live Stock, Dairying, Poultry, Beekeeping, Veterinary Science, Chemistry, Geology, Botany, Entomology, Bacteriology, English, Mathematics, Bookkeeping, and Political Economy.

Send for circular, giving terms of admission, course of study, etc.

JAMES MILLS, M.A., President,
GUELPH, ONT.

The Happy Thought Range

Over 50,000 in use in Canada,
and every user pleased

•••

It is said that the cooking apparatus is the most important article in any household. Then why not have the best? The Happy Thought Range combines perfection of operation with ease of management, it is always ready for work, and has more features of utility and convenience than were ever before combined. Other ranges may be sold for less money, not enough to make the Happy Thought extravagant, but sufficient to show its superiority. If you have any difficulty in getting particulars from your dealer, drop a card to the manufacturer.

WILLIAM BUCK, Brantford,
Buck's Stove Works.

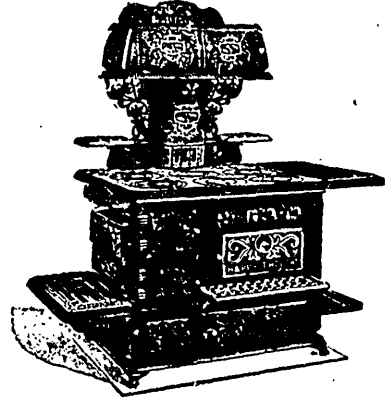

471

WE REFER TO OUR FENCE

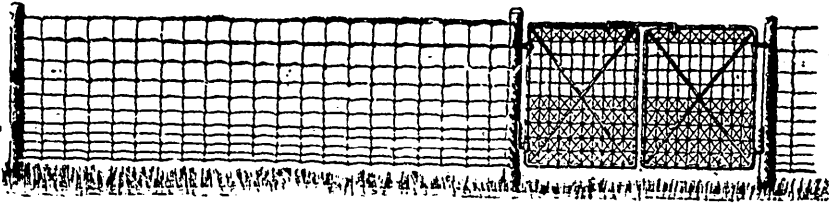

AS A TESTIMONIAL OF ITS VALUE.

Page Fence is now sold and used in nearly every county in Ontario, and is in the lead everywhere. "I will use nothing else" is the decision of hundreds of farmers who have seen and tried it. Our standard fence has eleven steel horizontal wires tied together every foot. It costs no more than is charged for half or two-thirds as many wires in other fences. Our free illustrated monthly paper tells all about it. Ask for it.

The Page Wire Fence Company of Ontario, Ltd.,

Walkerville, Ont.

258

MICA ROOFING

USE
**Mica
Roofing**

On all your buildings.
It is cheaper than shingles.
Waterproof and Fireproof.

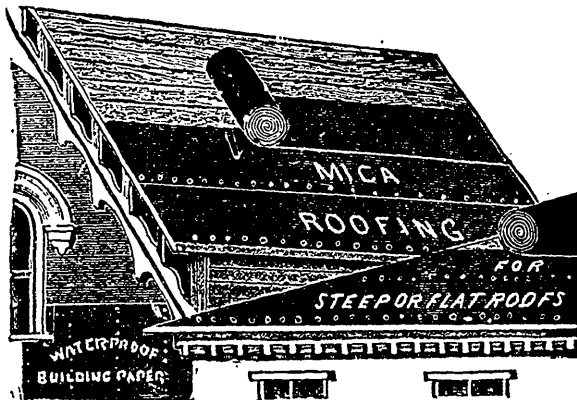

USE
**Mica
Paint**

To Repair Leaky Roofs.
Shingle, Iron, or Tin Roofs painted with it will last twice as long.

RAPIDLY TAKING THE PLACE OF SHINGLES.

Is put up in rolls of one square each, 40 feet long by 32 inches wide, and costs only \$2.25, including nails, thus affording a light, durable, and inexpensive roofing, suitable for buildings of every description—especially flat roofs—and can be laid by any person of ordinary intelligence.

HAMILTON MICA ROOFING COMPANY,

Office—101 Rebecca Street, HAMILTON, ONT.