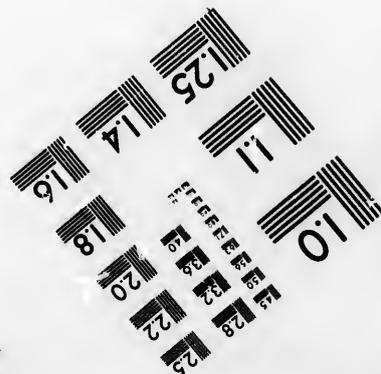
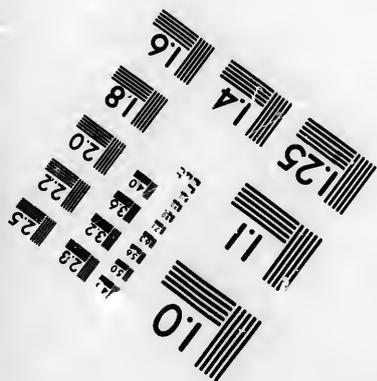
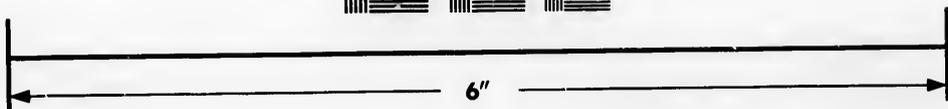
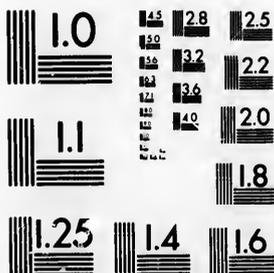

**IMAGE EVALUATION  
TEST TARGET (MT-3)**



**Photographic  
Sciences  
Corporation**

23 WEST MAIN STREET  
WEBSTER, N.Y. 14580  
(716) 872-4503

**CIHM/ICMH  
Microfiche  
Series.**

**CIHM/ICMH  
Collection de  
microfiches.**



**Canadian Institute for Historical Microreproductions / Institut canadien de microreproductions historiques**

**© 1984**

Technical and Bibliographic Notes/Notes techniques et bibliographiques

The Institute has attempted to obtain the best original copy available for filming. Features of this copy which may be bibliographically unique, which may alter any of the images in the reproduction, or which may significantly change the usual method of filming, are checked below.

L'Institut a microfilmé le meilleur exemplaire qu'il lui a été possible de se procurer. Les détails de cet exemplaire qui sont peut-être uniques du point de vue bibliographique, qui peuvent modifier une image reproduite, ou qui peuvent exiger une modification dans la méthode normale de filmage sont indiqués ci-dessous.

- Coloured covers/  
Couverture de couleur
- Covers damaged/  
Couverture endommagée
- Covers restored and/or laminated/  
Couverture restaurée et/ou pelliculée
- Cover title missing/  
Le titre de couverture manque
- Coloured maps/  
Cartes géographiques en couleur
- Coloured ink (i.e. other than blue or black)/  
Encre de couleur (i.e. autre que bleue ou noire)
- Coloured plates and/or illustrations/  
Planches et/ou illustrations en couleur
- Bound with other material/  
Relié avec d'autres documents
- Tight binding may cause shadows or distortion  
along interior margin/  
La reliure serrée peut causer de l'ombre ou de la  
distortion le long de la marge intérieure
- Blank leaves added during restoration may  
appear within the text. Whenever possible, these  
have been omitted from filming/  
Il se peut que certaines pages blanches ajoutées  
lors d'une restauration apparaissent dans le texte,  
mais, lorsque cela était possible, ces pages n'ont  
pas été filmées.
- Additional comments:/  
Commentaires supplémentaires:

- Coloured pages/  
Pages de couleur
- Pages damaged/  
Pages endommagées
- Pages restored and/or laminated/  
Pages restaurées et/ou pelliculées
- Pages discoloured, stained or foxed/  
Pages décolorées, tachetées ou piquées
- Pages detached/  
Pages détachées
- Showthrough/  
Transparence
- Quality of print varies/  
Qualité inégale de l'impression
- Includes supplementary material/  
Comprend du matériel supplémentaire
- Only edition available/  
Seule édition disponible
- Pages wholly or partially obscured by errata  
slips, tissues, etc., have been refilmed to  
ensure the best possible image/  
Les pages totalement ou partiellement  
obscurcies par un feuillet d'errata, une pelure,  
etc., ont été filmées à nouveau de façon à  
obtenir la meilleure image possible.

This item is filmed at the reduction ratio checked below/  
Ce document est filmé au taux de réduction indiqué ci-dessous.

10X	14X	18X	22X	26X	30X
<input type="checkbox"/>	<input type="checkbox"/>	<input type="checkbox"/>	<input checked="" type="checkbox"/>	<input type="checkbox"/>	<input type="checkbox"/>
12X	16X	20X	24X	28X	32X

The copy filmed here has been reproduced thanks to the generosity of:

Douglas Library  
Queen's University

The images appearing here are the best quality possible considering the condition and legibility of the original copy and in keeping with the filming contract specifications.

Original copies in printed paper covers are filmed beginning with the front cover and ending on the last page with a printed or illustrated impression, or the back cover when appropriate. All other original copies are filmed beginning on the first page with a printed or illustrated impression, and ending on the last page with a printed or illustrated impression.

The last recorded frame on each microfiche shall contain the symbol  $\rightarrow$  (meaning "CONTINUED"), or the symbol  $\nabla$  (meaning "END"), whichever applies.

Maps, plates, charts, etc., may be filmed at different reduction ratios. Those too large to be entirely included in one exposure are filmed beginning in the upper left hand corner, left to right and top to bottom, as many frames as required. The following diagrams illustrate the method:

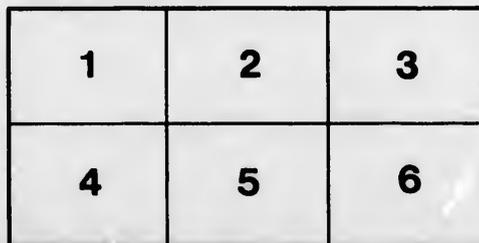
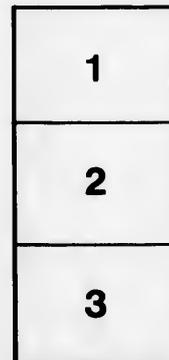

L'exemplaire filmé fut reproduit grâce à la générosité de:

Douglas Library  
Queen's University

Les images suivantes ont été reproduites avec le plus grand soin, compte tenu de la condition et de la netteté de l'exemplaire filmé, et en conformité avec les conditions du contrat de filmage.

Les exemplaires originaux dont la couverture en papier est imprimée sont filmés en commençant par le premier plat et en terminant soit par la dernière page qui comporte une empreinte d'impression ou d'illustration, soit par le second plat, selon le cas. Tous les autres exemplaires originaux sont filmés en commençant par la première page qui comporte une empreinte d'impression ou d'illustration et en terminant par la dernière page qui comporte une telle empreinte.

Un des symboles suivants apparaîtra sur la dernière image de chaque microfiche, selon le cas: le symbole  $\rightarrow$  signifie "A SUIVRE", le symbole  $\nabla$  signifie "FIN".

Les cartes, planches, tableaux, etc., peuvent être filmés à des taux de réduction différents. Lorsque le document est trop grand pour être reproduit en un seul cliché, il est filmé à partir de l'angle supérieur gauche, de gauche à droite, et de haut en bas, en prenant le nombre d'images nécessaire. Les diagrammes suivants illustrent la méthode.



OPERATIVE GYNECOLOGY

VOLUME I



# OPERATIVE GYNECOLOGY

BY

HOWARD A. KELLY, A. B., M. D.

FELLOW OF THE AMERICAN GYNECOLOGICAL SOCIETY;  
PROFESSOR OF GYNECOLOGY AND OBSTETRICS IN THE JOHNS HOPKINS UNIVERSITY,  
AND GYNECOLOGIST AND OBSTETRICIAN TO THE JOHNS HOPKINS HOSPITAL, BALTIMORE;  
FORMERLY ASSOCIATE PROFESSOR OF OBSTETRICS IN THE UNIVERSITY OF PENNSYLVANIA;  
CORRESPONDING MEMBER OF THE SOCIÉTÉ OBSTÉTRICALE ET GYNÉCOLOGIQUE DE PARIS,  
AND OF THE GESELLSCHAFT FÜR GEBURTSHÜLFER ZU LEIPZIG

*WITH TWENTY-FOUR PLATES AND OVER  
FIVE HUNDRED AND FIFTY ORIGINAL ILLUSTRATIONS*

VOL. I

TORONTO  
GEORGE N. MORANG  
63 YONGE STREET  
1898

COPYRIGHT, 1898,  
BY D. APPLETON AND COMPANY.

737534

Thomas J. Bule Library, Trent University 19215 18

TO  
ROBERT P. HARRIS, M. D.,  
WHOSE KINDLY SYMPATHY AND GOOD ADVICE  
HAVE AIDED ME FROM THE FIRST,  
I DEDICATE THIS BOOK.

“And this is the reason why the cure of many diseases is unknown to the physicians of Hellas, because they are ignorant of the whole, which ought to be studied also; for the part can never be well unless the whole is well.”

SOCRATES IN THE CHARMIDES OF PLATO.

*Translated by B. Jowett, vol. 1, p. 11.*

## PREFACE.

My aim in writing this book has been to place in the hands of the many friends who have from time to time visited me and followed my work, a convenient summary of the various gynecological operations I have found best in my own practice. It is far from my purpose to present a digest of the literature of the subject, or even to describe all the important operations; if I had set out to do this, the book would never have been written in the midst of the pressing practical duties of my work.

Gynecology is so young a science, and many of its surgical procedures are as yet so incompletely developed, that I think the best service a gynecologist can render his specialty is to record accurately his own experiences. Scientific accuracy is especially necessary in gynecology, in which the discovery of anesthesia and the perfection of an aseptic technique have rendered operations safe which a few years ago would have been necessarily fatal. It is comparatively easy now to open the abdomen; it is no easier than it ever was to combat the causes of disease. This fact is emphasized not only by the number and variety of operations proposed, but also by a healthy tendency toward conservatism. Although I have spent several years in the preparation of my book, so rapid have been the changes in the gynecological field that I have found it necessary to rewrite some of the chapters two and even three times.

I have few claims to originality to urge, and these are, I think, clearly set forth in the text. I should further explain that I have taken the liberty afforded by the more general scope of the work of often omitting references where it would have consumed time to search for them. My own special researches are connected with the operation for suspension of the uterus, and with the investigation of vesical and ureteral diseases. In the classification of tumors of the bladder, I have largely used the work of Clado.

I have many acknowledgments to make and many kind friends to thank for their aid throughout.

First of all, I want to express my indebtedness to Dr. Mary Augusta Scott, to whose constant kindly stimulus and friendly help more than to any one else the work owes its existence. Dr. Scott has arranged, revised, and edited the book.

I am glad of this opportunity to thank my colleague, Prof. William H. Welch, for suggestions as to Chapter I. I have also to thank Dr. B. Meade Bolton for Chapter III, and Dr. L. F. Barker for Chapter XXXVIII; and also

Dr. J. M. T. Finney. Dr. S. Flexner has kindly read over the section on peritonitis in Chapter XXII, and Dr. J. Whitridge Williams has reviewed the first part of Chapter XXXIV for me. Dr. W. W. Russell assisted in the preparation of Chapter XXX. Dr. Thomas S. Cullen has been a valuable helper throughout, furnishing pathological reports and identifying cases.

I am under especial obligation to Dr. John G. Clark for furnishing material and for criticising the work while in progress in places too numerous to mention. Dr. Otto Ramsay has carefully reviewed several of the chapters, especially Chapters XII and XIII, on the bladder and ureters, where his special studies have been of service in rendering the discussion of the subject more accurate. Dr. J. E. Stokes helped to identify cases from our histories, and read over Chapter II in the light of his experience in assisting me in operations in private. I must also thank Dr. J. H. Durfee, Dr. G. W. Dobbin, and Dr. B. B. Lanier.

The illustrations have all been made by Mr. Max Brödel and Mr. H. Becker. I am particularly indebted to Mr. Brödel for his unflagging interest and for the great zeal with which he has thrown himself into the work from the beginning. His pictures speak for themselves. Mr. A. S. Murray has been associated with my work for the past five years and has furnished me with over sixteen hundred photographs. The illustrations have been drawn partly from these photographs, and partly from my own sketches made on the spot, at operations or immediately afterwards. Mr. Murray has also devised various original ways of photographing patients on the operating table, among them vertical photography.

Finally, many thanks are due to Miss Jennie Gill, my efficient secretary, for setting up the manuscript.

HOWARD A. KELLY.

BALTIMORE, July 2, 1897.

## CONTENTS.

CHAPTER	PAGE
I. SEPSIS, ASEPSIS, AND ANTISEPSIS IN HOSPITALS . . . . .	1
II. ANTISEPSIS AND ASEPSIS IN PRIVATE PRACTICE . . . . .	23
III. BACTERIOLOGY . . . . .	32
IV. TOPOGRAPHICAL ANATOMY . . . . .	32
V. THE GYNECOLOGICAL EXAMINATION . . . . .	80
VI. GYNECOLOGICAL INSTRUMENTS AND DRESSINGS . . . . .	133
VII. ANESTHESIA . . . . .	145
VIII. GENERAL PRINCIPLES INVOLVED IN PLASTIC OPERATIONS . . . . .	159
IX. DISEASES OF THE EXTERNAL GENITALS . . . . .	168
X. RUPTURE OF THE RECTO-VAGINAL SEPTUM AND RELAXED VAGINAL OUTLET . . . . .	204
XI. OPERATIONS ON THE VAGINA . . . . .	230
XII. AFFECTIONS OF THE URETHRA AND BLADDER . . . . .	266
XIII. AFFECTIONS OF THE URETERS . . . . .	306
XIV. OPERATIONS UPON THE CERVIX OF THE UTERUS, INCLUDING DILATATION AND CURETTAGE . . . . .	478
XV. PROLAPSE OF THE UTERUS . . . . .	499
XVI. VAGINAL HYSTERECTOMY . . . . .	514
XVII. INVERSION OF THE UTERUS . . . . .	531
XVIII. VAGINAL EXTIRPATION OF SUBMUCOUS MYOMATA AND POLYPI . . . . .	538
XIX. THE UTERUS AS A RETENTION CYST . . . . .	549



## LIST OF ILLUSTRATIONS.

FIG.	PAGE
1. Steam sterilizer for dressings and dishes, the door partly open . . . . .	5
2. Sectional view of sterilizer for dressings and dishes, with steam in central chamber under pressure . . . . .	6
3. Instrument sterilizer . . . . .	7
4. Hand basins set on pivots for removal and sterilization . . . . .	9
5. Operating table, with stout brass legs and frame and heavy glass top . . . . .	10
6. Tanks for storage of hot and cold water . . . . .	11
7. Three sizes of silk . . . . .	12
8. Rolls of sterilized silk threads on glass bobbins . . . . .	13
9. Skeins of catgut sterilized with cumol . . . . .	14
10. Cumol sterilizer . . . . .	16
11. McKelway portable frame . . . . .	28
12. Edelohls portable table . . . . .	29
13. Sagittal section of child's pelvis . . . . .	43
14. Sagittal section of pelvis of adult woman . . . . .	44
15. Superficial layers of abdominal muscles . . . . .	45
16. Deep layers of abdominal muscles . . . . .	46
17. Transverse section through the abdominal wall above the semilunar fold of Douglas . . . . .	47
18. Transverse section through the abdominal wall below the semilunar fold of Douglas . . . . .	47
19. The celiotomy veins . . . . .	48
20. Mesentery of small intestine, the intestine removed . . . . .	50
21. Groups of small intestine . . . . .	51
22. Position of abdominal wall and intestines in emaciated patient (front view) . . . . .	52
23. Position of abdominal wall and intestines in emaciated patient (sagittal section) . . . . .	53
24. Topography of appendix vermiformis and termination of ileum . . . . .	54
25. Pelvic viscera in normal position . . . . .	55
26. The utero-sacral ligaments and Douglas's <i>cul-de-sac</i> . . . . .	56
27. Vascular trunks of lower abdomen . . . . .	57
28. Vascular trunks of lower abdomen, showing usual origin of ovarian arteries . . . . .	58
29. Relation of the ureter to the uterine vessels <i>in situ</i> . . . . .	59
30. Vascular supply of uterus, ovary, and tube . . . . .	60
31. Arterial blood supply of ovary . . . . .	61
32. Parovarium . . . . .	61
33. Lymphatic system of pelvic organs . . . . .	62
34. Vasularization of vault of bladder . . . . .	63
35. Vasularization of vesical mucosa . . . . .	64
36. Areas of vasularization of vesical mucosa . . . . .	65
37. Topography of fixed part of bladder . . . . .	66
38. Blood supply of lower sigmoid and rectum . . . . .	67
39. Sagittal section through the pelvis, showing vessels and nerves posteriorly . . . . .	68
40. Same after removal of the viscera . . . . .	69
41. Round ligament, inguinal and femoral rings, as seen from within . . . . .	70
42. Topography of round ligament . . . . .	71

FIG.	PAGE
43. The pelvis, after removal of the viscera, seen through the superior strait . . . . .	72
44. Course of the internal pudic artery from its origin to its termination . . . . .	73
45. Arterial vascularization of the perineum and pelvic floor from below . . . . .	74
46. Muscles and nerves of the perineum and pelvic floor, from below . . . . .	75
47. Origin and insertion of the fibers of the levator ani muscles . . . . .	76
48. Sagittal section showing the mechanism of the levator ani muscles . . . . .	77
49. Blending of the levator ani muscle with the muscle of the rectum . . . . .	78
50. Coronal section of the pelvis, showing its posterior half and the relations of the levator ani muscles to the rectum . . . . .	79
51. Sagittal section through normal adult body . . . . .	82
52. Enormous ovarian cystoma . . . . .	83
53. Characteristic outline of a large ovarian cyst, from below . . . . .	84
54. Abdomen distended by a large parovarian cyst . . . . .	85
55. Form of abdomen characteristic of a large globular myomatous uterus . . . . .	86
56. Abdomen distended by a large cystic myoma . . . . .	87
57. Abdomen distended by a large multinodular myoma . . . . .	88
58. Flaccid abdomen, with ascites . . . . .	88
59. Section through normal abdomen . . . . .	89
60. Section through ascitic abdomen . . . . .	89
61. Cylindrical flattened abdomen characteristic of ascites . . . . .	90
62. Ovarian tumor, with ascites . . . . .	91
63. Sims's posture . . . . .	92
64. Knee-chest posture . . . . .	93
65. Bimanual examination of the pelvic viscera (left view) . . . . .	95
66. Bimanual examination of the pelvic viscera (right view) . . . . .	96
67. Bimanual examination, showing deep invagination of the pelvic floor . . . . .	97
68. Palpating the roots of the sciatic nerve by the rectum . . . . .	99
69. Bimanual examination, with the uterus in artificial descensus . . . . .	101
70. External direct method of measuring the conjugata vera (first step) . . . . .	105
71. External direct method of measuring the conjugata vera (second step) . . . . .	106
72. Differentiation between a myoma in the anterior uterine wall and an enlarged uterus in antelexion . . . . .	109
73. Lateral displacement of the uterus by an ovarian cyst . . . . .	110
74. Same at a later stage . . . . .	111
75. Deviation of the sigmoid flexure . . . . .	116
76. Deviation of the sigmoid flexure . . . . .	117
77. Deviation of the sigmoid flexure . . . . .	118
78. Deviation of the sigmoid flexure . . . . .	119
79. Patient in position for a rectal examination . . . . .	120
80. Examination of the rectum by reflected light . . . . .	121
81. The four cardinal projections of the abdomen and pelvis . . . . .	128
82. Diagram showing how to use the projections of Fig. 81 in the case of a pelvic tumor, accurately locating it and registering its form . . . . .	130
83. Diagrams showing the directions of development of abdominal tumors . . . . .	131
84. Tumor in transverse colon . . . . .	132
85. Emmet's left-curved scissors . . . . .	134
86. Tenacula of various kinds . . . . .	135
87. Tenaculum forceps . . . . .	136
88. Three-pronged tenaculum forceps . . . . .	136
89. Long rat-toothed forceps . . . . .	137
90. Hemostatic forceps . . . . .	137
91. Miller's sponge forceps . . . . .	137
92. Placenta and polyp forceps . . . . .	138
93, 94, 95, 96. Rapid method of tying the square knot (in four steps) . . . . .	139, 140
97. Curved needles . . . . .	141

FIG.	PAGE
98, 99. Making the silk carrier (in two steps) . . . . .	141
100, 101. Needle forceps . . . . .	142
102. Packer . . . . .	143
103. Artificial respiration. Inspiration . . . . .	154
104. Artificial respiration. Expiration . . . . .	155
105. Swedish ball and nozzle irrigator . . . . .	162
106. Hematoma of the vulva . . . . .	169
107. Myoma of the round ligament . . . . .	172
108. Adeno-myoma of the round ligament . . . . .	173
109. A portion of the same, twelve times magnified . . . . .	174
110. Early epithelioma of the left labium majus . . . . .	175
111. Advanced epithelioma of right labium majus . . . . .	176
112. Cysts of left labium minor . . . . .	178
113. Section through small abscess of labium minor . . . . .	179
114. Preputial adhesions in a child one year old . . . . .	180
115. Concretion from beneath the prepuce of the clitoris . . . . .	181
116. Elephantiasis of labia minora . . . . .	182
117. Carcinoma of the glans of the clitoris . . . . .	186
118. Closure of wound after excision of the clitoris . . . . .	187
119. Ovoid fluctuating cyst of the clitoris . . . . .	188
120. Left vulvo-vaginal gland excised . . . . .	191
121. Abscess of left vulvo-vaginal gland . . . . .	192
122. Adeno-carcinoma of left vulvo-vaginal gland . . . . .	195
123. Agglutination of the labia in a little girl . . . . .	197
124. Same, after division of the membrane . . . . .	198
125. Tuberculosis of the vestibule . . . . .	200
126. Area of excision of the tubercular disease in same case . . . . .	201
127. Raw surface after excision of the disease, same case . . . . .	201
128. Flap taken from left anterior lateral vaginal wall . . . . .	202
129. Restoration of external urethral orifice . . . . .	202
130. Union of wound above urethra, in Y-form . . . . .	203
131. Normal vaginal outlet in a nullipara . . . . .	205
132. Complete tear of the recto-vaginal septum . . . . .	210
133. Complete tear of the perineum . . . . .	211
134. Rupture of the recto-vaginal septum . . . . .	212
135. Same, showing nearly intact hymen . . . . .	213
136. Complete tear of the recto-vaginal septum . . . . .	214
137. Same, with demulcation completed . . . . .	214
138. Same, with rectal sutures introduced, but not tied . . . . .	215
139. Same, with rectal sutures all tied, except those of silkworm gut . . . . .	216
140. Same, with rectal and vaginal sutures all introduced and tied, and the perineal sutures in place, but not yet tied . . . . .	217
141. Same, all three sets of sutures introduced and tied . . . . .	218
142. Scheme of operation for complete tear of recto-vaginal septum . . . . .	219
143. Method of demonstrating a relaxed vaginal outlet . . . . .	220
144. Test for relaxed vaginal outlet . . . . .	221
145. Test of a marked relaxation of the vaginal outlet . . . . .	222
146. Relaxed vaginal outlet . . . . .	223
147. Calibrator for measuring degree of relaxation of the vaginal outlet . . . . .	224
148. Relaxed vaginal outlet in a VII-para . . . . .	224
149. Relaxed vaginal outlet. Shepherd's crook tenacula fixed in both sides . . . . .	225
150. Relaxed vaginal outlet. Shepherd's crook tenacula and tenaculum forceps in place . . . . .	225
151. Relaxed vaginal outlet, with silkworm gut tension suture in triangle on right side . . . . .	226
152. Same, with the suture tied and pulled down . . . . .	227
153. Same, with inside sutures introduced and tied . . . . .	228

FIG.	PAGE
154. Same, showing the gathering suture . . . . .	229
155. Same, operation completed . . . . .	229
156. Entire absence of vagina . . . . .	233
157. Relations of rudimentary uterus, ovaries, and tubes in the case of absence of vagina . . . . .	234
158. Normal left tube and ovary, with uterine nodule . . . . .	235
159. Normal right tube and ovary, with uterine nodule . . . . .	236
160. Intact hymen after nine years of marriage . . . . .	237
161. Traumatic atresia of the vagina . . . . .	238
162. Double vagina with thick septum . . . . .	239
163. Double vagina with double cervix . . . . .	240
164. Atresia of vagina due to cup and stem pessary . . . . .	241
165. Cyst of right vaginal wall . . . . .	245
166. Cyst of anterior vaginal wall in pregnancy . . . . .	246
167. Abscess of the recto-vaginal septum . . . . .	247
168. Abscess of recto-vaginal septum from rectal fistula . . . . .	248
169. Section of wall of cyst from anterior vaginal wall . . . . .	248
170. Outline of cyst protruding from the vagina . . . . .	249
171. Section of wall of cyst from posterior vaginal wall . . . . .	250
172. Cross-section through wall of vaginal cyst . . . . .	251
173. Large, thick-walled cyst of posterior vaginal wall . . . . .	252
174. Primary carcinoma of posterior vaginal wall . . . . .	256
175. Primary vaginal carcinoma . . . . .	257
176. Atresia of the vagina . . . . .	258
177. Same, showing operation . . . . .	259
178. Atresia of vagina, in sagittal section . . . . .	260
179. Same, showing operation . . . . .	261
180. Atresia of the vagina in a negress . . . . .	262
181. Coronal section of an old atresia of vagina . . . . .	263
182. Same, after operation, with sutures in place . . . . .	264
183. Instrument for measuring calibers and diameters of specula . . . . .	276
184. Cystoscope and obturator . . . . .	277
185. Urethral calibrator and dilator . . . . .	277
186. Delicate mouse-toothed forceps . . . . .	278
187. Searcher for locating urethral orifice . . . . .	279
188. Examination of bladder in the dorsal position . . . . .	279
189. Vesical speculum introduced, knee-chest position . . . . .	280
190. Patient in a harness, knee-chest position, for cystoscopic examination . . . . .	281
191. Holding the vesical speculum ready for introduction . . . . .	282
192. Examination of bladder, knee-chest position . . . . .	283
193. Cystoscope with oblique end and obturator . . . . .	285
194. Instrument for internal vesical measurements . . . . .	285
195. Hypertrophy of urethral mucosa . . . . .	290
196. Hypertrophied external urethral orifice . . . . .	291
197. Operation for hypertrophied urethral mucosa . . . . .	292
198, 199. Urethro-vaginal and vesico-vaginal fistula in the same patient . . . . .	297
200. Same, showing method of introducing sutures . . . . .	298
201. Concealed abscess of Skene's gland . . . . .	301
202. Large suburethral abscess . . . . .	304
203. Urethral caruncle . . . . .	307
204. Exstrophy of bladder become cancerous . . . . .	320
205. Hairpin calculus . . . . .	328
206. Section of a vesical calculus . . . . .	329
207. V. Dittel's operation for vesico-uterine fistula . . . . .	330
208. Same, operation completed . . . . .	331
209. Scissors for paring edges of vesico-vaginal fistula . . . . .	337

FIG.	PAGE
210. Classical operation for vesico-vaginal fistula . . . . .	338
211. Scheme of same . . . . .	339
212. Vesico-vaginal fistula closed with buried catgut suture . . . . .	341
213. Dudley's operation for large vesico-vaginal fistula . . . . .	342
214. Same, showing smaller bladder . . . . .	343
215, 216. Vesico-vaginal fistula occupying entire base of bladder . . . . .	344
217, 218. Vesico-utero-vaginal fistula . . . . .	345
219. Suprapubic operation for vesico-vaginal fistula (Trendelenburg) . . . . .	349
220. Vesico-utero-vaginal and vesico-uterine fistula in the same patient . . . . .	350
221. Vesico-uterine fistula, showing treatment . . . . .	351
222. Vesico-uterine fistula, sutures in place . . . . .	352
223. Vesico-vaginal fistula caused by pessary . . . . .	353
224. Hypertrophy of anterior vaginal wall due to cystitis . . . . .	354
225. Pyuria due to suppurating dermoid cyst opening into bladder . . . . .	355
226. Pronged instrument for tying knot inside the bladder . . . . .	358
227. Linear ulcer of posterior wall of bladder . . . . .	365
228. Ulcer of the trigonum of the bladder . . . . .	366
229. Tubercular cystitis . . . . .	368
230. Two-way catheter . . . . .	371
231. Rubber balloon for treatment of cystitis . . . . .	372
232. Rubber balloon rolled and grasped in the forceps . . . . .	373
233. Bladder inflated by the vesical balloon . . . . .	373
234. Long metal ureteral catheter . . . . .	402
235. End of elastic bougie tipped with wax . . . . .	403
236. Sounding the left ureter with the searcher . . . . .	404
237. Using the goniometer . . . . .	405
238. Passing a metal ureteral catheter into the left ureteral orifice . . . . .	406
239. Washing out the pelvis of the kidney . . . . .	407
240. Catheterizing both ureters . . . . .	409
241. Sieve and graduate for filtering urine . . . . .	411
242. Instrument for collecting urine without catheterizing the ureter . . . . .	411
243. Composite temperature and pulse chart of ureteral fever . . . . .	416
244. Demonstration of stricture of the ureter and of hydroneureter . . . . .	428
245. Ends of dilating metal catheters . . . . .	436
246. Washing out the right kidney . . . . .	438
247. Washing out the kidney and ureter . . . . .	439
248. Diagnosis of abscess of kidney by the renal catheter . . . . .	443
249. Hydroneureter of both sides, with double ureter on the left side . . . . .	446
250. Hydroneureter and hydronephrosis . . . . .	447
251. Syringe and aspirator . . . . .	449
252. A ureteral calculus . . . . .	449
253. End of a wax-tipped catheter . . . . .	450
254. A calculus of the pelvis of the kidney . . . . .	451
255. Stone caught in the eye of a renal catheter . . . . .	451
256. Removal of the kidney and ureter without opening the peritonæum . . . . .	453
257. Prolapse of the ureteral and vesical mucous membrane . . . . .	455
258. Switching the ureter into the bladder by means of an artificial vesico-vaginal fistula . . . . .	458
259. Uretero-vaginal fistula . . . . .	459
260. Right uretero-cystostomy for uretero-vaginal fistula . . . . .	460
261. Uretero-cystostomy . . . . .	461
262. Uretero-ureteral anastomosis, showing the ureter divided and the lower end tied and split on one side . . . . .	466
263. Uretero-ureteral anastomosis, showing the ureter held in place by the traction ligatures . . . . .	467
264. Experimental uretero-ureteral anastomosis in a dog . . . . .	468
265. Showing the lines of incision in two cases of nephro-ureterectomy . . . . .	469

FIG.	PAGE
266. Total extirpation of a tuberculous left kidney with its ureter . . . . .	470
267. Removal of a tubercular kidney and ureter . . . . .	471
268. Removal of the kidney and ureter, showing the facility with which the ureter can be palpated all the way down to the common iliac artery . . . . .	472
269. Showing the method of removing the lower end of the ureter through a vaginal vault . . . . .	473
270. Removal of the kidney with the ureter . . . . .	475
271. Removal of kidney and entire ureter, nephro-ureterectomy . . . . .	476
272. Ends of three sizes of the Ellinger, and Goodell-Ellinger dilators . . . . .	479
273. Goodell-Ellinger dilator with spring between the handles . . . . .	480
274. Criminal abortion, with separated elm tent <i>in situ</i> . . . . .	481
275. Uterus perforated by a tupelo tent . . . . .	482
276. Sharp curette for removing the uterine mucosa . . . . .	485
277. Section of a glandular uterine polyp . . . . .	487
278. The spoon of the long, sharp curette . . . . .	492
279. Knife-blade tenaculum for depleting the cervix . . . . .	494
280. So-called "erosion" of the cervix uteri . . . . .	495
281. Bilateral laceration of the cervix . . . . .	496
282. Incision into the angles of the laceration . . . . .	496
283. Denudation of both lips for plastic union . . . . .	496
284. The cervix after all the sutures are tied on both sides . . . . .	497
285. Glass irrigator . . . . .	497
286. Complete prolapse of the uterus and vagina . . . . .	500
287. Complete prolapse of the uterus and vagina, with retroflexion . . . . .	501
288. Prolapse of the uterus, showing stages of descent . . . . .	502
289. Partial prolapse, with eversion of the vaginal walls . . . . .	503
290. Complete prolapse of the vagina and uterus, with retroflexion . . . . .	504
291. Partial prolapse of the uterus and vagina, with elongate lacerated cervix . . . . .	505
292. Partial prolapse of the uterus, with eversion of vaginal walls . . . . .	506
293. Partial prolapse of the uterus, with elongate hypertrophied cervix . . . . .	510
294. Operation for prolapse of the uterus by amputation . . . . .	511
295. Prolapse of the uterus, vagina, and rectum, with complete rupture of the recto-vaginal septum . . . . .	512
296. Vegetating epithelioma of the cervix . . . . .	514
297. Epithelioma of the cervix without vegetation . . . . .	515
298. Vaginal hysterectomy for cancer of the uterus; uterus and cervix enretted and the cervix sewed up . . . . .	516
299. Vaginal hysterectomy; cutting the cervix loose from the vaginal vault, under irrigation . . . . .	517
300. Vaginal hysterectomy; detaching the bladder from the cervix . . . . .	518
301. Aneurismal needle . . . . .	519
302. Vaginal hysterectomy; exposing and tying off the left broad ligament . . . . .	520
303. End of stout blunt tenaculum . . . . .	520
304. Vaginal hysterectomy; freeing the right broad ligament . . . . .	521
305. Vaginal hysterectomy; applying the last ligature . . . . .	522
306. Vaginal hysterectomy; the uterus brought outside . . . . .	523
307. Vaginal hysterectomy; the uterus removed . . . . .	525
308. Inversion of the uterus . . . . .	532
309. Inversion due to sarcoma . . . . .	536
310. Pediculated submucous myoma . . . . .	540
311. Pediculated submucous myoma, with partial inversion . . . . .	541
312. Large external pediculated submucous myoma . . . . .	543
313. Pediculated submucous myoma attached to the fundus posteriorly . . . . .	544
314. Sickle-shaped stout knife . . . . .	545
315. Pyo-physometra due to occlusion of the cancerous cervix . . . . .	554

## LIST OF PLATES.

PLATE	FACING PAGE
I. Various kinds of bacteria . . . . .	32
II. Dinguosis of abdominal tumor, showing also respiratory motion . . . . .	80
III. Pruritus vulvae . . . . .	198
IV. Caruncle of urethra . . . . .	307
V. Loculate bladder . . . . .	318
Fig. 1. The loculi surrounded by contracted muscular bands.	
Fig. 2. The same loculi with the muscular bands relaxed.	
VI. Trigonum of bladder before and after treatment with vesical balloon (Figs. 1 and 2) . . . . .	375
VII. Fig. 1. Normal bladder . . . . .	387
Fig. 2. Carcinoma of the bladder . . . . .	387
VIII. Tuberculosis of the endometrium . . . . .	489
IX. Fig. 1. Adeno-carcinoma of the body of the uterus . . . . .	491
Fig. 2. Epithelioma of the cervix . . . . .	491
X. Epithelioma of the cervix uteri (colored) . . . . .	493

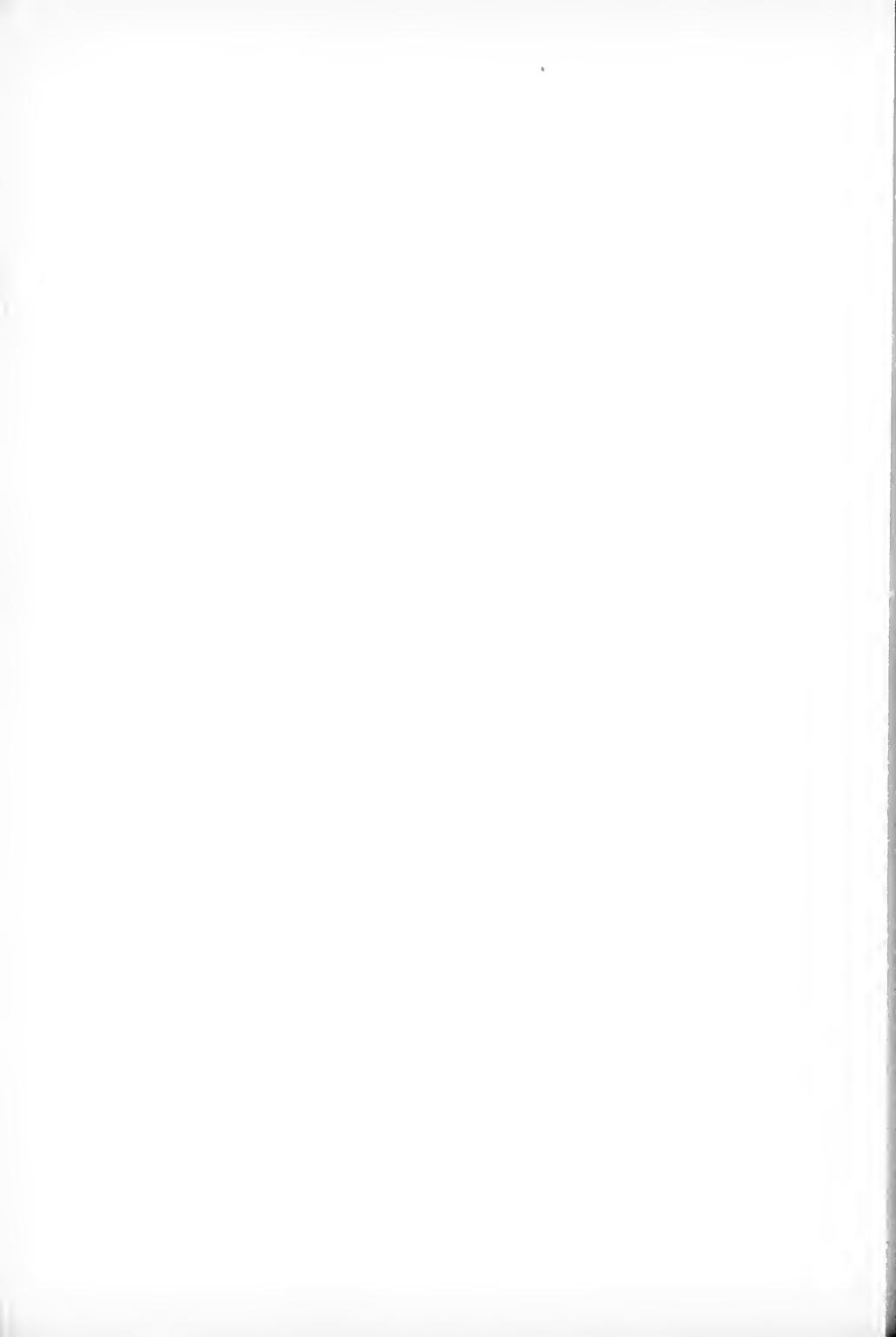

# OPERATIVE GYNECOLOGY.

## CHAPTER I.

### SEPSIS, ASEPSIS, AND ANTISEPSIS IN HOSPITALS.

1. Sepsis, definition of.
2. Asepsis.
3. Antiseptics. Soap and water. Dry heat. Dry-air oven. Steam oven or steam cylinder. Steam-Boiling soda solution. Chemical antiseptics.
4. Operating room. Table. Sterilized water. Sterilization and preservation of instruments. Sterilization and preservation of sutures and ligatures. Silkworm gut. Catgut. Gauze and cotton. Iodoform gauze. Sponges. Drainage cushions. Ovariotomy pad. Perineal pad. Vessels.
5. Preparation of surgeon, assistants, and nurses. Operating suit. Brushes. Cleansing and disinfecting the hands and forearms.

#### SEPSIS.

Surgical sepsis arises from the invasion of a wound by pathogenic micro-organisms which find in the tissues suitable conditions for their development and growth.

The micro-organisms most frequently concerned in traumatic infections are the pyogenic bacteria, of which the most important representatives are the pyogenic staphylococci and streptococci, although under special conditions many other bacterial species may cause suppurative inflammation. The simple conception which once prevailed that a wound becomes infected, in much the same way as an artificial culture medium, by the mere entrance of pathogenic bacteria, has been greatly modified by bacteriological studies of the conditions underlying the infection of wounds. There are various circumstances besides the mere presence of bacteria which determine the occurrence and the character of traumatic infections.

A fresh wound in healthy tissues, while it resembles an artificial culture medium in offering suitable food for the development of many kinds of bacteria, differs from such a medium in the presence of various properties of cells, tissues, and fluids which are hostile to the life and growth of many bacteria. In the study of the causation of traumatic infections it is important to consider not only the invading micro-organisms, but also the germicidal powers of the cells and fluids of the body. Experiments of Dr. W. H. Welch and others have demonstrated that even the most careful antiseptic or aseptic surgical technique often fails to exclude the entrance of bacteria, including sometimes even the ubiquitous pyogenic cocci, into wounds which heal without infectious inflammation. Under these circumstances the antibacterial properties of the living cells

and of the fluids in the wounded area suffice to inhibit the growth or the pathogenic manifestations of the invading bacteria. It is largely to these natural inhibitive forces of the living tissues that we must ascribe the good results obtained in many surgical operations conducted even under a bad technique.

It would, however, be a serious error to rely exclusively in surgical technique upon the germ-destroying powers of the living tissues and fluids of the body, great as these undoubtedly are and important as it is not to interfere with these natural germicidal agencies. In a large proportion of the cases in which bacteria have been found in so-called aseptic wounds the bacteria have been either non-pathogenic or possessed of little virulence. It is exceptional to find virulent pyogenic bacteria in wounds without any manifestations of their pathogenic activity.

The most common invader of wounds of the skin is a variety of the staphylococcus pyogenes albus called by Welch (*Conditions underlying the Infection of Wounds. Trans. of the Congress of American Physicians and Surgeons*, vol. ii) the staphylococcus epidermidis albus, as it is a regular inhabitant of the epidermis and hair follicles. The investigations of Drs. H. Robb and A. A. Ghriskey (*Johns Hopkins Hospital Bulletin*, vol. iii, p. 37, 1892) have shown that most wounds through the skin sooner or later become contaminated with this organism, and yet its presence may not interfere with primary union. An important point relating to the presence of the staphylococcus epidermidis albus in the healthy skin is that it lies so deeply in the epidermis or hair follicles that chemical disinfection of the superficial layers of the skin does not destroy it, as may be demonstrated by the following experiment: After thorough disinfection of the skin by permanganate of potash and oxalic acid, in the way subsequently described, cultures made from scrapings of the surface usually show no growth. If, now, sterilized silk sutures be passed one or more times through the skin in the disinfected area, and a tube of nutrient agar-agar be inoculated with the sutures, the presence of the white staphylococcus, often in pure culture, can be demonstrated in parts of the epidermis deeper than those acted upon by any chemical methods of disinfection of the surface of the integument.

Welch believes that the staphylococcus epidermidis albus is but rarely pyogenic, and that its pathogenic activity depends largely upon decreased resistance in the germicidal forces of the wound area.

The most recent bacteriological and practical experiments on infection of wounds point conclusively to the fact that the skin is a common habitat for various organisms, and that this must be taken into careful consideration in the preliminary disinfection of all operative fields. As already stated, in a large proportion of cases these organisms are non-pathogenic, and a fresh wound containing them may, from a surgical standpoint, be regarded as aseptic when the process of healing is in no way interfered with.

Cultures taken from beneath the most carefully applied surgical dressings very frequently show growths which can be accounted for only on the supposi-

tion that bacteria were present before the operation, or were deposited in the wound during the progress of the operation, or gained access later from the adjacent skin. Suppuration occurs when the organism is virulent, the condition of the wound favorable for growth, and the normal inhibitory activity of the tissues is reduced.

In the following quotation from Dr. Welch's paper he summarizes the conditions underlying wound infection: "The effects produced in the animal body by the pyogenic cocci are determined by many factors relating to the infections agent and to the individual exposed to infection. There are differences in these effects, depending upon the species of animal; upon the tissues and parts of the body infected; upon the readiness of absorption from the affected parts; upon the source, the number, and the virulence of the organisms; upon the nature and amount of toxic substances accompanying and produced by the bacteria; upon general predisposing conditions of the body; and upon local conditions in a wound, such as the presence of foreign bodies, of pathological products, of dead spaces, of bruised, necrotic, and strangulated tissues."

Notwithstanding the constancy of micro-organisms in the air and on all objects with which we come in contact, we are usually able, by carrying out a rigid technique, to prevent the invasion of a wound by virulent pyogenic organisms in sufficient number to produce harm. The realization of the difficulty of obtaining a germ-free wound should stimulate surgeons to observe the most painstaking care in the preliminary preparation in order to reduce the amount of contamination to a minimum.

#### ASEPSIS.

In a surgical sense asepsis is the absence of septic germs; an aseptic wound is one which remains free from invasion by these germs in sufficient number to disturb the healing process.

The common means for the introduction of the germs are the hands of the surgeon or of his assistants, the instruments, or the surgical accessories.

The surface of the body, the digestive canal, and the female genital tract up to the internal os uteri are normally the habitat of many species of micro-organisms. As it is not practicable to differentiate beforehand the specific character of the various germs which are present, especially as to their pyogenic properties and virulence, modern surgery first proceeds upon the assumption that the skin of the patient, of the surgeon, and of the assistants, the instruments, the dressings, etc., are in an infected state until rendered aseptic by the use of antiseptic measures; and second, it endeavors to maintain the aseptic condition thus established throughout and after an operation.

The surgeon must also be constantly alive to the fact that his work and that of his assistants and the nurses may bring them into daily contact with septic matter, and that extraordinary precautions are necessary to avoid conveying such infected material from case to case. There is a well-recognized

liability of septic cases to occur in groups in hospital practice. As an example of this in my own practice, in 1892 I ruptured a large streptococous abscess in removing it, and the patient died shortly afterward. Three cases immediately following this had an erysipelatous inflammation of the wound and narrowly escaped with their lives.

#### ANTISEPTIC.

**Antiseptic** is a term used to designate any active means whatever by which septic germs are removed, destroyed, or rendered inactive.

The antiseptic principle may be worked out in a variety of ways. The demonstration, however, of the value of any antiseptic procedure must come through the more rigid scientific methods of the bacteriologist, and in all cases of innovation as to ways and means his experiments must be recognized as the authoritative tests.

The mechanical removal of germs by scrubbing with soap and water, and their destruction by steam or boiling solutions, are the best antiseptic agents which we possess. It is a noteworthy fact that the housewife's simple remedies against dirt and against fermentation, as in preserving fruits, appear to be the final outcome in this direction of the surgical activity of the last half of this century.

The usual methods of applying heat as a germicide are the hot dry-air oven, the steam oven, or steam cylinder, and boiling soda solution.

**Hot-air disinfection** requires too high a temperature—176.6° C. (350° F.)—to be satisfactory for most purposes, and is injurious also to sharp instruments. I have for this reason abandoned it in favor of steam disinfection.

**Steam disinfection** in an oven, jacketed to prevent the steam from condensing, destroys the most resistant organisms.

In order to destroy all germs with their spores, sterilization by live steam must be repeated for two or more successive days, an hour the first time and half an hour on each subsequent occasion. The spores of pathogenic bacteria are less resistant than those of some saprophytic bacteria, such as the *Bacillus subtilis*, and the former are destroyed by exposure for half an hour to the temperature of live steam. Steam under pressure of ten or fifteen pounds destroys even the most resistant spores by a single exposure for twenty minutes to half an hour.

The Arnold or E. Boeckmann steam sterilizer, or some sterilizer similarly constructed, is cheap and effective. The steam is generated rapidly in a small, hollow plate by a Bunsen flame, and then passes through a short shaft into a jacketed cylinder containing the articles to be sterilized. Circulating from this into an outside copper jacket which covers the whole, it is recondensed and drips into a pan, from which it runs through small holes into the hollow plate, and begins to travel the circuit again.

Institutions supplied with steam heat may convey the live steam directly into the sterilizers—a practical, effective, and rapid means of sterilization. An apparatus long in use in the gynecological operating room of the Johns Hopkins

Hospital, connected in this way with the general steam-heating system, has proved most satisfactory.

Two sterilizers are employed—one for water, the other for dressings, etc. The sterilizer for dressings consists of a cylindrical copper reservoir containing a steam coil which enters from above, and has its exit from below. The bottom slopes toward the center, forming a shallow funnel with a drainage-tube for the escape of the condensed steam. A wire netting is placed two inches from the bottom, upon which the objects to be sterilized are deposited. The circulation is so arranged that when active sterilization is required live steam can be turned into the cylinder, penetrating the linen envelopes of the dressings and the cotton plugs of the flasks and tubes.

When the sterilization is completed the live steam is turned from the reservoir into the coil by simple gate-valves, and so quickly dries the dressings before they are removed from the sterilizer. In order that the drying process may be facilitated, the cover should be lifted and air allowed to enter.

Steam sterilization under pressure is more rapid and more effective than that conducted without it. One of the latest and best sterilizers on this plan is the Sprague, manufactured by Richard Kuy & Company, constructed on the principle of the autoclave used in the bacteriological laboratory.

The apparatus consists of an inner and an outer cylinder, the outer serving as a jacket for the inner one. The sterilizing chamber is barrel-shaped, and is closed by a secure door, which makes it steam-tight. A steam gauge indicates the pressure, which may be carried up to thirty pounds, and a safety valve is security against explosion.

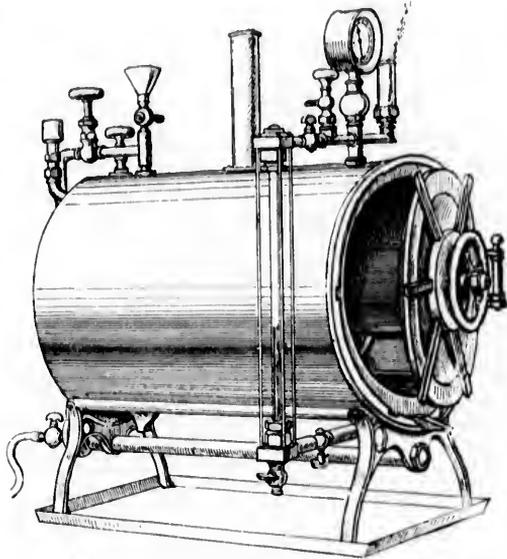

FIG. 1.—STEAM STERILIZER FOR DRESSINGS AND DISHES, THE DOOR PARTLY OPEN.

When the dressings are put in and the door closed a slight turn fixes the projecting lugs in under the rim; the ring in the center of the door is then revolved until the door is jammed down and a steam-tight joint secured. The steam is generated in the jacket by a long gas jet or steam pipes underneath. The amount of water in the jacket is indicated by the gauge at the side. The steam gauge on top registers the pressure inside the chamber. After heating and exhausting the air in the sterilization chamber the steam is let in by a screw and the sterilization begins. At the completion of sterilization the steam is turned off and the dressings in the boiler thoroughly dried before removal.

Before beginning the sterilization a small quantity of water is placed in the outer cylinder after the inner cylinder has been packed with the objects to be sterilized. The door is then closed and screwed down securely. The gas jet is lit under the cylinder and steam quickly generated, which passes up around the inner cylinder, where it enters a pipe on the top, to be conducted down beneath the perforated rack which supports the dressings; it then passes on up through the middle of the cylinder, and so through a vent into the outer cylinder.

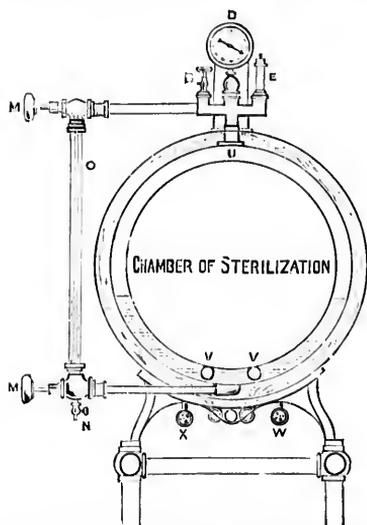

FIG. 2. — SECTIONAL VIEW OF STERILIZER FOR DRESSINGS AND DISHES, WITH STEAM IN CENTRAL CHAMBER UNDER PRESSURE.

*B* is valve for the discharge of air displaced by the water; *D* is pressure indicator; *E* is the safety valve; *M, M* are valves connected with water gauges; *V* is the draw-off valve, water from jacket, for cleansing purposes; *O* is glass water gauge; *F*, steam space in jacket; *X*, coils for heating water, using steam from the general plant of an institution; *F*, steam inlet valve; *A*, outlet valve, condensation from coil.

A convenient vessel for boiling instruments is a long, narrow tin bath or porcelain fish boiler, 5 to 7 centimeters (2 to 3 inches) deep, containing a tray for holding them during immersion. A row of Bunsen burners beneath the boiler raises the water to the boiling point in two or three minutes, and in five minutes more the sterilization is complete.

As a fixture in an operating room it is convenient to employ a receptacle, rectangular in form, measuring 15 inches in length by 8 inches in width and 6 inches deep, made of sheet bronze, polished on the outside, and coated internally with pure tin, over which a coating of nickel is deposited. The oval cover of the vessel opens on "slip hinges," and two perforated metal trays hold the instruments in the sterilizer. The instruments are immersed in a 1 to 2 per cent solution of the carbonate of soda, which is brought to the boiling point and kept there for five or ten minutes.

When the sterilization is completed a valve is opened and the air enters, quickly drying the small amount of moisture collected on the dressings.

In this way we can conveniently sterilize in the chamber, which measures 20 inches in diameter by 28 inches or more in depth, silk ligatures, dressings of all sorts, dishes, operating suits, visitors' gowns, sheets, towels, napkins, and blankets.

**Boiling Soda Solution.**—Boiling water containing 10 grams (150 grains) of powdered carbonate of soda to the liter is the best antiseptic for instruments, because it dissolves the capsule of the germs and destroys them within five minutes, while simple boiling water and steam demand a much longer time. The soda solution also has the great advantage of preventing rust.

The boiler is arranged for heating either by gas or by steam.

**Chemical Antiseptics.**—As far as possible, it is safer to depend upon steam or heat sterilization rather than upon chemicals.

Experiments have shown that the solution of bichloride of mercury, frequently employed in surgical work, does not under all conditions manifest its germicidal powers. It often merely inhibits germ growth, but to what extent this inhibition is valuable is as yet unknown. The inefficiency of bichloride of mercury as a cutaneous germicide can be tested for practical purposes by immersing the hands for ten minutes in a 1-500 aqueous solution, and then in a sterilized ammonium sulphide solution to precipitate the mercury. After this, by scraping the epithelium, cultures can usually be obtained which will grow in ordinary media.

If dishes and porcelain ware are to be efficiently sterilized by this means, they must be kept in a strong solution of corrosive sublimate (1-500) for fifteen minutes after they have been thoroughly scrubbed with soap and water; the sublimate kills most of the bacteria and renders the rest inactive.

In the experiments on skin disinfection we have a factor to consider which we do not meet with in the sterilization of the dishes. The albuminate of mercury which is formed in the tissues, when brought in contact with corrosive sublimate solutions, may encapsulate the organisms, and so render them incapable of growth. When dishes, on the other hand, are submerged in the disinfectant

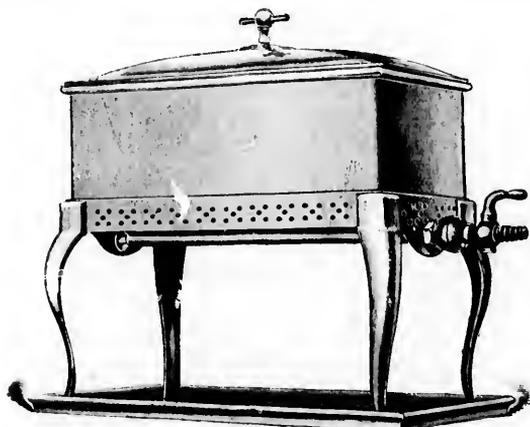

FIG. 3.—INSTRUMENT STERILIZER.

solution, the organisms are at once brought in contact with the bichloride of mercury without the formation of this albuminate, and the sterilization is more effective.

The use of chemical solutions, such as carbolic acid and corrosive sublimate, for disinfection of wounds is objectionable, because their value depends upon the

strength of the solution, and a solution of sufficient strength to act as a germicide acts as an irritant. Dr. W. S. Halsted has shown that the irrigation of fresh wounds with a corrosive sublimate solution as weak as 1-10,000 is followed by a distinct necrosis demonstrable under the microscope. This necrotic material may retard the healing process and act as a culture medium for any germs deposited in the wound subsequently; the danger of acute poisoning from the absorption of the mercury must also be considered.

I have long since given up the use of carbolic acid solutions for instruments, and only use sterilized water to submerge them in during operation. The germicidal effect of carbolic acid solutions is more than counterbalanced by the injury which it causes to the hands. I have seen the hands so badly cracked and chapped by the carbolic solutions that it was impossible to scrub them perfectly with nail brushes.

**The Operating Room.**—For private hospitals or small public institutions the best form of operating room is a simple, spacious, rectangular structure well lighted by skylight and northern windows. The various architectural details should be so arranged as to facilitate the work for which the room is designed, and to carry out the principles governing surgical procedures. The doors should be of the noiseless sliding kind, so as to offer no obstruction to the easy transportation of patients to and fro. Any elaborate ornamentation of the room must be eschewed. The walls must be smooth, of hard finish, or coated with enamel water-proof paint, to resist the disintegrating action of steam. The cleansing of the walls and floors is helped by rounded angles. The walls may be paneled with broad slabs of African marble, which extend five feet up from the floor as a wainscot, or, as in some clinics, all the way to the ceiling. There are several kinds of material useful for flooring; the most common are the square encaustic tiles and the mosaic blocks. When properly laid, so that there are no crevices or cracks, either makes a serviceable and ornamental floor. In paving the floor with the blocks care must be observed to secure a uniform smoothness over the entire surface. By mopping the floor daily and scrubbing it twice a week with sapollo its surface is kept clean. Where economy in construction is considered, a cement pavement or bolted boiler iron covered with ship's paint makes a good floor, which can be easily kept clean. The floors of some operating rooms are laid to slope toward the center or toward one corner of the room, where there is a drainage vent; this convenience would appear to be more dangerous than useful, for the waste pipe may become clogged.

Ventilation must also be considered, for, while we do not attribute so much risk to contamination from the air as formerly, we dare not ignore the fact that infection may occasionally be carried in this way. The entrance for fresh air and the exit for impure air should be so placed that the circulation will not be conducted over the operating table. This precaution is further necessary on account of the possibility of chilling the patient.

The ventilators should be so set that they can be easily taken out of their sockets and cleansed, and some filtering material may be placed in the ventilators.

A sloping skylight, looking to the north, gives an evenly distributed light, which is never glaring.

The equipment of the operating room must be simple.

A prime requisite is a row of large, oval marble basins plentifully supplied with hot and cold water. To facilitate the most perfect details of the aseptic principle, the taps may be connected with a pedal attachment like that devised by Dr. H. Robb, which permits the water to be turned on or off by the foot.

The most glaring inconsistency in the aseptic arrangement of most operating rooms is the impossibility of thoroughly sterilizing the hand basins, which are

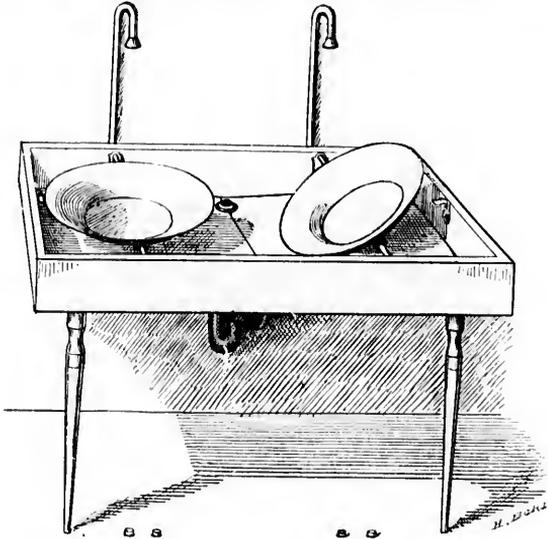

FIG. 4.—HAND BASINS SET ON PIVOTS FOR REMOVAL AND STERILIZATION.

The hot and cold water are mixed in a rose jet a foot above the basin. The flow of hot or cold water is controlled by the foot taps on the floor.

contaminated at every washing and are liable to hold grease. This may be avoided by using movable metal basins made of plated copper or solid nickel, and swung over a porcelain hopper or sink, as shown in the figure.

A large sink for the immersion of dishes, etc., and a hopper for waste water, should be in a convenient location. The traps in all the pipes must be inspected and disinfected frequently.

The room should be fitted with electric-light and gas fixtures, and an electric-light bracket should be placed near the operating table, so that a portable light with reflector may be attached easily. A group of four incandescents lights with reflectors should be suspended over the table.

The other furnishings of the operating room should be as few as possible; all apparatus—such as dressings, sterilizers, water-boilers, etc.—should be placed

in an adjoining room. The instrument case should be conveniently located, either near the operating table or in an adjoining room, so that at any time an instrument may be quickly obtained if required in the midst of an operation.

Glassware for instruments and solutions, and jars for sterilized ligatures, gauze, cotton, and towels, are kept in a room especially set aside for storage.

The sterilization of instruments, dressings, etc., should not be done in the operating room, as the combustion products vitiate the atmosphere, and during the summer months the temperature of the room becomes excessive with the additional heat.

The anesthesia room should be conveniently placed, but great care must be observed to have it so planned that noises from the operating room will not be heard by a waiting patient.

**Operating Table.**—The gynecological operating table should be of metal with a movable glass top, which can be raised or lowered as required.

The Kelly table shown in the figure is arranged with a support for the

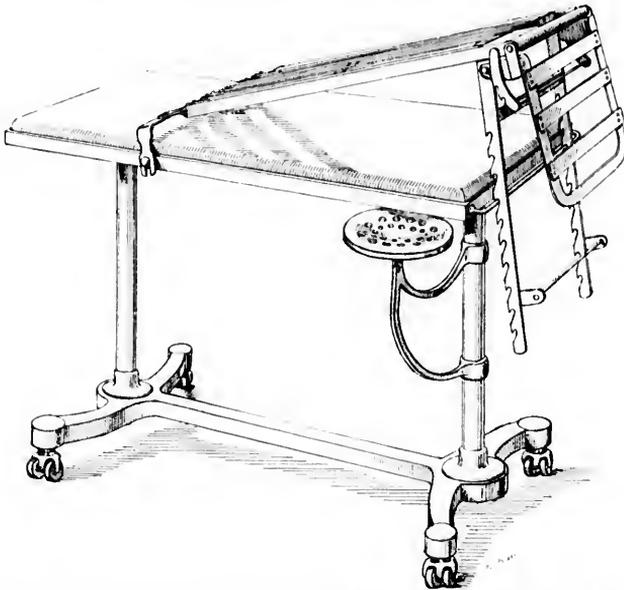

FIG. 5. —OPERATING TABLE, WITH STOUT BRASS LEGS AND FRAME AND HEAVY GLASS TOP.

Simple attachment with ratchet for the elevation of the pelvis. This is lifted off during vaginal operations, and the seat under the table drawn around for the anesthetizer to sit on, while the operator occupies a stool at the opposite end of the table.

patient's feet below the top. A simple lattice of interwoven metal slats, with a ratchet and crossbar, gives the needed elevation of the pelvis.

The height of the table is 78.5 centimeters (31 inches); width, 53.5 centimeters (21 inches); and length, 113 centimeters (44 inches).

Edebohls's table, one of the simplest and best constructed, and the Boldt table, which inclines the whole body, are both well arranged for self-drainage and easy adjustment.

**Sterilized Water.**—An abundant supply of sterilized water should always be on hand in the operating room. Water drawn from the tap can be sterilized by boiling it for half an hour. If it is allowed to stand covered for several hours after boiling, the organic matter settles to the bottom, and the clear water above this can be drawn off by a spigot placed in the vessel about 10 centimeters (4 inches) from the bottom. A ready method of sterilizing water in a clinic is by means of a copper reservoir lined with a steam coil. To use this, fill the reservoir with water, and then open a valve in the coil, letting in the steam, when the water is quickly brought to a boiling point. Another way of getting sterile water is by distillation; water can be distilled in quantity, from 80 to 120 liters (20 to 30 gallons) daily, by means of a gas flame, running water, and a small copper still, hung on a bracket against the wall. The cold-water faucet taking its supply from the street is connected with the still by a rubber tube and a slow flow started; a Bunsen burner beneath the still condenses a small portion of the water passing through it, and in this way 6 or 8 gallons or more can be secured every twenty-four hours. The distilled water is conveniently stored in large agate-ware pails and boiled as required for use.

In a large clinic the quantity of sterilized water, both hot and cold, which is needed for daily use is so great that an apparatus such as that shown in Fig. 6 is a great convenience.

The water, entering from the house tap, is first filtered in the narrow cylinder between the two large ones, to remove all visible impurities. It is then boiled, either by a gas engine, below in the center, or by steam coils, and stored in the large reservoirs seen at the sides, holding from 60 to 75 gallons or more, so arranged that one holds hot and the other cold water. Gauges show the amount of water in the tanks, and thermometers register the temperature. The water is drawn mixed at the desired temperature. Air-filtering vacuum valves above the cylinders provide for the entrance of pure air as the water is withdrawn.

**Sterilization and Preservation of Instruments.**—It is but a few years since the cure of the instruments amounted to nothing more than washing them, often

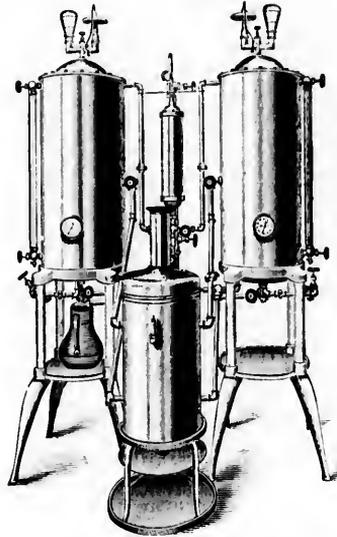

FIG. 6.—TANKS FOR STORAGE OF HOT AND COLD WATER.

hurriedly with soap and warm water, and putting them away in a velvet-lined case, ready for use at the next operation. A close observer could then frequently detect dried blood clinging to the joints of forceps and scissors, and dirt lodged in the eyes of the needles.

No part of the gynecological technique is to-day considered more important than the sterilization of the instruments. To facilitate cleansing, a preference must always be given to the simplest forms of instruments; joint corrugations, and rough surfaces on the handles must be avoided whenever possible. In the locks of scissors and forceps the screw joint must be rejected, and in its place the French lock, or one similar to a device of my own, are recommended.

After an operation the instruments are gathered together, the paired instruments, such as forceps and scissors, separated, and knives and needles laid apart. They are then placed with handles together in a large dish and washed with soap and hot water. If tarnished, they may be polished with the best grade of *sapolio*. The first assistant lifts up one instrument after another, rinsing it and wiping it clean; he hands it to the second assistant, who dries it, inspecting carefully all its parts before placing it on a clean dry towel spread on a table. When all the instruments have been cleaned, they are classified and put away in the instrument case on glass shelves to await the next operation. After septic operations, dealing with purulent peritonitis, abscesses, sloughs, etc., the instruments, in addition to being washed, must be sterilized before being returned to the case. By using water not far from the boiling point in cleansing them, the instruments become so hot that they dry much more rapidly.

Before every operation the proper instruments are selected and placed in a bag, or wrapped in a towel, and laid on a tray for sterilization, for five minutes in a 1 per cent bicarbonate of soda solution, as devised by C. Schimmelbusch.

When lifted out of the solution they are placed in glass dishes on a table close to the operating table, where they are classified by an assistant whose hands have been sterilized; they are then covered with hot water. One of the great advantages of the soda solution is that it does not tarnish and dull the edges of the instruments as steam sterilization does. Such glaring inconsistencies as drying the instruments with a soiled towel or taking them up with nuclear hands must be avoided. Instruments taken out of the case for inspection by visitors must be laid aside for sterilization before being returned.

Only the sterilized hands of the operator and his assistants should come in contact with the instruments used during the operation. An instrument which falls to the table or floor, or touches garments or face, is septic until re-sterilized.

**Sterilization and Preservation of Ligatures and Sutures.**—Silk and silkworm gut are sterilized by the fractional method.

The best quality of surgeon's twisted silk must be secured in three sizes:



FIG. 7.—THREE SIZES OF SILK USED—FINE, INTERMEDIATE, AND HEAVY.

fine (No. 2), intermediate (No. 3), and heavy (No. 4). The fine silk is used to make the carrier loops in the needles and for intestinal suture. The intermediate silk is used in general to tie vessels and to bring together wound surfaces, and often to tie small pedicles. The stout ligature is only used in tying a large quantity of tissue in a pedicle.

The following method of sterilizing silk we owe to Dr. W. S. Halsted, of the Johns Hopkins Hospital: The skeins of silk are opened and cut in lengths of 40 centimeters (14 inches) for carriers, and 24 to 30 centimeters (9 to 12 inches) for ligatures and sutures. Ten of these are wound on a glass reel, and several such reels of one size, or of assorted sizes, are dropped into a stout glass ignition tube devised for this purpose; several of these tubes, plugged loosely with cotton, are put in a steam sterilizer for an hour the first day, and on the two following days for half an hour each time. The steam passes through the cotton without restraint, and acts upon the silk as easily as if it lay loose in the sterilizer. On removing the tubes, the cotton in the mouth is pushed tightly in and they are stored away in glass jars until wanted. Silk which remains over after an operation may be resterilized in the same way, but it is apt to be weakened after the second sterilization.

If it is necessary to take but one reel of silk out of a tube, it may be done without contaminating the rest by carefully removing the cotton stopper between the third and fourth fingers, taking care that the surface of the cotton which comes in contact with the tube does not touch anything else, while holding the tube obliquely to facilitate removing the reel with a pair of sterilized forceps.

**Silkworm Gut.**—To sterilize silkworm gut, a dozen pieces or more are loosely twisted together, doubled, and put into an ignition tube or a piece of ignition glass tubing plugged at both ends, and sterilized in the same way as the silk.

**Catgut.**—The employment of catgut sterilized by defective methods has, in at least three recorded instances in my own practice, been productive of serious outbreaks of infection. That the majority of methods are unsafe is shown by the great number proposed. From 1890 to 1894 I used catgut prepared by soaking in ether and then boiling in alcohol under pressure. The results from its use were good until the beginning of 1894, when an outbreak of sepsis occurred which caused four deaths, and while we had no direct bacteriolog-



FIG. 5.—ROLLS OF STERILIZED SILK THREADS ON GLASS BOBBINS PRESERVED IN STOUT GLASS IGNITION TUBES.  $\frac{3}{4}$  ORDINARY SIZE.

ical evidence against the suspected catgut, all of which had been used, circumstantial evidence was so strong as to leave little doubt as to its rôle. Catgut was therefore given up entirely, and was not used again until 1895, when I adopted Krönig's emmol catgut.

Briefly stated, Krönig's method consists in the gradual heating of the catgut at 70° C. for two hours, to drive off the hygroscopic water; second, heating in emmol to a temperature of 165° C.; third, transferring to benzine, where it may remain until ready for use, or whence it can be transferred to Petri dishes.

The experiments made by Drs. Clark and Miller, of the Johns Hopkins Hospital gynecological staff, demonstrated beyond doubt the correctness of Krönig's method in general, but showed that it was defective, in that the catgut was transferred to benzine, which is not always sterile. It was therefore possible that the suture material might become reinfected by the benzine. As a result of their experiments the following modified method has been adopted:

1. Cut the catgut into the desired lengths and wind twelve strands into a figure-of-eight form so that it may be slipped into a large test tube.

2. Bring the catgut gradually up to a temperature of 80° C., and hold it at this point one hour.

3. Place the catgut in emmol, which must not be above a temperature of 100° C.; raise it to 165° C. and hold it at this point for one hour.

4. Pour off the emmol and either allow the heat of the sand bath to dry the catgut or transfer it to a hot-air oven, at a temperature of 100° C., for two hours.

5. Transfer the rings with sterile forceps to test tubes, previously sterilized as in the laboratory.

In making the catgut up into skeins it is only necessary to tie the ends in the isthmus of the figure of eight to hold them securely in proper shape. If conve-



FIG. 9.—SKEINS OF CATGUT STERILIZED WITH EMCOL AND PRESERVED IN GLASS IGNITION TUBES.  $\frac{3}{4}$  ORDINARY SIZE.

nient, it is better to use the hot-air oven for the drying process, but this is not absolutely essential, as a sand bath can be improvised, as suggested by Krönig, to serve this purpose. A beaker glass of at least a half-liter capacity is imbedded three fourths of its height in a tin or agate-ware vessel of sufficient capacity to permit three fourths of an inch of sand to be packed about the sides and beneath the glass.

In drying or boiling, the catgut should not come in contact with the bottom or sides of the vessel, but should be suspended on slender wire supports or placed upon cotton loosely packed in the bottom. During the drying process the beaker glass is covered with a sheet of pasteboard, through which a centigrade thermometer is thrust, so that the mercury bulb may be suspended about midway in the vessel. In this way the temperature can be regulated perfectly. A Bunsen burner is placed under the sand bath and the temperature in the beaker glass is slowly brought up to 80° C., where it is held for one hour to dry the catgut. A higher temperature than 100° C., before the catgut is thoroughly dry, renders it brittle; this step in the method must be carried out most carefully. When the drying process is completed the emul is poured into the beaker glass and brought up to a temperature of 165° C., a little short of the boiling point, with two Bunsen burners. A copper-wire netting should be placed over the beaker glass to prevent the ignition of the emul. This temperature is more than sufficient to kill all micro-organisms, and it is not necessary to allow the emul to boil, which causes unnecessary evaporation. The catgut is left for one hour at this temperature, when the emul is poured off for subsequent use.

Emul, which is of a clear lipid or slightly yellowish appearance when produced from the chemist, is changed to a brownish color by boiling.

The catgut is allowed to remain in the sand bath until the excess of emul is driven off and it appears entirely free from any oily matter. A period of one to two hours is usually sufficient to dry it thoroughly.

From the sand bath or hot-air oven it is transferred with sterile forceps to sterile test tubes, such as are used for culture media, in which it is preserved from contamination until ready for use. Small quantities should be placed in each tube, to obviate the necessity of opening them too frequently.

In conclusion, it is well to bear in mind that while emul is not explosive it is very inflammable, and great care should be observed in lifting the wire screen from the beaker glass to prevent drops of the emul from falling into the flame or on the heated piece of metal on which the sand bath rests, as it will take fire, flare up, and ignite the fluid in the beaker glass. Such an accident has occurred three times in our experience.

Catgut may be sterilized with perfect safety and with certainty by using the following apparatus constructed by Dr. J. G. Clark with the aid of Mr. A. V. M. Sprague: The materials are brass and copper, brass for the cast parts and copper for the cylinders. A cylindrical vessel of copper 6 inches in diameter and 8 inches high is fixed within a similar larger cylinder, so as to leave a space of one inch on all sides and at the bottom between the two. This space is com-

partly filled with dry sand. The apparatus is supported on legs raising it 6 inches above the tray on which it rests. The upper end terminates in a bronze metal flanged top, upon which rests a dome head of cast bronze. The head is bolted tightly to the body of the apparatus, but may be quickly removed so as

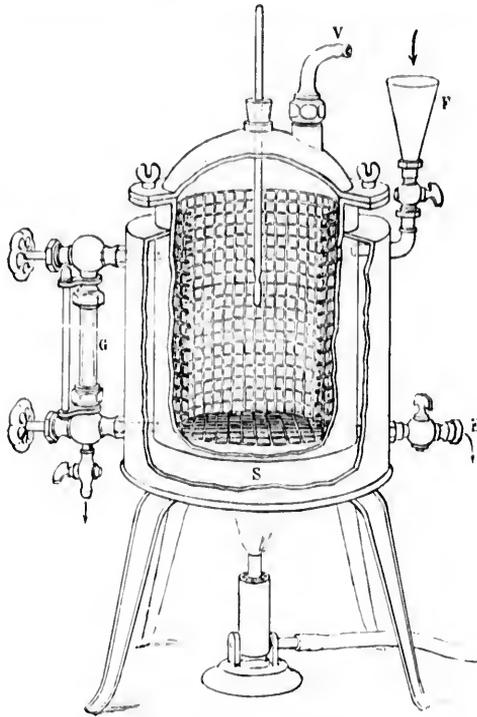

FIG. 10. CYMOL STERILIZER.

E, tap for removing cymol from cylinder; F, funnel through which cymol is poured into cylinder; G, glass tube connected above and below with cylinder to show the amount of cymol; S, sand between outer and inner vessels; V, vent.

to reach the interior. The sterilizer is provided with a glass gauge to show the quantity of cymol in the cylinder, and a thermometer registers the temperature of the fluid; there is an attachment for a hose to carry off the vapor as it is generated. The sand between the cylinders is heated by a Bunsen gas burner, which stands on the tray; a uniform heat is easily generated, raising the temperature of the cymol quickly to C. (331° F.), necessary for the sterilization.

**Gauze**, or cheese cloth, is used in large quantities during operations and for the dressings afterward, and is bought to advantage in bales of one hundred yards each. It forms the best covering for parts of the body around the field of operation, and is a good absorbent and protective when laid as a dressing, six to eight folds thick, on wounds. It is also valuable for making pads to be

used in the abdomen during an operation, and for small gauze sponges.

**Absorbent cotton**, which is common cotton cleansed and deprived of its oil in order to render it absorbent, is the most efficient dressing we possess for taking up discharges, whether applied to the vulva or over an abdominal wound, either directly or on top of a gauze pad. It is also used in padding the inequalities of the abdomen after an abdominal operation before applying a bandage.

Cotton bolsters covered with gauze are needed to hold back the protruding coils of intestines in abdominal operations. They are made of non-absorbent

cotton, which does not take up moisture, and so preserves its elasticity. The cotton is prepared in rolls 4 to 6 centimeters ( $1\frac{1}{2}$  to  $2\frac{1}{2}$  inches) in diameter, which are then cut in lengths of 12 centimeters (5 inches) and covered with gauze.

**Gauze, cotton, towels, and bandages** must be sterilized fractionally by placing them in the steam sterilizer for an hour, then taking them out and again sterilizing them for half an hour at a time on two successive days. After sterilization they should be preserved in large glass jars. It is easier to take what is wanted from the stock without contaminating the rest if, instead of keeping it in bulk, it is broken up into smaller packages before sterilization and rolled in towels or gauze. These small rolls should be kept unopened until needed. When called for, the nurse lifts one of the rolls from the jar, and, unpinning it without touching its contents, lets the ends fall back and holds it to the operator or dresser, who then takes what he wants. Dressings sterilized for immediate use may be used with perfect safety, the fractional sterilization only being necessary when they are to be stored for future use.

Where enormous quantities of gauze are used the expense may be diminished one half by sterilizing and using it over again, as suggested by Dr. J. C. Bloodgood, of the Johns Hopkins Hospital, where the gauze, after using it once, unless the case is known to have been a streptococcus infection, is washed out in cold water and then soaked in a strong solution of bicarbonate of soda to cleanse and remove the blood; it is then taken to the laundry, boiled and dried, and sent back. The patients now smooth it out and roll it up, after which it is sterilized in a steam sterilizer for a half an hour, and used in the ward for various dressings. But a layer of new gauze is always put next to a recent wound.

**Iodoform gauze** is prepared with aseptic hands by rolling plain sterilized gauze in 3-meter (about 3-yard) lengths, and then cutting up the roll into different lengths and breadths to meet the various requirements.

Before dividing the large roll into these smaller pieces it is saturated with the following iodoform mixture: To 180 cubic centimeters (6 ounces) of warm water, made into a good suds with Castile soap, add 45 cubic centimeters (an ounce and a half) of powdered iodoform, and mix it well in a clean basin with a glass rod. Then immerse the roll of gauze in the liquid, and work it with the hands until the iodoform has been completely taken up into the meshes of the roll. This is now sterilized three times in the steam sterilizer.

**Sponges.**—Sponges are difficult to sterilize, and for this reason were for some time largely abandoned, but at present they are again used more freely in abdominal surgery. When suitably sterilized, no other substitute possesses the same degree of elasticity and absorptive power. But the responsibility of sterilizing sponges is so great that it must never be left to druggists or instrument makers.

Steps in the preparation of sponges.

1. Lay them in a stout cloth and pound sufficiently to break up grit and lime.
2. Rinse with warm water ten or more times until it remains clear.

3. Immerse in a muriatic acid solution, 15 cubic centimeters to 1 liter (3 ij to Oj), for twenty-four hours.
4. Immerse in saturated warm permanganate of potash solution.
5. Decolorize in a hot saturated oxalic acid solution.
6. Pass through linewater to take out all the oxalic acid.
7. Rinse thoroughly in plain sterilized water.
8. Immerse in a 1-1,000 solution of bichloride of mercury for twenty-four hours.
9. Preserve, until used, in a 3 per cent carbolic acid solution.

The hands manipulating the sponges during these preparations, from step four on, must be sterile, and much of the manipulation may be done with instruments.

When wanted for use, the sponges are lifted out with a long pair of sterilized forceps and rinsed in sterilized water. I never use the same sponge twice, although this may be safely done after aseptic operations.

The best substitute for a sponge is Berlin wool made into a small ball and covered with gauze, which can be sterilized in the ordinary way in the steam sterilizer. Another good substitute for sponges are small gauze mops, made by cutting gauze into convenient strips and rolling them into small balls; a sufficient quantity of these sponges can be prepared before operation by the nurse and stored in linen bags and sterilized by the fractional method.

In operations in private houses, where the water supply is questionable, the so-called dry technique, in which dry gauze and sponges are used instead of water, is decidedly safer.

**Rubber drainage pads** are especially valuable in permitting an abundant use of water without wetting the patient's clothes or the floor. The largest size, devised for drainage in ovariectomy and abdominal surgery in general, is a circular sheet of rubber 62 centimeters (25 inches) in diameter, with a rim 10 centimeters (4 inches) in diameter, which is inflated when in use. An apron 61 centimeters (24 inches) long, extending over the edge of the table down into a bucket, carries away the waste. The patient rests with her buttocks at about the center of the cushion, and her clothes drawn well above it; all water poured on the abdomen runs over the sides or between the thighs down on to the rubber, where it is diverted by the inflated rim toward the apron, and so carried over the edge of the table into the bucket.

A **rectangular perineal pad** is needed in vaginal operations, facilitating the abundant use of water by protecting the back and sides, and diverting the water by its inflated rim and apron over the side of the table into a receptacle. Its measurements are: Width, 34 centimeters (14 inches); length of apron, 54 centimeters (22 inches); and size of inflated rim, 9 centimeters (4 inches).

These pads are cleansed by scrubbing after each operation with soap and water. If they are discolored they are sponged off with a saturated oxalic acid solution. If infected, they may be rinsed with a 1-500 bichloride solution and hung in a sunny place to dry.

**Vessels.**—Glass, hard-rubber, porcelain-lined, or agate-ware vessels hold the instruments, immersed in hot water, during the operation. The smooth, hard surface does not readily lodge septic material, and is easily cleansed after an operation. Rubber trays are useful in private practice, on account of lightness in transportation, and the fact that a number can be nested without chipping. Glass vessels are the most satisfactory for clinics and operating rooms; clear glass readily reveals spots and gives the appearance of cleanliness in harmony with the surroundings.

In clinics where the steam sterilizer is large enough the best way to sterilize the dishes is to put them in the steam bath along with the dressings.

#### PREPARATION OF THE OPERATOR, ASSISTANTS, AND NURSES.

Personal cleanliness must be observed by frequent bathing, changes of underclothing and of linen, and by wearing clean, well-brushed clothes. A man who is dirty in his general habits is unfit to practice surgery. The obligation to keep clean begins long before entering the operating room for the purpose of "washing up"; it is a duty devolving upon surgeon, assistants, and nurses, at all times, to avoid direct contact with septic materials whenever it is possible, and to scrub the hands thoroughly and, in many cases, to sterilize them carefully immediately after any such contact. Both surgeon and assistants should acquire a feeling of instinctive aversion to touching anything septic.

Septic cases must be relegated to the end of the operating list. On concluding a septic operation the conscientious operator will at once think of his next work, though it may be several days off, and he will immediately proceed, while his hands are still moist, to secure a thorough mechanical disinfection with soap and water. He will also do well to repeat this several times in the interval, at home or in the clinic.

The preparation for an operation begins, therefore, at the preceding operation; it may be days beforehand.

An assistant whose ward work brings him into direct contact with abscesses and sloughing carcinomatous cases, and, above all, one who has charge of or has examined a case of puerperal fever, must be debarred from helping at operations.

**Operating Suit.**—Preparatory to operation, the coat, vest, shirt, and trousers must be removed and a sterilized linen suit put on; the jacket is made with short sleeves, for the upper arm only, and buttoned up the back; the trousers, if made of a separate piece, have a draw-string at the waist, and are made without buttons or buckles. A sterilized linen cap and white canvas shoes complete a costume fulfilling the requirements of an aseptic technique. Just before each operation the nurse takes a sterilized apron out of her stock of supplies and puts it on the operator, covering that part of his suit which necessarily becomes contaminated in moving about the room before and between operations.

**Brushes.**—The brushes for scrubbing the hands and nails must be made of stiff bristles, or, better, of a vegetable fiber, such as the Mexican Tampico grass, of durable quality; they are sterilized after every use in the steam sterilizer, and kept in a wire basket. The brush should have a strong wooden back, to afford a good grasp, and should not measure less than 12 by 4.5 centimeters. The fiber brushes stand repeated sterilizations. As soon as the fiber gets soft the brush must be thrown away. The same brush must never be used by two different persons, or twice by the same person without re-sterilization.

As I visit various clinics I often see no more serious defect in the technique than the miserable, insignificant, flabby nail brushes often used by the surgeon and all his assistants in common, without any or with but one sterilization. Scrubbing the hands, and particularly the nails, with such brushes becomes a farce.

**Disinfection of Hands and Forearms.**—The first duty of the operator, assistants, and nurses upon entering the operating room is to remove from hands and forearms all contamination from the thousand contacts of daily life, as well as to destroy those germs which have their habitat in the superficial parts of the skin and under the nails.

Many methods of hand disinfection have been proposed. Among these, Fürbringer's is perhaps the most commonly known and generally used. To carry out this method the hands are actually scrubbed for a minute with soap and water as hot as can be borne; they are then rubbed for a minute with 80 per cent alcohol, and finally washed with a  $\frac{1}{2}$  per cent sublimate solution.

This method yields fair results, but it is not absolutely certain, as shown by my own experiments; for even after the most careful use of the agent, if the mercury is precipitated by a sulphide of ammonium solution, cultures can often be obtained from the scrapings from the skin.

Welch says in this connection: "It may be urged that it is not necessary actually to kill the bacteria upon the skin; it is sufficient if they are rendered incapable of growth; and as most of those which are not killed by the sublimate do not grow upon our ordinary nutrient media, it is reasonable to infer that they will not grow upon wounds. This line of argument certainly deserves consideration. Nevertheless, there is no positive proof that these bacteria will not grow in wounds under some conditions, and surely we shall feel safer with a method of disinfection which actually kills the bacteria."

I adopted, in 1889, the permanganate of potash and oxalic acid method of disinfection of hands, which had been used by Prof. F. Schatz, of Rostock, for the purpose of prolonging the act of washing the hands for greater security, but not with any germicidal intent. In 1891 my assistants, Drs. Ghriskey and Robb, carried out a series of bacteriological experiments to test the efficacy of this method, and these were embodied in an article written for the *Amer. Jour. of Obst.*, vol. xxiv.

From these studies I arrived at the following conclusions, which have stood the test of time:

1. *Staphylococci* are present on the hands of all persons.

2. It is impossible to get rid of these organisms even by scrubbing the hands and nails from ten to twenty-five minutes with a sterilized brush, soap, and water at a temperature of 40° C.

3. The bichloride of mercury solutions as used, up to 1 to 500, are not as germicidal as supposed, but they are inhibitory, as demonstrated by cultures growing after the precipitation of the bichloride with ammonium sulphide (Geppert).

At the time these experiments were conducted it was believed that the permanganate of potassium was the active germicidal agent, the oxalic acid being used simply to neutralize and decolorize the permanganate of potassium.

A series of experiments by Dr. Mary Sherwood, conducted in 1893, at my request, to determine the relative part played by these two chemicals in the process of disinfection, however, led to the conclusion that both the permanganate of potassium and oxalic acid were germicides, but that the oxalic acid, at a temperature of about 40° C., is a much more powerful germicide than permanganate of potassium. (See *Johns Hopkins Hospital Reports*, vol. iii, p. 359.)

The strong evidence furnished by these two series of experiments as to the efficacy of the permanganate and oxalic acid as disinfectants is further sustained by an extended practical experience.

In my clinic the cleansing and disinfection of the hands and forearms is accomplished in four steps:

1. The hands and forearms are first vigorously scrubbed for ten minutes with a brush, using common brown kitchen soap or green soap and hot water. Particular attention must be given to scrubbing the surfaces between the fingers, and to the nails, which must not be more than a millimeter in length. The most vigorous efforts in washing must be devoted to the spaces beneath and about the nails. The water should be as warm as can be comfortably borne, and either constantly changed with fresh water running in, or poured out and changed completely four or five times. The duration of this important step must not be measured by guessing; a clock must stand directly over the wash-basins, and assistants and nurses for the first three months should be required to spend never less than ten minutes in cleansing the hands. After the experience in washing thus gained, the time may be reduced to five minutes. Although the hands and arms now appear clean, they are not aseptic, for cultures taken from beneath the nails and from the skin will develop colonies of micrococci, often in large number, in spite of my washing, however prolonged and thorough.

2. The hands, thus mechanically cleaned and softened, are next immersed in a hot saturated solution of permanganate of potash until stained a deep mahogany color.

3. They are then immersed at once in a saturated solution of oxalic acid, which decolorizes and completely sterilizes them. The oxalic acid solution should be as warm as can conveniently be borne.

4. The oxalic acid may be removed by rinsing the hands in warm water, but

it is better for this purpose to keep a dish of sterilized limewater on hand, which at once precipitates the oxalate of lime.

After such a thorough preliminary disinfection it will be necessary to return to the wash-basins frequently during the preparations and during the operation to remove the contamination of various necessary contacts with substances not sterilized—such as the body of the patient, the outer surfaces of dishes, lids, etc.

By turning again to the wash-basins and vigorously scrubbing for ten or fifteen seconds with a fresh brush, the danger of contamination is removed.

Pads of sterilized gauze 15 centimeters (6 inches) square are useful in enabling assistants and nurses to touch handles and lids of jars, etc., without contamination.

With the completion of these antiseptic preparations the operator and his assistants are in a position to go on with their work dominated by a different impulse; for the efficient employment of antiseptics before the operation has secured a condition of asepsis which it will henceforth be the constant effort of surgeon, assistants, and nurses to maintain throughout and after the operation.

Although the methods just detailed are indispensable in the preparations for an operation, it is still more important that the surgeon, assistants, and nurses should live under such a keen realization of the vital relations of sepsis, antiseptics, and asepsis to their work that they shall always feel an instinctive repugnance to contact with any septic material. This sensibility must be especially alert in relation to intestinal and vaginal examinations, treating abscesses, handling sloughs, or touching pathological matter at autopsies, etc. The occasions are rare which justify a surgeon in engaging directly in a post-mortem examination or in handling septic specimens at all. After any such necessary exposure the operator should scrub his hands and forearms thoroughly with soap and warm water, and finally sterilize them with the hot saturated permanganate of potash and oxalic acid solutions.

Surgical assistants and nurses are at all times disqualified by their occupation from taking any part in a post-mortem examination. This instinctive shrinking from infection, keeping always on guard against sepsis, may well be termed "the antiseptic conscience."

## CHAPTER II.

### ANTISEPSIS AND ASEPSIS IN PRIVATE PRACTICE.

1. Difference between private and hospital surgery.
2. Three plans for preparing sterilized kit: In a public hospital. Room prepared in surgeon's own house. By associate in private hospital.
3. Equipment of sterilizing room at surgeon's house.
4. Sterilization of instruments, dressings, and ligatures.
5. Instrument bags. Contents. Plastic operations. Abdominal operations.
6. Preparation of room for operation.

**Difference between Private and Hospital Surgery.**—Antisepsis and asepsis can only be attained and carried out in private practice with a greater expenditure of time and trouble, in marked contrast to the facilities of the operating room in the modern hospital. With due care, however, and constant painstaking attention to details, a room in a private house may be so prepared that the principles already laid down need not be violated.

The chief difficulties encountered are the thorough sterilization and the preservation of the instruments and dressings in an aseptic state, and the proper preparation of vessels, towels, and sheets at the patient's home. The surgeon is sometimes compelled to intrust these matters to unskilled assistants, or, in an emergency, even to the family servants. Another reason why work in private houses is less satisfactory must not be overlooked; it is the embarrassment of the new surroundings to the surgeon himself. The number and disposition of assistants, the source of light, the slight delays on the part of the nurses in attending to their duties, as well as the many minor questions as to the bacteriological condition of this or that article, all contribute to emphasize the difference between routine and emergency work. Not the least distressing feature of surgical work in private practice is the liability to forget important instruments in packing the kit, or the awkwardness of a makeshift when an unexpected need has arisen which can not be supplied from the armamentarium at hand.

But, in spite of all the objections which may be raised, a large amount of gynecological work will continue to be done in private houses. Such are the emergency cases which dare not travel, and the patients of the surgeon without satisfactory clinical conveniences or whose practice lies largely in country districts, where a repugnance to a hospital still lingers.

In spite of all precautions and preparations, I confess to a feeling of anxiety after important operations in private, which is only relieved when the patient is convalescent. The first difficulty to be met is the need of suitable assistance. Every operator with a large practice must have a trained assistant to

help him in his private operations, to care for the instruments, and to make the necessary preliminary preparations for operation at the house of the patient. Such an assistant must be a man with a broad hospital training. The second point of importance is the sterilization of the instruments and dressings. The instruments may be sterilized either before going to the patient's house or upon arriving there; the dressings must always be sterilized beforehand.

My own method has been to sterilize and pack away all instruments and dressings immediately after returning from an operation, so as to be ready for a call at any moment. I keep prepared in this way three bags of instruments and dressings; one, for an ordinary gynecological examination and dilatation and curettage; another, for plastic operations; and the third, for abdominal surgery.

I have tried three plans in the preparation of an instrument kit; first, to have it prepared by my resident at a public hospital; second, to fit up a sterilizing room in my own house; and, third—my present plan—to place all preparations in the hands of my associate in my private hospital, who supervises the work of the operating-room nurse in putting them in order. The last plan is the most satisfactory, but, for the sake of the great number of surgeons who must prepare at home, I describe the

**Equipment of a Sterilizing Room at the Surgeon's Home.**—When possible, a special room should be set apart for this purpose. It need not be larger than 8 by 10 feet—big enough to hold the instrument case and receptacles for dressings, a sterilizer, and a washstand. It should be well lighted, with walls coated with a light enamel paint. If the floor is not close jointed, linoleum or oilcloth, turned up against the washboard at the edges, gives a clean surface, which may be frequently mopped.

A glass instrument case with a metal frame is the best for purposes of cleanliness, but one of hard wood, preferably oak, will answer. The shelves upon which the instruments lie should be of glass or covered with glass plates.

A steam sterilizer of the Arnold pattern occupies one corner of the room, with a large Bunsen burner beneath it. A sink, 2 by 4 feet, supplied with hot and cold water, is an important but not an essential convenience.

A wooden table with a glass or paraffined top, a bench, glass jars for dressings, sponges, and ligatures, 3 enameled tin basins, 1 enameled dipper of a liter capacity, 2 agate-ware reservoirs holding 10 gallons each, and a large shallow boiler on a gas burner for the instruments, complete the furniture of the room.

**Sterilization of Instruments, Dressings, and Ligatures.**—A large quantity of sterilized dressings, sponges, and ligatures ought always to be ready, so that they may be taken out of the supply jars at a moment's notice, without waiting to sterilize more; but the dressings should not be kept over a month without re-sterilizing them.

The instruments must be sterilized immediately after returning from an operation. To do this, they are first scrubbed with a brush with soap and warm

water, taking especial care to remove all visible traces of dirt from joints and corrugations. They are then wrapped in a towel and put on a rack in the long shallow boiler and boiled for five minutes in a 1 per cent solution of carbonate of soda. The knives must be wrapped separately in absorbent cotton to protect the edges.

Before beginning the preparations, the floor is mopped up and the table and bench washed off with hot water and soap to remove the dust. All the agate-ware vessels are scrubbed with soap and water and scalded out with boiling water, and the two large reservoirs are filled two thirds full with water boiled for half an hour, and one of them set aside to cool. A half liter of a saturated solution of oxalic acid and a half liter of a saturated potassium permanganate solution are prepared in two of the agate basins, while a third basin is left for the hands.

The hands are now scrubbed and disinfected by the permanganate of potash and oxalic acid solution, as described in Chapter I; or a pair of sterilized rubber gloves may be worn, and the thorough sterilization of the hands left until all the preparations have been made. The instruments are lifted out of the boiler and rinsed with plain boiling water taken with a sterilized cup from the agate-ware reservoir. They are laid on one of the sterilized towels and at once wiped perfectly dry with another towel. If the water used is hot, they will dry much more rapidly. They are next assorted, the knives put in a special sterilized metal box by themselves, and placed in a sterilized bag of butcher's linen. Sterilized instruments thus put away in a bag and stored in the kit will remain sterile until the bag is again opened.

Dressings, ligatures, and sponges are best sterilized in bulk beforehand, when the following preparations are necessary:

Silk and silkworm gut are cut the desired lengths and placed in stout ignition tubes, plugged with cotton, and put in a wire basket. A dozen assorted needles are threaded with carriers and stuck in a large gauze pad, like a needle-book, so as to be rolled up.

Towels are made up into bundles of two sizes, one containing 4 and the other 10 towels, and inclosed in a linen bag.

Cotton is cut in strips 30 centimeters (12 inches) in length, and made up into convenient-sized packages and rolled in towels securely pinned.

The gauze is doubled and cut in pieces one meter (40 inches) square and one half meter (20 inches) square, and into pads 15 by 20 centimeters (6 by 8 inches) in size and several folds thick. The large sizes are used to cover the abdomen in abdominal operations, and to cover the buttocks in vaginal operations; the medium sizes to lay in the abdominal cavity over the intestines during an operation; and the smaller pieces to protect the hands in grasping contaminated objects, such as cautery handle, etc. For abdominal cases four large, four medium, and four small pieces should be put up into one package, while for plastic cases only two of the large and two of the small pieces are required. Each package should be wrapped in a towel and then inclosed in an outer protector and sterilized. This enables the assistant to open the covering be-

fore sterilizing his hands, and so does away with the necessity of having some one else open the packages for him later on when his hands are sterilized. Protective stockings for perineal operations and T and abdominal bandages are hid in bags to be sterilized. Every bag before sterilization must bear a label stating its contents; this may be done by writing on the bag in large letters with indelible ink. When these packages are all ready they are put, loosely packed, together with the wire basket full of ignition tubes, into the sterilizer and steamed for one hour. Dressings thus sterilized only once should not be used except in cases of emergency; if there is time for deliberate preparation, the fractional method must be followed by sterilizing for half an hour upon each of the two following days. While the dressings are being sterilized the glass jars in which they are to be stored must be thoroughly washed with soap and water, and rinsed out with a 1-500 bichloride solution, followed by warm sterilized water. After the first sterilization the wire basket containing the ligatures is lifted out and set aside, preferably in a sunny place, until the next day. The dressings, protected by a towel, are left to dry in the sterilizer with the top off.

The following day the wire basket is again placed in the sterilizer with the dressings and steamed for half an hour, and after twenty-four hours the process is repeated, completing the fractional sterilization and destroying spores and germs absolutely.

The ignition tubes containing ligatures are now marked with a label stating the size of the ligatures and the date of sterilization, after which they are stored away in glass jars, ready for use at any time, safe from the invasion of micro-organisms, which will not penetrate the cotton plugs or the linen envelopes. The linen bags are made up, in various sizes, of heavy butcher's linen, closed with a draw-string. The bag should be enough longer than the instruments for the top to fold well over before tying. I use bags of the following dimensions: The larger size, 38 by 20 centimeters (15 by 8 inches), for instruments and dressings; the smaller sizes, 30 by 15 centimeters (11 by 6 inches), and 12 by 8 centimeters (5 by 3 inches), for the rubber tubing, needles, etc.

Rubber cloths and pads should be disinfected by scrubbing with soap and water and rinsing with boiling water, and finally sponging with a 1-1,000 bichloride of mercury solution, which is washed off, and they are dried in the sunlight and enclosed in linen bags. The agate instrument trays should be rinsed with boiling water and set aside, filled with a 1-1,000 solution of bichloride for an hour; they are then rinsed off and enclosed in linen bags. From 50 to 100 sponges should be sterilized at one time, according to the method described in the preceding chapter. They are preserved in a carbolic acid solution (3 per cent), which must be changed at least once in ten days. All the dressings, instruments, sponges, and accessories having been prepared, the operating bag may now be packed.

## INSTRUMENT BAGS.

Canvas telescopic bags make a satisfactory operating kit. The most useful sizes are 38 by 21 centimeters (15 by 8 inches), 60 by 30 centimeters (24 by 12 inches), and 56 by 30 centimeters (22 by 12 inches). The largest size is for the abdominal instruments and accessories, the intermediate for plastic operations, and the smallest for making examinations, removal of sutures, dilatation, and curettage.

To pack the bag, a sterilized linen cloth is first laid in it, hanging well out over the edges; then the instruments are put in, and finally a complete list, distinctly written on a card, is placed conspicuously on the inside cover. By consulting this list at any subsequent time the surgeon knows at once what articles the bag contains without opening the packages, and can add any special instruments needed for particular cases. As the nurse packs the kit, she keeps the appropriate list, for plastic or abdominal operations, before her, checking the articles as they are put in. The glass must be stored in the center to prevent breakage. When the bag is full a towel is laid over its contents, and the linen cover is brought together and pinned over all. The instruments to be taken in plastic cases will be found enumerated in Chapter VI.

Kit containing instruments and accessories for abdominal operations in private practice:

Four nail brushes, sterilized and wrapped in gauze.

Soap in metal box.

Tablets of bichloride of mercury, 5 grains each.

Tablets of sodium chloride.

Two ounces of oxalic acid in a bottle.

Two ounces of permanganate of potassium in a bottle.

Brandy, 8 ounces; alcohol, 8 ounces.

Iodoform and boric-acid powder (1 to 7).

Razor in case.

Ether and cone, chloroform and mask.

Hypodermic needle, with hypodermic tablets of strychnine, grain  $\frac{1}{10}$ , and atropine, grain  $\frac{1}{100}$ .

Gauze (2 large, 2 medium, and 4 small pieces in package).

12 sterilized towels in bag.

Seven sponges in 2 jars.

Iodoform gauze.

One package of absorbent cotton (6 pieces).

Irrigation bag with tube and glass nozzle.

Ovariotomy pad.

Abdominal bandage.

Storage battery and headlight.

2 porcelain-lined hand basins.

Rubber gloves, sterilized in the soda solution with the instruments and put in a linen bag.

2 rubber sheets.

Duck suits and canvas shoes for surgeon and assistants.

Safety pins.

If the operation is to be an abdominal one, it is essential to send with the kit a portable Trendelenburg table. One of the best I know of is that of Dr.

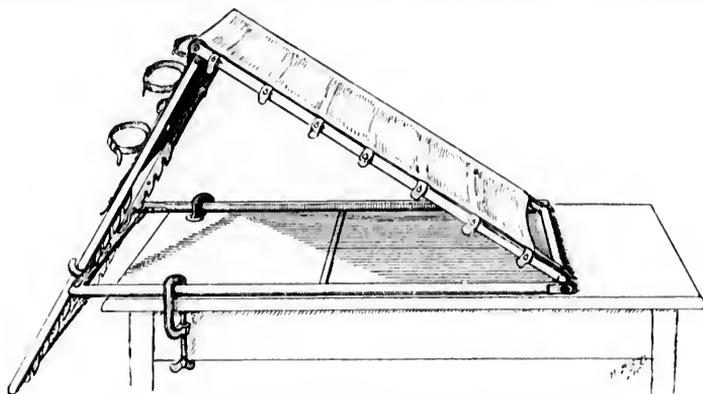

FIG. 11.—MCKELWAY'S PORTABLE FRAME FOR ELEVATION OF THE PELVIS.

The frame is made of tough wood, with a water-proof support for the body buttoned fast to it. It is kept in position by a simple latch, and it can be attached to any ordinary table by two clamps.

G. I. McKelway, of Philadelphia, made with a light wooden frame, with impermeable cover, weighing altogether 18 pounds. It is clamped on an ordinary kitchen table when used. Dr G. M. Edebohl, of New York, has devised a beautiful light metal table swinging on its support at any angle desired; it weighs 36 pounds in its case, ready for shipping, and 34 pounds without the case.

#### PREPARATION OF THE ROOM FOR OPERATION.

When possible, the surgeon, or his assistant, or a trained nurse, should go to the house of the patient the day before the operation to select a suitable room and to give directions how to prepare it, getting ready towels, bed linen, water, and vessels. It is my custom to forward these directions:

“Arrange, if you can, a room on the second floor, with good light and ventilation. Remove carpets, curtains, upholstery, and any unnecessary articles of furniture, such as sofas, rocking chairs, fancy tables, brackets, pictures, etc. Have the mattress thoroughly aired and the bed cleaned and made up with a fresh draw sheet with a rubber sheet beneath. I prefer a single bed. Scrub the floor thoroughly, wipe off the walls, and particularly tops of doors and windows, removing every particle of dust, and on the morning of operation go over all again with a wet cloth. Do not use a dry duster in the room.

“Provide these articles: 4 chairs with wood or cane seats; a table 4 feet

long, 2 feet wide, and 30 inches high (common kitchen table); 2 small square tables (1 can use a bureau or marble-top washstand if necessary); 2 clean buckets, a foot-bath tub, 3 china pitchers and basins, a dozen clean towels (not new), 2 sheets, 2 blankets, a new wash boiler, 8 bottles with corks for hot water, 2 pounds of absorbent cotton, a rubber sheet, and 1 bedpan."

I often add to the list a small tin sterilizer and a gas stove.

The wash boiler must be thoroughly scrubbed and rinsed with boiling water on the morning of the operation and filled with water, distilled if obtainable, and put on to boil for an hour, and set aside on the stove, well covered, keeping it at about 50° C. (120° F.) when desired for use. The three china pitchers must be scrubbed and scalded out and filled with water from the boiler, which has become cold, and then covered with towels. It is safer to have the dishes scalded once more just before use. Wash-basins must be scrubbed with soap and water, scalded, and turned upside down on clean towels so as not to catch the dust of the room.

When the surgeon arrives he should see for himself that his instructions have been fully carried out.

If it has been impossible to give full instructions beforehand regarding the selection and preparation of the room, the assistants and nurse must go to work at once on their arrival, and do the best they can under the circumstances in the time at their disposal. It is better not to take up the carpets on the morning of an operation, but unnecessary furniture should be removed, and a drug-get or dampened sheet spread on the floor.

To the operating table is clamped the portable Trendelenburg table covered with a folded blanket, protected by a sheet. A chair is placed at the end of the table, covered with a blanket and sheet, to serve as a rest for the patient's feet during a celiotomy.

The ovariotomy pad is placed on the table so that the patient's buttocks will

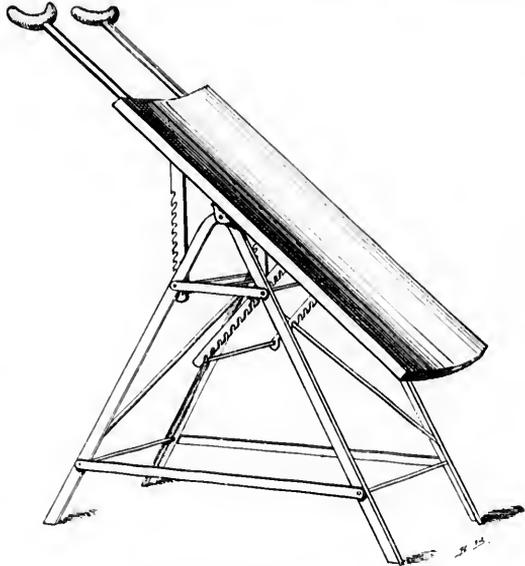

FIG. 12.—EDERHOLS' LIGHT PORTABLE TABLE.

The table weighs 34 pounds without the case, and 36 pounds cased; it holds the heaviest patients without rocking, and is easily changed to any degree of elevation.

lie squarely upon it, while its apron hangs over the edge, on the operator's side, into the foot bath or bucket. Two smaller tables are covered with sterilized towels, and are used by the assistants; upon one of them the dressings are placed, and upon the other the instruments, still in the bags.

The oxalic acid and permanganate of potash solutions are now prepared in two basins, and two other basins for the hands are filled, one with a bichloride solution (1-1,000), and the other with pure warm water, and placed on the chairs. The basin of bichloride must stand farthest from the operator, in order that he may be less likely to put his hands into it unintentionally during the operation.

The nail brushes, resting in the gauze they were wrapped in, and the soap, are hid by the basins. The rubber bag is filled with warm water and hung about three feet above the table. Basins for sponges and gauze are filled with boiled water, and the razor, soap, and solutions for cleansing the abdomen or perineum laid on a towel within easy reach.

The assistant now sterilizes his hands and forearms, scrubbing them with soap and water and disinfecting them with the permanganate and oxalic acid solutions, as described in Chapter I, and following the rules as to touching unsterilized objects in force in the operating room at the hospital. When packages are to be opened, pitchers to be picked up, etc., the nurse must be called upon to do it.

The instruments are arranged in one of the trays, and preferably covered with boiled water, although some surgeons like to use them dry. The needles, threaded with carriers, together with the suture materials, are placed in another tray. Antiseptic chemical solutions poured on the instruments and ligatures only injure them, and are dangerous to the patient, besides not helping the technique.

Three free sponges and four sponges on holders, in a basin near by, are sufficient for the average abdominal operation. With instruments and sponges arranged, the assistant turns his attention to the dressings, which are ready to be opened and handed to him by the nurse.

A sterilized bag of gauze sponges should be carried, so that in case it is impossible to obtain water which is unquestionably safe, the dry gauze may be used instead of the regular sponges.

When all these arrangements are completed, the assistant makes a final examination, inspecting the preparations and noting where the various articles required during the operation are to be found.

The patient, who has been anesthetized in the adjoining room, is now carried in and placed on the table. In helping to arrange the patient, shaving, and washing the abdomen, the assistant puts on the sterilized rubber gloves, which perfectly protect his sterilized hands from contamination during the various manipulations.

As soon as these preparations are completed the nurse draws the gloves off his hands; and he arranges the sterilized towels and gauze about the field of operation, and then takes his place opposite the operator.

A slit is made in the gauze sheet over the site of the incision, and the operator, who has also disinfected his hands, begins his work.

The small pads of sterilized gauze must always be used to protect the hands in taking hold of anything not sterilized, such as a cavity handle, a basin, or a pitcher.

The surgeon and his assistants must constantly be on the watch to see not only that they themselves commit no errors in technique, but also that the nurses, who are more easily embarrassed by their new surroundings, do not infringe on these rules as the operation progresses.

The after-care of the patient will prove easy or difficult, according as her surroundings have been altered to the simple arrangement of a hospital room. Plain, bare furnishings will also materially relieve the nurse in maintaining strict cleanliness. The high narrow hospital bed is convenient, because it facilitates dressing the wound and feeding and caring for the patient.

A small sterilizer on an alcohol or gas lamp, or even the kitchen range, will serve to sterilize the cotton, bandages, towels, and the instruments used in removing dressings each time just before use, so that this part of the technique need in no respect be inferior to that of the hospital.

## CHAPTER III.

### BACTERIOLOGY.

1. Two views of the normal vaginal organisms. Döderlein's: as long as the vaginal secretion remains acid and contains the Döderlein bacillus there is no danger of infection. Krönig's: that the normal vaginal secretion contains a number of different bacteria, which can be cultivated under anaërobic conditions only.
2. Natural safeguards against infection. Vagina normally closed. The vaginal secretion is germicidal. Law of Wyssakovitch: that the cells covering any part of the body, so long as they preserve their integrity, protect the underlying tissues. Law of Metschnikoff: wherever the body is attacked by bacteria the polymuclear leucocytes and the large mononuclear leucocytes quickly come to the rescue as phagocytes.
3. The probabilities of autoinfection.
4. Infection by way of the bladder.
5. Special consideration of the different forms of bacteria. Gonococcus. Syphilis, no micro-organism yet known as cause. Tubercle bacillus.
6. Suppuration. Streptococcus pyogenes. Staphylococcus pyogenes aureus. Staphylococcus pyogenes albus. Staphylococcus pyogenes citreus.
7. Bacillus aerogenes capsulatus.

AXTER from the relation which bacteria bear to general surgery, they also play an important and peculiar rôle in gynecological and obstetrical practice. Since the vagina forms one of the portals of entry for bacteria, and since the bacteria may thence find their way to all parts of the genital tract, it is essential at the outset to understand the conditions favoring their entrance into the vagina and their further progress, as well as the natural and artificial means for guarding against infection by this avenue. Unfortunately, it has not been possible to come to a decision in regard to some of the most important points at issue, and the results of the observation and experiments of equally trustworthy authorities are still at variance with one another. It may be broadly stated that these results fall into two categories—viz., one going to show that as long as the secretion of the vagina remains acid, as it normally is, and contains a peculiar bacillus, first described by A. Döderlein and called the Döderlein bacillus, there is no danger of infection. If, however, the secretion loses its acid reaction—as, for example, during the lochial discharge—this safeguard against infection is overcome. The normal vaginal bacillus present during pregnancy makes way for cocci in the lochia, but reappears under ordinary circumstances at the end of the puerperium. Döderlein therefore recommends the use of douches of lactic acid during the lochial discharge, in order to prevent the action of the normal secretion from being overcome. His object is to keep the discharges acid in order to furnish the conditions most favorable for the growth of the normal bacillus, and to prevent the growth of pathogenic micro-organisms, most of which, as is well known, prefer alkaline media.

Opposed to these results of Döderlein are those obtained by B. Krönig and others, which go to show that the normal secretions contain a number of differ-

DESCRIPTION OF PLATE I

FIG. 1.—Chains of streptococci in some places lying in single rows in other places grouped in rows. From a culture.

FIG. 2.—Cocci from pus from face and in the nose. Note their characteristic beak shape.

FIG. 3.—Tubercle bacilli. They are long and slender, straight or curved, and stain irregularly, leaving one the impression that they contain spores. The flat masses are the ends of cells. Clumpy bodies in the background are the ends of cells.

FIG. 4.—Bacillus coli communis. These bacilli are short, have rounded ends, and are rather plump, when very short they may be mistaken for cocci.

FIG. 5.—Streptococcus pyogenes. The cocci occur principally in masses somewhat resembling bunches of grapes. They are also found singly, and in masses in short chains.

FIG. 6.—Bacillus aerogenes capsulatus (Weich and Nuttall). A bacillus of variable length, occurring in pairs and surrounded by a clear capsule, as shown in the plate.

### DESCRIPTION OF PLATE I.

FIG. 1.—Chains of streptococci, in some places lying in single rows, in other places grouped in rows. *From a culture.*

FIG. 2.—Gonococci from pus, lying free and in the pus cells. Note their characteristic biscuit shape.

FIG. 3.—Tubercle bacilli. They are long and slender, straight or curved, and stain irregularly, giving one the impression that they contain spores. The blue masses are the nuclei of cells. Chiefly polymorpho-nuclear leucocytes.

FIG. 4.—*Bacillus coli communis*. These bacilli are short, have rounded ends, and are rather plump; when very short they may be mistaken for cocci.

FIG. 5.—*Staphylococcus pyogenes aureus*. The cocci occur principally in masses, somewhat resembling bunches of grapes. They are also found singly, and may be seen in short chains.

FIG. 6.—*Bacillus aërogenes capsulatus* (Welch and Nuttall). A bacillus of variable length, occurring in pairs and surrounded by a clear capsule, as shown in the plate.

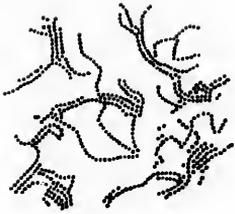

Fig 1

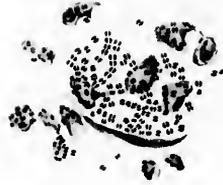

Fig 2

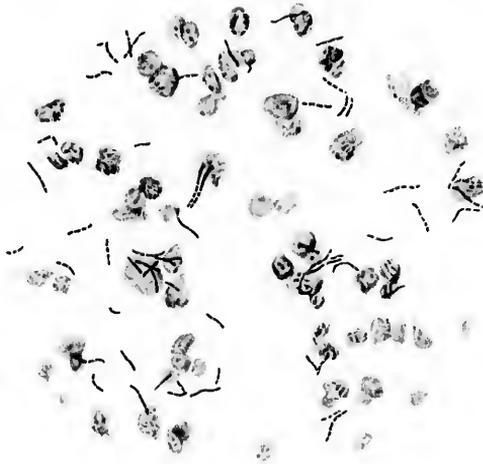

Fig 3



Fig 4



Fig 5



Fig 6



ent bacteria which can be cultivated, however, under anaërobic conditions only. Krönig has described two of these, both of them anaërobic, non-pathogenic streptococci. It is claimed that but few aërobic and facultative aërobic organisms are to be found, and that the latter prefer acid media, and, furthermore, that the vaginal secretion, whether normal or not, always destroys pyogenic micro-organisms introduced into the vagina. It is not yet known what element in the secretion acts as a germicide; but whatever it is, it is claimed by Krönig to be more active and efficient than any antiseptic applied in the form of douches.

It is still impossible to reconcile these contradictory views. It seems, however, well established that the portal of entry afforded by the female genital tract for the invasion of bacteria is provided with its own safeguards of defense. It has been pointed out that the vagina is normally closed and is opened only to allow the escape of the uterine contents during menstruation and parturition, and during coitus and vaginal examinations. Except under the last two conditions the natural tendency is rather to remove any micro-organisms already present than to admit them from the outside. The fact that the vagina is usually closed probably offers an obstacle to the invasion of the bacteria, but this would hardly be sufficient unless the secretion which glues the walls together is itself antagonistic to the bacteria, for the closure can hardly be so perfect that bacteria would meet with an efficient mechanical obstruction. Still this must be regarded as one of the safeguards, imperfect as it is. Another safeguard is undoubtedly the vaginal secretion, which, as has just been said, according to some authorities, acts only when it is normal, but according to others is equally effective even when it is pathological. Whatever the germicidal power of the vaginal secretion may be due to—whether to its acid reaction, or to a special bacterium, or to several bacteria which find nutrition peculiarly suitable to their growth in the secretion, or whether its action is purely mechanical in coating over the mucous membrane, in transporting the bacteria outward and hermetically sealing the vagina—it is agreed on all sides that the secretion does act as a protection against the invasion of the pathogenic bacteria. M. Walther has shown that this germicidal power is not due to the mucin present in the secretion.

Another safeguard to be considered is the law of Wissakovitsch, according to which the cells covering any part of the body protect the underlying tissue as long as they preserve their integrity. If, for example, the outer cells of the mucous membrane of the vagina are removed mechanically or by erosion an important safeguard is destroyed; this destruction may take place by the introduction of the finger or of instruments in examinations and in giving douches. In any enumeration of the means of defense against bacterial invasion in any part of the body the law of Metschnikoff should always be included, and no exception in this respect is found in the female genital tract. According to E. Metschnikoff, wherever the body is attacked by bacteria the polymorpho-nuclear leucocytes and the large mononuclear leucocytes quickly come to the rescue and act as phagocytes.

K. Menge sums up the means of defense and the circumstances which weaken these and make infection possible as follows :

"The normal conditions warding off the invasion of pathogenic bacteria are the various harmless bacteria and their products, the acid reaction, the secretion from the tissues, the leucocytes, and the insufficiency of oxygen. These safeguards are diminished in the newborn, and in the adult during menstruation, also where there is a superabundant secretion from the cervix and body of the uterus, or from the cervix alone, and at the climacteric. Infection is also apt to take place where the vulva gapes wide open and the vagina is everted."

If the safeguards are overcome in any way and infection takes place, the question arises whether this is due necessarily to bacteria introduced from without, or whether the bacteria have been lying in wait in the genital tract for an opportunity to attack the tissues. In regard to this important point opinion seems also to be divided. G. Winter finds micro-organisms, which may be pathogenic, constantly present in the lower part of the cervix in pregnant as well as in non-pregnant women. The wider the opening of the os, the farther up the organisms are found. The upper part of the cervix is free from micro-organisms. M. Walthard finds that the genital canal of unexamined pregnant women may be divided in this respect into the portions lying externally and more or less in communication with the outside, on the one hand, and those portions which are better protected, on the other. Bacteria are constantly present all the way from the vestibule to the upper part of the cervical canal, the uterus and tubes being free. He thinks the uterine cavity is protected by the mucus in the cervix. In the portions of the canal where the bacteria are normally found the number is small at the beginning of labor and larger at the close; and in pregnancy, parturition, and the puerperium the streptococcus, staphylococcus, gonococcus, and colon bacillus are often present. In twenty-seven cases out of a hundred, streptococci were found which were nonpathogenic, it is true, but which he thinks might have become virulent.

Fr. Vahle finds pathogenic bacteria present oftener than the staphylococcus aureus or albus. The number and virulence of the organisms are variable. It seems therefore probable that pathogenic bacteria are sometimes present in the genital tract, and under these conditions it requires only a transitory weakening of the normal safeguards to bring about an infection. It does not seem impossible, therefore, that autoinfection may take place; but where infection occurs it is most likely that the bacteria are introduced by manipulation of some kind shortly before the symptoms appear; for, after all, the pathogenic bacteria probably do not lie dormant in the genital tract for any great length of time.

The significance of the presence of pathogenic bacteria varies according to the species found, for this fact determines whether in case of invasion the process will remain purely local and insignificant, or will spread to other parts and so cause a general infection. If the staphylococci alone are present, especially the comparatively harmless citreus, albus, or epidermidis albus, the danger to the health of the patient is much less than in the case

of the streptococcus which tends to produce a general infection. If gonococci are found in the vagina the danger of an infection of the Fallopian tubes becomes imminent. In view of the proximity of the anus, the colon bacillus is frequently found, but its presence has little significance. The finding of an organism which retains its stain by Gabbett's method should not lead to a diagnosis of tuberculosis without other tests, for the smegma bacillus also holds this stain, and is in so far indistinguishable from the tubercle bacillus. Wertheim considers that a cover-glass preparation made and examined during the course of an abdominal operation is sufficient for the prognosis, and enables one to determine whether drainage should be used or not. He recommends drainage on the basis of such an examination only where streptococci or the staphylococci are found. Processes caused by the gonococcus, on the other hand, do not require drainage, since this organism causes at most only a local peritonitis, and never general sepsis.

In my own clinic drainage is rarely ever employed, and its use is uninfluenced by the character of the organisms found during the operation.

Besides the easy means of ingress formed by the vagina for micro-organisms, the female bladder is an easier avenue of entrance than the male bladder on account of its shorter urethra. Infection of the bladder usually takes place through the introduction of the bacteria upon unsterilized instruments or upon instruments contaminated during their introduction into the bladder by the bacteria at the vaginal outlet. The micro-organisms may find their way from the bladder up the ureters to the kidneys, or they may be conveyed to the kidneys and other parts of the body by the blood current, leaving the ureters unaffected. In the latter mode of spreading the smallest lesion or erosion of the wall of the bladder may afford the opportunity for the bacterial invasion. It is not always apparent why infection sometimes becomes general and sometimes remains local. The bacteria may attack the walls of the bladder immediately, or they may first cause an ammoniacal fermentation of the urine. According to Noël Hallé, the organisms most often concerned are the bacillus coli communis, the urobacillus liquefaciens septicus, the tubercle bacillus, and certain other bacilli and cocci. The pus cocci are also found, but not as frequently as other organisms.

The colon bacillus attacks the walls of the bladder immediately, without first causing fermentation of the urine. The colon bacillus, the pus cocci, and the urobacillus liquefaciens are not as prone to travel up the ureters as they are to be taken up by the blood current and form embolic foci in the kidneys and other organs.

#### PATHOGENIC BACTERIA MET WITH IN GYNECOLOGICAL PRACTICE.

**Gonorrhœa.**—According to E. Wertheim, gonorrhœa is the most frequent cause of suppurative met with in gynecological practice. It is caused by a specific organism, and hence can be contracted only by direct or indirect contact with a gonorrhœal discharge. According to Cahen-Brach, in children indi-

rect infection is more frequent than in grown persons. In children infection usually starts at the vulva, whence it spreads to the urethra and vagina, and seldom to the cervix and corpus uteri and tubes; in children also joint metastases are rare. In women, according to J. Veit, the first attack of gonorrhoea usually disappears spontaneously, and the tubes become involved in the first attack only in the rare cases of infection shortly before or shortly after delivery. During childbed gonorrhoea may cause a special form of peritonitis characterized by an explosion beginning in the latter days of confinement; repeated attacks only are to be regarded as dangerous.

Kaptyowsky finds that ten per cent of prostitutes still have gonococci in the vaginal secretions after they have been discharged from the hospital as cured of gonorrhoea. He finds that seven per cent of prostitutes admitted to the hospital for diseases other than gonorrhoea have gonococci in the secretion, and that eight per cent of all healthy prostitutes harbor the gonococcus. Klein has found that in chronic gonorrhoea the individual may become accustomed to the presence of the gonococci, but the micro-organisms from such cases may cause the virulent disease in other persons, and can then cause reinfection of the original person. Furthermore, that immunity after recovery does not seem to take place.

The *micrococcus gonorrhoeae*, or gonococcus, was first observed by Neisser in gonorrhoeal pus, and was subsequently cultivated by E. Bium upon artificial media, from which the cultures were successfully inoculated upon human beings. The gonococcus is found in the gonorrhoeal discharge lodged within the pus cells, and this is its characteristic feature. In gonorrhoeal pus numerous gonococci are also found lying free between the pus cells; frequently there are clumps of the cocci about the size and shape of a pus cell, evidently resulting from the destruction of the cell by the growth of the cocci. The cocci occur in pairs, occasionally as tetrads. Their opposing surfaces are flat or slightly concave.

The gonococcus is colored readily by the ordinary aniline stains, but does not retain the stain by Gram's method. In stained preparations the band between the cocci remains clear. The morphology and staining properties do not suffice alone to distinguish the gonococcus from other similar micro-organisms, but its peculiar grouping within the pus cells is quite characteristic. The gonococcus does not grow upon the usual culture media employed for other bacteria. It was first cultivated upon human blood serum, upon which medium it grows in the form of a thin layer, scarcely visible to the naked eye. The surface is smooth and glistening; by reflected light the color is grayish yellow. The growth is weak at best and ceases in two or three days; the organism often stops growing for no apparent reason.

E. Wertheim made an important advance in the study of the gonococcus by discovering that the micro-organism grows much better upon blood serum mixed with nutrient agar. The best plan is to use human blood serum, though cattle serum will also give some growth. The gonorrhoeal pus should be mixed with the coagulated serum, and the mixture added to one or two parts of melted

agar at about 40° or 45° C. This mixture is then allowed to solidify in an oblique position in the tube. The growth is particularly abundant in the absence of oxygen, as in Büchner's pyrogallie acid and potassium hydrate method. Superficial colonies are described as having a compact center with a very delicate, transparent, finely granular zone with projections, like peninsulas on a map. Deeper colonies have a solid, chunky appearance, but with a sharp, regular contour.

Wertheim, contrary to the experience of others, succeeded in getting a scanty growth of the gonococcus upon ordinary agar and upon glycerin agar; he also succeeded in getting the organism to grow and produce inflammation in the peritoneum of animals; white mice were found to be especially adapted to this experiment. The process always remains local, and does not lead to general peritonitis; it goes on, in other words, just as it does in the human peritoneum.

E. Wertheim's method as above described is the one most usually employed, but various other special media have been recommended. Abel recommends smearing the surface of an oblique agar tube with blood serum in the manner employed by Pfeiffer for cultivating the influenza bacillus. Ghon and Schlagenhauser also obtained results in this way, and by the use of one part of urine to two of agar. Blood serum and urine in the proportions of two to one have also been employed, and urine in various proportions to agar. Dr. Simon Flexner has cultivated the organism upon a medium prepared from the embryos of hogs.

Probably the most satisfactory medium is the one recently recommended by Young and Hagner. It is as follows:

Collect acid urine containing 0.5 per cent or more of albumin, allowing it to decompose. Boil the urine until a large albuminous precipitate falls, then filter. The filtered urine should be clear.

Boil the urine again, and add 1.8 per cent agar, 0.3 per cent beef extract, 0.5 per cent sodium chloride, and 1 per cent peptone; render neutral or slightly acid, and after cooling to 60° C. (140° F.), clear up with one or two eggs. In short, adopt the same procedure as in making simple agar, merely substituting the boiled and filtered albuminous urine for water. When the medium is ready for use, it is clear, neutral, or slightly alkaline, and may be treated as ordinary agar, being subsequently slanted or plated. On this albumen-urine-agar the gonococcus appears as small, round, elevated, grayish-white, semi-transparent colonies visible in from thirty-six to forty-eight hours. The virtue of this medium is probably due to albumin which is not coagulated by heat.

**Syphilis.**—No micro-organism has as yet been shown to be the cause of syphilis. A bacillus described by Lustgarten is in all probability not the cause. The disease is specific and infectious, and is conveyed, like gonorrhoea, by impure coitus and by contact with articles that have been contaminated with the virus of a syphilitic person. Owing to the obscurity of the etiology, the subject hardly belongs as yet to the domain of bacteriology.

**Tuberculosis.**—Primary tuberculosis of the kidneys, according to Dr. William Osler, is not rare, but is more frequent in men than in women, and the infection usually takes place through the blood; one or both kidneys may be involved, usually one kidney only, and the presence of tubercle bacilli may be demonstrated in the urine. Primary tuberculosis of the tube is not uncommon, but tuberculosis of the uterus is rare. The detection of the tubercle bacillus is usually a matter of little difficulty; it must be borne in mind, however, that the smegma bacillus, a normal inhabitant of the prepuce, may lead to error owing to its many points of similarity to the tubercle bacillus. The most probable source of infection lies in the dust that has become contaminated with sputum from a tuberculous individual. The portal of entry into the genito-urinary tract is not always apparent. The micro-organism which is the cause, and the only cause, of the disease, is the same as that which causes tuberculosis of the lungs, scrofula, lupus, and other tubercular processes.

The tubercle bacillus is a slender stave with rounded ends. It measures from a sixth to a half as long as the diameter of a red blood-corpuscle. In stained preparations portions of the rods frequently remain unstained, making it appear as if the rods were broken up into fragments. These fragments are often nearly or quite spherical, closely resembling streptococci, but they could never be mistaken for these, owing to the peculiar staining properties of the tubercle bacilli. Sometimes the unstained portions of the rods are more or less spherical, and resemble endogenous spores. It is probable, however, that the tubercle bacillus does not form spores.

The character which distinguishes this bacillus from nearly all others is its peculiar behavior toward staining dyes. The bacteria in general are readily stained with ordinary aqueous solutions of the aniline dyes, and are completely decolorized by treatment for a few minutes or seconds by dilute mineral acids. There have been a great many methods devised for differential staining of the tubercle bacillus. The formulæ for three of these methods are given below.

**The Koch-Ehrlich Method for staining Tubercle Bacilli.**  
—The solution consists of a saturated aqueous solution of aniline oil to which is added enough of a saturated alcoholic solution of fuchsin, or gentian violet, or methyl violet, to give a deep stain.

The Ehrlich-Weigert solution is practically the same as the Koch-Ehrlich, and is made by mixing 11 cubic centimeters of the saturated alcoholic solution of the dye, 10 cubic centimeters of absolute alcohol, and 100 cubic centimeters of the saturated aqueous solution of aniline oil. The saturated aqueous solution of aniline oil is prepared by shaking up thoroughly 6 or 7 cubic centimeters of aniline oil in 100 cubic centimeters of water, and filtering. The solution will be of about 5 per cent strength. The Koch-Ehrlich or the Ehrlich-Weigert stains should be allowed to act upon the material to be stained for about twenty-four hours in the cold, or fifteen to twenty minutes if heated. The material should be spread out thin over the cover glass or slide, allowed to dry in the air, and then fixed upon the glass by passing a few times through the Bunsen flame. Sections of tissue are simply left in the stain-

ing solution for fifteen to twenty minutes, when the solution is heated, or left for twenty-four hours in the cold. Decolorization is effected by immersion in a 33 per cent nitric acid solution, or more gradually in 3 to 5 per cent of hydrochloric acid in alcohol. With either agent the preparation is left in until there is little or no stain visible to the naked eye, when it will be found with the microscope that only the tubercle bacilli, if any are present, will be stained; some of the tissue nuclei may retain some stain, but none of the bacteria will retain it. The bacillus of leprosy is the only other organism known to hold its stain by this method of decolorization.

The Ziehl-Neelsen method of staining tubercle bacilli consists in using a solution of one gram of powdered fuchsin to 100 cubic centimeters of a 5 per cent solution of carbolic acid. This solution stains the tubercle bacilli in a few minutes; the decolorization of the rest of the preparation may be effected as above mentioned, or, according to Gabbett's method, with 25 per cent of sulphuric acid containing 2 per cent of powdered methylene blue. This not only takes the fuchsin out of the background, but stains the latter blue at the same time. Leprosy bacilli and the bacilli constantly present in the smegma of untidy persons retain the stain by this method as well as tubercle bacilli.

According to Grethe, the best ready method of differentiating between tubercle bacilli and smegma bacilli is Weichselbaum's method for staining tubercle bacilli—namely, by staining the preparation with carbolic acid fuchsin and counterstaining with concentrated alcoholic solution of methylene blue. Tubercle bacilli remain stained, but smegma bacilli become decolorized.

The tubercle bacillus is not only peculiar in its behavior toward staining dyes, but it is also peculiar in its requirements for cultivation upon artificial culture media. It will not grow upon most of the ordinary media used, and requires a temperature of about 35° to 39° C. on special media. Roux and E. Noeard state that the best temperature is 39° C. Many special media have been recommended, of which the most commonly used are beef-blood serum coagulated in oblique test tubes and sterilized, boiled potatoes in test tubes, and Roux-Noeard's glycerin agar, which consists of ordinary nutrient agar with the addition of 6 or 7 per cent of glycerin. The growth is slow, becoming appreciable to the naked eye in from four to six weeks.

#### SUPPURATION.

Although many different micro-organisms have been found as the active causes of the formation of pus, it is usual to restrict the term "micro-organisms of suppuration" to the streptococcus pyogenes and the staphylococcus pyogenes aureus, staphylococcus pyogenes albus, and staphylococcus pyogenes citreus. The gonococcus is a pyogenic organism, and the typhoid fever bacillus, the bacillus coli communis, and others have also been found as the cause of suppuration, but the organisms most usually encountered and referred to in this connection are the pus cocci already named.

The streptococcus pyogenes resembles closely, if it is not identical with, the streptococcus of erysipelas. It causes local suppuration in any part of the genital tract, and is prone to spread and cause peritonitis and general septicæmia. Most cases of puerperal septicæmia are probably due to this micro-organism. It is apt to cause a mixed infection, following in the wake of tuberculosis; its virulence is variable.

The individual streptococci are larger than staphylococci, and are usually made up of two symmetrical hemispheres. Frequently some of the cells are much larger and stain more deeply than the others. These are supposed to be arthrospores. It is one of the characteristic features of these cells that they hang together in longer or shorter chains. They stain readily with any of the ordinary aqueous staining solutions. They grow in the form of small, discrete, white colonies upon all the usual solid media, but most luxuriantly upon alkaline media, though they are said to retain their virulence best when gradually accustomed to acid media. In liquid media the chains are usually longer than on solid media. The growth in all cases is delicate.

The staphylococci are found in various pathogenic processes, either alone or in association with the streptococcus. They tend to remain local, but the staphylococcus pyogenes aureus may cause extensive lesions, or even general septicæmia. The aureus is the most virulent of the three, and the albus next, though the virulence of all of them is variable. They resemble one another closely under the microscope, and also macroscopically, in cultures, except for the difference in color, which makes its appearance in the culture of the aureus and citreus, as the names of these imply. For a day or more before the color develops they are indistinguishable. The growth on all media is much more vigorous than that of the streptococcus, forming dense masses. The cells are spherical and clump together in irregular masses, though sometimes there is a tendency to form short chains.

**Bacillus Aërogenes Capsulatus.**—There is another organism, which, although not pyogenic, is not infrequently the cause of death. This is the bacillus aërogenes capsulatus, first described by Welch and Nuttall in 1892 (*Johns Hopkins Hospital Bulletin*, July–August, 1892, p. 81). This bacillus has been found in the blood vessels during autopsies, in the wombs of women dying of septicæmia after confinement, especially after abortion cases, and in emphysematous gangrenes.

It is a large, straight bacillus, with rounded ends averaging 3 to 6 millimeters in length, and about three times as long as broad; it usually grows singly, but may occur in chains of three or four, but without the chain tendency, as seen in anthrax. One of its chief characteristics is a distinct capsule. The bacillus is not motile and only forms spores on blood serum; it is strictly anaërobic. It stains well with all the aniline dyes, and fairly well with Gram's solution. Capsules can sometimes be seen when ordinarily stained, but they are much more distinct if treated with acid and gentian violet, as advised by Welch. It is an obligate anaërobe, growing only when oxygen is entirely excluded, and

best at a temperature of 35° to 37° C. (95° to 99° F.); but it will grow at the ordinary temperature of a room.

On agar slants it appears at the end of twenty-four hours as a pale, whitish moist growth; sometimes a few gas bubbles are seen in the substance of the agar. In tubes containing one per cent of glucose or lactose agar, which have been melted and inoculated after cooling to 40° C., there is an abundant growth at the end of twenty-four hours, forming numerous fine white colonies, and the media are split up by an abundant formation of gas. Bouillon cultures show clouding at the end of twenty-four hours and a few gas bubbles on the surface, but after forty-eight hours the liquid clears and the growth sinks to the bottom; if sugar be added to the bouillon, the gas production is much more marked. Litmus milk is coagulated and acidified after forty-eight hours. In gelatin there is softening along the line of puncture after from five to six days, and the growth sinks to the bottom, but there is no general liquefaction of the media. On potato there is a faint white growth after forty-eight hours. Blood serum is not liquefied, but spores are found after twenty-four hours.

If inoculated subcutaneously it is pathogenic for mice, guinea-pigs, rabbits, and pigeons, the animal dying in from twenty-four to forty-eight hours with an enormous development of gas around the site of inoculation. If it is injected into the circulation it is rarely fatal; if, however, the animal is killed soon after receiving the injection and left in a warm place for ten or twelve hours, there will be an enormous development of gas throughout the tissues, which bursts when brought into contact with a light.

Dr. B. B. Lanier, in 1897, described a gas bacillus very like this one, agreeing with it in every particular, except growth in the presence of oxygen; it is found in the same class of cases. He calls the new organism the *bacillus aërogenes capsulatus* II.

## CHAPTER IV.

### TOPOGRAPHICAL ANATOMY.

1. Difference between infantile and adult uterus and adnexa (Figs. 13 and 14).
2. Superficial and deep layers of abdominal muscles (Figs. 15 and 16).
3. Scheme of relations of the muscles and fascia of the abdominal walls in transverse section (Figs. 17 and 18).
4. The "celiotomy veins" (Fig. 19).
5. The topographical anatomy of the small intestines (Figs. 20 and 21). (Grouping of intestines (Fig. 21). Relations of folds of mesentery (Fig. 20).)
6. Position of anterior abdominal wall and intestines in an emaciated body (Figs. 22 and 23).
7. Topography of appendix vermiformis and termination of ileum (Fig. 24).
8. The pelvic viscera in normal position (Fig. 25).
9. The utero-sacral ligaments and Douglas's *cul-de-sac* (Fig. 26).
10. Vascular trunks of lower abdomen and pelvis (Figs. 27 and 28).
11. Relation of the ureter to the uterine vessels *in situ* (Fig. 29).
12. Vascular supply of uterus, ovary, and tube (Fig. 30).
13. Arterial blood supply of ovary (Fig. 31).
14. Parovarium (Fig. 32).
15. Lymphatic system of the pelvic organs (Fig. 33).
16. Vascularization of the vault of the bladder (Fig. 34).
17. Vascularization of the vesical mucosa (Fig. 35).
18. Areas of vascularization of the vesical mucosa (Fig. 36).
19. Topography of fixed part of bladder (Fig. 37).
20. Blood supply of lower sigmoid and rectum (Fig. 38).
21. Sagittal section through the pelvis showing vessels and nerves posteriorly (Fig. 39).
22. Same, after removal of the viscera (Fig. 40).
23. Round ligament, inguinal and femoral rings as seen from within (Fig. 41).
24. Topography of round ligament (Fig. 42).
25. The pelvis after removal of the viscera, seen through the superior strait (Fig. 43).
26. Course of the internal pudic artery from its origin to its termination (Fig. 44).
27. Arterial vascularization of the perineum and pelvic floor from below (Fig. 45).
28. Muscles and nerves of the perineum and pelvic floor from below (Fig. 46).
29. Origin and insertion of the fibers of the levator ani muscles (Fig. 47).
30. Sagittal section showing the mechanism of the levator ani muscles (Fig. 48).
31. Blending of the levator ani muscle with the muscle of the rectum (Fig. 49).
32. Coronal section of the pelvis, showing its posterior half and the relations of the levator ani muscles to the rectum (Fig. 50).

A KNOWLEDGE of anatomy and physiology is just as essential to the gynecologist as a familiarity with the general principles of surgery; indeed, the very foundation stones of successful work are laid in envisaging the relations of the parts to be dealt with so clearly that the operator divides layer from layer almost as if the coverings of the body were transparent. Without this accurate knowledge of the component parts of the pelvis and abdomen and their mutual relations, to be gained only by actual dissections, surgery is not an art, but at best a haphazard procedure guided by luck; without a knowledge of physiology an operator will often ruthlessly sacrifice organs or parts of organs whose functional activity is essential to the happiness and well-being of the patient.

I wish to emphasize these facts because so many men enter the ranks of gynecology from general practice with only such medical training as is given in the schools—insufficient to make them safe operators.

I shall not attempt in this chapter to describe the pelvic anatomy as it is laid down in the various accessible mammals for dissectors, but shall rather take up the anatomy of the abdominal pelvic viscera, first, as they are approached in an operation from above, and then from below, purely from the practical standpoint. Descriptions of the relations of organs are so lifeless without satisfactory pictures that I have confined the text for the most part to the description of topographical drawings. These are all from original dissections except two.

From birth down to the period of full sexual maturity of women there is a gradual progressive change in the position and relations of the pelvic viscera—in fact, in the infant the bladder and the uterus can be named “pelvic viscera” only by reference to what they are to become, for at this early period both organs lie



FIG. 13. —INFANTILE PELVIS, NATURAL SIZE, SEEN IN SAGITTAL SECTION.

above the superior strait among the other abdominal organs, as shown in the figure drawn from a frozen section of a mature newborn child.

The comparison between the infantile and the adult pelvis is well shown by placing beside a child's pelvis of natural size that of a fully developed woman, reduced to correspond. (Figs. 13 and 14.)

One of the most striking differences to be noted is the alteration in the direction of the axis of the pelvis: in the child this is a simple straight prolongation of the abdominal cavity, in the woman the pelvic axis is set at a marked angle. While the uterus in the adult is seen lying in ante flexion wholly within the pel-

vis, at an acute angle with the vagina, with well-developed corpus and small cervix, in the infantile pelvis the uterus lies almost wholly within the abdomen, as a rule compressed between the rectum and bladder in an upright position, without any angle of flexion. In the example figured the uterus lies on the left side of the median line and is cut through close to the cervix; the fundus rests on the last lumbar vertebra, and the mesentery of the small intestine is situated in front of it between the uterus and bladder. The cervix is large as compared with the fundus; the long rugose vagina lies just anterior to the axis of the pelvis, following its curve, and without the sigmoid curve, which is so characteristic in the adult.



FIG. 14.—PELVIS OF ADULT WOMAN IN SAGITTAL SECTION, REDUCED TO THE SAME SIZE AS AN INFANTILE PELVIS FOR COMPARISON.

The thick-walled bladder lies in the anterior part of the pelvic cavity just above the symphysis. The almost straight rectum is divided into three cavities by two valve-like folds of mucosa, the lower one situated just above the middle of the vagina, on a line drawn from the lower border of the symphysis to the coccyx, the upper one opposite the vaginal vault. The umbilicus, as in the adult, is opposite the second lumbar vertebra.

Fig. 15 shows the oval contour of the abdominal cavity, covered by the external and internal oblique muscles; the right and left recti muscles form strong bands, uniting symphysis pubis to sternum; they are bound together in the center by the linea alba and bordered on their outer margins by the semilunar

lines. The sheath of the right rectus is opened below, showing the right pyramidalis muscle, which arises by a narrow base from the symphysis pubis and extends upward one third the way to the umbilicus, overlying the rectus.

The semilunar line on the left is seen about halfway out between the

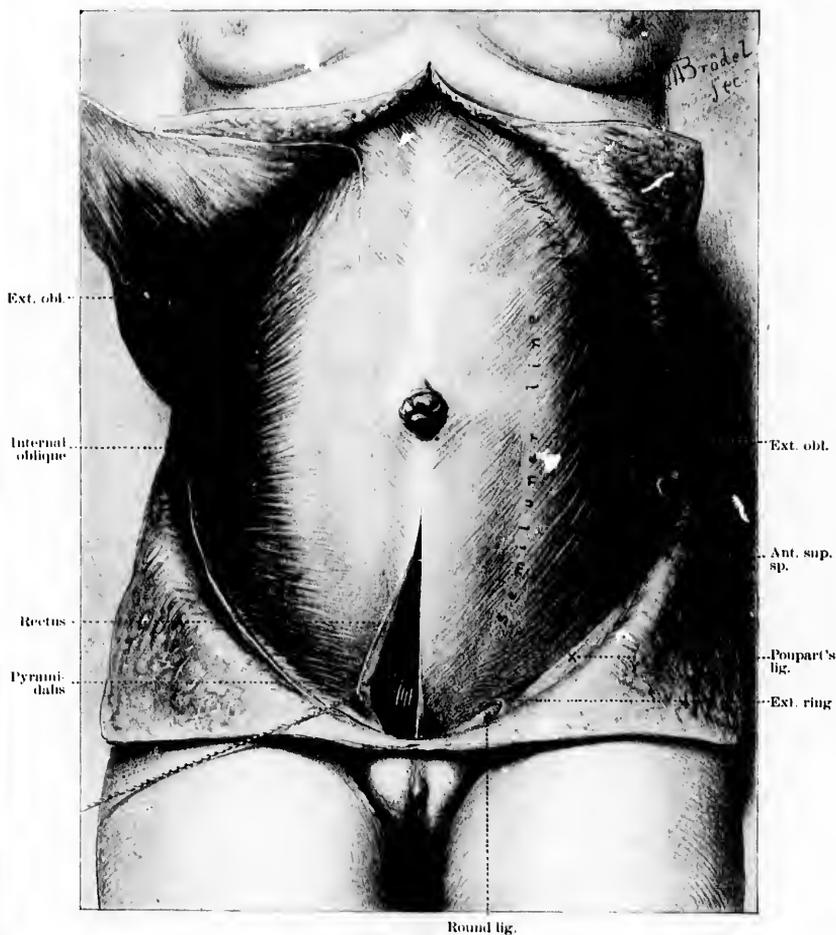

FIG. 15.

median line and the left lumbar region, looking at the body from the front. The external oblique muscle is well shown on this side with its fibers radiating from the costal margin and the left lumbar region out toward

the rectus of the same side. Below, just above Poupart's ligament, the parting of the fibers is seen at the external ring out of which the round ligament emerges.

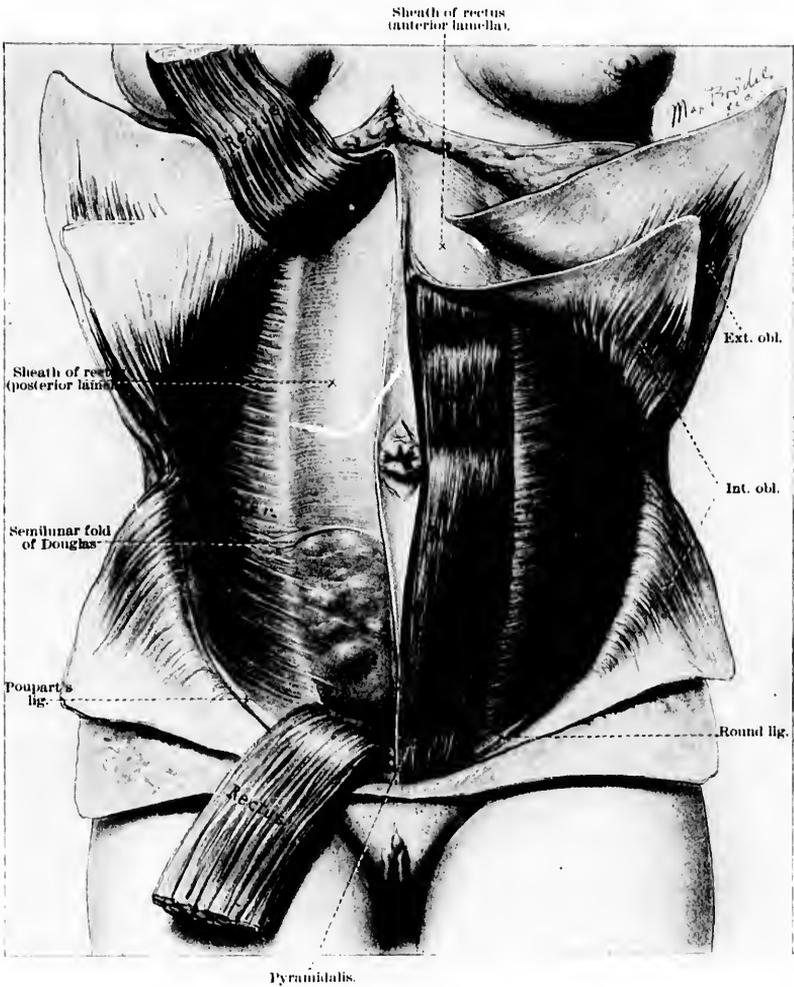

FIG. 16.

The position of Poupart's ligament between the spine of the pubis and the anterior-superior spine of the ilium is clearly indicated by the white line.

On the right side the external oblique muscle has been dissected off and reflected upward, exposing the internal oblique muscle; the tendinous aponeuro-

sis has been detached from the fibrous fascia overlying the rectus as far forward as the dissection could be carried.

Fig. 16. The deepest of the three muscular layers forming the abdominal walls are formed by the right and left transverse muscles, whose fibers run horizontally, and parallel to the short axis of the body. The external and internal

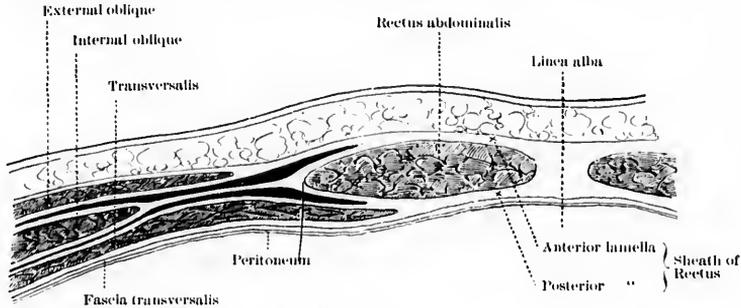

FIG. 17.

oblique muscles have been reflected, the external being turned up and the internal divided and turned both up and down on the margins of the ribs and Poupart's ligament.

The left rectus muscle is exposed with its pyramidal muscle below, and on the right the rectus has been divided in the middle, showing the transversalis fascia, which forms its sheath posteriorly, extending from the margin of the ribs down to the semilunar fold of Douglas, which lies at a point about 3 centimeters below the umbilicus. Below this point the thin tissue allows the convolutions of the intestines to be seen through the fascia and peritoneum. The

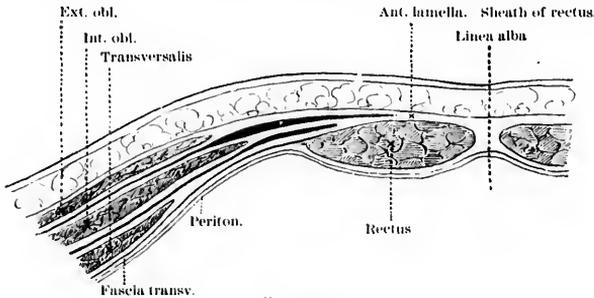

FIG. 18.

abdominal wall below the semilunar line owes the thinness of its fascia, posterior to the rectus, to the cessation of the transversalis fascia at this semilunar line.

Figs. 17 and 18. The scheme of the relations of the muscles and fascia of the abdominal walls as they are seen in transverse section has been made accord-

ing to Brunné. Fig. 17 shows the section of the walls above the semilunar folds of Douglas, and Fig. 18 shows the section below the folds of Douglas. Both pictures exhibit the relations of the oval recti to the transverse and internal and external oblique muscles.

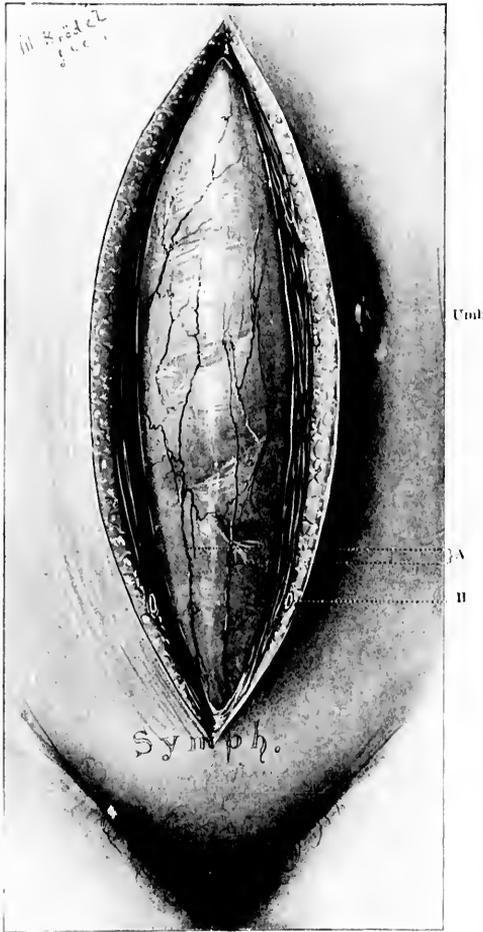

FIG. 19. — A, CELOTOMY VEINS; B, LARGE TRANSVERSE VEIN; Umb, UMBILICUS DRAWN TO THE LEFT.

to split, sending its entire tendinous aponeurosis in front of the rectus along with that of the transversalis muscle.

Fig. 19 shows what I have for some years been in the habit of calling "the celiotomy veins." In opening the abdomen in the linea alba in its lower third,

In the section above the folds of Douglas, Fig. 17, it is important to notice the relation of the aponeurosis, indicated by the white spaces between the muscles. The division of the fascia of the internal oblique muscle is seen at the rectus, one lamella passing in front to unite with the fascia of the external oblique, the other lamella passing posteriorly to join the transversalis tendon, and so to continue as a conjoint tendon until it unites with its fellow of the opposite side.

In Fig. 18 quite a different arrangement of the muscles is seen; the external oblique muscle remains about the same, while the internal oblique advances much closer to the rectus, and the transversalis, instead of passing behind the rectus, as in Fig. 17, lies farther back toward the lumbar region than either of the others. In Fig. 18 the fascia of the external and internal oblique muscles blend at a point nearer the median line, as shown also in Fig. 17.

The internal oblique also fails

these veins are almost invariably found lying just over the peritoneum. Sometimes there is but one large vein  $1\frac{1}{2}$  or 2 millimeters in diameter, but usually there are two of them from 1 to  $1\frac{1}{2}$  millimeter in diameter, separated by an interval of 3 or 4 millimeters; they follow a slightly winding, but in general straight, course down to the symphysis pubis, over which they pass to the neck of the bladder, where they empty into the large vesical plexus of veins. I have not seen any arteries accompanying these veins. They are usually large enough to give rise to some persistent oozing, if injured, and for this reason should be carefully observed in every case, in order to cut between them, or to one side when there is but one vein. In a series of twenty abdominal sections, taken consecutively, the celiotomy vein was seen sixteen times; in most cases it ascended straight up the median line just beneath the peritoneum, a little to the right or to the left; six times it was seen bifurcating. In four cases the diameter was at least 2 millimeters, in all the rest it was less than 2 millimeters.

In the subcutaneous fat the position of a transverse vessel is indicated on both sides of the incision at a point about 2 centimeters ( $\frac{3}{4}$  of an inch) above the symphysis pubis. This vessel is quite constant, and when divided spouts out a little stream of arterial blood on one side and venous blood on the other; sometimes there is arterial bleeding from both sides, showing a free anastomosis. The umbilicus in the figure is shown displaced to the left.

#### THE TOPOGRAPHICAL ANATOMY OF THE SMALL INTESTINES.

Figs. 20 and 21 have been drawn directly from the subject to demonstrate important points in the topographical anatomy of the small intestines. This subject has been carefully worked up by D. Sernoff (*Internat. Monats. f. Anat. u. Phys.*, Bd. xi, 1894) and others, and elaborated with important additions by Dr. F. P. Mall, whose demonstrations have been followed in preparing the figures.

In order to expose the intestines in their normal positions, the abdominal cavity has been opened by a crucial incision, and each of the four flaps reflected outward. Letters have been placed upon the small intestines, associating them in groups. Each one of these groups is so attached to a series of lamellæ of the mesentery that by picking up one of the groups of lamellæ at its base near the vertebral column the entire bunch of small intestines attached to it is also lifted up.

In describing the groups I begin at the duodenum, Fig. 20, and note the lamellæ under the left splenic flexure of the colon included in the letters A and B; from this group the mesentery crosses the vertebral column to the right side, where it forms a series of folds under the right hepatic flexure of the colon; this group is included between the letters B and C; crossing the vertebral column once more to the left, the next group is found lying in the left iliac fossa, included between the letters C and D; the fourth and last group of lamellæ, between D and E, fills the lower abdomen and right iliac fossa, and it is particularly important to note the straight line of the terminal portion ascending

from the pelvis to the head of the colon as the mesentery rapidly shortens from its extreme length down to nothing at all. The only loops of the intestines which in all cases cross the median line are those going from the first to the second and from the second to the third groups. The oblique attachment of the mesentery is well shown, extending from above downward and from left to right, in striking contrast to the horizontal attachment found in the fetus. I



FIG. 20.

have shown the relations of the folds of the mesentery in Fig. 20 in order to simplify the study of the relations of groups of intestines attached to them. It will at once be seen in glancing at Fig. 21 that while the relations of the mesenteric folds appear comparatively simple, the relations of the intestinal folds, which are precisely the same, appear much more complicated.

The cadaver from which the drawings have been taken represents the average normal relation as found in 21 out of 40 cases examined by Dr. Mall.

In order to facilitate the study of the groups of intestines, of which I have just described four, the same letters are used, marking the same divisions seen in the

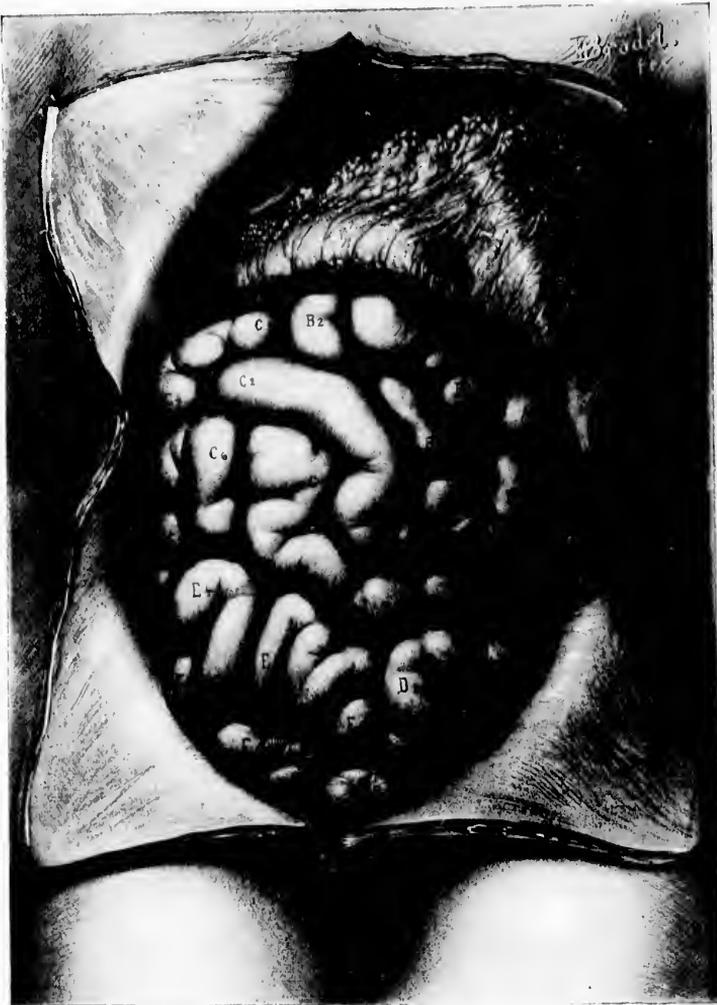

FIG. 21.

preceding figure. The figures accompanying the letters in Fig. 21 indicate the superficial direction of the bowel. Sernoff found that the exposed or periph-

eral part of the intestines constituted only about one sixth of the entire length of the canal from duodenum to cecum; the average length of the small intes-



FIG. 22.

tine, according to Sernoff, is 537 centimeters (214.8 inches). The distance from  $B_1$  to  $B_2$  and from  $B_2$  to  $B_3$ , etc., by no means represents a uniform space.

Group B (Fig. 21) of the bowels lies under the left splenic flexure of the colon, and, by passing the hand down to the mesentery at this point, can be picked up *en masse*. Group C, under the hepatic flexure of the colon, can be picked up by carrying the hand down to the mesentery between the colon and small intestines; by throwing this group over to the left side, the whole of the right renal region is exposed. Below B and above C there is a natural fissure or separation between the bowels (fissure of Henke) which goes all the way back to the psoas muscle.

The following variations in relation to these groups are often found:

Variation 1: Group C is displaced from its position under the right hepatic flexure over into the left flank.

Variation 2: Group B crosses the median line and occupies the position of Group C under the hepatic flexure, while Group C goes to the left.

Variation 3: Group C goes down to the left, and Groups B and D go across and ascend on the right to occupy its place.

Fig. 22. Almost all anatomical drawings of the abdominal cavity fall into the error of placing the anterior abdominal wall at too great a distance from the lumbar vertebrae; the separation between the two will vary according to the dis-

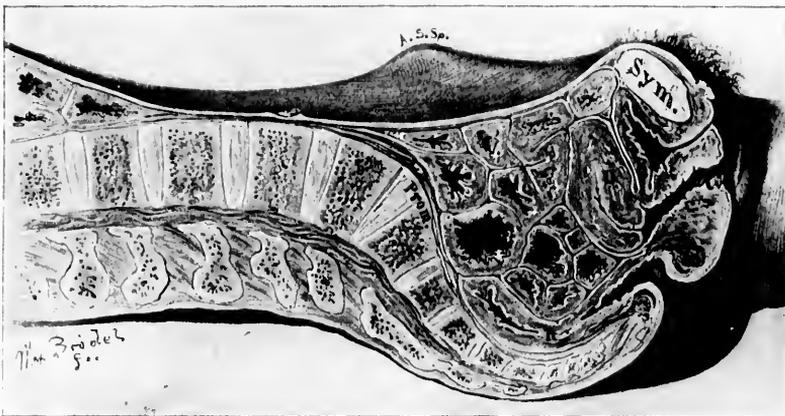

FIG. 23.

tention of the intestines, which float up and push the wall forward, and so lift it 2, 3, 5, or more centimeters from the promontory of the sacrum; as the intestines contract again they retire to the upper part of the abdomen, to the right and left flanks, and to the pelvis.

Fig. 23. In emaciated patients the anterior abdominal wall may not infrequently be found so closely applied over the lower part of the vertebral column that its rounded form is plainly seen. In one of my abdominal operations, removing an extensively adherent parovarian cyst, the collapsed walls actually became

adherent to the vertebral column, causing the patient great discomfort in her convalescence. Figs. 22 and 23 show an extreme case in which the abdominal walls were not more than 3 millimeters thick. Here the groups of in-

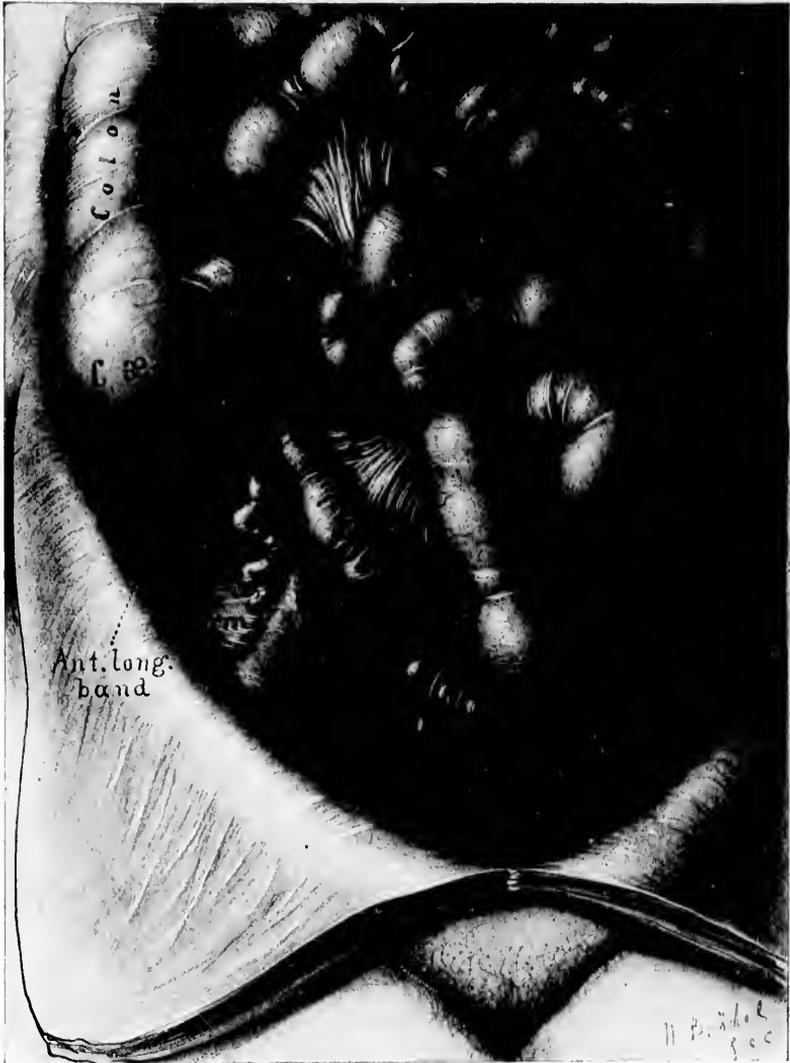

FIG. 21.

testines are all displaced toward the periphery, and the bowel crosses from right to left opposite the second instead of opposite the fourth and fifth lumbar vertebrae. Groups B and C are crowded up under the vault of the thorax, Group D lies in the left flank, while Group E has dropped into the pelvis, which it fills. The abdominal wall rests directly upon the aorta and the vena cava and the mesentery with its vessels. It is interesting to note the plastic flattening and the ridges on the body of the uterus due to post-mortem compression by the intestines, seen in both Figs. 22 and 23.

Fig. 24. It is particularly important to the gynecologist to be familiar with



FIG. 25.

the anatomy of the terminal portion of the ileum, that part of the intestine which is most liable to drop into the pelvis and to be involved in the various inflammatory gynecological processes.

The figure shows the cecum in the right iliac fossa with its longitudinal fibers leading down to the vermiform appendix, which lies coiled above the common iliac artery on the psoas muscle. The straight ascent of the ileum out of the pelvis and over the sacro-iliac junction to its point of exit in the cecum is especially noteworthy. This arrangement appears to be a mechanical necessity due to the triangular form of the end of the mesentery which terminates at the cecum in a point.

Fig. 25 shows the mutual relations of the pelvic viscera as seen upon opening the abdomen through the superior strait. The drawing is after nature exactly, and, although presenting some slight individual peculiarities, does not deviate in any important particular from the average case.

The bladder in front is moderately distended, somewhat gibbous in form, and fullest on the right side. The rectum passes down into the right of the promontory of the sacrum, necessitating a slight left lateral displacement of the uterus, which lies between the rectum and the bladder; this



FIG. 26.

has the effect of lengthening the right and shortening the left round ligament, and of causing their curves to differ. The tubes and ovaries on each side fill up the triangular spaces left between the rectum and uterine and the pelvic walls.

Fig. 26 shows the utero-sacral ligaments coursing from the cervix on the right and left in a curved line around the rectum. Below and between the ligaments in front and the rectum lies Douglas's *cul-de-sac*.

The next dissection (Fig. 27) exposes the great vascular trunks of the lower

roster  
sec.

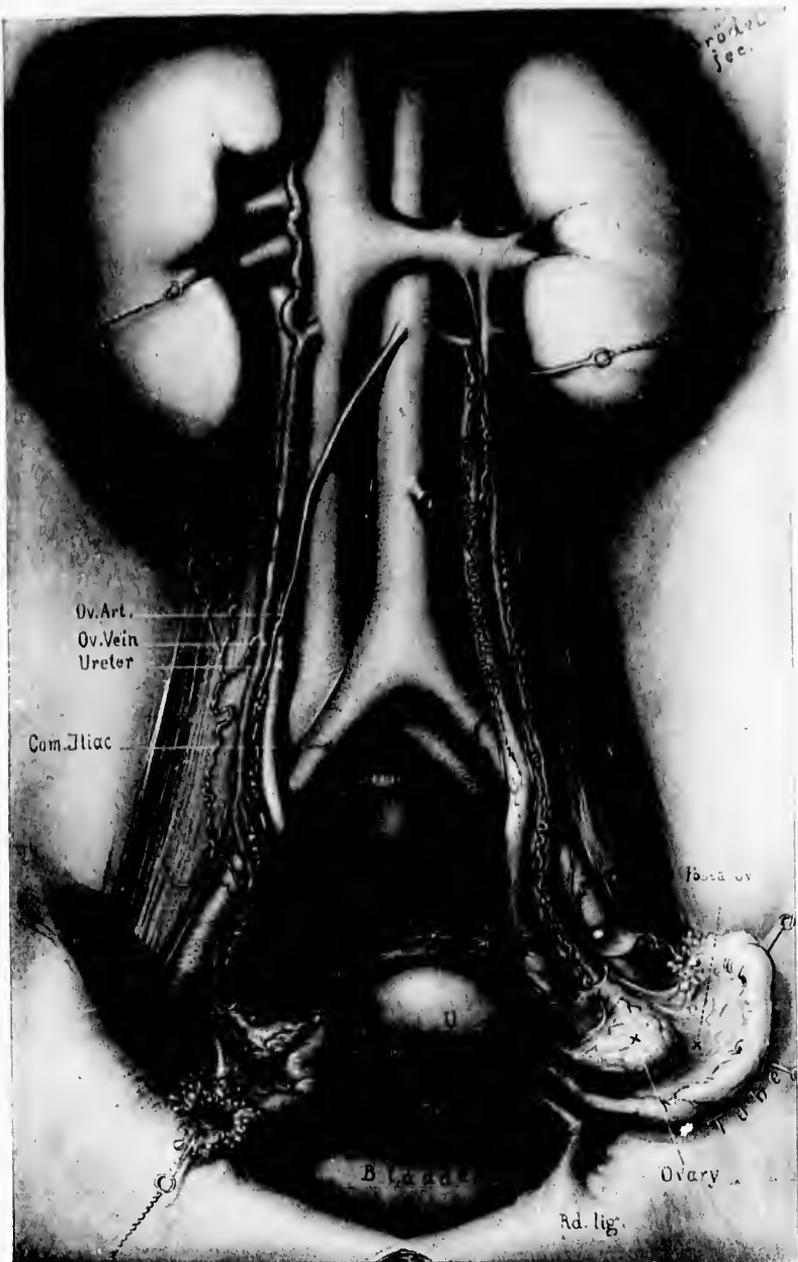

FIG. 27.—VASCULAR TRUNKS OF THE LOWER ABDOMEN.

abdomen and pelvis. The aorta is seen above on the left bifurcating in front of the last lumbar vertebra into the right and left common iliac arteries; the right iliac lies upon the common iliac vein, concealing it, while the left lies above and to the outside of the vein.

The ureters are seen descending from the kidneys into the pelvis; their upper extremities lie concealed behind the renal vessels. In the upper half of

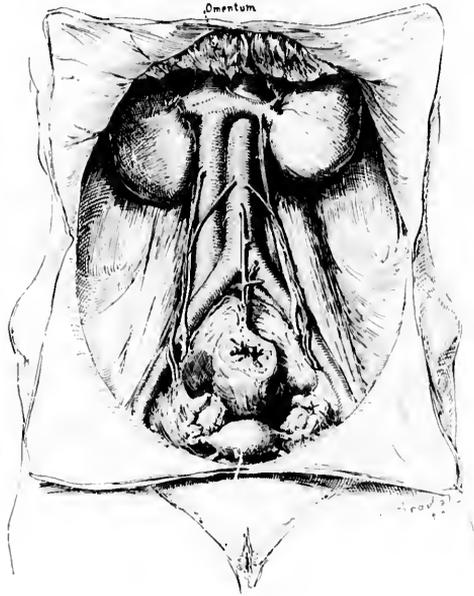

FIG. 28.

their course they lie posterior to the ovarian vessels, but in the lower half the ureter crosses and lies to the inside of the ovarian vessels and drops into the pelvis over its brim, from  $2\frac{1}{2}$  to 3 centimeters to the right and left of the promontory. The distance between them at the pelvic brim is about 5 centimeters (2 inches). The nutrient vessels accompanying the ureter are clearly seen on their surface, and on the left side there is an unusually injected large tortuous vein. The right ovarian artery is seen springing from the aorta, while the left in the direction before us arises from an aberrant renal artery. Fig. 28 shows the common method of origin of ovarian vessels. The ovarian veins on the right side empty into the vena cava at an acute angle, while those on the left empty into the left renal vein at a right angle; the mechanical disadvantage of the left side, as compared with the right, causes greater pressure, and hence a

more marked distention of the vessels on the left. On the right side three veins are seen in the pelvis in the neighborhood of the ovary, and as they ascend toward the brim two of these unite, making two veins; then the common trunk thus formed unites with the third vein to make but one on the surface of the psoas muscle. The cadaver was injected before dissection, which explains the great distention of the veins.

Fig. 29 shows a bird's-eye view of the important vascular trunks of the uterus on the left side, from the standpoint of the operator. The ureter is seen



Tubo. FIG. 29.

below beneath the vessels, and the bladder has been opened to show the point of entrance of the left ureter. The internal urethral orifice is well shown. The uterine artery is shown in its course from the bifurcation of the common iliac artery into the internal iliac and anterior and posterior trunks. The uterine

artery arises from the anterior trunk in common with the hypogastric artery. The origin of the vaginal artery is well shown. The ureter lies closer to the cervix uteri on the left side.

Fig. 30 is taken from an injected pelvis of a fully developed multipara, and



FIG. 30.

shows the entire vascular relations of the uterus, ovary, and Fallopian tube, as seen from the front. The anterior leaf of peritoneum has been removed, leaving the vessels *in situ*, and held in place by the posterior leaf.

The relations of the uterine vessels to the ureter, the cervix, and the vaginal vault should be carefully noted. The ureter lies below the uterine artery and two of its veins, and above a large vaginal and uterine vein. The uterine artery



FIG. 31.

ascends beside the uterus from 1 to 2 or 3 millimeters away from it, tortuous and interwoven with its veins. At the neck of the uterus, opposite the internal os, it gives off a large artery which penetrates the uterine body; all the other



FIG. 32.

branches which go to the uterus are small. Up near the cornu uteri the terminal branch of the uterine artery anastomoses with a branch of the ovarian artery.

The ovarian artery enters the pelvis in the suspensory ligament of the ovary (infundibulo-pelvic ligament); it divides just before it reaches the hilum of the

ovary into two branches, a and b; the main branch continues on in its course toward the cornu uteri, giving off numerous small vessels into the ovarian hilum; on reaching the utero-ovarian ligament, it penetrates it and passes through its substance until it reaches the side of the uterus, where it anastomoses with the uterine artery. In its course in the utero-ovarian ligament the ovarian artery gives off a secondary branch, c, which pierces the ligament about 1 centimeter from the uterus, and divides into two other branches going in opposite directions, one

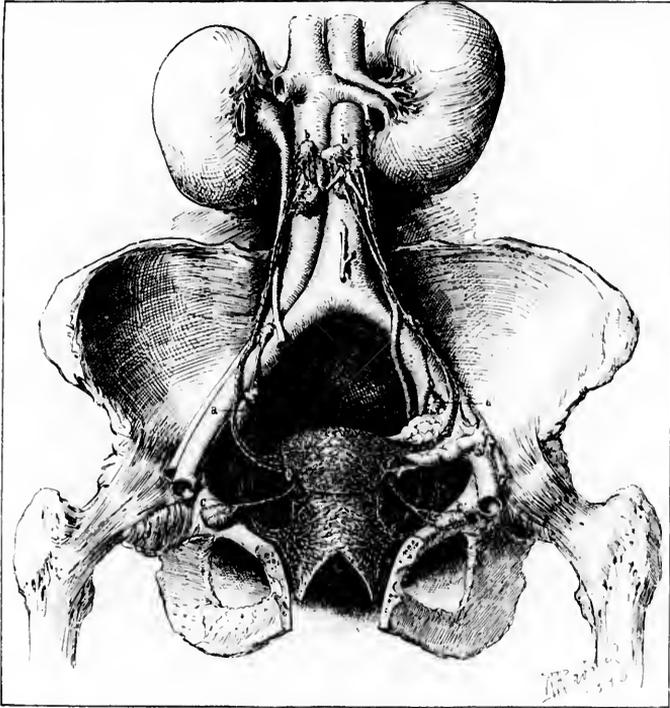

FIG. 33.

to supply the round ligament, and the other running along the base of the mesosalpinx parallel to the tube and anastomosing with the vessels of the first branch of the ovarian artery. The horizontal vessel formed by this anastomosis gives off from four to six ascending straight branches which traverse the mesosalpinx to the mesenteric attachment of the tube. These branches run out under the tube and form a series of loops by anastomosis.

Fig. 31 shows in accurate detail the ovarian artery as it reaches the utero-ovarian ligament, and divides into a uterine branch and a short trunk which

pierces the ligament to give off the round ligament artery and the horizontal tubal branch.

Fig. 32 shows the parovarium of a girl nineteen years old. The Fallopian tube is quite delicate. The ovary is not distinctly seen, because it lies behind



FIG. 31.

the broad ligament, which is viewed from the front. The attachment of the hilum of the ovary is, however, indicated by the shaded area. The delicacy of the blood vessels is striking. The parovarium, made up of horizontal tubules, is well shown lying in the mesosalpinx situated about halfway between the tube

and the ovary, running parallel to the tube and giving off about fifteen vertical tubules converging toward the hilum of the ovary. Some of the outer tubules are beautifully convoluted. The outer extremity of the horizontal branch ter-

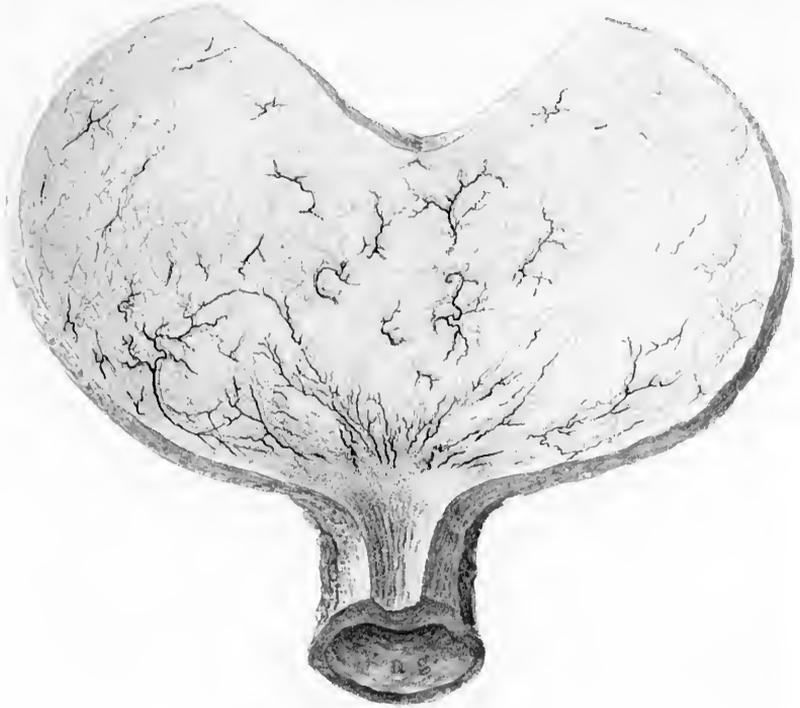

FIG. 33.

minates in two so-called hydatids, hanging free by a little pedicle from the front of the broad ligament across the tubo-ovarian fimbria.

Fig. 33. The lymphatic system of the pelvic organs. The uterus and its appendages and the vagina are everywhere covered by a rich network of lymphatic vessels with whose anatomical arrangement we have become acquainted through the observations of Mascagni and Poirier. This vascular network surrounds the uterus and vagina like the finest lace. Upon leaving the uterus, the smaller vessels collect into larger trunks, which then discharge into the various neighboring glands. From the upper part of the vagina and lower cervix the lymph vessels collect to enter the glands on the pelvic floor and accompany the uterine and internal iliac vessels, to the next system of glands, in the bifurcation of the common iliac arteries (a a'). From this point the lymph channel leads

over the artery to a gland often found on its upper side well above the bifurcation, and so on up to the lumbar glands (b b'). The lymph vessels of the body of the uterus either pass out through the mesosalpinx near the ovarium attachment, and on up the suspensory ligament of the ovary to the lumbar glands (b b'), or take quite another direction and course down the round ligaments to the deep inguinal glands (c c'). The lowest part of the vagina and external genitals are richly supplied with lymphatics, which communicate with the superficial and deep inguinal glands, and through these with the glands lying upon the external iliac arteries.

Fig. 34 gives a good idea of the vascularization of the vault of the bladder—that part of the bladder which is in relation to the peritoneum. The peritoneum has been dissected off to show the circulation. The veins are seen anastomosing across from one side to the other, and terminating below in the urethro-vesical plexus at the neck of the urethra. The superior vesical arteries are also seen. It is important to note the unusual injection in the neighborhood of the cervix uteri.

Fig. 35 shows the vascularization of the vesical mucosa, and exhibits beautifully the dendritic arrangement of the little branches of the superior, middle, and inferior vesical vessels as they plunge through the coats of the bladder and come to view on the mucous surface, branching out into small vessels and capillaries. It will be seen that certain definite areas of the bladder are constantly vascularized by the same groups of vessels.

The first great group is at the trigonal area where the vessels branch out into the bladder from the internal urethral orifice like a fan, appearing at the upper edges of the papillae and coursing toward the ureteral orifices; they then continue parallel to the ureteral folds, and so reach the side walls of the bladder.

This group of vessels anastomoses with the next, which is seen just below the edges of the cut; the second group is derived from the superior vesical vessels, and several vascular trees are seen coming through to the surface of the mucosa and distributing themselves over it in fine branches. In the posterior part of the bladder the middle vesical vessels occupy the area in the neighborhood of the cervix uteri; vascular trees from this source on the right and on the left side are quite constantly found, and form a characteristic landmark in the examination of the living subject through the speculum.

Fig. 37 shows the topography of the fixed part of the bladder—that part which is attached to the symphysis pubis, vagina, and cervix uteri, as contrasted with the upper movable peritoneal portion. The first striking feature is the hexagonal form, which is caused by the attachment

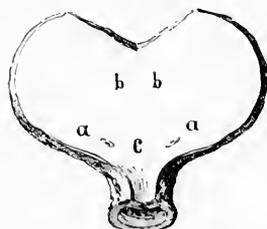

FIG. 36.—VASCULARIZATION OF THE VESICAL MUCOSA BY THE RIGHT AND LEFT SUPERIOR, MIDDLE, AND INFERIOR VESICAL ARTERIES.

The superior vesical arteries (a) are distributed over the superior and lateral regions of the bladder. The middle vesical arteries (b) are distributed over the posterior portion which lies in relation to the uterus and upper vagina. The inferior vesical arteries (c) are distributed to the trigonum and the middle part of the vagina.

of the bladder to the symphysis and its angular reflection out over the lateral pubic rami. From the posterior point of attachment to the pubic rami

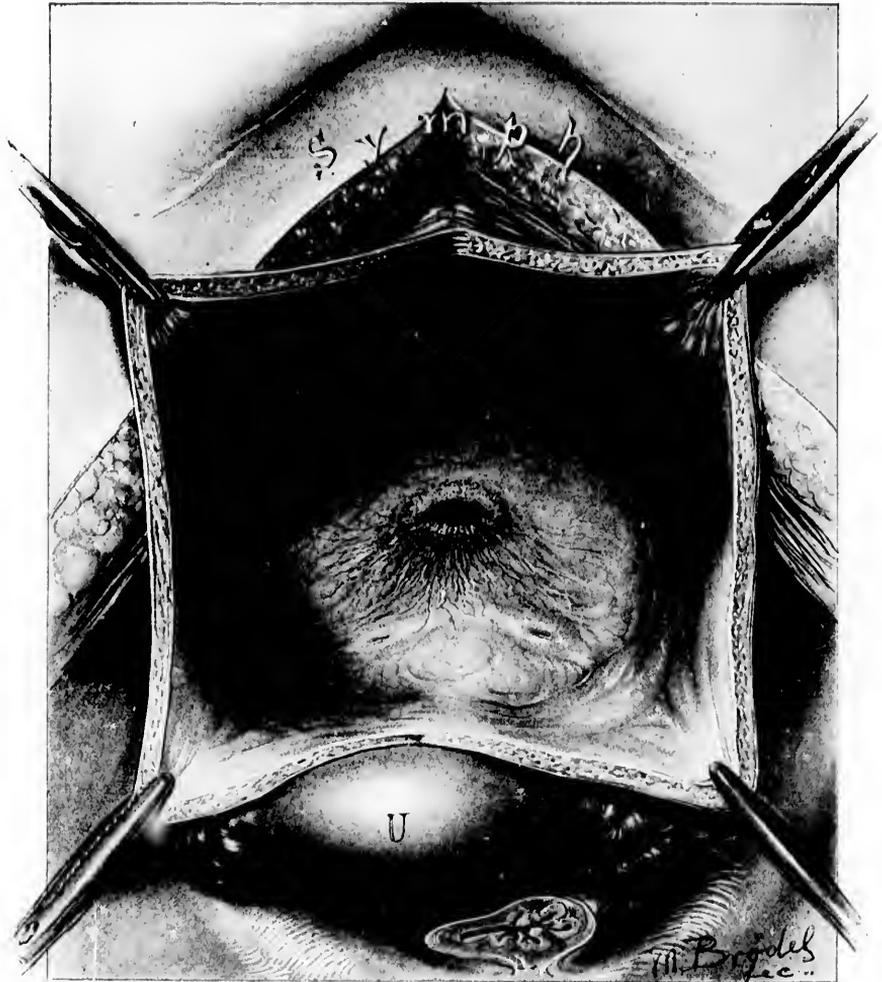

FIG. 37.

it is reflected again at an angle to its cervical attachment, which it also meets at an angle, completing the hexagon. The trigonum is well shown and the internal urethral orifice lies a little in advance of the center, forming a transverse fold with a sharp ridge above it, and with numerous fine radiating folds en-

tering the opening from below. The ureteral orifices are about  $2\frac{1}{2}$  centimeters apart, and the same distance from the urethra; each orifice is situated on a little mons ureteris. The inter-ureteric ligament is evident by a slight eleva-

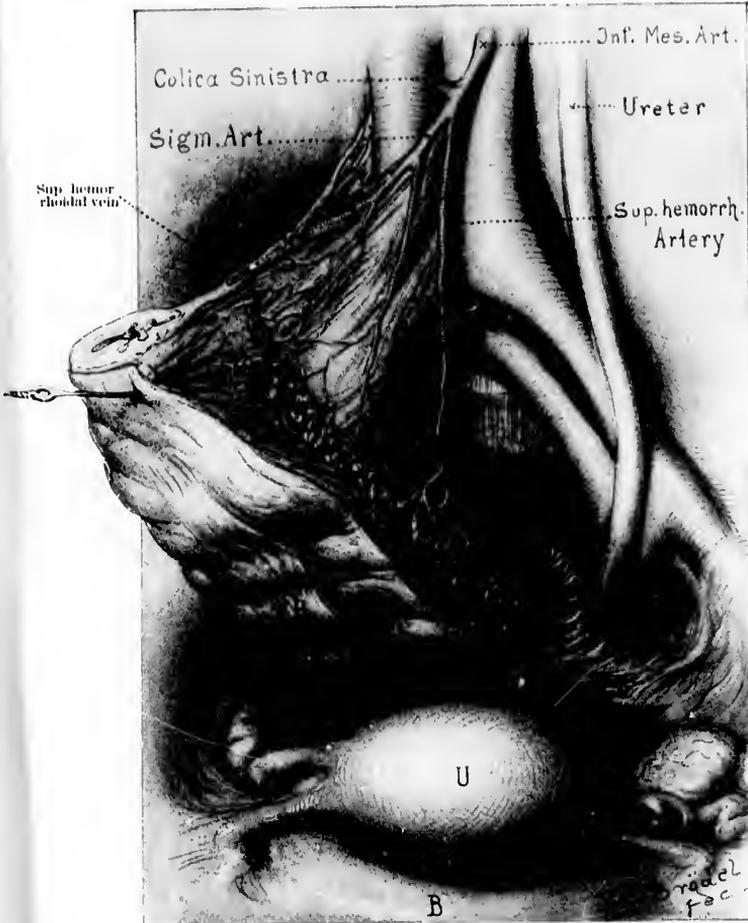

FIG. 38.

tion. Posterior to the inter-ureteric ligament is that part of the base of the bladder which lies in relation to the upper vagina.

Fig. 38 shows the blood supply of the lower sigmoid and rectum. In order to expose its vessels, the rectum has been thrown over to the right, uncovering

the left ureter. The inferior mesenteric artery is seen giving off the left colic branches and then its sigmoid branches, and terminating in the superior hemorrhoidal artery. All these branches radiate out toward the bowel, and the supe-



FIG. 39.

rior hemorrhoidal divides into two branches, one on each side of the rectum, lying close to the bowel in the pelvis. The large superior hemorrhoidal vein empties into the inferior mesenteric, and so into the portal.

Fig. 39 is a sagittal section of the pelvis, showing the rectum drawn away from the sacrum, in order to demonstrate the arteries, veins, and nerves of the sacral and lateral pelvic regions. The distribution of the superior hemorrhoidal vessels is the same as that shown in Fig. 38. The sacral plexus of nerves is seen to emerge from the sacral foramina, forming the lombo-sacral

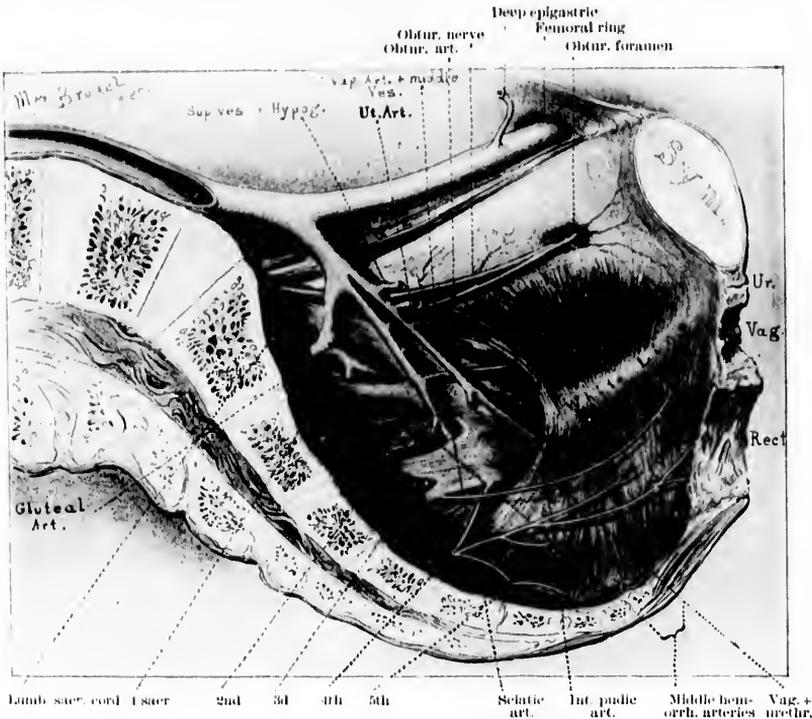
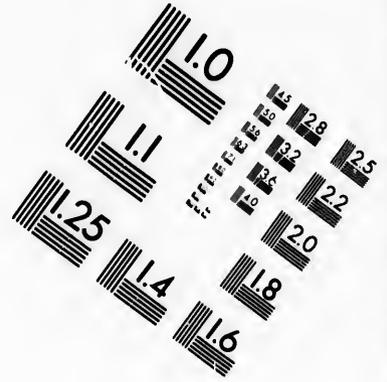
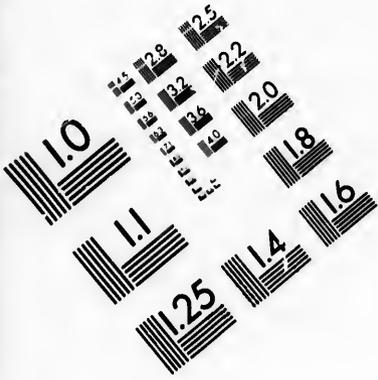

FIG. 40.

cord, and the first, second, third, fourth, and fifth sacral cords, which converge toward the great sacro-sciatic foramen, to unite in the sciatic nerve. The sacral ganglia of the sympathetic nerve are seen lying upon these nerves as they emerge from the foramen. Observe the nerves going from the fourth sacral cord to the lower part of the rectum and the coccygeus muscle.

Fig. 40 shows the muscles of the pelvis in sagittal section with arteries and nerves, after removal of the viscera. The psoas muscle is seen overhanging the brim of the pelvis and narrowing its superior strait; upon the psoas lie the common and external iliac arteries, and it is crossed by the internal iliac artery. The obturator muscle covers the obturator foramen, and its fibers converge



**IMAGE EVALUATION  
TEST TARGET (MT-3)**

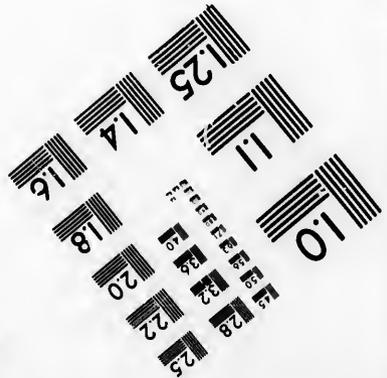
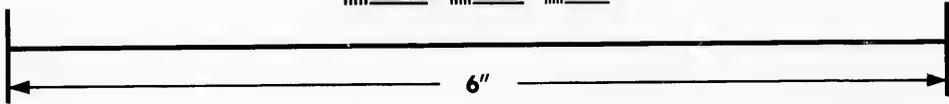
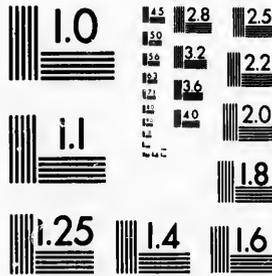

**Photographic  
Sciences  
Corporation**

23 WEST MAIN STREET  
WEBSTER, N.Y. 14580  
(716) 872-4503



to its tendon, which passes out of the pelvis through the lesser sciatic notch. At the lower margin of the obturator muscle is the white line of fascia which marks the upper border of the levator ani muscle. The levator ani seen arising from the fibrous line will be described more particularly in connection with Figs. 46 to 50. The coccygeus muscle borders the posterior margin of the

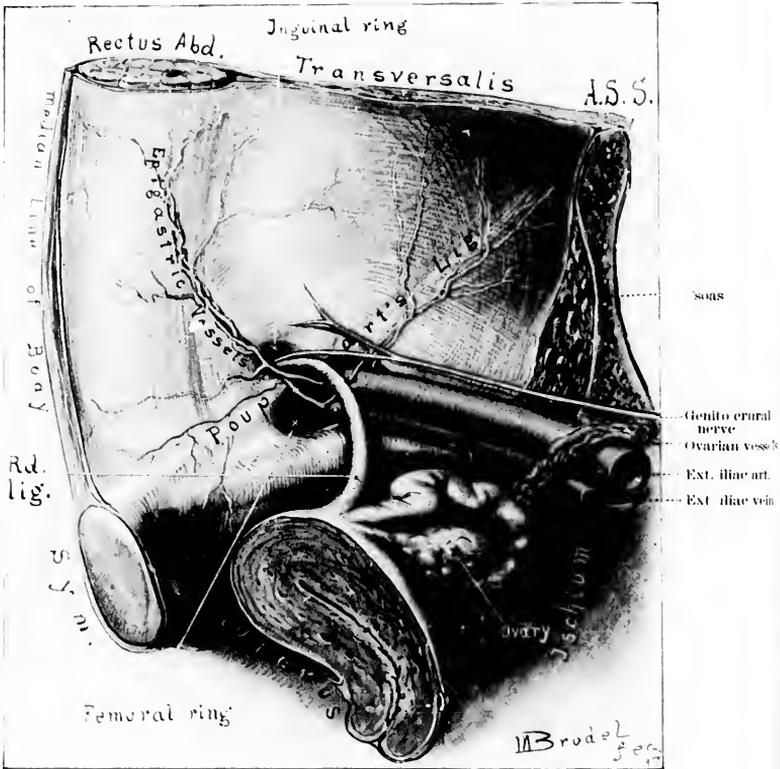

FIG. 41.

levator ani, is fan-shaped, and is attached by its base to the side of the lower sacrum and coccyx, and by its apex to the spine of the ischium. The pyriformis muscle pads the posterior part of the pelvis, rising in muscular bundles from the front of the sacrum and gradually converging and passing out of the pelvis through the great sacro-sciatic foramen, posterior to the sciatic nerve. The sacral plexus forming the sciatic nerve is seen as in Fig. 39. The obturator nerve courses around the pelvic wall parallel to and below the brim of the pelvis to the obturator foramen, where it leaves the pelvis. The vesical branch

from the third sacral cord is shown, and the nerves from the fourth sacral cord going to the rectum, levator ani, and coccygeus.

Fig. 41 shows the internal inguinal and femoral rings and the round ligament, as viewed from within the body. Poupart's ligament divides the inguinal ring above from the femoral ring below. The external iliac artery and vein pass out of the pelvis under Poupart's ligament, and give off the deep epigastric vessels which course up to the under surface of the abdominal wall around the inside of the internal inguinal ring. The epigastric artery courses in an

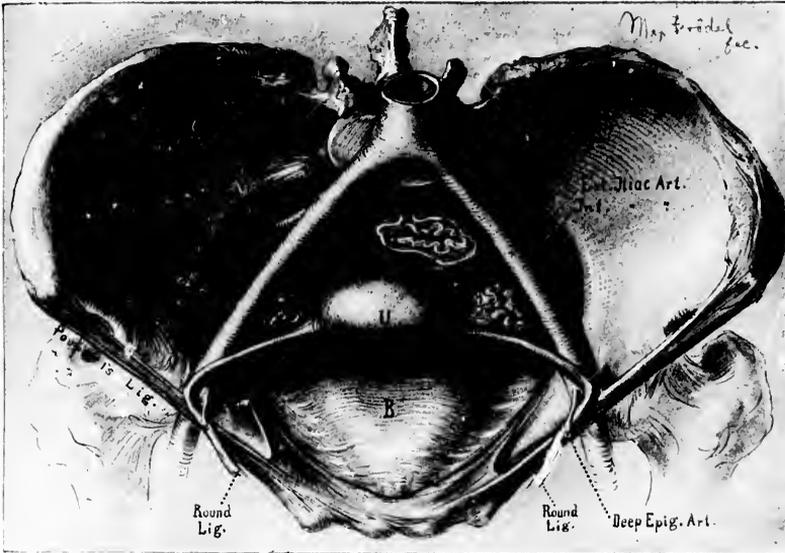

FIG. 42.

oblique direction to the rectus muscle, whose outer border it follows beneath the transversalis fascia for about 5 centimeters, when it pierces the rectus and lies well inside the semilunar line. The round ligament crosses and lies upon all these important vessels in its terminal portion in the abdominal cavity.

Fig. 42 shows the pelvic viscera and the round ligament from above. The directions of the round ligaments and the exact angles they make with the uterus and abdominal wall are accurately drawn in order to demonstrate the mechanical effects of traction made upon the ligaments at the internal inguinal ring; it is evident that the ligaments have more of a lifting effect upon the uterus, and do not serve to bring it forward to any marked extent.

Fig. 43 shows the pelvic floor as seen through the superior strait when all the viscera are removed. Note the relations of the three orifices of exit—the urethra, the vagina, and the rectum—in the muscular diaphragm of the pelvis

floor, and the relation of these to their surrounding bony supports. The pelvis is funnel-shaped and the orifices disposed in the anterior portion; the urethra appears as a small slit surrounded by thick walls just under the pubic arch.



FIG. 43.

Border of great sciatic foramen  
Obturator nerve

The vagina has the characteristic shape of the letter H lying on its side, and appears embraced by the muscular fibers of the levator ani, which hold the lower part of the rectum forward. The puckered rectal opening is grasped in

a sling of muscular fibers from the anterior portion of the levator ani, and attached posteriorly to the coccyx by a fibrous band. The levator ani extends from the inner surface of the pubic rami in a slightly curved line, which crosses the obturator internus to the spine of the ischium behind. From this line of origin its fibers converge to form a muscular sling, attached to and embracing the lower end of the rectum, so directed as to pull the rectum upward and forward. The anterior thick bundles of fibers arising from the upper inner part of the pubic rami serve to draw the lower part of the bowel well forward,



FIG. 44.

and so act indirectly as closers of the vagina. The action of the posterior fibers is simply that of holding the bowel up. The coccygeus, pyriformis, and psoas muscles are seen as described in Fig. 40.

Fig. 44 shows the mode of origin of the internal pudic artery as it arises from the anterior branch of the internal iliac, passes out of the pelvis through the great sacro-sciatic foramen, and crosses the spine of the ischium to re-enter the pelvis through the lesser sacral foramen. From this point it arches forward in a gentle curve, giving off its various branches, which course over the inner surface of the tuberosity of the ischium and cross from under the pubic arch, about halfway between the symphysis and the tuberosity, to the outer surface of the descending pubic ramus; it terminates on the anterior surface of the symphysis and the dorsum of the clitoris. The various trunks of origin of the

inferior hemorrhoidal, superficial perineal artery, artery of the bulb, and corpus cavernosum are all shown.

Fig. 45 shows the arterial vascularization of the floor of the pelvis as seen from without. The various arterial branches drawn are the derivatives of the internal pudic already indicated in their origin in Fig. 44.

Within the bony framework of the pelvic outlet, as formed laterally and posteriorly by the great sacro-sciatic ligaments, are seen the three pelvic outlets—the

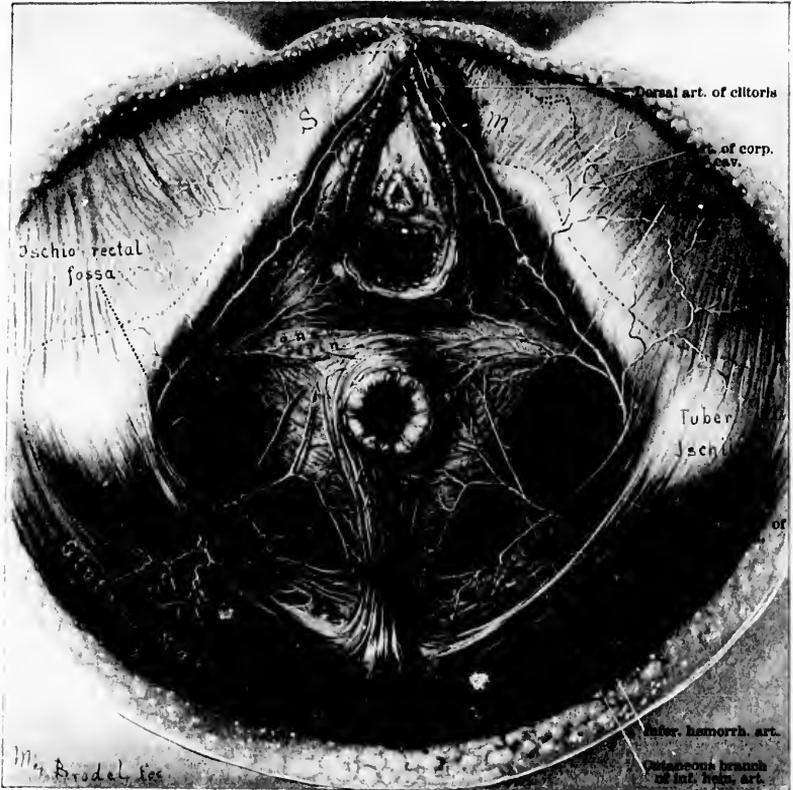

FIG. 45.

urethral, vaginal, and anal—corresponding to the same outlets seen from within in the complementary picture (Fig. 43). It is important again to notice the position of the urethra high up under the pubic arch, with the vagina immediately beneath it; the anal orifice is at about the center of the figure, halfway between the pubic arch and coccyx and the tuberosities of the ischium. A striking

feature in the picture is the ischio-rectal fossa between each tuberosity and the levator-ani muscle. Posteriorly the inferior hemorrhoidal arteries are seen emerging from the ischio-rectal fossae and curving forward, and branching over the levator ani muscle, to be distributed to the lower part of the rectum and the sphincter ani muscle. The superficial perineal arteries are seen emerging from the depths of the ischio-rectal fossae anteriorly, and coursing forward in front of the rectum over the transverse perineal muscles. The terminal branches of the internal pudic artery are seen in their distribution, a small branch going to

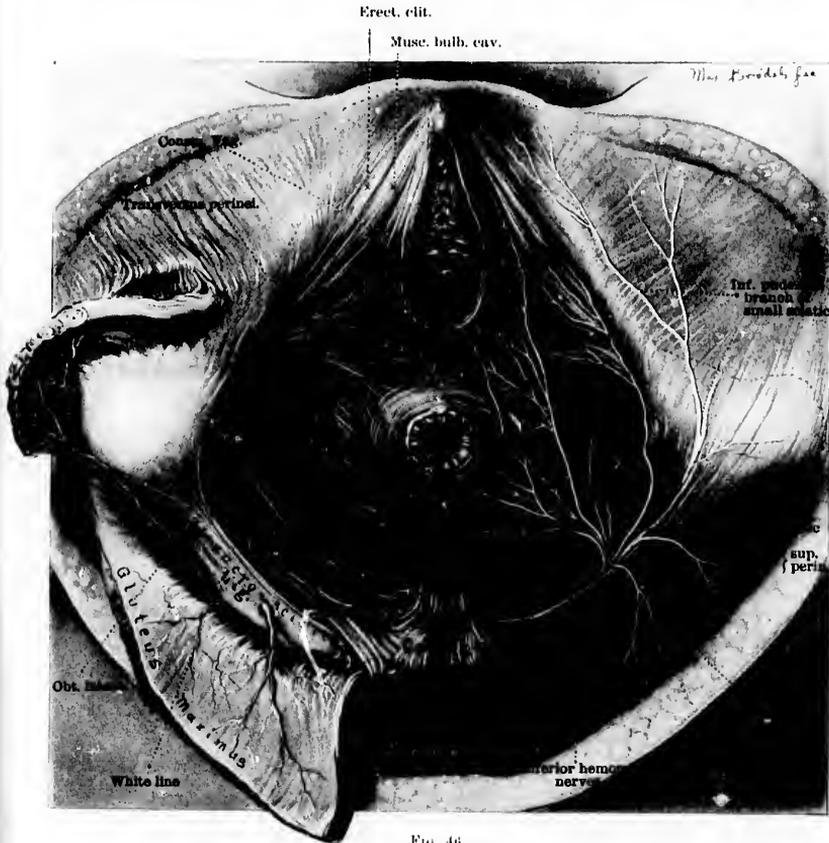

FIG. 46.

Bartholin's gland, a branch above this to the bulb of the clitoris, and the remaining branches supplying the corpora cavernosa and the dorsum of the clitoris.

Fig. 46 shows the muscles of the pelvic floor in their relation to the vaginal

and rectal openings, together with the distribution of the terminal branches of the nerves. Posterior to a line drawn between the anterior margins of the tuberosities of the ischium are seen the following muscles. The transverse perineal muscles take their origin beneath the tuberosities of the ischium and cross the perineal body horizontally between the vaginal outlet and the anal orifice, each one fusing with its fellow on the opposite side. A number of the muscular bundles diverge from the horizontal fibers anteriorly and posteriorly

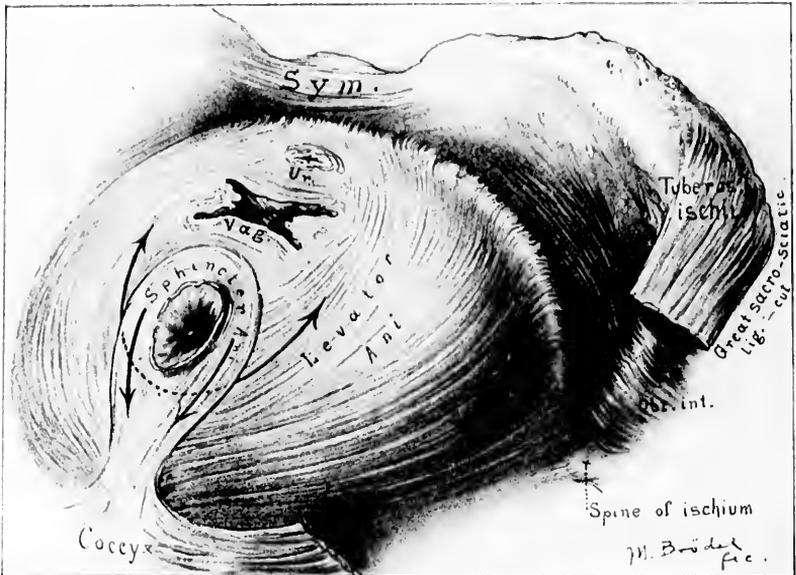

FIG. 47.

at angles of about 30 degrees, to fuse in front with the constrictor vaginae, and behind with the sphincter ani and levator.

The most conspicuous feature in the center of the figure is the roll of muscular fibers surrounding the rectal outlet, and so forming the external sphincter; these fibers posteriorly are seen attached to the end of the coccyx.

The levator ani muscles are seen on each side, filling the space between the sphincter ani and the tuberosities of the ischium. Each levator ani rises high up under the internal surface of the descending pubic ramus, from a white line of fibrous tissue stretching from the internal surface of the pubic ramus to the spine of the ischium. The anterior portion of the levator ani muscles can not be seen in this drawing, but a portion of the white fibrous line is well shown. Between this line and the tuberosity of the ischium a portion of the obturator internus muscle is visible. The coccygeus muscle, which appears almost as a

continuation of the levator ani posteriorly, is seen filling out the space between the levator and the great sacro-sciatic ligaments. In the anterior half of the picture, lying in front of the transverse perineal muscles, are shown the constrictor vaginae made up of a few delicate muscular fibers, embracing the vaginal outlet. External to the constrictor vaginae lie the bulbo-cavernosus and the erector clitoridis muscles, arising from the pubic arch posteriorly, and converging toward the dorsum of the clitoris. On the right side of the picture are shown the internal pudic nerve and the inferior pudendal nerve. The various branches of the internal pudic nerve, similar in name and distribution to the corresponding arteries as described in Fig. 45, are seen in their distribution to the muscles of the pelvic floor, perineum, and vaginal outlet.

Fig. 47 shows the origin and insertion of the fibers of the levator ani muscle, as seen from below. The sphincter ani, the lower part of the vagina, and the

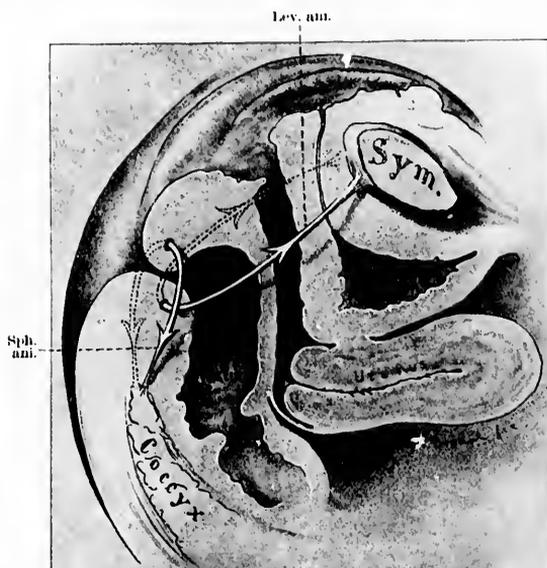

FIG. 48.—SAGITTAL SECTION OF PELVIS IN FIG. 47, DEMONSTRATING IN A SCHEMATIC WAY THE ACTIONS OF THE LEVATOR ANI AND THE SPHINCTER ANI MUSCLES.

extremity of the urethra have been cut off on a level with the attachments of this muscle. Important landmarks are the symphysis, coccyx, and the left tuberosity of the ischium. Just inside the tuber ischii the fibers of the internal obturator muscle are seen arising from the inner surface of the obturator foramen and the adjacent pubic ramus and converging to the tendon, which passes out of the lesser sacro-sciatic foramen. The great sacro-sciatic ligament has been cut away in order to expose the levator ani muscle in its entirety.

The line of origin of the levator ani is well shown, stretching from the inner surface of the pubic arch about 3 millimeters below its horizontal portion and back in a gently curved line to the spine of the ischium. The direction of the fibers of this muscle change from the anterior to the posterior part to such an extent that the fibers from the pubic arch form almost a right angle with the posterior fibers.

Owing to the direction of the anterior fibers, and their insertion into the fibrous tissues of the perineum and the sides of the rectum, they have a lifting power upon these structures which is efficient in closing the vaginal outlet (Fig. 48). It is important to note the blending of the levator ani muscle with the external longitudinal fibers of the rectum (see Fig. 49).

Fig. 50 is a coronal section of the pelvis through the iliac crests, the acetabula, and the tuberosities of the ischium, showing the posterior part of the

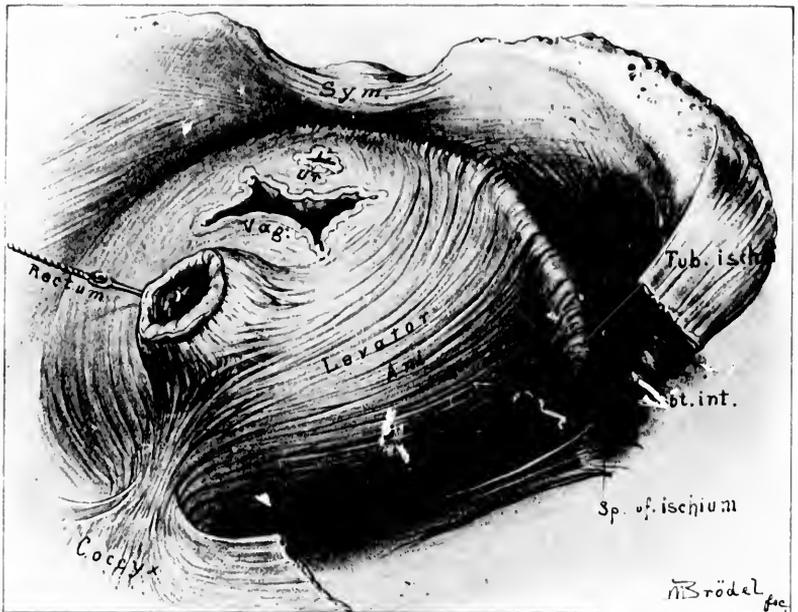
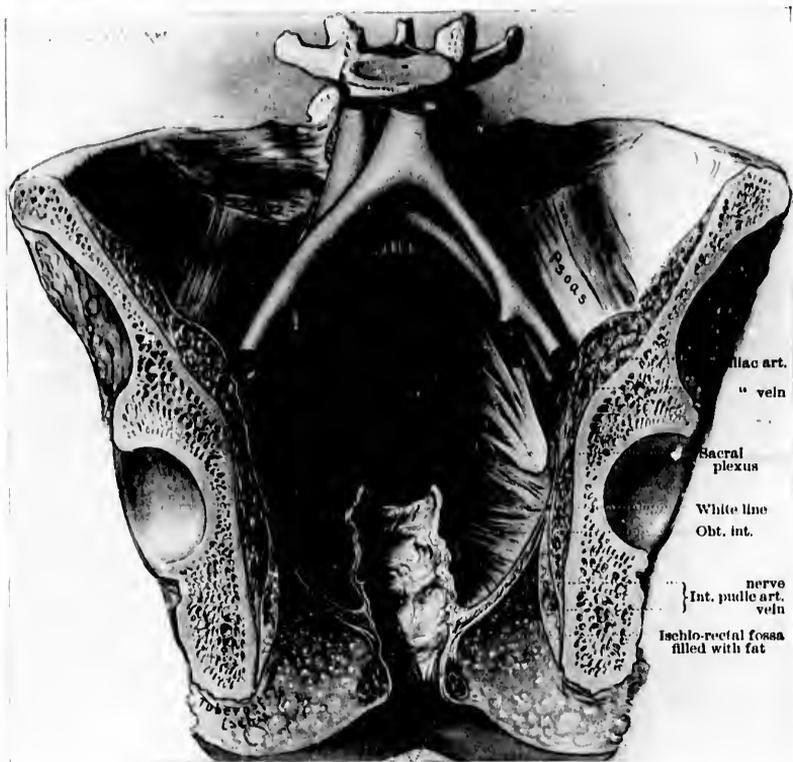

FIG. 49.

pelvis and the levator ani muscles and rectum in vertical section. The thin leaf-like nature of the muscle is well shown. The funnel shape of the posterior part of the levator ani muscle, extending from the spine of the ischium to the coccyx, is brought out. The broader surface of attachment is also shown blending with the longitudinal muscular fibers of the rectum and with the sphincter ani muscle. The division of the fascia ensheathing the obturator internus at

the point called "the white line" is shown. The obturator internus appears in section between the levator ani and the ischium, and in the depths of the ischio-rectal fossa below the levator appear the pudic vessels and nerves lying close to the tuberosity of the ischium. The coccygeus and pyriformis muscles appear



Sphincter and

Fig. 50.

as continuations of the levator, parallel to its upper fibers and clothing the posterior pelvic walls on both sides of the sacrum. The sacral plexus is seen overlying the pyriformis muscle on the left.

## CHAPTER V.

### THE GYNECOLOGICAL EXAMINATION.

1. The gynecological examination. Inspection. Measurements. Photography. The normal abdomen. Abdomen of ovarian cyst. Abdomen of fibroid tumors of the uterus. Aseptic abdomen. The use of specula in inspection. Percussion. Auscultation. Palpation. Postures employed. Standing. Squatting or crouching. Sitting and bending forward. The left lateral, or Sims's posture. The knee-chest. The dorsal. Examination of the pelvic organs in the dorsal position.—Simple examination with one hand in vagina or rectum. The bimanual examination:—With the organs *in situ*. Invagination of the pelvic floor. Examination of the uterus. Examination of the ovaries. Examination of the Fallopian tubes. Bimanual examination by the rectum and abdominal walls. Bimanual examination by rectum and abdomen after atmospheric distention of the rectum. Bimanual examination in the dorsal position with elevated pelvis: the same with the uterus in artificial retroposition. The bimanual examination with the uterus drawn down to the vaginal outlet. Examination of the anterior surface of the uterus through the rectum. Examination in pelvic disease. Pelvimetry:—Four ways of measuring the true conjugate diameter. Anesthesia. Rules for use of anesthesia. Preparation of patient. The examination. Displacements affecting position. Descensus. Antelexion. Retropositions. Ascensus uteri. Fixations and adhesions affecting mobility. Inflammation and tumors affecting size and form. Peculiarities of sensitiveness. Peculiarities of consistency. Information derived from curettage of the uterus. Microscopic examination of a piece of tissue excised. Microscopic and bacteriological examination of uterine, vaginal, and other discharges. Examination of the rectum. Examination of the vermiform appendix.
2. The general examination. Age. Heredity. Temperament. Habit. Color. Diseases to look out for. Lung disease. Affections of the heart and arteries. Affections of the alimentary canal. Diseases of the liver. Diseases of the kidney. Taking the history. Skeleton outlines of history and treatment. Diagrams of pelvic lesions. Minor examinations of gynecological cases.

The recent progress in gynecology is chiefly due to the new and better methods of examining patients, which constitute a fundamental difference between the gynecology of to-day and that of our immediate predecessors.

The gynecological examination includes both an investigation of any existing pelvic disorders and a careful inquiry into the patient's general condition. The natural order of inquiry is first to take the history, then to examine the pelvic organs, and finally to make the general examination.

#### GYNECOLOGICAL EXAMINATION.

The examination proceeds by making an orderly investigation of the pelvic and abdominal organs by means of inspection, palpation, percussion, and auscultation.

**Inspection.**—Inspection is limited to the surface of the abdomen, the external genitals, and those parts of the rectum, vagina, and cervix which can be exposed to view, either directly or by instrumental aid. In doubtful cases inspection may even go so far as to make a direct examination of the uterus, ovaries, and tubes through an exploratory incision in the abdominal wall.



DESCRIPTION OF PLATE II

Plaque of epidermal tumor by inspection. The dark line above the ampulla and the microscope for the tumor behind them. The dark line above the ampulla shows the respiratory motion.

#### DESCRIPTION OF PLATE II.

Diagnosis of abdominal tumor by inspection : the lower abdominal walls are splinted and held immovable by the tumor behind them. The hazy line above the umbilicus shows the respiratory motion.

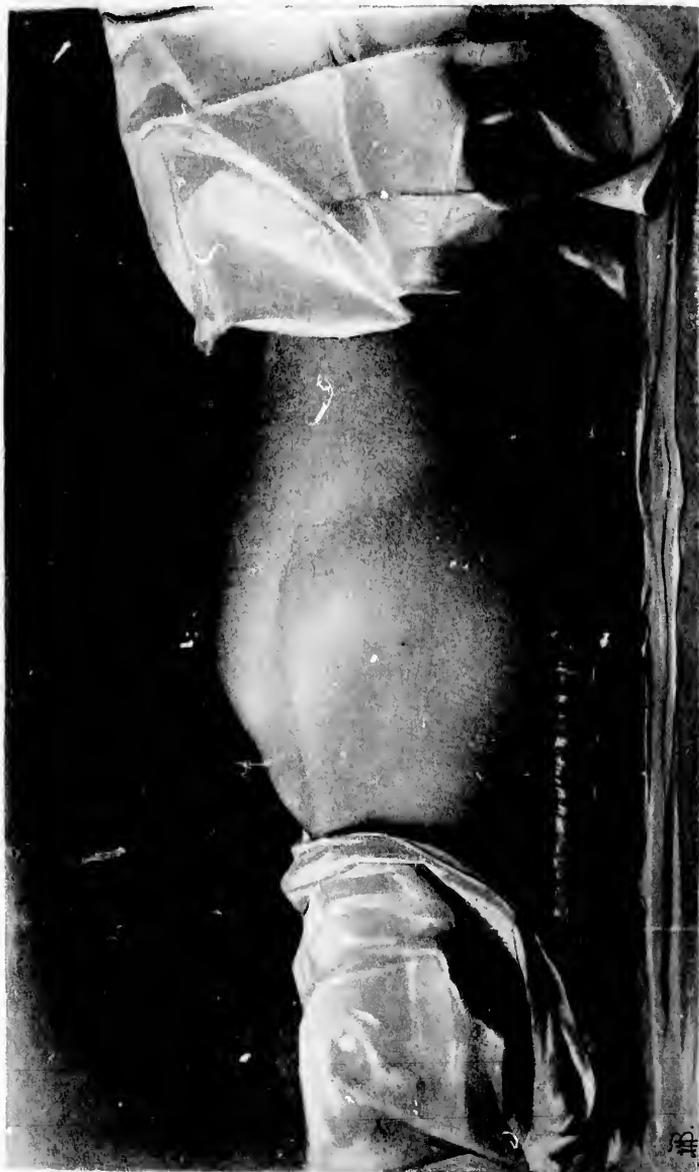

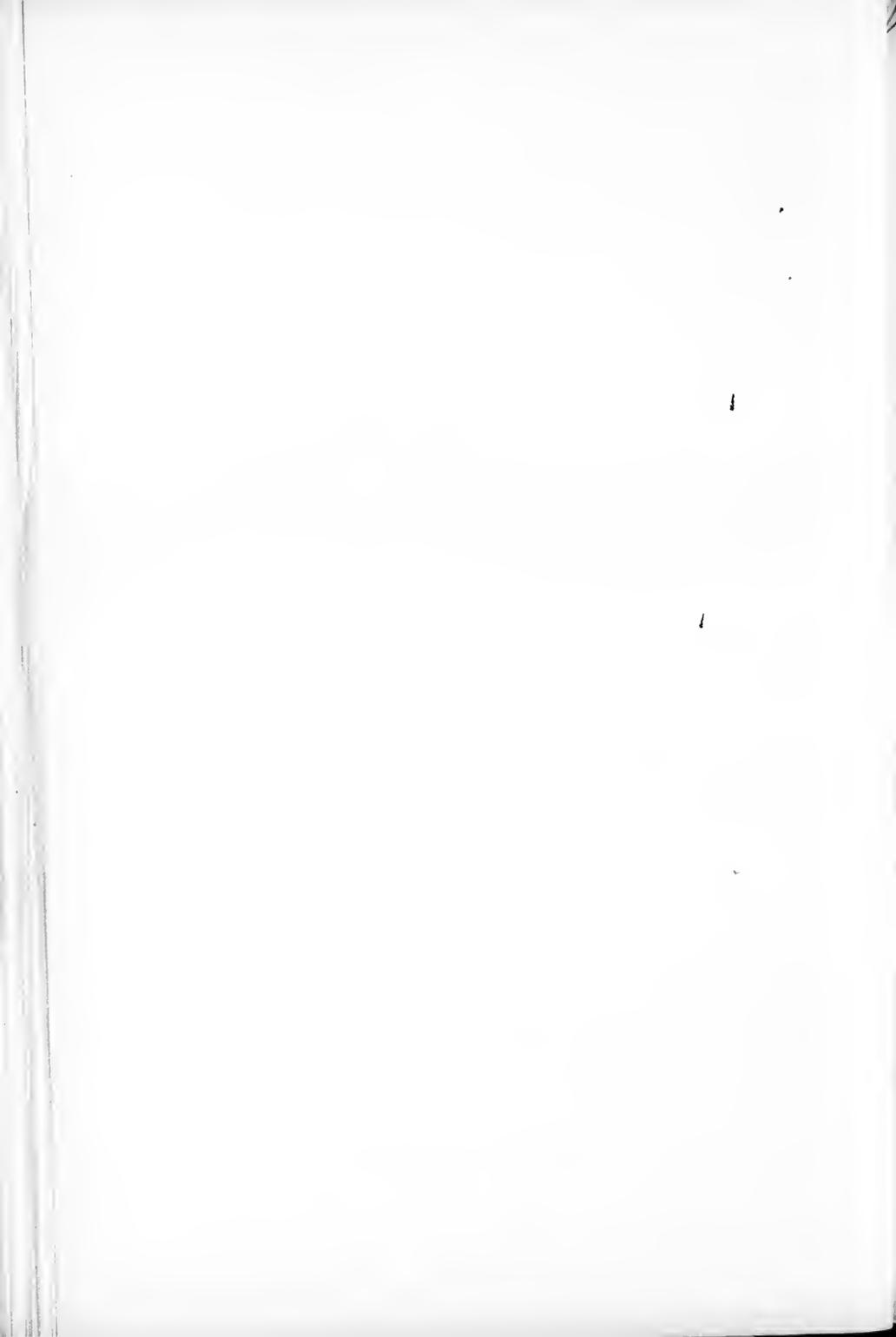

The general condition of the body—whether fat, well nourished, or emaciated—is naturally the first point to attract attention. Inspection also notes peculiarities of color affecting the skin and the mucous membranes. The greenish-yellow hue of the chlorotic woman will often at once explain an amenorrhœa; the cachexia of a cancerous patient is characteristic and easy to remember when once seen; the ovarian facies bespeaks malnutrition, and the pallor of hemorrhage in myomata or extra-uterine pregnancy is a diagnostic factor of the highest importance. The septic patient has a peculiar sallow, anemic appearance. Inspection also notes the face indicative of hysteria. The careful slow gait of the patient with pelvic peritonitis and any peculiarities in the way of protecting tender parts from touch or shock by pressure with the hands are also to be noted.

Inspection of the abdomen is of the greatest value when the eye is trained to know its various contours in health. Variations between the normal and abnormal contour of the abdomen produced by the growth of tumors, or by ascitic effusions, or by gas, can be readily seen. In abdominal tumors the inspection is limited to outlines, and is only one diagnostic measure, which, in association with other aids, enables us to arrive at a correct estimate of the character of the disease beneath.

While a simple inspection is sufficient for the immediate purposes of the diagnosis, careful measurements of abdominal enlargements should always be made and recorded. By means of measurements at different times changes in the size of a distended abdomen are made evident and imperceptible differences of a few centimetres can be accurately determined. Besides, we also do away with such vague terms as "a small tumor," or "a large" or "enormous one," eliminating the large personal equation lurking in these statements.

The following are the usual measurements made:

Circumference of the abdomen at the umbilicus.

Circumference halfway below the umbilicus.

Elevation of highest point of abdominal wall above the plane of the anterior-superior spines.

Distance from sternal notch to symphysis pubis.

Distance from umbilicus to pubis.

Distance from umbilicus to right and left anterior-superior spines respectively.

By such measurements the degree and form of abdominal enlargements are determined, whether more in the lower or upper abdomen, or in one flank, and whether symmetrical or asymmetrical.

Photography is a valuable adjunct to descriptive records; the photograph gives an instantaneous idea of form, often better than an elaborate description. The photograph with the patient lying on the table can be taken with advantage from three points of view: A profile from the side, showing the general enlargement of the abdomen; a profile from below, showing symmetry or asymmetry; while a quartering view halfway between these two posi-

tions and looking rather down on to the abdomen gives a general view of the relations of the parts of the tumor to the abdominal landmarks. When possi-



FIG. 51.—SAGITTAL SECTION THROUGH ADULT BODY, SHOWING THE NORMAL POSITION AND RELATIONS OF THE UTERUS, BLADDER, RECTUM, AND ABDOMINAL WALLS.

The intestines are not shown, and the dotted line represents the outline of the pelvic bones. It is important to note the proximity of the anterior abdominal wall to the sacral promontory.

ble, the umbilicus should be included in the picture, as the most important landmark. A profile view, with the patient erect, shows the anterior displacement of a large tumor.

A beautiful graphic record demonstrating the presence of a tumor within the abdomen is furnished by the profile photograph shown in Plate II. The diagnostic sign rests upon the hazy contour of the upper half of the abdomen, beginning at the umbilicus; at first sight, the indistinct line looks like a fault



FIG. 52.—ENORMOUS OVARIAN CYSTOMA, WITH GLOBULAR PENDULOUS ABDOMEN, AND THE CHARACTERISTIC EMACIATION.

in the picture, but this is due to the fact that it registers the natural movements of the abdominal wall during expiration and inspiration which are cut short below by the tumor splinting the lower abdomen so that it can not move, as it would do if no tumor were present.

Marked departures from the normal may occur within the limits of health, of which the most frequent are distention from tympany or the

accumulation of fat in the omentum and abdominal walls. Tympany produces a symmetrical form, by the uniform expansion of the intestines in all directions, the greatest prominence being around the umbilicus. The general appearance of such an enlargement may not differ at all from that of an encysted tumor. In a fatty abdomen, if the fat is in the walls, it is often



FIG. 53.—SYMMETRICAL CIRCULAR OUTLINE OF ABDOMEN CHARACTERISTIC OF A LARGE OVARIAN CYST.

characterized by the presence of creases from side to side; if it is inside the cavity, on the omentum and mesentery, in the nullipara, the rotundity is simply increased; but in the multiparous woman the walls appear flabby and the abdomen flat and distended in the flanks. These changes occur commonly after the menopause. If an abdominal tumor is present under these circumstances, it often becomes a difficult task to make a diagnosis, and the physician may easily be misled into concluding that there is no tumor within.

Fig. 51. The importance of knowing the normal abdomen and its variations within the limits of health becomes evident as we study the changes in form brought about by tumors in the peritoneal cavity. Such a pathological enlargement is either uniform over the whole abdomen or localized in some special area. The enlargement itself may present a uniformly convex surface,

or it may be marked by bosses and grooves. A uniform increase in the size of the whole abdomen is only produced by tumors of the largest size and by ascites. Such a case is shown in the figure of Mrs. D., who had an ovarian cyst weighing 100 pounds, which I removed in Philadelphia, in May, 1887. (Fig. 52.)

A symmetrical convex surface over an abdominal tumor indicates a corresponding symmetry of surface of the tumor within. The contrast afforded in this way with a bossed surface serves to distinguish certain groups of tumors. In gastric, splenic, or hepatic tumors of the upper abdomen the swelling is more above, while in pelvic tumors the enlargement is mostly below.

The pregnant uterus may be taken as the type of symmetrical lower abdominal and pelvic tumors; here the chief distention is below the umbilicus, and in the first pregnancy up to the eighth month the prominence in the median line is like that of an ovarian cyst or a myomatous uterus of the same size.

Fig. 53. The form characteristic of large ovarian cysts is an ovoid distention of a part or of the whole abdomen, with more or less smooth outlines. Such tumors at first involve the lower or infra-umbilical part of the abdomen greatly in excess of the upper part, and if the tumor is of enormous

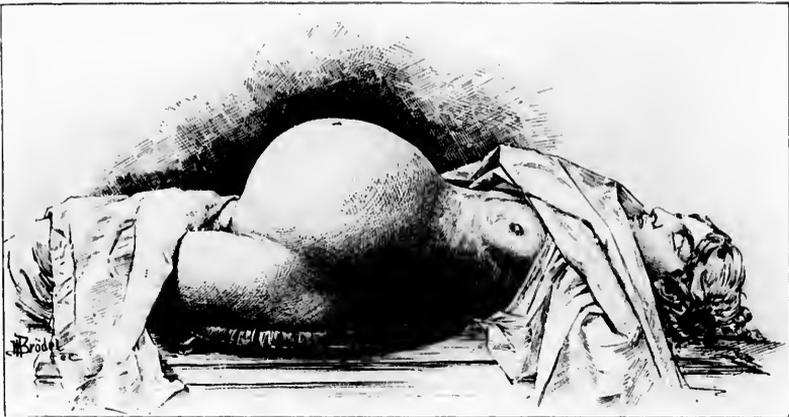

FIG. 54.—ABDOMEN DISTENDED BY A LARGE PAROVARIAN CYST.

Note particularly the gentle line of elevation from the sternum to the umbilicus, an area rarely encroached upon by myomata.

size it may even hang below the knees. The enlargement is always uniform in parovarian cysts, Fig. 54, and in polycystic tumors with but few bosses; in the latter case the smaller nodular prominences are usually displaced into the flanks by the movements of the abdominal walls accommodating the convex smooth surface of the tumor to the concave inner surface of the anterior wall. Sometimes the surface of the abdomen appears nodular from the presence within of

an ovarian tumor made up of a number of *loculi* of about the same size, or when adhesions prevent the tumor from rotating and accommodating itself.

Figs. 55 and 56. *Two forms of enlarged abdomen are characteristic of fibroid tumors of the uterus:* one in which the distention is spherical, looking as if the cavity contained a cannon ball, while the drop from the top of the tumor to the normal level of the abdominal wall, as the patient lies on her back, is often almost vertical. This is rarely seen in ovarian tumors. The other form has an appearance of irregular nodular masses distributed in the lower abdomen, Fig. 57.

Figs. 58, 59, and 60. Enlargement of the abdomen frequently arises from ascitic accumulations, which tend to take the form of a flattened

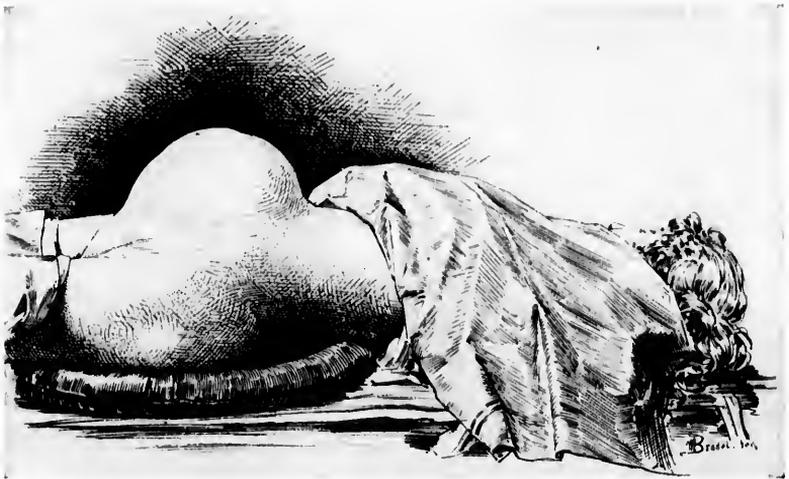

FIG. 55.—FORM OF ABDOMEN CHARACTERISTIC OF A LARGE GLOBULAR MYOMATOUS UTERUS. Note particularly the abrupt lines of elevation, especially from epigastrium to umbilicus.

ovoid, the regions of greatest prominence being in the flanks, whither the fluid gravitates. While the flattening is an important differential point between an ascitic accumulation and circumscribed encysted fluids, yet occasionally in a nullipara ascites may present the domelike prominence of a cyst, and the difference can only be detected after palpation and percussion in various positions. See Figs. 61 and 62.

Inspection is the essential factor in the diagnosis of diseases of the external genitalia, vagina, and vaginal cervix. The vagina and cervix can be exposed to view by the aid of instruments. Relaxed outlet, rupture of the outlet, prolapsus, and affections of Bartholin's glands, such as cysts and abscesses, etc., are diagnosed at once by simple inspection.

Inspection of the vagina and vaginal cervix is effected

by means of specula. The best are Fergusson's tubular, Sims's duck-bill, Goodell's bivalve, and Nelson's trivalve speculum, and Kelly's small cylindrical specula. The valvular specula are introduced to their full extent closed, and then opened, when the cervix is brought plainly into view. Upon withdrawing the speculum the vaginal walls are examined as they slowly roll over the end. Ordinary specula, however, must not be used in examining unmarried women, for they destroy the hymen and produce a dilatation of the vaginal outlet. I have often seen a distention from specular examinations great enough to admit four fingers. Small cylindrical specula, 9 centimetres ( $3\frac{1}{2}$  inches) long and 8, 10, 12, 14, and 16 millimetres in diameter, must be used in examining and treating the vagina and cervix in unmarried women and girls. The patient is put in the knee-breast position, and the speculum with an obturator introduced without injuring the hymen; as soon as the obturator is withdrawn the vagina fills with air, and every part of it, with the cervix, is plainly exposed to view by a light reflected from a head mirror.

**Percussion.**—Percussion is a valuable adjunct to inspection and palpation in the differential diagnosis of abdominal tumors. There are in general three kinds of percussion notes—flat, tympanitic, and dull. The flat note, drawn from the most prominent part of an ovarian or uterine tumor, is in striking contrast to the high-pitched tympany of the intestines sur-



FIG. 56.—ABDOMEN DISTENDED BY A LARGE CYSTIC MYOMA. ABDOMINAL WALL SIMPLY PUSHED OUT WITHOUT SAGGING. Note dilated superficial epigastric vein and edematous legs.

rounding it. The edge of the tumor is defined by an area of relative dulness or "tympanitic dulness."

The part of the abdomen from which an abdominal tumor has arisen may



FIG. 57.—SHOWING FORM OF THE ABDOMEN CHARACTERISTIC OF A LARGE MULTINODULAR SUBPERITONEAL MYOMA WITH THIN ABDOMINAL WALL.



FIG. 58.—CHARACTERISTIC FORM OF A FLACCID ABDOMEN WITH ASCITES.

The fluid has gravitated down into the flanks, and the anterior abdominal wall in the median line almost rests on the vertebrae.

often be determined by percussion, by outlining the growth and noting on which side the resonance is wanting; in almost every case that will be the original

habitat of the tumor from which it has developed out toward the middle of the abdominal cavity, the direction of least resistance.

The outlines of most pelvic tumors are more or less crescentic and surrounded by an area of resonance called the *coron*, *corona ovariana*, or *corona uterina*.

Percussion is of the greatest service in differentiating cystic and solid tumors from tympany and ascites. The tympanitic abdomen is resonant all over; the ascitic abdomen yields a dull note in the flanks and tympany above, from the

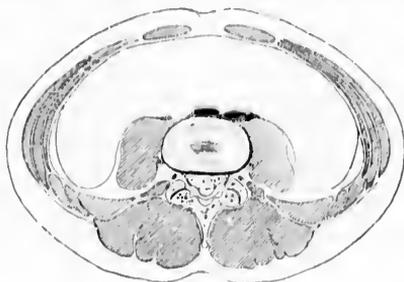

FIG. 59.

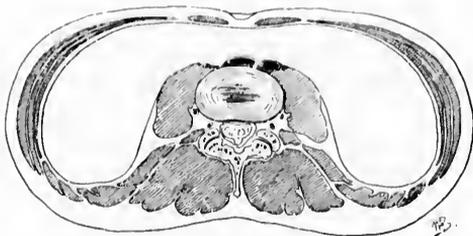

FIG. 60.

Characteristic form of section through normal abdomen (Fig. 59) compared with ascitic abdomen (Fig. 60). Section made through umbilicus and fourth lumbar vertebra.

gravitation of the fluid and the floating up of the intestines. When the accumulation is extreme, however, the distention of the abdomen may be so great as to lift the walls farther from the back than the mesentery can reach; in such cases the intestines are everywhere covered with fluid and percussion yields a flat or dull tympanitic note in all directions. Moderate accumulations may be made to gravitate from one side to the other, or into the lower or upper abdomen, by changing the position of the patient; and the dull and tympanitic areas will change with each alteration of posture.

The most important use of percussion in diagnosis is the recognition of an area of tympany overlying retroperitoneal tumors, usually renal, which lift the colon forward as they advance toward the anterior abdominal wall; in this

way the error of mistaking an enlarged kidney for an ovarian tumour is always to be avoided.

**Auscultation.**—Auscultation is limited to the surface of the abdomen and is chiefly valuable in discriminating abdominal tumors from pregnancy, where the sound of the fetal heart-beats is the distinctive sign. In fibroid tumors a loud bruit is often heard, caused by the free circulation of the blood in the great vascular channels; this must not be mistaken for the bruit of pregnancy. The only way to make the distinction clear is by discovering other signs of pregnancy.

**Palpation.**—After inspection and percussion we proceed to examine by touch. No other diagnostic procedure is equally satisfactory and so certain in its results as the sense of touch applied to the various organs through the abdominal,



FIG. 61.—CYLINDRICAL FLATTENED ABDOMEN CHARACTERISTIC OF ASCITES.

vaginal, or rectal walls. It is not unusual for the beginner to feel discouraged with the results of palpation, which at first are crude and indefinite, but by persistent practice the tactile sense becomes acute, and the consistence as well as the minuter outlines and relations of the various organs in health and disease are easily appreciated.

By palpation we outline structures normal and abnormal, and determine the relative position, consistence, mobility, and sensitiveness of the parts under investigation. In this way cystic tumors are at once differentiated from hard ones, and masses are easily detected in the lower abdomen, where they are hidden behind the symphysis, or in the flanks. Again, the degree of relaxation of the outlet and the condition of the vaginal walls and of the cervix are at once determined by digital palpation. Palpation is greatly facilitated by the use of certain postures, which are so important that I shall describe them in detail.

The various useful postures are the standing, squatting, sitting, and bending forward, the left lateral or Sims's, the knee-breast, and the dorsal or lithotomy.

**Standing Posture.**—In this posture the patient stands with one foot on the floor and the other resting on a stool six or eight inches high, while the physician stoops before her and, resting the elbow of his examining hand on his knee, proceeds to make a digital examination of the vaginal outlet, the vagina,

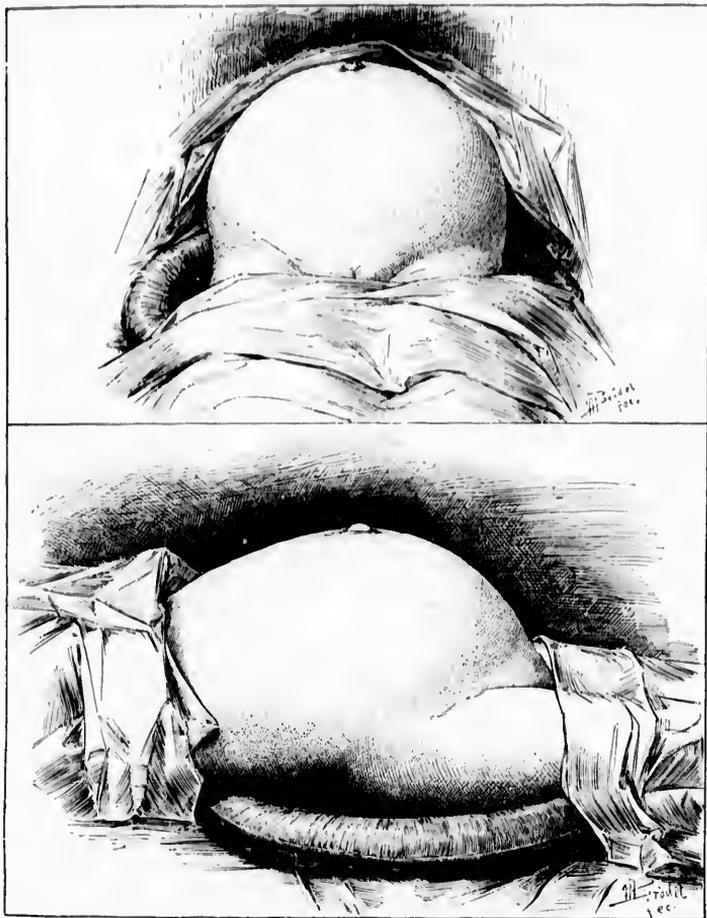

FIG. 62.—OVARIAN TUMOR WITH ASCITES.

The upper picture shows the form of abdomen as seen from below; the lower picture the form seen from the side. Note protrusion at the umbilicus. *M. E., op., Dec. 23, 1895.*

and the other pelvic organs. The hand can be placed at rest and the arm lengthened or shortened at will by supporting the leg on the ball of the foot,

keeping the heel off the floor. This gives a springy support and takes away the natural tendency to stiffen the arm in pushing the hand high up into the vagina. Relaxation of the vaginal outlet and descensus uteri are most easily recognised in this way. While standing, also, if there is a movable kidney, it drops forward and is readily grasped between the hands.

**Squatting or Crouching Posture.**—The patient takes the same posture as in defecation, and by a slight straining effort is able to demonstrate to the examiner behind her the least tendency to prolapse and eversion of the vaginal walls. The full effect of a relaxed outlet may be brought out in this way better than by any other means.

**Sitting and Bending Forward.**—The patient leans forward, resting the weight of her body on the shoulder of a nurse, and so thoroughly relaxes the abdominal muscles; the examiner then sits before her or at her side, and makes counter-pressure with one hand over the back while with the other he palpates deeply through the lax abdominal walls.

**Fig. 63. The Left Lateral or Sims's Posture.**—In this position the patient lies on her left side with her left arm behind her back and both legs flexed upon the abdomen, the right drawn up above the left, and the pelvis

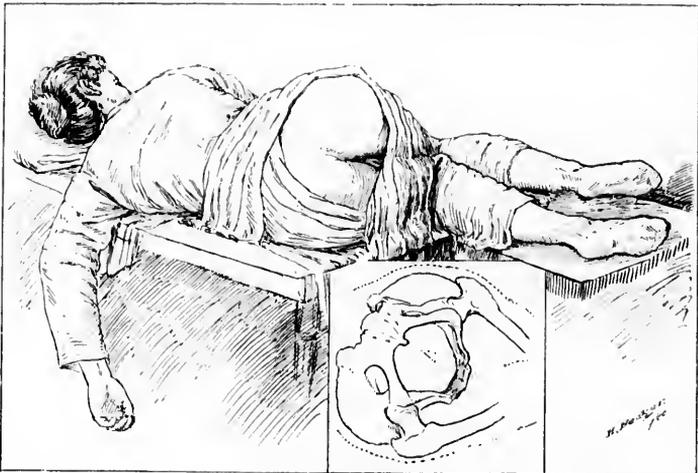

FIG. 63.—SIMS'S POSTURE.

Showing the position of the legs and chest, and especially the inclination of the pelvis, as seen in outline below.

tilted decidedly over toward the table, so as to facilitate the gravitation of its contents through the superior strait in the direction of the anterior abdominal wall; this causes the vagina to balloon out with air as soon as the posterior wall is retracted. The distention will not take place, however, unless the pelvis is sufficiently tilted, so that if the patient persists in lying with her right hip vertically above the left, the difficulty must be overcome by requesting her to

lie more on her stomach. This posture is useful for vaginal inspection, local treatments, and some operations. A digital examination in this position is always unsatisfactory, as the hand is impeded by the perineum.

To expose the cervix take a Sims's speculum, dip it in warm water, and anoint it with vaseline; the right buttock is then lifted with the left hand, until the vaginal outlet is seen, when the speculum is engaged in the fourchette and gently slipped back into the vagina, avoiding the urethral orifice, and following the sigmoid curve of the posterior vaginal wall, which it retracts at the same time.

If the outlet is relaxed, the posterior wall may be retracted with the fingers alone, and the vagina and cervix exposed as well as with a speculum. In this posture, in cases of pelvic inflammatory disease, the uterus and its appendages often do not recede into the pelvis, but remain fixed by their adhesion, while the vagina does not expand.

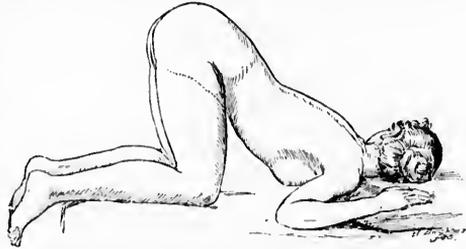

FIG. 64.—KNEE-CHEST POSTURE.

Fig. 64. The Knee-chest Posture, like the one described, is not often of special value in digital explorations, but for the inspection of the vagina and the vaginal cervix it is by far the best. In order to obtain the full advantage of the posture, the patient must be placed with her head turned sidewise upon the table so as to bring her chest as close to it as possible; then with the back bowed in, the pelvis is inverted so that the viscera naturally pitch downward toward the diaphragm. The effect of this posture may be exaggerated by lifting the pelvis with a pillow placed under the knees. The corset must always be removed and the clothes drawn above the knees on the table and over the hips behind. Upon introducing the Sims's or a tubular speculum the air rushes into the vagina and balloons it out, bringing the cervix and vaginal walls into perfect view. If there is an adherent inflammatory mass in the pelvis, the vagina will only distend to a limited extent and the swelling at the site of the tumor may be visible.

This is the best position in examining the virgin, for the whole vagina can be perfectly seen through a small cylindrical speculum only 10 or 12 millimetres in diameter, and without injuring the hymen.

The Dorsal Posture.—In this position the patient lies relaxed on a short table, with her head resting on a pillow and the legs and thighs flexed, and covered with a sheet. The clothing must be drawn above the hips behind and above the knees in front, and the corsets should be loosened. The effect is increased by elevating the head and chest upon pillows so as to shorten the distance between the symphysis pubis and the sternum. By this means the recti muscles are relaxed and offer less resistance to the invagination of the abdomi-

nal wall through the superior strait in a bimanual examination. The feet in the dorsal position should not be more than 15 to 20 centimetres (6 to 8 inches) apart, throwing the knees outward, and facilitating the investigation by permitting freer access to the pelvis. If the feet are widely separated—a fault common to the arrangement of most tables and gynecological chairs—the knees are thrown inward, and the patient's inclination becomes almost irresistible to draw the thighs together the moment the finger touches the vulva, rendering the examination difficult, or preventing it altogether.

#### EXAMINATION OF THE PELVIC ORGANS IN THE DORSAL POSITION.

For the sake of comparison, a knowledge of the normal pelvic organs is indispensable as a standard in judging of their condition in disease. Palpation, or examination by indirect touch, is the only accurate means of determining the condition of the uterus, tubes, and ovaries in the living subject. The normal uterus, broad ligaments, tubes, and ovaries can always be palpated by a skilled examiner.

The methods of examination are four:

First, a simple exploration with one hand by the vagina or rectum; second, the bimanual examination through the vagina or rectum and abdominal wall, with the organs *in situ*; third, the bimanual examination through the vagina or rectum and abdominal wall, with the uterus artificially displaced backward; fourth, the examination through the vagina, or rectum and abdominal wall, with the uterus drawn down to the vaginal outlet.

*a.* Simple examination with one hand in the vagina or rectum:

This is usually employed as a preliminary. Bartholin's glands are examined on both sides between the thumb and forefinger. The condition of the outlet is estimated by one or two fingers making backward pressure. The rugæ of the normal vagina are felt like rough ridges on the anterior vaginal wall, while they are smoothed out in the relaxed vagina.

The cervix is next felt as a knoblike prominence in the vault of the vagina, its axis pointing downward in a line with that of the vagina, or backward toward the sacrum, or forward toward the symphysis, depending upon the position of the uterus. If the os uteri points downward in the axis of the vagina in the nulliparous woman it indicates either a marked anteflexion due to an undeveloped uterus or a retroflexion, while in a child-bearing woman it means retroflexion. A lacerated cervix, infiltrated or studded with follicles, or the indurated ulceration of carcinoma, are readily distinguished from the normal, smooth, knob-like cervix. If the uterus is slightly anteposed, its body can not be felt by one hand alone; but if it is acutely anteposed, by giving the anterior vaginal vault in front of the cervix a quick blow the fundus will be detected as a resisting body.

In examining with one hand by the vagina, the ovary can not be felt unless it is abnormally displaced downward into the recto-uterine pouch, where it may

be discovered by pressure behind the cervix uteri a little to the right or left. It feels like a rounded, somewhat elastic body, slipping up and away under the pressure. Any attempt with one hand to feel the ovary not displaced fails, or gives at the utmost but an uncertain idea of its presence; because as soon as it is touched it yields to the pressure, and is displaced upward and out of reach. An examination of the deeper pelvic structures with one hand is therefore incomplete.

*b.* The bimanual method of examination is conducted either with the organs *in situ* or with the uterus in artificial displacement.

The bimanual examination with the organs *in situ* depends for its success upon the invagination of the abdominal wall just above the symphysis pubis,



FIG. 65.—BIMANUAL EXAMINATION OF THE PELVIC VISCERA.

Same as before, but with the third and fourth fingers flexed upon the palm and the pelvic floor, invaginated, adding an inch or more to the length of the fingers. Left view.

through the superior strait, with one hand, while with the other hand the examination is made through the inferior strait. The index finger, or both index and middle fingers, if the vagina is sufficiently lax, is introduced as far as the cervix. The palmar surface of the last joint of the finger must always be used in palpating; it is a beginner's error to use the radial side of the finger.

There are two ways of holding the rest of the hand which is outside during the examination, either with the fingers strongly flexed in the palm, Fig. 65, or with the thumb and fingers widely separated, the thumb resting upon the symphysis and the unemployd fingers on the perineum, Fig. 66. The first posi-

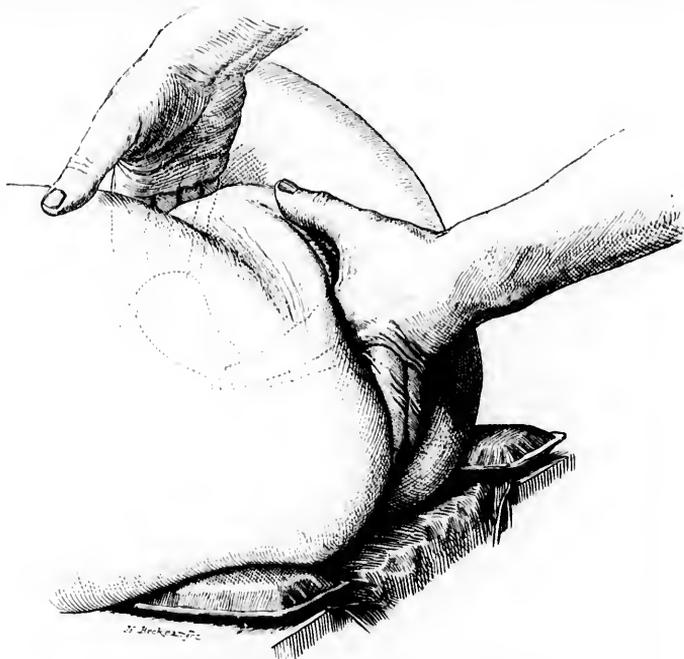

FIG. 66.—BIMANUAL EXAMINATION OF THE PELVIC VISCERA.

The upper, abdominal hand, pushes the abdominal walls in behind the uterus, while the lower, vaginal hand, catches the cervix. Note the position of the third and fourth fingers extended in the gluteal cleft. Right view.

tion is best when the examination can be conducted without bending the flexed fingers beyond a right angle with the examining finger; otherwise, the second method is preferable.

Simultaneously with the introduction of the finger into the vagina slight pressure is made over the middle of the superior strait, with the tips of the fingers of the other hand resting upon the abdomen above the symphysis.

In most cases only slight pressure is required throughout to make a complete examination of the pelvic organs; in other cases it is necessary to overcome resistance by making a gradually increased pressure downward until the structures are felt. As a rule, the outlines of the pelvic organs are not minutely examined by the abdominal hand, which serves more as a plane of resistance to prevent the upward displacement and gliding away of uterus and ovaries when touched

by the finger within the vagina. When the abdominal walls are thin and lax the outer hand may also be employed in studying the outlines of the organs.

Fig. 67. Invagination of the Pelvic Floor.—In spite of the assistance given by the external hand, the bimanual examination would often prove unsatisfactory if the vaginal hand were limited by the length of the index and middle fingers. Invagination of the pelvic floor is therefore a necessary



FIG. 67.—BIMANUAL EXAMINATION, SHOWING THE DEEP INVAGINATION OF THE PELVIC FLOOR, ADDING SEVERAL CENTIMETERS TO THE LENGTH OF THE FINGERS.

The left forearm and hand are placed at rest by making the pressure from the hip in the direction of the arrow.

aid, as by this means the examining finger is practically lengthened from 4 to 6 centimetres ( $1\frac{1}{2}$  to  $2\frac{1}{2}$  inches). This is accomplished by pressing the perineum up into the pelvis in the axis of the inferior strait. The pubic arch and the

tuberosities of the ischium are obstacles to invagination, but a skilful examiner may overcome them by eramping the fingers a little more closely together or by making pressure rather back. Another difficulty in the way of securing the fullest advantages from this method of examining is an involuntary stiffening of the wrist and finger muscles. This may be overcome by pushing from the elbow, while the hand remains perfectly flexible, in order not to interfere with the delicacy of its tactile sense. Where the resistance is unusually great or the act proves tiresome, the examiner will help himself materially by supporting the elbow on his pelvis and pushing from his hip, relieving the arm entirely.

The examination of the uterus is begun by the vaginal hand giving the cervix a slight blow, which sends it upward at the moment the abdominal hand bears down upon the same spot. Several such movements rapidly repeated in front of and behind the cervix at once decide whether the body of the womb lies in ante-position or retro-position. When the fundus lies in advance of the cervix, by sliding the vaginal finger forward and bringing the abdominal hand a little closer to the symphysis and pressing downward, a plane of resistance is furnished upon which the vaginal finger rolls and palpates the whole organ, while the hand above also appreciates every movement given, and so by their combined action a judgment is almost instinctively formed.

Examination of the Ovaries.—By carrying the vaginal finger far up into the lateral fornix posterior to the cervix, and then pushing out toward the lateral wall of the pelvis, while deep pressure is made with the abdominal hand in the same direction through the corresponding semilunar line, the ovary can usually be caught and palpated. It is not sufficient simply to touch the ovary, but it must be caught repeatedly and allowed to slip between the fingers in various directions until it has been thoroughly examined on both surfaces and its free border. The ovary feels like a firm body about as big as the end of the thumb, with a rounded border and convex surfaces, slightly irregular. It is freely movable in all directions.

Examination of the Fallopian Tubes.—These structures in their normal condition are not often easily felt with certainty through the vagina. If they are thickened by disease, the uterine end may be rolled between the fingers like a stout cord and traced outward toward the pelvic walls.

Bimanual Examination by the Rectum and Abdominal Walls.—A retroflexed fundus is felt and outlined with marvellous distinctness when held down upon the rectal finger by the abdominal hand pressing in through the superior strait. The crucial point in this examination is the recognition of the angle between the cervix and fundus, associated with the absence of the fundus in front. The ovaries are felt by making combined pressure in the same direction as in the examination through the vagina. If the ovary is not at once found, the surest guide is the utero-ovarian ligament, recognised as a prominent fold on the posterior surface of the broad ligament just below the cornu uteri; by following this out with the finger for 2 to 2½ centimetres ( $\frac{3}{4}$  to 1 inch) the inner border of the ovary is felt.

**Bimanual Examination by the Rectum and Abdomen after Atmospheric Distention of the Rectum.**—When the ordinary recto-abdominal bimanual examination is impeded by coils of small intestines filling the posterior pelvis and interfering with the fingers in their efforts to search out and palpate the ovaries and tubes, this difficulty may be removed by the following expedient: The rectum and bladder are first evacuated and the patient is put in the knee-chest posture and a speculum introduced into the rectum. This lets in a large amount of air, and the bowel balloons out and applies itself broadly over the sacral hollow and the posterior surfaces of the uterus and left broad ligament, and at the same time the small intestines fall away into the upper abdomen after a minute or two. The patient must then be turned on to her back, taking care to keep the pelvis constantly higher than the rest of the abdomen, so as not to let the intestines gravitate again into the pelvic cavity.

On making the bimanual examination the pelvic viscera are felt with startling distinctness, the rectal finger enters a large air cavity no longer impeded by

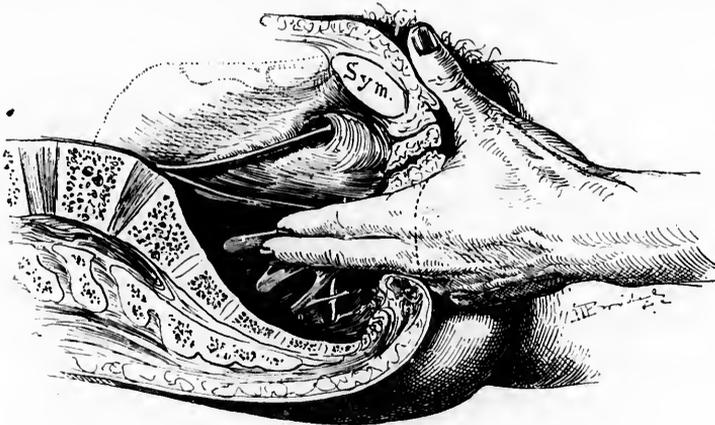

FIG. 68.—PALPATING THE ROOTS OF THE SCIATIC NERVE BY THE RECTUM.

the mucous folds, the opening from the ampulla into the upper bowel is readily found, and the posterior surface of the uterus and the ovaries and tubes feels as if skeletonized in the pelvis. They lie so clearly exposed to touch that their minutest surface peculiarities, fissures and elevations, and variations in consistence can be detected.

The roots of the sciatic nerve may also be palpated by the rectum, as shown in Fig. 68; such an examination will sometimes reveal the source of an obscure intra-pelvic pain which has previously been attributed to an ovarian or a uterine origin. The patient must be conscious, and as the fingers are drawn over the tender cord a cry of pain will be elicited.

c. Bimanual examination in the dorsal position with elevated pelvis; the same with the uterus in artificial retroposition:

If the pelvis of a patient in the dorsal position and with strongly flexed knees and thighs is elevated high above the level of the body on the table the intestines will gravitate upward and the lower abdominal walls fall in toward the pelvic viscera, which are now conveniently disposed for a searching deep bimanual examination through vagina or rectum and abdominal walls. The examiner now stands on one side of the patient and proceeds with the investigation with unusual ease, the curves of the flexed hands naturally following the hollow of the sacrum and the curved pelvic canal.

Not infrequently the posterior surfaces of the uterus, ovaries, tubes, and broad ligaments can not be distinctly palpated by any of these methods, either because the fundus lies too far forward, with the cervix too far back, or because the patient is so stout that the finger can not reach far enough. A satisfactory examination of the surface of the uterus and its adnexa can often be made under these circumstances by forcing the organ back into retroposition and pushing it down on the floor of the pelvis, where it is easily palpated, together with its adnexa, by the vaginal or rectal finger. In order to produce this artificial retrodisplacement it is generally necessary to have the patient under the influence of an anesthetic, so that she will be completely relaxed. The examination proceeds as follows: The abdominal hand is first pressed down behind the symphysis pubis to catch the fundus, while the other hand lifts it through the anterior vaginal wall. The fundus brought within the grasp of the external hand by this means is caught and pushed backward in the direction of the sacral hollow. The backward displacement is finally completed by continuing the pressure on the anterior face of the uterus with the abdominal hand, while the vaginal finger hooked behind the cervix rotates it forward and upward. Each of these three movements forms a step in the backward rotation of the uterus upon its transverse axis through the junction of the cervix with the body.

While the abdominal hand keeps up the pressure and so holds the uterus in its abnormal position, the vaginal finger is withdrawn and inserted in the rectum, up beyond the ampulla, through the sphincter-like orifice between the uterosacral ligaments, where the whole posterior surface of the uterus and the broad ligaments, including ovaries and tubes, can be minutely palpated. The utero-ovarian ligaments stand out as sharply defined folds on either side of the uterus just below its cornua, and form the best guides in locating the ovaries when they are difficult to find.

d. The bimanual examination with the uterus drawn down to the vaginal outlet:

The advantages of this mode of examination is that the uterus is acted upon in three different directions at once. It depends for its success upon the great natural mobility of the organ, which allows it not only to be forced back into retroposition, but tolerates a marked artificial *descensus*. The normal uterus may be displaced without injury downward in the vagina until the cervix ap-

pears at the hymen. In this way we secure the completest possible investigation of the condition of the peritoneal surfaces of the uterus and its adnexa, short of an exploratory celiotomy; and indeed in many cases it is quite as accurate.

Fig. 69. This method of examination is carried out as follows: First introduce the index finger up to the cervix, to act as a guide for the tenaculum



FIG. 69. BIMANUAL EXAMINATION WITH THE UTERUS IN ARTIFICIAL DESCENSUS.

The cervix is caught with the corrugated tenaculum and drawn down to the outlet: then the tenaculum is held against the ball of the thumb while the index finger is inserted into the rectum and used, in conjunction with the abdominal hand, to examine the pelvic organs.

forceps, or Kelly's corrugated tenaculum, which is firmly hooked in the anterior lip just within the canal. Then make traction, displacing the whole uterus downward in the axis of the vagina, until the cervix is at or near the vaginal outlet. An assistant now takes the tenaculum and retains the uterus there, and

the examiner employs the abdominal hand in pushing down on the fundus to steady it, while with the index finger of the other hand he palpates, through the rectum, the whole organ and its displaced adnexa with the greatest ease. If the corrugated tenaculum is used, the necessity of an assistant is dispensed with, for the corrugations afford a sufficient hold to be grasped between the ball of the thumb and the middle and ring fingers, or, exceptionally, between the palmar surface of the ring finger and the dorsal surface of the second joint of the little finger.

This method is of especial service in revealing small myomata on the uterus, from the size of a pea up, or cysts in either ovary, or light adhesions, or smaller degrees of hydrosalpinx. In some pelvic inflammatory conditions such traction is dangerous; it should therefore always be preceded by a preliminary bimanual examination, without displacement, when, if doubt remains, the traction may be begun and continued only under constant observation by the rectum, and any resistance on the part of the tissues should be respected by instant cessation.

One more manipulative procedure still remains for consideration.

The examination of the anterior surface of the uterus through the rectum:

This is done by displacing the uterus as just described, and adding to it a marked retroflexion, secured by hooking the index finger in the rectum over the fundus and gently pulling it down toward the anus. In this way a retroflexion is produced and the anterior wall can be as distinctly palpated as the posterior.

After a displacement examination of any kind it is not sufficient to release the cervix from the tenaculum or forceps in order to restore the parts, but the uterus should be carefully put back into its original situation. To do this, the hand which has been engaged in examining through the rectum is withdrawn and washed, and then introduced into the vagina, when, by pushing on the anterior lip of the cervix, the uterus is restored to its position in the pelvis, and at the same time, if necessary, the fundus is caught by the abdominal hand and drawn into ante flexion. The patient should remain undisturbed from twenty-four to forty-eight hours, or longer, if she continues to experience any discomfort from the examination. But the facility with which the whole manipulation is effected is usually so great that no after-effects are observed by the time the recovery from the anesthesia is complete.

#### EXAMINATION IN PELVIC DISEASE.

The beginner must train himself from the very outset to go through a certain routine in the examination of every case, for it is only in this way that a comprehensive view can be secured; by this routine he will also often discover important minor points which have a direct bearing on major lesions under investigation.

It is the serious fault of some examiners that as soon as they find a lesion

anywhere in the genital tract which may account for some of the symptoms they at once concentrate their entire attention and treatment upon that point, forgetting the fact that the patient may have other lesions as well. This is best illustrated by the numerous cases of lacerated cervix and "ulcers of the mouth of the womb" persistently treated where the serious disease lies in the inflamed Fallopian tubes.

To avoid this superficial treatment the examination begins by noting all the peculiarities of the external genitalia. The orifices of Bartholin's glands must be looked at for the *taches* significant of infection, and the glands themselves should be felt to see if they are enlarged or pus can be squeezed out of the duct. The state of the hymen must be noted—whether intact, dilated, or torn. The urethral orifice, by a puffy reddened condition, often gives evidence of a gonorrhoeal infection, and a little pus can be milked down the urethra by the finger stroking the anterior vaginal wall. By firmer pressure of the outer part of the urethra against the pubic arch, Skene's ducts are emptied of any accumulated pus. Scars at the vaginal outlet and the relaxed condition following childbirth or the use of large instruments are also to be noted, as well as the functional activity of the anterior fibres of the levator ani muscle.

The vagina is noted as short or long, and rugose or smoothed out, and especial note is taken of any cysts in it. The rectum can be palpated through the posterior vaginal wall, feeling like a stringy collapsed tube easily moved from side to side; if it contains any fecal masses this is evident to touch. Anteriorly the base of the bladder, and antero-laterally the ureters, can be felt through the vagina, and if they are inflamed, touch will always elicit complaint. The cervix is the most prominent feature in the vault of the vagina; its direction is important, whether lying in or across the vaginal axis, and its form, whether conical with a small os, or split and everted and containing distended follicles. At the vault of the vagina, in front of, behind, or at the sides of the cervix, hard masses may be felt which will require a careful bimanual examination to determine their identity. The condition of the rectum should be carefully inquired into in every gynecological case, and any symptoms pointing in that direction should be investigated with care. The gynecologist will in this way take particular note of hemorrhoids, fissures, fistula, proctitis, and especially of strictures.

The examination of the urethra, bladder, ureters, and kidneys are described in Chapters XII and XIII.

The bimanual examination by one of the methods described follows next; the position of the uterus is observed, together with its size, surfaces, mobility, and sensitiveness. Finally, the tubes, ovaries, and broad ligaments are palpated.

When such a routine is regularly followed, instead of merely noting one lesion, the observer will often find several, either independent or in conjunction, in the same patient; for example, a deep laceration or a complete tear through the septum at the vaginal outlet is often found associated with extensive scar tissue in the vagina, a lacerated cervix, and a retroflexed uterus; or, on the other hand, the external tear, which is the sign of a difficult forceps labor, is

associated with a pelvic tubal abscess, the sequela of a puerperal infection. One of the most striking complications I have seen was that of a patient with a gonorrhœal urethritis. Pressure on Bartholin's glands squeezed out a little pus and showed she had also Bartholinitis. Pus taken from the vagina contained numerous gonococci; an endocervicitis and an endometritis were also gonorrhœal. When the abdomen was opened, pus oozing from the tubes was found to contain the same organisms, and, lastly, they were found abundantly in pus taken from the peritoneal cavity.

**Pelvimetry.**—Pelvimetry is of the utmost service to scientific gynecology, and should be constantly practiced in all clinics, as the gynecological lesions found are often explainable by the discovery of a deformed pelvis. The various external measurements should be made as described in the obstetrical text-books—viz., the distance between the anterior-superior iliac spines, between the iliac crests, Baudelocque's diameter, and the intertrochanteric diameter.

There are four ways of measuring the true conjugate diameter of the superior strait, which is the most important single measurement: In the first place, it may be estimated, as usual, from the diagonal conjugate through the vagina; this, however, is often impracticable in gynecology, first, either because the vaginal canal is too short and rigid, or because of scar tissue at the vaginal vault, or of masses in the pelvis above the vault which prevent the necessary displacement of the vagina up to the sacral promontory. In the second place, a diagonal conjugate may sometimes be obtained under these circumstances by pressing the finger up through the rectum until it touches the promontory, and so measuring the distance to the under surface of the pubic arch. In the third place, I have found the following procedure, which I call "the external direct method of measuring the true conjugate," to be most generally useful:

The patient lies on the back, with slightly flexed thighs and knees, and the head and chest elevated, so as to relax the abdominal muscles perfectly. The examiner then stands on her right or left side, according as he intends to use his right or his left hand with the palmar surface down. Then with gently increasing pressure he makes deep palpation above the symphysis pubis backward toward the vertebral column, feeling for the promontory of the sacrum with the tips of the fingers, sweeping from the abdominal cavity down into the pelvis, deeper and deeper each time until the characteristic median projection of the promontory is recognized. As soon as the promontory is felt he sweeps the fingers of the open flat hand several times down over it into the pelvis, gaining a distinct impression as to its exact position; then the fingers are allowed to rest vertically above the promontory; in this way the posterior point of the conjugate diameter is fixed. The free hand now determines the anterior point, by pressing the middle finger down behind the symphysis pubis, until the most prominent point on its posterior border is distinctly felt. Directly over this an indentation is made with the finger nail on the outstretched hand, Fig. 70. The hand is then raised from the abdomen, keeping the fingers rigidly in the same position, and the distance from the tip of the finger to the mark made on the palm will be the true conjugate diameter, Fig. 71.

The chief sources of error arise either from measuring directly over the summit of the symphysis or from pressing the finger tips against the promontory instead of over it, thus interposing the thickness of the abdominal wall.

Judgment necessary to tell when the fingers are vertically above the promontory through abdominal walls of varying thickness is the chief factor in



FIG. 70.—FIRST STEP IN THE EXTERNAL DIRECT METHOD OF MEASURING THE CONJUGATA VERA.

The tip of the middle finger of the left hand rests just above the promontory of the sacrum, while the middle finger of the right hand indents the palm at a point just above the inner face of the symphysis. The distance marked off in this way is the true conjugate.

making the measurement. Experience will gradually eliminate grosser errors and bring a sufficient degree of certainty for practical purposes. The more contracted the pelvis the less is the liability to error.

In illustration I will cite the following case (see George W. Dobbin, *Amer. Jour. Obst.*, vol. xxxii, No. 2, 1895): Mrs. H., admitted to the Johns Hopkins Hospital, January 3, 1895, had had two severe instrumental labors within two years, both children dying during labor. Since the second labor she had had no control of loose bowels and there was a constant dribbling of urine.

The examination revealed an extensive dermatitis with edema of the external genitals. The recto-vaginal septum was torn through and the sphincter pits separated 3 centimeters ( $1\frac{1}{4}$  inch), although in spite of this the vaginal outlet was well lifted up. The vagina was smooth throughout; at the vault there was a sharp falciform sear at the junction of the right lateral and anterior vaginal walls. The cervix was stellately lacerated and divided into one posterior and two anterior portions. A sulcus of sear tissue between the two anterior por-



FIG. 71.—SECOND STEP IN THE MEASUREMENT OF THE CONJUGATA VERA.  
Taking the measure marked as described in Fig. 70.

tions ended at a vesico-vaginal fistula 3 millimeters in diameter. The uterus lay in retroposition reclining in the sacral hollow. The tubes and ovaries were normal. On account of the dense unyielding sear tissue in the vaginal vault, it was impossible to measure the oblique conjugate either by the vagina or by the rectum. By the external direct method the true conjugate was found to be only 7 centimeters

(3 inches). The patient had a flat pelvis of high grade, the obstetrical difficulties were fully explained, and the gynecological condition etiologically accounted for.

In the fourth place, the most accurate method of all is the direct measurement of the conjugate from sacral promontory to posterior surface of the symphysis pubis, through the abdominal incision in the course of a celiotomy; this is easily obtained by guiding the tip of a graduated sound to the promontory by the index finger, and then feeling for the posterior surface of the symphysis with the other index finger, and estimating the corresponding point on the sound, which is now taken out and the marking read off.

This is particularly useful in pelvic inflammatory cases where the disease has come from a difficult labor and the abdomen has to be opened to remove it.

#### EXAMINATION UNDER ANESTHESIA.

I feel that I can not emphasize too much the extreme importance of a routine use of ether or chloroform anesthesia to the point of complete relaxation in investigating intrapelvic diseases. Weeks, months, or even years of useless palliative measures will be saved in many cases if the patient is anesthetized and examined before beginning treatment. The purpose of the anesthesia is to do away with all resistance on the part of the patient, relaxing the abdominal muscles completely and preventing the possibility of unexpected resistance when tender points are touched. The examination with the anesthetic can be conducted with a thoroughness which is impossible without it, the uterus can be drawn down, adhesions pulled upon, the perineum deeply invaginated, and inflamed tubes and ovaries handled in a way which is impossible as long as the patient remains conscious.

I may add also that it is a definite advantage to the operator to be able to devote his concentrated attention to the examination and not to be distracted by his anxiety as to how much pain he is giving his patient.

**Rules for the Use of Anesthesia.**—I recommend, therefore, the following rules: Use an anesthetic in all cases

(a) Where doubt exists after an ordinary bimanual examination.

(b) Where a patient comes to the specialist after having had treatment for a long time at other hands without improvement.

(c) In all cases of pelvic peritonitis involving one or both ovaries or tubes, without producing any gross tumor, when the use of the anesthetic is to find out the extent of the disease.

(d) Always in unmarried women.

**Preparation of the Patient for Anesthesia.**—The lower bowel must be emptied by taking a purgative the night before, and if this does not act freely enough, an enema in the morning. The bladder should be emptied by catheter at the last moment. It is best to examine early in the morning and about an hour after a light breakfast, such as a cup of tea and a piece of toast. The early hour has the advantage of relieving the patient from a day of anxious expectation.

After completely anesthetizing her, if it is done in her room, she should be brought across the bed, with her hips projecting a little over the edge and legs and thighs held well flexed by assistants or a leg holder. It must be the aim in the examination to keep her unconscious as short a time as is consistent with a thorough investigation, in order to diminish the after-discomforts with the liability to distressing nausea. Patients who have come into the house from the outdoor department simply for the ether examination usually go home late in the afternoon of the same day, but it is better, as a rule, to keep them quietly in bed for a full day afterward.

Exposure of any part of the body during the examination must be guarded against as much as possible, no matter what the patient's station in life may be, partly on the ground of a proper respect for the sex in general, partly because of the sacred obligation to treat the patient in her helpless condition with that deference which is her due in return for her confidence in putting herself in this way into her physician's hands, and partly because of the inevitable demoralizing effect on nurses, the doctor, and assistants that comes from a careless indifference to the dictates of a proper modesty. While the patient is being examined no persons not directly interested, professionally or otherwise, should be present.

Classes of students must be admitted to the examining room in limited numbers only; in no case should more than three or four students examine the same patient, and the physician who is responsible for her must exercise a constant watchful care to keep any student from examining too long and from using unnecessary force.

The hands must be specially prepared for the examination by a thorough scrubbing with soap and warm water, and by cutting the nails short, so that they will not bruise the skin in making the biannual examination. After each examination the hands must be washed afresh to prevent carrying contamination from one case to another. An examination should never be made with a sore hand. Vaseline is a good lubricant for the vaginal and rectal fingers. When the hymen is intact the examination should be made, as stated in the rules, under an anesthetic; in this condition it is sometimes possible to introduce a small finger into the vagina without making any rupture, but it is better to omit the digital examination by the vagina entirely, and to conduct it wholly through the rectum and abdominal walls. If it is necessary to catch the cervix and draw the uterine down to get at the tubes and ovaries, this may be done by introducing into the vagina the bullet forceps closed, and then, guided by the rectal finger, which feels the cervix distinctly, to open the forceps and grasp the cervix.

A perfectly satisfactory inspection of the vagina, and without injury to the hymen, may be made by using a small cylindrical speculum in the knee-breast position.

**The Examination.**—The various methods of handling the normal pelvic organs and the different avenues of access to them are also used in investigating the diseases of these organs; and the knowledge acquired in gaining a thorough familiarity with the condition and relations of the healthy organs is indispensable

in estimating the presence and extent of disease, for the normal condition is the only standard of comparison. Owing to a want of familiarity with the normal structures, operators have frequently made the frightful mistake of removing sound organs.

Almost all morbid changes advanced enough to call for operative interfer-

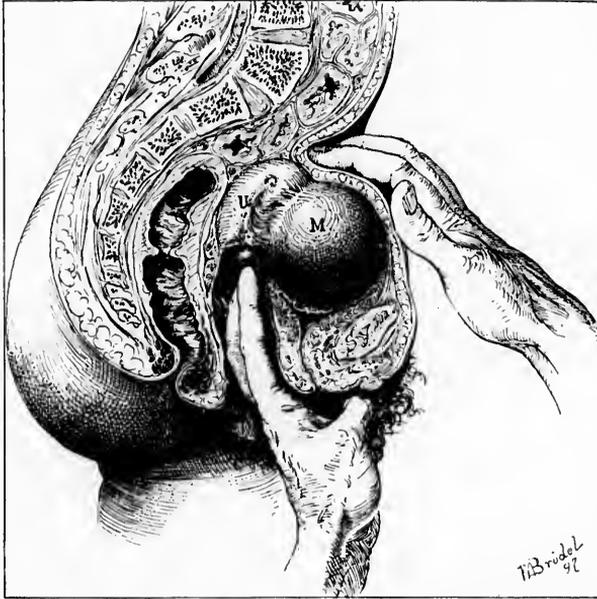

FIG. 72.—DIFFERENTIATION BETWEEN A MYOMA IN THE ANTERIOR UTERINE WALL AND AN ENLARGED UTERUS IN ANTEFLEXION.

By a bimanual examination, while the vaginal fingers, resting upon the cervix, hold the mass up, the abdominal fingers are able to discover the little sulcus between the fundus and the tumor, and to appreciate the slight but distinct mobility of the myoma as separate from the fundus. *Il. op.*, Oct. 24, '96.

ence produce alterations of the normal structures which can be recognized by an investigation which considers the following points:

- (a) Displacements affecting position.
- (b) Fixation and adhesions affecting mobility.
- (c) Inflammation and tumors affecting size and form.
- (d) Any abnormal sensitiveness.
- (e) Peculiarities of consistence.
- (f) Information derived from curettage of the uterus.
- (g) The microscopic examination of a piece of tissue excised.
- (h) The microscopic and bacteriological examination of uterine, vaginal, and other discharges.

The skilled examiner never makes his diagnosis by taking these questions up and applying them one after another, seriatim, to a case in hand; he proceeds, on the contrary, to make the investigation with a trained touch which at once recognizes any abnormalities, and instinctively selects the essential points for

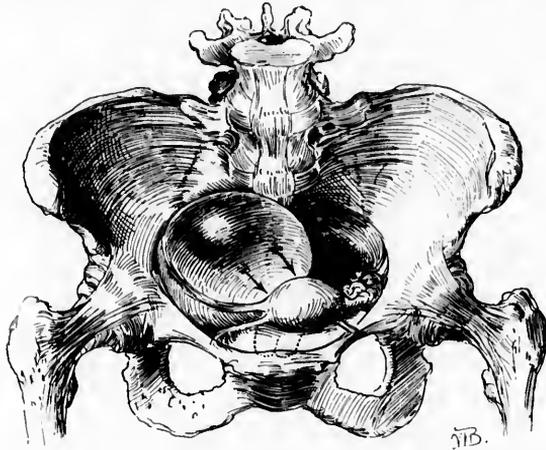

FIG. 78.—SHOWING THE LEFT LATERAL DISPLACEMENT OF THE UTERUS, WHICH IS PUSHED TO THE OPPOSITE SIDE, IN THE DIRECTION OF THE ARROWS, BY AN OVARIAN CYST ON THE RIGHT.

more special attention. Such a plan is not without the risk of occasionally overlooking some point of importance, particularly if the examination is a hurried one.

The beginner will always find it better to take the questions up and apply them categorically, at least until the routine becomes so fixed in his mind that its application is afterward more or less instinctive. This, too, is the only satisfactory plan for a text-book.

(a) **Displacements affecting the Position of the Pelvic Organs.**—**Descensus.**—The index finger carried up the vagina notes whether the cervix is well back in the pelvis or lies low down on the pelvic floor in the axis of the vagina, indicating a descent of the uterus.

**Anteflexion.**—A little sudden pressure against the anterior vaginal wall will often encounter a resisting body, which at once recedes by using the other hand to make counter-pressure through the lower abdominal wall; if the recession is prevented and the body, palpated carefully, is found to be movable, ovoid in form, and by carrying the bimanual palpation a little farther back, organically connected with the vaginal cervix, the uterus is in normal anteflexion. When the cervix lies in the axis of the vagina, and the body of the womb lies against the anterior vaginal wall parallel to it, the angle between the two is very acute and a pathological anteflexion exists. Fig. 72.

**Retropositions.**—The two forms of retroposition are retroversion and retroflexion, and a diagnosis is made by demonstrating bimanually (1) the ab-

sence of the fundus from its normal position in the front part of the pelvis, and (2) its presence somewhere in the back part of the pelvis, behind the cervix, by feeling it there with the vaginal finger as a round, resisting mass, and tracing its direct connection with the cervix. If the bridge of tissue joining the vaginal cervix to the body supposed to be the fundus can not be satisfactorily palpated, it will be felt more clearly if the cervix is caught with a tenaculum forceps and pulled down. The bimanual palpation sometimes shows that the fundus lies to the right or left in lateral flexion; this is due to adhesions drawing it in the direction of the flexion, or to a tumor filling the opposite side and pushing it over; or again to a large ovarian tumor of the side to which the uterus inclines, which pulls on the broad ligament as the tumor escapes into the abdomen. Figs. 73 and 74.

**Ascensus Uteri.**—In ascension the cervix is lifted up above its normal position in the pelvis, and in an extreme form the whole womb may be displaced out of the pelvis into the abdomen. This may happen in the case of a broad-ligament tumor, or of an ovarian tumor adherent to its posterior surface and drawing it into the abdomen.

(b) **Fixation and Adhesions affecting Mobility.**—If the uterus is found fixed in a certain position, and does not move easily upward in making slight pres-

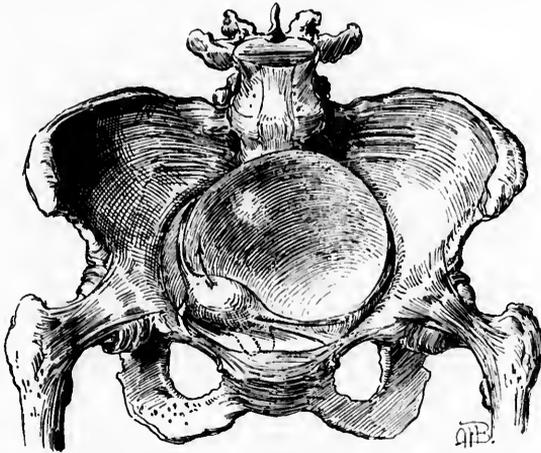

FIG. 74.—SHOWING THE DISPLACEMENT OF THE UTERUS TOWARD THE SIDE FROM WHICH THE TUMOR GROWS, DUE TO THE ENLARGEMENT OF THE CYST WHICH NOW FILLS THE PELVIS AND, BY TRACTION ON ITS PEDICLE, DRAWS THE UTERUS IN THE OPPOSITE DIRECTION.

sure on the cervix, its condition is abnormal, and the cause must be sought for. I know of but one apparent exception to this rule, and that is where the uterus responds but slightly to pressure on account of a stout tense abdomen and increased intra-abdominal pressure. When the cervix is occupied by a cancer which has extended out into one or both broad ligaments the whole organ feels

as if held in a vise by the hard masses extending out to the pelvic walls. Adhesions of the posterior uterine surface to the pelvic floor restrict its mobility, forming an adherent retroflexed uterus. This is tested by pulling down the cervix and trying to raise the fundus, when the adhesions are put on the stretch and felt. I would caution the beginner here not to conclude that a retroflexed fundus is adherent because he can not push it up through the vagina. The normal mobility is also greatly restricted in almost all cases of inflammation of the tubes and the pelvic peritoneum, which result in masses behind the broad ligaments. Ovarian and tubal adhesions are best felt bimanually with one or two fingers in the rectum. The adhesions, whether light and velamentous, like a web, or short and firm, binding the ovary to the posterior surface of the broad ligament, are easily felt upon attempting to handle the ovary in order to examine both its surfaces, as described in the examination of the normal ovary. An adherent tube is almost always involved with the ovary in pelvic inflammatory disease, and is also usually enlarged.

(c) **Inflammation and Tumors affecting Size and Form.**—Only the trained fingers familiar with the normal organs will recognize at once all deviations in size. Both the enlarged infiltrated and the cancerous cervix are characteristically different from the normal, and lacerated everted cervical lips can be recognized at once.

The trained clinician, knowing how large the normal nulliparous uterus ought to be, and what is the size of the average parous uterus, will have little difficulty in deciding whether the uterus of a young woman is undersized—that is, puerile or infantile; or in the case of a woman of advanced years, whether it is senile. The large body of a subinvolted uterus differs as much from the normal to the touch as a hydrocephalic head does from a sound fetal head.

The myomatous uterus, from the small nodules just projecting from the serous surface, often not as big as a pea, all the way to the vast masses filling the abdomen, presents unmistakable characteristics in the enlargements and irregular bizarre shapes assumed. Often the only suggestion of a cancer of the body of the uterus found at a first examination is the increased size and the globular form of the uterine body. In pregnancy we trace a uniform development in the size of the uterine body from the fourth week on to the end. The most sensitive touch will be the quickest to appreciate this change at its earliest stage, from the fourth to the sixth week.

The Fallopian tubes are changed in size and form by all inflammatory diseases, more particularly in those in which the outer extremities are occluded and the secretions retained, called *sactosalpinx*. With the thickening of its coats and the distention of its lumen the tube becomes harder and larger, and so is the more easily palpated. The inflamed tube assumes a sausage shape with two or three convolutions.

Alterations in the size and form of the ovaries may affect a part or the whole of the organ. A little hard mass projecting from its surface is most likely a *corpus fibrosum*; a nodular swelling projecting from one part of the periphery and not more than 2 or 3 centimeters ( $\frac{3}{4}$  to  $1\frac{1}{4}$  inch) in diam-

ter is a cystic Graafian follicle, or the last menstrual *corpus nigrum*. A larger cystic tumor with a smooth surface, from 4 to 6 or even 10 centimeters (1½ to 2½ or 5 inches) in diameter, is a Graafian cyst, or a cystic *corpus luteum*. Small dermoid cysts may also present similar characteristics. An ovarian abscess is usually distinguished by the dense surrounding adhesions, but a suppurating dermoid will also present these signs. The larger ovarian tumors are usually associated with a complete disappearance of the ovary and its replacement by a smooth or irregular mass, according as there is one or a number of cysts.

(d). **Peculiarities of Sensitiveness.**—Normally the pelvic organs are not at all sensitive to the ordinary bimanual manipulation. The ovaries alone are painful if a decided pressure is made upon them. Frequently, however, patients come for examination in whom the only discoverable difficulty is an abdominal sensitiveness, and the most painstaking investigation fails to show any other trouble. This hyperesthesia is often confined to one ovary, generally the left, which the patient can not bear to have touched; in other cases both ovaries are sensitive, and there may be a perfectly normal uterus, so tender that not even the lightest pressure can be borne. In extreme cases the whole pelvic and even lower abdominal peritoneum shows the same sensitiveness. I know of no cause for this; it is often associated with other disturbances which are presumably circulatory. It is important that every practitioner should recognize this ailment, so as to avoid the common mistake of estimating the amount of disease present by the tenderness complained of as soon as pressure is made on the pelvic viscera. Ovaries and tubes have been removed repeatedly where the only demonstrable difficulty was a persistent sense of discomfort and sensitiveness to pressure, only to discover that the mutilation has not in the least relieved the difficulty.

Pelvic sensitiveness is also peculiarly the mark of the hysterical patient whose attention has become fixed on these organs. All inflammatory affections are characterized not only by pain during the exacerbations, but by a persistent sensitiveness of the inflamed structures, which makes it difficult to handle and outline them. Under such circumstances it is necessary to put the patient under anesthesia to make a thorough investigation.

(e) **Peculiarities of Consistence.**—In addition to peculiarities in position, in mobility, in form, and in size, the pelvic organs in disease also exhibit marked peculiarities in consistence. Each organ has its own individual standard, differing from every other organ in this respect. For example, the consistence of the cervix is one thing, that of the uterus and ovary another. The most striking example is the change in the vaginal portion of the cervix in pregnancy from a firm, hard, resistant tissue to a soft and even flabby condition. The cheesy friability of a cancerous cervix also differs from any other state. There is a putty-like condition of the subinvolved uterus, which indents on pressure, and which ought to be a warning against the use of the sound. I have seen the sound go through the uterine wall in these cases with as much ease as if it were a piece of blotting paper. Again, the soft semifluctuation of the pregnant uterus from the third to the fifth months is different from the hard fibroid uterus. Occa-

sionally a vascular fibroid will simulate pregnancy. In diseases of the tubes and ovaries there is no more important distinction to be made than the changes in consistence. In infected cases a dense hardness, which replaces the soft pliability of the pelvic floor, is characteristic, and is only imitated by adherent cancerous ovaries. The consistence of the enlarged Graafian follicle is also characteristic in the paper-like thinness of its shell, which is easily recognized by the finger. I have twice recognized a rupture in an ovarian cyst made up of a mass of little cysts by putting the finger through the hole which happened to be on the pelvic floor and feeling the little cysts within. The consistence of an abdominal ascites, and of a parovarian cyst or a multilocular ovarian cyst, differs in each case, and is often the most characteristic diagnostic feature.

(f) **Information Derived from Curettage of the Uterus.**—By curettage of the uterus and a microscopic examination of the scrapings we determine the difference between glandular hyperplasia, endometritis, carcinoma, sarcoma, the remains of an abortion, and tuberculosis of the endometrium (for details, see Chapter XIV).

(g) **The Tissues.**—In the same way, by making a microscopic examination of a piece of tissue excised from the cervix, a differential diagnosis is established between inflammatory conditions and carcinoma (see Chapter XVI).

(h) **Secretions.**—The examination of the secretions, commonly called leucorrhœal, from the uterus, cervix, vagina, and vulva, often gives important information, and either throws light upon the cause of an existing disease or shows the presence of elements in these secretions liable under favorable conditions to endanger health and life. The purpose of this examination is to discover the presence of one or other of the commoner pyogenic organisms—the streptococcus, the staphylococcus, the gonococcus, and perhaps the tubercle bacillus and the colon bacillus. The examination includes observations as to the presence of any secretion, its location, quantity, appearance, consistence, chemical reaction, bacteriological character, and any local reaction.

For accuracy of investigation, the following regions should be examined :

The ducts of Bartholin's glands.

The vulvar commissure.

The urethral orifice and Skene's glands.

The lower vagina.

The vaginal vault.

The cervical canal.

The uterine body.

The normal secretions which contain numerous micro-organisms but none of the pyogenic bacteria form the standard of comparison. No bacteria of any kind are found in the cavity of the uterus.

In young women and in those not infected the secretions within the vulva and at the vaginal outlet are those which have escaped from the vagina above. The natural appearance of the secretion is scanty, milky-white; it consists of desquamated vaginal epithelial cells, with mucus and a few leucocytes, and its

chemical reaction is acid. The normal cervical secretion is a clear tenacious mucus. The secretion from Bartholin's glands is small in quantity and thin and clear. There is no secretion about the urethra.

In disease there is an entire change in the character of these secretions, which become abundant, and change to a mucopurulent character. By squeezing Bartholin's ducts a drop or two of pus is made to exude at the orifice, and on separating the labia the discharge may be taken up from the commissure. To get secretion from the vaginal vault and the cervix without contamination, the patient may be put in the knee-breast position and a small cylindrical speculum inserted, which admits air and does not touch the upper part of the vagina. In the infected cases the cervix is often puffy, and its everted mucosa weeps an abundant stringy mucopurulent discharge from its surface. The most striking example of the utility of the examination of these secretions is that of the puerperal infections, where the exact nature of the infection may be determined. The probable nature of a pelvic abscess may be traced to a gonorrhœal infection, if the gonococcus is found to be a resident in the lower genital tract. The commonest points in which a latent gonorrhœa may lurk are the cervix uteri, the ducts of Bartholin's glands, and Skene's glands.

The technique of the examination for these bacteria and the methods of cultivating them are described in Chapter III.

#### EXAMINATION OF THE RECTUM.

The close relationship between the rectum and the other pelvic organs involves both in many common affections, liable to affect any portion of the bowel, from anal orifice to the brim of the pelvis. The commonest of these diseases may be arranged under three heads: (a) Fistule and rupture of the recto-vaginal septum; (b) the extension of a malignant growth from one organ to the other; (c) compression of the bowel either by increase in volume of uterus or ovaries, or by inflammatory products which constrict its lumen.

Examination of the rectum is also frequently called for on account of the liability of the patient to refer disorders of the bowel to the uterus and its adnexa. In this way a fissure of the rectum may be overlooked and a long and useless course of treatment undertaken to relieve a pain from a source felt higher up in the pelvis; the congestion of hemorrhoids often produces a sense of weight and bearing down in the pelvis, easily mistaken for the symptoms of prolapse of the uterus.

For all these reasons it is important to make some statement about the condition of the rectum in every gynecological record. Sometimes it is well to make the examination without special preparation for it on the part of the patient, when the physician may better judge of the habitual state of the bowel. For a thorough examination the lower bowel must be completely emptied. Anesthesia is not necessary as a rule. There are two methods of examining—(a) by palpation, and (b) by inspection.

**Palpation.**—The finger introduced into the vagina easily feels the lower part of the rectum from the cervix down through the posterior vaginal wall, and by pressing upon it and rolling it from side to side, its size, mobility, and sensitiveness may be estimated. The normal rectal tube feels like a flat band with longitudinal striae, which, under pressure, slips freely from side to side and without pain. Any fecal accumulation presses forward into the vagina and gives the bowel a more cylindrical form. The presence of feces can be recognized by indenting the putty-like mass with the fingers.

The upper part of the rectum behind the cervix is often markedly sensitive, and becomes more so when it is distended. This must never be forgotten when a sensitive spot is found behind the cervix. I have seen an erroneous diagnosis made of tumor behind the uterus and "inflamed ovary" when there was really nothing the matter. A loaded upper rectum crowds out behind both broad ligaments, filling the pelvis with fecal masses readily confused with ovarian and

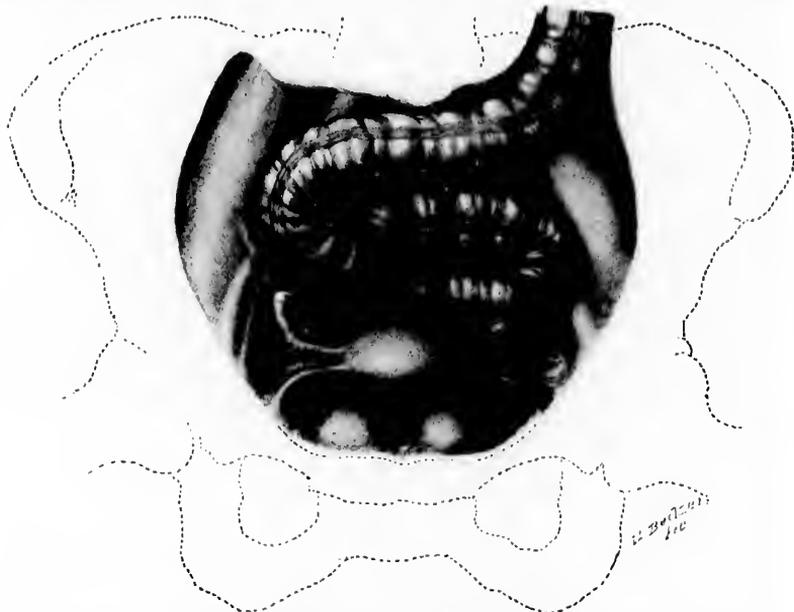

FIG. 75.—DEVIATION OF THE SIGMOID FLEXURE.

The bowel crosses the promontory of the sacrum on the right side, and then returns to the left pelvic brim and drops into the pelvis just behind the uterus.

tubal tumors. In a more moderate distention the mass may lie on the pelvic floor behind the left broad ligament. By palpation a distended upper rectum and sigmoid flexure can be easily mapped out through the abdominal wall, if it is not too thick and rigid. The differential diagnosis between these fecal tumors

and true pelvic tumors is so important that I present several diagrams, tracings from actual cases taken out of a large number which have come under my observation. (Figs. 75, 76, 77, and 78.)

In order to make the examination, the patient lies on her back in a position of relaxation, with her shoulders slightly raised and knees drawn up. The examiner then stands on her left side, and gradually makes deeper and deeper



FIG. 76.—DEVIATION OF THE SIGMOID FLEXURE.

The bowel skirts the anterior pelvic brim from left to right, and drops down into the pelvis on the right side.

pressure through the lower abdominal wall in the left semilunar line, until he reaches the pelvic brim, without giving any discomfort to the patient to cause her to resist. By gently drawing the fingers forward along the superior strait, the empty sigmoid is felt slipping beneath them like a large, flat cord. If it is distended it becomes still more distinct. In marked distention the bowel follows in general one of three directions: In the first, the bowel describes a sigmoid curve behind both broad ligaments, Fig. 75; second, it curves out into the anterior part of the pelvis over the bladder and then back to the sacrum, Fig. 76; third, the distention is upward into the abdomen and then down into the pelvis from the right side, Fig. 77; and, fourth, the bowel passes in front of the bladder almost to the region of the right round ligament, where it is bent on itself; when it reaches the promontory of the sacrum it makes a plunge down into the pelvis. Fig. 78.

These fecal tumors are diagnosed bimanually by being continuous with a fecal mass behind the vagina or behind the uterus low down, about the nature of which there is no doubt. They occupy peculiar positions in the upper pelvis, and are elongate, and markedly movable on account of a long meso-sigmoid;

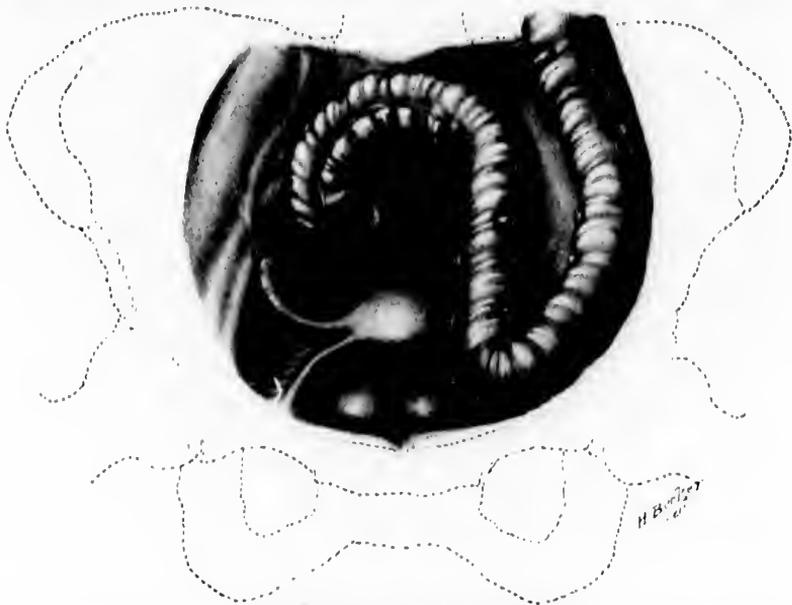

FIG. 77.—DEVIATION OF THE SIGMOID FLEXURE.

The bowel extends down to Poupart's ligament on the left side, and then skirts the left pelvic brim and drops into the pelvis on the right side.

they are often made up of a number of scybalous nodules. The customary sensitiveness must not be overlooked. Any doubt remaining after such an examination can be cleared up by a purgative or enema, and by an inspection with a sigmoidoscope.

A digital examination of the anus shows the existence of abnormalities, and when the finger is carried up into the ampulla and the rectum immediately above that it demonstrates the presence of any marked changes, more especially constriction by inflammatory masses; when the finger passes between the utero-sacral ligaments it seems to be entering a long, rigid tube with smooth walls. Amid the redundant folds of the ampulla it is sometimes hard to find the entrance into the bowel above. The proper point is best located by taking the cervix as a guide and seeking the opening right behind it.

**Inspection.**—Under inspection the whole mucous surface of the lower bowel is exposed to view, from its external orifice up to the sigmoid flexure and colon,

and any alterations in color or unevenness of surface and deposits, together with changes in caliber and points of fixation, are at once evident, Fig. 79. To make the best possible examination in this way, the bowel must be emptied of feces and the patient placed in the knee-chest posture; the thighs should be vertical, the back well curved in, and the chest as close as possible to the table; the patient should wear no corsets or any constricting garments on the upper abdomen. A cylindrical speculum of suitable length and caliber is now introduced and the bowel examined by a light reflected from a head mirror.

The following specula are useful: A short and a long proctoscope, a sigmoidoscope, and a sphincteroscope.

The cylinder of the short proctoscope is 14 centimeters ( $5\frac{1}{2}$  inches) long and 22 millimeters in diameter; the long proctoscope is 20 centimeters (8 inches) long and 22 millimeters in diameter; and the sigmoidoscope is 35 centimeters (14 inches) long and 22 millimeters in diameter. At the outer end of the cylin-

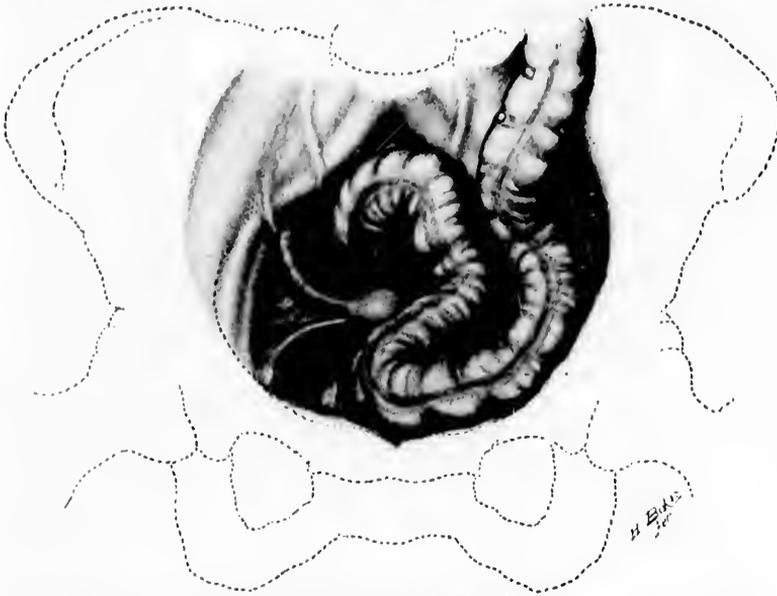

FIG. 78.—DEVIATION OF THE SIGMOID FLEXURE.

The bowel forms a sharp angle just behind the symphysis pubis, and then crosses the left broad ligament to the promontory of the sacrum and descends into the pelvis in the median line.

drial tube is a funnel-shaped rita to which the stout handle, big enough to be grasped in the whole fist, is attached. Each speculum has an obturator, blunt at the end and provided with a strong stem and handle.

The sphincteroscope is short and slightly conical, the diameter at the lower end of the tube being 2.5 centimeters (1 inch) and at the upper 3 centimeters

( $1\frac{1}{8}$  inch), while the outer rim of the funnel-shaped flange is 5 centimeters (2 inches) in diameter. The strong handle is set on this. The obturator is like that in the other specula.

To make the examination, the speculum is coated with vaseline and the buttocks are drawn apart, exposing the anus. The round end of the obturator is laid upon the orifice, and, grasping the speculum in the fist so that the palm



FIG. 79.—PATIENT SUPPORTED BY UPRIGHTS AND STRAPS IN POSITION FOR A RECTAL EXAMINATION.

The instruments—conical sphincter dilator, proctoscope, sigmoidoscope, applicator with cotton pledget—are reduced in proportion to the size of the patient.

keeps pushing the obturator in, it is carried into the bowel in a direction at first downward and forward, and then upward toward the sacral hollow. Sometimes the end catches in the groove between external and internal sphincters; if this happens, it must be withdrawn and pushed in again in a slightly different direc-

tion. As soon as it has fairly entered, the obturator is pulled out and the air rushes audibly in, widely distending the bowel. The examination is now made by reflecting the rays of light from an electric droplight, or a lamp, or good daylight, by a head mirror, down the tube into the bowel, which is so well illuminated that the smallest points on its surface become visible, Fig. 80. It is possible to detect differences not larger than the pores on the palm of the hand. It will often be found that the speculum is turned too much downward, and that it is necessary to drop the handle to bring an extensive area of bowel into view. By turning the tube a little from side to side the whole dilated ampulla

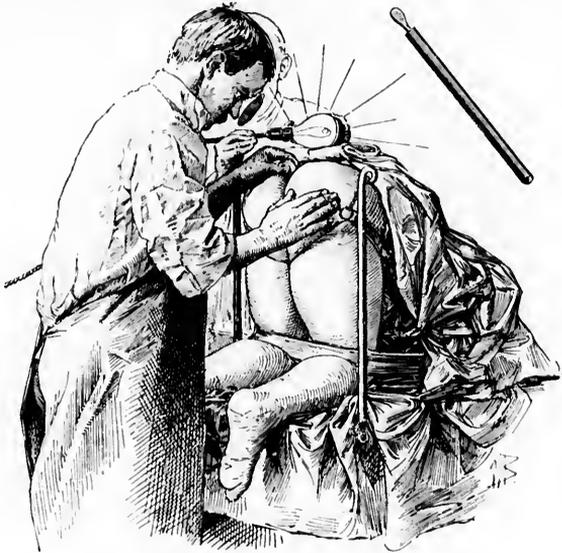

FIG. 80.—EXAMINATION OF THE RECTUM BY REFLECTED LIGHT.

The instrument seen above to the right, drawn on the same scale of reduction as the body, is introduced to its full length. The electric light, held by an assistant close to the sacrum, is reflected down the tube by a head-mirror. This picture is drawn from a photograph.

is inspected in a few moments. The ground color of this and other parts of the bowel is a pale red with large vessels like veins dividing up the surface at wide intervals. The normal bowel is never intensely red and injected in this posture, neither does it have a lazy appearance.

After studying the ampulla, upon looking up the lumen of the bowel a series of half valves are seen cutting into its lumen on the right and on the left. The tube passes easily through each of these, displacing first one and then another, without perceptible resistance, exposing to view successive lengths of the bowel hugging the sacral hollow. The promontory often appears characteristically projecting as a rounded smooth eminence on the upper surface; its bony nature is evident on touching it with the end of the speculum.

The bowel distends so widely in this position that any fecal masses lie loose in the lumen, and the speculum may often be carried beyond without removing them and without their choking its lumen. Sometimes, on introducing the speculum, the bowel will be found in the act of gradually opening up, expanding fold by fold. The dilatation ceases in some part of the sigmoid flexure, where the mucous surfaces suddenly come together, but a little pushing with the end of the speculum, or by observing the mucous folds as they part in the escape of flatus, the lumen is found, and the speculum can be pushed still farther up, although the view is no longer so perfect as in the lower atmospherically distended bowel.

To continue the inspection beyond the rectum on up into the sigmoid flexure, the longer reach of the sigmoidoscope is necessary. The direction of the instrument is no longer confined to the median line, but by degrees turns more and more to the patient's left. I have introduced this speculum as far as 30 centimeters (12 inches) beyond the anus.

The purpose of the inspection is to note all alterations from the normal appearance of the bowel, such as patches of congestion, mucus lying on the surface, ulceration, and polyps. Strictures are found most commonly, in connection with pelvic tumors, when there is a sudden narrowing of the lumen, beyond which the speculum can not pass, and the bowel seems rigidly fixed.

Pelvic peritonitis, especially that form due to abscesses in the ovaries and tubes, is particularly liable to produce stricture of the rectum at any point from the brim of the pelvis down to the ampulla. In one of my cases the rectum was choked by a large tubal abscess on the right side; above the constriction, which extended from the ampulla to the upper part of the pelvis, the bowel was greatly distended and there was an opening between the sac and the rectum. In another case, in which dense inflammatory masses with abscesses on both sides were taken out together with the uterus, a tight stricture of the bowel was found just below the promontory of the sacrum. This was about 4 centimeters ( $1\frac{1}{2}$  inch) long, and not more than  $1\frac{1}{2}$  centimeter ( $\frac{1}{2}$  inch) in diameter, measured on the outside.

A fistulous orifice seen foreshortened in the side of the bowel is easily passed over, and must be carefully sought for by pressing so as to flatten the mucosa out on the end of the speculum.

The sphincteroscope is used by pushing it into the ampulla, withdrawing the obturator, and then drawing the speculum out a little until the inner sphincter circle begins to close over it, and then pushing it back in. In doing this it does not re-enter the portion of the bowel just left, but simply spreads the area within view over the end, giving a flat field for inspection. In this way, step by step, the whole sphincter area is exposed, and any abnormalities easily detected. For children and nervous patients who are difficult to examine, a speculum 12 centimeters (5 inches) long and only 18 to 20 millimeters in diameter is most useful.

## EXAMINATION OF THE VERMIFORM APPENDIX.

The gynecologist must be familiar with the position and methods of palpating the normal and diseased vermiform appendix, in order not to confuse its affections with those of the right tube and ovary near by. We owe the discovery of this valuable means of diagnosis to Dr. George M. Edebohls, of New York (see *New York Jour. of Gyn. and Obst.*, Feb., 1894, and *Amer. Jour. of the Med. Sci.*, May, 1894).

Under ordinary circumstances the normal vermiform appendix can be felt through the abdominal wall against its underlying iliac muscle as a short distinct cord, moderately or not at all sensitive, extending from its base at a point in a line between the umbilicus and the right anterior-superior iliac spine, downward and inward to the pelvic brim. To find it the patient lies with the abdomen bare and knees and thighs flexed without effort, and the examiner, standing at the patient's right side, makes pressure inward in the right semilunar line just below McBurney's point. He increases the pressure gradually until the posterior abdominal wall is reached. This may be felt, if desired, to make certain of the position.

The fingers, keeping up the pressure, then glide in a direction downward and outward toward Poupart's ligament, until a delicate, cord-like structure is felt to slip beneath them. The maneuver is then repeated a little higher up, and then a little lower down, changing the position until the length and direction of the appendix are ascertained. The upper end disappears at McBurney's point, and the lower end at the brim of the pelvis as a rule. A loop of intestine or muscular fibers in the abdominal wall may be mistaken for the appendix, but any overlying small intestine may be disposed of by placing the patient for a few minutes in the knee-breast posture, and by careful attention the more superficial position of the muscular strands will be recognized. A diseased appendix is often still more easily recognized from its extreme sensitiveness and its increase in size, making it feel like a big hard cord, more or less fixed.

If there is an inflammatory exudate about the appendix the organ can not as a rule be felt, but the position and distribution of the mass are both characteristic of appendical as contrasted with tubal and ovarian inflammatory disease.

An exception to the general principles here laid down are those cases in which the inflamed end of the appendix lies in the pelvis involved with the right tube and ovary.

## INVESTIGATION OF THE GENERAL CONDITION OF THE PATIENT.

Upon completing the gynecological examination, the specialist must turn his attention to the condition of all the other vital organs in the body, associating the results with the facts elicited by the examination of the pelvic organs; he is then in a position to estimate the relative importance of any gynecological ailment.

This examination is valuable in several ways: It often happens that the pel-

vie disease is but a part of a general morbid condition, or is dependent upon disease elsewhere for its continuance; this is the case when pulmonary phthisis is associated with the tubercular tubes and ovaries, and tubercular peritonitis, or when a disposition to uterine hemorrhage is but one of the manipulations of a crippled heart or a cirrhotic liver. On the other hand, a pyonephrosis may be due primarily to a pelvic abscess blocking the ureter and furnishing the source of infection.

It often happens, too, that there may be some grave organic disease of one of the other organs which is simply an accidental complication, but nevertheless forbids the performance of any serious gynecological operation.

The inquiry will be commenced by asking about any strong family tendency to hereditary diseases which may bear an etiological relation to any local affection, or so complicate the local conditions that they must be taken into consideration in the prognosis and treatment. The risks attending a plastic operation upon the cervix or vagina, for example, are of no moment in properly selected cases, but they may be followed by disastrous results if certain constitutional diseases, such as advanced nephritis, tuberculosis of the lungs, diabetes, etc., are overlooked.

The main points of the general gynecological examination are age, heredity, temperament, habit, color, and the following diseases: tuberculosis, pneumonia, pleurisy, hydrothorax, heart disease, affections of the alimentary tract, diseases of the liver, spleen, and kidneys.

**Age.**—Other conditions being equal, women between the ages of twenty and forty withstand the effects of operation best. But, with Dr. Mary Sherwood, I have collected recently statistics in 100 cases which show that ovariectomy in women between the ages of seventy and eighty-two is attended with a mortality only slightly greater than in women of younger years (*Johns Hopkins Hospital Reports. Gynecological Fasciculus, No. II, p. 509*); in 115 cases in the hands of 66 operators, only 12 per cent died. (See Chapter XXI.)

Between twenty and forty women are in the prime of life, and resist the effects of shock, hemorrhage, and infection better than those whose vital forces are impaired by advancing years. In the aged the minor gynecological ailments, such as retroflexion, lacerated cervix, relaxed outlet, and often even the marked forms of prolapse of the uterus, should not be treated by operation unless the patient experiences serious discomfort. The old are much more easily depressed by the loss of blood, and recover more slowly from shock. Convalescence is longer with the aged, because the recuperative powers are feebler. Carcinoma of the uterus in its early stage and diseases of the appendages, which, if not interfered with, will destroy health or terminate life, should be submitted to operation regardless of age, if this is the only contra-indication.

**Heredity.**—The hereditary predisposition to certain diseases must be carefully inquired into, because any marked family tendency may have an important bearing on the etiology. When there is a hereditary tendency to insanity, especially in patients inclined to be morbid or melancholy, any operation is attended with risk of precipitating an attack of insanity, as a post-operative

complication. In neurotic families the results of surgical work are always less satisfactory. A family tendency to excessive menstrual flow may account for what would in other cases be significant of disease. A strong tendency to cancer in the family will arouse suspicion as to cervical erosions or persisting uterine hemorrhages.

A family tendency to tuberculosis of the lungs in a patient who has the general appearance of being tubercular, without signs of the disease, must put the operator on his guard, as the convalescence is apt to be slow, and the patient is often a long time in acquiring any vigorous health.

**Temperament.**—The temperament of the patient exercises more or less influence on the results of operation, and it is a good thing for the surgeon to study the character and disposition of his patient beforehand. Bright, cheerful women approach an operation with more composure and recover from its effects more rapidly than the despondent. A buoyant disposition is especially helpful in shortening the convalescence.

Hysteria and various neurotic ailments often accompany pelvic diseases in women, and the effects of their presence must be noted and weighed well before operation. On the other hand, certain classes of nervous patients need a strong mental impression made upon them, and are greatly benefited by even trivial operations. In hysterical women the convalescence is often marked by nerve storms which are difficult to control.

I have seen patients so discouraged by the naturally depressing effects of the disease, superadded to a despondent temperament, that they refuse to acknowledge they were any better after complete relief of their ailment.

**Bodily Habit.**—The better the general health of the patient, the better able is she to withstand the effects of operation. It is, however, a constant matter of surprise to note the rapid recovery of comparatively feeble and delicate women from the effects of a severe operation. A robust appearance is not always the best indication that the convalescence will be short. The imponderable factor of vitality has everything to do with it.

**Color.**—Contrary to the common dictum, I find the negress less demonstrative after operation than white women. She frequently approaches the operation with greater fear, but her naturally buoyant, forgetful nature gains the ascendancy soon afterward, and she makes a rapid recovery. The mulatto, on account of her mixed strain, may show the same characteristics as the negress, or she may partake of the higher nervous development of the white race.

In making an examination it is helpful to know of any special racial tendencies. I find that out of 100 operations for pelvic diseases in colored women, 32 per cent were for myomata; 50 cases were of pelvic inflammatory disease; there were 3 cases of extra-uterine pregnancy, and 1 ovarian cystoma; there were also 3 dermoid cysts, 1 papilloma, and 1 sarcoma. The marked preponderance of the fibroid tumors and inflammatory diseases and the conspicuous absence of the glandular ovarian cystomata are striking features in the *résumé* of cases.

After such a general consideration of the status of the patient following the

pelvic examination, all the important organs of the body should be examined seriatim. It is often most convenient to proceed directly from the pelvic examination to that of the abdominal viscera. When the history points to some chest complications the heart and lungs will naturally be examined first.

**Lung Diseases.**—Tuberculosis of the lungs must be sought for and its extent carefully noted. Even a pneumonia might be overlooked without making a routine examination and the dyspnea present attributed to the pressure of a large tumor. Pleurisy and effusions in the chest are by no means rare complications. Bronchitis is often made worse by the administration of an anesthetic, and may even cause death.

Emphysema and asthma should also be considered, as the embarrassed breathing, coughing, and deficient oxygenation render both operation and after-treatment difficult.

**Heart Disease and Arterio-sclerosis.**—In valvular diseases of the heart, the question to be decided in operative cases is whether the compensation will be sufficient to stand the strain upon it. So long as the function of the heart is well maintained, as indicated by the general health, minor degrees of valvular disease are of no particular moment. Failure in compensation, as shown by the impaired circulation in the extremities, difficulty in breathing on exertion, and attacks of dyspnea, must be carefully noted. I lost one case in this way; the patient was extremely cyanosed and suffered from a great dyspnea throughout the operation, from which she never recovered.

In all cases of painful menstruation and menorrhagia the heart must be carefully examined, as these disabilities may be associated with valvular diseases and venous stasis. One of the most important and serious affections is disease of the coronary arteries, liable to cause sudden death in the midst of an apparently perfect convalescence. Arterio-sclerosis, with its weakened vascular system, must be noted as it holds a definite relation to the repair of wounds, making vessels difficult to control and increasing the risks of secondary hemorrhage.

**Affections of the Alimentary Canal.**—Dyspepsia must be looked for together with its associated ailments, headache, depression, and nausea. Graver affections of the alimentary tract, such as aggravated forms of dyspepsia, gastric ulcer, and dysentery, are associated with depraved nutrition and demand close attention. A possible cancer of the stomach needs consideration. I have several times had such patients come to me for gynecological treatment.

Constipation is perhaps the commonest ailment associated with these affections; it is important to note its degree and the means habitually adopted by the patient to relieve it.

**Diseases of the Liver.**—In examining the right hypochondrium, cirrhosis, cancer, and abscess of the liver must be borne in mind. The palpating fingers should also always try to touch the gall bladder. I have several times found this enlarged. In one case of large papilloma of the ovary the gall bladder was as big as the fist, distended with a cement-like substance. In another, with a

dense fibroid weighing forty-nine pounds, much pain was felt in a nodule on the right on top of the tumor. I decided that this was the gall bladder, and, at the removal of the tumor, opened the gall bladder, letting out a quantity of pus and removing a stone.

**Diseases of the Kidney.**—The examination of the kidneys and their function must be more carefully conducted than that of any other extra-pelvic organ. They are the emmeteries whose activity is most important after any operation, and on account of the intimate association of the ureters with the uterus, ovaries, and tubes, their function may be seriously impaired when these organs are diseased. The presence of albumin and casts and pus and the amount of urea excreted must always be inquired into.

Diabetes is such a serious complication that it must be looked for in every instance.

#### TAKING THE HISTORY.

An accurate history of a case can not always be obtained at the first consultation, as nervous women frequently give such indefinite answers that it is best to leave some parts to be written at a future visit. I think it is a good plan to allow the patient to begin by describing her condition without plying any questions. During the recital the general appearance of the patient, her habit, complexion, temperament, peculiarities of manner or of conversation, and any other points which may have a bearing on her case should be noted. By associating this general view with the general physical examination, the gynecologist is able to form a better estimate of the possibilities of partial relief or of complete cure.

After the patient has talked a while, if she inclines to wander and be indefinite and trivial, I do not hesitate to interrupt with certain routine questions. To this end I find a skeleton outline in my case book invaluable in keeping important headings constantly in view. I insert a facsimile of one of the pages. As far as possible it is filled in at the first visit. It is important to note in every gynecological history the presence of a variety of associated ailments cited in the list, which may have a bearing in one way or another upon the pelvic affection.

Further, to avoid pursuing an aimless or indefinite line of treatment, I always record an outline of the course to be pursued in each case after a thorough examination. It is only by doing this that palliative measures may be tested satisfactorily, associated functional disorders relieved, and the patient placed in the best possible condition for an operation. For example, I note in a case of myoma of the uterus in which the patient is debilitated the following *régime*: "Rest in bed, with massage and electricity on alternate days; careful diet, largely liquid; regulation of bowels; when patient is sufficiently built up, the tumor to be removed by abdominal hysteromyomectomy."

A diagram representing the relations and lesions of the pelvic organs should accompany the history, for even if the sketch be a rough one, it often furnishes a more definite idea of the case at a later date than the elaborate description.

<i>Date</i>	<i>Diagnosis</i>		
<i>Name</i>	<i>S. W. M.</i>	<i>Age</i>	<i>Resides</i>
<i>Occupation</i>	<i>Par</i>	<i>Miscarriages</i>	<i>Patient of Dr.</i>
	<i>instr. deliv.</i>		<i>fever</i>
<i>Menstr. hist.</i>			<i>Gen. appearance</i>
			<i>Weight</i>
			<i>Headaches</i>
		<i>Leucor.</i>	<i>Sleep</i>
<i>Complains now of the following symptoms</i>			<i>Appetite</i>
			<i>Digestion</i>
			<i>Bowels</i>
			<i>Float, kid.</i>
			<i>Urination</i>
<i>History of development of present condition</i>			<i>Urinary analysis</i>
			<i>Bladder</i>
			<i>Rectum</i>
<i>General previous hist.</i>	<i>rheumatism</i>	<i>fevers, etc.</i>	
<i>Family history</i>			

## SKETCH

## PHYSICAL EXAM. OF PELVIS AND ABDOMEN

*Vag. outlet**Vagina**Cervix**Uterus**Fallopian tubes and ovaries**Outline of treatment to be followed*

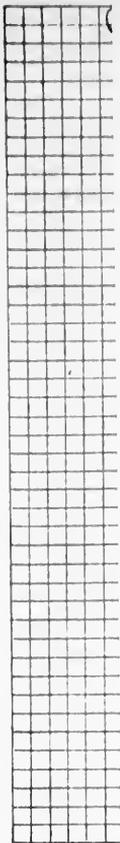

Any point  
superior strait.

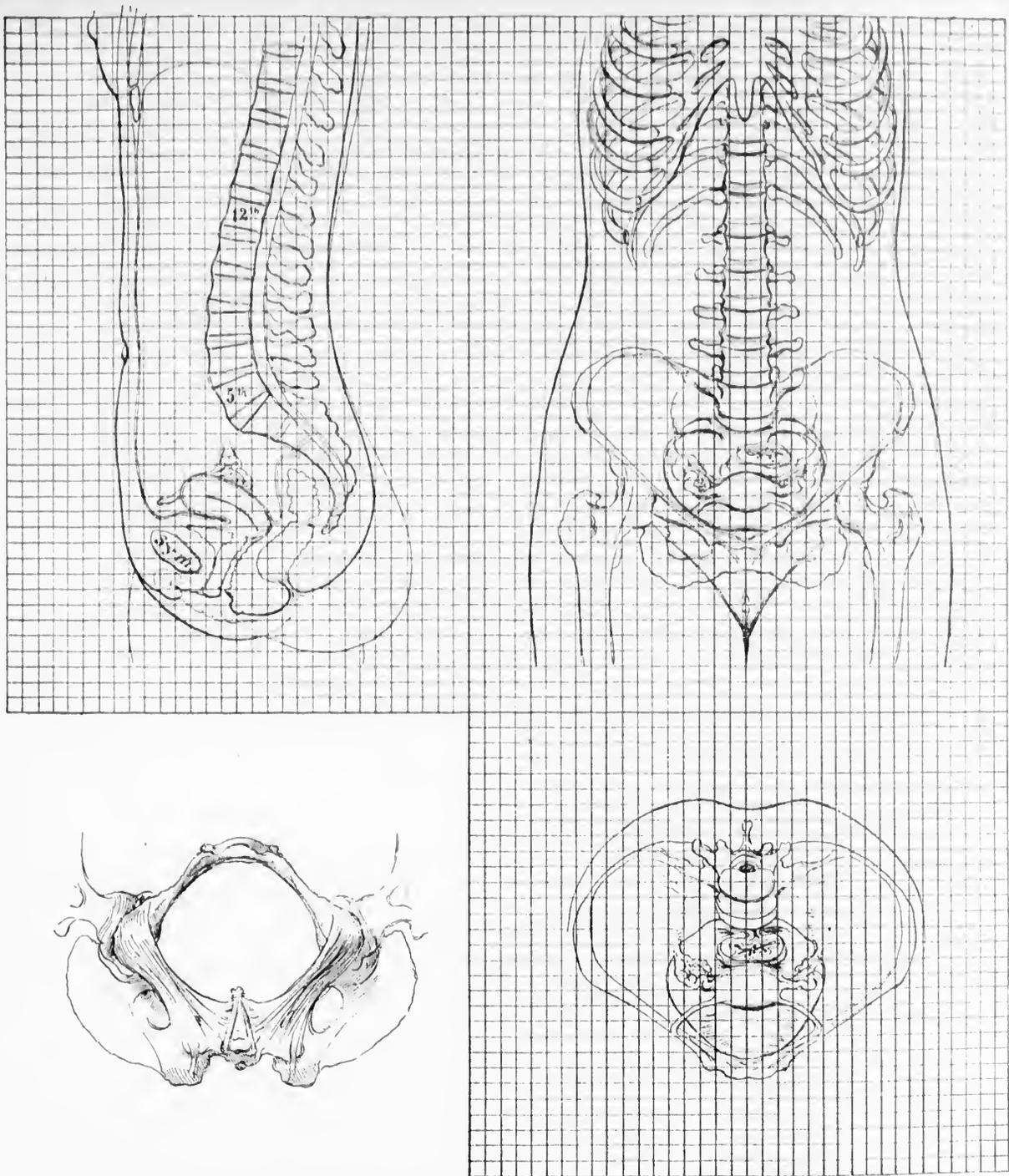

FIG. 61. THE FOUR CARDINAL PROJECTIONS OF THE ABDOMEN AND PELVIS, REDUCED ON THE SAME SCALE.

Any point in the abdomen can be located by following the parallel lines in the three projections. The lower diagrams are viewed perpendicularly to the plane of the superior strait.



There are four outlines necessary to illustrate properly the pelvis and its contents. Prof. Schultze, of Jena, and Dr. R. L. Dickinson, of this country, have devised rubber stamps by means of which a diagrammatic view of several aspects of the pelvis can be reproduced in a case book, or upon a history blank. I prefer in some instances, however, to make a free-hand drawing, because individual peculiarities may be best brought out in this way. A sagittal section is used to indicate uterine displacements and the position of tumors in front of or behind the uterus.

A coronal section through the crests of the ilia, the acetabula, and the tuberosities of the ischium is necessary to demonstrate lateral displacements of the uterus and the location of inflammatory masses on the right and on the left. If the examination be unsatisfactory, and there is doubt concerning the existence of disease on either side, an interrogation mark indicates that the question is unsettled, and leaves it open for future determination in an examination under anesthesia.

Lesions lateral or posterior to the uterus, in order to be properly indicated diagrammatically, require an outline of the pelvis looking in from above. Such a diagram is especially valuable for filling in after operation, because by it the exact position and relationship of inflammatory masses to the pelvic organs can be graphically shown. Adhesions are conveniently indicated by zigzag or straight lines.

Areas of resistance in the vault of the vagina not clearly outlined bimanually are best registered on a diagram of the inferior strait seen from below. Fig. 81 shows the three geometrical projections of the aenual body: first, a sagittal section, viewed perpendicularly to the cut surface; second, a front view of the body, seen perpendicularly to its long axis; and third, a view of the pelvis from above and perpendicular to the superior strait. These diagrams have been drawn on the same scale and are covered by a double system of parallel lines, thus dividing each of the three projections into a certain number of squares, which have their corresponding fellows on the other projections. In other words, the body has been imagined divided into a system of cubes, the projections of which we see in the three planes as a square network. The fourth diagram, in the left lower corner of the plate, is a view of the inferior strait seen from below. It is evident that by following this system every given point, or a tumor, in the body can be registered with great accuracy, as illustrated in Fig. 82, where the position of an ovarian cyst has been located in its three dimensions.

The location of abdominal tumors and dull and tympanitic areas may be indicated on a large diagrammatic outline of the abdomen. In Fig. 83, on the left, the abdomen is shown in outline with its contained viscera, and those organs from which abdominal tumors most frequently develop are seen distributed around the periphery; in Fig. 83, on the right, is a diagrammatic illustration of the directions taken by the various abdominal tumors in the course of their development, as indicated by the arrows. These directions, as will be seen, are centripetal—that is to say, from the more resisting periphery to the more yielding center.

The enlarging mass projecting toward the center in this way has a corona of resonance, with a dull base at its point of origin. Tumors of the omentum, as indicated by the circular arrow, are surrounded on all sides by an area of resonance.

The characteristic difference in the location of upper and lower abdominal

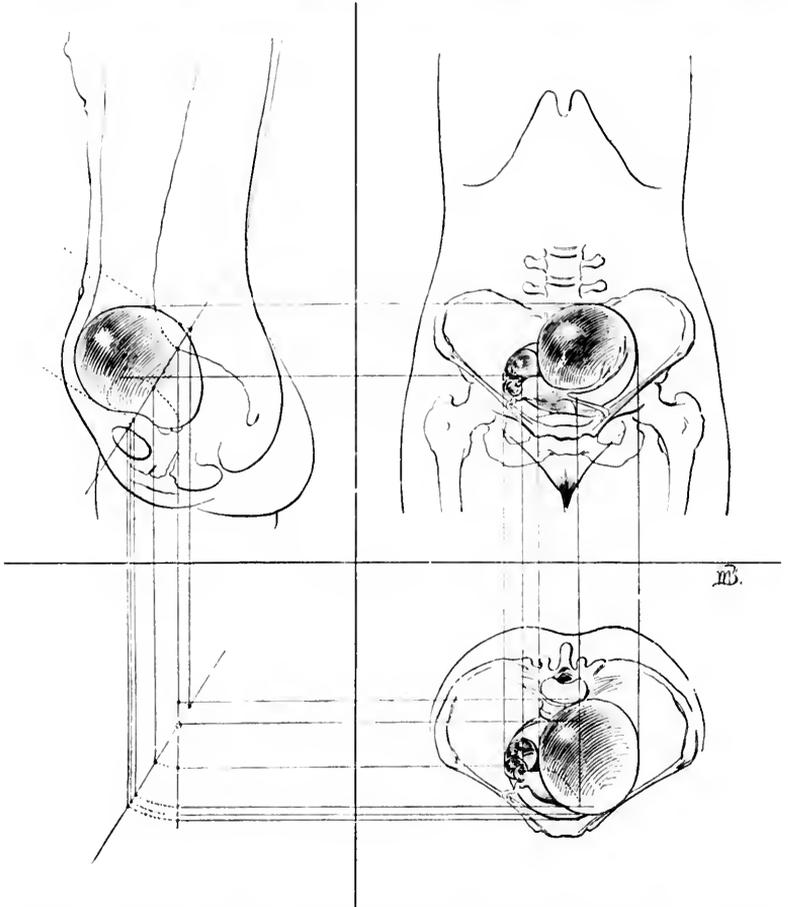

FIG. 82.—DIAGRAM SHOWING HOW TO USE THE PROJECTIONS OF FIG. 81 IN THE CASE OF A PELVIC TUMOR ACCURATELY LOCATING IT AND REGISTERING ITS FORM.

tumors is one which appeals at once to the eye, as shown in Fig. 84, drawn from life, in a case of enormous accumulation of feces in the transverse colon, due to carcinoma of the uterus and rectum.—*M. R., Op.* 7, 29, 96.

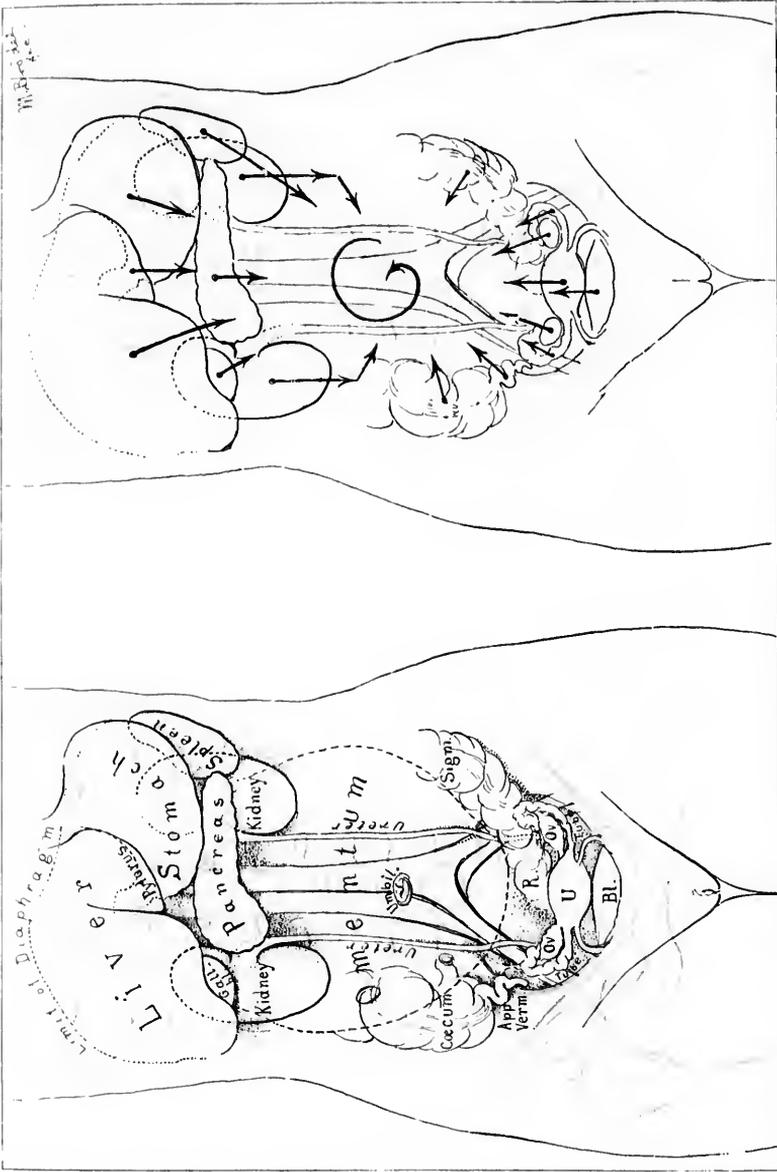

FIG. 83.—The left hand figure shows in outline, situated about the periphery, the various important abdominal organs from which tumors may arise. In the right hand figure, the arrows indicate the directions taken by these tumors from the periphery toward the centre, where the resistance is least.

Before closing this subject I wish to urge the importance of minute investigations, so as to bring out prominently the individual features. To the un-

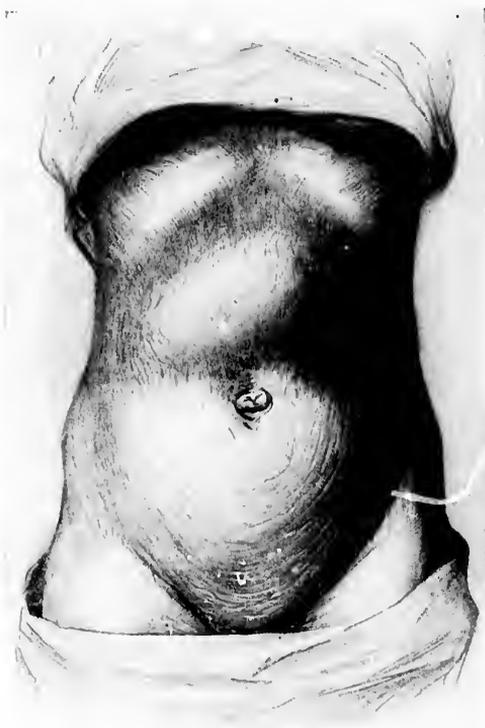

FIG. 84.—TUMOR EXTENDING TRANSVERSELY ACROSS THE UPPER ABDOMEN JUST ABOVE THE UMBILICUS, DUE TO A LARGE ACCUMULATION OF FECES IN THE TRANSVERSE COLON, FROM A CARCINOMA OF THE RECTUM AND UTERUS. RESONANCE ON ALL SIDES.

M. R., oper., July 29, '96.

scientific surgeon all cases are roughly classified under a few heads; one ovarian tumor is the same as another, except in size, and a prolapsus is a prolapsus, and nothing more. A closer scrutiny, however, will always bring out an infinite variety of individual differences, and attention to these in time serves to shed light upon the causes of disease.

To illustrate, in a relaxed vaginal outlet the following questions ought to be answered: The exact degree of the relaxation, the amount of protrusion of the vaginal walls, the condition of the levator fibers as felt through the vagina, the increase of the protrusion at the outlet on straining while standing, the difference in the degree of relaxation produced by anaesthesia, the tendency to prolapse; and the history should note the number and character of the labors (whether in-

strumental or natural) and the size of the children. Careful measurements should then be made with a pelvimeter to demonstrate whether difficult labors have been due to a contracted pelvis. All sorts of reflex disturbances ought also to be put down.

## CHAPTER VI.

### GYNECOLOGICAL INSTRUMENTS AND DRESSINGS.

1. Introduction.
2. Illumination.
3. Specula: Nelson's trivalve speculum. Goodell-Baer bivalve speculum. Kelly's small cylindrical specula for virgins. Sims's speculum. Simon's speculum.
4. Retractors, vaginal and abdominal.
5. Knives: Ordinary scalpel. Broad-bladed scalpel, with a large handle.
6. Scissors: Straight, sharp-pointed, and blunt. Emmet's left-curved scissors.
7. Tenucula: Straight. Curved. Corrugated. Shepherd's crook.
8. Forceps: Tenneum forceps. Long straight dressing forceps. Long rat-toothed forceps. Rat-toothed dissecting forceps. Hemostatic forceps. Sponge forceps. Polyp forceps.
9. Ligature and suture materials: Silk in three sizes—fine, medium, and stout. Silkworm gut. Catgut. Kangaroo tendon. Silver wire. Tying knots with silk and catgut.
10. Needles: Curved and straight. Carrier. Needle holder. Transfixion needles.
11. Packer.
12. Glass catheter.
13. Large glass trocars for tapping cysts, curved and pointed.
14. Leg holder.
15. Aspirator: Dienlafey-Potain aspirator. Syringe aspirator.
16. Cautey: Paquelin's thermo-cautey. Electro-cautey.

### GYNECOLOGICAL INSTRUMENTS.

A LARGE, carefully selected armamentarium is essential to the gynecologist. He needs instruments of three sorts:

- (1) Instruments for exposing the field of operation in vagina or abdomen.
- (2) Instruments for special operations.
- (3) Instruments and accessories for closing the wound.

The field of the operation is often remote from the surface, either deep down on the pelvic floor or at the vaginal vault, and necessitates the use of specula and retractors to make it accessible. But specula are useless without a good light well directed upon the field; for this reason I will consider first the prime requisite—illumination.

**The Illumination.**—For the illumination of the field of operation, a good diffused sunlight is best of all. This is attained in the operating room by plenty of windows and a large skylight, and by walls painted with a light color. The direct rays of the sun are embarrassing, and so a north exposure is best. No operator, however, can afford to depend on this source of light alone, on account of the uncertainties of the weather and the frequent call for an intense illumination localized at one point.

In an emergency in private practice a common candle with a tin reflector, or a mirror held so as to direct its rays, may be used. In the clinic the electric

light is the best artificial illuminant. The current may be conducted from a wall bracket by a long insulated flexible wire to the 16-candle-power lamp, with a tin reflector enameled white inside and attached to a handle, as shown in the figure in Chapter XX. This can be held by an assistant so as effectively to illuminate the wound area. A simple extemporized reflector may be made by enclosing the electric light in a cone of white paper covered with black cloth. Where an electric street current is not available, a storage battery is a satisfactory substitute, running a 6- or 8-candle-power lamp.

**Specula.**—For inspection of the vaginal vault the best specula are Nelson's trivalve speculum, Goodell's bivalve speculum, modified by B. F. Baer, and Kelly's small cylindrical specula, Nos. 12-15 of the cystoscopic set, for use in the virgin. The utility of these instruments is limited to an examination for diagnostic purposes, to treatments applied to the vaginal vault, and to the application of packings. Sims's and Simon's specula are useful both in making an examination and in exposing the field during an operation at the vaginal vault, serving the double purpose of specula and retractors. The Sims's speculum is most used by the New York school of gynecologists, and is more serviceable with the patient in the left lateral position. Several sizes are needed, differing in length and breadth, for narrow and relaxed and for long and short vaginas. The Simon specula are purchased in sets, and consist of two handles with adjustable blades of varying lengths and breadths, for both the anterior and the posterior vaginal walls. They are used in the dorsal position.

**Vaginal retractors**, with long light handles, are used to hold back the lateral and upper walls of the vagina, and to keep the field of operation free. The blades of these retractors should be of two sizes—2 by 7 centimeters and 3 by 7 centimeters.

**Abdominal retractors** serve to lift up or to draw aside one of the walls on either side of an abdominal incision to enable the operator to inspect the pelvic viscera. The best patterns are Halsted's, with concave blades, 4 by 7 and 6 by 7 centimeters in size.

**Knives.**—The knives used in gynecological surgery are the ordinary scalpels, made of solid metal, with handles smooth or grooved to afford a better grasp. For opening the abdomen, I like a broad-bladed scalpel with a large handle, and for marking areas of denudation in the vagina or on the cervix, or for delicate dissections in the pelvis, I prefer a knife with a slender blade and a sharp point.

In transporting or sterilizing knives the blades must be wrapped in cotton, or they must be fastened in a rack in a metal box to protect them.

**Scissors.**—**Scissors** are among the most important of all gynecological instruments, and, through the inventive genius and teaching of Dr. T. A. Emmet,



FIG. 85.—EMMET'S LEFT-CURVED SCISSORS FOR PLASTIC OPERATIONS AT THE VAGINAL OUTLET.

of New York, they have come to be so widely used in this country as to constitute a characteristic feature of American gynecology. Straight and curved scissors are used—the straight scissors for all ordinary cutting, and the curved scissors in making denudations. Two pairs of straight scissors are useful—one sharp-pointed, with a cutting edge  $5\frac{1}{2}$  centimeters long and handles 14 centimeters long, for removing sutures, cutting ligatures, and in making short, straight incisions; the other pair are blunt-pointed, with a cutting edge of 7 centimeters and a handle 18 centimeters in length, for enlarging the abdominal incision, for cutting the pedicles of tumors, and in excising thick areas of tissue. Large scissors angled on the edge are also used in extending the abdominal incision.

Emmet's left-curved scissors (Fig. 85) are invaluable in making denudations in the vagina, but it is necessary to see that these scissors have a good curve, and that they cut evenly from shoulder to end.

**Tenacula.**—Tenacula are used to catch and hold movable tissues which are being sutured, to steady the cervix uteri, and to catch bleeding vessels down in the pelvis and lift them up while a ligature is being applied; but the tenaculum has not the importance now that it had some years ago (Fig. 86).

There are two varieties of tenacula—the straight and the curved. The straight tenaculum, D, is employed in tucking in and in approximating tissue which pouts out of an incision while it is being sutured, as well as in catching up small areas of tissue which are to be trimmed off with knife and scissors. The curved tenacula are of three kinds: the simple curved, B, the corrugated, A, and the shepherd's crook, C. The simple curved tenaculum is used to catch tissue which is to be firmly held; the hooked end keeps it from slipping off.

The corrugated tenaculum serves as a tractor to bring the uterus down for examination. My shepherd's crook tenaculum is used in the operation for relaxation of the vaginal outlet. After this tenaculum is once put in place it may be dropped repeatedly without losing its hold on the tissue.

**Forceps.**—Under this name are classified a variety of instruments differing widely in use and construction, but having one common end in view—that of grasping and holding tissues.

The following kinds of forceps are used in gynecological surgery:

- Tenaculum forceps.
- Long straight dressing forceps.
- Long rat-rooted forceps.
- Rat-toothed dissecting forceps.

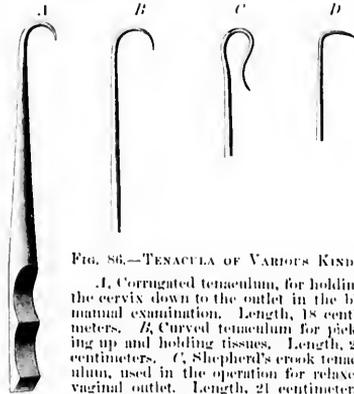

FIG. 86.—TENACULA OF VARIOUS KINDS

A, Corrugated tenaculum, for holding the cervix down to the outlet in the bimanual examination. Length, 18 centimeters. B, Curved tenaculum for picking up and holding tissues. Length, 22 centimeters. C, Shepherd's crook tenaculum, used in the operation for relaxed vaginal outlet. Length, 21 centimeters. D, Right-angled tenaculum used in turning in the edges of the tissues in approximation by suture. Length, 19 centimeters.

Hemostatic forceps.  
Sponge forceps.  
Polyp forceps.

**Tenaculum forceps**, or double tenaculum forceps, resemble two tenacula fastened so as to work together in opposite directions. They are used to grasp and draw the cervix down, to steady it while the uterine dilator is introduced, and to catch and hold a bleeding pedicle which has dropped back into the abdomen. They ought to be made strong enough to resist feathering, and the ends must be slightly curved at right angles to the shaft and tapered, as shown in the figure, to prevent tearing the tissues. The figure (Fig. 87) shows a small tenaculum forceps which I have found especially useful. If the tenaculum tears out, a three-pronged tenaculum may be used to advantage (Fig. 88).

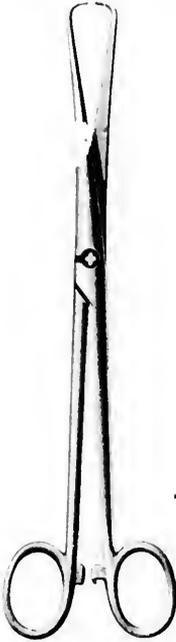

FIG. 87.—TENACULUM FORCEPS, WITH CATCH AND OPEN LOCK.  $\frac{1}{2}$  ORDINARY SIZE.

**Long straight dressing forceps** are constantly used in removing and applying dressings, in carrying pledgets of cotton into the vagina to cleanse it, and in making applications.

**Long Rat-toothed Forceps.**—I find a pair of long rat-toothed forceps, like those figured in the text (Fig. 89), one of my most useful instruments in abdominal surgery, effectually taking the place of a hand deep down in the pelvis.

**Rat-toothed dissecting forceps** are needed in picking up the layers of tissue, in making the abdominal incision, and in catching the tissue in vaginal and cervical denudations.

**Hemostatic Forceps.** At least two dozen artery forceps should be included in a set of abdominal instruments, but only four sets are required for most vaginal operations. The original forceps were devised by Koerberlé, of Strassburg, and are excellent for the compression of vessels lying in soft tissues, as in the abdominal walls and on the floor of the vagina. For general use the forceps figured in the text and in use in the Johns Hopkins Hospital are the most satisfactory (Fig. 90). They are 15 centimeters in length, and have a curved biting surface 4 centimeters long; the lock shown in the figure is an improvement on my own lock. The especial points of value in these forceps are (1) that the jaws are longer than usual and gently curved, and (2) that the tips of the jaws grasp the tissue before the first shoulder is reached. This permits a small bit of tissue or an artery to be clamped by the points if the



FIG. 88.—CELLEN'S THREE-PRONGED TENACULUM FORCEPS FOR HOLDING DOWN THE CERVIX UTERI. ACTUAL SIZE.

forceps are only closed one or two notches, while a large area may be clamped if they are closed completely.

**Sponge Forceps or Holders.**—Sponges in abdominal surgery are chiefly of service in cleansing the pelvic cavity, in taking up pus rapidly, and in holding back the intestines. The best sponge holder is my own with a lock devised by Dr. G. B. Miller, of the gynecological staff of the Johns Hopkins Hospital, and shown in the accompanying figures (Fig. 91). The essential features of these forceps are the blunt teeth at the lower end which hold the sponge, and the clasp which slides freely under one handle until it is slipped over the neck of the other handle and pushed down, fixing the sponge. The entire length of the forceps is 22.5 centimeters, and the whole separates into three pieces for cleansing.

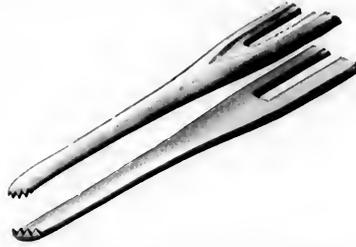

FIG. 89.—END OF LARGE RAT-TOOTHED FORCEPS, FOR USE DEEP IN THE PELVIS. WHOLE LENGTH, 3 CENTIMETERS.

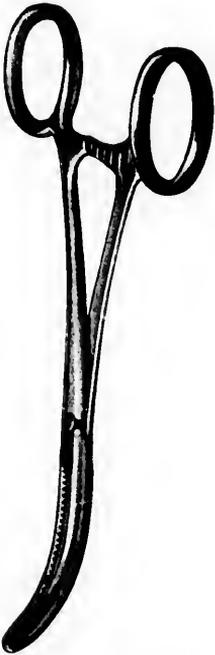

FIG. 90.—HEMOSTATIC FORCEPS WITH OPEN LOCK.

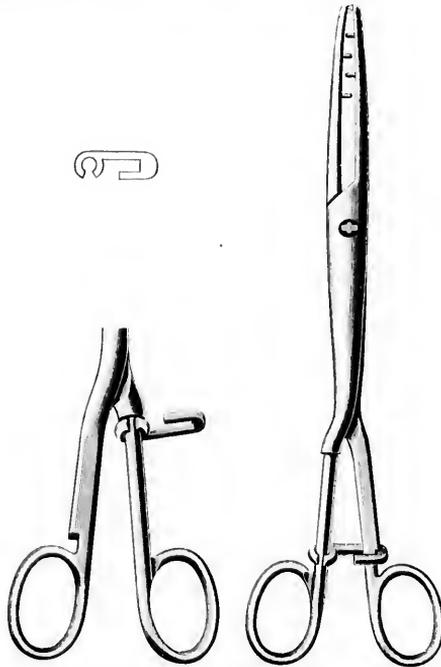

FIG. 91.—MILLER'S SPONGE FORCEPS.

The hook shown above, in outline, hangs loose on the round handle until the forceps are locked, as seen in the right-hand figure.

**Polyp Forceps.**—The best forceps for grasping small polyps or for removing a small ovum or pieces of placenta are those shown in the text (Fig. 92). The form of the blade is shown in the figure, and the handles are 27.5 centimeters long and provided with a catch.

The ligature and suture materials used in gynecology are silk, silkworm gut, catgut, and silver wire, which are conveniently abbreviated in clinical records by using the initial letters only before the word "suture," as s., s. w. g., e. g., s. w. sutures.

**Silk.**—Pure Chinese silk is used in three sizes—fine, medium, and coarse.

Fine silk is best adapted for the ligation of small vessels, for suturing the intestines, for approximating peritoneal surfaces, and for bringing wound surfaces into apposition when there is no tension.

Medium silk is used in ligating large vessels and in tying off the ovarian vessels in a bunch. This size should always be used in preference to heavier silk in all cases where it can stand the strain.

Coarse silk ligatures should only be used in vaginal hysterectomy in tying off the broad ligaments. Coarse silk ligatures are also used as tractors to pull the uterus down in vaginal hysterectomy.

**Silkworm gut** is one of the best plastic suture materials we have, and once introduced and tied or clamped with shot, preserves a well-rounded, elastic loop indefinitely or until it is removed. The fact that it possesses no meshes gives it a great advantage over silk, which in time forms a seton, furnishing a highway of communication for germs from the surface into the deeper tissues. Silkworm gut is rarely used as a buried suture, either in the abdominal cavity or in the vagina. It is used by many surgeons in closing the abdominal wound after celiotomy, in cervical operations, and as a tension suture in the operation for relaxed vaginal outlet or lacerated perineum.

**Catgut**, properly sterilized, is valuable as ligature and suture material, because it is absorbed by the tissues and does not require removal. The chief objections to catgut are the difficulty of sterilizing it, its too rapid absorption, and the fact that it may come untied. Only intermediate and heavy-sized catgut should be used, as finer strands are too weak. Water swells and softens catgut so quickly that it must be kept immersed in alcohol until it is used. The too rapid absorption of catgut is prevented by the preparation in emul (see Chapter I). In vaginal operations catgut is chiefly used as an accurate approximation suture; if it holds but four days, the tissues, as a rule, are sufficiently united, so that sutures are no longer necessary. Its greatest advantage here is that the removal of sutures is avoided.



FIG. 92. PLACENTA AND POLYP FORCEPS. LENGTH, 27.5 CENTIMETERS.

**Kangaroo tendon**, the split sinews of the kangaroo's tail, introduced by Dr. Henry O. Murey, of Boston, has the advantage of being absorbed much more

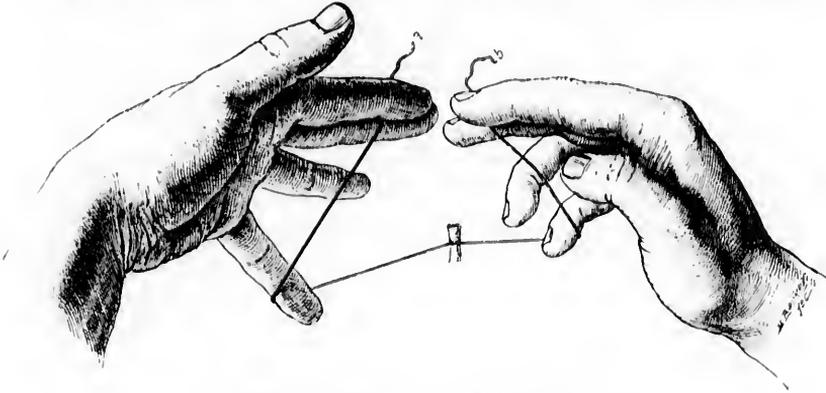

FIG. 93.—RAPID METHOD OF TYING THE SQUARE KNOT.

First step: the first knot is tied and the ligature grasped as shown in the figure.

slowly than catgut. It is useful in all forms of suturing and ligating, and Dr. Murey advocates it especially for radical hernia operations.

**Silver Wire.**—Stout silver wire has been introduced by Dr. W. S. Halsted as a buried suture. Its chief use as a permanent suture is in holding together

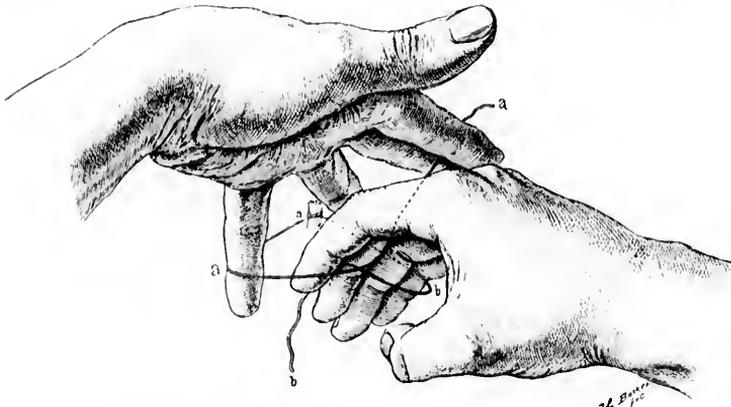

FIG. 94.—Second step: the end *b* is passed over *a* to make the second knot.

the fasciæ of the abdominal incision when it is closed, and in uniting the muscles and fasciæ in the radical cure for hernia. The wire is best introduced as a mattress suture, the ends twisted four times at an obtuse angle, cut off, and turned down at one side of the incision. These sutures re-

main indefinitely in place, and rarely have to be taken out, like buried sutures of silkworm gut.

**Tying Knots with Silk and Catgut.**—Much time may be lost by tying knots clumsily, and the surgeon will be a gainer all his life long if he will learn at the outset a definite rapid method of tying both silk and cutgut. I always tie in the following manner: the first knot is tied with the inner strand in the right hand, thrown *over* and then *under* the outer strand held in the left

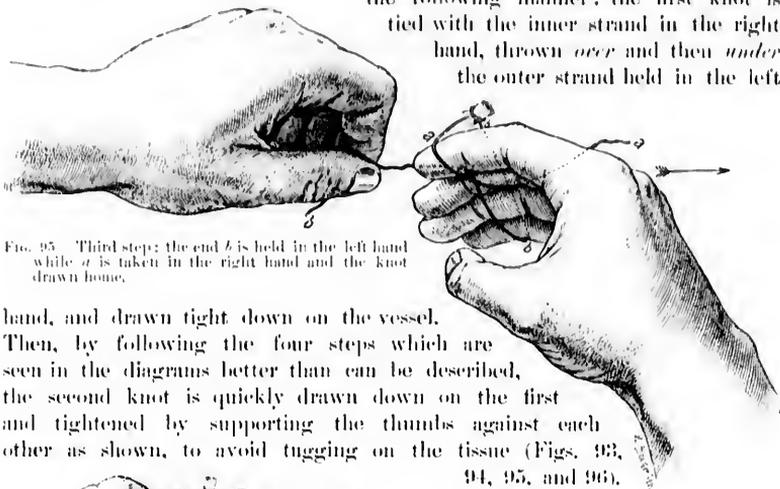

FIG. 95.—Third step: the end *b* is held in the left hand while *a* is taken in the right hand and the knot drawn home.

hand, and drawn tight down on the vessel. Then, by following the four steps which are seen in the diagrams better than can be described, the second knot is quickly drawn down on the first and tightened by supporting the thumbs against each other as shown, to avoid tugging on the tissue (Figs. 93, 94, 95, and 96).

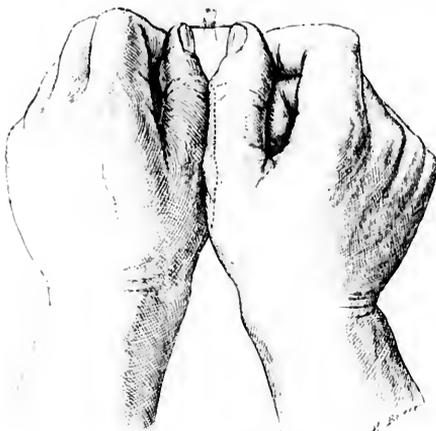

FIG. 96.—Final step: tying the ligature tight without rocking the tissue by buttressing the thumbs against each other. The dotted line shows the overlapping of the left thumb by the right.

should be of three sizes, as shown in figures, requirements: A good temper, a good open eye, a short straight shank just

Silkworm gut is best tied in a square knot, and after immersion in warm water. Catgut is best tied dry. If a third knot is added, either to the silkworm gut or the cutgut, as suggested by Dr. C. P. Noble, the ends may then be safely cut off close to the ligature: the use of a third knot leaves less foreign material behind, and the knot is less liable to slip, and also, in the case of silkworm gut, the little ends which are liable to irritate the tissue are removed.

**Needles.** — Curved needles (Fig. 97) are the best for almost all gynecological purposes; they and must answer the following

below the eye for the grasp of the needle holder, and a cutting surface not wider than the body of the needle; the point must follow the curve of the needle, and must not be bent inward. One of the commonest faults is a kink or a curve just below the eye, making the needle liable to break in the grasp of the holder. Simple straight eunibric needles, with a round sharp point and without any cutting edge, are the best for intestinal suturing; they are held in the fingers so that the sense of resistance at the point may enable the operator to recognize the position of the submucous fibrous coat, and so to pick it up.

**The Suture Carrier.**—The suture carrier is a silk loop tied to the eye of a needle for the purpose of pulling interrupted sutures through in rapid succession. It is tied by taking a long piece of medium silk 52 centimeters (21 inches)

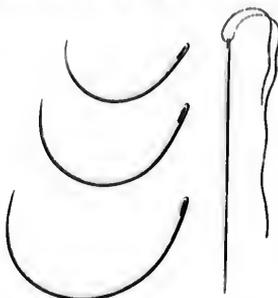

FIG. 97.—CURVED NEEDLES, 3 SIZES.

Used in plastic work and all kinds of suturing, except suture of the intestines. Straight straw needle, used in intestinal suturing, on the right.

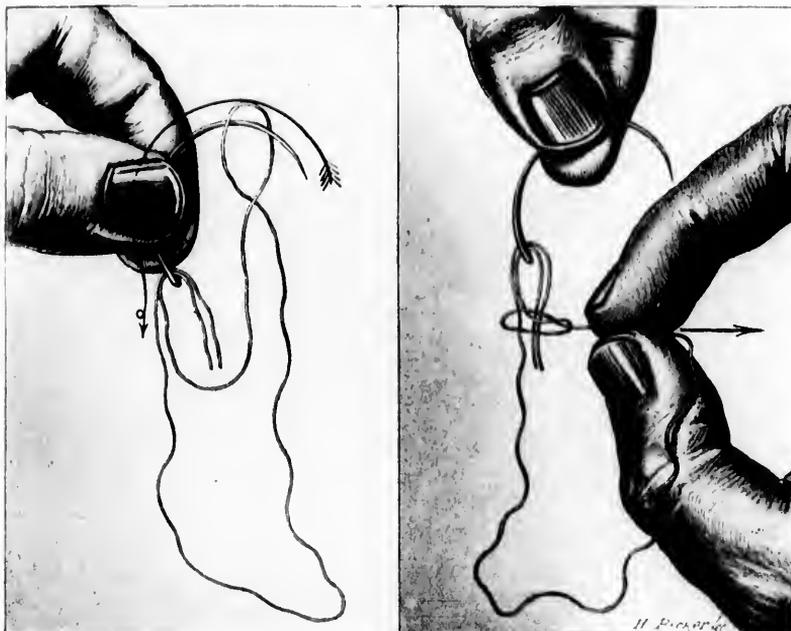

FIG. 98.

FIG. 99.

First and second steps in making the silk carrier. Both ends of the thread are put through the eye of the needle in the same direction, and a loop is formed passing over the needle in the direction of the arrow, as shown in Fig. 98; the loop is then brought down below the eye and drawn tight, fixing the carrier, as shown in Fig. 99.

long, putting both ends together through the eye of a needle, and then making a loop on one of the ends, slipping it over the needle beyond the eye, and pulling it tight (Figs. 98 and 99). The length of the carrier loop made in this way is 20 centimeters (8 inches) long. In using the carrier the needle is passed through

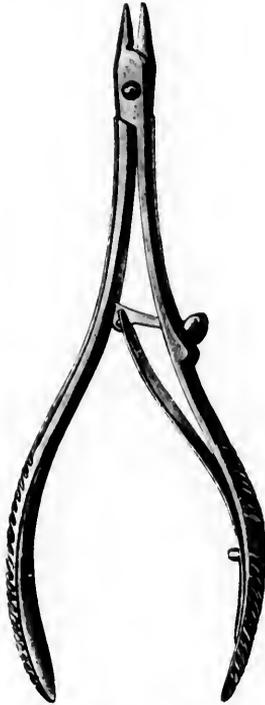

FIG. 100.—NEEDLE FORCEPS FOR CURVED NEEDLES,  $\frac{2}{3}$  ORDINARY SIZE.



FIG. 101.—NEEDLE FORCEPS SHOWING THE SHAPE OF THE BITE AND THE MANNER OF GRASPING THE NEEDLE ON THE FLAT PART JUST BELOW THE EYE.

the tissue, and when the loop, threaded by the assistant, is drawn through, the suture is in place. Sutures may be placed more rapidly in this way than by any other means. The intestinal needles are each armed with a single thread of fine black silk. The carrier is never used here to avoid making any larger hole than is absolutely necessary.

**Needle Holder.**—The most satisfactory needle holder for curved needles is the one figured here (Figs. 100 and 101).

It is important that the handles should be large enough to afford a good

grip, that the catch should work easily and smoothly, and that the end which holds the needle should be narrow, well tapered, and copper-faced.

**Transfixion Needles.**—Transfixion needles are used to carry stout ligatures through the broad ligament in vaginal hysterectomy. The important requisites are a big handle for a convenient grasp, a stout shank which will not bend, and a well curved end with a big eye just behind a point neither sharp nor very blunt. I only use the needle curved from right to left.

**Packer.**—A three-pronged packer, modeled like a miniature blunt pitchfork, is valuable in introducing dressings into the vagina and in arranging properly a gauze drain in the abdomen. It is also used in packing cotton, wool, or gauze against the vaginal vault while the patient is in the left lateral semiprone position (Fig. 102.)

**Glass Catheters.**—Short glass catheters should supersede the metal ones for women, as they are so easily made aseptic and kept clean by immersion in a carbolic or boric acid solution. There is no danger of the catheter breaking while being used if it is not cracked when introduced. The catheter measures 13 centimeters in length and 5 millimeters in diameter. It is gently curved in opposite directions at the ends, and there is a large eye on each side near the end, as well as a small hole at the end, to facilitate cleansing.

**Trocars. The Large Glass Trocars for tapping Cysts.**—For the evacuation of large ovarian cysts I use only glass trocars, curved at one end and pointed at the other, with large fenestræ on both sides, near the pointed end. The end of the trocar beyond the fenestræ is closed by a glass partition to prevent dirt lodging there, while the discharging end has a collar over which the rubber tube is slipped. The clear glass discloses the slightest trace of dirt and renders it possible to sterilize these instruments much more satisfactorily than the metal trocars.

**Leg Holder.**—In operations requiring the lithotomy position it is necessary to use some kind of a leg holder to retain the legs flexed and drawn upon the abdomen out of the way during the operation. My own leg holder, or Robb's modification of it, is the simplest form both for use and for transportation. The holder is composed of three parts: two canvas rings which are put on the thighs just above the knees, and a broad canvas strap which goes from one loop to the other around the neck. The rings are made of two thicknesses of heavy cotton flannel quilted together. The ring is widest below, where the greatest pressure comes, being 13 centimeters (5 inches) in width, and narrowest on top, 2½ centimeters (1 inch) in width, where a galvanized ring is placed to hold the neck strap. The canvas rings should be 50 centimeters (20 inches) in circumference. The neck strap is made of a double canvas quilted like the loops, 89 centimeters (35 inches) in



FIG. 102.  
PACKER FOR  
PLACING COT-  
TONS OR GAUZE  
IN POSITION.  
LENGTH, 20.5  
CENTIMETERS.

length, and  $6\frac{1}{2}$  centimeters ( $2\frac{1}{2}$  inches) wider in the middle, gradually tapering to the ends. Harness straps at the ends and three metal rings about 15 centimeters apart make the leg holder adjustable.

**Aspirator.**—The aspirator, at one time largely given up, has in recent years again become an indispensable instrument. The Dieulafoy-Potain aspirator is one of the best, and is so well known as to need no description. During the operation the aspirator should be in the hands of a competent assistant, who should be sure that the bottle is well exhausted and the suction channel unobstructed before use. Immediately after using the instrument the suction tube should be cleansed by creating a vacuum in the bottle and immersing the point in warm water. The tubing, after being washed out in this way, should be placed in a bichloride solution (1-1,000) for at least an hour, after which it is dried and put away in the case. The needles and trocars should be sterilized after every operation by boiling in a carbonate of sodium solution (1 per cent) for five minutes, and dried in a Bunsen or an alcohol flame. The receiving bottle should be sterile, as it is often desirable to make cultures from its contents.

**Syringe Aspirator.**—My own aspirator is like a large glass syringe, a pint in capacity, with a metal point to which a piece of rubber tubing, with a needle, is attached. The piston must fit perfectly to keep the air from entering. A switch and an opening on the side provide for the discharge of the contents of the barrel without withdrawing the trocar.

**Cautery.**—The term cautery is used in contrast to chemical cauterization produced by nitric acid, chloride of zinc, nitrate of silver and caustic potash, etc.

The irons of ancient surgery have been replaced in modern times by Paquelin's thermo-cautery or one of its modifications, too familiar to need description. One of the best forms is that in which the tube passes directly through the middle of a small bottle holding the benzine.

**The Electro-cautery.**—In the clinic room an electro-cautery is often more convenient than the thermo-cautery. The electricity is supplied from a storage battery, or, better still, from a street current which is cut down. I use in my clinic an alternating current controller, in which induction is used for resistance, in place of a sectional coil and point switch. A 52-volt alternating current is employed and reduced by the controller from 0 to 5 volts with an ampère of from 1 to 35.

## CHAPTER VII.

### ANESTHESIA.

1. Local and general anesthesia.
2. Local: Cold. Cocain. Endermic injections.
3. General anesthesia: Introductory. Anesthetizer. Signs of complete relaxation. Danger symptoms. Oxygen after anesthesia. Anesthesia slip.
4. Chloroform.
5. General rules for administering any anesthetic.
6. Rules for administering chloroform.
7. Resuscitation of the asphyxiated.
8. Ether: Operation under the primary effect of ether.
9. Death from anesthesia.

The choice of the best anesthetic and the safest method of administering it are questions of the utmost importance, for its improper use often mocks at skill and converts one of the greatest surgical blessings into an agent of death.

There are two forms of anesthesia employed in gynecology—local, in which only a small area of the body is anesthetized, and general, where the anesthetic is inhaled and induces a state of unconsciousness, during which the most extensive and prolonged operation can be done without pain.

#### LOCAL ANESTHESIA.

Local anesthesia is best adapted to those cases in which the operation is confined to a small exposed area, whether on the surface of the body or in the vagina, where the operation is of a minor character and of short duration. Local anesthesia is induced either by applying cold or a solution of cocain, or by injecting normal salt solution into the deeper layers of the skin, or by constriction.

**Cold.**—Cold anesthetizes the surface by reducing the temperature close to the freezing point, paralyzing the nerves of sensation. The application of cold for anesthetic purposes about the pelvis is restricted to a narrow field. It may thus be employed in "freezing" the skin over a labial abscess, which can then be quickly opened, or in numbing the skin on the lower part of the abdomen for the purpose of making a small incision through which a trocar is to be thrust to tap an ascites or an ovarian cyst.

Anesthesia by cold may be produced either by the application of ice or by directing a fine ether spray against the part for about five minutes. If a lump of ice is used it should be sprinkled with salt, wrapped in a thin cloth, and the salted side applied to the spot for about five minutes, when the blanched surface will show the effect of the agent. The refrigeration of the surface by ethyl chloride is perhaps the best way to apply cold over a small area, and I know of

no better arrangement than the ethyl chloride (Bengnó) supplied to the trade in glass vials with brass tops perforated by a capillary opening and closed by a screw cap. Each tube contains 30 grams of ether, and is sufficient for from ten to fifteen minor operations.

The efficiency of the ethyl chloride depends upon its low boiling point, which is  $12.5^{\circ}$  C. Ethyl chloride anesthesia will be found valuable in such minor operations as evacuating abscesses about the vulva, opening stitch-hole abscesses, incising a suppurating pile, etc. The anesthetic effect is obtained by holding the nozzle from six to eight inches away from the skin while the fine spray plays upon it. The color at once changes, and in less than half a minute a white parchment-like appearance is produced, with an anesthesia which lasts about two minutes. The freezing is more rapid in summer.

**Cocain.**—Cocain hydrochlorate may be used for short operations on the skin or the mucous membrane, either by local application or by injection under the surface of the skin. Operations to which cocain is best adapted are the removal of pediculated tumors, the incision of a suppurating gland or a vaginal cyst, or in the preparation of the surface of the rectal mucosa to render painless the injection of hemorrhoids with carbolic acid, or in allaying the sensitiveness of the urethra before introducing a speculum. It takes about five minutes to produce local anesthesia by this means. Solutions of cocain should never be injected into the urethra or rectum, as the drug is quickly absorbed, and in a certain percentage of cases its use is followed by collapse.

I did a celiotomy in 1888 under local anesthesia produced by injecting 10 or 12 minims of a 2 per cent solution of this drug at several points in the line of incision. The patient experienced no pain until the peritoneal cavity was opened and the pelvic organs were pulled upon. The incision was sewed up while the tissues were yet under the effects of the cocain, and the patient was put to bed, having been conscious of every step of the operation, with only slight pain.

For operations in the vagina requiring local anesthesia a pledget of absorbent cotton is saturated with a 5 to 10 per cent solution and applied to the part for five minutes. The application may be repeated from time to time during the operation, although a free flow of blood seriously interferes with the effectiveness of subsequent applications by washing away the solution as soon as it comes in contact with the tissues.

Cocain may sometimes be used to enable the surgeon to operate upon the perineum without resorting to a general anesthesia. In this case a few minims of a 2 per cent solution should be injected by multiple punctures quite superficially along the line of incision or denudation. Such an operation can only be done on a patient who has excellent control of her nerves. It is well to begin the operation about three minutes after the injection and before the fluid is absorbed; the denudation in the anesthetized tissues then permits the injected fluid to escape over the wound and keeps up an anesthetic effect. Such an operation must be performed rapidly, all materials must be at hand, and assistance must be prompt. The concluding steps are sometimes painful, and are

completed satisfactorily only by exercising a great deal of moral suasion over the patient. The great difficulty in local anesthesia by injecting cocaine is that it is often impossible to tell beforehand how long an operation will last, and in long operations cocaine can not be depended upon.

**Endermic Injections.**—This method has superseded in many clinics the use of cocaine, proving more efficient and less dangerous. The procedure is simple and rapid, and for minor operations on skin surfaces is the best method devised. It consists of injecting by the hypodermic needle some innocuous fluid into the deep layers of the skin, producing thereby a small area of localized edema. The principle is the same as that of inducing anesthesia by constriction, the distention being sufficient to stop the circulation and paralyze the terminal nerve endings. Sterilized normal salt solution is the fluid commonly used.

The technique of the method is as follows:

The field of operation must be thoroughly cleansed and the procedure conducted throughout with the usual antiseptic precautions. The filled hypodermic needle is then introduced as nearly parallel to the surface as possible until the deep layers of the skin are reached. The fluid is then slowly forced in until a wheal from 1 to 3 centimeters in size is raised. This becomes blanched and sharply defined from the surrounding skin. By successive injections into the periphery of the wheals an area of desirable size can be anesthetized without further pain. The effect disappears as the artificial edema is absorbed, but the period is of sufficient length to enable one to open abscesses, remove sutures, or excise small tumors.

Schleich advocates injecting in the same manner a weak solution of morphine and cocaine, but it does not seem to improve the efficiency of the method, the quantity of the drugs being too small to produce a decided physiological action.

#### GENERAL ANESTHESIA.

General anesthesia suspends consciousness, relaxes the whole body, and puts the patient for the time completely at the disposal of the operator. It is therefore suitable for prolonged, difficult, and painful operations.

**The Anesthetizer.**—The office of the anesthetizer is scarcely secondary in importance to that of the operator; it is one of the most serious errors to hold that this responsible position may be delegated to an inexperienced person or a mere student, for timidity or bad judgment on the part of the anesthetizer may result in an imperfect anesthesia which interrupts and harasses the operator, while too profound an anesthesia may kill the patient on the table or by an excessive use of the drug produce a bronchitis or pneumonia which may prove fatal.

An unskillful anesthetizer is also prone to forget his office and become absorbed in the operation with imminent risk to his charge. As the surgeon's attention must be engrossed by the operation, it is highly essential that the assistant who gives the anesthetic should be thoroughly reliable, because to him must be intrusted the administration of stimulants if danger symptoms arise; if

the operator has to direct the anesthetizer, it is confusing to both, and the anesthetic is likely to be improperly administered. If it is necessary to call upon an inexperienced person to administer the anesthetic, he should be fully instructed beforehand, and the operator should be constantly on the watch.

Ether and chloroform are the only anesthetics universally used, and each of them has its marked peculiarities. The employment of the one or the other is for the most part determined rather by national and geographical boundaries than by the special adaptability to the particular case. Chloroform, for example, is used almost universally in England and on the continent of Europe, although ether has been recently making its way more and more into the German clinics. Ether is par excellence the anesthetic of the United States, but this is not without the notable exception of nearly all the Southern States, where chloroform is used almost exclusively.

The anesthetic of the future will certainly be given in an atmosphere definitely diluted. Spenzer (*Western Reserve Medical Journal*, November, 1894) has recently definitely shown that ether in a 3.5 per cent solution can be given to dogs for hours without ill effects, while 6 per cent will prove fatal in a short time.

In prolonged operations or operations upon debilitated patients, the patient should be kept thoroughly warm, to counteract the depressing drop of temperature of the anesthesia; this is best accomplished by hot-water bags placed near different parts of the body.

**Signs of Complete Relaxation.**—1. Loss of conjunctival reflex. The common practice of testing the eye reflex by touching the conjunctiva with the finger tip is to be severely condemned, for not a few patients have developed a severe conjunctivitis from such treatment.

2. Fixed, contracted pupils.
3. Slow, regular, and deep inspiration.
4. Complete loss of general reflexes and resistance.

I have never had occasion to pass a ligature through the tongue to pull it forward. This can only be necessary during operation on the face or throat, where it is impossible to pull the jaw forward and throw the head backward, which if skilfully done will open the upper air passages. In hundreds of cases I have never been compelled to use swabs to clear the throat and mouth of mucus. If the position of the head and jaw is correct, the collection of mucus will work itself into the mouth, where it can be gently removed by a soft towel or a piece of gauze.

I have found the greatest difficulty in anesthetizing patients addicted to the use of morphine and alcohol. It is sometimes almost impossible to obtain complete relaxation, and the breathing throughout is stertorous, and interferes seriously with the proper exposure in abdominal operations by constantly forcing the intestines into the field of operation. Stertorous breathing, if prolonged, is an indication of asphyxia, and is usually quickly relieved by allowing the patient more air, or by throwing the head backward and the jaw forward, or by clearing the mouth of mucus.

The difference in color of the face between simple mechanical asphyxia and

that produced physiologically by the drug is worthy of attention; in the former the face becomes blue, the eyes protrude, and the features swell, while in the latter the change is more gradual, the face does not swell, it becomes livid, and changes slowly into a grayish pallor. This pallor is often the first signal of danger, as the respirations may become shallower and shallower imperceptibly without mechanical signs of interference, and the anesthetizer may be unaware of the change.

The danger symptoms are:

1. Cessation of respiration.
2. Stoppage of the pulse.
3. Sudden pallor.
4. Dilated, fixed pupils.
5. Dark-hued blood replacing bright arterial blood.
6. Sudden cessation of bleeding in the course of operation. The anesthetizer will naturally notice the first four points, and the operator the other two, and sometimes the first.

Pneumonia may follow the administration of the anesthetic, whether ether or chloroform is given. Out of 1,800 administrations I have seen this complication eight times. The liability to pneumonia is increased if the patient has a slight bronchitis or a coryza beforehand.

**Oxygen after Anesthesia.**—The administration of oxygen gas to the patient coming out of the anesthetic is at present being extensively employed, both to hasten the complete recovery of consciousness and to lessen the nausea. It is particularly recommended for old and feeble patients, and for those who have a tendency to bronchorrhea, and after prolonged, exhausting operations. The oxygen, stored in a small cylinder, is passed through a bottle containing water, by which the rate of flow can be estimated; it is then given diluted with the air by holding the end of a tube near the face. Chloroform may be administered in the same way by allowing the oxygen to pass through a bottle containing chloroform instead of water.

Oxygen is also often given during the anesthesia in the same manner by conducting a rubber tube connected with the cylinder of compressed oxygen under one side of the ether cone or through its point, or indeed by passing a small rubber tube into one nostril even. The gas liberated by the removal of the pressure slowly bubbles through the water bottle and enters the air passages along with the anesthetic with every breath.

Although many surgeons express great satisfaction with this adjuvant, its real value has not yet been determined and awaits careful investigation.

The following slip is kept and filled out by the anesthetizer in my clinic:

## ANESTHESIA SLIP.

	<i>No.</i>
<i>Name,</i>	<i>Ward,</i>
<i>Date,</i>	<i>Age,</i>
<i>General condition of patient,</i>	
<i>Examination of chest,</i>	
<i>Pulse before anaesthesia,</i>	
<i>Pulse after anaesthetic,</i>	
<i>Anaesthetic used,</i>	
<i>Anaesthetic started,</i>	
<i>Anaesthetic ended,</i>	
<i>Amount of anaesthetic consumed,</i>	
<i>Operation started,</i>	
<i>Operation completed,</i>	
<i>Diagnosis,</i>	
<i>Operation,</i>	
<i>Mode of closure of incision,</i>	
<i>Dressing,</i>	
<i>Operator,</i>	
<i>Incision closed by</i>	
<i>Saline infusion, by rectum,</i>	<i>into abdomen,      into cellular tissue,</i>
<i>Irrigation,</i>	
<i>Euema,</i>	
<i>Strychnine sulphate, gr.</i>	
<i>Atropine sulphate, gr.</i>	
<i>Nitro-glycerin, gr.</i>	

REMARKS.

## CHLOROFORM.

Only chloroform manufactured by perfectly responsible chemists should be used, owing to the increased dangers from adulteration.

The advantages of chloroform are in some respects greater than those of any other anesthetic. By its means we are able to bring the patient more quickly and more comfortably into a state of unconsciousness. She remains more quietly under its influence, and as a rule nausea is not so extreme as after taking ether. In my experience the percentage of cases entirely free from nausea is as great after ether as after chloroform anesthesia. Out of 50 cases of chloroform anesthesia, 6 were free from nausea afterward; and out of 200 cases of ether anesthesia, 28 were free. These advantages are more than counterbalanced, however, by the greater risk to life in using chloroform. The mortality from chloroform is about one case in 3,000. Chloroform is contra-indicated on account of its increased danger in a weak heart or in an overtaxed right heart. It is not contra-indicated in valvular disease with good compensation or in any particular form of abdominal disease. It is also probably better in nephritis, but, as Hare says, quantity for quantity, compared with ether, it is more irritating in this condition. Its administration is preferable in old people with atheromatous vessels, in children, or in patients who struggle violently.

Operations must not be performed under chloroform during the stage of primary anesthesia, so frequently utilized for short operations under ether. Deaths have occurred in this way which were apparently due to sudden inhibition of the heart from shock not felt in complete anesthesia. The quiet even anesthesia produced by chloroform is such an advantage in abdominal surgery that it would be indicated in all cases were it not for these dangers.

It kills by paralyzing either the heart or, more frequently, the respiratory centers, according to the report of the Hyderabad Chloroform Commission, which is supported by the investigations of Dr. H. A. Hare. The first symptom of danger is either a complete relaxation of the pupils, a sudden pallor of the face, or a weakening of the respiratory movements, which become feeble and intermittent, accompanied or followed by sudden or gradual failure in the pulse. It has been my experience in two cases to see the respirations fail first, while in at least two other cases there was an alarming failure in the heart's action, the respiratory movements being still good. The first warning may be the sudden ashy pallor, which should call for immediate resuscitative measures, as it is always a precursor of graver danger. The respiration should be as closely observed as the pulse, and any change in its depth or rhythm should be carefully noted.

Before giving any anesthetic at all the character of the respiration must be noted, and the heart must be carefully examined.

The nature and action of the anesthetic should be explained to the patient, and it is always best to tell her that she may hear peculiar sounds or that she may have the sensation of falling, etc.; otherwise the occurrence of these phenomena in the first stage of anesthesia may frighten her, causing her to struggle violently. The face should be lightly anointed with vaseline and the eyes and

mouth covered with soft towels. I have seen the whole side of the face badly burned by chloroform, due to the neglect of this precaution. The room must be perfectly quiet, and no talking should be permitted to excite the patient and retard the progress of the anesthesia.

It is best for the anesthetizer to accustom himself to taking the pulse in the temporal or facial artery. It is much more convenient than the radial pulse.

The following rules regarding the preparation for anesthesia apply to the administration of both ether and chloroform:

1. The diet should be carefully regulated, if possible, several days before administering an anesthetic, only easily digested foods being given. On the day preceding, liquid or soft diet should be insisted upon. During this period the bowels must be freely moved each day, either by an enema or a mild laxative. Nausea and vomiting will be much less if the patient fast at least six hours before taking the anesthetic.

2. In very nervous patients a small dose of morphine, given about half an hour before anesthetizing, renders them more tractable. Atropine, in doses of  $\frac{1}{10}$  to  $\frac{1}{40}$  of a grain, is said to lessen the bronchial secretion and to act as a mild respiratory stimulant, but in my experience it has not proved of great value.

3. False teeth and all foreign bodies should be removed from the mouth.

4. Bands which tend to constrict the neck or waist must be loosened.

**Rules for Administering Chloroform.**—The following rules are to be observed in the administration of chloroform:

(a) An examination of the patient beforehand as to the condition of her vascular system, lungs, and kidneys. A weak or a laboring, dilated heart are contra-indications prohibiting the use of chloroform.

(b) The assistant who gives the chloroform must be accustomed to its use, and must realize keenly that there is danger in every case.

(c) It is never right to assign the administration of chloroform to one who has been accustomed to administer ether only, and in no case should anesthesia by chloroform be intrusted to a nurse, unless a responsible physician keeps the patient constantly under his supervision during its use.

(d) Chloroform should never be given, except in obstetrics, without abundant help close at hand to resuscitate in case of asphyxia.

(e) The patient must not be disturbed in the early stages of anesthesia by slamming doors, loud walking, or talking. I have seen a patient jump up and refuse to take more when frightened in this way.

(f) Chloroform must be given from a graduated bottle containing a definite quantity, a few drops at a time on the inhaler, with an abundant admixture of air.

(g) The anesthesia must never be hurried, and, above all, the person giving it must not use the common exhortation, "Breathe deeply."

(h) The head must never be raised higher than the body, to avoid sudden anemia of the brain.

(i) If the patient vomits, the chloroform should be put aside and the jaw

drawn forward, by hooking the fingers behind the angle, and the face turned to the side, until she is quiet again, when the anæsthetic may be resumed.

(k) If the anæsthetizer notes any alarming change in the patient's pulse, respiration, color, or pupils, he must at once suspend the anæsthesia, and, if the condition persists, proceed to resuscitate.

(l) If the respiration becomes unequal or stormy the chloroform must be immediately withdrawn, as there is no way of judging how much more of the drug is being absorbed than under ordinary conditions of breathing.

The patient must be carefully and continuously watched after the anæsthesia is over until she becomes conscious, as she may die in this post-operative stage. When a patient does not rally well and promptly she should be watched with increased care, and stimulants in the form of external heat, stimulating rectal enemata, and hypodermics of brandy, digitalis, and strychnine must be given. In such cases death has occurred several hours or longer after the operation.

A satisfactory way of using chloroform is completely to anæsthetize the patient with it, and then to continue the anæsthesia throughout the operation with ether. Chloroform may be given at the start by a physician, and the ether anæsthesia kept up by an experienced nurse.

The best method of giving chloroform is with the Esmarch inhaler. A few drops—not more than four or five—are poured on the flannel hood covering the little rounded wire frame, which is held at least five inches from the face. The patient should be slowly and gently brought under its influence by adding a few drops from time to time, and gradually bringing the inhaler closer to the face.

In case of difficult breathing arising from the root of the tongue dropping back in the fauces, the lower jaw must be seized behind the angles and pulled forward, producing subluxation, and the head at the same time extended, so as to bring the upper air passages and the trachea into line. (H. A. Hare's method, *Johns Hopkins Hosp. Bull.*, January, 1895.) The practice of using much force in pulling the jaw forward is reprehensible; patients frequently complain for days of soreness at the angles of the jaw, and I have seen parotitis occur as a result of the traumatism. If moderate force is not sufficient to draw the jaw forward it should be protected with pads of cotton or gauze, or the mouth should be opened and the tongue pulled forward with a tongue clamp; but it is rarely necessary to resort to this measure.

In giving chloroform the anæsthesia must never be hastened; in this respect the rule is diametrically opposite to that for the use of sulphuric ether.

**Resuscitation of the Asphyxiated.**—As soon as a pallid face, dilated pupils, a feeble pulse, and cessation of respiration are noticed, no time must be lost in proceeding at once to resuscitate the patient.

The operation must be instantly suspended, arteries in the field of operation whose lumina can be seen (for they will have ceased to bleed) must be temporarily clamped, and the wound hastily protected with sterilized gauze, while an assistant jumps upon the table, grasps the patient's legs beneath the knees, and lifts the body up to an angle of 40 or 45 degrees, until it rests on the shoulders. In this way the blood gravitates down into the head and heart.

The surgeon takes his stand at the head, which lies extended over the edge of the table, and proceeds at once to establish artificial respiration by placing both hands behind the chest and drawing it toward him, producing inspiration (Fig. 103); by the reverse movement, pushing backward and inward, expiration is produced (Fig. 104). An assistant making pressure in the epigas-

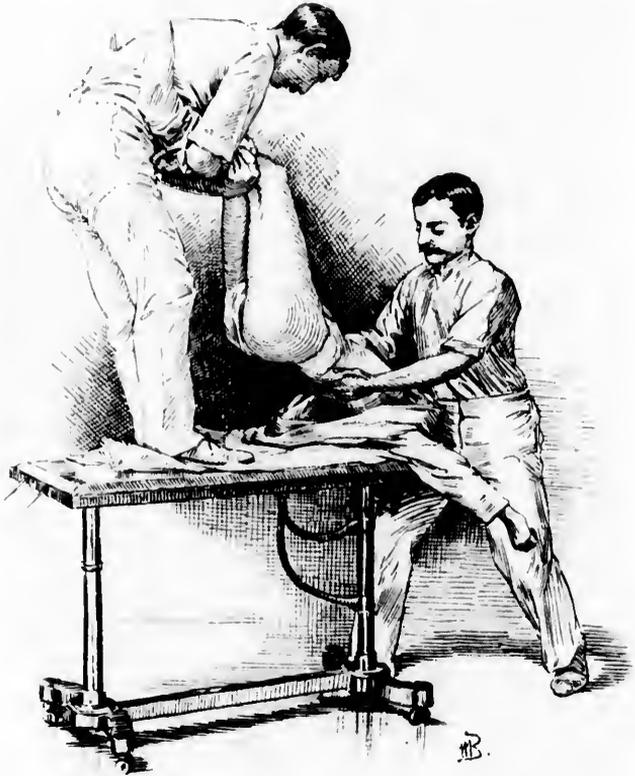

FIG. 103. INDUCTION OF ARTIFICIAL RESPIRATION AFTER CHLOROFORM ANESTHESIA.

The patient's head hangs extended over the edge of the table while an assistant at the table elevates her body. The operator then induces inspiration by drawing the lower thorax well forward.

trum prevents the effect of the respiratory efforts being lost on the abdominal viscera. The air can be heard rushing in and out, pulsation is soon felt at the wrist, at first feebly, then stronger, the color becomes natural, at-

tempts are made to respire, and in a short time the danger is past, when the operation may be resumed. If the pulse can not be felt at the wrist it may be found by feeling the abdominal aorta through the incision. If it is not

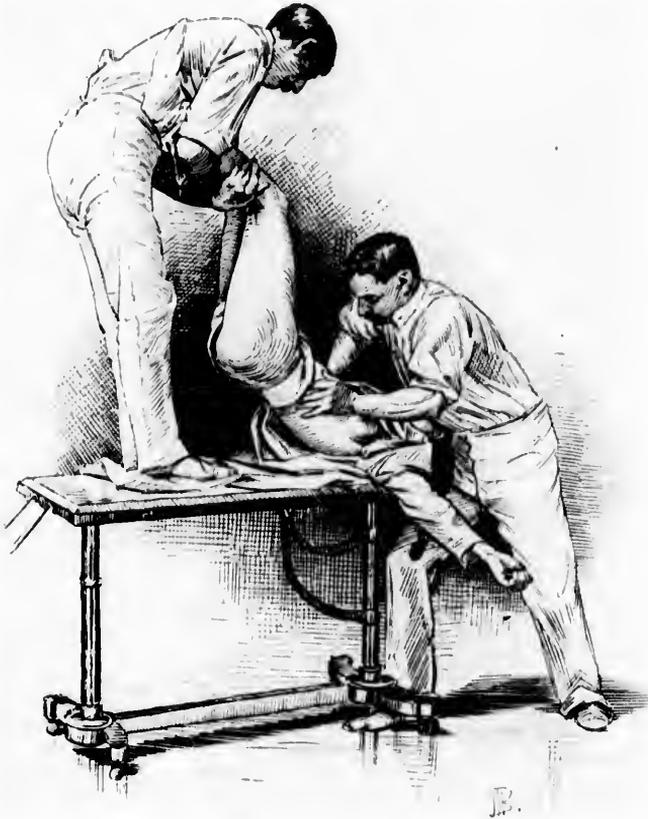
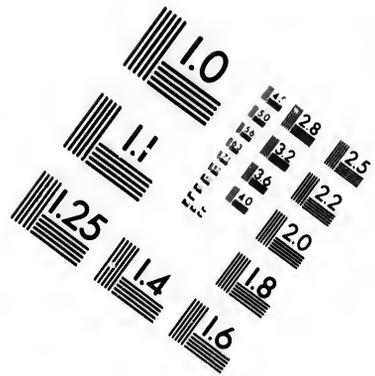
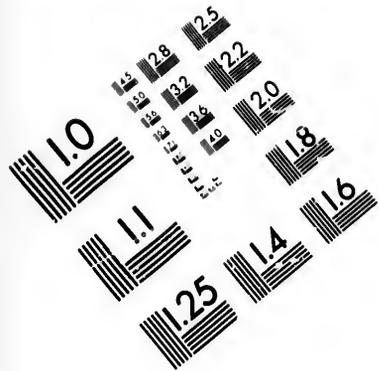

FIG. 104. THE INDUCTION OF AN INSPIRATION IS FOLLOWED BY THE COMPRESSION OF THE LOWER CHEST, PRODUCING A FORCED EXPIRATION.

felt there the hand may press up through the diaphragm and feel the heart directly.

Where the lower chest is contracted by the wearing of corsets and when the costal cartilages are calcified this manipulation will not produce respiration, and it is necessary to force air in and out of the chest by placing one hand on the middle or lower thoracic spine and the other on the sternum. Then, com-



# IMAGE EVALUATION TEST TARGET (MT-3)

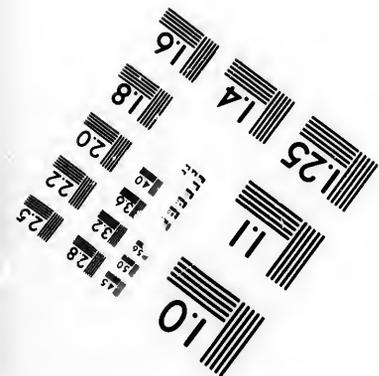
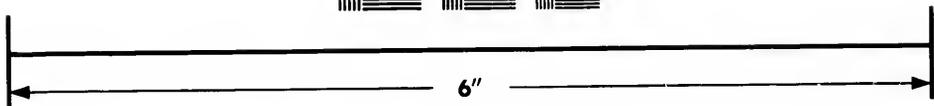
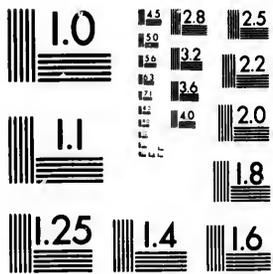

Photographic  
Sciences  
Corporation

23 WEST MAIN STREET  
WEBSTER, N.Y. 14580  
(716) 872-4503



pressing the chest, air is forced out, and by relaxing the pressure it rushes in again. In this way a regular respiration may be maintained until it is established voluntarily. The larynx can be kept open by hooking an index finger into it.

If it is necessary to resort to artificial respiration when there is not a sufficient number of assistants present to carry out the method just described, as may occur in private practice, the plan formulated by Dr. Sylvester should be followed. By this method the patient is quickly placed in position across the bed with a pillow or roll of clothing beneath the thorax. The surgeon, standing at the head of the patient, grasps her arms at the elbows and draws them upward and outward, describing a circle, until they meet above the head. This movement induces inspiration by expanding the chest through the agency of the pectoral muscles. After a pause of two or three seconds the arms are swept downward and outward to the sides of the chest, against which they are firmly pressed. This maneuver induces expiration by diminishing the capacity of the chest. The two movements should average eighteen to the minute.

#### ETHER.

Under this title, in America, washed sulphuric ether is universally understood. Only that brand known to be the purest in the market should be used. Ether is contra-indicated in bronchial catarrh, or where its use excites bronchorrhea, or constant coughing with asphyxia due to irritation of the air passages, or violent continuous nausea. Chloroform must then be used. It is not contra-indicated in kidney disease, nor in any other disease, except where the act of straining may prove injurious, or where the patient is so weak that any little additional exertion may prove fatal. I have lost but one case on the table from ether anesthesia, and the autopsy showed atheromatous arteries and chronic myocarditis.

Various styles of ether inhalers have been devised, but I consider the towel cone, stiffened with paper, as after all the most satisfactory; it is easily made, and a fresh one can be prepared for each patient. A stiff piece of blotting paper or moderately heavy manilla paper, 15 × 10 inches in diameter, should be covered with oiled muslin, and this in turn with a clean towel. The oiled muslin may be dispensed with if not at hand. This pad is then twisted into the shape of a cone and then pinned together. A moistened sponge or piece of cotton is lightly packed into the apex, and upon this the ether is poured. It is always best to give ether gently, soothing the patient and letting her grow gradually accustomed to the vapor as it is brought nearer and nearer to the face. A few minutes spent in this way will obviate entirely the necessity of forcing the patient down on the table and strangling her with the drug, a procedure never to be forgotten.

In the early part of the anesthesia only small quantities of ether should be used, and no attempt should be made to force the patient to take it rapidly. If the patient is told to breathe deeply the respirations will continue full and regu-

lar, according to the suggestion of the anesthetizer, until her volition is overcome, when there is a cessation in the breathing which prevents the even administration of the ether. For this reason I think it is best to instruct the patient to breathe naturally, and only to command her to breathe deeply when she persists in holding her breath. By gradually bringing the inhaler nearer the face and allowing at short intervals a breath or two of fresh air the disagreeable strugling sensation is avoided. As soon as she loses consciousness it is an error to remove the ether whenever there is a disposition to vomit; this is best overcome by increasing the quantity of ether and getting her more completely anesthetized. A timid anesthetizer, by hesitating at this point, can harass an operator throughout a long operation.

**Operation under the Primary Effect of Ether.**—At an early stage of the anesthesia, just as consciousness is lost, there comes a short period of relaxation and insensibility, which can be utilized for such short operations as paracentesis, dilating a sphincter, opening an abscess, excising a small tumor on the surface, or passing two or three sutures.

In two or three minutes this stage is passed and a noisy, excited stage may follow, which lasts ten or fifteen minutes or longer, finally passing into the stage of profound anesthesia. When this final stage is reached it is important to give just enough ether to keep the patient completely relaxed and unconscious, and not a bit more. While coming out of ether anesthesia the patient must be watched, and assisted when she vomits by turning the head and body to one side, cleansing the mouth, and keeping her face clean and her pillow protected. Care must be exercised to keep her fauces clear and to prevent her from inspiring regurgitated food.

The duration of the period of unconsciousness depends greatly upon idiosyncrasy and upon the amount of the anesthetic taken; while one patient may come to in a half hour, another will lie sleeping or in a dazed state for four or five hours. It is generally safe in private practice for the physician to leave her in the care of the nurse after she has spoken.

The liability of patients coughing and straining excessively as they are coming out of the anesthesia must be borne in mind, and stitches and ligatures must always be put in so that they can not possibly tear out or give way from any such cause.

**Death from Anesthesia.**—In about 8,500 administrations of ether I have lost two patients from the anesthetic.

One of these, a woman of forty, died after the removal of an adherent ovarian cyst, presenting no unusual difficulties and not involving the loss of much blood. She died as the wound was being closed, after an operation lasting forty minutes; the first danger sign was a deep congestion of the intestines followed by cyanosis of the face, bulging eyes with widely dilated pupils, and an imperceptible pulse. Respiration became shallower and shallower, and there was no response to any form of stimulation or to all efforts to induce respiration. No cause for the death could be discovered.

The second death after ether occurred shortly afterward in the case of a

woman sixty-four years old—L. T. N., 4232, March 18, 1896—after an abdominal hysterectomy for an adeno-carcinoma of the uterus, lasting two hours. The patient was obese, weighing 235 pounds, and took the ether badly from the start. The pulse, which had become steadily more rapid and small, ceased first, while the respirations, labored throughout, became more labored and gasping, and the face livid. Artificial respiration could not be carried out on account of the unwieldy form of the patient.

One death has occurred in about 1,500 chloroform anesthetics. This was the case of a colored woman of forty-seven—B. B., 3257, January 1, 1895—who died during the early stages of the anesthesia.

She had taken chloroform on one occasion before, and objected so strenuously to ether that chloroform was again used. The first part of the anesthesia passed off quietly, but when placed for operation she became so rigid that the Esmarch inhaler was brought closer to the face, at no time nearer than two inches. This did not help the rigidity, and the respirations grew shallower. The chloroform was taken away at once and ether sent for; but the temporal and radial pulses had become imperceptible, and then respiration ceased. Efforts at artificial respiration were utterly ineffectual, owing to the fact that she had a rigid chicken-breasted chest with calcified cartilages. The autopsy revealed also an adherent left lung, abdominal viscera everywhere mutually adherent and attached to the diaphragm, and atheromatous vessels (see *Johns Hopkins Hosp. Bull.*, vol. vi, May-June, 1895).

## CHAPTER VIII.

### GENERAL PRINCIPLES INVOLVED IN PLASTIC OPERATIONS.

1. Preparation. Rest. Bowels. Urine. Dress for operation.
2. Operation. Position of patient. Washing of genitalia. Assistants. Irrigation. The operation. Dressings after operation.
3. Care during convalescence. Position of patient in bed. Douching, if necessary. Catheterization. Care of bowels. Diet. Care of wound. Removal of sutures. Rest and tonic treatment. Hemorrhage following operation. Infection.

All plastic operations about the vulva, vaginal outlet, vagina, and cervix have certain common details, which may be considered in the following order:

1. Preparation for operation.
2. The operation.
3. Care during convalescence.

#### PREPARATION FOR OPERATION.

Every patient should be subjected to a thorough general physical examination before the performance of any gynecological operation, in order to exclude the possible presence of any obscure disease that might account for the condition of ill health. If the examination shows that an operation is necessary, and the general health of the patient is much impaired, a rest of a week or more in bed will hasten the convalescence, toning up the system and quieting the mind. Such a preparation is especially valuable in the case of nervous women. Constipation, which is obstinate in many uterine affections, should be overcome by a purgative, the continued use of mild laxatives, and a light but nourishing diet should be given. If there is loss of appetite, a simple tonic, such as tincture of nux vomica, calumbo, or gentian, is often helpful. Women with marked debility will be benefited by massage, cold baths, and electricity. When, however, the general health of the patient is good and she is clearly suffering from purely local symptoms, the preliminary period of rest and tonic treatment may be dispensed with, and the operation may be done with but one or two days' preparatory treatment.

The older gynecologists invariably put their patients under a protracted course of preparation for an operation, while the present rule is to operate immediately and to build up the patient during her convalescence.

Immediately preceding the operation the bowels should be carefully evacuated, so as to avoid disturbing them for at least two days afterward. To insure thorough purgation, ℥ij of licorice powder, or a similar amount of magnesium sulphate, should be administered (both morning and evening of the day before),

followed the next morning at six o'clock by a warm enema of a pint of soap and water. If the patient is delicate a milder purgative, such as a pill of aloes, strychnine, and belladonna, or the solution of citrate of magnesium,  $\mathfrak{z}$  viij, may be given with good effect. The enema should be given quite three hours before the operation, regardless of the effect of the purgative, as it is essential to have the rectum and sigmoid flexure clear of feces. The action of an enema given later than the time specified is often delayed until the operation is under way, when the surgeon may be annoyed by the constant ejection of semi-fluid feces over the gauze diaphragm in front of the buttocks.

The urine must always be carefully examined both chemically and microscopically before operation. Diabetes is a contra-indication to any surgical operation in most cases. Nephritis in its early stages does not materially decrease the patient's chances of recovery. If, however, the constitutional and local symptoms indicate advanced nephritis, the operation should in no case be performed.

The early morning is the best time to operate, when the surgeon feels fresh for his duty and his hands are free from the contamination of his daily work; the patient should also have a good night's rest, insured if need be by a mild sedative. The evening before operation the patient should take a hot bath, and immediately go to bed. The following morning, after the enema, the vagina should be thoroughly cleansed with a douche of carbolic acid solution (2 per cent), or boric acid (32 grains to the liter), at a temperature of 110 F. As a rule, no food of any kind is given on the morning of the operation. If, however, the patient is weak or feels faint, a glass of warm milk, or a cup of tea diluted with milk, may be given.

The patient's dress for operation consists of an undervest of warm flannel in winter, or of gauze in summer, a nightgown open up the back, and a pair of long woolen stockings. The hair is most conveniently dressed by plaiting it in two braids.

If the operation is to be performed in a private house, the patient should be anesthetized in a room adjoining the one selected for the operation: in a hospital the anesthetizing room is always separate from the operating room.

#### THE OPERATION.

**The Position of the Patient.**—The operating table is covered with a blanket protected by a sterilized sheet, and upon this, at the end of the table upon which the buttocks are to rest, is placed a rubber perineal drainage cushion. The buttocks rest squarely upon the cushion, projecting slightly over the edge of the table, and the legs and thighs are held flexed upon the abdomen by a leg holder. To apply Kelly's or Robb's leg holder, buckle one end of it around the thigh just above the popliteal space, taking care to keep the band smooth, so that it does not bind the leg too tight. The other end is then carried up under the shoulder, around the neck and down to the opposite side, where it is similarly buckled above the popliteal space. When the patient is thoroughly under

the anesthetic this leg holder simply detains the legs, without cramping them, and the knees fall apart naturally without the assistance of the leather crutches and bar so much used in the past. The arms of the patient should be folded across her breast and retained in this position by drawing the skirt of the under-vest well up over the elbows. The nightgown should be pushed up under the small of the back above the drainage cushion.

The external genitals are thoroughly soaped and shaved up to the mons veneris. Robb's razor, with a short fixed metal handle devised for this purpose, is useful. After shaving, the genitals should again be thoroughly washed with soap and water. Green soap or soft soap serves admirably for the purpose; it can be thoroughly rubbed into the skin, cleansing better than hard soap. Be careful to cleanse all furrows between the labia and about the clitoris.

After the external parts have been cleansed, the assistant takes a pledget of cotton covered with soap, and introducing it into the vagina with long forceps, under a stream of water from the irrigator, smooths out all furrows and scrubs thoroughly all accessible parts, so as to remove the discharges and accumulated epithelial *débris*. Then the vagina is douché with a 10 per cent creolin solution, which sterilizes and acts as an efficient detergent. This solution is followed by a bichloride of mercury solution (1-2,000), and this again by warm water. A thorough vaginal cleansing will require from three to five minutes.

Long sterilized cotton flannel stockings are now drawn over the patient's legs and fastened above the knees with a draw string. A protector 1 meter square (1 yard), composed of two thicknesses of gauze, is spread between the thighs, covering all the exposed parts, and hanging well down over the buttocks onto the cushion; as the surgeon takes his seat he cuts a small opening in the protector corresponding to the vulva so as to expose the field of operation.

**Assistants.**—For convenience of rapid work the surgeon will do best with four assistants—one to give the anesthetic, two standing on either side of the patient to help the operator, while the fourth hands the instruments and ligatures as wanted. In operations conducted in a private house or private hospital the operator can make shift with two assistants—one to give the anesthetic and one to assist him directly.

**Irrigation.**—Irrigation by a continuous stream of warm water directed over the field of operation is the best means of removing the blood, leaving the line of incision and denudation constantly clear. Sponging is not so good, only imperfectly removing the blood, which remains to coagulate about the ligatures and to cling to the hands of the surgeon, rendering them sticky and slippery. A glass reservoir holding several gallons of water should be placed on a shelf at an elevation of five feet above the operating table. The rubber tubing from the reservoir, when not in use, should be coiled and kept immersed in a 5 per cent carbolic solution. It is best to regulate the flow by a glass douche nozzle, an Esmarch's hard rubber stopcock, or an efficient ball-and-

socket nozzle, like the one here figured, because either can be easily detached for sterilization.

The assistant on the right hand of the patient takes charge of the irrigation, keeping the area upon which the surgeon is working free from blood.

In vaginal hysterectomy a normal salt solution ( $\frac{1}{10}$  of 1 per cent) should be used; it is not irritating and does no harm even though it enters the peritoneal cavity.

**The Operation.**—Just as the artist, with a few rapid strokes, sketches in the outline of his picture, so the surgeon will first outline his field of a plastic operation by incisions, marking its outer limits. This will enable him to judge more deliberately as to the amount of tissue to be removed; it is better, of course, to err on the side of a small outline than a large one, because a small outline may be enlarged so as to include more tissue, if found necessary. Outlining with the knife is especially important where scissors are to be used; the knife cuts a sharp line and the mucous surfaces then pull apart, permitting a rapid denudation with the scissors and subsequent accurate coaptation of the edges.

Bleeding is rarely active in plastic operations, the vessels being of smaller caliber. If, however, there is enough bleeding to annoy the operator, the vessels may be temporarily caught with artery forceps until the sutures are introduced. A large vessel which persists in bleeding after the forceps are taken off may be controlled by introducing one of the sutures approximating the parts, so as to grasp the vessel in its loop; this suture should be tied tighter than an ordinary approximating suture, so as to check the bleeding, and thus it serves the purpose of both suture and ligature.



FIG. 105. SWEDISH HARD RUBBER BALL AND NOZZLE IRRIGATOR.

By bending the nozzle in the ball at an angle the flow is controlled or stopped altogether.

The sutures are of three kinds—silkworm gut, silk, and catgut. Silkworm-gut sutures best bear the tension in bringing together widely separated areas. Silk and catgut sutures are used for accurate approximation, either to supplement the silkworm-gut sutures, or alone, where there is but slight tension in bringing the wounded surfaces together. Catgut is ill adapted for use, if there is any outward traction of the wound. The best suture for close approximation is fine silk, which offers the least possible opportunity for the entrance of septic matter. Silver wire is now rarely used, and there are no circumstances under which it is better than silkworm gut.

**Dressings after the Operation.**—At the end of the operation the vagina and external genitals are dried by pledgets of sterilized cotton. A strip of iodoform gauze may then be inserted into the vagina with the three-pronged packer as far up as the cervix, loosely filling the upper vagina and just appearing at the outlet; this should be taken out in five or six days and the vagina douched daily afterward.

It is my practice at present to use no vaginal dressing at all, but simply to

protect the vulva by a sterilized gauze pad held in place by a T-bandage. The pad is changed several times daily, and if there are any offensive discharges the vagina is douché out with a warm borie or carbolic solution once or twice a day. I have found a powder composed of borie acid, 3 ounces; alum, 1 ounce; carbolic acid,  $\frac{1}{2}$  ounce; and oil of peppermint,  $1\frac{1}{2}$  drachm, very satisfactory in relieving the odor and irritation which are sometimes distressing during the convalescence from a plastic operation.

Before removing the patient from the table draw the urine with a glass catheter, loosen the leg holder, and raise the buttocks by carrying the feet of the patient toward her head; dry the genitals, buttocks, and back with a towel, and remove the drainage pad.

The external genitals should be powdered with iodoform and borie acid (1-7), and then covered with a loose pad of sterilized cotton, held in place by a T-bandage.

#### CARE DURING CONVALESCENCE.

A nurse or doctor should remain with every patient, controlling any violent movements until she has fully recovered consciousness. In rectal and perineal operations it is not necessary to follow the old practice of restricting the movements of the legs with a binder after she becomes conscious. She may also be turned on her side if she wishes.

In perineal operations the bedpan must be used for two weeks and straining avoided. After cervical operations this restriction is not necessary, and cervical cases are required to stay in bed from seven to ten days only. If the patient can pass her urine voluntarily from the first she should be permitted to do so.

The vaginal pack is removed when a discharge appears externally, and when the discharge continues a douche is necessary; it should be given with the greatest care, to avoid pressure of the nozzle on the wound, once or twice daily. A trained nurse, or the physician himself, should attend to this duty, for it has not infrequently happened that an unskilled nurse or an ignorant attendant has thrust the point of the syringe through a recently repaired perineum.

The nurse should be instructed how to separate the labia and expose the outlet with one hand by pushing downward and backward without making traction on any sutures. Secretions are now removed with pledgets of cotton held in the dressing forceps, and the blunt glass douche nozzle, gently poised between the thumb and index finger, is introduced in a direction backward and inward. Be careful to expel the air from the douche nozzle before it is introduced into the vagina. After the douche is given the genitals are dried with pledgets of sterilized cotton dusted with iodoform and borie powder (1-7), and covered again with a sterilized cotton vulvar pad. Under no circumstances should the hands come in contact with the field of operation. Except in cases of infection, douches should not be given earlier than the seventh day.

**Catheterization.**—A serious complication to be guarded against in all plastic operations is a cystitis caused by catheterization, and for this reason I wish to speak with special emphasis about catheterizing and the care of the catheter.

In skilled hands the glass catheter is best. Immediately after use it should be rinsed in warm water and boiled for five minutes in a soda solution, and preserved aseptically, wrapped in sterilized gauze, or immersed in a bottle of carbolic solution (5 per cent); or it may be stored in a glass ignition tube, resting on cotton and plugged with sterilized cotton. Metal catheters should not be used. Rubber catheters are safest in untrained hands, and are sterilized by keeping them in a carbolic solution (20 per cent); the catheter should be rinsed in boiling water before using.

Catheterization must be performed in the following manner: The vulva is exposed under a good light, so as to bring the urethral orifice into full view upon separation of the labia with the thumb and forefinger of the left hand. Then, with the dressing forceps in the right hand, the parts immediately surrounding the urethra may be cleansed with pledgets of sterilized cotton saturated with boric acid solution; now take the catheter from its receptacle, without touching its vesical end, and introduce it gently into the bladder, not attempting in any way to control its direction; it will follow naturally the course of the urethra. Before withdrawing the catheter, stop up its outer end by the finger to prevent the urine from dribbling over the parts. Finally, dust the vulva with iodoform powder, and replace the sterilized T-bandage.

**Care of the Bowels.**—On the second evening following the operation a pill of aloin, strychnine, and belladonna, or two drachms of licorice powder, or a half drachm of cascara, is given, followed the next morning, if necessary, by a soap and water enema. The custom of confining the bowels for eight or ten days is reprehensible. There is no danger of fecal matter gaining access to the wound, even where sutures have been passed on the rectal surface if they have been properly placed and properly tied. There is likewise no danger of disturbing united wound surfaces by the downward displacement of the pelvic floor during defecation on the third or fourth day following operation, if the feces are soft or fluid. When the bowels are confined for a longer period, there is often great difficulty in securing a movement, and the effort to pass the scybalous masses is now attended with real danger, because the sutures have become loosened and the union of parts is not sufficiently firm to withstand the pressure.

Only a trained nurse or the surgeon himself should give the enema. I have known an inexperienced person to push the nozzle of the syringe through the coats of the bowel and force the injection into the pelvic cellular tissue. In one case I knew a nurse to push the end of the syringe through the stitches of a ruptured perineum and inject into the vagina. The most convenient position for giving the enema is with the patient lying on the left side. If a scybalous mass blocks the rectum the surgeon must himself introduce his index finger, break it up, and hook it out, making pressure in a direction away from the wound. When the bowels are once thoroughly opened, they should be kept open by a mild laxative, or an enema given every other day.

**Diet.**—No food is given until the patient has recovered from the nausea following the anesthetic. After from twelve to twenty-eight hours the stomach

is usually sufficiently settled to permit the retention of small amounts of liquid nutriment. It is best to commence with from 30-60 cubic centimeters (1-2 ounces) of milk every two or three hours, followed in a day or two by light broths of chicken, beef, or mutton. If nausea is persistent, a nutrient *enema* should be given to sustain strength, consisting of 60 cubic centimeters of milk and the yolks of two eggs, with enough water to make 120 cubic centimeters (4 ounces). Tea well diluted with milk, hot beef tea with the yolk of a raw egg stirred in, rice soup, kumiss, are usually well borne.

From the third to the seventh or tenth days soft diet is best—soft boiled eggs, sweetbreads, oysters, white meat of chicken, milk toast, rice, bread, mush, baked apples, and baked potatoes. After the seventh day full diet may be gradually resumed.

**Care of the Wound.**—Where the wound is entirely or partly on the surface, the chief point in its cure is to keep all objects which might convey infection from coming in contact with it; for this reason neither the surgeon nor the nurse should touch the wound with the hands in the subsequent dressings. The removal of discharge and arrangement of the gauze or cotton dressings should be effected with sterilized forceps.

If there is free discharge, it should be removed once or twice daily with pledgets of cotton, followed by a light dusting of the surface with the iodoform and boric powder mixture.

The length of time during which the sutures should be allowed to remain varies both with their position and with the results aimed at. If the healing is uninterrupted, the skin sutures may be removed with safety on the eighth day. Those within the vagina should not be removed before the twelfth day, or even later, on account of the danger of separating surfaces not yet firmly united.

Cervical sutures of silkworm gut may remain in place almost indefinitely, and, if the operation has been one of combined cervical and perineal repair, their removal should never be attempted until the perineum is quite firm and sound again, in from four to six weeks.

In order to remove the sutures, the patient is brought across the bed, or, better still, placed on a table, with the buttocks toward a good light, and the legs flexed upon the abdomen. The dressings and any incrustated powder are removed by sopping the parts with a warm boric acid solution; if the field of operation is within the vagina it is exposed with specula or retractors. In removing cervical sutures a Sims's speculum is inserted and the posterior vaginal wall retracted, while the anterior wall is elevated by a narrow flat retractor. The first suture seen is caught with forceps and pulled upon until its loop comes into view, which is then cut and the suture withdrawn. The remaining sutures are found by displacing the cervix first to one side and then to the other. Sutures upon the floor of the vagina can not always be readily exposed, and are often best located by touch and then grasped with forceps and removed.

Stitches on the rectal side are readily removed by drawing them through the fenestrum of a rectal speculum which is pushed into the bowel, exposing

the line of union, as practiced by Dr. G. M. Tuttle, of New York. Care must be taken in cutting the loop not to cut off both sides at once, as a loop thus left in the tissues will invariably cause persistent irritation and discharge, and must be removed sooner or later.

**Rest and Tonic Treatment.**—A patient upon whom a minor plastic operation has been performed should remain in bed for two weeks or longer, both for the purpose of securing firm union of the tissues, as well as for the equally important purpose of building up the nervous system and recruiting the general health. Advantage should be taken of the opportunity to keep neurasthenic patients in bed eight weeks or longer, giving them at the same time the benefit of a rest cure. From the fourteenth to the eighteenth day, depending upon the general improvement in symptoms, the patient may be permitted to put on a light wrapper and sit in a reclining chair or lie on a couch in sunny parts of the room. By the twentieth day she may resume her lighter duties, gradually increasing them during the succeeding days, until she has returned to her customary routine of work. The tendency of our hospitals is to make the stay of poor patients too short and to hurry them home.

It is a serious error to consider the function of the surgeon at an end when the wound is well healed and the operation in a technical sense successful. Patients who have long been in bad health before operation should be kept under observation for months afterwards, for the purpose of directing exercise, diet, and tonic treatment. Suitable exercise should be regularly and persistently taken, short daily walks in the open air, and rubbing down with alcohol or cacao butter on going to bed. Morning and afternoon the patient should rest for an hour on the back. Gymnastic exercises are not necessary, and exhausting exertion, such as shopping and dress fitting, must be avoided. Such tonics as tincture of *nux vomica* and the preparations of hypophosphites combined with cinchona often encourage a poor appetite. Koumiss, malt extract, or malt and milk, are valuable aids to the ordinary diet. One of the best therapeutic agents is a complete change of air for two or three months—in winter to a warmer climate, in early spring to the seashore, or in summer to the mountains.

In all of these cases it is absolutely essential to a perfect recovery to relieve the patient's mind of anxiety; for this reason the burdens of her regular duties, whether social or domestic, must be cast off or lightened as much as possible. As a general rule, the sexual relation should be prohibited for three months after plastic operations involving the vagina, and should then not be permitted oftener than once a week.

**Hemorrhage following Operation.**—An active hemorrhage is occasionally seen after a vaginal operation; it usually arises within the first week and persists for twelve twenty-four, or forty-eight hours, or even longer, if unchecked. Such bleeding, while rarely threatening life, is always an annoying complication on account of the difficulty of access to the bleeding point; it also renders the patient profoundly weak and anemic, and prolongs convalescence. To control the hemorrhage, bring the patient across the bed or on a table in the lithotomy position, with a good light on the parts. Withdraw the vaginal pack if there is

ne, and wash the vagina free of all clots; after the douche, elevate the anterior vaginal wall with a small speculum and expose the whole wound area, cleansing it with small pledgets of cotton until the bleeding point is found. A curved needle carrying a small silk suture is then passed deeply beneath the point and the suture tied, controlling the flow. When the circumstances are not favorable for such a prompt and direct treatment, a tampon of sterilized non-absorbent cotton must be applied in such a manner as to make pressure upon the whole wound area. After twenty-four or thirty-six hours the pack is removed, but if the oozing persists it must be again applied. A tight pack skillfully applied does not often interfere with the union of the parts.

**Infection.**—The symptoms of infection following plastic operations are similar to those which may arise from an infected wound anywhere in the body. Ordinarily they do not show themselves before the third day, and it may be even longer than that before the surgeon is able to differentiate clearly between the usual sequele of operation and an infected process. Fever is usually present, and the pain of beginning sepsis is lancinating in character, and extends from the labia down the inner thigh. When the patient locates pain in this region no time should be lost in discovering the seat of infection. If it is about one of the sutures, as is most likely to be the case, the suture should be removed at once, and if a pus cavity of considerable size is found, it must be freely drained. In the early stages, where the symptoms are suspicious but the seat of infection can not be accurately determined, the application of hot poultices will not only relieve the pain, but so hasten the inflammatory process that a definite diagnosis can be made.

Hot injections of a solution of bichloride of mercury (1-5,000) every four or five hours also gives relief. But this treatment should not be continued longer than forty-eight hours, on account of the danger of mercurial poisoning. If the whole wound looks red and angry, all the sutures must be taken out and the wound allowed to heal by granulation. Sometimes an abscess of considerable size forms laterally, near one or the other of Bartholin's glands; in this case an incision should be made directly into the cavity, as far as possible away from the seat of operation, so that the ultimate results of the operation may not suffer from the infection.

Very often, by taking out a single stitch, a small stitch-hole abscess will discharge and the trouble be over. The outcome of a bad infection, extensive in area, may sometimes be surprisingly good; I have seen a complete rupture of the perineum granulate down to perfect control over the sphincter ani.

## CHAPTER IX.

### DISEASES OF THE EXTERNAL GENITALS.

1. Advantages of superficial position for operation: *a.* Hemorrhage easily controlled. *b.* Defects easily covered. *c.* Asepsis. *d.* Sutures.
2. Diseases of labia majora: *a.* Lipoma. *b.* Hydrocele. *c.* Inguino-labial abscess. *d.* Pseudo-myxoma of the canal of Nuck. *e.* Hernia. *f.* Myoma of round ligament. *g.* Condyloma. *h.* Carcinoma.
3. Diseases of labia minora: Cysts.
4. Diseases of clitoris: *a.* Adhesions and concretions. *b.* Elephantiasis. *c.* Sarcoma. *d.* Carcinoma.
5. Diseases of vulvo-vaginal glands: *a.* Cyst; *b.* Abscess; *c.* Adeno-carcinoma; *d.* Myxo-fibro-sarcoma.
6. Affections of the vulvar mucosa: *a.* Cohesion. *b.* Pruritus.

IN considering the surgical diseases of the external genitals, we take up the affections of some five different structures—namely, the labia majora, the labia minora, the clitoris, the mucous membrane about the vaginal outlet, and the vulvo-vaginal glands.

There is no common principle other than contiguity uniting these diverse organs in their pathological affections, the list of which is but short, including neoplasms, elephantiasis, cysts, abscesses, and pruritus.

In spite of the situation of these organs upon the exterior of the body, they are so well protected by the thighs that they are but rarely subjected to violence. I have seen a case in which a hematoma has been produced by the kick of a brutal husband: a girl of twelve was brought into the ward of the Johns Hopkins Hospital suffering from a severe hemorrhage, with a large hematoma of the perineum and left labium, the result of a fall astride a fence rail on which she had been standing. I know of instances in which the external genitals have been injured in young girls by sliding down balusters and striking a low newel post. In one case, in the care of Dr. Jacob Price, of West Chester, Pa., a vulvar laceration was produced by the horn thrust of an angry cow.

Operations upon the external genitals are among the simplest and least dangerous gynecological procedures, on account of the superficial accessible position of the organs.

Hemorrhage, although often free, particularly in operations involving the clitoris, is always readily controlled. Deep sutures uniting the edges of the wound are usually sufficient to control the bleeding without the aid of buried ligatures. The free anastomosis of numerous smaller vessels is the means of effecting a rapid union of wound surfaces. It is also easy to cover up large defects created by the extirpation of tumors and neoplasms with the lax movable adjacent skin. Situated on the surface of the body, the wound is readily pro-

ected, and its aseptic condition easily preserved after operation; for this reason suppuration does not often occur.

For suture material I prefer silkworm gut as a tension suture, and fine silk or catgut for accurate approximation. The need for an absorbable material is not so great where the sutures can be so readily removed, but for greater convenience the subcuticular catgut suture is perhaps the best.

#### LABIA MAJORA.

**Lipoma.**—Lipoma, or fatty tumor, is one of the rarest gynecological affections; no writer has as yet recorded more than a single instance in his own practice. In the Johns Hopkins Hospital Reports, vol. iii, page 321, I collected all the cases I could find in the scattered literature, numbering only twenty.

Lipomatous tumors are usually easily recognizable, as they possess the same characteristics as lipomata elsewhere. The labium itself is enlarged when the tumor is attached to it by a broad base, or the tumor may hang by a pedicle more or less attenuated. In a case which I saw in the Episcopal Hospital, Philadelphia, an ovoid tumor, 8 centimeters (3 inches) long, hung from the middle of the right labium majus by a slender pedicle 5 centimeters (2 inches) in length and not more than 3 millimeters in thickness. The pedicle of a large lipoma, on the other hand, may extend up into the inguinal canal, in which case the tumor simulates a hernia. The base of the growth has

also been found extending back on to the perineum, or even up into the vagina. The length of the pendulous growth in one case was 55 centimeters (22 inches).



FIG. 106.—HEMATOMA OF THE VULVA OCCUPYING THE LEFT LABIUM MAJUS AND EXTENDING DOWNWARD ONTO THE PERINEUM.

The vaginal outlet is discolored and all of the surrounding parts distorted and infiltrated with blood. Below is an abrasion of the skin. The patient fell astraddle a chair.

Dr. William Goodell, of Philadelphia, observed a case attached by a broad pedicle hanging down to the knees. Balls-Headley, of Melbourne, removed a tumor which weighed 24 pounds.

The lipoma feels hard or soft, according as the fibrous septa or the fat predominates. When there is an excess of fat, the sense of fluctuation is so distinct that the inference that the tumor is cystic is almost irresistible. Under this impression Goodell inserted an exploring needle into his case.

It is easy to mistake such a mass for a hernia, where the pedicle is broad and extends up into the inguinal canal, and where there is impulse on coughing, together with some apparent reduction on manipulation and upon lying down, as has been recorded.

Age is not an important factor; the youngest patient I have found noted was eighteen, and the oldest, operated upon by Dr. A. H. Deekens, in Philadelphia, sixty-one.

The larger growths take years to develop. One woman carried her burden seventeen years.

A large tumor hanging between the thighs is apt to become ulcerated from attrition, and an extensive hemorrhage may arise from such an area.

The chief distress comes from interference with walking, with the sexual function, and in one case, obstruction of the vaginal outlet during labor. Both of these difficulties existed in one of my own cases, in which a large globular fatty tumor hung from the left groin close to the labium majus; nevertheless, the patient carried the growth thirteen years until it alarmed her by becoming ulcerated.

The diagnosis rests upon the following factors: The tumor is a well defined ovoid or round, softish, fluctuating or hard, generally pediculated, often covered with wrinkled or lobulated skin, not reducible, is slightly hardened by the application of cold, and the septa may be faintly outlined on the surface, and is painless unless ulcerated.

The treatment is extirpation; if the pedicle is long and thin, it may be simply constricted firmly or slightly abraded and surrounded for ten minutes by a pledget of cotton wet with a saturated solution of cocaine, and then cut off at a distance of 1 or 2 centimeters ( $\frac{3}{8}$  to  $\frac{1}{2}$  inch) from its attachment. The growth is often supplied by a single artery in the center, which should be tied with catgut. The wound is closed by catgut sutures, and the dressing applied. Where the pedicle is not so well defined, one may often be formed by grasping the tumor and drawing it out from the body. The incision must here be made well out from the body on the under side of the tumor, otherwise there will be a large defect in the skin when the tumor is taken away. There is no objection to utilizing a part of the skin covering of the growth in this way, as it is in all respects normal, and there is no danger of the tumor recurring.

Large sessile growths extending up into the inguinal canal, or into the vagina, or out on to the perineum, must be removed by making an oval incision through the skin over the growth, and shelling out the fatty mass, ligating bleeding vessels, and then approximating the skin with sutures. Injections with alcohol or

removal by burning through the pedicle with the cautery, or ligation of the pedicle, leaving it to slough off, as practised in the past, ought to be abandoned.

**Hydrocele** is an affection of the persistent canal of Nuck, characterized by an accumulation of fluid within it; it is exceedingly rare, owing to the fact that the canal is normally completely obliterated in the adult.

The hydrocele presents the appearance of a rounded elongate or moniliform cord extending like a string of beads from the region of the external inguinal ring down into the labium majus.

When the distended sac shows the constrictions, they appear in a succession of little swellings; at other times there is only a single elastic enlargement at the upper and outer angle of the vulva.

The diagnosis is established by noting the location of the affection, its direction upward toward the inguinal canal, and the fact that it does not give rise to any characteristic symptoms.

If the canal is patulous above, the fluid may be forced back into the abdomen.

The absence of any intestine from the canal may be ascertained both by percussion and by placing a finger over the ring and partially closing it, while the fluid is forced back into the abdomen by pressure made upon the tumor with the other hand; the sensation communicated is that peculiar to fluids alone.

When a hydrocele can not be differentiated from a small solid tumor in the canal, the use of the aspirator will determine the diagnosis in a simple and safe way.

Eucysted hydrocele should first be treated by aspiration, after cleansing and shaving the part immediately over the swelling; if the tumor returns, the sac should be exposed and dissected out of the labium, all hemorrhage stopped, and the wound closed with catgut.

A sort of false hydrocele of the upper part of the canal is often associated with the presence of a large amount of ascitic fluid in the abdomen, and depends upon the increased intra-abdominal pressure as its cause. The treatment then is that of the intra-abdominal condition producing the ascites, after which an operation may be called for to close the neck of the sac at the inguinal ring to prevent the occurrence of an inguino-labial hernia.

**Inguino-labial Abscess.**—I have found this condition in the left inguinal canal of a mulatto; it occupied the upper outer part of the labium, and was about 3 centimeters in length by 2.5 centimeters in width. The abscess was hard but slightly irregular, movable, very painful on pressure, and associated with a rise of temperature.

After due preparation an oval incision was made over the enlargement and the entire honeycombed abscess was enucleated from the inguinal canal down to the pubic ramus, which was laid bare. The chief difficulty in the extirpation arose from the extreme vascularity of all the surrounding adherent tissues. Hemorrhage was controlled by numerous ligatures passed deeply under the tissues and tied tight. A thin strip of iodoform gauze made an efficient drain for such oozing as could not be checked immediately. This was removed in

two days, and the wound healed throughout; the skin sutures were removed in a week.

**Pseudo-myxoma of the Canal of Nuck.**—I have observed this condition in a case of pseudo-myxoma of the peritoneum due to a ruptured ovarian cyst, in which

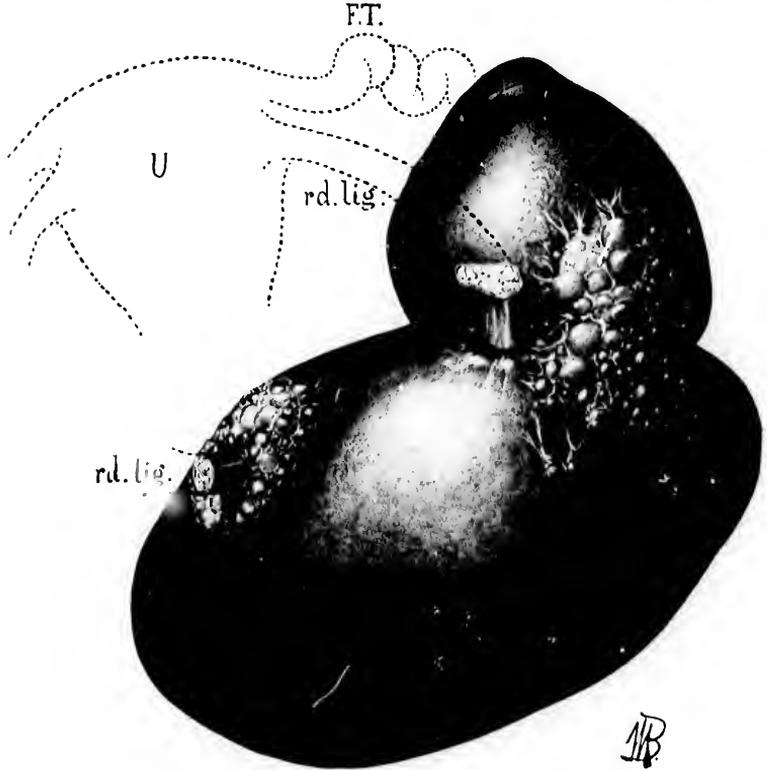

FIG. 107. MYOMA OF THE ROUND LIGAMENT WITHIN THE INGUINAL CANAL.

The tumor consists of two masses, of which the upper has pushed its way down into the pelvis behind the peritoneum, while the large mass filled the canal. The diagram shows its relations to the left round ligament; the little lobulated masses at each end are fat. Oct. 12, 1893. Natural size.

the encysted mass below the inguinal canal was about 3 by 2 centimeters, and shut off from the peritoneal cavity. The vermiform appendix was glassy and distended with the myxomatous material to three to four times its normal diameter.

**Hernia** appears in the form of *hernia inguino-labialis*. The hernial sac forms a pouchlike prolongation of the abdominal parietal peritoneum, and extends down into the labium majus, which may be greatly enlarged, displacing the vulvar orifice to the opposite side.

The sac presents a distinct swelling from its exit at the inguinal ring above down to its lower margin beside the vaginal outlet, and contains either omentum, or omentum and serum, or omentum and intestines.

The diagnosis is readily made upon observing that the tumor extends up into the abdomen, and that it is tympanitic, gurgles on pressure, and can be replaced by putting the patient on her back with elevated chest and flexed thighs in a position of relaxation; on standing and straining it descends again into the labium.

Tumors dull on percussion and irreplaceable are formed by a part of the omentum adhering to the neck of the sac, together with serous fluid transuded and incarcerated in the sac. The use of the fine needle of the aspirator will here settle the doubt. For description of the operation see Chapter XXXV.

**Fibroma and Myoma of the Round Ligament.**—The most common new growths of the round ligament are fibroma and myoma. Both of these tumors appear as small unilateral growths which gradually enlarge, giving, however, little or no pain.

The differential diagnosis between fibrous tumors of the round ligament and other affections of the inguinal canal is not difficult, depending upon the location, fixation, hardness, and painless character of the growth.

The following case of fibroma of the round ligament presented a typical history (C. H., October 13, 1893, Path. No. 65). The patient first noticed a small mass the size of a pea in the inguinal canal above the spine of the pubes, which grew gradually and never gave rise to any pain. On entering the hospital the tumor was about the size of an egg, slightly movable, painless on pressure, and irreducible.

The operation consisted in an incision along the course of the canal, exposure and ligation of the round ligament at the points of entrance and exit from the tumor, removal of the tumor, and closure of the canal.

**Pathological Report.**—Tumor, 8 by 6 by 5 centimeters, ovoid in shape, with a smaller mass springing from one side. The surface of the tumor is shaggy and in places masses of adipose tissue are seen. At the junction of the larger and the smaller mass is a cord, 5 millimeters in diameter, which runs directly into the mass. On section its fibers merge into those of the tumor. The tumor is dense, elastic on section, and of a uniform grayish color.

Microscopical examination: Tumor consists of fibrous tissues rich in nuclei; the fibers are more or less concentrically arranged around a central portion,

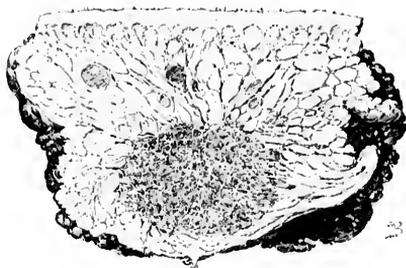

FIG. 108.—ADENO-MYOMA OF THE ROUND LIGAMENT.

Natural size in longitudinal section. The skin is above, beneath the skin is a coarsely reticulated fat with septa radiating from the adeno-myoma in the lower half of the specimen, and surrounding it. Several dark areas of hemorrhagic infarct seen in the fat.

which consists of non-striated muscle fibers with bands of fibrous tissue running between the striae. This center is definitely outlined from the surrounding fibrous tissues and is evidently the round ligament. The specimen shows every-

where groups of small canals lined by one layer of cells; these are probably lymph spaces. The specimen is poor in blood vessels.

**Diagnosis:** Fibroma of round ligament.

I have operated upon one case of adeno-myoma of the round ligament, one of the rarest of the tumors of this region. The growth is benign, and its clinical features in no way differ from fibroma. The tumor possesses considerable pathological interest conforming to the type described in Chapter XXXI, under the title of adeno-myoma of the uterus.

**Condyloma.**—Small condylomata are common in connection with gonorrhoea. I have seen but one case of extensive condylomata situated upon the lower left labium majus as large as a man's fist, in the practice of Dr. B. F. Baer, of Philadelphia. The patient was

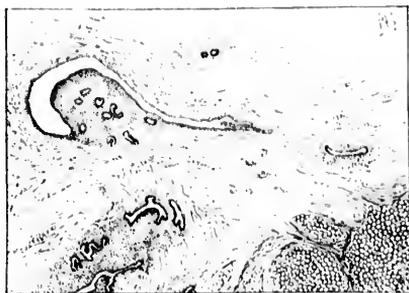

FIG. 109.—A PORTION OF THE ADENO-MYOMA, 12 TIMES MAGNIFIED.

The specimen consists chiefly of non-striated muscle fibers. In the right lower corner are masses of fat cells. In the vicinity of the left upper corner is a pseudo-glomerulus, composed of stroma, scattered throughout which are cross sections of several glands. The surface of the glomerulus is covered by one layer of cylindrical epithelium, and its capsule is composed of one layer of cells which in places are cuboidal or almost flat. The cells of the capsule have practically no underlying stroma, but lie directly on the muscle fibers. The space between the pseudo-glomerulus and the capsule, on tracing it to the right, is seen to be continuous with a gland cavity, and is nothing more than a dilated portion of the gland. Above and to the right of the pseudo-glomerulus are cross sections of two glands; below it are several longitudinal sections, one showing dichotomous branching. All of the glands are surrounded by stroma, which separates them from the muscle.

pregnant at the time, and the tumor hung from the vulva attached by a broad base to the sound skin, presenting a typical vegetating warty appearance, and was continually moistened with secretions.

The operation was by excision with the cautery knife. The better plan, according to present methods, is by excision with the scalpel and suture.

**Carcinoma.**—Carcinoma of the external genitals is commonest between the ages of forty-five and sixty. The disease is recognized in its earlier stages as a well-defined, hard, nodular mass, with everted margins, infiltrating the skin, and broken down and ulcerating in the flattened central portion. In the more advanced stages the numerous secondary nodules with the brawny skin and enlarged inguinal lymphatics can not be mistaken.

The tendency of the disease is to extend continuously up to the vaginal outlet, but not beyond it, and then across to the opposite side, or down over the perineum; if not checked, the growth always extends up into the groin. When the inguinal glands are infected, the labium also presents a choked, irregular, knotted appearance, with ulceration in the older portions of the disease. There is, in spite of these changes, always a marked tendency to preserve the general

contour of the labium, giving the cancerous mass a pyramidal form, with its base above. Its wet fissured surface secretes a fetid, watery fluid, and foci of suppuration are not uncommon.

In one case, in which the disease lay partly on the mucous surface, the corre-



FIG. 119. EARLY EPITHELIOMA OF THE LEFT LABIUM MAJUS, FORMING A HARD PROJECTING NODULE, FLAT ON TOP, COVERED WITH A THIN EPITHELIUM AND ERODED IN SPOTS.

No return two years after removal. The vaginal outlet is relaxed, there is a fibroma on the right side at the lower angle of the labium, and there are extensive external hemorrhoids. Path. No. 112.

sponding surface on the opposite side had a thick, white, macerated appearance, but did not appear to be affected with the disease. After a thorough extirpa-

tion of the right labium, the woman returned fifteen months later for operation upon an extensive involvement of the left labium. There was a brawny induration of the labium above the disease with deep pigmentation of the surrounding



FIG. 111.—ADVANCED EPITHELIOMA OF THE RIGHT LABIUM MAJUS.

skin; the infiltrated skin bordering on the tumor was of a dark-violet color, separated from the more prominent ulcerating mass by a sulcus.

The earliest case I have seen (Mrs. J. B. R., No. 3013, September 8, 1894), if I except the contact inoculation above mentioned, was a diseased area 2.5 centimeters (1 inch) in diameter, smooth, hard, white and bright red in places, circular, slightly elevated, painless, and situated on the lower part of the left labium (see Fig. 110). This was removed by a wide, deep excision, and in three

years there has been no evidence of a recurrence. The microscopic examination showed that it was an epithelioma.

The patient with carcinoma complains of itching, burning, shooting, and stinging pains. Bleeding is not a prominent symptom.

Excision is the proper treatment. The use of the cautery or destruction with caustic is no longer admissible. The operation should be performed under continuous irrigation. It is important to give the disease a wide berth by making the incision around it at least 2 centimeters (1 inch) distant on all sides, except the vaginal. It is not necessary to carry the incision inside the vagina, unless the disease extends up to the hymen. The whole labium is usually excised with as much of the surrounding skin as is necessary. In all cases the inguinal glands of the side on which the disease occurs must also be dissected out unless there is an extensive infiltration of these glands, which forms a contra-indication to any operative interference.

To remove the cancerous growth the oval incision around it is carried through the skin, and the mass covered with iodoform gauze, grasped, and drawn out from the body, while the scalpel cuts beneath it and rapidly dissects off the entire labium with its underlying fat down to the deep fascia. Two or three arteries, large enough to be troublesome, may need clamping, and afterward a fine ligature. It is best to free the inner side first by dissecting from within outward, to avoid buttonholing the mucous surface, which one is liable to do in dissecting in the opposite direction.

The large defect left by the removal is covered by drawing the outer margin to the inner with deep interrupted catgut sutures, making the line of union in the long axis of the labium removed; the skin is united with subcuticular catgut sutures, or interrupted silkworm gut with catgut between.

Where much tissue has been removed, the tension of bringing the edges of the wound together will distort the neighboring soft parts and drag the urethra toward the affected side. This distortion will necessitate careful attention in keeping the parts clean and dry during the convalescence, because the patient will not be able to urinate without wetting the wound. In such a case I leave a soft catheter in the bladder for the first forty-eight hours, and after that require the patient to be catheterized three times a day by a careful nurse who has had pointed out to her the new position of the orifice and the altered direction of the urethral canal.

#### LABIA MINORA.

Diseases affecting the labia minora alone are rare. These structures are more liable to be involved in processes starting in and implicating the neighboring organs at the same time; thus they are affected in carcinoma of the external genitals, in elephantiasis, and in pruritus. Under these circumstances and in inflammation the labia do not appear as distinct organs, but merely as coarse reduplications on the mucous surfaces of the labia majora.

In my private practice I have had one case of multiple cysts of the labia minora from a half to two centimeters in diameter (Fig. 112).

Small sebaceous cysts are sometimes met with, occasioning a slight irritation and necessitating an incision to evacuate the contents.

I have had occasion once to remove a small lenticular inflammatory mass from the upper part of the right nympha, brought about by the contusion of a bicycle seat (see Fig. 113). The little flat nodule, which occasioned the patient much discomfort, was excised under cocaine. The microscopic examination showed (Gyn. Path. No. 1776) that it consisted of a small firm nodule 1.6 by 0.8 centimeters, covered on its free surface by smooth skin. The center of the nodule was occupied by an inflammatory focus consisting of a dense mass of polymorphonuclear leukocytes, toward the periphery giving place to strands of



FIG. 112. CYSTS OF LEFT LABIUM MINUS. OCT. 17, 1893.

swollen connective-tissue cells and young blood vessels. The skin covering beyond a moderate leukocytic invasion was unaltered.

I also removed on one occasion a small fibroma of the labium minus (Path. No. 1470) which occasioned no symptoms at all. The tumor, a round hard nodule, 8 millimeters in diameter, was excised from the right labium minus, nearly in the median line, where it joins its fellow.

Histologically the surface was found to consist of several layers of stratified epithelium; the stroma was made up of a loose fibrillated tissue consisting of

spindle cells with spindle-shaped and oval nuclei. The protoplasm took but a faint nuclear stain. The superficial portion of the nodule was infiltrated with small round cells and a few polymorphonuclear leukocytes.

The treatment of growths of the labia minora is simple, consisting in the

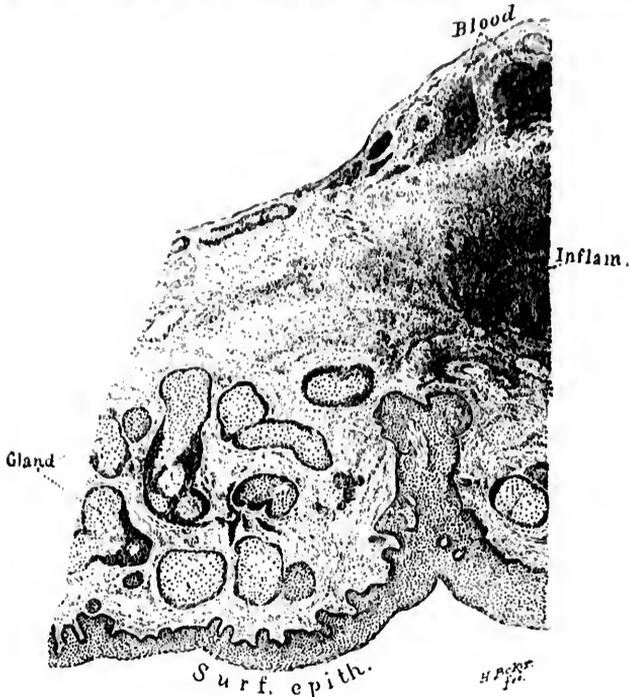

FIG. 113.—SECTION THROUGH SMALL ABSCESS OF THE LABIUM MINUS FOLLOWING A BEECLE TRAUMA.

excision of the affected labium or such portion of it as is involved in the disease, followed by interrupted or continuous subcutaneous catgut sutures.

#### CLITORIS.

With a single exception, diseases affecting the clitoris alone are exceedingly rare. In elephantiasis of the external genitals the clitoris is prone to be the organ most extensively involved.

**Adhesions and Concretions.**—The commonest affection of the clitoris is adhesions between the glans and the hood covering it. These adhesions are almost universally found, and never give rise to trouble unless an accumulation of retained smegma causes increased vascularity and irritation. In children these changes are apt to be followed by constant handling and friction.

In any irritation or ill-defined discomfort, or tendency to handle or rub the genitals, the clitoris should always be carefully inspected. This rule is the more stringent in the case of little girls, who can not locate the source of the discomfort (see Fig. 114).

An inspection of the glans of the clitoris should form a part of every gynecological examination which proceeds in a routine manner to investigate the condition of the sexual organs.

The glans is exposed by grasping the fold of mucous membrane covering it between the thumb and forefinger and drawing it upward, at the same time pushing in toward the symphysis and causing the glans to become extruded.

The adhesions will usually at once be seen in semicircular form on the convex surface of the glans back in advance of the corona.

The largest concretion I have seen I removed from the dorsal surface of the clitoris of an unmarried woman of twenty-five, who was hysterical and showed

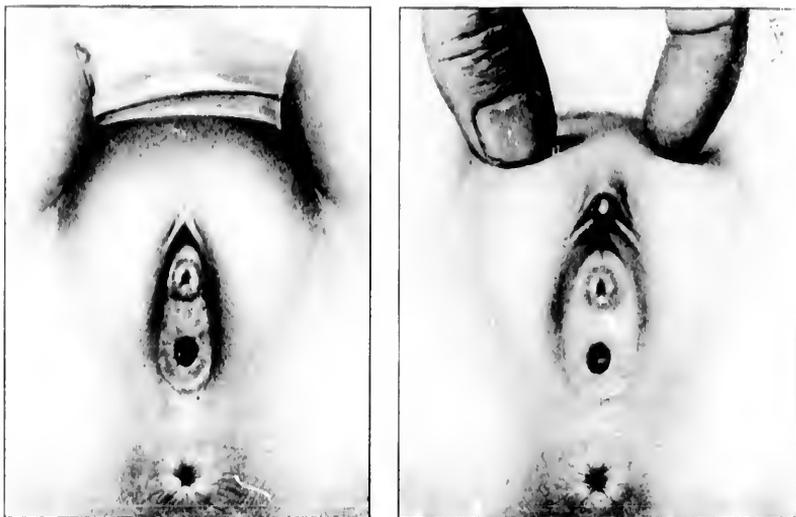

FIG. 114.—PREPUCEAL ADHESIONS IN A CHILD ONE YEAR OLD.

In the first picture the glans is completely covered in by the adherent prepuce and the diminutive labia minora. In the second picture the adhesions have been severed and the glans is exposed encircled by little accumulations of smegma.

signs of mental aberration (see Fig. 115). The mass was 1.2 by 1 centimeter, and beveled off at its discolored anterior extremity, which could be seen projecting from under the prepuce over the glans. The concealed portion was perfectly white. After releasing a few adhesions at the sides below it was easily lifted out of its bed.

The adhesions exposed by drawing back the prepuce should be freed with a small, blunt probe. If the patient is not too nervous the anesthetic action of a

strong solution of cocaine (20 per cent) applied for ten minutes will be sufficient to numb the sensibility. The exposed adherent surface, although denuded of its epithelium, bleeds but slightly. Here and there little white concretions of meqma, varying in size from a mere point to a mass a centimeter in diameter, come into view, as the adhesions yield to the strokes of the probe point.

The corona as well as the whole convex surface must be freed. The separation is completed when the sulcus back of the corona is exposed. The raw surfaces are now covered with vaseline. The patient should lie as long as walking produces discomfort.

The prepuce should be fully drawn back every day for two weeks and vaseline applied to prevent the adhesions from forming again.

This is best done with a little narrow spoon which I have devised for this purpose. The bowl of the spoon is filled with vaseline, and then placed under the prepuce, pushed gently up and turned from side to side, keeping the concavity over the glans which fits in it.

**Elephantiasis.**—Elephantiasis is a name given to an affection which must not be confounded with the elephantiasis of tropical countries, a parasitic disease affecting principally the lower extremities; this affection is rarely seen in this latitude, while elephantiasis of the genitals is by no means rare.

The resemblance between the two diseases is superficial only; in both, the organs affected exhibit a coarse hypertrophy with brawny indurations.

The negro race seems to be peculiarly susceptible; all but one of the cases I have seen have been negroesses.

The organs affected in order of susceptibility are first the clitoris and labia minora, and then the labia majora. The perineum may be involved, but beyond this the disease does not invade surrounding tissues.

My own observations lead me to conclude that it owes its origin to a chronic inflammation, associated with an obstruction of the lymph channels draining the external genitals. Syphilis is one of the commonest exciting causes.

I have seen eight well-defined cases, and in most of them areas of ulceration were to be found about the vulva with cicatrices in the inguinal region.

The enlargement may be more or less symmetrical when the clitoris is the chief organ involved, but when a labium majus is greatly enlarged, its fellow is usually but slightly or not at all affected. One or both labia minora may be affected.

The disease is of rapid growth, enlarging to a mass the size of the fist in the course of one or two years. It is usually attended with severe pain in the genitals, often worse at night. Cramps are also felt in the legs. One patient was bedridden on account of her sufferings. One under observation desires the removal of hypertrophied right nympha on account of the pain. Syphilis as a rule will account for cases associated with headache and nocturnal pain.



FIG. 115.—CONCRETION REMOVED FROM BENEATH THE PREPUCE OF THE CLITORIS.

The shaded part was exposed and stained dark. Natural size. Path. No. 183.

Painful micturition and even incontinence are common symptoms, due to areas of ulceration and the involvement of the urethra. Leucorrhœa almost always exists, and is often profuse.

The diagnosis is not difficult. Elephantiasis is separated from the other tumors by not possessing such sharply defined limits of growth. Close inves-



FIG. 116. — ELEPHANTIASIS OF LABIA MINORA; GREAT HYPERTROPHY OF THE LEFT SIDE.

tigation always shows it to be a more or less grotesque hypertrophy of normal structures. The brawny feeling and the lobulated fissured surfaces are also important clinical characteristics.

**Elephantiasis of the Clitoris.**—A good illustration of the disease was afforded by the following case. She was a poorly nourished negress, thirty-one years old. Her menstruation, at first regular and moderate, had be-

come irregular and profuse, and she had a constant free leucorrhœal discharge. She complained of pains in the small of the back and in the abdomen and of cramps in the legs, together with frequent painful urination, worse at night.

Upon examining her I found the vulvar cleft occupied by a large, pendulous, irregular tumor mass, attached at the anterior commissure and hanging down over the vaginal outlet. The vaginal outlet beneath this was found relaxed, the cervix stellately torn, and the uterus reclining in the sacral hollow. The tumor was shown by its relations to be an enormous clitoris, 10 centimeters long, 5 centimeters broad, and 4.5 centimeters (4 by 2 by  $1\frac{3}{4}$  inches) in antero-posterior thickness. Its lower rounded end was free and slightly notched beneath, having exactly the form of a large penis with a retracted prepuce. Back of the corona was a well-defined sulcus. Thickened preputial folds encircled the glans. At the sides lay the enlarged nymphæ. It had a broad base of attachment at the symphysis. The urethra lay intact beneath the clitoris, but the vaginal outlet was thickened and corrugated, and showed several superficial areas of ulceration from  $\frac{1}{2}$  to 1 centimeter in breadth. A fetid leucorrhœal discharge issued from the vagina. On the dorsal surface of the tumor was an irregular white patch 2 by 1 centimeters ( $\frac{3}{4}$  by  $\frac{2}{3}$  inch), probably representing an old area of ulceration in marked contrast to the surrounding deeply pigmented structures. Two little pediculated tumors, the size of a pea and a hazelnut respectively, hung from the junction of the right nymphæ with the clitoris. Scars in the left groin and in the supraclavicular region were evidences of old syphilitic disease.

The following case presents a picture of the disease when limited to the labia minora: The patient was twenty-eight years old, and had passed through three childbirths, all instrumental, the last premature at six and a half months, four years before. She had lived a loose life, separated from her husband, and had contracted an ulcer upon the external genitals two years before, where I found upon examination a cicatrix 1 by 1 centimeter, just within the posterior commissure. The urethral orifice was ulcerated and an ulcer lay on the anterior vaginal wall. The labia minora appeared as a lobulated tumor 9 centimeters long by 3 centimeters ( $3\frac{1}{2}$  by  $1\frac{1}{4}$  inches), projecting 4 centimeters ( $1\frac{1}{2}$  inch) beyond the normal labia majora, and below the clitoris. There was a deep sulcus between each labium at the frenulum of the clitoris. The outer surfaces of the labia were divided by shallow sulci, the inner surface being smooth and glistening (see Fig. 116).

The treatment of elephantiasis is by excision. Where syphilis is evident and still active, antisiphilitic treatment should be started at once, and by frequent bathing and enveloping the parts in borie acid solution, vaginal douches, and touching ulcerated patches with a five per cent nitrate of silver solution, the parts are brought into a suitable condition for operation.

After placing the patient under anesthesia and suitably exposing the genitals, the hypertrophied mass is enveloped in iodoform gauze, or gauze saturated with a bichloride solution, grasped with the left hand and drawn out from the body, to form a distinct pedicle when none exists naturally.

An incision is now made into the pedicle just above its base, leaving enough tissue to make flaps which can be easily brought together to cover the wound area. There is no danger of a recurrence of the disease from leaving a portion of the pedicle behind in this way.

The better plan is to amputate from above downward. If the bleeding is excessive, vessels may be clamped, or, better still, the wound surfaces may be immediately drawn together by deep silkworm-gut sutures, closing the upper portion of the wound and stopping the flow. The amputation is then continued on down, more sutures are applied, and so on until the whole mass is removed, and the wound completely closed.

Where the clitoris is removed it will usually be necessary to ligate a few large blood vessels, particularly those on the dorsum, with fine catgut. When clitoris and labia minora are removed together, the wound presents the appearance of an inverted Y ( $\blacktriangledown$ ): an inverted V-shaped wound ( $\blacktriangledown$ ) is left after removing both labia minora.

In the case figured (page 182) I adopted a slightly different procedure by pulling out the mass to form a pedicle, whose upper part was transfixed by three stout silk sutures, one below the other, and the corresponding part of the tumor severed from above downward, leaving a slightly cupped raw surface. The three sutures were then tied, firmly enough to serve the double purpose of approximating the opposite edges of the incision, and controlling the hemorrhage. By a succession of similar steps, first introducing the sutures, then severing that part of the pedicle overlying them and then tying the sutures at once, the large tumor was quickly removed with trifling hemorrhage.

**Sarcoma.**—One instance of this rare disease has come under my notice. The patient, a Pole, twenty-six years old, came to my service in the dispensary of the Johns Hopkins Hospital, complaining of constant pain in the genitals, increased by coitus.

A tumor,  $4\frac{3}{4}$  by  $2\frac{1}{2}$  centimeters (2 by 1 inches) in size, was found overlying the descending pubic ramus in the position of the left crus of the clitoris. It was pointed at both ends, above and below, hard, movable on its base, and slightly lobulated.

A wide incision should always be made; in this case the mass was removed by Dr. H. Robb, under cocaine anesthesia, by an incision in its long axis, splitting a fibrous capsule in which it lay. Excessive venous oozing followed the enucleation, and was controlled with difficulty by pressure and the application of tannin.

She was discharged from the hospital in a week with a small linear, non-suppurating wound, and has not been heard of since.

After hardening in Müller's fluid, sections were made showing two kinds of tissues, cells in groups or long rows, with a homogeneous substance between them. In some portions instead of cell groups there were single cells with long, irregular processes, communicating with each other, imbedded in the homogeneous material filling the interspaces. The cells in groups and rows were generally spindle-shaped, with long nuclei, some of which resembled closely non-

striated muscular fibers. All the cell groups and bands communicated so as to make the homogeneous material appear as islets between them.

In some portions of the tumor the cell groups made up the greater parts of the tissue; but every gradation existed between the groups and the single cells. In other places the intercellular substance predominated, and there were only scattered nuclei in the homogeneous material, with but little cell substance around them. In sections made after freezing, the homogeneous material swelled up and became transparent on the addition of acetic acid; in the hardened sections, it was in places slightly granular, and stained faintly with eosin.

Blood vessels were few, and were always found in the homogeneous material into which their walls gradually passed.

In sections stained with picro-carmin, the long bundles of cells where the nuclei were longest stained bright yellow, like muscle fibers. Nothing like this could be discovered in other parts.

The examination thus showed that the tumor was a sarcoma whose homogeneous intercellular substance was formed by a myxoid degeneration of the tissue; it was therefore a myxosarcoma.

**Carcinoma.**—Cancerous disease of the clitoris is rare. Two cases only have come into my hands for treatment. The first was a married woman, E. McD., No. 179, fifty years old, who had had three children, the last twenty-three years back.

She had ceased to menstruate four years previously, and since that time had suffered from severe itching of the external genitals, for which she had received local treatment without relief.

Two months before, she had noticed a spot of what she took to be proud flesh in the cleft of the vulva anteriorly; this grew rapidly until it reached the size of the end of the thumb. It was not painful.

I found on the dorsum of the clitoris an enlarged hard area, 1 by 8 centimeters in diameter, and its surface pouting, sharply defined, granular, warty, hard, and yellowish, and slightly reddened, not adherent to structures beneath. To the right of the glans was a small patch similar to the first, 3 millimeters in diameter. The labia minora were contracted down to short, thick rudimentary folds. These, together with the white patches, bore evidence to the changes induced by pruritus and scratching.

She was operated upon April 22, 1890. The whole body of the clitoris down to the crura, with both labia minora, were excised, making a wound the shape of an arrow head, whose edges were approximated by sutures passed transversely.

Twelve days later a recurrent nodule was found in the left labium majus, about 1 centimeter from the scar. The whole upper portion of the scar and the adjacent tissue were excised down to the symphysis pubis and closed with six silk-worm-gut sutures. The wound healed, and there was no recurrence at a later date.

The second case (C. L., No. 2465, December 23, 1893) was thirty-eight years old, the mother of four children, the youngest seven years old; her mother died of cancer of the lip.

For eight years she had noticed a reddened area gradually extending between the labia anteriorly, and for six months past growing rapidly. She had no pain



FIG. 117.—CARCINOMA OF THE GLANS OF THE CLITORIS, WITH AN AREA OF IMPLANTATION BY CONTACT ON THE LEFT LABIUM MAJUS.

The dotted line indicates the area excised. Dec. 23, 1893.

in it until within a few days; there was a mucoid discharge from the surface of the tumor.

I found upon examination a large rose-red glans clitoridis, protruding anteriorly between the labia majora, 3 centimeters ( $1\frac{1}{4}$  inch) long by 3.3 centimeters ( $1\frac{1}{2}$  inch) in breadth, ovoid in form, slightly indented on its under surface. On the convex surface to the right there was a pit 1.2 centimeter deep by 1.8 centimeter long, and on the right dorsum of the corona an irregular tongue of unaffected tissue 1.2 centimeter by 0.3 to 0.8 centimeter broad. There was an area of infiltration of the mucous surface of the left labium majus, 1 by 8 centimeters, where it lay in contact with the diseased glans (see Fig. 117).

Both labia majora were deeply pigmented from scratching, and the labia minora were withered, insignificant structures from old-standing pruritus.

The disease was extirpated by an oval excision 12 by 8 centimeters (5 by  $3\frac{1}{2}$  inches), extending from the mons veneris to the urethra.

Numerous actively bleeding vessels were clamped, and six of them were ligated. The wound was closed by bringing the edges of the incision

together from side to side by interrupted sutures. Primary union was secured, and the stitches removed on the seventh day.

The pathological examination showed that the specimen consisted of the clitoris with the surrounding skin and mucous membrane. The clitoris was converted into a mass  $2\frac{1}{2}$  by 2 centimeters, in whose center was an ulcerated cavity 1 centimeter deep, with necrotic grayish edges; the remainder of the mass was firm, of a grayish-pink color, and circumscribed in its growth.

Microscopically the tumor was made up principally of squamous epithelial cells, in part arranged in nests, some of them forming the typical pearly bodies, and in part growing free in tissue. The stroma was fibrous tissue and existed only in small quantities. Everywhere there were numbers of lymphoid cells.

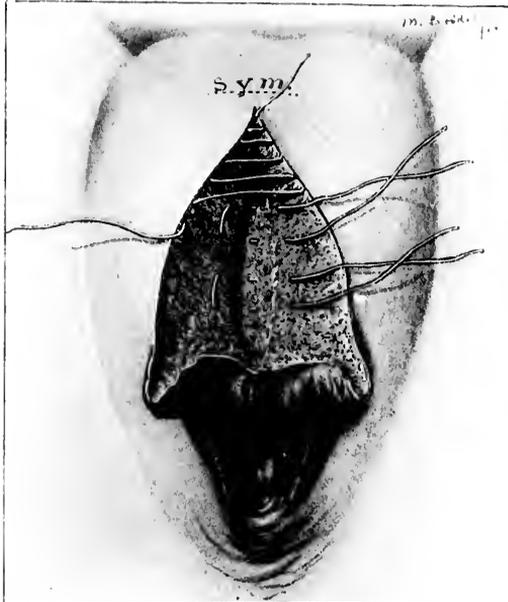

FIG. 118.—CLOSURE OF THE WOUND MADE BY EXCISION OF THE CLITORIS, BY MATRASS SUTURES OF BURIED CATGUT AND SUBCUTICULAR CONTINUOUS SUTURE.

The vascular area in the deeper part of the wound is controlled by the mattress sutures.

The edges of the ulcerated cavity were necrotic, showing little inflammatory reaction. Great numbers of nerve fibers were found everywhere. The epithelial growth was completely circumscribed by fibroid tissue and seemed to have no tendency to invade the surrounding tissues. Beyond the growth was the



FIG. 119.—OVOID FLUCTUATING CYST OF THE CLITORIS.

The prepuce encircles the convexity of the tumor, extending from one labium minus to the other, forming a shallow sickle-shaped fold. The dorsal veins are shown above. A little lenticular vaginal cyst lies at the base of the left labium minus. Oper. June 21, 1897.

normal mucous membrane, and beneath it the fat and fibrous tissue. The examination showed that the tumor was an epithelioma of the clitoris.

**Cyst of the Clitoris.**—I had occasion to remove (June 21, 1897) a large cystic clitoris, shown in Fig. 119. The following is the report of the pathological examination:

Mrs. S. C. (Path. No. 1795). The fluid is thick, sebaceous-like, and of a light brownish-yellow color. Microscopically it is found to contain numerous cholesterol and other irregular crystals. It also contains granular epithelial cells. On histological examination the outer surface of the cyst is seen to be covered by squamous epithelium; the walls are composed of wavy connective-tissue cells running mostly parallel to the surface. Near both the outer and inner surfaces are localized areas of small round-cell and polymorphonuclear infiltration. In one or two sections sebaceous glands can be seen. The inner surface of the cyst shows considerable variation in its epithelial lining, some portions being covered by three or four layers of squamous epithelium, the deepest layer of which is cuboidal, and others by one layer of cuboidal cells. In some portions where the epithelium is one layer in thickness the cells are columnar. The cyst has evidently arisen from the clitoris.

#### VULVO-VAGINAL GLANDS.

**Cyst of the Vulvo-vaginal Gland.**—Two kinds of cysts of the vulvo-vaginal gland are met with—simple and suppurating. Both forms are among the commonest of the vulvar diseases, while other affections of these glands are extremely rare.

The simple cyst is the result of an inflammatory occlusion of the duct of the glands, followed by a retention of the secretions and the formation of a tumor varying in size from that of a bean to that of a hen's egg. Inflammatory cysts are oftenest due to gonorrhœal infection, and the tendency just now is to attribute all of these cases to this source.

I have known instances, however, of small cystic accumulations in which gonorrhœa was probably not present. One of my patients for some time complained of a pruritus for which she had had much treatment without benefit, after which the cyst developed.

I have seen but one case in which both sides were involved.

The enlarged gland forms a projection more or less marked, according to its size, to the right or left of the outlet, in a position corresponding to that of the gland. The observer inspecting the tumor from the front is most struck by the marked deviation of the cleft of the vulva forming a curved line directed toward the sound side. The small cysts are located low down in the labium, in the position of the gland; but as they become larger they extend upward in the direction of least resistance, and more especially inward toward the mucous surface of the labium, where they become quite superficial; their mucous surface appears smooth and shining, and sometimes almost transparent. The fluid contained in the cysts is clear, yellowish or turbid, and generally of a gelatinous

consistence. The symptoms in the smaller cysts are negative, and for this reason they are frequently overlooked even by a specialist.

Not infrequently the contents of the cyst can be squeezed out of the orifice of the gland by steady pressure. It oozes out on the reddened surface about its orifice in crystal-clear droplets. In such cases the formation of the cyst has been simply due to an impediment to the outflow of the secretions.

The diagnosis of such a cyst is easy from its location, its ovoid form, and the manifest fluctuation.

The symptoms created by the larger cysts are tension, dragging, soreness, and obstruction to coitus.

The treatment is either by free incision into the lower portion, evacuating its contents, followed by an application of nitrate of silver solution and a pack in the cavity, or by total extirpation.

Incision and pack are simpler, but do not invariably effect a cure. For this purpose an anaesthetic need not be given as a rule. The vulva is shaved, and both vulva and vagina cleansed, and the tumor grasped and pressed forward from behind with the thumb and second finger reaching down from above and making it tense. A 10 per cent solution of cocaine is applied for ten minutes.

A narrow, sharp-pointed knife is then quickly plunged through the skin surfaces into the cyst, which is slit up for 3 or 4 centimetres (an inch or more), as it is in the act of collapsing. The bleeding is never more than moderate. The inner surface of the collapsed cyst is now painted with a 10 or 20 per cent solution of nitrate of silver, and packed with a long, thin strip of iodoform gauze. It is well to leave the gauze in until it is bathed in abundant suppuration, when it may be drawn out and a fresh piece laid within to keep the opening from closing until it is filled with granulations.

In making a complete extirpation of the gland three important difficulties must be overcome: First, to sever the close attachments to the deep cellular tissue under the pubic ramus; second, to control the free hemorrhage in the deeper parts; and third, to avoid perforating the thin septum on the mucous surface.

The enucleation is best conducted under a continuous irrigation. An incision is made through the skin surface of the labium over the whole length of the cyst down to its wall; with pressure on each side the incision is retracted, exposing the cyst, which is rapidly dissected free on all sides. The dissection must be slowly and carefully made on its inner side, to avoid cutting through the thin mucous surface.

It is best not to rupture the cyst in enucleation, so as to prevent the escape of its contents over the wound, as well as to avoid the difficulty of finding and removing all parts of the collapsed cyst walls. After the more exposed part has been freed, the cyst must be gently drawn to one side and then to the other with the fingers, while the posterior surface is freed. The cyst must not be grasped with forceps for fear of rupturing it.

The hemorrhage from numerous small vessels is controlled by the stream of

water constantly running over the field. When the vulvo-vaginal duct is cut the contents of the tumor often begin to exude by the fine orifice.

The removal of the cyst leaves a deep bleeding cavity in the labium. All persistently bleeding vessels are caught and tied with fine catgut. Neglect of this precaution will result in the formation of a blood tumor of considerable



FIG. 129.—LEFT VULVO-VAGINAL GLAND EXCISED AND THE WOUND CLOSED WITH FIVE INTERRUPTED CATGUT SUTURES.

size; I have seen one such hematoma containing 90 cubic centimeters (3 ounces) of blood, and the overflow into the patient's bed was estimated at a liter more. The pulse, which was normal, went up to 150. A profound anemia resulted.

After checking the bleeding, interrupted silkworm-gut or silk sutures are passed on the skin surface, the loop of each suture reaching to the bottom of the wound and bringing the surfaces together, leaving no pockets for the accumulation of blood. The usual dry dressing is placed on the surface, and the sutures removed in a week.

**Abscess of the Vulvo-vaginal Gland.**—The vulvo-vaginal glands are especially liable to become the seat of abscesses forming distinct tumors, in the lower part of one or the other labium, encroaching upon the vaginal outlet. These abscesses have the same topographical relations as the simple cysts just described. The overlying skin may appear normal or dark red, and injected in color.

They generally occur early, in the period of sexual activity, and are found most frequently as a result of gonorrhoeal vulvitis or vaginitis, and hence among the class of women most liable to impure contacts. Huguier, Velpeau, and Guérin thought that the abscess was often the result of the supervention of an inflammation in a cyst.

The youngest patient I have treated was sixteen years old, and the oldest thirty-eight; it is uncommon to find one over thirty. Velpeau cites a case of forty-five. I do not believe that sexual trauma is a provocative cause, although



FIG. 121.—ABSCESS OF LEFT VELVO-VAGINAL GLAND.

The distention is in the direction of least resistance, out from the left pubic ramus, partly covering the vaginal outlet.

numerous cases in the newly married have been cited to bear out this theory. The facts to my mind rather tend to show how many men enter into the married state with an uncurred gonorrhoea. Only about seven per cent of these cases have been noted in parous women. My own cases show a much larger percentage. One woman had borne four children, the last one only four months before the disease had developed.

The onset of the disease is acute, accompanied with throbbing pain, great local discomfort, and an irritated feeling about the genitals, swelling, and often edema, and a sense of weight in standing. Locomotion is painful. The pain radi-

ates down the thigh, and there is often inability to sit down without increasing the pain, together with a sense of pressure in the rectum. The gait is slow and straddling and the body bent forward. There are often chills and fever.

The general condition of the patient is one of extreme malaise. Oftentimes there is a history of leucorrhœa, offensive or irritating, with painful micturition.

One of my cases had an ulcer 1 centimeter in diameter at the fourchette and another in the inferior wall of the urethra, near its internal orifice, 6 millimeters by 10 millimeters in diameter. In this case the pus removed from the left vulvo-vaginal gland contained numerous typical colonies of gonococci within the cells. In most cases, however, the microscopic examination of cover slips has proved entirely negative.

The affection usually reaches its height in a few days; it may, however, be several weeks in developing; it tends toward spontaneous recovery by rupture on the mucous surface of the labium, discharging from 15 to 100 cubic centimeters ( $\frac{1}{2}$  to 3 ounces) of blood, grumous pus, or pure yellow pus. The exit may be by one or several small openings, which tend to close rapidly. But the disease is prone to relapse ("relapsing abscess") in such cases. I have had a patient who presented a history of repeated suppurations extending over many months. Other rare cases give a history of alternation (alternating abscesses) of the affection from one side to the other. Abscesses of the vulvo-vaginal gland is especially liable to recur, because the ultimate ducts become infected, and so the suppurative process may go on indefinitely, until the entire gland is either destroyed or removed by operation.

Ocasionally there is no enlargement of the gland visible on inspection. In spite of the fact that there is no evident tumor, there may be a more or less constant escape of pus, serving to keep up an infection of the rest of the genital tract.

The diagnosis, as a rule, is easily made upon associating the symptoms described with the discovery of a painful fluctuating tumor in the lower part of one of the labia. The cases most liable to cause a mistake in diagnosis are those in which the pus sac has thick walls and feels like a small, hard body, the size of a bean, deep in the labium, without fluctuation. I have seen several of these cases in which no diagnosis was made until the pus was let out. In one case even the little nodule was thought to be malignant.

A simple abscess must not be confounded with stercoro-vulvar abscess, due to a rectal fistula extending forward and discharging through a labium. I had one such case treated by one of my assistants in which the rectal communication was not recognized until the abscess was opened. This disease ought to be diagnosed beforehand by the brawny induration, extending back on to the perineum, and by the fistulous orifice which can be felt just inside the sphincter. The history also often shows that the distress was first felt in the rectum.

The proper treatment of abscess of the vulvo-vaginal gland is by free incision and packing. After suitably closing, shaving, and cleansing the parts, the abscess is made tense by pressure from behind on both sides, when it

is freely opened from below up. The incision is begun low down to give good drainage in the most dependent position.

After evacuation the lips of the incision are separated, the sac wiped clean, and its whole inner surface touched with pure carbolic acid on absorbent cotton. The incision must be kept from closing until the cavity is obliterated; to do this, the cavity is loosely packed with a thin strip of iodoform gauze, which should be replaced every two or three days. It will be noticed that it shrinks with surprising rapidity, holding less gauze each time the pack is removed. After healing, the fine linear cicatrix will be found with difficulty. Sutures and ligatures need not be used.

I object to making an incision on the mucous surface, unless the abscess is at the point of rupturing there, on account of the possibility of a tender cicatrix at this point. When the incision is made here, the anesthetic action of a twenty per cent solution of cocaine or ethyl chloride will suffice to blunt the sensibility.

In more than one instance I have known an abscess to rupture spontaneously on the night before the time fixed for operation. The opening thus made by nature in each of these cases was badly placed for the drainage, and too small to allow a pack to be inserted. It was therefore necessary to make it larger by incising it downward.

Where the abscess consists of a small indurated mass with a little pus in the center, the better mode of treatment is by complete extirpation of the gland, if possible without opening it. In one of these cases in my clinic it could only be extirpated piecemeal, on account of the hard, infiltrated surrounding tissue. The treatment of the cavity thus made is to close it completely, as described in the case of cyst.

After the incision, evacuation, and packing, the woman must lie abed for several days or a week or more. She may go about as soon as she has recovered sufficient strength, and the act of walking is not painful.

**Adeno-carcinoma.**—I report here in full a case of adeno-carcinoma of the vulvo-vaginal gland upon which I operated in December, 1891. (R. S., No. 1136, December 18, 1891.)

The writings of Gottschalk, of Berlin, Werth, of Kiel, and Koppe, of Moscow, have thrown a new light upon cysts of the upper portion of the labia major, which can no longer be looked upon as connected with the vulvo-vaginal gland. It has been shown that adenoid elements can occur in this region probably due to the misplacement of epithelial elements in early embryonic life; it is possible that the following case belongs to this group:

My patient was an American, fifty-five years old. She had had ten children and one miscarriage. The family history was negative. The menses had ceased seven months before she entered the hospital.

At Christmas time, 1890, she noticed a swelling in the left labium majus, which grew slowly for six months, and then for two months it grew rapidly. She had no pain, other than a dragging sensation.

Dr. H. Robb examined her upon entering the Johns Hopkins Hospital during my absence in the summer of 1891, and found a hemispherical enlargement

in the left labium majus, irregular and lobulated, as big as an orange, dark red on its surface, and fluctuating. It appeared to have bands of tissue running around it, and in two places the wall was thickened. There was well-marked venous congestion of its surface.

Under the impression that the contents were purulent, it was incised, and a large quantity of whitish and pinkish cheesy blood-stained *débris* escaped with clots. The cyst wall was lined with similar *débris* and shreds of connective tissue. It was evident that the sac could not be enucleated without great difficulty, and it was therefore cauterized and packed with iodoform gauze, and an



FIG. 122.—ADENO-CARCINOMA OF THE LEFT VULVO-VAGINAL GLAND.

The skin is thin, the pores coarse and widely separated, and a few hairs are seen scattered over the surface. A large vein courses over the right under-surface of the tumor, which contains a bloody fluid.

external dressing applied. After eighteen days pure carbolic acid was applied to the cavity, which showed no tendency to close. After twenty-four days infiltration and thickening were still noticeable, but not so marked as at first. A little whitish exudate was squeezed out.

She went home to return in four months, when I found a prominent tumor

4 centimeters ( $1\frac{1}{2}$  inch) in diameter occupying the left labium. It was encircled by an injected edematous area with two openings in it having dusky blue margins and discharging sanguinous fluid. From a third opening corresponding to the incision made in August projected a necrotic mass as big as the end of the thumb, which discharged about 60 cubic centimeters (2 ounces) of necrotic and bloody material upon being squeezed.

A microscopical examination of this material showed it to be made up of abundant epithelial cells and small blood vessels. A mucous follicle was found with marked granular fatty degeneration.

The whole left labium was excised, the incision, 14 centimeters ( $5\frac{1}{2}$  inches) long, beginning 2 centimeters (1 inch) above the symphysis and extending down to the posterior commissure. The wound thus made was at its widest above, 4 centimeters ( $1\frac{1}{2}$  inch), and narrowest below, 2 to 3 centimeters ( $\frac{3}{8}$  to  $1\frac{1}{8}$  inch). The edges of the wound were brought together from side to side by thirteen interrupted silkworm-gut sutures and thirteen catgut sutures between.

The tumor was hardened and examined in the pathological laboratory and found to be a typical adeno-carcinoma.

The following case (M. T., No. 3896, operation October 12, 1895), a tumor of the left labium majus, is interesting because, as there was no evidence of involvement of adjacent glands or tissues, the clinical history pointed strongly to ulceration of a cystic Bartholin's gland.

The ulcerated area suggested a malignant tumor, but was not diagnostic; the gland and a wide area of tissue were excised.

Patient first noticed a slight, hard, nodular, painless swelling in the left labium in the spring of 1894. This gradually enlarged until, about six months before she was seen, it took on a more rapid growth reaching the size of a small lemon, and for three months it was ulcerated slightly. She had a sharp pain and a burning sensation throughout the enlargement, and the whole mass at times became sore, the tenderness extending to her thighs. The ulcerated surface bled considerably at times, causing some relief from pain.

Examination.—The vaginal outlet is occluded by a large tumor of the left labium majus. The tumor is reddened, fluctuating, and on its vaginal surface presents an ulcerated area from which blood oozes. The tumor is well circumscribed in the area occupied by the Bartholin's gland and does not infiltrate the surrounding tissues. No enlargement of the inguinal glands on either side.

The cystic gland was excised with a wide area of skin around it; the tumor was lifted well out of its bed and an abundance of underlying tissue removed with it. All bleeding points were caught separately and ligated with catgut, and the wound closed with interrupted catgut sutures.

Pathological Report.—Myxo-fibro-sarcoma of the Labium Majus.—The tumor is globular, 5.5 centimeters in diameter, and for the most part smooth; the skin surface is an irregular elevation 3 by 2.5 by 1 centimeters, presenting a rough, eaten-out appearance, with a deep excavation in the center. With the exception of this nodule, the tumor is surrounded by a capsule; its central portion consists of a fibrillated, semi-gelatinous tissue, having bands of

denser tissue extending across it and partly around the periphery. The nodule on the surface consists of tumor substance which has broken through the capsule. Microscopically the tumor consists of loose fibrillated mesh-work, whose interspaces contain a substance which, with hematoxylin and eosin, is tinged blue. The cells, also tinged faintly blue, are long and spindle-shaped or branched, with elongated vesicular nuclei. Many hyperchromatic and irregular budding nuclei are also present, several times larger than the average. In the denser bands the cells are more abundant and occasionally arranged in whorls. Cells of the lymphoid variety in considerable numbers are evenly distributed throughout the tissue. The tumor is vascular throughout. Where it penetrates the capsule it is more vascular and especially rich in cell elements. The surface of the elevation closely resembles granulation tissue. From this description it will be seen that the growth is a sarcoma and that it has to a great extent been localized by a dense fibrous capsule; at one point, however, it has penetrated this and extended to the surface.

#### AFFECTIONS OF THE VULVAR MUCOSA.

**Congenital Cohesion.**—Abnormal adhesions between the mucous surfaces of the right and left sides, inside the labia majora below and the labia minora above, are not rare, although but seldom described.

They have been described by Saenger, of Leipzig, under the name "conglutinatio labiorum" (*Centrab. f. Gyn.*, 1891, No. 50), and by Bokai as "epithelial union of the labia." They are usually found in small children and appear to be either congenital or to result from inflammation, with destruction of the epithelium, followed by adhesion. Four cases of the affection have come under my notice, the youngest a little girl twenty months old, and the oldest one of six years; the difficulty was first discovered by the mother in each instance.

In the little girl twenty months old, seen in 1890, figured in the text, the labia majora were well formed; the hymen and vaginal surfaces were completely hidden by a thin, dark membrane with fine lines upon it, radiating upward and outward from a well-defined central vertical raphe. The only traces of the labia minora were the rudimentary folds covering the clitoris. The glands of the clitoris was well developed. Just under the glands was the genito-urinary opening, 3 millimeters



FIG. 123.—AGGLUTINATION OF THE LABIA IN A LITTLE GIRL.

There is a distinct raphe in the middle, with a translucent slightly furrowed membrane in both sides, which conceals the urethra and the hymen.

in diameter, the sole outlet for urine and vaginal secretions. A probe introduced through the opening and behind this membrane showed the depth of the anomalous interlabial septum to be 15 millimeters. On pushing the septum forward the raphe appeared white. The vagina was 5.5 centimeters ( $2\frac{1}{4}$  inches) deep.



FIG. 124.—AGGLUTINATION OF THE LABIA.  
The same case after division of the membrane; urethra and hymen exposed.

I look upon this case as simply an abnormally long fourchette, as there was no history of any inflammatory affection, and especially because of the well-formed raphe, which would not have been found on any adventitious membrane. In two other cases the membrane was similarly developed and appeared to be congenital.

**Treatment.**—The membrane was cut down to its base, exposing a normal urethra and hymen. The incision left a linear V-shaped wound on the mucosa. One suture was required to control bleeding.

**Inflammatory Cohesion of the Mucous Surfaces.**—A little girl of six presented herself at the clinic with an occlusion of the outlet, first detected when she was a year old. On inspection, a line of granular ero-

sion was found in the middle of the vulva posteriorly, and the labia were extensively united on their mucous surfaces, concealing the site of the hymen and urethra and the whole clitoris, but leaving a minute orifice just over the site of the clitoris. The vulvar mucous surface throughout its entire length was adherent. Under the influence of chloroform the adherent surfaces were stripped apart with a probe, exposing a vaginal orifice 10 by 5 millimeters, the urethra, and the clitoris. Lateral adhesions of the hood to the glans of the clitoris were also freed. Sometimes the adherent surfaces may be separated by using cocaine instead of a general anesthetic.

**Pruritus, or Vulvitis Pruriginosa.**—Pruritus is especially a disease of the old, and is one of the most distressing of all the gynecological affections not endangering life. It consists in a subacute inflammation of some portion or of all the external genitals, involving the deeper layers of the skin and the nerve endings; it is therefore a dermatoneuritis. I have adopted the term vulvitis pruriginosa, suggested by Säuger, of Leipzig (v. *Ges. f. Geburtsh.*, Leipzig, Oct. 16, 1893), as more correctly describing the morbid process. The common name "pruritus" means simply "itching" and nothing more, and merely describes a symptom common to many affections.

While the whole vulva may be involved, the disease is oftenest localized in the free portion of the clitoris with its coverings, the neighboring surfaces, and the labia minora. With these structures, the whole inner surface of the vulva may be involved, the hymen forming the limit of its extension in-

DESCRIPTION OF PLATE III

Fig. 1. The white areas represent the fibrous thickening of the plate  
Fig. 2. The black line in passage the area of oxidation in the center of the  
Fig. 3. The white areas represent the fibrous thickening of the plate  
Fig. 4. The black line in passage the area of oxidation in the center of the  
Fig. 5. The white areas represent the fibrous thickening of the plate  
Fig. 6. The black line in passage the area of oxidation in the center of the  
Fig. 7. The white areas represent the fibrous thickening of the plate  
Fig. 8. The black line in passage the area of oxidation in the center of the  
Fig. 9. The white areas represent the fibrous thickening of the plate  
Fig. 10. The black line in passage the area of oxidation in the center of the



The following is a description of the plates illustrating the operative treatment of pruritus vulvæ. The plates are arranged in three figures. Figure 1 shows the external view of the vulva, with the excised area indicated by a dotted line. Figure 2 shows the internal view of the vulva, with the excised area indicated by a dotted line. Figure 3 shows the vulva after the operation, with the sutures in place.

**DESCRIPTION OF PLATE III.**

**FIG. 1.**—Pruritus vulvæ. The excoriated spots following scratching are seen as yellowish areas. The whitish areas represent the fibrous thickening of the labia.

**FIG. 2.**—The dotted line represents the area of excision in the operative treatment of pruritus.

**FIG. 3.**—Operation completed—sutures in place.



Fig 1

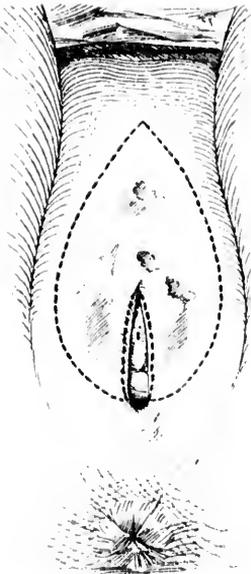

Fig 2.

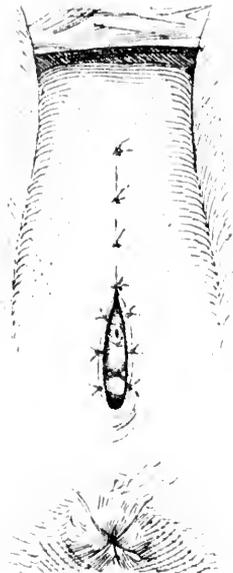

Fig 3



ward. The skin surfaces of the labia majora also become involved in aggravated cases.

I have seen the disease localized to small areas about the clitoris and fourchette; in another case the most marked alterations were in the labio-femoral folds.

The changes induced are a thickening due to an inflammation of the connective tissue in the corium. The mucous surfaces have a thick, dead-white, withered appearance. The glans clitoridis often completely disappears, leaving in its place beneath the thick white preputial folds a little pit. These white surfaces, as well as the labia on their outer surfaces, are streaked with fissures which are due to scratching; these are pink at the bottom and generally arranged vertically.

The real causes of pruritus are not known, although a number of provocative causes and conditions are well recognized.

In every case of intractable pruritus the urine should be examined for sugar, as some of these cases are diabetic in origin; this is due to the fermentation of the urine, which then acts as an irritant upon all the tissues with which it comes in contact.

A sero-purulent discharge from a myomatous uterus proved to be the exciting cause in one instance; all attempts to relieve the pruritus failed, until finally the patient was so harassed that she consented to operation. The uterus was extirpated for the myoma and the pruritus ceased.

Fissure in ano may be accompanied by pruritus of the vulva, which will be cured by the healing of the fissure.

An attempt has been made, without success, to demonstrate a bacterial origin. The initial stages may often be attributed to irritative vulvar and vaginal secretions, after which the more aggravated form of the disease develops from the repeated mechanical insults in rubbing and scratching the parts.

The proper treatment of the severer cases of chronic pruritus with the changes described is, as advised by Säuger, by excision of the diseased area. The free mobility of the external genitals and adjacent parts allows almost any defect created by an excision to be readily covered.

The following case will serve as an illustration of the operation where the disease involves all the external genitals except the skin surfaces of the labia majora:

The patient was a married woman, fifty-seven years old, and a nullipara; she had had one miscarriage twenty-five years ago; menopause sixteen months before operation. When younger she had had a milky leucorrhœa, but this had ceased for several years. She had suffered from itching in the genitals for twenty years, at first always connected with the menstrual period, beginning a day before and lasting twelve days; for three years past there had been a constant intolerable itching and burning, with burning micturition, keeping her awake almost every night, and nearly driving her insane. During this period she had noticed the formation of little blisters between the labia, which would break, leaving raw surfaces, discharging pus. These surfaces rarely appeared to heal.

I found the inner surfaces of the labia majora covered with irregular white patches of thickened epidermis, more abundant above, extending from the upper commissure down to the lower part of the vaginal outlet; below this the surface



FIG. 125. TUBERCULOSIS OF THE VESTIBULE.

The flat pinkish mammillated diseased area occupies the entire vestibule, encroaching on the upper margin of the urethra and extending slightly into the anterior vaginal sulci. There is no thickening or infiltration of the edges, which are raised about two millimeters above the level of the diseased area. The clitoris and the adjacent parts red and swollen.

was covered with a reddish glaze. At the angle between the inner mucous and external skin surfaces of the labia—that is, on the margin of the disease—was a line of whitish scales with slightly elevated edges. A few small superficial ulcers were scattered over the white area. The labia minora were withered down to insignificant rudimentary folds. The clitoris was completely concealed beneath the thickened diseased tissue, and a little hole only showed where the glans is usually found. The hymen was entirely absent; the disease was limited by a line encircling the vaginal outlet and including the urethra, which was not involved.

The whole of this diseased surface was excised under anesthesia by an operation lasting thirteen minutes. After a prolonged painstaking scrubbing an incision was made, outlining the area to be removed, beginning at the commissure above and extending down on either side along the angle between the outer and inner surfaces of the labia, to the level of the vaginal floor. From

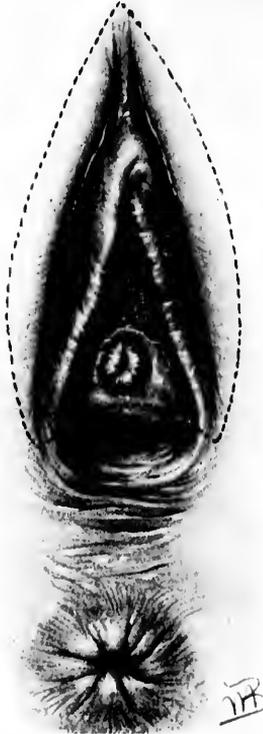

FIG. 126. AREA OF EXCISION OF TUBERCULAR DISEASE SHOWN BY THE DOTTED LINE; THIS INCLUDED THE CLITORIS, BOTH LABIA MINORA, AND THE ENTIRE VESTIBULE, WITH THE ANTERIOR PART OF THE URETHRA.

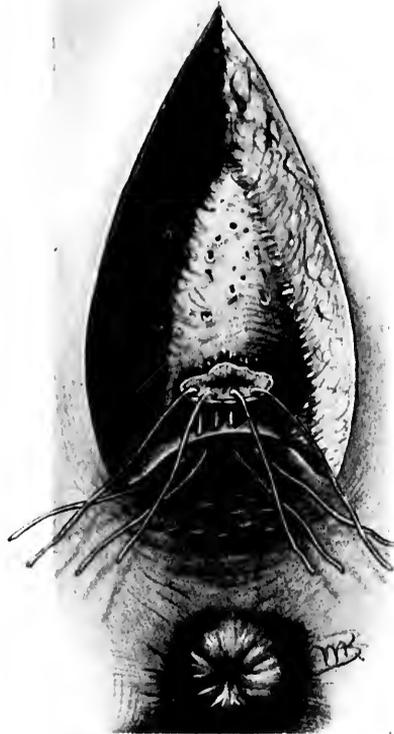

FIG. 127. RAW SURFACE CREATED BY THE REMOVAL OF THE DISEASED AREA, SHOWING FOUR CATGUT SUTURES ENTERING THE POSTERIOR MARGIN OF THE URETHRA TO THE VAGINAL MUCOSA.

this point the incisions were carried up to the vaginal outlet and around it, meeting over the urethra.

The area excised, roughly described, resembled a spearhead pointing upward with a deep notch at its base. The whole thickness of the skin thus outlined was rapidly dissected away, removing with it the labia minora and the body of the clitoris. The dissection was made from above downward by catch-

ing the apex above with forceps and drawing it down, detaching the flap with rapid strokes of the knife. Six artery forceps had to be applied to bleeding vessels. The bleeding from the cut edges of the clitoris was surprisingly small. No vessels were tied; all the hemorrhage was controlled by so placing the sutures approximating the edges of the wound as to catch the bleeding vessels in the loop and then tying the sutures tight.

The outer surfaces of the labia were now drawn together above, and in as far as the vaginal outlet on each side below, with silkworm-gut sutures about 1 centimeter apart. The line of union formed resembled an inverted Y ( $\Lambda$ ), the point of divergence being 1 centimeter above the urethra. There was no difficulty in covering the defect, and there was no tension on the sutures.

The patient was at once entirely relieved of her distressing disease.

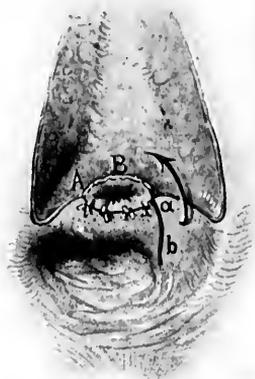

FIG. 128. — SHOWING THE FLAP *b* TAKEN FROM THE LEFT VAGINAL WALL AND DRAWN IN THE DIRECTION OF THE ARROW AND ATTACHED TO THE UPPER MARGIN OF THE URETHRA, A B

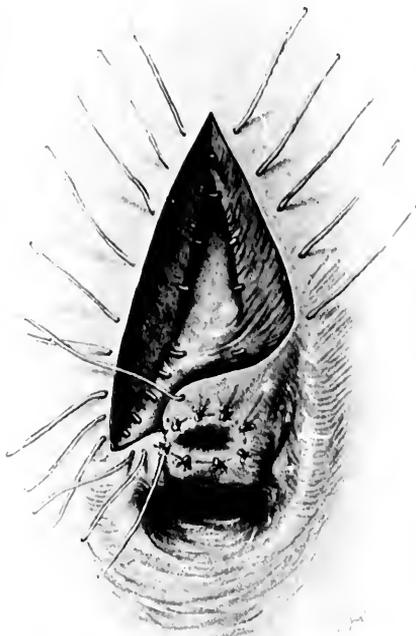

FIG. 129. — SHOWING THE RESTORATION OF THE EXTERNAL URETHRAL ORIFICE, COMPLETED; CAT GUT SUTURES INTRODUCED FOR THE CLOSURE OF THE REST OF THE WOUND.

The sutures were removed on the tenth day, and the wound found to have healed by primary union throughout.

The removal of the whole vulva in the more extensive cases is performed in the following manner:

An oval incision is made in the middle line in the *mons veneris*, starting at the upper limit of the disease and continuing down on either side, so as to include the whole of one or both labia majora, meeting below at the posterior commissure, or on the perineum or even at the anus, according to the extent of

the disease downward. Another incision encircles the vaginal outlet in the position of the hymen, beginning above the urethra. The whole area between these two incisions is rapidly excised from above downward, and bleeding vessels caught with forceps. The edges of the upper part of the wound are brought together from side to side with silkworm-gut sutures, down as far as the level of the urethra. Below this point they are drawn in on either side and attached to the vaginal outlet, covering the whole defect.

**Tuberculosis of the Vestibule.**—Tubercular disease of the external genitals is extremely rare, not more than three or four cases having been recorded. This disease is usually associated with pulmonary phthisis.

I have seen one case of tuberculosis of the vestibule. The patient, Mrs. S., a widow, aged fifty-five, complained chiefly of stinging pain on urination, caused by the urine flowing over the ulcerated area. A small ulcer first appeared one year before coming to me; this increased steadily in size until it occupied an area as seen in Fig. 125, Mrs. S. (Gyn. Path. No. 1756). The specimen removed consists of a triangular piece of tissue, the margins of which are covered by mucous membrane. The central portion presents an eaten-out appearance, and the deeper tissues are infiltrated, though not markedly indurated. Situated in this ulcerated area is the urethral orifice surrounded by a narrow band of smooth mucous membrane. Histologically, the surface of the ulcer is made up of the characteristic tubercular granulations, while typical tubercles are scattered throughout the deeper tissues, some being found immediately beneath the urethral mucous membrane. Tubercle bacilli are demonstrable in small numbers.

**Diagnosis.**—Tuberculosis of clitoris and vestibule.

The description of the operation is given in Figs. 126-130.



FIG. 130. SHOWING THE ULCER OF THE REST OF THE WOUND ABOVE THE URETHRA IS THE FORM OF AN INVERTED Y.

## CHAPTER X.

### RUPTURE OF THE RECTO-VAGINAL SEPTUM AND RELAXED VAGINAL OUTLET.

1. Physiological support of the vaginal outlet.
2. Operations for recent injuries to the vaginal outlet: External tear; internal, and combined external and internal tear; complete tear of recto-vaginal septum.
3. The intermediate operation for injuries to the outlet.
4. Old complete rupture of recto-vaginal septum; Operation for the same.
5. Relaxed outlet; Operation for the same.

**The Physiological Support of the Vaginal Outlet.**—The “vaginal outlet,” called “outlet” with reference to its parturient function, or “introitus,” “inlet,” or “vaginal entrance,” from its sexual function, forms the inferior extremity of the vaginal canal communicating with the external genitalia beneath the pubic arch. While the vaginal canal above and within the pelvis is broader and more capacious, inferiorly it suddenly narrows down to an outlet which is a canal 4 to 5 centimeters (2 inches) long.

The posterior wall of the vagina in sagittal section of the body forms a flattened sigmoid with the convexity of its lower curve directed forward behind the pubic arch. The peculiar funnel shape of the vagina—broad above and contracted below—appears most distinctly upon placing a woman who has never borne children in the knee-breast position and letting in air, when the intra-pelvic portion of the vagina will balloon out, while the outlet or introitus remains tightly contracted, closely hugging the pubic arch.

The mechanical theory advocated by some writers, that the closure of the outlet and its snug position beneath the pubic arch are dependent upon a thick wedge of tissue, a so-called “perineal body,” acting like a cork plugging a bottle, is erroneous. In consequence of this false conception absurd and unnecessary operations have been devised and extensively employed for injuries in this situation.

The error of this prevalent notion is evident upon examining the vaginal outlet, where the vaginal outlet and anus are both seen lifted well up under the pubic arch, and upon introducing the index finger into the vagina the pubic arch is felt in front, while posteriorly a broad, rounded, resilient band of muscular tissue, the levator ani, stretches behind the outlet from the right to left pubic ramus.

This examination readily demonstrates the important fact that the vaginal introitus is but a narrow chink between this posterior muscular band and the pubic arch. By making backward pressure upon the posterior wall of the

vagina within the introitus the hand yields, to return to its former position as soon as the pressure is withdrawn.

The fourchette and the supposed "perineal body," lying between the fourchette and rectum, should now be closely examined by placing the index finger of one hand just within the vagina and the other in the rectum and palpating so as to measure the size and thickness of these structures. It will be found that they are but slight tissues incapable of giving any support to the superjacent organs.

The real supporting mechanism of the outlet is not the perineal body, but the anterior portion of the levator ani muscle. This broad, rounded muscle arises on either side of the inner surface of the pubic ramus and passes back around the lateral vaginal wall to unite with its fellow behind the rectum, its fibers being intimately interwoven with the lateral walls of the rectum. These



FIG. 131.—NORMAL VAGINAL OUTLET IN A NULLIPARA.

The vagina is completely hidden and there is no flattening across the anus and the gluteal furrow as in the case of a relaxed outlet. The little concentric furrows surrounding the fourchette below are not found in the virgin.

important anatomical relations may readily be detected in the living subject by making pressure in each lateral sulcus of the vagina while one finger lies within the rectum.

From what has just been said, it is apparent that the vaginal outlet has no

direct means of closure such as would be afforded by a powerful sphincter muscle, but depends for its support upon the indirect action of the levator muscle. For by the contraction of this muscle the lower end of the rectum is tightly lifted up under the pubic arch and the vagina flattened out and held up between the two. It is further important to notice that the position of the plane of the pubic arch, in front of the plane of the levator fibers, renders the closure more efficient, like a "cut off." It is this arrangement which gives the sigmoid curve to the lower extremity of the vaginal vagina.

With rare exceptions, the important injuries to the vaginal outlet affect its caliber alone, and arise during parturition. It is not difficult to appreciate the rationale of this when we recall the fact that during the passage of the child's head the outlet, normally from 2 to 3 centimeters ( $\frac{1}{2}$  to 1 inch) in diameter, is dilated until it forms a ring 28 centimeters (10 or 12 inches) in circumference. In numerous instances, instead of the gradual and all-round dilatation of the outlet produced by repeated impacts of the advancing and retiring fetal head, the yielding is sudden and in one place, with rupture of the muscular fibers in consequence. The parturient canal represents a funnel within a funnel, the uterus and cervix representing the upper funnel, set within the upper vagina and outlet as the lower funnel. In consideration of this fact it is surprising that both the contracted outlets, cervical and lower vaginal, are not more frequently damaged during the passage of the large fetal ovoid. Injuries to the outlet similar in character often result from the removal of large submucous myomata lying within the vagina. The vaginal outlet may be injured from without by a variety of accidental causes, such as falling upon a chair post, or being gored by cattle, or in a child from sliding down a haymow on to a pitchfork handle, or sliding down a balustrade on to a low newel post.

The operation in all cases of injured outlet should be performed as soon as possible after the injury; all other operations at a later date act only as more or less efficient substitutes.

Recent obstetrical injuries at the vaginal outlet may, for practical purposes, be classified under three heads:

1. External superficial tear.
2. Internal, and combined external and internal tear.
3. Complete tear of the recto-vaginal septum.

**Recent External Superficial Tear.**—The simplest form of tear begins at the fourchette, extends backward through the skin in the median line, and involves the superficial wedge of lax tissue between the fourchette and the rectum; it may extend up into the vagina as far as the posterior column. This form of injury is the commonest and relatively the least important, and does not in any case affect the supporting structures at the vaginal outlet.

The only purpose of an operation for its relief is to avoid healing by granulation and the possible formation of a tender scar.

**Operation.**—In its slightest forms the external tear needs no further attention than strict cleanliness throughout the convalescence.

A deeper injury, with a base 2 to 3 centimeters ( $\frac{3}{4}$  to  $1\frac{1}{4}$  inch) in length,

may be sutured immediately after delivery, or on the following day, when the patient should be brought across the bed under a good light, with the legs flexed on the abdomen and held by an assistant or by a legholder.

The necessary instruments are a needle holder, medium-sized curved needles, and catgut and silkworm-gut sutures. These instruments should be close at hand on a sterilized towel. The hands of the operator should be carefully washed immediately before operating. The labia are now held apart with the first and second fingers of the left hand, exposing a torn triangular surface on either side posteriorly. A needle provided with a carrier threaded with a catgut suture is introduced in the sound tissue near the upper angle of the tear from a half to three quarters of a centimeter from its margin, brought out at the base of the wound, and re-entered, to emerge on the mucous surface opposite the point of entrance. A similar suture is placed about a centimeter below this. When both these sutures are tied the wound is closed down to a shallow pit on the skin surface, where two or three superficial sutures may be needed to complete the approximation.

The wound should be protected afterward with iodoform and borie-acid powder.

**Recent Internal Tear and Combined External and Internal Tear.**—Another common form of injury sustained in parturition is a slit in the mucosa, which may extend from the fourchette or from the hymen for 4 or 5 centimeters up into the vagina into one of its sulci. In another form the tear is forked and extends into both sulci. This injury is often caused by the head of the child starting within the vagina a tear, which is enlarged by the shoulder following, plowing its way down between the levator fibers and their rectal attachments on one or both sides. If this tear happens to be continued forward, it becomes associated with the external tear and forms a combined external and internal tear.

Neglect of this injury results at a later date in the serious disability which I describe as a relaxed vaginal outlet. The fact that this lesion within the vagina was not looked for by our older practitioners has induced many of them to assert that lacerations never occurred in their obstetrical practice. Teachers of obstetrics can not lay too much stress upon the necessity of a proper examination after labor and proper attention to this neglected form of primary injury.

Immediately after the birth, if the labia are separated and the posterior vaginal wall inspected under a good light, the ragged, bleeding surface of the tear stands out in marked contrast with the smooth vaginal wall, although both alike are uniformly deeply congested.

**The Operation.**—The lacerated surfaces must be repaired at once or on the day following delivery, for a few sutures skillfully applied at this time will accomplish the work of many more at a later date.

The patient should be placed as described in the operation for superficial external tear, resting upon a perineal drainage cushion. The use of an anesthetic is advisable if she is nervous, can usually be dispensed with if the operator is deft and can work quickly.

The following instruments are required: Needle holder, medium-sized curved needles threaded with carriers, 6 strands of silkworm gut, catgut sutures, a dozen intermediate silk sutures, a pair of scissors, and a Sims speculum or the retractor.

It is important to secure the utmost approximation of wound surfaces by sutures placed within the vagina.

The upper angle of the wound is exposed by elevating the anterior wall of the vagina with the speculum or retractor. If the field of operation is obscured by blood, a temporary pack should be placed within the vagina above the wound. The first suture is introduced close to the upper angle of the tear, the next about a centimeter below this, and so on down to the skin surface. The needle enters from 5 to 10 millimeters ( $\frac{1}{2}$  to  $\frac{3}{8}$  of an inch) from the margin of the wound, according to the character of the tissue, and farther if there is much contusion; it emerges at the bottom of the wound, toward the operator, and, re-entering close by, is brought out again at a point on the vaginal mucosa corresponding to the point of entrance. A second suture is introduced a centimeter below this, with its loop directed toward the operator, and so on until the wound is closed. If an external tear is associated with the internal, as is usually the case, the opening remaining on the skin surface is now reduced to a shallow pit, and so readily approximated by a few additional superficial sutures. Each suture is best tied as introduced. Silkworm gut softened in warm water is the best suture material for the operation. These sutures may be left in the vagina for several weeks.

I mention but to condemn the practice of closing this form of tear by sutures passed altogether on the skin surface in a wide sweeping curve beneath the lacerated tissues, leaving the important portion within the vagina unmited, for by this means a pocket is left in the posterior vaginal wall which accumulates secretions, defeating the union, or even burrowing through the perineum, leaving a fistula. I have often found good broad union of the skin surface accompanied by a relaxed outlet or even prolapse.

**A f t e r - t r e a t m e n t.**—It is unnecessary to keep the knees bound after the patient has returned to consciousness, if an anesthetic has been used, and there is no objection to her making gentle movements, turning carefully from side to side in bed, elevating the knees, etc.

The use of the catheter should be avoided if possible, and, if necessary at all, should be continued for a few days only after the operation. The bowels should be opened within two days afterward; straining efforts during defecation must be avoided.

The sutures may be removed in from eight to ten days after the operation, when the union will be found to be firm.

The patient should stay in bed from twelve days to two weeks after an operation, and for four weeks more she should go about with care, and do no work or lifting.

**Recent Complete Rupture of the Recto-vaginal Septum.**—This laceration begins at the fourchette and extends through the skin perineum in the median line, and

through the sphincter ani for a variable distance up the recto-vaginal septum. The tear into the rectum forms a serious complication, destroying the function of the sphincter muscle and causing incontinence of feces and flatus. By this accident a sensitive patient is cut off from the company of her nearest friends, and compelled to live in a state of isolation. Strange, however, as it may seem, if the operation is not performed at once, the patient may carry her malady for years without seeking the relief so readily afforded.

**Operation.**—An immediate operation is imperative. The parts should be suitably exposed, as described for the last operation, and under anesthesia, if the patient can not be perfectly controlled without it. The instruments required are a needle holder, scissors, curved needles, and catgut and silk-worm-gut sutures. The first step in the restoration is the closure of the rent in the bowel, which is effected by interrupted catgut sutures on the rectal surface at the upper end of the tear. Each suture pierces the margin of the mucosa and appears on the septum 4 or 5 millimeters ( $\frac{1}{2}$  to  $\frac{3}{4}$  inch) from the edge, to enter the septum on the opposite side, coming out again on the mucosa. The remaining sutures are passed in like manner, radiating out on to the skin surface and embracing the ruptured ends. Great care must be taken in bringing the sphincter ends into accurate approximation. The lower sutures alone are not sufficient to insure the sphincter union without the addition of a silk-worm-gut suture entering on the skin surface and emerging well behind the ends of the ruptured muscle and traversing the septum. The tear now presents the appearance of the simpler form just described, which is closed by interrupted silk-worm-gut sutures, for the most part placed within the vagina. Each suture is tied as passed, and a few superficial catgut sutures are passed between them, to insure perfect approximation. This operation skillfully performed is always successful if a puerperal sepsis does not interfere.

The bowels should be moved on the third day, and opened every second day afterward. Under no circumstances should they be allowed to become constipated.

It is important that the patient should remain at least two weeks in bed. The external sutures should be removed on the eighth day, and the internal a week or two later.

**The Intermediate Operation for Injuries to the Outlet.**—The intermediate period begins from five or six days and extends to two or three weeks after labor, while the unrepaired perineal wound is undergoing granulation and cicatrization. The parts at the bottom of the wound, naturally in close juxtaposition, often unite by first intention, while the remaining area is engaged in throwing off sloughing particles, granulating, and cicatrizing. In a few days small pink granulations are visible over the wound area, while the marginal epithelium as a fine white line invades it on all sides, contracting the wound from day to day. The granulating surface and the adjacent area is rigid and flushed by the new vascularization. The intermediate period, although not often selected as a time for operative interference, on account of prolonging the detention in bed, is not altogether

unsatisfactory, for a well-performed operation will be almost surely followed by a good result.

The wound is best exposed on a table, with flexed thighs, under a good light. Local anesthesia by means of cocaine will, as a rule, be sufficient. This is secured either by saturating a pledget of absorbent cotton with a 4 per cent solution and applying it for ten minutes to the wound and surrounding tissue, or by injecting a few minims around the margin of the wound. With a sharp scalpel or spoon curette, the operator vigorously scrapes off the granulations, using also scissors



FIG. 152.—COMPLETE TEAR OF THE RECTO-VAGINAL SEPTUM, SHOWING THE CHARACTERISTIC PENTAGONAL FORM.

The opening is filled up with the anterior vaginal wall. At each end of the horizontal bar of the pentagon below slight depressions, indicating the sphincter pits, are seen.

and forceps as needed to effect the denudation. The peculiarity of the tissue will be found to be its friability, which makes it difficult to denude evenly in the usual way with scissors and forceps. The denudation must everywhere extend down into the sound tissue below. If some time has elapsed since the injury, it will be necessary in denuding to allow for considerable contraction of the wound. In this case strips of adjacent mucous membrane must also be removed.

The sutures should then be passed as described in the repair of recent injuries, according to the character of the tear, whether external superficial, internal,

or combined internal and external. It is important to avoid introducing the suture too close to the edge of the wound to guard against the danger of their working through and becoming loose. The after-treatment is the same as has been described in the previous section.

If the injury to the vaginal outlet has not been repaired during the puerperal period, one of the two following conditions will be found at a later date: complete rupture of the recto-vaginal septum, or relaxed vaginal outlet.

**Old Complete Rupture of the Recto-vaginal Septum.**—In from four to six weeks after labor the extensive lacerated surfaces of a ruptured recto-vaginal septum contract down to a branching scar, forming a sharp ridge across the bowel, below which a few red folds of everted rectal mucosa project (looking like hemorrhoids and sometimes mistaken for them). In the absence of the perineum, rectum and vagina have a common outlet, or cloaca, characteristically pentagonal or triangular in outline. Notwithstanding the absence of the perineum, prolapse of the vagina and uterus but rarely occurs. This fact is irreconcilable with the view commonly held that the function of the perineum is to plug the pelvic outlet like a cork. The correct explanation is to be sought in the different loca-

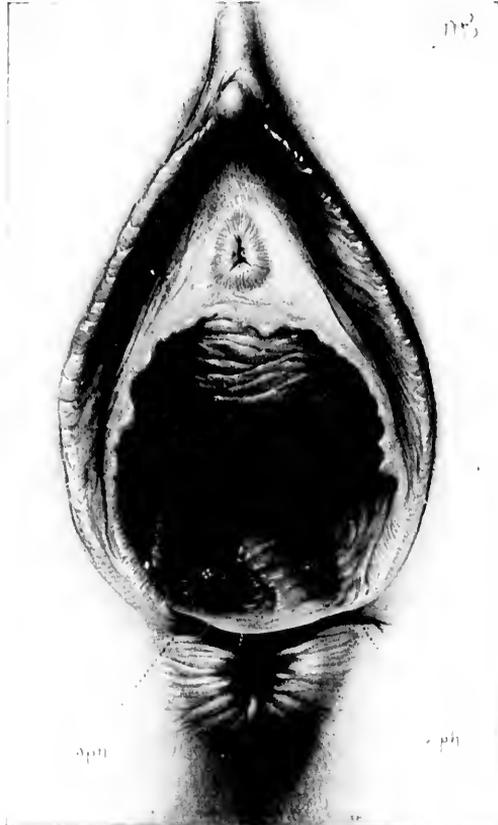

FIG. 133. COMPLETE TEAR OF THE PERINEUM, WITH WELL-DEFINED SPHINCTER PIT AND RETRACTION AND THICKENING OF THE MUSCLE, WITH A DEEP DIMPLE BEHIND IT.

A vaginal cyst due to inclusion of the vaginal mucosa in the healing process is seen in the right sulcus in the scar area. Oper. Feb. 6, 1896.

satisfactions of the tear; in most cases it extends up the median line, and only branches superficially into the sulci, leaving the lower fibers of the levator ani mus-

cle injured. When, in rare instances, the rupture both passes through the perineum centrally and extends deeply into one or both sulci, prolapse may occur.

The sphincter ani muscle in cases of complete tear will vary in form, in different cases, from a simple broken circle, with its ends still bound together, to

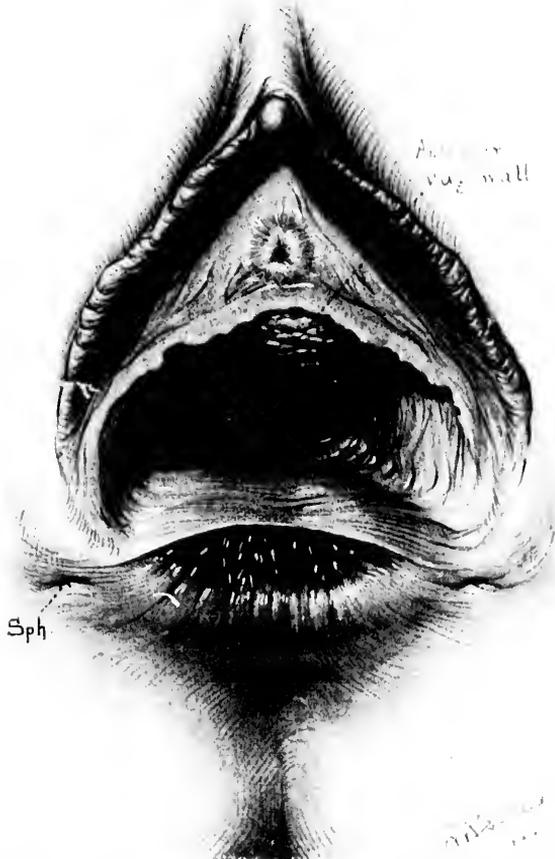

FIG. 131. RUPTURE OF THE RECTO-VAGINAL SEPTUM, ORIGINALLY EXTENDING HIGH UP ALONG THE POSTERIOR VAGINAL WALL, BUT NOW PULLED DOWN BY THE CONTRACTIONS OF THE SPHINCTER INTO A SHALLOW ARC, WITH EXTREME SEPARATION OF THE SPHINCTER ENDS. JUNE 21, 1897.

the way to a shallow arc, in which case the muscle is short and thick with a deep dimple in the skin behind it. A smooth glazed depression, at times puckered or pitted, at the lower angle of the perineal scar, frequently serves as the sphincter

landmark. A straight sphincter is the result of frequent contractions pulling down the angle of the tear so that ultimately a deep tear comes to look like a superficial one. Thus the extent of separation of the ends of the muscle becomes a measure of the depth of the original tear. It is sometimes difficult to identify the sphincter ends upon simple inspection, but by pulling on or pinching the



FIG. 155. SAME CASE SEEN IN FIG. 151.

On bringing the two sides together the hymen is found to be intact except posteriorly. The yielding of the vaginal orifice in labor has therefore been sudden, and all in one place posteriorly, instead of a slow, equable distention producing multiple tears in the hymen. June 21, 1897.

muscle so as to stimulate a contraction, the position of the ends may always be discovered. It is important not to be misled, by the ability of the patient to retain feces, into the error of thinking the tear can not be complete, for where the original rent is shallow and the cicatrix in the angle binds the

ends firmly together, the sphincter will often contract efficiently up to the point. A similar result is, in fact, all we can hope to attain by the best plastic operation.

**Operation.**—Women with complete rupture of the septum sometimes have a chronic diarrhœa. Here the only preparation necessary is an injection high into the bowel a few hours before the operation, clearing out all fecal matter. In other cases a free purgation must be secured the night before the operation, followed by an enema in the morning. Carbolyzed and mercurial solutions, if used at all in other cases, must never be used here for irrigation, on account of the danger of fatal poisoning from absorption



FIG. 156. COMPLETE TEAR OF THE RECTO-VAGINAL SEPTUM.

The sphincter pits are seen below on both sides of the rectal orifice, the shortened sphincter muscle is much thickened, and there is a characteristic pit just below it. The red line encloses the area to be denuded; it must not be forgotten that the triangles seen extending up into the vagina are greatly fore-shortened.

through the bowel. To prevent discharges from contaminating the field, one or two pledgets of iodoform gauze wrung out in warm water are pushed up into the lower bowel, to be removed when the operation is completed. The instruments necessary are scalpel, dissecting forceps, Emmet's left-curved scissors, needle holder, curved needles, and catgut and silk-worm-gut sutures. The area to be denuded must be outlined with the scalpel,



FIG. 157. COMPLETE TEAR OF THE RECTO-VAGINAL SEPTUM. DENUDATION COMPLETED.

which follows the direction of the scar tissue in a general way, greatly exaggerating its outlines; the cardinal principle in the denudation is to reproduce as nearly as possible the original injury.

The first incision splits the septum and includes the sphincter ends, from which a line is continued up under the pubic arch on either side; thence it goes down into each vaginal sulcus and back again, meeting in front of the posterior column, 1 to 2 centimeters ( $\frac{3}{8}$  to  $\frac{1}{2}$  inch) above the first incision in the septum. All of the tissue included within the outline is now removed. Begin at one of the sphincter ends, catching it up with tissue forceps and cutting it free with curved scissors. Continue the denudation around the sharp edge of the septum to the opposite end of the sphincter, which is denuded in the same way, taking care to remove all scar tissue. A second strip above and parallel to this is next cut off, a third, and so on, continuing the denudation up into the vagin until the whole area within the outline has been removed. It is important to bear in mind that the denudation within the vagina must extend a centimeter or more ( $\frac{1}{2}$  inch or so) above the angle of the tear in order to avoid the tendency to form a recto-vaginal fistula at this point. Silkworm-gut and catgut sutures are best adapted to the approximation of the denuded surfaces. Half-deep sutures of catgut are preferable for closing the rectal side of the tear, and for securing accurate approximation between the silkworm-gut sutures, which are used at wider intervals. The complication of the torn bowel is first disposed of by a series of interrupted rectal sutures, commencing at the upper angle of the tear, entering each suture at the margin of the rectal mucosa, and emerging on the wound surface 4 to 5 millimeters ( $\frac{1}{10}$  to  $\frac{2}{8}$  inch) distant, re-entering on the opposite side and coming out again on the margin of the mucosa at a point corresponding to that of entrance. This suture may be tied at once and dropped into the rectum, and a little less than a half centimeter ( $\frac{1}{2}$  inch) below this another suture passed in like manner, tied, and dropped, and so on until the whole of the rectal rent has been obliterated down to the sphincter. One of the most important points in the operation now is to secure an accurate approximation of the



FIG. 138. COMPLETE TEAR OF THE RECTO-VAGINAL SEPTUM.

Rectal sutures introduced, but not tied. Note the position of the silkworm-gut tension suture introduced well behind the sphincter ends and passing up through the septum.

Rectal sutures introduced, but not tied. Note the position of the silkworm-gut tension suture introduced well behind the sphincter ends and passing up through the septum.

sphincter ends by two or three sutures radiating from the rectal out on to the skin surface. The contractions of the sphincter render it necessary to assist these sutures with one of silkworm-gut introduced well behind to the denuded ends and passing up through the septum. When this has been done the rectal



FIG. 139. COMPLETE TEAR OF THE RECTO-VAGINAL SEPTUM.

The rectal sutures all tied except the silkworm-gut tension suture. The sutures are introduced but not tied in the right vaginal sulcus, one of silkworm-gut and two of cutgut above it.

rent is repaired, the wound is reduced from a complicated one involving three surfaces—rectum, skin, and vagina—to a simpler wound involving vagina and skin perineum.

The next step is the repair of the vaginal wound by a silkworm-gut suture in either sulcus, reaching down to the series of rectal sutures, at the bottom of the wound. The loop of the suture should lie in a plane nearer to the operator than its points of exit and entrance, so as to lift up the tissues at the bottom of the wound when it is tied. Superficial and half-deep cutgut sutures complete the union within.

There still remains an opening on the skin surface, which is readily brought

together by a silkworm-gut suture, aided by a few superficial or half-deep cat-gut sutures.

**The Relaxed Vaginal Outlet.**—The name "relaxed outlet" describes a loose, gaping introitus, a condition which is more frequently observed after multiple childbirth, each successive delivery distending the orifice, until it appears like the mouth of a bag without its draw string, as Dr. T. A. Emmet has long been in the habit of describing it. Although a frequent ailment, it is rarely recognized except under the title of some one of its attendant and accidental fea-

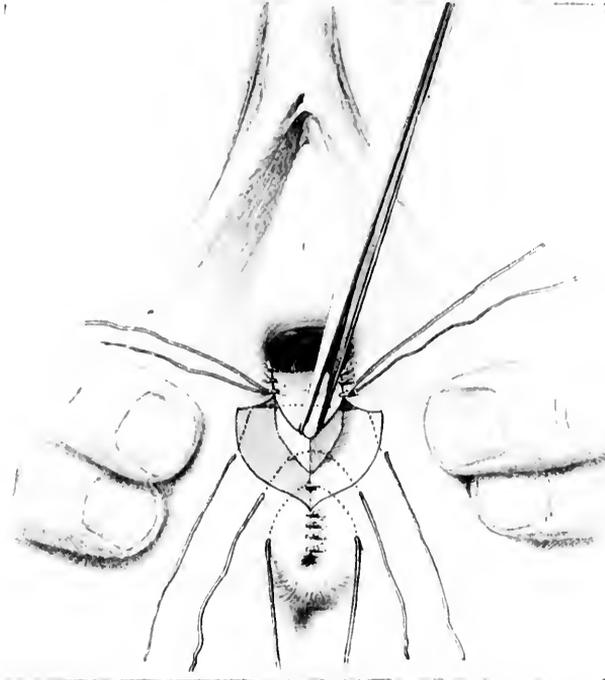

FIG. 110. COMPLETE TEAR OF THE RELAXED VAGINAL SEPTUM.

Rectal and vaginal sutures all introduced and tied, and the perineal sutures in place, but not yet tied.

tures, such as "rectocele," "cystocele," or "rectocele and cystocele," or "laceration of the perineum" in varying degrees.

**Clinical Appearance.**—Upon inspection of such a patient on the back, with the legs flexed, the cleft of the buttocks appears flattened and broad; the anus is often wide, somewhat everted, and displaced backward; the sphincter ring is clearly seen. The skin perineum is often preternaturally deep and the fourchette intact. In other cases the skin surface of the perineum is torn as

far back as the sphincter ani. The intact deep perineum has long been a gynecological stumbling block, on account of the inveterate habit of physicians of estimating the functional activity and efficiency of the vaginal outlet by its depth on the skin surface; a "good perineum," signifying that the distance from fourchette to anus measures  $2\frac{1}{2}$  centimeters (1 inch) or more, whence the faulty conclusion is drawn that the support at the vaginal outlet must likewise

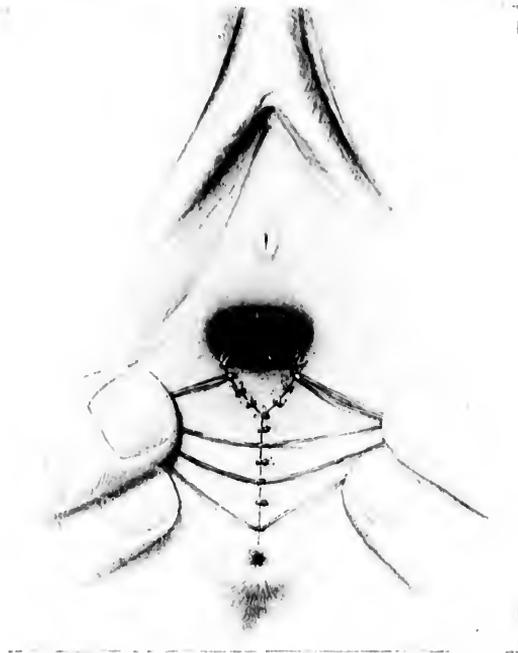

FIG. 141. COMPLETE TEAR OF THE RECTO-VAGINAL SEPTUM.

All three sets of sutures introduced and tied, the catgut suture cut off and the silkworm gut left long. The outlet is pulled open a little in order to show the inside suture.

be "good." The fact is that in many of the worst forms of relaxation the perineum is deeper on the skin surface than before childbirth, a condition due to the overstretching of the external skin at the time the outlet was broken down.

On separating the labia in a case of relaxed outlet the vaginal walls appear more or less pointing, and either the anterior or posterior walls may protrude to a marked degree. In rarer cases lateral, anterior, and posterior walls all protrude.

The relaxed condition of the vaginal outlet may be demonstrated in a variety of ways. Upon instructing the patient to bear down, both anterior and posterior

walls roll out, bringing into view a considerable portion of the lower vagina. We are thus enabled to estimate the effects of lifting, walking, or straining at a glance upon such a patient. If a finger is placed upon the cervix uteri, during the act of straining it will be felt descending in the axis of the vagina toward the outlet. The descent is especially marked if the patient is examined in the erect posture, when the surgeon will also be still better able to judge the effect of exercise upon her pelvic organs.

Upon placing the patient in the left lateral position and elevating the upper right buttock, air rushes audibly into the vagina and the posterior vaginal wall drops away from the anterior, leaving the gaping outlet as a large hole in the pelvic floor (*vide*, Fig. 144).

Palpation in the dorsal position reveals other important deviations from the normal outlet. The perineum is often but a lax, thin partition which may easily

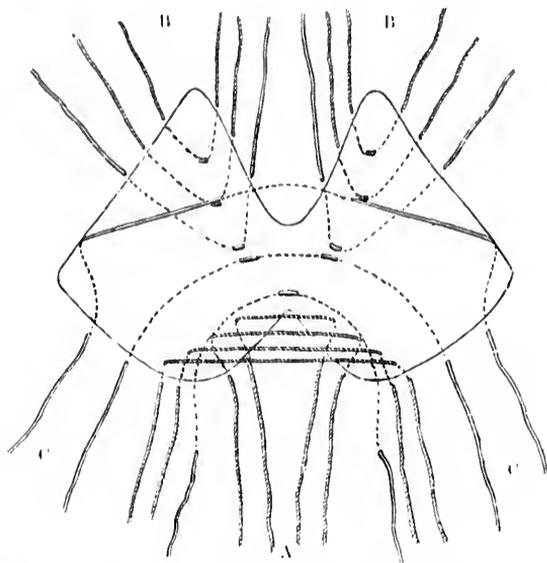

FIG. 142.—SCHEME OF THE OPERATION FOR COMPLETE TEAR OF THE RECTO-VAGINAL SEPTUM LAID ON A FLAT SURFACE.

The torn sphincter muscle is indicated by dotted red lines cross-hatched at each end. The deep indentation on the under side of the figure represents the rectal side of the tent, and the two red triangles above, one on each side, represent the demulsiptions extending up into the vaginal sulci. The sutures are passed first on the rectal side, A, radiating out into the perineum, then in the vaginal sulci, B, and finally on the perineal side, C. The cross-marked sutures are of catgut and the plain ones of silkworm gut. Note especially the silkworm-gut sutures passed in behind the sphincter ends and up into the septum.

be gathered up between thumb and forefingers of both hands and lifted up over the urethra and the clitoris. Many physicians are misled by the fact that, when the patient is lying in the dorsal position, the lax anterior and posterior vaginal walls apparently fill out the deficiency. Touch, however, ought to

demonstrate at once that the protrusions are loose, baggy tissue, incapable of affording any support. They are, on the contrary, danger signals, indicating progressive descent of the vaginal walls and the uterus.

Further palpation shows that the strong lower levator fibers stretching from one pubic ramus to the other, and supporting the outlet, have disappeared; in



FIG. 143. METHOD OF DEMONSTRATING A RELAXED VAGINAL OUTLET BY HOOKING THE FINGERS IN THE VAGINA ON BOTH SIDES AND PULLING OUTWARD AND BACKWARD.

The entire vagina and the cervix of the uterus are exposed by the fingers as by a speculum.

their place, the levator fibers are found more or less parallel to the lateral walls of the vagina. In the relaxed outlet, therefore, there is both a change in the direction of the lower levator fibers and a difference in the size of the levator loop surrounding the posterior vaginal wall. The broad, powerful transverse band, from pubic ramus to pubic ramus, has been replaced by a long, sharp-edged, lax loop, whose lumen is filled up by such soft, weakly resisting structures as vaginal walls and rectum.

The lesion is not always the same; the levator ani on one side sometimes remains intact, while its fellow of the opposite side is severed from its rectal and vaginal attachments. The difference in the direction of the fibers of the two sides is then marked, for while the intact side preserves a more or less horizontal direction its broken-down fellow hangs parallel to the lateral vaginal wall, at which point the finger may be buried in the deep sulcus between the rectum and the levator. Again, the attachment of the fibers on one side may be

nearer the outlet than the fibers of the opposite side, which lie in a different plane.

While the eversion of the relaxed outlet is often evident upon simple inspection, it may be most characteristically demonstrated by placing the thumbs on either side of the outlet behind and pushing outward and upward.

In many cases of reflex disturbances a relaxed outlet can only be detected



FIG. 141. TEST FOR THE RELAXED VAGINAL OUTLET, SHOWING HOW THE POSTERIOR VAGINAL WALL DROPS WELL AWAY FROM THE ANTERIOR WALL BY SIMPLY PLACING THE PATIENT IN SIMS'S POSTURE. external skin perineum is well preserved, but in spite of this there is a large lax, gaping orifice.

by examination under an anesthetic, for during a conscious examination the weakened levator is under tonic contraction and more or less efficiently closes the outlet, and the examiner may be so far deceived as to estimate a marked

relaxation as one of minor degree, or even to overlook the condition. In these cases "concealed relaxations."

It is a curious anatomical fact that the hymen is often better preserved in relaxed than in a normal parous outlet. The explanation lies in the mechanics of parturition. In the lax outlet the distention has not been equal on all sides, rupture has occurred and the hymen has given away in one or two directions. Thus the sequence of precipitate labor may be the curious anomaly of a greatly over-stretched outlet with an over-stretched hymen torn in but one or two places.

**Operation.**—The rational treatment for the relaxed outlet is resection. There are in general two modes of operating—the posterior median, and the posterior bilateral resection of the superfluous tissue, followed by suture. Since the



FIG. 145.—TEST OF AN EXTREME RELAXATION OF THE VAGINAL OUTLET.

Four fingers are easily introduced into the vagina and the thin pelvic floor pushed out, covering the rectum, and showing the entire absence of support.

natural outline of the vagina is **H**-shaped, the obvious inference is that the vaginal tissues will unite to best advantage in the limbs of the **H** that is in the sulci. This I believe is a correct inference, and I prefer, therefore, a bilaterally symmetrical operation extending up both sulci, based on the procedure of Dr. T. A. Emmet, of New York.

It is necessary to exaggerate slightly the effect of the operation in narrowing the vagina in order to counterbalance a slight relaxation which always follows.

The first step is to determine the limits of the demudation; this is done by

means of two tenacula shaped like a shepherd's crook, fixed on either side at the junction of the hymenal ring, or its remains, leaving sufficient tissue across the anterior vaginal wall between the tenacula to make a small outlet when the tenacula are brought together. These points mark the upper lateral limits of



FIG. 146. RELAXED VAGINAL OUTLET.

The fingers are demonstrating the position and the direction of the lower fibers of the levator ani muscle, which is grasped between them. The almost vertical direction of the levator loop is especially noteworthy as the most characteristic feature.

the resection. If they are fixed too near the urethra too much tissue will be removed and the new outlet will be too contracted; on the other hand, if they are fixed too low down the new outlet will continue to be too large, notwithstanding the operation. The correct pattern to have in mind in resecting is the nulliparous outlet.

A third tenaculum is now fixed in the vagina in the median line posteriorly, on the crest of the vaulted prominence of the rectocele, or posterior column (*vide* Fig. 150).

With these three points fixed, the area of denudation must now be outlined with a sharp scalpel. The bloody outline obviates the liability to error in a free-hand denudation. No one pattern will fit all cases; as an excessive relaxation requires a more extensive resection than one of moderate degree.



FIG. 117.—CALIBRATOR FOR MEASURING THE DEGREE OF RELAXATION OF THE VAGINAL OUTLET; GRADUATION IN CENTIMETERS.

The blades are closed and introduced just within the outlet and then opened as far as they will separate easily. The figures on the scale measure the degree of the relaxation.

The surface to be denuded is irregular in outline and occupies several planes, making it difficult to represent it adequately in a picture. In making the outline the central tenaculum and one of the lateral tenacula are drawn widely apart, downward, and outward, exposing one of the vaginal sulci. If there be a moderate degree of relaxation the apex of the triangle outlined in each sulcus is situated 3 centimeters ( $1\frac{1}{2}$  inch) within the outlet. By depressing the convex posterior vaginal wall a distinct line will be seen at the juncture of the anterior and lateral walls. An



FIG. 118.—RELAXED VAGINAL OUTLET IN A VULVARIA, WITH PERFECT PRESERVATION OF THE HYMEN, EXCEPT IN THE MEDIAN LINE POSTERIORLY.

Foissors were not used in any of the labors. Operation, June 1, 1897.

Incision should be made down to the lateral tenaculum through the vagina, parallel to and just below the anterior wall. From the same point within, the second side of the triangle is made by an incision down to the tenaculum at the cost of the rectocele. A narrow triangular undenuded area remains between the two triangles thus formed in the sulci (*c/h/h*, Fig. 151). The outline is now completed by a semicircular incision extending around the posterior wall, keeping within the hymen above, but embracing any scar tissue seen below. The center of this line falls 3 to 4 centimeters (1

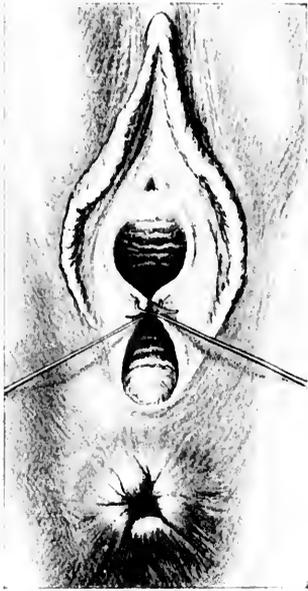

FIG. 149. RELAXED VAGINAL OUTLET.

Shepherd's crook tenacula fixed in both sides just within the hymen, mark the limits of the denudation. The tenacula are crossed to show the size to which it is proposed to reduce the reconstructed outlet.

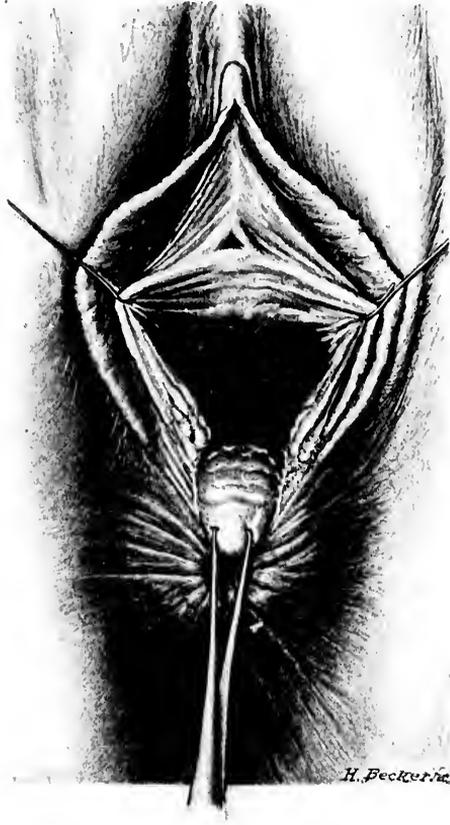

FIG. 150. RELAXED VAGINAL OUTLET.

Showing the shepherd's crook tenacula fixed at the sides, below the urethra, and the tenaculum forceps drawing the posterior column downward, so as to expose the lateral vaginal walls where the triangular denudations are made.

to  $1\frac{1}{2}$  inch) below the tenaculum fixed in the posterior column. The area thus outlined is rapidly denuded with Emmet's right curved scissors, removing the whole thickness of the vaginal walls in long strips 3 to 4 millimeters ( $\frac{1}{10}$  to  $\frac{1}{5}$  inch) broad. At first the strip of tissue follows the line of the incision down

to the apex of one of the triangles; then it continues back, and is carried to the front across the front and up into the other triangle; frequently the whole outlined area can be removed in a single strip. The dissection is often fac-



FIG. 151. RELAXED VAGINAL OUTLET.

The silk-worm-gut tension suture is placed in the triangle on the right side. The dotted lines represent the part of the suture which lies concealed under the surface. The short piece of the suture visible as a white line at the bottom of the demarcation is the part which is exposed by bringing the needle out at the bottom of the wound and re-entering it close by.

tated by running the ends of the scissors beneath the lax tissue on the floor of the vagina. Arterial and venous hemorrhage from cut vessels is sometimes free, but the venous flow lasts only a short time and ceases spontaneously. An actively spouting artery should first be clamped for a time in the artery forceps, and if it persists in bleeding after a few moments it may be tied with catgut. By judicious application of the deep tension and the approximation sutures, much hemorrhage can be checked without the use of buried sutures at all.

The large wound area is now accurately approximated by means of from three to four silk-worm-gut sutures, and from eight to twelve half-deep and superficial catgut sutures. But one silk-worm-gut suture is placed within the vagina, in either sulcus. An assistant exposes one of the triangular areas by drawing the tenacula at its base downward and outward; a carrier is entered upon the

mucosa on the lateral vaginal wall near the incision, a little below the middle of the triangle, and carried under the tissue toward the operator, appearing at the bottom of the sulcus, considerably below the point of entrance; it is re-entered close by and carried in the reverse direction, finally emerging on the mucosa of the opposite side of the triangle (and opposite the point of entrance). A stout silkworm gut suture sharply bent upon itself, 2 centimeters ( $\frac{3}{4}$  inch) from the end, is hooked into the loop of the carrier and drawn through, then pulled up and tied in a square knot, care being taken to adjust accurately the edges of the wound before tying. The suture thus placed draws together a large area of tissue. To close the wound accurately above the suture its ends are grasped between the third and fourth fingers, and by traction the upper part of the triangle is exposed, as a narrow ellipse, with loosely approximated sides. Perfect



FIG. 152.

The silkworm gut suture is tied and pulled down, exposing the catgut sutures in place and ready to be tied, closing accurately the upper part of the denudation, already brought loosely together by the silkworm gut. These catgut sutures must pass deep into the tissues so as not to leave a pocket in the wound below them.

union is secured here by fine catgut sutures, carried deeply from side to side. The first is placed but a short distance above the one of silkworm gut, tied here, and used in its turn as a tractor, exposing the wound immediately beyond; then the next suture is passed and tied and so on, until the upper part of the triangle is closed and all bleeding has stopped. The opposite sulcus is closed in the same

way with a single suture of silkworm gut and several of fine cutgut. These sutures should check all hemorrhage, but if there is persistent oozing it must be controlled by additional sutures tied tightly at the bleeding point. In this way a large part of the resected area within the vagina has been approximated, and the vaginal canal markedly narrowed within the pelvis. When the triangular areas in the sulci are large, a half-deep cutgut suture should be added below the one of silkworm gut.

Most of the remaining area may be brought together by a single gathering suture of silkworm gut, embracing the upper angles on the sides and transfixing the rectocele (*vide* Fig. 153).

An additional silkworm-gut suture may sometimes be necessary on the skin



FIG. 153. RELAXED VAGINAL OUTLET.

The inside sutures are now introduced and tied in both sides. The gathering suture of silkworm gut is introduced above across the angles, but is not tied. An auxiliary suture introduced to close the wound below this is also left untied.

surface extending through to the bottom of the wound. Half-deep and superficial sutures will complete the union.

The duration of the operation is from fifteen to thirty minutes. The outlining takes about one minute and a half, the denudation three or four minutes, and passing the sutures ten minutes longer; various minor matters may lengthen the time to half an hour.

The result of the operation is now evident in the change in the position, size, and direction of the vaginal outlet. It has been lifted and restored to its position well beneath the pubic arch. Its size has been reduced from 5 or 6 to  $1\frac{1}{2}$  or 2 centimeters ( $2\frac{1}{4}$  to  $\frac{3}{4}$  inches) in diameter. The examining finger no longer enters in the direction of the promontory of the sacrum, but goes backward



FIG. 154. RELAXED VAGINAL OUTLET.

Showing how the gathering suture above draws together the tissues.



FIG. 155. RELAXED VAGINAL OUTLET.

Operation completed. The sutures with longer ends, two inside and two outside, are of silk worm gut; the others are all of catgut.

toward the coccyx. This change in direction and position of the outlet removes it from the line of intra-abdominal pressure in which it has lain. Instead, therefore, of the constant tendency to eversion of the vaginal wall through a wide opening, the pressure is spent in forcing the anterior vaginal wall down upon the posterior one, and both upon the restored pelvic floor.

The external sutures should be removed from the eighth to the tenth day. Those in the inside may remain several weeks.

The immediate result of this operation is a complete restoration, and even the hymen is often restored. Subsequent labors will not destroy the effects of the operation, unless unskillfully conducted or attended by complications.

## CHAPTER XI.

### OPERATIONS ON THE VAGINA.

1. Introductory: *a.* Anatomy. *b.* Intrinsic affections, few. *c.* Traumatic affections, largest group. *d.* Diseases from extension.
2. General surgical principles.
3. Congenital affections: *a.* Absence of the vagina. *b.* Imperforate hymen. *c.* Atresia of one side of the uterus. *d.* Vaginal septa. *e.* Double vagina associated with uterus bicornis duplex.
4. Foreign bodies.
5. Vaginitis.
6. Vaginal cysts.
7. Abscess of Gartner's canal.
8. Neoplasms: *a.* Benign. *b.* Sarcoma and carcinoma.
9. Traumatic affections: of the vault; of the orifice; of the canal. Strictures—falciform and annular. Atresia.
10. Recto-vaginal fistula.

The vagina is a simple musculo-membranous canal, lined by stratified epithelium. It is distinctly funnel-shaped, its lower extremity being contracted and lying beneath the pubic arch, while its expanded upper end, flattened antero-posteriorly, rests upon the pelvic floor and receives the cervix of the uterus.

The list of its surgical affections is a short one. The most frequent and important are the ruptures at either extremity occurring during parturition; those above are produced by the extension of a tear beginning in the cervix and continuing out into the vaginal vault on one or both sides, while those below are oftenest found in association with a lacerated outlet. Other vaginal affections, such as malformations, cysts, and neoplasms, are rare.

Uterine tumors, such as a polypus or an inverted uterus filling the lumen of the vagina, are not reckoned among vaginal diseases.

The vagina being in the form of a sac, all of its surgical diseases, except fistula, in one way or another affect the size of the canal; foreign bodies, cysts, abscesses, neoplasms, cicatrices, and atresia encroach upon the lumen and diminish the caliber to a varying degree. The injury at the outlet alone has the effect of enlarging the canal at this point. Destructive diseases, such as sloughs, ulcers, and carcinoma, perforate the walls, establishing fistulous communication with the bladder in front, the rectum behind, or even the small intestines above.

### GENERAL SURGICAL PRINCIPLES.

The surgical principles involved in the treatment of vaginal diseases relate to:

1. The thorough cleansing of the field.
2. The proper exposure for operation.

3. The careful removal of existing disease, avoiding injury to important neighboring viscera.

4. The control of hemorrhage.

5. The closure of the wound by suture.

The vagina must be thoroughly cleansed before every operation. After bringing the buttocks to the edge of the table on a drainage pad, as in all plastic operations, the assistant retracts the posterior commissure with two fingers, or in a virgin with a narrow speculum, and introduces into the vagina a ball of cotton about 3 centimeters (1 1/2 inch) in diameter, coated with soft soap, grasped in a pair of forceps; warm water is then poured in from a vessel above, and the upper vaginal tract thoroughly cleansed by vigorously scrubbing for several minutes in all directions, taking care to distend and cleanse between the folds. All parts of the vault will be better reached if two fingers are introduced, the middle finger pushing the vaginal tissue down or to one side, while the index finger pushes the cervix in the opposite direction. By repeated washings with fresh pledgets of cotton and soap, followed by douching with warm water, all *dibris* and loose epithelium are gradually softened and removed. The lower vaginal tract is cleansed in like manner. Where discharges are escaping out of the cervix there is a constant liability to reinfection. It is best in such a case to dilate and curette the uterus, and then to pack the vault of the vagina with iodoform gauze during the performance of an operation.

**Exposure of the field.** In women who have borne children there is usually no difficulty in opening the vaginal outlet wide enough to expose and permit easy access to all parts of the canal by means of retractors in front and behind. The upper retractor fitting under the symphysis pubis should be narrow, with its blade spreading outside to keep the labia minora from dropping over the outlet and so obstructing the view; the posterior retractor must be broad enough and long enough to stretch the vagina and afford a good view of its walls, including the cervix. I found it necessary in one case, in order to reach a malignant disease of the vault of the vagina, to split the pelvic floor from the fourchette around the anus to the sacro-coccygeal joint, and dissect down beside the rectum, turning it to one side.

In the removal of diseased tissue it is important to bear in mind the topographical relations of the parts. In the first place, there are no organs except the ureters in the vicinity whose integrity is essential to life; thus, if uterus, bladder, or rectum are involved together with the vagina, portions of these structures may be sacrificed in removing the diseased tissue.

Even a considerable segment of the rectum may be removed and the upper and lower ends brought together. The excision of portions of the bladder requires careful attention to avoid injuring the ureters, whose location is indicated by the ureteral folds in the anterior vaginal wall.

The hemorrhage encountered in vaginal operations is never alarming, and is readily controlled by forceps and ligatures. Bleeding from the vaginal walls may always be controlled by the sutures approximating the edges of the wound.

Silkworm gut is the best suture material where there is tension, but silk and catgut may both be used.

Cleanliness is maintained after the operation by keeping the vaginal outlet dry and well protected. As soon as there is any discharge from the vagina the pack should be removed, and if the discharge is sweet-smelling the further care should consist in applying iodoform and boric acid powder (1 to 2) and absorbent cotton over the outlet. If the discharge is ill-smelling at any time, the vaginal douches must be given once or twice daily. I find the pleasantest and most efficient douche to be two drops of menthol and bicarbonate of soda and borax, a teaspoonful each, dissolved in half a liter of hot water and used warm.

The various surgical affections of the vagina may be considered under the following heads:

1. Congenital affections.
2. Foreign bodies.
3. Cysts.
4. Neoplasms.
5. Traumatic affections and atresia.
6. Recto-vaginal fistulae.

#### CONGENITAL AFFECTIONS.

Congenital affections are imperforate hymen, absence of the vagina, atresia of the upper part of the vagina with bicornute uterus, double vagina, and vaginal septa.

**Absence of the Vagina.**—When the vagina is absent, the uterus, ovaries, and tubes are also usually either absent or rudimentary. The exact condition of the organs higher up must be determined by a bimanual examination under anesthesia through the emptied rectum and the abdomen; the examination may also sometimes be made by a finger in the rectum and a sound or a finger in the bladder. An operation attempting to establish a connection between rudimentary organs and the vulva can not be serviceable, and is therefore unjustifiable. It is also useless to attempt to form a deep pocket between the rectum and bladder simply for sexual purposes, as such an opening can not be maintained.

**Transplantation for Atresia of the Vagina.**—An absent vagina may be replaced by the transplantation of new vaginal tissue from a case of prolapse, when the uterus, tubes, and ovaries are present, or when there is a unicorn uterus with hematometra and hematosalpinx. As W. Nagel has pointed out, in many apparently congenital cases the atresia of the vagina is really due to an unnoticed local inflammation in early childhood.

The formation of a new vagina has been twice successfully done by A. Mackenrodt (*Centralb. f. Gyn.*, 1896, No. 21, p. 546) as follows: A transverse incision is made in the septum between the urethra and the rectum, and the vesical and the rectal sides of the septum are separated from each other by a blunt dissection, with finger and instruments; on reaching the cervix both index

fingers are inserted and the future vagina widened. The wound surface is now packed firmly with an iodoform-gauze tampon, which is changed every few days, until the whole surface becomes covered with healthy granulations. At this juncture the transplantation is done either at one or at several sittings, according to the amount of the tissue available to make the new vagina. Unusual care must be taken in preparing the flaps which must be carefully cleansed first, and then cut out without crushing or bruising, and with as little as possible of the underlying connective tissue. The flaps are then put aside, wound surface to wound surface, and kept warm and covered in a sterile dish until the pro-lapse operation has been completed, when they are laid with great care on the dried aseptic wound surface and pressed down, until they adhere as if by suction; they are then fixed in place by an iodoform-gauze tampon, which remains undisturbed for about ten days, while the patient is kept absolutely quiet in bed. The replacement of the whole vagina at one sitting is more difficult; the flaps formed as described are spread out lengthwise on a Cusco's speculum, with the epithelial surfaces turned inward; they are then sewed loosely together so as to allow any secretions to escape between them. At the inner end of the speculum they are connected by a few threads which form a loose pocket; then the upper end of the speculum is filled with iodoform gauze and inserted into the wound, and as the speculum is withdrawn more gauze is packed in, all in one piece, until the tamponade is completed. Especial care must be given to keeping the tampon from being wet with urine. In two weeks the parts appear normal.

When both the vagina and the uterus are absent and the ovaries are present and functionally active, the recurring monthly paroxysms of pain, associated at times with a vicarious menstruation, may necessitate ovariectomy for the removal of the ovaries, as in the following case:

B. M. (No. 2190, Sept. 9, 1893), an anemic woman twenty-eight years old; at the age of twelve began to have periodical monthly severe headaches, accompanied by dizziness and flushes of heat over the entire body; her face flushed readily, and she was annoyed by frequent blushing; she also had sharp, cutting pains in the region of the left ovary; between the attacks she felt well. In her twentieth year she began to have convulsions, as many as four and five in a day. The first hemorrhagic discharge from the rectum took place in her fourteenth year at one of the periods. The flow was dark brown in color, clotted, and not offensive, and continued one day; after this there was no discharge for three years, but the feeling of fullness and pain in the abdomen still recurred every month. In her seventeenth year she had a second hemorrhage, which continued for six weeks.



FIG. 156.—ENTIRE ABSENCE OF THE VAGINA, WITH INDICATION OF DOUBLE HYMEN. THE EXTERNAL GENITALS NORMAL. SEPT. 9, 1893.

During the convulsive attacks, which persisted at variable intervals, she became weak and nervous, and the abdomen was swollen and tender. Six months before entering the hospital the rectal flow began, and continued up to the day of operation with the exception of a few days, accompanied by much pelvic pain.

**Examination.**—Scanty growth of pubic and vulvar hair. Esentences of the female type. External genitalia perfectly formed rudimentary hymen, and the vagina is entirely absent, being represented by a narrow fibrous column which can be palpated by the rectum.

Both ovaries and tubes are apparently normal, but seem to fuse into two nodular masses corresponding to the cornua of a uterus, but no uterine body can be felt.

**Diagnosis.**—Total absence of vagina and uterine cervix; two rudimentary uterine bodies; ovaries and tubes normal. Menstrual molimina with rectal discharge.

**Operation.**—Celiotomy for the removal of undeveloped uterus, ovaries, and tubes. The bladder lay transversely across anterior part of the pelvis, and the small intestine and the rectum filled the posterior two thirds. On the pelvic floor a fleshy nodule, 1.8 centimeter in diameter, was found in the median line,

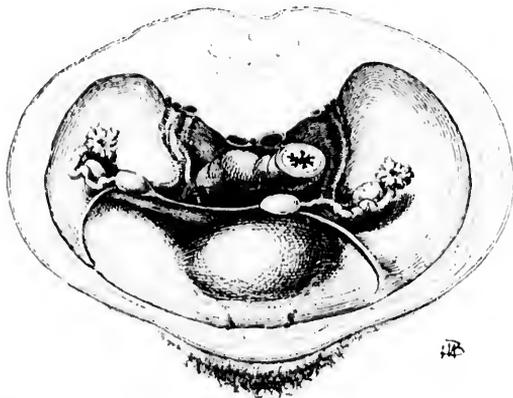

FIG. 157. RELATIONS OF THE RUDIMENTARY UTERI, THE TUBES, AND THE OVARIES IN THE CASE OF ABSENCE OF THE VAGINA.

The left uterine nodule lies upon the bladder near the median line, the right nodule is close to the pelvic brim, and the two are connected by a thin fleshy band. Note the large oval nodule beneath which lay a small ovary. Operation for vicarious rectal menstruation with extreme nervous discomforts.

from which a well-formed uterine tube extended out and up to the brim of the superior strait on the left side, terminating in a fimbriated extremity beneath which lay a small ovary.

This central nodule was connected by a fold of peritoneum with a second similar but smaller nodule on the right side. From this nodule also a uterine

tube extended out to an ovary. Both tubes were patulous down to the fleshy nodules, from which well-formed, round ligaments extended out to each inguinal canal.

A fibrous band about 4 centimeters long, about 5 millimeters broad, and 2 to 3 millimeters thick, extended down under the bladder, representing the va-

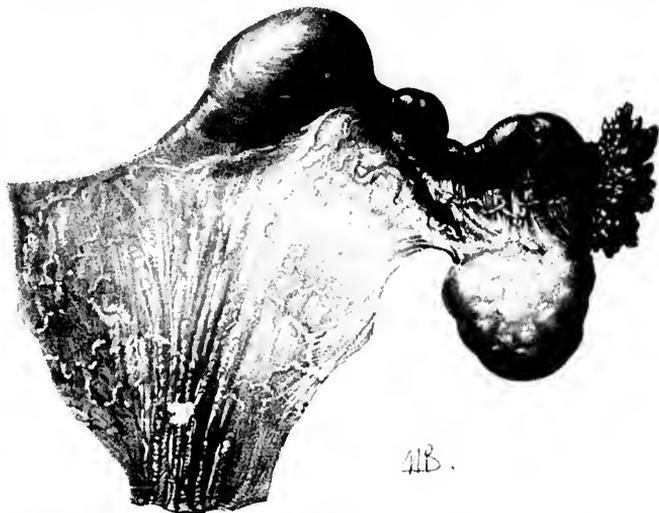

FIG. 158. LEFT TUBE AND OVARY AND UTERINE NODULE, THE TUBE AND OVARY NORMAL IN SIZE.

The membrane below, with parallel folds, occupies the position of the uterine body and the upper vagina. Sept. 9, 1893, No. 54. Natural size.

gina. The rudimentary uterine cornua tubes and ovaries were removed and the patient made a good recovery.

**Microscopical Examination.**—Tubes normal, well developed, nothing atypical in their histology. They end in two *culs-de-sac* in fleshy nodules slightly larger than the tubes and containing some normal uterine mucosa and glands.

The ovaries contain Graafian follicles in various stages of development. Corpora lutea and corpora fibrosa are present.

**Diagnosis.**—Rudimentary bicornute uterus, absence of cervix and fundus of uterus, normal ovaries and tubes.

**Imperforate Hymen.**—The simplest form of vaginal atresia is that of its lower extremity at the hymen. The closure here affects the vaginal mucous membrane alone and does not consist, as in atresia above, of an absence of the entire wall with a replacement by fibrous tissue, forming the septum. The hymen in these cases usually forms a thick, tough, resisting membrane.

The upper vagina, uterus, ovaries, and tubes are, as a rule, well formed and functionally active in such cases.

This condition of the hymen is rarely recognized until puberty, when the failure of the appearance of the menstrual secretions is the occasion of an examination, which at once reveals the anomaly. It may, however, be discovered in quite young children by the accumulation of mucus within, causing the hymen to pout out, forming a whitish sac between the labia beneath the urethra, which becomes more prominent when the child cries. If this sac is cut open with a pair of scissors a little mucus is discharged and no further difficulty is experienced.

After puberty, as each menstrual period pours its secretions into the uterus and vagina, the more fluid parts are absorbed and leave behind a thick tarry substance. In the course of time, between the ages of seventeen and twenty, the vagina may become distended into a sac big enough to fill the pelvis. The upper end of the sac is formed by the expanded uterus, often with dilated tubes at

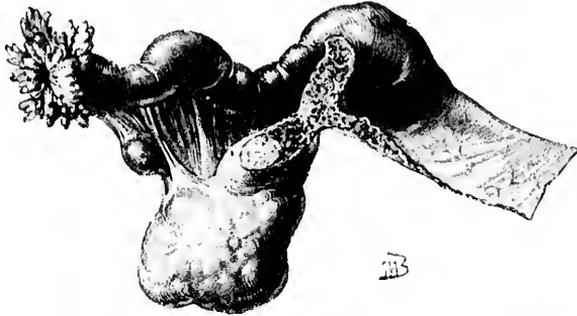

FIG. 159.—RIGHT TUBE, OVARY, AND UTERINE NODULE, SHOWING THE NORMAL SIZE OF THE TUBE AND OVARY.

either horn, and a greatly distended cervix. The distinction between uterine cavity proper and cervical canal is marked by the internal os uteri, which preserves its identity although much dilated. The lower uterine segment opens up so as to appear like a continuation of the vagina; indeed, the external os is often difficult to find. One of the most important complications is the distention of the uterine tubes by the backing up of the retained menstrual secretions.

The changes at the lower end of the vagina are quite characteristic and afford valuable diagnostic points, as they are readily accessible to inspection and touch. There is a marked bulging convex tumor protruding between the labia, which fluctuates distinctly upon touch; posteriorly it is limited by the perineum, laterally by the inner surfaces of the labia, and anteriorly it reaches the posterior margin of the urethra. If the tumor is large enough to fill the lower abdomen, rising as it may as high as the umbilicus, the wave of fluctuation is readily transmitted from above downward as far as the tumor at the vulva. The rectal examination reveals an elongate sac filled with fluid occupying the position of the uterus and conforming in its general direction to the axis of the pelvis.

**Treatment.**—Lives have been repeatedly lost from sepsis coming on rap-

idly after opening these accumulations, especially where the tubes have been dilated. The blood adhering to the sac and the thin walls, together with the sudden change in the pressure upon the blood vessels, affords nutrient material for sepsis and a ready avenue for its entrance into the neighboring peritoneal cavity through necrosis of the thin walls. This danger will be avoided by a thorough cleansing of the field, by taking care not to infect the tract while operating, and by a careful packing with iodoform gauze so as to protect the field for some days after operation.

After cleansing the external genitals the bulging membrane is opened by a crucial incision, dividing it into four triangular flaps. The thick fatty fluid is allowed to escape slowly; the canal above it is washed out from five to ten minutes with a saturated boric acid solution introduced through a long curved glass douche nozzle. Pains must be taken to empty the whole vaginal and uterine cavities of all the blood. An abundance of iodoform and boric acid powder is dusted into the vagina and iodoform gauze loosely packed in from the vaginal vault to the outlet. The urine is drawn, the powder sprinkled over the outside, and a pad of sterilized cotton laid on, held in place by a T-bandage. These dressings may be left in four or five days or even longer, provided all is going well and they do not become saturated earlier.

At any time as soon as they are wet with secretions the dressings must be changed by bringing the patient conveniently to the edge of the table or bed under a good light and withdrawing the pack with forceps and reinserting it with a packer, using every care to avoid contact of the gauze with fingers, buttocks, etc. By this mode of treatment sepsis will be kept out and the one great danger eliminated.

In some rare cases a thick, tough hymen, almost imperforate, forms an insuperable barrier in married life. Such a malformation is generally soon discov-



FIG. 169. HYMEN INTACT AFTER NINE YEARS OF MARRIED LIFE.

The membrane was thick and tough and perforated by two small orifices. Oper. June 5, 1897.

ered and easily relieved by a simple incision with the surgeon's knife. In a figure (160) I show a case, however, in which this barrier still existed after nine years of married life.

**Atresia of One Side of the Uterus.**—Another form of congenital atresia affects but one horn of a bicornute uterus. The menstrual secretions are here retained in the one side, and as the accumulation increases a pelvic tumor is formed, bulging into the vault of the vagina on the defective side, where there is a distinct ovoid swelling, more or less tense and fluctuating to touch, displacing the uterus toward the opposite side.

The treatment of this form of gynatraesia is by making a cruciform incision and evacuation and thorough irrigation, followed by the most rigid aseptic precautions during the convalescence.

**Vaginal Septa.**—Septa when congenital are usually found in the upper part of the vagina. They appear as falciform processes, involving only the mucous membrane and encroaching upon the lumen of the canal. The cervix may be entirely hidden and the avenue of communication from the vagina below to the vault above may be but a small orifice placed at one side.

Sometimes the septum extends transverse-

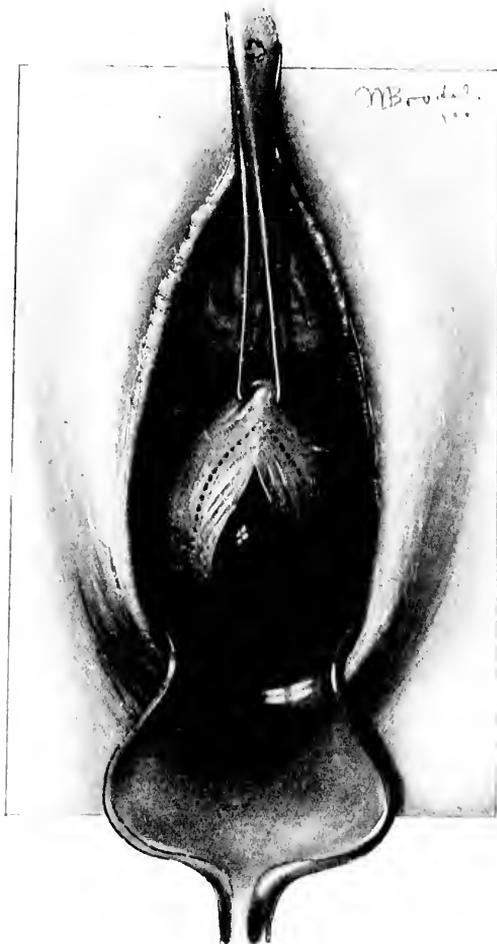

FIG. 161.—TRAUMATIC ATRESIA OF THE VAGINA WITH ACCUMULATION OF THE MENSTRUAL SECRETIONS ABOVE.

A median incision allowed the thick, tarry blood to escape and accumulate in the speculum as shown. The membrane was then excised along the dotted line. Dec. 5, 1896.

across the entire vagina, forming an atresia, as in the case shown in fig. 161.

Such septa may mechanically cause sterility. They may also act as pockets in which irritating secretions are retained. The treatment is simply to divide the septum with a scalpel in one or two directions down to its base without an anæsthetic. If the septum is thin and membranous no sutures will be needed; if fleshy and bleeding at the base, two or three fine silk sutures at this point will draw the upper and lower surfaces together and stop the flow. These septa must not be confused with the acquired cicatricial septa, which need a different treatment.

**Double Vagina associated with a Septate Uterus.**—When there is a fusion of the Müllerian ducts without the absorption of the septum, uterus septus and double vagina are formed. These cases are not rare, and often present a history like the following: M. C. (No. 4887, December 28, 1896), aged forty-one, married twenty-six years; iii-para; labors difficult, but not instrumental; three miscarriages.

Menstruation began at fifteen, regular, moderate, lasting two to three days, always with much pain.

**Examination.**—External genitals normal; hymen beginning on left side below urethra around to posterior margin is intact, beyond this on the right side broken in three places, leaving caruncle between.

A prominent bridge of tissue extends from a point 1 centimetre below the everted urethra to the posterior margin of the hymen, where it curves upward and joins the hymen on the left side. This bridge between the anterior and the posterior walls is thick and fleshy, looking like normal vaginal tissue. It begins on the anterior wall 1.5 centimetre broad, is about 5 millimeters broad in the middle, and 2 to 3 millimeters in width where it joins the left side of hymen. Two vaginal orifices are formed in this way, the left crescentic with the lower sharp horn of crescent encroaching on the left side; the right opening is oval, 3 by 2 centimeters in size when held slightly apart. The redundant vaginal walls pout into both of these orifices.

The vaginal introitus looks as if the right side had been broken down and its folds smoothed out by labor, while the left side remained intact. This doubling of the vagina, apparent at the orifice, is continued all the way up to the flattened double uterine cervix, and upon introducing a bivalve speculum, two little cervixes appear at the vaginal vault, one in each half of the vagina, with both

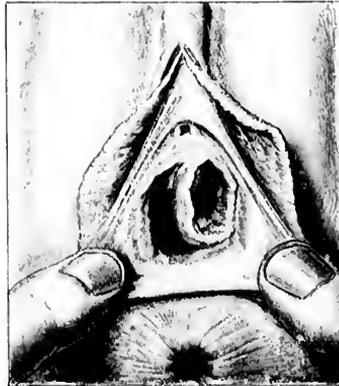

FIG. 162. DOUBLE VAGINA WITH A THICK FLESHY SEPTUM. THE LEFT ORIFICE IS OVAL, WHILE THE RIGHT IS CRESCENTIC. DEC. 28, 1896.

openings turned toward the septum. The septum is not quite so thick above and below, and it measures about 3 centimeters from anterior to posterior wall.

A diagnosis of pelvic abscess was made in this case, and in order to evacuate it by the vagina and to secure good drainage in a dependent position it was necessary to excise the entire septum, and so unite the right and left vaginæ in



FIG. 163.—DOUBLE VAGINA AND DOUBLE CERVIX, WITH A BLADE OF A BIVALVE SPECULUM INTRODUCED INTO EACH SIDE, SO AS TO SHOW BOTH CERVICES AND THE SEPTUM IN THE MIDDLE.

one. This was done by cutting it away with scissors at a little distance from the vaginal walls. The bleeding was moderate and easily controlled by a continuous catgut suture along the anterior and posterior vaginal walls.

An exploratory abdominal incision was then made and the vagina opened and drained in the vault behind the cervix under guidance of the fingers in the abdomen, and the patient recovered.

**Foreign Bodies.** The one foreign body found in the vagina with any degree of frequency is a pessary, introduced for therapeutic purposes. The pessary becomes injurious when it is too large, or when, owing to its composition, it gives rise to foul

secretions, or when left in too long. It was more a fault of our predecessors than of present-day practitioners that they tried to effect by the size of the pessary what they could not attain by its skillful adjustment. I once removed a Hodge pessary large enough for a mare, which had been thrust into the vagina years before to relieve a simple flexion. In another case I found an old woman in a low typhoid condition which was inexplicable, until a fetid leucorrhœal discharge was discovered; then on vaginal examination a large, thick ring pessary was felt choking the vagina. On removal, it was found to be made of cloth covered with an impermeable paint and stuffed with fiber. It had been introduced in Germany fifteen years previously, and had produced such extensive ulceration of the vagina with absorption from the raw surfaces as to bring on the typhoid condition in which the patient died, in spite of the removal of the cause and repeated careful cleansing of the wound surfaces.

In another instance a stem pessary, which had been introduced by the family physician, was thought to have been lost, as examination failed to reveal its presence in the vagina. Later, the patient began to suffer intensely, and

came to the hospital in a septic condition, and on examination, the pessary was found lying transversely across the vagina, one end having buried itself in the perineum, where it was felt as a hard body, while the eup had ulcerated its way into the bladder, producing a vesico-vaginal fistula. It was removed by breaking it to pieces with the bone forceps. The patient did not rally from the septic condition, and died in a few days.

Soft-rubber ring pessaries commonly produce a free leucorrhœa, often with intense itching of the external genitals, and for this reason I have abandoned them. The effect of a hard-rubber pessary, which is too large, is to imbed itself in the posterior vaginal wall. On removing such a pessary a deep semi-circular sulcus may be seen back of the cervix and extending out on the lateral walls. When the granulations meet over the posterior bar, this part of the pessary is completely buried, and must be cut out to be removed.

In more extreme cases the ulceration extends through into the rectum behind, and the anterior bar pushes through the vesico-vaginal wall into the bladder in front, forming recto-vaginal and vesico-vaginal fistulae. Instances of ulceration even into the peritoneum are also recorded.

The treatment is the removal of the foreign body and keeping the wound clean by repeated irrigations until it is healed, and then closing the fistula. Careful note must be taken of the fact that where the foreign body has been in place for years the vaginal orifice often becomes so contracted as to prevent its withdrawal by simple traction through the outlet without laceration. The effort may be first made to remove it by traction in the direction of least resistance, after cleansing the vagina thoroughly and injecting into it a large quantity of vaseline. If the pessary can not be extracted in this way without injury, either on account of its size or because of the incrustations covering it, the operator must remove it in pieces. To do this he will have better command of the field and be less liable to injure the vagina with the patient in the knee-breast position and the posterior vaginal wall well retracted by a broad Sims speculum. The pessary is then easily seen and caught with a pair of stout forceps, which fix it firmly, while with bone forceps it is cut into pieces small enough to be readily removed. If the forceps can not break it, a metacarpal saw may be used.

Ulcerated areas should be freely penciled with a 5 per cent nitrate of silver solution every four or five days, and warm borie acid douches used twice daily until the wound has healed.



FIG. 161. ATRESIA OF THE VAGINA DUE TO A CUP AND STEM PESSARY.

Above the atretic area the vagina is filled with pus. The stem of the pessary is outlined where it is buried in the tissues to the right.

**Vaginitis.**—Vaginitis, or, more correctly, colpitis, is an inflammatory affection of the vaginal mucosa usually due to a bacterial infection.

Vaginitis may also be the result of the application of an irritant to the vagina, but the disease does not persist unless the inflammation is kept alive by the invasion of one or another of the pathogenic organisms. A vaginitis is also often produced by the irritant effect of a foreign body in the vagina, such as a pessary, particularly if the pessary has been transferred from another person without being sterilized.

Although a variety of micro-organisms form the real basis of the different forms of inflammation of the vagina, but few of these have as yet been identified, and it is often impossible in a given case to name the true cause. The best known forms of bacteria liable to produce a vaginitis are the gonococcus, the tubercle bacillus, an organism resembling the *oidium albicans*, and a gas bacillus.

Gonorrhœal vaginitis is rare, and so experienced an observer as Bunn (Veit's *Handb.*, Bd. i, p. 474) declares that he has only seen five cases all told.

Too great care, therefore, can not be taken in establishing such a diagnosis. Bunn considers that the cases commonly considered as gonorrhœal vaginitis are merely the result of the secondary irritation proceeding from the stagnation of purulent discharges from an infected cervix. He quotes further experiments made in v. Rineecker's clinic in Würzburg, in 1880, where the vagina was allowed to remain for twelve hours in contact with a gonorrhœal secretion without any manifest result.

Veit, on the other hand, is inclined to lay much stress on the gonococcus as an etiological factor.

The exemption of adult women is apparently due to the thick impervious vaginal epithelium; in young children, on the other hand, and even in young women, where the vaginal epithelium is tender and succulent, an infection of this sort is far more liable to occur.

Pregnancy, by the increased blood supply to the genital organs, with the attendant softening of the tissues, increased moisture, and loss of the superficial layers of the vaginal epithelium, predisposes to inflammatory processes, and a slight trauma may suffice to bring about an acute colpitis. At this time we observe the two following forms, which are almost unknown at any other period.

The aphthous vaginitis is due to the presence of a vegetable parasite, resembling closely the *oidium albicans*, which appears in white raised patches on the reddened vaginal wall, and in the shape of small white flakes in the vaginal discharges.

The other form of vaginitis is known as colpo-hyperplasia cystica, and is characterized by the presence of gas cysts in the vaginal mucosa, the formation of gas being due to a bacillus which has been isolated by several observers. The gas is found in cavities in the interstices of the connective tissues.

A vaginitis may also be due to contact with the irritating discharges of a carcinoma of the cervix.

Senile vaginitis is peculiar to old age, when the vagina is atrophic and has a poor blood supply; if at this time an inflammation is set up by an irritating uterine or cervical discharge, or if a trauma occurs from coitus or other cause, the result is an ulcerated area which is slow to heal, or adhesions may form chiefly at the vaginal vault, giving rise to the adhesive vaginitis of old age.

Finally, there is found at times, accompanying febrile or exanthematous diseases, a severe form of vaginitis, which may present the picture of diphtheritic vaginitis, so called from the false membrane formed, either in localized areas or almost entirely covering the vagina. The inflammation may even be severe enough to terminate in gangrene and sloughing of the vagina.

These cases are usually masked by the acute general symptoms of the disease, and in the worst forms are almost always fatal. The results of the less severe forms are seen afterward in atresia or stenosis of the vagina.

A chronic form of vaginitis is also seen, characterized by thickening and prominence of the papillæ of the mucous membrane, by a thin purulent discharge, and sometimes by ulcerated areas in various parts of the vaginal wall.

The symptoms of a vaginitis vary greatly from the acute form, where the patient is unable to move on account of the severe pain, with its attendant vesical and rectal tenesmus, to those cases where the only complaint is of irritation of the external genitals, with some vaginal discharge.

On examination in an acute case, the labia and surrounding skin show signs of inflammation, being reddened, thickened, and smeared with a whitish purulent discharge. On separating the labia the discharge will be seen issuing from the vaginal orifice, which may be pointing and of a deep red color. On introducing the finger the vagina will be found hot and swollen and sensitive, the tissues feel softer than normal, and on withdrawing the finger it may show a little streak of blood. Under the speculum the vagina is of a deep red color, the mucosa looks thicker than normal, and in places a velvety appearance, from the prominent papillæ, is noted. Small blood-red areas may also be seen which bleed on touch; these are points where the mucosa is thinned out and the blood vessels show more distinctly. This latter appearance was the origin of the name of "colpitis granulosa" for one variety of vaginitis.

The symptoms in the senile vaginitis are usually but slightly marked, and the condition is often discovered accidentally. There is usually a little purulent discharge, the vagina is smooth, injected uniformly or spotted with red, diminished in caliber and length and coitus is interfered with.

In vaginitis accompanying pregnancy the principal complaint is the almost unbearable itching, which at times prevents the patient from sleeping.

The diagnosis of vaginitis can only be made by a thorough examination of the parts. The presence of a profuse curdy secretion covering the walls

should not suffice, but this must be wiped off and the color and amount of swelling or thickening noted. The aphthous vaginitis may be distinguished by the small white flecks on the surface, which can not easily be wiped off, and by a microscopical examination of the discharge. The colpo-hyperplasia cystica is recognized by the presence of the cysts, which, on opening, are found filled with gas.

The diagnosis of gonorrhoeal vaginitis must always be carefully made, and if there is any doubt a gonorrhoeal source should not be suggested to the patient. The acute history, with the onset following six or eight hours after coitus, the profuse yellowish discharge with a slight pungent odor, the involvement of the urethra, cervix, and perhaps one of the vulvo-vaginal glands, will all help in the diagnosis, which must also be strengthened by a microscopical examination of slides, stained by the Gram and other methods.

The treatment of vaginitis depends to a large extent on the cause of the inflammation. The proper plan is to discover the cause when possible and to remove it, and then to treat the remaining disease.

For example, a foreign body must be immediately removed, and in many cases this will be the only treatment necessary. The irritating discharges from a carcinomatous cervix or from a sloughing uterine myoma must first be checked by the removal of the growth and by vaginal douches.

The local treatment may be carried out by using medicinal substances in a watery solution, introduced through a syringe into the vagina, or by medicinal substances applied directly in viscous solutions or as dry powders.

Irrigation of the vagina is best practiced with a fountain syringe with a glass nozzle, which can be easily and thoroughly cleansed by boiling. The reservoir of the syringe should only be raised a foot or eighteen inches above the patient, and the injection should always be taken in the reclining position, allowing the fluid to enter the vagina slowly, the nozzle not being introduced over two inches. The patient should also lie quietly for a time, allowing the last of the irrigation to remain in contact with the vaginal mucosa for a short time.

Various substances are used in this way, either for their antiseptic or astringent action, and combinations may be made in which both actions may be taken advantage of. The watery solutions which are most frequently used are bichloride of mercury, in strengths of from 1 10,000 to 1 10,000; carbolic acid, 20 or 30-1,000; potassium permanganate, 5 1,000; boric acid, 30 or 40 1,000; also, as astringents, tannin from 10 to 30 1,000; acetate of lead, 1 to 5 1,000; alum, 10 to 25-1,000.

When the discharge is acid, it will often prove of distinct advantage to use alkaline douches, such as lime water, soda water, etc.

The use of cotton tampons soaked in viscous solutions of various agents is also a good method of treating vaginitis, with, however, the drawback that the patient must see her physician every time it is necessary to renew the tampon, for it is usually impossible for her to introduce it herself. The tampons may either be introduced in the knee-breast or in the left lateral

position, or they may be introduced in the dorsal position, using a bivalve speculum. The tampon should either be soaked in the fluid or the fibers can be separated enough to form a cavity in the center, in which the fluid may be poured. Each one must also have a cord attached firmly to it to facilitate the removal.

The substance generally used for the vehicle is glycerin, as this has itself a

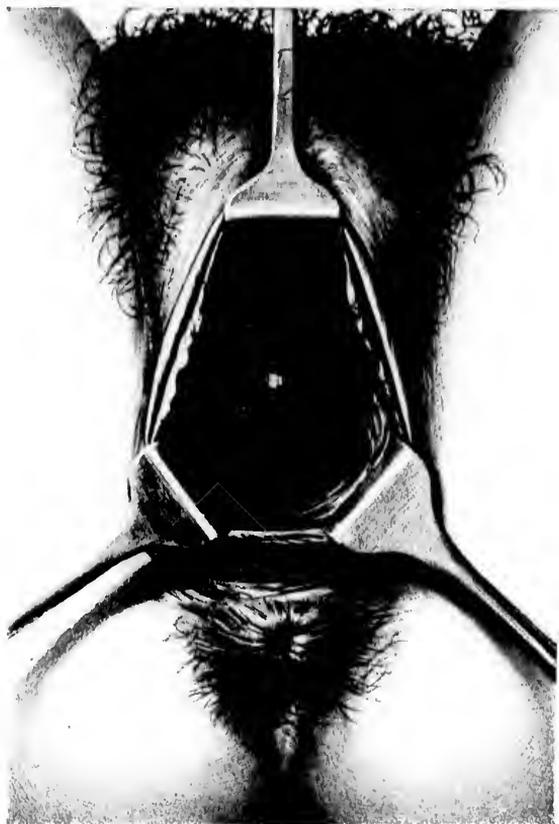
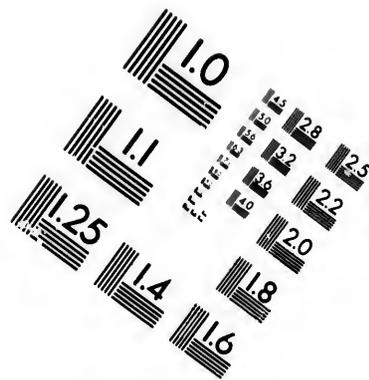
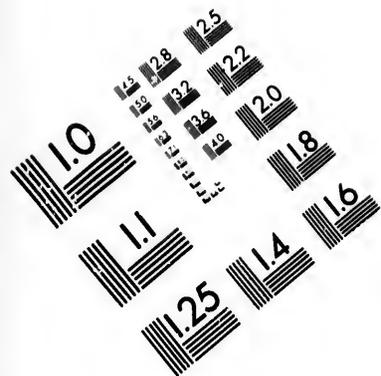

FIG. 165. TWIN WALLED CYST OF THE RIGHT VAGINAL WALL.

The cyst is somewhat acuminate and the base is much smaller than the greatest circumference. Path. No. 128.

certain amount of action on the vagina. In this may be dissolved alum, 5-100, boric acid, 10 to 20-100, or ichthyol of 5 or 10 per cent strength.

Dry powders may be applied to the vaginal surface through a powder blower



**IMAGE EVALUATION  
TEST TARGET (MT-3)**

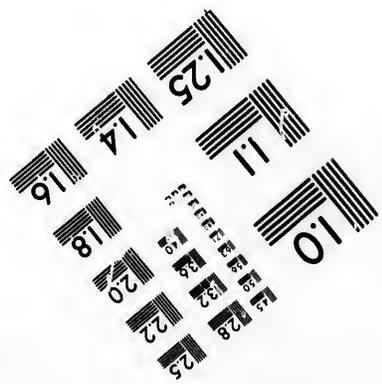
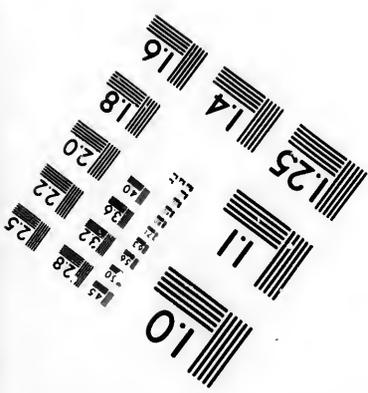
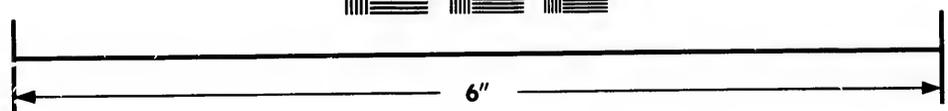
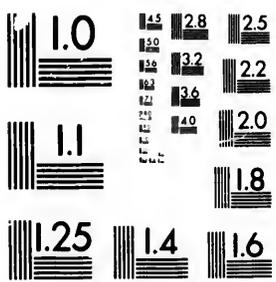

**Photographic  
Sciences  
Corporation**

23 WEST MAIN STREET  
WEBSTER, N.Y. 14580  
(716) 872-4503



or by means of a brush, or they may be inclosed in a wad of wide-meshed gauze and introduced.

Nitrate of silver, in 5 or 10 per cent solutions, may be applied locally to ulcerated areas by an applicator wound with cotton.

The prognosis of most cases of acute vaginitis is good if the cause can be removed. Gonorrhoeal vaginitis usually heals quickly, though there is always a chance of reinfection from the cervix or urethra, unless these also receive careful and prolonged treatment. The chronic and senile forms are hard to heal on account of the marked changes which the tissues have undergone, rendering rejuvenation impossible; the prognosis as to complete cure in these cases must therefore be guarded.

**Vaginal Cysts.**—Cysts in the vaginal wall are not so rare as is commonly supposed, for if all cases were examined carefully enough small cysts would be frequently found which are ordinarily overlooked; cysts, however, as big as a hen's egg or even larger, are uncommon. Cysts may spring from any portion of the vaginal walls, and are usually hemispherical or ovoid, rounded or flattened on top, shining and translucent when the vaginal mucosa is thinned out over them, and projecting into the vaginal lumen, which may



FIG. 166. CYST OF THE ANTERIOR VAGINAL WALL IN PREGNANCY. The entire cyst is translucent, with whitish bands interlacing over the surface. Note the well-defined blood vessels. Natural size. Dec. 9, 1895.

be seriously encroached upon. I saw one clear thin-walled cyst lying behind the cervix, reniform, concave anteriorly, extending transversely across the vaginal vault, about 3 centimeters (1.2 inch) long by 1 centimeter in breadth. Several small cysts are occasionally found in a group.

The cyst contents are thin and watery, glrey, opalescent, or even purulent. I have seen purulent vaginal cysts five times, three of the anterior wall and two of the posterior, all of them extremely painful and sensitive to the slightest touch and associated with fever. Two of those on the anterior wall, however, were not true vaginal cysts, but were suburethral abscesses, discharging into the urethra; another, a true vaginal cyst with a thin wall, was seen with Dr. A. K. Minich, of Philadelphia, and was situated within the vagina on its anterior wall, ovoid, and as big as a hen's egg; it was cured by a simple incision, evacuating the pus. The fourth was 4 centimeters (1.6 inch) in diameter and

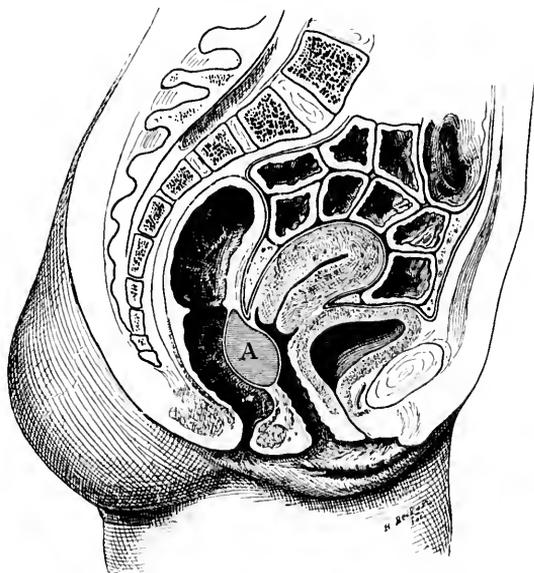

FIG. 167.—ABSCESS OF THE RECTO-VAGINAL SEPTUM (A) IN THE UPPER PART OF THE VAGINA.

3 centimeters (1.2 inch) thick, situated in the posterior vaginal wall, high up, just below the vault and seemed fixed to a firm base. It caused paroxysms of agonizing rectal pain, during which the patient would stand grasping a chair and screaming. On incising it, thick, yellow, odorless pus escaped; the walls of the cavity were smooth, rigid, and irregular above. There was no communication with the rectum in this case, as noted in an abscess of the recto-vaginal septum reported by Heydrich (*Centralb. f. Gyn.*, 1891, No. 21). The remaining case involved the posterior vaginal wall, low down, and was caused by a rectal fistula, so that out of the five four were pseudo- and but one was a true vaginal cyst.

**Etiology.**—The current belief that the true vaginal cysts are commonly formed in Gartner's ducts is erroneous, for two reasons—the superficial site of

these cysts, and their indifferent positions on the anterior, lateral, or posterior walls. The case mentioned above is also quite conclusive evidence against the

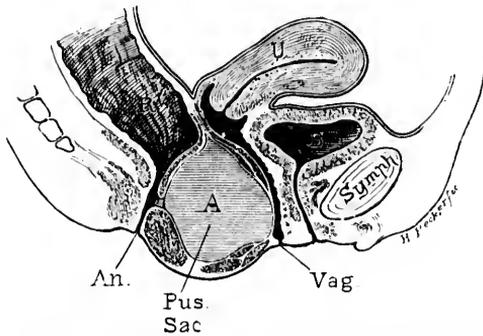

FIG. 168.—ABSCESS OF THE RECTO-VAGINAL SEPTUM FROM A RECTAL FISTULA, DESCENDING THE PERINEUM AND THE POSTERIOR VAGINAL WALL.

theory, inasmuch as the cyst lay quite superficial, and crossed the vaginal vault from side to side with its long axis horizontally. Another objection is the fact that a group of small cysts may be found irregularly distributed on one side of the vagina, and not arranged in a curved or in a straight line, as would be the case if they originated in Gartner's duct. The same objections can not be urged against the cases cited by Kiwisch and Veit, in which a row of cysts were distributed in line along the anterior vaginal wall on either side. Nor can any objection be urged against the supposition that cysts at the vaginal vault, lateral to the cervix and extending up into the parametrium above the vault, have developed in the remains of the duct.

I would divide vaginal cysts, according to their origin, into those arising—

1. From the vaginal glands.
2. From epithelial nests included in the scar tissue following a trauma.
3. From Gartner's ducts.

The vaginal glands are sparse and are lined with cylindrical epithelium; when the duct becomes choked the accumulating secretion within pushes out into the vagina in the direction of least resistance and a cyst is formed. The evidence we have of this

mode of origin of some vaginal cysts depends upon the researches of F. von

the same objections can not be urged against the cases cited

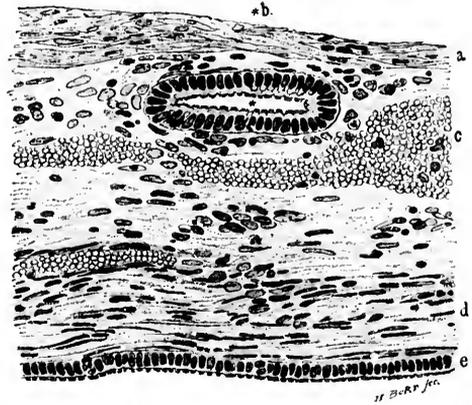

FIG. 169.—SECTION OF THE WALL OF A CYST FROM THE ANTERIOR WALL OF THE VAGINA, JUST TO THE RIGHT AND POSTERIOR TO THE URETHRAL ORIFICE.

The cyst walls were smooth, thin, and transparent; the cavity was empty, except for a few clumps of round cells here and there. *a*, Stratified epithelium; *b*, a vaginal gland lined with ciliated cylindrical epithelium situated in the connective tissue in the wall of the cyst; *c*, blood lying free in the stroma; *d*, large spindle-shaped connective-tissue cells; *e*, cylindrical ciliated epithelium lining the cyst cavity. Path. No. 1502. Magnified 360 times.

Preuschen and the discovery by C. Ruge of a gland in one of his sections of a vaginal cyst.

I am prepared to strengthen Ruge's position by showing a similar case in which a vaginal cyst 1 by 1.5 centimeter in size was removed and found lined with columnar ciliated epithelium; between the cyst and the typical vaginal epithelium lay a flattened vaginal gland lined with columnar epithelium similar to that of the cyst, and radically different from the vaginal epithelium.

The cysts due to epithelial inclusion (see Fig. 171) are entirely different in their microscopic characters; they are usually small and located in the posterior vaginal wall at the outlet or near it. I have seen one case in which

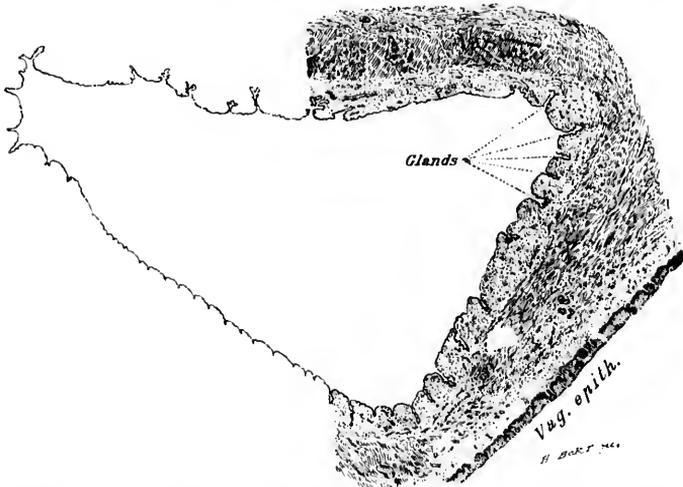

FIG. 170.—CYST 8 BY 5 CENTIMETERS IN DIAMETER PROTRUDING FROM THE VAGINA AND COVERED ON ITS EXTERNAL SURFACE BY SMOOTH VAGINAL MUCOSA; EGG-SHAPED AND DENSELY ADHERENT TO THE STRUCTURES ABOVE THE VAGINAL VAULT.

The walls, 3 millimeters in thickness, are of a dark-grayish opaque color, and the cavity contains a scanty, greenish substance. The cyst is lined with a single layer of high cylindrical epithelium, a true prototype of that found in the cervix. In places there are islets lined with epithelium like that lining the surface of the cyst; these islets sometimes dip down into the wall of the cyst a centimeter or more, and closely resemble true glands in their structure. Just beneath the lining epithelium of the cyst cavity there is a layer of connective tissue, and next to this came a broad layer of non-striped muscle fibers cut longitudinally, transversely, and obliquely. A layer of normal stratified squamous epithelium lies over one portion of the outer surface. Case of Dr. C. P. Noble. Path. No. 1775. Magnified four times.

a cyst almost 2 centimeters in diameter lay on the left side, situated in a complete tear of the septum; in two other cases the formation of the cysts followed operations on the posterior wall in which islets of undivided tissue were undoubtedly left behind; in one of them three or four cysts followed the line of the sear, in the other the cyst was in the sulcus and was 2 by 1.5 centimeters in diameter. In all cysts of this group the epithelium is squamous, and usually in two or three layers; in one instance piles of desquamated epithelium were found in the cyst cavity.

Cysts developing from Gartner's ducts are found in rare instances at the vaginal vault extending up between the folds of the broad ligament.

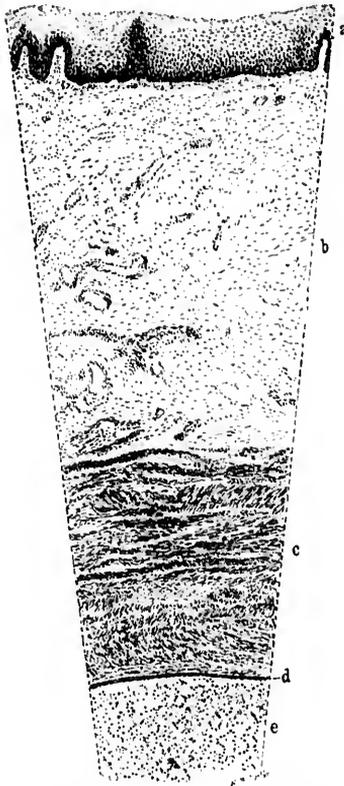

FIG. 171. SECTION FROM THE WALL OF A CYST, 2 BY 25 CENTIMETERS IN DIAMETER, TAKEN FROM THE POSTERIOR WALL OF THE VAGINA.

The walls are thin and transparent, and the cyst cavity is nearly filled with large cells. *a*, normal stratified squamous epithelium of the vaginal mucosa; *b*, connective tissue showing a number of small blood vessels; *c*, a layer of muscle fibers cut longitudinally and transversely; *d*, two, and in places three, layers of rather flat epithelial cells lining the cyst cavity. Other portions of the cyst are lined with several layers of typical squamous epithelium. *e*, large cells lying free in the cyst cavity, probably desquamated epithelium. Path. No. 1111. Magnified 50 times.

brane dissected out, and the wound then closed by suture. In suppurating cases after proper cleansing, a large segment of the whole thickness of the cyst wall is

distinguished from the atresia of a rudimentary horn of the uterus, which forms a prominent fluctuating tumor at the vault or extending from the vault down the lateral wall. In these cases there is a history of pain associated with the retention, and a bimanual examination through rectum and abdomen will show that the tumor extends well up into the pelvis. A suburethral abscess is peculiar in its position beneath the urethra, the thick vaginal wall covering it, its extreme tenderness, and in that it discharges its contents through the urethra on pressure.

A cystic dilatation of a blind ureter beneath the urethra may easily be confused with a simple vaginal cyst. Such was the case of E. G. Orthmann (*Contrib. f. Gyn.*, 1893, No. 7). The cyst occupied the lower two thirds of the vagina and grew year by year. The diagnosis of a vaginal cyst was made, but in dissecting it out it was found that the contents had disappeared, and on reaching its long pedicle above, a correct diagnosis of a forked ureter with a blind end dilated into a cyst was made.

The small cysts occasion no symptoms whatever. The chief clinical symptoms of the larger ones are obstructions to marital intercourse and to labor; often the patient's first intimation that there is anything wrong is when a part of the cyst protrudes at the vulva. The suppurating cyst alone is painful.

The treatment is simple and free from risk. Small cysts may be excised without opening them and the wound closed with catgut sutures; larger cysts may be freely opened, the lining mem-

brane dissected out, and the wound then closed by suture. In suppurating cases after proper cleansing, a large segment of the whole thickness of the cyst wall is

excised from end to end, its contents removed, and the vagina and remaining portion of the cyst packed with gauze. This is renewed from time to time until the raw surface has healed.

**Abscess of Gartner's Canal.**—I have seen a single instance of this rare affection. A young Jewish girl of about fifteen years, a patient of Dr. G. W. Guthrie, of Wilkesbarre, Pa., developed severe pain in the genitals with high fever, which continued for several days. A fluctuating sac was found extending from the vault of the vagina on the left side close to the cervix, down along the antero-

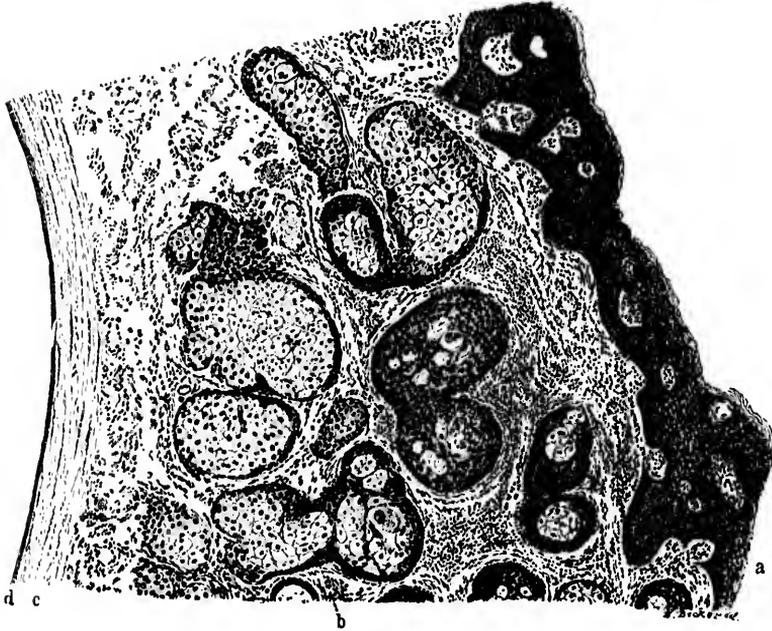

FIG. 172.—CROSS SECTION THROUGH THE WALL OF A CYST 1 CENTIMETER IN DIAMETER; THE CYST WAS FOUND SO NEAR THE EDGE OF THE VAGINA THAT ITS OUTER WALL IS SKIN.

At *a* the epidermis is normal, and scattered throughout the tissue are sebaceous glands, as seen at *b* and other points. *c* indicates spindle-shaped connective tissue cells running parallel to the cyst wall. *d* shows the inner surface of the cyst lined by one layer of cuboidal epithelium. Path. No. 1390. Magnified 36 times.

lateral wall to the vestibule, to the left of and on a level with the posterior urethral wall, where it shortly opened spontaneously, discharging pus. I saw her afterward in consultation with Dr. Guthrie, and was able to pass a probe through the external orifice clear up to the vault of the vagina, but not beyond.

The quickest way to effect a radical cure of such a case would be to pass in a probe and to lay the sac open throughout its whole length in the vagina so as to get good drainage.

## NEOPLASMS.

Benign neoplasms originating in the vagina are extremely rare, and the only forms found are the myomata.

The etiology of these tumors, as in those occurring in the uterus, is still unknown, though Veit, following Recklinghausen (*Hand. d. Gynäkol.*, Bd. i, p. 348), speaks of the possibility of their originating in Gartner's ducts.

Myomata appear in the vagina either as polypoid growths with long pedi-



FIG. 173.—LARGE, THICK-WALLED CYST OF THE POSTERIOR VAGINAL WALL PROJECTING FROM THE VULVA.  
SEPT. 14, 1894.

cles or as more diffuse rounded tumors with wide bases extending out into the connective tissue surrounding the vagina.

The symptoms depend upon the size of the growth and the obstruction of

the vagina and pelvis. The patient may complain of a sense of weight in the pelvis, tenesmus of the bladder, and even partial retention may occur, as direct effects of the pressure. There may also be constipation and rectal tenesmus. Pain in coitus has been noted, and the tumor may at times attain a sufficient size to interfere with delivery.

With necrosis and gangrene of the tumor we find the added symptoms of profuse ill-smelling vaginal discharge, with an accompanying irritation of the surrounding parts.

The treatment is removal of the growth. Pediculated tumors are easily amputated, the vessels controlled, and the base sutured, bringing the tissues evenly together. In the case of a larger tumor with a wide base it may be necessary to enlarge the vaginal opening by making lateral incisions before the growth can be satisfactorily reached and removed. The way to remove sessile tumors is to make a linear incision through the overlying vaginal wall and then to enucleate the growth. The cavity remaining after such an enucleation may be closed completely by suturing the vagina after checking all hemorrhage. The opposed sides are kept together by packing the vagina with gauze, which is allowed to remain undisturbed for from four to seven days.

Malignant neoplasms are represented by sarcomata and by carcinomata.

**Sarcoma** appearing in the vagina, according to Steinthal (*Virch. Arch.*, Bd. cxl, p. 449) and Kolisko (*Wien. klin. Wochenschr.*, 1889), may be sharply divided into two classes. In young children they are usually polypoid in form and situated on the anterior vaginal wall, while in adults the sarcoma is usually a diffuse growth found in any portion of the vaginal canal.

When secondary to sarcoma of the uterus it appears first in the vaginal vault as a dark bluish knobbed or polypoid outgrowth.

In children the first symptom noticed is a rounded or irregular berrylike tumor appearing in the vulvar cleft and accompanied by pain. Pain on micturition and constipation may be present. In adult patients a vaginal discharge usually makes its appearance early in the course of the disease, and there are at times slight hemorrhages from the surface of the growth.

There is a great tendency in all of these tumors to undergo necrosis, and this, together with the foul discharges, opens up an avenue for the entrance of an infection, which in the end often causes death. Cystitis and pyelonephrosis also often accompany the growth, as well as pyometra and purulent peritonitis.

The diagnosis in all of these cases must be made by a microscopical examination of the tumor, but in case of sarcoma it must be remembered that delay makes the prognosis more serious.

The treatment is by early and radical removal of the growth.

Four cases have been reported—two in children and two in adults—in which permanent recovery has followed removal.

The various methods of operating are similar to those described under the treatment of carcinoma.

**Carcinoma of the Vagina.**—Primary cancer of the vagina is rarely seen. Hecht (*Jung. Dis. München*, 1891) found that a little over one per cent of

eases of cancer in women were vaginal. In the majority of these cases the posterior wall is affected first. Out of eighteen cases cited by Olshansen of Berlin thirteen involved the posterior wall. The disease usually appears in the form of a fungating mass of tissue, easily breaking down and bleeding. Another form appears as a granular ulcerated area with hard infiltrated margins. In a still rarer form of carcinomatous infiltration the vaginal walls simply become rigid and contracted.

While primary cancer is rare, a secondary involvement from extension to the vaginal vault from a cancerous cervix is quite common—so common, indeed, that it is often necessary to remove a considerable part of the upper vagina with the uterus in hysterectomy for uterine cancer.

Nothing is known as to the cause of this affection. Heredity and trauma during childbirth have not been shown to be active, as in the case of cancer of the cervix. The tendency of the disease located in the upper part of the vagina is to extend over onto the posterior cervical lip, rendering it impossible at times to determine whether the cervix or the vagina was the original starting point. Where there is a large cancerous area at the vault of the vagina with an involvement of the outer surface of the cervix, which is continuous with it, the disease may without hesitation be stated to be vaginal in its origin instead of cervical.

Hemorrhages, vaginal discharge, dull aching pain, and difficulty in defecation and micturition are common symptoms. As the disease extends rapidly into the neighboring lymph channels cachexia becomes more and more marked, until the patient dies of exhaustion.

The treatment is extirpation in all cases in which there is no involvement of the connective tissue laterally. Such an implication must be discovered by estimating the mobility of the diseased area by pressing directly upon it, and by palpating around its margins through the rectum.

There are in general four ways of operating upon a cancerous vagina:

First, a simple excision of the cancerous area through the vaginal outlet.

Second, a circular incision of the vagina below the diseased area, followed by a stripping off of the whole circumference of that portion which is to be extirpated; after this an abdominal incision, freeing the uterus and removing it with the upper part of the vagina.

Third, a transverse incision through the perineum and extending on up through the recto-vaginal septum to the diseased area, which is then removed through the incision.

Fourth, a posterior incision from sternum to fourchette beside the rectum, splitting the vagina up to the diseased area.

First, if the disease is discovered when it is still quite superficial and limited in its area, it may be extirpated with knife, or scissors and forceps, operating through the vaginal orifice, cutting around it on all sides at a distance of 1.5 or 2 centimeters and loosening it up from its base with the fingers and removing it, and finally bringing the margins of the wound together by catgut sutures.

The second method consists in a circular incision of the vagina well below the disease; afterward it is stripped up to the vault with the fingers and detached on all sides. The abdomen is then opened from above and the uterus and detached portion of the vagina removed. It is especially important here to determine that the vaginal infiltration does not extend into the surrounding tissues; careful examination must also be made by the rectum to discover any infiltration of the broad ligaments; should this be found a radical operation is contra-indicated. The operation may sometimes be concluded after stripping the vagina loose posteriorly and at the sides, and in front as far as the vault, by cutting and drawing down the cervix and applying ligatures to the broad ligaments, and removing the uterus, as in vaginal hysterectomy. Sometimes the whole upper third of the vagina may be removed in this way.

The third method, proposed and used by Prof. Olshausen (*Centralbl. f. Gyn.*, 1895, No. 1), consists in the removal of the cancerous vagina through a transverse incision in the perineum, and a separation of rectum and vagina up to Douglas's *cul-de-sac*. If the uterus is to be removed, the peritonem is opened and the uterus inverted and freed by tying off the broad ligaments from above downward toward the cervix. When this separation is partly effected, the loosened vagina is cut through with scissors and the carcinoma detached, and finally, after releasing the bladder, the cervix uteri is tied off. If the uterus is not to be removed, the separation of vagina and rectum is carried up to the cervix uteri, and the vagina in the neighborhood of the disease is freed on all sides from the subjacent tissue. An incision is then made into the vagina at a suitable point and the diseased portion excised with scissors. In a contracted vagina the last part of the excision is facilitated by splitting its posterior wall from the frenulum up, giving a broad view of the field.

I prefer the fourth plan to this, as less awkward and as enabling me to reach the parts more directly, the extirpation by an incision beside the rectum, adopted in the following case.

The cancerous patch was situated at the vault of the vagina posteriorly, and was 3 by 4 centimeters (1.2 by 1.4 inch) in diameter, and involved as well the outer surface of the cervix. It could not be drawn down, so as to attack it from below, so the patient was placed upon her left side and an incision made from the end of the sacrum, beside the coccyx, and continued in a slightly curved line down beside the rectum and around the right margin of the anus, through the perineum to the fourchette. By carrying the incision deep enough the rectum was exposed and easily drawn toward the left with retractors, in this way exposing the vagina.

The posterior vaginal wall was then split from the fourchette to the cervix and the diseased portion freed at the sides with the fingers and removed. It included the posterior two thirds of the upper portion of the vagina and the posterior lip of the cervix above the vault. I now brought the uterus down in retroposition, and united its posterior surface to the vaginal wall, where it was cut off, filling in the gap left, leaving a shortened but entire vaginal canal. The posterior wound was closed with interrupted sutures. The patient recovered

and the uterus united in its new position, but the disease, which had extended beyond the limits of the field of operation, continued to advance, and she died at her home some months later.

If the uterus is to be removed as well, the peritoneum may be opened at Douglas's *cul-de-sac* and the uterus drawn through the incision and its broad



FIG. 17. A CASE OF ADENOCARCINOMA OF THE POSTERIOR VAGINAL WALL, BY IMPLANTATION FROM AN UNSUSPECTED ADENOCARCINOMA OF THE BODY OF THE UTERUS.

ligaments tied off; then, using it as a tractor by pulling it well out of the wound, the vagina is made tense and easily outlined while the finger is engaged in freeing it from the tissues at the sides and from the bladder in front. As much of the vagina as is necessary may be removed with the uterus. Care must be taken not to wound the ureters by placing bougies in them before beginning the operation. If the uterus is not to be removed the peritoneum must be pushed up without opening it, and the vagina freed on all sides in the neigh-

borderhood of the diseased portion, and then opened and the diseased area excised.

**Traumatic Affections.**—Traumatic affections are frequently found in the vagina, the result of injuries incurred in labor. They are usually located either in the vault or near the outlet, and involve one or both sides, extending down or up in the axis of the vagina. Any marked narrowing of the vaginal canal due to cicatricial contraction between the vault or the outlet is unusual.

Extensive sloughing in the middle of the vagina may produce a concentric contraction, narrowing the caliber even down to complete closure (utresia vaginae), and followed by retention of the menses (hematoecolpos and hematometra). The cicatricial bands radiating out from the sides of a vesico-vaginal fistula and narrowing the lumen of the vagina serve to illustrate another mode of the production of a vaginal stenosis.

The vaginal cicatrices may be classified under two general heads, corresponding also to the difference in etiology, viz., cicatrices whose direction is in the axis of the vagina, and cicatrices whose direction is transverse to the axis of the vagina.

Cicatrices of the first class in the axis are usually found at either extremity of the canal, and are associated, as stated, with a lacerated cervix or a ruptured outlet.

Cicatrices of the second class crossing the axis are the result of pressure and sloughs during parturition or of syphilitic sores.

At the vaginal outlet the principal scars extend from the posterior median line up the right or left sulcus on one or both sides of the posterior column. The scar tissue at this point must be regarded as a conservative effort of Nature in her endeavor to fill out and draw together the rents produced in childbirth. The symptoms produced by such scars vary from the slightest all the way to a severe neurosis. Rarely a scar is so tender as to require excision. A scar at the vault may be the cause of a lateral displacement of the uterus. Cicatricial contraction of the canal will interfere with all its functions, even rendering the escape of the menses impossible or endangering life in case of pregnancy. Too much stress, however, must not be laid on this last point, as labor has progressed normally in such cases in which the outlook seemed almost hopeless at the start.

The treatment differs according to the form and extent of the disease. The best method, in general, is a complete excision of the scar extending well into the subjacent tissue, supplying the defect created by sliding over it the sound tissue from above and below.



FIG. 175.—SECONDARY VAGINAL CARCINOMA.

Sagittal section of the cervix (C) and vagina, showing the isolated carcinomatous nodules on the posterior wall. Case same as Fig. 174. J. S., Nov. 11, 1895.

Small falciform cicatrices at the vault of the vagina on the right or left side may be treated by drawing the cervix in the opposite direction with a tenaculum, making the scar tense, and cutting across it in several places down to its base. This may be done under cocaine, and if the cutting is repeated several times, the cervix will finally be freed. If the cervix is torn deeply, as is usually the case, the cervical tear may be repaired and the scar excised at the same time. Care must be taken to avoid the mistake of simply removing that portion of the scar which projects into the vagina. The dissection must be carried well below the vault, removing all of the scar tissue. The chief dangers are of injury to a ureter which has been drawn out of its normal position, and perhaps caught in the scar tissue, and of cutting a uterine artery, which is also brought nearer the vault than normal.

To avoid injuring the ureter, a bougie should be placed in it before beginning any extensive operation at the vault. The ureter can then be readily felt from time to time, and if involved will be easily dissected out and restored to its proper place without injury.

The artery will be avoided by a slow, careful dissection, palpating the structures often as it progresses. The wound thus created is closed by interrupted sutures, and a dry dressing applied. Cicatrices in the lower part of the vagina are always removed in the course of the operation for relaxed vaginal outlet.

Atresia of the vagina following labor may involve any portion of the canal. The closure is due to sloughing from pressure during labor, followed by a cicatricial contraction. The area cut off may be from one to several centimeters in diameter. Oftentimes the atresia is incomplete, when a superficial examination would lead the observer to assert that it was complete. One or two minute orifices may be detected in the transverse scar at the bottom of the vaginal *cul-de-sac*, and pressure made above may cause a little dark fluid to exude.

The severest symptoms arise in atresia from the apparent amenorrhea, which might be called an *amenorrhea paradoxica*, as the menstrual function continues normally, while the secretions accumulate above the stricture. The pain at the menstrual period is often agonizing. With the increasing accumulation the vagina expands, and the cervix and uterus, and sometimes the uterine tubes, dilate, until the pelvis is choked, and a large mass may be felt projecting into the abdomen.

Atresia may arise from extensive ulceration in the vagina, but the one com-



FIG. 176.—ATRESIA OF THE VAGINA, SHOWING THE SCAR AT THE POINT AT WHICH THE ANTERIOR AND POSTERIOR VAGINAL WALLS COME TOGETHER. A. M., JAN. 18, 1896.

men cause is the traumatism of a delayed labor in a contracted pelvis. From this cause one of my patients recovered, not only with an atresia, but with a vesico-vaginal fistula, and a recto-vaginal fistula as well.

The diagnosis is made by the history of a severe labor, by the subsequent amenorrhea with severe menstrual colic, and by the impediment to sexual intercourse. An examination reveals the nature of the affection, as the finger enters a short sac, or if the urethra is dilated, as is often the case, the finger may enter the bladder without difficulty, greatly puzzling the physician for a time.

An examination *per rectum* shows the presence of a fluctuating sac above the atresia, and above this, it may be, one or two other sacs, separated by one or two well-defined transverse constrictions.

The treatment is to remove the scar tissue which closes the vagina and establish a permanent free communication between the separated parts of the vagina by a plastic operation; this is completed in three steps: first, opening up the channel and allowing the accumulated fluids to escape; second, removing the scar tissue; third, uniting the sound upper and lower portions of the vagina over the defect.

Before, throughout, and after the operation the most painstaking antiseptic precautions must be taken, as the accumulated fluid is peculiarly liable to undergo rapid decomposition, and the walls of vagina, uterus, and tubes are in a state of extraordinary susceptibility to infective processes. Death from infection has so often followed the simple evacuation of the fluid that many surgeons dread the operation.

I can not illustrate the further steps of the operation better than by describing one of my cases (*Johns Hopk. Hosp. Rep.*, vol. iii, p. 429).

The patient was a negress about twenty-two years old. She had had a still-born child after a prolonged instrumental labor eight years before I saw her, and had suffered ever since the birth. Her periods had always been regular before, but she had never menstruated since, although suffering greatly with the monthly moulimina and from backache and pains in the lower abdomen. Six months before I saw her she had been kept in bed eight weeks by an attack of peritonitis.

On making a vaginal examination under a bed cover, the finger entered a large, smooth-walled cavity in which none of the expected landmarks could be recognized. This was found to be the bladder, with the urethra so widely dilated that two fingers could be introduced without pain; the external urethral

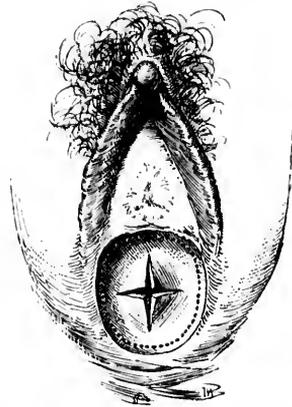

FIG. 177.—OPERATION FOR ATRESIA OF THE VAGINA CAUSED BY AN ADHESION OF THE ANTERIOR AND POSTERIOR WALLS IN THE FORM OF A SEPTUM JUST ABOVE THE HYMEN.

The cruciform incision is made first to permit the thorough washing out of the sac; the dotted line indicates the area excised in restoring the caliber of the vagina.

orifice hung patulous and everted under the pubic arch. All that was left of the vagina on the vulvar side was a little pit of firm scar tissue 1 centimeter in depth just behind the urethra.

Upon making a bimanual examination a chain of tumors was found filling the pelvis, lying one above another; at first they felt like a group of myomata, but

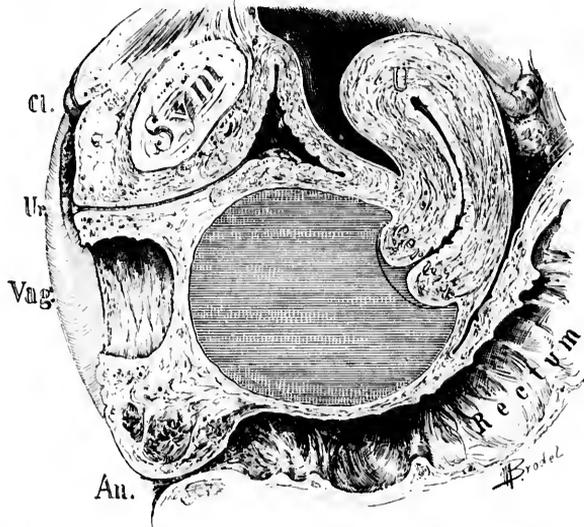

FIG. 178.—ATRESIA OF THE VAGINA SEEN IN SAGITTAL SECTION; THE VAGINA ABOVE THE ATRESIA IS DISTENDED WITH THE ACCUMULATED MENSTRUAL FLUID. THERE IS NO DISTENSION OF THE UTERUS.

a closer examination showed that they fluctuated and formed a continuous cavity, with two shallow sulci between. The obliterated portion of the vagina was 4 centimeters long.

The operation was performed in this way: The left index finger was introduced into the bladder and the thumb into the rectum until they touched the sac of fluid and held the atresic area between their palmar surfaces. Guided by these fingers to avoid injuring the rectum or the bladder, a large trocar was entered in the pit beneath the urethra and pushed up through the obliterated septum until it penetrated the sac. Upon withdrawing the trocar 500 cubic centimeters (about 16 ounces) of tarry blood escaped and the three sacs collapsed. By means of a uterine dilator the trocar puncture track was now enlarged until it reached from one pubic ramus to the other. Abundant room was thus secured to catch the margin of the vagina just above the stricture and dissect it loose on all sides for a distance of a centimeter. This loosened collar was then pulled down over the dilated atresia and attached by a series of interrupted sutures to the margin of the vagina just below it. By this means, by sliding the normal vaginal tissue down over the cicatricial area, the canal was restored without leav-

in an exposed raw area to undergo subsequent contraction. The caliber of the new vagina was now normal, and a month later, when the patient was discharged, it even appeared normal in length.

If resisting scar tissue is felt after opening up the canal, it must be dissected out. Where the urethra is not dilated, the finger in the rectum alone will serve as a guide for the trocar.

**Recto-vaginal Fistula.**—Recto-vaginal fistulae are abnormal channels of communication between the rectum and the vagina, generally situated at one end or the other of the vaginal canal.

The cause of the fistula in the upper vagina is commonly an extension of a cancerous disease from the cervix on to the vagina and through the recto-vaginal septum; in the lower vagina the commonest cause is a failure in the attempt to restore a complete rupture of the recto-vaginal septum. After this operation, if the suturing is imperfect, fecal matter is apt to be forced into the upper part of the wound upon the denuded surfaces, producing suppuration and failure of union, and leaving a fistulous orifice opening either on to the vulva or into the vagina.

Other causes, such as syphilis and stricture of the rectum, produce fistula in some cases. I have seen but one case where it was due to labor. I have also seen one case where it followed the excision of hemorrhoids, and another where a necrosis had been produced by the pressure of a badly fitting pessary.

The symptoms arise from the escape of fecal material into the vagina, or, if the orifice is minute, from the escape of gases by this avenue.

The cancerous fistulae are particularly distressing from the disgusting condition in which the patient is apt to be kept by the constant emission of feces from the vulva.

Fistulae low down in the vagina are often so small that they are detected with difficulty, and yet the inability to control the gases, which escape audibly, keep the patient in a constant state of nervous apprehension.

The diagnosis is made either by simple inspection, or by passing a probe into any suspicious pits and thus tracing the connection with the bowel, or by introducing the finger into the rectum and palpating its anterior surface from the sphincter up. The rectal end of the fistula is marked by a distinct depression easily felt; this can be pushed forward and the vaginal opening made visible.

A further demonstration may be made by injecting milk into the rectum

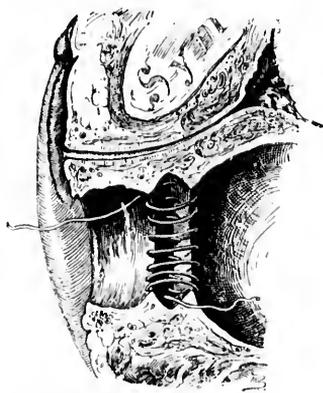

FIG. 179. OPERATION FOR ATRESIA OF THE VAGINA SEEN IN SAGITTAL SECTION, SHOWING THE CONTINUOUS SUTURE APPLIED IN THE RIGHT HALF OF THE VAGINA, BRINGING THE VAGINAL MUCOSA ABOVE DOWN TO THE VAGINAL MUCOSA BELOW THE ATRESIA, IN THIS WAY BRIDGING IT OVER WITH MUCOUS MEMBRANE.

and watching for its avenue of escape by the vagina. The patient herself often calls attention to her inability to retain rectal enemata, which escape by the vagina.

The proper treatment of a recto-vaginal fistula depends upon various associated conditions.



FIG. 180.—ATRESIA OF THE VAGINA IN A NEGRESS.

The index finger is introduced through the dilated urethra into the bladder, and with the thumb in the rectum clearly defines the position and thickness of the recto-vesical septum. Only a shallow vaginal pocket is visible between the thumb and the finger.

Fistula from the extension of cervical cancer is not, as a rule, amenable to treatment. The utmost that can be done is to keep the parts as clean as possible by securing a daily free evacuation of the bowel, avoiding the constant leakage, and by the frequent use of vaginal douches.

In event of a slow progressing cancer at the vault, it would be quite right to try to give some relief by making the fistulous opening large enough to establish a free communication with the bowel, and then to denude a circular strip on the vaginal wall below this and to close the vagina with interrupted silkworm-gut sutures (partial colpocleisis).

There are three ways of closing a recto-vaginal fistula by suture:

First, by a funnel-shaped denudation of the edges on the vaginal side followed by suture, after the pattern of the vesico-vaginal fistula operation.

Second, by splitting the perineum and recto-vaginal septum and completely separating the rectal from the vaginal portion of the fistula, followed by a separate suture of the rectum.

Third, by splitting the recto-vaginal septum vertically as far as the fistula, which is then denuded and the recto-vaginal septum closed as in a case of complete tear.

Before operation the intestinal tract must be thoroughly emptied, the parts cleansed, the sphincter and stretched so as to paralyze it, and a loose iodoforn-gauze pack put well up in the rectum to keep its discharges out of the vagina and off from the wound during the suturing.

In determining what form of operation will be best in a given case, the position of the fistula, the condition of the surrounding parts, and the presence or absence of scar tissue must be considered. Any complication on the rectal side, such as

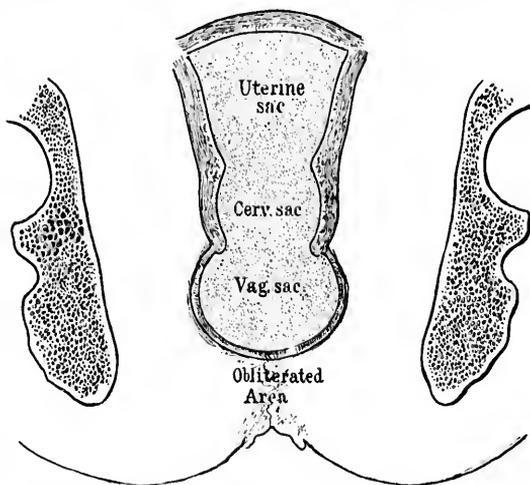

FIG. 181.—CORONAL SECTION OF AN OLD ATRESIA OF THE VAGINA WITH DISTENSION OF THE VAGINA, CERVIX, AND UTERINE CAVITY WITH MENSTRUAL FLUID. THE ATRESIA OCCUPIES THE LOWER THIRD OF THE VAGINA.

a deep pit or an ulcer or granulation tissue, must also be taken into consideration, as these conditions almost necessarily defeat union.

First. The simplest form of operation, a funnel-shaped denudation and suture, will be selected when the opening lies above the sphincter and levator ani area, and when it is free from bands of scar tissue, and the rectal surface is healthy and does not present a deep pit. After suitable exposure the parts are numbened with cocaine applied for ten minutes. The area to be excised is then outlined with the point of a sharp knife about 1 centimeter away from the edge of the opening on all sides. This is now denuded by catching the edge with forceps or a tenaculum, cutting away strip after strip with a pair of delicate scissors until the whole is bare and bleeding down to the rectal mucosa, which now lies at the bottom of a wide-mouthed funnel opening on the vaginal surface. The wound is now closed by a series of interrupted silkworm-gut sutures,

three to the centimeter, passed in the direction of least resistance, generally from side to side, and tied firmly. Superficial cutgut sutures are used between the silkworm gut if the line of approximation is not perfectly accurate. The gauze pack is now taken out of the rectum and the vagina washed out and a piece of iodoform gauze inserted loosely. The after-treatment consists in a restricted

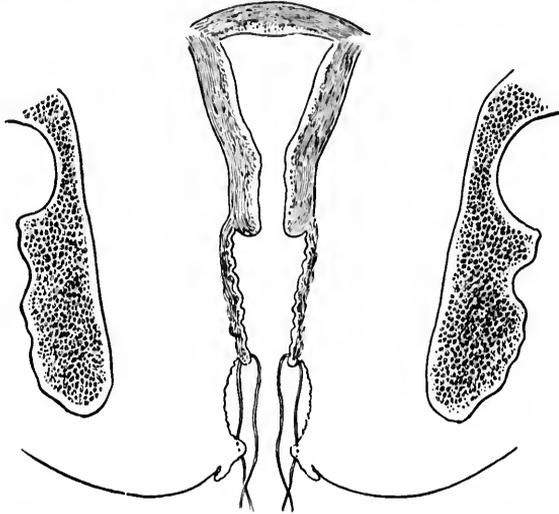

FIG. 152.—OLD ATRESIA OF THE VAGINA OPENED AND EVACUATED; INTERRUPTED SUTURES IN PLACE TO DRAW THE VAGINAL MUCOSA DOWN TO THE MUCOSA AT THE VAGINAL OUTLET, BRIDGING OVER THE DENUDED AREA IN THE CONNECTIVE TISSUE.

diet and regular daily movements of the bowels, preferably secured by medicine taken by the mouth. In eight days the stitches are removed, and the patient may go about.

In one of my cases there was a small opening 3 millimeters in diameter just beyond the internal sphincters, and the surrounding tissue was soft and natural and free from scars. I applied cocain, and denuded and closed it on the vaginal surface, as described, and allowed the patient to rise at once from the table and go home to continue her usual occupations without interruption. In eight days she returned, and I removed the silk sutures and found that perfect union had taken place. Such treatment as this will only succeed in the most favorable cases, and ought rarely to be tried. The proper after-treatment of a simple fistula is to keep the patient quiet in bed for a week.

Second. When the fistula is up above the sphincter area and is surrounded by scar tissue, the best plan is to dissect the rectum free from the vagina, either by splitting the perineum from side to side and working up to the fistula between rectum and vagina, or by raising a flap of vaginal tissue below the opening and dissecting it up to the fistula, which is then freed from its vag-

anal attachments on all sides. Interrupted sutures are now passed through the muscular coats of the denuded bowel, avoiding the mucosa and closing the rectal opening. They are left long and brought out through the fistulous vaginal opening, which need not be closed. The incision in the recto-vaginal septum, through which the separation was made and the sutures passed, is finally closed, and a dry dressing placed in the vagina.

The success of this procedure depends upon the invariable soft, yielding condition of the bowel, which is well adapted for plastic union when detached from the rigid cicatricial vaginal tissue, which prevents the sides of the wound from coming together without undue traction.

I succeeded in one case (K. S., No. 2916, Sept. 5, 1894) in doing this where the rectal fistula was 2 centimeters long at the top of an obliterated upper vagina, with a vesico-vaginal fistula directly opposite. There was a large amount of scar tissue on all sides, rendering union by suture after denudation a hopeless undertaking. I therefore made a transverse perineal incision 4 centimeters long and dissected between the vagina and rectum up to the fistula, which was then split, making two fistulous orifices out of one, the posterior opening leading into the rectum and the anterior into the vagina. The rectal opening was then closed separately by interrupted fine silk sutures brought out through the vaginal opening. The perineal wound was closed, and the result was immediate union throughout.

Third. When the fistula is low down, close to the vaginal outlet in the sphincter area, the better plan is to cut entirely through the septum, reproducing the complete rupture, and then to denude the margins of the fistula and for some distance above it, and close the whole as in a case of complete tear. This is better than an attempt to effect closure by a denudation on the vaginal side alone, for three reasons: In the first place, the position of the opening on the rectal side is unfavorably situated, as in any bowel movement unusual pressure is brought to bear on the anterior wall of the rectum at this point by the fecal masses, and is so great that some particles of fecal matter are inevitably forced into the wound, preventing union. In the second place, there is always a pit on the rectal side in these sphincter fistulae which catches fecal matter. In the third place, the bridge of tissue below the fistula which the operator endeavors to save by simple denudation and approximation is often insignificant; this is especially apparent after it has been cut through.

I would repeat the caution not to forget to carry the denudation on the vaginal surface well above the fistula. The further denudation and suture must be made as fully described in the treatment of complete rupture of the recto-vaginal septum in Chapter X.

## CHAPTER XII.

### AFFECTIONS OF THE URETHRA AND BLADDER.

1. Brief historical sketch. Celsus; calculus. Fatio; vesico-vaginal fistula. Simon; dilatation of the urethra. Grünfeld; introduction of light into bladder. Rutenberg's air-pumping speculum. Nitze's cystoscope for examining the male bladder modified for the female. Pawlik's method of catheterizing the ureter free-handed. Slinger; palpation of the ureters. Kelly; examination under atmospheric distention induced by posture. Bibliography.
2. Topography of the bladder in women. Natural landmarks within the bladder. The relations of the bladder to surrounding structures. Artificial division into hemispheres and quadrants.
3. Examination of the urethra and bladder: Urinalysis and examination of discharges; percussion; palpation; inspection without instruments; urethroscopy; cystoscopy; Its fundamental principles; instruments used—the light, the reflector, vesical specula with obturators, dilator, evacuator, ureteral searcher. The cystoscopic examination; aepsis; preparation of patient; anæsthesia; postures, dorsal and knee-breast; calibrating and dilating the urethral orifice; the lubricant; introducing the speculum; inspection.
4. Diseases of the urethra. 1. Malformations; hypospadias; epispadias; atresia of the urethra; totally deficient urethra. 2. Displacements; prolapse of the mucosa. 3. Dilatation. 4. Stricture. 5. Ischuria. 6. Fistula. 7. Foreign bodies. 8. Urethritis; acute; chronic: (1) diffuse chronic urethritis; (2) circumscribed chronic urethritis. 9. Suburethral abscess. 10. New growths: carcinoma; fibroma; cancer; sarcoma.
5. Diseases of the bladder. 1. Introductory. 2. Diagnosis: by history and symptoms; by urinalysis; by palpation; by inspection under illumination. 3. Methods of treatment in general. 4. Classification of diseases: Congenital defects: (1) double bladder; (2) loculate bladder; (3) exstrophy. Displacements: (1) lateral; (2) upward; (3) downward; (4) eversion. Foreign bodies in the bladder: (1) calculi, pessaries, catheters, etc.; (2) removal—through urethra; through vaginal incision; through suprapubic incision. Vesical fistula: (1) historical sketch; Luiz de Merado, Felix Plater, Hendrick Roonhuyzen, J. Fatio, A. J. Jobert, G. Simon, J. Marion Sims, T. A. Emmet, Nathan Bozeman, A. Martin, L. von Dittel, A. Mackenrodt, W. A. Freund, E. C. Dudley, H. A. Kelly; (2) causes; (3) symptoms; (4) diagnosis. 5. Treatment. (a) general, (b) of fistula of large size: A. Martin—closure by turning up vaginal flaps to form the new base of the bladder; F. Trendelenberg—closure by transplanting a flap from the posterior vaginal wall; E. C. Dudley—closure by suturing the denuded vesical mucosa to its anterior margin; A. Mackenrodt—closure by detaching the bladder from the vagina and suturing it independently; H. A. Kelly—closure by detaching the bladder posteriorly and suturing it to the denuded vaginal wall anteriorly; W. A. Freund—closure by suturing the body of the uterus into the defect. Of vesico-utero-vaginal fistula: H. C. Coe, Otto v. Hertf, H. A. Kelly, F. Trendelenberg. Of vesico-uterine fistula: F. H. Champneys, H. A. Kelly. Of other vesical fistula: G. C. Blackburn. Hemorrhoids. Hyperæmia. Cystitis: (1) bacteriology; (2) acute; (3) chronic; (4) treatment of chronic cystitis—medication, irrigation or instillation, direct topical treatment, surgical treatment; (5) tubercular cystitis; (6) exfoliative cystitis.
6. Tumors of the bladder: 1. Classification. 2. Benign tumors: papilloma; fibroma; adenoma; myoma; cystic follicles; dermoid cysts. 3. Malignant tumors: epithelioma; myxoma; sarcoma. 4. Clinical history of vesical tumors. 5. Diagnosis. 6. Operative treatment: by a dilated urethra; by vaginal incision; by suprapubic incision; by symphysectomy; cystectomy; K. Pawlik's case.

PREVIOUS to the latter half of the century just closing but little was known about diseases of the urinary apparatus in women.

And while the relatively more urgent and dangerous diseases of the male organs had exacted the closest attention, the modesty of women, as well as the inaccessible nature of the affections, all conspired to hinder an earlier scientific investigation of the female organs.

The shortness of the female urethra was known and special suitable metal catheters devised and used before the Christian era, and Celsus in the first half of the first century carefully describes an operation for stone in the bladder in women—cutting for the stone from the outside through the vestibule into the neck of the bladder, cautioning the operator to insert the finger, as a control, into the vagina in a married woman, but into the rectum in a virgin. Calculus in the female therefore attracted attention at an early date, on account of the surprising observation that enormous stones could safely pass through the short and more easily relaxed female urethra (*que et brevior quam in masculis et laxior est.*—Celsus).

Johannes Fatio, of Basel, late in the seventeenth century recognized, treated, and cured cases of vesico-vaginal fistula by denuding the margins with scissors and drawing the edges together with a sharpened quill wrapped with thread.

A new interest was aroused in diseases of the bladder by the labors of G. Simon, of Rostock, who carefully determined the extreme degree of safe dilatability of the urethra for digital palpation of the bladder, using a series of conical dilating specula with obturators, with diameters increasing up to 20 millimeters.

Simon was also able in some cases to feel a ureteral orifice, and, under the guidance of touch, to slip in a ureteral catheter; he did this seventeen times in eleven cases, but never made any practical use of it. Indifferent as was Simon's success, this was the starting point of all recent important work in connection with the diagnosis of affections of the female urinary organs.

Josef Grünfeld, of Vienna, in 1874, filled the bladder with water and then examined it through a short, straight speculum, with a piece of glass set obliquely in its tube, so as to prevent the escape of the fluid and at the same time to permit the direct passage of light without reflection.

Rutenberg devised a speculum, about 20 millimeters in diameter, with a glass partition and a tube attached for injecting air into the bladder, while a mirror placed inside the bladder reflected various parts of its walls. It was necessary to anesthetize the patient to relieve the pain produced by this examination, and Rutenberg never succeeded in finding the ureteral orifices.

Max Nitze, of Dresden, with real genius, constructed a cystoscopic apparatus for the male bladder, consisting of a long tube-like catheter with a short beak carrying a small electric lamp at the tip and a prism at the eye through which the light, reflected from the walls of the bladder distended with water, is directed into the tube, which further contains a telescopic arrangement of lenses so as to give a wide field of vision to the observer at the outer end. A larger, shorter and straighter tube has been made after the same plan for use in women.

Through this elaborate and delicate but most useful instrument Nitze and his followers, who are now to be found among the genito-urinary specialists in all the larger cities, are able not only to examine the bladder but also the ureteral orifices, and even to catheterize the ureters with a flexible catheter, introduced in a small tube beside the speculum. Nitze himself is also able even to operate successfully upon small tumors within the bladder.

K. Pawlik, of Prague, made one of the most important additions to this

subject when he improved Simon's ureteral catheter for women, and demonstrated the feasibility of introducing it free-hand into the ureter through the urethra and bladder. This is done by retracting the posterior vaginal wall while the bladder is moderately distended with water (150 to 200 cubic centimeters), when the two "ureteral" folds come into view on the anterior vaginal wall, sweeping backward from the neck of the bladder toward the cervix and marking the site of the ureters just above them. These folds determine the direction of the tip of the catheter in the bladder as it is made to glide along its base while seeking the ureteral orifices. The finger at once recognizes the fact that the catheter has become engaged in the ureter by its assuming a certain fixed direction.

M. Sanger, of Leipzig, added another fact of the highest importance when he pointed out the ease with which the lower ends of the normal ureters could be felt through the vaginal walls, and the increased distinctness of enlarged diseased ureters.

My own method was first published in the *Johns Hopkins Hospital Bulletin* for November, 1893, and in a longer and more fully illustrated article in the *American Journal of Obstetrics* for January, 1894. Its essential features are:

1. An atmospheric dilatation of the bladder induced by posture.
2. The introduction of a simple straight speculum as a rule of small size and without fenestra.
3. The examination of the mucous surface of the bladder and urethra by means of a reflected light or an electric headlight.

I have further demonstrated the ease with which flexible catheters can be introduced into the ureters in this position, and by their use I have been able to reach the pelvis of the kidney, and to diagnose accurately such renal diseases as hydronephrosis, pyelitis, calculus, etc.

The whole field of investigation of bladder, ureteral, and renal affections is in this way thrown open to easy investigation.

Since the publication of my method K. Pawlik has described a modification of it consisting in a dilatation of the urethra under anesthesia sufficient to admit a large open speculum, the atmospheric distention of the bladder, and its examination by means of a little electric light introduced into the bladder through the speculum (*Central. f. Gyn.*, May 5, 1894).

But few treatises devoted to urinary diseases in women have as yet appeared. Seanzoni's, in 1854, was the first. A. J. C. Skene's book on *Diseases of the Bladder and Urethra in Women* was published in New York in 1882; F. Winckel's elaborate and valuable contribution appeared in Billroth and Luecke's *Handbuch*, Stuttgart, second edition, 1886; H. A. Kelly's *Diseases of the Female Bladder and Urethra*, *Twentieth Century Practice*, William Wood & Co., was issued in January, 1895; and finally we have *Die Krankheiten der weiblichen Blase*, by H. Fritsch in Veit's *Handbuch der Gynekologie*, 1897.

## TOPOGRAPHY OF THE BLADDER.

The fact that we are now in possession of a simple means of observing all sorts of bladder affections characterized by changes of form or color, bringing under observation and within the reach of local treatment even minute lesions, emphasizes the need for other and more accurate ways of describing the location, form, and extent of such diseases in their relationship to the bladder wall, as well as of registering such changes as may be found from examination to examination. It is also important, if we would convey any accurate impression of our observations to others, to use a more precise phraseology than such vague generic anatomical terms as "vertex" and "base," and to substitute in their place an accurate schema of the interior of the bladder with suitable divisions and subdivisions.

I will therefore consider the topography of the bladder from three stand-points, each of which will be useful to the specialist in describing what he sees through the speculum:

1. The natural landmarks within the bladder.
2. The relations of the bladder to surrounding structures.
3. An artificial division into hemispheres and quadrants.

1. **The Natural Landmarks in the Bladder Itself.**—The internal orifice of the urethra, which begins as a narrow margin to shut in over the end of the speculum, and continues to increase in breadth as the speculum is slowly withdrawn from the bladder, forms one of the most important points of departure in the description of lesions which may extend from the bladder into the urethra, or vice versa, or in the location of lesions limited to the area adjacent to the urethra; we have in this way a perineurethral area circumscribed by a circle of say about 4 centimeters in diameter around the internal urethral orifice.

"Opposite the urethral orifice" is also sometimes a convenient expression to designate the location of an affection involving the small area of the posterior vesical wall, the part first seen on withdrawing the obturator.

The ureteral orifices are the most important of all the natural landmarks in the bladder, and any account of a lesion in their immediate neighborhood is readily described as located either between them (interureteric) or posterior, anterior, or lateral, to one or the other.

In the knee-breast posture the ends of the ureters often stand out prominently, forming a truncate cone from 5 to 8 millimeters in diameter at the base, and from 3 to 4 millimeters high, with the orifices at the top or a little to the anterior inner side; I have named this eminence the *mons ureteris*; it is a valuable landmark in accurately locating minuter lesions directly about the orifices.

I have given the name "ureteral folds" to marked rounded elevations in the vesical mucosa, about 2 centimeters ( $\frac{3}{4}$  inch) long, sometimes seen in the knee-breast position, stretching from each ureteral orifice backward and outward toward the pelvic walls. These folds manifestly correspond to the terminal

portions of the ureters which pass through the bladder wall. When the rest of the bladder expands with air the resistance of the firmer tissue of the ureter causes the elevation.

The vesical triangle, or trigonum, with its three apices at the ureters and the internal urethral orifice, defines an area about  $2\frac{1}{2}$  centimeters ( $\frac{1}{2}$  inch) wide at the base and 2 centimeters ( $\frac{3}{4}$  inch) long on the sides, easily distinguished by its deeper injection from the rest of the bladder mucosa. This is one of the most important landmarks, and as an area it is peculiarly susceptible to certain affections rarely found elsewhere.

The interureteric ligament, connecting the ureteral orifices, is sometimes seen as a distinct fold elevated above the level of the bladder behind it; it is usually marked as a line separating the deeper injection of the trigonum from the paler mucosa of the posterior part of the bladder.

A shallow depression 2 or 3 centimeters (about 1 inch) broad is sometimes seen posterior to the interureteric line, and is formed by the bladder ballooning out in the direction of the vagina, while the less yielding trigonum resists the expansion.

Important points of reference also are those relating to the fixed and the movable portions of the bladder. As the bladder is emptied, the upper, more movable portion, covered with peritonemum, settles down into the lower and relatively more fixed portion, which lies in close relation to the vagina, until it comes to lie within it as one saucer rests in another. During respiration the free upper half may often be seen moving on the lower half, as if hinged, and the line of demarcation between them may be distinctly made out. This difference between mobility and relative immobility seems to determine to some extent the localization of the inflammatory affections.

At the edges where the two saucers meet, three folds are formed which can be most easily seen by examining a patient in the dorsal position, even without any, or with but little, elevation of the pelvis. I call these folds the *pliee vesicales* right, left, and posterior. The posterior fold stretches from side to side in front of the uterini; it is gently convex forward, and ends in front of each broad ligament, where each lateral fold begins, and extends horizontally around toward the urethra. These folds represent the physiological hinges on which the bladder moves in expanding and collapsing. I have called the apices where the posterior fold meets the lateral folds in front of the broad ligaments the right and the left vesical cornua.

**2. Relations of the Bladder to Surrounding Structures.**—To the specialist a familiarity with the exact relationships existing between the hips and bladder and its enveloping structures is of the highest importance, on account of the liability of the bladder to be affected by or to participate in the diseases of these structures.

The upper half of the bladder is covered with peritonemum, and may be called the subperitoneal area. This does not include an area above the urethral orifice, in relation to the space of Retzius and the symphysis pubis—the symphyseal area.

The trigonum and a broad strip of tissue extending back from it lies in close relation to the anterior vaginal wall—the vaginal area of the bladder. Just above this vaginal area is a narrow strip in close relation to the anterior portion of the supravaginal cervix uteri, as far up as the internal os, the uterine area. Laterally the two broad ligaments lie in contact with the right and left cornua.

3. **Artificial Division of the Bladder into Hemispheres and Quadrants.**—When the bladder is distended with air it forms a hollow sphere, flattened antero-posteriorly, and the observer, looking through the speculum, simply peeps through a hole in its wall, and by turning the speculum brings all parts, even those nearest the speculum, into view.

From the observer's standpoint it is easy to consider the bladder simply as a mathematical figure, a sphere divided into hemispheres. For example, the sagittal plane of the body which divides the pelvis into right and left halves, also cuts the bladder into right and left hemispheres by an imaginary line easily and accurately followed by simply elevating and depressing the handle of the speculum.

A point opposite the end of the speculum in the fully distended bladder, in the knee-breast position, in the center of the posterior hemisphere, may be taken as a posterior pole, corresponding to the internal urethral orifice, the anterior pole.

The position of the posterior pole determined in this way is not always in the same horizontal meridian, even in the same patient at different examinations; it is, however, always in the same vertical plane, and near enough the same horizontal position for practical purposes, so that, after assuming a certain point, as the posterior pole, and describing any lesions near by in relation to it, the same point is easily located at a later date for further comparison.

With a fixed posterior and an anterior pole, we may then consider the bladder as further divided by a horizontal plane passing through these poles. The sagittal and the horizontal planes, intersecting at the poles, further subdivide the bladder into quadrants.

Lesions at and around the posterior central point we may speak of as polar and circum-polar; lesions above or below the horizontal plane and to the right of the sagittal plane are described as located in the right upper or lower quadrants, and on the left side as in the left upper or lower quadrants.

By using this simple but purely artificial scheme an irregular patch of disease can be accurately mapped out on a diagram, and any alterations in its form easily noted from time to time.

The chief use of this system of division is to locate lesions in the posterior part of the bladder, where there are no natural landmarks which are readily available.

## EXAMINATION OF THE URETHRA AND BLADDER.

There are, in general, four ways of making a physical examination of affections of the urethra and bladder, namely, by

1. Urinalysis.
2. Percussion.
3. Palpation.
4. Inspection, urethroscopy, cystoscopy.

1. **Urinalysis.**—The fullest physical, chemical, microscopic, and bacteriologic examination of the urine should be made in every case where any morbid changes are found.

The color, odor, and specific gravity must be noted, together with the degree of the alkalinity or of the acidity, and the presence of albumin, sugar, pus, blood, mucus, or fragments of stone; minute stones may be seen under a weak lens and tested micro-chemically; the microscope may reveal pus corpuscles and blood, even in minute quantities, as well as casts and various crystalline substances. Bacteria must be noted and identified as far as possible by the various staining and culture methods. Bits of tissue and epithelial cells may also be discovered. The bacteriologic examination of an uncontaminated specimen of urine will sometimes reveal at once the true cause of disease, such, for example, as the tubercle bacillus, gonococcus, or colon bacillus.

As a rule, in inflammatory diseases of the urethra, by stroking it from above downward on its vaginal surface, sufficient secretion may be brought to the meatus for a cover-slip examination. After exposing the inner surface of the bladder to view in the manner to be described, secretions clinging to the bladder wall, or issuing out of a sinus, or from a ureteral orifice may be taken up on a platinum loop for further examination.

2. **Percussion** is of use in outlining a bladder full of urine or containing air. If percussion over the lower part of the abdomen above the symphysis yields everywhere a tympanic note, it is certain that the bladder can not be more than moderately distended with urine. When there is a decided fluctuating swelling just above the symphysis, and extending even as high as the umbilicus, a flat percussion note all over the enlargement, with a corona of resonance above and at the sides and a broad dull base below, almost surely indicates an overdistended bladder.

After examining the bladder under atmospheric distention, upon withdrawing the speculum, the overlying abdominal wall yields a high-pitched, tympanic note on percussion until the air is discharged.

3. **Palpation.**—Valuable information can often be gained in urethral and vesical diseases by the sense of touch alone. Changes noted in this way relate to sensitiveness and to variations in form or consistency. The urethra is palpated indirectly through the anterior vaginal wall by rolling the index finger over it from side to side, pressing upward, and using the under and the posterior surfaces of the symphysis pubis as a point of counter-pressure. An inflamed

urethra feels tense and swollen and elicits a cry of pain; a suburethral abscess feels like an elastic round lump projecting into the vagina; a cancerous urethra is hard and fixed like a rigid cord, and often nodular.

The external urethral orifice is best felt with the index finger pressing up onto the symphysis just over the vaginal outlet. An inflamed orifice or a sensitive caruncle makes pressure intolerable; a cancerous orifice is hard and ragged. If the urethra is excessively dilated, as from coitus in atresia of the vagina, the finger may go into the bladder so easily as to produce the impression that it has entered a capacious vagina.

By palpating the empty bladder bimannally between two fingers in the vagina and a hand pressing down over the symphysis, the fingers can be brought close together, with only the abdominal wall, vagina, and upper and lower walls of the bladder intervening; by carrying the fingers back in the direction of the cervix, the posterior part of the bladder, where it is reflected on itself, is often distinctly felt as it slips from under the touch. In cystitis pain is felt on making this pressure, in advanced tubercular cystitis the thickening in the bladder walls is easily appreciated. In one of my tubercular cases the bladder was felt firmly contracted down behind the symphysis, and big and hard like a hen's egg.

A stone or a foreign body may be caught between the fingers and outlined, and a diagnosis made in this way.

A still better way to palpate the bladder bimannally is by putting the patient in the knee-chest position and letting air into the vagina, when the fingers of both hands can be brought close together and the whole organ felt with wonderful distinctness. The time has forever gone by for dilating the urethra to admit the index finger for the purpose of palpating the inner surface of the bladder. No useful information can be gained by this crude procedure which can not be better secured, and without pain and risk of incontinence, by the simple method of inspection.

4. **Inspection.**—In almost all affections of the urethra and bladder direct inspection yields the most positive results in the diagnosis of disease. An inspection without the use of any instrument may afford much valuable information. Almost all the affections of the urethral orifice may be diagnosed by an inspection, in which nothing more is done than to separate the labia minora wide enough to expose it. By placing a finger close to each side of the urethra and drawing its lips apart, the lower end of the canal is exposed to view, including the orifices of Skene's ducts posteriorly and just within them. By retracting the vaginal outlet, the vaginal surface of the urethra and of the floor of the bladder are seen, and a tumor of the urethra projecting into the vagina, or a displacement of the bladder, or a vesico-vaginal fistula may be diagnosed. Such marked displacements as a cystocele or a prolapse of the vagina and bladder are best observed when the patient stands erect.

When the abdomen is opened the peritoneal surface of the bladder is exposed to view, and anything affecting it, such as adhesions, or tumors pressing on it, or a hypertrophy, are easily seen.

**Urethroscopy.**—When a urethral or a vesical disease is far enough advanced to call for an investigation, there will almost always be found morbid changes distinct enough to be recognized by a cystoscopic or a urethroscopic examination.

The urethra is examined by introducing into the bladder a speculum 8 or 10 millimeters in diameter and withdrawing it gradually, all the while studying the urethral mucosa as each successive part of the canal passes over the end of the speculum from above downward. At first the end of the speculum coming out of the bladder just clears the rim of the internal urethral orifice, then on continuing the withdrawal the rim approaches the center, forms the central figure, and then disappears from view as the lower walls successively come to occupy the field.

The endoscopic picture resembles a flat funnel, and, as suggested by Grünfeld, is so named; the portion in the middle where the urethral walls meet is called the central figure, and the portion of the urethra exposed to view between the central figure and the rim of the speculum is the funnel wall.

The central figure forms a large free opening only at the internal urethral orifice, where, surrounded by a narrow margin of mucosa, it is at first almost as large as the speculum; it decreases in size as the speculum is withdrawn, until the walls approach on all sides and form a small quadrilateral or oval figure, finally closing altogether; lower down in the urethra the central figure forms a transverse line, which finally assumes a vertical direction at the external urethral orifice.

The funnel walls are made up of numerous folds which radiate out from the central figure to the margin of the speculum. From eight to twelve of these may be seen at once. The posterior fold in the upper part of the urethra is the largest and is a continuation of a triangular elevation on the trigonum in the bladder, named by J. C. L. Barkow *colliculus cervicalis*. Numerous delicate vessels are plainly visible on the urethral walls, one or two on each fold, running longitudinally with it.

In the lower part of the urethra, near the external orifice, the longitudinal folds are crossed by a transverse fold, which subdivides the urethral mucosa into a kind of lattice work with shallow pits between.

The orifices of the urethral glands, Morgagni's crypts and Littre's acinous glands, appear as fine points, often in groups disposed longitudinally, or as larger yellowish spots; they can be better seen by changing the position of the speculum so as to displace the central figure and bring one side of the urethral wall flat against its end.

**Cystoscopy.**—The fundamental principles of a cystoscopic examination are:

1. The introduction of a simple cylindrical speculum into the bladder.
2. The atmospheric distention of the bladder induced solely by posture.
3. The illumination and inspection of the vesical mucosa, either by means of a direct light, such as a little electric lamp attached to the forehead or the mouth of the speculum, or by means of a strong light reflected by a head mirror.

The view of the bladder obtained in this way is a direct one; and the open

speculum allows the operator to touch any part of the bladder with a sound, and to introduce various instruments with ease.

**The Instruments Used.**—The necessary instruments are the following: A strong light, a head mirror, vesical specula with obturators, a urethral calibrator and dilator, an evacuator for removing urine, long mouth-toothed forceps, and a ureteral searcher.

In case of emergency the instruments absolutely necessary for an examination are but few and simple. The light is always easily obtained, and every physician owns a throat mirror. An evacuator can be made by attaching a piece of rubber tubing to the end of a syringe; and the dilator, forceps, and searcher can be dispensed with, so that the vesical speculum is really the only novel indispensable instrument, and even that could be extemporized from a piece of tin or a bit of cardboard.

**The Light.**—The best illuminant is the strong white electric light. I commonly use a sixteen-candle-power droplight set in a socket on a short wooden handle, with a simple tin reflector, evenly coated with white enamel paint on the inside, covering half of it; the current is conveyed from the wall by cords, and the connection with the wall is made by means of a movable socket; it is ready for use at any moment, and can be carried from room to room.

When there is no electric light available, I take with me a small storage battery weighing ten pounds and measuring 10 by 6½ by 4½ inches, which runs a six-volt four-candle-power mignon lamp for fifteen hours. The little light is attached to the head band and inclosed in a short metal cylinder with a reflector behind it. A tube carrying a convex lens fits over the cylinder, covering in the light, and moves on a ratchet, affording an adjustment which concentrates the illumination on a small circle at the desired point. If a direct electric current is available, the battery can be recharged without sending it away, by connecting it with the wires from the street, with a current adapter interposed.

Strong daylight or sunlight gives a good illumination, and although at times invaluable, it is uncertain, and awkward to direct to all parts of the bladder, necessitating moving the patient about instead of the mirror.

A short candle may be used, but its light is too feeble for a minute examination. Lamps and gas burners are the most unsatisfactory light, because they can not be held close enough to the patient, and they give out enough heat to make the examiner uncomfortable.

The head mirror is a simple concave reflector with about 30 centimeters (12 inches) focal length. The large circle of light which is thrown by this mirror around the orifice of the speculum is a necessity, for, if the circle were a small one, the slightest movement of the head would darken the field in the bladder, while the larger circle allows considerable latitude of movement.

I like the mirror attached to a flexible steel band crossing the top of the head better than the elastic bands encircling it; the steel band is more quickly put on and removed without disarranging the hair. A steel segmented band covers and protects the mirror when out of use, and is the safest and most convenient device for transportation.

**The Vesical Specula.**—The specula are simple cylinders 8 centimeters ( $3\frac{1}{8}$  inches) long, and equal in diameter throughout; they are preferably made of German silver and nickel plated. There is a funnel-shaped expansion at the outer end of the speculum 15 millimeters long, inclined at an angle of sixty degrees to the cylinder. The handle, 8 centimeters (3 inches) long and 12 millimeters broad and 5 millimeters thick, is attached to the funnel and is large enough to afford a convenient grasp which does not tire the hand during a prolonged examination.

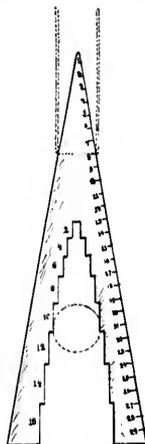

FIG. 183.—GRADUATED INSTRUMENT FOR MEASURING CALIBERS AND DIAMETERS OF SPECULA.

The caliber is measured by inserting the end into the speculum as far as it will go and reading off the size on the scale. The diameter is measured by dropping the speculum into the graduated opening and reading off the size. By joining the caliber from the diameter the thickness of the wall is measured.

The dilator is made stout enough not to bend in withdrawal, and the handle is large, so as to give a good hold for the thumb and index finger.

To facilitate the introduction of the cystoscope there must be no shoulder to injure the urethra between the end of the speculum and its obturator.

The dilator is a conical instrument 7 centimeters (3 inches) long, with a blunt point 3 millimeters in diameter; it is 16 millimeters in diameter at its base. It is graduated from point to base in millimeter diameters from 4 to 16 millimeters. A handle attached to the base is large enough to afford a convenient hold for three fingers, and a flange at the base keeps it from slipping all the way into the urethra.

I have devised the one simple conical dilator representing an infinite series on its sides, to take the place of the interrupted series of the Hegar dilators commonly used, as I have found by careful investigation that the external orifice is the only part of the urethral canal is so elastic that it yields at once to the obturator and opens up to the full size of the speculum without previous dilatation and without injury.

The evacuator is used to empty the bladder of the residual urine

which the patient often can not expel, and which can not be removed by a catheter, amounting to 4 to 10 cubic centimeters. It must also be used from time to time to remove the urine accumulating during a prolonged examination. The evacuator is a small hollow, perforated metal ball, connected by fine rubber tubing, about 35 centimeters (14 inches) long, with a rubber exhausting bulb. The rubber tube is cut about 5 centimeters (2 inches) from the ball, and a piece of glass tubing inserted which serves

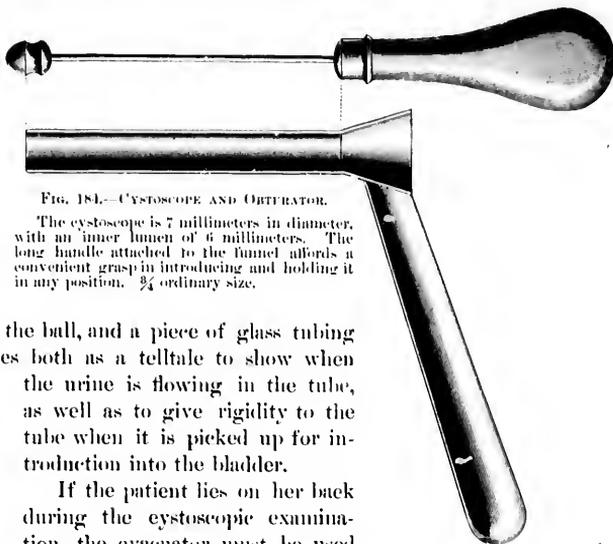

FIG. 184.—CYSTOSCOPE AND OBTURATOR.

The cystoscope is 7 millimeters in diameter, with an inner lumen of 6 millimeters. The long handle attached to the funnel affords a convenient grasp in introducing and holding it in any position.  $\frac{3}{4}$  ordinary size.

both as a telltale to show when the urine is flowing in the tube, as well as to give rigidity to the tube when it is picked up for introduction into the bladder.

If the patient lies on her back during the cystoscopic examination, the evacuator must be used much oftener, as a small quantity of urine easily obscures the field of view in this posture. In the knee-breast position, on the other hand, a little clear urine in a pool in the inverted vault of the bladder in no way interferes with a thorough inspection of all parts.

The evacuator is used in the following manner: The assistant, grasping the rubber bulb, pushes its base in with his thumb and forces out all the air; while the examiner, holding the other end, drops the little perforated ball through the speculum into the pool of urine, when the assistant removes his thumb, and the bulb slowly expands, sucking up the urine. The evacuation will be more rapid if the suction bulb is held well below the level of the bladder. If there is only a little urine to be taken up, it will escape faster by withdrawing the ball a little occasionally so as to suck up some air with the urine.



FIG. 185.—URETHRAL CALIBRATOR AND DILATOR.

The numbers indicate the diameters in millimeters.

Dr. G. E. Shoemaker, of Philadelphia, has devised a simple evacuator consisting in a little tube with perforations and slightly bent at both ends, and connected with an exhaust bottle emptied by a syringe (see *Annals of Surgery*, November,

1895). Dr. W. L. Burrage, of Boston, has also made an attachment for the cystoscope to effect the same end.

The long mouse-toothed forceps are a light pair of forceps 24 centimeters (9 inches) long, with long slender arms 10 centimeters (about 4 inches) long, and at the ends delicate slightly recurved mouse teeth. The handles are fenestrated for lightness. They are useful in cleansing the lumen of the speculum of drainage of urine, or in taking up a little urine out of the bladder with small pledgets of cotton, or in wiping off small areas of the vesical mucosa.

The ureteral searcher is a small rod 18 centimeters (7 inches) long with a little bulbous end 3 millimeters by 1.5 millimeter, and a handle 6 centimeters ( $2\frac{1}{2}$  inches) long set at an angle of 120 degrees. It is used in touching any part of the bladder wall, in exploring a sinus, and particularly in locating the ureteral orifices in doubtful cases.

Applicator.—Any piece of flexible wire about 15 centimeters long will do as an applicator to carry medicated cotton to all points on the bladder or the urethra.

Other useful instruments are a speculum graduated in centimeters for measuring the distance between points on the bladder wall, the external or internal urethral orifices, and a flattened searcher, likewise graduated in centimeters and half centimeters.

**The Technique of the Examination.**—Asepsis.—Asepsis must be maintained throughout every examination by handling only aseptic instruments, introduced by clean hands, through a cleansed urethral orifice.

All the instruments used must have been sterilized and be laid in a clean tray on a sterilized towel. The external urethral orifice must be wiped clean with a boric acid solution before introducing the speculum to remove any leucorrhœal or other discharges often contaminating its lips.

The hands must be scrubbed clean, and as far as possible the utmost precaution must be taken to avoid touching any part of the instruments but the handles. If this were always done, no infection could occur even with infected hands. Every instrument should be constantly inspected to detect any rough or scaling surface liable to cut the mucous membrane.

**Preparation of the Patient.**—The patient should come to the examining table with the lower bowel emptied. I find that in many cases it makes a decided difference if she has just eaten a meal, when the bladder does not always expand so well. Immediately before the examination she must empty the bladder in a sitting or standing posture. If the nurse



FIG. 186.—DELICATE MOUSE-TOOTHED FORCEPS FOR CONVEYING PLEDGETS OF COTTON INTO THE BLADDER.

The teeth should be more recurved.

draws the urine with a catheter, or if she passes it on the table, the evacuation will not be nearly so complete.

**Anesthesia.**—A general anesthetic is only needed for a nervous woman. Local anesthesia by means of a 10 per cent solution of cocaine applied on a pledget of cotton wound on a metal rod and introduced just within the external

FIG. 187. SEARCHER FOR LOCATING THE URETERAL ORIFICE.

urethral orifice for five minutes beforehand, is sufficient to benumb the sensations so entirely that any required dilatation may be made and the speculum introduced without much discomfort.

**Posture of the Patient.**—Two postures are available, an elevated dorsal and a knee-breast. The dorsal position is the most convenient to use and the least tiring to the patient, but it is only of service in thin patients, and the atmospheric expansion is not so good; the bladder of a fat woman will rarely distend at all in this posture. The head and thorax rest on the table, while the pelvis is raised by putting one or two bran cushions under the but-



FIG. 188.—EXAMINATION OF THE BLADDER IN THE DORSAL POSITION, WITH ELEVATED PELVIS.

The electric light held close to the symphysis is reflected by the head mirror into the bladder. The angle of reflection must be as small as possible, so as to avoid constantly displacing the pencil of light with slight movements of the head.

tocks, so as to elevate them 20 or 30 centimeters (8 or 12 inches) or more above the table level. This gives a pitch to the pelvic and lower abdominal viscera which makes them gravitate toward the diaphragm, and as soon as a speculum is introduced the bladder sucks in air enough to distend it.

When the bladder does not expand, and yet it is particularly desirable to

use the dorsal position on account of the inability of the patient to stand the inconvenience and fatigue of the knee-breast position, the bladder may be distended and the pelvis relieved of the small intestines by first placing her in the knee-breast position for a minute and letting in air with a catheter; she is then



FIG. 189. VESICAL SPECULUM INTRODUCED WITH THE PATIENT IN THE KNEE-BREAST POSTURE.

turned on her back with hips elevated on the cushions, taking care to keep the pelvis all the time well above the level of the abdomen. The speculum may now be introduced and a satisfactory examination made. A bladder distended in this way will often remain well distended until the hips are let down again to the table level.

The knee-breast position is the one position most satisfactory and applicable in all cases. The patient kneels with her knees separated 10 or 12 inches, close to the end of the table, and, keeping the buttocks as high as possible, lets the back curve in, and brings the side of the face down on the table. If she squats a little, drooping the buttocks slightly toward her feet, she will

be more conveniently disposed for the examination. Sometimes, to get a good expansion, it is necessary to push the thighs in the opposite direction beyond the vertical. If she is under an anesthetic, the best way to hold her in the knee-breast position is for two assistants to stand, one on each side, close up to the body to prevent it from falling sidewise, each grasping the body with one arm thrown over the back, and holding the leg in the crotch of the knee with the other hand to keep it from slipping up or down.

An apparatus like that shown in the text (Fig. 190) and devised by Dr. G. B. Miller is useful where assistants are scarce, but the thigh bands must not be allowed to cut into the femoral fold.

Calibrating and dilating the Urethral Orifice.—Before dilating the urethra and introducing a speculum it is well to calibrate it, that is, to measure its diameter in millimeters as a guide to the amount of dilatation needed to admit a speculum; for example, if the urethral orifice has a diameter of 6 or 7 millimeters only, it can not be dilated up to 10 or 12 millimeters without a slight rupture of its margins; calibration in this case would induce one to use a speculum a size or two smaller than usual. Again, the calibration often

shows that the orifice is already so large that it needs no preliminary dilatation. A practiced eye will usually be able to gauge the size of the urethral orifice at once, and to select the exact size of speculum suitable for introduction.

To calibrate the orifice, the small end of the conical dilator, Fig. 185, is pushed into the urethra until it fits snugly, when the index finger marks the point in contact with the urethral orifice; the dilator is then withdrawn and the diameter in millimeters read off. If it is 9 or 10, the speculum of the same number is taken up and introduced without dilatation; if the number indicating the diameter is 7 or 8, the urethra must first be dilated up to the size of speculum to be used.

Boroglycerid forms the best lubricant for dilator and speculum because it is colorless. Vaseline sometimes leaves a film behind which looks like pus.

To dilate the orifice, the dilator, which is one and the same instrument with the calibrator, is introduced into the urethra in the direction of its

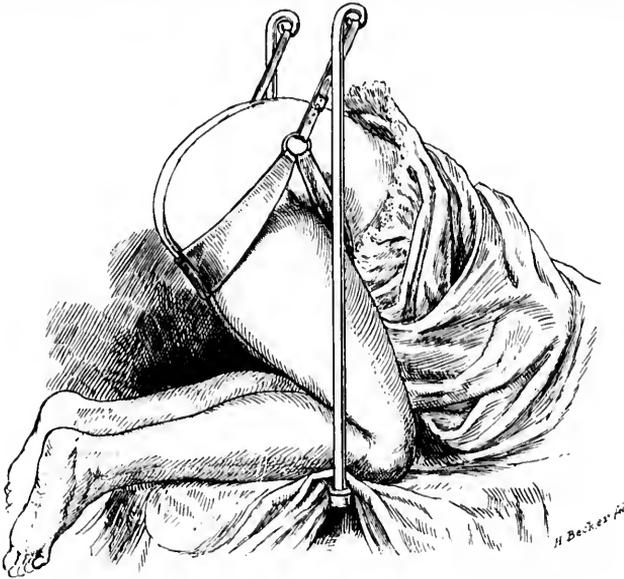

FIG. 190.—PATIENT IN A HARNESS IN THE KNEE-BREAST POSITION FOR CYSTOSCOPIC EXAMINATION. The squatting attitude is a little too much exaggerated for the average case.

axis, with a slight boring motion, until the required distention is reached in a few seconds. Often there is no injury at all from such a dilatation, while at other times one or two shallow ruptures 1 millimeter deep and from 3 to 5 millimeters long are made at the posterior margin. I have never seen any serious bleeding nor have had to treat the ruptures later as fissures; only two or three

times have I had to put in a fine suture to stop the oozing. An unusually small and rigid orifice should be cut posteriorly, as suggested by Simon; then, after the examination, the cut is closed with one or two fine silk sutures.

**Introducing the Speculum.**—A skillful examiner will select a suitable speculum (Fig. 184), a No. 7, 8, 9, or 10, or one of the half sizes between, according to the case, the age of the patient, and the purpose of the examination; a patient with a sensitive urethra may often be treated with less discomfort and with equal facility through a No. 7½ or 8 speculum. The smaller sizes are better adapted to girls and to young women with small urethrae. Beginners in cystoscopy are apt to select a larger speculum, using always a No. 10 or 11; with experience they will drop a size or two.

To introduce the speculum, it is grasped as shown in Fig. 191, and the obturator is kept from slipping back into the cylinder by a decided pressure with the thumb, continued until the end has entered into the bladder. The urethra, wiped clean with a boric acid solution, is exposed by an assistant holding the buttocks and the labia well apart, while the point of the speculum, coated with the boroglycerid solution, is applied to the urethral orifice, and pushed through the urethra into the bladder with a gentle sweep around the pubic arch. The handle of the speculum is now firmly grasped, while the obturator is withdrawn with a slight rotary motion. If the internal urethral orifice is drawn well into the pelvis by the posture, the urethra is so much curved that there is danger of injuring it by pushing the speculum hard against its posterior wall; this must be avoided by introducing the speculum in a decided curve. The moment the obturator is taken out the air rushes in and the bladder is dilated and ready for the inspection.

If the bladder does not expand in this way the examiner will usually find that the patient has assumed a faulty position, and as soon as this is corrected the expansion occurs.

**Viewing the Bladder.**—It takes far less time to view the whole interior of the bladder than it does to describe the method of inspection (Fig. 192);

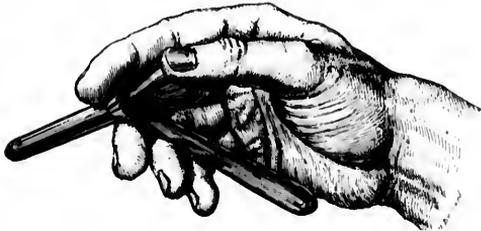

FIG. 191.—HOLDING THE VESICAL SPECULUM READY FOR INTRODUCTION; THE THUMB PASSES THE OBTURATOR FIRMLY IN.

indeed, after practice, a few seconds will be sufficient to determine actual sight whether any portion of the interior is sound or diseased.

If the patient is in the knee-breast position the examiner sits on a stool with his eyes a little below the level of the urethra, grasping the handle of the speculum, which is turned up-

ward, and he should wear the head mirror over the same eye he uses at the microscope.

The assistant now holds the electric droplight close to the end of the speculum,

which is protected from the heat by one or two towels, and the lower margin of the head mirror is drawn away from the face and turned until the reflected light spot falls within the bladder. Men accustomed to throat and eye work will find no difficulty in putting a good illumination at once just where they want it, while to the inexperienced man the apparent waywardness of the light will be his chief trouble throughout. The direct ray of the little electric headlight makes the illumination of the field an easier task.

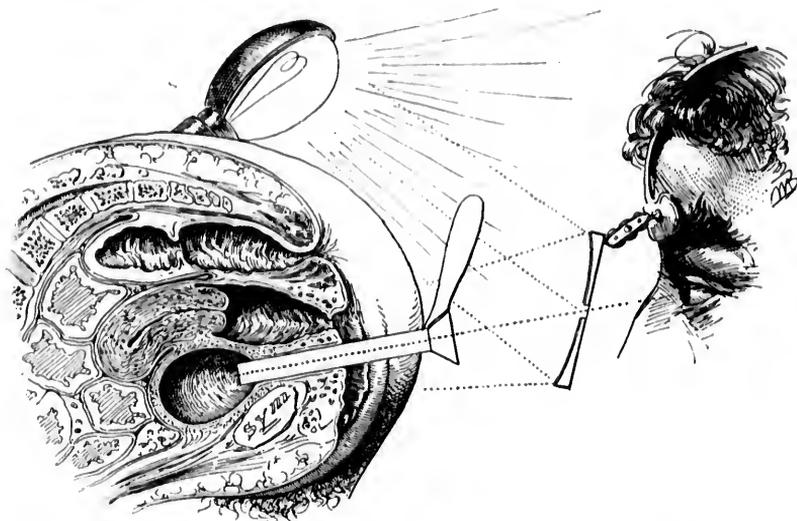

FIG. 192.—EXAMINATION OF THE BLADDER WITH THE PATIENT IN THE KNEE-BREAST POSITION.

The inspection of the bladder naturally begins with the posterior hemisphere about the posterior pole, opposite the internal urethral orifice, from 3 to 5 centimeters distant from the anterior wall, but not more than 2 or 3 centimeters from the end of the speculum, which is pushed well into the bladder.

The whole posterior hemisphere is first examined as the end of the instrument is directed to the right and to the left, by alternately raising and dropping the handle so that every part of the mucosa is passed in review at least twice.

The normal background of the inflated bladder seen in this way is a dull white, with here and there large vessels branching and anastomosing over it in an irregular manner. The fine rosy capillary injection seen in a contracted bladder is not visible when it is distended with air, for the minor vessels are emptied, both by the expansion and by the posture of the patient. At a point 1 or 2 centimeters above the posterior pole a rounded red spot of capillary injection is often seen, which may easily be mistaken for a localized inflammation, but which is merely a suction hyperemia induced at this point by contact with the end of the speculum during the withdrawal of the obturator.

The larger blood-vessels spring out of the submucosa, where they are first seen in a hazy way, becoming clearer and with sharply defined outlines on the surface, where they divide and subdivide into numerous branches. Occasionally an artery is seen pulsating, and a large dark vein may sometimes be seen gradually disappearing from view as it penetrates the walls obliquely. The mucous-surface on the right and the left of the posterior hemisphere is often divided up by shallow interlacing ridges, or again a sharp ridge 2 to 3 centimeters long is seen to cross the field obliquely; these ridges are formed by the inner muscular bundles irregularly arranged. Numerous little glistening points are due to moisture on slight inequalities of surface which catch and reflect the light.

By dropping the handle of the speculum decidedly, its inner end is raised and the vault or summit of the bladder is brought into view, and every part of the organ inspected by moving the end from side to side. By elevating the handle decidedly, the floor of the bladder is examined in the same way, and then by moving it to the left and to the right the right and left walls come into view.

The only parts which remain unexamined are those contiguous to the internal urethral orifice, and these are now seen by a still more decided elevation and depression of the handle. With a marked depression of the speculum the vesical triangle comes into view, always a little more injected than the rest of the bladder, due to the fact that the mucosa and the underlying tissues are intimately connected, which prevents this part from expanding and becoming anemic like the rest of the bladder.

Turning the speculum from fifteen to twenty degrees—generally the latter—to the right or to the left a little pinkish prominence is seen—the mons ureteris which marks the position of the ureteral orifice; this usually looks like a fine transverse line about 2 millimeters long on the side of the mons. It is sometimes a faint streak, like a little water line on paper. At other times the orifice appears as a little pit or a mere point. Immediately around the ureteral orifice is a paler area about 1 millimeter broad, and surrounding this a rosy area 3 or 4 millimeters broad. I have several times seen a blood vessel emerging out of it on to the vesical mucosa. If a **V** with its angle at thirty degrees is marked on the cylinder of the speculum, near the handle, by bringing one of the arms of the **V** parallel to the axis of the urethra the other arm will then point toward one of the ureteral orifices, which may now be found at once on looking through the speculum.

If the ureteral orifice is watched for half a minute or so a little clear urine will be seen to spout out from the surface, forming a jet which lasts two or three seconds, to be repeated again in the course of a minute.

Sometimes the urine spurts up free from the surface of the bladder and shoots into the lumen of the speculum and trickles down to the outer edge. By holding the end of the speculum close up under the ureter, or by using the oblique speculum adapted specially to this purpose, Fig. 193, enough urine can be caught up with pledgets of cotton or in a small graduate to answer the purposes of a physical, chemical, and microscopic examination. When the bladder is inflamed

or ulcerated, it is sometimes of great advantage to get a little urine from one or both sides in this way, because it avoids the risk of a possible infection of a ureter by putting in a catheter.

The interureteric line is often distinctly seen, either from its having a little deeper color than the bladder behind it, or from a slight elevation.

In the process of the examination of the entire bladder conducted in this way the field of vision has changed from the posterior wall perpendicular to the plane of vision to the triangular area which lies almost parallel to it; at right angles differences in color are best seen, while in the plane of vision outlines which cross it come out more distinctly.

The retrosymphyseal area comes into view on elevating the handle of the speculum so as to direct the inner end toward the symphysis pubis.

Occasionally a bladder will be found which does not remain ballooned out with air, but undergoes periods of more or less rhythmic contraction, each of which lasts half a minute or more. With the contraction there is an influx of blood into the capillaries, and the mucous membrane assumes a rosy hue, becoming more intense as the contraction in-

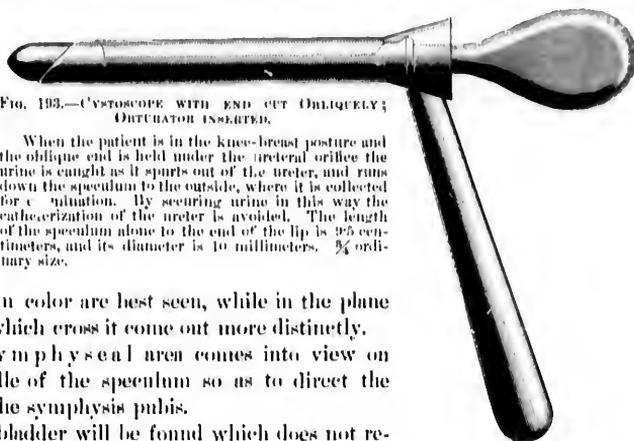

FIG. 193.—CYSTOSCOPE WITH END CUT OBLIQUELY; DISTICULATOR INSERTED.

When the patient is in the knee-breast posture and the oblique end is held under the ureteral orifice the urine is caught as it spurts out of the ureter, and runs down the speculum to the outside, where it is collected for examination. By securing urine in this way the catheterization of the ureter is avoided. The length of the speculum alone to the end of the lip is 35 centimeters, and its diameter is 10 millimeters.  $\frac{3}{4}$  ordinary size.

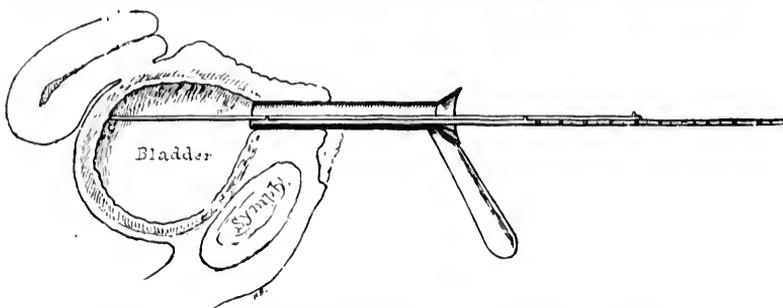

FIG. 194.—INSTRUMENT FOR MEASURING THE DISTANCE BETWEEN THE INTERNAL ORIFICE OF THE URETHRA AND VARIOUS POINTS ON THE VESICAL WALLS.

The distance in millimeters is registered on a graduated arm on the outside. One arm slides along the other and the lower one is provided with a little hook on its inner end to hold it against the inner end of the speculum. Knee-breast posture.

erases, until the whole organ is thrown into small folds like a labyrinth of cerebral convolutions. With the contraction the air is audibly expelled and often

urine comes sputtering out with it. After waiting from half a minute to a minute the contraction relaxes and the bladder expands, and the examination can be continued. The color and appearance of the walls and of the vessels of a normal bladder must be well fixed in the mind by numerous examinations, because the normal conditions are the standards of comparison in determining the presence of areas of congestion, inflammation, or other diseases.

Insufficient expansion of the bladder will be noticed in advanced pregnancy, or in the case of a tumor blocking the pelvis, or in ascites. It may also be due to the fact that the patient in taking the knee-breast posture arches her back, and raises her chest too high from the table, and so interferes with the action of gravity on the intestines. Often, too, a little time must be allowed for the viscera to gravitate slowly toward the diaphragm, and so create the necessary suction for the distention of the bladder.

Too great an expansion of the bladder may also be troublesome. The difficulty is that the trigonum and the ureteral orifices are then lifted up so high that the examiner has to bring his head so far under the patient that his position is extremely awkward and he does not get enough light for the inspection. This may be remedied in several ways:

a. Before introducing the cystoscope a speculum is always put into the vagina, which then balloons out with air and lets its anterior wall with the floor of the bladder drop in the direction of the symphysis; then when the vesical speculum is introduced the available expansion space of the pelvis, already partly occupied by the distended vagina, is so diminished that the floor of the bladder remains more nearly in the plane of vision. In parous women the atmospheric expansion of the vagina is usually spontaneous. Distention of the rectum with air will sometimes produce the same effect.

b. By putting a cotton pack in the vagina or by depressing its anterior wall with a spatula, any particular portion of the base of the bladder can be held down in view.

c. Cases where there is a tendency to an excessive expansion may, as a rule, be easily examined in the dorsal posture, when it is naturally not so great.

The presence of air in the bladder is rarely painful so long as the urethra is open and the air enters and escapes freely with each respiratory movement. But not infrequently as soon as the speculum is taken out the patient feels a cramping pain, which is not relieved until she has been able to seat herself on a vessel to expel the air. To avoid this after-pain, the examiner may leave the speculum in place, or slip a catheter in, and then lower the patient gently from the knee-breast posture on to her side, so as to let the air out gradually.

It is not necessary to take any special precaution after a vesical examination, unless it has been prolonged enough to weary the patient, or unless she is feeble or nervous; under these circumstances rest for an hour or two with a half teaspoonful of aromatic spirits of ammonia may be prescribed.

The field of usefulness of the cystoscopic method just described is a large one, commensurate with the entire field of vesical diseases, and the practitioner

who uses it liberally will be rewarded by constantly discovering that affections hitherto described as merely functional have definite local lesions as their basis, and are often speedily amenable to simple methods of treatment.

I wish further to insist that a cystoscopic examination should be made in every case where a vesical affection is more than transient and the diagnosis is not absolutely clear without it, and that every part of the bladder should then be thoroughly inspected.

#### AFFECTIONS OF THE URETHRA.

Short as the urethral canal is in women, it is liable to a variety of diseases, some of which are peculiar to the sex. These affections are chiefly those which either interfere with function or affect the caliber of the urethra. As the final avenue of egress of the urine the urethra holds a position analogous to the short anal canal in its relation to the rectal ampulla and the intestines above. Owing to its relation to the external genitals, which are infested with micro-organisms, the urethral orifice is constantly exposed to the risk of infection from without. Its position under the resisting pubic arch renders the urethra liable also to damage from prolonged pressure during labor, or to compression by a tumor which chokes the pelvis. It is protected from external injuries by its concealed position between the thighs and labia.

Affections of the urethra may conveniently be considered under the following heads: Malformations, displacements, dilatation, stricture, ischuria, fistula, foreign body, hyperemia, urethritis, new growths.

Congenital malformations of the urethra are among the rarest gynecological affections. The commonest is a distinct lateral displacement of the external orifice, generally about 2 millimeters, to one or the other side. A shallow vertical fissure corresponding to the urethral orifice may be found on the opposite side with a sharp ridge between the two: this gives the appearance of a double urethral orifice.

Most malformations of practical importance are due to a deficiency of the development of some part of the urethral canal.

These may be classified as: (a) hypospadias, (b) epispadias, (c) imperforate urethra, (d) totally deficient urethra.

**Hypospadias.**—In hypospadias part of the inferior wall of the urethra is wanting and the external urethral orifice opens at some point in the anterior vaginal wall. One of the best described cases is that of A. Lebedeff (*Arch. f. Gyn.*, vol. xvi, p. 290). The patient was a married woman, twenty-three years old, a nullipara. She had always been well in every respect until five years married, when she began to experience a pressure on the bladder and to suffer from an involuntary escape of urine, at first at night after coitus, but soon becoming constant. An examination showed normal labia, nymphæ, and clitoris. But in the vestibule, instead of a urethral canal, there was a furrow, lined with a delicate mucous membrane, and leading back over the anterior vaginal wall, between vaginal folds so closely applied as to form a distinct ridge; this furrow

ended in a canal 2 centimeters long situated 2 centimeters within the introitus which admitted two fingers directly into the bladder. The upper wall of the furrow, seen on drawing aside the protecting vaginal folds, was covered throughout with a bright-pink mucous membrane crossed by a fine network of vessels. The fact that the patient had never borne a child, and the straight course of the canal, associated with the entire absence of any cicatricial tissue, showed that the condition was a congenital defect of the inferior wall of the urethra extending as far up as the neck of the bladder. The incontinence had been brought on mechanically by coitus.

A case of my own, more properly classified, as F. Winekel has pointed out, as a persistent urogenital sinus, was a nullipara forty-six years old; the external genitals were normal as far as the introitus of the vagina, where the only opening between clitoris and rectum was found. There was no hymen, and the smooth orifice beneath the pubic arch had the form of a transverse slit. If the finger was pushed in, it invariably entered a short muscular canal, which was the shortened urethra, and so passed directly into the bladder. The urethral orifice was in this way situated about 1 centimeter behind the pubic arch, and the urethral canal was only 1 centimeter long. While the inferior wall of the urethra was absent, the anterior wall continued on out as far as the vestibule, but was not of normal length. The upper wall of the introitus was vascular and of a deep-red color, and presented numerous longitudinal mucous folds. There was a gaping slit in the anterior vaginal wall 1 centimeter long, which shortened the caliber of the urethra by so much. If now the point of the sound introduced into the vagina was turned sharply down over the perineum, it would then enter one or the other of two orifices lying side by side, and separated by a fleshy septum; this was a double vagina about 8 centimeters (5 inches) deep, with a small cervix in the vault of each half. The incontinence and distress the patient had complained of in coitus was relieved, and the channels returned to their normal usage by a plastic operation, freshening and uniting the edges of the flaps, and converting the two vaginæ into one by removing the septum.

Similar to this was the case of a short dilated urethra reported by Dr. W. H. Baker, of Boston (*New York Jour. of Gyn. and Obstet.*, Oct., 1893); here there was no trace of an upper urethral wall, and there was therefore a complete absence of the external part of the urethra, *defectus urethrae externae*.

**Epispadias.**—In epispadias there is a defect of the upper wall of the urethra associated with a separation of the labia minora and division of the clitoris. In its extreme form the symphysis gapes, the anterior wall of the bladder is deficient, and the bladder becomes everted (exstrophy).

**Atresia.**—Congenital atresia of the urethra may be due either to defective intra-uterine development, when it is associated with other anomalies, or it may be acquired late in intra-uterine life by an agglutination of a portion of the urethral canal. The latter condition was clearly the one obtaining in the case of a child two days old (Mandl, *Wien. Klin. Wochenschr.*, 1891, p. 515), which vomited and had general convulsions until the atresia was broken down by

a sound, when turbid concentrated urine escaped and the disturbances ceased. There was no marked distention of the bladder or evidence of hydronephrosis.

When the atresia is due to defective development a number of other coexisting defects are usually found, as in the instance reported by F. Schatz (*Archiv. f. Gyn.*, i, p. 12), where there was a double uterus, double vagina, and double bladder. As there was no urethra, each of these bladders opened by an orifice in its base into the corresponding vagina.

If the atresia is a complete one, in order that the child so affected shall live, nature must have provided some other channel for the escape of the urine, such as an opening into the bladder through the symphysis, or a patulous urachus, which discharges at the navel. If there is no avenue of escape for the urine, this will, even in the intra-uterine life, accumulate in such quantity as to produce an enormous distention of the bladder, ureters, and kidneys, with ascites. Under these circumstances the distended abdomen forms a serious hindrance to the birth.

**Congenital Absence of Urethra.**—In these cases all trace of the urethra is wanting, both external and internal orifices, and upper and lower walls, and the base of the bladder opens directly into the vagina, with which it forms one common canal.

The urethra is liable to displacements of two kinds: (1) Those affecting the entire urethra with the adjacent tissues; (2) those affecting the mucous membrane of the urethra alone.

**Displacement of the Entire Urethra.**—The anatomical and topographical relations of the urethra are such that it is most favorably situated to prevent displacement. Its shortness, its position directly under the pubic arch, and the dense fibrous connection with the adjacent parts all resist any ordinary efforts to force it out of its natural position. The commonest change in position is noticed when the vaginal outlet is relaxed and gaping, and the base of the bladder descends with the anterior vaginal wall to fill up the gap. Careful inspection and the use of a sound then show that the urethra has rotated outward and forward around the symphysis as its axis; the external orifice lies farther forward and its direction more upward than normal, while the internal orifice has sunk with the bladder. In prolapse of the elongated cervix uteri with a vesical diverticulum in the pouch the urethra often undergoes a still more marked change in its direction, gradually yielding to the traction of the prolapsed sac, first at its internal orifice, and then the lower portions, until the whole urethra finally lies outside the body. The canal sometimes assumes a sigmoid curve, which makes it difficult to pass a catheter.

The symptoms of this condition are those referred to the prolapsus and those which arise from difficulty in emptying the bladder. Unless the patient is in the habit of pushing up the sac for this purpose, the evacuation is often incomplete and decomposition of retained urine may set in with all its untoward sequelae.

Upward displacement of the urethra occurs during labor and when the urethra is drawn up by a full bladder. It also occurs in the case of large

subperitoneal tumors of the uterus, which drag the bladder high up, and with it the urethra, sometimes changing its horizontal direction to a vertical one. The difficulty of emptying the bladder may be great, but it is sometimes also surprisingly easy. In relieving the patient, it is safer to use a soft catheter,



FIG. 195.—HYPERTROPHY OF THE URETHRAL MUCOSA AT THE EXTERNAL ORIFICE. APR. 16, 1896.

which finds its own way into the bladder. If a metal or glass catheter is used it must be done with the gentlest touch, feeling for the channel with each advance of the instrument. I know of a doctor who decided to perform a Cæsarean section on a woman in whom the head of the child was sticking in the pelvis. As a preparatory measure he attempted to empty the bladder, but instead of doing that he forced the catheter through the urethra into the child's head several times, and when the catheter was removed its eye was found full of brain tissue. The operation was abandoned on this account, and in several days a dead child was born spontaneously, with perforations in its head which were the cause of much curious speculation on the part of the friends.

#### **Prolapse of the Urethral Mucosa.**

—A more or less complete eversion of the mucous membrane of the urethra is found in rare instances. While the rest of the urethra remains in its normal position the mucosa becomes loosened from its submucous attachments and is gradually extruded at the external orifice, forming a pale, deep-red, or bluish tumor, which swells and be-

comes edematous and even gangrenous if left to itself. As the anterior, posterior, and lateral walls of the urethra are all involved, the protruding mass is tubular, and is lined within as well as covered without by a sensitive, easily bleeding mucous membrane. No age is exempt from prolapse of the urethral mucosa, but the affection is far commoner in young children; in two cases reported the patients had reached the advanced age of seventy and seventy-two years.

The prime cause of the affection is usually struma, but the immediately ex-

causing cause may be a blow, straining, or coughing, or rape. Inflammation of the mucosa also occasionally produces a prolapse, which is as a rule only partial.

The diagnosis will be made upon separating the labia and observing at the site of the urethra and choking its orifice a vascular tumor with a slit in the center of it opening into the bladder. This condition must be distinguished from caruncle of the orifice or a hemorrhoidal pointing of the mucosa at the orifice, as well as from eversion of the mucosa of the bladder or of the ureter.

The seat of a caruncle is usually on one side of the external urethral orifice. An eversion of the mucosa of the orifice forms but a shallow protrusion not more than 5 or 6 millimeters long.

In everted bladder the base of the tumor is found by a sound to be within and attached to the bladder, instead of at the external orifice of the urethra. The bladder tumor also lacks a canal. An everted ureter is attached to the bladder wall and a fine sound or catheter  $1\frac{1}{2}$  millimeter in diameter passes through the tumor on up over the pelvic brim into the kidney.

The treatment will vary with the conditions. The cauterly so often used ought to be given up entirely for cleaner surgical methods. It is also inadvisable to transfix and ligate the protruding mass and allow it to slough or to cut it away below the ligatures, as has been done.

The first and simplest plan to be tried in a recent case is reposition, after getting rid of the sensitiveness, either by means of a weak solution of cocaine or by anesthesia. By compressing the tumor on all sides and at the same time pushing it back into the urethra a replacement may be effected which will prove permanent; the patient should be kept in bed afterward, and a vulvar compress applied, and small doses of belladonna should be given as a sedative by rectal suppository.

If the tumor can not be replaced or if it escapes again directly after replacement, an operation will be necessary, and the best is the excision of the protruding portion with knife or scissors, followed by a carefully applied continuous suture of fine catgut, uniting the cut edges and checking the hemorrhage. It is important to catch both edges as they are cut to prevent an inversion with excessive hemorrhage.

**Dilatation of the Urethra.**—Variations in the caliber of the urethra, both dilatation and stricture, are of rare occurrence. Dilatation, however, a disease never found in men, is far commoner than stricture, a disease so often found in them.

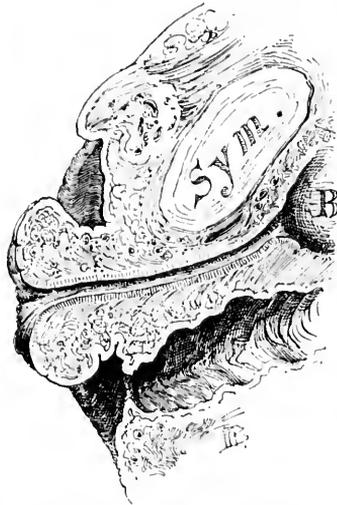

FIG. 196.—HYPERTROPHIED EXTERNAL ORIFICE OF THE URETHRA SHOWN IN SAGITTAL SECTION.

SYM. is the symphysis; B, the bladder; the vagina lies below.

Dilatation of the urethra is an enlargement of its lumen, the result of an injury to the circular fibers by a trauma from without, or by some object forced through its canal in either direction. All grades of dilatation are found from a slight one which permits an escape of the urine only noticed on coughing, sneezing, or lifting, to the extreme forms where the bladder is incapable of holding even a few drops of urine. The worst forms entail all the miseries of a large vesico-vaginal fistula.

The commonest cause of extreme dilatation is coitus *per urethram* in women with either a congenital or an acquired atresia of the vagina. In these cases the external urethral orifice is gaping and everted, and the examining finger is often carried into the bladder without any apparent resistance. I have seen three cases, in one of which two fingers could be easily introduced into the bladder, where a distinct contraction was felt at the position of a much thickened internal vesical sphincter. The consequences of a dilatation of this character are often less serious than would be anticipated, for, in spite of the extreme distention of the urethra, the patient is often able to retain her urine for several hours, or at most notices a decided incontinence following coitus only.

It is quite otherwise with the cases of dilatation of the urethra where a large finger has been bored in for diagnostic purposes. The extensive rupture of the muscular fibers is then followed by an incontinence which is often permanent. These cases are fortunately becoming rare, as this barbarous way of examining the bladder is being given up. With our present facilities for examination, we are never warranted in introducing a finger through a urethra which is not already dilated so as to admit it without resistance.



FIG. 197. OPERATION FOR HYPERTROPHIED URETHRAL MUCOSA.

A circular amputation with approximation of the tissues of the vestibule and the anterior vaginal wall to the urethral mucosa. The vagina is shown below.

Another cause of dilatation is that which acts from within outward, as when a large stone under the spasmodic contractions of the bladder is pushed down into and on out through the urethra, or when a stone is grasped and dragged out by a stone forceps. It is remarkable, however, what the urethra will stand in this way, for a stone even an inch or more in diameter passed spontaneously in this way may not be followed by more than a transient incontinence.

The partial incontinence following repeated births is undoubtedly due to injury to the circular fibers of the urethra by the compression produced by the child's head, and is apt to increase after each fresh insult.

**Treatment.**—If the dilatation has been but recently and suddenly produced, as by the passage of a stone or by forcing a finger or too large dilators through the urethra, and there is no evident laceration, it will be well to wait a

few days, simply keeping the parts clean and free from contamination by vaginal douches and local application of a boric acid solution; and if there is any definite improvement it will be well to wait as long as it continues. If there is any evident hæmation at the external meatus, this should be sutured under cocaine, first trimming off all unevenness and then uniting the parts from side to side with fine interrupted silk sutures, using a small fine needle. When the relaxation is due to coitus and the abnormal channel has been created in place of an atresic vagina, nothing can be done until the vagina is restored to its integrity.

The condition of a patient with an incontinent urethra is so pitiable that as eminent an authority as Rutenberg (*Wien. med. Woch.*, 1875, No. 37) proposed to cure it by closing the urethra entirely and making a suprapubic fistula, which was to be controlled by the pressure of a pledget.

In general four plans have been tried with varying success in attempting to overcome incontinence. These are:

- (a) A vaginal pessary.
- (b) A longitudinal resection of the vaginal wall, with or without a piece of the urethra.
- (c) An operation to flatten out and compress the external orifice.
- (d) Twisting the urethra spirally so as to narrow its caliber.

It is not possible in the absence of a larger experience to speak with decision as to the comparative merits of the three operative procedures proposed, but I would prefer as a first resort to resect after the plan proposed in (b).

If the incontinent urethra was near the normal caliber I should use Pawlik's plan (c).

If the incontinence is due to the traction or scar tissue in the anterior vaginal wall on the neck of the bladder, this must first be freely incised to do away with the traction. Permanent relief has even been obtained in this way.

(a) F. Schatz (*Arch. f. Gynäkol.*, vol. xi) has been able to give relief by means of his funnel-shaped pessary, which presses directly upon the urethra. Similar results have occasionally been secured by the use of a ball pessary large enough to press the urethra against the symphysis and hold the urine back until the intravesical pressure has increased to a certain degree. An intact levator ani is necessary for the successful use of a pessary, which can not give relief in a relaxed vaginal outlet.

(b) An excision of the superfluous relaxed portions recommends itself as the most rational plan, and it has yielded excellent results in the hands of Frank and Engström.

Frank's procedure (*Centralbl. f. Gynäkol.*, 1882, No. 9) is to lay a small catheter in the urethra and then to excise a wedge-shaped piece from the posterior urethral wall, including the vaginal as well as the urethral mucosa, and extending from the external urethral orifice to within about one centimeter of the internal orifice. The incision is now continued in an elliptical form on the vaginal wall beyond the neck of the bladder. By a transverse row of interrupted

sutures the whole wound surface is now accurately approximated. The lower anterior part of the incision underlying two thirds of the urethra simply resects the relaxed canal, while the width of the elliptical portion of the denudation has been calculated so as to form a sort of buttress behind the neck of the bladder like the third lobe of a prostate in the male.

Engström (*Berl. klin. Woch.*, 1887, p. 744), in an anemic, badly nourished woman, fearing a failure of union on the side of the urethral mucosa, carried his excision on the vaginal septum down to the urethral mucosa, but did not include it. The wound suppurated and healed by granulation with the formation of scar tissue, and as a result the patient was able to hold her urine four hours by day, and all night.

(c) By flattening the outer end of the urethra and bending it at the same time, Pawlik (*Wien. med. Wochenschr.*, 1883, Nos. 25 and 26) relieved several patients of incontinence. His plan is to draw the orifice of the urethra well forward toward the clitoris and sharply to one side; then, marking the point on the side to which it could be drawn without excessive traction, a long, narrow denudation about 2 centimeters long ( $\frac{3}{4}$  inch) is made in the sulcus and sutures passed to hold the urethra in that position. After a week, when the sutures are removed, the other side of the urethra is drawn upward and outward in the same manner, and the sulcus on that side denuded and sutured. By this means the urethra receives a sharp bend forward and the posterior wall is strongly flattened against the anterior by traction on both sides.

(d) Torsion of the urethra is a plan proposed by R. Gersuny (*Centrbl. f. Chir.*, 1889, p. 433). The whole urethral canal is dissected out from the surrounding structures as far as the neck of the bladder, and the urethra is then twisted on itself, so as to form a series of spiral folds, when it is sutured so as to be held in this position. Gersuny relieved his patient after twisting the urethra one and a quarter times on itself—that is, through an arc of 450 degrees.

Desnos (*Ann. des mal. des org. gen.-urin.*, 1890, p. 344) partially relieved the patient by ligating the urethra. He first introduced a catheter into the bladder, and then cut through the vaginal mucosa so as to expose the upper two thirds of the urethra; this portion was then isolated by a catgut ligature placed 2 or 3 millimeters from the neck of the bladder and tied so tight that the catheter could just be moved. The vaginal incision was then closed with silkworm gut. A small wedge was also taken out of the gaping external orifice. The result was an immediate power of retention for three hours, afterward reduced to one hour and a half.

**Stricture of the Urethra.**—A stricture of the urethral canal so large as to interfere with the free exit of the urine from the bladder is rare. Strictures of large caliber in which there is no evident impediment to miction or to the passage of an ordinary catheter have been described and their importance insisted upon by Dr. Ely Van de Warker (*Medical News*, Philadelphia, 1887, p. 59). They are to be recognized by using olive-pointed bougies, which catch and trip in the stricture as they are withdrawn. Dr. Van de Warker finds that the evil results of a neglected stricture of large caliber in women

are similar to those in men; but confirmation of these important conclusions are still wanted from other clinicians.

A variety of causes may operate to produce a stricture, some of which are:

1. A localized thickening produced by a chronic gonorrhœal urethritis.
2. A cicatricial contraction in the anterior wall of the vagina following a slough produced by labor.
3. The cicatrization of a chancre, whether in the vagina or in the urethra.
4. Carcinoma of the urethra.
5. Extreme contraction of the external meatus without assignable cause.

Gonorrhœal stricture is the commonest of all forms, although it has as yet received but little attention in women. Its history is often difficult to obtain, owing to the slightness of the symptoms produced by a chronic gonorrhœal urethritis. The slough which follows labor is more apt to result in a urethro-vaginal fistula than in a stricture.

The symptoms of stricture are difficulty and pain in micturition, the urine being expelled in drops or in a fine stream with considerable straining. These difficulties increase as the caliber of the stricture lessens, although occasionally even an extreme contraction of the urethra may elicit no complaint. I remember well my first case, a German woman of about fifty-two, from whom I removed 252 gullstones. After the operation she could not urinate lying on her back, nor could the nurse catheterize her. I found just within the external orifice a cicatricial narrowing of the urethra, which only allowed a fine catheter 2 millimeters in diameter to pass with difficulty. The patient was not conscious of there being anything wrong, nor was I able to get any history or to determine the cause of the stricture.

The diagnosis will be made readily if every case complaining of any urinary disturbances is examined locally. The effort to catheterize or to pass a vesical speculum will at once tell whether an obstruction exists or not, and if so, the urethra may be calibrated with bougies and the stricture studied urethroscopically, determining its exact size, position, extent, appearance, and consistence.

The treatment will depend upon the form of the stricture and its cause. In secondary cancerous disease which can not be eradicated, in the earlier stages the bladder should simply be catheterized regularly; later, when the obstruction increases, a vesico-vaginal fistula may be made, or, if necessary, the ureters may be set free and turned into the vaginal vault. In one of my cases of syphilitic thickening the urethra was reduced to a rigid canal, with extensive ulcerations at the external orifice; the patient had beside this a universal cystitis and hypertrophy of the bladder walls.

In cicatricial contraction of the anterior vaginal wall compressing the urethra, if the cicatrix is narrow, the plan of making multiple incisions into it under cocaine, may be tried. If this does not succeed, the cicatrix should be dissected out, even going so far, if necessary, as to resect the lower walls of the urethra with it; then, after an exact closure of the wound with fine interrupted sutures passed close together, a catheter should be left in the bladder for four or five days to relieve the canal of any strain.

When the stricture is narrow and more or less circular, as in the gonorrhoeal stricture, the lumen should be enlarged by incising or dilating it.

A stricture which allows a bougie 2 or 2½ millimeters in diameter to pass may be dilated by passing the bougies daily, until a No. 4 or 5 is passed. After three or four days a No. 5, 5½, and 6 may be passed, and so on gradually up to No. 10, the maximum. A smaller stricture, admitting only a No. 1 or 1½ bougie, may be exposed through the urethroscope, its edges incised slightly, and then dilated up to No. 3 or 4, gradually followed by the larger dilators until the lumen is restored to the normal size.

Care must be exercised to keep the field free from contamination, and not to transport the germs on the external urethral orifice into the canal every time the dilators are used. If the stricture is limited in its extent, and an examination shows that there will be but little risk of an extensive rupture, a rapid dilatation may be practiced, as recommended by E. Hermann (*Trans. of the Obst. Soc. of London*, for 1887, xxix, p. 27), restoring the urethra to a normal caliber at the first sitting.

All cases treated by dilating must be kept under observation for a long time, as a good percentage show a decided tendency to relapse, when the dilatation must be repeated. I gave one of my patients, who was an intelligent nurse, a glass catheter, with the instruction to use it at intervals to discover whether the stricture was recurring and to keep it open, and she did this with good effect.

A stricture confined to the external meatus is easy to treat by benumbing the part with a strong solution of cocaine and using the conical urethral dilator, or, if it is very tight and the scar tissue extends deep, an incision 5 millimeters deep may be made through the posterior margin and the urethral and vaginal mucosae sewed together.

**Ischuria.**—Ischuria is an affection in which the patient, often without a demonstrable mechanical cause, is unable to void the urine which is then retained in the bladder. It is sometimes seen in hysterical girls, and often in the puerperal state, where it is probably due to pressure on the neck of the bladder by the head of the child during its descent, benumbing the nerves and so destroying for a time the reflex sensibility. That this is probably the correct explanation is borne out by the fact that it oftenest follows forceps labors.

The diagnosis is usually easy to make by the discovery of a distinct tumor just above the symphysis pubis; on introducing the catheter the urine escapes and the tumor at once disappears. I had one case in a young woman with *anorexia nervosa*, in whom I palpated and percussed the flat lower abdomen and concluded that there was no urine in the bladder, but on putting in a catheter 500 cubic centimeters of urine escaped; the bladder had distended laterally.

The best way to treat puerperal cases is first to try letting the patient urinate by sitting erect on the vessel, and if this does not succeed to practice a rapid dilatation of the urethra under cocaine. The external genitals are carefully cleansed and the caliber of the urethral orifice taken. Cocain (10 per cent solu-

(ion) is then applied for five minutes in the canal and the first dilator used, followed immediately by a size a half millimeter larger, and this by the next size, and so on up to No. 12 or 14 millimeters in diameter. Often the patient will be permanently relieved at once, or at most the passage of the same numbers once more after an interval of a day or two will relieve the ischuria.

In an anemic, hysterical patient the condition of the blood, and the nervous symptoms, the bowels, and the digestion should receive especial attention. Strychnin is one of the best systemic remedies given in full doses.

**Urethral Fistula.**—A urethro-vaginal fistula following labor is a rare occurrence. When the urethra is involved the lesion is located in the upper part, oftenest at the neck of the bladder, and is frequently found in association with an extensive injury to the base of the bladder, forming a vesico-urethro-vaginal fistula. Not so rare, however, is a fistula artificially created to draw out a redundant urethral mucosa and relieve dysuria (Emmet's buttonhole operation).

Urethral fistulae usually involve the lower wall only, and appear either as elliptical openings from 1 to 1.5 centimeter long or as a fine circular opening not larger than a pin head. If the fistula is close to the neck of the bladder there may be a frequent involuntary escape of urine. If it is further down in

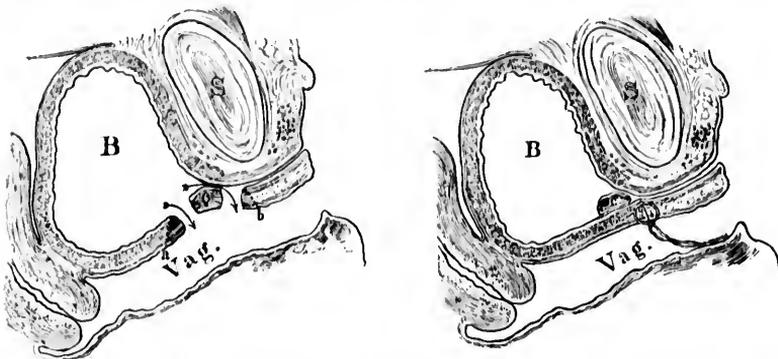

FIGS. 198, 199.—URETHRO-VAGINAL AND VESICO-VAGINAL FISTULA IN THE SAME PATIENT.

A small bridge of tissue (c), including the neck of the bladder remained intact. The upper border of the vesico-vaginal fistula (a) and the lower border of the urethro-vaginal fistula (b) were denuded and united without sacrificing the neck of the bladder (c). See also Fig. 200.

the canal there may be no symptoms at all pointing to its existence, and under these circumstances there is no reason why the fistula accidentally discovered should be operated upon.

I have seen but two cases, both resulting from the traumatism of labor. In one there was an elliptical opening in the floor of the urethra at about the middle, 1.5 centimeter long by 3 millimeters in width, and the other a round opening about 4 millimeters in diameter, just in front of the neck of the

bladder, while just behind the neck there was a vesico-vaginal fistula a little larger in diameter.

The treatment of a simple fistula which does not involve more than one third of the lumen of the urethra is like that of vesico-vaginal fistula, by a funnel-shaped denudation of its margins, broad on the vaginal surface, and reaching up to but not including the urethral mucosa. Fine silk-worm-gut sutures are then passed transversely, and tied so

as to bring the edges into exact apposition. It is better to leave a catheter in the bladder for five days. The stitches should be removed in from seven to ten days.

In a case in which a urethral fistula just below the sphincter was complicated by a vesical fistula just above it, leaving intact the vesical sphincter ring at the internal urethral orifice, the problem was to save this important bridge of tissue with the hope of retaining its sphincter action. The bridge was so narrow that both sides of it could not be denuded and sutures passed, so the plan was adopted of denuding the margins of both vesical and urethral fistulae, treating them as if they constituted one large fistula instead of two small ones; the urethral sphincter lying between them was not touched. The denudation was made down to the vesical and urethral mucosae, and extended out broadly on to the vaginal mucosa, and interrupted sutures of silk-worm gut were passed in an antero-posterior



FIG. 200.—THE METHOD OF INTRODUCING THE SUTURES IN THE CASE OF VESICO-VAGINAL FISTULA (B), AND URETHRO-VAGINAL FISTULA (C).

The bridge of tissue between U and B is the neck of the bladder.

direction, so as to make the line of union a transverse one. The union was complete and the patient had entire control of her urine, in spite of the fact that a short circuit was made in this way from the bladder under the sphincter portion into the urethra.

**Foreign Bodies in the Uret** —Foreign bodies are but seldom found in the urethra. They arise either as a calculus escaping from the bladder and caught in the urethra, or introduced from without through the external urethral orifice, or the body formed within the urethra itself.

In case the foreign body forms in the urethra or is lodged there from the bladder, it is quite sure to be a phosphatic calculus.

When the foreign body is introduced from without, if it remains long enough, it becomes incrustated with phosphates, and so forms a calculus. I have the specimen of a peculiar form of urethral calculus in a case in which the bladder was choked with a large ovoid stone, from one end of which a mass about 3 centimeters long and 2 centimeters in diameter projected into the urethra. The outer end is pointed, while a constriction at the upper end indi-

ates the position of the neck of the bladder. These calculi closely resemble the calculi filling the pelvis of the kidney, and projecting into the ureter.

The symptoms of a urethral calculus are frequent and difficult micturition, with alkaline urine containing mucus, pus, or blood.

The examination by the vagina reveals an enlargement in the anterior vaginal wall, somewhat movable and tender on pressure and densely hard, feeling through the thick mucous covering like cartilage. On attempting to introduce a catheter into the bladder, the point strikes against the hard substance and the diagnosis is clear.

Treatment.—The best mode of treatment, when the stone is not too large, is to extract it by the meatus in the manner proposed and practiced by Prof. A. J. C. Skene (*Diseases of the Bladder and Urethra in Women*, New York, 1878, p. 345). In one of Dr. Skene's cases the stone was lodged near the meatus; the forefinger of the left hand was introduced into the vagina and pressed above the calculus to steady it. A wire curette was passed through the meatus beyond the stone, when by traction with the curette and pressure with the finger the stone was extracted. This is not unlike the classical method of treating vesical calculi in women. In another case of a stone higher up in the urethra Prof. Skene was able to fix it firmly by pressure through the vagina so as to grasp and extract it by forceps.

In a case of Prof. F. Schutz (*Verhand. d. deutsch. Gesell. f. Gynäkol.*, II Cong., Leipzig, 1888, p. 115) a urethral stone weighing 100 grains formed around a hairpin which had escaped into the urethra in masturbation three quarters of a year before. The stone was 8 centimeters (3 inches) long, and projected well back into the bladder. The patient passed this stone spontaneously with severe straining and bleeding for two hours; she afterward suffered from incontinence. Similar to this was the case of A. Muzario (*Sichold's Jour., f. Geb. und Frauenzim. und Kinderkrankh.*, No. 7, p. 794). The patient had thrust a long sewing needle into the meatus, which penetrated the urethro-vaginal septum and was lost. A calculus formed in the wall between the vagina and urethra, which was removed by cutting down through the meatus half an inch on both sides of the tumor and pressing it out by a finger in the vagina. After removing the stone, the finger could easily be introduced through the dilated urethra into the bladder. The stone was three inches long and four inches and a quarter in greatest circumference. The patient recovered.

When the calculus is small enough to pass without injury, or when it is lodged behind the contracted external meatus, and is cylindrical or narrow and fusiform, it should be removed by simple traction and pressure, or, if necessary, by dilating and incising the meatus. Soft phosphatic calculi may be broken by crushing with forceps, and so removed piecemeal. A large stone projecting into the urethra from the bladder should be removed from the bladder by a vaginal or a suprapubic incision. In other cases it is better to extract the stone by making a longitudinal incision through the vagina into the urethra or into the urethral sac in which the stone lies.

This was done in a case of Serflioti reported by Piascki (*Nouv. arch. d'obstet. et de gynéc.,* 1892, p. 236). The patient, sixty-five years old, began to experience discomfort twenty-five years before, immediately after her last confinement. For three years she had suffered intensely with painful micturition, passing her urine as often as ten times daily and almost as often at night. Upon examination,  $1\frac{1}{2}$  centimeter from the meatus a densely hard, incompressible angular mass was felt in the anterior vaginal wall, about as big as a nut, painful on pressure, and movable. The urine contained a muco-purulent sediment. The stone lying in a pocket with a small orifice of communication with the urethra was not touched by the first sounding efforts.

An incision was made through the anterior vaginal wall  $2\frac{1}{2}$  centimeters (1 inch) long over the calculus, and it was extracted and the wound closed with a continuous silk suture. The calculus was pipe-shaped, the size of three little hazelnuts superimposed, and was made up of earthy phosphate. A complete recovery followed.

**Urethritis.**—Urethritis in woman is a disease quite common, but rarely noted, owing to the frequent use of the endoscope by gynecologists. Moreover, many of the cases of urethritis are diagnosed symptomatically as "cystitis" or "irritation of the bladder." Inflammation of the urethra in the absence of such a local cause as a foreign body is usually due to the gonococcus, which lingers in the urethra as its seat of preference long after all traces of infection have disappeared from every other part of the genito-urinary tract. Sometimes the patient presents a history of an acute inflammation, but oftener there is no definite history of such an attack or some slight disturbance only is recalled.

Vaginitis, endocervicitis, and inflammation of the vulvo-vaginal ducts may be found coexistent with an old urethritis.

B. Tarnowski (*Vorträge über venerische Krankheiten*, Berlin, 1872) in 750 cases of gonorrhœa found acute or chronic urethritis in 286, or 38 per cent. Steinschneider (*Berl. klin. Woch.*, 1887, No. 17, p. 301), in a study as to the localization of the gonorrhœal infection in 34 fresh cases, found gonococci in the urethra in all of them.

The secretion may be discovered bathing the urethral orifice, or on separating the little urethral labia, or by milking the urethra from above downward, when a little purulent or brownish or bloody fluid will exude from the external orifice. This should be done before urinating, so that the secretion will not have been washed away.

The disease is particularly apt to linger in a chronic form in Skene's glands, which can be milked out by making the pressure from above downward, first on one side of the urethra and then on the other. One or two drops of thick pus will often exude from the orifice of the duct just inside the urethra, giving evidence of its source by adhering more to the side from which it was squeezed. Long after a gonorrhœa is apparently well a fresh attack may start up by auto-infection from a chronic gonorrhœa which has lingered in these glands.

In acute gonorrheal urethritis the symptoms are a persistent intense burning, frequent urination with pain, and sometimes a discharge of blood. Vulvitis and vaginitis may be associated with them. In the subacute form the discomforts may be transitory and not serious.

It is important in all cases to examine the urethral secretion microscopically for gonococci, and confirmatory evidence will be gained if the presence of gonococci in the cervical secretions can be demonstrated. Should they be found in the cervix and not in the urethra the evidence would still be in favor of a gonorrheal urethritis.

The urethroscopic examination must be made in every case where the purpose of the examiner is not only to know the nature but its grade and its extent as well. The diseased conditions are found almost exclusively in the mucous and submucous tissues, and are more apt to be localized in the anterior or posterior portions of the urethra than in the middle.

In making a direct examination several precautions must be taken :

1. A small-sized speculum must be used (say a No. 8) in acute cases in order to do as little harm as possible to the mucous membrane.

2. The external meatus must be well cleansed to avoid pushing any pus on the surface up into the urethra and bladder on the end of the obturator.

3. The manipulations must all be conducted with extreme gentleness and delicacy so as to avoid producing lesions which might open up an avenue for septic invasion of the submucosa.

**Acute Urethritis.**—In florid gonorrhœa with a pointing swollen meatus secreting abundant pus the examination may be foregone with advantage to the patient until the swelling of the mucous membrane has somewhat subsided.

If the examination is made, a strong solution of cocaine should first be used to diminish the extreme sensitiveness of the mucosa, especially at the external orifice, which is swollen, red, and everted. Often here the little dilated orifices of a few glands can be seen exuding minute drops of pus. This condition is shown by the urethroscope to extend a short distance back, to be less intense about the middle, and often to assume a marked intensity again near the internal orifice. The use of the speculum always does some injury, making small fissures and producing slight hemorrhages.

Linear ulcers from 2 to 4 millimeters long and 1 millimeter broad are not rare on the inferior wall; they are painful and exhibit a yellowish area of necrosis in the center with an injected margin. The whole mucous membrane is deeply injected, and so swollen that it looks edematous, pointing into the lumen of the speculum and obliterating any distinct funnel form. Pus is seen abundantly between the mucous folds (See, v. Janovsky, *Arch. f. Dermat. und Syph.*, 1891, p. 925).



FIG. 201.—CONCEALED ABSCESS OF SKENE'S GLAND.

A drop of thick pus has been squeezed out of the right gland and lies upon the right labium urethrae. The orifice of the left gland is seen just inside the left labium urethrae.

Under the name *urethritis externa* Guerin has described a localization of the gonorrhœal process which Dr. E. Finger (*Die Blenorrhoe des Sexualorgane und ihre Complicationen*, Leipzig and Wien, 1893, p. 300) speaks of as follows: "The gonorrhœal inflammation of the follicles at the orifice is either chronic, when there are no symptoms and a small amount of pus, or acute and relapsing. One or the other follicle swells, giving the urethral orifice an asymmetrical appearance, and the mucous membrane over the follicle is reddened. Soon a little point of pus appears. An abscess has formed in the follicle, and speedily opens, the pus escapes, and the follicle closes. In a short time the same thing occurs again in the same or another follicle, and so it continues for a long time.

"The only symptom of this unappreciated condition is some pain on touching the orifice. By a rupture of the abscess into the urethra and vagina simultaneously, a fistula is formed."

Chronic urethritis, the commonest form seen by the gynecologist, presents characteristic lesions easily noted through the urethroscope.

That the chronic form is a common sequel of the acute has been shown by the investigations of Finger and Janovsky (*ut supra*).

It exists in two forms:

1. The diffuse chronic urethritis is especially apt to follow on the acute form when located in the anterior part of the urethra. It is marked by small abscesses, especially involving Skene's glands, and by a diffuse chronic swelling in the anterior urethra. The funnel wall in these cases is thickened and points into the speculum, and the central figure may be displaced laterally. The vessels are deeply injected, giving the mucosa a livid color. The mucosa in older cases presents grayish or slate-colored patches, 2 or 3 millimeters in diameter. The disease is commonest in prostitutes.

Janovsky states that diffuse hyperplastic processes extend out on to the submucosa from the diseased Skene's glands.

2. *Circumscribed chronic urethritis*.—The subjective symptoms of circumscribed urethritis are mostly slight, often amounting to nothing more than an itching or burning sensation. The discharge is thin and contains but few gonococci; when the disease is localized in the glands it is known as *glandular urethritis* (*Oberländer*). Patches of deeply reddened mucosa are seen for the most part up near the internal and down near the external orifice. In these, particularly along the posterior wall, groups of yellow spots about half a millimeter in diameter are seen surrounded by a reddened area. In a more advanced stage anemic streaks of scar tissue may be seen and the tissue resists the passage of the speculum, even tearing when more pressure is made.

*Treatment*.—No active local treatment should be undertaken during an acute urethritis. The patient must rest in bed and receive frequent hot vaginal douches; she must bathe the parts externally with lead water and laudanum and receive a belladonna suppository (0.03 grain), or if the pain is too great an opium suppository. As soon as the acute stage has subsided, an iodoforn suppository may be inserted once daily into the urethra with benefit.

The chronic form must be treated by exposing the affected areas and making applications of a 3 to 5 per cent solution of nitrate of silver at intervals of from three to five days. Skene's glands should be emptied daily by pressure from above downward on each side of the urethra. If there is a chronic diffuse inflammation about these tubules they should be laid open in the direction of the vagina, and their lining mucosa burned with a silver stick.

Ichthyol (the ichthyo-sulphate of ammonia), first employed therapeutically by Uuna, in 1883, in cutaneous diseases, is now widely used as a gonococccicide, and Jadassohn vaunts its germicidal powers in a 1 per cent solution as more efficient than resorcin or permanganate of potash, already much used. It has no toxic or irritant effect, and is best used in solutions of from 1 to 10 per cent strength. Jullien (*Internat. Cong.*, Rome, 1894) uses ichthyol with remarkable effect in urethritis in the following manner: A delicate piece of metal roughened for about 8 centimeters (3 inches) of its length is wrapped in absorbent cotton, which is then soaked with an ichthyol and glycerin solution (1 to 10, or 1 to 5), and introduced into the urethra; by making pressure in various directions the folds of the urethra are effaced, the glands pressed upon, and the solution squeezed out of the cotton and brought into contact with all parts of the mucous membrane. At the same time the urethritis is under treatment gonorrhœa of the vagina and cervix must be actively treated by vaginal tampons.

**Suburethral Abscess.**—There is a peculiar affection of the urethra about whose etiology we are still in the dark; it has been variously called "suburethral abscess," "abscess of the urethro-vaginal septum," "chronic abscess of the female urethra," "urethral urinary pocket," "urethral diverticulum," and "urethrocele." The essential features of the disease are an abscess cavity in the urethro-vaginal septum communicating with the inferior wall of the urethra. The disease presents itself as a symmetrical rounded swelling of the anterior vaginal wall beneath the urethra, varying in size from two to three centimeters in diameter. It is sometimes ovoid and as big as a hen's egg, with its longest diameter in the axis of the vagina.

The enlargement begins one or two centimeters behind the external urethral orifice, and may extend back to the base of the bladder; it is sharply circumscribed, and can, as a rule, be seen at once, filling the vaginal outlet, on separating the labia. In one case which I have seen it was situated farther back toward the neck of the bladder, and was first detected by the finger recognizing a peculiar cushiony resistance at this point. The surface of the tumor is smooth, sometimes tense, and elastic or yielding to touch. If firm pressure is made upon the tumor it diminishes in volume as the contained pus flows out of the urethra. It is extremely painful to handle. A urethroscopic examination shows a deeply congested mucosa, and on withdrawing the speculum a few drops of pus suddenly gush into its lumen as it passes a certain point, and on moving it to and fro until the exact place is fixed, and elevating the handle a little to bring the floor of the urethra into better view, a small longitudinal fissure may be seen about the middle or a little behind the middle of the urethra. A

probe passed through the speculum into this opening is felt *per vaginam* in the sac.

When the cases come into the gynecologist's hands the patients have, as a rule, been suffering for some years, and have often been treated for a long time.



FIG. 202.—LARGE SUBURETHRAL ABSCESS OCCUPYING THE ANTERIOR VAGINAL WALL AND DISCHARGING PUS INTO THE URETHRA THROUGH A NARROW SLIT NEAR THE INTERNAL URETHRAL ORIFICE. OPERATION, JAN. 17, 1894.

for an irritable bladder. They are usually married women in the thirties, and complain of painful micturition, excessive pain in coitus, and a sense of discomfort and bearing down as if a foreign body were in the vagina. The patient herself often notices a discharge of pus from the urethra, sometimes fetid. In

urinating, Huguier noticed first an escape of pus, then pus and urine, and finally clear urine (*Mém. de la soc. de chir. de Paris*, 1847).

Huguier is supposed to have been the first to describe this disease, but curiously enough I have found the first real description in William Hey's *Practical Observations in Surgery*, published in Philadelphia in 1805, p. 304. Hey gives a typical history as follows: "In 1786 Anne Miller came under my care as an out patient of the General Infirmary at Leeds for a node on the tibia, which I suspected to have had a venereal origin. When she was about to be discharged cured, she informed me that she had been troubled for fifteen or sixteen years with sudden and irregular discharges of purulent matter from the vagina. These discharges, she said, were frequent, and sometimes considerable, yet she never perceived any matter to be mixed with her urine.

"Upon examination, I found a roundish tumor at the os externum, appearing to be formed by an enlargement of the bulbous part of the urethra. When the tumor was compressed pure pus issued from the urethra, yet her urine, when drawn off with a catheter, did not contain the least mixture of purulent matter. Upon introducing a bent probe into the urethra, I could easily push it to the most depending part of the tumor, and I could feel the probe distinctly by a finger introduced within the vagina.

"I divided the tumor longitudinally at a time when it was distended with matter. That part of the vagina which I cut through was not thinned by the distention, but was rather tough. The cavity of the cyst was smooth. As the opening which I had made was depending, and as the removal of any part of the cyst would have been attended with difficulty, I only filled the cavity with lint. A small artery was opened by dividing the cyst, but the hemorrhage did not continue long. This patient recovered speedily, and got quite free from the complaint."

The microscopical examination of the sac in one of my cases (L. J. P., 3095, i, 17, 1894), a nulliparous colored woman, thirty-one years old, showed on the outer vaginal surface a typical mucous membrane beneath which was connective tissue rich in oval and spindle cells, with numerous dilated blood vessels. The inner lining of the sac consisted in mucous membrane eroded in places, and beneath this were irregular aggregations of polynuclear leucocytes, and the surface was rough, with many elevations and depressions. In some of the depressions irregular oval cells with small oval nuclei were found, either in short rows or scattered without order, appearing identical with urethral epithelium.

The clinical history would appear to indicate that the sac was a urethral diverticulum probably starting in an abscess formed in one of the crypts on the floor of the urethra.

A wide distinction must be drawn between these sacs, with a small orifice of communication with the urethra, and cases of urethrocele, in which there is a bulging out of the entire posterior wall of the urethra, and vaginal cysts occupying the same position, but not sensitive, incompressible, and containing a viscid fluid. The vaginal wall is generally thinned over a vaginal cyst.

They must be distinguished, too, from a small abscess in one of the hæmæ

of Morgagni which is not large enough to produce any swelling in the vagina, or a calculus, arrested or forming in the urethra and carried in a diverticulum, recognized by its density and the sensation of a stone communicated to the probe.

Trauma due to an injury in labor, where there is an abrasion of the mucous membrane, followed by the formation of a little urinary pocket, with decomposition of the urine and inflammation, may also be mistaken for a suburethral abscess. (S. Duplay, *Poches urinaires*, *Archiv. gén. de méd.*, No. 146, 1880, p. 12.)

**Treatment.**—Four plans have been followed :

- a. Dilating the urethra sufficient to introduce the finger and enlarge the fistula by forcing it into the sac, and so giving free exit to the accumulations.
- b. A simple longitudinal, vaginal incision into the sac with a knife or cautery.
- c. Excision of an elliptical piece of the urethro-vaginal septum, including part of the sac wall, with or without suture.
- d. Excision of the entire sac and closure of the wound.

Winckel (Billroth and Lücke, *Handb. d. Frauenkrankh.*, Stuttgart, 1886, iii, p. 361) had a case which, he says, took care of itself, the patient emptying the sac frequently and using lead-water applications.

The best and simplest plan to bring immediate relief is the old one of William Hey—a longitudinal incision into the sac. After numbing the vaginal mucosa with a 10 per cent solution of cocaine, the sac is split open from end to end with a knife. The sac wall may then be painted with a strong tincture of iodine and packed with lint. The excision of an elliptical piece prevents the edges coming together and gives freer drainage. In one of my cases I split the vagina and dissected out the urethral sac with great difficulty, on account of its intimate relations with all the surrounding parts and the free bleeding throughout. I then closed the longitudinal wound under the posterior urethral wall with a series of interrupted silkworm-gut sutures. The patient recovered completely. I was not so fortunate in a second case in which union was delayed, leaving a urethro-vaginal fistula, which had to be closed by a subsequent plastic operation.

If the simple incision and drainage is not sufficient, the contracted sac can be just as well dissected out at a later date, removing a small oval piece of the vaginal wall, but taking care to leave enough tissue to close the defect left by cutting out the sac.

#### NEW GROWTHS FROM THE URETHRA.

The following forms of new growths have been observed in the urethra :

1. Caruncle.
2. Fibroma.
3. Carcinoma.
4. Sarcoma.

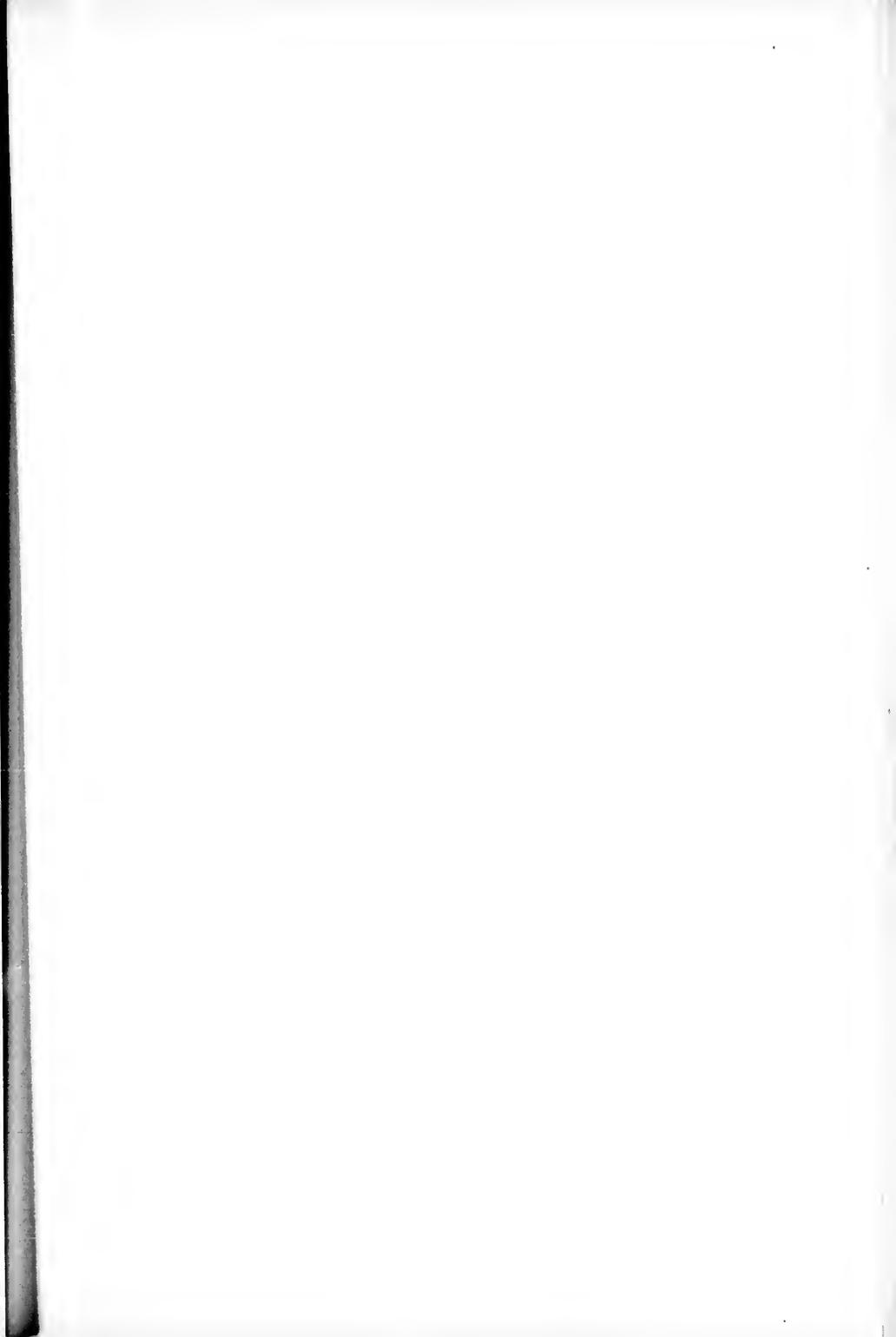



Faint, illegible text at the top of the page, possibly a title or header.

Faint text on the left side of the page, likely a description or caption for the illustration.



**DESCRIPTION OF PLATE IV.**

**Caruncle of urethra.** The caruncle is seen as a bright red growth like a cockscomb attached to the lower margin of the urethral orifice. Note the flattening of the tumor due to the constant lateral pressure between the labia.

Faint text at the bottom of the page, possibly a continuation of the description or a separate section.



DESCRIPTION OF PLATE 17

... of the ... The ... is seen as a bright red growth like a ...  
... to the lower margin of the ... Note the flattening of the ...  
... to the constant lateral pressure between the ...

All of these affections are rare. Caruncle is the commonest form, cancer comes next, and fibroma and sarcoma are found with extreme rarity.

**Caruncle.**—Urethral caruncle, or vascular tumor of the meatus, was first described by Samuel Sharp in 1750 (*Critical Enquiry into the Present State of Surgery*, 1750, p. 1688). He says: "Small excreescences may occasion violent disorders in so tender an organ as the urethra. I have seen a notable instance in the urethra of a virgin, where they grew in small quantity upon the orifice of the meatus urinarius, and for many months had produced the most excruciating torment, which continued until I had totally extirpated them."

In the same year G. B. Morgagni described a case in a post mortem examination upon a girl fifteen years old. "*Ex urethra osculo corpusculum prominbat rubellum*" (*De Sed. et Causis Morborum, Lib. iv, de morb. Chir., Ep. 50, 51, first edition, Venice, 1751*).

Since this time English writers in particular have devoted much attention to this affection.

The growth is usually seated upon the external orifice of the urethra somewhere on the lower half; it is of a florid or a dusky-red color, and is attached to the margin of the urethra by a pedicle or by a broad base, which sometimes extends up into the urethral canal. The appearance varies greatly. Sometimes it is flat and rugose and but slightly elevated, and looks much like a raspberry; at other times nodose, or, as in the accompanying plate, the tumor is narrow, with a pedicle and a sharp, crenated edge, and stands out from the urethra with its long axis vertical, compressed by the labia on the sides.

Histologically the tumor is made up of connective tissue and hypertrophied papillae, with numerous dilated vessels. It is covered with pavement epithelium. The presence of any unusual number of nerve fibers or any unusual arrangement of the nerve endings has not yet been satisfactorily demonstrated, although this statement of Sir J. Y. Simpson (*Clin. Lect. on Dis. of Women*, Phila., 1863,

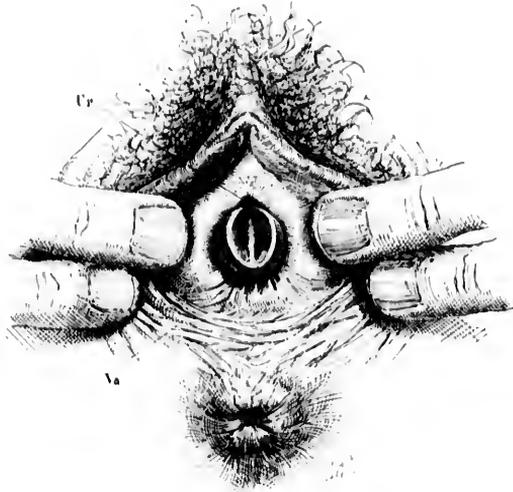

FIG. 203.—URETHRAL CARUNCLE OCCUPYING THE POSTERIOR AND LATERAL MARGINS OF THE URETHRA (Ur) AND LYING IN FRONT OF THE VAGINAL OULET (Va).

The growth is crescentic, and concave on its inner surface, and has a broad base with a narrow outer margin. It is smooth and glistening, slightly papillary, pink at its base, and deep red at the outer margin. Path. No. 1536. Oct. 24, 1896.

p. 137) is still largely quoted: "The late Dr. John Reid once examined for me most carefully with the microscope a very sensitive and painful caruncle which I had removed from a patient, and he came to the conclusion that there was a very rich distribution of nervous filaments in it."

The clinical history of a urethral caruncle is a striking one. While some of them are painless, the majority cause exquisite pain during urination. One of Simpson's patients suffered so that she was in the habit of going some distance from the house to urinate, so that her moans and screaming might not be heard. Another patient, a young girl at puberty, would hold her water for twelve hours at a time to escape the pain of passing it, looking forward with horror to the time when the bladder must be emptied. In married women the sexual relation is often intolerable. From the site of the growth the pains radiate up through the pelvis into the bladder, vagina, and uterus, and down the thighs. The wear and tear of the extreme suffering on the nervous system is so great that the health may be completely wrecked, and the patient does little else than nurse her misery.

William Goodell (*Lessons in Gynecology*, Phila., 1879, p. 26) presents a typical picture of an extreme case—that of "a young married lady who was broken down in mind and body by her sufferings. She was peevish, morose, and melancholic, and had dysmenorrhea and every imaginable ache. Coitus had not been indulged in for months, and she had taken to her bed. Neither her medical attendant nor myself could believe that the presence of a urethral caruncle satisfactorily accounted for pale lips, hollow cheeks, sunken eyes, and for her grave mental and physical manifestations. . . . Yet after we removed the caruncle she became another woman. As if by magic, all her pains and aches, even her dysmenorrhea, left her."

When the growth is unusually vascular and its dilated vessels lie near the surface, hemorrhages are frequent and may become alarming.

The diagnosis is readily made upon separating the labia and inspecting the external genitalia, when the striking red excreescence at the urethral orifice is at once noted. If the patient is examined first by touch, the finger may reveal the seat of the suffering; but as a rule she will shrink so from the examination that the examiner will be unable to bring the finger into contact with the parts, and will be apt to be misled into concluding it is a case of vaginitis. Dysmenorrhea and ovarian disease are among the commonest mistakes made when the diagnosis is based on the patient's description of sufferings which she may be unable to locate precisely. Cystitis is also often erroneously thought to be present after the loose fashion of diagnosing diseases of the bladder in women.

The treatment must look to the complete extirpation of the growth. Anything short of its entire removal will almost certainly be followed by a return after a few months or longer.

Galvano-puncture has been used with eminent success by Dr. L. M. Sweetnam, of Toronto, Ontario. The growth is covered with a 10 per cent solution of cocaine for five minutes, and then the red-hot galvanic needle is plunged into

its most prominent part down to the base from five to ten times, according to its size. This has the immediate effect of blanching it and causing it to diminish in size. The treatment is painless, and may be repeated one or more times until the entire mass has disappeared.

The use of caustics, which has been advocated in the past, is to be entirely rejected on account of the subsequent dangerous cicatricial contraction of the urethral orifice.

The removal with the knife, followed by suture, is the usual plan of treatment, but to be successful this must be thoroughly done. For a small or a pediculated tumor anesthesia is not necessary, as the parts can be sufficiently benumbed with cocaine; but if the growth has a broad base or extends up into the urethra, the operation must be done more deliberately and anesthesia used. The growth is clasped in a pair of small fenestrated forceps, drawn forward, and an incision made on all sides, one or two millimeters from the base of the pedicle; then the pedicle is cut through, step by step, and the tissues approximated in the direction of least resistance with a fine continuous catgut suture, covering in the raw surface as the growth is cut away. Any large actively bleeding vessels must be tied separately with fine catgut.

**Fibroma of the Urethra.**—Connective-tissue growths in the urethra are rare. Judging by the few cases described they would appear to occur with greater frequency in little girls.

C. Hennig (*Jahrb. f. Kinderheilk.*, N. F., 1868, Bd. i, p. 101) notes a case in which he was called to remove a growth from the genitals of a recently born girl. It consisted of a fleshy, soft, pendulous tumor about the size and form of a lupine seed, with a pedicle 3 centimeters ( $1\frac{1}{4}$  inch) long and 2 to 3 millimeters thick, and was attached to the posterior margin of the urethra; it was visible as soon as the legs were separated. The little growth was removed with scissors, with very slight bleeding.

Another case observed by the same author was that of a prematurely born girl 45 centimeters (18 inches) long. A soft rose-colored mass, 4 millimeters long and 5 by 3 millimeters thick, with a pedicle 3 millimeters in length, hung down from the right inferior margin of the urethra. This little polypoid tumor was tied with a string and cut off on the following day between the child and the ligature; there was considerable bleeding. Microscopic examination showed that the growth consisted of a whitish connective tissue in almost parallel layers frequently running into one another, so as to form numerous meshes, and provided with numerous long nuclei characteristic of connective tissue.

C. Mettenheimer (*Jahrb. f. Kinderheilk.*, N. F., Bd. vi, 1873, p. 323) reports a case similar to that of Hennig in which the little girl was six years old. He found on examination a soft, elongate, red body, compressed by the labia of both sides, secreting mucus and hanging down over the frenulum. The base of this tumor was attached to the inferior margin of the urethra and somewhat cretated. At each side of the base were two little wartlike outgrowths connected with the larger mass. The growth became markedly sensitive during

the use of local applications, and was removed with difficulty on account of the resistance of the child.

Microscopic examination showed on the surfaces several layers of pavement epithelium with markedly granular cells. The stroma of the tumor consisted of a thick connective tissue, whose fibrille were densely interwoven. Between the fibers were numerous fine granules. At a later date the remainder of the tumor, which was imperfectly removed at the first operation, was extirpated under chloroform narcosis.

Dr. H. Hoening, of Breslau (*Berl. klin. Wochenschr.*, 1869), reports a case of a large fibroid polyp attached to the inferior margin of the urethra, choking the vagina and projecting out beyond the vulva. I shall refer but briefly to this case, as it belongs to a group of tumors of the urethro-vaginal septum, included under urethral diseases with doubtful propriety.

The patient had noticed a year before a painless elastic swelling projecting out of the vaginal orifice, looking like a bladder, and producing a sensation of tension and occasional retention of urine. This grew rapidly and she was finally obliged to be catheterized regularly. According to her statement, a physician cut off a mass, as large as a child's head and weighing two pounds, fourteen days before she entered the gynecological clinic at Bonn.

Upon examination, a mass was found projecting from the genitals about the size of the fist, ulcerating and breaking down, and extending into and choking the vagina. It was the shape of a dumb-bell with the marked constriction under the pubic arch. At the operation the vaginal tumor was drawn outside by strong traction, when it was found attached to the anterior vaginal wall under the urethra by a short pedicle about as thick as the finger. This was cut through with scissors and the tumor removed. Some free hemorrhage was checked by ligatures. The vagina had been converted by the tumor into a large sac in its highest part, and was extensively ulcerated by pressure. The mass weighed nearly three pounds, and was 20 centimeters (8 inches) long by 9 centimeters (3½ inches) in breadth at the thickest place.

The microscopic examination was made by Prof. E. Rindfleisch, who reported that the tumor was an edematous soft fibroid without any admixture of suspicious elements.

**Myoma of the Urethra.**—Büttner describes (*Zeitsch. f. Geb. und Gyn.*, vol. xxviii, Part I, p. 136) a case of myoma of the urethra observed at F. Ahlfeld's clinic in Marburg in September, 1893.

The patient, forty years old, had had a sensation of pressure in the region of the urethra for a year back; four weeks before, she noticed a small tumor at the vulva, which apparently grew rapidly. There was no other disturbance produced by its presence than the frequent evacuations of the bladder.

The examination revealed an ulcerated tumor the size of a hen's egg protruding from the genitals, which was separated from the clitoris by a broad area of sound tissue; the orifice of the urethra was converted into a crescentic slit 4 to 5 centimeters wide, encircling the tumor on its under side. The anterior

part of the urethra could not be distinguished, as the tumor was attached at that point. The base of the tumor was apparently covered with a thin connective-tissue layer, and numerous reddish fibers from the sphincter muscle of the urethra. The tumor was only moderately sensitive to touch. The firm circumscribed tumor of considerable size, distinctly attached to one part of the urethra, bleeding but slightly and not breaking down or bleeding under handling, differs in these important characteristics from a carcinoma or a sarcoma of the urethra. The extirpation was made without any difficulty by catching the projecting mass with forceps and pulling it forward, and cutting around it so as to split the capsule, which was then easily pushed back much as a uterine myoma may often be shelled out of its capsule. There was scarcely any hemorrhage. The finger could be introduced into the pit in the anterior wall of the urethra at its external orifice, and back of this the finger could feel the firmly closed normal urethra. The patient made a rapid and complete recovery.

The microscopic examination showed that the tumor was made up almost entirely of the smooth muscle fibers of the urethra, with a minimal admixture of fibrous tissue.

**Cancer of the Urethra.**—Cancer of the urethra belongs to the rarer diseases and appears in two forms, either as a primary cancer, affecting, as a rule, at the outlet the mucous surface of the urethra, or as a peri-urethral cancer.

In two cases of cancer of the epithelial surface of the urethra published by P. Reichel (*Phys.-Med. Ges.*, Würzburg, 1891, p. 48) the patients were both sixty years old, and the extensive carcinomatous affection of the entire urethra seemed to have taken its starting point at the external orifice, where the disease was most advanced.

Dr. T. G. Thomas (*Amer. Jour. of Obstetrics*, 1877, p. 114) exhibited a cancer of the urethra of a patient, twenty-nine years of age, who two months previously had noticed a pinkish discharge from the vagina, increasing until it amounted almost to hemorrhage. Upon finding a growth at the orifice of the vagina she consulted a physician, who discovered a tumor as large as an English walnut projecting from the urethra. The tumor was removed, together with the entire urethra up to the neck of the bladder, and the specimen examined by Dr. Francis Delafield was pronounced to be carcinoma. The patient recovered, and had complete control of her bladder function.

Winckel (Billroth and Luecke's *Handbuch*, 2d ed., Bd. iii, p. 381) describes two cases of primary urethral cancer. In one he was able to extirpate the isolated urethral tumor, which was 3 by 1 centimeters in size. In its center was the urethra with its mucous surface broken down and ulcerated. Close to the external orifice the vaginal mucosa bordered directly upon the whitish-gray crumbling tumor mass filled with yellowish spots. Plugs of pavement epithelium were separated from each other by bundles of muscular tissue. The tumor was separated from the vaginal epithelium by the normal vaginal mucosa containing an unusual number of leukocytes. In his second case, figured in his book (page 382), the patient had a carcinomatous urethro-vaginal fistula and a secondary cancer of the bladder.

In October, 1891, J. Schramm (*Centb. f. Gyn.*, 1892, p. 236) exhibited, at the Gynecological Society of Dresden, a primary peri-urethral cancer, removed from a patient fifty-six years old. The tumor was larger than a walnut, and caused incontinence. It was removed by scraping, and the surface treated with the Paquelin cautery.

In 1869 Melechioli and Riberi described five cases of peri-urethral cancer (*Schmidt's Jahrb.*, Bd. cxlvi, p. 314). They found that the peri-urethral cancer started in the vestibule close to the urethra and then developed in the cellular tissue inside the urethra, without affecting the urethral walls or mucosa. The nodules were hard and showed no signs of ulcerating at the beginning, but occasioned lancinating pain. In some cases they were ulcerated and bleeding when first discovered at a later stage of the growth.

I have myself seen two cases of secondary peri-urethral cancer. In both the urethra was converted into a small rigid tube, easily bleeding upon introducing a glass catheter into the bladder, and the patient suffered from extreme difficulty in emptying the bladder. In one of these cases the disease extended from a cancer of the labium majus down over the vestibule around the urethra; in the other, a small-celled cancer extended from the vault of the vagina down around the urethra, after an extirpation of the uterus and the upper vagina for cancer of the cervix, with metastases in the vault. The patient came back six months later, with a nodular infiltration of the rest of the vagina and an infiltration underlying the whole urethral tract, converting the urethra into a rigid tube.

**Treatment.**—The treatment of carcinoma of the urethra is by extirpation in all cases where the disease has not progressed so far as to make a radical procedure absolutely hopeless. The removal of the disease in its earlier stages, when it is confined to the neighborhood of the external orifice, is easy. This should be done with a knife, and the carcinomatous mass should be given a wide berth, cutting as high up in the vagina as it may be necessary. The vaginal mucosa can afterward be approximated, and the vaginal and urethral mucosa sutured together to preserve, as far as possible, the normal caliber and direction of the urethra.

Thomas's case cited above shows that with destruction of the urethra, even down to the neck of the bladder, continence may still remain.

In the case operated upon by A. F. McGill (*Lancet*, 1890, p. 966) the cancer involved two thirds of the urethra and the lower part of the bladder. It was treated as follows: The pelvis was elevated and the abdominal walls opened a half inch above the pubis by a transverse incision three inches long; a transverse incision into the bladder under this was fixed to the skin by sutures to keep the bladder from dropping away. Then putting the patient in the lithotomy position, the entire cancerous mass was removed with knife and scissors, an assistant pressing it down into the vaginal opening from above. A vaginal opening, made in the bladder by this excision large enough to admit two fingers, was closed by five sutures. On putting the patient again in the Trendelenburg position, the suspending sutures were cut and the suprapubic incision closed down to a

small orifice left for drainage. The wound in the vagina broke down, leaving a vesico-vaginal fistula; but this healed spontaneously in thirty-seven days and the patient went home wearing a urinal.

**Sarcoma of Urethra.**—But four cases of sarcoma of the urethra have been described, affecting the external orifice.

II. Beigel (*Die Krankh. des weiblichen Geschlechtes*, Bd. ii, Stuttgart, 1875, p. 654) cites the case in a patient, fifty years old, who suffered from pain and hemorrhages. The examination revealed a tumor made up of three vertical folds occupying the position of the urethra and projecting out so as to separate the labia majora, the whole mass being about the size of a walnut. On the 29th of Nov., 1873, the tumor was removed with scissors. The operation only occasioned a moderate amount of bleeding, which was checked by the application of chloride of iron. Beigel gives a picture of the tumor *in situ*, together with two pictures of the microscopic sections, showing that the tumor was a sarcoma.

E. Ehrendorfer describes a second case (*Centralb. f. Gyn.*, 1892, No. 17, p. 321) very like Beigel's. The patient was fifty-two years old and past the climacteric. For eighteen months she had noticed an enlargement in the neighborhood of the urethral orifice, but it gave no trouble until shortly before the examination and treatment. Her attention was first directed to the swelling by the discharge of a bloody watery fluid without any bad odor. She also suffered, as in Beigel's case, from bleeding at coitus. An examination showed the tumor projecting out over the vulva, pushing aside the labia majora and minora. The mass was made up of several deep-red, injected, rounded, and cockscomblike protuberances, divided, in general, by three deep sagittal fissures. In places there was a loss of the superficial epithelium, and a discharge of bloody fluid. Several small areas appeared edematous. The length of fold of the right side was 3 centimeters ( $1\frac{1}{4}$  inch); of the left and middle folds, 4 centimeters ( $1\frac{1}{2}$  inch); the thickness varied from  $\frac{1}{2}$  to 2 centimeters ( $\frac{1}{8}$  to  $\frac{1}{2}$  inch); and it projected from 3 to  $3\frac{1}{2}$  centimeters ( $1\frac{1}{4}$  to  $1\frac{1}{2}$  inch). These masses were attached to the inferior lateral margin of the external urethral orifice, and connected with some smaller masses surrounding the upper margin, so that the orifice was completely encircled and formed a distinct pedicle for the tumor. Between the larger masses hanging down from the inferior orifice and the smaller masses above, the urethral opening was easily found. There was no infiltration, and no nodules were found in the surrounding tissue. The growth was moderately resisting and elastic.

The tumor was removed, at the request of the patient without anesthesia, by grasping it and drawing it forward moderately and incising the mucous membrane just behind the pedicle on all sides with a knife. Keeping up the moderate traction, the urethral mucosa was also cut through, and the whole mass completely removed. There was a moderate amount of parenchymatous bleeding, and only one vessel was tied. The urethral and vaginal mucosa were united with catgut sutures, and a dry iodoform dressing applied. The wound did not heal by first intention, but in four weeks the patient was discharged cured.

Microscopic examination showed that the smaller tumors on section appeared like lymphatic glands made of numerous small cells poor in protoplasm. Between the crowded cells in the thin places was a fine reticulated intercellular substance, more fibr. in some places than in others. Toward the periphery appeared scattered, or grouped smaller round cells (small-celled infiltration). The tissue was vascular, and a few of the larger veins were choked with blood. The vessel walls were thin without endothelium. The outer covering in the smaller tumors was made up of pavement epithelium, wanting in places, where it was replaced by flat granulations. The larger masses consist in their deep portions of the same crowded round cells found in the small tumors. More superficially, however, there was a firmer, large meshed stroma poor in round cells. In places the pavement epithelium was made up of many layers, and showed no atypical penetration into the depths of the mass. At no place was there any gland or glandlike outgrowth. With reference to the lymphoid cells poor in protoplasm, disposed partly in a network and partly in bands between intercellular substance without epithelioid character, and without alveolar arrangement, it is evident that the tumor was a small, round-celled sarcoma, closely resembling fresh granulation tissue. Free pigment found in places was evidently due to interstitial hemorrhages or blood corpuscle columns.

Galabin (*Trans. London Obst. Soc.*, vol. xxxviii) also reports a case of "myxosarcoma of the urethra in a child."

The patient, a little girl three years old, was first admitted to the medical ward of the hospital, but, on account of hematuria, was transferred to the gynecological division. On examination a tumor was found between the labia extending from a dilated urethra. This tumor measured about three inches in both principal diameters, and the surface was bright red and lobulated. The growth was removed with the galvanic cautery, and after removal the urethra was found dilated enough to allow a finger to be introduced. The child died soon after leaving the hospital. Microscopical examination showed the tumor to be a round-celled sarcoma, myxomatous in places.

A case of melano-sarcoma of the urethra occurring in a single woman, aged sixty-four, is reported by Dr. C. A. L. Reed, of Cincinnati (*Lancet Jour. of Obs.*, Dec., 1896, p. 861).

The patient discovered the tumor herself some months previous to the examination upon suffering pain and noticing blood in the urine. After this there was a more or less constant pinkish discharge. At the examination a black, lobulated, eroded mass about 3 centimeters in diameter was found separating the labia, with the urethra in its center.

Almost the entire urethra was removed with the growth, in spite of which the patient was able to retain her urine, and made an excellent recovery as far as the local condition was concerned. She died six months and a half later with a large nodular tumor filling the abdomen above the navel.

Microscopical examination of the urethral tumor showed it to be a typical melano-sarcoma.

## AFFECTIONS OF THE BLADDER.

Affections of the bladder may in general be classified as:

1. Those originating in some part of the bladder wall itself.
2. Those connected with its functional activity.
3. Those due to the extension of disease from some other organ.

The bladder is a thin walled musculo-membranous sac, imbedded in connective tissue, and partly covered by peritonium, and any disease originating in it must first involve one of the component layers of its walls, either the mucous, the muscular, the fibrous, or the peritoneal coats. The list of such purely local affections is short; we may have, for example, an inflammation of the mucosa, cancer of the mucosa, or myoma and fibroma of the muscular and fibrous layers. No disease limited to the small area of its peritoneal covering has as yet been observed. The physiological activity of the bladder as a recipient of the urine, as a reservoir, and as a detrusor urinae, render it liable to certain diseases depending upon pathological conditions of the urine.

Stones are formed in the bladder from nuclei which may be either transferred from the kidney or may originate in the bladder *de novo*. The bladder is also often inoculated by bacilli brought down to it from a tuberculous kidney. When there is an obstruction to the outflow of the urine the bladder walls become either abnormally thin or hypertrophied.

The topographical relations of the bladder, its continuity and contiguity with neighboring structures, are a fruitful source of secondary affections. A conspicuous example of this sort is the cystitis following upon a gonorrhoeal urethritis. The peritoneal covering is also often involved in any extensive pelvic peritonitis, and the bladder then forms adhesions to the uterus, to ovarian and tubal tumors, and even to the rectum. I have often seen these adhesions between the bowel and bladder so extensive as to bury the uterus completely out of sight.

When we come to look over the list of the diseases which are due to contiguity of tissue we find the bladder liable to participate in a variety of vaginal, uterine, tubal, and ovarian affections. As each of these organs exhibits a well-defined tendency toward certain peculiar affections, and only a limited portion of the bladder lies in contact with it, certain areas of the organ are also in this way rendered more susceptible to particular affections, which are distinctly regional in character. A conspicuous example is the fistulous communication between the vagina and the base of the bladder. Again, that portion of the bladder which touches the cervix is apt to be invaded by a cancerous disease extending from the uterus; ovarian and tubal abscesses may break through the broad ligament into the bladder posteriorly in the neighborhood of the vesical cornua.

The diagnosis of diseases of the bladder is made

First, by careful study of the history and the symptomatology.

Second, by urinalysis.

Third, by a direct examination, by palpation, and inspection of every part of the illuminated inner surface under simple atmospheric distention in the way described.

With the new and easy methods of diagnosis which at once separate the simpler from the graver cases, and the localized from the diffuse affections, rational plans of treatment may now readily be adopted, superseding the older ways.

First, topical applications can be made over small areas under direct inspection, even using strong caustic solutions, which would be dangerous if applied to the whole interior of the bladder.

Second, irrigation with medicated solutions is valuable in extensive affections involving almost its entire inner surface.

Third, ointments can be applied to the mucosa by inflating a rubber balloon.

Fourth, the snare and other instruments can be used to remove pediculated growths.

Fifth, diseased areas can be excised, and sound tissues brought together by sutures.

**Classification of Diseases.**—It is important in taking up diseases of the bladder in women to avoid the old error of transferring to this field the clinical observations gathered in the study of the vesical diseases of men, for both the symptomatology and the frequency of the various diseases differ vastly in the two sexes. Many of the vesical diseases of women are entirely different from those in men, and the modes of treatment should be different also, on account of the different anatomical relations.

Diseases of the bladder in women may be classified as—

1. Congenital defects.
2. Displacements, with alterations in form and capacity.
3. Neuroses.
4. Foreign bodies.
5. Traumatic affections.
6. Inflammatory affections.
7. Neoplasms, benign and malignant.

Congenital defects of the bladder are but rarely seen. They are (a) double bladder, (b) loculate bladder, (c) exstrophy.

**Double Bladder.**—This anomaly is due to the want of fusion between the right and left parts of the allantois in early fetal life. Only a few cases are known to have occurred; the first is the observation of Gerard Blasius (*Observ. Medicar. Rariorum*, Amsterdam, 1700, p. 59), in which a complete double bladder was found in an adult; his account of it occurs in his nineteenth observation, entitled "Another Example of Double Bladder." "At the post mortem of a man who died of phthisis in 1657 the outside of the bladder had a longitudinal depression extending throughout its length, and when the bladder was laid open a thick membranous septum was found completely dividing it into two cavities and extending down to the orifice of the single urethra, into which each cavity opened. Each of these cavities had but one ureter."

A similar case occurred in the practice of Dr. Alan P. Smith, of Baltimore, to whom the patient came for a stone in the bladder (see *Trans. Med. and Chir. Faculty, State of Maryland*, 1878, p. 91).

The patient was a middle-aged man with a double penis, separated by a deep sulcus above, below closely united; on the right side there was a normal urethra beginning at the extremity of the glans; on the left side the urethral orifice was found just in advance of the scrotum; in front of this the organ was perfectly solid. On the surface of the organ and midway between the umbilicus and the pubis was an irregular smooth patch with a slightly concave surface not covered by true skin, formed by the wall of a partly extroverted bladder. The scrotum was normal and contained two normal testes. The patient urinated at will from the right or the left ureter, and doing this in presence of the doctor, he first discharged a quantity of clear amber-colored, healthy urine from the right side, and then immediately afterward emptied the left side into a separate vessel, discharging ammoniacal urine, turbid with mucus and pus. The left urethral orifice was dilated and the stone removed from the bladder, after which the patient recovered.

Several similar cases have been observed in young children, respectively fifteen days, two months, and twelve hours old, by I. Cattier, S. T. von Soemmering (v. Winckel, Billroth and Luecke's *Handbuch*, iii, p. 407), and F. Schatz (*Archiv f. Gyn.*, No. 1).

Cattier's case is clearly told (see Petri Borelli, etc., *Centuria iv. Accesserunt D. I. Cattier Obs. Med. raræ, Parisiis*, 1657, Obs. xx, p. 76). "An infant monstrosity with double urinary bladder and misplaced rectum and uterus. The aforesaid D. Rousseau related to me that he was called to open a cadaver of a child fifteen days old, in which he noted many abnormal things; for example, there were two bladders in the hypogastrum, separated by the breadth of a finger, into each of which one ureter passed directly."

Dr. Futh, of Metz, describes a case of double bladder (*Central. f. Gyn.*, 1894, No. 14) in a boy of four months. The bladder was divided by a septum into right and left halves communicating by means of a small opening 5 millimeters in diameter at the apex of the trigonum. A single ureter opened into each half. The urine of the right side was obliged to pass through the opening in the septum in order to escape. There was also a separation of the symphysis, ventral hernia, and adhesions between the bladder and the rectum, as well as a lengthened meso-sigmoid.

Partial division of the bladder by septa extending a short distance into its lumen in the median line are not so rare.

**Loculate Bladder.**—Congenital loculi or diverticula forming smaller or larger pockets projecting like bosses on the outer surface of the bladder are not so rare. They are undoubtedly due to a defective development of the muscular wall of the bladder, allowing a part of the mucosa to be forced out between the bundles of muscles during the contraction. These anomalies are liable to be confounded with similar pockets which are the result of inflammatory diseases, and which not infrequently lodge calculi. They were also mistaken by the

earlier observers for supernumerary bladders. A. Molinetti, for example, describes a woman with five urinary bladders (*Dissertationes Anatomico-Pathologicae*).

Blusius, too, just quoted, mistook such a case for a double bladder. In 1670 he examined a man of thirty, whose bladder just back of the urethra, corresponded in all respects to a natural organ, but in its upper part, communicating by an extremely fine opening, was found a second bladder of less capacity. The relation of the two parts is clearly shown in his work on Plate 6, Fig. 11.

I have found two cases of loculate bladder in the course of my cystoscopic examinations in women. In the first there was an opening in the right wall of the bladder 1 centimeter in diameter, leading into a basin-shaped cavity a centimeter in depth, situated above and posterior to the ureteral orifice, and near enough to it to be mistaken at first sight for a large utereral opening. While under observation the bladder contracted rhythmically, throwing the mucosa into numerous folds. With each contraction the oval opening into the diverticulum closed down smaller and narrower, until nothing was left of it except a fine line, with finer lines radiating out from it into the surrounding mucosa.

In another case a number of these loculi were seen in the posterior wall of the bladder in front of the broad ligaments, where its walls were almost cribriform. The pits appeared to be formed by long muscular bundles elevated 2 or 3 millimeters above the surrounding surface, and crossing one another in various directions. The mucous lining of the bladder, passing over and dipping down between these bundles, formed a number of narrow oval pits from 3 to 8 to 10 millimeters in diameter. The larger of these pits varied in size and form according as the muscular fibers were contracted or relaxed. This condition requires no treatment, but demands recognition on account of the liability of small stones to lodge in the pits and the possibility of mistaking it for the result of an inflammatory process. Loculate bladder may be readily distinguished from the pits left by inflammation by the absence of whitish scar tissue, which differs both in appearance and in touch, as tested by the end of the searcher, from the normal mucous surface. Scar tissue is firm and resisting, while the mucosa is soft and yielding.

**Exstrophy of the Bladder.**—Exstrophy, or eversion of the bladder, from a fissure or defect in its anterior wall, is much commoner in the male than in the female. This defect is due to a failure of the abdominal laminae to unite in early fetal life, and is analogous to a harelip.

Less degrees of the same defect are more frequently found, such as a superficial furrow in the abdominal wall, dividing the clitoris into right and left halves and separating the labia. A narrow furrow over the symphysis, extending up over the anterior abdominal wall to the umbilicus, is also an indication of a fissure just avoided. The failure of the nuchus to close high up leaves a vesico-umbilical fistula, through which the urine escapes; again, instead of a

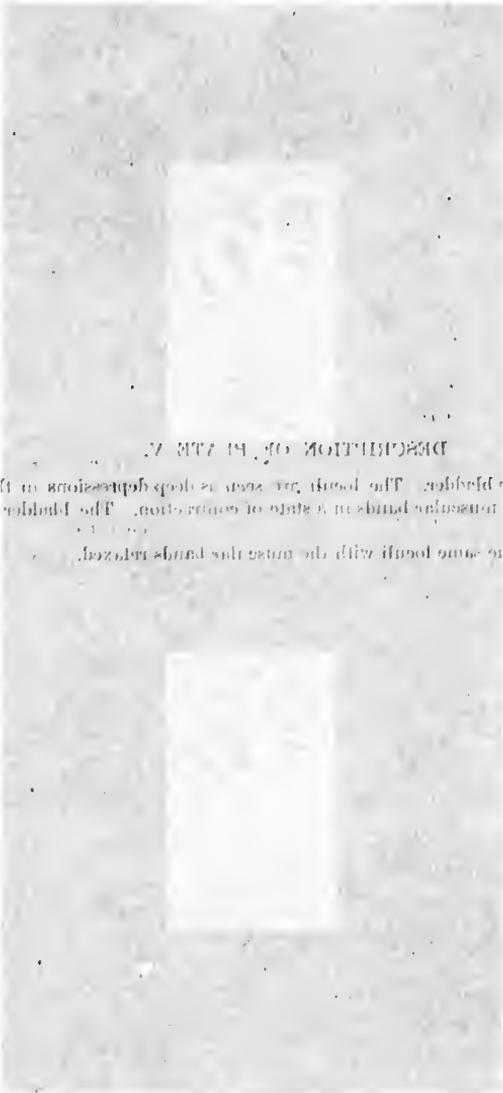

DESCRIPTION OF PLATE VI

FIG. 1. The bladder. The deep depression on the left side is the depression in the bladder wall caused by the contraction of the muscle bands. The bladder is shown in a contracted state. The bladder is shown in a relaxed state. The bladder is shown in a contracted state. The bladder is shown in a relaxed state.

The bladder wall is composed of an inner layer of mucosa, a middle layer of muscularis, and an outer layer of serosa. The muscularis is composed of two layers of smooth muscle fibers. The inner layer is the detrusor muscle, which contracts to expel urine from the bladder. The outer layer is the external oblique muscle, which contracts to increase the volume of the bladder. The mucosa is composed of a simple cuboidal epithelium. The serosa is composed of a simple squamous epithelium. The bladder is innervated by the autonomic nervous system. The sympathetic nervous system (S1-S11) innervates the detrusor muscle, causing relaxation. The parasympathetic nervous system (S2-S4) innervates the detrusor muscle, causing contraction. The bladder is also innervated by the somatic nervous system (S2-S4) via the external oblique muscle.

**DESCRIPTION OF PLATE V.**

**FIG. 1.**—Loculate bladder. The loculi are seen as deep depressions in the bladder wall surrounded by muscular bands in a state of contraction. The bladder mucosa is apparently normal.

**FIG. 2.**—Shows the same loculi with the muscular bands relaxed.

The following text is extremely faint and largely illegible. It appears to be a detailed description of the anatomical structures shown in the figures, possibly including measurements and observations of the bladder wall and its components.

PLATE V

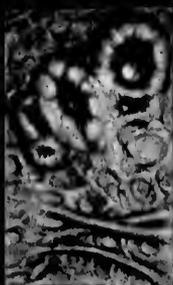

Fig 1



Fig 2



fistula, we may have a fissure into the upper part of the bladder, exposing its mucous surface; and when the defect is still more extensive the fissure is lower down, and, in extreme cases, the whole anterior bladder wall is wanting. When the fissure involves the whole anterior wall of the bladder the symphysis pubis is invariably wanting too, and the right and left pubic rami are simply connected by a fibrous band from 1 to 8 centimeters ( $\frac{3}{8}$  to 3 inches) long.

An admirable description of the appearance of the parts is given by Dr. J. J. Schneider (Siebold's *Journal f. Geburtsh.*, etc., Bd. xii, 1832, p. 279). The navel is displaced downward, and sometimes all evidence of its presence is wanting. The recti muscles are widely separated, and a thin membrane between them covers in the abdominal cavity. Low down in the pubic region a rounded mass appears just above the position of the vaginal orifice, the size of a nut or a fist, with its transverse diameter greater than the vertical; its color varies from pale rose to dark red and liverlike. The surface is irregular and wrinkled, or granular and indurated in patches; in fact, the whole external bladder looks like a spongy mass of excoriated flesh. The parts are covered with slime and constantly wet with odorous urine. In children the sensitiveness is generally extreme. The ureters are seen each opening upon the surface of this mass, sometimes between mucous folds, sometimes on the apex of a marked elevation. The orifices discharge jets of urine at intervals, often projecting it a foot from the body. A sound carried into the ureter passes up to the kidney; and frequently a catheter may show a marked dilatation of the ureter above its vesical orifice. In girls the urethra is generally wanting. There may also be an atresia of the vagina and incomplete development of the uterus. Many of these cases are in other respects so malformed and puny that they are born only to die in early childhood; still a number have lived to old age, and several cases of pregnancy under these conditions have been observed.

C. C. T. Litzmann (*Archiv f. Gyn.*, Bd. v) and A. Gussierow (*Berl. klin. Wochenschr.*, 1879, No 2) have studied with especial care the abnormal mechanism of labor, with separated symphysis, and without abdominal pressure. In Gussierow's case a dead child in foot presentation had to be extracted on account of the inability of the mother to complete the labor without the assistance of the abdominal muscles.

In a case of a girl of fifteen (G. T., No. 3869, October 14, 1895) the pubic bones were separated 4 centimeters with a thin, sharp-edged fibrous band between them; above this there had been a total defect of the anterior bladder wall, covered in by inverted flaps of skin taken from the sides, and so adapted as to leave only a small orifice open just above the fibrous band, through which all the urine escaped. By a rectal examination I found an infantile uterus and small ovaries, and on making a cystoscopic examination through the orifice left between the flaps two little oval openings representing a double hymen were discovered on the posterior wall of the bladder; a sound passed through them led up to the cervix uteri.

An extrophied bladder may become carcinomatous, as shown in Fig. 201.

Treatment.—Success in the treatment of extrophy will vary according to the extent and position of the defect. Where the opening is high up and not accompanied by any defect in the genitals and lower part of the urinary ap-

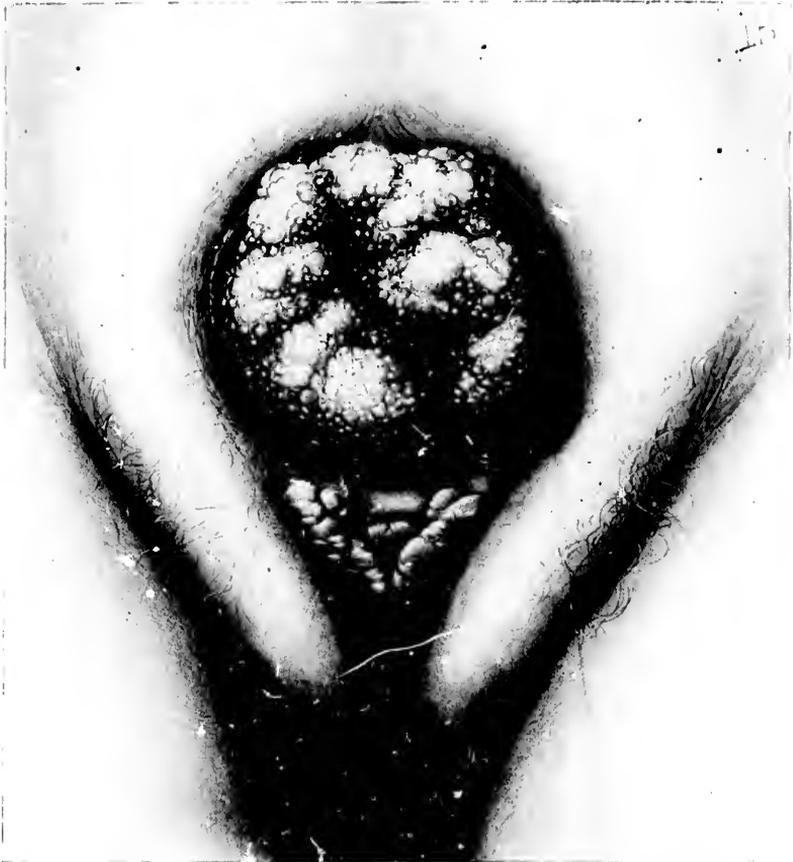

FIG. 201.—EXTROPHY OF THE BLADDER CONVERTED INTO A CARCINOMATOUS MASS.

Catheters mark the urethral orifices. The labia majora are widely separated and covered with sparse hairs; between the labia and below the bladder lie the separated halves of the clitoris, with the divided nymphæ to right and left. The vaginal orifice is marked by a transverse slit between the halves of the clitoris.  $\frac{2}{3}$  nat. size.

paratus, a cure may be effected by a careful funnel-shaped denudation around the opening and side-to-side approximation with silk or silkworm-gut sutures. If the urethra is normal and there is no obstruction to the escape of urine by

this avenue, this simple plastic operation, analogous to that done for vesico-vaginal fistula, ought always to succeed. Where the defect is extensive and a urethra is absent a complete cure is unattainable. The best that can be done is to cover and protect the raw mucous surfaces with flaps from the neighboring skin, reducing at the same time the size of the orifice through which the urine discharges. The operator would better avoid turning the skin surface in, on account of the urinary incrustations which are likely to form on the hairs and keep up a constant irritation. Where a urethra is wanting, no satisfactory substitute for its function can be formed.

For closing in the defect in the abdominal wall the following plans have been successfully tried:

First, by taking three skin flaps from the sides of the opening, one above, and one from each side, leaving them attached by a broad pedicle; the flaps must be large enough to allow for a decided subsequent contraction. They are brought across the orifice and sewed together accurately, closing the defect.

Billroth's plan of treating exstrophy is to loosen up two broad lateral flaps left attached both above and below. These flaps are dissected loose by cutting down to the fibrous aponeurosis overlying the recti, so as to be sure to have enough thickness of tissue to preserve their vitality; then, in about two weeks, when the under surface is freely granulating, they are drawn together and united in the median line over the bladder. If the flaps are made broad enough, it is, as a rule, not necessary to close the openings left at the side, for in five or six weeks they will close of themselves. No attempt is made to close the fistula left above at the navel until after the artificial urethra has been made; then the umbilical fistula is closed by denudation and suture.

**Displacements and Alterations in Form and Capacity of the Bladder.**—The bladder in women is liable to a remarkable series of peculiar displacements and alterations of form in its effort to carry out the function of a urinary reservoir in spite of a variety of hindrances.

In determining the existence and extent of such abnormalities, the normal conditions must be borne in mind as the sole standard of comparison, and it must not be forgotten that while the male bladder is more or less spherical and has its greatest diameter in the antero-posterior direction, the greatest diameter in the female bladder in moderate distention is transverse, owing to the increased resistance to its expansion backward furnished by the uterus and broad ligaments.

The uterus lying in normal ante-position forms an indentation in the median line of the distended bladder, which can be touched and recognized by a sound introduced through the urethra. The physiological peculiarity in the form of the female bladder disappears after the removal of the uterus, and the male type is assumed with its greatest expansion from before backward.

In marked distention the female bladder rises into the abdomen and has its greatest diameter vertically, when the vault of the bladder may even reach the umbilicus and the distended vagina appear like a large mono-cystic tumor springing from the pelvis. A case of this kind was brought several hundred miles to

see me, expecting an operation for an abdominal tumor. The tumor collapsed as soon as a catheter was introduced, and a large basin of ammoniacal urine was withdrawn.

In another case, by palpation, percussion, and bimanual examination, a mono-cystic pelvic tumor, rising well up into the abdomen, had been demonstrated, and the patient was brought under anesthesia for operation. Upon passing a catheter, a large amount of limpid urine was discharged and the tumor immediately collapsed.

The distention of the bladder may also take place markedly to the right or to the left side, giving it a gibbous form and making it more liable to be mistaken for a fluctuating tumor connected with the broad ligament. This obliquity of form can be easily demonstrated by passing a sound, which goes in 10 or 11 centimeters outward and backward on one side and but 6 or 7 centimeters on the other. These lateral obliquities are produced by any obstacle to expansion, such as an inflammatory mass or a tumor fixing one broad ligament.

An upward displacement of the bladder not associated with distention is noted in numerous cases in which a large uterus fills the pelvis and the lower abdomen. The most frequent cause of this form of displacement is a fibroid uterus in which both the cervical and fundal ends are involved; the top of the bladder may even come to lie on a level with the umbilicus flattened out on the anterior face of the tumor mass. The simple choking of the pelvis by a mass is sufficient to force the distending bladder up into the abdomen. Among a large number of such cases of upward distention I have seen but one where there was a great hypertrophy of the bladder walls. In cases of upward displacement a moderate amount of fluid in the bladder is often visible to the eye, forming a cushiony prominence on the tumor above the symphysis, fluctuating on palpation.

Downward displacement of the bladder is found in cases with a weak pelvic floor, with relaxed outlet, or where the intra-abdominal pressure is excessive. This displacement is also found in extreme prolapse of the rectum, drawing the posterior vaginal wall well into the sac, and dragging the uterus and the anterior vaginal wall down with it. Where there is a gaping vaginal outlet, the base of the bladder pouts into it as a soft, round, ovoid prominence, yielding to touch, and easily displaced by pressure; the swelling diminishes when the bladder is emptied and returns again as soon as it is distended with urine, or when the patient stands on her feet and the intra-abdominal pressure is exerted. This form of displacement is appropriately called "a cystocele."

*Pati passu* with the displacement of a prolapsed uterus, that part of the bladder which is attached to the anterior vaginal wall and the lower part of the uterus is likewise displaced, escaping with the vagina and the uterus outside of the pelvis (see Chapter XV). A part of the bladder remains within the abdomen and a part in the prolapsed sac; in this way the organ assumes the form of an hourglass. The entire bladder is rarely found within the prolapsed sac, and even then any marked degree of distention must take place into the pelvis.

In rare cases the bladder becomes completely detached from the vaginal wall and uterus in prolapsus and remains entirely inside the pelvis.

I reported a case of this kind (*Johns Hopk. Hosp. Rep. on Gynecology*, vol. ii, 1892, p. 311) where a large prolapsed sac lay between the thighs, and in front of and behind the uterus were masses of intestines (anterior and posterior enterocele), while the bladder, completely detached from its vaginal and uterine detachments, lay within the pelvis.

Eversion of the bladder through a dilated urethra is the most unusual form of displacement. In eversion both mucous and muscular layers are involved, and the tumor appears between the labia as an ovoid red mass covered with furrows. A careful examination of the under surface may show the presence of the ureteral orifices. The causes of the eversion are an increased intra-abdominal pressure, associated simultaneously with a relaxation of the bladder wall and dilatation of the internal urethral orifice. That part of the bladder which lies opposite to the internal urethral orifice, the posterior pole, is first engaged, and, under the influence of straining efforts, forced down through the urethra, dragging more and more of the viscus with it until the whole organ is turned inside out. Eversion is observed oftener in young children and in the aged.

The bladder may also be displaced by being drawn into the inguinal and femoral canals, and even through the foramen ovale with hernia.

**Diagnosis.**—The diagnosis of the form of displacement of the bladder in any given case is not difficult. After distention with fluid a bimanual palpation will outline the different parts, and by means of a graduated sound introduced *per urethram*, measurements made in various directions will determine the exact form.

The diagnosis of an eversion of the vesical mucosa must be made under anesthesia by carefully examining the tumor protruding from the dilated urethra, and if a sound is passed through the urethral canal, the bladder cavity is found to be absent and the pedicle of the tumor at the internal urethral orifice. On pushing back this mass, the bladder cavity is restored, and, if the urethra is sufficiently dilated, by introducing a finger, the absence of any tumor is demonstrated.

**Treatment.**—The treatment of the various displacements of the bladder often resolves itself into the treatment of the associated conditions which have caused the displacement. By removing ovarian tumors choking the pelvis, and inflammatory masses lateral to the uterus, the free distention of the bladder within the pelvis once more becomes possible. By removing a fibroid uterus the bladder is let down to its normal pelvic position.

Other displacements are treated by repairing the relaxed vaginal outlet so as to lift up the pelvic floor and give an adequate support to the anterior vaginal wall; I rarely find it necessary, as was the custom ten years ago, to operate upon the cystocele itself. In prolapse of the uterus the bladder is restored to its normal position by the operations upon the uterus and the pelvic floor, retaining the uterus in its normal position.

In treating eversion we must, in the first place, put the bladder back into its normal place by elevating the pelvis in the knee-breast posture; with gentle compression and manipulation the tumor may now be forced back into the pelvis. The patient should then be kept in bed, with the foot of the bed elevated, to reduce the pressure on the pelvic viscera. If the displacement persists in returning, a plastic operation may be performed, narrowing the urethra by placing a catheter in its canal as a guide for the size of a new urethra to be formed, and then excising a wedge-shaped piece with its base on the vaginal surface extending through to the urethral mucosa. The denuded surfaces are then brought together by interrupted sutures passed from side to side.

**Foreign Bodies in the Bladder.**—A variety of foreign bodies are found in the bladder. They either form in the bladder itself, as in the case of vesical calculi, or they may reach the bladder from the exterior, either by perforating its walls, or by descending a ureter into the bladder, or by being introduced through the urethra.

The commonest foreign bodies are calculi, formed of incrustations of phosphates and urates. Small oxalic acid and uric acid calculi may descend from the kidney and lodge in the bladder, and grow there to a large size by the accretion of phosphates and urates.

Foreign bodies may also enter the bladder from the side of the peritoneum, the tubes, or the ovaries, as well as from the vagina. In this way echinococci have ruptured into its cavity; silk ligatures about the pedicle of an ovarian tumor have ulcerated through its walls; dermoid cysts have opened and discharged quantities of hair by the bladder; and the bones of an extra-uterine fetus have also found an exit in the same way. The commonest foreign body which makes its way into the bladder from the vagina is a pessary, usually of large size, which has ulcerated through the vesico-vaginal septum.

By the urethra a large variety of foreign bodies have been introduced; these are usually several inches long, and of a caliber somewhat smaller than the urethra. The commonest object is a bit of a catheter broken off or an entire catheter which has slipped out of the fingers and so entered. Other articles which have been found have been introduced by the patient herself, such as hairpins, toothpicks, crochet needles, etc.

The symptoms produced are at first those of irritation of the bladder, followed later by inflammation.

The patient complains of a suprapubic pain and a frequent desire to urinate; the urine becomes cloudy, and pus soon appears. In a few weeks the foreign body becomes incrustated with urine salts, and the symptoms of cystitis become more urgent and the distress increases.

A small foreign body, such as a renal calculus, may only lodge temporarily, and with its spontaneous escape by the urethra the symptoms cease.

Bodies of an elongate form will, if large enough to put the bladder walls on the stretch, ulcerate through either into the vagina or into the peritoneum, in the latter case producing a rapidly fatal peritonitis.

**Diagnosis.**—The presence of a foreign body in the bladder may be determined either by touch or by inspection. If the body is long, or is of large size, it may often be easily felt bimanually by palpating the emptied bladder between two fingers in the vagina and the hand pressing down over the symphysis. Upon passing a sound into the bladder the presence of the foreign body may also be demonstrated by the sense of contact with a hard body, as well as by the audible click produced upon striking it.

The simplest and surest way to make a diagnosis is by inspection. The patient is put in the knee-breast position and the vesical speculum introduced, and the bladder, distended with air, is then easily examined in all its parts as already described. If there is any foreign body present which is not wedged in between the bladder walls it will drop into the most dependent part, where it is most easily seen. By means of inspection the diagnosis of the absence or presence of a foreign body can be made with certainty; by this means also its form and position are noted, together with any alterations produced in the bladder walls by its presence.

**Treatment.**—The treatment in every case is directed to the speedy removal of the foreign body. There are three ways of doing this: (1) Through the intact urethra, (2) through an incision in the bladder walls made through the vagina, and (3) through a suprapubic incision.

1. A small foreign body not more than 10 or 15 millimeters in diameter and a long narrow body, such as a needle or a glass catheter, may be removed through the vesical speculum. The bladder being empty, the speculum is introduced in the knee-breast position, and the object exposed. If it is a small round object it may be picked up by the mouse-toothed forceps and simply lifted out through the speculum, or it may be caught in a scoop and held against the end of the speculum, and withdrawn together with the speculum.

A long body like a glass catheter may be removed by introducing a straight instrument, such as a searcher, into its open end, and then manipulating the end of the speculum until the catheter slips into it; then by pushing the speculum well down on the catheter engaged in this way, its end can be easily caught and withdrawn.

The older writers were wont to try to deliver a calculus through the urethra by catching it between the fingers of one hand in the vagina, or in a virgin in the rectum, and the other hand pressing down above the symphysis, and so forcing it into the urethra and on out.

I succeeded in July, 1895, in removing a glass catheter in this way. The patient was a young woman, about twenty-three years old, with a spherical myomatous uterus filling the pelvis and reaching up to the umbilicus. She had been suffering from retention of urine, and as her physician introduced a glass catheter 13 centimeters (5 inches) long into the overdistended bladder, it slipped out of his fingers and was lost in the bladder. When I examined her I found the myoma and a long rigid body in front of it, with its blunt end projecting into the anterior vaginal wall to the right and its upper rounded end pressing upward directly under the anterior abdominal wall, 4 centimeters below the um-

bilious. The hymen was relaxed, so that by careful manipulation with two fingers in the vagina I was able to push up the lower end of the catheter while pushing the upper end to the right; by doing this I brought the end into the urethra, when it descended at once, and escaped with a quantity of bloody urine. The patient suffered no further inconvenience from its twenty-four hours' stay in her bladder.

Bodies from 10 to 20 millimeters in diameter may be removed through the urethra after dilating it. Simon has shown that even after a dilatation of 20 centimeters incontinence does not occur if it is carefully done. Two posterolateral incisions, 2 or 3 millimeters deep, must be made into the external urethral orifice to avoid tearing it when the dilatation is carried up to 20 millimeters or near it; the rest of the urethra, which is more elastic, is then enlarged by a series of successive dilators up to the required size, and the foreign object is either removed through one of the larger specula or grasped by a pair of small stone forceps introduced through the urethra and so withdrawn. The lateral incisions in the urethral orifice are then closed with fine catgut sutures.

Calculi, like other foreign bodies, may be removed either (1) by the urethra, (2) by vaginal incision, (3) by suprapubic incision, or (4) by crushing with the lithotrite.

Stones from 2 to 3 centimeters in diameter should be crushed by means of an instrument introduced through the urethra. If the bladder is first moderately distended with water and a lithotrite inserted, the stone is readily caught in the open beak of the instrument and broken up, and the pieces afterward removed through a speculum from the bladder distended with air.

Dr. H. J. Bigelow's apparatus for litholapaxy, which has served so well in men to reduce the number of cutting operations, by both crushing and washing out the bits of stone, is also available and even easier of application in women, although it has never been widely used on account of the great simplicity of the older operation through the short urethra.

Dr. E. T. Caswell, of Providence, R. I., reported a case (*Med. News*, Aug. 26, 1882) in which he crushed a phosphatic stone weighing, when dried, 100 grains. He used a modified Thompson's fenestrated lithotrite, and washed the fragments out through a straight tube (28 French).

Dr. D. F. Keegan (*Lancet*, Jan. 9, 1897) in an instructive article on *Litholapaxy in Girls and Women*, reports eighteen cases of calculi occurring in women, where he used the lithotrite with success. The calculi were of different varieties—namely, phosphatic, oxalate of lime, and uric acid; the smallest weighed 72 grains and the largest 702 grains. The average length of stay in the hospital was only 5.3 days.

Although nature and art have succeeded in removing stones of large size by the urethra without any diminution of their volume, this is a hazardous procedure, and ought not to be imitated, on account of the imminent risk of a permanent incontinence following.

An extreme case of this sort is reported by Dr. Alex. Dunlap, of Springfield, Ohio (*Amer. Jour. of Obst.*, vol. xiv, p. 853); upon examining the patient, who

was twenty-eight years old, he found a large stone 2 by  $2\frac{1}{4}$  by  $1\frac{1}{2}$  inches in diameter in the bladder; she would not allow any cutting operation to be done, so he caught the stone with a pair of forceps introduced through the urethra, and delivered it slowly by traction. The external meatus was the most resistant portion, but he succeeded in working it through in about three quarters of an hour, by pressing back the tissues over the stone much as an obstetrician may try to help the perineum back over the advancing head of the child. The stone was rough on one side and tore the mucous membrane of the canal considerably; this produced a sharp venous hemorrhage of short duration. In spite of this enormous dilatation, she suffered no serious inconvenience, although unable to hold her water as long as before.

2. The vaginal incision is to be preferred for stones which are so large that they can not safely be removed through the urethra, and is adapted to all but the largest calculi.

The operation may best be conducted with the patient lying in the left semi-prone position, with the posterior vaginal wall well retracted, so as to expose clearly the entire extent of the anterior wall from cervix to urethra. A blunt instrument like a male sound is now introduced through the urethra into the bladder, and the vaginal wall is pushed forward in the median line and cut through, opening the bladder; the incision is now extended by drawing apart the edges of the wound and cutting back toward the cervix and forward toward the neck of the bladder until it is large enough to permit the introduction of the blades of a pair of stone forceps, which are used to grasp the stone by its smallest diameter and draw it out through the wound endwise, without laceration of the tissues.

The incision must then be accurately closed with interrupted sutures either of fine silk or silkworm gut. If the bladder is then drained for five or six days the clean-cut vaginal wound ought to heal promptly, leaving no fistula behind. It is best to close the wound at once in this way, although even large wounds may heal spontaneously. Such a case is the one of Dr. F. R. Eccles, of London, Ontario, figured in the text. The patient introduced a hairpin into the urethra and it escaped into the bladder. She married soon after, and at her confinement a large foreign body was felt in the way of the head as it descended; it was pushed up, however, and the labor proceeded normally. Dr. Eccles was called in later and removed the hairpin, incised with large, fused twin calculi through an incision in the anterior vaginal wall. No sutures were used to close the wound, which healed spontaneously within five weeks.

3. The suprapubic operation for the removal of calculi (*sectio alta*) is best adapted to those of the largest size, filling the bladder. It is especially suitable for children, where the vaginal route is not available.

After distending the bladder with water, a vertical incision 6 to 8 centimeters long is made in the middle line just above the symphysis, separating the recti and the pyramidales muscles, and pushing aside the fat underlying them, but taking care not to cut the peritonem. In this way the bladder is exposed and its wall cut through vertically and the stone extracted. The incision in the

bladder wall is now closed with fine interrupted cutgut sutures placed close together and embracing the entire thickness of the wall down to but not including the mucosa. The incision in the abdominal wall is then closed with

buried silver wire for the muscles and fascia and cutgut for the skin. Then, the bladder is kept well drained for a week, the wound in its vault will heal by first intention.

The stone which is shown in the figure was removed from a little girl only eight years old by Dr. F. R. Eccles by the suprapubic operation; the wound, which was not closed completely on account of the unhealthy condition of the vesical mucosa, healed spontaneously in four weeks.

**Vesical Fistulæ.**—Vesical fistulæ are abnormal channels of communication between the bladder and contiguous or adjacent organs; they are found, for example, (1) between the bladder and the vagina, (2) between the bladder and the uterus, and (3) between the bladder and some portion of the intestinal tract.

**History.**—It is a remarkable fact that no clear references to these common and distressing disorder are found in the earliest writers preceding the Christian era, and for nearly sixteen hundred years afterward. Toward the end of the sixteenth century and early in the seven-



FIG. 205. PHOSPHATE CALCULI FORMED UPON A HARPIS IN THE BLADDER.

teenth several clear descriptions appear almost simultaneously in the writings of Luiz de Mercado, a Spanish physician (1520-1600). Felix Plater (Basel, 1536-1614), and Severin Pineau (born in Chartres in the middle of the sixteenth century).

Plater (see I. Spach, *Gynec.*, etc., Argent., 1597) gives two clear descriptions of fistulæ following difficult childbirths; the second case is appropriately entitled *vesicae cervicis alia rupta in partu*. "As a sequence of a difficult first labor, a young country girl had the opening of the bladder rent to such a degree that there was a long gaping furrow in its place, and the open bladder could be seen. I have twice inspected it myself, and discovered that it was so by using a probe. On account of this injury there is a constant involuntary discharge of urine, and the surrounding parts become excoriated and inflamed."

H. van Rooenhuyzen (1663) first proposed the closure of such a fistula by suture.

J. Fatio (*Wehr-mutter*, Basel, 1752, p. 284) gives an admirable description

of the way in which he carried this proposal out in 1675 and 1684 by placing his patients in the lithotomy position and exposing the fistula with a speculum; he then freshened its margins with a delicate pair of scissors, and brought the edges together by passing a sharpened quill through them and winding a thread over the ends of the quill to keep it from coming out. Both cases recovered.

A. J. Jobert de Lamballe (*Comptes rend. de l'Acad. des sci.*, 1850, and *Traité des fistules*, Paris, 1852) was the first operator who systematically took hold of this perplexing question and treated a large number of cases, many of them successfully. His plan of treatment for the simpler cases was to bring the cervix of the uterus down by traction with forceps so as to expose the fistula, followed by a broad denudation of the edges of the fistula and their exact approximation by interrupted sutures. When the fistula was a large one, and the approximation difficult on account of the tension, he made incisions in the lateral vaginal walls parallel to the edges of the fistula, so as to permit the tissues to be drawn together ("par glissement"). An incision through the vaginal vault detaching the cervix for this purpose has since been known as the incision of Jobert.

G. Simon (*Ueber die Heilung der Blasescheidenfisteln*, Giessen, 1854), did away with these lateral incisions, and substituted in their place a method with which his name is still connected, the use of a double set of sutures, one introduced at a distance from the wound for the relief of tension (sutures of detention), the other to secure accurate approximation (sutures of reunion).

J. Marion Sims (*On the Treatment of Vesico-vaginal Fistula*, *Amer. Jour. of Med. Sci.*, 1852, vol. xxiii, p. 59), working independently in America, accomplished three things: (1) He devised the duck-bill speculum for the exposure of the fistula with the patient lying in the left semi-prone position; (2) he clearly described the best method of denuding the margins in a funnel form and down to but not including the vesical mucosa; and (3) he sutured the edges of the wound accurately together with the non irritating (antiseptic) silver wire, and by this means, coupled with his great skill as an operator, he attained a degree of success in the treatment of these cases never before reached.

T. A. Emmet (*Vesico-vaginal Fistula*, etc., New York, 1868, and *Principles and Practice of Gynecology*, Phila., 1879) and Nathan Bozeman (*The Gradual Preparatory Treatment of the Complications of Urinary and Fecal Fistula in Women*, *New York Jour. Med. Sciences*, October 1, 1887) developed the method of treating large and complicated fistulae by gradual preparatory treatment, incising the bands of scar tissue, and softening them by pressure so as to make the vaginal walls supple enough to be drawn together.



FIG. 206.—SECTION OF A VESICAL CALCULUS OF THE BLADDER. NATURAL SIZE, REMOVED FROM A GIRL EIGHT YEARS OLD.

In spite of the advances made by these great surgeons, a large number intractable cases remained.

Colpocleisis, or a surgical closure of the vagina so as to make a common passage out of the vagina and the bladder, was performed in such cases by Simon, 1855, and has been practiced more or less ever since. The great advances which have been made recently can best be signalized by citing the eight indications for colpocleisis accepted by Simon, with the remark that not one of them looks good to-day. They were:

- (a) An extensive loss of tissue, rendering it impossible to approximate the margins of the fistula.
- (b) Inaccessible fistula.
- (c) Destruction of the uterine cervix, bringing the peritoneum dangerously near the seat of operation.
- (d) Severe hemorrhage into the bladder after an operation.
- (e) Incarceration of the cervix uteri in the bladder.
- (f) Atresia of the vagina above the fistula.
- (g) Atresia of the urethra, with a fistula above and below it.
- (h) Uretero-vaginal and uretero-utero-vaginal fistula.

The first active steps taken in an entirely new direction, with the object in view of relieving these cases without resorting to a procedure involving so much mutilation as does colpocleisis, were those of Rydygier (*Berl. Klin. Wochenschr.*, 1887, No. 31) and of A. Martin, of Berlin (*Zeit. f. Gyn. and Geb.*, 1891), who planned to cover in the defect with large flaps dissected up from the contiguous vaginal walls.

L. von Dittel (*Abdom. Blasenscheidenfisteln Operation*, *Wien. med. Woch.*, 1893, No. 25) made a radical departure from all precedent by opening the abdomen and detaching the bladder from the uterus, and so exposing the fistula, which was then sutured up; the sutures only included the bladder walls, and after closing in this way, the vesico-uterine peritoneum was again united and the abdomen closed.

A. Mackenrodt, of Berlin (*Centraltb. f. Gyn.*, 1894, No. 8), adopted a somewhat similar plan, but one making a definite advance on the preceding, in that he operates through the vagina and detaches the bladder on all sides from the

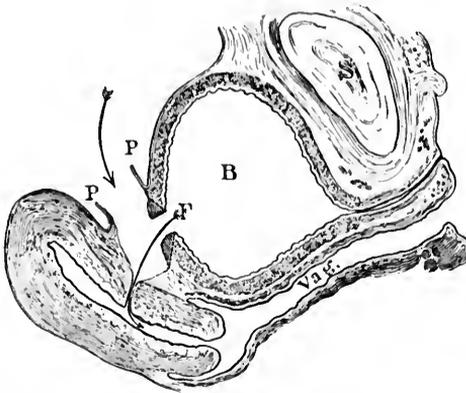

FIG. 297. TREATMENT OF VESICO-UTERINE FISTULA BY A SUPRA-URETHRIC INCISION. (V. DITTEL.)

The vesico-uterine peritoneum (P P) is divided, the fistula freed from the uterus, and its margins united by suture.

fistula, and then sews the bladder up independently and closes the opening in the vagina by drawing its sides together, if possible; if he can not do this, he uses the anterior face of the uterus to fill out the defect. With the exception of this last step, the important outlines of this operation were already defined by Säger (*Volk. Samm. klin. Fort.*, No. 301) and Walcher (*Centr. f. Gyn.*, 1894, p. 1).

W. A. Freund (*Eine neue Oper. z. schliessung gewisser Harnfisteln beim Weibe.*, *Samm. klin. Fort.*, N. F., 1895, No. 118) again operated in a radically different direction when he used the body of the inverted uterus, bringing it into the vagina through the posterior fornix, to close a large defect in the vesico-vaginal septum.

Dr. E. C. Dudley, of Chicago, succeeded in closing a large intractable fistula by making a semicircular demarcation inside the bladder on its mucous surface, extending from one margin of the fistula around to the other; he then sutured this demarcated surface to the anterior part of the fistula, and so obtained a closure.

My own plan (*Johns Hopk. Hosp. Bull.*, Feb., 1896) is to split the margin of the large fistula posteriorly, separating the bladder wall from the vagina, and then to denude its anterior margin on the vaginal surface, and to suture the movable posterior bladder wall to the fixed anterior vaginal wall.

**Causes.**—Vesico-vaginal fistulae are commonly caused by the traumatism of a difficult labor, resulting from the impaction of the child's head in a narrow pelvis. In consequence of the prolonged pressure, the vitality of the vesico-vaginal septum is destroyed at the point at which it is compressed between the head and the symphysis pubis; in a few days a slough has formed, and the piece of tissue drops out, leaving an opening between the bladder and the vagina. I have repeatedly made pelvic measurements in these cases, and rarely found a fistula following parturition which was not in a contracted pelvis. (See Dr. G. W. Dobbin, *The Use of Pelvimetry in Gynecology*, *Amer. Jour. Obst.*, August, 1895, p. 201.)

The impression which has prevailed in the profession that these fistulae are often due to the use of the obstetric forceps is erroneous, for they are undoubtedly due not to the use of the forceps, but to too long a delay in using them.

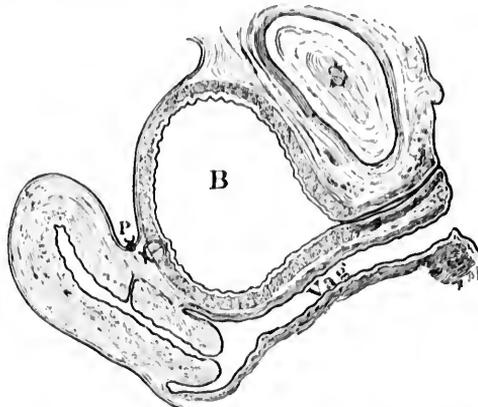
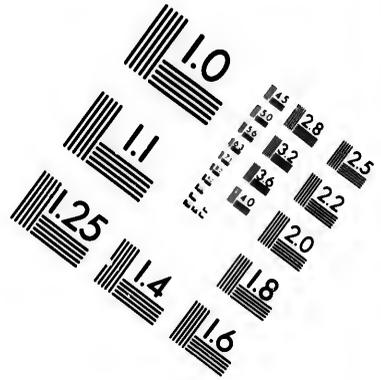
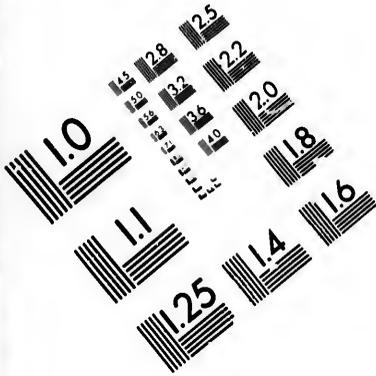
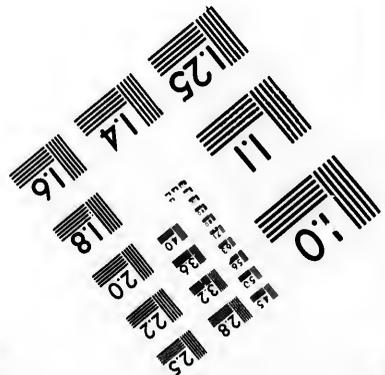
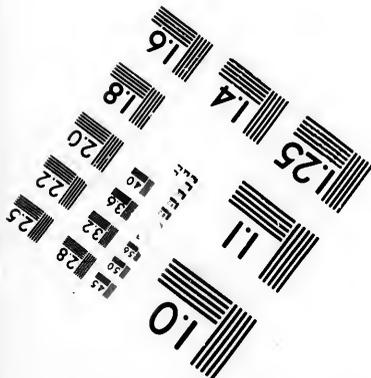
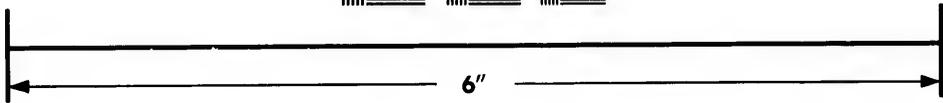
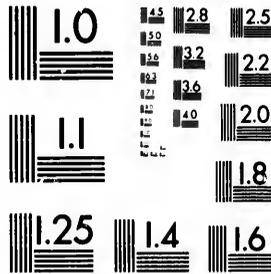

FIG. 208. SUPRABUCIC OPERATION FOR VESICO-UTERINE FISTULA. (V. DITTEL.)

The operation completed, the bladder and the peritoneum sutured.



**IMAGE EVALUATION  
TEST TARGET (MT-3)**



**Photographic  
Sciences  
Corporation**

23 WEST MAIN STREET  
WEBSTER, N.Y. 14580  
(716) 872-4503



This point was insisted upon by W. T. Schmidt in 1828 (v. Siebold's *Jour. f. Geb. und Frauenz. und Kinderkrankheiten*, Bd. vii, p. 339), and in our own day by T. A. Emmet, of New York.

Other causes are foreign bodies, such as stem pessaries, working their way from the vagina into the bladder, or *vice versa* (Figs. 168 and 170); syphilis; a cancer extending from the cervix uteri will often destroy the anterior vaginal wall and so create a fistula; the perforation produced by a pistol ball (Emmet); hematoma of the septum from coitus, followed by sloughing; the wounds of a vaginal hysterectomy are also to-day a frequent source of vesico-vaginal fistula.

The course of a fistula uninterfered with is toward closure, either by primary union or by granulation, cicatrization, and contraction, of its edges. In this way, by cicatrization, a small fistula will usually close entirely in a few weeks' time, and large ones will be reduced to one half or one third their original size. A clean-cut opening, such as that made for the extraction of a stone, may possibly close of itself without any suture, even if it is a large one. In time the margins of a large fistula grow sharp and hard with cicatricial tissue, and in bad cases the cicatrices radiate out over the vaginal walls or pin the fistula down to a pubic ramus. The posterior walls of the vagina may also be involved so as to close the vagina so tight that it is difficult to see the fistula.

Although the tendency of the smaller fistulae is always toward a spontaneous cure, in some instances a minute opening may persist for many years. I operated, for example, upon a patient who had had a fistula for twenty-three years, and the opening was not much larger than a hair, and yet large enough to permit the constant escape of urine into the vagina with all its disagreeable consequences.

**Symptoms.**—The symptoms produced by vesico-vaginal fistulae are quite characteristic. Soon after the confinement which causes it there may be bloody urine, difficulty in urination with symptoms of cystitis, and marked febrile disturbances, followed in a week or more by the escape of a slough, after which the urine, instead of accumulating in the bladder, escapes at once through the opening into the vagina, and so out over the vulva, perineum, and adjacent parts, which are constantly kept wet. The effect of this upon the skin is to produce a painful dermatitis and excoriations, and the vulvar hairs often become incrustated with the urine salts. Areas of excoriation are also found within the vagina, often coated with sabulous material and incrustations. The parts involved may be so exquisitely tender that the slightest movement is painful, and anything like a thorough examination is often impossible without anesthesia.

If the fistula is a small one, the patient may in certain positions retain a considerable amount of her urine and void it naturally. If the vaginal outlet is not broken down, considerable urine may accumulate within the vagina in the recumbent posture to escape on rising; this often leads the patient into the erroneous idea that she holds the urine in the bladder while lying and passes it

naturally afterwards; one of my patients was able to hold even as much as 300 cubic centimeters of urine in this way.

The effect of a fistula on the patient's general health is often most marked; the local discomforts compel her to remain pretty constantly in one place and in one position, preventing her from getting exercise and fresh air; nutrition fails, she becomes emaciated, excessively constipated, depressed, and peevish, and has a cachectic appearance.

In spite of the obstacles rendering conception rare, it has occurred. In one of my own cases, the patient, having a fistula 1.5 centimeter in diameter just back of the neck of the bladder, conceived, and passed through a natural labor and a normal puerperium, after which the fistula was operated upon and cured.

In a case in the hands of L. Winckel (*Handb. der Frauenkrankh.*, vol. iii, p. 441) a patient with a fistula became pregnant and passed through her confinement at term, after which the fistula actually healed spontaneously.

**Diagnosis.**—In making a diagnosis of a vesical fistula, the examiner must investigate all the associated conditions which tend to complicate the case. In doing this he will not only note the size, the form, and the exact site of the fistula, but will also carefully inquire into the condition of the surrounding vaginal walls: whether soft and yielding or fixed by scar tissue, whether the anterior lip of the cervix is involved in the fistula (cervico-vesico-vaginal), whether the neck of the bladder is included (vesico-urethro-vaginal), and whether the fistula is fixed to one or the other pubic ramus. It is most important also to note the position of the ureteral orifices in their relation to the edges of the fistula. Other complications which may occur are the existence of two vesico-vaginal fistulae, or of a vesico-vaginal fistula and a urethro-vaginal or a vesico-uterine fistula existing together. I have seen one case of vesico-vaginal fistula following a severe labor complicated by a recto-vaginal fistula, and an atresia of the upper vagina with hemato-metra. In another case with a vesico-vaginal fistula there was also a complete rupture of the recto-vaginal septum (see F. Plater's first case in I. Spach's *Gynæc. Libri*, Argent., 1597, p. 23, index). In still another instance in my hands a large vesico-vaginal fistula, adhering to the pubic ramus, was associated with a wide separation of the symphysis pubis ruptured in a badly managed forceps labor.

The diagnosis of a vesical fistula is made by a consideration of the history, by touch, and by inspection.

The patient gives a history of a constant discharge of urine over her person, dating usually from a severe confinement or from a hysterectomy; if, in spite of the fact that she has this constant flow, she also passes water at regular intervals, the probable diagnosis will then be one of ureteral and not of vesical fistula.

By touch the examiner will often feel more or less scar tissue in the vagina and a large hole in the anterior vaginal wall, which may be filled with the soft prolapsing mucous membrane of the bladder, and the finger can be introduced through this hole into the bladder and carried forward so as to feel the internal orifice of the urethra.

Inspection affords the fullest information about the fistula and the associated conditions. To make a vaginal inspection the posterior vaginal wall must be drawn back and the anterior wall exposed. A large fistula is seen as soon as the accumulated urine is dried out of the vagina; to find a smaller one it may be necessary to hunt among the vaginal folds, when it will often be found near the vault and to one side of the cervix or the other. A vesico-uterine fistula gives evidence of its presence by the urine which escapes from the cervix uteri.

When the fistula can not be found in this way it will usually be detected by injecting the bladder with an aniline solution or with sterilized milk, and then watching to see at what point the colored fluid runs out. If a fine sound is carried into the bladder through the urethra its end can usually be brought out through the smallest fistula.

The cystoscope may also be used to examine the fistula from the vesical side, but this is not so easy as the vaginal examination, because the floor of the bladder lies almost in the plane of vision, and the hole in it with its inverted mucous membrane is seen so foreshortened that it may easily escape notice altogether. It is therefore necessary, in order to get a good view of it, to lift the floor up on the end of the speculum, so as to bring it across the plane of vision.

**Treatment.**—In describing the various modes of treatment, I shall consider vesical fistulae under the following heads:

1. Vesico-vaginal fistula.
2. Vesico-utero-vaginal fistula.
3. Vesico-uterine fistula.
4. Entero-vesical fistula.

When the injury occurs to which the fistula owes its origin, the physician is not as a rule aware of the nature of the accident until the slough comes away; then the constant involuntary escape of the urine signalizes what has happened. It may be, however, that the urine will begin to escape some days before the sloughing is complete, when the examining finger detects a soft, crackling mass in front of the cervix; it is important at this time to begin at once the use of mildly antiseptic vaginal douches several times daily, to prevent the accumulation of fetid discharges in the vagina, and to keep the wound as clean as possible. The convalescence will be hastened if the slough is exposed and caught with forceps and the dead tissue cut away; small particles which still adhere to the edges of the wound will then soon detach themselves and leave a clean, granulating surface.

Mild boric acid or mild carbolic acid douches should now be kept up until the fistula is healed either spontaneously or by operation. A spontaneous cure may reasonably be expected only in the case of small fistulae 1 or 2 centimeters in diameter and may be awaited as long as the wound shows signs of contracting; such a closure may take place in from two to four months, and in exceptional cases after six or eight months.

The efforts made by our predecessors to bring about a cure by simple pos-

ture, or by putting a catheter in the bladder through the urethra, or by placing pledgets of cotton in the vagina, can not be recommended with any assurance of their utility; such measures belong rather to the days when local treatment in gynecology was universal.

Cauterization was at one time extensively employed, and many cures were made in the case of smaller fistule. The edges of the sound were treated with the nitrate of silver stick, Vienna paste, caustic potash, tincture of cantharides, or the hot iron, and later with the Paquelin cautery.

The cautery is applied to the edges of the fistula on the vaginal surface so as to destroy the superficial tissue and provoke active granulations, which, meeting across the opening and uniting, close it at once; or in the case of a large opening the further cicatricial contraction is brought about. It is, as a rule, necessary to keep this treatment up at intervals of a week or ten days for two or three months. Such plans of treatment have to-day almost entirely passed out of vogue, and will only be resorted to in the early stages of the affection when it is too soon to operate, or when for some other reason the operation can not be performed.

It is a significant fact that the best results by this plan of treatment have been reached during the early stages of the disease, at a time when the spontaneous cure takes place if it is going to take place at all.

Operation.—The operative treatment is as a rule the only form of treatment to be considered, for in the simpler cases it is invariably successful, and in the more complicated cases nothing short of operation will bring relief.

Preparatory treatment is necessary in most cases where the vagina contains sloughing necrotic tissue and incrusted urine salts, and where the contiguous parts are raw and granulating; these complications will be removed by prolonged repeated warm borie acid vaginal douches, a repeated painstaking cleansing of vagina and vulva, using forceps and cotton to remove and wipe off sloughs and *débris*, followed by occasional applications of weak solutions of the nitrate of silver to the raw surfaces. At the same time bands of scar tissue may be incised so as to diminish the tension on the wound edges.

If a recto-vaginal fistula exists also, in order to avoid infection of the wound, this must either be closed and healed before operating upon the vesico-vaginal fistula, or both closed at the same time. It will be safer in most cases to close the rectal opening first, because there is always a greater risk of this breaking down, in which case the vesical wound would almost certainly be infected and give way too.

The operator need not be embarrassed by finding a marked stenosis of the vaginal orifice at the time of operation, for this may be at once extensively divided with the knife by an incision down beside the rectum, giving all the room necessary to get at the fistula; and after the vesical operation is completed the incised edges may be accurately united again.

With more recent advances made in operating on bad fistule, we are able to dispense with some of the elaborate time-consuming preparatory treat-

ment in the way of incisions and vaginal dilators used to get rid of the scar tissue.

The best time to operate is within six or eight weeks after labor, while the tissues are soft and yielding, vascular, and free from the fixation and the atrophy caused by scar tissue. If the fistula is a small one and its edges can be easily drawn together with tenacula, with a little freshening of its margins and several sutures to unite them, primary union is easily secured; large and irregular fistulae are far more difficult to unite. The operation becomes more difficult after the formation of the scar tissue distorting and fixing the edges. Even pregnancy forms no contraindication to operation, as shown by the successful work of Schlesinger and others.

**INSTRUMENTS** needed for the operation are: Speculum, lateral retractors, tissue forceps, fistula knife, fistula scissors, tenaculum, needles, silkworm gut, catgut, and silk.

There are, in general, as briefly indicated above, seven different ways of closing vesico-vaginal fistulae:

1. The classical method of denuding the margins on the vaginal surface and uniting them by suture (Roonhuysen, Jobert, Sims, Simon).

2. Covering in the defect by flaps transplanted from the contiguous vaginal walls (Rydygier, Martin, Trendelenburg).

3. Opening the abdomen and cutting through the vesico-uterine peritoneum, and so detaching the bladder from the fistula, sewing up the bladder wound, and then reuniting the peritoneum and closing the abdomen (von Dittel).

4. Denudation on the vesical mucosa from one side of the fistula around to the other, and uniting this surface to the freshened anterior part of the fistula (Dudley).

5. Dissecting the bladder loose from the vagina and sewing up the vesical wound separately (Sänger, Walcher, von Winkel). The anterior face of the uterus is used to close the vaginal defect (Mackenrodt).

6. Freeing the bladder around the posterior two thirds of the fistula, and bringing it forward and uniting it to the anterior third, which is freshened on its vaginal surface (Kelly).

7. The posterior fornix is opened and the body of the uterus brought through it inverted and attached to the edges of the fistula on all sides, so closing it (Freund).

Curing a vesico-vaginal fistula by denudation of its margins and approximation of its edges by suture. This is the simplest mode of treatment, and is adapted to all fistulae in which the edges can be drawn together without much tension; if this can be done with tenacula beforehand, the operator may feel reasonably sure of a successful result. The easiest fistulae to close in this way are all the small ones, and the larger ones which are situated in the upper part of the vagina near the cervix, where the vaginal tissue is more lax and abundant; and the easiest large fistulae are the transverse ones.

When the edges can not be brought easily together by traction with the

tenacula in any direction, the denudation and approximation by suture may still be tried if the operator has had such experience in plastic work that he is able to form a good judgment as to the extent to which he will be able to relieve the tension by lateral incisions through the scar tissue, which fixes the edges of the wound. It is worse than useless to denude the edges of a large fistula without having any definite idea as to what can be accomplished until the stitches are put in and pulled upon. It would be far better to let the patient entirely alone, and to confess honestly an inability to relieve her, than to go on cutting away valuable tissues and increasing the size of the fistula every time, with a vague idea that by some chance the operation will succeed. I have seen several women who have been operated upon as many as five and six times in this way who were nothing better, but far worse for it.

The patient is put on the table, either in the left lateral or in the lithotomy position, or with elevated hips, after Simon, in whichever way the fistula can be exposed best; I prefer myself, in almost all cases, to put the patient on her back.

The posterior vaginal wall is drawn strongly backward, and lateral retractors are used on one or both sides, to give a perfect exposure to the field of operation.

The steps of the operation are: (1) Paring the edges of the fistula; (2) passing and tying the sutures.

The edges of the fistula should be pared on the vaginal surface entirely; this creates a freshened area from 5 to 6 or 8 millimeters in breadth, extending down to but not including the mucous membrane of the bladder.

Either a knife or scissors may be used to remove the tissue; a knife is necessary where there is much friable tissue, but in most cases I prefer a delicate pair of scissors which I have had made for this purpose, and I denude in the following manner:

With a knife I first outline the limit of the denudation all around the fistula, and when this is done I take the rat-toothed forceps and catch a piece of the tissue to be removed, and begin cutting it off with the scissors. This can be done rapidly, as the outer limit is marked out by the incision with the knife, and the operator does not have to pause to exercise his judgment about it; in addition to this, the sharp straight cut of the knife is better than the jagged edges made by the scissors.

The freshening must be carried down into sound tissue, avoiding the error of simply paring off the surface. Every particle of the tissue within the limits

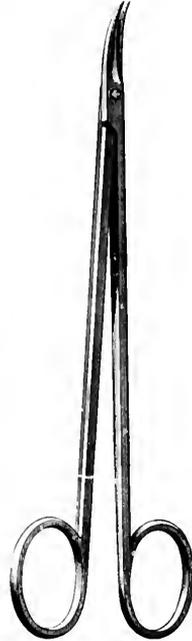

FIG. 209. — SCISSORS FOR PARING THE EDGES OF THE VESICO-VAGINAL FISTULA.

The shanks are made long and slender and the blades are delicate and curved on the flat.  $\frac{3}{8}$  ordinary size.

defined must be removed, or union will not take place; and to make sure that this has been done, little islets of undenuded tissue must be carefully sought out and picked up with a tenaculum and snipped off.

Constant irrigation with a fine stream of water is the best way to keep the field clear of blood during the cutting, but a little piece of sponge grasped in a pair of forceps will often be needed to make firm pressure on some spot which is obscured by the free oozing; this blanches the tissue for a second or two, and as the bleeding begins again the operator can see whether there are any little undenuded areas which do not bleed. The entire wound now has a fresh edge gently beveled on to the vaginal surface.



FIG. 210.—CLASSICAL OPERATION, SUTURES INSERTED TRANSVERSELY INSTEAD OF VERTICALLY.

Passing and tying the sutures is the next step. To do this I use the ordinary needle holder and small curved needles armed with a carrier made of fine silk.

A tenaculum is often needed to steady the tissues while passing the needle through them, and to catch and hold the point of the

needle as soon as it emerges, until it can be grasped by the needle holder again and drawn completely through.

By simply following the direction of least resistance in passing the sutures, in a variety of cases the resulting wound will assume the form of a **U**, **V**, **~**, **-**, **I**, or **N**. When possible it is best to avoid bringing three points together as in an **H** a **Y** or a **X**.

As a suture material I prefer to use a fine, flexible silkworm gut, often using catgut between them. Before passing the first silkworm-gut suture, the operator must determine in which direction the edges of the wound will come together with the least traction; he then passes the suture which is to lie in the middle of the wound when it is closed. To do this the needle must pierce the vaginal mucosa about 3 millimeters from its edge, and appear just under the mucous membrane of the bladder; it then enters the opposite side at the

border of the freshened surface and the bladder mucosa, and finally emerges on the vaginal surface 3 millimeters away from the edge of the wound, corresponding to the point of entrance.

Other sutures are similarly introduced on both sides of this first one, about half a centimeter apart, until there are enough sutures laid to close the wound from side to side. Especial care must be taken to secure an accurate apposition of the wound at its angle. The suture first introduced is then tied, and after that those at the sides. The amount of tension made in tying them must be just enough to bring the tissues snugly together; constriction of the tissues within the grasp of the suture loop must be avoided. As a rule there is a little pointing between each of these silkworm-gut sutures, and this is best corrected, after tying them, by passing a sufficient number of fine catgut or even fine silk sutures with a small needle penetrating only about halfway through the septum.

If the fistula lies near the neck of the bladder, the operator can not be too careful to avoid including one or both ureteral orifices in his sutures. This has often been done, and the patient has as a consequence either lost her life, or the intense renal colic brought on has compelled the operator to remove his sutures soon after the operation. This accident will only be avoided by (1) examining the edges of the opening beforehand and making sure that the little ureteral orifices are not situated there, and (2) by taking care not to pass the sutures so deeply that a ureter which opens somewhere near the wound will be caught in its loop.

If the ureteral orifice is found in the margin of the fistula it must be put out of harm's way either by introducing a catheter into it and dissecting it up for a short distance and turning it into the bladder, and then completing the denudation and suture of the fistula, or else by denuding farther out onto the vagina, and so securing a wide enough surface for the closure of the fistula, without coming into contact with the ureteral orifice. This has the effect of turning the ureter up into the bladder without disturbing it.

Where the fistula is pinned down at one of its angles to one of the pubic bones, a plan which I adopted in one of my cases may sometimes be put into successful practice. I introduced a long delicate tenotomy knife on the vulvar surface about 3 centimeters from the fixed point, and carrying it under the mucous membrane as far as the fixed point, cut it loose from the bone without puncture. The hemorrhage was but slight.

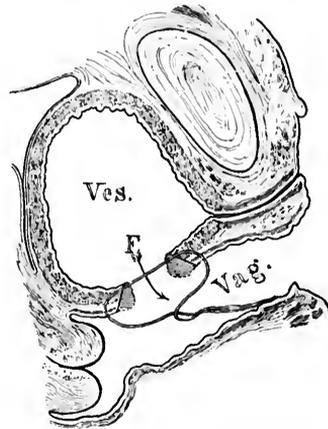

FIG. 211.—CLASSICAL OPERATION FOR VESICO-VAGINAL FISTULA.

The parallel lines show the tissue removed in denuding the edges of the fistula, and the suture is placed ready to tie. The entire thickness of the vesico-vaginal wall, excepting the bladder mucosa, is included in the suture.

I was then able to bring the tissues together without undue traction, and a perfect union resulted.

Aside from the danger of including a ureteral orifice in a suture, there is one other risk connected with the operation, and that is hemorrhage into the bladder from the edges of the incision. This occurred in a case operated upon by one of my assistants, and the wound had to be reopened five hours after the operation, when 700 cubic centimeters of blood clots were removed. The stitches were put in again, this time including the mucosa, and the patient then recovered with perfect union. In a case operated upon by J. Bäcker (*Cent. f. Gyn.*, 1893, No. 38) the bladder became distended with blood almost to the navel and ruptured into the peritoneal cavity under violent straining efforts, and the patient died forty-five hours after the operation of acute sepsis.

**After-Treatment.**—The cure of the patient after the operation consists in keeping the bladder empty for five or six days and requiring her to remain in bed. It is a good practice to put a soft gauze pack in the vagina to give gentle support to its walls; a soft-rubber catheter is put in the bladder and retained there for from four to seven days, according to the size of the fistula. I find it tends to relieve the irritation often produced by taking this out for an hour every morning and evening. The vaginal pack should be replaced when it becomes soiled.

In small fistulae, or larger ones, where the approximation has been easily made, I often do not leave a catheter in at all, but order the patient to empty the bladder herself or have it emptied every three or four hours for four days, when the interval may be lengthened.

The bowels should be opened on the third day by giving a purgative followed by an enema.

The silkworm-gut stitches may be removed in twelve or fifteen days.

The ability to retain the urine always increases as the bladder grows accustomed to the resumption of its normal function.

In addition to the classical method of closing an ordinary vesico-vaginal fistula which I have just described, two other essentially different plans have been successfully carried out by F. Vulliet and A. F. McGill.

Vulliet's procedure (*Youv. arch. d'obst. et de gyn.*, 1887, p. 512) consists briefly in the union of the tissues denuded on the vaginal surface by two layers of sutures, one buried and one superficial.

The patient had had a fistula for seven years, and had already been operated upon three times, with the effect of filling in the deficiency, about 2 centimeters in diameter, with a thin layer of scar tissue perforated in three places like a sieve. This tissue, not available for plastic purposes, was sacrificed, and a denudation 8 millimeters in diameter made around its border in the sound tissue. The anterior and posterior extremities of the fistula were then caught with forceps and pulled in opposite directions until the edges came into contact. The first suture was then introduced, threaded directly in a small needle. The suture, made of silk and permeated with iodol and glycerin, was passed continuously along the

margin of the fistula, entering and re-entering at points close together. By this means alone the closure was so effective that no more fluid escaped from the bladder in spite of the coughing and straining under anesthesia. Another layer of sutures was then applied below this one, completely closing the wound. Seven days later the superficial sutures were taken out and the union found perfect.

An interesting new method is that of A. F. McGill, of Leeds (*Lancet*, November 8, 1890, p. 967), entitled *An Operation for Vesico-vaginal Fistula through a Suprapubic Opening in the Bladder*. The patient, seventeen years old, had an opening in the vesico-vaginal septum just in front of the os uteri large enough to admit the tip of the index finger.

The operation was performed January 11, 1890. The pelvis was elevated and the bladder opened above the symphysis by a transverse incision, and fixed to the abdominal wall.

The fistula was then pushed up within reach by an assistant with two fingers in the vagina, its edges freshened, and then completely closed by four chronicised catgut sutures passing through the vesical mucosa only.

She was then placed in the lithotomy position and the wound closed on the vaginal surface with four silk sutures, including all the layers but the vesical mucosa.

The suprapubic wound was now closed in three layers—bladder, abdominal muscles, and skin—leaving an opening for a drainage tube, which was removed on the fifth day. On the eighth day she passed urine by the urethra, in less than a month the suprapubic wound closed, and on February 13th she returned home well.

A method recommended by Sanger and von Waleher involves the separate suture of the mucosa after freeing it from the margin of the fistula. The catgut which unites the mucosa is then buried by a separate layer uniting the vaginal opening (see Fig. 212).

**Vesico-vaginal Fistulae of Large Size.**—The type of a simple fistula of small or medium size, in which the edges can be brought together after deaundation without undue traction, has just been described. When, however, the defect in the floor of the bladder is large, and there is a great deal of scar tissue in the vaginal walls, it may be difficult or even quite impossible to draw the edges together. Even when the operator succeeds in doing this the sutures are sure to cut through before union has taken place. Among these cases must also be placed a little group in which a fistula of medium size is converted into a large one by the successive parings of unsuccessful operations.

Cases classified under this group have in the past either been cured only

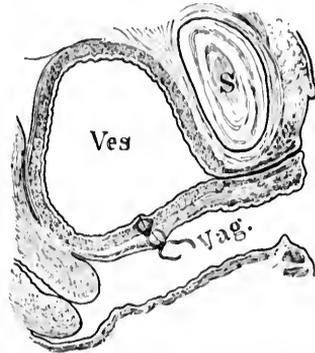

FIG. 212.—VESICO-VAGINAL FISTULA CLOSED BY USING A BURIED SUTURE OF CATGUT IN THE BLADDER WALL AND THEN UNITING THE VAGINA OVER THIS.

after months of preparations and repeated operations, or they have been abandoned as incurable, and colpocleisis has been done as a last resort.

Within the past few years a number of operative procedures have been devised which now enable us to cope with even this hitherto hopeless class.

I will now describe some of these various methods in detail dwelling particularly on the fact that the most important principle is the fact that we are able to detach the flexible bladder from the rigid vaginal wall, and to draw it together and sew it up independently.

**Closure of a Fistula by turning up Vaginal Flaps to form the Base of the Bladder.**—One of the first efforts in a new direction in the treatment of fistula was that of A. Martin, of Berlin (*Zeitschr. f. Geb. und Gyn.*, No. 19, p. 394), in the case of a large fistula of fifteen years' standing, comprising the entire vesico-vaginal septum, and already operated upon twice unsuccessfully.

To get the tissue to form a new base for the bladder incisions were made through the vaginal wall at some distance from the fistula and parallel to its edges. The vaginal tissue thus outlined was then loosened up in the direction of the fistula, and the edges of the flaps made in this way were drawn together and sewed as in a cleft palate operation; by doing this, that part of the vaginal

mucosa which lay between the incision and the edge of the fistula was turned upward so as to form a new floor for the bladder, leaving the raw surface exposed on the anterior vaginal wall. This raw surface was then closed in by using a continuous suture to draw it together as in an anterior colporrhaphy.

The wound healed in spite of a catarrh of the bladder down to an opening at the cervix.

This method is analogous to Volkmann's operation for ectopia of the bladder, in which

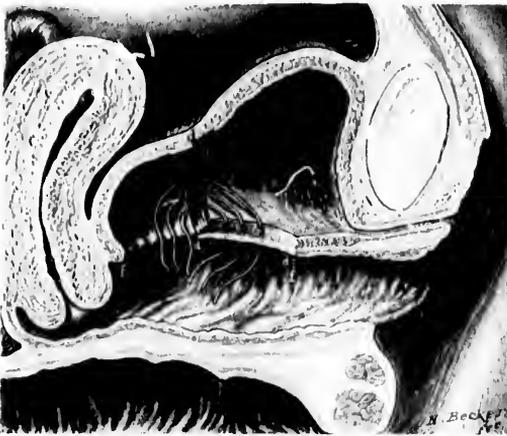

FIG. 213.—DUDLEY'S OPERATION FOR LARGE VESICO-VAGINAL FISTULA WITH RIGID MARGINS.

The diagram shows the left half of the bladder. The denudation includes the anterior part of the fistula *f, f* from *d* to *d', f*, and then extends up over the vesical mucosa as shown. Three of the sutures are represented in place, but not tied.

the skin surface of the abdomen is turned inward to form the upper wall of the bladder.

Somewhat analogous to this is the plan of F. Trendelenburg (*Samm. klin.*

Fort., 355, 1890), who closed a fistula as big as the end of the index finger, already operated on seven times, by transplanting a flap from the posterior vaginal wall.

The lower and lateral borders of the fistula were freshened, and then at a corresponding point on the posterior vaginal wall a horseshoe-shaped flap was detached on three sides and sutured to the edges of the fistula. Four weeks later the pedicle was cut through and sutured to the freshly denuded upper edge of the fistula. As the former operations had failed on account of the occurrence of cystitis, a suprapubic opening was made for drainage of the bladder. The case made a complete recovery.

**Closure of a Fistula by suturing the Denuded Vesical Mucosa to its Anterior Margin.**—This plan was carried out by Dr.

E. C. Dudley, of Chicago (*Chicago Med. Journ. and Examiner*, May, 1886). In the case operated upon the entire vesico-vaginal septum and the vaginal portion of the cervix with its anterior wall had sloughed away, and the fissures could not possibly be drawn together in the usual way.

The mucous membrane of the bladder, however, when caught with a tenaculum could be drawn forward to the neck of the bladder at the extreme anterior margin of the fistula without undue traction. The operator therefore began to close the fistula by denuding a strip on the mucous surface of the bladder from side to side about an inch above the posterior edge of the opening. The anterior margin of the fistula was now denuded on its vaginal surface, and the denuded vesical mucosa drawn forward and attached to it on all sides by twenty-two silkworm-gut sutures.

By this remarkable procedure the vesico-vaginal septum was replaced by that portion of the bladder wall which lay posterior to the line of denudation, and the new bladder formed was in this way just so much smaller. The operation was successful and the patient was able to retain her urine all night.

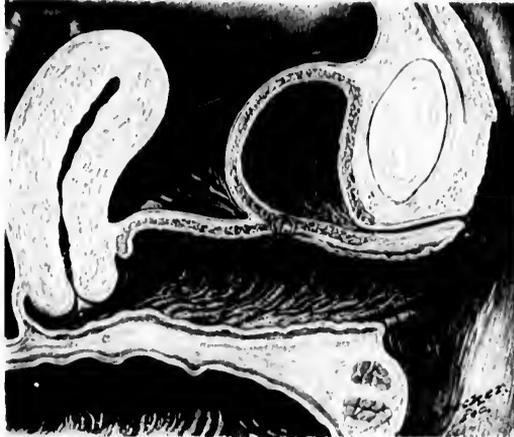

FIG. 211.—DUDLEY'S OPERATION COMPLETED, SHOWING THE NEW SMALLER BLADDER.

The anterior vaginal wall lying between the cervix and the suture consists now of the bladder mucosa thrown out of use by the operation.

Closure of the Vesico-vaginal Fistula by detaching the Bladder from the Vagina and suturing it Independently (Figs. 217, 218).—A. Mackenrodt, of Berlin (*Centralblatt, f. Gyn.*, No. 8, 1894), made a remarkable step in advance when he devised the following plan:

*a.* The fistula is exposed, and the cervix at one end and the urethral prominence at the other, each caught with a pair of tenaculum forceps, and the tissues between made tense by traction in opposite directions.

*b.* An incision is next made in the median line extending across the fistula

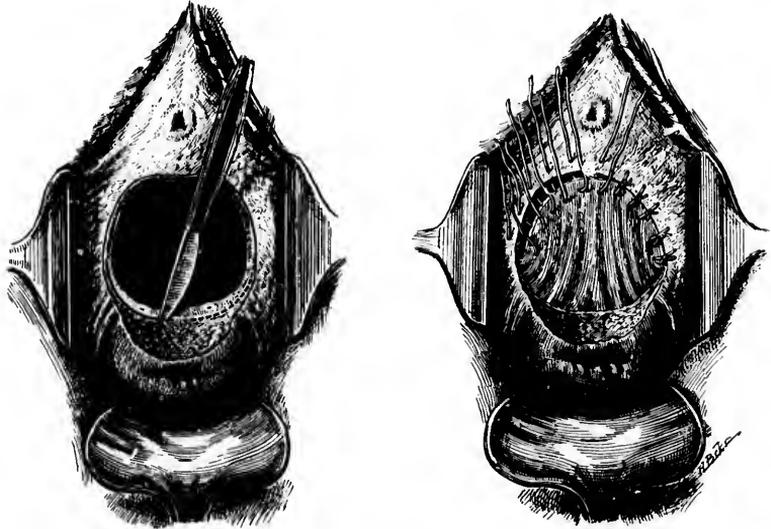

FIGS. 215, 216.—VESICO-UTERO-VAGINAL FISTULA OCCUPYING THE ENTIRE BASE OF THE BLADDER WITH DENSE CICATRICIAL EDGES AND WITH THE URETERAL OPENINGS IN THE UPPER MARGIN.

The bladder was dissected loose from the uterus and from the lateral vaginal walls around the upper half of the fistula. The lower half of the fistula was then denuded on its vaginal surface and the raw surface of the loosened bladder united to the vaginal denudation.

and through the vaginal walls and down to the bladder, so as to expose the entire base of the bladder.

*c.* The edges of the fistula are then split so as to separate the bladder from the vagina, and the separation is carried out widely on all sides, extending upward, if need be, as far as the vesico-uterine peritoneum.

*d.* The movable elastic bladder is now closed by denuding its edges and drawing them together by fine silkworm-gut sutures. Beneath these a second and even a third row of sutures may be placed.

*e.* After closing the bladder in this way the vaginal wound is approximated as far as the tissues will permit by denuding its borders and drawing the corpus uteri forward and passing sutures from side to side so as to bring the margins together and at the same time hold the uterus in ante flexion. If the vagina

will not come together the uterus is used to fill in the gap, making a firm base in place of the fistulous opening.

Closure of the Fistula by detaching the Bladder Posteriorly and suturing it to the Denuded Vaginal Wall Anteriorly.—My own plan (*Johns Hopkins Hospital Bulletin*, February, 1896) for the treatment of large fistula, inoperable by the classical method, is one which was carried out in a case already operated upon five times, with the consequent loss of the entire base of the bladder, including the internal orifice of the urethra and the anterior lip of the cervix.

The patient (M. Y., 3811, Sept. 25, 1895) was forty years old and had had five children; the fistula dated from the third labor eight years ago, and each one of the five efforts made to close it had only served to increase the defect without mending any part of the tissue.

The opening was 4 by 3 centimeters in size; the ureteral orifices were seen on its posterior border after replacing the congested bladder, which was inverted through it into the vagina; the edges of the fistula were fixed by scar tissue and by scars radiating out over the vaginal walls.

The steps of the operation were the following:

*a.* A crescentic incision was made around the posterior two thirds of the fistula, separating by a blunt dissection the bladder with its muscular and mucous coats from the vagina and the cervix laterally, and all the way up to the peritoneum.

*b.* The remaining anterior third of the fistula was then pared on its vaginal

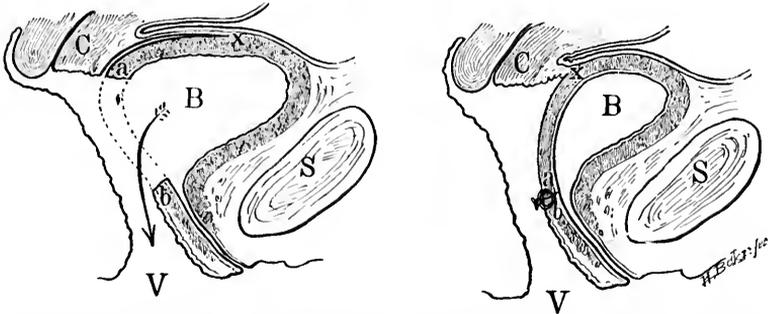

FIGS. 217, 218.—VESICO-UTERO-VAGINAL FISTULA, SHOWING THE WAY IN WHICH THE BLADDER WAS DETACHED FROM THE UTERUS ABOVE FROM *a* TO *c* AND BROUGHT DOWN AND ATTACHED TO THE DENUDED VAGINA AT *b*.

surface, extending the denudation down to but not including the vesical and urethral mucosae.

*c.* The ureters were marked out and protected during the next step by passing two flexible ureteral catheters 2½ millimeters in diameter through the urethra, one into each ureter.

*d.* The detached part of the bladder behind was now easily drawn forward and accurately united by interrupted fine silkworm-gut sutures to the immov-

able anterior third of the fistula on its vaginal surface; each suture caught the under surface of the muscular wall of the bladder so as to turn its edge up into the newly formed bladder. The ureteral orifices were in this way directed upward, and they escaped compression and transfixion through the presence of the catheters. The vaginal opening was not closed.

I left the ureteral catheters in place three days to drain each kidney through the urethra and put the bladder entirely at rest thus avoiding any strain on the healing tissues.

The wound healed throughout, except at the left upper angle, where a fistulous sinus 1 millimeter in diameter was left; through this a little urine escaped occasionally. On leaving the ward the patient could hold 100 cubic centimeters, and did not have to empty the bladder oftener than once in three hours. The raw surface on the anterior vaginal wall was replaced by a firm contracting cicatrix.

**Closure of an Extensive Vesico-vaginal Fistula by suturing the Body of the Uterus into the Defect.**—This operation was devised and practiced with success in two cases by W. A. Freund (*Samm. klin. Fort.*, No. 118, 1895). The first patient was forty years old, and had lost the posterior wall of the urethra and a considerable part of the sphincter area at the neck of the bladder. The opening into the bladder easily admitted the index finger; the tissues around the fistula were bound to the pelvic bone by extensive radiating scars, and the cervix was hidden in a mass of scar tissue at the vault of the vagina.

Douglas's pouch was opened and the retroflexed uterus drawn out into the vagina and scraped on both sides in front of the broad ligaments until it bled, it was then sutured to the freshened edges of the opening in the bladder and the posterior half of the urethra. The fundus uteri was then removed so as to expose its cavity, and the edges of the wedge-shaped excision were united, providing an exit for the menstrual discharges. After a protracted convalescence, marked by attacks of fever and the discharge of sutures and a varying degree of continence, the patient was able to retain the urine, so that five months later she only passed it twice in three and a quarter hours, and could void it voluntarily as soon as there was any accumulation in the bladder.

Four months after the first operation the defect of the anterior part of the urethra was made up by drawing over it the contiguous vaginal walls and suturing them together. Menstruation took place from the new cervix formed at the open fundus.

The second case was that of a young woman twenty years old, in whom the entire base of the bladder had been lost. The perineum was torn back into the lax sphincter, and there was a recto-vaginal fistula high up. The urethral orifice formed a slit opening into a urethra  $1\frac{1}{2}$  centimeter long. The edges of the fistula were surrounded with extensive scar tissue, and the cervix was concealed in a mass of scars at the vault.

At the operation Douglas's *cul-de-sac* was opened; then the recto-vaginal septum was split from the incision in the vaginal vault down through the recto-

vaginal fistula and on downward through the anus. The edges of the large defect in the anterior vaginal wall were now encircled by a broad area of denudation, and the retroverted uterus drawn out through Douglas's pouch and freshened by scraping its borders in front of the broad ligaments. The uterus was now attached to the edges of the fistula on all sides by silk sutures, which had been previously laid through the margins of the fistula.

The scar tissue and edges of the fistula in the recto-vaginal septum were now removed and closed on the rectal side with catgut, and on the vaginal side with silk sutures. The body of the uterus was next united to the urethra, and the fundus uteri removed in a wedge-shaped excision and sutured on all sides. Finally the perineal wound was closed with wire sutures uniting the sphincter and about 1 centimeter of the tissue above it. The bladder was drained with a catheter and the wound healed throughout, except for the formation of a small recto-vaginal fistula, which closed spontaneously after the escape of some silk threads.

Three months after the operation there was no incontinence of urine, and the weak sphincter had recovered its power under the use of hypodermics of strychnin in its immediate neighborhood. All lateral expansion of the bladder had disappeared, and instead of this there was a distention of 18 centimeters upward.

**Vesico-utero-vaginal Fistula (Fistula Laqueatica).**—These fistulae are situated at the vault of the vagina close against the cervix, which is frequently involved by the destruction of a portion or all of its anterior lip.

They occur either from extensive sloughing in this region, or more frequently from a laceration of this part of the cervix, often due to the obstetric forceps, extending into the vault of the vagina and on into the bladder. This mode of origin is well shown in a case reported by Dr. H. C. Coe (*Amer. Jour. Med. Sci.*, 1890, p. 487), in which he did a successful suprapubic amputation of the uterus for rupture during labor. Before Dr. Coe operated on the woman, however, an attempt had been made to introduce the forceps through the malilated cervix, which resulted in a rupture of the cervix extending into the bladder and leaving a cervico-vaginal fistula behind.

A similar case of double fistula is also figured by Otto v. Herff (*Zeit. f. Geb. und Gyn.*, vol. xxii, 1891, p. 10).

A case of my own, which I saw April 1, 1885, also goes to prove that these fistulae are often the result of a tear rather than a sloughing. The patient had had a severe instrumental labor with a stillbirth six weeks before; she came to me with a small fistula just at the vault of the vagina on the right side against the cervix. This fistula opened two ways, from the bladder backward into the cervical canal, and downward into the vaginal vault. See Fig. 220. There is, I think, no other conceivable way in which such fistulae, lying so close together in this position, could have been brought about, except by a tear extending through the cervix and forward into the bladder, followed by a healing of the vaginal cervix between.

The fistula following a tear is apt to be small, while that following a slough may take in the whole anterior part of the vaginal vault.

**Treatment.**—A small fistula of recent origin may get well spontaneously, or, as in my own case just cited, may recover after stimulating applications; used the nitrate of silver stick several times with improvement, and after the patient went home she recovered entirely.

The essential difference between the treatment of these and the vesico-vaginal fistula lies in the close proximity of the rigid cervix whose tissues can not be drawn together like that in the flexible vaginal walls. In addition to this, the fistula may form a sinus longer than the ordinary vesico-vaginal fistula, and the denudation and approximation may effect only the closure of the bottom of the sinus, which for this reason refuses to heal.

A variety of operations have been proposed, among them the following are of practical value:

A simple closure may be effected in the absence of any scar tissue surrounding a small fistula by making a deep funnel-shaped denudation on the vaginal surface, and then passing several silkworm-gut sutures from before backward through both edges of the fistula and the anterior cervical lip as well. This will not succeed if there is much destruction of the cervix with scar tissue.

The anterior lip of the cervix may be effectively utilized to close a larger defect in the vault by paring its edges and attaching them by sutures directly to the sides and edges of the fistula pared on its vaginal surface. If there is too much tension created in pulling the cervical lip down and attaching it to the fistula in this way, this may be relieved by splitting the cervix bilaterally up to or above the vaginal vault, in this way elongating the anterior lip, which is then easily pulled out so as to cover in the defect.

The posterior lip of the cervix is in some cases easier to approximate to the anterior edge of the fistula than the anterior lip. When this is denuded and attached so as to fill in the defect, the cervical canal is turned into the bladder, and menstruation henceforth takes place through this viscus.

Dr. N. Bozeman has advocated the preparation of those cases where there is scar tissue and fixation by catching the uterine horns with forceps and dragging it down daily for some weeks beforehand, so as to gradually overcome the resistance.

**Detaching the Uterus from the Bladder and then suturing the Fistula.**—The best plan of all, and one doing away with the difficult dealing with the scar tissue, is the following (see A. Wöfler in v. Herff's paper, *Zeit. f. Geb. und Gyn.*, 1891, p. 5):

*a.* The cervix is caught and drawn down and backward, and separated from the vaginal vault in front. This separation is continued well above the fistula by detaching a part of the bladder from the supravaginal cervix.

*b.* The edges of the fistula are then pared down to the vesical mucosa, taking care to get rid of all scar tissue.

*c.* The fistula may then be closed by interrupted fine silkworm-gut sutures, or by buried continuous catgut sutures in two or three layers.

*d.* After this the cervix may be attached again to the vaginal vault by means of several silkworm-gut sutures.

It is important, for five or six days after the operation, to keep the bladder

empty, and to avoid an infection at the vault by keeping a clean, loose iodoform pack in the vagina.

Trendelenburg (*Volkman's Samml. klin. Vort.*, 355) recommends the following plan of dealing with vesico-vaginal fistula when they can not be satisfactorily exposed on the vaginal side; also for fistulae in the immediate neighborhood of the ureter, for vesico-uterine, uretero-cervical, and uretero-vaginal fistulae:

The patient is placed on the table with the pelvis well elevated at an axis of not less than forty-five degrees to the horizontal; by this posture, when the

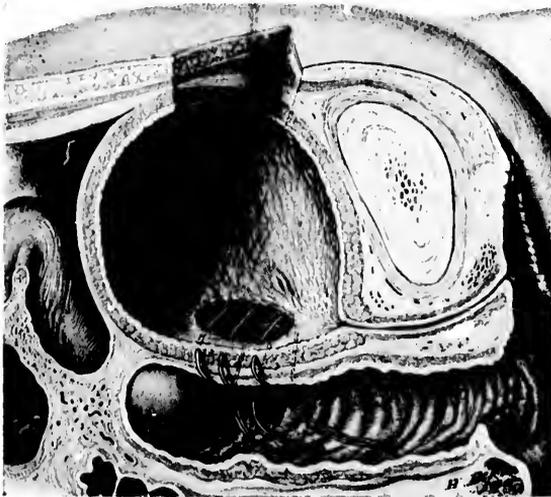

FIG. 219.—SUPRAPHIC OPERATION FOR VESICO-VAGINAL FISTULA (TRENDLENBURG). SAGITTAL SECTION. SUPRAPHIC INCISION SEEN ABOVE.

bladder is incised, it at once fills with air, and its entire interior is well exposed to view.

The bladder is opened by making a transverse incision 10 centimeters long across the upper border of the symphysis, separating the attachments of both recti muscles and exposing the prevesical space; a transverse opening in the bladder is then made 5 to 6 centimeters long. The edges of the fistula now exposed are denuded in the form of a shallow funnel in such a way as to remove a broad band of tissue from the bladder mucosa, and a narrow one from the vagina and cervix. The edges are brought together with silkworm-gut sutures; in the first cases these were tied in the bladder, but later two needles were threaded on one suture, and both ends were passed through into the vagina, where they were tied.

The incision into the bladder is now closed down to an opening left for a T-drain. The patient is compelled to lie in Sims's position until the fifth day,

when she may turn over for a time on her back. The drainage tube is removed from the ninth to the twelfth day, after which the abdominal wound heals of itself.

While the attempt to close a fistula in this way failed in the first two cases it succeeded in the two following. In the case described in detail by the author the fistula was the size of a plum stone, fixed by scar tissue, and associated with the loss of the right half of the cervix.

Dr. H. C. Coe's case, cited above, in which the uterus had been amputated for a parturient rupture, had a fistula to the left of the cervix situated in cicatricial tissue; a probe entered through the opening into the bladder but not into the cervical canal, although there was a communication on that side too, shown by milk injected into the bladder coming out of the canal. The operation performed was a unique one. He first divided the bridge of tissue separating the fistula from the cervical canal, and then pared the edges of the fistula and excised the entire remaining cervix, leaving nothing but vaginal mucous membrane to be included in the sutures along the entire line of the wound. The opening of the ureter was identified in the upper margin of the fistula and avoided. The wound was now closed by thirteen silver wire sutures and three silk ones. The recovery was complete.

**Vesico-uterine Fistula.**—The causes which produce a vesico-uterine fistula are the same as those producing some cases of cervico-vesico-vaginal fistula—that is, a tear of the cervix which extends through into the bladder, up into

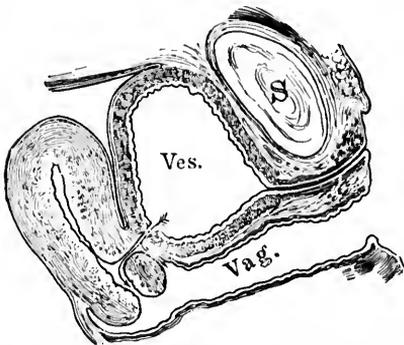

FIG. 220.—VESICO-UTERINE-VAGINAL AND VESICO-UTERINE FISTULA IN THE SAME PATIENT.

the uterus, and which heals in this group of cases in its lower part, leaving a persistent opening between the bladder and the cervical canal. The result of this is that the urine constantly dribbles out through the cervix into the vagina. If the opening is small the patient may pass some urine naturally, leading the physician to the erroneous conclusion that the fistula communicates with one of the ureters and not with the bladder. This will be disproved by injecting milk into the bladder and seeing it ooze out through the cervix, and by examining

the bladder with a cystoscope and inspecting the fistulous orifice, as well as by noting the fact that the discharge of the urine from the cervix lacks the peculiar intermittency of a ureteral flow. If necessary the ureters may be catheterized and their patency demonstrated.

The proper treatment of a vesico-uterine fistula is well described by F. H. Champneys (*Trans. of the Obst. Soc. of London*, 1888, vol. xxx, p. 348), in an article entitled *Description of a New Operation for Vesico-uterine Fistula*.

The procedure is as follows: The patient, thirty-eight years old, had had four severe labors, the last two instrumental. Her pelvis was generally contracted and flattened, and the last labor continued four days and was terminated by the forceps; on the same day the urine began to flow by the vagina, and continued to do so up to the day of operation.

On examining *per vaginam*, the cervix was found rather large and flabby and the canal big enough to admit the index finger for an inch. On injecting the bladder a large stream escaped from the cervix, and a bent probe introduced through the urethra could be passed on directly into the cervical canal.

Operation May 12, 1887. *a.* After passing a probe through the fistula as just described, and bringing it out at the cervix, the latter was steadied with a volsella forceps.

*b.* A transverse incision  $3\frac{1}{2}$  centimeters long was made through the anterior fornix from the vagina and the bladder dissected up from the cervix with scissors and fingers as in a vaginal extirpation of the uterus. The dissection was carried well above the fistula, dividing it into two parts, one opening into the bladder and the other into the cervix, each admitting the index finger easily.

*c.* No freshening was required, as the whole surface was raw. Seven fine silver sutures were passed from side to side to close the opening in the bladder, each one being entered an eighth of an inch from the hole and brought out on its edge, avoiding the mucosa. Four similar sutures closed the cervix. These sutures were all cut short.

*d.* The vaginal wall was then united to the cervix by four long silkworm-gut sutures, subsequently removed.

A self-retaining catheter was left in the bladder and a gauze pack put in the vagina. The result was a perfect recovery of function.

I operated January 12, 1893, on a somewhat similar case. The patient (F. H., 1750), forty-six years old, had had twelve children, the last two born instrumentally. At the last confinement she was four weeks abed instead of four days, as usual, and from the fourth day on she suffered from incontinence of urine.

Both vaginal walls were found lax and pointing, and the anterior lip of the cervix was completely destroyed. At a point well above the vaginal vault a fistula 1.5 centimeter in diameter opened into the anterior cervical wall. This was treated by exposing the cervix with a speculum and drawing it down, and

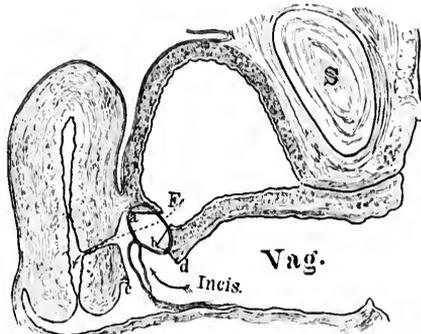

FIG. 221.—VESICO-UTERINE FISTULA TREATED BY DISSECTING THE BLADDER FREE FROM THE UTERUS AND SEWING UP THE FISTULA.

The long arrow shows the position of the fistula, the short arrow points to the line of incision in front of the cervix separating the cervix (*c*) from the vagina (*d*); the edges of the fistula (*a b*) are then approximated and (*c d*) united again.

then cutting across the vault of the vagina and detaching the cervix from the bladder and so separating the fistula for 1.5 centimeter on all sides from the vagina and uterus, laying bare a hole in the bladder wall 8 millimeters in diameter. This was closed by four silkworm-gut sutures introduced from side to side



FIG. 222.—VESICO-UTERINE FISTULA, SUTURES CLOSING THE BLADDER IN PLACE BUT NOT YET TIED.

with fine catgut between for accurate approximation; the cervical part of the fistula was left open, and the vaginal vault was not closed. See Fig. 222. A vaginal pack was then put in and the bladder drained by a catheter.

In two weeks the silkworm-gut sutures were removed and the union found perfect throughout.

**Other Vesical Fistulæ.**—Aside from the genital fistulæ which have just been discussed, fistulous communications with other organs are but rarely observed. This immunity is due to the fact that some unusual accident is necessary to

establish a communication between the bladder and any of the other abdominal or pelvic viscera.

A communication may be formed in this way between the bladder and a tube or an ovary and between the bladder and the small or large intestine. When the bladder communicates with a tube or an ovary this is brought about in one of two ways: either (1) an abscess of the tube or ovary perforates the broad ligament at its base and so finds its way into the bladder, or (2) an ovarian tumor forms adhesions with the peritoneal portion of the bladder; the septum becomes thinned out and finally breaks, and the contents of the cyst escape by this avenue.

An abscess perforating the broad ligament commonly finds its way into the bladder in the neighborhood of the right or left cornu—that is, at either end of the posterior fold. I have seen a case of a tubercular abscess of the tube on the right side of the pelvis discharging in this way.

A suppurating dermoid cyst may break through into the bladder and the nature of the abscess be determined by the escape of hair (pilimiction) or bones discharged *per urethram*, or even by a tooth found as the nucleus of a vesical calculus. A case of this sort is well described by Dr. G. C. Blackman (*Amer. Jour. of the Med. Sciences*, January, 1869, p. 49). The patient, thirty-six years old, first noticed air escaping from the bladder, then urine passed by the rectum, and she suffered from a cystitis. A calculus was found and removed. This contained a tooth, and in the course of seven years four similar calculi containing teeth as nuclei were extracted. Some months after the last one was removed she began to pass hairs incrustated with phosphatic deposits. Dr. Blackman also gives a careful review of the literature of the subject.

Fig. 225 shows the condition found in a patient of Dr. Henry Elsner, of Syracuse, N. Y., in a case of pyuria due to a dermoid cyst. The patient, forty years old, had known of the existence of the tumor for over twenty years.

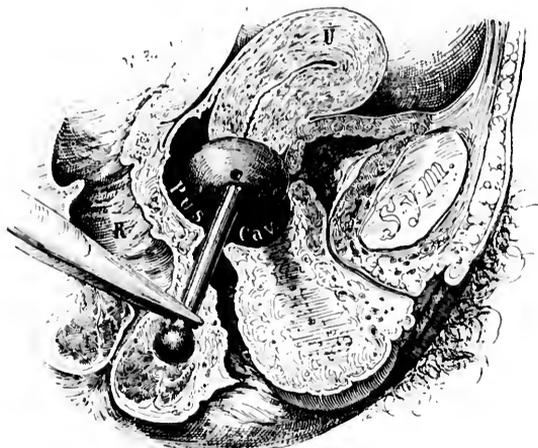

FIG. 223.—VESICO-VAGINAL FISTULA, CAUSED BY A PESSARY SEEN IN SAGITTAL SECTION.

The shank of the pessary lies buried in the recto-vaginal septum. The vagina is atretic and the pus cavity in its upper portion discharges into the bladder, which lies contracted behind the symphysis, by a fistulous opening caused by the cup of the pessary. The hypertrophy of the vesico- and urethro-vaginal septum is also shown, as also in Fig. 224.

Three years before the operation the previously movable tumor became fixed above the symphysis, and for the same length of time she suffered from a pyuria.

The tumor was found at the operation to be a right dermoid cyst densely adherent to and discharging its contents into the bladder; after freeing numerous surrounding adhesions, the dense, fibrous sinus, 3 centimeters in diameter, was

dissected out down to the bladder just above the symphysis pubis and cut off, exposing a lumen of about 3 millimeters.

This was closed by six interrupted buried catgut sutures and the vesical peritoneum was then drawn over it and united by six more catgut sutures, leaving a longitudinal linear wound at the site of the attachment. No drain was used. The pus disappeared at once and a perfect recovery followed. When drainage is necessary it is easy to make the wound entirely extraperitoneal by uniting the peritoneum from the bladder up on to the abdominal wall, so as to leave whatever space is desired between the peritoneum and the symphysis.



FIG. 224.—ENORMOUS HYPERTROPHY AND EDEMA OF THE ANTERIOR VAGINAL WALL SIMULATING CYSTOCELE, DUE TO CYSTITIS. NOV. 27, 1895.

An extra-uterine sac may also suppurate and open into the bladder, and the nature of the affection first be made clear by the escape of one of the bones through the urethra.

Therig (*Centralbl. f. innere Med.*, Bd. xv, p. 97) has observed in women two cases of paratyphlitic (vermiform appendix?) abscesses breaking into the bladder; both recovered under irrigation.

A case of colo-vesical fistula is reported by R. Harrison (*Twentieth Century Practice*, New York, 1895, vol. i, p. 222). Air bubbles escaped through the urethra and granular cells and spiral vessels were found in the urine, and after death the colon was found adherent to the bladder and a cherry-stone lying in a diverticulum among the adherent intestines. The *débris* in the urine evidently came from the disintegrating kernel of the stone.

The symptoms produced by the communication of any of these extra-

vesical sacs with the bladder are those of cystitis, often with fever and chills, and the admixture of varying amounts of pus with the urine, and it may be with other elements which characterize the kind of tumor.

The diagnosis will be made by the ordinary routine cystoscopic examination, which reveals the secondary catarrhal condition of the vesical mucosa and the intenser area of inflammation around the fistulous opening in whatever part of the bladder it is located; and by passing a searcher into the fistula, and in some cases on into the sac. The bimanual examination will also often show the presence of an inflammatory mass in close communication with the bladder, and in an entero-vesical fistula the passage of air bubbles by the urethra is significant.

In the case of tubercular abscess referred to above I found pus in the urine, varying in quantity at different times, and occasionally tubercle bacilli. The inflammation in the bladder was most intense at the right cornu—that is, in front of the right broad ligament, where there was a group of fleshy granulations. A little bubble of air oozing out between these one day when the patient was being examined in the knee-breast position revealed the presence and position of a fistulous orifice. An examination under anesthesia now showed that the right tube and ovary were contracted down into a small hard mass adherent to the base of the broad ligament, through which they communicated with the opening in the bladder.

Dr. C. P. Noble, of Philadelphia (*Med. and Surg. Reporter*, January 19, 1889), had a case of recto-vesical fistula following an ischio-rectal abscess five years before. After the abscess discharged she passed wind and small pieces of fecal matter by the urethra at irregular intervals.

At the examination an extensive old scar from a pessary was found on both sides, and in the posterior fornix of the vagina, but no fistula could be found after the most careful search. At Dr. Noble's suggestion, however, on the following day hydrogen gas was forced into the rectum, found its way into the bladder, and was lighted at the end of a catheter introduced into the urethra.

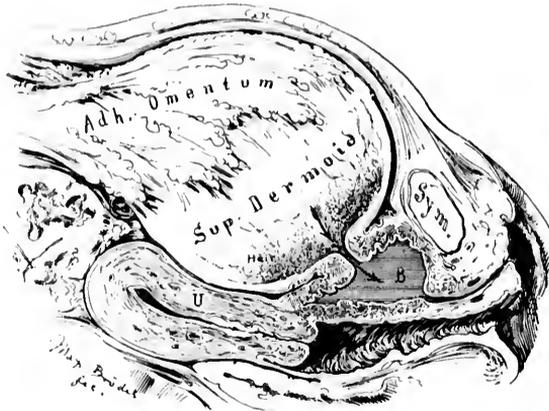

FIG. 225.—PYCRIA DUE TO SUPPURATING ADHERENT DERMOID CYST OPENING INTO THE BLADDER (B). DEC. 17, 1896.

**Treatment.**—The proper line of treatment must depend on the individual case; no general rules can be laid down. The local affection of the bladder tends to a spontaneous recovery when the cause is removed. If the patient's health will permit it, a sac which opens into the bladder should therefore either be enucleated and the source of the discharge stopped, or evacuated and drained in some other direction—into the vagina, or by the abdominal wall—so as to give the bladder a chance to recover.

In one of the worst cases of pyuria I have ever seen a cure was effected by opening and draining the abscess, which lay in front of the uterus, through the anterior fornix in the vagina. In another case a pelvic abscess on the right side, discharging through the bladder, was relieved by enucleating both tubes and ovaries with the uterus, leaving the vaginal portion of the cervix, which was sewed over the fistulous orifice at the base of the broad ligament, so as to divert any discharges into the vagina. The fistula could not be closed by direct suture on account of the friable inflammatory tissue composing its walls.

**Hemorrhoids.**—**Varicose Bladder.**—A hemorrhoidal condition of the bladder or vesical varix is a rare affection, in spite of the fact that all the favoring conditions for its frequent occurrence seem to be supplied in the venous stasis so often found in the pelvis, in the enormous congestion of hemorrhoidal venous sinuses, as well as in the congestive disturbances found in association with retroflexion of the uterus. The frequency of inflammatory disturbances in the neighboring genital organs, and the great development of crural and labial varices in pregnancy, as well as the increased amount of blood observed in the bladder in that condition, would also lead one naturally to expect to meet with a varicose condition of the bladder as a common occurrence under these circumstances. When found in men vesical varix is apt to be associated with rectal hemorrhoids. The cause of vesical varix has been shown in them to be due to an insufficient size of the venous channels above the communication of the hemorrhoid and the vesical plexuses, so that a lower rectal congestion brings with it at the same time a vesical stasis. In 1854, Guyon exhibited a case at the Anatomical Society of Paris in which the neck of the bladder was surrounded by a varicose venous circle with diverging dilated submucous ramifications.

H. Picard (*Traité des mal. de la vessie*, Paris, 1878, p. 284) found in an autopsy on a man who died of this disease that the large venous plexuses surrounding the prostate communicated with the hemorrhoidal plexus. The mucosa of a large part of the bladder itself bristled with a great number of varices, forming little bluish tits about its neck, on the base, and extending high up on the lateral walls. Each little titlike projection was the elbow of a vein projecting from 1 to 2 millimeters beyond the surface of the bladder. Some of the vessels near the neck showed abrasions, and others were perforated, demonstrating the source of hemorrhage, and probably of the infection of which the patient died.

In the clinical history the one characteristic symptom is the repeated hemorrhages. In men retention of the urine has also been noted as a common symptom.

The diagnosis between this condition and papilloma and cancer in its

early stages, by symptoms and an external examination, is only made with difficulty. If the hemorrhages come on with an attack of the piles, vesical varix may be suspected, especially if difficulty in urination occurs at the same time. Vesical varix is also found when there is a periodical bleeding alternating between the rectum and the bladder.

All doubt may be easily cleared up in women by making a direct cystoscopic examination of the mucous surface of the bladder, when the blue congested vessels may be easily inspected and their number, size, and distribution determined. In such a case it is better to examine first in the dorsal position under a moderate degree of elevation, to avoid the tendency of the knee-breast position to produce an artificial anemia, temporarily relieving the very condition one wants to see. The inspection should be carefully extended over the whole circumurethral area, and from thence down the urethra as the speculum is withdrawn.

Arbutnot Lane, at a meeting of the Clinical Society of London (*Lancet*, March 18, 1895, vol. ii, p. 1252), reported a rare condition under the title of *A Nevoid Growth of the Mucous Membrane of the Bladder*.

A child, aged three years and a half, had been passing bloody urine for two years, the blood at times coming away in large clots. When seen by Lane the hemorrhage was so severe and had been so long continued as to endanger life. On examining the patient, several nevoid patches were seen around the anus and on the buttocks. By abdominal palpation the bladder could be distinctly felt above the pubes. When the bladder was opened above the symphysis pubis, large nevoid masses, some as large as grapes, protruded through the wound; most of these were soft and bled easily; a few were hard and apparently cystic. Almost the whole of the mucous surface of the bladder was affected.

As an operation seemed to be practically out of the question, the incision was closed, and afterward the hemorrhage practically ceased, the urine being only a little blood tinged at times.

**Treatment.**—If the discovery of the varicose condition is made accidentally, and there are no urgent symptoms, nothing should be done, but in a persistently bleeding case in a woman, after diagnosing the cause of the bleeding and locating its position in the bladder, one of several plans may be followed; in a mild case the galvano-cautery introduced through the speculum may be used over small areas at several sittings.

If the urethra is dilated to admit a No. 15 to 18 speculum, one or more ligatures even may then easily be thrown about several of the larger venous trunks by means of a fine curved needle on a fixed handle carrying fine silk, which can then be tied by using a little instrument pronged like a pitchfork to afford a point of counter pressure within the bladder. A more active and direct interference may be made by means of an incision through the anterior vaginal wall, everting and exposing the veins at the neck of the bladder. Several of the larger trunks may then be tied with fine silk and the vaginal incision closed again.

Dr. W. Ryan, of Springfield, Ill., had a case of varix in a woman which he

successfully treated by a suprapubic incision. The patient was thirty-one years of age and married, and for six months had passed large quantities of blood with her urine, in clots; whenever the bladder became distended with the

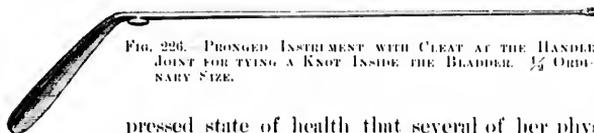

FIG. 226. PRONGED INSTRUMENT WITH CLEAT AT THE HANDLE JOINT FOR TYING A KNOT INSIDE THE BLADDER.  $\frac{1}{2}$  ORDINARY SIZE.

clots her suffering was extreme. She was so anemic and in such a generally depressed state of health that several of her physicians thought she was suffering from a serious renal affection. There were no rectal hemorrhoids at all. Washing out the bladder and the use of injections only made her worse.

On December 19, 1890, Dr. Ryan opened the bladder above the symphysis pubis and found an extensive dilatation of the veins about the neck of the bladder, at the base, and running up on the sides just under the intact mucosa, about 2 millimeters in diameter. In opening the bladder, some veins about the neck were cut, and continued to bleed moderately through a drainage tube which was left in for five days. After this simple treatment, incision, inspection, and drainage, she made a perfect recovery.

**Hyperemia.**—By hyperemia or a congestion of the vascular system of the bladder is meant either a local or a general flushing of the vesical capillaries, producing an increased redness of the surface, in contradistinction to a hemorrhoidal condition, where the venous trunks are involved and the capillary veins are greatly distended. A physiological hyperemia of the bladder may be observed when nature determines any large amount of blood to a neighboring organ, as, for example, in pregnancy. A localized hyperemia of the vesical mucosa is often found also associated with inflammatory disease in the immediate neighborhood. The withdrawal of the obturator from the end of the vesical speculum always produces a little patch of hyperemia on the posterior vesical wall by acting for a moment as a piston and sucking the vesical mucosa into the end of the speculum.

**Hyperemia of the Trigonum.**—This is a common condition localized in the trigonum, and rarely extends beyond its limits, except into the urethra.

The entire surface of the trigonum may be of a deep rosy red, the injection extending around both ureteral orifices; the border of the injected area becomes gradually merged into the surrounding sound tissue. The surface of the mucosa sometimes has a slightly puffy or edematous appearance. The injection may be of a patchy nature only surrounding the ureteral orifices, or it may even be limited to the neighborhood of one ureteral orifice.

The margins of the injection when not limited by the interureteric line are irregular in outline. The most intense injection is often in the area closest to the urethra, which is also deeply injected in its upper part, and characterized by prominent lacunae.

The symptoms produced by a hyperemia are characteristic. The patient

suffers from a desire to empty the bladder at frequent intervals, either by day or by night, or both; she often complains of a burning or bearing-down sensation, or of a feeling of fullness about the neck of the bladder. The act of urination is sometimes painful, but not always; very often after urinating there is a distressed feeling about the parts, which persists for some minutes or even an hour or more, leaving her much depressed. Other patients may not feel the desire to urinate more frequently than ordinary, but the distress is experienced afterward. The whole area is extremely tender to the touch either by the end of the speculum or a probe.

The causes of this disease are sometimes difficult to determine. I find it in all those cases which have hitherto been diagnosed as "irritable bladder," or "teasing of the neck of the bladder from retroflexion of the uterus," or "pressure of an ante-flexed uterus on the bladder," or "neuralgia of the bladder"; it is also the only lesion existing in many of the cases under treatment for a supposed cystitis.

It is frequently observed after abdominal pelvic operations, and appears to be due in these cases to the irritation of the vesical mucosa by the highly concentrated urine discharged during the first few days. I have for the past two years almost eliminated it from my wards by giving every such patient a large rectal enema of normal salt solution before she leaves the operating table; the salt solution dilutes and greatly increases the flow of urine.

Another fruitful cause of hyperemia of the trigonum is the slight mechanical insult of catheterization. It may be that a mild infection lies at the bottom of some of these cases, and that the affection is in reality a form of trigonitis, but this remains to be proved.

**Diagnosis.**—The diagnosis will not be difficult if all cases of "vesical irritability" are examined by the direct method.

The marked redness in the trigonum is at once apparent, and the evidence is still more decided when there is a patch of it on one side while the other remains clear. Often the patient complains bitterly when the end of the speculum touches this spot, and if it is touched with a searcher she will declare at once that the seat of her discomforts is located there.

The examiner must guard against two errors in making the diagnosis: First, he must not mistake the physiologically greater injection of the trigonum over that of the rest of the bladder for a hyperemia; he will avoid this by familiarizing himself with the appearance of the normal trigonum, and allowing for the slight difference in color which always exists.

In the second place, he must not mistake the hyperemic blush about a urethral orifice, which is so commonly met with as a sign of disease of the kidney or ureter of that side, for a simple hyperemia. A few leucocytes are sometimes found in the urine when the hyperemia is intense.

**Treatment.**—The treatment should be directed to the cause when it can be discovered. If it follows an operation, recovery is usually spontaneous within two or three weeks. If the urine is highly charged with urea, diluents should be given; water and flaxseed tea, and citrate of potash and lithia in large doses are all useful. I have found the most relief from half-teaspoonful doses of

sweet spirits of niter repeated every two hours; fluid extract of *zea mays* and *tritium repens* in half-teaspoonful doses are valuable, particularly the first remedy. Any articles of diet, such as tomatoes, fruits, or acids, should be avoided when the patient finds that they aggravate her condition. The bowels must be kept well opened all the time. A prolonged hot vaginal douche often gives great relief.

When these means fail, direct topical treatment should be begun by placing the patient in the knee-breast position and exposing the affected area, and applying a 3 to 5 per cent solution of nitrate of silver to the affected area alone. It is easy to do this with a little absorbent cotton twisted on a wire applicator. These applications may be repeated every three to five days as long as the affection continues to improve. If the convalescence comes to a standstill I then inject 4 to 6 cubic centimeters of a 2 to 3 per cent solution of ichthyol in glycerin into the empty bladder, and insert Clark's rubber balloon as described in the next section on cystitis, inflate it, and leave it in for from five to ten minutes.

**Cystitis.**—**Bacteriology:** Cystitis is a disease much less frequent in women than in men, and exceedingly rare in children. An infection is the true cause of every case of cystitis, and the continuance of the disease depends upon the continued action of one or other of the various pathogenic micro-organisms. The term cystitis is therefore a collective name for a variety of inflammatory affections having certain symptoms in common in their early stages, but often differing widely in their final forms.

The commonest avenue of infection is through the urethra, in which numerous organisms are constantly found normally; these organisms, together with organisms from the vulva lodged on the external urethral orifice, may be carried into the bladder by the catheter, sound, or other aseptic instrument, or they may be introduced on nucleon instruments, and the infection started up in this way. It is also necessary to allow for a few cases in which the organisms enter the bladder from the urethra without instrumentation, especially where the urethra is dilated and patulous, as in women who have borne many children.

The bladder may also be infected from the kidney either when the kidney or its pelvis is diseased, as in pyelitis or pyelonephrosis, or, as has been shown, even when the kidney itself is healthy, the organisms may be eliminated from the body through it, and so may infect the bladder. A chain has also been made by Wreden (*Arch. des Sciences Biologiques*, St. Petersburg, Bd. ii, 5, 1894) that a direct infection of the bladder may take place from the intestine under certain conditions; in support of this are the experiments upon animals, occluding both rectum and urethra, with the invariable result of occasioning a true cystitis, in which usually pure cultures of the organism used in the experiments may be isolated from the bladder.

C. Posner and H. Lewin report a series of experiments (*Centralbl. f. Harn- und Sexual-Organen*, Bd. vii, Heft 7, 1896) which throw much light upon this question of a direct infection; they found, after closure of both the rectum and the urethra, that while they were always able to get pure cultures from the blad-

der of either the colon bacillus or the special organism used, these organisms were always present in the blood, and in the substance of the kidneys as well, so that although the result of the investigation does not entirely preclude the possibility of a direct passage of the intestinal bacteria into the bladder, it renders it less probable, while the chances are that the infection travels through the blood into the kidneys and so enters the bladder. In several cases in which they injected coloring matter into the rectum, in no instance did it appear in the bladder or bladder wall. The entrance of the organisms into the blood is explained by the fact that there was always some wound of the intestine or rectum, from the clamp or a ligature, opening up an avenue for their direct passage into the finer blood vessels or into the lymphatics.

It is also possible that as a result of the ligation changing the circulatory conditions from the normal the organisms may have penetrated the unwounded intestinal wall, and so have entered the lymphatic circulation. That this sometimes occurs in the human being is beyond question, for we know that while the bacteria are unable to pass through the normal intestinal mucosa, they do penetrate the mucosa and enter the peritoneal cavity when the vital activity of the intestine is lowered or dead, as, for instance, where there is a strangulation of the intestine, or where the blood supply is cut off. The colon bacillus is not infrequently found free in the peritoneal cavity under such circumstances.

On the other hand, Reymond (*Ann. des mal. des organes gen. urin.*, April, 1893) has proved beyond any question that bacteria can enter the bladder directly from inflammatory areas in the neighboring organs. He was struck by the frequent occurrence of cystitis in women suffering with inflammation of the uterus or of the Fallopian tubes, and in most cases proved by culture that the organism was the same in both organs; as an additional proof, he found in a case of salpingitis in one tube a localized cystitis on the same side in the bladder. To complete his chain of evidence it was necessary to prove that the organisms could pass directly through the walls of the bladder from the neighboring inflamed area. To do this he laparotomized dogs and injected 2 or 3 centimeters of a culture of the uro-bacillus liquifaciens of Krogins, which he had isolated from a case of salpingitis and cystitis, under the peritoneum covering the bladder.

Ten hours latter, on removing the ligature from the penis, he found a cystitis present, and was able to obtain pure cultures of the uro-bacillus from the bladder, cultures from the blood and kidneys remaining sterile. He also demonstrated the organisms in the bladder walls under the spot where the incision was made, and at this place the cystitis was most marked, showing in one case an ulcerated area. By further experiments he proved that the organism was able to penetrate the peritoneum.

The clinical cases, together with the experiments on animals, prove his conclusion that cystitis may arise from the passage of organisms directly from a diseased tube or ovary, the blood, kidneys, and other organs remaining sterile, when the predisposing condition is present in the form of a congestion of the bladder caused by the neighboring infected area.

Finally, the infection may come from rupture into the bladder of purulent collections in the other abdominal viscera, as, for instance, in the rupture of tubal, ovarian, or perityphlitic abscesses.

The direct predisposing causes are still to some extent unknown. We do know, however, that in the normal bladder, though there are often pyogenic organisms present, cystitis is not set up; this has been amply proved by experiments both on the lower animals and on the human being, for we know that the typhoid bacillus and many other pyogenic organisms are excreted by the kidneys and pass through the bladder without the least harm being done. This fact gives us an important starting point for our investigations, as it proves that the presence of the bacteria alone is insufficient in the normal bladder to cause an inflammatory reaction.

Melchoir (*Cystite et infection urinaire*, Paris, 1895) found in numerous experiments, after injection of cultures of the various pyogenic organisms, and ligation of the urethra to cause retention, that he was always able to produce a cystitis in animals, the urine containing blood, pus cells, and many bacteria; cystitis superinduced in this way clears up, however, in a few days. This explains the frequent occurrence of cystitis in old men with enlarged prostate glands, and also in women who are suffering with prolapsus of the uterus dragging down the bladder; in both cases there is always a certain amount of residual urine in the bladder.

Melchoir also found that after a slight traumatism of the bladder wall cystitis occurred readily, and under this head we can place the cystitis following catheterization and instrumentation of the bladder, also the cystitis following childbirth.

Stone in the bladder, by pressure and injury to the vesical walls, is often a predisposing cause, and cystitis accompanies very often the growth of either benign or malignant neoplasms of the bladder walls. Further, the ingestion of irritating drugs by their irritating or caustic effects on the vesical mucosa prepare a suitable soil for the entrance of the bacteria. The scanty urine highly charged with urea and various other salts, which is excreted after operation, also acts in the same way. Finally, the congestion of the bladder as a result of pelvic inflammation is an important cause, as proved by Raymond.

The alkaline or ammoniacal urine which was formerly considered as a cause of cystitis is now known to be merely a secondary result of it; it follows the decomposition of the urea into carbonate of ammonia, this decomposing power being the property of certain bacteria.

Many different organisms have been isolated in cystitis. Clado (*Étude sur une bactérie septique de la vessie*, Paris) found one bacterium occurring so often and so virulent in character when injected into mice that he turned his attention entirely to it; he describes it under the name of "Bactérie septique de la vessie." Since the work of Clado many articles have appeared describing various other organisms found in the urine taken from cases of cystitis.

Albarran and Hallé (*Note sur une bactérie pyogène et sur son rôle dans l'in-*

*fection urinaire*, *Bull. de l'acad. de méd.*, 1888) describe an organism found by them in forty-seven out of fifty cases of infection of the urinary tract, the organism being present in pure culture in fifteen out of the forty-seven cases; this was named by them "bactérie pyogène."

Doyen (*Journal des connaissances médicales*, 1888, p. 226) studied the organisms present in cases of ascending pyelonephritis, and found three varieties of the proteus.

Rovsing (*Blasen-Entzündungen*, Berlin, 1890) studied the urine from thirty cases of cystitis, all but three of which were ammoniacal, and found in five of the thirty the tubercle bacillus, in eight the staphylococcus pyogenes aureus, and in three the staphylococcus pyogenes albus and citreus; he also found in the other cases various undescribed organisms—the streptococcus pyogenes ureæ, the diplococcus ureæ pyogenes, in two cases the cocco-bacillus ureæ pyogenes, and in one case micrococcus ureæ flavus pyogenes.

Krogius, the author of several articles on the bacteriology of cystitis and other urinary infections, has come to the conclusion that the organism, a short bacillus commonly found by him, was in fact an intestinal bacillus, probably the colon bacillus.

Melchoir published in 1895 the results of the bacteriological examinations in thirty-five cases of cystitis, and found that among these the colon bacillus was present in pure culture seventeen times, and was present altogether twenty-four times. The streptococcus pyogenes was found four times, the proteus of Hauser four times, the tubercle bacillus three times, and the gonococcus and typhoid bacillus each once; the remaining organisms were undescribed until he isolated them.

Melchoir also thinks that the organisms described by Clado, as well as those described by Albarran and Hallé and Morelli, are in fact only the colon bacillus which he found so many times, and he compares the modes of growth, size, and general morphology in a convincing manner.

Besides the above, Heyse (*Zeitschr. f. klin. Med.*, Bd. xxiv, 1894, p. 130) has described an interesting case of cystitis from infection by the bacillus lactis aërogenes, with the formation of gas in the bladder. He traced the infection from the intestines, where the bacillus was present in large numbers, to the vagina, where it had also evolved gas, from whence it had evidently been carried into the bladder by catheterization. Heyse also cites a case of pneumaturia described by Senator, who found the torula cervisiæ to be the cause of the gas formation in a diabetic patient.

The bacillus aërogenes capsulatus of Welch has also been isolated from several cases of pyelonephritis, and in one case reported by Goebel, from an autopsy performed at the Hamburg General Hospital, on an old man who had an enlarged prostate, the bladder was found filled with gas, and there were numerous gas blebs beneath the mucous membrane.

Fr. Vahle (*Inaug. Diss.*, Marburg, 1895) describes a case of exfoliative cystitis in a woman suffering with a myoma incarcerated in the pelvis, in which the

organism present was the *streptococcus pyogenes*; the patient died later of a septic peritonitis.

As in the bacterial infections in other parts of the body, we are likely to find in cystitis two or more varieties of organisms present at the same time, or, in other words, a mixed infection. This is especially likely to be the case in the more chronic forms of cystitis.

For example, Melchoir found in one case of cystitis accompanying carcinoma of the bladder the *baecillus coli communis* and the proteus of Hauser, in another case of cystitis of long duration, following a urethral stricture, the *baecillus coli communis* and the *streptococcus pyogenes*, and in still another case of long-continued cystitis the proteus of Hauser and the *streptococcus pyogenes*.

The pathogenic bacteria which have been most commonly isolated from the inflamed bladder may be summarized as follows:

The *baecillus coli communis*, the *streptococcus pyogenes*, the *staphylococcus pyogenes albus*, *citreus*, and *aureus*, the *baecillus lactis aërogenes*, *urobaecillus liquificiens*, the gonococcus Neisser, the typhoid bacillus, the tubercle bacillus, and several varieties of the proteus.

One can well see from this list that almost any pyogenic organism, entering the bladder under favorable conditions, may set up an inflammatory action.

Certain of these micro-organisms seem to follow some definite route of entry to the bladder: the gonococcus, for example, always travels up the urethra, and the cystitis which develops from it belongs to the group of ascending infections; the colon bacillus may take the same route, or it may penetrate the tissues and pass more directly from the bowel into the bladder. This is especially likely to happen if the bowel is adherent to the bladder or opens into it.

The bacillus tuberculosis is often a descending infection, finding its first habitat in the kidney and then traveling down the ureter to the bladder.

Finally a condition has been described by H. Krogius (*Annales des maladies des organes genito-urinaires*, 1894, p. 96, 210), B. Goldberg (*Centralbl. f. Harn- und Sexual-Organ*, Bd. vi, 1895, p. 352), and others under the name of "bacteriurie," in which, with no sign of cystitis except the presence of a few pus cells, the urine simply swarms with bacteria when voided, and has a peculiar fetid odor.

To summarize, we find the following facts:

1. That cystitis is always caused by the presence of bacteria.
2. That the mere presence of bacteria is insufficient to cause a cystitis, a further predisposing cause is necessary.
3. That there are various modes of entrance for bacteria—through the urethra, through the ureter from the kidney directly, from inflammatory areas in the uterus or Fallopian tubes, and probably from the rectum under like conditions; still another probable avenue of entrance is through the blood.
4. That under favorable conditions any pathogenic organism may give rise to cystitis.

**Distribution of the Inflammatory Area.**—From a purely clinical standpoint cases of cystitis may also be classified, according to the location and distribution of the inflamed area, as—

Diffuse cystitis (*cystitis diffusa*), involving the entire mucosa of the bladder;

Circumscribed cystitis (*cystitis circumscripta*), where the disease is confined to a patch; or

Scattered cystitis (*cystitis dispersa*), where the disease is distributed in patches over the surface.

Such a division of the forms serves to direct the attention to a fact of the utmost importance hitherto overlooked in the treatment of these cases—that the cystitis is not always a disease of the entire mucosa of the bladder, but is far oftener found in patches with sound areas between, the sound portion usually preponderating. The practical corollary from this is, that it is irrational to treat the whole inner surface of the bladder by the injection of a strong solution which may seriously harm the sound mucosa.

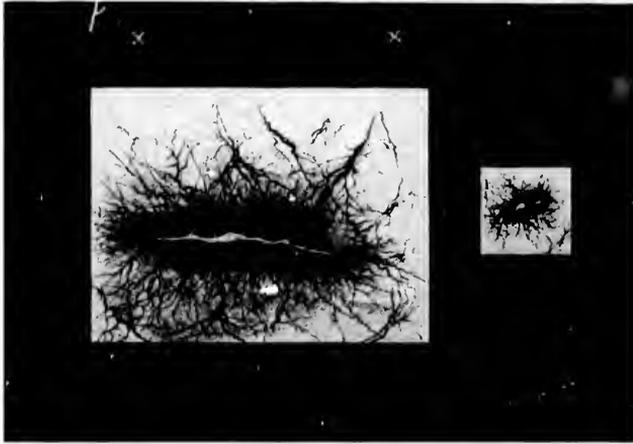

FIG. 227.—LINEAR ULCER OF THE BLADDER ON THE POSTERIOR WALL, APPEARING AS A YELLOWISH-WHITE SURFACE SURROUNDED BY AN AREA OF INTENSE INJECTION, ABOUT 3 MILLIMETERS BROAD; THIS AGAIN IS SURROUNDED BY AN AREA OF INJECTED LARGE VESSELS, WHICH APPEAR TO CENTER IN THE ULCER.

The location of the ulcer is shown by the ureteral orifices. Two other small round ulcers in the same bladder, shown in their relative positions near by. Patient of Dr. P. Harris. Exam. Jan. 19, 1897.

According to the location of a circumscribed cystitis, it may be designated as trigonal, periurethral, fundal, apical posterior, right or left lateral.

If we add to this description of the form and location of the disease the name of the pathogenic organism, the outlined description becomes fairly complete; for example, we often have a *cystitis trigonalis* (*gonococcus*), a *cystitis posterior* (*tuberculosa*), or a *cystitis universalis* (*bacillus coli communis*).

**Pathological Anatomy.**—In acute cystitis the mucous surface of the bladder becomes intensely red and swollen and sometimes ecchymotic; in the chronic forms the bladder becomes discolored and grayish and the mucosa thickened and the tissue beneath it infiltrated.

In the more advanced stages there is a breaking down of the tissues in the center of the inflammatory area and an ulcer is formed. An ulcer of this kind, characteristically linear, is shown in Fig. 227; in other instances the ulcers are small, round, and grouped. When the inflammation is localized in the trigonum the ulcer formed often gives rise to excessive hemorrhages, runs a protracted course, and responds slowly to all but the most energetic plan of treatment. (See Fig. 228.)



FIG. 228.—ULCERS OF THE TRIGONUM OF THE BLADDER, LOCATED BETWEEN, AND A LITTLE IN ADVANCE OF, THE URETERAL ORIFICES.

Note the white surface of the ulcers and the deeply injected margins. Patient of Dr. Neff.

When the inflammation extends into the muscular vesical wall (cystitis parenchymatosa), abscesses may form and rupture into the bladder. In exfoliative cystitis the entire mucous lining may be thrown off like a cast, often bringing with it some of the muscular coat.

**Clinical History.**—The chief symptom common to all cases of cystitis is the frequent passage of urine accompanied with pain, most marked when the disease is situated near the neck of the bladder. The frequency varies from an hourly evacuation all the way down to one every five or ten minutes; tenesmus exists when there is great straining with the passage of small amounts of urine.

The amount of urine evacuated at one time varies from 15 to 20 cubic centimeters to but a few drops, and its emission is not followed by any sense of relief. The urine passed is turbid, flocculent, or contains mucus, and in aggravated cases blood. Pressure over the symphysis and on the base of the bladder through the vagina is painful, and can not be borne in a severe case. Fever and chills are absent, as a rule, and if present usually indicate an involvement of one of the kidneys by an extension of the infection up the urethra. Any instrumental examination of the bladder is so painful that it ought not to be persisted in without anesthesia; for this reason catheterization ought not to be practiced.

When the mucous secretion is in excess, but few corpuscles are found in the urine; in other cases, when there is a higher grade of inflammation (cystitis purulenta) there is a marked amount of pus deposited.

Gas in the urine (pneumaturia) comes from the gas bacillus (see Heyse,

*Centr. f. Klin. Med.*, Bd. xxiv), or from the decomposition of diabetic urine; gas is also observed when there is an entero-vesical fistula.

The duration of a cystitis varies from a short-lived affection to one of years' standing; the gonorrhoeal cases in women are most apt to recover quickly and spontaneously. The catarrh of the bladder which is found associated with calculus recovers when the cause is removed. The most protracted cases are those of tubercular origin and those following labor. When cystitis is associated with a diphtheritis or gangrene of the bladder the termination is speedily fatal. In cases of old standing the muscular walls may become so hypertrophied as to form a hard mass like a tumor behind the symphysis.

**Diagnosis.**—It is always easy to diagnose a case of cystitis if the proper examination is made; this includes (a) a history of the illness, (b) examinations of the urine, and (c) an examination of the mucous surface affected.

Many women actually under treatment for cystitis only suffer from hyperemia of the trigonum, or mild inflammation of the upper urethra; with a careful examination of the urine and inspection of the bladder such a mistake in diagnosis could not occur. The history of the case includes the characteristic symptoms just referred to, either coming on gradually or dating from some particular occasion; strangury and tenesmus are the most important symptoms. The examination of the urine reveals the presence of bacteria, and when they are found in pure culture they are usually the cause of the cystitis.

In tubercular cystitis the discovery of only a few of the characteristic tubercle bacilli, made after repeated searches, will be sufficient to make the diagnosis clear. In one of my patients, my assistant, Dr. J. G. Clark, exposed an ulcer in the bladder distended with air, and curetted off a little portion, in which numerous tubercle bacilli were found. When the colon bacillus is the infecting organism it is often found in the urine in pure culture.

The direct examination of the inflamed bladder gives the surest information as to the existence of the disease, its grade, and its extent.

The knee-breast position is the most convenient one for seeing all parts of the organ, but in milder grades of cystitis the artificial anemia induced by the posture and expansion tends to obliterate the characteristic signs; it is better, therefore, in these cases to examine in the dorsal position with a slight elevation. The patient should be put under anesthesia for the first investigation, so that it may be thoroughly made. The inspection begins at the posterior wall, and extends in an orderly manner over the whole organ, as described.

In this class of cases one is apt to find at the posterior pole a superficial layer of blood on the mucosa, which has come from the trauma of the end of the specula impinging on the inflamed delicate mucosa. The difference between this and the submucous hemorrhage can be detected by wiping the surface with a pledget of cotton, when the blood comes off. The affected areas are rendered strikingly apparent by contrasting the normal whitish background and the deeply injected patches of inflamed tissue. In the sound parts the capillaries are rarely seen, and the pale mucosa is mapped out by larger branching vessels, but the dis-

cases areas show a fine capillary network, or capillaries so numerous that a general red color of varying intensity prevails.

By the bimanual examination the bladder is found tender to touch, and when the muscular coat is thickened it may feel like a tumor behind the symphysis. In one of my cases I found a hard ovoid mass as big as a hen's egg lying transversely in front of the uterus; this proved to be a tuberculous bladder in the last stages of the disease. (Fig. 229.)

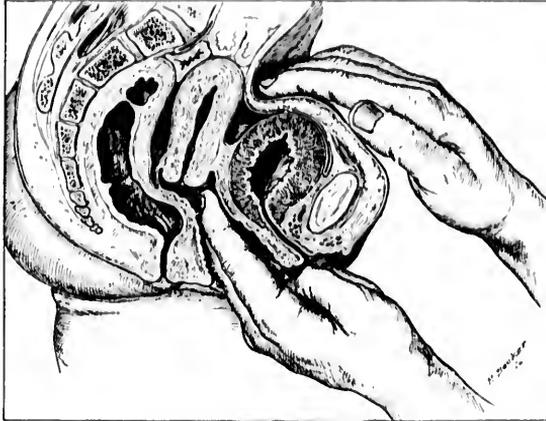

FIG. 229.—TUBERCULAR CYSTITIS.

Shows the markedly thickened vesical walls and the method of palpating the bladder bimanually.

**Treatment.**—The treatment of a cystitis will vary widely, according to the cause and character of the inflammation. When there is a continuously acting cause, such as a stone in the bladder, or urine pouring out of an infected kidney, or a stagnation of the urine in an imperfectly emptied bladder, these conditions must be relieved before any progress can be made toward a cure. As a rule, it is sufficient to remove the cause to effect a cure, and this will be done in the instances cited by lithotomy, or by nephrectomy, or by nephro-ureterectomy, when the ureter is involved too, or by relieving a prolapsus of these uterms and the bladder, and washing out the stagnant urine two or three times daily with warm borie acid solutions (2 to 3 per cent).

**Treatment of Acute Cystitis.**—An expectant palliative plan of treatment should be pursued in acute cases; under these circumstances local treatment or interference of any sort aggravates the intensity of the inflammation. The patient must stay in bed in a warm room, the bowels be kept open, and the diet reduced to liquids and soft food; all stimulants must be prohibited. Prolonged vaginal douches, lasting fifteen to twenty minutes, given three times daily, help to relieve the congestion; hot applications should be kept on the lower abdomen, if they give comfort. Hot sitz baths and dry hot bran bags are also valuable adjuvants.

While the pain is excessive and persistent it is necessary to give the patient as much relief as possible, and to insure some hours of rest and sleep every day. Morphine meets this indication better than any other drug, and the best way to use it is to give enough of it hypodermically in two or three doses to secure about eight hours of continuous rest. During the remaining sixteen hours codeia may be tried, and hyoscyamus and belladonna should be given in suppositories, or an occasional rectal enema of 30 drops of deodorized tincture of opium in 100 to 120 cubic centimeters of warm starch water.

As soon as the inflammation begins to subside, as shown by the lessened pain and frequency of micturition, the convalescence will be greatly promoted by washing out the bladder two or three times daily with lukewarm water containing 2 per cent of boric acid or 2 per cent of ichthyol.

**Treatment of Chronic Cystitis.**—The treatment of chronic cystitis must always be one of active interference. Four plans of attack are available: (a) medication, (b) irrigation or instillation, (c) direct topical treatment, (d) surgical treatment.

**Medication.**—A great variety of drugs have been recommended as beneficial in curing or relieving chronic cystitis; there is a large amount of trustworthy testimony in favor of salol in doses of from 3 to 5 grams daily in divided doses; under its use the symptoms abate, and the bacteria in the urine diminish in numbers. Quinin, which is largely eliminated by the kidneys, has a sedative effect on the urinary organs, and is said to act effectively in sterilizing the urine. Salicylate of soda in a 5 to 10 gram dose is also used in some cases with good effect.

In the rarer gonorrhœal cases oil of sandalwood or oil of copaiba in capsules, 5 to 10 minims each, give excellent results. Eucalyptus oil has also been found useful in 10 minim doses every two hours. Fluid extract of *zea mays* corn-silk), in half teaspoonful doses, is the best drug I know to allay the irritability of the bladder; fluid extract of *triticum repens* is used in the same way.

A milk diet is of the best service in many cases.

**Irrigation.**—Irrigation, or washing the bladder out, is a necessary adjunct to other means of treatment; by this means the bladder is thoroughly cleansed, and enormous numbers of bacteria removed with mucus and other *débris*, often imperfectly discharged in micturition, and for a time at least the bladder walls are relieved from the constant contact with toxic products.

The irrigation may be carried out in two ways: either by letting small quantities of the fluid run in and directly out again, or by injecting larger quantities, so as to distend the bladder sensibly, and then, after an interval of from a few seconds to a minute, letting it flow out again. The latter plan has the advantage of distending the bladder so that its entire mucous surface is cleansed by coming into contact with the solution. The amount of discomfort experienced by the patient should serve as a guide as to the amount of distention to be practiced at each sitting, and with repeated trials it will be found that the bladder grows more tolerant. The irrigating solution is apt to give pain if its specific gravity

is much below that of the urine; for this reason plain warm water, although useful mechanically, is not well tolerated.

A satisfactory solution (see A. S. Lobingier, *Medical News*, Philadelphia, Oct. 15, 1892, p. 425) is made with a powder of boric acid, borax, and chlorate of soda in the respective proportions of 4, 2, and 1 grains dissolved in half a liter of hot water, and used warm.

Solutions of the bichloride of mercury have a bactericidal effect and are of the utmost service in most cases of chronic cystitis. It is best to begin using weak solutions of 1 to 100,000 in water in which a little common salt has been added (6 per cent), and to increase the strength each time until they are used as strong as 1 to 10,000 or 1 to 5,000. It is well to vary these irrigations with the milder boric acid solutions, using them on alternate days, or one in the morning and the other in the evening.

Weak solutions of carbolic acid, not stronger than 1½ per cent, often do good service. When the distressing symptoms have cleared up and the urine still remains purulent, Mr. Nunn (*Lancet*, Feb. 23, 1878) recommends the use of a quinin wash, beginning with one grain of the neutral sulphate to the ounce of water, with one drop of muriatic acid.

When the urine remains alkaline and there is a tendency to throw down phosphates, Mr. R. Harrison (*Twentieth Century Practice*, vol. i, p. 239) recommends irrigation with 5 to 10 grains of citric acid dissolved in a pint of warm water.

The technique of the irrigation is as follows: The patient is put on a table, or if she is too weak she is brought to the edge of the bed with the thighs flexed and the buttocks resting on a perineal drainage pad; the parts are then freely washed with a weak boric acid solution, taking particular care to remove all visible foreign material from the urethral orifice.

As an irrigating apparatus I use a simple glass funnel connected with a glass catheter by a piece of rubber tubing four feet long. A clip or a pair of forceps on the tubing controls the flow of the fluid. Unless the person giving the injection can be relied upon to do it skillfully, it is better to use a rubber catheter in place of a glass one, which may bruise the tissues.

The solution is now poured into the funnel, and allowed to run down and fill the tube and catheter; the injection of any air must be avoided, because it is painful. The catheter is then introduced into the bladder and the funnel held high enough to force the fluid slowly into the bladder; after waiting a while the funnel is now dropped below the level of the table and the fluid flows back again. If the solution is comparatively clear the maneuver may be repeated, but as often as it becomes turbid it should be renewed. Irrigation may also be practiced through a two-way catheter, such as that shown in the text; the fluid runs in the upper arm in the direction of the arrow and returns by the lower.

**Instillation.**—Instillation differs from irrigation in that the medicated solution is injected in smaller quantities and is left in the bladder for a time in order to secure a more protracted action on the bladder walls. In this way

solutions of nitrate of silver (1 to 2 per cent), sublimate solutions, and iodoform emulsions (5 to 10 per cent) have been used.

Instillations have been systematically used with excellent results by M. Guyon, of Paris. Small quantities of fluid have been used, in accordance with Guyon's dictum that the bladder does not possess an anatomical but a physiological capacity, and a painful bladder must not be distended. Solutions of the bichloride of mercury are used, in a strength varying from 1-1000 to 1-500, beginning with the weaker and gradually increasing up to the stronger solutions, and injecting

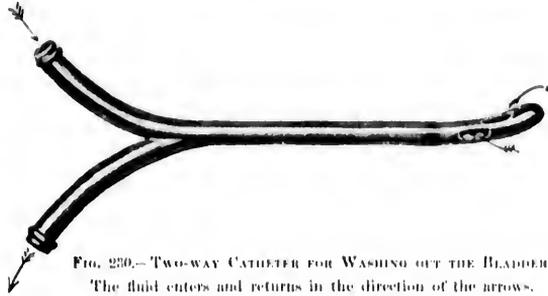

FIG. 250.—TWO-WAY CATHETER FOR WASHING OUT THE BLADDER.  
The fluid enters and returns in the direction of the arrows.

at first every other day and then every day as the patient's tolerance is tested. A syringe is used holding about 5 grains ( $1\frac{1}{4}$  drachms), and from 2 to 5 grains are injected slowly into the bladder and allowed to remain there from fifteen minutes to half an hour. The treatments must be continued for a period varying from some days to several weeks. Out of 34 cases so treated, 12 were cured, 9 were very greatly improved, 9 improved, and 4 unimproved.

**Direct Topical Treatment.**—By far the most efficient way of treating chronic cystitis is by direct topical applications, which, however, should not entirely supersede the use of internal medication or of irrigations or instillations.

There are two ways of treating the affected areas directly: either by exposing them to view and then applying a medicated solution, or by using a rubber balloon, which is inflated in the bladder so as to distend its walls and bring every point of its mucosa into contact with a medicated substance.

The first plan of exposing and treating the diseased patches is best in old chronic cases where the patches are few in number and do not cover much surface. This is done in the same way and with the same ease with which the bladder is inspected. The patient is put in the knee-breast position and the vesical speculum introduced, the air-distended bladder inspected, and the extent of the disease accurately determined and mapped out on a diagram for future comparison. The application is then made under direct inspection by means of a pledget of cotton twisted on a wire applicator, taking care to touch nothing but the diseased spots. This is easy if the parts are kept under view, and if the cotton is not too wet with the solution. The amount of surface treated at one time must be regulated by the kind of application made and by the extent of the disease. It is also well to proceed cautiously at first by trying any of the stronger stimulating drugs on a limited area and watching the effect. I often use at first a 5 per cent solution of nitrate of silver, following it up by a 3 per

cent solution every four to five days. If the mucosa is acutely inflamed at any point these solutions must not be applied.

The Vesical Balloon.—Dr. J. G. Clark's balloon treatment is applicable to all chronic cases where the disease is not so far advanced as to render any active local interference dangerous on account of the weakened condition of the patient. It is carried out as follows (see *Johns Hopk. Hosp. Bul.*, Feb. March, 1896):

Method of applying the Vesical Balloon.—Before using the balloon it should be boiled and placed in a boric acid solution or in sterilized water. The capacity of the balloon should always be accurately determined previous to its use by inflating it to the size desired, and counting the number of cylinders or bulbs of air required to fill it.

By observing this precaution there is no danger of overdistending the bladder, as the exact degree of distention is determined by the number of cylinders of air introduced.

The external urethral orifice and surrounding parts are cleansed with soap and water and bichloride solution (1 to 1,000) by the nurse, after which the bladder is catheterized and the patient placed in the knee-breast posture, carefully protected by a sheet.



FIG. 231.—RUBBER BALLOON FOR TREATMENT OF CYSTITIS, HALF BOLLED, FOR INTRODUCTION INTO THE BLADDER. (ORDINARY SIZE.)

The patient should lie with chest flat on the table, her arms hanging over the sides, in order to make the bladder distend perfectly when the speculum is introduced.

A small pledget of cotton rolled on an applicator is saturated with a 20 per cent solution of cocaine and inserted into the urethra and allowed to remain for three minutes, when a No. 10 vesical speculum can be introduced without giving the patient much pain. Frequently the patient complains of no discomfort whatever until the end of the speculum impinges upon the inflamed mucous membrane of the bladder wall.

Before the patient is placed in position, the gelatin, which has been previously sterilized, is immersed in a water bath and melted. For ordinary use in private practice, or in a limited hospital service, it is not necessary to have an elaborate apparatus, but a small metallic ointment box is sufficient for all practical purposes.

The temperature of the water bath should be just sufficient to reduce the gelatin to the consistence of cold olive oil, as in this state it will adhere better to the balloon, which can be more easily rolled into the form of a suppository.

Before preparing the balloon for introduction into the bladder the hands should be disinfected. The bag is rolled between the thumb and forefingers in

the same way as a hand-made cigarette. Into the concavity which naturally forms when the balloon is completely collapsed the gelatin is poured to overflowing, and the balloon slowly rolled, more gelatin being added until it as-

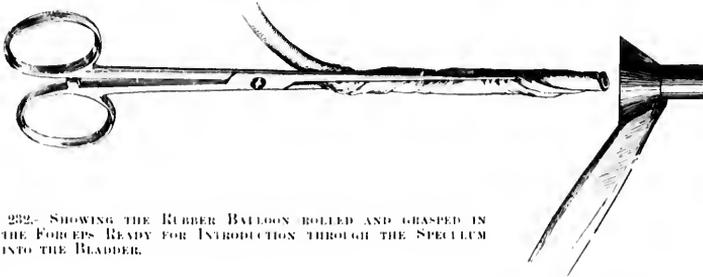

FIG. 232.—SHOWING THE RUBBER BALLOON ROLLED AND GRASPED IN THE FORCEPS READY FOR INTRODUCTION THROUGH THE SPECULUM INTO THE BLADDER.

sumes the form of a suppository well covered with the semi-fluid gelatin. It is now clasped with a long, slender crane's bill forceps (Fig. 232) and inserted through the speculum into the bladder and released.

As the distention progresses the patient suffers considerable pain and an

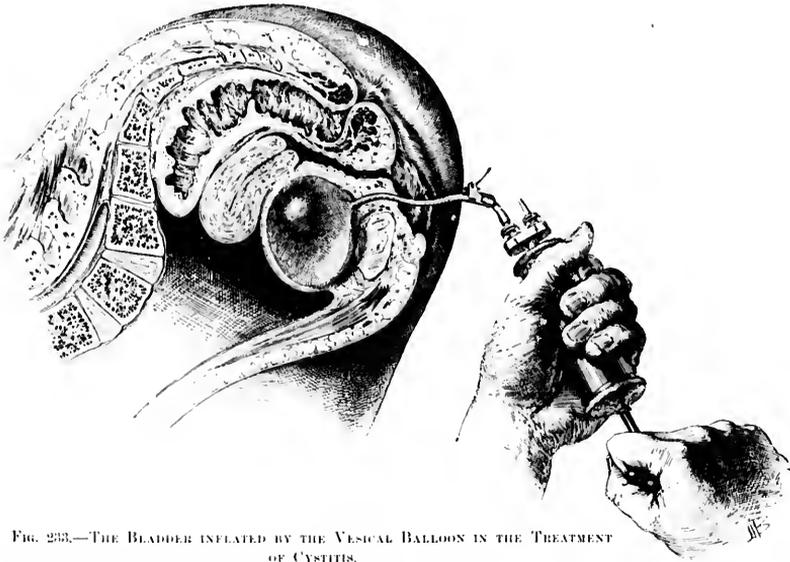

FIG. 233.—THE BLADDER INFLATED BY THE VESICAL BALLOON IN THE TREATMENT OF CYSTITIS.

The patient is in the knee-chest position. The force pump is being used to distend the balloon.

urgent desire to void her urine. By forewarning her of these attendant symptoms she will be able to withstand the pain, and the inflation can be carried up to the desired degree in from three to five minutes.

The pain in chronic cystitis is usually severe during the first two or three applications, but the patient as a rule experiences so much relief subsequently that she is willing to persevere in the treatment.

A rectal suppository of 1 grain of opium, introduced immediately after the treatment, is of great service in alleviating the subsequent suffering. Having inflated the bag up to the required size, the clip on the rubber tube is closed to prevent the escape of the air, and the patient assumes the dorsal or lateral posture.

It is best to leave the balloon in place for fifteen or twenty minutes; to remove it the clip is released, when all but a small amount of air escapes and the rest is aspirated with the air pump, when the collapsed rubber bag is easily pulled out through the urethra.

Another way of using the balloon is the following: The patient empties her bladder and then lies in the right or left semi-prone position, while the urethral orifice is exposed and cleansed. From 5 to 8 centimeters of a 2 per cent solution of ichthyol in glycerin is then injected into the bladder by means of a delicate long-nozzled syringe. The balloon, completely exhausted of all air, is now taken up with aseptic hands, stretched out a little, and rolled together in small compass around a metal staff, so that the rubber projects a little beyond its end. A clasp on the tube prevents air from entering too soon. The size and shape of the balloon rolled up in this way is much like that of a catheter, and the staff gives the stiffness necessary for introduction. The balloon, coated with the ichthyol glycerin, is now grasped so as to prevent its unrolling and pushed through the urethra into the bladder and the staff drawn out. The clasp is then taken off and the balloon inflated, either by a rubber ball insufflator, such as is used in throat work, or by the force pump of an aspirator. The inflation should be great enough to be felt decidedly, but not to cause much pain, when the rubber tube is clamped to prevent the escape of the air. The inflated balloon distends the bladder and brings every point of its mucosa into contact with the ichthyol already injected. The amount of the distention can also be gauged by introducing a finger into the vagina and palpating the base of the bladder, or by examining bimanually. The bladder should not be larger than a goose egg.

The balloon is left in place from ten to twenty minutes, according as the patient can bear it; it comes out collapsed upon letting out the air and pulling on the rubber tube.

A history of a case, of a severe type of chronic cystitis of thirteen months' standing, well represents the efficiency of the vesical balloon.

M. J., admitted October 21, 1895, colored, aged thirty-five years, had been married ten years, with no children, and no miscarriages. She suffered from frequent and painful micturition and hematuria.

About thirteen months ago she began to have slight pain on urination, which grew rapidly worse, and for the last five months blood has frequently appeared in the urine.

The frequency of urination is much greater at night, when she is compelled



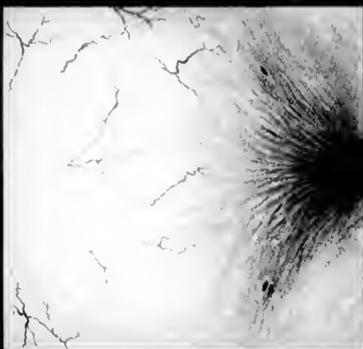

Fig. 2

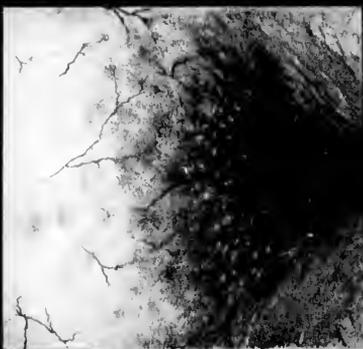

Fig. 1

DESCRIPTION OF PLATE VI.

FIG. 1.—Appearance of the trigonum and the base of the bladder before treatment.

FIG. 2.—Appearance of the same part of the bladder after treatment with the vesical balloon.

DESCRIPTION OF PLATE VI

FIG. 1--Appearance of the trigonum and base of the bladder before treatment.  
FIG. 2--Appearance of the same part of the bladder after treatment with the vesical balloon.

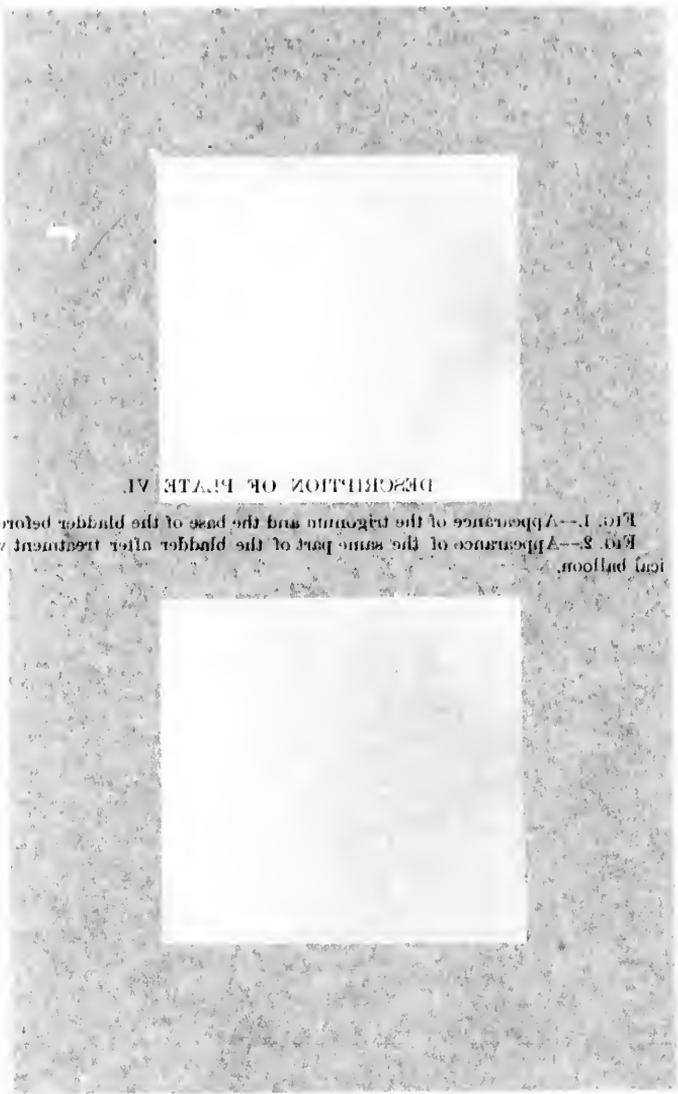

to get up eight to ten times; a week ago she had agonizing pain and several blood clots were passed. There is now a constant dull pain over the bladder, which becomes sharp and cutting during micturition. When the pyroxyisms come on the patient has an expression of intense suffering.

Upon making a direct examination of bladder the urethra was found congested, the vesical trigonum intensely reddened, the rugæ standing out prominently, and over the surface of the bladder flakes of pus and small blood clots. The intensest inflammation was in the inter-ureteric area gradually shading off toward the fundus of the bladder. Where the inflammation was greatest the mucous membrane was of an angry red color and bled when touched lightly with the ureteral searcher. The capillaries were indistinguishable in the inflamed areas, and a careful search of the bladder failed to reveal the ureteral orifices. In the less congested areas above the trigonum the capillaries were prominent, and at various points small, intensely red congeries of minute vessels were seen. The anterior wall of the bladder in isolated places appeared normal.

The treatment by an application of 10 per cent ichthyol gelatin by means of vesical balloon gave great pain at the time of the application.

October 22: Greatly relieved two hours after treatment, and still feels much better than before the treatment.

October 23: Balloon again applied, still very painful; the bladder appears less congested and the ureteral orifices are faintly visible. Marked improvement in symptoms; urination much less painful. She rose only three times last night. A colored drawing of the bladder as it now appears is shown in Plate VI.

November 10: The bladder has been treated every third day since the last note was made, and now appears almost entirely well. The patient no longer experiences any pain between the treatments and thinks she is entirely well. Advised to remain one week longer.

November 19: Patient discharged to-day. The mucous membrane has assumed a perfectly healthy hue, except a slightly increased reddening around the ureteral orifices. No treatment since the last note. The pain is entirely relieved, and the patient got up but once last night to urinate. The second colored drawing (on Plate VI) shows the present condition of the bladder.

Applications may be made in this way every day or every second day; the improvement is usually marked from day to day, and old cases are sometimes relieved in less than a dozen treatments. Glycerin must be used as the vehicle for the drug injected into the bladder, and to coat the balloon when the bladder is simply to be distended, as vaselin and oils ruin the rubber bags.

**Surgical Treatment of Chronic Cystitis.**—In obstinate cases associated with great pain relief has often been given by making an opening in the base of the bladder so as to let the urine escape into the vagina, keeping the bladder empty and giving it a complete physiological rest for a period of several months or longer until the cystitis is cured. This procedure has had a warm advocate in Dr. T. A. Emmet, who has repeatedly employed it with success.

But as the constant dribbling of the urine through such an artificial fistula entails all the distressing disagreeable consequences of a fistula from any other

cause; it is to be expected that the field for this operation will be limited to the cases not relieved by the direct plans of treatment just described.

The operation is done in the following manner: The patient is put in the dorsal position with flexed thighs, a sound is introduced into the bladder distended with water, and the base of the bladder well behind the urethra is pushed forward into the vagina into the median line on the end of the sound. The anterior vaginal wall being well exposed by retractors, the operator cuts through the vesico-vaginal septum onto the sound with a narrow-bladed knife; a gush of water shows that the bladder is opened and the sound passes through into the vagina. As the water escapes, the hole is quickly enlarged backward until it is at least 2 centimeters long. The sound is then taken out and the vesical mucosa drawn over the intervening cut surface of the septum and attached to the vaginal mucosa on all sides by a continuous catgut suture; this prevents the fistula from closing spontaneously, as it would do if raw surfaces were left exposed and in contact. The vagina should be irrigated daily, and the external parts protected by a stiff zinc oxide ointment. Clean gauze pads must be kept under the patient at night and fresh ones applied often by day. When the inflammation has subsided, in the course of several months, then the edges of the fistula should be pared and the opening closed.

**Tubercular Cystitis.**—Tubercular disease of the bladder in women is observed with a frequency which increases just in proportion as careful direct examinations and bacteriological investigations of the urine are made. It is either primary in the bladder or descending from the kidney to the bladder, or again a part of a general tuberculosis.

R. Uitzmann (*Die Krank. der Harnblase*, Stuttgart, 1890, p. 151) states that tubercular cystitis often complicates other inflammatory processes, and more especially those due to gonorrhœa, when the gonococci may be found in close association with tubercle bacilli.

T. Rovsing (*Die Blasenentzündungen*, etc., Berlin, 1890) declares that tubercle bacilli can not engender a tubercular cystitis in a sound bladder, not even when there is a retention of urine, but that a direct inoculation into the mucosa or a preliminary suppurative cystitis are necessary factors.

The disease is not often seen in its initial stages, when there is simply an intense catarrhal condition of the bladder. In cases of infection from a tubercular kidney or a tubercular abscess behind the broad ligament discharging into the bladder, the infection is most marked in a path in front of the ureteral orifice of that side, or in front of the sinus opening into the abscess where infected urine meets the mucosa before dilution. In addition to the catarrhal cystitis found here, there are often numerous little scattered whitish nodules having the appearance of tubercles. Sooner or later caseation occurs and the tubercles break down, leaving a deep ragged-edged ulcer; the urine then contains pus and mucus and blood.

The tubercular ulcer or ulcers may advance but slowly; in the worst cases the entire bladder is involved, and the bloody urine is constantly expelled in small quantities with great suffering. The trigonum, the base, and the posterior

walls are oftenest affected. If the disease is left to run its natural course it is always chronic, extending over a period of many years with slow changes. In a more intense form, when the entire bladder participates in the disease, it may terminate fatally in a few months or a year.

The family history may give the right clew to an obscure obstinate form of cystitis, as in the following case occurring in the practice of Dr. L. M. Sweetnam, of Toronto:

The patient, a young woman twenty-three years old, began to have severe pain in the urethra, and died eleven months after the onset of an extensive tuberculosis involving the bladder, the urethra, and the right ureter and kidney; the temperature at one time reached 108° F. In the same family twin sisters died of pulmonary tuberculosis; another sister had tubercular glands in the neck four months after the extraction of some teeth; a fourth sister lost one eye and a nasal bone, and had five or six tubercular skin lesions, a spina ventosa affecting three metacarpal bones, and a tubercular tarsus. A brother, twelve years old, and both parents were healthy. In four cases of tuberculosis of the bladder reported by Dr. Edward Reynolds (*American Medico-Surgical Bulletin*, April 4, 1896) the family history was negative in two and distinctly tuberculous in two.

**Diagnosis.**—A cystitis occurring in a phthisical patient not exposed to gonorrhœa is most likely tubercular too. All cases of cystitis in young persons are open to this suspicion if they are clearly not gonorrhœal. S. Bontor (*British Med. Jour.*, 1893, vol. i, p. 1058) reports a case of a tubercular ulcer over the left ureteral orifice in the bladder of a child five years old. Chronic ulcers found in the bladder are usually tubercular.

The diagnosis is made certain by finding the tubercle bacilli either in the urine or in the tissues themselves. When the disease is advanced the bacilli can usually be found in large numbers without any trouble, but in other cases repeated examinations must be made to find even a few of them. The surest way to find the bacilli and so clear up the diagnosis is to expose the diseased area and enquette off a little piece of the tissue from the margin of the ulcer; the microscopic examination of this may show the presence of the bacilli when they have been sought in vain in the urine.

In Reynolds's four cases there were a few isolated papules discovered in each case. They were about the size of a grain of rice, slightly oblong, glistening, rounded, and round above the surface of the mucous membrane. These papules were carefully watched, and were found to break down and form tuberculous ulcers.

The tubercular ulcer is characterized by a granulating base, sharp, irregular edges, with small hemorrhagic foci surrounding it. In the most advanced cases the contracted bladder simply appears as a mass of ulcerations with irregular surfaces filled with pus and blood and mucus. When the disease descends from the kidney, the part first affected is that about the ureteral orifice of the affected side.

E. H. Fenwick (*Lancet*, 1891, p. 935) injected tuberculin in a patient with

a tubercular ulcer with the result of bringing on a violent attack of hematuria; others have used the injections with negative results.

**Treatment.**—The outlook in a case of tuberculosis of the bladder from a therapeutic standpoint is no longer so hopeless as it was before the use of the endoscope. We are able with our present diagnostic methods not only to determine the specific nature of this disease, but to discriminate between the extensive cases and those which remain localized and are more amenable to treatment.

In all these cases the general health demands the most painstaking attention; associated with rest, abundant nutritious food, suitable exercise in the fresh air, and it may be change of climate and scene, we must also depend largely upon such medical agents as cod-liver oil, iron preparations, and other tonics which have been found useful in combating tubercular processes of all kinds.

When the bladder disease forms but a part of a more general infection, or is associated with an extensive lung affection, but little will be accomplished locally in staying the progress of the affection. When the disease is in some neighboring organ, as in a kidney or a uterine tube, and the bladder is only secondarily involved, the original focus must be removed before any results may be expected from the treatment of the bladder, and if the disease is but limited, it may clear up without further assistance.

The direct treatment of a tubercular bladder is either by injection, by topical applications, or by surgery.

As injections, iodoform emulsions (5 to 10 per cent), solutions of corrosive sublimate (from 1 to 5,000 to 1 to 500), nitrate of silver (1½ to 2 per cent), and lactic acid (5 per cent solution with cocain) have been used; good results are to be looked for from the use of iodoform made into an emulsion (5 to 10 per cent) with glycerin, gma acacia, and water. This should be injected into the bladder and applied evenly to the whole surface under moderate pressure by using Clark's balloon as described in the last section. Such treatments continued every two or three days are calculated to yield the maximum effect of local treatment. By the instillation methods above described Guyon has been able out of sixteen cases of tubercular cystitis to cure three, to improve six greatly, and to improve five.

A case of vesical tuberculosis reported by Dr. J. O. Polak, of Brooklyn (*Amer. Gyn. and Obs. Jour.*, January, 1897, p. 41), is a model of clear description and effective treatment.

The patient, a single Swedish girl, twenty years old, during an attack of anemia three years ago began to suffer sharp lancinating pains on urination; she lost weight and had frequent hematuria. In the latter part of April, 1896, she had an unusual vesical hemorrhage with inability to void the urine and a constant intense tenesmus; several ounces of bloody urine were drawn by catheter drop by drop. The temperature was 102° and the pulse 120. On palpation, there was exquisite tenderness all over the region of the bladder and blood dripped from the urethra.

By means of a large cystoscope the bladder was found filled with clots of

blood; after washing and sponging them out, an ulcerated area was detected on the right side near the neck of the bladder, about 3 centimeters in diameter, with raised irregular edges and studded with tubercles; the remaining mucosa was normal. This patch was thoroughly curetted through a cystoscope, and vesical drainage established by a coil of gauze enclosed in gutta-percha tissue.

Three days later the urine still contained pus, blood, and tubercle bacilli. Daily vesical irrigations were used, and a 50 per cent emulsion of iodoform injected after each one.

May 15: A direct examination revealed an area of ulceration with pale, flabby granulations, and appearing as though varnished with a thin coat of serum. A solution of nitrate of silver (80 grains to the ounce) was carefully applied to the dried surface of the ulcer, followed by a daily irrigation with a solution of salicylate of soda. Prompt improvement followed, the bacilli steadily diminished in numbers, and by June 1st the urine was normal.

June 10: By direct cystoscopy a normal mucous membrane was seen, and the place of the ulceration was occupied by a pale cicatrix. After this the patient gained twenty-five pounds in weight.

October 15: No recurrence of symptoms.

Petit (*Injec. contre la tuberculose de la vessie, Semaine méd.*, 1892, t. xii, p. 42 [annexes]) uses an emulsion consisting of iodoform, 20 grams, glycerin, 10 grams, and water, 6 grams, with gum tragacanth, 0.25 grams. A teaspoonful of this mixture is added to 150 grams of warm water with 10 drops of laudanum, and the whole is injected slowly into the bladder; half the quantity is allowed to run out in two minutes and the rest to remain as long as possible. This same formula may also be used with the rubber balloon.

Topical Applications.—The means we now have of exposing the tubercular ulcer and of making direct applications to its surface opens up an entirely new field for therapeutic research, since we shall be able to apply concentrated solutions to the diseased spots without risk of injuring the sound mucosa elsewhere. After making such an application the bladder may be filled with water and washed out repeatedly. The application in this way of varying strengths of silver nitrate from a 20 per cent aqueous solution to the solid stick have proved of great value in Reynolds's hands.

Surgical Treatment.—The surgical treatment of such an obstinate affection will prove the most satisfactory way of dealing with it in selected cases. The various surgical methods are curettage, cauterization, and excision.

Curettage of the Bladder.—Curettage has been successfully practised by Guyon and others in cases of rebellious cystitis and for tuberculous cystitis. Curettage is an eminently rational plan of treatment for two reasons: in the first place the lesions of both forms of cystitis are as a rule localized in the more superficial parts of the bladder in the mucosa, and hence easily removed without risk, and in the second place the regeneration of the mucosa, even after an extensive destruction, takes place readily.

The procedure is conducted in this way: A sharp curette is used, the patient placed in the lithotomy position, and the bladder thoroughly washed out with a

mild antiseptic solution and emptied. The finger is then inserted into the vagina and the curette directed through the urethra into the bladder, where it is first employed in curetting the base of the bladder, using the finger as a point of counter pressure; at the same time the amount of force employed can be readily estimated; then the curette is next used over the vesical surface behind the symphysis pubis. After cleansing out the bladder the curette is again introduced, and the posterior lateral and superior portions are next attacked. Such is the procedure in the rare cases of aggravated cystitis which has gone so far as to involve the entire vesical mucosa; by making a careful cystoscopic examination beforehand those cases in which the lesions are localized in certain areas of the bladder will also be recognized, and the curettage will then of course only be directed against the diseased portions, sparing the sound tissues any unnecessary insult.

It will now be easy to use the galvano-cautery through the cystoscope in the air-distended bladder, and to continue its use from time to time so as to test the efficiency of this mode of treatment.

The ideal mode of treatment of a tuberculous ulcer, which is not relieved by the simpler plans just detailed, is its exposure and excision, followed by suture. This is easily practicable through a longitudinal suprapubic incision without opening the peritoneum; the bladder is incised parallel to the abdominal wound, and its edges temporarily stitched to the skin surface to keep it from dropping out of easy reach during the operation; then in the more superficial cases of the disease the mucosa may be extensively excised, being cut through a short distance from the affected edges and detached by a blunt dissection. Any little patches of sound mucosa must be carefully left, as they will materially aid in the rejuvenation of the mucosa, acting like grafts on the skin surface.

R. Bardenheuer (*Centrallbl. f. Gyn.*, 1894, Bd. xviii, p. 336) has even excised the entire mucosa without interfering seriously with the bladder function. It is a question whether in such cases the new mucosa grows out from the urethral and ureteral orifices, or is reproduced from minute portions left in numerous little depressions. When the disease extends deeply into the vesical walls, the tuberculous area must be cut out and the edges then brought together by interrupted catgut sutures as in the treatment of a vesico-vaginal fistula.

When the tuberculous area is about one of the ureteral orifices, the operator must determine whether the upper urinary tract of that side is affected; if it is not, the area may be excised and the ureter turned into the bladder at a point farther back.

It will be best in these cases not to leave a suprapubic drainage opening. The incision into the bladder through which the operation has been conducted should be sewed up independently of the abdominal incision by using a series of interrupted catgut sutures catching only the muscular walls. The abdominal incision should be closed by interrupted silkworm gut or silver wire sutures, and the bladder kept drained through the urethra for five or six days.

If the sutures in the bladder do not come away in twelve or fourteen days,

and there is any evident irritation from their presence, they may be exposed and cut and taken out through a No. 12 or 14 vesical speculum.

**Exfoliative Cystitis.**—The expulsion of a part of the whole of the mucous membrane of the bladder sometimes occurs as a form of cystitis (cystitis exfoliativa). This is a disease to which women are peculiarly liable, although it is also rarely seen in men.

There is a clear and excellent account of a case in Nicholas Tulp's *Observationes medicæ* (Amst., 1672, lib. 2, cap. xlviii), under the title *membrana lapidescens* (membrane turning into stone). Gerbreghita Rotaria, thought to have a calculus, finally passed a large membrane covered with little stones and with a perforation in the middle, so that the urine could escape through it. But some pieces of the membrane remained behind, and until Nature freed her from them she suffered excessively. The fibers of the bladder being relaxed, there was an involuntary escape of the urine, which was finally relieved by tissue-strengthening medicines.

The causes of such a detachment of the mucous membrane are various, the commonest being retroflexion of the gravid uterus, which is found in 50 per cent or more of the cases; other causes are protracted birth (25 to 30 per cent), the pressure made by a myoma choking the pelvis (see A. Gottberg, *Inaug. Dis.*, Kiel, 1892, and Fr. Vahle, *Inaug. Dis.*, Marburg, 1895), retention of urine and in one case the injection of a strong saline solution into the bladder (Bégouin, *Jour. de méd. de Bordeaux*, t. xxii, p. 158).

The common factor underlying all the various causes is probably the ischemia produced by pressure, for the cutting off or lessening of the vesical blood supply results in an ischemic necrosis with or without an infection.

The detached membrane may be extruded either entire or in small pieces; the mucous surface may be so altered by the necrotic changes that it is recognizable with difficulty, and its surface is often studded with uric acid crystals. Adhering to it are often found more or less extensive portions of the muscular coat, and in the worst cases the peritoneal coat is also involved; in this way three grades of the affection are established (H. Boldt, *Supplicative Exfoliative Cystitis*, *Amer. Jour. of Obstet.*, vol. xxi, 1888, p. 361).

H. S. Coerem reports a case four months pregnant (*Medical News*, Phila., vol. lxiii, p. 633) in which the bladder was distended to within an inch of the ensiform cartilage, the entire mucosa became detached and was expelled, and the openings for the ureteral orifices could be seen in it. The patient was able to leave the hospital in twenty days, and recovered completely.

The clinical history shows frequent micturition and overdistention of the bladder, often with dribbling, associated with a retroflexion of the gravid uterus, or a pelvic tumor, or following a difficult childbirth. Schabert reports a case (*St. Petersburg. med. Woch.*, Bd. xix, p. 373) following the birth of twins. The bladder becomes exceedingly tender, and there is an acceleration of the pulse with fever, and all the disturbances usually associated with a severe septic process.

In a case of my own, where an overdistention of the bladder followed ovari-

otomy, portions of the mucosa were cast off, and the patient had a high fever and became insane; she was put into an asylum, where she died more than a year later from pulmonary phthisis.

The urine, at first turbid, becomes fetid, and in a few days pieces of the membrane are expelled; when the membrane becomes detached and endeavors to escape entire, it may block the internal urethral orifice for a time, causing a renewed retention of the urine. Its expulsion may be brought about with great pain and straining, and after this there is a more or less permanent dribbling of the urine. In some cases, in time the bladder regains its function to an unexpected degree; in others it is never able to hold more than a little urine at a time.

Death may occur from sepsis, or from one of the complicating conditions, such as peritonitis, or pyelitis from an upward extension of the infection, or later from uremia.

The diagnosis is made by recalling the clinical history of the case associated with a cystitis and discharge of the vesical tissue. On examining the base of the bladder by the vagina, it is found thickened and tender, and in cases where the loosened tissue obstructs the urethra the catheter may perforate this and let out a lot of foul urine from behind it. The difference between these septic cases with such a history, and the prolapse of the vesical mucosa occurring mostly in children, is so marked as to need reference only.

The treatment must first be directed to the condition which causes the retention, if it is still active, and, secondly, to the condition of the bladder itself. If the uterus is retroflexed and incarcerated, the patient must be put under an anesthetic, if necessary, in order to reduce the flexion, when it may be kept in place by an appropriate vaginal pack.

If the pelvis is choked by a myoma, an effort should be made to dislodge it into the abdomen. If this can not be done, it will scarcely be advisable to open the abdomen and remove the tumor until the vesical symptoms have subsided.

The bladder itself must be carefully watched to prevent any large accumulation of urine in it, and when the membrane is in the process of detachment and expulsion it is best to assist nature by gentle traction, and cutting off any protruding portions. If the membrane chokes the urethra and prevents the escape of urine, the accumulation will be voided by passing a glass catheter through it.

After the early acute symptoms have passed off, the patient will be greatly benefited by washing out the bladder two or three times daily, using a warm boric acid solution, and the irrigation must be kept up as long as there are pus and bacteria in the urine.

#### TUMORS OF THE BLADDER.

A variety of tumors are found in the bladder in women, but not so frequently as in men, the proportion being about one to three or four. They may be grouped according to their clinical significance—that is, their tendency to remain

localized or to invade the surrounding tissues, as benign and malignant (see G. Clado, *Traité des tumeurs de la vessie*, Paris, 1895, p. 63).

I. The benign tumors are papilloma, fibroma, adenoma, myoma, dermoid cysts.

II. The malignant tumors are carcinoma, sarcoma.

The malignant group further includes all forms of tumors of a mixed nature except fibro-myomata and all forms of degenerated tumors.

If we bear in mind the several component tissues of the bladder walls—the mucosa and submucosa and the muscular layer—and examine the various neoplasms found there from the standpoint of origin, they may be classified as follows (Küster, *Vollst. Sammlung klin. Vort.*, 1886):

I. Connective tissue tumors of the mucosa and of the submucosa: Papillomata and fibroid polyps, mucous polyps, sarcomata.

II. Tumors of the muscular tissue: Myomata.

III. Tumors of the glandular tissue and epithelium: Adenomata, epitheliomata.

Tumors are furthermore primary when they originate in the bladder, and secondary when they extend to the bladder from other organs. The secondary tumors are naturally of the malignant type; the commonest form is carcinoma of the cervix uteri which advances to the bladder.

Nothing whatever is known as to the etiology of primary vesical tumors. J. Albarran (*Les tumeurs de la vessie*, Paris, 1892) is of the opinion that the chronic irritation produced by the presence of micro-organisms is an efficient cause.

The villous outgrowths covering the interior of the bladder (*vesica villosa*), in some cases associated with calculus, are undoubtedly the product of mechanical irritation, but these can scarcely be called neoplasms in the strict sense.

Clado has shown that the normal bladder contains villi, which throws light on the frequent association of villous outgrowths with all variety of bladder tumors.

Secondary tumors of the bladder are not usually metastatic in the ordinary sense, but invade it by contiguity of tissue. In men, most of these tumors are furnished by the prostate and the rectum, and in women the enormous frequency of cancer of the cervix uteri is the occasion of the frequent involvement of the base of the bladder. I have seen the most extensive sarcoma of the genital system from the vagina through the uterus and out onto the peritoneum without any bladder affection.

The seat of vesical tumors is found more frequently in certain areas than in others. The places of predilection are exhibited in Féré's table, where, out of 107 cases, there were in the base of the bladder alone, 25; attached to both base and the walls together, 13; on the posterior wall, 17; close to the right ureter, 5; close to the left ureter, 8; anterior wall, 2; anterior and superior wall, 1; right or left lateral walls, 4; multiple tumors, 12; diffuse tumors, 8, etc.

Out of 634 cases of polypi, Fenwick (*British Medical Journal*, 1888, vol. ii, p. 666) found that the tumors were single in 60 per cent and multiple in the remaining 40 per cent.

Albarran (*ut supra*, page 61), in an analysis of 82 cases, found that the tumors were single in 61 and multiple in 21 of the cases, a proportion of about 75 per cent.

One of the most important statistical subdivisions of these tumors, from a clinical and a therapeutic standpoint, is that which is based on the nature of the attachment of the neoplasm to the vesical walls. Albarran (*ut supra*, page 53) found in seventy-eight personal observations of tumors of the epithelial type (in which are included all the commonest forms—the papillomata, cysts, adenomata, and epitheliomata) that they were attached as follows: Pediculated, 28; sessile, 9; encephaloid (infiltrating), 31; emeroïd (mammilated, bossed, ulcerated), 10.

No two writers are precisely agreed in their classification of these tumors, and in many of the instances reported the diagnosis has been made purely from the macroscopic appearances, and this accounts for the enormous preponderance of tumors described as “papillomata,” which really include fibroid, adenoid, and malignant epithelial growths. Although it is true that a benign growth may exist in the same bladder with a malignant one, or that a benign growth may become malignant, this transition would not be noted so frequently in the literature if careful microscopic examinations were made in all cases.

**Papilloma.**—As J. Orth (*Lehrb. d. Speciel. Pathol. Anat.*, Berlin, 1889, Bd. ii, p. 214) very properly says, the general name papilloma may be given to the group of pediculated tufted tumors as long as we do not know to which special class the growth belongs; it may be either a benign papillary fibroma or a malignant papillary cancer. We see from this that the term papilloma is often employed simply to describe the form and general appearance of the tumor, without conveying any information as to its real character.

If, on the other hand, we limit the term papilloma to the group of benign tumors, we are met with the further difficulty as to the propriety of the name according as we consider the tumor primarily an outgrowth from the epithelial or from the connective tissue.

If it is a tumor of the submucous connective tissue, covered by the mucosa and pushing out into the cavity of the bladder as it grows, then the proper name is papillary fibroma (Virchow, 1885); this view makes the papillomata one of the group of fibromata which differ among themselves in possessing more or less connective tissue.

Clado, on the other hand, considers papillomata as epithelial growths of the mucosa of an exogenous type—that is, one in which the epithelium is confined to the exterior. This classification groups them with the adenomata and establishes also a certain relationship between them and the epitheliomata, which are of the endogenous (ingrowing) type.

The benign papillomata are made up of a framework of connective tissue, more or less abundant, richly supplied with blood vessels, and covered everywhere with the vesical epithelium. They usually have a tufted, villous, branching appearance, and are so vascular that the name “villous anginoma” has been given to them. Sometimes the interspaces between the prolongations are filled with detritus, when the fungating appearance is lost.

They occur at any age—from six and nine months (Stein) to seventy-seven years (Gaillard)—and may be either single or multiple, and they frequently complicate other tumors.

Clado distinguishes three varieties—the villous, the pediculated, and the coronoid. The villous papilloma appears in the form of filaments growing from the surface of the mucosa, and they are more or less grouped. When the whole bladder is covered by them the name *vesica villosa* (Käster) has been given it. These filaments assume a shape like that of a finger or ribbon, cylindrical or conical, and often subdivide once or twice. The pediculated polyps, constituting the commonest form, are grouped on a cylindrical pedicle which may be several centimeters long. In the coronoid form the affected portion of the bladder has the appearance of a number of crests closely applied and looking individually like a cock's comb.

In all benign papillomata the pedicle never passes beyond the limits of the mucosa, however thickened or infiltrated this may become by inflammation, although the base of the growth may sometimes contain muscular tissue. The size of a papilloma varies from that of a pea to a walnut; they are rarely as large as a hen's egg.

**Fibroma.**—The fibromata or fibroid polyps form a group of benign tumors in which the connective tissue elements are in excess. They are less frequent than the papillomata, which have but a scanty fibrous framework and appear to occur oftener in men than in women.

The tumor is usually pediculated and its surface is smooth or slightly lobulated, and the pedicle is usually a delicate one. When the tumor is sessile and situated within the bladder wall, its connections with surrounding tissue are such that it can be enucleated. Although the pedicle and the mucous surface of the tumor are vascular, the interior is but poorly supplied with blood vessels. The fibromata often enter the group of mixed tumors by undergoing a myxomatous degeneration (see F. Schütz, *Fibromyroma teleangiectodes vesicæ*, etc., *Archiv. f. Gyn.*, 1876, Bd. x, p. 356).

**Adenoma.**—The adenoma is a benign epithelial tumor of the glandular type rarely met with; it is sessile or pediculated, and has a smooth, lobulated, or papillary surface. When sessile, the tumor can be easily enucleated with the finger without hemorrhage.

It is difficult, in the light of our knowledge of the histology of the bladder, an organ which is remarkably deficient in glandular elements, to account for the origin of these tumors; for this reason Klebs and others have insisted that these growths must take their origin in the prostate gland in the male. R. Kaltenbach (Langenbeck's *Archiv für klin. Chir.*, 1884, xxx, p. 659), however, has described a papillary adenoma which he removed by a vesico-vaginal incision from a woman forty-four years old, the origin of which Prof. Boström traced to the mucous crypts of the bladder. Von Fritsch has also described a fibro-adenoma of the bladder in a girl three years old; it was covered with a calculeous deposit and filled the whole bladder. These cases, of course, show that such tumors do occur in the bladder independently of the prostate.

The adenoma may be either sessile or pediculated, and its surface smooth, lobulated, or villous.

Clado cites exceptional cases where "adenomata" (cylindrical-celled epitheliomata) have relapsed after extirpation, and infiltrated the bladder walls like ordinary epitheliomata. This rare occurrence must be distinguished from the tendency to relapse *in situ* after incomplete extirpation which the adenomata share in common with the simple papillomata.

**Myoma.**—Myoma is one of the rarer vesical tumors, first described by Virchow (*Die Krankhaften Geschwülste*, Bd. iii, p. 121, myocarcinoma). It takes its origin in the muscular coat of the bladder, and is therefore made up of smooth muscular fibers with more or less connective tissue, and grouped or interlacing as in uterine myomata. The tumor either develops out into the bladder cavity upon a thick pedicle or it remains sessile.

W. T. Belfield (*Wien. med. Woch.*, 1881, No. 12, p. 329) has described a new variety of external vesical myoma occurring in a woman fifty years old. It was ovoid in form, 2 by 1 by 2 centimeters, and attached to the outside of the muscularis by four strands made up of blood vessels and muscular tissue.

J. Verhoogen (*Cent. f. Harn und Sexual-Organen*, 1895, p. 132) describes a like case, occurring in a man aged twenty-three years. The tumor at the operation was found to be about the size of a child's head. It arose from a pedicle, just above the prostate gland, and extended backward and upward, almost filling the pelvis. Microscopically it was found to be a fibro-myoma.

Cases are also described by Felix Terrier and Henri Hartmann in the *Revue de chir.*, Paris, 1895, p. 181.

The mucous covering of the vesical myomata is intensely congested, and the remaining muscular coat of the bladder hypertrophied. Ulceration of the surface is rare.

**Cystic Follicles.**—Small cysts are sometimes found on the inner surface of the bladder due to an occlusion of the mucous follicles; they appear scattered or in groups, forming little translucent elevations from 2 or 3 millimeters in size up to the size of a split pea. I have observed these in a case of chronic cystitis; on touching a cyst with the point of a knife the contents immediately escape, and the only trace which remains is a slight hemorrhage from the base. This affection has been called vesical herpes. Malignant tumors also often undergo cystic degeneration.

**Dermoid Cysts.**—Dermoid cysts of the bladder are so rare that Orth (*ut supra*) says that only one well substantiated observation exists, that of Sir James Paget (*Surg. Path.*, 1853). Albarran cites a case of Boucher (*Soc. anatomique*, 1840) somewhat doubtfully, stating that there was a cyst containing a fatty liquid at the top of the bladder, and communicating with it by a narrow opening.

Outside of these rare observations, cases have been recorded in which dermoid cysts outside of the bladder (see Säuger, *Archiv. f. Gyn.*, 1879), or ovarian dermoids, have discharged their contents into this organ, and hairs have escaped by the urethra (pilimiction).

In the group of malignant tumors we find two types of tumors repre-

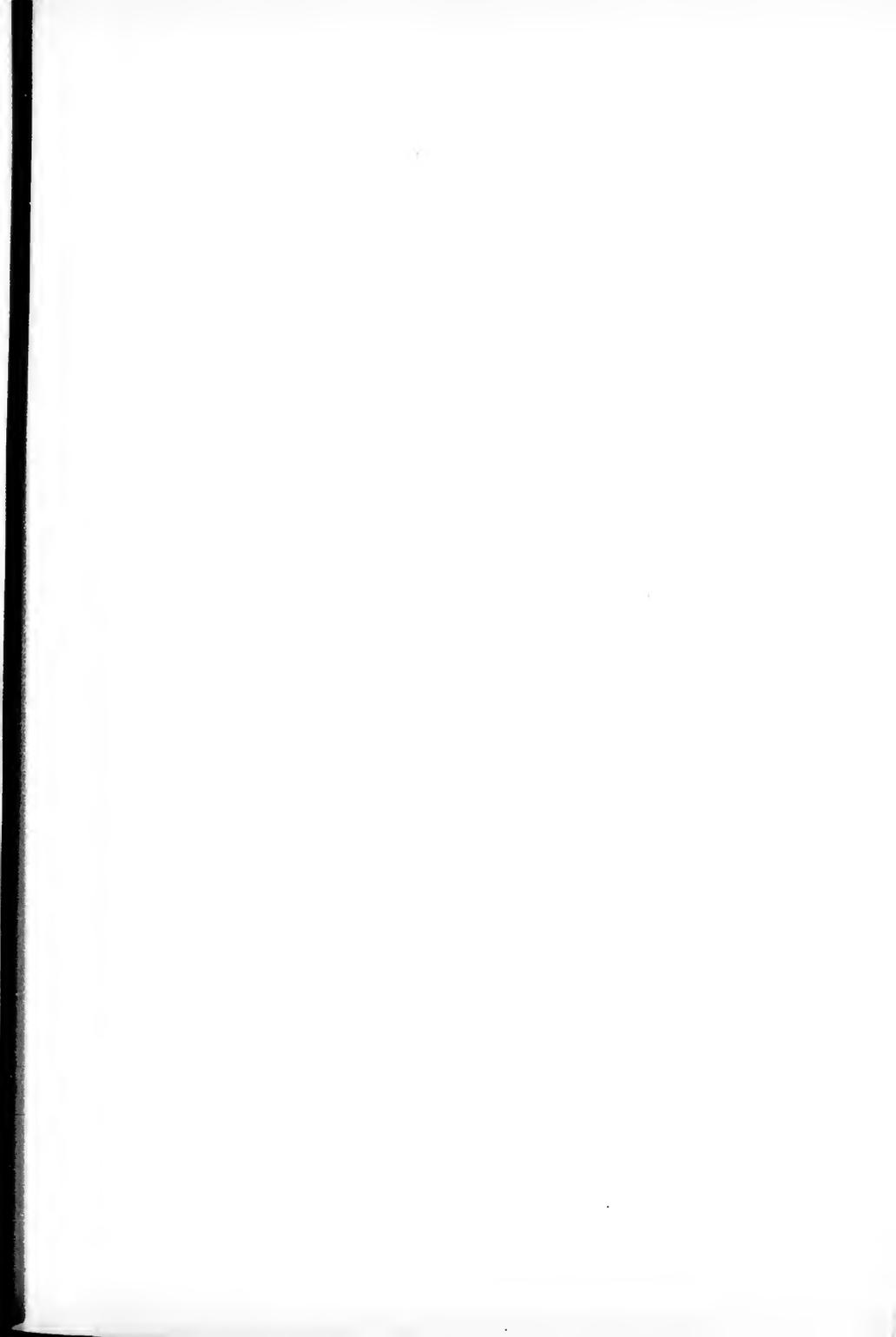

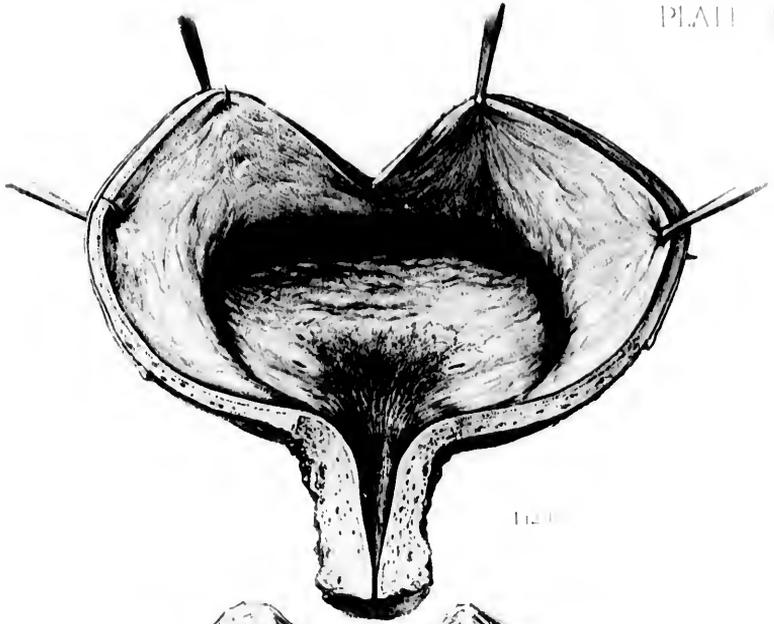

Fig. 1

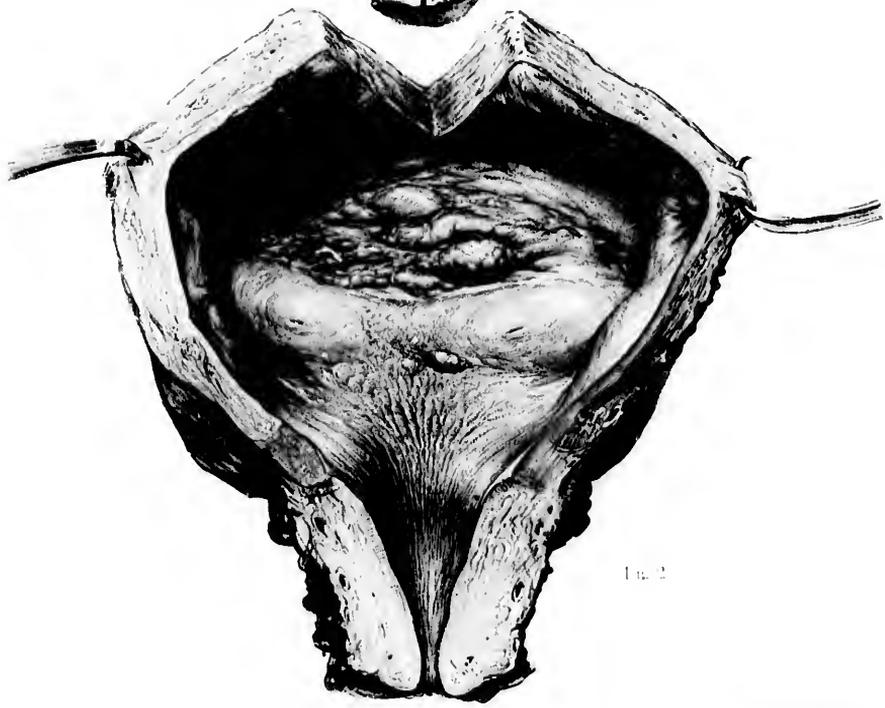

Fig. 2

#### DESCRIPTION OF PLATE VII.

FIG. 1.—Shows the normal bladder laid open by an incision through the anterior wall. The ureteral orifices are seen as narrow slits at the two posterior angles of the trigonum; the third angle is at the internal urethral orifice. The trigonum is characterized by its increased vascularity between these three points. The longitudinal vesical folds entering the urethral orifice are well shown.

FIG. 2.—Secondary carcinoma of the bladder following carcinoma of the cervix. The carcinoma appears in the form of rounded nodules in the bladder wall, mainly in the vicinity of the cervix. One small nodule is seen in the trigonal area. Note also the thickened walls of the bladder.



DESCRIPTION OF PLATE VII

FIG. 1. Shows the normal bladder lid open by an incision through the anterior wall. The urethral orifices are seen as arrow heads in the two posterior angles of the lid. The third angle is at the internal urethral orifice. The trigonum is clearly shown by its increased vascularity between these three points. The longitudinal folds entering the urethral orifice are well shown.

FIG. 2. Secondary carcinoma of the bladder following carcinoma of the cervix. The carcinoma appears in the form of rounded nodules in the bladder wall, a cavity in the vicinity of the cervix. (On small nodules is seen in the trigonal area. Note the thickened walls of the bladder.)



sented—the epithelial type, the carcinomata, and the connective tissue type, the sarcomata. The most frequent are the carcinomata, and these are commonest in men as primary tumors of the bladder, while in women they invade the bladder as secondary tumors extending from the uterus.

**Carcinoma.**—The carcinomata consist of two kinds of tumors, the first made up of the squamous and the second of the cylindrical celled epithelium; they are characterized by a tendency to infiltrate the bladder walls and invade all surrounding tissues. The tumors thus formed are usually multiple, and project into the lumen of the bladder, where they are covered with villousities (“villous cancer”); again others are mulberrylike in appearance. There are often several larger masses with broad pedicles, and a number of small tumors near by.

The infiltrating form of epithelioma without villousities is rarer than the vegetating villous form; the friability of these tumors is especially marked. In some cases the epithelioma can only be shown to have infiltrated the tissues by a microscopic examination (the larvaceous or masked form of Guyon). The surface is less frequently ulcerated in the epithelioma than in carcinoma.

The carcinoma appears in the forms commonly known as encephaloid, scirrhus, or colloid cancer. The ulcerations most commonly observed in the infiltrating form arise either from fatty degeneration or interstitial hemorrhage or gangrene.

The walls of the bladder not involved in the new growth are hypertrophied, partly from the thickening of the muscular coat, and partly from an interstitial muscular sclerosis, the product of irritation (Clado).

Cancer of the bladder exhibits the same tendency as does cancer of the body of the womb to remain localized for a long time in its own viscus, an important fact bearing upon the operative treatment.

These cancers are liable to undergo certain changes; inflammation easily supervenes in the exposed lowly organized tissues, especially after instrumental interference; cystic degeneration is common on the surface or in the walls of the growth, and gangrene may follow interstitial hemorrhages in infected cases.

**Sarcoma.**—The vesical sarcomata form a group of rare tumors of the connective tissue type, malignant in character.

The first description was given by Guersant (*Arch. gén. de méd.*, 1853, second series, p. 311), and since that time but few cases have been added to the literature. Albarran and Clado out of a large experience have only observed three instances.

McWeeny (*British Med. Jour.*, vol. i, 1893, p. 647), under the title of “Spindle-celled Sarcoma of the Urethra,” reports a case which from the description that follows was apparently a pediculated sarcoma of the bladder.

The patient, a woman aged thirty-two years, had suffered from pain on micturition for some months, and was admitted to the Mater Misericordie Hospital under the care of Dr. Madden and Mr. Hayes, who found a soft vascular tumor projecting from the urethral orifice, and traceable along the roof of the urethra up into the bladder. On removal it proved to be a typical spindle-celled sarcoma.

Sarcoma appears to occur about one third oftener in women than in men, at almost any period of life from early childhood up to fifty-nine years of age. The tissue in which the neoplasm takes its origin is probably the stroma of the mucosa, which ordinarily contains round, embryonic cells.

The tumors are usually multiple and almost always sessile, varying greatly in size and having, as a rule, a smooth surface; the color is red, violaceous, or even blackish. The parts of the bladder adjacent to the base are usually infiltrated. In women the sarcoma is especially prone to extend out through the urethra, appearing at the external orifice.

**Myxoma.**—Myxoma is a form of degeneration grafted upon one of the primary forms of tumors; it is always found, therefore, in a mixed form. The commonest are the myxo-fibromata and the myxo-sarcomata.

Such myxomatous tumors are usually pediculated and occur in groups; they are commonly found in early life, grow on the floor of the bladder near its neck, and present much the appearance of nasal polyps, but they are more vascular, and are firmer. Owing to their situation, one of the tumors may easily escape from the urethra and appear at the vulva.

The tissue of the myxomatous tumor is made up of embryonic cells and myxomatous cells with anastomosing prolongations; the capillaries are numerous, and elastic fibers are found abundantly. They show a remarkable tendency to return rapidly after removal (see Schütz, *Archiv f. Gyn.*, Bd. x, 1876, on Fibromyxoma).

**Clinical History of Vesical Tumors.**—In their earlier stages the symptoms of tumors, both benign and malignant, are much alike. As a malignant tumor progresses, the emaciation and constitutional symptoms become pronounced features in the case, but these features may be simulated to some extent by a benign tumor associated with cystitis and hemorrhages.

The earliest and the commonest of all symptoms characteristic of vesical tumors of every kind is a decided tendency to bleeding from the bladder.

Clado has demonstrated by an analysis of a series of cases that a cystitis is the first symptom in 8 per cent of the papillomata, in 20 per cent of the sarcomata and myxomatata, and in 25 per cent of the carcinomata and epitheliomata.

In a few cases retention or incontinence of urine are the first indications of the growth.

Hemorrhages from the bladder may appear in the form of urine more or less deeply discolored by blood, or in the form of clots, or it may be discovered only upon making a microscopic examination of the urine (colorless hemorrhage, globulinuria). They appear, persist, and disappear, to reappear without any apparent cause whatever; sometimes the urine remains bloody for years; in other cases a hemorrhage comes on after exercise, or some violent motion, as horseback riding. Little decolorized filaments and irregular clots of blood collecting on the interstices of the tumor and finally washed away by the urine are characteristic of villous tumors. Epithelial cells and fragments of the tumor may be found adherent to such clots.

When a large hemorrhage takes place, and the blood accumulates in the

bladder, the distention may be so great as to reach even as high as the umbilicus.

Frequent micturition is another common symptom due to the presence of a tumor; the increase at first may scarcely be noticed, but later the bladder may require to be emptied every few minutes. When cystitis is superadded, this of course of itself induces both pain and frequency.

Suppression of the urine is brought about mechanically by a pediculated tumor which lies near enough the urethral orifice to cover it and interfere with the flow, or when the tumor is attached farther away from the orifice but has a long pedicle. A tumor so placed as to press habitually upon one of the ureteral orifices will in time cause a hydro-ureter and hydronephrosis of that side. A retention of the urine may be caused by a distention of the bladder with blood clots, and if the pressure from this source continues to increase, the urine may be even prevented from entering the bladder (amuria); the patient under these circumstances suffers from great pain and straining.

Pain is not a common symptom except when clots accumulate in the bladder, or when there is a coincident cystitis, which is one of the commonest complications liable to arise at any time, and exceedingly obstinate, rarely disappearing so long as the tumor remains.

*Prognosis.*—The ultimate outcome varies, of course, with the nature of the tumor; the benign cases run on for years and do harm by the severe hemorrhages, by the diminished capacity of the bladder, due to the presence of the tumors, or by the cystitis, which may be intense in its character and may travel upward, producing a pyelonephritis.

The malignant neoplasms destroy life in the course of a few years or sooner, according to the rapidity of their growth and to the hemorrhages, cystitis, ulcerations, or gangrene associated with renal infection, pyemia, or peritonitis.

*Diagnosis.*—The diagnosis of a vesical tumor will be made by (a) a study of the history; (b) examination of the urine; (c) palpation of the bladder; and (d) a direct cystoscopic inspection.

Although the direct examination gives at once a positive diagnostic answer, the remaining means of investigation should not be neglected.

The history is as a rule in no respect characteristic.

The examination of the urine shows the presence of blood; and if there is cystitis, pus and micro-organisms and various crystals, and rarely bits of the tumor. Earlier writers laid great stress on finding these pieces of the neoplasm, and judged from them the character of the disease. The opinion now held is that even when the presence of a tumor may be inferred in this way, no definite conclusions can be drawn as to its nature, not even as to whether it is benign or malignant.

One of the rarest symptoms, only observed in connection with vesical tumors, is the spontaneous coagulation of the urine (*fibrinuria*) after escape from the body, due to an excess of fibrin discharged with the blood into the bladder.

The use of a catheter to bring away a piece of a neoplasm in its eye is too

uncertain, and the use of a eurette, guided solely by touch, is too dangerous to be practiced, now that other simple and safe diagnostic measures are always available.

Palpation of a bladder emptied of its urine may give interesting information by revealing a localized thickening of the tissue when a tumor of a size and consistency sufficient to be felt bimanually is present. Touch is especially valuable in the case of malignant tumors in determining whether the disease has already passed beyond the limits of the bladder. In such a case the examination must be made with especial care through the lateral vaginal fornices to find any fixation on the side of the pelvic walls, and through the rectum to find any enlarged glands on the pelvic walls or between the external and internal iliac arteries, or even up on the common iliac artery.

**Direct Inspection.**—This mode of investigation at once gives a positive answer to several important queries in the diagnosis: (a) Whether or not a tumor is present; (b) whether the tumor is single or multiple; (c) the seat of the tumor; (d) its size, form, and color; (e) the kind of pedicle; (f) any complicating conditions, such as calcareous incrustations, cystitis, and ulceration.

If examination hurts the patient, it will be best to anesthetize her, and then, after emptying the bladder, to put her in the knee-breast position and introduce a No. 9 or 10 speculum. The examiner, looking into the air-distended bladder in this position, will see pendant any tumors springing from the trigonum or the base. By a minute investigation he will be able to determine in most cases the chances of a successful operation, although it may not always be possible to distinguish with certainty between malignant and non-malignant growths.

In general it will do to recall the fact that the simple papillomata have small pedicles, while the pedicle of a simple epithelioma is much stouter, and in a sarcoma it is quite broad. Any nodules about the base of the tumor will also be detected and regarded with suspicion.

The presence of a cystitis or of any ulceration of the surface of the bladder complicates an operation. When the tumors are found clustered around the neck of the bladder they may be looked upon as certainly malignant.

**Operative Treatment.**—There is but one way of treating vesical tumors, and that is by eradicating them by operation whenever possible. A palliative plan must be adopted only when the condition of the patient or the extent of malignant disease forbids operation.

The conditions most favorable for operation are general good health, urine clear from infection, albumin, and casts, and a single tumor with a pedicle. In old age and in childhood under five years the tumor is almost certainly malignant and inoperable.

Before proceeding with the operation it is important to gain an exact estimate of the patient's general condition, and to have made one or more thorough cystoscopic examinations for the purpose of studying the peculiarities of the tumor.

The avenues of extirpation are: (a) By the dilated urethra; (b) by a vaginal

incision; (c) by suprapubic incision; (d) by symphyseotomy; (e) the removal of the entire bladder (cystectomy).

The choice of the mode of operation will depend on the size of the tumor and its pedicle, on its seat, and on the presence of such complications as multiple tumors, infection, anemia, and extreme prostration.

The least dangerous ways of operating are by the dilated urethra and through a vaginal incision.

The suprapubic incision is more formidable on account of the risk of opening the peritoneum and urinary infiltration or infection of the loose cellular tissue, and the symphyseotomy is the most formidable of all.

The operation in a particular case may be no more than the severance of a delicate pedicle setting free a tumor, or it may involve the resection of a portion of the mucosa, or a portion of the entire bladder wall, or in extreme cases the sacrifice of the whole bladder.

(a) By the Urethra.—Simon (*Samm. klin. Fort.*, No. 88, 1875, p. 8) has shown that the urethra may be safely dilated to a diameter of 2 centimeters after making two lateral incisions in the posterior margin of the external urethral orifice to keep it from tearing at this its narrowest part. A series of dilators differing 1 millimeter in diameter is then passed in, beginning with a No. 8 or 10 and ending with No. 20. After this the largest speculum (No. 20) may be inserted and the tumor exposed for operation. Through a speculum of this large size we may safely remove most of the pediculated tumors of the bladder, either by the galvano-caustic loop, or by using a delicate, properly bent cautery knife.

In using either of these means to extirpate the growth, it is possible under the control of the sight to adjust the loop or to use the knife so as to effect an amputation close to the bladder; this avoids leaving any of the pedicle behind, and produces also a slight destruction of tissue on the bladder wall itself, sufficient to prevent recurrence of a benign growth.

A tumor removed in this way must be carefully examined microscopically, and if it is found to be malignant the operator must be prepared to resect a portion of the bladder wall through a vaginal or a suprapubic incision as soon as upon inspection there is any evidence of return. Sessile tumors and infiltrating growths can not be treated in this way.

(b) The vaginal route (colpocystotomy) is best when a limited portion of the bladder wall has to be excised with the tumor. It is easier to operate in this way upon the upper portion of the bladder, and when the vaginal outlet is relaxed and the anterior wall naturally tends to drop down; it is awkward and difficult with a tight vaginal outlet.

To make the vaginal incision the perineum is retracted and the cervix fixed with tenaculum forceps; the base of the bladder is then cut through onto a sound introduced through the urethra, and the incision enlarged, if need be, forward to the internal orifice and back to the cervix. The edges of the incision are now drawn apart and the neoplasm, already located cystoscopically, is drawn through the opening into the vagina, everting with it the contiguous portion of the blad-

der wall. If it occupies but a small area it may now be excised piecemeal, suturing step by step; and if the bleeding is free, tying the sutures as they are passed. If the area of excision is a larger one, and if the cut goes deeply in or through the bladder wall, it will be best to transfix the wall in several places at a distance from the field of operation to hold it in place while the extirpation and suturing are going on; by doing this the great risk of hemorrhage and delay from the open wound pulling back into the bladder will be avoided.

If the field of extirpation lies in the neighborhood of the intravesical portion of a ureter, it will be safer to insert a bougie beforehand so as to protect it.

(c) **Suprapubic Incision** (hypogastric route).—By this avenue tumors of larger size may be safely extirpated and the operation safely controlled throughout when it is necessary to extirpate any considerable portion of the bladder with the tumor.

The important practical questions whether the bladder may be safely sutured so as to avoid the risk of peritonitis after cutting into it on the peritoneal side, and whether any considerable part of the bladder may be removed and the defect made good by proper suturing, can be readily answered by some of the accidents met with in removing large myomatous uteri. I have several times cut into the bladder and closed the incision with interrupted sutures without any ill consequences. In one case I cut off a piece of the bladder as big as the palm of my hand, and closed the defect by interrupted sutures in the muscular coat without any after-effect.

The bladder may be exposed either by a transverse incision, which gives more room, or by a vertical incision in the median line; the disadvantage of the transverse incision is the severance of the recti muscles and the liability of the wound to gap open during the healing. If it is possible to avoid it the peritoneum ought not to be opened on account of the increased dangers of infection, which are greatly multiplied when cystitis is a complication.

The incision begins just above the symphysis pubis and is made 6 or 8 centimeters ( $2\frac{1}{2}$  to 3 inches) long. The prevesical space is exposed, and the peritoneum is pushed up off the anterior abdominal wall, so as to expose the vault of the bladder; if the pelvis is a deep one and the abdominal walls thick, it is well to fill the bladder beforehand with water so as to bring it within easy reach just under the incision. In a thin patient there is no difficulty in picking it up and opening it. A vertical incision is now made through the muscular and mucous coats of the bladder long enough to give plenty of room to get at the tumor and handle it easily. When the tumor lies deep down in the pelvis and is hard to reach, the steps of the operation will be greatly facilitated by temporarily attaching the sides of the incision in the bladder to the skin of the abdominal incision, so as to hold the whole bladder well up in view and within easy reach.

Superficial tumors covering a wide area may be extirpated by incising the mucosa on all sides and dissecting it up so as to remove it with the tumors. Almost the whole of the vesical mucosa may be taken away and yet it will re-

generate, but wherever little islets or strips of sound mucosa can be left this should be done, as the new mucous membrane starts to grow from these centers. As much of the defect as possible should be covered in by drawing together the remaining mucous membrane with a continuous catgut suture.

When the disease goes deeper than the mucosa it is safe to excise even the entire thickness of the bladder wall, if necessary trenching on its peritoneal portion too. In this way a large part of the bladder, a half or even two thirds of it, may be resected, and the portion remaining will be able in great measure to maintain its function. After cutting through the walls, the rest of the bladder can be loosened from its attachments by a blunt dissection with fingers or a knife handle. On the vaginal side, although adhering more closely, the bladder can be detached in the same way without opening the vagina. All bleeding vessels should be tied at once with catgut.

After resection, the wound must be accurately closed, when possible, by interrupted catgut sutures applied close together, after which the bladder is kept empty from six to eight days by drainage through the urethra. The way in which the sutures are tied will depend on the position of the tumor; when this is situated on the base or on either side they may all be tied in the bladder, but at the vault they should be tied on the outside of the bladder. Each suture tied on the outside should grasp the muscular surface alone; those on the inside should include the mucosa too. When the peritoneum is cut, this should be drawn over the line of sutures to form an additional protection to the abdominal cavity.

If the tumor occupies the site of one of the ureteral orifices it will be easy to extirpate it, first cutting off the end of the ureter, if necessary, and transplanting it into a part of the bladder posterior to the wound. I should do this by puncturing the bladder wall on that side where I wished to introduce it, loosening the ureter and bringing it through the opening. The new ureteral orifice should be cut obliquely and attached to the bladder, in its new position, by four or five fine catgut sutures. The wound made by taking out the tumor may then be closed by interrupted catgut sutures, taking in all layers. After closing the bladder wound perfectly the abdominal wound should be brought together by silkworm-gut sutures through the fascia and catgut through the fat and the skin.

If the wound in the bladder can not be perfectly closed, it is necessary to use a gauze drain above the pubis as well as by the urethra, so as to avoid urinary infiltration of the tissues; when the wound begins to close down to a small opening a rubber tube may replace the gauze.

Sonnenburg (*Berl. klin. Woch.*, 1884, No. 52) describes a resection of the bladder in a woman for a fibro-sarcoma. The tumor on the anterior wall of the bladder was 3 or 4 centimeters in diameter, and had an ulcerated surface. A suprapubic incision was made and the bladder freed and the tumor excised, leaving only a part of the posterior wall and the base of the bladder with the ureters. The peritoneum, which had been opened, was brought together by suture and the bladder drained, both by the urethra and through the abdominal wound,

which was left to close by granulation. The patient survived the operation ten weeks.

(d) *Symphycotomy* is used to secure a large field of operation when the tumor is situated at the neck of the bladder, but the bladder in women is so accessible by the suprapubic route that it can hardly be necessary in any case to resort to so serious a procedure.

(e) *Cystectomy*.—The removal of the entire bladder is required when its entire wall is occupied by a malignant growth, but it rarely happens that a patient with such an extensive disease will be in condition to stand such an operation, even if the disease has not extended beyond the bladder.

The following case of cystectomy admirably devised and successfully practiced by K. Pawlik (*Gen. f. Gyn. Beilage*, 1890, p. 113) deserves careful study as a model on which to base any similar attempts in the future; it was conducted by the following steps: Transplantation of the ureters into the vagina; extirpation of the bladder; construction of a new bladder out of the vagina.

The patient had complained of painful micturition and bloody urine, and the removal of a vesical polyp was followed by relief for a time; but later, papillary growths of the bladder, accompanied with hematuria, gave so much distress that Dr. PAWLIK determined to remove the entire bladder.

On August 3, 1889, he performed a preliminary operation—the establishment of uretero-vesical fistule. Having introduced a Simon speculum into the vagina and sounds into the ureters to mark them out, he dissected them free from the bladder by a vaginal incision 2 centimeters long, tied silk ligatures around them on the vesical side, split them open longitudinally, and then sutured the openings with fine silk sutures into the upper part of the vagina; he then cut off each ureter below the ligature. The discharge from the bladder no longer receiving any urine, was at first a thick, brownish liquid, but later it contained nothing but some mucus.

Three weeks later the bladder was extirpated; after suitably preparing the field of operation he filled the bladder with an iodoform emulsion, and introduced into the ureters elastic sounds with mandarins. He then made an incision 10 centimeters (4 inches) long in the linea alba, extending down to the symphysis pubis, and, without cutting into the peritoneum, he detached the distended bladder easily on all sides, except at the artificial ureteral openings into the vagina. Here there was considerable hemorrhage, which was controlled by tampons. Having dissected the entire bladder free down to the urethra, he finished the operation of removing it by the vaginal route. A transverse incision was made in the anterior vaginal wall just above the urethra, and the emptied bladder was drawn through this opening and severed in the plane of the internal urethral orifice. As the papillomata grew thick about the orifice, he dissected away the mucosa widely around this point.

The urethra was finally fitted into the vagina by suturing its anterior wall to this transverse vaginal incision, and attaching the remaining portion to the lateral and posterior walls of the vagina, which was now denuded around its entire cir-

circumference. This had the effect of converting the vagina into an artificial bladder, and of retaining the entire urethra as its outlet.

The abdominal wound was drained. The suprapubic fistula was long in closing, as was also a fistula behind the urethra, and there was at one time an obstruction of the right ureter. This was, however, relieved, and a quantity of urine escaped. The patient recovered and with a small fistula had good control of the new vaginal bladder, which had a capacity of 400 cubic centimeters.

## CHAPTER XIII.

### AFFECTIONS OF THE URETERS.

1. Anatomy. 1. The abdominal portion of the ureter. 2. The pelvic portion of the ureter.
2. Physiology.
3. Methods of examining the ureters. 1. Inspection. 2. Palpation. 3. Catheterization: (*a*) instruments used; (*b*) introduction of speculum and location of ureteral orifices; (*c*) introduction of the flexible silk catheter; (*d*) how to secure urine from both ureters at the same time; (*e*) how to obtain uncontaminated urine; (*f*) how to secure urine directly from the ureter without catheterizing; (*g*) catheterization of the ureters without elevation of the pelvis and without atmospheric distention of the bladder; (*h*) points to be observed in securing separated urines; (*i*) analysis of separated urines. 4. Sounding the ureters. 5. Catheterizing the pelvis of the kidney: (*a*) flexible silk catheter; (*b*) introduction of catheter; (*c*) asepsis. 6. Ureteral fever.
4. Congenital affections of the ureters. 1. Ectopic ureteral orifice. 2. Cystic dilatation of an occluded ureter. 3. Congenital flexure of the ureter.
5. Ureteritis and periureteritis. 1. Causes. 2. Symptoms. 3. Prognosis. 4. Diagnosis. 5. Treatment.
6. Tubercular ureteritis. 1. Symptoms. 2. Diagnosis. 3. Operative treatment.
7. Obstruction of the ureter. 1. Causes. 2. Clinical symptoms. 3. Diagnosis: (*a*) palpation; (*b*) catheterization. 4. Operative treatment.
8. Stricture of the ureter. 1. Gonorrhoeal stricture of the vesical end. 2. Atresia of the ureter: (*a*) of lower end after extirpation of kidney and upper part; (*b*) of lower end after catheterization; (*c*) of renal end. 3. Traumatic strictures. 4. Hydroneurter.
9. Pyoureter.
10. Ureteral calculus. 1. Form and situation. 2. Symptoms. 3. Diagnosis. 4. Operative treatment.
11. Prolapse of the ureter.
12. Ureteral fistula. 1. Causes. 2. Diagnosis. 3. Treatment: (*a*) fistula in the lateral wall of the ureter; (*b*) ureteral fistula at the base of the bladder; (*c*) ureteral fistula at the vaginal vault; (*d*) uretero-cystostomy performed seven weeks after vaginal hysterectomy; (*e*) extra-peritoneal uretero-cystostomy; (*f*) ureterostomy; (*g*) ureterotomy; (*h*) uretero-ureterostomy; (*i*) nephro-ureterectomy.

**Anatomy.**—The ureters (see Figs. 27–29, Chap. IV) are two symmetrically disposed, flattened, whitish cords lying in the loose connective tissue behind the abdominal and pelvic peritoneum, from 25 to 30 centimeters (10 to 12 inches) long. The left ureter is longer than the right because of the higher position of the left kidney. Each ureter begins funnel-shaped at the renal pelvis, follows an irregularly curved course, and terminates at a little eminence (in the knee-breast posture) in the bladder at the end of the inter-ureteric fold. The diameter of its lumen is about 3 millimeters, and is uniform throughout except at each extremity, where there is a slight narrowing. The abdominal portion is from 2 to 3 centimeters ( $\frac{3}{4}$  to  $1\frac{1}{4}$  inch) longer than the pelvic portion.

The course of the abdominal portion of the ureter, from renal pelvis to pelvic brim, starts out from the kidney 4 centimeters ( $1\frac{1}{2}$  inch) from the median line, crosses forward over the psoas muscle and then inward until it reaches a point, at about the middle of its length, from 2.5 to 3 centimeters (1

to 1½ inch) distant from the median line; here it diverges slightly outward and crosses the pelvic brim 3 centimeters (1¼ inch) from the median line.

Throughout the larger part of its abdominal course it lies upon the great psoas muscle, which it crosses obliquely. It holds no important relationship to any other vessels until joined at about the middle by the ovarian vein and artery. On the right side, above the brim of the pelvis, it lies behind the caput coli and the ascending colon; on the left side it lies behind the sigmoid flexure at the brim, and above this behind the descending colon.

The whole of the abdominal portion of either ureter can be exposed through a lateral incision without injuring any important structure or ligating any vessels, and without opening the peritoneum, by simply lifting up the ascending or descending colon and drawing the bowel toward the median line.

At the brim of the pelvis each ureter lies upon the common iliac artery, crossing it at about 3 centimeters (1¼ inch) from the middle of the sacral promontory; just below this it crosses the common iliac vein as it drops into the pelvis beside the internal iliac artery, and usually behind it.

The ovarian vessels cross the ureter, and leave it at the brim as they enter the top of the broad ligament.

Within the pelvis the ureter pursues a sigmoid course, running at first behind the peritoneum of the posterior lateral pelvic wall, close to the internal iliac artery, and then turning forward and crossing under the uterine artery, and passing through a sort of membranous foramen at the base of the broad ligament halfway between the cervix and the pelvic wall, nearer to the cervix on the left side. Beyond the cervix it runs at first parallel to the upper anterior vaginal wall, which it crosses, to pierce the bladder wall obliquely forward and inward, ending at the ureteral orifice at the *trigonum vesicæ*.

The landmark for the first part of the pelvic portion of the ureter is the internal iliac artery. The ureter can be found on a rectal examination lying just behind the artery, which it sometimes crosses so as to lie in front of it.

In its relation to the vaginal walls the lower ends of the ureters may be located by the "ureteral folds" seen on the anterior vaginal wall.

**Physiology.**—The function of the ureters is simply to transmit the urine from the pelvis of the kidney to the bladder. This function is an active and not a passive one. The urine first accumulates in the renal pelvis and enters the ureter intermittently, where it is caught and carried down by a peristaltic wave about 25 centimeters long, which travels the length of the ureter every ten to twenty or thirty seconds. As the wave passes, there is a distinct vermicular movement, at first a contraction then a lengthening of the ureter, which moves forward under its peritoneal cover. I have seen this phenomenon repeatedly in the course of operations. I have also excited the wave movement by light tapping or by lifting the ureter up, pinching, and dropping it; this act may also excite a reverse peristalsis. Each ureteral contraction is signalized at the orifice of the ureteral catheter by the sudden expulsion of a few drops of urine, or if the caliber of the catheter is quite small, by a jet lasting two or three seconds. An observer watching the vesical orifice of the ureter with the patient

in the knee-breast position sees little jets of urine spurting out every few seconds. The inner coat of the normal ureter is not sensitive to the contact of the flexible silk ureteral catheter as it is introduced.

#### METHODS OF EXAMINING THE URETERS.

The ureters can be examined by inspection, palpation, catheterization, and sounding.

**Inspection.**—But one portion of the ureters, the vesical orifices, can be seen by a cystoscopic examination without a preliminary operation. When the patient is in the knee-breast position a distinct ridge is often seen on the vesical mucosa extending from each ureteral orifice out to the pelvic wall, which corresponds to the lower extremity of the ureters. I have exposed and examined the vaginal portion of the ureter by an incision extending from the vault halfway down through the antero-lateral vaginal wall. By separating the edges of the incision, the ureter will be found in the loose cellular tissue just above the vagina, close to the pelvic wall. It can be located with greater ease if a bougie has been placed in it beforehand, converting it into a hard cord easily distinguished.

The posterior pelvic and lower abdominal portions on either side can readily be inspected, when the abdomen is opened, by drawing the sigmoid flexure toward the right side to expose the left ureter, and by lifting up the caput coli and drawing it also to the right to expose the right ureter. The ureters appear as whitish, flat cords, often with a little tortuous artery coursing down them, beneath the peritoneum, and lying close to the inner side of the ovarian vessels at the brim of the pelvis. If not seen, the ureter can be found by picking it up just above the brim of the pelvis with the ovarian vessels and the adjacent cellular tissue; the ovarian veins collapse at once on pressure, and the artery is small, but the ureter forms a distinct flat cord readily recognized by touch. This cord is easily followed by touch and sight down over the pelvic brim, and then, by holding it out from the pelvic wall and floor, a sort of meso-ureter is formed, and it is traceable as far forward as the uterine artery.

If there is much fat in the abdomen it is sometimes hard to find the ureter. In such cases I pick up a fold of peritoneum overlying the common iliac artery near its bifurcation and incise it for 2 or 3 centimeters ( $\frac{3}{4}$  to 1 inch). By drawing apart the edges of this incision and getting rid of the fat and then looking closely, the ureter will be found beneath. If necessary to trace it farther it may be held up and the peritoneum split up or down, laying it bare.

The abdominal portions of the ureters can be laid bare for inspection by incising the peritoneum reflected over the ascending and descending colon on the outer side, where there are no vessels; then, by displacing the colon toward the median line, the ureter is exposed on the psoas muscle.

I have also inspected the entire abdominal portion of the ureter through an incision beginning in the flank in front of the quadratus muscle and extending down just above and parallel to the brim of the pelvis as far as the anterior superior spine. This can be done most conveniently when the kidney is removed

and detached from everything but the ureter. By pulling the ureter so as to make it tense, its course is easily followed by the finger down in the loose cellular tissue. It will be important to do this in tubercular disease of the kidney to see if the ureter is involved too, or in the case of a suspected stone in the ureter.

**Palpation.**—The whole pelvic portion of the ureter is accessible to palpation in two ways—either by the vagina or by the rectum.

By the vagina the ureters are most accessible to palpation at their lower extremities, from the bases of the broad ligaments beside the cervix down to the terminus in the bladder. To palpate the ureter the bladder and rectum should be empty, and the patient lying on her back with flexed thighs. The index finger is now carried high up into one of the vaginal fornices, pushing it upward and outward toward the pelvic wall, which is then gently stroked downward and backward. The ureter feels to the finger tip like a flat cord which is constantly slipping away. The cord is palpated again and again, each time bringing the finger nearer the outlet, and so tracing the course of the ureter down the pelvic wall to the point at which it passes between the anterior vaginal wall and the bladder.

Sometimes the ureter will be found lying close to the pelvic wall, and at others in the loose cellular tissue several millimeters distant. When the ureter is out of easy reach it can be better felt by a bimanual examination, the upper hand pressing down through the abdominal wall. By this manœuvre the abdominal hand displaces the organ slightly, and at the same time offers a plane of resistance against which the ureter can be readily palpated by the vaginal finger. In advanced pregnancy, where the head is low in the pelvis, the ureters are markedly displaced and can be felt with extraordinary distinctness against the child's head.

In palpating its lower extremity the ureter is distinguished by its direction, its size, its consistency, and its mobility. It may be confused with an obturator artery pursuing a course parallel to the vagina, but the artery is small and round, and it will be felt to pulsate. The obturator nerve also lies parallel to the course of the ureter above, but it may be traced down to the obturator foramen, and produces pain in the leg on pulling it. The sharp tendinous arch of the levator muscle may also be mistaken for the ureter, but a closer palpation will correct this source of error, as well as the impression at first produced by strands of the internal obturator muscle.

The ureter lies loosely in its cellular bed, and so can be sometimes displaced downward 1 or 2 centimeters, and if a hand rests over the abdominal portion at the pelvic brim in a thin patient, when a finger draws down the vaginal end and lets it snap back, like a cord of a bow, the impulse may sometimes be felt at the brim of the pelvis.

The normal ureter can only be palpated with certainty through intact abdominal walls at the pelvic brim when the walls are extremely thin. I have felt them distinctly through the lax umbilical ring immediately after childbirth. A diseased ureter, usually extremely sensitive, can be readily located by the pain on pressure at its point of transit from the abdomen into the pelvis.

To make this examination the patient lies on her back with shoulders raised on a pillow and thighs moderately drawn up, and the large bowel and bladder must be empty. The examiner stands on the side he wishes to palpate and begins by making a gradually increasing deep pressure through the abdominal walls until the promontory of the sacrum is found; 3 centimeters (1¼ inch) to the right or left side of this point and a little below it is the point at which the ureter crosses the pelvic brim. By making deep pressure through the semilunar line over the brim at this point in an oblique direction from above downward, and sliding the fingers up and down, the patient will at once complain of pain and possibly of a desire to urinate if the ureter is inflamed. A large diseased ureter—tuberculous, for example—will feel through a thin abdominal wall like a stout cord rolling under the fingers.

The abdominal portion of an inflamed ureter above these points may be traced by following the line of tenderness developed on making deep pressure.

By the rectum the ureter can be felt from the pelvic brim to the pelvic floor through the empty bowel; the left ureter is the most accessible. The pelvic floor is invaginated by strong pressure and the finger carried up to the bifurcation of the common iliac artery, from which point down the internal iliac artery is easily followed. Guided by these landmarks, the finger palpates carefully behind and close to the internal iliac artery until a flat yielding cord (the ureter) is detected, which can be traced at first downward and then forward. A ureter whose walls are thickened can be still more readily found and palpated. If the ureter is not found in this way, it can be palpated with perfect ease throughout its whole pelvic course by first placing a hard-rubber bougie or a catheter within it.

In abdominal operations, when the broad ligament is opened, if the ureter is not marked out by a catheter lying in its lumen, it may be found by touch alone by separating the anterior from the posterior layer of peritoneum and carrying the thumb and forefinger deep down to the pelvic floor, and gathering up the cellular tissue and letting it slip out between the fingers; after a few efforts the ureter will be distinctly recognized, and then easily traced in its course into the anterior part of the pelvis.

**Catheterization.**—The most important means of investigation at our command is catheterization, by which we may establish the existence of a stricture, a hydronephrosis, a pyonephrosis, or a calculus of the ureter, or secure evidence of disease of the kidney above, or settle the question as to whether one or both ureters are involved; catheterization also gives precise information as to the extent and location of the disease.

We are able by catheterization to receive directly from the ureter the urine discharged from the kidney without contamination with the surface of the bladder and urethra and before mixture with the urine from the opposite kidney. By catheterizing both ureters and leaving the catheters in, the urine from both kidneys may be collected separately, throwing the bladder for a time entirely out of use. Catheters may even be left in place for several hours, or even in exceptional instances, as suggested by Dr. F. Henrotin, for three or four days.

The utmost pains must be taken throughout to avoid the introduction of septic matter into the ureter by the catheter.

The best way to catheterize the ureters in women is under an atmospheric distention of the bladder, secured by posture, and a direct inspection of the ureteral orifices through a cystoscope.

The following instruments are required :

A conical urethral dilator ; several specula with obturators, Nos. 8, 8½, 9, 9½, 10 ; a light ; a head mirror ; an evacuator ; long recurved mouse-toothed forceps ; a ureteral searcher ; flexible ureteral and renal catheters ; a metal ureteral catheter ; hard-rubber bougies ; and a series of dilating catheters.

A description of the urethral dilator, various specula, light, mirror, evacuator, forceps, and searcher, used also in examination of the bladder, has been given in Chapter XII.

**Flexible Catheters.**—Flexible catheters which readily follow the curves of the ureters and do not injure them during introduction are used to drain the urine from the ureters ; they can easily be carried beyond the pelvis into the abdominal portions even as far as the kidneys ; with their use also there is no liability of hurting the patient or of the catheter slipping out during the subsequent manipulations necessary to put the patient in a satisfactory position in the bed, when the catheter is to be left in for any length of time.

Two kinds of flexible catheters are made, ureteral and renal, differing only in length, the former 30 centimeters (12 inches) and the latter 50 centimeters (20 inches) long. These catheters are made of woven silk, many times coated with varnish and rubbed down until they have a highly polished surface. The end of the catheter is blunt, conical, with a large oval eye 2 centimeters (¾ inch) from the tip. Both kinds are made in diameters which run from 1½ millimeter to 3 millimeters. The following sizes are furnished : 1½, 2, 2¼, 2½, 2¾, 3. The name of the size specifies the diameter in millimeters.

It is possible in almost all cases to introduce a catheter into the ureter through one of the plain cylindrical cystoscopes without anesthesia and without any or but slight dilatation of the urethra. The bladder should be distended with air by the knee-chest or elevated-dorsal posture and illuminated by a simple reflected light (see Chapter XII).

A wire stylet is necessary to give the catheter the needed stiffness during its introduction into the ureter. The catheters should be kept dry and straight. If they are bent they tend to crack and blister and little scales rise which cut like a knife. After use each catheter should be thoroughly cleansed by forcing through it with a syringe a warm bichloride-of-mercury solution (1 to 1,000) followed by warm water. After septic cases it must be sterilized by boiling two minutes in pure water, after which it should be laid away in sterilized towels or cloth in a warm place and kept quite straight four or five days until thoroughly dried, when it may be put away in a case until wanted for further use. It is especially important to make sure that no particles of dirt are left in the lumen of the catheter ; microscopic particles can be detected by the interference with the flow of water from end to end, as well as by holding the catheter up to the

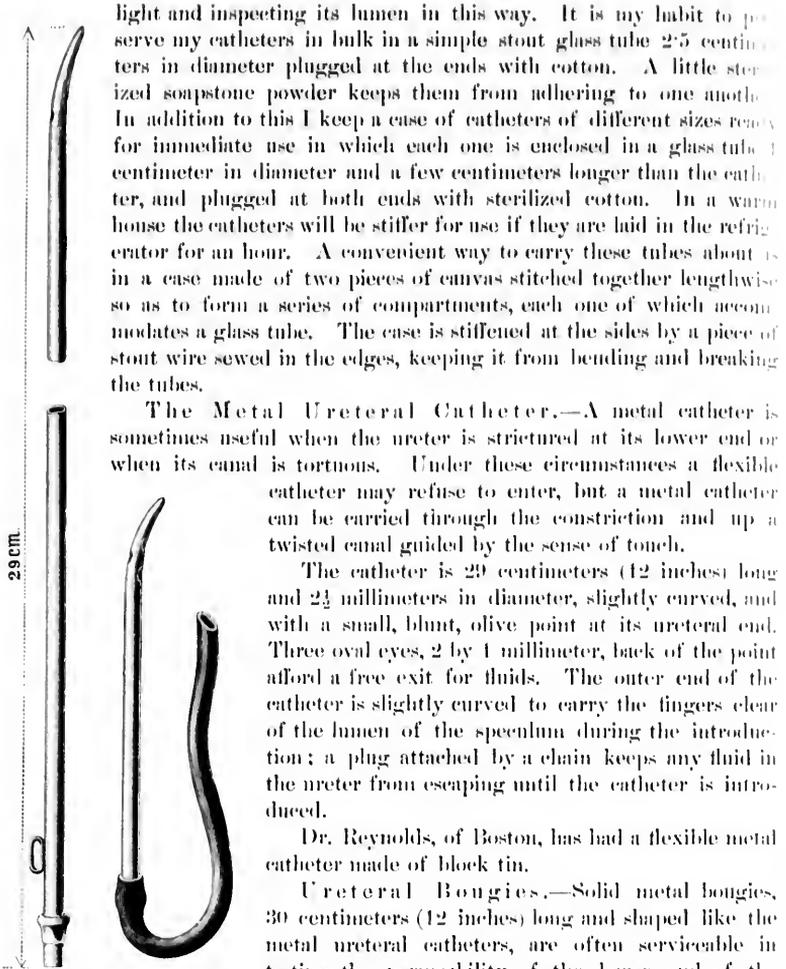

FIG. 231. LEFT-HAND FIGURE, LONG METAL URETERAL CATHETER FOR THE LOWER PART OF THE URETER.

Used chiefly in stricture of the vesical end of the ureter. The short metal catheter with the rubber tube is often used to collect the urine from one side when a long flexible catheter can not be carried up to the kidney. A catheter  $\frac{1}{2}$  to 1 millimeter smaller in diameter than that shown in the figure is usually used.

light and inspecting its lumen in this way. It is my habit to preserve my catheters in bulk in a simple stout glass tube 2.5 centimeters in diameter plugged at the ends with cotton. A little sterilized soapstone powder keeps them from adhering to one another. In addition to this I keep a case of catheters of different sizes ready for immediate use in which each one is enclosed in a glass tube 1 centimeter in diameter and a few centimeters longer than the catheter, and plugged at both ends with sterilized cotton. In a warm house the catheters will be stiffer for use if they are laid in the refrigerator for an hour. A convenient way to carry these tubes about is in a case made of two pieces of canvas stitched together lengthwise so as to form a series of compartments, each one of which accommodates a glass tube. The case is stiffened at the sides by a piece of stout wire sewed in the edges, keeping it from bending and breaking the tubes.

**The Metal Ureteral Catheter.**—A metal catheter is sometimes useful when the ureter is strictured at its lower end or when its canal is tortuous. Under these circumstances a flexible catheter may refuse to enter, but a metal catheter can be carried through the constriction and up a twisted canal guided by the sense of touch.

The catheter is 29 centimeters (12 inches) long and 2½ millimeters in diameter, slightly curved, and with a small, blunt, olive point at its ureteral end. Three oval eyes, 2 by 1 millimeter, back of the point afford a free exit for fluids. The outer end of the catheter is slightly curved to carry the fingers clear of the lumen of the speculum during the introduction; a plug attached by a chain keeps any fluid in the ureter from escaping until the catheter is introduced.

Dr. Reynolds, of Boston, has had a flexible metal catheter made of block tin.

**Ureteral Bougies.**—Solid metal bougies, 30 centimeters (12 inches) long and shaped like the metal ureteral catheters, are often serviceable in testing the permeability of the lower end of the ureter, or in recognizing a calculus in its pelvic portion, or in locating and dilating a stricture in the ureter not far from the bladder. I have had a series of these bougies made 2 millimeters in diameter, with a bulbous enlargement about 7 millimeters back of the point, varying in size in the different numbers of the series from one which is but slightly larger than the shaft of the bougie itself up to one 4 milli-

meters in diameter. I have tested whalebone and found that, on account of its elasticity, it does not make a good ureteral bougie. The best bougies are made of hard rubber 2 millimeters in diameter and 50 centimeters (20 inches) in total length. There is a slight narrowing below the end which is rounded off into a point shaped like an olive. The handle, large enough to be taken conveniently between the thumb and forefinger, is 6 centimeters ( $2\frac{1}{2}$  inches) in length and passes easily through the No. 8 vesical speculum. This bougie easily adapts itself to the curves of the ureter and can be pushed on up into the pelvis of the kidney without danger. It becomes more flexible when warmed.

The ureteral and renal catheters are also made without any eye for use as flexible bougies; these are the safest in performing hysterectomy, on account of the liability of the hard rubber to break when bent suddenly and sharply.

I have also had a long hard-rubber bougie made with a little notch running lengthwise at the tip on two sides, intended to catch and hold the dental wax with which the end is coated when the bougie is used as a searcher for a renal calculus. If a calculus is present and the bougie comes in contact with it, the shining impressionable surface of the wax is scratched, and the scratch marks can be seen under the lens of a low magnifying power. A silk renal catheter tipped with wax detects the stone equally well, and so serves the double purpose of bougie and catheter.

**Dilating Catheters.**—The dilating catheters are used to dilate ureteral strictures near the bladder. They are nickel-plated metal tubes, 25 centimeters (10 inches) in length, slightly curved at the tapering conical point, which is well rounded and blunt so as not to hurt the ureteral wall. The slight curve, which is shown in the picture, facilitates the introduction through a stricture. There are four eyes, arranged in pairs, one eye below the other on opposite sides of the catheter, and located within 2 centimeters of the end. The outer end of the catheter is curved in an opposite direction from the curve of the point, so as to keep the fingers out of the way during introduction. At the outer end there is a little bulbous enlargement to hold rubber tubing slipped over it; a plug and chain are attached to keep the catheter closed until introduced. The sizes vary in diameter from  $2\frac{1}{2}$  to 6 millimeters, the difference between the sizes being half a millimeter.

**Introduction of the Speculum and Location of the Ureteral Orifices.**—The bladder is first emptied of its urine by voiding it in a sitting or a standing posture. The evacuation is more complete when it is so voided than when drawn by catheter in the dorsal posture. The patient is then placed on a table in the knee-breast or elevated-dorsal position, the labia separated, and the urethral orifice exposed and cleansed with a borie acid solution to avoid carrying surface contamination into the bladder on introducing the speculum.



FIG. 235. SHOWS  
END OF ELASTIC  
BOUGIE, TIPPED  
WITH WAX.

A bladder speculum, No. 8, 9, or 10, is introduced as described in Chapter XII. The light is then reflected into the bladder, and illuminates the posterior wall. The speculum is next withdrawn until the internal urethral orifice begins to close over the end, when it is pushed farther in, about a centimeter, and turned from 25 to 30 degrees, either to the right or left, while the handle is dropped to bring the base of the bladder into view. The ureter itself, or the area immediately adjacent to it, now lies within the field of vision, about 1.5 centimeter ( $\frac{1}{2}$  inch) distant from the end of the speculum. In thin patients the dorsal posture works very well, but in a patient of medium size the bladder may not distend well until she assumes the knee-breast position. Stout women must always be examined in the knee-breast posture.

In virgins and nullipare the bladder walls balloon out so much upon atmos-



FIG. 236.—SOUNDING THE LEFT URETER WITH THE SEARCHER BEFORE INTRODUCING THE CATHETER. The patient is in the elevated dorsal position, and the electric headlight is used to illuminate the bladder.

pheric distention that the base is carried up toward the sacrum, and becomes so markedly concave that the ureteral openings can scarcely be seen; if the patient is in the knee-breast position, the observer has to drop the handle of the speculum to such an extent that he is obliged almost to bring his head under the pelvis to find them. This difficulty will be obviated by first introducing into the vagina a little speculum, not more than 1 to  $1\frac{1}{2}$  centimeter, which lets

in the air and causes the anterior vaginal wall to drop down, bringing the base of the bladder into the plane of vision. If the distention is still too great after this manoeuvre, the difficulty may then be overcome by introducing within the vagina a cotton pack large enough to hold the anterior wall down, or a small inflatable rubber bag, or an instrument shaped like a spatula with a strongly curved handle to make pressure on the vaginal wall and bring the ureteral orifice into view.

While the ureter is generally found at an angle of from twenty-five to thirty degrees with the urethra, it may be either more or less. I have often seen it upon simply carrying the speculum straight into the bladder without deviating more than from three to five degrees to the right or left. I use a simple device, figured in the text as a goniometer, to measure the angle between a line connecting the ureteral orifice with the internal orifice of the urethra and the axis of the urethra. The zero line of the goniometer is held in the line of the urethra while the long arm points to the ureteral orifice, when the angle can be read off on the graduated arc. In inflammatory cases the ureter is often drawn markedly to one side.

If the abdomen is filled with ascitic fluid, or if there is a tumor wedged in the pelvis, or if inflammatory disease is present, the bladder may not distend enough to allow the ureteral orifices to be seen. In such cases the orifice may be sought in the dorsal position without elevation.

The ureteral orifice is recognized as soon as it comes into the field of the speculum as a fine transverse slit, 2 to 3 millimeters long, like a little dark line on the bladder wall, not unlike a water mark in paper. At times it appears more distinct, owing to a slight injection of its borders. Rarely it looks like a fine dark point or a distinct hole. In the knee-breast position a decided eminence, having the form of a truncated cone, marks its site, and the opening is situated on top or on the anterior urethral side of this. I have called this elevation the *mons ureteris*. In one of my cases there appeared to be two left ureteral orifices, parallel and exactly alike, about 2 millimeters apart, but on passing the catheter into the lower one on the edge of the mons instead of going up a ureter, it reappeared in the bladder and the false orifice was found to be a little bridge of unconsolidated tissue, 2 or 3 millimeters long and about as wide.

When the ureteral orifice is not seen at all after a careful search it may be

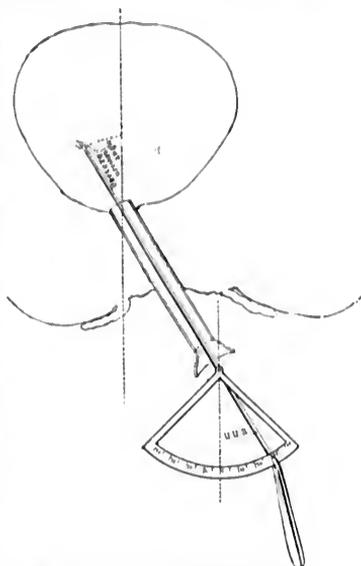

FIG. 237.—USING THE GONIOMETER TO DETERMINE THE ANGLE MADE BY THE AXIS OF THE URETHRA, WITH A LINE DRAWN FROM THE INTERNAL URETHRAL ORIFICE TO THE URETER.

found by directing the speculum to the area where it should be, taking care that it is not pushed too far in so as to cover it, and then with the searcher systematically and gently running over the whole surface feeling for it. Sooner or later the point catches and enters and the orifice is evident. The searcher upon enter-



FIG. 258.—PASSING A METAL URETERAL CATHETER INTO THE LEFT URETERAL ORIFICE, WHICH IS EXPOSED BY THE LUMEN OF THE SPECULUM. THE PATIENT IS IN THE KNEEL-CHEST POSTURE.

ing separates the lips of the orifice a little, making them pale and opening up a dark hole about 2 millimeters in diameter, especially striking to an on-looker watching for a demonstration of the possibility of catheterizing the ureter in this way.

**Introduction of the Flexible Silk Catheter.**—The location of the orifice is carefully noted, and while the speculum is grasped firmly so as to keep it in full view, the sterilized flexible silk ureteral catheter, projecting a

little from its glass tube, is held over the shoulder—in the left hand for the right ureter and in the right hand for the left ureter—and slowly guided up the tube, where its point is engaged in the orifice and pushed on from 10 to 15 centimeters (4 to 6 inches).

The end of the catheter must be lubricated by dipping it in a boro-glyceride solution before introduction, and before taking

FIG. 239. — WASHING OUT THE PELVIS OF THE KIDNEY BY CONTINUOUS IRRIGATION.

The renal catheter has been inserted up to the kidney (confined through the body) and then connected with a funnel containing the irrigating solution. An ordinary glass catheter inserted into the bladder drains it by a short rubber tube into a bowl. Upon elevating the funnel, the solution runs out of the end of the renal catheter and circulates in the pelvis of the kidney, which it distends, and then escapes freely down the ureter, beside the catheter, into the bladder and so out through the catheter into the bowl. The arrows indicate the course of the fluid.

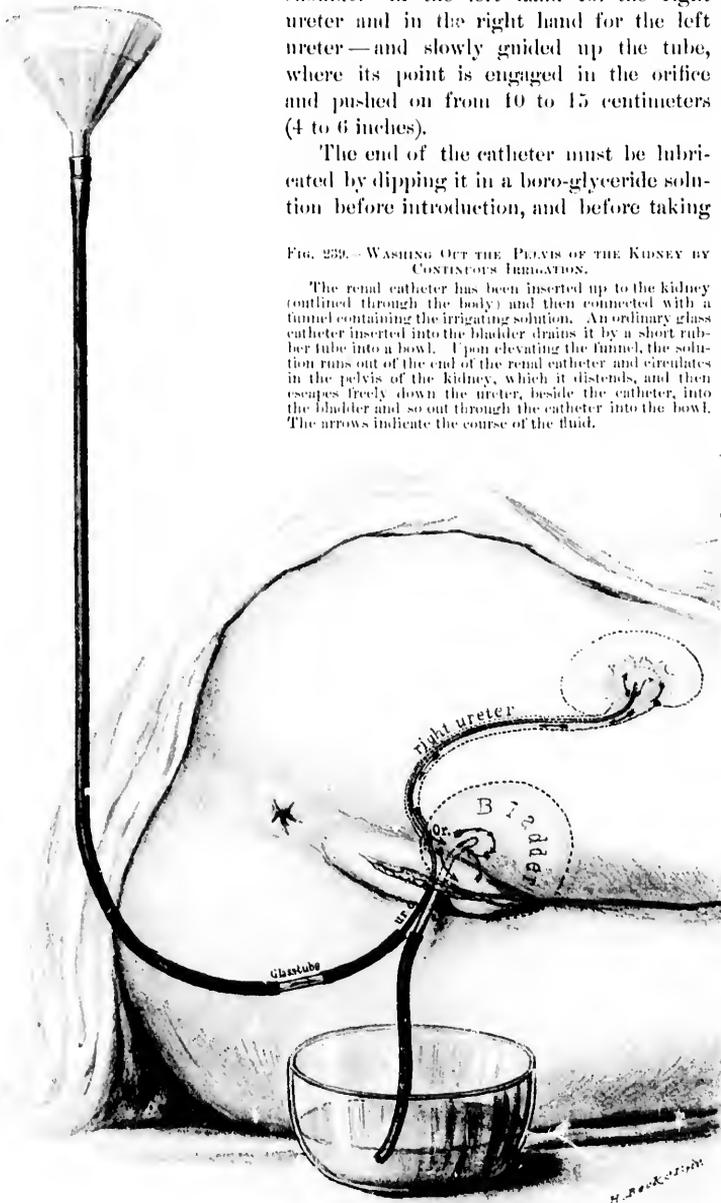

hold of the end of the catheter sterilized rubber finger stalls must be drawn over the thumb and forefinger, to avoid direct contact with the fingers, and to avoid a possible infection of the ureter. If there is any inflammatory process in the bladder, the ureteral orifice must be cleansed with a pledget of cotton held by the mouse-toothed forceps, and the lumen of the speculum must be cleansed in the same way.

In introducing the long renal catheter when the glass tube is not used, the handling of its upper part, which is to lie inside the body, may be avoided by first locating the ureteral orifice and then asking for the catheter. The assistant takes it up from the sterilized towel in which it rests by the outer end and hands it to the operator, who likewise receives it by this end, and slowly guides the swinging tip into the speculum and so on up into the ureteral orifice, when it is then easily run off from its stylet and on up the ureter.

When the catheter is in place the speculum is withdrawn, while the operator holds on to the catheter to keep it from being pulled out too. If the catheter is to remain in but a short time the patient may stay in the same position; otherwise she should be carefully turned over on her back or side, avoiding any pull on the catheter.

In many cases when a catheter not larger than 2 or 2.25 millimeters is used to wash out the pelvis of the kidney the fluid only distends the pelvis a little and then begins to run down the ureter and back into the bladder outside the catheter. Owing to this circumstance, in cases of catarrhal pyelitis and of pyelonephrosis it is often possible to wash the kidney out thoroughly by keeping up a continuous irrigation for from ten to thirty minutes or longer.

After the renal catheter is inserted the patient lies on the opposite side and a glass catheter is inserted into the bladder. It is well to color the irrigating solution with aniline dye to demonstrate its return to the eye. On raising the funnel and letting the fluid run into the kidney the return flow into and out of the bladder is noticed at an interval of from fifteen to seventy-five seconds. The end of the catheter is placed in a sterilized test tube to collect the escaping urine. If the tube is left in after the patient is put to bed it is best held in a block of wood in an angle hole bored at an angle as shown in the figure.

When the short metal catheter with a piece of rubber tubing on the end is inserted into the ureter for the purpose of collecting the urine of one side, it is best to drop a small quantity of a concentrated aniline solution into the bladder so as to have positive evidence that the clear fluid escaping by the catheter is not contaminated by the fluid in the bladder and that the catheter remains in place in the ureter.

In making a thorough examination of urine collected directly from the ureter five things must be inquired into:

1. The amount of fluid escaping at once upon the introduction of the catheter.
2. The rate of flow during catheterization.
3. Physical properties, specific gravity.
4. Chemical properties.

## 5. Bacteriological condition.

The watch is taken out and the time of introduction noted, so that the rate of secretion may be determined by measuring the amount collected within a definite time.

When both ureters are to be catheterized the speculum is withdrawn and re-inserted beside the first catheter, and the other orifice found and catheterized in like manner.

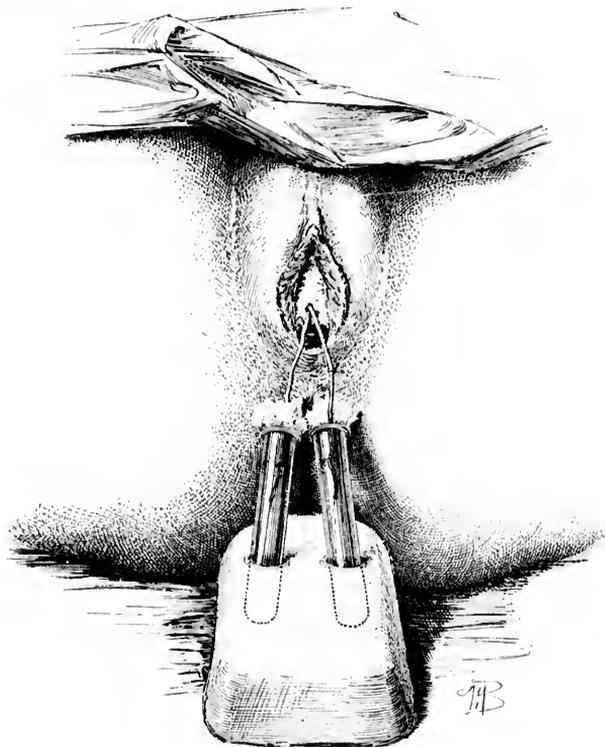

FIG. 210.—CATHETERIZING BOTH URETERS; THE SEPARATED URINES ARE BEING COLLECTED IN TEST TUBES PLUGGED WITH COTTON AND HELD IN A BLOCK.

Another way of securing separated urines from both ureters at the same time is to place one of the larger ureteral catheters in one ureter and then carefully remove all fluid from the bladder with the suction apparatus and pledgets of cotton. The patient lies on her back and the urine drains, say for an hour, through the ureteral catheter into a vessel in the bed. The urine which collects in the bladder during this hour may be assumed to come from the other kidney if it presents different chemical and microscopic char-

acteristics; it is removed either by an ordinary vesical catheter, before taking out the ureteral catheter, or by introducing a speculum and using the suction apparatus. This plan needs further trial and is not available when there is inflammation of the bladder which contaminates the urine accumulating in it.

A method of separating the urines from the right and left ureters without catheterizing the ureters has been devised by Dr. Neumann (*Deutsche med. Woch.*, No. 43, 1897). The patient is seated on the very edge of a table, with her feet on the floor or a stool. An instrument is then inserted which is intended to divide the bladder for a time into right and left halves, and at the same time to provide a free exit for each half, in this way separating the urines. The instrument is constructed like a catheter, 4 centimeters long and 1 centimeter in diameter, with a vertical partition down the middle; this partition is continued 4 centimeters beyond the body of the instrument, and ends in a blunt rounded point, connected with the end by two fine wires on each side. The distal end of the catheter ends in two little tubes, one for each side; on these little graduated are hung to collect the urine. The whole instrument has a gentle curve, like Hegar's cervical dilators.

The urines are separated by first washing the bladder out from one tube through the other, and then introducing the index finger into the vagina and pressing the base of the bladder firmly up against the instrument, which now fits snugly behind the symphysis pubis. The urine escaping from the ureters now flows down the tubes on the right and left sides completely separated.

How to obtain Uncontaminated Urine. — Sterilized urine, or urine free from any contamination from external sources, may be obtained by covering 3 or 4 centimeters ( $1\frac{1}{4}$  to  $1\frac{1}{2}$  inch) of the outer end of the sterilized ureteral catheter with a protecting rubber sleeve, and then introducing the catheter as described; the sleeve is then removed and another piece of longer sterilized tubing slipped over the end and used to convey the urine into a suitable sterilized glass tube plugged with cotton, resting in a block. To avoid contaminating the end of the catheter by contact with the sides of the speculum, it may be introduced into the bladder loosely covered with a sterilized rubber sleeve, which is pulled off as soon as it is well in; but I prefer simply cleansing the inside of the speculum with a boric acid solution.

It is also possible to obtain uncontaminated urine after introducing the catheter in the ordinary way by boiling the first drop of urine appearing at the end with an alcohol flame held under it; the urine which follows this is then in no danger of contamination by picking up germs at this point.

For a bacteriological examination and cultures it is sufficient in this way to let a few drops fall directly from the end of the catheter on to the slide or into the culture tube. It is always well to test alkalinity or acidity as the urine escapes.

How to secure Urine from the Ureter without using a Ureteral Catheter.—Sometimes there are serious objections to passing a catheter into a sound ureter; when, for example, the bladder is extensively inflamed the examiner will hesitate, on account of the risk of opening up the

ureter and of the dangers attendant upon the slight trauma under such circumstances. But it is almost always possible to get enough urine for a microscopic and chemical examination without even touching the ureteral orifice. This is

done by putting the patient in the knee-breast position, exposing a ureteral orifice, wiping it off, and then holding the end of the speculum close up under it until a jet of urine escapes; the drop is caught in the lumen of the speculum and runs down its side on to the outer lip, where it may be taken at once on to a slide and examined or collected in a minim graduate. The microscopic examination in this way of a drop or two may be just as satisfactory as a large quantity secured by the ureteral catheter. (See *Twentieth Cent. Prac. Med.*, vol. 3, 1895, p. 690.)

I have had a speculum made for this special purpose (see Fig. 193) with the end cut off obliquely to fit in better under the orifice in the knee-breast position.

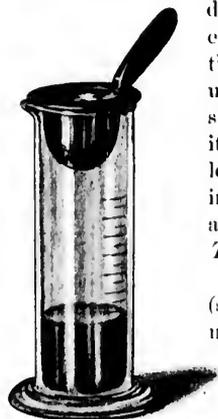

FIG. 241.—SIEVE AND GRADUATE FOR FILTERING AND COLLECTING A FEW DROPS OF URINE CAUGHT UP IN COTTON FROM THE URETERAL ORIFICE, THROUGH THE SPECULUM, WITHOUT CATHETERIZING THE URETER.

**Catheterization of the Ureters without Elevation of the Pelvis and without Atmospheric Distention of the Bladder.**—Under certain circumstances, when it is awkward or when it consumes too much time to place the patient in the knee-breast position and to elevate the hips on cushions, I am in the habit of introducing the catheter in the follow-

ing simple manner without elevation or atmospheric distention of the bladder:

The patient lies on her back on a flat table, with thighs well drawn up on the body, and the bladder is emptied. The No. 9 or 10 cystoscope is now introduced, its outer end strongly elevated, and the inner end turned toward the right or left side of the base of the bladder. The head mirror is now turned so as to

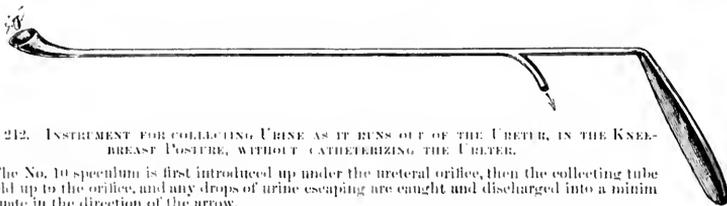

FIG. 242. INSTRUMENT FOR COLLECTING URINE AS IT RUNS OUT OF THE URETER, IN THE KNEE-BREAST POSITION, WITHOUT CATHETERIZING THE URETER.

The No. 10 speculum is first introduced up under the ureteral orifice, then the collecting tube is held up to the orifice, and any drops of urine escaping are caught and discharged into a minim graduate in the direction of the arrow.

illuminate the portion of the wall of the bladder at the end of the speculum. The speculum is now withdrawn as far as the urethral orifice, to locate its position, and then pushed in again and turned to one side with the idea of bringing the ureteral orifice at once within the lumen of the speculum. Sometimes it can be seen immediately, even through a little layer of clear urine; at other times it is necessary to keep the speculum against the bladder wall, and then, after drying out the few drops of urine in it, to find the ureteral orifice by gliding the instru-

ment over the vesical mucosa. Any depression resembling the mouth of the ureter is first tested with the searcher, and then if it is found the catheter is pushed in. By introducing the flexible catheters in this way just before a vaginal or abdominal hysterectomy the ureter is converted into a cord easily felt throughout the operation.

It not infrequently happens that the patient, with carcinoma of the cervix, is either so heavy that she can not be put into the knee-chest posture with the limited assistance at the command of the operator, or that she is so feeble that the operator feels unwilling to lose the amount of time necessary to change her position in order to find the ureteral orifices for catheterization. Under these circumstances I have often resorted to the method just described with perfect satisfaction. It will, however, hardly be possible for one not thoroughly used to the simpler way of catheterizing the ureters in the knee-breast posture, and so familiar with the exact location of their vesical orifices, to find them in the dorsal position with a collapsed bladder.

#### Points to be observed in securing Separated Urines.

I use the plural urines advisedly to make a distinction, hitherto impossible, between the mixed urine in the bladder from both sides and that from each kidney separately before mixing.

The purpose of the examination is to estimate correctly the status of each kidney by determining (1) its working coefficient as estimated by the amount of urea being secreted; (2) the existence of various morbid products, such as casts, albumin, pus, and bacteria.

To reach accurate conclusions, the following points should be observed in catheterizing both ureters:

1. The exact time of introduction of each catheter is noted. It is well to attach the note to the catheter on a card.
2. The time of withdrawal is noted and also written on the card, giving the exact duration of the flow.
3. The exact amount of secretion collected in the test tube is noted.
4. It is well to compare the rate of secretion, determined by noting the amount of flow in a given unit of time, say from five to fifteen minutes or longer, with the entire amount passed in the twelve hours during which the examination is made. If the amount secured is too small or too large the error may be rectified in this way. A nervous patient, for example, will sometimes pass an excessive amount through the catheter.
5. An analysis of each urine is made investigating its physical, chemical, microscopical, and bacteriological characters. Especial attention must be paid to the urea as the most important representative of the physiological activity of the kidney. It is better to keep a book of charts for recording each analysis under some such plan as the following:

## ANALYSIS OF SEPARATED URINES.

*Name,**Date,**Diagnosis,**Time of insertion of catheter,**Right or left ureter catheterized,**Size of catheter used,**Time of withdrawal of catheter,**Amount of urine secured,**Average amount in twenty-four hours,**Appearance of urine on withdrawal,**Sediment,**Specific gravity,**Reaction,**Albumin,**Urea,**Microscopic examination,**Bacteria, cover-slip, and cultures,*

**Sounding the Ureters.**—Sounds are introduced into the ureters to find a stricture or an obstruction, to dilate a stricture, and to convert the soft ureter into a firm resisting cord easily found and kept under the fingers during a pelvic operation.

In most instances the catheters serve the purpose of bougies as well or better than a solid instrument. The catheter, for example, gives evidence of the passage of a stricture by the difficulty of entrance, by the bite of the stricture, as well as by an immediate gush of urine, and the long, flexible silk catheters serve just as well to splint the ureter and mark out its course to prevent injury during an operation. The catheter, however, can not so well detect and estimate the character of resistance, and the force used in overcoming it can not be so well gauged. For these purposes I use hard-rubber bougies 30 centi-

meters (12 inches) long and 2 millimeters in diameter for the pelvic portion, and 50 centimeters (20 inches) long for the entire ureter and pelvis of the kidney.

These bougies are smooth and flexible, and easily follow the course of the ureter. The ureteral orifice is exposed as for catheterization, and the point of the bougie engaged. By pressing on one side or the other of the speculum the end may be brought to bear directly upon the ureteral orifice and slipped in.

By a gentle forward movement it is carried on and upward toward the kidney, easily guided by the ureter and taking all its curves.

**Catheterizing the Pelvis of the Kidney.**—The pelvis of the kidney can be catheterized by means of long, flexible silk catheters.

To introduce the renal catheter, the hands are carefully washed and sterilized, the ureteral orifice exposed, and the catheter, taken from the refrigerator or stiffened with a stylet, is coated with boro-glyceride at the end and slipped through the speculum and pushed on until its point is engaged in the ureter. The long outer end of the catheter, wrapped in a piece of sterilized gauze, or still lying in the sterilized towel, out of which it is drawn as it is introduced, must hang over the shoulder. The rate of introduction should be slow, 2 or 3 centimeters at a time, and the examiner should take care to keep the end of the speculum close to the ureteral orifice, and watch to see that the catheter does not kink in the bladder or speculum. The patient may have no sensation at all as the catheter goes in, or may be only conscious as the end touches the upper margin of the pelvis of the kidney.

When from 32 to 37 centimeters (13 to 15 inches) have been pushed in beyond the external urethral orifice the end will lie in the upper part of the renal pelvis.

If the catheter is soft and has to be braced by a stylet, this must not reach quite to the end, and as soon as a few centimeters of the catheter are engaged in the ureter the stylet is pulled out for the same distance, after which the catheter is stripped off from the stylet and pushed on up the ureter into the kidney.

Normally there is but little urine collected in the pelvis of the kidney, and it is necessary to wait a while for the catheter to fill and begin to discharge the droplets. The respiratory movements may be seen in the play of the drop to and fro as it hangs from the end of the catheter. When there is a stricture in the ureter or at the pelvis of the kidney there is an accumulation of urine or pus within the pelvis. The renal catheter relieves this retention by drawing off the fluid and discovers lesser grades of hydronephrosis and pyonephrosis which have hitherto escaped attention. I estimate the degree of hydronephrosis by measuring the exact amount of fluid discharged in a steady stream or by continuous dropping with the catheter held down so as to act as a siphon. If the catheter is a small one and it takes a long time to empty the sac, I then allow half a cubic centimeter per minute for the activity of the kidney during the time of evacuation. As soon as the flow begins to come at intervals it is evident that this is dependent on the present secretory activity of the kidney, and the accumulated urine has been exhausted.

**Asepsis.**—The whole technique of the examination and exploration of the ureters must be aseptically conducted. The danger from introducing septic material directly into a ureter is sufficiently obvious, and is illustrated by numerous examples of a fatal infection ascending from the urethra up to the kidney. If an infection of the urethra or bladder can spread in this way, it goes without saying that an infection introduced in the ureter will also spread.

The various manipulations ought to be conducted with a care in the aseptic technique equal to that of any surgical procedure, so that there is therefore no excuse for any ill sequel from a simple examination in a healthy case.

The aseptic technique is divided into two stages: (1) The care of the instruments; (2) care during their introduction.

The silk catheters must be sterilized before using by boiling two minutes in plain water, and washed immediately after every use with hot water, boiled for two minutes in pure water, and laid away on a sterilized towel until perfectly dry inside and out. They may also be washed out with a saturated solution of oxalic acid. They are then put singly or several together in a long sterile glass tube plugged at each end with cotton. The metal catheters are sterilized in the same way as other metal instruments, by boiling five minutes in the soda solution (see Chapter I).

In introducing the catheters the greatest care is necessary at every step to avoid contamination by the assistant, the speculum, the bladder wall, or the fingers of the examiner.

The lumen of the speculum and the ureteral orifice are cleansed with a pledget of cotton saturated with a boric acid solution held by the mouse-toothed forceps.

The metal catheter is held by its outer end, avoiding at all times touching the end that is to go into the ureter; it is then guided up the speculum and introduced. To introduce the flexible ureteral and renal catheters, the end is pushed a little way beyond the glass tube and dipped in boro-glyceride, and then the glass tube is rested on the examiner's shoulder. He now takes hold of it with thumb and forefinger covered with sterilized rubber finger stalls, draws it out of the tube, and guides it on into the ureter. By using these simple precautions all risk is avoided.

**Ureteral Fever.**—I have seen ureteral fever following the introduction of the ureteral catheter in four cases. In each of these cases the upper urinary tract was already infected, and the urine contained pus coming from the pelvis of the kidney.

One patient had a stricture at the vesical end of the ureter and a dilated pyoureter and pyelitis. On two occasions, while washing out the ureter and kidney, in a case under treatment for some time without any change in the technique, the introduction of the catheter was followed by a chill and fever, with an elevation of the temperature as high as 104° F. The pulse increased in rapidity in proportion to the fever, the face became flushed, and the patient was restless and had severe headache. From the second day on to the fourth or fifth day the temperature declined to normal. During the attack chilly sensations were repeated daily, and there was a decided tenderness over the course of the catheterized ureter.

In another case the attack began with a decided chill on the evening of the day of irrigation, which was practiced through a metal catheter injecting a bi-chloride of mercury solution (1 to 50,000). The patient complained of pain along the course of the ureter and in the back, and had a hot flushed face with headache and malaise. The temperature was highest on the second day, reaching  $103^{\circ}$ , and declined to normal on the fourth day. In a second attack, follow-

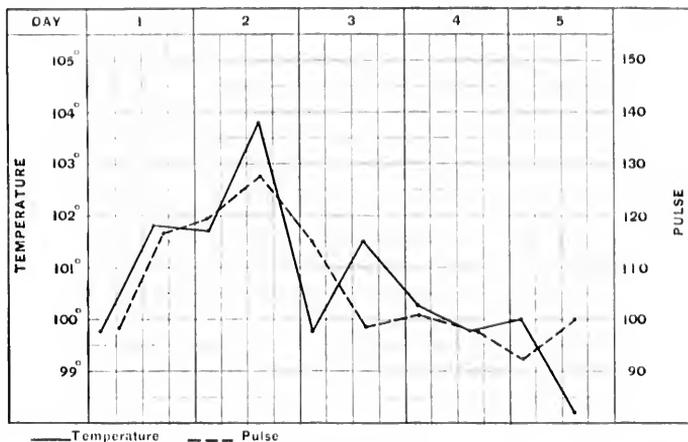

FIG. 213.—COMPOSITE TEMPERATURE AND PULSE CHART OF TWO CASES OF URETERAL FLUOR PRODUCED BY INSTRUMENTATION.

ing treatment four days later, there was malaise and a temperature of  $101.8^{\circ}$  F. on the second day, but no chill. The temperature became normal on the third day. The other two cases were similar. In no case did any harm result. I give in the text a composite chart constructed by combining the two cases mentioned.

#### CONGENITAL AFFECTIONS OF THE URETER.

Anomalies of the ureter are rare, and especially rare are those which produce disturbance of function. In their extreme forms ureteral malformations are found oftenest in non-viable fetal monstrosities; for example, one ureter has been found entirely wanting, while the other was converted into a fibrous cord. (Förster, *Mishbildungen*, Plate XXIII, Fig. 19.)

**Double Ureter.**—A double ureter is the commonest of all anomalies, and occurs in several forms; it may either start at the kidney from two distinct pelvis, and then unite at some point below to form a single canal, or it may continue double all the way down, and end by two orifices in the bladder, one behind the other. This condition has been found on both sides in the same patient. The ureter starting from the upper pelvis of the kidney is the longest and crosses its fellow to end nearest the urethra. The duplication may, on the

other hand, be due to a split which begins at any point below the normal renal pelvis, and the ureter continues double all the way to the bladder; or again the two canals may fuse at any point on the way down.

An interesting case of complete duplication of the left ureter occurred in one of my patients and is reported by Dr. Otto Ramsay (*Johns Hopkins Hospital Bulletin*, November-December, 1896). The patient (A. W., 4154), forty-five years of age, was admitted to the ward with an inoperable cancer of the cervix and died soon after admission. Autopsy (No. 813, June 22, 1896).

Anatomical diagnosis: Sloughing carcinoma of the uterus, perforation into the rectum. Involvement of the ureters, with hydronephrosis and slight hydro-nephrosis.

The two left ureters begin at the hilum of the kidney in two separate pelves and run down into the pelvis side by side, closely bound together, but separate, to the bladder, which they enter by distinct orifices 1.5 centimeter apart. They are dilated from the point where they are involved in the cancerous growth near the cervix, all the way up to the kidney. Each one is about the size of the little finger and has clear contents. They show a marked contraction where they pass through the growth. The drawing on page 446 well illustrates the condition.

Such forms of duplicature have no pathological significance. Two other forms of malformation, however, are of the highest importance; these are the ectopic ureteral orifice and the dilatation of an occluded ureter.

**Ectopic Ureteral Orifice.**—An ectopic ureteral orifice is one located either in the vagina, or in the urethra at the external urethral meatus, or under the hood of the clitoris.

The one common symptom observed in such cases is a persistent leakage of urine, noted from childhood up, but varying in amount at different times as measured by the napkins worn. In spite of this constant discharge, the patient empties her bladder at regular intervals, and the abnormal flow continues as active after micturition as before it. The abnormally displaced orifice may be either the only one connected with the kidney, or a supernumerary orifice, the other opening normally into the bladder. The practical importance of distinguishing between these two allied and, to a superficial examination, similar conditions is evident.

**Diagnosis.**—In incontinence of urine not due to gross and easily demonstrable lesion, such as a vesico-vaginal or uretero-vaginal fistula, the inquiry into the cause must be made in a careful and orderly manner in order to discover cases of this kind.

The first question to be answered is whether the involuntary discharge of urine comes through the urethra, and if it does whether it is simply due to a breaking down of the sphincter fibers at the neck of the bladder, or whether there is some extraordinary channel of communication between the ureters or bladder and the genital tract.

If the patient is a virgin or has never borne children, and her bladder has not been subjected to any manipulative interference, and if the disease has

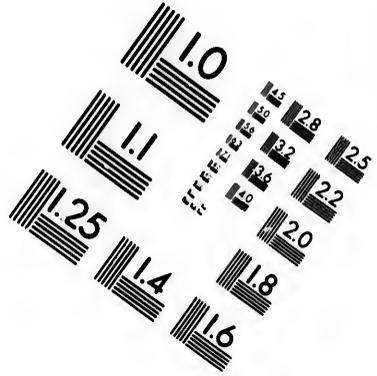
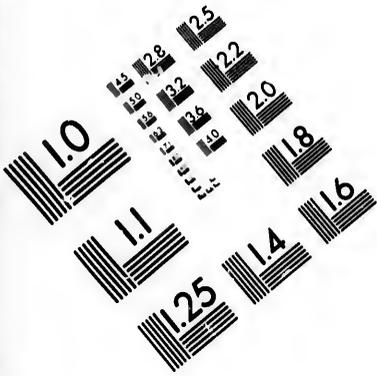

**IMAGE EVALUATION  
TEST TARGET (MT-3)**

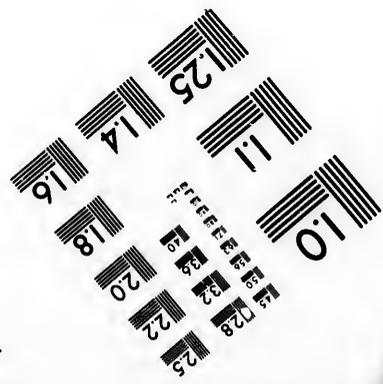
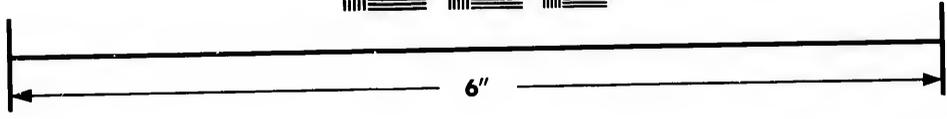
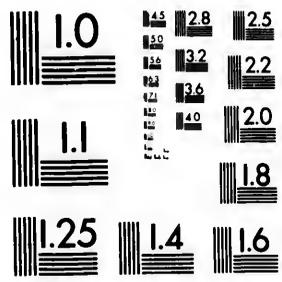

**Photographic  
Sciences  
Corporation**

23 WEST MAIN STREET  
WEBSTER, N.Y. 14580  
(716) 872-4503



existed from earliest childhood, the presumption is at once in favor of a congenital malformation.

If, on the other hand, after lying down for a while a certain quantity of urine is found accumulated within the vagina, a vaginal orifice of discharge may be looked for. By drying out the vagina and placing in it dry pledgets of absorbent cotton, and at the same time filling the vulvar cleft with cotton, and waiting a few minutes, it will be easy to determine the fact of a leakage, by noticing the spots on the cotton, where a little urine has accumulated, and this will also approximately fix the position of the opening. By injecting the bladder with an aniline or sterilized milk solution, its independence of this viscus will be demonstrated. A prolonged careful inspection of the area indicated by the spot of urine on the cotton will reveal the minute orifice through which intermittent discharges of urine escape. If the discharge comes from the urethra, a careful urethroscopic examination must be made of the entire tract from the internal sphincter down to its external orifice by withdrawing the urethroscope millimeter by millimeter, constantly watching the funnel-shaped figure of the urethra at the end of the speculum for any small opening or jet of urine.

On finding the orifice the questions now to be answered are these:

1. Is the abnormal opening a ureteral orifice?
2. On which side is it located—that is to say, to which kidney does it belong?
3. Is it a single or a double ureter? If double, has it also a normal opening into the bladder?
4. If double, does it continue so all the way up to the kidney, or does it unite with its fellow at some point above the bladder?
5. If double all the way up, do both ureters enter a common pelvis, or have they separate pelvis?

First, it is a ureteral orifice if, by injecting the bladder with a colored solution, none of the fluid escapes by the opening, demonstrating its independence, and if, in spite of the passage of urine at regular intervals from the bladder, little jets of urine are seen coming from the orifice, with intermissions not longer than a few seconds.

Second, the assurance that the opening is ureteral, and the answer to the question on which side it is located, to which kidney it belongs, is given by passing a long renal bougie through the opening up into the pelvis of the kidney, from 25 to 30 centimeters or more, and then by observing to which side of the cervix uteri the bougie turns, and by palpating the bougie through the vagina and rectum.

The third question, whether it is a single or double ureter, is answered by placing the patient in the knee-breast position and introducing a No. 10 vesical speculum and looking for the ureteral orifices within the bladder. If the orifices are found on both sides in normal position, it is evident that the ureter is supernumerary or split.

The fourth question, whether a double ureter continues so all the way up to the kidney, may, I think, be answered in the following way: I would pass a

catheter, 2.5 millimeters in diameter, large enough to fill the lumen of the abnormal ureter, all the way up to the pelvis of the kidney. I would then introduce a renal catheter into the normal vesical orifice of the same side and push it up. If the two ureters unite into one a short distance above the bladder, or at some point in the abdomen below the kidney, I should expect the second catheter to be stopped short in its course upon striking the first. The catheters could now be withdrawn after carefully noting the exact distance to which each had been introduced, and by laying them together on a sheet of white paper in a similar position a tracing of the form of the ureter could be made. To make sure of the diagnosis it would then be well to reverse the procedure by introducing a long catheter up into the kidney through the vesical orifice of the ureter, and then pushing up another catheter through the abnormal orifice, until it is stopped by the first catheter. Again noting the exact distances to which the catheters have been introduced, and withdrawing them, and reconstructing the ureteral situation on paper, the diagnosis will be confirmed if the two drawings correspond.

To determine whether the ureter is double throughout, and if double, whether the kidney has one or two pelves, the following plan will be sufficient: A renal catheter is passed through each ureter up to the renal pelvis and a sterilized aniline solution is injected into one, when, if there is a communication between the pelves, the colored fluid will immediately flow from the other; if there is no communication, it will simply be returned, while the other side discharges clear urine.

These various points in diagnosis are of practical importance in determining the nature of the operation to be performed.

When the opening is at the urethral orifice, the anterior wall of the vagina may present a characteristic prominent curved ridge, which covers the ureter, as in the case of Dr. F. H. Davenport, of Boston (*Trans. Amer. Gyn. Soc.*, 1890, p. 343), in which the orifice was in the posterior wall of the external urethral orifice. W. H. Baker's case opened similarly about two lines to the left of and below the urethra (*Boston Med. and Surg. Jour.*, Dec., 1878). It was not determined in either of these cases whether or not the ureter was double, which could now be done either by examining the orifices in the bladder cystoscopically or by passing a renal catheter up to the kidney pelvis and injecting an aniline solution, and noting whether the urine in the bladder is colored.

Erlach reported a case before the Vienna gynecological society, December 4, 1888, in which he found post mortem a right ureter double throughout, each ureter starting in a separate pelvis above. One of the ureters opened naturally into the bladder and the other into the urethra just below the internal orifice. In spite of this, there was no history of incontinence.

A case of congenital anomaly of the ureter has been observed by Baum in which the supernumerary opening was close to the external urethral orifice. The normal orifice was seen upon opening the bladder from above.

In a case of Massari (*Wiener med. Wochen.*, 1879, No. 33) a child four years old, with a preternatural vaginal anus, suffered from constant leakage of

urine, the cause of which was only explained post mortem, when the kidney were found to be fused across the vertebral column. The right ureter was normal throughout, but the left one had no vesical orifice; instead, it passed the bladder in its course and discharged by a minute orifice just under the prepucis of the clitoris. The vagina was double and the uterus normal.

**Treatment.**—The object of the treatment is to get rid of the constant leakage by turning the urine into the bladder.

Two plans in general have been tried to effect this. First, by dissecting out the extremity of the ureter from its bed and turning it into the bladder, and, second, by a suprapubic incision into the bladder and then opening the ureter beneath the base of the bladder and establishing a communication between the two, after which the distal end of the ureter beyond the opening may be ligated. The suprapubic incision is closed at the end of the operation.

In case the ureter is double with a single renal pelvis above, it would be proper to try the plan of ligating the abnormal ureter at any point in its course where it could most conveniently be laid bare; the operator might introduce a flexible renal catheter, and, using this as a guide, incise the vaginal wall somewhere from 2 to 3 centimeters beyond the abnormal orifice, laying bare the ureter in its course. It should be then carefully dissected out from the surrounding tissues and freed on all sides sufficiently to allow a ligature to be placed about it. It may then be ligated with silkworm gut or fine silk, dropped, and the vaginal incision closed over it.

By the plans pursued by Baker and Davenport, the ureter is dissected out from its external orifice back to the base of the bladder by splitting the vaginal wall, exposing the abnormal canal, and carefully freeing it on all sides from the cellular attachments. When it has been freed up to a point under the base of the bladder corresponding in position to that of the normal ureteral orifice, an incision is made through the vesico-vaginal septum into the bladder a little less than a centimeter in length. The end of the ureter which has been dissected out is now cut off and the new orifice slit up for about 6 millimeters to make a larger opening. The end is then turned into the bladder through the opening, which is closed by two or three silkworm-gut sutures extending through from the vaginal surface to the vesical mucosa. The uppermost suture is made to include the muscular coats of the ureter at a point about on a level with its opening into the bladder. Another fine suture below this penetrates the vesico-vaginal septum for a short distance and catches the ureteral coats again. The ureter being fixed by the two sutures, the remainder of the vaginal incision from which the ureter has been dissected is closed by interrupted sutures.

This was done by Dr. W. H. Maxson, of St. Helena, Cal. (*Med. News*, March 21, 1896, p. 323), who operated upon a young woman twenty-two years old for an incontinence of urine dating from her earliest recollection. He found the orifice of the left ureter about a quarter of an inch within the external urethral orifice. At the operation the ureter was dissected out through the vagina for three inches and a half and drawn through a small opening made in the base of the bladder close by, after cutting off an inch and a half of the lower end. The

ureter was then stitched to the bladder wall with catgut and the vaginal incision closed. A complete recovery of function ensued.

It is important, as a preliminary precaution, to determine by a cystoscopic examination whether the ureter is single or double. If it is double, a bougie must be placed in the normal ureter opening into the bladder, so that in transplanting the abnormal orifice the normal one will not be cut or included in the sutures.

The plan of establishing a communication between the abnormal ureter and the bladder by a suprapubic incision in the bladder was adopted in Bann's case to avoid dilating the vaginal orifice in a girl eighteen years of age. The right ureter, discharging close to the urethral orifice by a fine opening, was greatly dilated in the neighborhood of the bladder. The base of the bladder was incised through a suprapubic incision and the dilated ureteral sac opened from above. A piece of the sac about a centimeter in diameter was now excised and the edges of the incision stitched together. The part of the ureter beyond this new opening was now ligated. A portion of the abdominal incision was closed with suture, and the prevesical space drained with iodoform gauze. After this operation urine passed naturally. The patient passed a urinary concretion five months later and suffered from a hernia.

**Cystic Dilatation of an Occluded Ureter.**—A rare but practically important anomaly of the ureter is that in which the lower end has failed to communicate either with the bladder or with any part of the genital tract, and remains occluded. If this forms the only avenue of discharge for the corresponding kidney . . . part of the kidney, complete atrophy of the organ depending upon it is a necessary consequence.

Where the terminus of the ureter is under the base of the bladder, and the lower end is dilated into a spherical or ovoid cyst, this has been seen projecting into the bladder, forming a prominent rounded tumor, occupying one side of the base, as in F. Tangl's case, where the patient was a woman sixty-seven years of age and the left ureter was affected, ending in a sac-like projection into the bladder. The kidney of the same side was extremely atrophic and displaced downward. The right kidney was in a state of chronic interstitial nephritis. The tendency of such anomalies to be associated with other malformations was shown by the fact that the patient had a *uterus bilocularis unicollis*.

A similar case to this was that of Kolisko, where the right ureter was double throughout. The abnormal ureter began in a separate pelvis in the upper part of the kidney which was atrophied, and in its passage downward crossed its fellow and ended below the orifice of the normal ureter in a sac-like dilatation, which projected into the lumen of the bladder and extended down into the urethra. This tract had thick muscular walls. It was quite evident in this case that the kidney was a fused one, and that the maldeveloped ureter belonged to the upper kidney.

One of the most remarkable cases of cystic dilatation of the lower end of the ureter is that of Dr. E. G. Orthmann, of Düsseldorf, in which the cyst presented the characteristics of a vaginal cyst. The patient was twenty-seven years old,

and presented a circumscribed cystic tumor of the anterior vaginal wall which she thought was a prolapse of the uterus. This gradually kept increasing in size and was associated with drawing pains in the left side, extending around into the small of the back. The tumor was elastic and circumscribed and occupied the lower third of the vagina down to within a finger's breadth of the external urethral orifice. It could be pushed back, but returned on the least straining. Careful examination showed that it had no connection with the urethra or bladder. At the operation the thick walls of the tumor were dissected out up to a long pedicle on the left side which was bared from 8 to 10 centimeters (3 to 4 inches), when it became evident, from the way in which the tumor emptied itself upward, that there was a communication with the ureter above. The pedicle was tied and cut and retracted into the cellular tissue out of sight. The wound was closed with catgut and the convalescence was undisturbed.

In another group of cases of ureteral anomalies the lower end of the ureter may end in a blind pit without any dilatation. In these cases the kidney of that side is entirely absent or atrophic. When the ureter comes from a separate portion of the kidney by a pelvis of its own the atrophy may be limited to this part. Such is the case reported by F. Tangl (*Virchow's Archiv*, Bd. cviii, p. 414), in a patient sixty-five years old, with extreme atrophy of the left kidney and a double right ureter which united below and ended in a blind canal, recognized as Gartner's duct, in the anterior vaginal wall. The right kidney was affected with chronic interstitial nephritis. There was a bilocular uterus with one cervix.

Haller (*Deut. Arch. für klin. Med.*, Bd. v, Heft 2) and Weigert (*Virchow's Archiv*, No. 70, p. 490) report cases where, with complete duplication of the ureter and pelvis, one of the ureters ended blindly in the bladder wall, causing in this way a partial hydronephrosis.

**Congenital Flexure of the Ureter.**—A case of congenital flexure of the right ureter with extreme hydronephrosis is described by Weigert. The large kidney extended 3 centimeters ( $1\frac{1}{4}$  inch) beyond the middle line. The right ureter pursued a normal course from the bladder to a point 21 centimeters ( $8\frac{1}{2}$  inches) above it, where it reached the lower border of the tumor. At this point it bent suddenly to the left, forming a sharp kink, beyond which there was considerable enlargement of the lumen. It extended from this point to the left border of the tumor into which it merged. The lower margin of the dilated ureter curved around on to its left side, while at the upper margin there was a second sharp flexure. There was no thickening or evidence of inflammation, and after releasing the flexure the fluid escaped easily.

**Ureteritis and Periureteritis.**—Ureteritis and periureteritis are found associated with a variety of urinary diseases. In ureteritis there is an inflammation and thickening of the coats of the ureter, the disease beginning with the mucous coat which is most exposed.

Periureteritis, on the other hand, is an inflammatory affection involving the cellular tissue in which the ureter lies throughout its whole course, from renal pelvis to bladder. The peritoneum overlying the ureter may also be involved

by contiguity. Periureteritis often arises in an affection of the cellular tissue, extending upward from the vaginal vault. I have seen two such cases following the division of the ureter in a vaginal hysterectomy, leaving a fistulous opening at the vault of the vagina. In one case I opened the abdomen some weeks after the operation to transplant the fistulous orifice into the bladder, and found the cellular tissue surrounding the ureter on that side dense and rigid from the vaginal vault up to the brim of the pelvis. The structures were so hard and immobile that any attempt to dissect the ureter out of its bed and lift it up could not even be considered. A periureteritis due to an inflammation extending from the interior of the ureter outward is rare; I have not yet encountered it in any case.

The causes of ureteritis are threefold: (1) by extension of the disease upward from the bladder; (2) by extension of renal disease downward into the ureter; or (3) the inflammation may originate from some cause located in the ureter itself, such as a calculus. The first and second causes are the most frequent.

In ureteritis due to calculus the evidences of the disease are found in a thickening and contraction of all its coats, forming a stricture below the stone lodged in it. When several stones are lodged in one ureter, a series of strictures are found with dilatation above each.

The most rational classification of the various forms of ureteritis induced by vesical or renal disease is that which depends upon the special exciting cause. We may thus distinguish a ureteritis due to streptococcus or staphylococcus infection, ureteritis due to gonorrhoeal infection, and finally a tubercular ureteritis. Of these forms, the first three commonly originate in the lower urinary tract, infecting first the urethra and bladder, and then the ureter through the continuity of mucous surfaces, while the tubercular disease more commonly starts in the kidney and affects the ureter from above downward.

It is remarkable how frequently extensive inflammatory lesions are found, either in the bladder or in the kidney, without any marked participation of the ureter directly continuous as it is with the bladder below, and constantly bathed with the infectious renal discharges from above.

Another and rare form of inflammation affecting the ureter and pelvis of the kidney is cystic ureteritis and pyelitis, characterized by the formation of little cysts projecting from the mucous surface the size of a hemp seed, or smaller, containing a thin watery or tenacious fluid. These cysts are more abundant in the upper part of the ureter, and probably originate in the sparse glands or crypts in the mucosa.

The symptoms common to the various forms of ureteritis arise either from the inflamed ureter itself, or from the interference with function resulting from the inflammation. Owing to the fact that the ureteritis is always secondary and is usually simply an extension of grave renal or cystic disease, its own peculiar symptoms are often masked. This is particularly the case in acute forms resulting from a severe infectious process extending rapidly from the bladder up to the kidney.

In chronic ureteritis the most marked symptoms are the pain localized on one side extending up into the flank, with frequent and painful micturition. Pus is always found in the urine, and sometimes blood.

The prognosis in the acute forms, while depending somewhat upon the involvement of the ureter, will be better guided by the condition of the bladder or kidney which can be investigated and estimated, while that of the ureter can only be surmised. In the chronic forms the prognosis depends entirely upon the cause; the gonorrhoeal ureteritis tends to form stricture just as in the urethra. When not actively treated, the tendency is to run a long course, often extending through a series of years. It is important to note that, in spite of extensive involvement of the ureter, the function of the kidney is rarely entirely lost.

The diagnosis of ureteritis is not difficult to make with the direct means of investigation at our command. The subjective symptoms often so closely simulate cystitis that a differentiation cannot be made by symptoms alone, the most characteristic of which is pain along the ureter.

Infallible diagnostic points are found by making a digital examination. After emptying the bladder and rectum, upon introducing the finger into the vagina, and palpating the antero-lateral vaginal wall in its upper part, a large, thick, exquisitely tender cord is found sweeping upward to the vaginal vault and disappearing at the side of the cervix under the base of the broad ligament. It is often nodular, and when felt for the first time in the vaginal vault it invariably creates the impression that it is an adherent ovary or tube. I have known inflamed ureters to be mistaken for ovaries in this way. The pain provoked by the examination is usually so great that an anesthetic is necessary to outline thoroughly the structures. The thickened ureter is often movable in the cellular tissue; by introducing the finger into the rectum it may be traced over the sciatic notch and on up toward the brim of the pelvis, where it is found lying close to the internal iliac artery. Upon palpating through the abdominal wall, down upon the pelvic brim, at a point 3 centimeters ( $1\frac{1}{4}$  inch) to the right or left of the promontory of the sacrum and a little below it, the patient will complain of pain, and, if the abdominal walls are unusually thin, the thickened ureter may be felt rolling under the fingers. If the umbilical ring is relaxed the ureter can be felt through it with the utmost distinctness. Upon continuing the palpation upward in the course of the ureter, it can be traced by the pain elicited when the pressure is made directly over it. Through an open abdominal incision, by preference in the semilunar line, the thickened left ureter may readily be found at its point of transit from the abdomen into the pelvis, by lifting up the sigmoid flexure to the right and exposing the ureter just beneath the peritonemum, crossing the common iliac artery beside the ovarian vessels. On the right side the ureter will be exposed by lifting up and drawing the head of the colon to the right.

By making a cystoscopic examination with the bladder distended with air, the ureteral orifice of the affected side will often be found the center of an area of intense injection, situated on a truncate cone, sometimes surrounded by papil-

lary eminences, and not infrequently markedly everted. If the orifice is watched for a time, turbulent or purulent urine may be seen escaping.

By means of a catheter, urine may be collected from an infected ureter, and if the catheter is not contaminated in the introduction, a bacteriological examination of the urine obtained will often reveal the cause of the inflammatory trouble, whether due to tubercle bacillus, gonococcus, or streptococcus.

As we can do nothing directly to the ureter in an acute inflammatory condition which will be beneficial, the treatment of this form of ureteritis is purely expectant, and devoted to the associated disease in the bladder or kidney.

In its chronic form the treatment must vary according to the extent of the disease, and to the changes it has produced in the kidney. If the result of the ureteritis has been simply to thicken the coats of the ureter, forming an obstacle to the downward passage of urine, the urinary channel above such an obstacle will be dilated with urine or pus, and in all cases, before any more radical measures to relieve the obstruction are adopted, a renal catheter must be passed in order to determine the degree of stricture estimated from the bite on the catheter and from the amount of urine behind it, and the character of the infection by the pus secured. If pus is present, an effort should be made to sterilize the upper urinary tract by emptying it and washing it out with weak bichloride solution (from 1-100,000 to 1-10,000) every two or three days. For treatment see under Stricture of the Ureter.

**Tubercular Ureteritis.**—One of the most frequent forms of ureteritis producing profound alterations in the coats of the ureter is due to tubercular infection. This commonly involves its entire length, and arises secondary to a tubercular kidney. The thickening of the ureteral coats converts the organ into a rigid tube, irregular on its outer surface, and presenting marked irregularities in its lumen.

The rare cases which present themselves for treatment, if of long standing, are one-sided.

The lining membrane of the ureter is ulcerated and the pelvis of the kidney filled with pus. When more advanced still, the bladder mucosa is affected, varying from some disseminated tubercles sowed about the ureteral orifice, all the way to an extensive diffuse infection with areas of ulceration.

The chief clinical symptom is the frequent painful urination, the patient being obliged to sit on the vessel every few minutes, and rarely being able to wait half an hour or longer.

Blood is only found in the urine in advanced cases, when it generally comes from the bladder. Pus secreted by the ureter is always present in varying quantities. Large amounts may be passed at intervals, being held back by the constriction of the lumen of the ureter, until sufficient pressure is developed in the upper ureter and renal pelvis to break through the obstruction. In this way we have intermittent pyuria, accompanied by a constant pyuria of lesser degree.

Fever is a symptom of cases in which the pus is held back in the kidney in quantity.

The diagnosis is, as a rule, not difficult to make when the various means of investigation at our command are employed. These consist in palpation by the vagina, rectum, and abdomen, a cystoscopic examination of the ureteral orifice of the bladder, rarely in a direct inspection through an abdominal incision, and in catheterization with the isolation of urine from the infected area, and above all in the demonstration of the tubercle bacillus in the urine.

It is often necessary to make repeated examinations before the tubercle bacillus can be found. A source of error here is the smegma bacillus which is found around the genitals of both sexes and which has the same staining qualities and the same size and form as the tubercle bacillus.

Grünbaum (*Lancet*, January 9, 1897), who has studied the question experimentally, comes to the conclusion that, "as a rule, careful catheterization eliminates all sources of diagnostic error." These conclusions he drew from the examination of the urine from 47 persons—10 male and 37 female. The urine in all cases was centrifugalized and stained in the ordinary manner for the tubercle bacillus. He could not find the smegma bacillus in any of the ten specimens voided by the men, though its presence in the male urethra has several times been demonstrated.

Of the thirty-seven specimens from the women, eleven were obtained by the catheter, and in none of them was the smegma bacillus found, while, on the other hand, in twenty-nine voided specimens the smegma bacillus was found seventeen times.

Another method of deciding definitely whether the tubercle bacilli are present is by the inoculation of the suspected urine into animals. I have operated on a case where the presence of a tuberculous kidney was first diagnosed in this way by Dr. T. K. Holmes and Dr. A. McPhedran, of Canada. They made inoculations both into the eye of a rabbit and into the peritoneal cavity of a guinea pig, and in both places the tubercular lesions were readily demonstrated.

The method of inoculating the peritoneal cavity is easy, a few centimeters (2 or 3) of the suspected urine being injected into the unopened peritoneal cavity of the guinea pig with a clean hypodermic syringe. The animal dies, as a rule, in three or four weeks.

Strong presumption of a tubercular ureteritis exists if the vaginal examination reveals a ureter greatly enlarged, thick, hard, exquisitely sensitive, and more or less nodular, lumpy, or uneven, and traceable under anesthesia by the rectum up to the pelvic brim. The characteristic tender spot will always be found at the brim upon palpating through the abdominal wall.

By cystoscopic inspection of the bladder we may infer the specific nature of the ureteral inflammation, either by the areas of extensive ulceration in the advanced cases, or by the scattered tubercles in the milder ones, located mostly at the base of the bladder and about the orifice of the affected ureter. An intense injection about the ureteral orifice may be the only vesical sign pointing to the affected side.

By catheterization of the ureter unmixed urine is obtained, which, in the earliest stages of the disease, may exhibit no changes at all; later, sparse tu-

terele bacilli may be found after repeated use of the centrifuge. When the tubercular disease is in an advanced stage, urine is obtained which is milky or thick with pus, peculiarly pale in color, and sometimes alkaline, and containing a markedly diminished amount of urea. The tubercle bacilli are found in the flocculent sediment, which begins to fall as soon as the urine stands for a short time. It may take five or six examinations to find the bacilli, when they will often appear in great abundance.

The prognosis of the affection is years of invalidism, and life is finally destroyed when the kidney is full of pus, the ureter choked, and the bladder infiltrated and converted into a mass of ulcerations. Oftentimes, also, there is extensive tubercular disease of other organs.

The treatment is either palliative or radical, and the palliative course is only resorted to in order to improve the patient's condition for an operation if possible. Where the ureter is obstructed, and pus is dammed up above the stricture and in the kidney, a catheter may be passed, the pus drawn off, and the dilated portion washed out with a bichloride solution, beginning with 1 to 20,000. This may be repeated every few days until the general condition is so improved that the disease may be safely extirpated with the knife. Nephroureterectomy, or extirpation of the infected kidney and ureter, is the only possible means of cure. I have done this in three instances, and will describe the proper method of operating by giving the details of one case, which I owe to the courtesy of Dr. M. D. Mann, of Buffalo.

C. R. (No. 1836), aged thirty-one, began to suffer at the age of fifteen with an "irritable bladder" at the menstrual periods, the difficulty extending into the intermenstrual period as well after six months. Pain in the bladder soon became constant, and to this was added in another year pain in the left loin and down the thigh. In about five years she was pretty constantly confined to her room. No treatment produced more than temporary relief from the agonizing pain and spasms accompanying the act of micturition every few minutes by day and night, when her screaming could be heard at a long distance.

Upon examination, the left ureter was found thick, hard, and nodular, as if slightly constricted at irregular intervals, and in the left fornix it felt like a distinct mass in the broad ligament. The slightest pressure on it produced exquisite pain and a desire to urinate. On catheterizing both ureters at the same time, several cubic centimeters of amber-colored urine collected from the right side, while none at all escaped on the left, but on pushing the catheter farther in, behind the broad ligament, there was then a sudden escape of pale lemon-colored urine flowing in a steady stream until the beaker was filled (see Fig. 244). The urine on the right side was acid, while that on the left was alkaline, and also contained abundant pus and tubercle bacilli.

On trying to withdraw the left catheter, it was found firmly held in the bite of the strictured ureter. The presence of the stricture was further demonstrated by passing into the ureter a small bulbous bougie, which entered the enlarged portion and came out over the stricture with a decided jump. The rate of discharge from the left side further demonstrated the existence of a large pyo-

ureter for 150 cubic centimeters (5 ounces) escaped in three minutes; at this rate of secretion the amount passed per diem would have been 72 liters, or about 18 gallons—a *reductio ad absurdum*.



FIG. 241.—DEMONSTRATION OF STRUCTURE OF THE URETER AND OF HYDROURETER.

Both ureters are catheterized; the catheters are crossed in the urethra so that the beaker on the patient's right side collects the urine from the left side. In the same time that the small quantity of dark acid urine collected in one glass, the pale lemon-colored alkaline urine poured out and almost filled the other glass. The catheters in this case entered as far as the brim of the pelvis only.

*Nephro-ureterectomy*, or extirpation of tuberculous left kidney together with its ureter, was performed March 30, 1893. After due cleansing, an incision 16 centimeters ( $6\frac{1}{2}$  inches) long was made just outside of and parallel to the linea semilunaris, terminating below over the brim of the pelvis. The peritoneum was then opened, the small intestines displaced to the right, and the sigmoid flexure lifted up at the pelvic brim and carried to the right side, making tense its peritoneal fold, the outer layer of the meso-sigmoid. This was incised and the greatly thickened ureter exposed, crossing the common iliac artery. The incision through the posterior peritoneum was now carried on upward, freeing the descending colon up to the middle of the abdomen and laying bare the entire ureter, easily traced from its pelvic end up the kidney. The kidney was found in its normal position, covered with peritoneum and fat cellular tissue.

The peritoneum was next incised over the kidney and the process of enucleation begun. The separation was effected with difficulty, owing to the dense adherent fibrous tissue interpenetrating the fat and sticking tight to the kidney, especially about the hilum. Slowly, and with much care, the large vessels were freed and tied with four fine silk ligatures, and the kidney severed from all its attachments, except the ureter. Now, taking the kidney in hand, it was pulled downward and the ureter gradually dissected out of its bed of cellular tissue all the way to the pelvic floor. The ovarian vessels were tied in the abdomen at about the middle of the ureter.

The ureter was then ligated at the pelvic floor, and cut off wedge shaped 1 centimeter above the ligature, forming flaps for easy closure. Care was taken throughout not to contaminate the peritoneum with the infected end, which was finally burned out with a Paquelin cantery down to the ligature, and the flaps united with fine silk sutures. The left flank was then pushed out by two fingers and pierced with a knife, making a hole 3 centimeters ( $1\frac{1}{4}$  inch) long in the line of the iliac crest, just in advance of the spinous muscles. A gauze drain reaching the ureteral stump below was put in here, 14 centimeters ( $5\frac{1}{2}$  inches) long by 3 centimeters ( $1\frac{1}{4}$  inch) wide, and the anterior incision was closed. The colon fell into its natural position without suture.

On the first day there was a free bloody serous discharge, which gradually decreased, and the drain was taken out on the fifth day. The patient made a quick, undisturbed recovery, and is still living, three years later, remarkably improved. For the removal of the entire ureter with the kidney by an extraperitoneal operation, see Nephro-urectomy.

The following is the pathological report:

**Kidney Macroscopically.**—The mass representing the kidney is made up of four large lobules, separated from one another by shallow sulci. The upper third of the organ is least affected, though this is deeply pitted in every direction, and contains a number of small cysts, which become distended on injecting the pelvis of the kidney, proving direct connection. This portion measures 6 by 4.5 centimeters ( $2\frac{1}{2}$  by  $1\frac{3}{4}$  inches), while the whole kidney mass measures 11 by 6 by 3.5 centimeters ( $4\frac{1}{2}$  by  $2\frac{1}{2}$  by  $1\frac{1}{2}$  inches). Below the mass just described on the anterior face is a cyst measuring 5.5 by 5 centimeters ( $2\frac{1}{4}$  by 2 inches), and below this two yellowish masses, 7 by 4.5 centimeters (3 by  $1\frac{3}{4}$  inches), independent of one another but connected by a shallow sulcus. All the cysts are covered by the capsule. The weight of the whole organ with the attached ureter is 100 grams.

The capsule of the kidney is thickened and intimately adherent in places. On section, about 65 cubic centimeters (2 ounces) of fluid escapes from the cysts; in one it is white and flaky, consisting almost entirely of fatty debris; in another, the fluid resembles blood-stained urine. These cysts are all found to communicate with the pelvis of the kidney and represent dilated calices. The parenchyma of the kidney is largely destroyed. In one place an area of cortex is found 7 millimeters in depth, but elsewhere the kidney substance is represented by layers averaging 1.3 millimeter in thickness spread out over the dilated calices.

Frozen sections of the kidney show a diffuse infiltration with fatty granulation tissue, with here and there areas of complete necrosis, with fragmentation of nuclei. Numerous definite tubercle nodules, containing giant and epithelioid cells, can be made out. The tuberculous process goes gradually over into the more healthy kidney substance, and here and there a single tubule or glomerulus can be seen in the diffuse tuberculous tissue.

Ureter.—The ureter presents two points of constriction, respectively, 3 and 8 centimeters ( $1\frac{1}{4}$  and  $3\frac{1}{4}$  inches) from the kidney. The hilum of the kidney is filled with dense adherent fat, preventing dissection of the stricture without tearing it.

The ureter is much dilated, more at some points than at others, the caliber of its lumen varying from 1.7 to 3 centimeters ( $\frac{1}{2}$  to  $1\frac{1}{4}$  inch). Its wall is much thickened, measuring in places from 5 to 6 millimeters. The mucous membrane is of an opaque buff color, and at one spot, near the pelvis, there is a superficial area of calcification 5 millimeters in diameter.

Frozen section of the ureter shows that the epithelium is entirely absent from the surface, and that the mucous membrane is converted into a mass of diffuse tuberculous tissue, in which here and there definite tubercular nodules can be made out. The surface is not infrequently quite necrotic, and the cells near it have undergone fatty degeneration. The muscular layer has been involved, and there are many aggregations of small round and epithelioid cells there. In some places there is cell proliferation in the fibrous layer of the ureter. The connective tissue is from three to four times thicker than normal.

This ureter had been catheterized previous to the operation, and numbers of tubercle bacilli demonstrated in the pus which was present in the urine thus obtained. Cultures made from the pelvis of the kidney and from the kidney substance on ordinary agar-agar remained sterile.

Diagnosis.—Tuberculosis of kidney, pelvis of kidney, and ureter.

Although in the case just cited a transperitoneal route was followed, the best routine way to reach the ureter is entirely extraperitoneal (see *Johns Hopkins Hosp. Bul.*, Feb. and March, 1896), by means of a long incision beginning back in the loin in front of the quadratus muscle, halfway between ribs and ilium, and continued in an oblique direction downward and forward, skirting the anterior superior spine within 4 centimeters ( $1\frac{1}{2}$  inch) of it, and ending in the semilunar line over the top of the broad ligament. The skin, fat, muscles, and fascia are divided down to the peritoneum, which is then dissected up by the fingers, being lifted toward the opposite side; the ureter is found, after raising the colon, crossing the belly of the psoas muscle with the ovarian vessels, and if not seen at once, it may be traced from the pelvis of the kidney down. It may further be recognized by tapping it sharply, or by watching a peristaltic wave pass downward. The peritoneum need not be opened at any point. After freeing the kidney by ligating its vessels and detaching the abdominal portion of the ureter as described, the pelvic portion is then freed by following the upper portion as a guide, while the fingers readily lift the pelvic peritoneum from the vessels which drop with the ureter over the brim. By pulling it out the ureter

may be freed not only down to the floor of the pelvis, but well forward. To complete the enucleation as far as the vesical attachment, the uterine artery and veins must be tied and divided.

**Obstruction of the Ureter.**—Obstruction of the ureter, diminishing or obliterating its lumen, will be more frequently diagnosed when the opportunities of examining the ureters afforded by abdominal surgery and catheterization are more generally embraced. The importance of recognizing the existence of a ureteral obstruction can not be overestimated, on account of its damaging effect upon the kidney, diminishing or even suppressing its excretory power; the danger of an obstruction is vastly greater when both ureters are involved.

The immediate effect of obstruction is to back up the urine above it in the pelvis and calices of the kidney, producing hydroneurter and hydronephrosis, varying in their clinical appearance according as the obstruction is produced gradually or suddenly, is partial or complete. If the hydroneurter and hydronephrosis become infected, we have then to deal with a pyoneurter and pyelonephrosis above the obstruction.

**Causes.**—Ureteral obstruction may be produced in a variety of ways, and is far more common in women than in men, being frequently associated with diseases of the uterus and ovaries. They may be classified in general as—

First, causes acting from without and occluding the ureter by pressing upon it or overstretching it; such are—

1. Ovarian tumors.
2. Uterine tumors.
3. Cancerous infiltration of the broad ligaments.
4. Cancer of the cecum.
5. Retroperitoneal pelvic sarcoma.
6. Aneurism of the iliac artery.
7. Scar tissue in the broad ligament.
8. Perineuritis.
9. An omental adhesion to the pelvic brim.
10. Thickened bladder walls.
11. Sarcoma of the bladder.
12. Pediculated tumor of the bladder.

Second, foreign bodies lodged in the ureteral canal:

1. Calculus.
2. Blood clot.
3. Echinococcus cyst.

Third, affections of the ureteral walls themselves:

1. Ureteritis bacilli coli communis.
2. Ureteritis gonorrhoeica.
3. Ureteritis tuberculosa.
4. Valve formation in the ureteral wall.
5. Gumma in the wall.
6. Cancer of the ureter.
7. Psorospermatid cysts.

Some of the twenty-two causes of obstruction just cited act unilaterally, while others are more apt to act on both ureters at once; it therefore becomes important from a practical standpoint to divide them further into groups according to this tendency.

Both ureters are apt to be obstructed by cancer of the cervix uteri extending out into the broad ligaments, by thickened bladder walls, by some large sub-peritoneal fibroid tumors, and in rare instances by calculi.

But one ureter is apt to be involved in parametritis, small pelvic tumors and inflammatory masses posterior to the broad ligament, gonorrhoeal stricture, and tuberculosis.

The location of the obstruction in almost all cases is in the pelvic portion of the ureter, at some point between the brim of the pelvis and the vesical end. The reasons for this predilection lie, on the one hand, in the proximity to the ureters of the uterus, tubes, and ovaries, and their liability to inflammatory affections or new growths, and, on the other hand, to the fact that the ureters are enclosed with these organs in the unyielding bony pelvic canal, which affords a point of resistance against which pressure can be made. Next in frequency to the pelvic extremity is the involvement of the upper end near the pelvis of the kidney.

The clinical symptoms of obstruction are variable, depending on the cause and the completeness of the occlusion, as well as the rapidity with which it is produced. In the milder grades, where the distention is not great, there may be no symptoms at all. I have a patient whose right ureter and renal pelvis are dilated by a stricture at the vesical end of the ureter until they hold 100 cubic centimeters of urine without producing any subjective sensations whatever. Extreme dilatation may be produced without pain if the cause acts slowly. I had one case, a little girl about three years old, in whom the right ureter was lifted out of the pelvis and dilated to a diameter of  $1\frac{1}{2}$  centimeter by a retro-peritoneal sarcoma.

Where the obstruction depends upon inflammatory disease the chief symptom is frequent painful urination; in cases of tumors and pelvic inflammatory masses the ureteral symptoms are often masked by the associated complaint. The sudden closure of one ureter, as by a ligature, produces violent pain in its course, extending into the kidney, associated with restlessness, a hot, dry skin, and fever and diminished urine. If both ureters are obstructed, uremia develops soon after the pressure in the sac of urine formed is equal to that in the blood vessels, checking further secretion.

To make a diagnosis three questions must be answered:

First, Is the ureter obstructed at all?

Second, What is the nature of the obstruction?

Third, What is its degree?

A diagnosis from symptoms alone can only be made in that small percentage of cases in which the occlusion has taken place suddenly, as in the case of a calculus or clot descending from the kidney and lodging in the ureter and blocking its flow, or when in an operation the ureter is tied and the persistent agoniz-

ing ureteral and renal colic definitely located in its course leave no doubt as to the nature of the difficulty.

There are no reliable symptoms of a dilatation of an aseptic ureter that has developed slowly. A diagnosis of obstruction with dilatation may be made with assurance whenever uremic symptoms are noted in the course of a cancer of the cervix.

While diagnostic means heretofore have been indirect and unsatisfactory, enabling us only to infer the existence of obstruction, and that in a small percentage of cases, the means of direct exploration of the whole ureteral tract now at our command leave but little to be desired in the way of accuracy. These are the inspection of the ureteral orifices and the catheterization and sounding of the ureters.

Before describing the actual use of these methods it will be important to consider first in what class of cases it is desirable to try to ascertain whether there is or is not an obstruction. I should always make an examination for obstruction where there is persistent pain in the course of a ureter; where the patient is distressed by frequent urination, for which a sufficient cause does not exist in the bladder or urethra; where there is pus in the urine in cases of pelvic inflammatory diseases; and where pelvic tumors might be supposed to make pressure on a ureter.

In investigating an obstructed ureter we wish to determine—

1. Whether there are any abdominal or pelvic tumors or masses which could press upon a ureter.
2. Whether any form of ureteritis exists.
3. Whether the ureter is blocked by a stone or clot.
4. Whether two of these conditions do not act in combination.

The presence of an abdominal or pelvic tumor pressing on a ureter can be determined by a bimanual and rectal examination and deep abdominal palpation under anesthesia. Sufficient cause for an obstruction exists when a band of scar tissue, following injury in childbirth, is felt in the parametrium, dragging the uterus to one side, or when an inflammatory mass is felt fixed to the pelvic wall and floor, or when there is a uterine or ovarian tumor choking the pelvis, or some other tumor filling the lower abdomen.

Palpation of the ureter through the vaginal walls shows whether it is thickened or not, and so demonstrates the presence or absence of a ureteritis.

The blocking of the ureter by a stone or clot can only be demonstrated by the passage of a sound or catheter, and this brings us to the method of demonstrating with absolute certainty the existence of an obstruction. In examining any given case the investigation must not cease when one cause sufficient to explain an obstruction is found; other associated causes must always be sought for, and their absence definitely proved, before the one cause found is finally accepted. For example, an inflammatory obstructive ureteritis may be found associated with a pelvic abscess of the same side.

By the direct examination the existence of an obstruction is proved either when (1) a ureteral catheter or sound passes freely up the ureter until it is sud-

denly checked, or (2) when each time after passing a certain point in the ureter there is an immediate continuous flow of urine of from several up to a hundred or more cubic centimeters in quantity. Sufficient time must be allowed to elapse for more urine to accumulate before repeating the examination. The demonstration is still more complete in a case of this kind if the instrument is distinctly grasped in the bite of the stricture and resists withdrawal.

In sounding and catheterizing a ureter for obstruction, the metal catheter is only of use for the lower part of its course, from the vesical orifice to the posterior pelvic wall. With gentle tact the metal catheter may sometimes be coaxed through a tight stricture impassable to the yielding silk catheters. As a rule, it can not be pushed in more than from 4 to 6 centimeters ( $1\frac{1}{2}$  to  $2\frac{1}{2}$  inches) under inspection with the patient in the knee-breast position, and it is better after introducing it to turn her over to the dorsal position, or to put it in, in the first place, in the dorsal position, and to let the air out of the bladder with a catheter, and then to guide the further progress of the ureteral catheter with a finger at first in the vagina and then in the rectum. It is needful to empty out the air, as the distended bladder splints the catheter and impedes its onward movement.

An ordinary solid sound has no advantage over a catheter, which does equally well as sound and catheter. The only sound I have ever used with advantage is one made like a catheter, but solid, and with a slight bulbous enlargement, 1 centimeter back of the point, which trips in passing any narrow place in the lumen.

The short flexible ureteral catheter is only valuable in locating strictures in the lower ureter, but is easy to introduce and is safer in experienced hands. The long flexible catheters, 50 centimeters (20 inches) in length, are used to locate strictures in the upper ureter all the way up to the pelvis of the kidney. It is always important in searching for a stricture to pass the catheter up slowly, so that the flow of urine will make it evident as soon as the stricture is passed. If the catheter is pushed up rapidly, the end may be several centimeters or more beyond the stricture before the flow begins, and the stricture in this way estimated to be higher up than it really is. A good telltale is made by dipping the finger in water and touching it to the end of the catheter, which is then closed by a thin film of water until the urine begins to flow, forcing the air out and pushing the water off from the end of the catheter in the form of a little bubble, in this way announcing the coming of the urine some seconds in advance of its actual appearance. The escape of urine backed up behind an obstruction is different from the intermittent normal flow drop by drop. The urine which has been held back often pours out of the catheter in a steady stream until it has almost all escaped, when it continues to drop steadily for a while longer, and so the sac is emptied. The fact that the urine has been backed up, and that it is not simply an abnormally rapid secretion, can be proved by a simple calculation. For example, if the normal secretion is about 1.5 liter per diem (3 pints), this makes about 1 cubic centimeter per minute from both sides combined, or half a cubic centimeter from one side. If now I collect 90 cubic

centimeters in three minutes after putting one catheter in, that equals 30 cubic centimeters in one minute, or sixty times the normal amount, 90 liters (180 pints) a day, manifestly impossible.

An important part of the investigation is to decide exactly where the stricture ends and the dilated portion of the ureter begins. This is done by withdrawing the catheter slowly during the escape of the urine, and noting the moment the flow is checked; the length of the catheter inside, of course, then measures the distance of the upper end of the stricture from the meatus. To determine the distance from the vesical end of the ureter, the distance of the external meatus to the ureteral orifice is measured with the searcher and deducted.

The treatment of ureteral obstruction depends upon the cause; in some cases it can be easily removed, in others it is irremediable. An obstruction should never be allowed to persist if it can be removed without undue risk to life. The danger of surgical interference is greater where both ureters are involved, and is greatest of all if infection of one or both sides is superadded. Where both sides are occluded by a cancer in the broad ligaments, the plan proposed of prolonging life by severing the ureters just under the kidneys, and turning the ends out to discharge the urine in the flanks is rarely applicable on account of the condition of the patient by the time the disease has advanced so far. In case uremia is threatened from occlusion of both ureteral orifices by thickened, inflamed bladder walls, it will be proper to save the kidneys and preserve life by opening each antero-lateral vaginal wall, isolating the ureters, and making a longitudinal incision in them 1 centimeter long, so as to suture them to the vaginal wall (kolpo-ureterostomy). In case of recovery of the bladder, the ureteral fistulae could afterward be closed.

Where the ureteral dilatation comes from the pressure of a pelvic tumor, it is treated by taking away the tumor and removing the pressure. Indeed, this is often done in removing pelvic tumors without the operator knowing all that he has accomplished. In all cases of pelvic tumors both ureters should be inspected before removing the growth, for dilatation in varying degrees (hydro-ureter) will be discovered with surprising frequency. If to the dilatation an infection has been added, this will need treatment later, either by washing out the pelvis of the kidney and the ureteral tract, or by opening the pelvis in the loin. I have twice seen pelvic abscess in the left side associated with pyoureter and pyelonephritis. In another case a densely adherent ovarian cyst on the left side blocked the ureter. The upper ureter and pelvis of the kidney were filled with pus, and the enlarged kidney contained multiple abscesses. I removed the tumor and the kidney, and the woman regained complete health and is still living three years later.

Ureteritis as a cause of obstruction is quite common. The ureteritis itself can not be directly treated unless it has formed a stricture and the ureter is dilated above it; the treatment is then directed to the dilatation of the stricture and the removal of the infection. Where it is due to stone, relief will be obtained only by uretero-lithotomy. I have seen two cases of colon bacillus infec-

tion producing ureteritis. In one of them I opened the pelvis of the kidney and took out a small stone fitting like a valve into the mouth of the ureter when the pus disappeared from the urine.

Tubercular ureteritis can only be cured successfully when it is unilateral, and then by the extirpation of the ureter and its kidney. The kidney is generally so extensively diseased in these cases that the question of sacrifice does not arise.

**Stricture of the Ureter.**—Under stricture of the ureter I desire to discuss the treatment of localized contractions or occlusion of the lumen, due to inflammatory thickening or valve formations. According as these strictures differ in their causes, character, and location, so do the plans of treatment vary.

Where the closure is effected by a thickening of the walls of the pelvic portion, much will be gained by passing through it successively catheters increasing in size, 2, 2½, 3, 3½, 4, 4½, 5 millimeters in diameter and 28 centimeters (13 inches) long. The stricture is not entirely relieved by this plan, but the quantity of urine held above it is markedly lessened and relief from pain is afforded. This is the best, the safest, and the easiest mode of direct treatment in all strictures located low down in the ureter and due to chronic inflammation, excepting in tubercular ureteritis; here, too, temporary relief will sometimes follow a moderate dilatation and evacuation of the accumulation, with a regular washing out of the tract above.

A case of tubercular ureteritis, in which I found a tight stricture well back in the pelvis, and drew off from time to time 100 cubic centimeters (over 3 ounces) of pale lemon-colored alkaline urine, the patient felt better after each evacuation, but made no permanent improvement, as it was impossible to keep the channel open even for a short time.

My method of treating a gonorrhœal stricture of the vesical end of the ureter with pyoureter and pyelitis is demonstrated by the following case:

The patient came to me with an extensive accumulation of pus in the left ureter, extending up into and filling the pelvis of the kidney, caused by a cork-screw stricture of the vesical end of the ureter. This was due to a gonorrhœal infection.

I treated the stricture by dilatation with a series of ureteral catheters, increasing in diameter from 2 to 5 millimeters. After drawing off the purulent fluid, the ureter and pelvis of the kidney were washed out with medicated solutions. The caliber of the stricture was enlarged by the dilatations so as to reduce the quantity of the accumulation above it from 150 to 100 cubic centimeters.

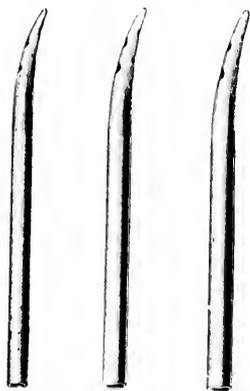

FIG. 245.—THE ENDS OF THE DILATING METAL CATHETERS, THREE SIZES (2, 3, 5, AND 4), USED IN DILATING STRICTURE OF THE LOWER EXTREMITY OF THE URETER.

The purulent character of the secretion was removed and all trace of gonococci, at first abundant, disappeared.

My patient (E. S., Sum. 96) was a married woman, thirty-one years of age, of slight build and haggard-looking. She had had one child four years before without special difficulty, the only pregnancy in six years of married life. The menses were regular and without pain. Headaches were rare; the appetite was good and the bowels regular. She had no chills.

She had been feeling depressed for some months and had lost weight, and complained of severe pain on urinating, which persisted for a half hour or longer. There was a sense of pressure in the bladder, and she was obliged to urinate every two or three hours by day and oftener by night. There was no acute pain, but aching in the limbs and discomfort of the lower abdomen. She noticed that the appearance of the urine varied greatly, being clear at times, and at other times containing much yellow sediment.

My examination showed that the vaginal outlet was torn superficially back almost to the anus; the cervix was in the axis of the vagina, somewhat low down, showing a slight tear, and the uterus was in retroflexion; the left ovary was displaced downward, not adherent, and tender on pressure. On examining the anterior wall of the vagina, no special tenderness was developed on palpating the bladder.

The ureters were then palpated by the vagina. The left felt distinctly harder than normal and somewhat thickened, but was without marked tenderness; it was also displaced toward the pelvic floor.

The bladder was then examined under atmospheric dilatation, with the patient in the knee-chest position, through the No. 10 speculum. There was evidence of a patchy, mild cystitis. The field opposite the ureter, the posterior pole, and its surrounding area were mottled, red, and injected, the vessels being obscured; the injection increased toward the vault, which was covered over an area 4 by 5 centimeters by fine granules, averaging one or two to the square millimeter, most marked on the right side. The tips of each of these granules reflected the light and gave the surface a bright studded appearance. On the left side in places the surface presented a superficial worm-eaten appearance. On the right lateral wall,  $2\frac{1}{2}$  centimeters behind the ureteral orifice, was a ridge 2 millimeters in height, extending downward to the base of the bladder. Near the right ureteral orifice was an area of intense congestion, presenting an edematous appearance, surrounding the ureter, whose orifice could only be located by a little pallor in the form of a crescent. Posterior to the right ureter was a superficial ulcer 2 by 3 millimeters, with a narrow red border and a yellow center.

The left ureteral orifice was situated on a truncate cone, about 6 millimeters in diameter at its base and 2 millimeters at the top. It was slightly edematous, and on the urethral side broken up by a number of irregular papillary eminences. The sight of the ureteral orifice at the first examination was marked by a yellow spot of pus. On introducing a searcher into the opening of the orifice, a thin stream of pus escaped and ran down on the bladder wall.

Upon leaving the ureteral catheter in the left ureter for three minutes, 17 cubic centimeters of dark fluid escaped, followed by 6 cubic centimeters of fluid containing much pus. In the twenty-four hours following the examination the patient passed 700 cubic centimeters of urine.

During the whole time the patient was under treatment, from the 2d of March to the 2d of June, 1894, I catheterized her left ureter about one hundred and twenty times in all. The first three weeks of her stay were passed in repeated vain endeavors to get the ureteral catheter through the stricture into the ureter. Three difficulties prevented this at first. In the first place, the irregular papillary prominences on the left side, in the neighborhood of the ureteral orifice, obscured it, and made it impossible to locate it with precision subsequent to the first examination, in which pus was seen coagulating out; in the second place, the location of the ureteral mass and its orifice were in extreme displacement to the left; in the

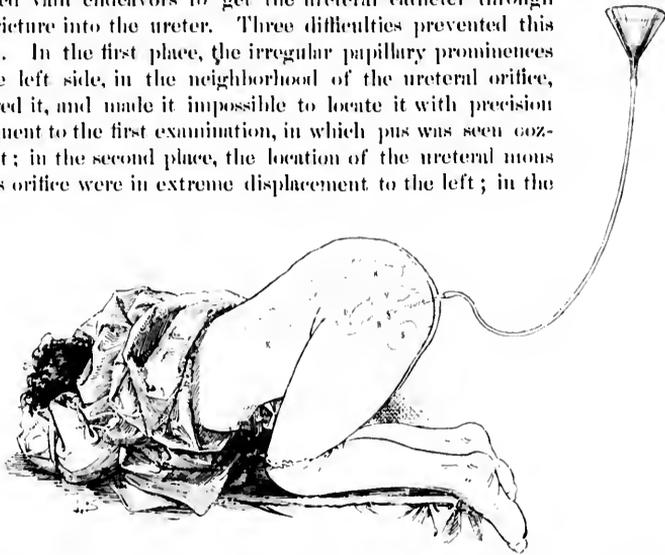

FIG. 246.—WASHING OUT THE RIGHT KIDNEY FOR GONORRHEAL URETERITIS AND PYELITIS.

A flexible catheter is usually used. In this case a metal catheter was passed through a stricture at the lower end of the ureter and the solution carried up to the kidney by gravity by means of a funnel and long rubber tube. The patient is in the knee-chest position to aid gravity.

third place, there was a spiral stricture of the intravesical portion of the ureter, and it was necessary for me to learn the twist of the stricture before I could pass the catheter at once at every sitting.

After almost daily efforts for three weeks the stricture was finally cleared by an accidental turn of the hand; this was more readily repeated on two or three occasions subsequently, but not without many discouraging failures, after which the ureteral orifice was definitely located on the side of the pyramid in relation to certain papilla, and the direction of the stricture was ascertained, so that the catheter could be passed with ease. After pushing the catheter through the stricture with a half turn it entered about 8 centimeters; a distinct sense of resistance was felt in attempting to withdraw it, due to the bite of the stricture, about  $1\frac{1}{2}$  centimeter long. So long as the point of the catheter went no farther than the stricture, no urine escaped; but as soon as the catheter cleared the stric-

ture, pale urine began to pour out in a steady stream, continuing until 150 cubic centimeters were collected in three minutes. Sometimes the first urine drawn off would be of a reddish-brown color, followed by a whitish sediment, and at the last a thick, creamy fluid like pure pus.

The fact that so much urine escaped in so short a time proved conclusively that there was an extreme dilatation of the left urinary channels above the stricture, for the normal rate of secretion being at the most 1 cubic centimeter a minute for both ureters together, or  $1\frac{1}{2}$  in three minutes for one ureter. The discharge of 150 cubic centimeters would be twenty-nine times the normal amount, or at the rate of about twenty-two gallons a day for both sides together, proving that there was a dilated pyonreter and pyelitis.

After drawing off all the fluid, a piece of fine rubber tubing with a funnel at the end was connected with the catheter, and a saturated boric-acid solution, equal to two thirds of the quantity of fluid taken out, was run into the ureter by gravity by simply elevating the funnel filled with the fluid from 40 to 60 centimeters above the level of the bladder. Care was taken to have the tubes full of fluid, so as not to inject air. The patient, during all these manipulations, was in the knee-breast position. She took no anesthetic, as the treatment was not painful. After the catheter was in the ureter she raised herself on her hands and knees to dispose the fluid to run out faster. When the injection was given she again let her chest down to the table, and rose again when it was to flow out. I found that I could wash the urinary tract repeatedly with the same fluid, if I desired it, by holding the funnel high for the fluid to run in, and by holding it an

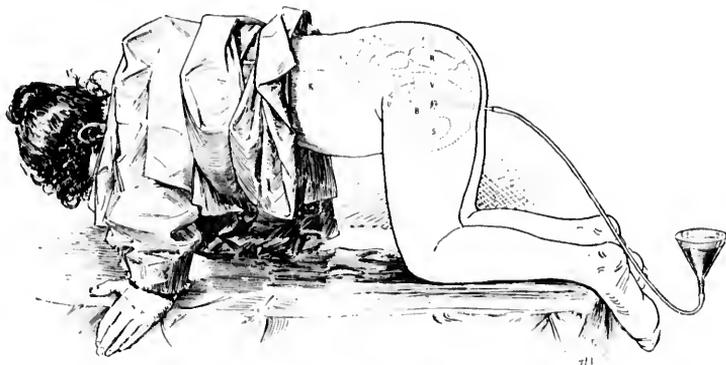

FIG. 247.—WASHING OUT THE KIDNEY AND URETER.

Letting the fluid run back again into the funnel from the kidney and ureter. The funnel is held low and the patient rises on the hands and knees to facilitate the outward flow. San., Mrs. S.

equal distance below the level of the table for it to run out again, often bringing with it a considerable amount of shreddy white *débris* from the ureter.

A small Y-shaped switch with a stopcock in the angle was used at times to facilitate the inflow and outflow of the solutions.

After the first few treatments she began to experience relief from pain and was less frequently disturbed at night.

Examination of the urine by Dr. Barker in the pathological laboratory of the Johns Hopkins Hospital showed that it was straw-colored, neutral in reaction, and contained abundant mucopurulent, stringy, tenacious sediment. There was a small amount of albumin, but no sugar and no casts. The specific gravity was 1.032. There were many polymuclear leucocytes, crowds of pus cells, and many diplococci, nearly all of which were within the protoplasm of the leucocytes. Octahedra of calcium oxalate were found, and a few cylindroids. There were no tubercle bacilli, and no other bacteria than diplococci, which were of the typical appearance of gonococci, and much smaller than staphylococci or streptococci.

The bladder walls were treated by occasional applications of a 5 per cent solution of nitrate of silver, applied directly to the affected areas on absorbent cotton with an applicator, and by daily irrigations of a bichloride solution (1-150,000).

My first effort in the treatment of the case was to secure a continuous drainage of the ureter, avoiding all accumulation above the stricture, hoping by this plan to induce a contraction of the ureteral walls. To do this I made a short ureteral catheter 2 millimeters in diameter and 5 centimeters long, with a little shoulder about 2 centimeters back of the inner end to keep it from slipping out of the ureter after introduction, and with a flange 6 millimeters in diameter at the lower end to keep it from slipping altogether into the ureter. I placed this in the ureter by means of a searcher used as a mandrin to conduct it through the stricture. I found, however, that its presence gave so much pain and increased the irritation of the bladder, after being in place for twelve hours, that I was obliged to abandon its further use, although it acted well mechanically.

My next plan, which was successful in curing the case, was to have ureteral catheters made in four sizes, increasing from the smallest, 2 millimeters, to the largest, which was 6 millimeters in diameter. The points of the catheters were blunt and straighter than the ureteral catheters ordinarily used, on one side almost on a line with the shaft.

In the course of two months of such treatment the ureter was dilated sufficiently to permit the introduction of the largest catheter, from the end of which the accumulated urine would drop in a large free stream. With the catheters I began systematically to wash out the ureter and kidney with a bichloride of mercury solution (1-150,000), constantly increasing the strength until 1-16,000 was used. The treatment with the bichloride was interrupted several times for the injection of a 1 per cent nitrate of silver solution, and once for a weak iodine solution. Toward the end, while using the larger catheters, I was obliged some six times to suspend the treatment for from two to three days, on account of a chill followed by elevation of temperature from 102° to 104° F., with a quickened pulse (120), headache, nausea, and pain in the left inguinal region and legs. The patient was flushed and restless, and suffered from sleeplessness at these times.

The result of the bichloride washings was a complete disappearance of pus cells, leucocytes, and gonococci from the urine, and the reduction of the size of the distended ureteral tract from one holding regularly from 140 to 150 cubic centimeters down to 90 or 100 cubic centimeters. The bladder assumed a normal appearance and she became able to sleep through the night without rising once. She gained 20 pounds in weight and resumed the rosy appearance of perfect health, with a corresponding remarkable improvement in spirits.

The treatments were discontinued August 8, 1894, and I saw her again in January, 1895, and then on two occasions catheterized the ureter, drawing off only 90 and 100 cubic centimeters of clear urine from the left ureter without a trace of pus or cocci. She has therefore recovered from the infection, but still has a stricture of the ureter of larger caliber with a lax distended ureter above it.

I made several attempts to empty the ureter by massage, with considerable success at first, but the procedure became so painful that it had to be stopped. Just before the massage the bladder was emptied by catheter, and immediately after treatment as much as 90 cubic centimeters of urine were secured.

I demonstrated the success of the massage and mapped out the exact positions in which to make pressure by placing the patient in the dorsal position and then introducing a catheter with a rubber tube attached to its outer end, when a straight glass tube, 50 centimeters long, attached at the other end of the rubber tubing, filled at once with urine to the level of the ureter and acted as a manometer. Respiratory movements were traced by its rhythmical ascent and fall. On making pressure over the ureter through the abdominal wall the column ascended in the vertical glass, and, by increasing the pressure, could be forced out over the top. If the pressure was made to one side of the ureter there was only a slight effect or none at all. By marking all the points of effective pressure on the skin, and afterward connecting the markings, the course of the ureter was accurately mapped out.

The following important points are demonstrated by this case:

1. Stricture of the lower extremity of the ureter can be diagnosed without any operation by using the cystoscope with the bladder dilated with air by posture.

2. Stricture of the ureter can be improved by gradual dilatation by a series of hollow bougies (catheters) and without a kolpo-ureterotomy. (See *Johns Hop. Gyn. Rep.*, No. 4.)

3. A stricture through which a No. 5 (5 millimeters in diameter) bougie is passed every day for several weeks will still hold back the urine if the walls of the ureter above have lost their contractility.

4. Pyoureter and hydroureter can be diagnosed by drawing off in a few minutes such a quantity of fluid as it is manifestly impossible for the kidney to secrete in that amount of time.

5. Pyoureter and pyelitis can be cured by washing out the ureter and pelvis of the kidney without any preliminary cutting operation to disclose the ureteral orifice (as in kolpo-uretero-cystotomy, Bozeman).

6. Variations in pressure in the column of fluid in a distended ureter can be demonstrated by a manometer attached to the ureteral catheter.

7. In this way the course of the ureter can be mapped out.

There are several sorts of stricture in the upper part of the ureter at or about the junction with the pelvis of the kidney.

In one important group of cases the closure is intermittent, or depends on a ureteritis without a definitely localized stricture.

Complete closure may be congenital or it may follow an injury or inflammatory disease. The treatment will depend upon the length of time which has elapsed since the occlusion was effected as well as upon the result of the occlusion. Where the kidney has undergone atrophy nothing need be done. If it has become greatly distended, temporary relief may be afforded by tapping. If the occlusion is but recently acquired, the effort should be made by operation to make the passage pervious.

I have examined the first patient on whom I performed a nephro-ureterectomy, leaving 6 or 8 centimeters of the lower end of the tuberculous ureter, and found the position of the ureteral orifice in the bladder marked by a shallow pit impervious to the sound.

In another case of an intermittent hydronephrosis of long standing, due to a stricture of the ureter just below the pelvis of the kidney, in attempting to locate the stricture by means of a catheter the vesical opening was lacerated; a few days later the kidney was exposed and the ureteral stricture divided and sutured so as to make a free opening from the kidney into the ureter. The pelvis of the kidney was drained through an incision in the dorsum so as to allow the repaired stricture to heal at rest. During this time the bruised lower end of the ureter, no longer kept open by the passage of the urine, closed completely, as I found by a cystoscopic examination several weeks later, when no efforts made to pass the sounds succeeded.

The following case of complete occlusion of the renal end of the ureter came under my care in May, 1894.

C. F. (San. 109, May, 12, 1894), twenty-three years old, was suffering from an old fistula discharging pus beneath the left anterior superior spine. Her trouble began ten years before with "awful spells of pain" in the left side, extending around into the small of the back. These came about twice yearly and lasted two weeks at a time, when she had to stay abed on account of the pain and fever attending them. In the intervals she suffered from constant soreness in the left side. In 1890 she had a spell lasting a year, treated as "typhoid fever," and terminating in April, 1891, in an abscess in the left inguinal region, which was opened and 2 liters of pus and blood evacuated. The abscess continued discharging until October, 1892, when it closed. In June, 1893, she got worse again and the abscess reformed; it was opened in August, and since then the discharge had been constant. Several gritty particles escaped recently from the wound. Seven months before coming to me she had been in a sanitarium, where she was treated for spinal caries. Each time the sinus closed and pus accumulated she had a chill with pain and fever until it was reopened.

She was a little woman, under five feet in height, and well nourished. I found in the crease of the left groin, just under Poupert's ligament, the funnel-shaped orifice of a fistula, 2.5 by 1 centimeter (1 by  $\frac{3}{8}$  inch), discharging a little thin, watery pus. The sound entered readily for 16 centimeters ( $6\frac{1}{2}$  inches) back toward the lumbar vertebrae. Her hip movements were normal. The back was tender but showed no abnormality. There was an ill-defined but positive sense of resistance in the flank under the left ribs. The examination of a bit of gritty substance discharged from the fistula showed that it was made of amorphous urates.

A positive diagnosis was arrived at in the following way, by an examination under anesthesia. She was put in the knee-breast position and the No. 10 bladder speculum introduced. I was then able to pass a flexible renal catheter 26 centimeters ( $10\frac{1}{2}$  inches) on the right side. On the left side the catheter stopped suddenly, as if meeting an obstruction 23 centimeters (9 inches) in, nor could it be induced to go farther. I then left the catheter in the left ureter over an hour, with its outer end lying in a receptacle. No urine at all escaped during this time. The diagnosis therefore was complete occlusion of the left ureter at the kidney, with abscess of the kidney discharging by a long fistulous tract at the anterior superior spine. The kidney was so completely disorganized that there was no chance of restoring its function, and the effort of the treatment was directed simply to doing away with the fistulous tract.

A cure was effected by making an incision 8 centimeters ( $3\frac{1}{4}$  inches) long, between the crest of the ilium and the ribs, down through the muscles and a mass of inflammatory tissue, opening and evacuating several sacs of clear fluid, and scraping out one sac of cheesy material. Nothing was done to the ureter. A drain was left in and gradually withdrawn; she made a complete recovery and is well and married now, three and a half years later.

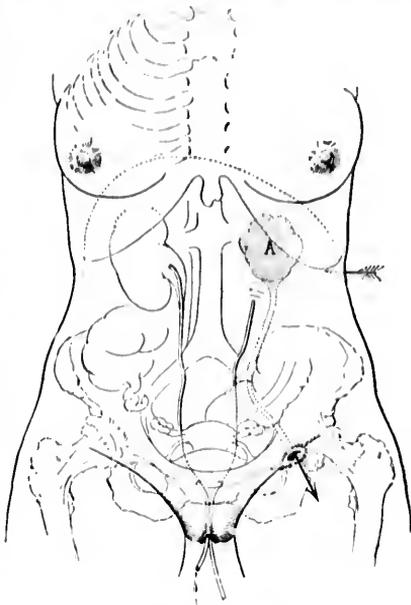

FIG. 218. DIAGNOSIS OF OLD ABSCESS OF THE LEFT KIDNEY BY MEANS OF RENAL CATHETERS.

A sinus discharging under the left anterior superior spine had been treated as a psoas abscess, but on inserting a renal catheter up to the right kidney and another up to the left, the catheter on the left side entered four centimeters short of that on the right side, and upon leaving both catheters in the ureter for an hour, that on the right side discharged urine freely, while none at all came through the left ureter. Upon cutting down on the left side in the direction of the arrow, an old cheesy focus was found occupying the situation of the kidney.

Traumatic stricture is a rare occurrence on account of the protected condition of the ureters. External injuries, involving a ureter, are almost invariably associated with such extensive damage to other important viscera that the patient does not often survive. In spite, however, of this comparative immunity, cases do now and then occur.

The accidents most liable to reach the ureter are stab and gunshot wounds, a kick of a horse, a severe blow, or the crushing wound of a cart wheel. Manifestly men are far more exposed to such injuries than women. As Christian Fenger has said, "Early diagnosis in these cases is often difficult, if not impossible, because of the uncertainty of the symptoms. A slight transient hematuria, which might easily be overlooked, was noted in three cases. Hematuria may be entirely absent. If no injuries to other organs complicate ureteral rupture, there are no grave symptoms in the beginning."

Swelling from the accumulation of urine around the place of rupture is often from one to seven weeks in developing.

In Fenger's analysis he shows that the treatment has never yet been directed at an early stage to the ureter itself, but consisted in puncture of the sac when forming, or in incision and drainage. Most of these cases became septic, and made a secondary nephrectomy necessary to save life. In some cases where the collection was not opened the patients survived, either with an obliteration of the ureter or a stricture.

The treatment of strictures will vary according to their location. Those most amenable to treatment will be found located at the vesical and renal ends. I should propose to treat a stricture of the vesical end surgically by opening the vault of the bladder above the symphysis (*sectio alta*), and exposing the orifice, so as to slit it back into the dilated portion, and then to unite the edges of the V-shaped cut with a fine continuous catgut suture which will stop the bleeding and keep the urine out of the cellular tissue.

Fenger's plan (*Surgery of the Ureter, Trans. Amer. Surg. Assoc., 1894*) for treating a traumatic stricture of the ureter in its upper part is by a linear longitudinal incision dividing the stricture. The ends and the sides of the incision are then sutured together so as to make a ureter of enlarged caliber. This was successfully carried out in the case of a man of forty-seven years, in whom the stricture was close to the junction with the renal pelvis, and the patient had suffered for four years with intermittent pyelonephrosis. As the attacks increased in frequency a nephrotomy was performed, but no stone was found in the sacculated kidney. The ureteral entrance could not be discovered either through the renal incision or after incising the pelvis. After making a longitudinal incision in the ureter below, the stricture was located in its upper part, and treated by making a longitudinal division and approximating the sides of the incision by sutures. Recovery took place in six weeks without a fistula.

Prof. E. Küster, of Marburg (*Arch. f. Klin. Chir.*, Bd. xlv, chap. xxxvii, p. 850), had a case in a boy eleven years old in whom he divided the ureter below a stricture at the renal junction, and transplanted the divided ureteral end into the pelvis of the kidney.

Two years before, the boy had had a left hydronephrosis for which a lumbar incision was made, resulting in a fistula; from this time on little or no urine came from the bladder, showing that the right kidney was either absent or inacti.e. In order to make the ureter patent, Küster made a lumbar incision and opened the pelvis of the kidney, exposing the ureteral orifice. On cutting this down to make it patulous, he discovered a stricture 2 centimeters (3 inches) below the kidney, necessitating cutting off the ureter transversely below the stricture. The lower end of the ureter was now enlarged by splitting it longitudinally, and then suturing it into the incision in the renal pelvis. The rest of the wound in the renal pelvis was closed with catgut.

The result was that four months later the patient was able to pass 100 centimeters ( $3\frac{1}{2}$  ounces) of urine by the bladder in twenty-four hours, while the rest escaped by a fistula in the loin. This was closed by curetting and dilating the sinus and using buried sutures, when the recovery was complete, with a lumbar hernia.

Stricture is also formed by an abnormal entrance of the ureter at an acute angle into the renal pelvis, replacing the normal funnel-shaped opening. The orifice is situated high up in the side of the renal pelvis, and is valve-shaped or minute and punctate. The nature of the obstruction is easily demonstrated by injecting fluid in both directions. It will be found to pass readily upward into the pelvis, but to escape from the pelvis into the ureter with difficulty. This condition of the ureter has especially been studied in its relation to hydronephrosis, which in some cases is caused by it, while in others it would seem that the twisting of the distended kidney produced the occlusion of the lower border of the ureter.

In the treatment of these cases two things must be done: First, the accumulation must be relieved if it is distressing; and, second, the passage must be made patulous. The proposition to extirpate such a kidney should no longer be seriously considered, for even after a blockade of weeks or months the kidney retains to a remarkable degree its excretory power. In a case under my care I evacuated a hydronephrosis of six years' standing, withdrawing 155 cubic centimeters of urine, in which I found 0.039 gram of urea to the cubic centimeter. This was done by placing the patient in the knee-breast position, and with the speculum and head mirror exposing the right ureteral orifice, when a delicate renal catheter was passed up into the ureter and the sac evacuated. If the stricture proves impassable, then the second procedure alone remains to be carried out—that is, the exposure and plastic repair of the contracted portion.

Fenger's plan of treatment of the valvular orifice is the best. He has carried it out successfully in the following way:

The patient was a woman, twenty-eight years old, having intermittent hydronephrosis with severe pain. The lower third of the kidney was drawn forward into the wound in the left loin, and the posterior surface of its pelvis exposed and freed of the enveloping fat. An incision was then made, about 2 centimeters ( $\frac{3}{4}$  inch) long, through the thickened pelvis. On holding this open with forceps, a small semicircular opening was seen at the lower portion of the

inner wall, with its posterior border convex and the anterior straight, forming a valvelike fold over the entrance likely to close the ureter when the pelvis becomes moderately distended.

This stricture was overcome by making an incision through the mucosa



FIG. 249.—HYDROURETER OF BOTH SIDES DUE TO STRICTURES PRODUCED BY A CANCER OF THE UTERUS: DOUBLE URETER ON THE LEFT SIDE FROM KIDNEY TO BLADDER.

Note the separate vesical orifices on the left, and the position of the right orifice on top of a cushioned eminence.  $\frac{2}{3}$  nat. size. June 22, 1896.

the muscular wall of the renal pelvis and ureter without cutting through into the surrounding cellular tissue. The lower ends of the cut in the ureter and in the renal pelvis were now simply united by a single very fine silk suture, changing the vertical incision into a horizontal line, giving a wide exit into the ureter. In place of the No. 5 French bougie introduced at the outset, a No. 11 could

now be passed. This was left in the ureter and brought out of a wound in the dorsum of the kidney to keep the ureter open while healing. The opening into the renal pelvis was closed by ten fine interrupted silk sutures, not piercing the mucosa. The wound was partially closed with extensive drainage. The bougie in the ureter was taken out on the second day. The woman recovered without a fistula, and had no return of the hydronephrosis.

**Hydroureter**, or an abnormal distention of the ureter with urine, is but the complement of stricture which we have just considered. The cause of the hydroureter and hydronephrosis, which is genetically the same and always associated with it, is invariably due to an obstruction to the outflow of the secretion without infection. The various causes, therefore, are those just enumerated, which need not be cited again.

Bilateral hydroureter and hydronephrosis may arise from an obstruction as low down as the urethra, or from a hypertrophy of the bladder walls. It has been noticed arising from the compression of the orifices in exstrophy of the bladder.

Pelvic tumors, neoplasms, and inflammatory diseases act on one or both ureters according to their disposition. The hydroureter always extends from the point of constriction up into the pelvis of the kidney, which it involves (hydronephrosis). The tract included is therefore greater or less, according to the location of the obstruction. It is greatest when the stoppage is at the extreme lower end of the ureter, as in the case of a calculus plugging its orifice. One of the commonest forms, generally of lesser degree, is that produced by the pressure of large uterine or ovarian tumors, which is almost always greatest just at the pelvic brim, so that the hydroureter affects the abdominal portion only.

A marked case is shown in the figure taken from one of my patients (S. A. H., 4039, Dec. 30, 1895), who died with an enormous carcinoma of the cecum filling the whole abdomen and pelvis. Following the distention the ureter be-



FIG. 250.—HYDROURETER AND HYDRONEPHROSIS, SHOWING KINK IN URETER DUE TO BAND OF ADHESION STRETCHING FROM THE LOWER PART OF THE PELVIS OF THE KIDNEY ALMOST DOWN TO THE PELVIC BRIM.  $\frac{2}{3}$  NAT. SIZE.

Sarcoma of peritoneum. H. B. Autopsy, April 4, 1895.

came kinked, and adhesions formed which bound the kinks together and would tend to keep up the distention even if the cause were removed.

In one instance figured in the text (Fig. 250) the ureter was obstructed by the pressure of a sarcomatous growth of the peritonæum; as the ureter distended it kinked and became further obstructed by a band of adhesion uniting it to the pelvis of the kidney.

A sharp line of distinction between hydroureter and pyoureter can not be drawn; in many cases of hydroureter pus is found in small quantities. In some instances this increases while under observation until it is so abundant that there can be no hesitation in calling it pyoureter; in other cases a pyoureter will rapidly improve and the pus diminish from day to day, ultimately leaving behind a simple hydroureter without the observer being able to decide just when the transformation took place.

**Pyoureter.**—Pyoureter is an accumulation of pus in the ureter. In order to bring this about, two things are necessary: first, an obstruction, and, second, an infection, or the infection may take place first and the obstruction develop afterward. A common example of the first class is a hydroureter which becomes infected, while the second class is typified by the case cited under gonorrhæal stricture of the ureter. Properly speaking, many of these cases should be classified under ureteritis and its sequelæ. The quantity of pus found varies from a large deposit falling as a sediment in the urine as soon as it is withdrawn, or a thick and creamy pus only brought out of the catheter by suction, all the way down to a small quantity of pus just sufficient to give the urine a turbid or milky appearance, or the pus may even not appear at all until the urine is centrifugized and put under the microscope. The same causes may act to produce pyoureter as hydroureter, of which the former may sometimes be considered an advanced stage.

Fever is, as a rule, only an occasional symptom. I have seen several cases where an intense intermittent colic was the most pronounced symptom, and where no calculus was present.

The diagnosis is made by the ureteral and renal catheters. Upon introducing the catheter and clearing the obstruction the pus or purulent urine will begin to flow. It must be borne in mind that urine thickened by pus will escape much more slowly than normal urine; if necessary, the discharge at the end of the catheter may be hastened by applying suction with an air-tight syringe.

Whenever the pus is inspissated or too thick to flow readily through the small catheter, it is best to dilute it by injecting some warm boric acid solution and allowing it to mix well with the pus before escaping again; by repeating this maneuver an accumulation may be evacuated in a few minutes which could not otherwise escape in the course of several hours. When the thick pus is in the pelvis of a large kidney the dilution may be aided after injecting the solution by manipulating the kidney freely between two hands.

I have met a number of cases due to tubercular ureteritis with stricture, and the one case cited of gonorrhæal infection.

The prognosis depends upon the cause. In tubercular cases the disease is

progressive until removed. In other cases the infection involves not only the ureter but the pelvis of the kidney, and the kidney substance too, impairing the secreting function.

The treatment will also depend on the cause, and the possibility of completely removing any obstruction to a free outflow. Disinfection of the whole urinary tract up into the kidney may be carried out as already detailed.

**Ureteral Calculus.**—A calculus lodged somewhere in the course of the ureter is far more rarely found than in either the renal pelvis or in the bladder.

The chemical characters of such calculi are the same as those found in the kidney; the form, however, of a calculus which has lodged in the ureter for some time is peculiar, being elongate, from four to six or more times its diameter, which averages about 5 millimeters, and pointed at both ends. The forms of these calculi and the appearance of the layers show that they gain by accretion at the ends and lose by attrition at the side. A ureteral calculus has been observed 12.5 centimeters (5 inches) long. Small calculi may be round or even horseshoe shaped, as in Dr. R. B. Hall's case (*New York Medical Record*, Oct. 18, 1890). The pelvis of the kidney is the source of these calculi, which drop down into the ureter or are slowly forced down until they lodge somewhere in its course.

I had one case of a ureteral calculus forming upon a silk thread used to suture the opened ureter to the vaginal vault (kolpoureterostomy) for the purpose of treating a stricture of the ureter. The patient suffered intense pain from vesical spasms until I discovered the stone and took it away. It was about 6 millimeters in diameter.



FIG. 251.—SYRINGE AND ASPIRATOR WITH COCK FOR INJECTING AND WASHING OF THE PELVIS OF THE KIDNEY THROUGH THE RENAL CATHETER, OR TO INSERT FELIX SO AS TO BLUET A COLLECTION OF PUS TOO THICK TO RUN OUT THROUGH THE CATHETER.



FIG. 252.—A URETERAL CALCULUS WHICH WAS PASSED SPONTANEOUSLY, SHOWING THE CHARACTERISTIC OVOID FORM. ACTUAL SIZE.

Ureteral calculi lodge by preference within certain well defined limits—for example, just below the renal pelvis, about the flexure at the pelvic brim, and the pelvic floor, are decidedly points of predilection.

The symptoms produced by a stone lodged in the ureter are attacks of severe pain extending from the kidney down the course of the ureter, and sometimes accompanied by rigors. The pulse is elevated and there is fever. The point of location of the stone is tender on deep pressure. These attacks are intermittent, and recur at variable intervals as long as the stone remains. With the attacks may often be noticed the formation of a tumor in the loin of that side. Where the stone is not lodged, but is gradually descending toward the bladder, its advance can be traced by the patient, and is often marked by bloody urine. Mechanically the obstruction produces a hydroureter and hydronephrosis, varying in grade according to the completeness of the obstruction; if there is infection, pyoureter and pyonephrosis may arise. In time the function of the kidney becomes greatly impaired, but it is remarkable how persistently it continues to excrete a diminished percentage of urea after months and years of such interference.

The valve action of a stone in plugging the ureter and then permitting the dammed-up contents to escape suddenly is well shown by the history of Dr. Hall's case cited above, in which he found a renal tumor the size of a pint cup, which was not present the day before.

A presumptive diagnosis will be made when all the symptoms above described are found. It must be remembered, however, that the passage of a blood clot, or the temporary closure of the ureter by an inflamed thick mucosa, may give rise to similar symptoms. The most certain of all means of diagnosis is the direct examination by vagina, by rectum, or by cystoscope and catheterization of the ureter, or by an abdominal incision. A stone of good size lodged in the ureter in advance of the broad ligament can be felt through the antero-lateral wall of the vagina and rolled under the finger. Back of this point the normal ureter is easily accessible *per rectum*, all the way up to the pelvic brim, by following the landmarks described, and the palpation is all the easier if the ureter contains a foreign body.

A cystoscopic examination may be so fortunate as to disclose a stone projecting partly into the bladder. By using the metal catheter with a diaphragm on

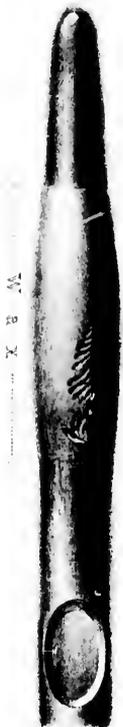

FIG. 252.—END OF A WAX-TIPPED CATHETER.

Diagnosis of renal calculus by means of a wax-tipped catheter. The scratch marks were made by the calculus shown in Fig. 251. Four times enlarged.

the end a stone can be recognized all the way back to the posterior pelvic wall, or even up above the brim, by the click when struck. Above this point the diagnosis must be based upon the fact that an obstruction exists in the form of a foreign body, which is demonstrable upon passing the flexible renal catheter, tipped with wax, which takes an impression from the stone.

It has not yet been my good fortune to sound for a stone in a ureter with a wax-tipped catheter, but I offer as bearing upon the method of diagnosis some of the evidence gathered in searching for renal stones, with the remark that it would be better in the case of a ureteral calculus to put the wax on the very tip of the catheter.

Mrs. P. had a calculus in the pelvis of her right kidney, and a catheter coated with dental wax softened with olive oil was passed up into the kidney, the vesical speculum was removed, and the catheter then withdrawn. Upon placing the glistening wax surface under a lens the scratch marks seen in Fig. 253 were plainly visible, and at the operation the calculus shown in Fig. 254 was removed.

Another patient, sent to me by Dr. F. Henrotin, of Chicago, had a calculus in the kidney which gave the following evidences of its presence: The renal catheter was passed into the pelvis of the kidney, and upon withdrawing it its end was found hammered down and scratched, as seen in *b*, Fig. 255; in the eye of the catheter was lodged a bit of a stone (see *a*, Fig. 255), and upon magnifying this (*c*, Fig. 255), it was found smooth, black, and mammillated on one surface, and on the other jagged, crystalline, and buff-colored, showing that it had been broken off from a larger stone.

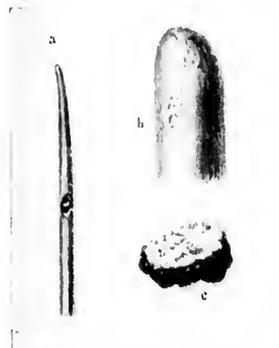

FIG. 255.—*a*, STONE CAUGHT IN THE EYE OF A RENAL CATHETER. ACTUAL SIZE. *b*, END OF CATHETER HAMMERED DOWN AND SCRATCHED. MAGNIFIED. *c*, FREE AND BROKEN-OFF SURFACE OF THE SAME STONE. MAGNIFIED.



FIG. 254. CALCULUS OF THE PELVIS OF THE KIDNEY, FOUND BY THE WAX-TIPPED CATHETER INTRODUCED BY THE FIG. 253. NATURAL SIZE. JAN. 29, 1896.

The treatment is both palliative and radical. It is proper to use palliative treatment during the attacks, relieving the pain with hypodermics of morphia, and producing relaxation by hot baths and packs. Where a number of stones have passed previously, it is best to wait and see if the attack in question will not also pass off in the same way. When, however, the stone is caught and refuses to advance, if the symptoms are urgent and the formation of a renal tumor shows that the stoppage is complete, no time should be lost in delaying a resort to surgical measures.

In the surgical treatment of ureteral calculus its removal is effected by an extraperitoneal or by a transperitoneal route. In the extraperitoneal method the peritoneum is not opened at all, but even when the stone is caught in a por-

tion of the ureter lying beneath the peritonæum, the latter is loosened and turned to one side and the ureter arrived at in this way from behind. In the transperitonæal method the anterior abdominal wall is opened, preferably in the semilunar line, and the ureter exposed and incised, making in this way two incisions through the peritonæum on opposite sides of the abdomen.

The extraperitonæal route is always to be preferred, on account of the danger of peritonitis, and on account of the risk of a urinary fistula, which will be safer behind than across the peritonæum.

In two positions the stone must always be taken out by the extraperitonæal route: first, when lodged anywhere between the kidney and the superior strait; second, when lodged in the anterior part of the pelvis, under or in front of the broad ligament. The ureter is more easily accessible from the brim of the pelvis down to the broad ligament after opening the abdomen, but even here it is better to make a long lateral incision and peel up the peritonæum so as to get at the stone in this way.

The presence or absence of infection also influences the choice of route. When the urine is discharging pus from the affected side, the extraperitonæal route must always be followed, on account of the enormously increased risks of infection if the peritonæum is opened. As stated in discussing the diagnosis of stone in the ureter, it may be proper in doubtful cases to make a preliminary abdominal incision in the semilunar line in order to locate the stone, and then to remove it by a lateral incision.

The various operations for ureteral calculus are performed as follows: When the stone is found lodged in the lower vaginal part of the ureter, if its end can be seen through the cystoscope projecting into the bladder, the effort should be made to grasp it with a pair of ordinary forceps, or alligator forceps, with a hook, or in a noose, and by traction, aided by pushing from behind with one finger in the vagina, to draw it out of its bed and through the urethra.

If this fails, and whenever the stone is behind the vesical orifice of the ureter, it must be reached by a vaginal incision.

After definitely locating by touch the part of the vagina nearest the stone, the patient is put on her back, or in the lateral posture, and the posterior vaginal wall retracted, exposing the anterior and the lateral walls.

The bladder is emptied and a longitudinal incision is made through the vaginal wall about 3 centimeters ( $1\frac{1}{4}$  inch) long; pulling apart the borders of the incision and dissecting down into the cellular tissue, the enlarged ureter is exposed and caught by passing blunt hooks under it, above and below the stone. A longitudinal incision is then made in the ureter over the end toward the bladder, just large enough to push the stone through endwise without any tearing. After this is accomplished a bougie is run up the ureter to make sure there are no more stones above, and the ureteral incision is sewed up with five or six fine interrupted catgut sutures, introduced with a delicate curved intestinal needle, each one embracing the outer coats and avoiding the mucosa. If a good closure is secured and there is no infection, the vaginal wound may be closed too, but if there is much pus in the urine it is safer to drain the vaginal incision.

The remainder of the ureter can be exposed by the incision in a line beginning in front of the quadratus muscle, halfway between the crest of the ilium and the ribs, and extending obliquely downward and forward above the anterior superior spine to the semilunar line, where it ends over the pelvis. The incision, which must be a generous one, is carried boldly through the skin, and three layers of muscles down to the fat overlying the peritoneum. Most of the bleeding vessels are best clamped, but the arteries should be tied with fine catgut. As soon as the fat layer is reached the knife is laid aside and the incision drawn widely open with retractors, while with the fingers alone the perito-



FIG. 256.—REMOVAL OF THE KIDNEY AND URETER WITHOUT OPENING THE PERITONEUM.

The operation is here done on a cadaver and photographed. The figure is used in this place to demonstrate the course of the incision from the lumbar region around the anterior superior spine to the semilunar line above the pubis; through this incision the whole ureter can be reached extraperitoneally.

neum and cellular tissue are easily lifted up and dissected back toward the spine. In this way the ascending or descending colon is drawn to one side, and the ureter is exposed in its course across the psoas muscle. If not readily found it may be detected by finding the kidney first and then tracing it down from the pelvis.

The stone will be found easiest, if it is a small one, by grasping the ureter between the thumb and forefinger and passing it between them from above downward until the foreign body is felt. A longitudinal incision is then made over the end of the stone, it is taken out, and the opening is closed at once with fine catgut sutures, embracing all but the mucous coat. Where the pelvis of the kidney has been opened to extract renal calculi, and a doubt is felt as to whether or not there is a calculus in the ureter, this may be determined by passing a sound down the ureter toward the pelvis. If a stone of any size is found the instrument will be checked, and a little wax on the tip will demonstrate the nature of the obstruction. The diagnosis of stone in the upper ureter may also be made by passing the finger through the lumbar incision made for nephrotomy down along the course of the ureter. I have been able to palpate

the ureter in this way all the way to the pelvic brim over the common iliac artery without making a longer incision than necessary to deal with the renal stone.

The transperitoneal plan of removing calculi is safe and proper when there is no infection, and the stone is fixed in the ureter at a point near the pelvic brim. In this position the ureter is easily found and exposed, and may be treated through an incision in the semilunar line with the pelvis well elevated. The stone is then removed by a longitudinal incision closed by catgut mattress-sutures embracing peritoneum and muscular coats. If the suturing is accurate, and there is no stricture below to dam back the urine, there is no need of a drain, and the abdominal wound should be completely closed.

W. A. Lane, of Guy's Hospital, operated on a calculus impacted in the ureter for twenty years (see the *Lancet*, Nov. 8, 1890, p. 967).

The patient was twenty-three years old and began having violent abdominal pains when she was three years old; she had hematuria when eight years old. Attacks of violent pain were referred to the left side low down and were accompanied by great irritation in the urethra. After each attack abundant pus appeared in the urine.

At a first operation a lumbar incision was made and the kidney explored; a "kink" in the ureter was found and corrected, but the pain soon recurred.

On July 5, 1890, an abdominal incision was made in the left linea semilunaris and the ureter palpated about the pelvic brim, where a stone was felt and pushed up; a longitudinal incision was made in the side of the ureter and a small oval stone three quarters of an inch long was removed, and the opening closed with a fine continuous silk suture. The wound healed without leakage and the patient recovered. The calculus was made up of alternating layers of uric acid and urates.

**Prolapse.**—An eversion or prolapse of the ureteral mucosa is one of the rarest of the ureteral affections. It is commonest in female children and oftenest congenital. The prolapse usually depends for its origin upon a narrowing or stricture at the ureteral orifice, the pressure of the urine filling the pelvis of the kidney and the ureter behind this is then sufficient to cause the ureteral mucosa to pout out into the bladder in the form of a cystic tumor with the obstructed ureteral orifice at some point of its periphery. In the child the prolapsed ureter may even escape through the urethra and appear at the vulva, where it may be mistaken for an everted urethra. An example of an acquired prolapse in a man following an acute cystitis five years before death is shown in Fig. 257, examined and reported by Dr. George Blumer (*Johns Hopkins Hospital Bulletin*, Sept.-Oct., 1896, p. 174). The patient died of an extensive urinary infection, to which this class of cases is peculiarly liable. The enormously hypertrophied bladder, in one place 3 centimeters thick, was corrugated and covered with diphtheritic patches. On the right side there was a hydronephros and a cushiony protrusion into the bladder as big as the end of the thumb. On the left side a pyramidal sac occupied the position of the ureteral orifice.

The sac was fluctuating, 8 centimeters long, 3 centimeters in diameter at the base, and 9 centimeters in diameter near its extremity. High up on one side the minute ureteral orifice was found (see Fig. 257 *a*) as big as a pin point and



FIG. 257. PROLAPSE OF THE URETERAL AND VESICAL MUCOUS MEMBRANE, MOST MARKED ON THE LEFT SIDE, SLIGHT ON THE RIGHT. DEPTHULERIC INFLAMMATION OF THE BLADDER AND LEFT URETER.

Note the position and narrowness of the ureteral orifices at *a* and *b*, and the large pyoureter above the bladder on the left and the smaller hyoureter on the right side.  $\frac{2}{3}$  natural size.

situated in the center of a small area of dense fibrous tissue. On opening the thin-walled sac, the finger could be carried directly up into the ureter.

**Ureteral Fistula.**—A ureteral fistula is an abnormal opening through which the urine is discharged directly from a ureter on to the surface of the body or into some part of the genital or alimentary tract, and in so far as the affected ureter is concerned the bladder is thrown out of use.

Ureteral fistulae are the result of a trauma, or of ulceration, or they are congenital, and by far the commonest are the involving the anterior part of the pelvic portion of the ureter.

A uretero-vesical fistula is produced by a ureteral stone ulcerating through the ureteral walls into the bladder, or by the artificial making of a communication between the bladder and the ureter behind a strictured orifice. Such a fistula requires no treatment, and only needs mention.

The commonest causes of ureteral fistula were formerly the traumatism of labor, tearing open the uterus, vagina, bladder, and ureters, and leaving a permanent communication between the ureter and uterus or ureter and vagina, forming a uretero-uterine or a uretero-vaginal fistula. Other causes acting but rarely were the ulceration through the vagina into the ureter, produced by a large pessary, or the cutting of a ureter on opening a pelvic abscess *per vaginam*. To-day the commonest cause of ureteral fistula is to be found in the frequently performed vaginal and abdominal hysterectomies in which the ureter is accidentally injured. In vaginal hysterectomy for cancer the wonder is that the ureter is not more frequently tied or cut, as it lies so close to the field of operation and is often so intimately involved in the disease. Indeed, it seems quite certain that this accident must occur with far greater frequency than is apparent from the reported cases. In rare cases both ureters are injured, forming a double ureteral fistula.

The diagnosis of ureteral fistula is not difficult. The traumatic form must first be distinguished from the congenital. Congenital ureteral fistula almost always open at a point below the neck of the bladder, even as low down as the external genitals, while the traumatic forms open either at the base of the bladder, or, more commonly still, at the vault of the vagina, or into the uterus. An additional distinguishing feature is the fact that the congenital fistulae are known to have existed from childhood, while the traumatic take their origin from some definite period in adult life.

The next step of importance is to distinguish ureteral from vesico-uterine and vesico-vaginal fistulae. A fistula involving one ureter discharges constantly, while the patient is also emptying the bladder at regular intervals to discharge the urine received from the sound ureter. Care must also be taken to distinguish cases of small vesico-vaginal fistulae situated high up in which the bladder still retains some of its functional activity, discharging urine *per urethram*, in spite of more or less leakage.

By injecting the bladder by an aniline solution, or with sterilized milk, if the case is one of vesico-vaginal fistula, the colored fluid will escape by the vagina; if, on the other hand, the fistula is ureteral, the flow from the vagina will continue clear.

Berard's method of diagnosing between a ureteral and a vesical fistula is to empty the bladder and then cause the patient to sit on a vessel for two hours, when, if the fistula is a ureteral one, the amount of urine collected ought to approximate that drawn by a catheter at the end of this time.

Upon exposing the anterior vaginal wall and the vaginal vault the ureteral

fistula is found usually near the cervix, imbedded in scar tissue. Upon introducing a flexible catheter or bougie into a ureteral fistula the instrument can be pushed up beyond the pelvis into the abdomen as far as the kidney, and if left in place the urine is seen dropping at intervals from the end of the catheter.

In every case of vesico-vaginal fistula a careful search must be made to be sure that the ureteral orifice does not open on the margin of the fistula. Winckel has reported a case in which a minute fistula communicated with the bladder and the ureter at the same time.

A sure sign of a ureteral fistula is obtained by exposing the ureteral orifice and passing into it a sound or a catheter. It will be found that the sound will only enter a short distance, not more than 3 or 4 centimeters, on the injured side, where it is stopped, and if the orifice is watched no urine will be seen to escape. On the sound side the metal catheter or sound can be carried back to the posterior pelvis and a flexible catheter can be pushed up to the kidney, and, if left in, the urine is discharged through it.

Treatment.—Various plans have been devised for the purpose of diverting back into the bladder the urine which discharges through the fistula. The following is an outline of some of these methods:

1. By buttonholing the bladder and making an artificial vesico-vaginal fistula close to the ureteral fistula, and, after this has healed, bridging over a channel between the two fistulous orifices by drawing together the sound vaginal tissues at the sides.

2. By making an artificial vesico-vaginal fistula close to the ureteral fistula and then encircling both orifices in a ring of vaginal denudation, which is folded on itself so that the urine flows first from the ureter into a little vaginal pocket and then into the bladder by way of the vesico-vaginal fistula.

3. By dissecting out the end of the urethra and, after splitting it to prevent contraction of the orifice, to turn the end into an opening made into the base of the bladder.

4. By making a big vesico-vaginal fistula in the vaginal vault near the ureteral fistula and closing the upper part of the vagina (partial colpocleisis).

5. When the ureter is not completely severed and the fistula simply involves its lateral wall, by closure of the fistula, by means of denudation and suture of its margins.

6. By opening the abdomen to release the end of the ureter and turning it into the bladder (abdominal uretero-cystostomy).

7. By total occlusion of the vagina after making a large vesico-vaginal fistula (total colpocleisis).

8. Removal of the kidney corresponding to the fistulous ureter (nephrectomy).

Of these various plans of treatment, no one is adapted to all cases, but that plan is to be selected which best meets the individual requirements of the particular case. In general the simplest plan must be followed, involving least risk to life and avoiding if possible any extensive mutilation or the sacrifice of such an important organ as the kidney; the last thing to be thought

of is colpocleisis or nephrectomy, and the abdomen must not be opened if a simple anastomosis can be effected *per vaginam*.

The condition of the patient must be carefully considered. I have had patients referred to me for the treatment of a ureteral fistula following vaginal hysterectomy, who were suffering from pelvic cellulitis and periureteritis, and so prostrated that I was unable to perform an operation. In one case the patient was emaciated, had a rapid pulse, and a constantly elevated temperature.

When the fistula is traumatic the best time to operate is some months after the receipt of the injury, because for several weeks after its formation the mass of fresh young scar tissue forming in the vaginal vault is unfavorable for any kind of plastic operation.

**Fistula in the Lateral Wall of the Ureter.**—A fistula in the lateral wall of the ureter is easily

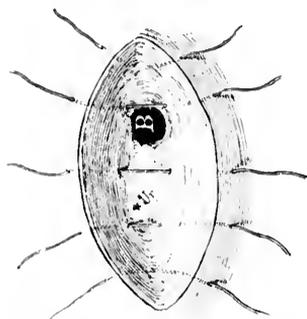

FIG. 258. SWITCHING THE URETER (*U*) INTO THE BLADDER BY MEANS OF AN ARTIFICIAL VESICO-VAGINAL FISTULA (*B*).

The area of indurated vaginal mucosa is seen between *U* and *B*. The five sutures bring the denuded vaginal mucosa together over this.

closed by making a circular denudation in the vaginal wall around the opening about 1 millimeter in breadth, similar to the denudation for a vesico-vaginal fistula. The sides of the denudation are then brought together by means of a series of interrupted silk or fine catgut sutures approximating the tissue in the direction of least resistance. I have had one operation of this sort to perform upon a patient upon whom I had previously opened the lateral wall of the ureter near the vaginal vault and sutured it to the vagina in order to get at and dilate a ureteral stricture in the back part of the pelvis. The denudation was made and the sutures were applied as just described, and the wound healed *per primam*.

#### Ureteral Fistula at the Base of the Bladder.

—A ureteral fistula situated at the base of the bladder is best treated by dissecting up the ureter to the extent of 1 or 2 centimeters, and then perforating the base of the bladder and turning the end of the ureter into the bladder. The vaginal part of the incision is closed by interrupted sutures, taking care to catch the outer coats of the ureter in one or two of the upper sutures so as to hold it fixed in the incision and so prevent retraction as described in the treatment of ectopic ureteral orifice.

**Ureteral Fistula at the Vaginal Vault.**—When the fistula lies in the vault of the vagina and there is enough loose vaginal tissue around it, the best plan of treatment is the formation of a vesico-vaginal fistula near by, not less than a centimeter in diameter, and then making a circular denudation, including both fistulae, as shown in Figs. 258 and 259. The sides of the denudation on the vaginal surface are brought together by interrupted silk or catgut sutures. The difficulty in this operation is the tendency of the vesico-vaginal

fistula to contract and close, and for this reason the opening must be made sufficiently large and the mucous surfaces of the vagina and bladder accurately approximated.

**Uretero-cystostomy.**—The abdomen should be opened and the end of the ureter freed and turned into the bladder in those cases where a sound kidney is discharging its urine into the vaginal vault, and where, at the same time, on account of the scar tissue or its retracted position, a vaginal operation establishing the connection between the ureter and the bladder is impossible.

Contraindications to abdominal uretero-cystostomy are an enfeebled condition of the patient, fresh scar tissue in the vaginal vault and pelvic floor, and an extensive perimreteritis. I have twice been obliged to abandon the operation on account of perimreteritis. This can be detected by first recognizing the mass of resistant tissue in the vaginal vault, and then passing a catheter up the ureter

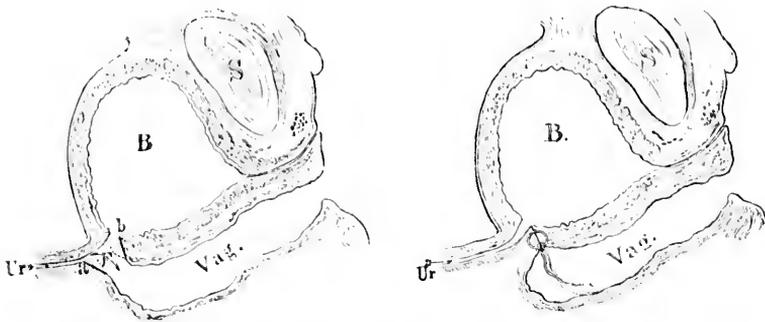

FIG. 259.—URETERO-VAGINAL FISTULA, SWITCHING THE URETER INTO THE BLADDER THROUGH A VESICO-VAGINAL FISTULA. *a, b*, AREAS; *c*, DENTURATION.

The union of the edges of the fistula is shown in the second picture. March 8, 1896.

and examining by the rectum, when the ureter will be found to be no longer free and movable, but is distinguished with difficulty imbedded in a mass of hard tissue, extending a variable distance up toward the superior strait.

Similar operations have been successfully performed by Drs. C. B. Penrose, of Philadelphia (*Urer. Mag.*, April, 1894), and Florian Krug, of New York. (See J. M. Baldy, *Amer. Gyn. and Obs. Jour.*, Nov., 1894, and H. J. Boldt, personal communication).

It is important to note that the operations of uretero-ureteral anastomosis and uretero-cystostomy must not be looked upon as rivals in the same field. Where the ureter is cut far enough back from the bladder to permit an anastomosis of the upper into the lower end, the distance between the upper end and the bladder is too great to allow a uretero-cystostomy to be considered. Where, on the other hand, the ureter is cut near enough to the bladder to allow the upper end to be turned into the bladder, it will be found that the lower end is so short and so awkwardly placed that a uretero-ureteral anastomosis is not to be thought of.

There is but one class of cases in which the procedure is elective; that is when the ureter has become lengthened and dilated by displacement upward over a uterine myoma. I would in this case elect to do a uretero-ureteral anastomosis if the ureter were dilated, or a uretero-cystostomy if it were of normal caliber.

The method of performing uretero-cystostomy is described in the following case, operated on seven weeks after vaginal hysterectomy: The patient (B. Z. 2990) entered the hospital in August, 1894, with an extensive carcinoma of the cervix, for which Dr. W. R. Russell, then the resident gynecologist, performed vaginal hysterectomy. The disease had extended so far out into the broad ligaments that he was obliged to place the ligatures at a greater distance from the cervix than usual. She recovered rapidly from the hysterectomy, but retained as a sequel a ureteral fistula in the vault of the vagina near the middle of

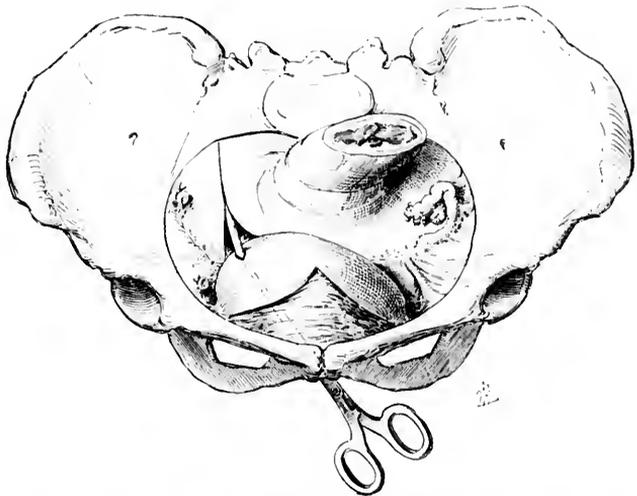

FIG. 260.—RIGHT URETERO-CYSTOSTOMY FOR URETERO-VAGINAL FISTULA FOLLOWING HYSTERECTOMY FOR CANCER OF THE CERVIX.

The ureter has been dissected out of its bed and cut off close to the base of the right broad ligament; it was too short to reach to the bladder, so the bladder was loosened from its attachments to the anterior pelvic wall and thrown back 3 centimeters to meet the ureter.

the cicatrix. From this there was the usual constant leakage of urine, although she regularly passed the urine accumulating in the bladder from the other kidney. From a simple vaginal inspection it was impossible to say whether the flow from the cicatrix came from the right side or the left. It clearly did not come from the bladder, for it remained unchanged by the injection of a sterilized solution of milk into that viscus.

To decide which was the severed ureter I placed the patient in the knee-breast position and introduced my No. 10 cystoscope, when the bladder filled with air and I was able to inspect the ureteral orifices. By introducing a

searcher into the left ureteral orifice I found that this ureter was intact as far as the posterior wall of the pelvis. Upon introducing the searcher into the right ureteral orifice it could not be carried in more than 2 centimeters, on account of meeting an impassable obstruction. The urine was seen flowing from the left ureteral orifice while nothing escaped from the right side. The demonstration was thus complete that it was the right ureter which was injured and the left was intact.

Having cleared up the diagnosis in this way, I proceeded to operate to relieve the condition, in October, 1894, seven weeks after the original operation.

**Operation.**—The patient was placed in the Trendelenburg position and an incision 12 centimeters long made through abdominal walls loaded with fat. Every step throughout the operation was embarrassed by the obesity of the patient. After opening the abdomen, the large fat omentum and intestines were dislodged from the lower abdomen and pelvis with great difficulty, and held away by means of cotton gauze pads.

The end of the ureter could not be found on the pelvic floor on account of the rigidity and inflammation surrounding the line of scar tissue between the rectum and bladder. The right ovary and tube, which had been left, were also pinned down to this scar tissue by numerous vascular adhesions. The attempt to reach the ureter at this point was therefore abandoned and it was sought out at the pelvic brim, where it was readily found after lifting up the caput coli and incising the peritoneum and pushing aside the fat. It was then traced from the point where it crosses the common iliac artery down to the pelvic floor, exposing the whole length of the pelvic portion by splitting the peritoneum over its upper surface. The anterior portion was involved in the inflammatory material surrounding the scar, which bled so freely that no attempt was made to dissect it out. Four centimeters of the lower end of the ureter lying directly behind the scar tissue were dissected loose and the ureter lifted up from its bed and divided close to the scar, sacrificing as little as possible of its length.

I now found that although I had cut the ureter to the best advantage possible

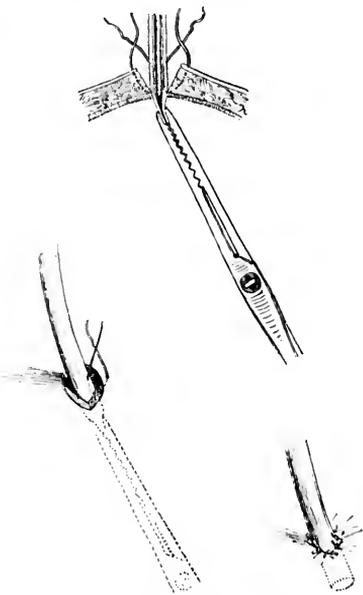

FIG. 261. URETERO-CYSTOSTOMY.

Showing in the upper figure the end of the ureter drawn through the opening made into the bladder by a pair of forceps passed through the urethra. The middle figure shows one of the sutures introduced, holding the ureter in place. The lower figure shows the ureter secured in the bladder by sutures, deep and superficial on all sides.

under the circumstances, I could not do more than merely bring it into contact with the bladder by pulling on it. It was evident that if I were to suture it to the bladder, exercising this degree of traction, it would pull loose soon after the operation, leaving a uretero-abdominal instead of a uretero-vaginal fistula to deal with.

I was able to cope successfully with this formidable difficulty in the following manner: The bladder was dissected free from its attachments to the horizontal rami of the pubis on both sides, with scissors and fingers, and dropped down into the pelvis so as to extend it and carry it more into the back part of the pelvis, gaining at least 3 centimeters in this way. By this means the ureter and the bladder were now easily approximated without strain. I then made a small incision through the bladder wall, which was covered with fat at least a centimeter thick, at the point on the right side nearest the ureteral end drawn straight across the pelvis. This incision passed through the peritoneum and was not more than 3 or 4 millimeters in length, and just large enough to receive the ureter snugly.

I then slit up the under surface of the ureter for about 4 millimeters, enlarging the caliber of its orifice to avoid a stricture, and with a pair of long delicate forceps introduced through the urethra, the bladder, and through the incision, I caught the ureteral end and drew it into the bladder and held it there while it was being attached to the bladder wall by about six fine interrupted silk sutures passed through the muscular tissue of the bladder and the peritoneal and muscular coats of the ureter on all sides, beginning with the under side.

The ureter thus dissected out of its bed, and attached to the bladder, was stretched like a lax cord from the posterior part of the pelvis to the bladder, which lay gibbons and flattened out on the pelvic floor.

The abdominal incision was closed down to its lower angle, where a narrow gauze drain was inserted for fear of leakage. Care was taken in closing the incision not to draw together the peritoneum underlying its lower end, to avoid raising the bladder and indirectly pulling upon the ureter. No leakage occurred and the drain was removed, and the wound healed without suppuration. Her urinary difficulties were immediately and completely relieved with the perfect restoration of continence.

At a subsequent cystoscopic examination I discovered the abnormally placed ureteral orifice opening into the posterior hemisphere of the bladder into which it freely discharged its urine.

This case is one of especial interest for the following reasons:

I was able to determine on which side the injury had been sustained by sounding the ureter in the knee-breast position with the bladder distended with air. I was enabled, by a simple but delicate plastic procedure, to secure at once a perfect restoration of function without sacrificing any such important structure as a kidney. (*See J. H. H. Bull.*, February, 1895.)

The only case I know of in which a double ureter has been accidentally divided in the course of an operation, and then anastomosed into the bladder, was reported to me by Dr. Anna M. Fullerton.

"On March 10, 1897, the patient, R. L., thirty-six years old, the mother of six children, entered the Woman's Hospital, of Philadelphia, for a double pyosalpinx with ovarian abscesses. She had been ill and confined to bed for three months before admission to the hospital.

"At the operation the uterine appendages alone were removed; the uterus, not being especially enlarged, was allowed to remain, because the patient was not in fit condition for a prolonged operation. Dense adhesions existed; on the right side the adhesions were so firm that some of them required to be cut. Enucleation of the appendages was very difficult; a band passing across the pelvis a little below the brim was firmly adherent to the broad ligament a little below the uterine tube and at the junction of its middle and outer third. Not thinking of its being the ureter in that location, I severed it with scissors close to its attachment to the broad ligament. Upon doing this I found I had severed two canals covered with peritonemum and lying side by side imbedded in a common sheath of connective tissue. Each was the size of a normal ureter. No blood or fluid appeared to escape from the canals at any time. A sound was passed down through each canal to the bladder, and struck upon a catheter placed in the bladder. Similarly a long sound was passed upward through the superior pair of orifices, and passed several inches toward the kidney, proving the condition to be one of double ureter traversing the pelvis at a much higher point than normal, and thence passing between the folds of the broad ligament to the point of attachment to the bladder. The vesical ends of the ureters being ligated, the portion communicating with the kidneys was drawn down, and the two orifices introduced into the bladder by a common opening made in the superior portion of the organ a little to the right. The patient made a perfect convalescence, and was discharged, April 18th, in good health."

Extra-peritoneal Uretero-cystostomy.—O. Witzel, of Bonn (*Centralbl. f. Gyn.*, 1896, No. 11), has devised a plan for the anastomosis of the ureter into the bladder by bringing the ureter under the peritonemum in a new direction, so as to shorten its course. In addition to this, the bladder was detached and drawn out in the manner just described. The patient had ureterovaginal fistula operated on in vain by the vagina. The abdomen was opened, and the thickened ureter found at the pelvic brim and traced downward, and divided at about the middle of the broad ligament. The lower end was closed by sutures and dropped, while the upper end was brought to the upper part of the incision at the brim of the pelvis, and drawn down beneath the peritonemum above the innominate line by a pair of long forceps started upward under the peritonemum to the right of the bladder.

The incisions in the pelvic peritonemum and the peritonemum in the median line of the abdomen were now closed, and the remainder of the operation conducted extraperitoneally.

The bladder was now pulled up on the right side until it reached more than 4 centimeters ( $1\frac{1}{2}$  inch) beyond the end of the ureter, where it was attached by some stout catgut sutures.

The ureter was then transplanted into the bladder by forming an oblique

channel; the end of the ureter was cut off obliquely, and its mucous coat attached by fine catgut to the mucosa of the bladder, exposed through a small opening made over the end of a pair of forceps introduced through the urethra. Another row of catgut sutures outside of this attached the ureteral walls firmly to the vesical walls.

The oblique channel was then formed by miting the bladder walls over the ureter on both sides. A drain was put in through a separate opening in the bladder, and the bladder was drained for four days.

The patient made a perfect recovery.

Nephrectomy, removing the kidney corresponding to the fistulous ureter, must be performed when the kidney is extensively diseased and the seat of suppurative septic affection. An attempt should be made, however, to save the kidney by washing the renal pelvis to cure any existing pyelitis, after the manner described in the treatment of pyelonephrosis.

G. Simon, of Heidelberg (*Chir. der Nieren*, 1871), first extirpated the kidney for uretero-abdominal and uretero-vaginal fistulae.

Schede (*Münc. med. Wochenschr.*, 1888, p. 512) extirpated the kidney in a case of uretero-uterine fistula after several plastic operations had failed.

Ureterostomy.—When the ureter is cut off in the course of an abdominal operation, and the upper end can not be grafted into the lower (uretero-ureterostomy), the only alternatives left are either to bring the ureter out onto the skin surface and to let it discharge there, or to extirpate the kidney of that side.

The plan usually adopted has been to bring the ureter out onto the surface of the abdomen in the incision in the median line. I have the report of such a case furnished by Dr. C. P. Noble, of Philadelphia.

The patient, thirty years old, had an extra-uterine pregnancy, requiring the removal of both tubes and ovaries together with the uterus. She had a pulse rate of 160, and was so prostrated toward the end of the operation, when the right ureter was found cut off above the brim of the pelvis, that the only thing to be done was to get through as soon as possible by closing the incision and sewing the ureter into it. The patient has recovered with a urinary fistula. Although ureteral catheters were kept in this ureter for more than six days, there was no infection, or fever, or chill.

I am indebted to Dr. Noble also for a remarkable case in which he assisted at the operation.

The patient, a German woman fifty-eight years old, had a papillary tumor of the ovary, forming a large mass filling the pelvis and the lower abdomen. At the operation the abdomen was opened and 2,500 cubic centimeters of fluid withdrawn from a cyst, whose wall was found densely adherent and continuous, with an extensive cancerous involvement of all the pelvic organs. The cyst was peeled out of the left broad ligament and tied off and removed. The left ureter was then found divided, but the patient was in such a bad condition that it was deemed inadvisable to prolong the operation, and the end of the ureter was brought out in the abdominal incision, which was closed. A flexible catheter was put into the ureter to conduct the urine away from the wound, but no

urine ever flowed from that side, showing that the kidney was completely atrophied.

**Ureterotomy.**—Ureterotomy, or incision into the ureter (see *Johns Hopkins Hospital Bulletin*, Dec., 1894, p. 137), is practiced either for the removal of a foreign body from the ureter, or in order to pass a bougie into its lumen, with a view to ascertaining whether or not it is patulous.

The alternative of a ureterotomy is a cystotomy or incision opening the bladder and exposing the ureteral orifice, which can then be catheterized.

The method of performing ureterotomy is to expose the ureter by making an incision into the peritoneum 3 centimeters long, preferably near the pelvic brim, where it is easiest to pick up and to handle the ureter, and then lifting it up a little out of its bed, to incise it longitudinally, cutting through its muscular coat and exposing and cutting the mucosa also, taking care not to injure its opposite wall. The delicate tortuous ureteral artery must also be carefully avoided. The incision should not be longer than 5 to 6 millimeters.

It is closed with three or four interrupted sutures of fine silk passed with a delicate needle, including the muscular coats and leaving out the mucosa.

After neatly approximating the edges in this way, the ureter should be watched until two or three peristaltic waves of urine have passed down, to make sure that there is no leakage.

I have performed ureterotomy in one case to remove a foreign body (J. D. S., 4038, Dec. 27, 1895). It was an abdominal hysterectomy for cancer of the cervix, and hard-rubber bougies had been introduced into both ureters before the operation, in order to keep them perfectly distinct throughout. The result of the manipulation during the emeclation was that the right bougie broke off about 10 centimeters (4 inches) behind its vesical orifice. I could not work the upper part of the bougie down into the bladder without injuring the mucosa with its sharp edge, so I lifted the ureter up and made the upper end prominent, and cut a hole in it just large enough to draw the broken bougie through. The little opening, 3 millimeters long, was closed with two interrupted silk sutures penetrating the muscularis, and it healed without a fistula remaining.

I have also cut into the ureter four times, at a point varying from 3 to 4 centimeters below the brim of the pelvis, for diagnostic purposes. The incision was made in each case with a view of determining whether the ureter was included in a ligature in the broad ligament.

In none of these cases had a bougie been placed in the ureter before the operation, so that the exact relation of the ureter to the cervix was a matter of doubt. After placing numerous ligatures close to the cervix to control oozing veins, the ureter was traced into close proximity to the ligated masses, in a case of hysteromyomectomy, one of hysterosalpingo-oöphorectomy for pelvic inflammatory disease with dense adhesions, and in two cases of panhysterectomy for carcinoma uteri.

In two cases after opening the ureter the bougie stopped short at the ligatured area, and the ureter had to be freed by cutting the ligatures. Although

the ligatures were tightly tied, the ureter appeared to have suffered no harm from its brief constriction.

The little longitudinal incision in the ureter was closed with fine silk mattress sutures in two cases, and with interrupted sutures in the other two cases, each suture including the muscular coat. If mattress sutures are used, it is important to make the loop a narrow one, so as not to pucker the delicate ureter.



FIG. 262.—URETERO-URETERAL ANASTOMOSIS.

Showing the ureter divided and the lower end tied and split on one side, ready to receive the upper end which is drawn down into it by two traction ligatures. The operation was done on the right side after division of the ureter in a hysteromyomectomy. Recovery.

**Uretero-ureterostomy.**—Uretero-ureterostomy is the anastomosis of the upper end into the lower end of a divided ureter as a means of re-establishing its lumen.

The plan of implanting the upper end of a cut ureter into the side of the lower end was devised and successfully practiced on the dog by Weller Van Hook, of Chicago (*Jour. of the Amer. Med. Assoc.*, vol. xxx, March 4, 1893), and utilized by me in the human being May 1, 1893 (*Annals of Surgery*, Jan., 1894, p. 70).

The patient was a negress (F. M., 1946) with a large myomatous uterus filling the lower two thirds of the abdomen, and lifting the right ureter high out of the pelvis.

The ureter, exposed for 7 centimeters of its length on the anterior surface of an intraligamentary myoma 18 centimeters (7 inches) in diameter, looked like a large whitish, flat vein; it disappeared from sight at the cornu uteri among a number of other vessels. I took it for a vein, and doubly ligated and cut it in two, but a sound passed down into the bladder and another up to the kidney, after cutting the ligatures, at once demonstrated the error. After removing the



FIG. 263. — URETERO-URETERAL ANASTOMOSIS,

Showing the ureter held in place by the traction ligatures which have now been tied. The five untied sutures unite the entering ureter to the cut edges of the intussusceptent ureter.

uters down to the vaginal cervix, and closing the cervical stump, I anastomosed the upper end of the ureter into the lower in the following manner:

The lower end was tied with a silk ligature close to its cut extremity, and then a slit about 1 centimeter long was made lengthwise in the ureter just below this. The upper end was cut obliquely to avoid too great a contraction of its orifice, and was drawn down by means of a fine silk traction suture snugly into the slit, so as to project into the lower end, where it was held by fine silk interrupted sutures, each one of which grasped the edge of the cut and the wall of the intussuscepted end as shown in the figures.

The peritoneum should be drawn over the whole area of bared pelvic connective tissue, and the abdomen closed without a drain, such as was used in this

first case. There was no leakage, and the patient recovered and is now in good health, over three years after the operation.

A sketch and a diagram are also shown of a similar operation performed upon the dog by Dr. Bloodgood at the Johns Hopkins Hospital. (See Fig. 261.) See also important papers by Bache Emmet, *Amer. Jour. of Obs.*, April, 1897, and J. W. Bovee, *Annals of Surgery*, January, 1897.

**Nephro-ureterectomy.**—Nephro-ureterectomy, the extirpation of a kidney with its ureter, is indicated when there is a tuberclosis localized in one kidney and ureter, or when there is other extensive inflammatory disease of the kidney associated with such alterations in the ureteral coats as renders the recovery of the ureter after extirpation of the kidney improbable.

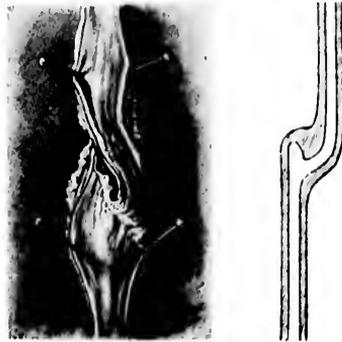

FIG. 261.—EXPERIMENTAL URETERO-URETERAL ANASTOMOSIS IN A DOG.

The ureter is laid open and its lumen exposed by four pins. The direction of the lumen and the little diverticulum above the anastomosis are shown in the right-hand figure. Actual size. Operation by Dr. J. Bloodgood.

The kidney and ureter may be removed by one or by two steps; by the first plan the kidney is separated from its connections, and the ureter is taken out immediately afterward; by the second plan the kidney is removed, and at some subsequent date its ureter, which has proved troublesome, is removed also (ureterectomy); such an operation as the last was performed on a man by Reynier, and reported at the Surgical Society of Paris (*Sem. méd.*, vol. i, No. 8, Feb. 24, 1893); his patient was twenty years old, and had a uretero-pyelo-

lonephritis, for which the right kidney was removed. He continued to suffer so much with the same side that five inches of the upper end of the ureter was removed by extending the lumbar incision, and, as he still did not improve, an unsuccessful effort was made to reach the pelvic end by a pararectal incision. At a later date the last five inches of the ureter were removed through a suprapubic incision parallel to the inguinal canal, and the patient then made a complete recovery.

The better plan is to remove both kidney and ureter together. This operation is more formidable and more time-consuming than a nephrectomy, and for this reason the indications for its performance must be well established. By this I mean:

- (a) The disease must be sufficiently advanced on one side to demand nephrectomy.
- (b) The opposite side must be either sound, or so near sound as to be capable of supporting life by itself.
- (c) The ureter of the diseased side must also be affected in the same manner as the kidney, either by a tubercular ureteritis or a pyo-ureteritis, or by a calculous ureteritis.

Unless much caution is exercised, the operator will often be tempted to proceed to this more formidable operation upon a false indication. For example, out of three cases which I have treated in this way (nephro-ureterectomy), all tubercular, the first had an extensive ureteritis, and the kidney was removed with its ureter down to the floor of the pelvis, but in the other two cases, although the kidneys were extensively diseased, tubercle bacilli were demonstrated, and one ureter appeared thickened and tender to vaginal touch, with a marked mammillated, inflamed area about its vesical orifices; yet, in spite of all these indications, only a slight inflammatory thickening was found on removal, insufficient to justify this part of the operation.

It is clear from this that an irritation or a slight inflammatory thickening may be excited throughout the ureteral tract by a tuberculous kidney, and that this will disappear of itself when the kidney is removed.

I would therefore make these distinctions: The ureter must not be removed with the kidney simply because it feels thickened and tender and its vesical orifice is inflamed, but it must be removed when it forms a large, hard, somewhat gristly, irregularly nodular, exquisitely tender mass, which, as a rule, is strictured and dilated in different portions.

The first case, removed transperitoneally, has already been described in a section on tubercular ureteritis. I have operated on two other cases, in each

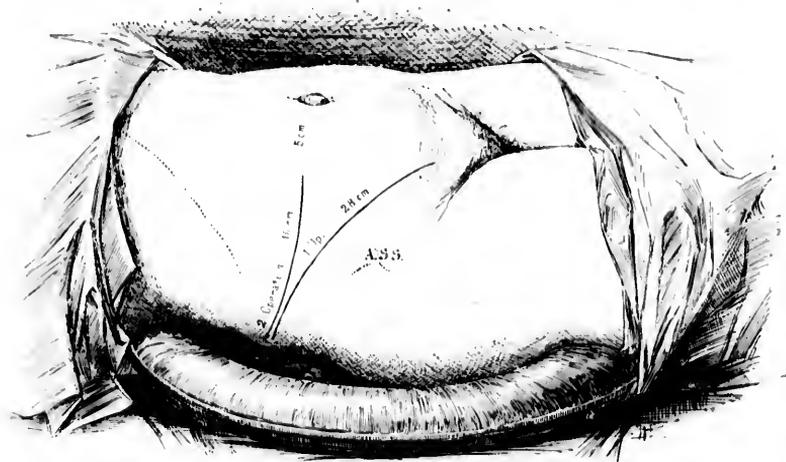

FIG. 265. SHOWING THE LINES OF INCISION MADE IN THE TWO CASES OF NEPHRO-URETERECTOMY, IN THE FIRST OPERATION 25 CENTIMETERS LONG, AND IN THE SECOND OPERATION 28 CENTIMETERS LONG.

one removing the kidney, once the right and once the left, with a ureter all the way down to the vesical end. In the second case I lengthened the lumbar incision down to a point just above the pubic spine, and by detaching the

peritoneum from the iliac fossa and the lateral pelvic wall, succeeded in taking the right ureter out after doubly ligating and cutting the uterine vessels, without tying any other vessels or without opening the peritoneum at any point.



FIG. 266.—TOTAL EXTIRPATION OF A TUBERCULOUS LEFT KIDNEY WITH ITS URETER BY THE LONG INCISION.  $\frac{2}{3}$  NATURAL SIZE. P. DEC. 13, 1895.

Removal of the Right Kidney and Ureter through a Short Lumbar and a Vaginal Incision (see *Johns Hopkins Hospital Bulletin*, Feb., 1896, p. 34).—The plan of operation adopted in this case worked so well that I shall describe it fully.

The patient (K. W., 4012, Dec. 21, 1895) was a large, stout woman, weighing 225 pounds, and thirty years old. She had suffered for two years with attacks of violent pain, beginning in the region of the right kidney and extending around to the front of the abdomen and down into the pelvis. She also suffered from frequent burning micturition. There was some pus in the urine, but she had never passed any blood or a stone. The attacks of pain, which at first were infrequent, finally came on as often as three or four times weekly, beginning under the right shoulder blade. They were so violent that she was wont to throw herself down on the floor screaming.

A urinary analysis, made after catheterizing both ureters, showed that the urine from the right side contained pus while that from the left was free from it, and that the percentage of urea from the right kidney was 2.1, while it was 2.6 from the left kidney. No tubercle bacilli could be found.

**Operation.**—The fat on the abdominal walls was 7 centimeters thick, and the margin of the ribs close to the crest of the ilium.

A transverse incision was made, beginning in front of the quadratus lumborum muscles and extending 16 centimeters across the abdomen in the umbilical line, reaching almost to the right linea semilunaris. Numerous bleeding vessels were clamped and tied with catgut. One large nerve, with vessels accompanying it, was divided between the transversalis and the peritoneum in the posterior part of the wound.

The perirenal fat was freed on all sides of the kidney, completely detached, and brought out of the incision. By drawing it down over the lower lip of the incision the renal vessels were exposed, with the pelvis of the kidney lying beneath them.

An examination was now made to determine, first, whether the kidney was

diseased at all; second, whether a conservative operation could be done; and, third, whether extirpation was necessary.

The capsule of the kidney became almost completely detached in the simple manipulation necessary to bring it out of the incision. The upper and lower portions of the organ looked like a normal kidney substance intensely congested. At the middle there was a zone 3 to 4 centimeters wide where the kidney was greatly thickened. This zone was of a pale color, slightly lobulated, and fluctuated on pressure, showing the presence of considerable fluid within. The peeling off of the capsule disclosed a markedly granular white surface over an area about 2½ centimeters in diameter on the anterior surface near the pelvis. A similar irregular depressed area with numerous white granules was also seen near the lower pole of the kidney, surrounded by tissue apparently healthy. The case was one of tubercular nephritis, limited to the right side, as shown by the previous examination of the urine separated from that of the opposite side. The broad affected zone extending entirely through the central portion of the kidney rendered any conservative resection impossible. The renal vessels were therefore clamped in three artery forceps 1 centimeter from the kidney, after freeing them from the surrounding fat. Each of the vessels was tied with a silk ligature cut short. The vein, which was 8 millimeters in diameter when flattened out, slipped from the grasp of its ligature as it sank back



FIG. 297. REMOVAL OF TUBERCULAR KIDNEY AND URETER.

The kidney is brought out of the horizontal incision in the right loin; the vessels are exposed and ready to tie. The ureter is seen behind the vessels.  $\frac{2}{3}$  natural size. First step.

into the abdomen, but forceps at once checked a hemorrhage which would otherwise have been excessive. As it was, there was a free oozing from both ends of the mouth of the large vein, but it was fortunately found and caught by the forceps again deep down in the abundant fat under the ribs, and another ligature placed about it, using a needle and carrier without drawing it up. Two other small actively bleeding vessels were also tied in the perirenal fat.

The kidney and the entire ureter were now removed in the following manner: By pulling on the kidney and ureter, the latter was made tense and so

easily followed and dissected out of its cellular bed, with the index and middle fingers pushing the peritonæum, the ascending colon, and the caput coli to one side, and stripping off the loose cellular tissue surrounding the ureter. This dissection was carried down to the brim of the pelvis, and the common iliac artery could be felt with the tips of the fingers over its entire length, with the thumb resting on the surface of the abdomen, the end of the thumb reaching the anterior superior spine.

I now freed the ureter down to its vaginal portion by introducing the entire hand and part of the forearm into the cellular tissue, at first between the



FIG. 265. REMOVAL OF THE KIDNEY AND URETER, SHOWING THE FACILITY WITH WHICH THE URETER CAN BE PALPATED AND FEELT ALL THE WAY DOWN TO THE COMMON ILIAC ARTERY WITHOUT INTRODUCING THE ENTIRE HAND INTO THE TRANSVERSE INCISION. SECOND STEP.

peritonæum and the abdominal wall, then under the peritonæum of the false pelvis, and finally between the peritonæum and the walls of the true pelvis. This blunt dissection with the fingers was facilitated by pulling on the kidney and making the ureter tense. In this way I freed it and followed it forward to the broad ligament. At this point considerable resistance was felt, and the ure-

ter appeared to the touch to pass through a hole with a sharp border in its upper part. Above this I distinctly felt the uterine artery pulsating.



FIG. 269. SHOWING THE METHOD OF REMOVING THE LOWER END OF THE URETER THROUGH THE VAGINAL VAULT.

The upper hand introduced through the horizontal incision holds the ureter and lifts up the uterine artery, while the vaginal vault is opened by a pair of sharp-pointed scissors to allow the ureter to be drawn through. Third step.

At this juncture the ureter broke, about 6 centimeters from the kidney; the lower end was at once caught in forceps and held, while by dint of pushing and

working in my finger I succeeded in freeing about two centimeters more of the ureter. Before doing this, however, I put a stout silk ligature over the abdominal end of the ureter, and by means of one hand in the pelvis and the other holding the long outside end of the ureter I succeeded in tying a knot about it, just behind the broad ligament; then with a long pair of scissors introduced through the abdominal incision and controlled by the hand introduced into the pelvis in the same way, the ureter was cut off half a centimeter above the ligature, after taking care to milk back any of its contents and to keep the upper end tight squeezed until it was removed.

The vagina was now thoroughly disinfected, and, with the patient still lying on her left side, I passed two fingers of my right hand up to the vaginal vault, and with my left hand introduced into the pelvis through the abdominal incision, I brought both hands together with nothing but the vaginal tissue between them. I now made an opening in the vaginal vault and brought the end of the ureter through it and clamped it in a pair of forceps, until the abdominal wound was closed, when the vaginal end was removed also.

This opening was made in the following manner: I passed my entire left hand through the abdominal wound down into the pelvis and pressed the index and middle fingers against the right vaginal fornix, at the same time lifting up the uterine artery on the index finger so as to avoid any danger of cutting it; the end of the ureter lay between these fingers. The index and middle fingers of the right hand were now introduced into the vagina (the patient was lying in the left lateral posture) and pressed up against the fingers of the left hand in the abdomen, the palmar surfaces of both hands being turned upward. The opening in the vault necessary to draw the end of the ureter into the vagina was now made by the assistant, who introduced a pair of sharp-pointed scissors along my fingers up to the vaginal vault and pushed them through the thin septum, guided by my instructions; he then spread the blades of the scissors and withdrew them, in this way enlarging the hole in the vault to about 2 centimeters. The opening was situated about 2 centimeters to the right of the cervix. The bleeding from this torn wound was venous and slight. With a pair of forceps pushed through this vaginal opening, the ligature attached to the end of the ureter was now caught, and the ureter drawn through the vagina and held there by forceps while the abdominal wound was being closed.

**Closure of the Abdominal Incision.**—The whole wound tract was first irrigated with normal salt solution. Although the bleeding was slight, a drain was put in on account of extensive separation of the cellular tissues and the fear of the accumulation of the products of a serous weeping. The fascia and muscles were brought together by interrupted silver-wire sutures, with a gauze drain in the middle, and the fat and skin were closed by buried and subcuticular cat-gut sutures.

The condition of the patient was excellent, and the pulse as quiet as if no operation had been performed at all. I therefore did not hesitate to put her at once in the lithotomy position and proceed with the extirpation of the remainder of the ureter *per vaginam*. The end of the ureter and the hole in the vault

were exposed by using retractors and catching the right side of the cervix with a bullet forceps and drawing it strongly to the left. By pulling on the forceps holding the ureter it was made tense, while I cut down through the vaginal wall, at first at the side between the anterior and the lateral walls, and then curving the incision forward under the base of the bladder to a point within  $1\frac{1}{2}$  centimeter of the end of the ureter in the bladder. The ureter broke off 3 centi-



FIG. 270. REMOVAL OF THE KIDNEY WITH THE URETER.

The last step, the removal of the lower end of the ureter through the vagina. The ureter has been drawn through the opening made in the vaginal vault. The dotted line indicates the direction of the incision to expose the ureter down to its vesical extremity. Fourth step.

meters below the vaginal vault, and I had some difficulty in finding the short end in the tissue by the sense of touch and in grasping it with the forceps. There was a free venous oozing from the cut vagina below the vault. The ureter broke once more, and this time at its vesical extremity, and as I could not find the end again I closed the wound and stopped the bleeding by introducing

about six catgut sutures, tied tightly. The hole in the vault communicating with extensive cellular area above was left open for an inferior drain, which was now inserted, pushing a piece of iodoform gauze well up into the cavity and leaving its end hanging down in the vagina.

The recovery of this patient proceeded without a single unfavorable symptom, and she is well two years later.

**Pathological Report.**—The specimen consists of the left kidney and ureter. The lower half of the kidney is 6.5 centimeters long, 4 broad, and 5

thick. It is for the most part of a dark-red color, but on its anterior surface presents three pale, slightly elevated areas composed of aggregations of minute yellow tubercles. The remaining portion of the kidney presents a lobulated appearance, and is 6 by 4.5 centimeters in its various diameters. This portion of the kidney is soft and yielding, and on section is found to consist of three or four large caseous abscesses containing thick, creamy, odorless fluid. The lower half of the organ is in most parts normal in appearance, but at one point contains a caseous nodule 1 centimeter in diameter. The pelvis of the kidney is smooth and glistening. The ureter is 19 centimeters in length; in the vicinity of the kidney it is 5 millimeters in diameter, at its vesical end 9 millimeters; it is firm and somewhat rigid.

The walls of the abscesses are composed of typical tuberculous granulation tissue, lined by caseous detritus. The tissue in the vicinity of the tuberculous abscesses is greatly altered.

FIG. 271.—REMOVAL OF KIDNEY AND ENTIRE URETER (NEPHRO-CYSTERECTOMY).

Tubercular zone on surface of kidney. The two lower pieces of the ureter below the ligature were removed through the vaginal vault.  $\frac{1}{2}$  natural size. W. Op. Dec. 21, 1895.

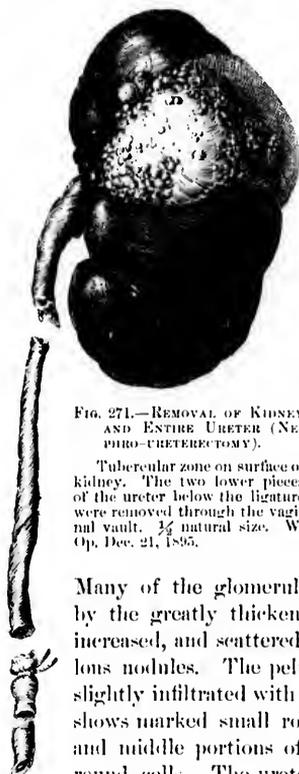

Many of the glomeruli are completely hyaline, others are compressed by the greatly thickened capsule. The connective tissue is markedly increased, and scattered here and there throughout it are young tuberculous nodules. The pelvis of the kidney has an intact surface epithelium slightly infiltrated with small round cells. The stroma beneath, however, shows marked small round-celled infiltration. Sections from the upper and middle portions of the ureter are also slightly infiltrated by small round cells. The ureter in the vicinity of the bladder, although dilated, is little altered. The ureter throughout its course shows no trace of the tuberculous process. Tubercle bacilli were found in the wall of the caseous areas in the kidney.

**Diagnosis.**—Tuberculosis of the kidney.

The diagnoses were made in this and in the second case referred to by symptoms, by palpation, by inspection, and by the analyses of the separated urines.

The patients—all three—presented a history of pain in the side, extending down the course of the ureter and accompanied by frequent painful micturition.

In the first case the renal symptoms were masked by the strangury in the bladder, due to cystitis and some tubercle nodules.

In the second case the intense pain in the left side, and in the third case in the right side, accompanied in both cases by attacks of intense renal colic, pointed toward the chief focus of the disease.

By palpation in all cases the pelvic portion of the ureter was found to be enlarged and thickened, but only in the first case did it show any nodular enlargement. There was also in each case a point of tenderness at the place where the ureter crosses the pelvic brim. It was also shown by palpation that the ureter of the opposite side was normal.

By inspection the bladder was shown to be normal excepting around the orifice of the ureter on the diseased side, where there was a reddened granular, mammillated appearance.

The separated urines showed that the abnormal constituents of the urine came entirely from the side indicated by this appearance in the bladder, and that the opposite side was sound.

Tubercle bacilli were found in the first case after a patient search; in the second case bacilli, undoubtedly tubercle bacilli, were found which had some of the characteristics of the smegma bacillus. In the third case no bacilli were found, and the diagnosis depended upon the history and the physical examination. (See *J. H. H. Bull.*, Feb. and March, 1896.)

## CHAPTER XIV.

### OPERATIONS UPON THE CERVIX OF THE UTERUS, INCLUDING DILATATION AND CURETTAGE.

1. Dilatation.
2. Curettage: 1. Preparation and examination of uterine scrapings. 2. Normal uterine mucosa. 3. Acute endometritis. 4. Chronic endometritis. 5. Decidual endometritis. 6. Mucous polypus. 7. Remnants of abortion. 8. Tuberculosis of the endometrium. 9. Cancer of the body of the uterus. 10. Adeno-carcinoma of the body of the uterus. 11. Sarcoma of the uterus. 12. Curettage for cancer of the cervix: *a.* Epithelioma of the cervix. *b.* Adeno-carcinoma of the cervix.
3. Repair of the lacerated cervix.

#### DILATATION.

THE cervical canal is dilated for the relief of dysmenorrhœa, and for the purpose of removing portions of the endometrium, or the remains of an incomplete abortion, and to overcome sterility.

For dysmenorrhœa, the operation of dilating the cervix does not yet stand upon a scientific basis, as its mode of action is not clear and the results are far from uniform. While a small percentage of cases are cured, and a larger percentage are relieved, still a considerable number are not in the slightest degree benefited. A common cause of failure is a want of care in selecting suitable cases. The general practitioner, and even many specialists, fall into a common error of beginning the treatment of all cases of dysmenorrhœa by a dilatation, without a proper preliminary search for other causes of pain, such as tubal and ovarian disease, pelvic peritonitis, and the presence of small fibroids in the uterine walls. It must not be forgotten that dysmenorrhœa is but a symptom common to a variety of diseases, and to make clear its relation to a variety of pelvic affections which are most apt to escape detection upon a superficial examination, I have analyzed 255 of my cases of pelvic peritonitis with adherent ovaries and tubes, tubercular peritonitis, hydrosalpinx, pyosalpinx, and catarrhal salpingitis, taken consecutively. Of these 255 cases, 185 suffered from dysmenorrhœa, and it was absent in but 70 cases; therefore, from this analysis it would appear that 72 per cent of pelvic inflammatory cases present dysmenorrhœa merely as a complication.

In spite of failure, even in many of the well-selected cases, the relief and the occasional cures effected make dilatation one of the most important, and often one of the most satisfactory, of all the minor gynecological procedures.

The most suitable cases for dilatation are those in which the pain is spasmodic, begins with the flow, and is most intense during the first day or two.

Operation.—Dilators of the Goodell-Ellinger pattern, of three sizes, are needed; the smallest, having smooth blades, is 4 millimeters in diameter, and the

two larger 5 and 6 millimeters in diameter, respectively, both corrugated, as recommended by the late Dr. William Goodell. My own dilators have a spring between the handles, but are not provided with ratchet or screw. The handles are bent at an angle and made large enough to be grasped in the full hand; the dilating end is blunt and but slightly curved (Fig. 273). Light instruments with a strong curve and a tapering point are dangerous and must be avoided.

Slow dilatation by means of sponge or tupelo tents, formerly so much used, has, by common consent, been generally abandoned on account of the great danger of septic infection. The uteri, which need dilatation and curettage, are often already infected, and the use of a hard foreign body, which bruises and lacerates the tissue and makes a constantly increasing firm pressure, seems to offer just those conditions which are most favorable to the rapid introduction of pathogenic organisms into the system. In many instances the patient survives such a treatment with a chronic pelvic inflammation. Two such cases have come under my notice recently; one lady, a prominent member of society, died, and the other would have died if she had not been promptly relieved by skillful surgery.

The first case was examined by my assistant, Dr. T. S. Cullen (*Johns Hopk. Rep.*, vol. vi, Path. No. 869). Criminal abortion had been induced in the fourth month of pregnancy and the patient died of a septic peritonitis in sixteen days. At the autopsy the peritoneum contained several quarts of purulent fluid, and the enlarged soft uterus was removed. On section its walls were found to contain numerous small abscesses; the alcoholic specimen measured 13 by 9 by 6 centimeters, and its cavity was 9 centimeters long and contained six pieces of wood (parts of an elm tent), which, united, formed a perfect cone with a hole perforating its base. The uterine walls were extensively necrotic, and coeci were found everywhere in the vessels and in the thick sheet of fibrin which covered the uterus.

In another case, the physician in attempting to induce an abortion, thrust a wooden tent through the posterior wall of the uterus into the peritoneal cavity; the tent entered the uterine wall at its junction with the cervix, and transfixed it obliquely, emerging through the peritoneal surface near the fundus. The patient was brought to Dr. W. E. Ashton, of Philadelphia, who opened the abdomen (March, 1889) and removed the uterus, tubes, and ovaries. The patient recovered.

The antiseptic preparations for dilatation and curetting consist in a thorough preliminary cleansing of the vagina, as described in Chapter VIII.

I always precede dilatation and curetting by a careful bimanual examination to determine the condition of the

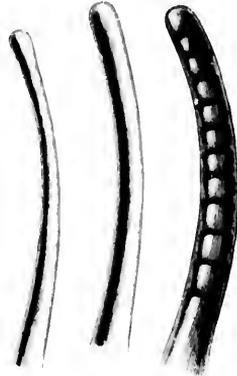

FIG. 272. THE DILATING ENDS OF THE TUBULE SIZES OF THE ELLINGER AND GOODELL DILATORS, SHOWING THE SLIGHT CURVE AND RELATIVE SIZES. ORDINARY SIZE.

organs and the exact position of the uterus. If the direction of the uterine canal is known it aids greatly the introduction of the uterine dilator.

In the virgin the index finger must be introduced into the vagina slowly and gently, to avoid injuring the hymen. When the finger touches the cervix a pair of tenaculum forceps is introduced and the cervix firmly grasped by its anterior lip. The finger is now withdrawn and traction made with the forceps until the os uteri is seen at the vaginal outlet.

When the orifice is small, or the examining finger large, in order to avoid injuring the hymen the position of the cervix must be determined, without vaginal examination, by a careful rectal palpation; the tenaculum forceps are now introduced into the vagina, and, under the guidance of the rectal finger, the anterior lip of the cervix is cautiously caught and drawn down to the outlet.

In married women and those who have borne children the posterior vaginal wall may readily be retracted by a Sims or Simon speculum, or indeed with two fingers, exposing the cervix, which is grasped with the tenaculum forceps and drawn down.

The smallest dilator is now taken up, poised delicately between the fingers just like a pen, and gently introduced within the external os, and pushed up the canal to the internal os. The dilator must never be grasped with handles braced against the palm of the hand and forced through obstructions. When resistance is encountered, as it commonly is, in passing from the internal os into the uterine cavity, the dilator must be withdrawn a little and gently coaxed up in a slightly different direction, until by repeated efforts, without force, it finally passes the obstruction and slips in.

I have seen a death result from neglect of this precaution and the use of a sharp dilator (see *Amer. Jour. Obs.*, Jan., 1891). The surgeon pierced the posterior wall of the anteфлекted uterus at its cervical junction, and tore a wide hole into the peritoneum. He then inserted a coarse sponge tent into the cervix, which projected partly within the peritoneal cavity. The patient died in a few days of peritonitis, in spite of an effort which I made to save her by opening and draining the abdomen. The risk of perforating an anteфлекted uterus in this way is so manifest that I can not escape the conviction that such an accident has happened more frequently.

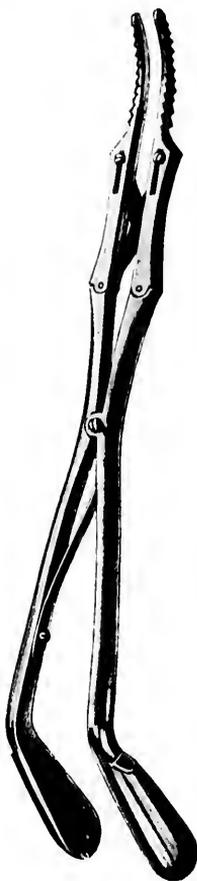

FIG. 273.—GOODELL-ELLINGER DILATOR, WITH SPRING BETWEEN THE HANDLES, BUT WITHOUT A RATCHET.

The corrugations on the blades prevent slipping during the dilatation.  $\frac{1}{2}$  ordinary size.

With the blades of the instrument well introduced, I dilate the canal first in one direction, then relaxing the pressure, the blades close and I rotate the dilator a little, gently dilating another portion, and so on, continuing all around the circle back to the first point. The cervix, yielding to these repeated gentle impacts from within on all sides, gradually and equably dilates to the necessary degree without laceration. In this way in a minute or two the canal opens

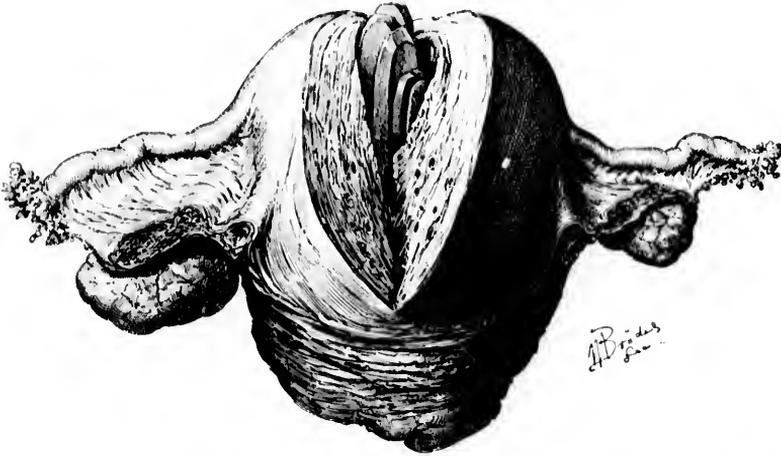

FIG. 271. CRIMINAL ABORTION, WITH SEPARATED FETAL MEMBRANE STILL PARTIALLY PERFORATING THE UTERINE WALL. SEPTICAEMIA AND DEATH. SPECIMEN REMOVED AT AUTOPSY.

up enough to admit a larger corrugated dilator, with which the dilatation is continued in like manner from side to side, antero-posteriorly and at all points between. This extent of dilatation, large enough to allow the introduction of a bougie 1 centimeter in diameter, is usually sufficient for the relief of dysmenorrhoea or for curettage. A somewhat greater dilatation may be secured by using the largest-sized dilator, but not without risk of too great injury to the cervix. It is unjustifiable to attempt to dilate a cervical canal sufficiently to permit the introduction of the index finger into the uterine cavity, for such a degree of dilatation can only be effected by extensive rupture of the cervix.

Such a method of dilating, by repeated impacts on the cervical canal from all directions, is far better than the common method of opening a dilator controlled by a ratchet or screw, and expending all the force in one direction, until the cervical fibers split and a tear is produced. The objections to this method are the damage done the cervix, the greater danger of septic infection, and the scar left when the rent heals, with the possibility of a carcinoma.

While the operation of dilatation and curettage is usually considered a safe procedure, and is followed by little or no mortality, it may have decided dangers which must be considered.

Normally, the uterine wall is firm and resistant, and even marked pressure made upon it by the sharp curette would not be sufficient to perforate its wall; but occasionally the muscular tissue is thin and friable, and even the slightest pressure suffices to cause a rupture. This is especially liable to occur in curettage after abortion or in septic cases. I have known of three deaths occurring in young women from peritonitis produced by perforation with a curette, and several dreadful accidents have been recorded.

In a case of tuberculosis of the uterus, occurring in my service at the Johns Hopkins Hospital, the cervix was ruptured by the dilator laterally into the

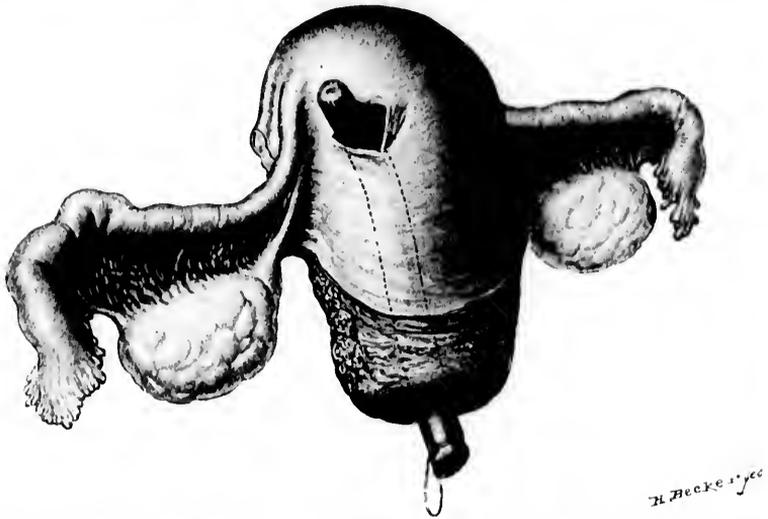

FIG. 275. UTERUS PERFORATED BY A TUPALO TEST. PERITONITIS, HYSTERO-SALPINGO-OOPHORECTOMY RECOVERY. OP. BY DR. W. E. ASHTON.

broad ligament and then into the peritoneum, so that a portion of the omentum escaped through the opening. The cervix had been but moderately dilated, when, on starting to curette, the tip of the omentum was seen projecting from the cervix, at once revealing the character of the accident. Abdominal section was at once performed, the prolapsed omentum withdrawn, and the opening into the broad ligament sutured. An unsuspected general tuberculous of the peritoneum, with tuberculous appendages, was then discovered. The appendages were removed, and the patient made a good recovery. In this case the uterus was thin and softened by the tuberculous process.

In case of perforation of the fundus by the curette, there are two plans of treatment feasible—either to pack the uterine cavity with gauze and allow the opening to close of itself, or to open the abdomen and suture the rent with cat-gut. Unless the rupture is extensive, I advise the former course; if there is any escape of bowel or omentum it will be safest to do a celiotomy.

Perforation of the fundus with a uterine sound has occurred six times in my personal experience without any serious trouble following the accident, but death from peritonitis followed in a case in the hands of one of my assistants.

In a case seen by Dr. M. D. Mum, of Buffalo (*Amer. Jour. of Obs.*, 1895, p. 603), a young practitioner forcibly dilated the cervix in order to remove the ovum in an early abortion which the patient had induced by means of a catheter. In using a sharp curette and his finger, after clearing out the ovum, he caught hold of and tore a loop of the intestine. Dr. Mum was called in within an hour and a half, opened the abdomen, and found a hole in the center of the fundus of the uterus large enough to admit the finger; the ileum was divided close to the ileo-cecal valve, and was separated from its mesentery fully six inches; the head of the colon was bruised and infiltrated, and the abdomen contained some blood and feces. The patient recovered after the closure of the hole in the uterus, and the inversion of the head of the colon, followed by the removal of the detached bowel and the making of a new ileo-colic anastomosis with a Murphy button.

Dr. J. B. Harvie, of Troy, N. Y., had personal cognizance of a case in which, after dilating the uterus, a young practitioner passed in a pair of forceps to catch the ovum and drew out and cut off six feet of bowel (!) without realizing what he had done.

In a similar case of extensive intestinal injury following the perforation of the uterus with a curette, Dr. C. P. Noble, of Philadelphia, opened the abdomen and resected three feet of the small intestine successfully.

#### CURETTAGE.

Curettes are used to remove the superficial portions of the uterine mucosa in endometritis; to secure bits of tissue for diagnostic purposes in suspected cancer of the body; to remove portions of an ovum incompletely cast off; and to clean out the broken-down tissue of a cancerous cervix where the disease has progressed beyond hope of a radical cure. Sharp curettes, handled with extreme delicacy, are most serviceable; the blunt curettes often advocated are but insufficient substitutes.

A careful microscopical study of the tissue should follow the removal by the curette in every case, and the following conditions should be looked for:

- Normal uterine mucosa.
- Acute endometritis.
- Chronic endometritis.
- Endometritis decidualis.
- Mucous polypi.
- Remnants of abortion.
- Taberculosis of the endometrium.
- Carcinoma of the body of the uterus.
- Sarcoma of the uterus.
- Cancer of the cervix.

### Preparation and Examination of Uterine Scrapings.

In examining portions of the endometrium I use the formalin method introduced by my assistant, Dr. T. S. Cullen (*Johns Hopk. Hosp. Bull.*, April, 1895), which obviates the tedious delays of ten days or two weeks incident to older methods of preparation and permits a diagnosis to be made within fifteen minutes—that is to say, while the patient is still under anesthesia; if necessary, a radical operation may then be performed at once.

The procedure is the following:

- (a) Place frozen sections of the fresh tissue in a 5 per cent aqueous solution of formalin for from three to five minutes.
- (b) Immerse in a 50 per cent alcohol solution for three minutes.
- (c) Place in absolute alcohol one minute.
- (d) Wash in water.
- (e) Stain in hematoxylin for two minutes.
- (f) Decolorize in acid alcohol.
- (g) Rinse in water, to which Dr. T. Brown has recently recommended the addition of two or three drops of ammonia, which rapidly brings back the characteristic hematoxylin color.
- (h) Stain with eosin.
- (i) Transfer to 95 per cent alcohol.
- (k) Pass through absolute alcohol, creosote, or oil of cloves, and mount in Canada balsam.

A cylinder of condensed carbonic-acid gas is kept in a room adjoining the operating-room, in order to facilitate the immediate making of the frozen sections, to be passed at once through the routine described.

By securing an early diagnosis in this way the patient is often relieved of the necessity of taking an anesthetic twice, and cases arriving from a distance save from ten days to two weeks of their time in the hospital.

It is easier to cut fine sections after the tissue has been first hardened in the formalin, according to the second plan also recommended by Dr. Cullen, as follows:

The scrapings are placed immediately in a 10 per cent formalin solution, kept in small specimen bottles, always at hand. In two or three hours after they are sufficiently hardened to cut readily, frozen sections are made and left in a 50 per cent alcohol solution three minutes, when the succeeding steps are as described above.

The curetted specimens should be placed in a bottle by themselves and labeled at once, and when the sections are cut no similar open dishes containing sections should be lying about, nor should they be passed through the fluids together with other sections, in order to avoid the terrible mistake of confusing two cases, and so drawing erroneous conclusions. In all my experience of many hundreds of examinations this accident has happened once.

The patient had a uterus of normal size, and was nearly exsanguinated by protracted excessive hemorrhages. I operated upon her for a cancer of the

body of the uterus, diagnosed from curettings. Upon opening the abdomen I found not a cancer, but a small pediculated fibroid tumor, lying in the cervix, which had not been felt during the curettage upon which the diagnosis had been made. It was afterward discovered that the scrapings had been mixed with those from another patient.

**Normal Uterine Mucosa.**—The standard of comparison for all curetted specimens is the normal uterine mucosa; this presents, microscopically, an even surface covered by a single layer of cylindrical ciliated epithelium. The glands are round or oval on cross section, and in a few places may be seen opening on the surface.

They are usually equidistant, and are lined with one layer of cylindrical ciliated epithelium; hence they appear as reduplications of the surface epithelium. An occasional bifurcation is seen in the deeper portion of the gland. In the floor of the gland there is not infrequently a small filike ingrowth. Lying between the glands is found the stroma of the mucosa or so-called lymphoid tissue. The cells, however, are much larger, and on close examination bear no resemblance to lymphoid tissue; the nuclei of the stroma cells are oval, vesicular, and appear to best advantage in specimens hardened in Müller's fluid. The arteries of the stroma are usually found in small bunches; the veins are large and single and thin-walled.

The blood in the veins is separated from the stroma cells by but one layer of endothelium. The line of demarcation between the mucosa and the muscle is usually well defined; occasionally, however, a gland penetrates the muscle for some depth, when it is invariably accompanied by a considerable amount of stroma. This dipping of a gland into the muscularis must not be mistaken for a pathological condition.

**Endometritis.**—Curettage for endometritis follows immediately upon dilatation, and is performed in this way: The sharp perforated spoon curette, poised between thumb and first and second finger, is easily introduced through the dilated canal. The whole inner surface of the uterus over the fundus and from fundus to cervix is now carefully scraped, completely removing the superficial portion of its lining membrane in strips and short pieces. The sound basis is recognized by its greater resistance, and a slight grating sensation communicated to the fingers. The separated lining membrane is expelled through the cervix by a series of intermittent uterine contractions; its discharge may also be assisted by using the curette to scoop it out. The hemorrhage after this operation is never serious enough to call for measures to control it. The patient should be kept abed from three days to a week; it has never been my practice to introduce gauze into the uterine cavity.

Acute endometritis is generally found in acute septic processes involving the entire genital tract, but on account of the predominating symptoms



FIG. 276.—SHARP CURETTE FOR REMOVING THE UTERINE MUCOSA. ORDINARY SIZE.

of the other organs, it is usually overlooked. Under any circumstances it is a rare affection.

The surface epithelial cells are swollen often as much as two or three times their normal size, while the adjacent cells may be compressed. There is also a tendency to cell proliferation, and between the epithelial cells are many polymuclear leucocytes and some small round cells. The glands in the superficial portions show similar changes, a swollen epithelium with some tendency toward proliferation, and a small round-celled and polymorphonuclear infiltration; leucocytes are found partially filling some of the gland lumina. The deeper portions of the glands near the muscle are often normal.

The stroma shows superficially much infiltration, with polymorphonuclear leucocytes and small round cells, the infiltration diminishing toward the muscle. Alterations are rarely made out in the muscular tissue beneath.

Chronic endometritis is also rather rare. The prevailing habit of describing all scrapings, particularly because of their abundance in some cases, as examples of endometritis, is greatly to be deplored. It interferes with our getting any satisfactory ideas as to the frequency of the real affection, and tends to encourage unnecessary operating. The so-called "fungoid endometritis" is not a pathological entity at all, and the name ought to be expunged from gynecological works.

Chronic endometritis is oftenest associated with old cases of pyosalpinx; it is rarely ever found in the ordinary scrapings. The slight liability of the uterine mucosa to this affection may be ascribed to two factors: In the first place, the tendency of pus-containing tubes is to complete closure at the uterine end, and so shutting off one a cune of infection, and, in the second place, the form and position of the uterine canal is such as to afford good drainage.

The surface of the mucosa may be rather uneven, and the epithelium stunted, low, cylindrical, or cuboidal. The glands are in places diminished in number, and vary much in size; some of them are narrow superficially and distended below. The epithelium of the dilated glands is somewhat flattened.

The stroma is denser than normal, especially in the superficial portions, its nuclei tend to become spindle-shaped, and there is much small round-cell infiltration. There are practically no polymorphonuclear leucocytes to be seen. The stroma in its deeper portions is often normal, and there are no changes in the muscle.

**Decidual Endometritis.**— This is always found after an abortion in the early months, and is often probably the cause of the abortion.

The decidua shows marked polymorphonuclear infiltration, especially in its superficial portions; the leucocytes are so abundant that the individual decidual cells are separated from one another. Some small round cells usually accompany the infiltration. The deeper portions of the decidua are usually unaltered.

**Mucous Polypi.**—A mucous polyp is a localized outgrowth of the uterine mucosa forming one or more small tumors within its cavity. The tumors do not often attain a size greater than 2 by 3 centimeters. They occur in a variety

of forms, either fingerlike, round and pediculated, pear-shaped, or like a cock's comb with a broad base.

In one of my cases a flattened ovoid polyp 1.5 centimeter long was found lying in the cervical canal and attached to the fundus by a threadlike pedicle 1 millimeter in diameter and between 4 and 5 centimeters long. The velvety appearance of the polyp, with its slight indentations, resembles that of the uterine mucosa; often small cysts, formed by distended glands, can be seen on the surface.

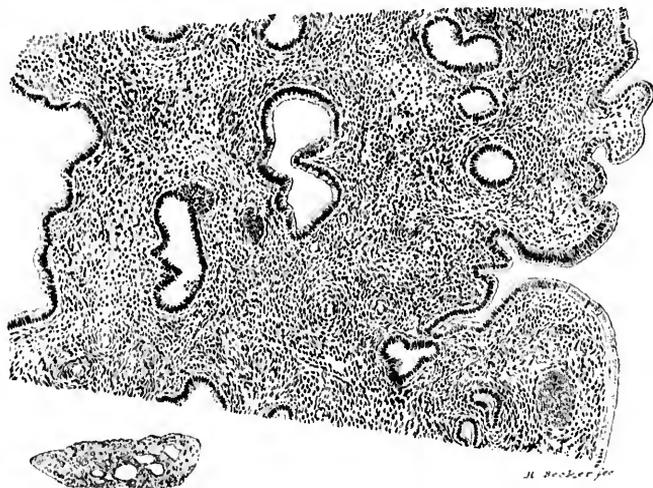

FIG. 277. SECTION OF A GLANDULAR UTERINE POLYP.

The small figure below shows a section of the polyp magnified three times; the larger section above is magnified seventy times. The dilated glandular spaces are seen lying in the connective-tissue stroma. Specimen 682.

They sometimes give rise to protracted hemorrhages, but as a rule they produce no symptoms at all.

Histologically, the epithelium is the same in character as that lining the uterine cavity with which it is directly continuous.

The entire polyp is made up of uterine mucosa, epithelium, glands, and stroma. The glands are mostly normal, but where they are dilated and form small cysts, the epithelium becomes cuboidal and the cavities contain some desquamated epithelial cells. The stroma, especially near the tips, often shows hemorrhage and edema.

In sharp contrast to the usual isolated mucous polyps just described is the rare general excessive hypertrophy of the mucosa, of which a single instance has come under my notice (A. L., 3476, May 7, 1895).

The entire uterine mucosa was thickened to about three times the normal diameter, and appeared everywhere in the form of flattened domelike elevations,

separated from each other by shallow furrows 2 or 3 millimeters in depth; the microscopic appearance was strikingly like that of malignancy. Microscopically, the excessive growth was limited to the glands, which, although normal in number, were increased in size and markedly convoluted. The stroma was normal.

**Remnants of Abortion.**—In curetting to remove a dead ovum or an incomplete miscarriage, the chief danger lies in the readiness with which sepsis may invade the upper genital tract. In cases which are already septic, the avoidance of a general infection and the safety of the patient depend upon the complete removal of the ovum, and the efficient drainage established through the dilated cervix. There is no way by which we can thoroughly disinfect a septic uterus. Cases which are not septic will not become so if the operation is aseptically performed, and the aseptic conditions are maintained afterward. When the flow does not begin to diminish within two days after an abortion, or when the temperature rises three or four degrees, I at once advise curettage. The cervix in these cases is usually soft, and dilatation more easily effected in consequence, and not infrequently the cervix is so open as to need no dilatation at all.

The anterior cervical lip is caught with tenaculum forceps, and a blunt spoon curette introduced and used with gentle force over the whole inner surface of the uterus, loosening and bringing down the membranes which begin to pour out of the os. Undue force must not be used lest the curette perforate the softened uterine wall and pass into the abdominal cavity, exposing the patient to the imminent risk of a septic peritonitis. After loosening the membranes with the curette, a pair of fenestrated placental forceps (see Chap. VI, Fig. 92) is inserted, which brings away the placenta, decidua, and fetus, if not previously expelled, whole or in pieces.

When the canal is large enough, as is usually the case in a miscarriage after the third month of pregnancy, the index finger well sterilized should be introduced and the whole interior of the womb palpated.

Unsuspected pieces of tissue will often be found clinging especially to the placental area. These can be freed by the palmar surface of the finger, assisted by the external hand acting through the abdominal walls, affording a point of resistance. The uterine wall thus bared in places feels almost as thin as paper, and must be gently handled. Where the curetting is difficult and uncertain the entire separation of the remains of the ovum may be thus effected by the finger alone, assisted by the hand making counter pressure through the abdominal walls.

The finger nails must never be used to scrape tissue off from the uterine walls, as such a practice would often introduce sepsis, and if the case was already septic the operator would then be sure to carry the infection away with him to inoculate other patients.

Irrigation of the uterus after curetting is not necessary, unless the contents are septic, when the cavity must be repeatedly washed out with a warm boric-acid solution introduced by means of a curved glass douche nozzle, using the blunt end of the nozzle over the uterine surface to aid in detaching clots and small particles of debris. The uterus may be drained for forty-eight hours by





X 70

#### DESCRIPTION OF PLATE VIII.

Tuberculosis of the endometrium. This is a typical picture of early tuberculous of the endometrium. Above is the normal uterine muscle, on the left side is a dilated gland lined with flattened epithelium, while in the middle of the section and at the lower margin two practically normal glands are seen. Scattered throughout the stroma of the mucosa are typical tubercles, most of which show giant cells. The intervening stroma is the seat of marked small-celled infiltration. There are no caseous areas present.

DESCRIPTION OF PLATE VIII

The tubercles of the endometrium. This is a typical picture of early tubercles of the endometrium. Above is the normal uterine muscle on the left side as a dilated canal lined with flattened epithelial cells in the middle of the section and in the lower margin two perfectly normal glands are seen. Sectioned through the center of the tubercles are typical tubercles most of which show giant cells. The tubercles are in the seat of marked small vessel infiltration. There are no eosinophils present.

packing its cavity loosely with gauze, the ends of which are allowed to hang out of the cervix into the vagina; my own practice, however, is simply to place a loose gauze pack in the vagina, which is renewed every twenty-four hours.

Patients should be kept in bed after enretting for abortion for two weeks or longer, to allow involution of the uterus to take place; cure of the patient is just as important at this time as in the puerperium after a normal labor.

**Microscopic Examination for the Remnants of an Abortion.**—We usually have in these cases the clinical history of a recent miscarriage, and the amount of material removed by curettage is often abundant. As a rule, there is no suggestion as to their source in the microscopic appearance of the tissues; occasionally little villous threads can be seen.

Histologically, the appearance of glandular hypertrophy predominates; the glands are dilated, convoluted, and show little titlike processes springing into their lumina; the epithelium is a little flattened and the stroma of the mucosa shows marked swelling of its cells in the superficial portion, forming typical decidual cells which persist for several weeks after the abortion.

These appearances are suggestive of pregnancy, but a positive diagnosis must rest upon the discovery of villi; these in the early months still show two layers of epithelial covering, the inner of which is made up of cuboidal cells; the outer syncytial layer appears as a ribbon of protoplasm with nuclei distributed through it; this outer layer sends out protoplasmic buds which form the new villi, and in the centers of these buds are found from five to forty nuclei, forming the so-called placental giant cells, because when cut across they present the appearance of a typical giant cell. The interior of a villus is composed of mucoid tissue rich in blood vessels.

In one obscure case nothing was found in the curettings but some glandular hypertrophy, ill-defined decidual cells, and a single free giant cell; this latter structure led to a further searching investigation, which was rewarded by the discovery of villi, confirming the diagnosis of pregnancy.

**Tuberculosis of the Endometrium.**—In the early stages the epithelium of the surface is intact, the glands normal, and the tubercles are found scattered throughout the superficial portions of the stroma, consisting of aggregations of epithelioid cells; later they are surrounded by small round cells, and at a still later date giant cells are found in the center.

The surface epithelium over a superficial nodule is often somewhat flattened and pale. In a marked case the glands are encroached upon, and it is at times almost impossible to distinguish some of the epithelioid cells from the gland epithelium; in other glands, tubercles are seen partly projecting into and obliterating the cavity; again the gland may be filled with caseous material.

In the most advanced cases where the cavity of the uterus is lined by caseous material, the surface is covered by a necrotic material devoid of nuclei, below which lies a zone of typical tuberculous tissue, consisting of epithelioid cells and tubercles; in the deeper portions a stray gland may survive; where the process has gone deep enough to involve the muscle, the glands are often entirely absent.

Bacilli are found with varying frequency, sometimes sparse, sometimes

abundant, and most numerous in the advanced cases with marked caseation; in my experience they are much more readily found than in tuberculous of the tubes.

In the early stages of the disease the tubercular process may be entirely unsuspected, and the curettings may look like normal uterine mucosa; but where the disease is advanced, the presence of soft cheesy masses will at once arouse suspicion. Necrotic carcinomatous tissue may present a somewhat similar appearance, but the characteristic branching is found here and does not occur in tuberculous. In advanced cases the diagnosis may also be reached from an examination of the uterine discharge which contains tubercle bacilli.

On histological examination, the diagnosis of tuberculous is readily established, as the tissues present the usual tubercular picture. Dr. T. S. Cullen (*Johns Hopkins Reports*, vol. iv, p. 91) reports several cases of tuberculous of the endometrium occurring in my wards.

It has happened several times in my experience that the tuberculous has been found in a purely accidental way, as it were, while submitting the uterine scrapings to the routine examination. Again, I have found a tubercular endometrium on curetting the uterus immediately after removing tubercular tubes and ovaries.

Tubercular affections of the endometrium are either miliary, or part of a general tubercular process, or of the chronic diffuse form.

The chronic diffuse tuberculous is that form with which we have to do; it begins, as a rule, near the fundus secondary to a tubercular tube. The first visible alterations are little yellowish-white nodules under the surface, 1 to 2 millimeters in diameter, which may increase in size and numbers, and then coalesce and break down, forming an ulcer with undermined edges. The disease extends from the endometrium down into the uterine muscle.

**Cancer of the Body of the Uterus.**—The curette is used in these cases for two purposes: first, to remove some of the lining membrane of the uterus for diagnosis, and, second, to remove as much of the diseased tissue as possible, so as to check hemorrhage and to clean out septic debris, in order to give the patient a chance to recruit before undertaking the total extirpation. In both instances the use of the curette is simply preparatory to hysterectomy.

The cancerous tissue breaks down readily under the curette, which must be used with unusual care and with gentler force than in endometritis, to avoid perforating the uterine wall in the more extensively infiltrated areas.

As a rule, the whole endometrium is affected, but where the disease is still localized its position may be recognized by the distinct difference in the sense of touch, communicated through the instrument, between the diseased tissue as it breaks down, and the soft sound mucosa with its firm substratum of normal muscle.

Even the macroscopic appearance of the curettings in carcinoma of the body is quite characteristic, and much valuable information may be gleaned from a careful inspection; while the normal uterine mucosa has a comparatively smooth surface and is usually from 1 to 2 millimeters thick, in the carcinoma the surface, if still intact, has a branching or treelike appearance. This may





Fig 1

X 12

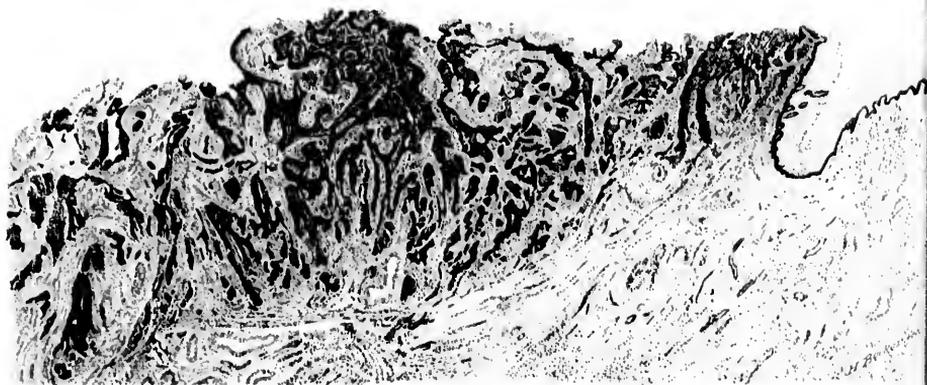

X 3

Fig 2

#### DESCRIPTION OF PLATE IX.

FIG. 1.—Adeno-carcinoma of the body of the uterus ( $\times 12$ ). The section is taken at a right angle to the surface of the uterine mucosa, and the upper border corresponds to the uterine cavity. The thickening of the mucosa is due to the teatlike outgrowths; at the same time there is a growth into the muscle represented by the groups of glands seen in the lower part of the picture. This is an instructive picture, as it shows the early changes, before any necrosis has occurred. Path. No. 559.

FIG. 2.—Epithelioma of the cervix. The normal mucosa, composed of several layers of squamous epithelium, is seen to the right. This ends abruptly and is replaced by masses of epithelium, which penetrate the tissue in all directions. Note the transition of the normal epithelium into that of the new growth, the continuity between the superficial and the deeper portions of the tissue, and the deep stain taken by the carcinomatous cells. The uneven upper surface is due to loss of tissue. Path. No. 169.

DESCRIPTION OF PLATE 12

Fig. 1 - A portion of the body of the mouse (817). The section is taken in a right angle to the surface of the brain removed and the upper part corresponds to the anterior cavity. The thickening of the mucosa is due to the trachea and oesophagus. The same time there is a growth into the nasal region and by the growth of the same seen in the lower part of the figure. There is an infection of the nasal cavity by the same particles before any bacteria has occurred. (Plate 12, Fig. 1)

Fig. 2 - Epithelium of the ovary. The normal mucosa composed of several layers of squamous epithelium is seen to the right. The ends rapidly and is replaced by masses of epithelium which penetrate the tissue in all directions. These the formation of the normal epithelium into that of the new growth. The connection between the superficial and the deeper portions of the tissue and the deep stain in the upper portion cells. The mucosa appears to be in a state of loss of tissue. (Plate 12, Fig. 2)

not at first sight be detected, as the mucus tends to glue the little projections together. Nearly all of these little stems or branches have delicate capillaries in their centers. One of the most striking points is the large amount of the tissue removed, together with the size of the individual pieces. Normally only a drachm or slightly more can be removed; in carcinoma, however, from 4 to 8 drachms may come away, and the individual pieces may reach 1 centimeter or more in thickness and are very friable.

In curetting to check hemorrhage the whole endometrium should be scraped as rapidly as possible down to the firm muscular tissue, as by this means the hemorrhage is less than if the instrument is used slowly and timidly. The use of the curette under these circumstances is followed by a firm vaginal pack of iodoform gauze. Hemorrhage is caused in these cases by the superficial necrosis which opens up the vessels or permits them to rupture easily; it is therefore necessary to get well below this tissue when the vessels cease to bleed by their normal contraction.

Cancer of the body of the uterus is found in two forms—epithelioma, made up of squamous epithelial cells, and adeno-carcinoma; not more than eight cases of the former have been observed.

**Adeno-carcinoma of the Body of the Uterus.**—As stated, abundant scrapings are usually furnished for examination—an amount never found normally.

These often have quite a characteristic appearance even on a microscopic examination; they appear as short, broken, irregular, friable bits of tissue, whitish and waxy in places, with little knoblike projections with coagula between them. Microscopically, the surface has usually disappeared, and the remaining tissue is made up of groups of small and large glands, varying much in appearance; some are lined by one layer of cylindrical epithelium, others by two or three layers, and still others are choked with cells. Large areas of epithelial cells are often found in which the glandular form has almost disappeared, due to an excessive overgrowth of the epithelium in which numerous glands are crowded together.

The stroma between the glands is composed of spindle cells, and shows much small round-celled infiltration.

It is not necessary, as commonly held, to demonstrate a penetration of the muscular layer by the glands in order to make the diagnosis of carcinoma. The diagnosis must rest upon the characteristic appearances above detailed as found in the mucosa alone, and this is fortunate, for the curette rarely penetrates as deep as the muscularis.

**Sarcoma of the Uterus.**—This rare disease is not often found in the uterine scrapings.

In my experience, the round or the round and spindle-celled sarcomata have been found most commonly.

The macroscopic appearances are not characteristic, but microscopically large areas are found composed of round or of spindle cells, many of them containing nuclear figures and an increased amount of chromatin, as evidenced

by the intense staining of the nucleus; there is also an absence of the uterine glands in these areas. Such a picture is strongly suggestive of sarcoma.

Where the superficial tissue is broken down and the muscularis is invaded by the characteristic cells the diagnosis is more certain.

I have operated in a single instance upon a case of sarcoma of the uterus in which the diagnosis had been made by curettage. No enlargement of the uterus could be detected bimanually, but, relying entirely upon the microscopic examination, I performed vaginal hysterectomy, and found a sarcomatous nodule 1 centimeter (0.4 inch) in diameter in the left horn of the fundus projecting into the uterine cavity. The patient recovered, and has had no return of the disease in over four years.

**Cancer of the Cervix.**—Curettage for cancer of the cervix is employed for two purposes: First, to remove the septic, breaking down cancerous material, and leave a clean field for hysterectomy; second, to remove as much of the disease as possible where it has advanced too far for complete extirpation.

Sometimes the uterus is more or less anchored at the vaginal vault by the extension of the disease into one or both broad ligaments. The amount of this infiltration can be better estimated by a rectal than by a vaginal examination. Such cases of cancer of the cervix in which a broad, hard mass is detected on

either side, extending out to the pelvic wall, interfering with the mobility of the uterus, are unsuitable for hysterectomy, and are best treated by thorough curettage. Even those advanced cases with marked cachexia and foul discharges, bedridden and suffering from nausea, will often be much benefited by thorough curettage, which removes the friable, sloughing masses, and leaves in their place a clean, cone-shaped excavation. I have found that the severe pain so often noted in these advanced cases is due to a choked cervix with retention of the discharges, forming a pyometra. Complete relief follows the evacuation of this fluid if the canal is kept open.

The two most efficient forms of curettage are the fingers and a long scoop curette on a stout handle. The friable, redundant portions of the disease are best brought out by vigorously using the end of the index and middle fingers as a curette. It is astonishing how much of the affected tissue can be removed in this way. The scoop curette follows

the fingers and is held firmly, and used boldly and rapidly, breaking down the diseased tissue under the guidance of the index finger, which locates the points to be curetted, and prevents the instrument from advancing too far in the direction of bladder, rectum, or peritoneal cavity.

The limit of the diseased tissue which can be removed in this way is recognized by the scraping sound and sensation, indicating that a hard base has been reached. Less blood is lost by working rapidly down to the healthier tissue than by a slower procedure, which allows the rigid diseased vessels time to bleed.



FIG. 278.—THE SPOON OF THE LONG SHAFT CURETTE FOR REMOVING THE CANCEROUS TISSUE OF THE CERVIX. ORDINARY SIZE.



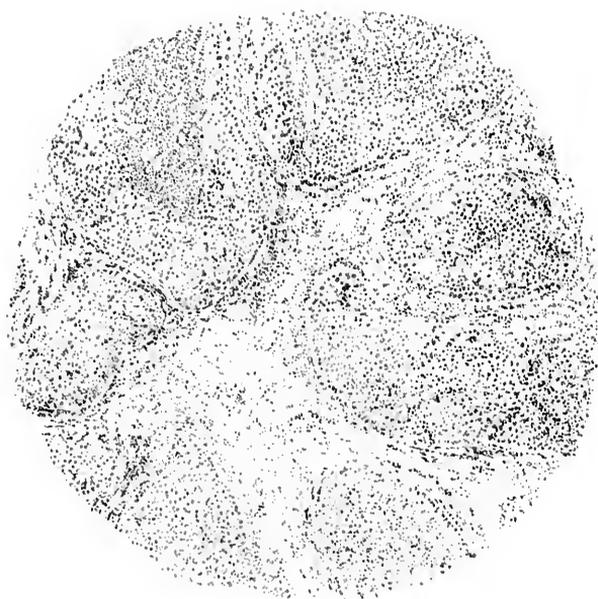

#### DESCRIPTION OF PLATE X.

Epithelioma of the cervix uteri. This specimen was obtained by curettage. It shows a central branching portion, consisting of a stroma with a marked round-celled infiltration, and enclosed in this stroma are epithelial nests composed of groups of polygonal cells. A few dark dots which may be seen in the center of some of these nests are polymorpho-nuclear leucocytes. The central portion of the two upper nests are filled with these leucocytes.

DESCRIPTION OF PLATE X

The specimen was obtained by sectioning the basal part of the embryo. The section was stained with a mixture of a weak *h* and a weak *e* and mounted in cedar oil. The section shows the following features: a large, dark, rounded, and somewhat flattened body, which is the embryo, and a smaller, lighter, and more elongated body, which is the yolk. The embryo is situated in the center of the yolk. The yolk is surrounded by a thin layer of albumen. The section is shown in Plate X, Figure 1.

When the disease has extended so far that the operator feels uncertain whether the next effort will invade bladder, rectum, or peritoneum, it is important to advance more slowly, controlling the curettage by repeated examinations. A finger in the rectum or a sound in the bladder will assist in determining the thickness of the septum. If the peritoneal cavity is accidentally opened, an iodoform gauze tampon should at once be closely packed within the rent and the operation continued until all septic and sloughing masses have been removed down to a clean wound surface. The vagina is now cleansed, the gauze removed, and a fresh pack inserted, projecting a short distance into the pelvic cavity; this is allowed to remain in place for three or four days, when it is removed and a fresh pack inserted, not quite so far up. The excavated area and the vagina must also be loosely filled with an iodoform gauze pack and protected by the vulvar occlusive dressing.

Two forms of cancerous disease are found in the cervix uteri—epithelioma and adeno-carcinoma.

To make a diagnosis in the early stages of carcinoma of the cervix, it is necessary for the clinician to send the pathologist a wedge of the suspicious portion, which should be at least 1 centimeter in depth; this may readily be removed without pain after injecting a few minims of a 4 per cent solution of cocaine deep into the cervical tissue, when two or three catgut sutures may be passed to close in the wound. Where the cervical disease is far advanced the ordinary curettings will be sufficient for the diagnosis.

**Epithelioma.**—The surface of the cervix is covered by several layers of squamous epithelium, which, however, can be seen penetrating the stroma in the form of fingerlike or branching masses of cells; many of these branches when cut transversely or obliquely appear as round, oval, or irregular groups of cells lying deep in the stroma. On other parts of the surface slight elevations are found which consist of a central blood vessel surrounded by little or no stroma and covered externally by numerous layers of squamous epithelium, indicative of an outgrowth of blood vessels and stroma with a disproportionate increase in the epithelial layers.

The cervical glands are usually normal, with the exception that in some cases the squamous epithelium may be found projecting into the lumen of the gland and partly occluding it; in more advanced cases the glands are completely obliterated.

Such a macroscopic appearance affords conclusive evidence of the existence of epithelioma of the cervix.

**Adeno-carcinoma.**—The disease here first manifests itself inside of the cervical canal, and is often invisible upon inspection and beyond the reach of touch even when it has extended out as far as the broad ligament.

The examination by curettage reveals in most cases an absence of the surface epithelium. When the epithelium is intact, there is sometimes a marked proliferation of the cells which form titlike outgrowths, which, developing in excess, form new glands.

The cervical glands are in some places normal, while in others there is an

increase in the epithelium, and the gland, ordinarily lined by one layer, now shows two or three layers of epithelium. Other glands show titlike epithelial excreescences projecting into their cavities which choke the lumen in the obstructions of the disease. The glands appear to run riot in the tissue, interpenetrating the cervix in all directions.

#### REPAIR OF THE LACERATED CERVIX.

Almost all cervixes in parous women show distinct evidence of injury, which take the form of single, bilateral, or stellate lacerations. These lacerations vary in extent all the way from a slight indentation to a deep rent, completely separating anterior and posterior lips and extending far out into the vaginal vault.

The mere fact of the existence of a tear, however deep, by no means constitutes an indication for operation. I constantly receive patients who have been sent long distances for the surgical treatment of harmless injuries of this kind.

Cases suitable for operation are those only in which the lips are infiltrated, congested, and pouting, oftentimes with choked glands, pouring out a tenacious mucous secretion. A potent reason for operating upon these diseased cervixes is the remarkable frequency with which they are found associated with cancer.

The patient, when possible, should be prepared for the operation by rest, hot vaginal douches once or twice daily, and by keeping the bowels regular. Every four or five days the physician should treat the cervix by puncturing any dilated follicles, and relieving the congestion by a scarification, drawing off from 15 to 30 cubic centimeters ( $\frac{1}{2}$  to 1 ounce) of blood each time.

To deplete the cervix I use an instrument with a short knife blade bent at right angles to the handle to prevent it from penetrating too deep into the tissues. To do this the cervix is exposed with a speculum and caught with a tenaculum forceps, and the knife-blade tenaculum plunged rapidly and deeply into the congested extremity and vaginal surfaces, four or five times in either lip. I have never seen any alarming hemorrhage follow this treatment. Should the oozing at any point prove too persistent, it may be controlled by a suture. After each treatment a pledget of cotton is laid in the vagina saturated with boro-glyceride, supported by a wool pack below, and left in place for twelve hours.

With such preparatory treatment carried out every five



FIG. 279.—KNIFE-BLADE TENACULUM FOR DEPLETING THE CERVIX.

The blade, set at an angle on the shaft, is prevented from penetrating too deeply.  $\frac{2}{3}$  ordinary size.

or six days an infiltrated everted cervix, so rigid that the lips can not be drawn together, will soften sufficiently for operation in the course of two or three weeks.

There is a condition which is commonly known by the erroneous title of erosion of the cervix, which must be carefully distinguished from laceration.



FIG. 250.—SO CALLED "EROSION" OF THE CERVIX UTERI.

There is no laceration, but an infection of the cervical glands which has caused the mucosa to swell up and roll out into the vagina, partially everting the cervix. Age 29. Gyn. No. 1865. Dec. 12, 1896.

The os forms a wide transverse slit, and the surfaces of both lips are covered with an angry red, glistening, fissured surface, upon which a closer examination reveals the orifices of numerous glands. This is due to an infection of the cervical glands and a swelling of its mucosa, which, having no room inside, is compelled to roll out on to the vaginal surface; it is therefore an eversion of the cervical mucosa.

**Operation.**—The plastic operation for the repair of a lacerated cervix was devised by Dr. T. A. Emmet (*Principles and Practice of Gynecology*, Philadelphia, 1884, p. 466).

The posterior vaginal wall is retracted by a Sims or Simon speculum, cervix exposed, and its anterior and posterior lips each caught in the center by



FIG. 281.—BILATERAL LACERATION OF THE CERVIX, WITH PUFFY, INFILTRATED LIPS.



FIG. 282.—INCISIONS INTO THE ANGLES OF THE LACERATION EXTENDING DOWN THROUGH THE SCAR TISSUE.

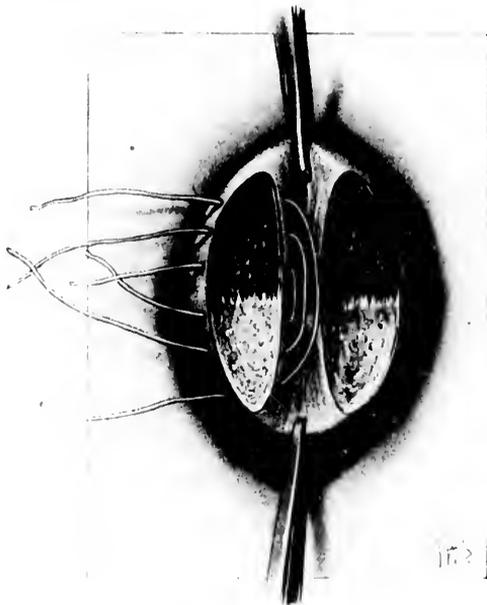

FIG. 283.—DENUDATION OF BOTH LIPS FOR PLASTIC UNION. THE SUTURES LAID IN PLACE ON THE RIGHT SIDE BUT NOT TIED.

pair of tenaculum forceps and drawn toward the vaginal outlet. Retractors on both sides hold back the lateral walls and expose the angles of the tear.

There are two steps in the operation: First, the denudation of the lips; second, the approximation by suture.

**Denudation.**—The accumulation of scar tissue in the angles of the rent between the lips must always be removed; serious disturbances have arisen from forcibly uniting the lips over such a rigid fibrous plug. To I commence the denudation by an incision into one of the angles entirely through the scar until the sound tissue below is reached. This limits the depth of the denudation in the angles of the tear. I next outline the area of denudation with a sharp knife, by deep incisions on both anterior and posterior lips.

The outline extends from each end of the incision in the angle out to the end of the lips. If the tear is bilateral a similar incision is made in the angle of the opposite side, and the area to be removed is similarly outlined on the lips of that side. A strip of mucosa  $\frac{1}{2}$  centimeter wide must be left between the lines of incision for the cervical canal. The outlined area is now denuded by catching the tongue of tissue between the incisions with rat-toothed forceps and removing it completely with knife or scissors. A serious and not uncommon error is to denude by shaving off the surface of the cervix on its vaginal side. The lips of a cervix so held together present a good external appearance, but a sound introduced within the canal demonstrates at once that the apparently normal cervix is but a pouch with a thin septum of vaginal tissue on each side, and the cervical tear is no more repaired than it would be if a suture were simply passed through the ends of both lips and drawn up and tied.



FIG. 284.—THE CERVIX AFTER ALL THE SUTURES ARE TIED ON BOTH SIDES.

FIG. 285. GLASS IRRIGATOR FOR WASHING OUT THE VAGINA AND THE CERVIX.

The irrigator is sterilized by boiling and kept standing in a carbolic-acid solution,  $\frac{1}{2}$  ordinary size.

The fear of wounding a circular artery in denuding the cervix is groundless. Any vessel which may be cut will readily be controlled by bringing the lips firmly together.

**Sutures.**—The proper sutures are silkworm-gut or catgut. The sutures are introduced by means of a stout medium-sized needle and a carrier. As a rule, two or three silkworm-gut sutures on each side are enough; fine superficial catgut sutures are used between them for accurate union.

The first silkworm-gut suture is introduced up at the angle, entering upon the vaginal surface and coming out on the uterine surface of one lip, and reëntering on the uterine surface and coming out at the corresponding point of the opposite lip. All the sutures are best introduced

first on both sides, and then tied successively from above downward. In case the vaginal outlet is operated upon at the same time, the assistant will find it easier to locate the loop for removal of the sutures if they are clamped with perforated shot instead of being tied. Fine superficial catgut sutures are used to secure accurate approximation between the silkworm-gut sutures. All the silkworm-gut sutures are now cut about  $2\frac{1}{2}$  centimeters (1 inch) long, to facilitate their removal later.

A loose gauze pack is placed in the vagina to absorb the discharges for the first two or three days, after which it is removed and the outlet simply protected by boric-acid powder and a vulvar pad. If there is any discharge after this the vagina may be douched out daily with a weak menthol, soda, and borax solution. It will not be necessary to catheterize as a rule.

Where no operation has been performed at the vaginal outlet, the cervical sutures may be removed in ten days or two weeks. When the outlet has been repaired, the cervical sutures need not be touched for four weeks or longer. The sutures are most readily exposed and removed with the patient in the knee-breast or in the left lateral posture.

## CHAPTER XV.

### PROLAPSE OF THE UTERUS.

1. Definition.
2. Forms of prolapse: *a.* Entire uterus, *b.* Cervix, *c.* Vesical diverticulum, *d.* Prolapse without vesical diverticulum, *e.* Rectal diverticulum, *f.* Enterocele, *g.* Prolapse with complete tear.
3. Accurate description of cases necessary.
4. Causes of prolapse: *a.* Congenital, *b.* Strain, *c.* Childbirth.
5. Symptoms and complications.
6. Operative treatment: *a.* Simple prolapse: 1. Supravaginal amputation of cervix, 2. Resection of lax outlet, 3. Anterior colporrhaphy, 4. Suspension of the uterus, *b.* Complicated prolapse: 1. Complete tear of septum, 2. Prolapse of rectum.
7. After-treatment.

**Definition.**—Prolapse of the uterus and falling of the womb are terms applied to a hernia, sometimes appropriately called “sacro-pubic hernia,” occurring at the vaginal outlet, in which the uterus lies within the hernial sac.

Although the term “falling of the womb” is sanctioned by long usage, it is seriously misleading, inasmuch as it implies nothing more than a simple displacement of the uterus, which in fact never occurs alone, but is always associated with eversion of other important structures, usually the vaginal walls and a part of the bladder, these organs hanging together out of the vulvar cleft below the pubic arch, like a large mucous pouch.

An illustration of an extreme form of prolapse, representing the most advanced degree attainable, is furnished by one of my patients, a woman twenty-two years old, with complete eversion of both vaginal walls, and complete prolapse of the retroflexed uterus as well. The sketch shows the relations of the sac as viewed from the side.

**Forms of Prolapse.**—Under the comprehensive title “prolapse” are gathered a variety of interesting forms which may, however, be arranged under two cardinal divisions—prolapse of the entire uterus, and prolapse of the cervix only.

In the first case the uterus descends as a whole, the fundus sinking *pari passu* with the cervix, following it out as it passes beyond the vaginal outlet; in its descent the uterus occupies an infinite number of positions between the normal anteflexion, and a condition of complete extrusion.

In the second case the fundus of the uterus descends but slightly in the pelvis, while the cervix, advancing more rapidly, escapes at the outlet, with the everting vaginal walls; this form of prolapse involves only the lower extremity of the uterus and is therefore incomplete.

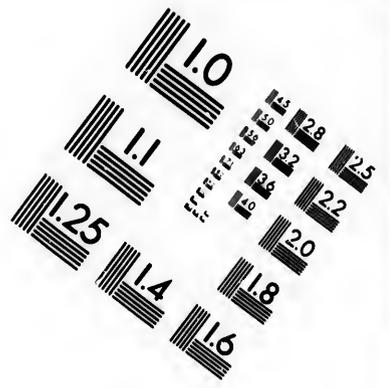
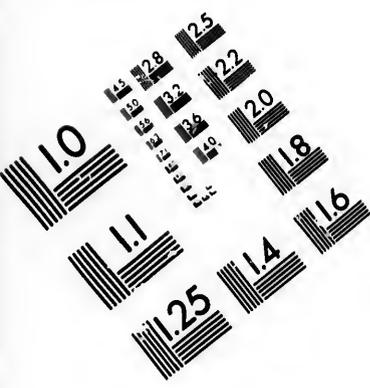

**IMAGE EVALUATION  
TEST TARGET (MT-3)**

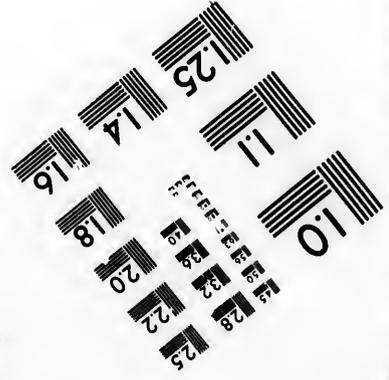
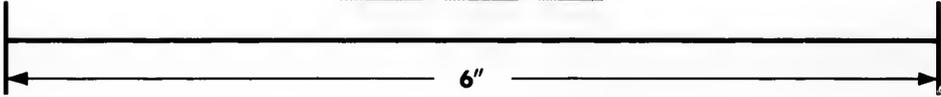
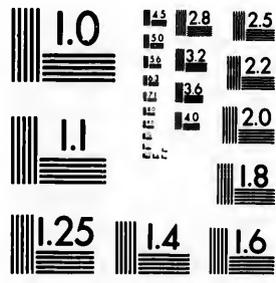

**Photographic  
Sciences  
Corporation**

23 WEST MAIN STREET  
WEBSTER, N.Y. 14580  
(716) 872-4503



A good illustration of the elongation of the cervix just above the vaginal vault is afforded by the relations of the parts in one of my patients.



FIG. 286.—COMPLETE PROLAPSUS OF THE UTERUS AND VAGINA, FORMING A LARGE MUCOUS POUCH ERODED IN DARK AREAS.

The patient, a negress, is seen from behind, in order to expose the sac better.

Here there was a little atrophic cervix at the end of a prolapsus hanging 7 centimeters (3 inches) below the vulva. The sac was but 10 centimeters (4 inches)

in circumference. The length of the uterine canal was 11 centimeters ( $4\frac{1}{4}$  inches), and the body of the uterus lay entirely within the pelvis. A diverticulum of the bladder entered  $3\frac{1}{2}$  centimeters ( $1\frac{1}{2}$  inch) into the sac, while the rest of the bladder extended 9 centimeters ( $3\frac{1}{2}$  inches) up into the pelvis. On returning the sac, nothing was apparent but a relaxed outlet and a cystocele of moderate size.

This remarkable displacement owes its occurrence to a ductile condition of the supravaginal portion of the cervix, where it joins the uterine body, allowing it to be drawn out from 3 to 6 centimeters (1 to  $2\frac{1}{2}$  inches) longer than normal.

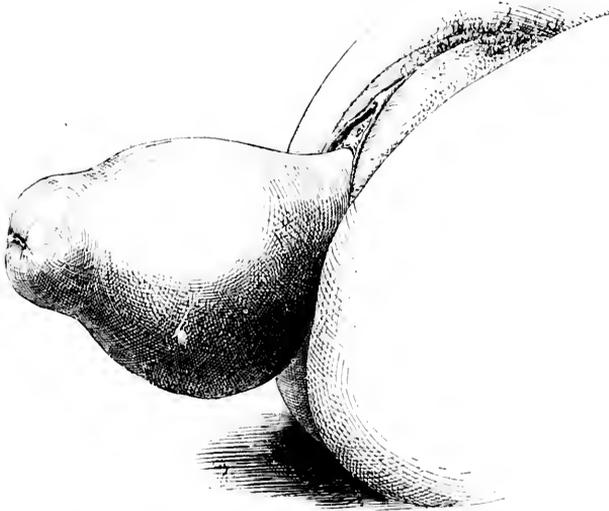

FIG. 287.—COMPLETE PROLAPSE OF THE VAGINA AND UTERUS, WITH RETROFLEXION.

Note the narrow neck at the junction with the body and the prominence posteriorly. M. K., 653.

Variations of these two cardinal divisions of prolapse are formed by the presence of a longer or shorter bladder diverticulum, or even by the absence of any portion of the bladder within the sac.

A rectal diverticulum may be found in the prolapsed posterior vaginal wall, but is one of the rarer complications. The presence of small intestines in the sac in front of or behind the uterus (anterior or posterior enterocele) is an unusual complication; it is most rarely found in front, as this space is usually filled by the bladder.

Prolapse of the uterus with complete rupture of the recto-vaginal septum is also rare. The rarest of all forms is that of complete prolapse with rupture of the septum and prolapse of the rectum.

In investigating the relations of the body of the uterus to the sac, in complete displacement, the fundus will be found in some rare instances lying either in marked antelexion or in marked retroflexion.

**The Vesical Diverticulum.**—The bladder, in close anatomical relation with the cervix, almost always accompanies the uterus in its descent.

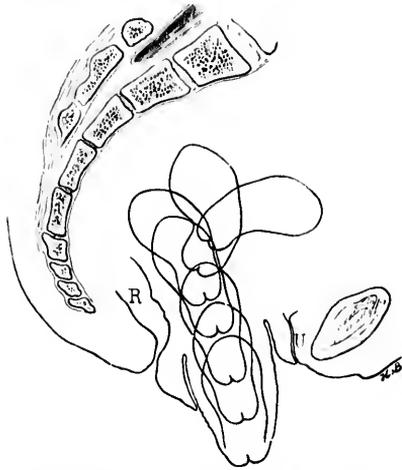

FIG. 288.—PROLAPSE OF THE UTERUS, SHOWING THE INTERMEDIATE STAGES BETWEEN THE UTERUS IN ANTELEXION AND IN COMPLETE PROLAPSE.

First the uterus descends a little and drops into retroflexion; then it descends farther and the flexion is straightened out; then the cervix appears at the vaginal outlet, to escape beyond it in the next stage; and, finally, the whole uterus lies outside enclosed in the vaginal sac.

In the middle of the sac, in the diverticulum of the bladder, lay a large calculus. The intra-pelvic portion of the bladder contained a second stone of equal size. She had also passed three small calculi before I saw her. The calculi were removed by an incision 4 centimeters ( $1\frac{1}{2}$  inch) long through the prolapsed anterior vaginal wall, beginning 3 centimeters (1 inch) above the cervix. The mucous membrane of the bladder was found thick and inflamed and covered with false membrane in places. The incision was closed at once with silkworm-gut sutures, and the prolapse operated upon at the same time by the method about to be described. The wounds all healed and the patient was entirely relieved.

The urethra sometimes presents a marked deviation from its normal direction, the external orifice being displaced forward and upward, while its canal curves down into the sac.

Involvement of the ureters in the displacement may give rise to hydro-ureter and hydronephrosis. From the frequent and futile efforts of the bladder

A part of the bladder only is involved in most cases, the greater portion still remaining within the pelvis, attached to the pubis and lower abdominal walls by its suspensory ligament. The bladder is thus divided into two lobes, with constriction at the neck of the prolapse. In one of my cases the intra-pelvic portion was so large that the sound entered 11 centimeters ( $4\frac{1}{2}$  inches) and struck the sacrum. The lobe in the sac is no longer under the control of the vesical muscles, and therefore is incompletely emptied. On this account urine will accumulate and cystitis arise from its decomposition, and even calculi may be formed.

In one of my cases, a woman of sixty-eight, a large sac hung out at the vulva 12 by 9 by 8 centimeters (5 by  $3\frac{1}{2}$  by 3 inches). The vagina was completely everted, and the uterus lay entirely within the

to expel the residual urine, its walls may become enormously hypertrophied; in other cases they may stretch and become thin.

**Prolapse without Vesical Diverticulum.**—Although rare, prolapse without vesical diverticulum is occasionally found, the bladder remaining entirely within the pelvis, being separated from its uterine connections. An



FIG. 289. PARTIAL PROLAPSE; EVERSION OF THE ANTERIOR, POSTERIOR, AND LATERAL VAGINAL WALLS. The vaginal canal is seen in the middle, and the cervix is still invisible within the pelvis.

interesting case of this character entered my clinic in April, 1891 (see *Johns Hopkins Hospital Report in Gynecology*, vol. iii, p. 311). The accompanying figure represents the appearance at the time of the first operation. The patient (M K., 653, April 2, 1891) was thirty-two years old, of slight build, weighing less

than one hundred pounds, married ten years, and the mother of three children—nine, seven, and three and a half years old. Both cervix and perineum were torn in an unassisted first labor, and a protrusion at the vulva was noticed then.

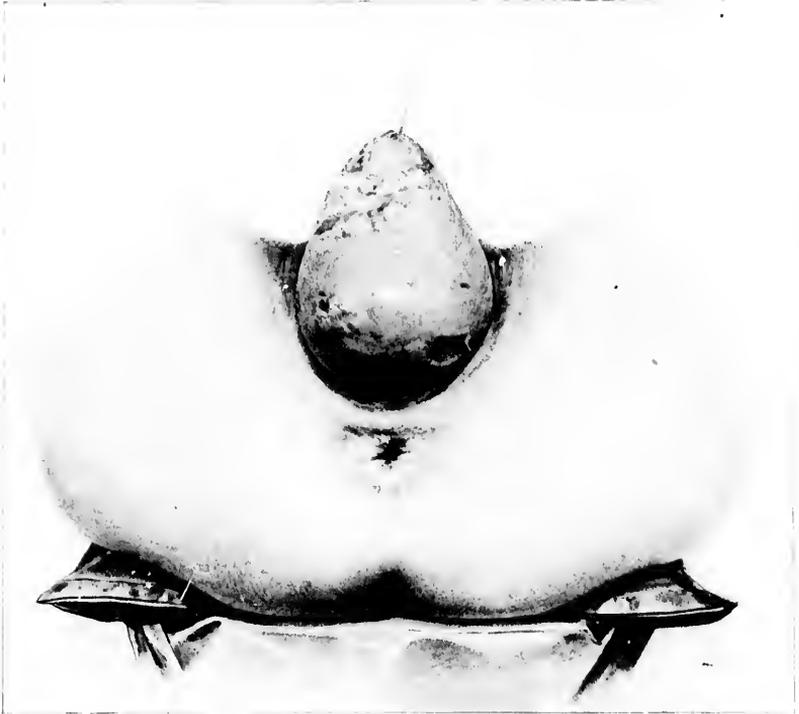

FIG. 290.—COMPLETE PROLAPSE OF THE VAGINA AND UTERUS, WITH RETROFLEXION OF THE PROLAPSED UTERUS, AS IS EVIDENT FROM THE DOME-LIKE PROMINENCE ON THE UNDER SURFACE OF THE SAC.

The lacerated everted cervix and areas of ulceration are plainly seen.

which increased after the birth of a second large child; after this she suffered from excessive constipation, frequent micturition, and dragging pains, and the effect of the third labor was a prolapse which hung 10 centimeters (4 inches) below the vulva.

I found at my first examination a large sac between the thighs dependent from the vulvar orifice, and the anterior wall of the vagina everted from cervix to methral orifice, the vagina posteriorly, on the contrary, presenting a depth of about 7 centimeters (3 inches) within the pelvis. The uterine cavity measured 7 centimeters (3 inches) in length. The body of the uterus was still within the pelvis in a direct line with the axis of the sac. There were no apparent elonga-

tion or thinning of the supravaginal cervix felt through the sac wall. The anterior and posterior part of the prolapse were distended with soft, irregular masses, gurgling on pressure, and tympanitic on percussion. These masses were easily reducible and were evidently coils of intestines. The urethra lay just beneath the pubic arch. Upon introducing a sound within the bladder, it entered the pelvis 8 centimeters (3 inches) in the median line, and 9 centimeters (3½ inches) on either side, but no part of the bladder entered into the sac.

I should explain the absence of vesical diverticulum in this way. The tendency of the bladder when markedly distended is to assume the spherical or ovoid form, which accommodates the largest amount of fluid in the smallest space. In a prolapse, in the process of formation, the upper lobe of the bladder in expanding constantly exerts traction upon the lower lobe and tends to draw it up out of the sac into the pelvis, by which means the cellular attachments between

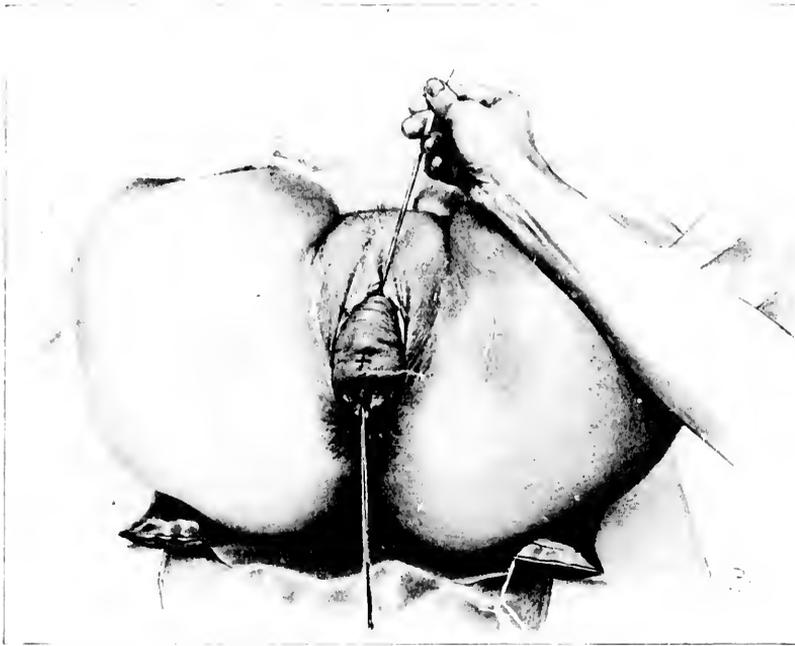

FIG. 291. —PARTIAL PROLAPSE OF THE UTERUS AND VAGINA, WITH ELONGATE LACERATED CERVIX.

The sound is introduced into the bladder to show the altered direction of the urethra and the vesical diverticulum in the sac. The light spot plainly shows the position of the end of the sound in the bladder.

uterus and bladder are stretched and yield more and more, until the separation is complete and the whole bladder comes to lie free in the pelvis. This separation of the uterus from the bladder may go on progressively with the descent

until the prolapse is complete. With the bladder thus lying in the pelvic cavity, while the uterus is prolapsed, the vesico-uterine has become transformed into a utero-vaginal pouch in front, analogous to the recto-uterine one behind.

In but one case have I seen the bladder lying entirely within the prolapse, without any portion in the pelvis or attached to the symphysis. At a subsequent examination, when the bladder contained more urine, it was found extending back toward the sacral hollow.



FIG. 292.—PARTIAL PROLAPSE OF THE UTERUS, WITH PARTIAL EVERSION OF THE POSTERIOR VAGINAL WALL AND COMPLETE EVERSION OF THE ANTERIOR VAGINAL WALL.

The cervix is elongate. The point of special importance is the complete detachment of the bladder from its uterine and vaginal attachments, with the presence of the intestines in the sac both anterior and posterior to the uterus (vaginal enterocele).

introducing the finger within the bowel. These various possible complications must all be noted before operation on account of the danger of opening the peritoneum or the bowel.

Complete tear of the recto-vaginal septum is not often found with prolapse; this is due to the fact that the direction of the tear for the most part is central, and so does not involve the levator ani muscle to any great extent, leaving the outlet well supported. In a small percentage of cases, however, the association is observed.

An unusual complication is prolapse associated with vesico-cervico-vaginal fistula. I operated on such a case April 9, 1892. The patient (K. W., 1320) was fifty-three years old, and had a large prolapsus sac with an irregularly torn posterior cervical lip; the anterior lip was gone, and in the midst of a mass of scar tissue in its place was a fistula 2 millimeters in diameter. The cervix was elongated, the fundus uteri remaining in place in the pelvis. She had been operated upon unsuccessfully twenty-one years before by Prof. Nathan Smith, of Baltimore, and had become a confirmed morphine eater. I made the classical oval denudation on the vaginal mucosa 3 centimeters (1 inch) long, funnel-shaped, with the bladder mucosa at the apex, and united the edges of the wound from side to side with interrupted silkworm-gut sutures. The

In addition to the form of enterocele thus described, another form in which the intestines crowd into the sac posterior to the uterus is more frequently found.

A rectal diverticulum is rarely found in the prolapse, although it may happen, and a considerable fecal stasis be discovered at this point. The relation of the anterior wall of the rectum to the sac may be readily ascertained by

whole operation was peculiarly easy with the parts lying displaced exteriorly. She was carefully watched during her convalescence, and both the morphine habit broken and the fistula cured.

One of the rarest complications is that presented by a fifty-year-old patient, who had a prolapse with hypertrophic elongation of an infiltrated lacerated cervix, and just below the cervico-uterine junction a complete atresia of the uterine canal.

Prolapse cases differ so widely in their individual features that all operators should make note of the following characteristics :

Dimensions of the prolapsed sac.

Appearance and position of the cervix.

Presence of ulcerated areas.

Complete or incomplete eversion of both anterior and posterior vaginal walls.

Length of uterine canal, noting whether the cervical portion is drawn out.

Exact position of the fundus uteri—in the pelvis or in the sac.

Relations of the bladder to the sac.

Relation of the rectum to the sac.

Position of the peritoneal pouch, posterior to the sac.

Presence of intestines in the sac.

Appearance of the outlet when the sac is returned.

Pelvic measurements, to explain if possible the cause of a difficult labor.

**Causes of Prolapse.**—Congenital defects in the vaginal outlet and pelvic floor may supply the factors necessary for the formation of a prolapse which may be found at birth. Protrusion of the pelvic viscera has been observed from the strain of a fall.

But the conditions essential to the production of a prolapse are most frequently found after multiple pregnancy. The large, heavy uterus following a puerperal infection, by its weight alone predisposes to prolapse where the woman has gone to work too soon. The direct causal relationship between labor and prolapse is shown by thirty-five of my cases in which there was but one who had had no pregnancy, and here the prolapse was but partial.

Twenty-seven women of whom I have accurate notes had had an average of 3.8 children. Nine of these women had borne children after the appearance of the prolapse.

A tight obstetric binder, by throwing the uterus into retroposition, also favors prolapse. If the binder is used, it must under no circumstances be applied tightly within the first ten days after labor. To aid the uterus in regaining its normal size the patient should remain in bed for two weeks, during which time the physician should from time to time assure himself of its position by palpation through the abdominal walls, drawing the fundus forward if he finds a tendency toward retroflexion. It is best for her not to lie much in the dorsal position, but to turn in bed as often as she wishes, assuming any comfortable posture. Cases of prolapse will also be avoided if retroflexion and relaxed outlet receive timely treatment.

Prolapse owes its origin therefore to an insufficiency of the intrapelvic uterine supports associated with a weakness of the pelvic floor.

A tight, well-closed vaginal outlet, depending upon the integrity of the anterior part of the levator ani muscle, is the most important factor in retaining the uterus within the pelvis. This muscle controls the outlet and prevents prolapse in three ways: (1) It retains the normal outlet in its position forward under the pubic arch, out of the line of abdominal pressure; (2) it gives to the outlet the size and form of a narrow slit, preventing the protrusion of the pelvic viscera; (3) it directs the axis of the vaginal canal forward instead of directly downward, so that the intra-abdominal pressure strikes the pelvic floor at a right angle.

If these functions of the levator ani are impaired or destroyed by extreme dilatation or laceration of its fibers, the vaginal outlet is no longer supported, but drops open and falls back toward the sacrum, and the canal assumes a direction more or less in a direct line with the abdominal pressure, the first effects of which are to crowd the adjacent anterior and posterior vaginal walls down into the outlet, still further distending it.

If the body of the uterus is retained within the pelvis by its broad ligament attachments, as the cervix descends, the portion between the cervix and the body becomes drawn out and thin, a condition readily diagnosed by squeezing the sac between the fingers, when the upper cervix is felt in the middle like a long, thin cord.

The essential intrapelvic supports of the uterus are those which tend to keep its upper pole (the fundus) in front, and its lower pole (the cervix) in the back part of the pelvis. The attachment of the vesico-uterine peritoneal folds high up on the anterior face of the uterus serves to hold the fundus behind the symphysis, while the utero-sacral muscles at the opposite pole serve to hold the cervix back. So long as these supporting structures remain intact, displacement can not occur. If, however, the utero-sacral folds relax, the cervix drops away from the sacrum in the only possible direction, down the vagina. The body of the uterus then remains no longer ensheathed upon the upper surface of the bladder, but at once begins to hang as a dead weight, and is forced step by step down upon the pelvic floor by the force of gravity, combined with the intra-abdominal pressure. In the descent the cervix is involved first and the fundus next, and it is only a question of time when the prolapse will be complete.

Retroflexion of the uterus is often but an initial step in the formation of prolapse, which will occur when the retroflexion is associated with a relaxation at the vaginal outlet.

**Symptoms and Complications.**—I find that in 35 of my cases the average age was forty-two years, and that only 4 were below thirty, 2 being but nineteen years old; 10 were between thirty and forty, 8 between fifty and sixty, and 13 between forty and fifty.

The most distressing symptoms of prolapse are backache and a dragging sensation in the pelvis and lower abdomen, producing a general feeling of weakness; locomotion is often painful—as one patient expressed it, she always “felt

as if she could go no farther." Sitting is sometimes painful. Frequent urination is common; the bowels are often constipated and the appetite poor.

From stagnation of urine in the vesical diverticulum intense cystitis is sometimes found. The bladder walls first become thickened and the ureters are compressed. The infection often travels up to the pelvis of the kidney, producing pyelonephrosis and death. In rare cases calculi are found in the pouch.

In one of my cases there was a complete prolapse with retroflexion and a myoma on the posterior wall of the fundus. This was about 3 centimeters in diameter and made a distinct elevation on the everted vaginal surface.

The vaginal mucous membrane covering the sac loses its rugose appearance, becomes smooth, hypertrophied, and callous. Rubbing on the thighs and garments often causes ulcers with deep, sharply defined borders.

**Operative Treatment.**—The normal supports of the uterus and vaginal outlet can never be perfectly restored. Therefore that operation is best which offers the most efficient substitute. I prefer the following procedure: A resection of the relaxed vaginal outlet, restoring its caliber, changing the direction of its axis, and changing its position, associated with a supra-vaginal amputation of the cervix; in bad cases the abdomen is opened and the uterus suspended to the anterior abdominal wall.

The resection of the vaginal outlet alone is not sufficient when there is a ductile cervix, which will afterward worm its way out of the smallest canal; amputation of the cervix therefore deprives the uterus of its leader, as it were, and is always necessary except when it is unusually small or senile.

Hysterectomy is not necessary to cure prolapse, and if the operations upon the outlet and cervix are skillfully performed, it will not often be necessary to suture the uterus to the anterior abdominal wall. Where there is extreme relaxation, and the outlet has not been satisfactorily lifted up by the resection, a suspension of the uterus to the anterior abdominal wall is then advisable (see Chapter XXV). This, however, will never be sufficient by itself.

**Amputation of the Cervix.**—To amputate the cervix both anterior and posterior lips are caught with tenaculum forceps and pulled well out of the body, or instead of tenaculum forceps, two long, stout silk sutures may be passed through both lips of the cervix and used as tractors. A circular incision is made immediately above the cervix through the vaginal wall and the uterus pulled downward, while the vaginal vault is stripped off with the thumb and first and second fingers pressing against the cervix, and rubbing the vagina up in front and behind. The separation is always incomplete at the sides where the vessels enter the uterus. Injury to the bladder will be avoided by directing the force of the separation movement toward the cervix, and by occasionally inserting a sound into the bladder in case of doubt as to its exact relations.

The amount of cervix bared is 5 to 6 centimeters (2 to 2½ inches). The uterine vessels on each side of the cervix are now tied as high up as possible by a catgut ligature passed close to the side of the cervix. This materially lessens the hemorrhage in the subsequent steps. It is not necessary to expose the

peritoneum either in front or behind, although no harm will be done if it is opened.

The cervix is now amputated; it is first split from its external orifice to the upper limit of the denudation, after which the lips are drawn apart and a stout curved needle, carrying a catgut suture, is entered at the anterior vaginal

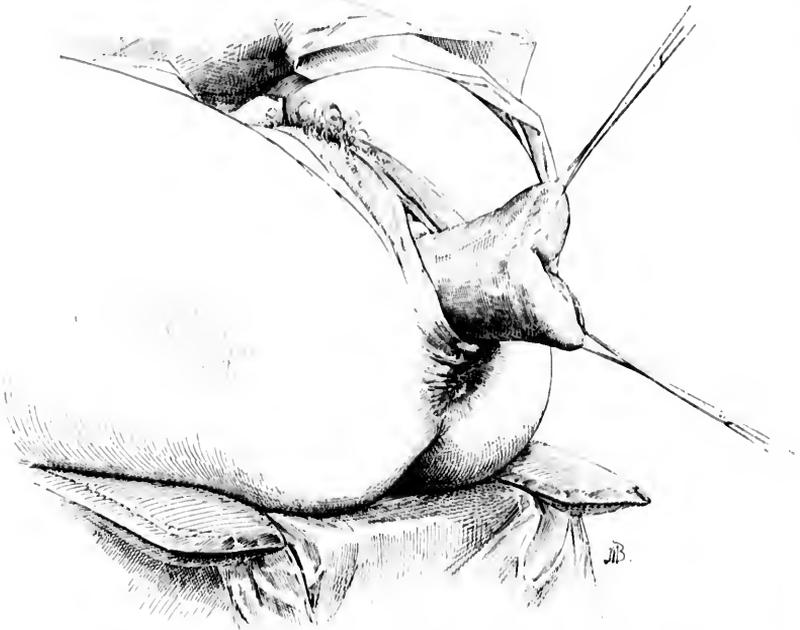

FIG. 285. PARTIAL PROLAPSE OF THE UTERUS, WITH ELONGATE HYPERTROPHIED CERVIX. The cervix is drawn down and held for the circular amputation, the first step in the operation.

wall close to the incision, carried under any oozing points in the loose cellular tissue in its track, and made to emerge on the mucosa in the cervical canal 4 or 5 millimeters below the angle of the slit. A similar suture is passed through the vaginal wall and the posterior cervical lip. After this several other sutures are passed on either side of these, and the cervical lips are then amputated in such a manner as to leave the canal the most prominent portion on the stump. The vaginal mucosa is then drawn in to the cervical mucosa by means of these sutures, which are now tied.

The elliptical openings in the vaginal vault to the right and left of the cervical canal are closed by three or four catgut sutures, bringing vaginal mucosa to vaginal mucosa, and passing under the deep parts of the wound, so as to include all bleeding vessels in their embrace. These sutures must be so applied as not

to leave any pockets beneath the surface, as blood is certain to accumulate and distend such spaces, causing infection, which will work its way to the surface at a later date in the form of an abscess.

The only large abscess I have ever seen in the cellular tissue anterior to the uterus was in a patient who had been operated on for prolapse at another clinic, and came to mine with high fever and severe pain, when I discovered and opened an abscess between the uterus and the bladder containing about 150 cubic centimeters (5 ounces) of pus.

Accurate superficial approximation of the wound at the vault is secured by fine catgut sutures between the deep ones.

This first step in the operation does not occupy longer than ten or fifteen minutes.

**Resection of the Vaginal Outlet.**—The resection of the vaginal outlet in these cases is in general similar to that described in Chapter X. The only important difference lies in the greater length and breadth of the triangles of denudation extending up into the vaginal sulci, thus resecting a larger area of the vagina. It is both more difficult and awkward to outline the area to be excised within the vagina, on account of the laxity of the tissues and the fact that the well-defined posterior column has disappeared, and in its place is a thick, wrinkled, redundant mass. The line between anterior and lateral walls is fortunately distinct, affording a guide for the outer border of each triangle, just under and parallel to it. The undenuded tongue in the middle, which is left to form the floor of the new vagina, must be made narrow as well as long.

**Anterior Colporrhaphy.**—While in a large percentage of cases the anterior vaginal wall is well supported by the resection of the posterior vaginal wall, occasionally the "cystocele," or prolapsed bladder, persists in pointing out at the vaginal orifice, which in course of time it dilates, and so destroys the effect of the operation.

An anterior colporrhaphy for the relief of the cystocele is indicated only in cases of extreme relaxation.

The essential step in the operation for cystocele is the removal of an oval piece of tissue large enough to reduce the hernia and to support the base of the bladder without encroaching upon the proposed field of operation upon the posterior wall.



FIG. 291.—OPERATION FOR PROLAPSE OF THE UTERUS BY AMPUTATION.

Amputation of the cervix at 1, oval resection of the anterior vaginal wall at 2, restoration of the vaginal outlet at 3, and suspension of the uterus at 4.

The operation for cystocele should follow immediately upon the amputation of the cervix, and so forms the second step in the train of three operations—namely, amputation of the cervix and closure of the vaginal vault, resection of the anterior vaginal wall for cystocele, and resection of the relaxed vaginal outlet.

The cervical and the urethral extremities of the cystocele are grasped with tenaculum forceps, pulling in opposite directions and drawn down into the vaginal outlet, while the lateral walls of the vagina are held away by flat retractors.

An oval incision, 4 to 6 centimeters long and  $2\frac{1}{2}$  to 3 centimeters broad, through the entire thickness of the vaginal mucosa, outlines the area to be denuded. If the denudation is made too broad the suturing of the posterior vaginal wall in the next step will be difficult.

The separation of the flap which has been outlined may be effected by loosening one of its ends and then completing the detachment by a blunt dissection

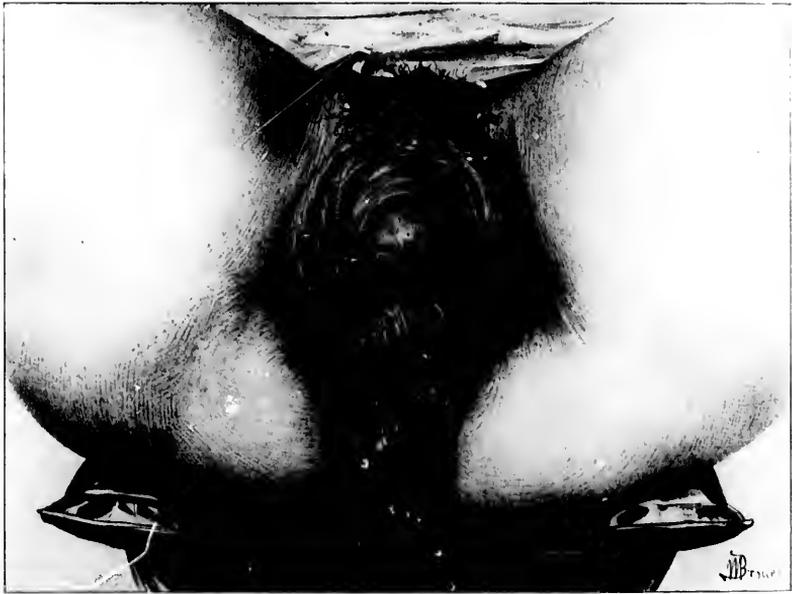

FIG. 295.—PROLAPSE OF THE UTERUS, VAGINA, AND RECTUM, WITH COMPLETE RUPTURE OF THE RECTO-VAGINAL SEPTUM. M. W., PHILADELPHIA.

with the fingers; constant care must be taken not to tear the bladder wall which is exposed. The wound made in this way does not usually bleed much, and any hemorrhage may be controlled by the interrupted silk-worm-gut or catgut sutures, introduced from side to side across the axis of the oval denudation, about a centi-

meter apart. The sutures must not penetrate the bladder or catch the ureters. On tying the sutures only a linear wound is left. They may be removed in about two weeks.

**Suspension of the Uterus.**—In those cases in which the vagina has been completely everted the lax outlet is resected with difficulty, and there still exists a marked tendency of the uterus and the upper part of the vagina to bear down upon the repaired outlet. A decided mechanical advantage will be secured by making a small abdominal incision just above the symphysis pubis, and attaching the posterior surface of the uterus to the anterior abdominal wall by three permanent sutures, in the manner described in Chapter XXIV. The manifest advantages of this step have been insisted upon first by Dr. G. M. Edebohl and then O. Küstner.

**Prolapse of the Uterus with Complete Rupture of the Recto-vaginal Septum.**—Where the laceration is complete, tear of the recto-vaginal septum deviates markedly to one side or the other, the lateral fibers of the levator ani muscle may be ruptured as well, and prolapse occur. If the tear has extended above the sphincter area, there may be also a prolapse of the rectum. The treatment of this complex condition is similar to that just described, with the exception of the restoration of a ruptured instead of a relaxed vaginal septum in the manner described in Chapter X.

## CHAPTER XVI.

### VAGINAL HYSTERECTOMY.

1. Indication for vaginal hysterectomy.
2. Preparation of the patient. *a.* Preliminary curetting.
3. Operation: *a.* Traction ligatures. *b.* Collaring cervix. *c.* Tying off one broad ligament. *d.* Delivery of uterus. *e.* Tying off the other broad ligament. *f.* Thorough inspection of field. *g.* Dressing.
4. After-treatment: *a.* Changing pack. *b.* Removing ligatures.
5. Accidents and complications: *a.* Hemorrhage. *b.* Ligation of ureter. *c.* Rupture of bladder. *d.* Injury to the small intestine. *e.* Pelvic abscess. *f.* Ovarian tumor. *g.* Incomplete emuciation of the disease.

The removal of the entire uterus by the vagina through the inferior pelvic strait has been the operation most frequently performed in the past for cancer

of the cervix, or of the cervix and fundus together, or of the fundus alone.

For the last three years my own practice has been to limit the indications for vaginal hysterectomy, choosing in preference the more radical enucleation through the abdomen, for by the vagina only the uterus and little or none of the adjacent broad ligaments can be removed, and so carcinomatous tissue is often left behind which might have been removed by a more careful dissection from above.

Vaginal hysterectomy is still indicated in fat women, whose thick abdominal walls form an almost insuperable obstacle to a complete operation from above. It is not

because the difficulty in removing the uterus by the abdominal method is so great in these cases, but the fact that a wide excision of the broad ligaments

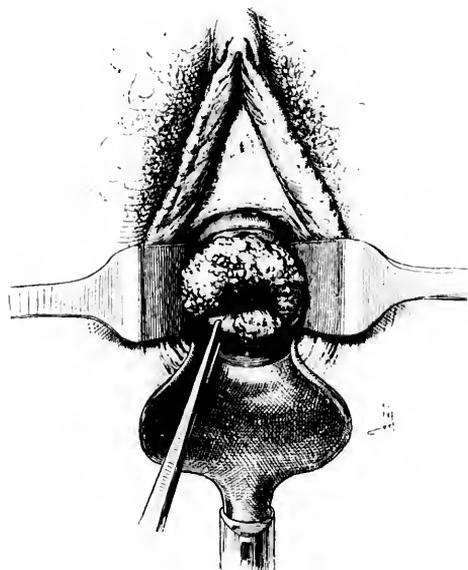

FIG. 295.—VEGETATING EPITHELIOMA OF THE CERVIX.

and removal of the pelvic glands is almost impossible, on account of the mechanical hindrances offered by the thick walls and the deep pelvis.



FIG. 297.—EPITHELIOMA OF THE CERVIX WITHOUT VEGETATION.

The vaginal vault is converted into a flat granulating surface. The cervical opening is seen in the center.

**Preparation of the Patient.**—The patient must be duly prepared by rest, baths, vaginal douches, and above all by a thorough evacuation of the bowels.

If the cancerous disease has advanced to the sloughing stage, or so far as to cause any odorous discharges, or to form a mass protruding into the upper vagina, the danger of sepsis will be greatly increased unless the field is first

cleansed by a thorough curettage, removing as much of the diseased tissue as can be scraped away with a sharp curette (see Chapter XIV). If the vagina is packed every two days after doing this, in a week or ten days the patient will be ready for the radical operation. In an urgent case the curettage may be done just before the uterus is removed.

*Operation.*—The patient is brought to the edge of the table in the lithotomy position, with the limbs well flexed and the buttocks resting on the perineal pad. The assistant then shaves the external genitals, washing them well, together with the vagina, and curettes away all redundant cancerous masses with fingers and scoop unless this has been already done.

The posterior vaginal wall is then retracted with a large Sims or Simon speculum, exposing the vault of the vagina and the cervix. If the vaginal outlet is narrow, hindering a view of the cervix, a greater degree of dilatation may



FIG. 298.—VAGINAL HYSTERECTOMY FOR CANCER OF THE UTERUS.

The uterus and cervix curetted thoroughly and the cervix sewed up with stout silk sutures left long for traction. The field of operation exposed by retractors.

be secured by boring in the hand with the tips of the fingers held together, making a conical dilator, or, better still, by using a conical rectal dilator, 6 centimeters in diameter at the base. If the rigidity can not be overcome in this way, one or two deep lateral incisions through the posterior commissure and

extending around one or both sides of the rectum and up into the vaginal sulci, will give the necessary enlargement. The hemorrhage from the surfaces thus incised is rarely great enough to call for the use of forceps or ligatures.



FIG. 290.—VAGINAL HYSTERECTOMY.

Beginning the operation by cutting the cervix loose from the vaginal vault, under continuous irrigation.

Continuous irrigation is used to keep the field clear of blood during the first part of the operation, until the peritoneum is opened.

The vault of the vagina and the cervix being exposed as described, the anterior lip of the cervix is caught by tenaculum forceps and drawn down; the posterior lip is also caught, and a stout needle is passed through the anterior and posterior lips, carrying a heavy silk suture about 40 centimeters (16 inches) long. Three or four of these ligatures are passed, and each one tied tightly, drawing the lips firmly together and completely closing the cervical canal and covering in the diseased area, to prevent the escape of any of the intra-uterine contents over the wound area during the enucleation. The ligatures are left long to serve as tractors, and enable the operator to hold the uterus down near the outlet, and to keep pulling it farther and farther down, delivering it gradually as its attachments are severed.

The cervix is first drawn down toward the vaginal outlet as far as it will

come, often outside, and an assistant on either side holds back the lateral vaginal walls with a retractor so as to prevent them from hiding the field of operation. The operator, pulling on the traction ligatures, now makes a circular incision around the cervix and through the entire thickness of the vaginal vault, not less than 2 centimeters ( $\frac{3}{4}$  inch) distant from the margin of the disense. The Paquelin or galvano-cautery may be employed in this stage of the operation, instead of a knife, to check the oozing. Moderate bleeding from its margins may be disregarded until the close of the operation. More profuse bleeding should be controlled at once by ligatures passed through the vaginal walls, so as to grasp the vessels.

The knife or scissors are now laid aside, and the operator begins to push up and peel back the cellular tissue from its cervical attachments in front and be-



FIG. 300.—VAGINAL HYSTERECTOMY.

The finger is engaged in pushing up the bladder, detaching it from the cervix.

hind the cervix with index and middle finger. There is usually no resistance and rarely any serious hemorrhage, for the important blood vessels lie in the broad ligaments at the sides. Care must be taken in pushing back the tissues and freeing the cervix to keep the ball of the finger always directed toward the cervix. If the separation is carelessly performed and this precaution neglected,

there is danger of perforating the bladder or unexpectedly entering the peritoneum, especially if the disease has extended in either of these directions. As soon as the peritoneum behind the uterus is reached, the fact is readily recognized by the fluctuation of a little fluid in Douglas's *cul-de-sac*, or by the smooth anterior and posterior surfaces gliding over each other. It is opened by catching a fold of it with forceps and making a small cut into it with seissors; one index finger is then thrust in, enlarging the opening, and then the other index finger is introduced, tearing the incision as wide as possible from side to side, well out to the bases of the broad ligaments.

As soon as the peritoneum is laid open the irrigation must cease. A sterilized sponge, or pledget of gauze with string attached, is now pushed into Douglas's *cul-de-sac* to prevent the entrance of fluids or the escape of *débris* from the field of operation up into the peritoneum. A pair of artery forceps, clamped at the end of the string, distinguishes it at once from the ligatures applied to the broad ligaments.

The anterior vesico-uterine fold of peritoneum is next reached in like manner after completely detaching the bladder from its uterine connections. It is also recognized by the gliding of its peritoneal surfaces over each other. An opening is made by pushing in a pair of sharp-pointed seissors under the guidance of the index finger, spreading the handles and withdrawing them. The index fingers are then introduced as just described and the hole enlarged out to the broad ligaments on either side. This leaves the uterus hanging in the pelvis attached by the broad ligaments alone.

The anterior peritoneal fold may sometimes be more readily reached after the lower parts of the broad ligaments have been ligated and severed from the cervix, permitting a greater downward displacement of the uterus, and making this part of the peritoneum more accessible.

The accident of pushing the finger through the bladder will be avoided by frequently introducing a sound into the bladder as the operation progresses, to determine its exact position, and the thickness of the intervening wall. An accidental rent in the bladder at once shows itself by a sudden gush of urine into the vagina. This is most apt to occur when the disease has progressed through the cervix into the bladder wall. A fistula made in this way should be closed, after paring the edges to remove the disease, with interrupted silk sutures, when the enucleation of the uterus is completed. If this operation is performed immediately, it is rarely unsuccessful.

The next step in the enucleation is to tie off the broad ligaments with stout silk ligatures, introduced by a strongly curved blunt aneurismal needle. In introducing the first ligature—say on the right side—the cervix is drawn strongly to the left, and the right vaginal wall held out of the way by a retractor. The left index finger is placed beside the cervix, behind the broad ligament, and the aneurismal needle, armed with a ligature, is passed through, from before back-



FIG. 501.—ANEURISMAL NEEDLE WITH LEFT CURVE FOR PASSING LIGATURES THROUGH THE BROAD LIGAMENTS IN VAGINAL HYSTERECTOMY.



FIG. 202. VAGINAL HYSTERECTOMY.

After freeing the bladder in front and opening the *cul-de-sac* behind, the base of the left broad ligament is exposed by pulling the cervix to the right, and tied off by passing a stout silk ligature in an aneurism needle.

ward, onto the tip of the finger. This ligature includes a bunch of tissue about a centimeter in diameter, and is entered about a centimeter distant from the cervix, out toward the pelvic wall. The loop of the ligature is caught with a stout, blunt tenaculum, pulled out, and the needle is withdrawn. The ligature is tied at once, as tightly as possible, and drawn aside, and the broad ligament divided between the ligature and uterus, nearer the latter. All cutting is done with scissors, carefully snipping the tissues of the broad ligaments as they are drawn forward on the index finger. As soon as a little oozing of blood is seen to follow a cut, it means that an area of tissue is uncontrolled and another ligature must be inserted in a similar manner just above the last. The assistant must use the retractor with care, so as not to pull on the ligatures already tied. After introducing two or three ligatures in this way, one above the other, the cervix is drawn to the opposite wall, and the base of the left broad ligament ligated and severed in like manner.



FIG. 202.—THE END OF THE STOUT, BLUNT TENACULUM, USED FOR CATCHING THE LIGATURE AND DRAWING IT DOWN IN VAGINAL HYSTERECTOMY.

An extensively infiltrated cervix occupies a considerable space in the narrow pelvis, and in consequence lies in close contact with the ureters. In such cases, as advised by Pawlik, a bougie or a catheter should be placed in each ureter before the operation. The exact position of the ureter is thus constantly evident to the fingers throughout the enucleation, and injury to the organ is avoided with ease and certainty. I have in this way several times avoided this accident. In one patient, after removing a large cancerous uterus, I found a separate mass in the left broad ligament, which I proceeded to enucleate with forceps and scissors, actually dissecting it off from the ureter, which was bared for 7.5 centimeters (3 inches), without injury, it being plainly defined the whole time by a bougie 2.5 millimeters (0.1 inch) in diameter.



FIG. 304.—VAGINAL HYSTERECTOMY.

Freeing the right broad ligament from the uterus. The cervix lies to the left; the first ligature to the base of the broad ligament has been tied and hangs loose; the second ligature, including the uterine artery, has been tied just above the first as shown, and the scissors are just about to divide the broad ligament between the ligature and the right border of the uterus.

Moderate traction may be made upon the ligature when tied, assisting in exposing the area to be divided by the scissors; but as soon as the division is

effected all traction must cease at once, lest the ligatures be pulled off. The uterine artery should be included in the second or third ligature applied. As soon as the peritoneum is opened the index finger will find the artery pulsating



FIG. 305. - VAGINAL HYSTERECTOMY.

The cervix and uterus pulled well over to the left. The right broad ligament has been tied all the way up to the top, which will be tied next. The index finger is hooked behind the top of the broad ligament, pulling it down into view for the application of the last ligature. The round ligament and the tube are seen at their uterine ends.

beside the cervix near the internal os. Its exact position once fixed serves as a guide in estimating the amount of tissue to be included in the ligatures in order to catch it in the second or third. The artery, when laid bare, is easily distinguished as a large, white, tortuous trunk with a lumen 2 or 3 millimeters in diameter, strongly pulsating on its proximal side. As soon as the uterine arteries of one side are secured and severed from the uterus the operator continues to tie off the remainder of the broad ligaments on that side up to the top. When near the top of the broad ligament the finger is passed over the tube close to the uterine cornu, which is hooked down into view and tied.

If the cancer affects the body of the uterus, or there is a pyosalpinx or other pelvic inflammatory disease complicating it, the ligatures should be placed on the outer pelvic side of the ovaries and tubes which are removed together with the uterus. It is more difficult to complete the operation in this way with the

removal of the ovaries and tubes, because the ligatures placed nearer to the pelvic wall are not so easily tied, and are more apt to slip off. The ligature at the top of the broad ligament must be tied with especial care, and the tissue cut at a distance from it, to avoid the risk of its slipping off. As soon as the whole of the right side of the uterus is freed, two fingers are inserted, the fundus caught from behind, and the body of the uterus slowly and carefully delivered sidewise through the opening in the vaginal vault, down through vagina and out into the vulvar cleft, where it hangs attached by the upper part of the left broad ligament. The enucleation is now completed by tying off the opposite side from above downward with two or more ligatures.

It is possible by removing the uterus in this way, from above downward, to apply the ligatures at a safe distance from the side which is most diseased; for this reason, in cases of advanced disease, it is best not to apply more than a single ligature below on the worst side.



FIG. 306.—VAGINAL HYSTERECTOMY.

The uterus entirely freed on the right side and brought out onto the vulva. The remainder of the left broad ligament is now tied from above downward.

As soon as the uterus is removed, the operator takes the sponge from the pelvis and separates the ligatures into right and left groups, holding them without traction, while an assistant pours a hot sterilized normal salt solution, 43.3° C.

(110° F.), into the vagina, and cleanses the lower pelvis with a sponge held in the forceps. The irrigation is continued until the water returns perfectly clear.

If omentum, or a loop of intestine, falls into the vagina, it must be carefully pushed back. While washing out the lower pelvis he must inspect the peritoneum as well, in order to discover and remove any coagula lodging there.

The next step is the investigation of the condition of all the ligatures and the search for bleeding points. A slight traction of the upper ligatures, aided by a sponge pushed into the peritoneum, and then partially withdrawn, brings the broad ligament forward, and exposes first one part of it and then another. Any ligature which seems loose must at once be replaced by transfixing the broad ligament at that point. A few fine silk ligatures are usually required to control small vessels under the first ligatures, just below the bases of both broad ligaments. A persistent flow from a hemorrhoidal vessel in the recto-vaginal septum must also be controlled by a ligature placed beneath the bleeding point. The wound area underlying the base of the bladder but rarely bleeds.

The ligatures on either side are now tied in two bunches, and the ends cut off just within the vagina.

As a final step, the pelvis is dried with a small sponge, and a dressing applied of strips of iodoform or sterilized gauze, 45 centimeters (18 inches) long by 5 centimeters (2 inches) in breadth. To insert the gauze, the operator, taking the packer, pushes a strip in between the ligatures until the whole space between the broad ligaments is loosely filled out. The vagina below is also packed with gauze somewhat firmly to prevent the intestines from escaping in this direction. This packing of gauze supports the small intestines, omentum, rectum, and bladder, and drains off any fluid into the vagina. Too tight a pack does not drain well. A loose pack, on the contrary, favors prolapse of the bowel into the vagina. I lost one patient through a loose pack, from peritonitis, due to the infection of a knuckle of intestine forced down beside the pack. It is a good plan to unite the peritoneum in the middle by one or two sutures, leaving a little opening on either side for drainage, supporting the intestines and lessening the liability to prolapse. Iodoform and boric-acid powder is dusted freely into the vaginal outlet as the speculum is withdrawn.

The urine is now drawn, and, if clear, conveys the assurance that the bladder has not been injured. Bloody urine may indicate an injury to the bladder or ureter. A roll of sterilized absorbent cotton is applied over the vulva, held in place by a T-bandage.

**After-treatment.**—When the effects of the anesthesia have worn off, it is not necessary to keep the patient on her back. She will be greatly relieved from time to time by being gently turned over on one side or the other; after a few days she may turn on her face and urinate in this posture. At first the catheter should be used three or four times daily. The bowels should be moved on the third day by a laxative pill, followed by a warm enema of oil and soap-suds, or of glycerin and oil, 180 centimeters (6 ounces). During the evacuation she must avoid straining. If the fecal matter does not easily pass out, the nurse

must assist with her fingers. After this, a movement must be secured every other day.

The diet during the convalescence should consist for the first two or three days of liquids, followed by soft foods, nourishing soups, toast, soft boiled eggs, oyster soup, various starchy foods, etc.



FIG. 307.—VAGINAL HYSTERECTOMY.

The uterus removed, the ligatures on the uterine arteries seen on either side. The anterior and posterior peritoneal layers are brought together in the middle by one suture. The long ligatures on the broad ligaments are left out of this picture.

Pain following the operation is often entirely absent and is rarely unbearable. Hypodermics of morphine should be used sparingly to relieve severe pain during the first twenty-four hours.

If the pack continues dry, and there is no discharge from the vagina, it may be left there five days or longer. To remove the pack the patient is brought

with the buttocks to the edge of the bed with the thighs flexed. The operator slips a narrow Sims speculum into the vagina, retracting the posterior wall, and with dressing forceps draws the strips of gauze out from between the ligatures. As soon as the strips are removed the vaginal vault must be cleansed with pledgets of absorbent cotton, and a fresh pack inserted.

No vaginal douches of any kind should be used until three weeks have passed, when a 3 per cent warm carbolyzed douche or boric-acid douche may be given once or twice daily, using a short nozzle and taking great care not to push it too far in. When silk ligatures are used the discharge is sure to become odorous sooner or later, and the vagina must be cleansed more frequently. The ligatures loosen and come away with a little traction, in bunches, in from four to six weeks. It is a good plan not to wait for them to become detached, but in the course of three weeks to expose and remove them with forceps and scissors. These sutures can be removed most easily with the patient in the knee-breast or Sims posture.

In eighteen days the patient may sit in a reclining chair a little while each day, and after this gradually increase her movements, until after four weeks, when she is able to be up all day. At this time an examination will show that the vaginal vault is closed, and the wound area has contracted down to a transverse granulating linear scar, with the granulations more abundant at each end. After six or eight months this whole line has contracted still more, until it is a thin white cicatrix, closing the vault.

After a hysterectomy the patient should avoid hard work, heavy lifting, and prolonged exertion for several months. Recovery of health is usually rapid; within a few months a pale, emaciated woman often regains all her lost vigor. But the surgeon still has a duty to perform in continuing to watch these cases, examining them at first at intervals of two or three months, and later every six months, in order to detect at once any recurrence of the disease. It will occasionally be necessary to cut out a small area of recrudescence in the vaginal vault, which will be detected at an early stage by this careful inspection.

In two instances in which the uterus was enucleated without removing the uterine tubes or the ovaries I found at a later date the vault of the vagina occupied by dark red, funguslike masses, which at first sight suggested a rapid return of the disease; on removing these, however, they proved to be the uterine tubes inverted through the incision at the angles, exposing to view their inner mucous lining.

The accidents and complications that arise during vaginal hysterectomy are:

1. Hemorrhage.
2. Ligation of one or both ureters.
3. Rupture of the bladder.
4. Injury to the small intestine.
5. Pelvic abscess.
6. Ovarian tumor.
7. Incomplete enucleation of the disease.

**Hemorrhage.**—The various sources of hemorrhage are the hemorrhoidal, uterine, ovarian, and vesical arteries and veins. Slight hemorrhage from small arteries is usually easily controlled by clamping them for a time with forceps; if they continue to bleed they must be ligated with fine silk or catgut. Hemorrhage from such large vessels as the uterine and ovarian arteries may prove embarrassing from the constant flow of blood which obscures the field; the difficulty of managing it increases the greater the distance of the bleeding point within. Such a hemorrhage is most apt to arise from cutting too close to one of the ligatures, so that the short bunch of tissue in its grasp slips from under the constricting loop. The worst form of hemorrhage is seen where the effort has been made to grasp the entire broad ligament in a clamp. This form of hemorrhage is treacherous, because it is liable to occur some hours after the operation.

The following instruments and accessories should always be within easy reach to meet such an emergency: A Sims speculum, two long flat retractors, dressing forceps, three sponges in holders, six artery forceps, perineal pad, iodoform gauze, transfusion apparatus, and a liter of normal salt solution. A hypodermic injection of strychnin ( $\frac{3}{16}$  grain) should be given at once.

To control the hemorrhage the patient is put under chloroform and brought to the edge of the bed under a good light, or, better still, placed on a table. As soon as she is sufficiently relaxed by the anesthetic, the operator must proceed rapidly, as prolonged anesthesia is especially dangerous in the shock following an extensive hemorrhage.

The saturated gauze pack is removed, and with fingers and sponges on holders the vagina and pelvis are rapidly cleared of the large clots which sometimes extend high up into the abdomen as far as the umbilicus. By gentle traction upon the bunches of ligatures, the broad ligament of one side and then that of the other is drawn into view and the loose ligature loop found and the broad ligament clamped. If active hemorrhage is going on, the quickest way to detect its source is to introduce a clean sponge on a holder between the broad ligaments and leave it there for a few seconds. The deep blood stain in one spot reveals the corresponding position of the hemorrhage. If, however, the precise area can not be determined by inspection, the broad ligament on the bleeding side should be caught by traction forceps, introduced under the guidance of the index finger, and drawn down step by step until the bleeding point is seen. As soon as discovered, a pair of artery forceps is applied, or several forceps in rapid succession if needed, until the whole area is under control. If the patient is much shocked by loss of blood, the quickest and most satisfactory plan is to leave the forceps in place for from thirty-six to forty-eight hours, without attempting to apply a ligature. When a large area of the broad ligament has slipped up into the pelvis and the bleeding is active, and proper assistance is wanting, a bold and successful method of finding the bleeding vessels is to take a pair of bullet forceps and carry them up into the pelvis, guided by the touch; the broad ligament is then seized and drawn down into view, and so clamped from end to end with artery forceps. The operator must constantly bear in mind that an active hemorrhage almost invariably arises from one of four vessels, the two uterine and the

two ovarian arteries; each one of these must be inspected in searching for the source. A persistent exhausting hemorrhage may also arise from patulous atheromatous vessels in the septum between bladder and cervix or between cervix and rectum. One of my patients nearly lost her life from a slow continuous oozing from a small vessel of this sort.

Where the mucous surfaces are blanched by the hemorrhage, the respiration quickened, and precordial distress felt, and there is a rapid, thready, scarcely perceptible pulse, or even where there is only well-defined shock, infusion of a liter of salt solution under the breasts should be resorted to during the operation.

**Ligation of one of the Ureters.**—This is an accident to which a beginner is peculiarly liable, and comes from passing the first ligatures too far out from the cervix toward the pelvic wall.

The most skilled operator may make this mistake, when the cervix is unusually enlarged by cancerous infiltration, diminishing the distance to the pelvic wall, and bringing the cervix and the ureters into an abnormally close relationship. In such cases the only absolute assurance of safety lies in a preliminary sounding of the ureters, by placing a flexible bougie in each one, where it remains until the operation is over (see Chapter XII). By its means, as soon as the peritoneum is opened, the ureter can be felt at once against the side of the pelvis like a hard, firm cord, which the bougies keep splinted out upon the pelvic wall at the greatest possible distance from the cervix. The extreme importance of placing a sound in the ureters has been repeatedly illustrated in my cases where the ureter has been bared for one or more inches by a careful dissection.

**Rupture of the Base of the Bladder.**—This accident will not occur in an ordinary vaginal hysterectomy if the uterus is freed from its vesical attachments by constantly directing the end of the finger toward the cervix. Occasionally the operator will be surprised by discovering that the disease has extended beyond the cervix and involved the base of the bladder, which breaks down, allowing the finger to enter the bladder in the enucleation, in spite of every precaution. This accident is signalized by a gush of urine mixed with blood. The exact location of the tear should at once be determined, either with the finger, or by introducing a sound into the bladder through the urethra, and bringing the point out through the hole.

Care must be taken during the further steps of the operation not to convert a small rent into a large ragged opening. If the danger of further rupture is imminent, while using the finger, the remainder of the bladder may be dissected off from the cervix with forceps and scissors. As soon as the extirpation of the uterus is complete, the rent in the bladder should be exposed by a little traction on its peritoneal fold, and if there is any suspicion of infiltration, the margins of the rent should be liberally excised and the fistula closed by interrupted silk sutures, not including the mucosa, and the vesical peritoneum drawn down over the closed fistula and attached to the anterior vaginal wall, thus burying the fistula and relieving it of any tension as the bladder distends with urine.

After such a complication, the urine should be drawn every four hours for two or three days. If the approximation is good, this operation is almost invariably successful, and a vesico-vaginal fistula will not complicate the convalescence.

**Injury to the Small Intestine.**—The small intestine may be injured where adhesions to the uterus have been formed, in consequence of pelvic peritonitis of tubal origin, or from extension of cancer of the body of the uterus to the contiguous viscera.

By palpation on opening the peritoneum and a careful separation of adhesions, any serious injury to the bowel will usually be avoided, and its lumen will not be opened unless invaded by the disease; in such a case the best plan is to draw the affected loop of bowel down out of the pelvis, cut out the diseased area, and close the opening by sutures. Such cases as these ought not to be operated on through the vagina if the extent of the disease is suspected beforehand; an abdominal incision reveals the exact condition, which can then be dealt with under actual inspection.

**Pelvic Abscess complicating Vaginal Hysterectomy.**—Vaginal hysterectomy, where there is an abscess in one or both tubes and ovaries, is made more difficult by the fixation of the uterus through the inflamed adherent lateral masses, which interfere with the downward displacement. The danger of general peritonitis is also enhanced by the contamination of the pelvic peritoneum by the escaping pus. The best plan of procedure is to go on as far as possible with the enucleation of the lower part of the uterus without rupturing the abscess, and then to protect the peritoneum thoroughly with a gauze pack while evacuating the pus with an aspirator.

When the peritoneum is opened, gauze should be packed on all sides in protecting the abdominal cavity.

If the abscess involves but one side, the unaffected side should be freed first and the uterus brought out, when the affected tube and ovary may be removed with the uterus by introducing two fingers and separating the adhesions and drawing the organs outside, and then ligating and cutting, first the ovarian vessels near the line of the pelvic brim and continuing on down the broad ligament until the whole mass is freed.

If the abscess has ruptured and its contents escaped over the peritoneum and the wound, some of the pus should at once be examined under the microscope for organisms, and if any of the various pyogenic cocci are found in abundance, the sponging out should be more thorough, washing the whole pelvis with extreme care, and a more abundant gauze drain should be placed higher up within the pelvis at the end of the operation.

If the enucleation is impeded by an ovarian tumor, this should be freely opened and evacuated and drawn out in a collapsed condition and the ligatures applied to the broad ligaments as usual.

**Incomplete Enucleation.**—An incomplete enucleation is the result of an operation undertaken by mistake when the disease is too far advanced for radical treatment, and I know of nothing more unsatisfactory than the discovery,

after the operation is well under way, that a portion of the disease has advanced beyond the possibility of removal. One may find a nodular mass adhering by a broad base to the pelvic wall, or an infiltration of the upper part of the broad ligament through which it is necessary to cut to free the uterus; or, again, the uterus may be so friable as to break down as soon as it is handled, leaving a ragged infiltrated area extending into the broad ligament.

Separate masses plastered on the pelvic wall must be let alone, for complete extirpation is here impossible, and the attempt would excite a hemorrhage which might easily become uncontrollable.

Where the broad ligament is found widely infiltrated after the operation has advanced too far to be abandoned, the uterus must be removed as nearly as possible in one piece and any remaining cancerous areas with friable tissue energetically curetted, the hemorrhage checked with forceps left on from twenty-four to forty-eight hours, the pelvis washed out with the utmost care, and an extensive gauze pack inserted, completely enveloping the infiltrated area on all sides.

## CHAPTER XVII.

### INVERSION OF THE UTERUS.

1. Definition and description.
2. Various forms: *a.* Acute. *b.* Chronic. *c.* With fibroid tumor.
3. Diagnosis.
4. Prognosis.
5. Treatment—reposition: *a.* By manual efforts. *b.* Vaginal amputation of the uterus. *c.* Pan-hysterectomy. *d.* Küstner's method—opening Douglas's pouch and incising the sac and reinverting.
6. Inversion due to malignant disease.

THE uterus in inversion is turned inside out, so as to form a hollow tumor projecting into the vagina; its walls are externally the uterine mucosa, internally the peritoneum, and between the two lie the muscular coats of the uterus. The uterine end of the tubes and the utero-ovarian ligaments enter into the pouch formed by the inverted peritoneum, and the ovaries and outer ends of the tubes lie just above it. The sac within is not more than 2–2.5 centimeters ( $\frac{3}{8}$  to 1 inch) deep, and its orifice forms a narrow slit or a puckered orifice opening into the peritoneum.

**VARIOUS FORMS.**—Various forms of inversion exist which it is important to recognize, as the mode of treatment differs in each.

Acute inversion is the form found immediately after labor; it is often due to unskilled efforts in delivering the placenta by traction upon the cord. This is oftener seen by the obstetrician than by the gynecologist.

The chronic form is either simply a survival of the acute form or is slowly produced in a non-puerperal uterus along with the expulsion of a tumor attached to its walls; this is the form which is most frequently seen in our gynecological clinics.

The commonest cause of inversion is a submucous fibroid tumor attached to the fundus uteri. The mechanism of its formation under these circumstances is the relaxation of the uterine cavity below the tumor, produced by expulsive efforts like those of labor, by which the tumor is finally forced into the vagina, dragging with it the attached portion of the uterine wall.

If the tumor is submucous and becomes pediculated, the peritoneal surface of the uterine wall undergoes no displacement and there is no inversion; if, on the other hand, the tumor remains sessile, as it descends the whole thickness of the uterine walls and the peritoneum may follow, creating on the peritoneal surface an indentation, at first slight but becoming more and more deeply depressed until complete inversion is brought about by the escape of the tumor into the

vagina or even out onto the vulva, when we have inversion with prolapse. The tumor causing the inversion need not arise from the fundus, but may be attached to a lateral wall. It may be that only a part of the uterine wall is involved in the inversion, as in a specimen I saw in the collection of Prof. Werth, of Kiel, where there was a little inverted peritoneal pit projecting into a pediculated myoma while the rest of the uterus appeared normal. It has been suggested that a partial inversion of this sort might be brought about artificially by traction on the tumor at the time of operation, but that such was not the case here was

evident from the delicate bands of peritoneal adhesions stretching from side to side inside the inversion sac, showing that it had existed for some time.

An inversion is sometimes found in which the tumor producing it has sloughed off. I had a case in which this mode of production was evident from the transverse linear scar 3 centimeters long on the inverted fundus, with fine cicatricial lines radiating out from it in all directions.

Diagnosis.—The commonest symptom of inversion is hemorrhage, which occurs with great ease from the exposed mucosa. In puerperal cases the hemorrhages date from the last labor, and are usually particularly severe just after it.

The patient often comes to the gynecologist with a high degree of anemia, and complains of a tumor which she, and often her physician, have mistaken for a cancer.



FIG. 308.—INVERSION OF THE UTERUS, SHOWING THE INVERTED UTERINE BODY FILLING THE UPPER VAGINA, AND THE CERVICAL RING THROUGH WHICH THE INVERSION HAS TAKEN PLACE.

The ovaries and the uterine tubes lie at the entrance to the inversion funnel.

It is best to make the examination under anesthesia, when a thorough investigation of all the associated conditions may also be made. The diagnosis is easy if a red, bleeding, pyriform tumor, about 3 centimeters in diameter, larger below and contracted above, is found filling the vagina; by bimanual palpation a depression is distinctly felt entering the tumor on its peritoneal surface, and the absence of the uterus in its normal position is demonstrated. When the inversion is complete the cervix can not be distinguished at the vaginal vault, which seems to be continuous

with the tumor. If the inversion is incomplete the cervix remains as an enlarged ring, and a sound may be pushed into it for a short distance up to the neck of the sac.

In the case of a tumor projecting into the vagina with a partially inverted uterus, the uterine attachment of the tumor presents a depression which may be felt through the rectum. When the inversion is partial any undertaking to enucleate the tumor in ignorance of this complication is most hazardous; the peritoneum has been opened under such circumstances and the life of the patient lost, through the tendency of the uterine wall thus cut through to retract out of sight and to bleed into the peritoneal cavity. The difficulty of getting hold of the edges of the wound, together with the injury and exposure of the peritoneum, made such an accident one of the gravest mishaps which formerly could befall a gynecologist. The proper plan now in event of such an accident would be to open the abdomen immediately and deal with the bleeding area directly by suture.

The rule, therefore, in every case of a submucous myoma, is to assume that an inversion does exist until the contrary is proved by a careful rectal and bimanual examination—palpating the peritoneal surfaces of the uterus over the point of attachment of the tumor.

The prognosis of an inversion left to itself is unfavorable. But few cases undergo spontaneous reposition, the hemorrhages endanger life, and ulceration of the exposed mucous surface may give rise to sepsis. In one instance recorded there was a spontaneous amputation of the body of the uterus. (R. M. Murray, *Edinburgh Medical Journal*, vol. xxviii, p. 901.)

**Treatment—Reposition.**—The most satisfactory plan of treatment is by a reposition of the displacement. This is usually easy in a puerperal case seen soon after its occurrence, when with the thumbs or fist an indentation is started at the most prominent part on the wall of the inverted sac, and by continuing to push up in the axis of the pelvis the depression is made deeper and deeper until reinverted tissue, acting as a wedge, enters and dilates the cervix and passes into the pelvis, when the replacement is shortly completed. The difficulty of keeping the uterus up in its place is often greater than that of returning it. To hold it in place, an iodoform gauze pack may be introduced within the cavity, filling it, and supported by a vaginal pack, which is changed from day to day, until by contraction and recovery of tone the danger of recurrence is past.

When the inversion is caused by a tumor attached to the fundus, it will usually be sufficient to take away the tumor to bring about an immediate return of the uterus to its normal shape. On account of the facility with which reposition occurs under these circumstances, it is important to pass all the sutures necessary to close the wound and stop bleeding before detaching the tumor; otherwise the bleeding surface once reinverted can not be reached.

In chronic cases one of the following three plans of treatment may be adopted:

First, by manual efforts.

Second, by vaginal amputation.

Third, by opening Douglas's pouch and incising the sac from fundus to cervix and reinverting.

Manual efforts at reposition should be made first. To do this, the tumor is squeezed with one hand to make it longer and smaller, and then pushed with the other hand, like a wedge, up into the cervix, through which it gradually returns in the reverse order of its formation, if the effort is destined to succeed. Another way is to grasp the tumor in the full hand, slipping the extended index and middle fingers of the same hand inside the cervical ring to dilate it, at the same time attempting to push the uterus up through the dilated ring. The other hand makes counter-pressure simultaneously through the abdominal wall, over the ring, helping to roll the cervical tissues back over the neck of the uterine tumor.

The difficulties in the way of a manual reposition are usually insuperable; they arise from the altered rigid fibrous character of the uterine tissue, with vascular engorgement and edema, as well as from the fact that the rigid neck of the inverted peritoneal sac is so much smaller than the body of the uterus which is to pass through it.

The surgeon is not warranted in making prolonged forcible attempts at manual reposition on account of the inevitable bruising of the tissues and the danger of laceration at the cervix. In a case of marked fatty degeneration of the uterine walls of six and a half years' standing, Dr. A. Martin, of Berlin, perforated them in attempting to effect a manual reduction; the patient died in collapse a few days later (*Path. and Therap. der Frauenkrankheiten*, 3d ed., Wien und Leipzig, 1893, p. 158).

A most natural suggestion to the surgical mind, in the present stage of abdominal surgery, upon the failure of manual efforts, would be to open the abdomen, to dilate the contracted canal from within by fingers and dilators, and then to push the uterine body up from the vaginal side through the enlarged canal into its normal position; this has been tried, but has not proved very successful.

I note a failure of my own in a case of long-standing inversion with prolapse, in Philadelphia, eight years ago. The proposed plan was to open the abdomen and expose the neck of the inverted sac, and then to stretch this with strong dilators, and with the help of an assistant to force the body of the uterus up through the enlarged neck of the sac, producing reposition. I had further intended to prevent the recurrence of the inversion and prolapse by stitching the fundus to the anterior abdominal wall (Suspension of the Uterus, Chapter XXIV).

I opened the abdomen and exposed the narrow slit-like orifice at the site of the inversion, but my utmost efforts to make any impression upon the opening with fingers or dilators were unavailing, and I was obliged to abandon the attempt and relieve the patient by amputating the uterus through the vagina.

On the other hand, a successful operation of this kind was performed by Dr. T. G. Thomas, of New York, in September, 1869 (*Amer. Jour. of Obst.*, vol. ii). The patient was put under ether, when an assistant so forcibly lifted the uterus

up against the abdominal wall that the intestines were displaced and the cervical ring could be felt. A small incision was then made in the median line of the abdominal wall down on to the ring, opening the peritoneum. The operator now grasped the inverted uterus in the vagina, and at the same time introduced a powerful steel dilator into the neck of the sac on the peritoneal surface. The dilatation proceeded easily and rapidly, and the uterus was reinverted and restored to its normal form in twenty-seven minutes. The patient recovered and left her bed on the eighth day.

The second method, vaginal amputation of the uterus, remains a satisfactory alternative in case of failure of the preceding means.

After a thorough cleansing of the field, the uterus is enveloped in sterilized gauze, grasped, and drawn down and exposed by pulling back the posterior vaginal wall with a speculum, so that the neck of the sac at the vaginal vault is accessible. The amputation is now begun by cutting two flaps at the neck of the inverted uterus, one anterior and one posterior, just below the vault of the vagina. Before the peritoneum is opened, three or four stout silk ligatures are passed with a large curved needle completely through the uterine stump in an antero-posterior direction.

The peritoneum is now cut through in front, and by continuing the incision cautiously out to the sides, the uterine arteries and veins are found, clamped, and tied as high up as possible with fine silk. An assistant keeps up a strong traction on the ligatures to keep the stump from inverting into the peritoneum. The operator now takes the ligatures one at a time and ties them tightly, bringing the lips of the stump firmly together. Additional deep sutures must be passed, if necessary, to check bleeding and secure accurate approximation. The stump closed in this way soon slips through the cervix and a partial reinversion is established.

The most important point to bear in mind throughout, is that the ligatures passing through the stump must keep the lips of the wedge-shaped incision firmly approximated even after reinversion has occurred. A dry dressing should be kept in the vagina; the sutures may be removed in ten days or two weeks.

Complete vaginal hysterectomy (pnhysterectomy) may be performed by opening Douglas's pouch from side to side and the vesico-uterine pouch in front, and then hooking the index finger around one side of the cervix and passing a succession of ligatures through the tissue intervening between the finger and the vault, tying each ligature, and cutting between it and the cervix, taking care not to cut too near the ligature. The amount of tissue severed is small and the uterine artery is soon ligated; an additional ligature must be applied to its free end.

The opposite side is ligated in like manner, and the uterus freed. The bladder does not enter the inversion sac. If there is no bleeding, the peritoneal surfaces of the wound may now be drawn together with a running suture, the ligatures arranged on the right and the left side, and the vault of the vagina packed with iodoform gauze.

Prof. O. Küstner's method of reposition in chronic cases resisting

simpler methods of reduction (*Centrbh. f. Gyn.*, 1893, No. 41) is in entire accord with the recent developments of gynecological surgery, and promises success in cases which it has hitherto been found impossible to treat in a conservative manner. I have not yet had a case upon which I could try it, but, in view of the apparent feasibility of the plan, I give the details of the operation. It is briefly this: The peritoneum is opened posterior to the uterus and the neck of the sac is incised, relieving the constriction and making it large enough to push the fundus through. The steps are conducted in the following manner:

First, a wide transverse incision in Douglas's *cul-de-sac* opening the peritoneum.

Second, the introduction of the index finger through this opening into the inversion funnel of the uterus, and separation of any adhesions found.

Third, a longitudinal incision through the posterior uterine wall, as nearly as possible in the median line. This begins about 2 centimeters below the inverted fundus and ends about 2 centimeters above the os externum, and extends all the way down to the peritoneum.

Fourth, reinversion of the uterus by fixing the funnel with the index finger in Douglas's pouch, and pressing in the fundus with the thumb of the same hand.

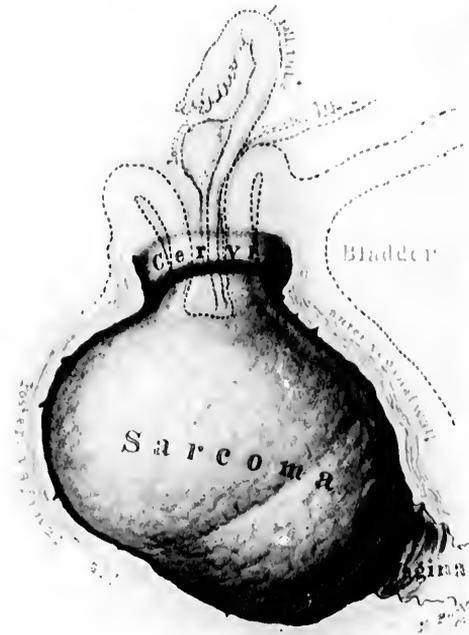

FIG. 309.—INVERSION OF THE UTERUS DUE TO SARCOMA. Hysterectomy, recovery. San. Jan. 19, 1897.

Fifth, suture of the uterine incision by deep and superficial sutures passed on the peritoneal surface.

Sixth, closure of Douglas's *cul-de-sac* with sutures.

**Inversion due to Malignant Disease.**—Inversion due to a malignant tumor of the fundus is rare, and I have seen but one case. The patient (J. H. B., No. 410, San., Jan. 19, 1897) presented herself on account of a fetid, watery, blood-tinged discharge which had continued for about a year with hemorrhages at intervals.

I found the whole vagina above the levator ani filled with an ovoid mass about 8 by 6 by 4 centimeters, flattened antero-posteriorly, and attached at the

cervix by a pedicle 2.5 centimeters in diameter. The external os formed a sharp rim around the pedicle, and the depth of the canal was from 2 to 2.5 centimeters.

Bimanually the uterine body was found absent, and in its place was a pit which entered the cervical ring, close to which both ovaries could be felt, the left one entering it for a short distance. The ovoid body filling the vagina was made up of the inverted uterine body and a sessile tumor of a light grayish color covered with little tags of tissue.

In grasping this mass it broke down, and was so friable that the entire enucleation had to be done with the fingers. There was no capsule at all, and no line of demarcation between it and the uterine tissue at the base, covering an area of 2.5 by 2 centimeters, where the uterine vessels appeared white and non-vascular. The fundus went up through the cervix after seventy-two hours, upon releasing a pair of forceps detaining it, so as to obviate the risk of a hemorrhage, which could not be controlled by suture in the friable tissue.

The tumor removed was broken up into a number of irregular pieces, and was easily penetrated by the fingers in all directions, without any hard or resisting nodules; the tissue toward its base had an edematous appearance and was longitudinally striate and tore in shreds, like the meat of a crab's claw.

A microscopic examination showed that the tumor was a spindle-celled sarcoma. A complete abdominal hysterectomy was therefore done a week later, after which the patient recovered.

## CHAPTER XVIII.

### VAGINAL EXTIRPATION OF SUBMUCOUS MYOMATA AND POLYPI.

1. Description and position of myomata.
2. Symptoms: *a.* Hemorrhage. *b.* Pain. *c.* Suppuration.
3. Diagnosis: *a.* History. *b.* Palpation. *c.* Difference between fibroid polypi and cancer.
4. Treatment—extirpation: *a.* Selection of cases. *b.* Cutting through the pedicle. *c.* Removal of sessile submucous fibroids: (1) Plicement, with forceps and scissors; (2) by splitting the capsule; (3) by both these methods combined; (4) by celiotomy.
5. Complications: *a.* Hemorrhage. *b.* Sepsis. *c.* Rupture of uterus. *d.* Death from exhaustion.
6. Polyps.

#### Description and Position of Submucous Myomata.—

Quite often a myomatous tumor, originating in the submucosa or interstitially in the uterus, is carried, in the course of its development, down into the uterine cavity, where it is found attached by a broad base or by a pedicle of varying length. The tendency to develop in this way is greatest where there is a single tumor, which may vary from the size of an egg to that of a mass big enough to choke the pelvis. Small submucous myomata are also occasionally found associated with large interstitial and subserous tumors. The tumor, which lies at first concealed in the uterine cavity, may, in the course of time, be extruded through the plastic cervix until it comes to lie partly or wholly within the vagina, or even outside the vulva, where it may be found associated with an inverted uterus or with a long, slender pedicle. Large sessile tumors are sometimes grasped so firmly by the cervix, when only partially delivered out of the cavity of the uterine body or into the vagina, as to show a deep encircling furrow at the point of constriction at the internal or external os. The pedicle of such a tumor may be attached to any part of the uterus from fundus to cervix. The most usual position is an attachment to the body just above the cervix.

The submucous myoma in the early stages is covered by the mucosa, which gradually becomes thinner, and not infrequently entirely disappears in places. This atrophy is due to pressure and attrition. The uterine mucosa between two adjacent submucous myomata is frequently thickened because it is protected from pressure. Apart from these inequalities in the thickness of the mucosa it is usually unaltered in other respects. Occasionally, however, the mouths of the glands become occluded, and small cysts develop; in one of my cases the uterine cavity was studded with clear lenticular cysts, and some of them were 8 millimeters in diameter. The presence of submucous myomata does not preclude the possibility of endometritis or tuberculosis, or of other changes in the mucosa,

such as carcinoma and sarcoma. Cysts found in the middle of such tumors lined with cylindrical ciliated epithelium have been explained as originating in a portion of the glandular tissue nipped off early in the development of the tumor.

**Symptoms.**—The most characteristic symptoms are hemorrhage and pain. The hemorrhages are often excessive, and make the woman extremely anemic. They are worse at the menstrual periods, but may last for weeks or months together. The pains arise from the expulsive efforts of the uterus trying to push the foreign body without the cervix; they are severe, intermittent, and expulsive in character, like those of labor; they often continue for years. Occasionally cases are observed where the pain has been slight, or absent altogether, and the only symptom is hemorrhage. A thin serous oozing from the mucous surface, resembling that of early cancer, may be the first symptom to call the woman's attention to her condition.

Most myomata are interstitial in their beginning, and only become subserous or submucous as they grow, depending upon their situation and the resistance encountered.

The myomatous tumor takes its origin in a little muscular whorl which is poorly vascularized, and secures its blood supply from the capillaries of its periphery, which send their branches into the tumor along its connective-tissue septa. As the tumor increases in size the vessels are thickly crowded together around its periphery, and as it becomes submucous it pushes down toward the uterine cavity and begins to infringe upon the mucosa. It crowds this against the opposite wall, and thins it out until it loses its normal characteristics and the vessels are exposed; then hemorrhage occurs. At first there is but slight increase in the length and quantity of the menstrual flow from the erosion of the mucosa. A real hemorrhage first takes place when the mucosa is so thin that the underlying meshes of vessels which belong to the tumor itself are infringed upon. Then a large vessel may rupture, or many smaller ones, simultaneously, during the menstrual congestion. The vessels form a deeply injected corona around the projecting myoma at its periphery, and the hemorrhage is largely from this area, after the most prominent portion of the tumor has been thinned down to its non-vascular area. In the advanced stages of the submucous tumors the freest hemorrhage is therefore on the border line between the thicker mucosa and the attenuated envelope of the tumor. As a rule, these submucous tumors produce a corresponding cup-shaped depression on the opposite uterine wall, and in the depression formed by the projecting tumor the same vascular phenomena are found. I have made these deductions from a careful study of this subject by Dr. J. G. Clark.

Often, when a total extirpation of the uterus has been made for multiple myomata, all the symptoms have really been due to a small submucous tumor projecting into the uterine cavity and causing the hemorrhage. If such a tumor is removed by a thorough curettage, little or no further trouble may be experienced unless another tumor pushes down under the mucosa.

A small pediculated tumor may descend into the vagina with each menstrual period and return into the uterus afterward, in this way appearing intermittently.

A large tumor choking the pelvis often gives rise to serious pressure symptoms on the part of the bladder and rectum. The pedicles of small tumors may in time become so attenuated as to break, allowing the tumor to escape spontaneously. Larger masses sometimes become necrotic, and break down into a fetid, gangrenous, suppurating mass, which extends up into the center of the tumor like a wedge, producing fever and cachexia with profound exhaustion. Several of the worst septic cases I have ever seen have been of this kind. In one the tumor had disappeared, and left behind only its muscular and mucous covering, which hung limp out of the cervix.

Injection of the blood vessels of myomata of the uterus clearly explains why sloughing and necrosis of the submucous tumors occur, for their internal blood supply is almost invariably poor, and frequently even before they reach the



FIG. 310.—PEDICULATED SUBMUCOUS MYOMA BROKEN DOWN AND COLLAPSED.  
The sloughing mass of tissue hanging out of the vulva is soft and flaccid, like a wet rag.

mucous or serous surfaces a necrotic or calcareous core is found. If the tumor becomes submucous, and the wreath of vessels and the mucosa are eroded away, either sloughing from a necrobiosis or suppuration from infection may occur.

**Diagnosis.**—The diagnosis is made from the history of intense menstrual pains and excessive flow, and by a direct examination which reveals the presence of a rounded tumor in the vagina or just inside the cervix. By passing the



FIG. 311.—PEDICULATED SUBMUCOUS MYOMA, WITH PARTIAL INVERSION OF THE UTERUS.

finger round it on all sides, the tumor is found to be smooth and to have a pedicle within the uterus; if the tumor is still retained within the uterine cavity, its pedicle may be demonstrated by passing the sound around on all sides. A differential diagnosis must be made between the myoma, of which we speak, and the uterus inverted, either whole or in part. This can only be done by careful palpation of the peritoneal surface of the uterus, by abdomen and rectum bimanually, when, if there is any inversion, the corresponding depression on the peritoneal surface will be felt. If a satisfactory examination has not been made, it must be repeated with the patient anesthetized. A mistake may be made in diagnosis by confusing submucous myoma with a cancerous cervix. I have several times had polyps brought to me with the diagnosis of cancer. This error is the more pardonable when the patient has frequent hemorrhages and acquires a somewhat cachectic look, and where there is a sloughing of the myoma with frequent discharges. This will be avoided by observing the density of the myoma in contrast with the friable cancer. The smaller myomata are quite smooth on the surface, while the larger only are nodulated. The myoma presents a distinct, well-rounded tumor, contracted above to a pedicle which enters

a canal; the cancer is a tumor whose broad attachment is not within the uterus but to the cervix, and often to one lip. It has a peculiar friable hardness, and when advanced tends to infiltrate laterally.

The differentiation between a small submucous myoma which can not be seen or felt, and a cancer of the body of the uterus, may be extremely difficult to make from the clinical history and examination. By splitting the cervix up on both sides, and so opening the uterine cavity, the myoma may be readily seen and felt, but this will not be necessary if the endometrium is curetted and examined microscopically, when the characteristic changes are always found in cancerous cases; the same difficulty may be experienced in differentiating a myoma from a small sarcoma. I have dwelt fully on the microscopic signs of the malignant tumors in Chapter XXX.

A myoma still within the cervix has a characteristic feel, just like a smooth ball in a cup, and it may sometimes be rotated, showing that it has a narrow pedicle above.

A myoma sessile within the uterus will be diagnosed without difficulty if the cervical canal is large enough to admit the index finger, which is introduced and palpates the convex surface of the tumor, while the uterus is held down by a pair of bullet forceps grasping the anterior lip of the cervix; or, if necessary, by using the other hand in making counter pressure through the abdominal walls.

A sound may be employed in the uterus in the same way when the canal is too small to admit the finger. By noting the increased depth of the uterine cavity and tracing its irregular form with the sound moving about within it, and by palpating *per rectum* and *per abdomen* at the same time, an accurate idea is gained of the size and location of the tumor.

**Treatment.**—The treatment of a submucous myoma is by extirpation. The method will vary according as it has or has not a pedicle, and according to the site and the size of the tumor, and may be either by the vagina or by the abdomen.

In determining whether or not to operate by the vagina, there should be no hesitation about attacking by this avenue pediculated tumors and those which are sloughing. It is sometimes necessary to remove by the vagina large submucous fibroids which are sloughing or causing profuse hemorrhages, even when the uterus contains also many other interstitial and subserous tumors. The immediate indications under these circumstances are fully met by such a palliative procedure, relieving the dangers to life and health; it is then left for the patient to regain sufficient health and strength to undergo a further abdominal operation if needed.

Suppurative disease of the appendages is a contraindication to the vaginal extirpation of sessile myomata, as the manipulation of the uterus may originate an attack of peritonitis; in the experience of Freund, a pyosalpinx ruptured in this way was the cause of a fatal peritonitis.

If the uterus is of great size and the patient is suffering from the pressure, the whole mass is better removed at once by the abdomen. In cases of sessile myoma in women who are near or beyond the menopause it is better to do an

abdominal hysterectomy than to risk a difficult vaginal enucleation of the tumor alone.

When the pedicle is long and attenuated, from 1 to  $\frac{1}{2}$  a centimeter, and can be easily reached in the vagina, it may be simply ligated 2 or 3 centimeters from the tumor and divided with scalpel or scissors close to the tumor, and a dry dressing placed in the vagina. An attenuated pedicle which can just be reached within the uterus may be safely treated by torsion, grasping the tumor with museum forceps and slowly turning it until the pedicle breaks off. I have also followed the plan of clamping the pedicle within the uterus with an ordinary pair of artery forceps and then cutting the tumor away and leaving the forceps *in situ* in the midst of a gauze pack for forty-eight hours; after this there is no more danger from hemorrhage, and they are removed.



FIG. 312.—LARGE PEDICULATED SUBMUCOUS MYOMA HANGING OUTSIDE THE VULVA.

A stout pedicle, 2 centimeters or more in diameter, may be grasped with bullet forceps, or held by passing two or three sutures through it near the tumor, to prevent retraction when the tumor is removed, and then cut through in such a way as to make anterior and posterior flaps, taking care to do the cutting on the convex surface of the growth. After removal of the tumor the sutures are tied, bringing the flaps together to control bleeding. By observing the principle of effecting the separation on the surface of the tumor, instead of following the natural inclination, which is to amputate the pedicle as high up as it can be reached, the danger of cutting the uterine wall and opening a partially inverted peritoneum is obviated. When the tumor is so large as to fill the vagina, pre-

venting easy access to its pedicle, it is a good plan to seize it with a pair of obstetric forceps and bring it outside, using the forceps as in delivery of a child's head when it has reached the pelvic floor. But if the woman is unmarried or has not borne a child, the attempt to drag a large tumor through the outlet will cause an extensive rupture. I saw a case of this kind in a single woman with Dr. A. K. Minich, of Philadelphia, in 1883, where the tumor was about 6 centimeters in diameter, and it was necessary to suture the perineum after delivering the tumor.

In such cases it is better to make a clean cut through the hymen down beside the rectum to remove the tumor and then to close the cut again. The écraseur

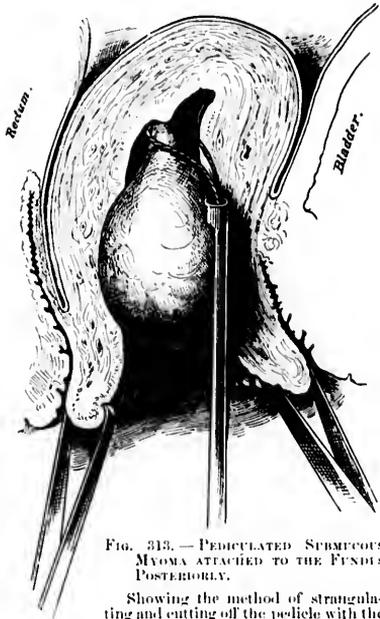

FIG. 313. — PEDICULATED SUBMUCOUS MYOMA ATTACHED TO THE FUNDUS POSTERIORLY.

Showing the method of strangulating and cutting off the pedicle with the écraseur after splitting the cervix and holding its lips apart to expose the tumor.

is valuable for removing those pediculated tumors lying within the uterus where the pedicle can not be reached in any other way. The tumor is grasped and fixed with museum forceps, while a loop of strong twisted piano wire attached to the écraseur is slipped over the forceps and up over the tumor on to its pedicle. The loop is then rapidly reduced to the size of the pedicle, after which the screw is slowly turned, until the pedicle is cut through. It may be necessary in such a case to divide the vaginal cervix on both sides in order to expose the tumor before it can be grasped and removed with the écraseur.

Sessile submucous fibroids may be attacked in a variety of ways, either removing them piecemeal with forceps and scissors, or they may be enucleated entire by splitting the capsule, or by both methods combined, or, if the tumor is entirely within the uterus and as large as a child's head, it will better be removed by an abdominal incision.

The last plan was adopted by Dr. A. Martin, of Berlin, in an operation which I saw, and which is described by Dr. W. Nagel in the *Centralblatt für Gynäkologie*, July 31, 1886, under the title *Extirpation eines grossen polyposen Myom des Corpus uteri durch Laparotomie*. The tumor measured 16 by 12 by 9 centimeters.

When a portion of the tumor projects from the uterus, or the cervix is sufficiently dilated to allow it, it may be removed piecemeal (morellement) by grasping the presenting part firmly with the museum forceps and cutting boldly in beside the forceps with knife or stout scissors, removing as large a

wedge-shaped piece as possible; the part adjacent to this is then caught and pulled more into view and attacked in the same manner. After several such wedges have been removed, the cutting may be continued more deeply into the tumor, when the sides will collapse, allowing the remainder to be easily shelled out or cut away. If the tumor is covered by a capsule, it is best to incise this broadly and strip it back before attacking the tumor itself. The latter part of the enucleation may often be easily completed by the fingers, but it is safest to stick to the instruments and to strip the tumor out of its base with blunt scissors, sound, or spatula, while keeping up the traction with the forceps.

When the tumor is so dense that the scissors make but little impression on it, the enucleation may be more rapidly effected by cutting out wedges with a sharp sickle-shaped knife, like that shown in the figure; this has the advantage of burying itself deeply in the tissues and cutting as it is drawn toward the operator.

In order to expose a tumor which can not be reached through an undilated cervix the vaginal vault is exposed by retractors, and the anterior and posterior cervical lips caught and held apart with tenaculum forceps, while a deep incision is made on each side, splitting the entire cervix up into the uterine cavity. This lays bare the tumor, which is carefully explored with the finger or a sound to determine its size or location. If it is interstitial the capsule is split from end to end and worked back with a blunt instrument on all sides, so as to expose as much as possible of the fibroid mass beneath. The most accessible portion is now grasped with stout museum forceps and forcibly drawn down, while a wedge-shaped segment is removed with knife or scissors. In this way piece after piece is extracted, until the tumor has been sufficiently diminished in size for the rest to be withdrawn through the cervix.

Hemorrhage is, as a rule, only moderate, and occurs at once after the extirpation. The reason why profuse hemorrhage rarely occurs after these operations can be well demonstrated by the injected specimens, which show that there is no large artery present; as soon also as the tumor is removed the contraction of the uterine muscle acts as an efficient hemostatic.

At the completion of the operation the uterus is thoroughly washed out with warm water, the incisions in the cervical lips closed with silk-worm-gut sutures, and the vagina packed with iodoform gauze.

If a sloughing fibroid has been extracted, it is best not to try to unite the



FIG. 314.—SICKLE-SHAPED STOUT KNIFE USED IN EXTIKATING LARGE SUBMUCOUS MYOMATA.

cervical lips, but to pack the uterus with gauze, to be removed in two or three days and followed by daily irrigation.

The plan of splitting the capsule and enucleating the tumor with a blunt instrument is also well adapted to large sessile cervical fibroids. In a case (C. V. B., 3295) upon which I operated Jan. 30, 1895, the anterior cervical lip was occupied by a large dense fibroid tumor choking the entire vagina; the posterior lip was high up in the pelvis and intact. The tumor was sessile, with a base of attachment extending from a point halfway down the anterior vaginal wall to a point high up on the uterus.

A sagittal incision 6 centimeters ( $2\frac{1}{2}$  inches) long was made over the most prominent portion, through the vaginal capsule, which was half a centimeter thick; the sides of this incision were then peeled back to right and left and the exposed white nodular fibrous surface grasped with forceps and pulled upon, while the enucleation was continued with a blunt instrument, peeling the tumor out of its fibrous investment, which extended above the vault of the vagina up under the bladder as high as the internal os uteri. There was a little bleeding from the bottom of the large hole made in the vaginal vault, which was easily controlled by a continuous buried catgut suture, approximating the sides and diminishing the size of the cavity. The external incision appeared collapsed and irregular and could not be neatly approximated in one line, so I brought it together by a single silkworm-gut, purse-string suture. A dry dressing was applied and an uneventful recovery ensued without suppuration.

**Complications.**—The following complications may occur in consequence of these operations: Hemorrhage, sepsis, rupture of the uterus, and death from exhaustion.

Hemorrhage is usually moderate, and if the bleeding area can not be seen and controlled by ligature, the flow may be checked by a firm pack of wool or sterilized non-absorbent cotton left in the uterus from twenty-four to thirty-six hours.

I have in four instances encountered a hemorrhage after the removal of a fibroid tumor attached to the fundus which was persistent in spite of the adoption of all ordinary means to control it. The first case was in Philadelphia, Feb. 3, 1889. The patient (M. R.), already almost exsanguine from the constant flow from the pediculated fibroid, bled so fast after the removal of the tumor that I feared she would die at once. I therefore packed the uterus with gauze and completely closed the vaginal cervix with silkworm-gut mattress sutures, passed through both lips and tied tightly. This stopped the flow, and in forty-eight hours I cut the sutures and removed the pack.

I have done the same thing since then in three similar cases in the Johns Hopkins Hospital with a like result. There were no symptoms after this closure pointing either to the damming up of blood in the uterus or to its escape out through the uterine tubes onto the peritoneum in any of the cases.

Sepsis may readily arise after the extirpation of a sessile tumor if the technique is imperfect, and it is most liable to occur when the tumor is deep-seated and difficult of access. I lost under these conditions an elderly woman with a

tumor 3 centimeters (1¼ inch) in diameter at the fundus, firmly fixed and hard to get at. The tumor was much torn and the removal was incomplete, and, in spite of careful cleansing and an intra-uterine pack of iodoform gauze, she died within a week of sepsis.

**Rupture of the Uterus.**—The gravest accident liable to occur in removing these growths, when they are sessile and intimately connected with the uterine muscle, is rupture or puncture of the uterine wall. This is most serious when the tumor is out of sight in the uterine cavity, because the injury may take place without its becoming evident. Such an accident, fortunately now quite rare, was much commoner when the spoon saw was used to detach the tumor from its bed.

Rupture has occurred once in my experience, with a fatal result (S. L., 1441, June 21, 1892). The tumor, which was about the size of an apple, was situated in the right lateral wall of the uterus, and was removed with great difficulty by torsion and morcellation. The temperature reached 103° the day immediately following the operation, but from that time gradually subsided until it became about normal on the seventh day. There was a persistent bloody oozing and several hemorrhages, the largest being about three ounces. The patient then became irritable and complained of sharp pain in the lower abdomen; up to the eleventh day the pulse and temperature continued about normal, when the pulse quickly became very rapid and small and the temperature fell to 96°, and death ensued within a few hours. The autopsy showed a ragged hole through the uterine wall between the leaves of the broad ligament. Cultures from this area and all the organs were negative.

Anatomical diagnosis of this case: Saperina; sloughing mass of tissue in the uterus; perforation of uterus into broad ligament; mucous polypus of uterus; submucous myoma; fatty degeneration of heart, liver, and kidneys; general marked anæmia.

Death may occur shortly after the operation if the patient is already in a state of profound exhaustion when seen by the surgeon. I lost a feeble old woman, already greatly reduced by hemorrhages, in this way; she had a simple pediculated fibroid as large as two fists, and its removal was rapidly accomplished without difficulty and without any hemorrhage, but she simply died of exhaustion within twenty-four hours, in spite of all sorts of stimulation.

**Polypi.**—Polypi are soft growths produced by a hypertrophy of the uterine mucosa, often associated with an endometritis, and frequently found in fibroid uteri. Their histological peculiarities are described in Chapter XIV.

The size varies from that of a pea to that of a walnut, and rarely they are larger. Those within the uterine cavity are usually found near the tubal ostia and are more commonly sessile.

Cervical polypi are most frequently pediculated, and protrude from the external os. Upon pressure they often recede into the uterus.

**Symptoms.**—Hemorrhages are the only clinical sign of polypi. These are rarely severe, and the patients are most often brought to the consultant through the fear of a tumor.

These growths should never be neglected, on account of a liability to malignant changes. Extirpation and a careful microscopic examination is always indicated. If the growth is readily accessible the pedicle should be ligated with a strand of catgut and excised. Those higher in the uterine cavity can be more easily treated by dilating the cervical canal and removing, either by torsion or by écraseur.

## CHAPTER XIX.

### THE UTERUS AS A RETENTION CYST.

1. Definition.
2. Causes.
3. Symptoms.
4. Diagnosis.
5. Treatment: *a.* Hematometra. *b.* Pyometra. *c.* Physometra.

**Definition.**—The conversion of the uterus into a sac containing fluid or gas is caused by the occlusion of the lower genital tract at any point from the cervix down. When the uterus alone forms the sac, it is most likely to contain blood during the early childbearing period of life; or pus, and rarely pus with gas, during the later childbearing period and after the menopause.

The sac so formed is made up of the more or less thinned-out uterine walls, and is lined everywhere by the uterine mucosa. The formation of such a sac is brought about by the closure of the three avenues by which the uterus communicates with its neighboring cavities—namely, the uterine openings into the uterine tubes and the cervical canal. When the occlusions are found in the vagina and at the outer extremities of the uterine tubes, the uterine retention cyst then forms but one part of a large irregular sac, the rest of which is made up of the vaginal and tubal cavities with free communications from one to the other.

The names of these conditions, applied from the nature of their contents—“hematometra,” “pyometra,” “hydrometra,” and “physometra”—are really misnomers, and will be misleading unless it is expressly borne in mind that the terms are used for clinical convenience, merely to designate a prominent feature of an affection of the cervix or of the vagina. The real disease, on the other hand, is that which effects the closure, and causes the accidental sequelae of accumulation and distention above it.

The terms pyuria and pyosalpinx, equally unscientific, are used in exactly the same way, purely for clinical convenience.

**Causes.**—The causes of retention cysts are various. They may be due to congenital malformation of the vagina, or to the occlusion of one half of a bicornute uterus, or to operative interference with the cervix by knife, cantery, or écraseur, or to an extensive traumatism of the vagina during labor, or to an

endocervicitis, or to cancer of the vaginal cervix blocking the canal and preventing the escape of the secretions from the upper part of the cancerous area.

I have found a pyometra above a cervical cancer so often that I always have it in mind, and if a patient complains much of pain in the lower abdomen I examine for it carefully. It is evident, as the history of the cases shows, that the accumulation takes place gradually from week to week, or with each menstrual period. In cases of vaginal and cervical atresia following the menopause there is no accumulation above, and no symptoms arise unless there is a senile endometritis. I have seen cervical atresia of this kind in a prolapsed uterus and in a large fibroid uterus. Hennig reckoned that three per cent of all women over the climacteric had this acquired atresia.

The size of the sac will depend upon the activity of the secretion and the length of time the obstruction has lasted. It may be a small one, containing but a few cubic centimeters of fluid, incapable of producing any symptoms, or it may attain a great size, even filling the lower abdomen.

**Symptoms.**—The symptoms produced arise both from the degree of the distention and the nature of the contents. When the sac is tense, constant pain is felt in the lower abdomen, which is too sore to bear pressure, and with this are apt to be associated urinary and rectal disturbances, together with a variety of nervous phenomena common to many pelvic diseases. The pain itself is apt to vary in intensity, and at the menstrual period is paroxysmal, each attack being accompanied by the most intense suffering.

If the cervical or vaginal passage is not perfectly closed there will be a little dribbling leakage of pus or blood, evident on inspection. When pus is retained there may be a moderate fever.

**Diagnosis.**—Upon making a digital examination, the diagnosis is usually easy if there is a considerable accumulation distending the uterus and it feels like a tense bag; it is more difficult if there is much disease at the point of occlusion and but little accumulation above it, and in this case, as I shall point out, the symptoms deserve a most careful consideration.

To make a thorough examination it is best to put the patient completely under the influence of an anesthetic. The bowels should be well emptied and the bladder catheterized. It also aids greatly in the palpation of a uterine cyst, which may be flaccid and not clear in its outlines, if the patient is first put in the knee-chest position for about three minutes to dislodge the small intestines, skeletonizing the pelvic viscera, as it were. The examination is then continued in the dorsal position.

By the finger inserted in the vagina the point of the occlusion below is fixed as vaginal or cervical, and whether fibrous or cancerous. A vaginal inspection may reveal one or two minute orifices, showing that the closure is not complete.

The extent of the occluded area, whether due to a contraction or a thickening, and the position, size, and relations of the sac itself, must be studied by the bimanual, rectal, and abdominal examination.

With a finger in the vagina and a finger in the rectum, the lower limit of

the atresia at which the rectal palpation is to begin is fixed. Then placing the hand on the abdomen, both to furnish a plane of counter pressure and to aid in palpating, the rectal finger investigates the atresic area above its lower vaginal limit and palpates the uterine body on all sides. A uterus even moderately distended, so as to hold from 50 to 100 cubic centimeters of fluid, lies more or less median and assumes a globular form. Its walls feel tense, rounded, and elastic, often conveying at once the impression of extreme distention.

The dangers of this condition, if left undisturbed, are rupture and general infection; rupture has occurred into the peritoneal cavity, bowel, and bladder. Occasionally such sacs will open spontaneously through the cervical canal.

**Treatment.**—The treatment in all cases is operative, and holds two objects in view:

First, to evacuate the contents of the sac, and

Second, to keep a channel of normal caliber open into the vagina to prevent a reaccumulation. (For atresia of the vagina and congenital forms see Chapter XI.)

The evacuation is always easy, but it is often most difficult to keep the channel patulous in the cervical region.

**Hematometra.**—Hematometra is an accumulation of blood within the uterine cavity, brought about by a congenital or an acquired occlusion of the cervix, vagina, or hymen.

In operations to remove the cervical stricture the vagina must first be carefully disinfected, and extreme care taken throughout not to convey the slightest infection into the uterine cavity; then, if a small opening exists, a uterine sound is passed in and, assisted by a finger in the rectum, carried up into the sac. If this succeeds, a small-sized dilator is next introduced and the opening enlarged so as to let the fluid out; this is followed by a larger dilator, until the opening is quite patulous; the evacuation of the fluid may be hastened by mopping out the uterine cavity with iodoform gauze. It is not necessary to wash the uterus out—the less done to its cavity the better. An iodoform-gauze pack is put into the vagina and changed every two to four days. After a week or ten days the vault of the vagina is exposed, and a dilator of the Hegar pattern passed up into the uterus. This is repeated every two or three days for some weeks to insure the canal's remaining open.

If the closure is complete, then the sac must be opened by pushing a large trocar and cannula up through the atresia as near as possible in the position of the cervical canal, under the guidance of a finger in the rectum resting on the lower part of the sac. As soon as the trocar is taken out the fluid escapes, and on withdrawing the cannula the dilators of different sizes, from small to large, may be used, so as to open the cervix from side to side well up into the uterine sac. The anterior and posterior lips of the fibrous cervix are then excised and interrupted sutures passed through the part of the uterus just above this, drawing it down and attaching it to the anterior and posterior vaginal walls. A pack is then put into the vagina and the wound allowed to heal.

**Pyometra.**—Pyometra is usually due to a cancer of the cervix blocking up the canal, or to an endocervicitis causing adhesions between the cervical surfaces. Then pyogenic organisms gain access to the retained fluid, and an accumulation of pus results. I have also seen a large fibroid uterus with an intact mucous surface filled with a pale, thin pus, which poured out on amputating the cervix. Pus in considerable quantities is also often discharged from a large uterus containing a sloughing fibroid tumor. It is my intention here, however, to dwell only upon the cases in which the quantity is sufficient to distend the cavity, forming a retention cyst. The ages of five of my cases of pyometra were fifty-seven, sixty, sixty-one, sixty-two, and sixty-seven years, respectively.

The treatment is first to open up the canal and let out the pus, then wash out thoroughly, drain, and keep the passage open. Where the pyometra is due to a senile endocervicitis, a part of the cervix, or a pit at the vaginal vault, representing the cervical canal, can usually be distinguished in the midst of a granular area. Through this the uterine sound may be passed with slight force, followed by dilators, letting out the pus. The uterine cavity is then washed out with a warm saturated boric-acid solution; after this an iodoform-gauze drain should be placed in the uterus, to be removed the next day, after which the cavity is kept open and disinfected by washing it out daily with a 1-10,000 bichloride of mercury solution, using a long, curved glass tube for the douche nozzle. Nitrate of silver solutions of 10 or 5 per cent strength should be applied to any granulating areas about once in five days.

It is not enough simply to dilate the canal and let out the pus, for these cases show a strong tendency to relapse, and must be kept under observation for a long time. The following was a typical case: Mrs. S., sixty-seven years old, had ceased to menstruate at fifty, and had remained perfectly well until within a year, when she was taken with violent pains in the lower part of the abdomen, which she thought were neuralgic. She had fever at the same time, and was so prostrated that she had to go to bed for five weeks, when a slight fetid discharge began to issue from the vagina, and she felt better. This came only when she was up, and was greatest in the morning.

I found a smooth senile vagina and a diminutive cervix with an obliterated canal. The uterus, felt *per rectum*, was tense and globular in form, and as large as a two and a half months' pregnancy. A dilator was easily passed through the closed cervix and 180 cubic centimeters (6 ounces) of thick, fetid green pus escaped. The canal was well dilated and kept open, and she was at once free of all pain and began to improve. She left me, returning several weeks later with some discomfort, when I found the canal contracted, and let out 30 cubic centimeters (1 ounce) of thick pus mixed with blood. After this the canal was kept open by passing dilators at intervals.

When cancer of the cervix is the cause of the occlusion and pyometra, the treatment must be different, and is directed both to the cancerous condition as well as to the pyometra. If the disease has not spread too far beyond the uterus a total extirpation must be performed (see Chapter XXX), in this way curing

the trouble by removing it. If the cancerous affection is too advanced to admit of this radical treatment, a thorough curettage must be made under anesthesia, removing as much of it as possible, and opening a wide channel up into the uterine cavity.

In one of my patients who had a long, irregular cervical canal obstructed by cancer, considerable difficulty was experienced in relieving her of her intense pains attributed to the progress of the malignant disease, until I learned the direction of the canal so well that an irrigating catheter could be passed with ease, and after that the pains disappeared and the irrigation was kept up daily for some months until her death.

**Physometra.**—Physometra, or tympany of the uterus, is a term used to designate a collection of gas in the uterus usually found in pregnancy or the puerperal condition and associated with sepsis. In gynecological cases the physometra is a rare accompaniment of a pyometra, probably due to the presence of gas-producing bacilli.

I have seen but three cases of physometra, two complicating large sloughing submucous fibroids, and one associated with a pyometra due to a cancerous cervix.

**Physometra due to Cancer.**—The patient was a black woman, sixty-one years of age, sent me by Dr. C. M. Cheston, of West River, Md., in July, 1890. Although she ceased to menstruate ten years before, she had had hemorrhages for two years. She had no leucorrhœa, but complained of a burning feeling across the back and abdomen, and the hemorrhages, which continued, as a rule, for two days, and were followed by a watery discharge. She had several times been insane.

The cervix was high up in the vagina and fixed to the left pelvic wall, and on its right side, easily felt through the vagina and thin abdominal walls, was a globular fluctuant tumor about 10 centimeters (4 inches) in diameter. The cervix was the seat of a cancerous degeneration measuring 3 centimeters (1¼ inch) in diameter, from which numerous shreds of tissue hung down into the vagina with excavated areas between them, freely bleeding when touched. The cancerous tissue was first broken down with the fingers, followed by a sharp curette, and the base, which was superficial, was thoroughly cauterized; it appeared to be one of the slow-growing cancers of old age.

On making a bimanual examination to locate the fundus, the vaginal finger suddenly entered a large smooth cavity, and this was signalized by an audible report like the pop of a gun, and rush of gas out of the sac, followed by 90 cubic centimeters of thick, intensely fetid pus (pyo-physometra). (See Fig. 315.)

The body of the uterus was distended to the size of a four months' pregnancy and its thin walls collapsed without contracting. The sac was douched out with a weak bichloride solution, and the vagina packed with iodoform gauze.

During her convalescence the patient became actively delirious and left for home in twelve days, and subsequently died in an insane asylum.

**Physometra due to Sloughing Fibroid Tumors.**—In January, 1887, I saw a colored woman, a patient of Dr. H. Williams, of Philadelphia, who was extremely emaciated and hectic, with a dry tongue and a pulse of 140. The abdomen was as large as that of a woman eight months pregnant, tense and tender. Palpation showed that the uterus was converted into a mass of fibroid tumors, but the percussion note over the mass was

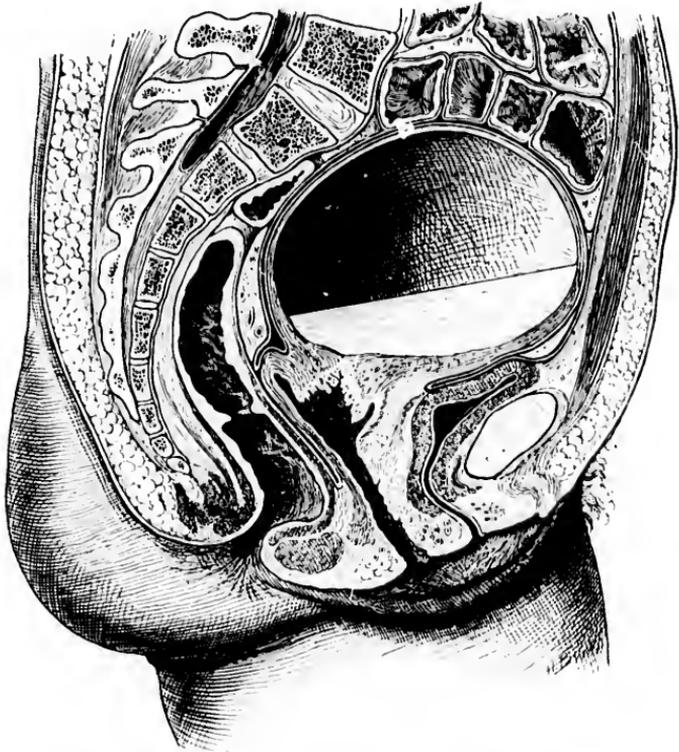

FIG. 315. PYO-PHYSOMETRA DUE TO OCCLUSION OF THE CANCEROUS CERVIX.

Note the thin distended uterine wall, containing pus in the lower part of its cavity, with a large gas space above. An explosion of gas took place as soon as the instrument broke through the barrier at the cervix.

tympanic. At the operation I introduced my hand into the uterine cavity and easily removed a sloughing fibroid which would fill a one and a half liter measure, and then broke through the thin septum of a second large sessile fibroid tumor, when two liters of intensely fetid pus escaped, with large quantities of gas. The pulse after the operation was 184; the patient was free from pain and lost no blood, but she died a week later worn out by the prolonged suppuration.

**Physometra in Pregnancy.**—The commonest of all forms of physometra is that met with in pregnancy or in the puerperium. It is oftenest observed in women with narrow pelves, where labor is protracted and where manual or other operative interference has been found necessary, and is always due to an infection by a gas-producing bacillus.

It is still the common impression that the gas in the uterus is due to the entrance or introduction of air from without, or to the formation of gas blebs in a dead fetus macerated in a moist medium. For example (C. Bamberg, Inaug. Dissert., Halle, 1877), in the case of a primipara with prolapse of the cord, the patient was put in the knee-elbow posture and the cord replaced. The next day the patient had a chill, the pulse rose to 124, and the temperature was 41.4° C., and percussio over the uterus yielded perfect tympanitic resonance. The child was perforated and delivered, and after the escape of the head a quantity of extremely foul gases poured out of the vagina with the fetid waters.

The child is always dead, and the waters, as a rule, ruptured when the tympanites is found.

The true cause of the tympany is the bacillus *aërogenes capsulatus*, and this is well shown by a case investigated by Dr. George W. Dobbin, the first case in which the bacillus has been demonstrated ante-mortem (*Puerperal Sepsis due to Infection with the Bacillus Aërogenes Capsulatus*, *Johns Hopkins Hospital Bulletin*, Feb., 1897).

The patient, a Polish woman, had been in labor for two days, attended by a midwife. She was found by Dr. Dobbin in a state of extreme exhaustion, with a pulse of 130 to 140, and with a large dead fetus impacted in a pelvis, with a true conjugate measuring approximately 8 centimeters (3½ inches). There were no regular labor pains, and there was a continuous escape of gas and frothy fluid from the vagina. A sweetish offensive odor was noticeable about the bed, and a distinct bubbling, crackling sound could be heard. The child was delivered by a craniotomy, and immediately following the delivery a large amount of offensive gas escaped from the uterine cavity. Great numbers of the bacillus *aërogenes capsulatus* were demonstrated in the fetus, placenta, and uterine lochia, and a fatal prognosis was given.

Death occurred on the third day after delivery. No autopsy was allowed. Dr. S. Flexner saw the patient six to eight hours before death, and endeavored in vain to find any evidences of the formation of gas in the tissues remote from the genitalia. But six or seven hours after death the appearances presented were those of extensive gas formation everywhere in the soft tissues and serous cavities, and from the nose and mouth frothy bloody serum exuded, which in cover-slip preparations showed the characteristic bacilli.

This is a confirmation of the prediction made by Welch and Nuttall that many of the cases of supposed entrance of air into the uterine sinuses would be found to be due to infection with a gas-producing micro-organism.

The diagnosis is made by percussing the tympanitic, distended uterus, sometimes helped by noticing the escape of fetid waters mingled with little gas bubbles. The uterus may contain a small quantity of gas, which always assumes

the highest position in turning the patient; in other cases the uterus is so distended that the danger of rupture seems imminent, and breathing is greatly embarrassed by pressure on the diaphragm.

The treatment is to empty the uterus as soon as possible, without reference to the child, which is already dead, and then to wash out the uterine cavity with an antiseptic douche, such as carbolic acid, 3 per cent, and to repeat the douches frequently enough to sterilize and keep sterile the genital tract.

## INDEX OF CASES FROM THE JOHNS HOPKINS HOSPITAL.

	PAGE
Adeno-carcinoma of Bartholin's gland . . . . .	R. S., 1136, December 18, 1891 . . . . . 194
Carcinoma of clitoris . . . . .	E. McD., 179, April 22, 1890 . . . . . 185
Carcinoma of clitoris . . . . .	C. L., 2465, December 23, 1893 . . . . . 185
Carcinoma of external genitals . . . . .	J. B. R., 3013, September 8, 1894 . . . . . 176
Death from anesthesia . . . . .	L. T. N., 4232, March 18, 1896 . . . . . 158
Death from anesthesia . . . . .	B. B., 3257, January 1, 1895 . . . . . 158
Double vagina . . . . .	M. C., 4887, December 28, 1896 . . . . . 230
Double ureter . . . . .	A. W., 4154, February 17, 1896 (admission). . . . . 417
Exstrophy of bladder . . . . .	G. T., 3869, October 14, 1895 . . . . . 319
Fibroma of round ligament . . . . .	C. H., Path. No. 65, October 13, 1893 . . . . . 173
Gonorrheal stricture of ureter . . . . .	E. S., San. 90, March 2 to June 2, 1894 . . . . . 437
Hydroureter . . . . .	S. A. H., 4039, December 30, 1895 . . . . . 447
Hypertrophy of uterine mucosa . . . . .	A. L., 3476, May 7, 1895 . . . . . 487
Inversion due to malignant disease . . . . .	J. H. B., San. 410, January 19, 1897, . . . . . 536
Myxo-fibro-sarcoma of labium majus . . . . .	M. T., 3890, October 12, 1895 . . . . . 196
Prolapse with vesico-cervico-vaginal fistula . . . . .	K. W., 1320, April 9, 1892 . . . . . 506
Prolapse without vesical diverticulum . . . . .	M. K., 653, April 4, 1891 . . . . . 503
Recto-vaginal fistula . . . . .	K. S., 2916, September 5, 1894 . . . . . 265
Removal of kidney and ureter . . . . .	K. W., 4012, December 21, 1895 . . . . . 470
Rupture of uterus . . . . .	S. L., 1441, June 21, 1892 . . . . . 547
Stricture of ureter . . . . .	C. F., San. 109, May 12, 1894 . . . . . 442
Submucous myoma . . . . .	C. V. B., 3295, January 30, 1895 . . . . . 546
Suburethral abscess . . . . .	L. J. P., 3095, January 17, 1894 . . . . . 304
Tubercular urethritis . . . . .	C. R., 1836, March 30, 1893 . . . . . 427
Undeveloped uterus, ovaries, and tubes . . . . .	B. M., 2190, September 9, 1893 . . . . . 233
Ureterotomy . . . . .	J. D. S., 4038, December 27, 1895 . . . . . 465
Uretero-cystostomy . . . . .	B. Z., 2990, October 6, 1894 . . . . . 460
Uretero-ureterostomy . . . . .	F. M., 1946, May 1, 1893 . . . . . 466
Vesico-uterine fistula . . . . .	F. H., 1750, January 12, 1893 . . . . . 351
Vesico-vaginal fistula . . . . .	M. Y., 3811, September 25, 1895 . . . . . 345

## INDEX OF CASES FROM THE LITERATURE.

Atresia of urethra . . . . .	MARDL . . . . . 288
Atresia of urethra . . . . .	F. SCHATZ . . . . . 289
Calculus impacted in ureter . . . . .	W. A. LANE . . . . . 454
Cancer of urethra . . . . .	A. F. MCGILL . . . . . 312
Cancer of urethra . . . . .	T. G. THOMAS . . . . . 311
Cancer of urethra . . . . .	WINCKEL . . . . . 311

	PAGE
Colo-vesical fistula . . . . .	R. HARRISON . . . . . 354
Congenital anomaly of ureter . . . . .	MASSARI . . . . . 419
Congenital anomaly of ureter . . . . .	W. H. MAXSON . . . . . 421
Congenital flexure of ureter . . . . .	WEIGERT . . . . . 422
Cystic dilatation of ureter . . . . .	E. G. ORTHMANN . . . . . 421
Cystic dilatation of ureter . . . . .	F. TANGL . . . . . 422
Dermoid cyst suppurating into bladder . . . . .	G. C. BLACKMAN . . . . . 353
Double bladder . . . . .	I. CATTIER . . . . . 317
Double bladder . . . . .	FUTH . . . . . 317
Double bladder . . . . .	A. P. SMITH . . . . . 317
Exfoliative cystitis . . . . .	NICHOLAS TULP . . . . . 381
Extirpation of bladder . . . . .	K. PAWLAK . . . . . 394
Extraperitoneal uretero-cystostomy . . . . .	C. WITZEL . . . . . 463
Fibroid polyp . . . . .	H. HOENIG . . . . . 310
Fibroma of urethra . . . . .	C. HENSIG . . . . . 309
Fibroma of urethra . . . . .	C. METTESHEIMER . . . . . 309
Foreign bodies in bladder . . . . .	A. DUNLAP . . . . . 326
Foreign bodies in urethra . . . . .	A. MAZARIO . . . . . 299
Foreign bodies in urethra . . . . .	PIASIESKI . . . . . 300
Foreign bodies in urethra . . . . .	F. SCHATZ . . . . . 299
Foreign bodies in urethra . . . . .	A. J. C. SKENE . . . . . 299
Hypospadias . . . . .	A. LEBEDEFF . . . . . 287
Melano-sarcoma of urethra . . . . .	C. A. L. REED . . . . . 314
Myoma of urethra . . . . .	BUTTNER . . . . . 310
Myxo-sarcoma of urethra . . . . .	GALABIN . . . . . 314
Nevoid growth in bladder . . . . .	ARBUThNOT LANE . . . . . 357
Nephro-ureterectomy . . . . .	REYNIER . . . . . 468
Rupture of uterus by curettage . . . . .	M. D. MASS . . . . . 483
Rupture of uterus by curettage . . . . .	J. B. HARVIE . . . . . 483
Rupture of uterus by a wooden tent . . . . .	W. E. ASHTON . . . . . 479
Sarcoma of bladder . . . . .	McWEENEY . . . . . 387
Sarcoma of urethra . . . . .	H. BEIGEL . . . . . 313
Sarcoma of urethra . . . . .	E. EURENDORFER . . . . . 313
Stricture of ureter . . . . .	C. FENGER . . . . . 444
Stricture of ureter . . . . .	E. KESTER . . . . . 444
Suburethral abscess . . . . .	WILLIAM HEV . . . . . 305
Traumatic stricture of ureter . . . . .	C. FENGER . . . . . 445
Ureterostomy . . . . .	C. P. NOBLE . . . . . 464
Uretero-ureterostomy . . . . .	A. M. FULLERTON . . . . . 462
Urethral caruncle . . . . .	WILLIAM GOODELL . . . . . 308
Vesico-uterine fistula . . . . .	F. H. CHAMPNEYS . . . . . 350
Vesico-vaginal fistula . . . . .	A. F. MCGILL . . . . . 341
Vesico-vaginal fistula . . . . .	W. A. FRIEND . . . . . 346
Vesical tuberculosis . . . . .	J. O. POLAK . . . . . 378

## I N D E X .

- Abdomen, myoma of, 86-88.  
   ovarian cyst of, 83-85.  
 Abortion, curettage for remnants of, 488.  
 Abscess of Gartner's canal, 251.  
   of the vulvo-vaginal gland, 191.  
   suburethral, 303.  
   pelvic, 529.  
 Absorbent cotton, 16.  
 Adeno-carcinoma of cervix, 493.  
   of the vulvo-vaginal gland, 194.  
   of body of uterus, 491.  
 Adenoma of the bladder, 385.  
 Affections of the bladder, 315.  
   of the vulvar mucosa, 197.  
   of the ureters, 396.  
 Analysis of separated urines, 413.  
 Anatomy, pelvic, 42.  
   of ureters, 396.  
 Anesthesia, 145, 279.  
   general, 147.  
   local, 145.  
   slip, 150.  
 Anesthetics, 148.  
 Anesthetizer, 147.  
 Antiseptics, 4.  
 Antiseptic conscience, 22.  
   methods, 4.  
 Applicator, 278.  
 Aseptic abdomen, 88, 89.  
 Asepsis, 3, 278, 415.  
 Aspirators, 144.  
 Assistants in plastic operations, 161.  
 Atresia of one side of uterus, 238.  
   of vagina, 258.  
   of urethra, 288.  
 Auscultation, 90.  
 Auto-infection of genital tract, 34.  
  
 Bacillus *aërogenes capsulatus*, 40, 41.  
 Bacillus *coli communis*, 35, 39.  
 Bacteria, 34, 35.  
 Bacteriology, 32.  
 Bimanual examination, 95-101.  
  
 Bladder, artificial division of, into hemispheres  
   and quadrants, 271.  
   calculi of, 324.  
   classification of diseases of, 316.  
   congenital defects of, 316.  
   displacements and alterations in form and  
   capacity of, 321.  
   eversion of, 323.  
   extrophy of, 318.  
   foreign bodies in, 324.  
   natural landmarks of, 269.  
   relations of, to surrounding structures, 270.  
   rupture of, 528.  
   boiling soda solution, 6.  
 Bongie coated with wax, 403.  
 Brushes, 20.  
 Bichner's pyrogallie acid and potassium hy-  
   drate method, 37.  
  
 Calibrating and dilating the urethral orifice, 280.  
 Calibrator, 277.  
 Carcinoma of bladder, 387.  
   of body of uterus, 490, 514.  
   of cervix, 492, 514.  
   of clitoris, 185.  
   of labia majora, 174.  
   of urethra, 311.  
   of vagina, 253.  
 Care of bowels after plastic operation, 164.  
   during convalescence, 163.  
   of wound, 165.  
 Carrier, suture, 141.  
 Caruncle of urethra, 307.  
 Catgut, 13, 138.  
 Catheterization, 163.  
   of pelvis of the kidney, 414.  
   of the ureters, 400.  
   of the ureters without elevation of the pelvis  
   and without atmospheric distention of the  
   bladder, 411.  
 Catheters, dilating, 403.  
   flexible ureteral, 401.  
   flexible renal, 401.

- Catheters, glass, 143.  
     metal ureteral, 402.  
 Cauteries, 144.  
 Celiotomy veins, 48.  
 Central figure of bladder, 274.  
 Cervix, lacerations of, 494.  
     operations on, 495.  
     amputation of, 509.  
 Chemical antiseptics, 7.  
 Child killed in utero by catheter, 200.  
 Chloroform, 151.  
     rules for administering, 152.  
 Clitoris, diseases of, 179.  
 Cocain, 146.  
 Colpocleisis, 330.  
 Colpocystotomy, 391.  
 Colporrhaphy, anterior, 511.  
 Condyloma of labia majora, 174.  
 Corn silk, 360, 369.  
 Cultures, 36, 37.  
 Cumol, 13.  
 Curettage, 483.  
     for cancer of cervix, 402.  
     of bladder, 379.  
 Cyst of the clitoris, 189.  
     of the vulvo-vaginal gland, 189.  
 Cystectomy, 394.  
 Cystic follicles, 386.  
 Cystitis, 360.  
     acute, 368.  
     chronic, 369.  
     exfoliative, 381.  
     tubercular, 376.  
 Cystoscope, 277.  
 Cystoscopy, 277.  
  
 Death from anesthesia, 158.  
 Dermoid cyst suppurating into bladder, 353.  
     cyst of bladder, 386.  
 Diagrams of pelvic lesions, 130, 131.  
 Diet, 164.  
 Difference between private and hospital surgery,  
     23.  
 Dilatation, 478.  
 Dilator, 276.  
 Diseases of external genitals, 168.  
 Disinfection of hands and forearms, 20.  
 Döderlein's bacillus, 32.  
 Double bladder, 316.  
     ureter, 416.  
     vagina, 239.  
 Douching, 163.  
 Drainage pads, 18.  
 Dress for plastic operations, 160.  
 Dressing forceps, 136.  
 Dressings after operation, 162.  
  
 Ectopic ureteral orifice, 417.  
 Edebohl's portable table, 29.  
 Ehrlich-Weigert solution, 38.  
 Electro-cautery, 144.  
 Elephantiasis, 181.  
 Ellinger dilators, 478.  
 Emmet's left-curved scissors, 135.  
 Endermie injections, 147.  
 Endometritis, acute, 485.  
     chronic, 486.  
     decidual, 486.  
 Enema, 160.  
 Enterocoele, 501.  
 Epispadias, 288.  
 Epithelioma of bladder, 387.  
     of cervix, 491.  
 Equipment of sterilizing room at surgeon's  
     home, 24.  
 Ether, 150.  
 Ethyl chloride, 146.  
 Evacuator, 276.  
 Examination of pelvic organs in the dorsal po-  
     sition, 94.  
     in pelvic disease, 102.  
     under anesthesia, 107.  
     of urethra and bladder, 272.  
     of vermiform appendix, 123.  
 External direct method of measuring the conju-  
     gate vera, 104.  
  
 Facsimile of page from case-book, 128.  
 Fallopian tubes, examination of, 98.  
 Féré's table, 383.  
 Fibroma and myoma of round ligament, 173.  
     of bladder, 385.  
     of urethra, 309.  
 Fissure of Henke, 50, 53.  
 Fistula in lateral wall of ureter, 458.  
     of ureter at base of bladder, 458.  
     of ureter at vaginal vault, 458.  
 Fistula, colo-vesical, 354.  
     recto-vaginal, 261.  
     recto-vesical, 355.  
     ureteral, 455.  
     urethro-vaginal, 297.  
     vesical, 328, 352.  
     vesico-vaginal, 341.  
     vesico-uterine, 350.  
     vesico-utero-vaginal, 347.  
 Flexible catheters, 401.  
 Forceps, 135.  
     hemostatic, 136.  
     long mouse-toothed, 278.  
     long rat-toothed, 136.  
     long straight dressing, 136.  
     polyp, 138.

- Forceps, rat-toothed dissecting, 136.  
     sponge, 137.  
     tenaculum, 136.  
 Formalin, 484.
- Gabbett's method of staining, 35.  
 Gauze, 16, 25.  
 General anesthesia, 147.  
 Goniometer, 405.  
 Gonococcus, 35.  
 Gonorrhoea, 35, 39.  
 Gonorrhoeal stricture of ureter, 430.  
 Gram's method of staining, 36.  
 Gynecological examination, 80.
- Hand basins, 9.  
 Head mirror, 275.  
 Hematokolpos, 257.  
 Hematometra, 551.  
 Hemorrhage, 165, 527.  
     sources of, 546.  
 Hemorrhoids, 356.  
 Hemostatic forceps, 136.  
 Hernia, 172.  
 Hot-air disinfection, 4.  
 Hyderabad Chloroform Commission, 151.  
 Hydrocote, 171.  
 Hydrometer, 447.  
 Hymen, imperforate, 235.  
 Hyperemia of bladder, 358.  
     of trigonum, 358.  
 Hypospadias, 287.
- Ichthyol treatment for urethritis, 363.  
 Ignition tubes, 13, 14.  
 Illumination, 133, 225.  
 Imperforate hymen, 235.  
 Incomplete enucleation in vaginal hysterectomy, 529.  
 Infection following plastic operations, 167.  
 Inguino-labial abscess, 171.  
 Injury to small intestine, 529.  
 Inspection, 80-86, 87.  
     of bladder, 273.  
     of rectum, 118-121.  
     of the ureters, 398.  
 Instillation of bladder, 370.  
 Instrument bags, 27.  
     sterilizer, 7.  
 Intestine, injury to small, 529.  
 Introduction of flexible silk catheter, 406, 414.  
     of speculum and location of the ureteral orifices, 403.  
 Invagination of the pelvic floor, 97.  
 Inversion of the uterus, 531.  
 Investigation of general condition of patient, 123.
- Iodoform gauze, 17.  
 Irrigation of the field of operation, 161, 338.  
     of bladder, 369.  
 Ischuria, 290.
- Kangaroo tendon, 139.  
 Knives, 134.  
 Koch-Ehrlich method for staining tubercle bacilli, 38.
- Labia majora, 169.  
     minora, 177.  
 Law of Metschnikoff, 33.  
     of Wissakowitsch, 33.  
 Leg holder, 143, 160.  
 Ligatures, 138.  
 Lipoma of labia majora, 169.  
 Litholopaxy, 326.  
 Local anesthesia, 145.  
 Location of ureteral orifices, 403.  
 Loculate bladder, 317.  
 Lubricant, 281.
- Malformations of urethra, 287.  
 Measurements of abdominal enlargements, 81.  
 Melano-sarcoma of urethra, 311.  
 Metal ureteral catheter, 402.  
 Methods of examining ureters, 398.  
 Micrococcus gonorrhoeae, 36.  
 Müller's fluid, 181.  
 Myoma of bladder, 386.  
     of urethra, 319.  
 Myxoma of bladder, 388.  
 Myxo-fibro-sarcoma of labium majus, 196.  
 Myxo-sarcoma of urethra, 314.
- Needle-holder, 142.  
 Needles, 140.  
 Nephrectomy, 461.  
 Nephro-ureterectomy, 428.  
 Nevoid growth of bladder, 357.  
 Normal abdomen, 84.  
 Normal uterine mucosa, 485.
- Operating room, 8.  
     suit, 19.  
     table, 10.  
 Outlet, resection of, 511.  
 Ovaries, examination of, 98.  
 Oxygen after anesthesia, 149.
- Pack, changing it, in vaginal hysterectomy, 525.  
 Packer, 143.  
 Palpation, 90.  
     of bladder, 272.  
     of the ureters, 399.  
 Papillary fibroma, 384.

- Papilloma of bladder, 384.  
 Pathogenic bacteria met with in gynecological practice, 35.  
 Pedicle, ligation of, 543.  
 Pelvic abscess, 529.  
 Pelvimetry, 404.  
 Perensson, 87.  
   of bladder, 272.  
 Perineal pad, 18, 160.  
 Perinurethritis, 422.  
 Pessaries, 240.  
 Photography, 81.  
 Physometra, 554.  
 Pneumaturia, 360.  
 Pneumonia after anesthesia, 149.  
 Polyps, 480, 547.  
   forceps, 438.  
 Position of patient for plastic operation, 160.  
 Posture of patient for examination of bladder, 299.  
 Postures, 90.  
 Preparation of patient for examination of bladder, 279.  
   of patient for anesthesia, 107.  
   of patient for plastic operation, 159.  
   of room in private house, 28.  
   of surgeon, assistants, and nurses, 19.  
 Prolapse of urethral mucosa, 454.  
   of urethral mucosa, 290.  
   of uterus, 499.  
   without vesical diverticulum, 503.  
 Pruritis, 498.  
 Pseudo-myxoma of the canal of Nuck, 172.  
 Pyometra, 552.  
 Pyoureter, 448.
- Rat-toothed forceps, 436.  
   dissecting forceps, 436.  
 Rectal diverticulum, 501.  
 Recto-vaginal septum, operations on, 208.  
 Rectum, examination of, 98, 99, 115.  
   prolapse of, 513.  
 Relaxed vaginal outlet, operation for, 247.  
 Rest and tonic treatment, 466.  
 Resuscitation of the asphyxiated, 154-156.  
 Retention cysts, 549.  
 Retractors, 144.  
 Roux-Noeud's glycerin agar, 39.  
 Rubber drainage pads, 18.  
 Rules for administering any anesthetic, 152.  
   for administering chloroform, 152.  
   for use of anesthesia in examinations, 107.  
 Rupture of uterus, 547.
- Sarcoma of bladder, 387.  
   of body of uterus, 491.  
 Sarcoma of clitoris, 184.  
   of urethra, 343.  
   of vagina, 253.  
 Scalpels, 134.  
 Scissors, 134.  
   straight scissors, 135.  
   Emmet's left-curved scissors, 135.  
 Searcher, urethral, 278.  
 Sepsis, 1.  
 Septum, complete tear of, 208, 211, 513.  
 Signs of complete relaxation in anesthesia, 148.  
 Silk, fine, medium, and heavy, 13, 138.  
 Silkworm gut, 13, 138.  
 Silver wire, 139.  
 Smegma bacillus, 35.  
 Specula, use of, in inspection, 87.  
 Speculum, Goodell-Baer bivalve speculum, 134.  
   introduction of, into bladder, 282.  
   Kelly's small cylindrical speculum for girls, 134.  
   Nelson's trivalve speculum, 134.  
   Simon's speculum, 134.  
   Sims's speculum, 134.  
 Sponge forceps, 137.  
 Sponges, 17.  
 Staphylococcus aureus and albus, 34, 39, 40.  
   citreus, albus, 34, 39, 40.  
   epidermidis albus, 2, 34.  
 Steam disinfection, 4.  
 Sterilizer, 5, 6.  
 Sterilization and preservation of instruments, 11.  
   of catgut with eumol, 14.  
   of gauze, cotton, towels, and bandages, 12.  
   of instruments, dressings, and ligatures, 21.  
   of sutures and ligatures, 12.  
 Sterilized rubber gloves, 25.  
   water, 11.  
 Sterilizers, 5-7.  
 Streptococcus pyogenes, 39, 40.  
 Stricture of ureter, 436.  
   of vagina, 257.  
   traumatic, of ureter, 444.  
 Submucous myomatous, 538.  
 Suburethral abscess, 303.  
 Suppuration, 39.  
 Suspension of the uterus, 513.  
 Suture materials, 138.  
 Sutures, removal of, 165.  
 Swedish ball irrigator, 162.  
 Symphysectomy for vesical tumors, 394.  
 Syphilis, 39.
- Taking the history, 127.  
 Tanks for storage of hot and cold water, 11.

- Tementa, 435.  
 Tenuculum forceps, 430.  
 Topographical anatomy, 42.  
   anatomy of small intestines, 40.  
 Topography of the bladder, 200.  
 Transfixion needles, 143.  
 Trocars, 143.  
 Tubercle bacillus, 35, 38, 39.  
 Tubercular cystitis, 376.  
   ureteritis, 425.  
 Tuberculosis, 38.  
   of endometrium, 489.  
   of genital tract, 38.  
   of the vestibule, 203.  
 Tumors of the bladder, 382.  
 Tying knots with silk and catgut, 110.  
   off one broad ligament in vaginal hysterectomy, 519.  
 Typhoid fever bacillus, 39.  
  
 Ureter, anatomy of, 396.  
   catheterization of, 400.  
   congenital affections of, 416.  
   congenital flexure of, 422.  
   cystic dilatation of occluded ureter, 421.  
   introduction of flexible silk catheter into, 406.  
   ligation of, 528.  
   location of ureteral orifices, 403.  
   methods of examination, 398.  
   obstruction of, 431.  
   physiology of, 397.  
   sounding, 413.  
   stricture of, 436.  
 Ureteral bougies, 452.  
   calculus, 449.  
   fever, 415.  
   fistula, 455.  
   folds, 269.  
   syringe, 278.  
 Ureteritis, 422.  
   tubercular, 425.  
 Uretero-cystostomy, 459.  
 Ureterostomy, 464.  
 Ureterotomy, 465.  
 Uretero-ureterostomy, 466.  
 Urethra, affections of, 287.  
   atresia of, 288.  
   cancer of, 311.  
   caruncle of, 307.  
   congenital absence of, 289.  
   dilatation of, 280.  
   displacements of, 289.  
   fibroma of, 309.  
   *Urethra, fistula of*, 297.  
   foreign bodies in, 298.  
   myoma of, 310.  
   new growths of, 306.  
   sarcoma of, 313.  
   stricture of, 294.  
   *Urethral dilator*, 277.  
   *Urethritis*, 300.  
   *Urethroscopy*, 274.  
   *Urimolysis*, 272.  
 Urine, analysis of separated urines, 413.  
   how to obtain uncontaminated urine, 410.  
   how to secure urine from both sides at the same time, 409.  
   how to secure urine directly from the ureter without catheterization, 410.  
   points to be observed in securing separated urines, 412.  
   *Urine scrapings*, 484.  
 Uterus, examination of, 98.  
  
 Vagina, absence of, 232.  
   anatomy of, 230.  
   congenital affections of, 232.  
   double, 239.  
   foreign bodies in, 240.  
   neoplasms of, 252.  
   traumatic affections of, 257.  
 Vaginal cysts, 246.  
   hysterectomy, 514.  
 Vaginal outlet, obstetrical injuries of, 206.  
   physiological support of, 204.  
   resection of, 511.  
   septa, 238.  
 Vaginitis, 242.  
 Varicose bladder, 350.  
 Vesical bacteria, 35, 364.  
   balloon, 372.  
   diverticulum, 502.  
   herpes, 486.  
   specula, 276.  
 Vulvo-vaginal glands, 189.  
  
 Washing of genitalia, 161.  
 Weichselbaum's method of staining tubercle bacilli, 39.  
 Wertheim's method of staining the gonococcus, 36.  
  
 Young and Hagner medium, 37.  
  
 Ziehl-Neelsen method of staining tubercle bacilli, 39.