

**CIHM
Microfiche
Series
(Monographs)**

**ICMH
Collection de
microfiches
(monographies)**



Canadian Institute for Historical Microreproductions / Institut canadien de microreproductions historiques

© 1997

Technical and Bibliographic Notes / Notes techniques et bibliographiques

The Institute has attempted to obtain the best original copy available for filming. Features of this copy which may be bibliographically unique, which may alter any of the images in the reproduction, or which may significantly change the usual method of filming are checked below.

- Coloured covers / Couverture de couleur
- Covers damaged / Couverture endommagée
- Covers restored and/or laminated / Couverture restaurée et/ou pelliculée
- Cover title missing / Le titre de couverture manque
- Coloured maps / Cartes géographiques en couleur
- Coloured ink (i.e. other than blue or black) / Encre de couleur (i.e. autre que bleue ou noire)
- Coloured plates and/or illustrations / Planches et/ou illustrations en couleur
- Bound with other material / Relié avec d'autres documents
- Only edition available / Seule édition disponible
- Tight binding may cause shadows or distortion along interior margin / La reliure serrée peut causer de l'ombre ou de la distorsion le long de la marge intérieure.
- Blank leaves added during restorations may appear within the text. Whenever possible, these have been omitted from filming / Il se peut que certaines pages blanches ajoutées lors d'une restauration apparaissent dans le texte, mais, lorsque cela était possible, ces pages n'ont pas été filmées.
- Additional comments / Commentaires supplémentaires:

L'Institut a microfilmé le meilleur exemplaire qu'il lui a été possible de se procurer. Les détails de cet exemplaire qui sont peut-être uniques du point de vue bibliographique, qui peuvent modifier une image reproduite, ou qui peuvent exiger une modification dans la méthode normale de filmage sont indiqués ci-dessous.

- Coloured pages / Pages de couleur
- Pages damaged / Pages endommagées
- Pages restored and/or laminated / Pages restaurées et/ou pelliculées
- Pages discoloured, stained or foxed / Pages décolorées, tachetées ou piquées
- Pages detached / Pages détachées
- Showthrough / Transparence
- Quality of print varies / Qualité inégale de l'impression
- Includes supplementary material / Comprend du matériel supplémentaire
- Pages wholly or partially obscured by errata slips, tissues, etc., have been refilmed to ensure the best possible image / Les pages totalement ou partiellement obscurcies par un feuillet d'errata, une pelure, etc., ont été filmées à nouveau de façon à obtenir la meilleure image possible.
- Opposing pages with varying colouration or discolourations are filmed twice to ensure the best possible image / Les pages s'opposant ayant des colorations variables ou des décolorations sont filmées deux fois afin d'obtenir la meilleure image possible.

This item is filmed at the reduction ratio checked below / Ce document est filmé au taux de réduction indiqué ci-dessous.

	10x		14x		18x		22x		26x		30x	
									✓			
	12x		16x		20x		24x		28x		32x	

The copy filmed here has been reproduced thanks to the generosity of:

National Library of Canada

The images appearing here are the best quality possible considering the condition and legibility of the original copy and in keeping with the filming contract specifications.

Original copies in printed paper covers are filmed beginning with the front cover and ending on the last page with a printed or illustrated impression, or the back cover when appropriate. All other original copies are filmed beginning on the first page with a printed or illustrated impression, and ending on the last page with a printed or illustrated impression.

The last recorded frame on each microfiche sheet contains the symbol \rightarrow (meaning "CONTINUED"), or the symbol ∇ (meaning "END"), whichever applies.

Maps, plates, charts, etc., may be filmed at different reduction ratios. Those too large to be entirely included in one exposure are filmed beginning in the upper left hand corner, left to right and top to bottom, as many frames as required. The following diagrams illustrate the method:

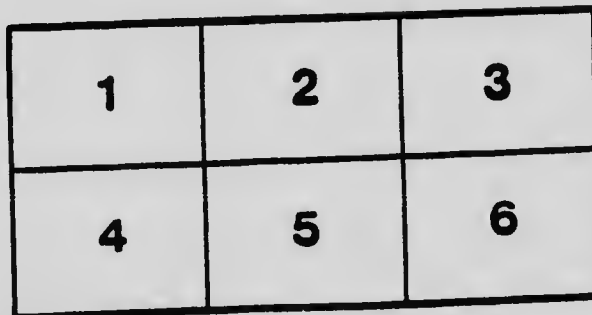
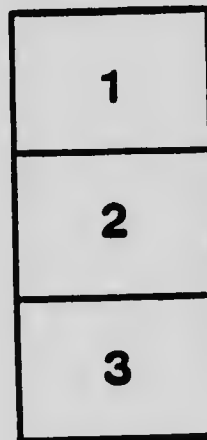
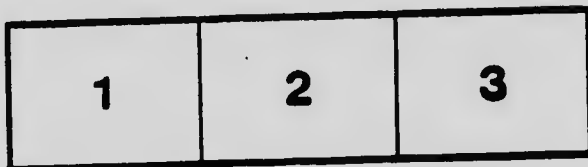

L'exemplaire filmé fut reproduit grâce à la générosité de:

Bibliothèque nationale du Canada

Les images suivantes ont été reproduites avec le plus grand soin, compte tenu de la condition et de la netteté de l'exemplaire filmé, et en conformité avec les conditions du contrat de filmage.

Les exemplaires originaux dont la couverture en papier est imprimée sont filmés en commençant par la première page et en terminant soit par la dernière page qui comporte une empreinte d'impression ou d'illustration, soit par la seconde page, selon le cas. Tous les autres exemplaires originaux sont filmés en commençant par la première page qui comporte une empreinte d'impression ou d'illustration et en terminant par la dernière page qui comporte une telle empreinte.

Un des symboles suivants apparaît sur la dernière image de chaque microfiche, selon le cas: le symbole \rightarrow signifie "A SUIVRE", le symbole ∇ signifie "FIN".

Les cartes, planches, tableaux, etc., peuvent être filmés à des taux de réduction différents. Lorsque le document est trop grand pour être reproduit en un seul cliché, il est filmé à partir de l'angle supérieur gauche, de gauche à droite, et de haut en bas, en prenant le nombre d'images nécessaire. Les diagrammes suivants illustrent la méthode.

MICROCOPY RESOLUTION TEST CHART

(ANSI and ISO TEST CHART No. 2)

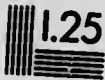
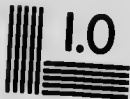

APPLIED IMAGE Inc

1653 East Main Street 14609 USA
Rochester, New York
(716) 482 - 0300 - Phone
(716) 288 - 5989 - Fax



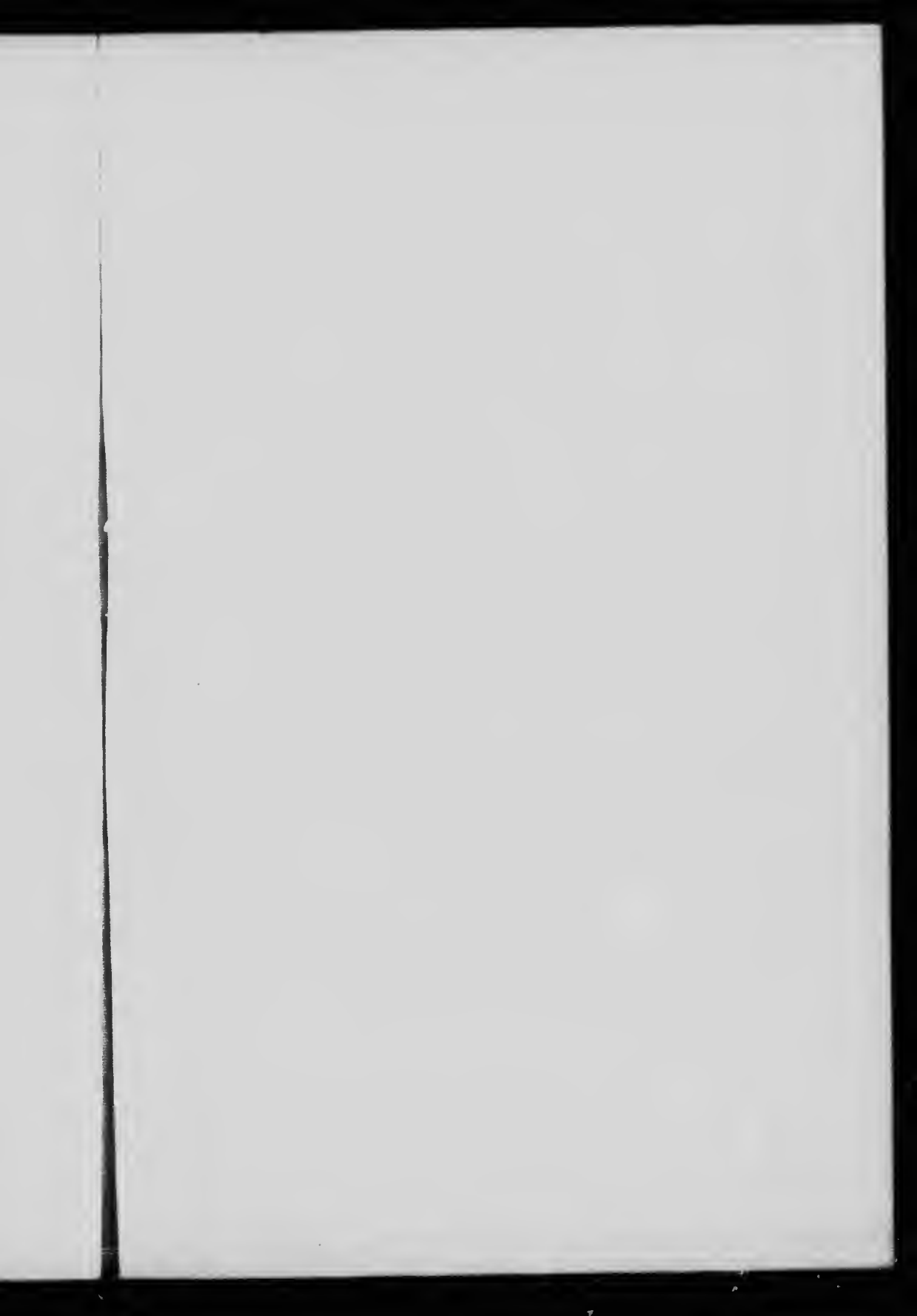

DEPARTMENT OF THE INTERIOR
HON. CLIFFORD MIFTON, MINISTER.

ON THE LOCATION AND EXAMINATION
OF
MAGNETIC ORE DEPOSITS
BY
MAGNETOMETRIC MEASUREMENTS

BY
EUGENE HAANEL, PH. D. (BRELAU)
SUPERINTENDENT OF MINES.

OTTAWA, CANADA.

1904.

SIR,—

I have the honour to submit herewith a report on the Location and Examination of Magnetic Ore Deposits by Magnetometric Measurements, which was read at the Annual Meeting of the Canadian Mining Institute on March 5th, 1903.

I have the honour to be,

Sir,

Your obedient servant,

EUGENE HAANEL,

Superintendent of Mines.

HONOURABLE CLIFFORD SIFTON

Minister of the Interior,

Ottawa,

00925055

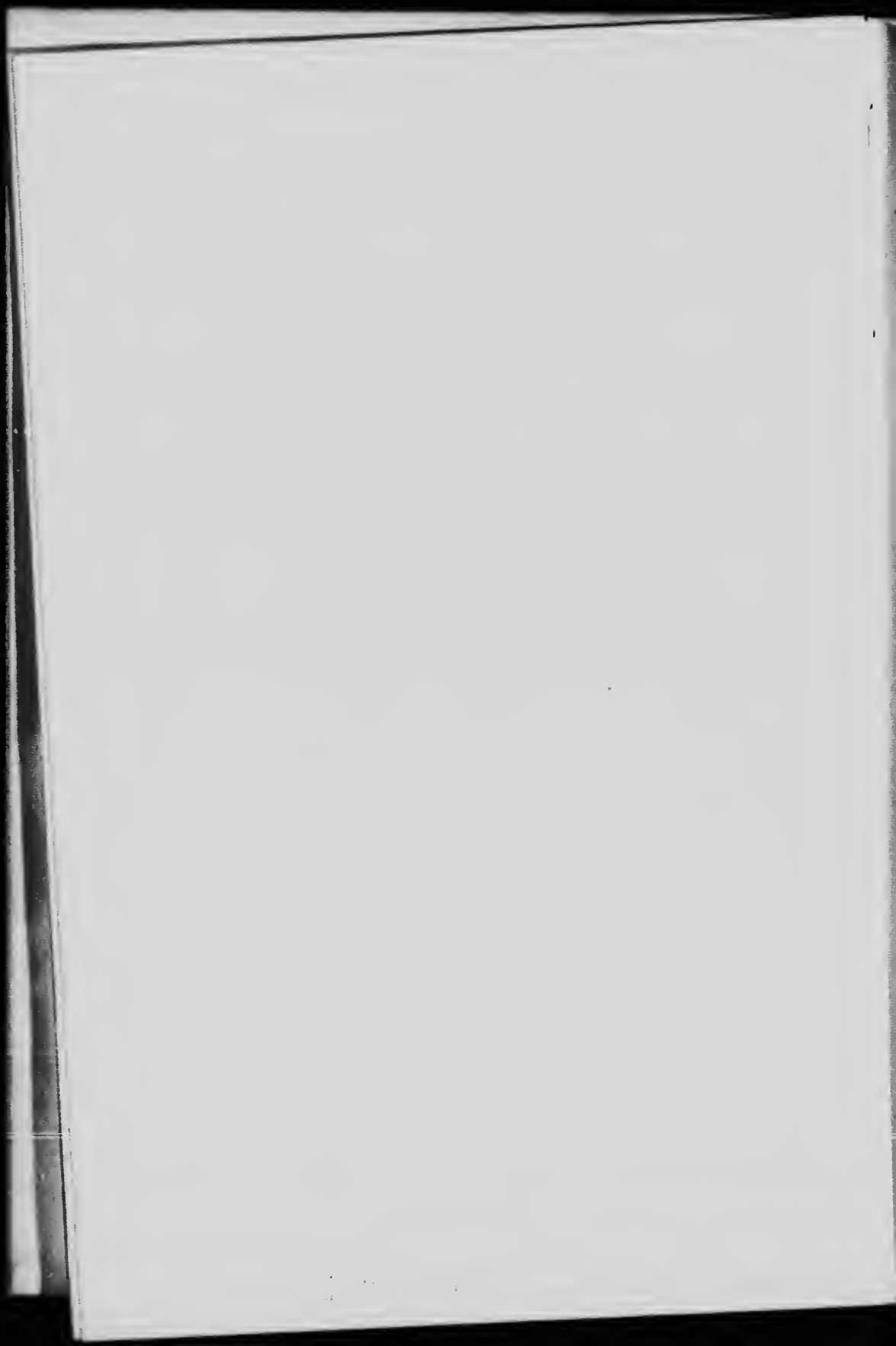

TABLE OF CONTENTS.

	PAGES
Introduction	1 2
CHAPTER I.	
MAGNETS AND THEIR PROPERTIES.	
Definition of magnet. Poles. Law of attraction and repulsion. Theory of the constitution of magnets	3 4
CHAPTER II.	
THE MAGNETIC FIELD.	
Lines of force. Strength of a magnetic field at a point. Conservation of flow of force. Construction of diagrams of magnetic fields. Diagrams of unipolar magnetic fields. Diagrams of bipolar magnetic fields. 1st: Two unlike poles of equal strength; 2nd: Two unlike poles of different strengths. Equation of a line of force. Inductive effect of the magnetic field upon magnetic bodies..	4-13
CHAPTER III.	
The earth's normal magnetic field	14-16
CHAPTER IV.	
THE DISTURBED TERRESTRIAL FIELD OF FORCE.	
Relation of dip to intensity of magnetization	16-18
CHAPTER V.	
Effect of a magnet on a compass needle in a normal terrestrial field	18-23

CHAPTER VI.

THE THALÉN-TIBERG MAGNETOMETER.

PAGES

Description : The compass. The support of the compass with its deflecting magnet.

Testing and adjusting the magnetometer :

1. Examination of error due to eccentric suspension of compass needle.
 2. Examination whether axis of rotation of support is perpendicular to plane of box-level D , on base plate P_3 .
 3. Examination whether axis of compass box is perpendicular to vertical axis of rotation of support.
 4. Examination whether the vertical screw of bar Q when in contact with the lower plate of compass box renders compass box horizontal.
 5. Examination whether the horizontal screw of the bar Q when in contact with plate P_2 of compass box indicates its vertical position.
 6. Neutralization of the vertical component of the earth's normal field.
- Precautions to be observed in taking observations with the magnetometer 24-32

CHAPTER VII.

Method of observation : (With the Thalén-Tiberg magnetometer).

Horizontal Intensity of a magnetic field 33-36

CHAPTER VIII.

DAHLBLOM'S MODIFICATION OF THE SINE METHOD.

Method of observation. Calibration of millimeter scale and construction of scale for reading R

direct 37-42

CHAPTER IX.

	PAGES
The value of the horizontal intensity in a terrestrial field of force, disturbed by the presence of a magnetic ore body	43-48

CHAPTER X.

THE VERTICAL INTENSITY OF THE DISTURBED FIELD.

Theory of the Inclinometer. Determination of the value of <i>K</i> . Method of observation	49-56
---	-------

CHAPTER XI.

THE THOMSON-THALÉN MAGNETOMETER.

Description. Theory. Calibration	56-65
---	-------

CHAPTER XII.

Description of the Swedish mining compass	65-66
--	-------

CHAPTER XIII.

INVESTIGATION OF MAGNETIC ORE DEPOSITS BY
MAGNETOMETRIC MEASUREMENTS.

Chart of the Horizontal Intensity. Charts of Vertical Intensity	67-74
--	-------

CHAPTER XIV.

Information conveyed by the charts of magnetic intensity	74-80
---	-------

CHAPTER XV.

Determination of the distance of the upper pole of a magnetic ore body beneath the surface. Four methods	81-86
---	-------

CHAPTER XVI.

Determination of the extension in depth of a magnetic ore body. 1st: Method by Dahlblom. 2nd: Method by Robert Thalén	87-94
--	-------

CHAPTER XVII.

	PAGES
Laboratory Practice	94-99

APPENDIX.

THE DAHLBLOM MAGNETOMETER.

Description of the Magnetometer. Adjustment of the Magnetometer. Measurement of Horizontal Intensity. Measurement of Vertical Intensity . .	99-105
---	--------

LIST OF TABLES.

Table I. Table of values of $\frac{\sin a_0}{\sin a}$	106-110
Table II. Table of values of $\frac{\tan a_0}{\tan a}$	111-115
Table III. Table of values of $\left(\frac{1}{\mu}\right)^{\frac{1}{3}}$ from $\mu = 0.01$ to to $\mu = 5.00$	116
Table IV. Table of natural tangents	117
Table V. Table for the reduction of the angles e observed with the Tjberg Inclinator:	
V_n from 1 to 41; k_n from 0.50 H to 0.90 H	118
V_n from 42 to 90; k_n from 0.50 H to 0.90 H	119
V_n from 1 to 49; k_n from 0.95 H to 1.40 H	120
V_n from 50 to 90; k_n from 0.95 H to 1.40 H	121
V_n from 1 to 51; k_n from 1.45 H to 1.80 H	122
V_n from 52 to 90; k_n from 1.45 H to 1.80 H	123
Table VI. Table of $\cot x$ and x°	124-125
Index	127-132

LIST OF PLATES.

- PLATE A.
The Dahlblom Pocket Magnetometer. (Face).
- PLATE B.
The Dahlblom Pocket Magnetometer. (Back).
- PLATE C.
Thalén-Tiberg Magnetometer. (Set up as Inclinator).
- PLATE D.
Thalén-Tiberg Magnetometer with Dahlblom's arm.
- PLATE E.
Thomson-Thalén Magnetometer. (Glass cap removed).
- PLATE I.
Vertical section of the field of force through the station
line *m* of Plates II and III.
- PLATE II.
Isodynamic lines of horizontal intensity *R*.
- PLATE III.
Isodynamic lines of vertical intensity *G*.
- PLATE IV.
Isogonic lines δ^0 .
- PLATE V.
Isodynamic lines of the horizontal intensity of a deposit of
magnetite.
- PLATE VI.
Isodynamic lines of the vertical intensity of a deposit of
magnetite.
- PLATE VII.
Chart of isodynamic lines of an acted ore body.
- PLATE VIII.
Field of force of an ideal magnet.



Introduction.

IN 1843, Freiherr von Wrede, impressed with the work done by Lamont in determining the characteristic elements of the earth's magnetic field with his newly invented theodolite, was the first to realize that by measuring the changes in the earth's normal field, caused by the presence of magnetic ore deposits, the location and extent of these ore deposits might be determined.

Nothing was done by him, however, to carry this thought into execution, nor was his method published until he became acquainted with Professor Robert Thalén's publication in 1879: "On the Examination of Iron Ore Deposits by Magnetic Measurements." This publication laid the foundation for the practice of the magnetometric method in the field.

As experience accumulated, new methods were invented, giving better results, or solving new problems. The old magnetometer also became transformed by reconstruction, which permitted the use of the compass as a Tiberg inclinometer, into the convenient field instrument—the Thalén-Tiberg magnetometer—as now furnished by the Swedish mechanics.* To these instrumental appliances for magnetic surveys of ore deposits has recently† been added the Thomson-Thalén magnetometer, which, based upon a zero method, especially facilitates the determination of the distribution of the vertical intensity over magnetic ore fields.

In the hands of *experts*, furnished with such instruments, the Swedish methods yield data from which magnetic ore bodies may be located, and in many cases their strike, direction of dip, and depth below the surface determined.

* Instrumentmakar, J. Fr. Berg, Stockholm.

† 1899.

That so valuable a method should fail of recognition in other countries, and be confined in its application almost altogether to Sweden, led the late Professor Nordenström, of Stockholm,* to express himself as follows: "It is astonishing that people in these countries" (referring to European countries other than Sweden) "have not already learned to appreciate the great advantages which are offered the practical miner by the use of magnetic instruments."

As late as March, 1899, P. Uhlich states † that nothing had appeared on this subject in German literature except an article in 1879 by A. Felix, on Thakén's method. This also is the case as regards the English literature on the subject, no detailed account of the Swedish method having yet appeared in the English language. What has been published contains so meagre an account, and is so fragmentary, that it is useless for purposes of instruction.

In view of this, it occurred to me that a service might be rendered the mining profession by furnishing so full an account of the Swedish method and practice as would enable any mining engineer, with proper training and in possession of the proper instruments, to employ the method in the field.

The tables which accompany this paper are intended to facilitate the calculation of results, and have been calculated for me through the courtesy of Mr. King, chief astronomer of the Department of the Interior, or have been taken from P. Uhlich's "Markscheidekunde," ‡ unless otherwise stated. The drawings and plates have been prepared for the engraver by Mr. Erik Nyström, M.E.

* "The most Prominent and Characteristic Features of Swedish Iron Ore Mining," by Professor G. Nordenström, London, 1899, page 22.

† "Ueber Magnetische Erzlagerstätten und deren Untersuchung durch Magnetische Messungen," von Th. Dahlblom.

"Übersetzt aus dem Schwedischen," by P. Uhlich, Freiberg, 1899, Vorwort des Uebersetzers.

‡ "Lehrbuch der Markscheidekunde," von P. Uhlich, Freiberg in S., 1901.

CHAPTER I.

MAGNETS AND THEIR PROPERTIES.

Definition of Magnet.—By the term magnet we usually designate a piece of steel which has the property of attracting certain substances termed magnetic bodies, such as iron, nickel, cobalt, etc.

Poles.—This attractive power is concentrated at certain points in the magnets termed poles. In long and very thin magnets these poles are situated at the ends. In massive magnets the poles are situated at points about $\frac{1}{2}$ of the length of the magnets from each end. The line joining the poles is termed the *magnetic axis*. A magnet suspended so that it may swing in a horizontal plane comes to rest in a definite position, with its axis in general in a north-south direction. If the end pointing north be marked, it will be found that this end at every successive trial points north. Hence this pole is termed the north-seeking pole, or shortly, the north pole, the other the south pole.

Law of Attraction and Repulsion.—If a north pole of one magnet is made to approach the north pole of another, suspended from its center of gravity, the latter will be repelled; if made to approach its south pole, it will be attracted. Similarly, two south poles will repel. Hence like poles repel, unlike attract. The force with which this attraction and repulsion acts has been found to be proportional directly to the product of the strengths of the poles and inversely as the square of the distance between the acting poles. If σ and μ are the strengths of the respective poles and d the distance between them, the force f , acting between them = $\frac{\sigma \mu}{d^2}$.

Theory of the Constitution of Magnets.—If a glass hardened steel spring be magnetized, it is found that when broken each piece constitutes an independent magnet, with

a north and south pole. This will hold true for the smallest piece which can be obtained by the process of fracture. This leads to the conception that every magnet is an aggregate of elemental magnets with their axes so arranged that they are parallel and like poles point in the same direction. The justice of the conception that the magnetism of a magnet depends upon the *arrangement* of the elemental magnets of which it consists, receives corroboration from the internal structure and properties manifested by a glass tube filled with steel filings in the non-magnetic and in the magnetic state. When first filled with neutral steel filings, the tube as a whole shows none of the properties of a magnet. On magnetization, the filings at once assume new positions and arrange themselves in the form of filaments, which traverse the tube from end to end. The contents of the tube now exhibit fibrous structure, and the tube as a whole will now behave like an ordinary magnet. Forceful destruction of this arrangement by shaking is accompanied by destruction of manifestation of magnetism, to be recovered only by reproducing the filamentous arrangement by process of magnetization.

I may call attention at once here to the important fact that magnets, through jarring or other rough treatment which produces internal molecular movement, lose strength, and hence the necessity of carefully guarding against such loss when engaged in making a set of magnetometric measurements, for during the time occupied by these measurements the magnets employed are assumed to remain of the same strength.

CHAPTER II.

THE MAGNETIC FIELD.

The space about a magnet, in which it exerts force, is termed its *magnetic field*.

Lines of Force.—According to the conception of Faraday, this field is traversed by lines of magnetic force, which are

defined as the paths traced out by a free north pole placed in the field. The direction of these lines is the direction of the movement of the free north pole, as it sweeps out a line of force. In the case of a thin, long magnet, with poles at the ends, the lines of force *all* start from the north pole and in curves pass through the intervening space to the south pole and through the substance of the magnet back to the north pole. These lines of force are, therefore, closed curves, with the exception of the line passing out of the magnet in the prolongation of its axis. The magnet just described is an ideal magnet. The field produced by a massive magnet is not so simple. The poles are not at the ends, and lines of force start out, not from a pole considered as a point, but from the north pole area, and also from the sides of the magnet, to find their way through the surrounding medium into corresponding points on the south end of the magnet. The lines of force play an important part in the determination of the depth of magnetic ore deposits. The conception of a free north pole, employed in defining a line of force, is a convenient mathematical fiction and cannot be realized in practice, since north polarity cannot be separated from south polarity in a magnetized substance, so that one piece might simply be north polar and another piece exhibit only south polar magnetism.

A common way of showing these lines of force consists in sprinkling iron filings upon stiff but smooth paper, placed over a magnet. The filings arrange themselves along lines of force, and may be photographed for further reference; or since a line of force indicates at every point of it the direction of the magnetic force, these lines may be traced out by a delicate small compass, about $\frac{3}{4}$ inch in diameter. The needle of the compass will place itself with its axis tangent to a line of force. To employ this method the compass is placed in the field of force upon a sheet of paper of sufficient size to contain the field of force to be mapped and the position of its poles marked by a pencil point. The compass is now advanced a distance equal to its diameter, and placed with its north pole over the point

previously occupied by the south pole and the new point indicated by a pencil mark. The line resulting by joining these points is a line of force. In this manner the whole field of force may be mapped out.

The representations of lines of force thus obtained are lines of force in a plane, and to form a conception of their distribution in space it is necessary to revolve the representation of the field about the axis of the magnet. The lines of force will then sweep out surfaces upon which the lines of force lie.

Strength of a Magnetic Field at a Point.—The strength of a magnetic field at a point is a number expressing the force exerted by the magnet on a unit north pole at this point in terms of unit force—the dyne*—and this number is by convention taken as equal to the number of lines of force passing perpendicularly through unit area (1 cm.^2) placed with its geometric center at the given point. From this it follows that in the stronger parts of the field the lines of force are crowded more closely together than in the weaker parts of the field. This is shown by representations of fields of force by iron filings. The lines of force are seen to be crowded more closely together in the region of the poles than in the space midway between the poles. But it must not be imagined that in this crude representation of a magnetic field of force the spaces between the trains of iron filings are regions which are not traversed by lines of force. No space in the field of a single magnet is free from lines of force. The definition of the strength of a field of force by the number of lines of force passing through unit area is merely a convenient convention; attention being drawn to just *that* number of lines of *all* the lines passing through the unit area which correspond to the number of dynes exerted by the field upon a unit north pole at the given point.

A tube of force is a channel bounded laterally by lines of force.

* The dyne is a force which acting for one second upon unit of mass equal to one gramme imparts to it an acceleration equal to one centimeter.

The flow of force F is the product of the cross-section s of a tube of force into the value of the magnetic force H at the place of the cross-section s , hence :

$$F = Hs.$$

Conservation of Flow of Force.—Considering the field of force of a single ideal magnet, it is evident that the number of lines of force of its field are constant, *i.e.*, no new lines are originated, nor do those existing vanish. Through every cross-section, therefore, of the same tube of force the same number of lines of force must pass. If s and s' are the cross-sections of the same tube of force at different places in the field, the flow of force for both cross-sections must remain the same. We have, therefore :

$$F = Hs = H's'.$$

Construction of Diagrams of Magnetic Fields.—

If we imagine a sphere described with radius unity (1 cm.) about a magnetic pole of unit strength, the magnetic force due to this pole will at every point on the spherical surface equal unity. Since there are 4π square centimeters in the surface of this sphere, it is evident that if we desire to represent the intensity of the field by the number of lines of force passing through unit area, we must conceive 4π lines passing out of the pole into the surrounding space. The whole flow of force in this case is 4π . If the strength of the pole = σ , $4\pi\sigma$ will be the number of lines passing out from such a pole and the whole flow of force will equal $4\pi\sigma$ units.

Diagrams of Unipolar Magnetic Fields.—A pole of strength $\sigma = \frac{30}{4\pi}$ will send out 30 lines of force and the entire flow of force is equal to $4\pi\sigma$ or 30 units. To represent this distribution of magnetic force diagrammatically, we require to subdivide the space surrounding the magnetic pole into 30 single spaces, through each of which unit flow of force passes. This is accomplished as follows :—

About the pole P (see Fig. 1), of strength $\frac{30}{4\pi}$, describe a

circle with any convenient radius and draw a diameter through *P*. This diameter is divided into 30 equal parts and lines are drawn perpendicular to the diameter through the points of division, until they intersect with the circumference. Through these intersections lines are drawn from the centre of the circle. These lines represent some of the lines of force which pass from the pole into space. If now we imagine the figure to revolve

Fig.1

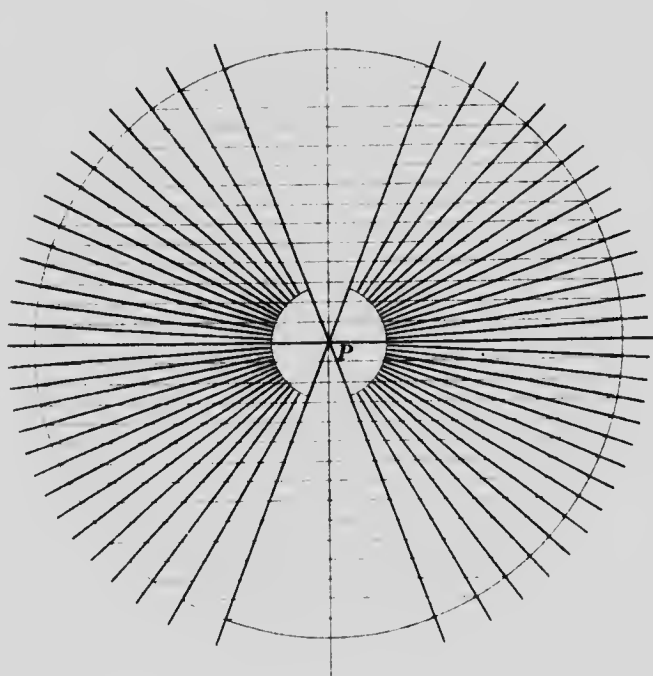

about the diameter, these lines of force will describe cones which cut out of the surface of the sphere zones of equal area. Since the flow of force proceeds uniformly in all directions from the pole, each unit area of the sphere will be traversed by the same quantity of flow of force, hence each zone is traversed by unit flow of force. In the figure those lines of force only appear which pass at the limit of the zones of equal area.

Diagrams of Bipolar Magnetic Fields:—

1st—Two unlike poles of equal strength.

Let the poles, as in the previous case, be of strength $\sigma = \pm \frac{30}{4\pi}$ *. The north pole will send out 30 lines of force and the south pole receive an equal number. To represent diagrammatically the flow of force in this case, join the poles by a line to serve as axis and construct upon this axis the unipolar field for each pole. (See Fig. 2). If now we imagine the figure to revolve about the axis, the lines of force describe 2×30 interpenetrating cones. Through 30 of these the north pole sends out for each a unit flow of force, which enters the 30 corresponding cones of the south pole. This system of cones must coalesce, dividing the space into channels of flow of force, which pass continuously from the north pole to the south pole. The combination of the two fields into one is effected by drawing the diagonals of the four-sided figures, which result from the cutting of the lines of force. We thus obtain lines of force passing from the north pole to the south pole, which appear as broken lines: which, however, approach continuous curves with increase of the subdivision of the channels of force.

2nd—Bipolar fields of magnetic force of two unlike poles of different strengths. (Fig. 3).

The construction is the same in principle as in the previous case. The length of the radii of the circles is taken in the ratio of the total flow of force sent out or absorbed by the pole, and the number of subdivisions of the diameters of each circle corresponds to the total flow of force emitted by, or vanishing into, the pole. Thus, if the north pole is of strength $+\frac{30}{4\pi}$ and the south pole of $-\frac{10}{4\pi}$, the radii of the circles are made respectively 30 and 10 and the subdivisions also of their diameters are 30 and 10 respectively.

* North seeking polarity is indicated by +, south seeking polarity by -.

Fig. 2

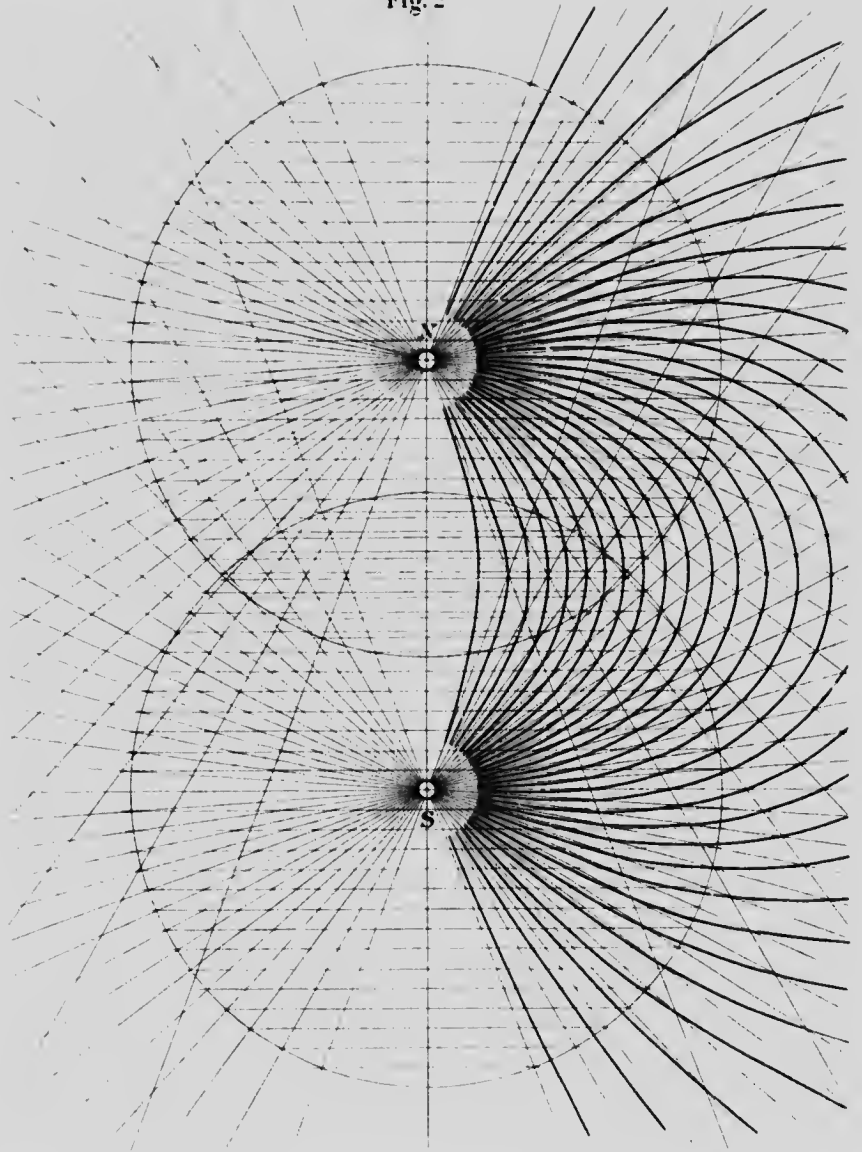
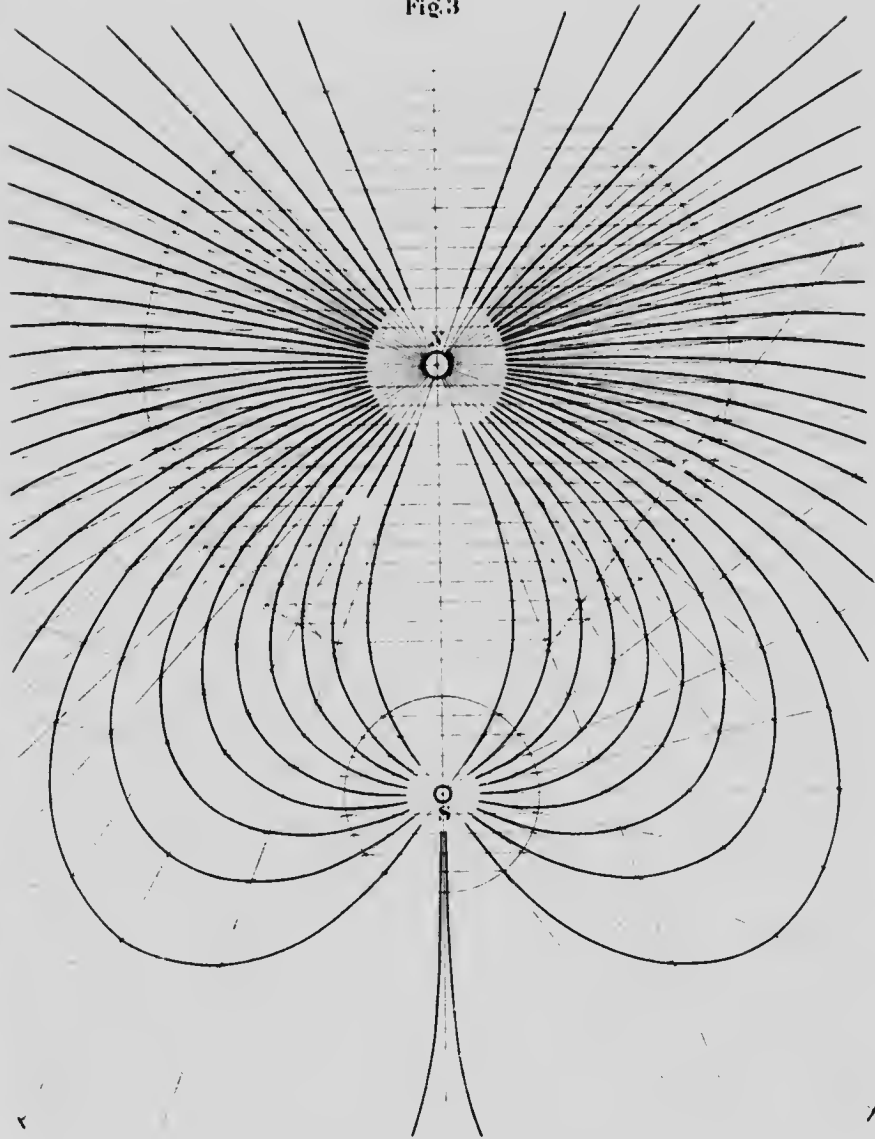

Fig 3



Equation of a Line of Force.

The line passing through the points $N x y z$ (Fig. 4) is part of a line of force. Let NS , the length of the magnet,

Fig. 4

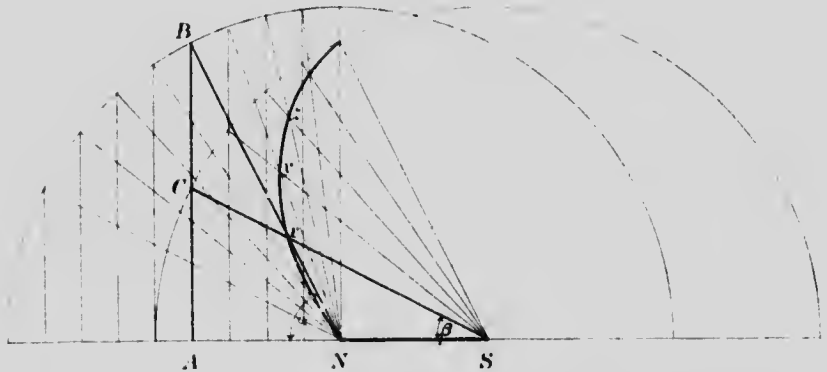

$= a$, r the radius of the auxiliary circles, the angle $BNA = a$ and the angle $CSA = \beta$; then for the point x of the line of force we have:

$$AN = r \cos a$$

$$AS = r \cos \beta$$

$$AS - AN = a = r (\cos \beta - \cos a)$$

and $\frac{a}{r} (\cos \beta - \cos a) = C$, a constant. (1)

This relation is termed the equation of the line of force and r its parameter. To each line of force belongs a separate value of r .

Inductive Effect of the Magnetic Field Upon Magnetic Bodies.—If a magnetic body, such as a piece of soft iron, be placed in a magnetic field, the original field is greatly altered. The lines of force of the field in the vicinity of the iron concentrate in the space occupied by the iron. A south pole will be developed in the iron where the lines of force enter, a north pole where they pass out of the iron into the space of the field. The soft iron, while in the field, is thus a

magnet with its own field induced by the original field and the magnetic field as a whole is a composite field of two magnets. The soft iron, when taken out of the field, loses its polarity. If the piece of soft iron be placed transversely across the pole of a magnet, without touching it, it will be seen that the lines of force enter the iron, divide, and pass out at both ends, so that a south pole will be developed in the center of the piece of iron and two north poles, one at each end. The space beyond the iron in the direction d will be free from lines of force. (See Fig. 5).

Fig. 5

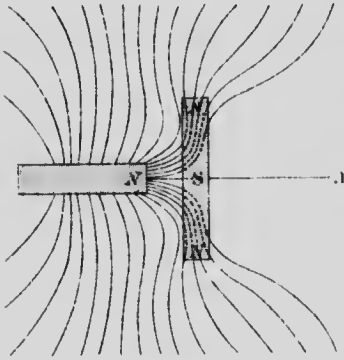

The lines of force are thus shown to pass more readily through iron and in general through magnetic bodies than bodies which are non-magnetic. This is usually expressed by saying that the *permeability* of magnetic bodies is greater than that of non-magnetic bodies, and is greatest for soft iron. The intensity of the disturbance of a magnetic field of force produced by a magnetic body is in general proportional to the permeability.

The permeability of hardened steel is much less than that of soft iron, but the polarity developed in it by a strong field is retained by it after removal from the field. Magnetite, jakobsite and pyrrhotite behave in this respect like steel, and when once magnetized, are capable with their own field of acting inductively upon other magnetic bodies. These have been designated by the Swedish authorities as "attractorily" magnetic bodies. The minerals: menaccanite, olivin, augite, hornblende and pyrite are termed "retractorily" magnetic bodies. These, though attracted by a strong magnet and of permeability greater than that of non-magnetic bodies (*i.e.*, bodies indifferent to magnetic force, as glass, quartz, etc.), lose the polarity developed in a magnetic field, when removed from it.

CHAPTER III.

THE EARTH'S NORMAL MAGNETIC FIELD.

A magnetic needle, free to swing in any plane, placed in a magnetic field will place itself tangent to a line of force. If this experiment be made on the surface of the earth in different localities, it will be found that the needle will in general place itself with its axis in a plane north and south, stand horizontal in the vicinity of the equator, but dip more and more, with its north end toward the perpendicular, with increase of latitude north, and stand vertical at 70.5° north latitude and 98.5° W. longitude Greenwich. Passing south from the equator, the dip is reversed, the south pole of the needle dipping more and more toward the perpendicular with increase of southern latitude, until at 74° south latitude and about 148° east longitude Greenwich, the needle again stands vertical. In each place of observation the position of the axis of the needle indicates the direction of the lines of force of the earth's magnetic field. If the places, for which the angles of dip are equal, be joined, curves result, which are similar to the parallels of latitude, but do not coincide with them, nor are they even parallel to each other. These lines are termed *isoclinals*. The line of no dip is termed the *magnetic equator*.

A compass needle does not in general point to the astronomical north on the surface of the earth, but the vertical plane passing through its axis, when at rest, includes an angle with the astronomical meridian. This angle of deviation from the astronomical meridian is termed the *angle of declination*. If these angles be observed for different localities on the surface of the earth and the localities, having equal declination, be joined, lines result, which are termed *isogonic* lines, and which have in general similar directions as the astronomical meridians, but do not coincide with them, nor will their contours be similar. Another set of lines, termed *isodynamic* lines, may be drawn on the surface of

the earth, which connect places of equal intensity of magnetic force.

These are the usual elements, which enter into the mapping out of the earth's magnetic field of force.

Although the total intensity of the earth's magnetism may for each locality be readily measured, it is found to be more convenient to represent the total force by its horizontal and vertical components and to measure these.

Fig. 6

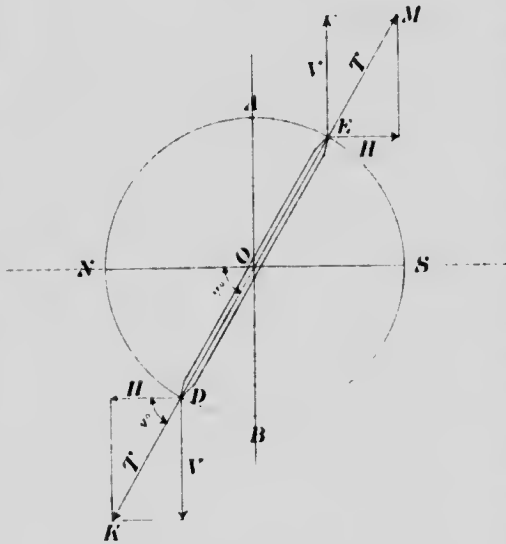

If the circle (see Fig. 6) $NASB$ be in the plane of the magnetic meridian and the magnetic needle at the place of observation come to rest, making an angle v with the horizon NS , the needle will be tangent to the line of force of the terrestrial field passing through the point of suspension O .

The force of the field acts with equal intensity on the north pole at D and the south pole at E , but in opposite directions.

The resultant is zero and the needle at rest.

Let $DK = EM$ represent by their length the intensities of the acting forces and the arrow points indicate the directions in which they act. We may then regard DK and EM the total intensities as the resultants of the components H and V , of which the former represents the horizontal intensity, the latter the vertical intensity of the earth's field.

From the figure we have:—

$$V = H \tan v \quad (2)$$

$$\text{and } DK = EM = T = \sqrt{H^2 + V^2}, \text{ or } \frac{H}{\cos v} \quad (3)$$

hence T and V become known, when H and v are known. The values H and v are given for different places in the published magnetic charts of the terrestrial field.

It requires to be pointed out that the elements of the magnetic field of the earth, represented by the isogonic, isoclinal and isodynamic lines, are not constant, but are subject :

1st.—To sudden variations, due to cosmic magnetic disturbances.

2nd.—To annual variations, which progress at a definite rate and in a definite direction, which, when known, render the true value for any year calculable.

3rd.—To daily variations, which in general are small.

CHAPTER IV.

THE DISTURBED TERRESTRIAL FIELD OF FORCE.

We have already seen that if part of a magnetic field of force includes a medium of greater permeability than the rest, the lines of force by preference pass through the more permeable medium, thus modifying the distribution of the lines of force of the original field of force, so that more lines of force pass through the more permeable medium than through the less permeable medium immediately surrounding the former. From this it results that deposits of "attractorily" magnetic bodies, such as magnetite or pyrrhotite, attract the lines of force of terrestrial magnetism and become themselves magnetic. The extent to which these bodies modify the distribution of the normal* terrestrial field depends upon their volume, shape, position with reference to the lines of force of the normal terrestrial field, and their depth below the surface of the earth. In the case of the "retractorily" magnetic substances, the permeability

* The terrestrial field undisturbed by magnetic bodies or deposits.

is not much superior to that of non-magnetic substances, and hence their effect in modifying the distribution of the lines of force of the terrestrial field is correspondingly small.

Cases occur where non-magnetic ores and rocks become magnetic through the presence of magnetite as an accessory ingredient and thus become causes of disturbance of the terrestrial field. The hematites of Sweden, and certain copper, lead, and zinc ores are illustrations of ores which are often magnetic, and diabase, diorite and hyperite often contain so large a percentage of magnetite, and of such uniform distribution through their mass, that the magnetometric method may be employed "in tracing them from localities where they outcrop, through areas in which they are buried and in determining whether the rocks are flat lying or highly tilted, the direction of their strike and dip, and, in some cases, the depth to which they are buried."*

If the magnetite is arranged through the igneous rock along lines corresponding to the lines of force of the normal terrestrial field, the magnetic effect produced may become very great.† Magnetic disturbances of the earth's field, however great, do not therefore justify the conclusion that they are caused by *workable* magnetic ore deposits.

Relation of Dip to Intensity of Magnetization.—

If a soft iron bar be placed with its axis parallel to the lines of force of terrestrial magnetism, it will be found, if the experiment be made in the northern hemisphere, that the upper end of the bar has acquired north-pole attraction, the lower end south-pole attraction, and that the bar in this position exhibits all the characteristics of a magnet, with the poles near the ends of the bar. If the strength of the magnetization of the bar be tested, it will be found that it is a maximum in this position; a minimum when the length of the bar occupies a position perpendicular

* Henry Lloyd Smyth: "Magnetic Observations in Geological Mapping," *Transactions American Institute of Mining Engineers*, Vol. XXVI, pp. 641 and 642.

† See page 3. Theory of the Constitution of Magnets.

to the lines of force of the terrestrial field; and of intermediate intensity in intermediate positions.

If the inductive action of the earth's field be regarded as the cause of the magnetization of a magnetic ore-body, it is evident that we may expect that the dip of the ore-deposit will in a similar manner be connected with the strength of its magnetization, as in the case of the iron bar, *i.e.*, it will be at a maximum when the dip is parallel to the lines of force of the terrestrial field, a minimum in a position at right angles to these lines, and of intermediate intensity when the dip corresponds to intermediate positions.

In judging, therefore, of the massiveness of an ore deposit from the intensity of its magnetic effect, the direction of the dip of the deposit in relation to the lines of force of the terrestrial field must evidently be taken into consideration.

CHAPTER V.

EFFECT OF A MAGNET ON A COMPASS NEEDLE IN A NORMAL TERRESTRIAL FIELD.

Throughout a space of small dimensions, compared with that of the earth's radius, the normal magnetic terrestrial field is sensibly uniform, the lines of force of the horizontal magnetic field will in this space be parallel.

If a compass be set up horizontally in such a field, the needle will come to rest and be in equilibrium when it occupies a position such that its magnetic axis is in the magnetic meridian NS of figure 7. In this position the forces of the horizontal field acting on the needle are of equal intensity and in opposite directions and the resultant is equal to zero. If, under these conditions, a magnet $S'N'$ be placed with its axis in a position at right angles to the magnetic meridian and in the same horizontal plane with the compass needle and with the center of its axis at distance d from the point of suspension o , the needle will be deviated and come to rest in a new position with its axis

parallel to the lines of force of the resultant field, compounded of that of the earth's field and that of the deflecting magnet. If the south pole of the deflecting magnet faces the compass (as shown in the figure) the north pole of the needle will be deflected toward the east of the magnetic meridian.

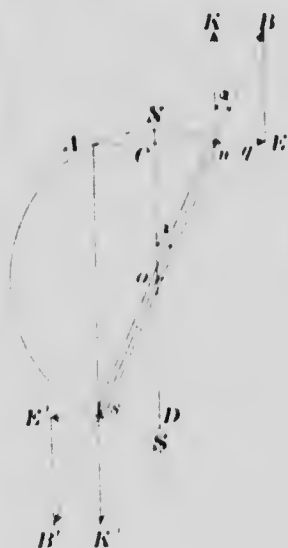

Fig. 7

$S' \quad \sigma \quad S'$

To obtain an expression for the effect of the deflecting magnet, let:

- μ = the strength of a pole of the compass needle,
- σ = the strength of a pole of the deflecting magnet,
- $2l$ = the length of the compass needle,
- $2L$ = the length of the deflecting magnet,
- $2\mu l = m^*$ the moment of the compass needle.
- $2L\sigma = M$ the moment of the deflecting magnet.
- H = the intensity of the earth's horizontal field.
- d = the distance of center of deflecting magnet from σ ,
the point of suspension of compass needle.

* The moment of a magnet is defined as the product of the strength of one pole into the length of the magnet.

F_H = the force with which the earth's horizontal field acts upon the poles of the compass needle.

F_D = the force exerted by the deflecting magnet upon the poles of the compass needle.

M_H = the moment of the couple due to the earth's field.

M_D = the moment of the couple due to the field of the deflecting magnet.

It is assumed that the field produced by the deflecting magnet is of equal intensity at the points n and s and that the lines of action of the force proceeding from the poles of the deflecting magnet are parallel to ox , which is not strictly true.

For the position of equilibrium the moments of the two oppositely directed couples M_H and M_D must be equal, hence :

$$M_H = M_D$$

$$F_H 2l \sin a = F_D 2l \cos a$$

$$F_H \tan a = F_D \quad (4)$$

$$F_H = H \mu \quad (4a)$$

and F_D is the resultant of the action of the poles of the deflecting magnet upon the poles n, s of the compass needle. Denoting attraction by the minus sign and repulsion by the plus sign, we have for the attraction of the south pole of the deflecting magnet upon the north pole of the needle :

$$\frac{-\sigma \mu}{(d-L)^2}$$

and for the repulsion of the north pole of the deflecting magnet upon the north pole of the compass needle :

$$\frac{+\sigma \mu}{(d+L)^2}$$

The action line of these two forces is assumed to coincide, hence :

$$F_D = \sigma \mu \left\{ \frac{1}{(d+L)^2} - \frac{1}{(d-L)^2} \right\} = \frac{4 \sigma \mu L d}{d^3 \left(1 - \frac{2L^2}{d^2} + \frac{L^4}{d^4} \right)}$$

Neglecting $\frac{L^4}{d^3}$ as too small sensibly to affect the result, we have :

$$F_D = \frac{2 M \mu}{d^3} \left(\frac{1}{1 - \frac{2 L^2}{d^2}} \right) \quad (5)$$

If d is made large in comparison with $2 L$, the length of the deflecting magnet, the expression $\left(1 - \frac{2 L^2}{d^2} \right)$ does not greatly differ from unity and we may write :

$$F_D = \frac{2 M \mu}{d^3} \quad (6)$$

Substituting values for F_H and F_D in equation (4) we have :

$$H \mu \tan \alpha = \frac{2 M \mu}{d^3} \quad (7)$$

$$H \tan \alpha = \frac{2 M}{d^3} = q = n H. \quad (8)$$

$$\text{and } q d^3 = 2 M = \text{a constant } C. \quad (9)$$

Retaining the factor $\frac{1}{1 - \frac{2 L^2}{d^2}}$ of equation (5) we have from equation (7) :

$$M = \frac{1}{2} \tan \alpha H d^3 \left(1 - \frac{2 L^2}{d^2} \right) \quad (10)$$

an equation useful for determining the moment of a magnet in terms of H , or in absolute units, when the value of H in absolute units for the place of observation is known.

In the foregoing demonstration it was assumed that the strength of the field of the deflecting magnet was the same at the points n and s , but it is evident that the strength of the field, due to the deflecting magnet *near* the compass needle, will be the same only for points at equal distances from the center of the deflecting magnet, and that, therefore, the force of the deflecting magnet exerted upon the compass needle will, with this method of producing the angle of deflection, vary with the angle α . This tangent method will, therefore, yield only approximately correct results.

The value of q can, however, be rendered independent of the angle of deflection by revolving the compass with its arm, which carries the deflecting magnet, about a vertical axis, passing through the point of suspension of the compass needle, until the needle stands at right angles to the deflecting arm, as shown in figure 8.



Fig. 8

In this position both north and south poles of the compass needle are at equal distances from the center of the deflecting magnet, and therefore occupy positions in its field of equal strength.

The number of degrees through which the needle passes back to a position in the plane of the magnetic meridian, when the deflecting magnet is removed, measures the angle of deflection in this case.

Let this angle be denoted by a_0' we shall then have (see Fig. 8):

$$q' = H \sin a_0' \quad (11)$$

Since q' for this method (the sine method), is constant, and q for the tangent method very nearly so, we have for different points in a magnetic field, in which the value of H differs:

$$q = H \tan a = H' \tan a'$$

$$\text{or } H' = H \frac{\tan a}{\tan a'} \quad (12)$$

$$\text{and } q' = H \sin a_0' = H' \sin a''$$

$$\text{or } H' = H \frac{\sin a_0'}{\sin a''} \quad (13)$$

From these equations it follows that the value of H' differing from H may be found by either of these two methods, in terms of H , the value of the horizontal component of the magnetic field at one station taken as a unit.

CHAPTER VI.

THE THALÉN-TIBERG MAGNETOMETER.

Description.—This apparatus is a combination of Thalén's magnetometer and Tiberg's inclinometer, and as now constructed by mechanic Berg, of Stockholm, constitutes a very convenient instrument for field work. It permits by its construction the determination not alone of the different values of the horizontal components of a disturbed magnetic field, but also the more important determination of the different values of the vertical components. Its principal parts are the compass and its support.

The Compass.—(See Figs. 9, 10, 11 and 12.) The compass *K*, consists of a low, hollow cylinder, of about 8 cm. diameter, closed top and bottom by quadratic plates P_1 and P_2 with sides of about 9 cm. The top plate is broken through by a circular opening, concentric with the cylinder and 7.5 cm. in diameter. This opening renders the interior accessible and is closed by a removable glass cap. The center of the bottom of the cylinder carries a jewel for the reception of one end of the axis of rotation of the magnetic needle, the other end of the axis is supported by a jewel carried by an arm, screwed to the inner side of the cylinder. A flat ring, of diameter 6 cm., graduated into degrees, is fastened to the inside of the cylinder, parallel to the quadratic plates, at such distance from the base that its edge bisects the knife-edge poles of the magnetic needle. The north and south directions, parallel to one parallel pair of sides of the quadratic plates, are marked 90°. The ends of the east and west diameter are at divisions marked 0°. The directions marked west and east correspond, when the needle marks 90° N., to the astronomical directions.

Screwed to the compass box, in the prolongation of the east and west directions, are two cylinders Z_1 and Z_2 , of 8 mm. diameter, which permit the compass to be placed into bearings

FIG. 9

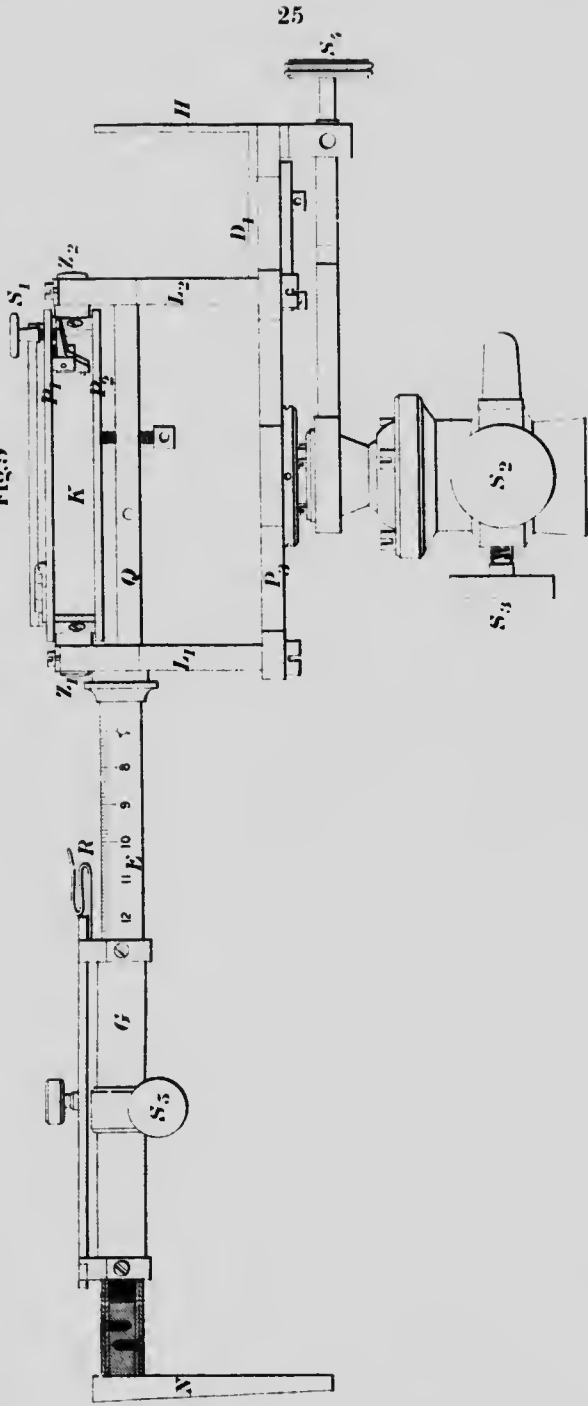

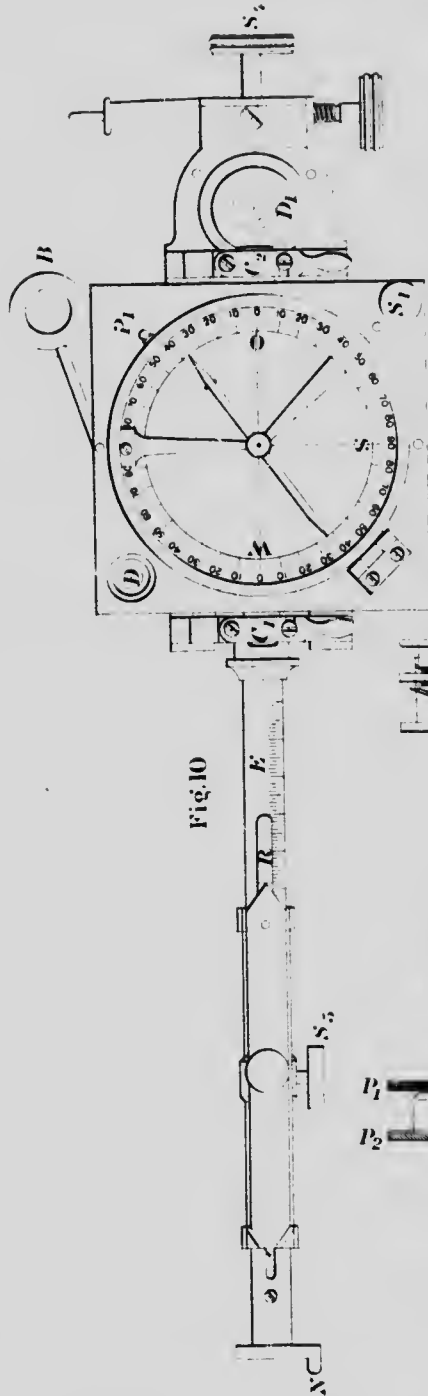

Fig. 10

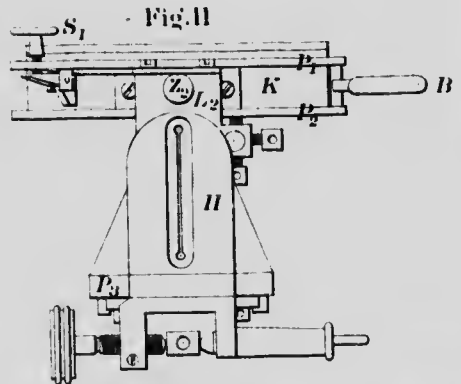

Fig. 11



Fig. 12

of the support and there secured. Between the two plates and visible through *D*, the compass box is provided with a box level of a sensibility of 6' for 1 mm. deviation of bubble. This box level permits the levelling of the compass when in use without its usual support. On the diagonally opposite corner, on the top plate, is situated the screw head *S*₁, which operates the arrest of the needle.

The needle, for the greater part of its length, is bar

shaped, with cross sections of about 2.9 mm². The poles are ground into knife edges, par-

allel to the axis of rotation. The axis of rotation is represented by a steel cylinder, which passes perpendicularly through the middle of the magnetic axis of the needle. In the vicinity of this axis the shape of the needle is such that the center of gravity, when the needle swings in a vertical plane, is situated,

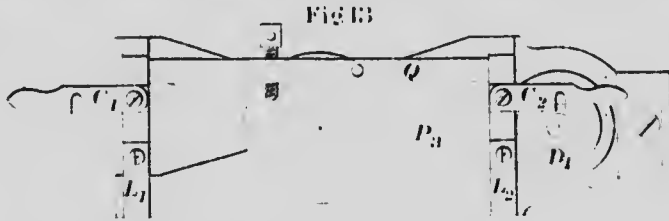

as in the case of the beam of a balance, below the axis of suspension. A sliding weight permits of the counteraction of the vertical intensity of the normal terrestrial field, so that when free to swing in a vertical plane perpendicular to the magnetic meridian the needle gives a reading 0 in such a field.

A brass arm, ending in a ring *B*, is pivoted on the compass box midway between the square plates. This arm serves as a suspension when the compass is to be used by an observer as an inclinometer, without the support.

The Support of the Compass with its Deflecting Magnet.—(See Figs. 9, 10,

11, 13 and 14.) Two uprights L_1, L_2 , screwed perpendicularly upon the base plate P_3 , support in their bearings the cylinders Z_1, Z_2 of the compass. Z_1, Z_2 are retained in their bearings by the slides C_1, C_2 . The height of the bearing above the base plate is such that the compass may be revolved into a vertical position.

Two set-screws, passing, the one vertically, the other horizontally, through the rod Q , connecting L_1 with L_2 , limit the rotation of the compass box to one-quarter revolution. These set-screws, when once regulated, enable the observer, by bringing the square plate P_2 into contact with either one of them, to



place the compass box without delay into position either parallel or perpendicular to the base plate P_3 . A box level, of sensibility 3' to 1 mm. deviation of bubble, secured to base plate P_3 at D_1 serves to indicate its horizontal position. The underside of the base plate is screwed upon a cone F (Figs. 15 and 16), which fits into a ball and socket joint, firmly secured upon a tripod. By means of two screws S_2 , S_3 , and spring, operating (as shown in Figs. 15 and 16), upon the extension of the ball and socket joint, the base plate P_3 may be levelled. Rotation about a vertical axis of the support is accomplished by the movement of the cone in its bearing, and may be secured in any position by the clamp-screw S_4 shown in the figure.

Fig. 15

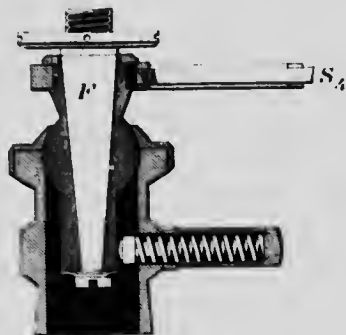
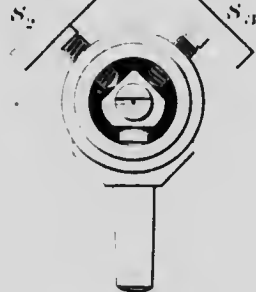

Fig. 16



Fastened to the upright L_1 , and parallel to the axes Z_1 , Z_2 , a cylindrical arm E of 22 cm. in length is situated (see Figs. 9 and 10). To render this arm light and yet sufficiently rigid, it is made of two concentric cylinders of brass soldered together. This arm carries a frame G for the reception of the deflecting magnet. The frame is moveable along the rod and may be clamped in any position by screw S_5 , and is of such height that when the deflecting magnet is placed upon it the axis of the deflecting magnet will be in the horizontal plane in which the compass needle swings. A millimeter scale on one side of the arm, with its zero point in the center of the axis of rotation of the compass needle, serves to indicate the position of the

deflecting magnet from the center of the compass needle. At the end of the arm and vertically downward, a foresight N of special and very convenient construction is attached. Just behind the box level D_1 is the backsight H , consisting of a brass plate with its vertical slit. The uprights L_1 and L_2 are broken through, and when the compass is in the horizontal position the sights may be employed to bring the arm E into any desired direction. The deflecting magnet is 1.1 cm. wide, 10 cm. long, and 0.2 cm. thick. Its north end is marked, as in the case of the compass needle, by an inserted brass pin. A button attached to the middle of the magnet permits its removal from and insertion into the frame, without touching the steel, of which it is composed. A spring R retains the magnet in its frame.

Testing and Adjusting the Magnetometer.—Although the instrument is tested and adjusted by the maker before it leaves his shop, it is advisable for the observer not to rely upon the shop adjustment, but to test the magnetometer for himself before use, and make any required correction.

1. Examination of error due to eccentric suspension of compass needle.

The compass is removed from its support and placed upon a level plane. The needle is now read at both ends and the compass turned through an angle and a second reading taken as before. This process is continued until a complete revolution has been made. A constant difference in the readings of the north and south ends indicates that the magnetic axis of the needle does not pass through the suspension of the needle. A periodic variation of a difference in the readings indicates that the axis of rotation of the needle does not pass through the center of the graduated circle. By reading both ends of the needle and taking the mean the eccentricity error is eliminated.

2. Examination whether axis of rotation of support is perpendicular to plane of box level D_1 on base plate P_2 .

The magnetometer is screwed on the head of the tripod, rotated so that the arm E is over one of the screws of the ball

and socket joint, and by means of the two levelling screws the bubble of the box level is brought to the center. The magnetometer is now revolved through an angle of 180° , which is easily effected by taking the reading of the compass. If the bubble in this new position is displaced, indicating that the axis of rotation is not perpendicular to the plane of the box level, correction is made by decreasing the displacement of the bubble to $\frac{1}{2}$, which is accomplished by means of the three screws passing through the bottom of plate P_3 provided for this purpose.

3. Examination whether axis of compass box is perpendicular to vertical axis of rotation of support.

Place a rider level upon axes Z_1, Z_2 and rotate support about vertical axis until Z_1, Z_2 is in line with one levelling screw. By means of the levelling screws bring the bubble of rider level to the center. Now revolve support about vertical axis through 180° , as indicated by compass reading. If, in this new position, the bubble is displaced, the vertical and horizontal axes are not perpendicular to each other. Correct through $\frac{1}{2}$ the displacement of the bubble by screws provided for that purpose, or, if these be wanting, by elevating the proper upright L_1 or L_2 by placing paper between it and the base plate P_3 .

4. Examination whether the vertical screw of bar Q, when in contact with the lower plate of compass box, renders compass box horizontal.

The magnetometer upon its tripod is levelled, the lower plate of compass box brought into contact with the vertical screw on bar Q . A sight is now taken along the top of the compass box and at right angles to the arm E , on a scale suspended vertically beyond the magnetometer, and the reading recorded. The support is now revolved about the vertical axis through 180° , indicated by the compass reading, and a second reading taken on the scale as before. If the readings differ, the screw must be turned in the proper direction until this difference is made one-half. The bubble of the box level D , between plates P_1, P_2 , must now be in the center. Any deviation of the bubble must be corrected by the screws provided for that purpose.

5. **Examination whether the horizontal screw of the bar Q when in contact with plate P₁ of compass box, indicates its vertical position.**

The magnetometer is set up and levelled as before, and P₂ brought into contact with horizontal screw. Verticality of plate P₂ may now be tested by a plumbline or sight taken along plate P₂ on a scale placed horizontally beneath the magnetometer, as in 4. Correction required is made with horizontal screw. Base plate P₃ is broken through to permit this adjustment to be made.

6. **Neutralization of the vertical component of the earth's normal field.**

The magnetometer in the normal field, properly levelled, is rotated until the needle reads 90°, the compass is then placed vertical, the small slotted aluminium plate, provided for producing this correction in modern instruments, moved toward the south arm of the compass needle until the needle reads zero. The plate is then fixed in position by means of screws provided for that purpose. A thread, tied on the south arm and cautiously pushed into the required position by a sharpened match, may, in case of necessity, replace the small weight. The thread being, however, more or less hygroscopic, its weight will not be constant, but depend upon the state of the weather.

Precautions to be Observed in Taking Observations with the Magnetometer.

1. The observer should assure himself that his person is free from magnetic bodies, such as pocket knives, keys, etc., which would influence the reading of his instrument.

2. Magnetic bodies which occur in the field and which cannot be removed, such as iron roofs of buildings, magnetic ore dumps, etc., must have their location accurately determined and their position marked in a sketch, to be transferred to the accurately drawn plans of the magnetic field, when their disturbing effect may be estimated.

3. Wiping the glass cap of the magnetometer tends to

electrify the glass, which renders the indications of the needle untrustworthy. By breathing upon the electrified glass, the electricity is discharged from its surface.

4. Accumulation of dust in the jewelled bearings of the suspension of the needle depresses the sensitiveness of the compass. It is advisable, therefore, to open the glass cup as seldom as possible.

5. Readings in the field are best taken on cloudy days. In bright sunshine the magnetic meter must be protected from the direct rays of the sun by a screen not containing iron or steel in its structure. Elevation of temperature of the magnets to any great extent is always to be avoided, since the moment of a magnet decreases with increase of temperature, recovering its normal value only when the magnet returns to normal temperature.

A more serious cause affecting the value of the moment of a magnet is *concussion*, since this diminishes the strength of a magnet permanently when subjected to it. The extent of the deflection of a compass needle by the deflecting magnet depends upon the moment of the latter; the value of K , the constant of the inclinometer, upon the moment of the compass needle. It is, therefore, evident that in the investigation of a magnetic field, concordant results of readings can only be obtained, when during this investigation the moments of the magnets have remained unchanged. Hence, every precaution should be taken to keep these moments constant by avoiding all causes which tend to decrease them.

6. Accumulation of moisture on the needle of the magnetometer during damp weather may impair its balance, and thus give rise to error when using the magnetometer as an inclinometer. Moisture from both the glass cover and the needle is best removed by allowing the magnetometer to stand open in a warm room until dry. Wiping the needle or interior of the compass with a cloth should be avoided.

CHAPTER VII.

METHOD OF OBSERVATION.

Horizontal Intensity of a Magnetic Field. The horizontal intensity of a magnetic field may be determined with the instrument as described by measuring the angle of deflection of the compass needle produced by the deflecting magnet, when it occupies a definite position on the arm E of the magnetometer. Both the tangent and sine method may be employed in producing the angle of deflection.

In the application of these methods, the magnetometer, with compass in horizontal position, is placed with its tripod over the place of observation and the bubble of the box level D_1 brought to the center by the employment of the levelling screws.

In the case of the tangent method, the magnetometer is revolved about a vertical axis until the compass needle reads 90° . This reading is made certain by tapping the glass cover lightly with the rubber end of a pencil, to overcome the friction of the pivots on which the needle moves. The magnetic axis of the compass needle is now parallel to the magnetic meridian of the place of observation, and the arm E is perpendicular to the plane of the magnetic meridian. The deflecting magnet is now placed in its frame on arm E and secured in its position by the spring R and binding screw S_3 . It is necessary, in placing the magnet upon the frame, to avoid setting the needle into violent oscillations, as otherwise too much time is lost in waiting for it to come to rest in its new position. Its position is made more definite by tapping the glass case as before. The angle a_0 is now read and $90^\circ - a_0 = a_0'$ will correspond to the angle of deflection produced. Assume that the magnetometer is set up in a normal terrestrial field, we then have:

$$H \tan a_0 = q = H \cot a_0. \quad (14)$$

If however, the magnetometer be set up in a field disturbed by a magnetic ore body, the needle with deflecting magnet re-

moved, when reading 90° , will be parallel to the direction of the horizontal component of a compound field of force. This horizontal component R will evidently be the resultant of H , the horizontal component of the normal terrestrial field, and F the horizontal component of the individual field of force of the magnetic ore body. These two components will in general include an angle n in their directions at the place of observation, and we shall obtain for the value R in terms of H and F and the angle included between them from the triangle of forces (Fig. 17):

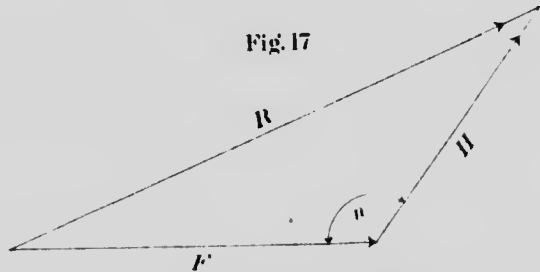

$$R = \sqrt{H^2 + F^2 - 2HF \cos n} \quad (15)$$

If a is the angle of deflection, produced by the deflecting magnet in this compound field, we shall have:

$$R \tan a = q = R \cotang a \quad (16)$$

hence from equations (14) and (16) we have:

$$R = \frac{\tan a_0}{\tan a} H = \frac{\cotang a_0}{\cotang a} H \quad (17)$$

In this equation, R is obtained in terms of the horizontal component of the normal terrestrial field, for which the angle of deflection was found to be a_0 .

As stated before, this method yields only approximate values. For more accurate work the sine method is employed. In this method, after the magnetometer has been placed over the point of observation in a normal terrestrial field and levelled, the deflecting magnet is first secured in its frame and the magnetometer is then revolved until the needle reads (after tapping) 90° . In this position the axis of the needle is perpendicular to

the direction of the axis of the deflecting magnet. On removal of the deflecting magnet, the needle moves through an angle into a position of parallelism of its axis with the magnetic meridian of the place of observation. The angle a_0' is now read, and $90^\circ - a_0' = a_0''$ will correspond to the angle of deflection produced by the magnet. We then have:

$$H \sin a_0' = H \cos a_0'' = q' \quad (18)$$

If a'' is the angle of deflection in a compound field, we have:

$$R \sin a'' = R \cos a'' = q' \quad (18a)$$

hence:

$$R = \frac{\sin a_0'}{\sin a''} H = \frac{\cos a_0''}{\cos a''} H \quad (19)$$

From equation (14) it follows that since H varies with the locality, if q , the deflecting force of the deflecting magnet, remains constant, the angle a_0 must also vary with the locality. This angle a_0 for the locality in which a disturbed field is to be examined, is best taken as the mean of a number of observations made in different parts of the normal terrestrial field, surrounding the disturbed field. It is only when angles are obtained by this method, which do not differ to any extent, that the observer can at all be sure that his observations have been made in a normal terrestrial field.

The tangent method is very convenient when only approximate results are required. It absorbs little time, and the instrument set up for it is, by the removal of the deflecting magnet and the setting of the compass vertical, converted into an inclinometer, ready for observations of the vertical intensity of the field. Moreover, from equation (16) we have:

$$\tan a = \frac{q}{R}$$

that is, a definite angle will always correspond to the ratio $\frac{q}{R}$ whatever the separate values of q and R may be, since the tangents of all angles are comprised between $+\infty$ and $-\infty$.

The sine method, on the other hand, gives accurate results,

but is less convenient, in that more time is absorbed in making one observation, and that it requires that the instrument must be revolved into proper position before the compass can be placed vertical to convert the instrument into an inclinometer. Further, from the equation :

$$\sin a'' = \frac{q'}{R}$$

it is evident that since the limits within which the sines of all angles are comprised are $+1$ and -1 , no angle corresponds to a value of $\frac{q'}{R} > 1$, or when $q' > R$. At a station where this takes place the compass needle cannot be made to occupy a position perpendicular to the axis of the deflecting magnet. This serious defect of the sine method can to some extent be overcome by increasing the distance d of the center of the deflecting magnet from the center of suspension of the compass needle. Since q varies inversely as d^3 , q rapidly diminishes with increase of d , and with smaller q the method can be employed to measure smaller values of R . As q diminishes, a_0 also becomes smaller. In order, therefore, to measure small values of R , small values of a_0 must be chosen by the observer; greater values of R require, on the other hand, greater values of a_0 .

To facilitate the calculation of results by the methods just described, tables are appended of the ratio of $\frac{\sin a_0}{\sin a}$ and $\frac{\tan a_0}{\tan a}$ (see tables I and II). The angles a_0 , corresponding to the deflection of the normal terrestrial field, are given from 10 to 30 inclusive, progressing by single degrees.

CHAPTER VIII.

DAHLBLOM'S MODIFICATION OF THE
SINE METHOD.

In the methods described, the deflecting magnet retained a definite position on the arm E and q was, therefore, kept constant while the angle of deflection constituted the variable. In Dahlblom's method the angle of deflection is kept constant and q is made the variable. This method gives good results and overcomes the defects of the sine method, as commonly employed.

To apply this method an extra arm E_1 (see Fig 18) is screwed to the compass box of the Thalén-Tiberg magneto-

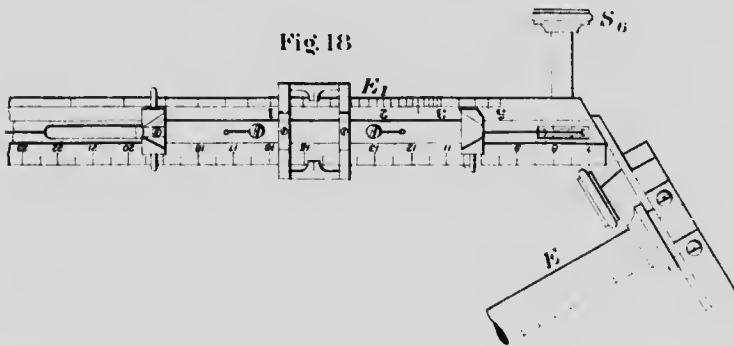

meter. This arm E_1 points to the center of the suspension of the compass needle and makes an angle of 30° with the arm E . It carries a frame for the reception of the deflecting magnet, the magnetic axis of which, when placed in position, is in the same horizontal plane with the magnetic axis of the compass needle. The frame can be moved back and forth along the arm by means of wires attached to the frame. These wires pass over pulleys and are operated by the screw S_6 . Along one side of the arm is a millimeter scale, the zero of which is at the center of

the axis of rotation of the compass needle. The frame is provided with an index, so that the position of the center of the deflecting magnet can be read to some tenths of a millimeter. The other side of the arm can be provided with a scale, which gives R direct for the different distances of the center of the deflecting magnet from the zero.

Method of Observation.—The instrument is set up exactly as in the case of the tangent method. The deflecting magnet is placed on the frame and screw S_6 manipulated until the deflecting magnet occupies its proper distance on the arm E_1 , i.e., when the compass needle stands at right angles to E_1 and reads 60° in the north-east quadrant. The position of the deflecting magnet is now read on the millimeter scale and R corresponding to this reading taken from a table calculated for the instrument, or R is read off direct, if the arm is provided with such a scale. The deflecting magnet is now removed, the compass needle returns to the reading 90° and the instrument, by placing the compass vertical, is ready for observation of the vertical intensity.

Calibration of Millimeter Scale and Construction of Scale for reading R direct.—We have seen, equation (9), that the product of the effect of the deflecting magnet q into the cube of the distance of its center from the zero of the scale is a constant quantity, hence :

$$q_0 d_0^3 = q_1 d_1^3 = q_2 d_2^3 = \dots q_n d_n^3 = C \text{ a constant.}$$

If H is the horizontal intensity of the normal terrestrial field and q_0 the effect of the deflecting magnet when the compass-needle stands perpendicular to the Dahlblom-arm in this field and R and q corresponding values for a compound field, we have for the Dahlblom method :

$$H \sin 30^\circ = q_0$$

$$R \sin 30^\circ = q,$$

$$\text{from this, } H = 2 q_0 \text{ and } R = 2 q = n H \quad (20)$$

$$\text{but } q d^3 = C. \quad (9)$$

Substituting in this equation for q its value from equation (20) $R=2q$, we have :

$$\frac{R}{2}d^3=C,$$

$$\text{or } R=\frac{2C}{d^3} \quad (21)$$

$$\text{and } d=\left(\frac{2C}{R}\right)^{\frac{1}{3}}=\left(\frac{2C}{nH}\right)^{\frac{1}{3}} \quad (22)$$

From equation (21) R can be calculated for any value of d and from equation (22) d can be calculated for any value of R , when C is accurately known. The value of C may be experimentally obtained as follows :

The magnetometer is set up in a normal terrestrial field with compass horizontal and properly levelled. The magnetometer is then revolved about the vertical axis until the Dahlblom arm coincides in direction with the magnetic axis of the compass needle. The north end of the needle will then read 30° . The deflecting magnet is now carefully placed upon its frame on the Dahlblom arm, with its north pole facing the north pole of the compass needle and cautiously moved, by manipulation of screw S_6 , toward the compass needle, until the needle is at right angles to the arm. The deflection produced is 90° and the distance d_1 of the center of the deflecting magnet from the zero is now accurately measured. For this position d_1 we have :

$$q_1=H \sin 90^\circ=1^*$$

$$\text{and } C_1=1 d_1^3$$

The deflecting magnet is removed, the frame pushed back and the magnetometer revolved until the axis of the compass needle makes an angle of 5° with the Dahlblom arm. The north end of the needle now reads 35° . The deflecting magnet is now placed in its frame, cautiously moved forward until the compass needle is again at right angles to the Dahlblom arm. The distance d_2 of the center of the deflecting magnet is again accurately measured. The deflection produced is 85° and :

$$q_2=H \sin 85^\circ \text{ and } C_2=q_2 d_2^3=1 (\sin 85^\circ d_2^3)=0.99 d_2^3$$

* H taken equal to unity.

Similarly the different values for d are measured with the following deflecting angles :

Compass needle before deflection reads :	Corresponding deflection when needle stands vertical to Dahlblom-arm.	Values of C .
40°	80°	$C_3 = \sin 80^\circ d_3^3 = 0.98 d_3^3$
45°	75°	$C_4 = \sin 75^\circ d_4^3 = 0.96 d_4^3$
50°	70°	$C_5 = \sin 70^\circ d_5^3 = 0.94 d_5^3$
55°	65°	$C_6 = \sin 65^\circ d_6^3 = 0.90 d_6^3$
60°	60°	$C_7 = \sin 60^\circ d_7^3 = 0.86 d_7^3$
65°	55°	$C_8 = \sin 55^\circ d_8^3 = 0.82 d_8^3$
70°	50°	$C_9 = \sin 50^\circ d_9^3 = 0.76 d_9^3$
75°	45°	$C_{10} = \sin 45^\circ d_{10}^3 = 0.70 d_{10}^3$
80°	40°	$C_{11} = \sin 40^\circ d_{11}^3 = 0.64 d_{11}^3$
85°	35°	$C_{12} = \sin 35^\circ d_{12}^3 = 0.57 d_{12}^3$
90°	36°	$C_{13} = \sin 30^\circ d_{13}^3 = 0.50 d_{13}^3$
85° N.E. Quadrant	25°	$C_{14} = \sin 25^\circ d_{14}^3 = 0.42 d_{14}^3$
80° " "	20°	$C_{15} = \sin 20^\circ d_{15}^3 = 0.34 d_{15}^3$
75° " "	15°	$C_{16} = \sin 15^\circ d_{16}^3 = 0.26 d_{16}^3$
70° " "	10°	$C_{17} = \sin 10^\circ d_{17}^3 = 0.17 d_{17}^3$

The 17 values of C , thus determined, which differ among themselves, are combined into a mean value C_m and with this mean value the distances d_1, d_2 , etc., may be corrected by substituting in the equation

$$C_m = \frac{d^3}{q}$$

the separate values of q_1, q_2 , etc.

We may now proceed either to calibrate the millimeter scale of the Dahlblom arm by finding the values of R , corresponding to the separate millimeter divisions on the scale, or we may construct a scale on which the different values of R for the different distances are marked, which may then be transferred to the Dahlblom arm on the side opposite to that on which the millimeter scale is placed.

Calibration of the Millimeter Scale.—By substituting in the equation

$$R = \frac{2 C_m}{d^3}$$

the centimeter divisions of the scale, we obtain the values of R corresponding to these divisions. A curve may now be plotted with the millimeter scale as abscissas and the corresponding values of R as ordinates. For the plotting of R , a scale should be chosen, which will not make the ordinates inconveniently long and yet show the differences for the different millimeter divisions sufficiently distinct. From this curve the value of R may be taken out for any division of the millimeter scale.

Construction of Scale for reading R direct.—By substituting in the equation

$$d^3 = \frac{2 C_m}{R} = \frac{2 C_m}{n H}$$

$$d = (2 C_m)^{\frac{1}{3}} \left(\frac{1}{n H} \right)^{\frac{1}{3}} \quad (23)$$

values for n , we obtain the corresponding values of d . To facilitate this calculation, a table giving the different values of $\left(\frac{1}{n}\right)^{\frac{1}{3}}$ and their logarithms for values of n from 0.01 to 5.00 is appended (see table III).

A curve may now be plotted, as before described, with values of R as abscissas and corresponding values of d in centimeters as ordinates. These ordinates appear as abscissas on the scale. The scale is first marked on paper and tested. If x is found on test to be the value of R for a deviation of 30° , for which the sine is $\frac{1}{2}$, $2x$ must be indicated by the index of the frame for a deviation of 90° , for which the sine = 1.

Large values of R are best determined with Dahlblom's method by the employment of a special deflecting magnet of great pole strength. For this magnet the value of C_m will differ from that calculated for the usual magnet, and must, of course, be separately determined and curves constructed for it, as previously described. The value of C_m depends on the permanency

of the strength of the deflecting magnet and on the value of H at the place of observation. Change of either of these values necessitates a new determination of C_m . The permanency of the strength of both compass needle and deflecting magnet cannot be guaranteed. Magnets gradually weaken, which may in a great measure be obviated by using molybdenum steel for their construction and aging them artificially by boiling in oil. It need scarcely be mentioned that accidental dropping of the deflecting magnet renders a new determination of C_m imperative.

From the equation :

$$R = \frac{2 C_m}{d^3}$$

we obtain for the same d , but for a new value C_m' , the expression :

$$R' = \frac{2 C_m'}{d^3}$$

and hence,

$$R' = \frac{C_m' R}{C_m} \quad (24)$$

from which it follows that in the case of a new determination of C_m the ordinates of the calibration curve of the millimeter scale of the Dahlblom arm are converted into the new ordinates of the new curve, corresponding to the new value C_m' , by multiplying the old ordinates with the ratio $\frac{C_m'}{C_m}$. In the case of the reconstruction of the scale, giving R direct, due to a new value C_m' , the table giving the values of $\left(\frac{1}{n}\right)^{\frac{1}{3}}$ is always applicable.

The applicability of Dahlblom's method is based on equation (9) :

$$q d^3 = C.$$

This equation is, as has been shown, not strictly correct, and Uhlich* has found that an equation of the form :

$$q d^3 + c q d^2 = C,$$

in which the factor c is smaller than unity, gives better results. Experience, however, has shown that for all practical purposes the equation :

$$q d^3 = C$$

is sufficiently accurate.

* Page 364, "Lenrbuch der Markscheidkunde," P. Uhlich, 1901.

CHAPTER IX.

**THE VALUE OF THE HORIZONTAL INTENSITY IN
A TERRESTRIAL FIELD OF FORCE, DIS-
TURBED BY THE PRESENCE OF A
MAGNETIC ORE BODY.**

In a disturbed field, the horizontal intensity R , as has been previously shown,† is the resultant of the horizontal intensity of the earth's normal field and the horizontal component of the magnetic force of the magnetic ore-body. If the former is symbolized by H , the latter by F ,

$$R = \sqrt{H^2 + F^2 - 2HF \cos \alpha}.$$

In the disturbed field, H remains constant in direction and intensity, F variable in direction and intensity, the latter depending on the horizontal distance of the point of observation from the point over the pole of the ore-body.

Assume the normal terrestrial field to be disturbed by a magnetic ore-body, with its pole, exhibiting north pole attraction, in a vertical direction below the point O , and (see Fig. 19) the ore-body to extend vertically downward to such depth that the effect of the lower pole upon the field of investigation may be neglected. It will then be evident that for the point of observation A , if H and F in intensity and direction represent at this point the horizontal components of the field, the diagonal R of the parallelogram constructed on these components will in direction and intensity represent the resultant horizontal intensity of the field at A . For every point at equal distance OA from O , both H and F remain constant in intensity, H remains constant also in direction, but F , being directed to the center O , varies in direction for every point of the circumference. There are four points in this circumference of special interest :

At E the angle α is 180° and the equation for the resultant becomes :

† Fig. 17, eq. 15, page 34.

$$R = \sqrt{H^2 + F^2 - 2HF \cos 180^\circ} = H + F \quad (25)$$

The resultant for this point equals the sum of the components.

At K the angle $\alpha = 0$ and

$$R = \sqrt{H^2 + F^2 - 2HF \cos 0^\circ} = H - F \quad (26)$$

Fig. 19

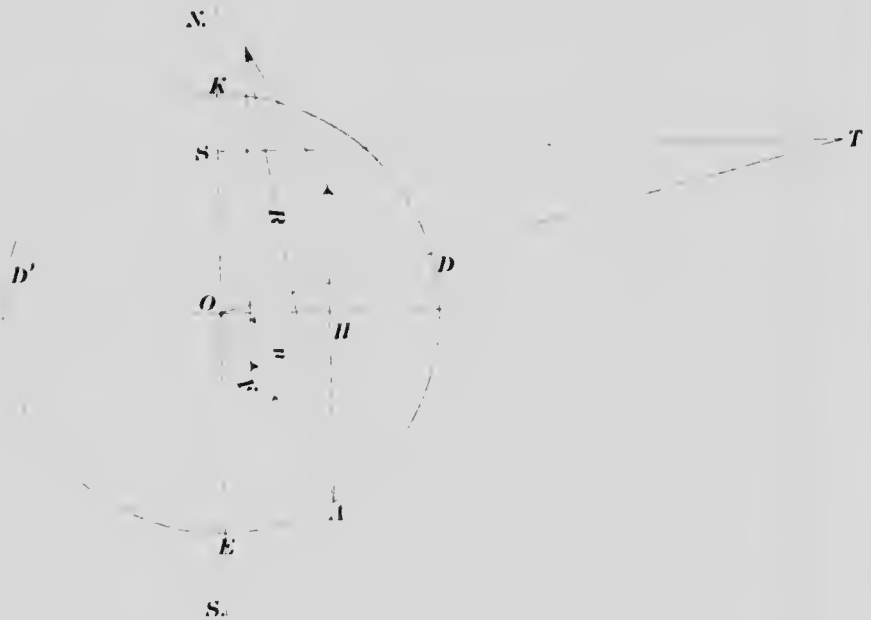

or the resultant for this point is equal to the difference between the components. The horizontal intensity is, therefore, at a maximum at E and at a minimum at K . For these two points the angle of deflection is respectively a minimum and maximum.

The line drawn through the three points O , E and K , constitutes the magnetic meridian of the field.

Between these two points for R_{\max} and R_{\min} the value of R for intermediate points on the circumference assumes all intermediate values.

If in the equation for the resultant, we put $R = H$, we have:

$$F - 2H \cos \mu = 0$$

$$\text{and } \cos \mu = \frac{F}{2H}$$

By constructing this angle the two points D and D' on the circumference where $R = H$ are found. The construction may be carried out as follows (Fig. 19):

From O toward K on line OK lay off the length F to obtain point S . At this point erect a perpendicular and from O , with length $2H$, cut perpendicular in T . The line OT cuts the circumference at D . At this and the corresponding point D' the angle of deflection is α_0 , the angle of deflection of the normal terrestrial field.

At the point O the force of the pole of the ore-body is directed vertically downward and $F = 0$, consequently the angle of deflection at this point is due only to H and is, therefore, also equal to α_0 .

So long F does not become greater than $2H$, there will exist two points on every circumference drawn within the field, about O as center, at which the angle of deflection is α_0 .

If the points in the disturbed field, for which the angle of deflection equals α_0 , are found, the curved line resulting (termed by the Swedish authorities the "neutral line") will pass through the point O , which is also the point through which the line joining R_{\max} and R_{\min} passes.

This fact may be employed for the location of the pole of the ore-body, when F is small compared with H , which will be the case with a weak magnetic ore-body, or when the location of the pole is at considerable distance from the surface.

(The angle a_0 may be calculated from the known values of a_1 and a_2 , which correspond respectively to the maximum and minimum values of R . For we have:

$$q = (H + F) \sin a_1 = (H - F) \sin a_2 = H \sin a_0.$$

From this we obtain:

$$\frac{H}{F} = \frac{\sin a_0}{\sin a_1} - 1 = 1 - \frac{\sin a_0}{\sin a_2}$$

$$\text{and} \quad \frac{1}{\sin a_1} + \frac{1}{\sin a_2} = \frac{2}{\sin a_0} \quad (27)$$

The calculation of a_0 is facilitated by using the formula:

$$\sin a_0 = \frac{\sin a_1 \sin a_2}{\sin \frac{1}{2} (a_2 + a_1) \cos \frac{1}{2} (a_2 - a_1)}$$

It is evident that if a_0 and either a_1 or a_2 are known, the unknown a_1 or a_2 may be calculated from equation (27). The usefulness of such calculation leading to the determination of the location of the pole of the ore deposit will appear by considering that, if on a meridian, north of the pole of the deposit, the angle of deviation a_2 has been observed for any point P_2 , this value must correspond to the minimum value of R for a certain circumference, of which the pole is the center, but the radius of which is unknown. If then, we determine from equation (27) the angle a_1 , corresponding to the maximum value of R and find among the observed values upon the meridian the point P_1 , corresponding to this value of R , $P_1 P_2$ will be the required diameter of the circumference and the pole of the deposit will be midway between P_1, P_2 .)

This neutral line divides the field of investigation into an area of minimum horizontal intensity, lying north of the neutral line and an area of maximum horizontal intensity, lying south of it.

At O the value of F is zero: from this value, proceeding outward in the field, the value of F increases to a maximum, beyond this F again diminishes practically to zero at the limit of the field. There is then one circumference, for which F is a maximum, beyond this are the concentric circles with decreasing values of F , and within the area bounded by the circumference for the maximum are the concentric circles with values of F , corresponding to those of the circumferences beyond that, for which F is a maximum. In going outward, therefore, from O ,

F_{\max} is encountered but once, but intermediate values of F twice.

If $F_{\max} < H$, the free compass needle will always point north, along the direction of the magnetic meridian. If $F_{\max} = H$, a point will be found on the meridian, where $F_{\max} - H$ is equal to zero. At this point, the point of indifference, which lies to the north of O , the free compass needle will indifferently occupy any position. If $2H > F_{\max} > H$, there will be two points of indifference, one lying within the circumference for the maximum and another beyond it. Passing beyond the first point of indifference, the needle reverses and points south, until the second point of indifference is reached, where it reverses again, to point north once more.

In this case also one neutral line will divide the field into the two areas of maximum and minimum horizontal intensity.

When, however, $F_{\max} > 2H$, two neutral lines will be found between the two indifferent points. One a closed curve, passing through the pole point O , "the false neutral line," and a second open curve, lying beyond the former, to the north, "the true neutral line." In the case of such strong fields, as may occur in the case of magnetic ore bodies rising above the surface, the rule for finding the pole point O , by means of the neutral line, is, of course, no longer applicable, since the true neutral line does not pass through the pole point.

The resultant horizontal intensity along the meridian in fields where $F_{\max} = H$, $2H > F_{\max} > H$ and $F_{\max} > 2H$, is represented by figures 20, 21, 22.

Fig. 20

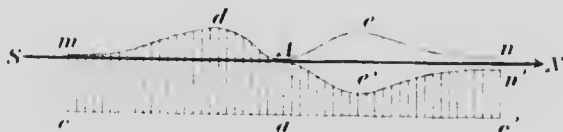

Fig. 21

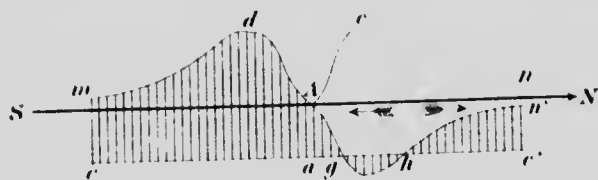
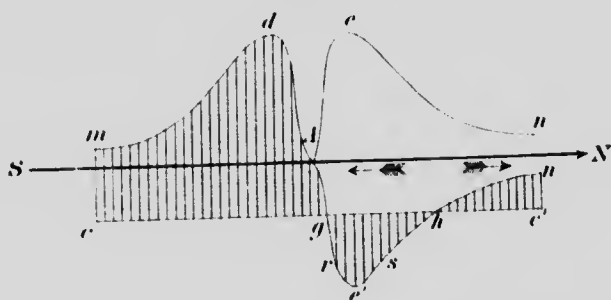

Fig. 22



In these figures the curve above the line SN represents the variation of F along the meridian, with A as the pole point. The line $c'e'$, parallel to SN , is drawn at a distance $= H$. In figure 20 R is constantly positive and the free compass needle points continuously north along the meridian. In figures 21 and 22 g and h are points of indifference, between these points the resultant is negative, the free compass needle points south. At r and s , (figure 22) the resultant is equal to $-H$, through r passes the "false," through s the "true" neutral line.

CHAPTER X.

THE VERTICAL INTENSITY OF THE
DISTURBED FIELD.

Theory of the Inclinometer. - It has been shown that a magnetic needle, free to swing in any plane, will tend to place itself in the terrestrial field with its magnetic axis tangent to a line of magnetic force and that in the northern hemisphere the axis of the needle with north pole pointing downward will in general make an angle e with the horizon. In this position of rest the total magnetic force of the field, acting along the axis of the needle, may be resolved in two directions perpendicular to each other: H , the horizontal component, and V , the vertical component. For the vertical component we have obtained the expression, equation (2), page 15.

$$V = H \tan e.$$

With the needle as constructed for the inclinometer, the angle e depends in addition to the action of the magnetic forces upon the action of gravity, applied at the center of gravity of the needle, which is situated below the point of suspension. To obtain an expression for the value of V in terms of the angle e and the constant of the inclinometer, when the needle is in equilibrium under the action of these forces, let the plane of the paper represent the plane of the magnetic meridian and assume the needle to be in equilibrium in the position shown in the figure, its axis

Fig. 23

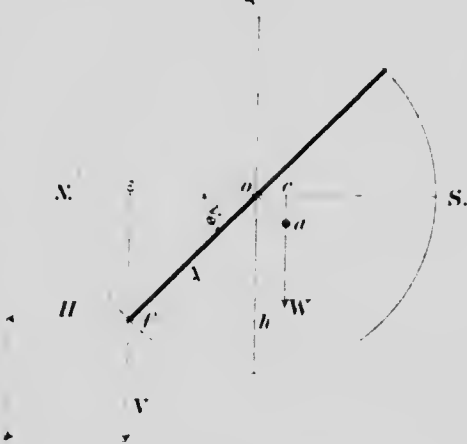

making the angle v_0 with the horizon NS . Let o be the center of gravity of the needle and d its distance from the point of suspension a . Let W , the weight of the needle, be regarded as concentrated in o . Let $l = \frac{of}{2}$ the length of the needle, H and V respectively the horizontal and vertical components of the magnetic force of the field, and μ the strength of the pole f of the needle. Then it is evident that V tends to increase the angle v_0 , *i.e.*, produce left handed rotation, whereas H and gravity tend jointly to decrease the angle v_0 , producing right handed rotation. In the position of equilibrium the moments of couples producing oppositely directed rotation about the point o are equal.

The moment of couple due to $H = M_H = H \mu 2 o b = H \mu 2 l \sin v_0$

The moment of couple due to $V = M_V = V \mu 2 r o = V \mu 2 l \cos v_0$

The moment of gravity referred

$$\text{to axis of rotation} = M_g = W o c = W d \sin v_0$$

$$M_H + M_g = M_V$$

$$\text{or} \quad (H \mu 2 l + W d) \sin v_0 = V \mu 2 l \cos v_0$$

$$\text{hence: } V = \left(H + \frac{W d}{2 \mu} \right) \tan v_0 = \left(H + \frac{W d}{m} \right) \tan v_0 \quad (28)$$

If the vertical plane in which the needle swings makes an angle γ with the magnetic meridian, we have for the component of H , acting along that plane, its projection $H \cos \gamma$ and the expression becomes:

$$V = \left(H \cos \gamma + \frac{W d}{m} \right) \tan v_1 \quad (29)$$

With the inclinometer the observations are made in a plane perpendicular to the magnetic meridian, *i.e.*, $\gamma = 90^\circ$, and we have for the value of the vertical intensity:

$$V = \left(\frac{W d}{m} \right) \tan v_2 \quad (30)$$

In this equation $\frac{W d}{m}$ is a constant. Let this constant be represented by K and the equation becomes:

$$V = K \tan v_2 \quad (31)$$

In a field disturbed by the presence of a magnetic ore deposit,

the vertical force is the resultant of the vertical component of the normal terrestrial field V and the vertical component of the field of the magnetic ore body $\pm G$. The plus sign signifying north pole attraction, the minus sign south pole attraction on the inclinometer needle. The horizontal force R acting on the needle is the resultant of the horizontal component of the normal terrestrial field H and the horizontal component of the ore field F .

If the plane of the inclinometer is in the plane of the magnetic meridian, we have (see eq. 28) for G , if it acted alone:

$$\pm G = (R + K) \tan \nu_0' \quad (32)$$

If γ is the angle made by the plane of the inclinometer with the plane of the magnetic meridian, we have (see eq. 29):

$$\pm G = (R \cos \gamma + K) \tan \nu_1' \quad (32a)$$

For $\gamma = 90^\circ$, i.e., when the plane of the inclinometer is at right angles to the magnetic meridian, we have (see eq. 31):

$$\pm G = K \tan \nu_2' \quad (32b)$$

The expression for the resultant vertical intensity is, therefore:

$$V \pm G = K (\tan \nu_2 + \tan \nu_2') \quad (33)$$

In the Tiberg inclinometer the vertical force of the normal terrestrial field V is counterbalanced by a small weight on the south arm of the needle and $\nu_2 = 0$. With this adjustment made the working equation for determining the vertical intensity of the ore field becomes:

$$\pm G = K \tan \nu_2' \quad (33a)$$

If the adjustment for neutralizing V is not perfect, but leaves an index

error of a small angle ν_0 above the zero (due to over correction).

Fig. 24

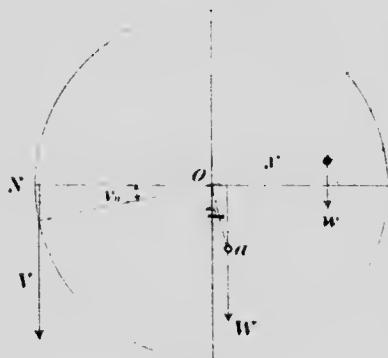

or below it (due to under correction), we have in the normal field for the condition of equilibrium, if w is the small weight on the south arm of the needle:

$$V - 2 \mu l \cos e'' = W d \sin e'' + w x \cos e''$$

and
$$V - \frac{w x}{m} = \frac{W d}{m} \tan e'' - K \tan e'' \quad (34)$$

If with an index error e'' below the zero, we read for the north pole in the disturbed field e' , the reading is evidently due to:

$$\left(V - \frac{w x}{m} \right) + G$$

or
$$K \tan e'' + G = K \tan e'$$

and
$$G = K (\tan e' - \tan e'') \quad (35)$$

If the index error is above the zero, we have:

$$-\left(V - \frac{w x}{m} \right) + G = K \tan e'$$

or
$$G = K (\tan e' + \tan e'') \quad (36)$$

By the use of equations (35) and (36) the correction of the error, introduced by defective adjustment is easily made.

If the angle e'' is very small, we may put:

$$G = K \tan (e' \mp e'') \quad (37)$$

Determination of the Value of K .—In the expression $K = \frac{W d}{m}$, W and m may be determined with accuracy, but m changes with time, decreasing in value, and d cannot be accurately ascertained: the value of K is, therefore, best obtained experimentally by the following methods:*

1. The magnetometer, set up in a strongly magnetic field, with compass box horizontal, is revolved until the axis of the needle is parallel to the axis $Z_1 Z_2$ of the compass box.

The compass box is now set vertical and the needle is free to swing in a plane parallel to the magnetic meridian. If R is the horizontal intensity of the field and v_0 the reading of the north end of the needle, equation (32) becomes:

$$G = (R + K) \tan v_0' \quad (38)$$

* Before proceeding to ascertain the value of K by these methods it is requisite to compensate the needle for V , the vertical component of the normal field. (See page 31).

The compass box is again placed horizontal, the magnetometer revolved through a right angle, the compass box placed vertical and a second reading of the needle taken: let it be v_2' . In this position R , being at right angles to the plane of motion of the needle, its effect on the position of the compass needle is zero and we have for this position:

$$G = K \tan v_2' \quad (39)$$

From equations (38) and (39):

$$\begin{aligned} R \tan v_0' &= K (\tan v_2' - \tan v_0') \\ K &= \frac{\tan v_0'}{(\tan v_2' - \tan v_0')} R \end{aligned} \quad (40)$$

R may then be determined by the sine method and substituted in the equation.

2. In the normal field we may employ either of the two following methods:

(a) Beneath the magnetometer suspend centrally and vertically, south pole upward, a strong magnet. A reading is taken with the plane of the inclinometer at right angles to the magnetic meridian, angle $\gamma = 90^\circ$ and hence from eq. (32b):

$$G = K \tan v_2$$

A second reading is taken, with the arm E turned south, *i.e.*, with inclinometer turned 180° from the magnetic meridian, γ of equation (32a*) = 180° and we have:

$$G = (K - H) \tan v_3$$

hence:

$$K (\tan v_3 - \tan v_2) = H \tan v_3$$

and

$$K = \frac{\tan v_3}{\tan v_3 - \tan v_2} \cdot H \quad (41)$$

A mean value K_m , obtained from different values of K for different distances of the south pole beneath the magnetometer, is made the working value.

(b) The magnetometer is set up in the normal field, as for the tangent method, the compass box is placed vertical and the deflecting magnet in its frame on arm E , with its north pole facing the north pole of the compass needle, *cautiously* moved

* Since the horizontal intensity of the magnet acting on the needle is zero $R = H$.

forward until the compass needle stands nearly vertical. The resolved part of H along the plane of rotation being zero, we have,

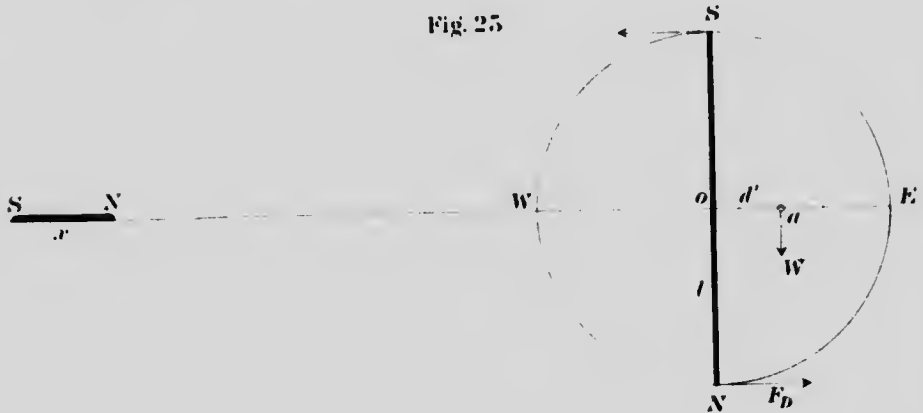

if F_D represent the force exerted by the deflecting magnet on pole of strength μ of the inclinometer needle, M_F the couple due to the deflecting magnet, M_g the moment due to force of gravity applied at a :

$$M_F = F_D \cdot 2l$$

$$M_g = W \cdot d'$$

For position of equilibrium,

$$F_D \cdot 2l = W \cdot d'$$

$$F_D = \frac{2M\mu}{d^3} \quad (6)$$

$$\text{and} \quad 4 \frac{M\mu l}{d^3} = \frac{2Mm}{d^3} = W \cdot d'$$

$$\text{and} \quad q = \frac{2M}{d^3} \quad (8)$$

$$\text{hence:} \quad q = \frac{W \cdot d'}{m} = K$$

The value of q is then determined with *unchanged* position of deflecting magnet by the sine method, and we have finally:

$$q = K = H \sin \alpha_0 \quad (11)$$

From this equation it is further evident that K can only be determined in the normal field if $K < H$. If $K > H$, it must be determined in a disturbed field south of the neutral line.

The sensitiveness of the inclinometer increases with decrease of K . K itself varies directly as W and d' and inversely as $2\mu l$. Sensitiveness is best attained by making d' small and both μ and l great. In the Swedish instruments the value of K varies from $0.5 H$ to $1.5 H$.

The value of K obtained by the methods described is in terms of H and, therefore, G , as determined by the inclinometer, is also expressed in terms of H .

For the purpose of determining the value of the magnetic moment of the compass needle and the deflecting magnet, the following simple method may be employed:

Draw upon a plane table a line in the direction of the magnetic meridian, as indicated by a compass and a line perpendicular to it, intersecting the meridian line. On this intersection place a small compass, with the axis of rotation of the needle coinciding with the intersection. Place the magnet (compass needle, or deflecting magnet), the moment of which is to be determined, with its axis coinciding with the line drawn perpendicular to the magnetic meridian and with its center at a certain distance d from the intersection of the lines. Read the deviation of the compass needle φ , reverse the magnet, maintaining the same distance of its center from the intersection, and read the deviation φ' , which will now be in the opposite direction. Take the mean φ_m of the two readings, then, if $2l$ is taken as $\frac{2}{3}$ of the actual length of the magnet, measured in centimeters, and d , the distance of the center of the magnet from the intersection of the lines, be accurately measured in centimeters, we have from equation (10) page 21:

$$m = \frac{1}{2} d^3 H \left(1 - 2 \frac{l^2}{d^2} \right) \tan \varphi_m$$

In this equation m is given in terms of the value of the horizontal component of the earth's normal field. If this is known

in absolute units and introduced in the equation, m is obtained in absolute units.

Method of Observation. — The magnetometer is set up at the place of observation, as described for the tangent method, the compass needle reading 90° . The compass box is placed vertical and the angle of inclination e of the needle read from its north end (after tapping, by allowing brass ring of suspension arm to fall gently upon the box). For preliminary observation the compass box is lifted from its bearings, held horizontally over place of observation, rotated about a vertical axis until the needle reads 90° , and turned into the vertical position about the axis passing through $0^\circ - 0^\circ$ and the angle e read as before from its north end.

CHAPTER XI.

THE THOMSON-THALÉN MAGNETOMETER.

Description. — The latest form* of this instrument consists of two parallel magnetic needles A_1, A_2 (see Figs. 26 and 27), of cylindrical form, $2\frac{3}{4}$ inches long and about $\frac{1}{15}$ inch in diameter. These magnets are mounted upon a brass ring I , with like poles in the same direction. The ring is provided with pointed hardened steel screws B_1, B_2 , which rest upon agate supports C_1, C_2 , carried by the pillars D_1, D_2 , and permit the magnetic needles to swing in vertical planes about the diameter of the ring which passes through the magnetic equator of the needles.

To prevent the motion of the magnetic system and lift the points of suspension from the agate supports, when the instrument is not in use for observation, an arrest is provided, which consists of a second brass ring $K K$, situated below the magnetic system. Upon this ring are mounted four forks, L_1, L_2, L_3, L_4 , which receive and support the ring of the magnetic system.

* February, 1903.

Fig. 26

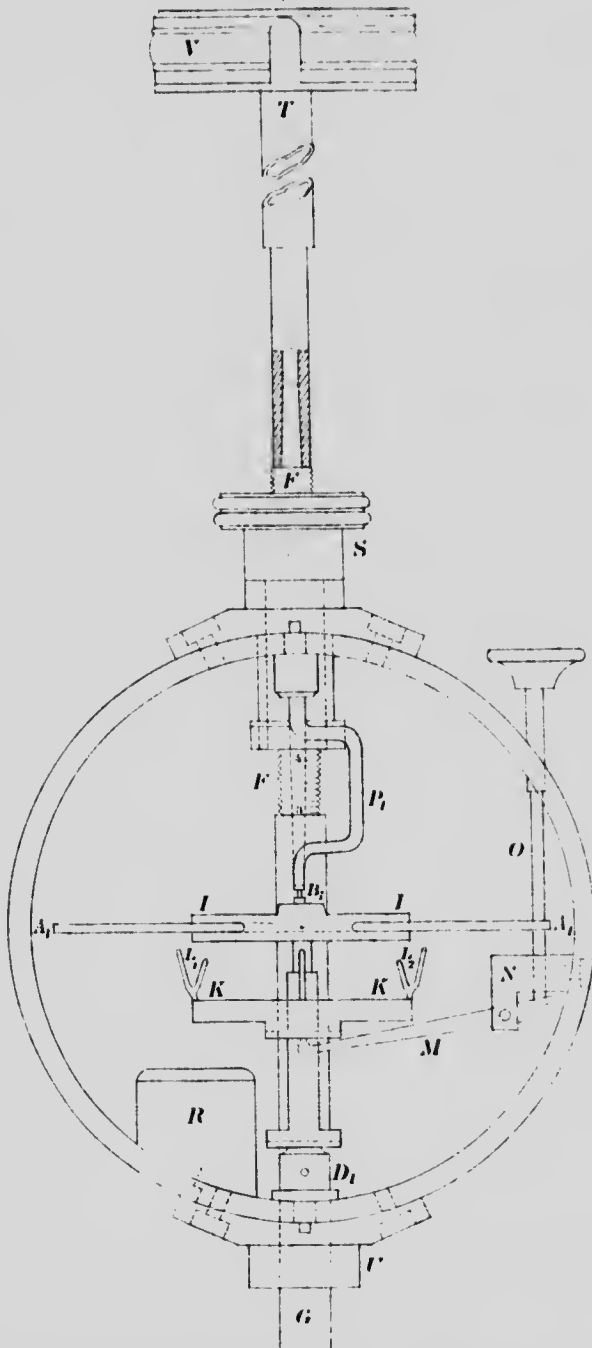
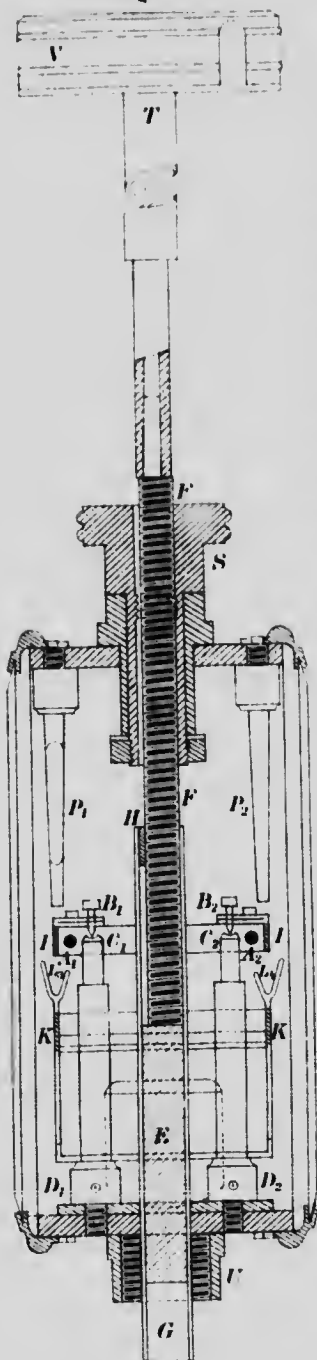

Fig. 27



Release and arrest are accomplished by lever *M*, actuated by screw *O*, and when ring *K* is raised by lever *M* to its limit the mounting *I* is pressed firmly against the stops *P*₁ *P*₂, holding the magnetic system immovable in position. The center of gravity of the magnetic system is below the point of suspension, as in the case of Tiberg's inclinometer, but in the Thomson-Thalén magnetometer may be adjusted to decrease or increase the sensitiveness of the system, by raising or lowering the pivot screws *B*₁, *B*₂.

The inclination of the magnetic system produced by the vertical components of the magnetic forces acting upon the needles may be compensated by a cylindrical magnet *E*, north pole upward, mounted in a brass cylindrical casing, as shown in Figs. 26 and 27, and attached to a brass screw *F*, by the elevation or depression of which the distance of the upper pole of magnet *E* from the plane of the magnetic needles may be varied. This screw is operated by the screw head *S*, situated on top of the containing case. The position of the north pole of the compensating magnet with reference to the center of the ring carrying the magnetic needles is indicated on a scale en-

graved on the faced-off part of the screw. To permit the reading of the scale, the brass cylindrical case of the magnet is for a short distance cut away in front. In Fig. 26 the divisions 3 and 4 are seen. The distance between the threads of the screw is 0.03 of an inch and the head of the screw *S* is divided into 100 parts. This permits the determination of the distance of the deflecting magnet from the axis of revolution of the magnetic needles to within the 0.0003 of an inch.

The working parts described are mounted in a cylindrical brass case, closed front and rear by removable glass plates. Upon each of these glass plates a horizontal line is engraved to indicate when the needles are in horizontal position and the vertical components of the magnetic forces acting upon the needles have been compensated by the magnet *E*. A small box-level *R*, situated within the case, indicates when the axis of rotation of the magnetic system is horizontal.

A small compass *V*, mounted on a brass stem *T*, five inches long, placed, as shown, on top of the case and removable, gives the direction of the magnetic meridian and serves the purpose of bringing the horizontal axis of rotation of the magnetic system into the magnetic meridian.

The magnetometer is mounted on a tripod with head for levelling, as previously described for the Thalén-Tiberg magnetometer.

As at present constructed, the instrument has the serious defect of rendering the reading of the scale of the deflecting magnet difficult. The brass pillar, which limits the motion of the arrest, is parallel to and in front of the scale, obstructing the field of view, and the divisions and scale numbers are indistinct. By replacing the pillar with a brass piece, bent as shown in the figure (the original pillar is indicated by the dotted lines) and cementing upon the front glass plate, with Canada balsam, a plano-convex lens of proper focus, the reading of the scale would be greatly improved.

Theory of Thomson-Thalén Magnetometer.

Fig. 28

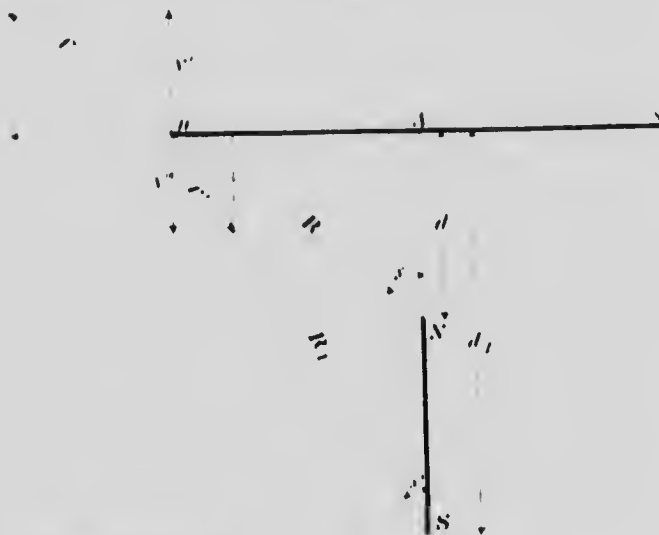

In Figure (28) let

NS be the compensating magnet,

Au the distance from center of axis of revolution of the magnetic system to the pole u of one of the needles,

$d = AN$, the distance of the north pole of the compensating magnet from A ,

$d_1 = AS$, the distance of the south pole of the compensating magnet from A ,

a . The strength of one of the poles of the compensating magnet,

u . The strength of one of the poles of the magnetic needles,

R = The distance of north pole of compensating magnet from u , the north pole of one of the magnetic needles,

R_1 = The distance of south pole from the same point u .

$x =$ Angle $A N u$.

$x' =$ Angle $A S u$.

We have for the force f exerted by N upon u

$$f = \frac{\sigma \mu}{R^2}$$

for the vertical component of this force e' ,

$$e' = f \cos x = \frac{\sigma \mu \cos x}{R^2} = \frac{\sigma \mu \cos^3 x}{d^2}$$

Similarly for the vertical component of the force f' exerted by S upon u :

$$f' = \frac{\sigma \mu'}{R_1^2}$$

and for its vertical component e''

$$e'' = f' \cos x' = \frac{\sigma \mu' \cos x'}{R_1^2} = \frac{\sigma \mu' \cos^3 x'}{d_1^2}$$

and since these act in opposite directions, we have for the resultant vertical force e'''

$$e''' = (e' - e'') = \sigma \mu \left\{ \frac{\cos^3 x}{d^2} - \frac{\cos^3 x'}{d_1^2} \right\}$$

If $2l$ is the length of the magnetic needles, we have for the couple due to the compensating magnet upon one needle:

$$\begin{aligned} e''' 2l &= \sigma \mu 2l \left\{ \frac{\cos^3 x}{d^2} - \frac{\cos^3 x'}{d_1^2} \right\} \\ &= \sigma m \left\{ \frac{\cos^3 x}{d^2} - \frac{\cos^3 x'}{d_1^2} \right\} \end{aligned} \quad (42)$$

For the second needle with strength of poles μ' we obtain similar expression:

$$e_1''' 2l = \sigma m' \left\{ \frac{\cos^3 x}{d^2} - \frac{\cos^3 x'}{d_1^2} \right\} \quad (42a)$$

The resultant couple due to the compensating magnet upon both needles will equal the sum of the separate couples, hence:

$$(e''' + e_1''') 2l = \sigma (m + m') \left\{ \frac{\cos^3 x}{d^2} - \frac{\cos^3 x'}{d_1^2} \right\} \quad (42b)$$

The rotation of the magnetic system produced by this couple will be right or left handed, as $(e''' + e_1''')$ is positive or negative.

If $(V - G)$ is the vertical intensity of the disturbed terrestrial field, compensation is effected when:

$$(V - G) = (e'''' + e_1''''')$$

The value $(e'''' + e_1''''')$ depends upon the distance of the poles N and S of the deflecting magnet from O , as will be seen from the curve constructed for the instrument described.

In figure (29) $A_1 A_1$ is one of the needles of the magnetic system, with n its north pole, s its south pole, P_1, P_2 the north and south pole respectively of the deflecting magnet. The distance $P_1 P_2 = \frac{2}{3}$ of the actual length of the deflecting magnet. F is the brass screw, to which the deflecting magnet is attached, by means of which the distance of P_1 from O may be altered. The graduation is shown on the faced-off part of the screw. The abscissis of the curve, a, b, c, d, e, f, g , are the distances d_n of P_1

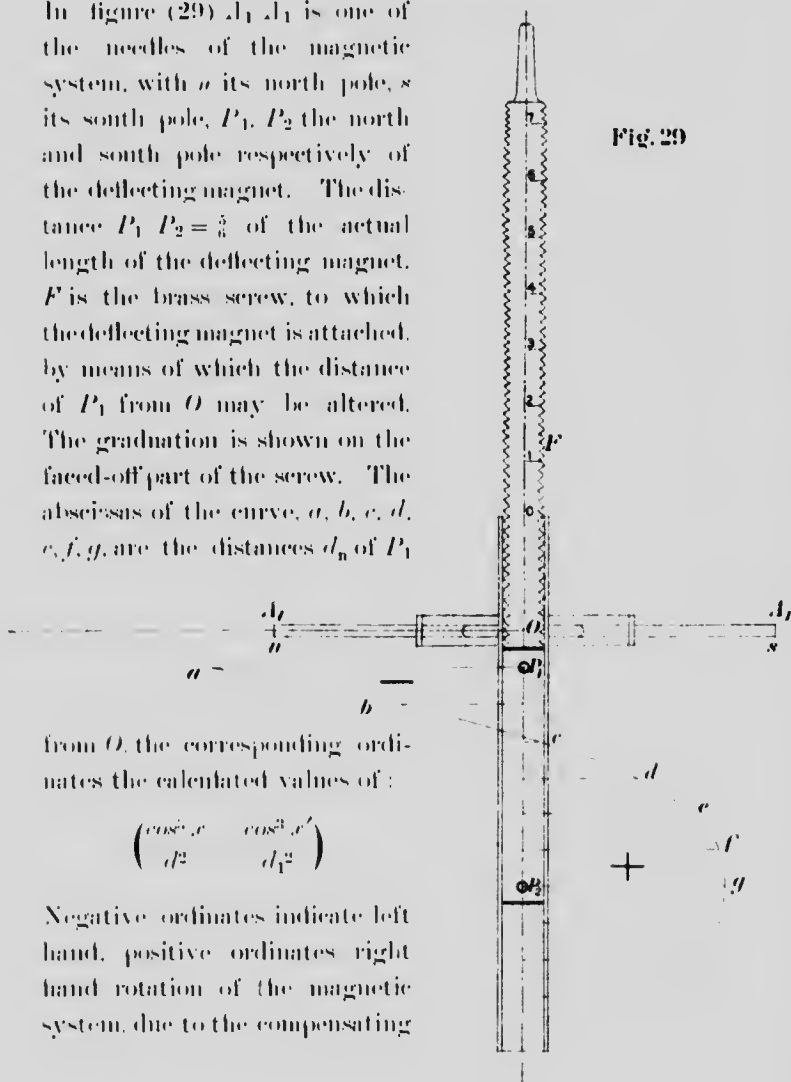

from O , the corresponding ordinates the calculated values of:

$$\left(\frac{\cos^2 x}{d^2} - \frac{\cos^2 x'}{d_1^2} \right)$$

Negative ordinates indicate left hand, positive ordinates right hand rotation of the magnetic system, due to the compensating

magnet. When north pole P_1 is situated just above ordinate c , the effect of the deflecting magnet upon n of the needle $A_1 A_1$ is zero. When P_1 occupies position P_2 , the effect of the compensating magnet to produce right handed rotation of the magnetic system is a maximum, corresponding to ordinate g .

It will be seen from figure (29) that the greater the force required to compensate north pole attraction of the disturbed field, the greater will be the value of the scale reading \dot{z}_n , but that the greater the force required to compensate south pole attraction, the less will be the value of the scale reading.

If \dot{z}_0 is the reading on the scale when the needles of the magnetometer stand horizontal in the normal field and $\dot{z}_1, \dot{z}_2, \dot{z}_3$, etc., the readings for different places in a disturbed field, the readings corresponding to the values of the vertical components of the ore deposit for these places will evidently be $\dot{z}_1 - \dot{z}_0, \dot{z}_2 - \dot{z}_0, \dot{z}_3 - \dot{z}_0$, etc. These readings will, therefore, be positive or negative as \dot{z}_0 or $-\dot{z}_0$. In the first case north pole attraction, in the second case south pole attraction is being compensated and the numerical value $\dot{z}_n - \dot{z}_0$ indicates the compensated intensity of the vertical component of the ore body on an arbitrary scale.

The readings $\dot{z}_1, \dot{z}_2, \dot{z}_3$, etc., depend, in addition to the intensity of the magnetic forces to be measured, upon the moments of the magnetic needles of the instrument and that of the compensating magnet. It is, therefore, evident that since these quantities vary for different instruments, the readings of two different instruments are not comparable. For that reason and for the purpose of calculations of the depth of ore bodies, etc., it is necessary to express the readings \dot{z}_n for G in terms of H . This may be accomplished by the following method of calibration:

Calibration of the Thomson-Thalén Magnetometer. The instrument, set up in the normal field, is properly levelled and the axis of rotation, by means of the small compass, brought into the magnetic meridian and the compensating magnet elevated or depressed by screw, until the magnetic axes of the

needles are in the same plane with the horizontal line on the glass cover. The reading λ_0 is obtained from the scale and graduated screw-head.

A strong magnet is now placed vertically and centrally, south pole upwards, beneath the magnetometer, at distance d_1 . The needles are now rendered horizontal by compensating magnet and reading λ_1 obtained. This is repeated for different distances of the magnet from axis of revolution of the needles and the readings $\lambda_2, \lambda_3, \lambda_4$, etc., for the different accurately measured distances d_2, d_3, d_4 , etc., observed and recorded. The magnet is now removed and the Thomson-Thalén Magnetometer replaced by an inclinatorium (see Fig. 6), with axis of revolution of the needle accurately perpendicular to the magnetic meridian. A magnet, south pole downwards, is suspended centrally *over* the inclinatorium, at a distance which will exactly compensate V , the vertical component of the earth's field. The needle of the inclinatorium is now horizontal and its magnetic axis in the magnetic meridian.

The former magnet is now successively placed at distances d_1, d_2, d_3 , etc., from the point of suspension of the needle and the angles I_1, I_2, I_3 , etc., corresponding to the distances d_1, d_2, d_3 , etc., ascertained and recorded.

Since V , the vertical component of the earth's magnetism, has been compensated, the only forces acting to produce the angle of deflection I_1, I_2 , etc., are H , the horizontal intensity of the earth's magnetism and G , the vertical component of the magnet below the instrument. We have therefore:

$$G = H \tan \theta I = \mu H.$$

A curve may now be constructed with tangents I_n as abscissas and readings λ_n, λ_1 , etc., as ordinates. From this curve (see Fig. 30) for any reading λ_n , we obtain the corresponding tang I_n . We have then:

$$G_n = \tan \theta I_n = \mu^*$$

G_n expressed in terms of H .

* H taken equal to unity.

Thus for a certain instrument (see Fig. 30), λ_0 was found to be equal for a certain locality to 16.70 scale divisions, for $\lambda_1 = 18$ the corresponding value of $\text{tang } I_1 = 0.52$, for $\lambda_2 = 19.15$ $\text{tang } I_2 = 1$, and so on. By the plotting of these values, the curve of Fig. 30 was obtained.

Fig 30

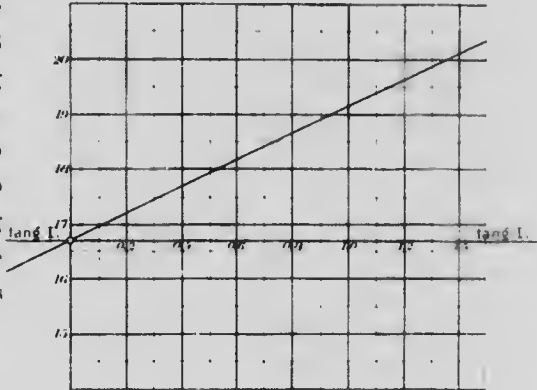

CHAPTER XII.

DESCRIPTION OF THE SWEDISH MINING COMPASS.

This valuable instrument for preliminary examination of a magnetic ore field, as now constructed by Swedish mechanics, is substantially the same as the one invented by Daniel Tilas in the eighteenth century.

It consists of a light cylindrical brass case $f_1 f_2$ (see Fig. 31) enameled white on its inner surface. The case is closed at bottom by a removable brass plate $g g$, on which, facing the interior, the points of the compass are marked out in black on white ground. From the center of this plate rises a light brass pillar i , which ends in a fine, pointed, steel needle. This needle acts as the vertical axis of rotation of the suspension b, c_1, c_2 . The suspension is provided at b with a jewel. The horizontal axis of the magnetic needle is supported by the suspension at c_1, c_2 . To permit the needle to move in a vertical plane, the needle is broken through in the region of its equator, as shown in figure 32. This method of suspension permits the movement of the needle in any plane.

Fig. 31

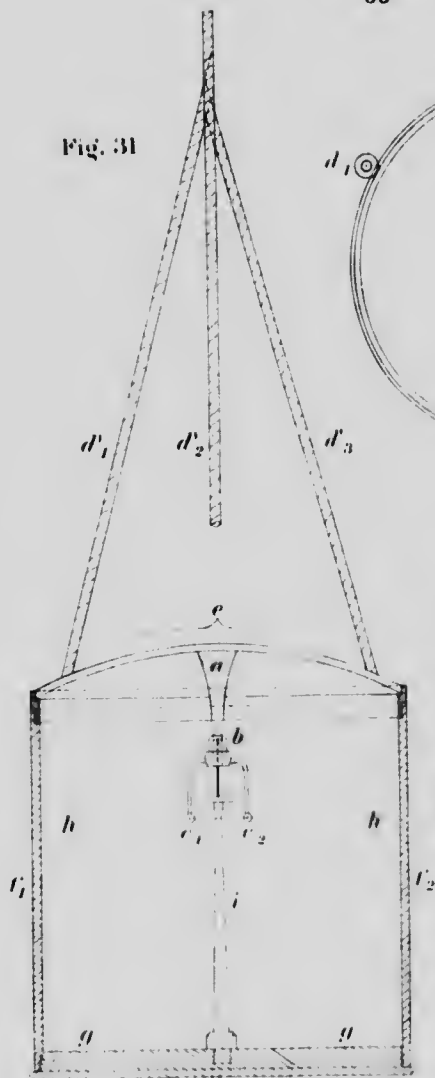
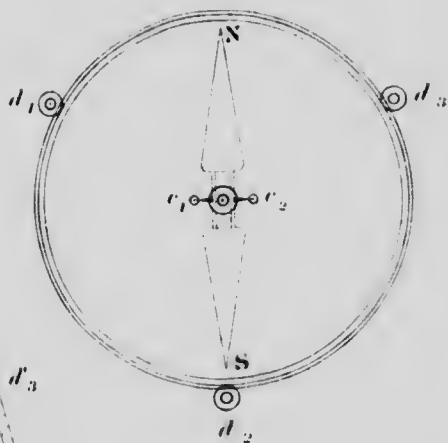

Fig. 32



To prevent the unshipping of the suspension, an ivory stop *a* is cemented to the curved glass cover. A line *h h*, in black on the inner face of the case, indicates when the needle is horizontal. Through the eyes *d*₁, *d*₂, *d*₃, the three cords *d*'₁, *d*'₂, *d*'₃, are knotted, by which the instrument is held suspended, when observations are made.

To compensate the vertical component of the earth's normal field, the base plate *g g*, carrying the magnetic needle and its support, is removed and the needle rendered horizontal by means of a small piece of wax attached to the south end of the needle.

CHAPTER XIII.

INVESTIGATION OF MAGNETIC ORE DEPOSITS
BY MAGNETOMETRIC MEASUREMENTS.

If a preliminary investigation of a field, made with the Tiberg Inclinator, or preferably with a mining compass, reveals by the varying inclination of the needle in passing over the field that we have to do with a disturbed terrestrial field, places of greatest inclination* are first located and marked. A line

* It is to be noted that in the case of the mining compass, the needle of which always swings in the vertical plane passing through the resultant of the acting horizontal forces, the maximum inclination will not be found directly over the pole of the magnetic ore-body, but north of it, as is evident from the following (see Fig. 33):

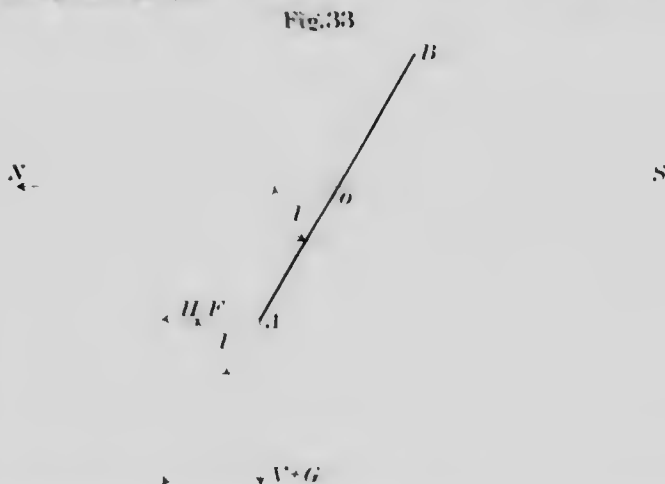

The resultant R along the meridian NS in the ore field to the north of the upper pole of the ore-body is equal to $H - F$ and the vertical resultant = $V + G$. We have, therefore:

$$\frac{V + G}{H - F} = \tan I$$

or, if V is compensated:

$$\frac{G}{H - F} = \tan I'$$

This value will be greatest for $H - F = 0$, which can only take place north of the pole of the ore body.

joining these gives the general direction of the strike of the ore field. The magnetometer is then set up in the field over one of the places of greatest inclination and a line run in the direction of the strike by means of the sights of the magnetometer and this line is extended through the field to places where $G=0$.

On this line, the principal line, are then laid off distances conveniently of 30 feet, commencing at the stake for maximum value of G , and stakes driven to mark these distances. From these stakes and at right angles to the principal line, subsidiary lines are run to the limit of the disturbed field and on the lines distances of 30 feet laid off, commencing at the stake on the principal line. In this manner, the whole field to be investigated is laid out in squares.

For the purpose of identifying individual squares in the field, the rows of stakes, parallel to the principal line, are marked with letters, those at right angles with numerals, *i.e.*, on each stake is marked the letter and number of the respective rows to which it belongs. For the purpose of re-measurement of certain values of R or G , or for the extension of the field, should this prove advisable, it is necessary to mark more permanently some of the stations, both in the principal line and in the lines perpendicular to it.

The stations are then transferred upon squared paper, conveniently on a scale of 1 inch = 60 feet. On this preliminary sketch are also marked in their proper location important objects occurring in the field, such as houses, roads, shafts, ditches, streams, etc. For the correct interpretation of the results of the magnetometric measurements made, it is very desirable that on the sketch the terrane be represented quantitatively by approximately correct contour lines.

After these preparations of the field and the preliminary sketch, the magnetometer is examined in the normal field and tested as to its adjustment and necessary corrections made. The inclinometer needle is brought to the zero by adjusting the little weight, or the index error read and noted, so that it may be taken account of in the final calculation of the vertical intensity.

The work of making the magnetometric measurements may now be begun. The magnetometer is first set up in several places in the normal field and the characteristic angle α_0 determined for these places.* The magnetometer is then set up successively at each stake and the respective values of angles α (or R) and c determined for these stations. These, as soon as measured, are transferred to the preliminary sketch at the corresponding points. South pole attraction is indicated by placing the minus sign in front of the recorded angle. In case of rapid change of the magnetic intensities measured, it becomes necessary to take observations at stations intermediate between the stakes, on the sides of the squares and also within the squares. The additional values of the angles α (or R) and c , thus obtained, are recorded in their proper place on the sketch.

It is in many cases valuable, and for a complete investigation of the field, necessary, to observe the angle which the resultant R makes with the lines either at right angles to or parallel to the principal line. For this purpose the magnetometer, set up over a stake, is brought with its arm E , by means of the sights, into line with the stake line and the angle δ included between the stake line and the magnetic axis of the needle read and recorded on the sketch for that point of the square. The observation does not take too much time and should be made at every station. The mean of the angles δ_0 observed at the limit of the field where $G=0$ and $R=H$, indicates the mean direction of the magnetic meridian of the field of investigation.

If observations are to be made with the Thomson-Thalén magnetometer, which permits only the determination of the different values of the vertical intensity of the ore field, the method to be pursued is as follows:

The instrument is set up in the normal field and levelled. By means of the small compass, mounted on top of the case, the horizontal axis of revolution of the needles is rendered parallel to the magnetic meridian, the magnetic needles released, and, by

* See page 35.

means of the compensating magnet, brought into horizontal position, λ_0 is then read. This operation must be repeated for different places and only such values joined to a mean value λ_{0m} , which do not differ much from each other. The instrument is then set up over the different stakes of the field and the position of the compensating magnet $\lambda_1, \lambda_2, \lambda_3$, etc., which brings the needles to the horizontal position, read for every station and recorded.

The values obtained by these measurements are then utilized for the construction of charts, which show the distribution of the horizontal and vertical intensities and the varying direction of R in the field of investigation. It is usual to construct a separate chart for each of these quantities. By joining the points of equal horizontal intensity in the one chart and the points of equal value of G for the other chart, we obtain for each a system of isodynamic lines. By joining the points of equal declination for the third chart, we obtain a system of isogonic lines.

Plates II, III and IV are illustrations of such charts, constructed for an ideal magnet 100 meters in length and including an angle of 53° with the horizon, with its upper pole 30 meters below the plane of observation and of pole strength 5,400,000 C. G. S. units.

Plate I is a vertical section of the field of force through the station line m of Plates II and III, giving the curves of the vertical and horizontal intensities of the upper and lower pole respectively of the magnet. The arrows indicate the direction in which the forces act, the ordinates the intensities on a scale of $0.60 = 5$ inches, and the abscissas the different stations along the line m , on a scale of 20 meters to the inch. The calculation of the intensities is shown by diagram for station 4 to the right of zero, in which the line $P_s = \frac{\sigma}{d^2} = \frac{5,400,000}{(5020 \text{ cm})^2} = 0.214$ in length and direction represents the total intensity of the pole S at station 4. The line $P_n = \frac{\sigma}{d_1^2} = \frac{5,400,000}{(11200 \text{ cm})^2} = 0.043$ similarly represents in length and direction the total intensity of the pole

N at the same station. F_h, F_v and G_h, G_v are the horizontal and vertical components of P_h and P_v respectively.

From the curves, Plate I, the horizontal and vertical intensities and the angle δ which the resultant of the horizontal intensity makes with the magnetic meridian are easily found for any station in the plane of observation, as will appear from the following illustrations: Fig. 45, Plate I, for the station j 3.

P_h and P_v correspond to the points m 0 and m 6 respectively. The point $f = j$ 3 lies to the right of P_h , therefore, from 0 to the right lay off $P_h f = 0g$ on line m and $P_v f$ to the left of m 6 (since f lies to the left of P_v) $= 6h, G_h = g a, G_v = -c h$ and G for station j 3 $= g a - c h$. Similarly $F_h = g b$, acting along $P_h f$, as shown in Fig. 45, and $F_v = d h$, acting along $P_v f$. By constructing the parallelogram and drawing the diagonal, we find F in intensity and direction for the station j 3. Upon $F f$ and $f H$ (the horizontal intensity of the normal field) construct the parallelogram and draw the diagonal, which will be R for the station j 3 and angle $R f H = \delta =$ the angle which the resultant horizontal intensity makes with the magnetic meridian.

Chart of the Horizontal Intensity.—In these charts the isodynamic lines are curves, which result from joining points for which either the angles of deflection α or R have the same values. In the first case the curves are constructed for maximum values of α , corresponding to $R < H$, from 10° to 10° and for minimum values of α , corresponding to $R > H$, from 5° to 5° . In the second case, points may be joined, for which $R = 1.00, 1.20, 1.30, 1.70, 2.50$.*

It is customary in Swedish practice to employ colours in representing the distribution of R . The "neutral line" ($R = H$ or $\alpha = \alpha_0$) may be drawn out in brown (brunt sicma), curves of

* It is not important to adhere to the values just given for the construction of isodynamic lines, which are recommended by the Swedish authorities. They are stated to serve only as a guide. The point to be kept in mind in the construction of magnetic charts is to choose such values for the lines as will most fully represent the distribution of the magnetic force in the field, without overloading the chart with too many lines, which would obscure, rather than emphasize the salient features of the deposit.

maximum value of α , corresponding to minimum value of R may be represented in green (Hooker's green No. 2), and curves of minimum value of α , corresponding to maximum value of R , in red (crimson lake.) The areas within the bounding lines are laid in with their proper colour and of a tint the more intense the greater the variation of the bounding curves from the value $R = H$. Objects, such as houses, etc., are represented by lines in India ink.

It is important for future reference and for comparison with charts of other deposits to indicate upon the plan, beside the name of the observer, the exact location of the deposit and time when observations were made, also the method employed, the instrument used and the normal angle α_0 if R has not been obtained direct with the Dahlblom arm.

Charts of Vertical Intensity.—If the observations have been made with the Tiberg Inclinator, the curves in these charts may join either points for which the angle ν or the value of $G = K \tan \nu$ is the same. For the calculation of G from the angles of observation ν , a table of natural tangents is appended. (See Table IV).

The curves may be constructed for degrees varying from 10° to 10° , or from 5° to 5° , or for G in terms of H for values 0.0, 0.1, 0.2, 0.4, 0.8, 1.6, 3.2.

In the case of observations having been made with the Thomson-Thalén magnetometer, lines are drawn through places for which λ_n or $(\lambda_n - \lambda_0)$, or the corresponding values of $\tan I_n$, giving G in terms of H , are the same.

The colours in these charts to bring out the distribution of the vertical intensity adopted are: blue (Prussian blue) for north pole attraction, and yellow (gamboge) for south pole attraction. The areas between the bounding curves are laid in with appropriate tints, as described for the plans of the horizontal intensity.

For the purpose of comparing different maps, plotted from observations with instruments, for which K differs, in addition to the name of the observer, etc., the value of K must be stated.

To facilitate this comparison, by reducing K_n of any instrument to $K = 1.0 H^*$, a table is appended (see table V.), in which:

V_n = the observed angle of the inclinometer needle with constant K_n .

and V = the angle which corresponds to the angle V_n for an inclinometer with constant $1.0 H$.

The value of G in a field disturbed by the presence of only one magnetic ore deposit varies from a maximum, directly over the pole of the ore body, with distance from the maximum in general at first rapidly, then more slowly, to zero, becomes weakly negative and at greater distances becomes again zero (see Fig. 34). Flattening of the crest of the curve, correspond-

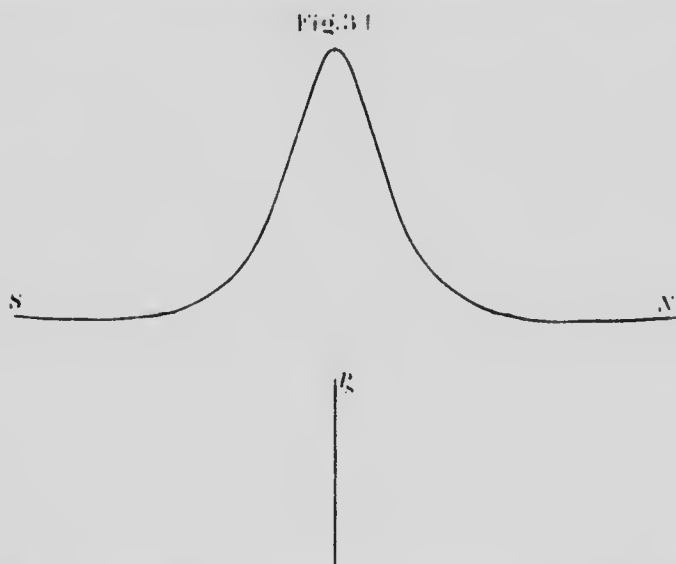

ing to slow decrease from maximum, indicates either great depth below the surface, or a small angle of dip of the ore deposit.

In the case of very complex fields, due to the presence of a number of magnetic ore bodies, it becomes necessary, for the

*It is evident that in the case of this reduction the value of K must be referred to the same locality, since H differs for different places. For Ottawa, Ont., $H = 0.15$. (C. G. S.)



MICROCOPY RESOLUTION TEST CHART

(ANSI and ISO TEST CHART No. 2)



APPLIED IMAGE Inc

1653 East Main Street
Rochester, New York 14609 USA
(716) 482 - 0300 - Phone
(716) 288 - 5989 - Fax

purpose of determining the extent of the individual ore deposit, to construct profile curves (see Fig. 35). These curves are obtained by taking the values of G across the deposits for ordinates and the distance between the stakes of the field (marking

Fig. 35

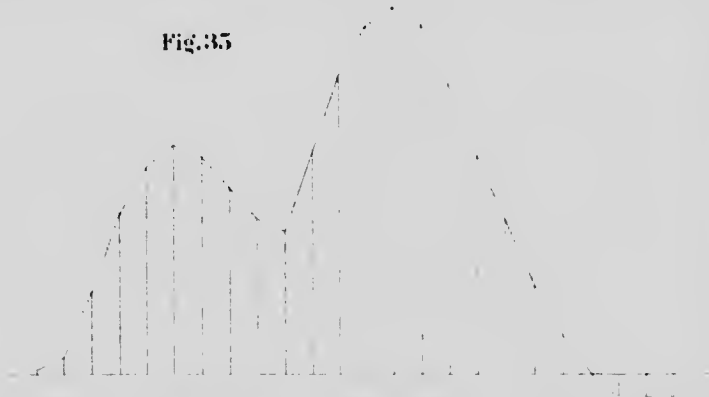

the points of observation) for abscissas. A number of such profile curves constructed for different parts of the field may be required for the determination of the extent of the different ore bodies.

CHAPTER XIV.

INFORMATION CONVEYED BY THE CHARTS OF MAGNETIC INTENSITY.

Plate II. shows the distribution of the isodynamic lines of the horizontal intensity of an ideal magnet. The neutral line is seen to intersect with the magnetic meridian over the pole P_s . A and B are points of indifference. Between these points the compass needle points south. Plate V^* shows the distribution of the horizontal intensity of a deposit of magnetite. The ore body being buried about 10 feet, the terrane nearly level and the ore body of a regular lense shape, consequently the curves,

* Redrawn and coloured for this report by E. Nyström from illustration in "Teknisk Tidskrift," January 25th, 1902, by H. Sundholm.

showing the magnetic intensity, are comparatively regular. The intersection of the neutral line with the line connecting the maximum and minimum gives in this case the location of the pole.

Platc VII. shows the distribution of the horizontal intensity of another magnetic ore deposit. Here the neutral line $M N$ divides the field into two general areas of maximum and minimum value of α . The maximum value of α is at G , the minimum value at F . The letters ty in front of the numerals indicate that for these stations the sine method could not be employed, and α was obtained by the tangent method. The neutral line $M N$ is deflected by the small minimum area K , which is surrounded by another neutral line. The intersection of the neutral line $M N$ with the magnetic meridian at Q does not in this case determine the location of the pole of the main ore body at this point, the pole being situated much further north.

Within the minimum area occurs at H a small maximum area surrounded by a neutral line. The pole giving rise to this maximum area is located at P , the intersection of the neutral line with the magnetic meridian, which is drawn out in black.

From a mere inspection of the map it would appear that the areas H and I correspond to an independent small ore-body and it is only by a study of the distribution of the vertical intensity of the ore field (which is given in the same plate) that it is found not to be an independent ore-body, but a stringer in connection with the main ore-body.

From these illustrations it will be seen that charts for the horizontal intensity are useful for single and simply shaped ore-bodies but that they become complex in the case of a number of ore-bodies, or an ore-body with several branches. For the solution of the problems presented by the more complex magnetic fields, produced by the joint distributing action on the normal terrestrial field of a number of magnetic ore-bodies, the charts of the vertical intensity, in conjunction with profile

curves, furnish most information. The isodynamic curves of these charts may be looked upon as contour lines and the chart as a topographical chart of the occurrence of the ore-body. Curves, long, narrow and of somewhat regular elliptical form, point to an ore deposit of regular form. The strike of the ore-body is along the direction of the longest axis of the curve of maximum intensity. Irregularities in these curves are occasioned either by neighbouring magnetic ore-bodies, or by the topographical features of the terrane, which necessitated measurements at equal distances from the pole to be made at different altitudes. Hence the necessity, as pointed out previously, to incorporate the topographical features of the terrane in the chart.

Very irregular curves indicate irregular distribution of ore masses. Such deposits often show nearly circular areas of maximum intensity which changes very little within the area. Calculations of depth below the surface give, in most cases, very discordant results. It is not possible to decide from magnetic measurements alone whether such deposits are workable or not.

If the distance between the curves on the one side of the maxima is farther apart (*i.e.*, the vertical intensity decreases more slowly in this direction) than on the other side, either the ore deposit dips in this direction,* or the altitude of the terrane diminishes rapidly in this direction.

The action of the lower pole of the ore-body comes into evidence in the production of an area of south pole attraction, which occurs with every magnetic ore deposit and which surrounds the area of north pole attraction. If the ore-body extends vertically to a great depth, the south pole attraction is correspondingly feeble, but increases in intensity as the dip of the ore-body decreases and the lower pole approaches the surface. (See Figs. 36 and 37).

* Page 45, "Om Magnetiska Fyndigheter och deras Undersökning medelst Magnetometer," af Th. Dahlblom. Falun, 1898.

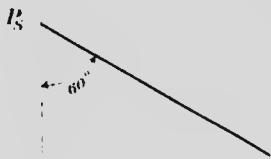
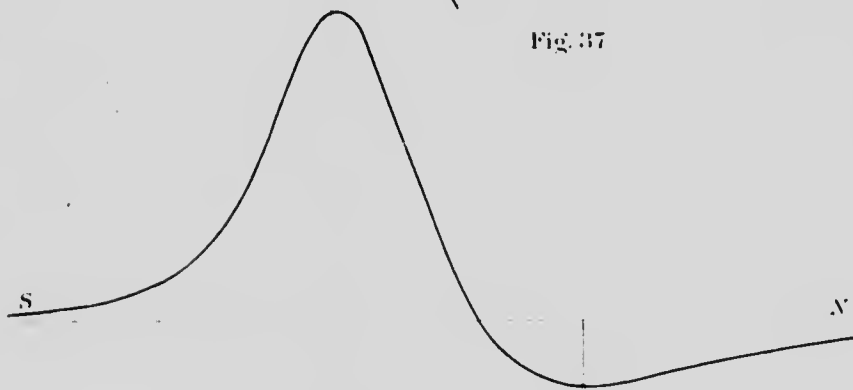
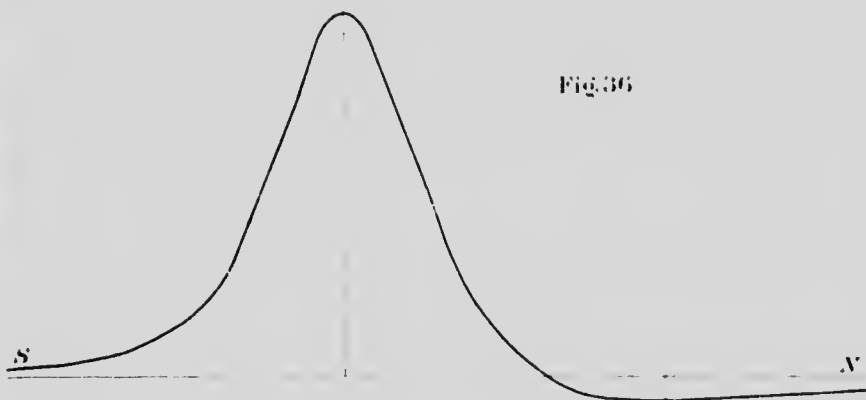

South pole attraction will in general be observed in the level terrane, free from ore, contiguous to a cliff in which the ore crops out. The extent of the area of this south pole attraction increases with the depth of the ore-body, and this may serve as a valuable indication of the extension of the ore-body in depth.

Plate III shows the distribution of the vertical intensity in a horizontal plane of an ideal magnet. The upper pole is vertically beneath P_s , the lower pole beneath P_n , the inclination of the magnetic axis is toward the area of maximum south pole attraction.

Plate VI shows the distribution of the vertical intensity of a deposit of magnetite (see page 74). The curves are here regular and of elliptical shape, indicating a concentrated mass of ore of regular shape, the strike being in the direction of the longest axis of the curves of maximum intensity and the dip to the north (about 65°). The influence of the rock dump (containing some ore) in giving rise to new curves at the portion of the field covered by the dump is especially instructive*. The width of the deposit was about 15 feet and the length about 165 feet.

In the case of the ore field, Plate VII, *A*, *B* and *C* are areas of maximum north pole attraction. *A* and *B* are elevations of the pole area of the main ore body, between these areas the pole area is concave. *C* is a stringer in connection with the main ore body. The magnetic axis of the deposit dips toward the south-east. The strike of the upper pole area is north-east and dips in that direction. The area of south pole attraction to the west of *A* is due to the fact that the terrane slopes rapidly from *A* toward *D*, which locates the stations of observation of area *D* below the pole of the main ore body.

In the case of an ore deposit with extension in length several times greater than in depth, south pole attraction is in general developed at the north end of the deposit, particularly when the strike of the deposit is in the N. S. direction and the

* See also map of horizontal intensity, Plate V.

intensity of such attraction is especially manifest in cases where the north end of the deposit pinches out wedge shape. The lines of force of the earth's magnetism enter the north end of the deposit and there develop south pole attraction. They then travel, on account of the greater permeability of the ore deposit, through the greater length of the deposit, leaving it at the south end, where north pole attraction is consequently developed (see Fig. 5).*

Two magnets of equal strength, with extended pole areas, placed with their axes parallel, a short distance apart and with like poles in the same direction, produce a field of force, in which the lines of force are shown crowded together in the space adjacent to the space separating the magnets. The lines of force proceeding from the north pole areas, which would return through the space between the magnets to the south pole, are deflected outward in a direction parallel to the axes of the magnets. The consequence of this is that the field of force, in a plane perpendicular to the axes of the magnets and a short distance from the poles, shows only one maximum of vertical intensity directly over the point midway between the magnets. From this maximum the intensity decreases, at first slowly, then more rapidly, so that a profile curve will exhibit flattening of the crest. Two maxima will appear, when the distance between the poles is greater than the distance of the poles from the plane of observation. The maxima will, however, not be directly over the centers of the pole areas, but their position will be found shifted in the direction of the space separating the magnets.

These observations will evidently also be made in the case of two parallel magnetic ore bodies. If the distance separating them be not great, only one area of maximum vertical intensity

* If the magnetic north pole of the earth be regarded as the north pole of a magnet, a magnetic needle will point with its north seeking pole in a direction north, and since opposite poles attract, this pole will be the true south pole (Lord Kelvin's designation of north seeking pole). We shall, therefore, have at the north end of the deposit the south seeking, or true north pole, at the south end the north seeking, or true south pole of the needle, attracted downwards.

will be observed, as in the case of a single ore body. If the space between the ore bodies is greater than the distance of the poles from the plane of observation, the differentiation into two ore bodies will be shown by the occurrence of two maxima of vertical intensity.

Whenever the profile curves show complicated or unusual forms, it becomes necessary to analyse the complex curve into its component curves, by constraining trial curves within the complex curve, until the algebraic sum of the ordinates of the overlapping trial curves corresponds to the actual ordinates of the complex curve.

Fig.38



Figure (38)* is an illustration of a complex profile curve, representing the actual occurrence of an ore deposit, consisting of four separate layers. The dotted curves show the final trial curves. The algebraic sum of their ordinates corresponds to the ordinates of the curve obtained by the magnetometric measurements.

* From Uhlich, *Markscheidkunde*, page 383.

CHAPTER XV.

**DETERMINATION OF THE DISTANCE OF THE
UPPER POLE OF A MAGNETIC ORE BODY
BENEATH THE SURFACE.**

1st Method.—By treating a magnetic ore body as an ideal magnet, in determining the distance of its pole from the plane of observation, results are obtained, which experience has shown accord fairly well with fact.

Let the line $A B$ in Fig. 39 be a line drawn through the place of maximum vertical intensity G_m . Let G be the value of the vertical intensity at B , and further, let d = the distance of the plane of observation above P , the pole of the magnet. Let θ_m be the angle ascertained with the normal at A , θ the angle between the normal at B and the line $B P$, then:

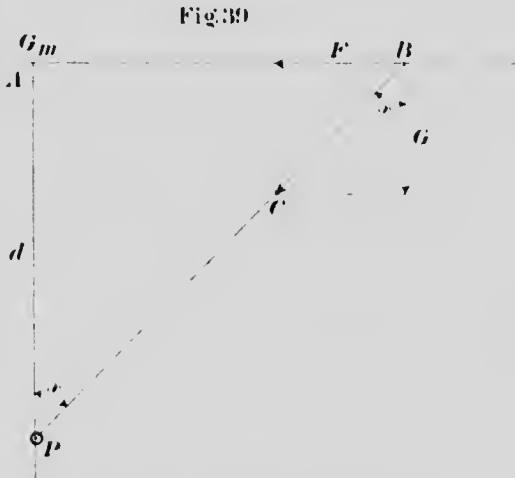

Let σ = strength of pole P , f_A the magnetic force at A , due to the pole P , f_B the magnetic force at B , due to the pole P , r the angle between $A P$ and $B P$, then:

$$f_A = \frac{\sigma}{d^2} = K \tan \theta_m = G_m \quad (43)$$

$$f_B = \frac{\sigma}{(B P)^2} = \frac{\sigma}{\left(\frac{d}{\cos \theta}\right)^2} = \frac{\sigma}{d^2} \cdot \cos^2 \theta = C B \quad (44)$$

$$f_B \cos \theta = C B \cos \theta = G = \frac{\sigma \cos^3 \theta}{d^2} = K \tan \theta \quad (45)$$

From (43) and (45) we have:

$$\frac{\sigma}{d^2 K} = \frac{\tan \epsilon \cos^3 x}{\tan \epsilon_m}$$

and

$$\cos^3 x = \frac{\tan \epsilon}{\tan \epsilon_m} \quad (46)$$

we have, further, see Figure (39):

$$d = AB \cot x \quad (47)$$

The values x and $\cot x$, corresponding to the values $\frac{\tan \epsilon}{\tan \epsilon_m}$ may be taken at once from the tables accompanying this paper. (See Table VI).

For the application of this method two values of G are required to be accurately determined, G_m for A and G , which should not be less than $\frac{1}{3} G_m$, for B . The distance AB is accurately measured. The best results are obtained when AB is laid off from the point of maximum intensity across the strike and on the side of most rapid variation of G .

If y' and y'' are the distances from the point where G is a maximum to points where $G = \frac{G_m}{3}$ and $\frac{G_m}{2}$ respectively, we have, see equations 43, 45 and 46:

$$\cos^3 x = \frac{K \tan \epsilon}{K \tan \epsilon_m} = \frac{G}{G_m} \quad (48)$$

$$\text{and hence for } G = \frac{G_m}{3}$$

$$\cos x' = \sqrt[3]{\frac{1}{3}}$$

$$\text{and for } G = \frac{G_m}{2} \quad \cos x'' = \sqrt[3]{\frac{1}{2}}$$

The cotangents of x' and x'' equal nearly 1 and $1\frac{1}{3}$ respectively, hence:

$$d = y' = \frac{4}{3} y'' \quad (49)$$

or the depth of the upper pole of the ore deposit below point A , for which G is a maximum, is equal to the horizontal distance from A to the point for which $G = \frac{1}{3} G_m$, or equal to $1\frac{1}{3}$ times the distance from A to the point for which $G = \frac{1}{2} G_m$.

Equation (45) $\frac{\sigma}{d^2} \cos^3 x = G$ represents the equation of the vertical intensity curve.

From equation (44) :

$$CB = f_B \frac{\sigma}{r^2} \cos^2 \alpha$$

we have for the horizontal intensity F , the expression :

$$F = f_B \sin \alpha \frac{\sigma}{r^2} \cos^2 \alpha \sin \alpha \quad (50)$$

which represents the equation for the horizontal intensity curve.

This method is applicable only to ore bodies which are vertical or very nearly so.

2nd Method.—The lines of force passing out of the north pole of a magnet, which make a small angle with the prolongation of its axis, are very nearly straight lines. This fact may be employed for the following method of determining empirically the distance of the pole beneath the surface :

A line is laid off through the point of maximum value of G and perpendicular to the strike of the ore-body. On this line, commencing from the point of maximum intensity G_m , distances of from 2 to 5 yards are staked out and for these points G , R and δ are accurately determined. If the magnetic meridian has

previously been determined, the component F of R is found by the following construction :

Let δ_0 be the angle included between the magnetic meridian and the station line and δ_1 the angle included between this line and R at station S_1 . (See Fig. 40.)



Through S_1 , representing a station, lay off a line making an angle δ_0 with the station line, and on it, from S_1 , cut off any

convenient distance taken as unity. From the same point S_1 set off a line of length $\propto H - R$, making an angle δ_1 with the station line and complete the parallelogram with R as the diagonal. $S_1 B$ will then be F , the component of R required, and its intensity will be represented by its length on the same scale employed for H and R . The values of F are thus obtained by construction for every station and the angle ζ which the direction of the total magnetic force, due to the magnetic deposit, makes with the horizon, can now be calculated from the expression:

$$\tan \zeta = \frac{G}{F}$$

or may be constructed for the different stations from the known values of G and F .

A line is now drawn to scale, on which the different stations are set off, and at each station S_1, S_2, S_3, \dots etc., the calculated angles $\zeta_1, \zeta_2, \zeta_3, \dots$ etc., laid off. These lines are prolonged until they intersect, and the mean distance of the intersections from the line, representing the plane of observation, is taken in terms of the scale employed, as the distance of the pole of the deposit from the surface.

3rd Method.—A third method is based upon the fact that the curves of *total intensity* drawn about the poles of ideal magnets are in the vicinity of the poles very nearly circular. The method consists in finding three points for which the total intensity is the same. These three points will lie on the circumference of one of the isodynamic curves of total intensity about the pole. (See Fig. 41).

To apply this method stake off a line through the point A , at which G is a maximum, at right angles to the strike of the ore body and observe at distances of three yards along the line very accurately the values of G , R and δ . Erect a scaffolding or a step-ladder over the point A , for the purpose of determining the value of G at different heights above A , for which station the values of F along the vertical line of observation

are equal to zero, and, therefore, the different observed values of G equal to the total intensities T . Calculate, as previously indicated, the value F

for each of the stations on the line sketched off through A and find two stations on this line for which the total intensity T

$\pm F^2 + G^2$ has the same value as one of the observed values of G above A . If b is the accurately measured height above A , for which the value G is equal to the values $\pm F^2 + G^2$, for the other two stations we have, if d is the distance from A to one of these stations, D the distance of the pole of the ore body below A and r the radius of the curve of total intensity (see Fig. 41).

$$r = \frac{d^2 + b^2}{2b}$$

$$\text{and} \quad D = r - b = \frac{d^2 + b^2}{2b} - b = \frac{d^2 - b^2}{2b} \quad (51)$$

As an illustration of this method we find for the ideal magnet (Plate I), for $b = \frac{10}{3}$ meters above the point O , $m, G = 45.5$ and

Fig. 41

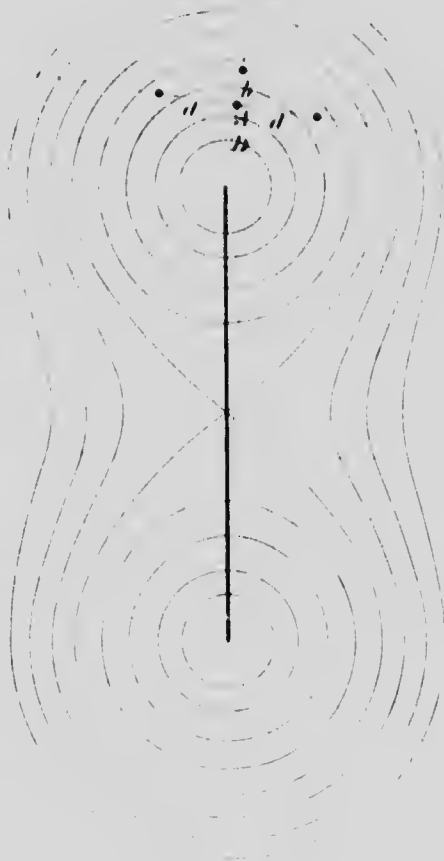

by the use of the curves (Plate I), $d = 14.5$ meters, for which $\sqrt{F^2 + G^2}$ has the same value, hence:

$$D = \frac{\sqrt{14.5^2 - 100}}{\frac{20}{3}} = 29.87 \text{ meters,}$$

which differs only by 0.13 meters from the true value.

4th Method.—The following method* requires only the determination of G_{\max} and a value of G at a short distance vertically above the point for which $G = G_{\max}$. It is, moreover, independent of the nature of the terrane.

Let σ equal the pole strength of the magnetic ore deposit, D the distance of the pole from the plane of observation at the point where $G = G_{\max}$, and d the distance between this point and the one vertically above it, for which G may have the value G_1 .

We then have:

$$\frac{\sigma}{D^2} = G_{\max},$$

$$\frac{\sigma}{(D+d)^2} = G_1$$

$$G_{\max} D^2 = G_1 (D+d)^2$$

and

$$D = \frac{d \cdot \sqrt{G_1}}{\sqrt{G_{\max}} - \sqrt{G_1}} \quad (52)$$

To illustrate the applicability of this method, $G_{\max} = 57.0$ for point $0, m$, Plate III, G_1 for a point at a distance of 3 meters, vertically above it, was found to be 46.7. Hence:

$$D = \frac{3 \cdot \sqrt{46.7}}{\sqrt{57.0} - \sqrt{46.7}} = \frac{3.683}{8.68} = 30.13$$

which result differs only by 0.13 meters from the actual depth of the pole beneath the plane of observation, which was taken as 30 meters.

* Dahlblom loc. cit., pp. 53 and 54.

CHAPTER XVI.

DETERMINATION OF THE EXTENSION IN DEPTH
OF A MAGNETIC ORE BODY.

This determination consists in finding the length of the magnetic axis of the ore deposit, *i.e.*, the distance between the upper and lower pole of the ore body, which, in the case of massive magnets, is $\frac{2}{3}$ of the actual length.*

1st Method.—The following method is due to Dahlblom and is based upon the fact that the contours of the lines of force of a magnet are independent of the length of the magnet, as is evident from the fact that in the equation of the lines of force,

(Eq. 1) $\frac{G}{r}$ is constant. The magnetic ore deposit is treated as an ideal magnet and the inclination of its lines of force to the plane of observation determined along a section perpendicular to the strike of the ore deposit. For this purpose a line is staked out across the point of maximum vertical intensity and extended over a distance on both sides of G_{\max} double the length of the north pole attraction. Distances of 30 feet are laid off on this line and for each station the values δ , R and G are accurately determined. (R by the sine method).

The direction of the meridian is determined from the average value of δ at places where G is nearly equal to zero and R nearly equal to H , or from the known declination of the locality and the astronomic meridian. From the values δ , R and H the values P are obtained for the different stations S_n , as previously explained,† and φ , the angle of the lines of force with the plane of observation for these stations, calculated from the equation :

$$\tan \varphi = \frac{G}{P}$$

* According to Dahlblom, $\frac{2}{3}$ corresponds in practice better in the case of ore deposits.

† See page 83.

A line AB is now drawn through the diagram of the lines of force of an ideal magnet (see Fig. 42), at an inclination to

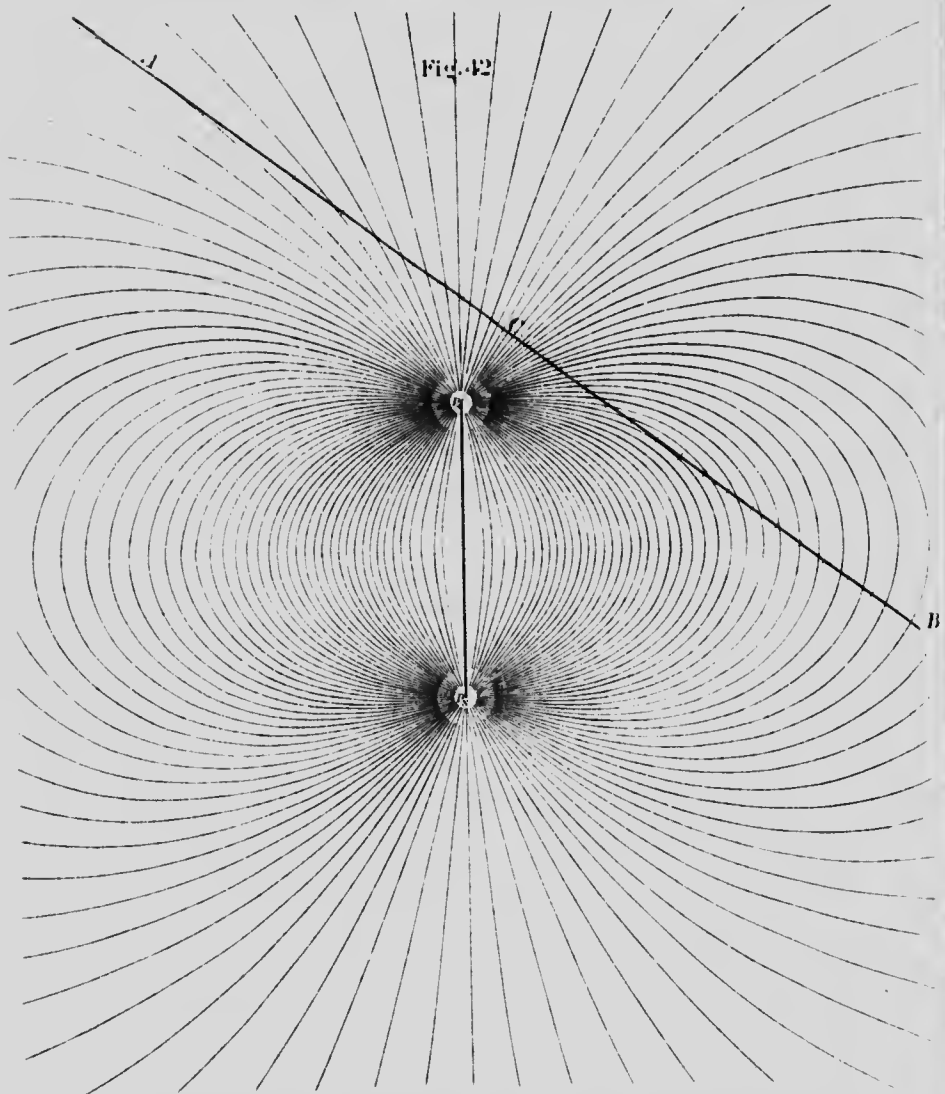

P, P_w , corresponding to the dip of the ore body. At the points of intersection between the line AB and the lines of force, the

angles φ , which the lines of force make with the line AB , are measured with a protractor. The line is now separately drawn, (see Fig. 43), the points of intersection of the lines of force with it laid off and the corresponding angles φ written beside them.*

It becomes now a question to ascertain on what scale the diagram of the lines of force of the ore-deposit requires to be drawn, in order that the observed values of φ may coincide with those points on the line AB , at which the lines of force of the experimental diagram (see Fig. 42) include the same angle with the line AB . If the scale of the two diagrams were as 1 : 2000, the magnetic axis of the ore deposit would be 2000 times the length of the magnet of the experimental diagram.

The following example, taken from the plotting of the isodynamic lines (see Plates II and III) of an ideal magnet 100 meters in length, with its upper pole 30 meters below the plane of observation and dip of 53° to the horizon, will show the procedure of determining this scale.

Fig. 43

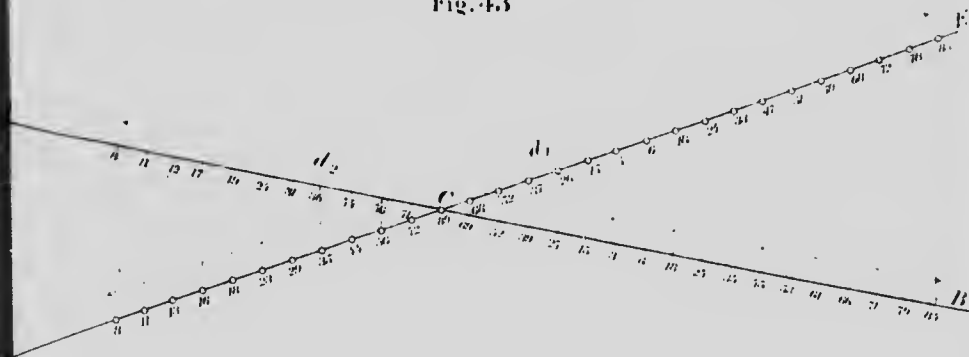

Through the point C , (see Fig. 43) corresponding to the value $\varphi = 90^\circ$, another line DE , making any convenient angle

* Instead of measuring the angles of the intersection with AB of all the lines of force of the diagram (Fig. 42), it is, in most cases, sufficient to choose along the line AB points at equal distances apart, corresponding to the stations in the ore field, and to determine the angles of intersection of the lines of force with AB at these points only. If lines of force in the diagram (Fig. 42) do not pass through these points, such lines are easily intercalated and the angle of intersection with AB ascertained.

with AB , is drawn, and upon it, starting from the point C , corresponding to G_{\max} , the stations S_1, S_2 , etc., are marked on each side of C , on any convenient scale, as 1 : 2000. The scale employed in this particular case is 1 : 2362. The points for which φ has the same value on AB and DE are now joined by lines, which would be parallel, if the construction were free from error.

If $2L$ = the length of the magnetic axis representing that of the ore deposit,

$2l$ = 4.064 cm., the length of the magnetic axis of the ideal magnet, (Fig. 42).

d_1 = 11.84 cm., the distance on a scale of 1 : 2362 on the line in the ore field through G_{\max} , between the points for which φ has the value of 8° and -84° .

d_2 = 11.35 cm., the distance on scale 1 : 1 on the line AB , between points for which the angles φ have the same values.

We have the proportion :

$$2L : 2l = d_1 : d_2$$

and

$$2L = \frac{11.84}{11.35} \cdot 2362 \cdot 4.064 = 10012 \text{ cm.} = 100.12 \text{ meters.}$$

Such nearly perfect parallelism of the lines joining equal angles on AB and DE cannot be expected in the case of an actual ore body, because it is not an ideal magnet nor are the observations free from error. Moreover, the distance of the plane of observation from the upper pole and the inclination of the magnetic axis to this plane are not accurately known. It may, here, become necessary to try other lines at different inclinations to $P_s P_n$ (Fig. 42), and at different distances from P_s and select that one for the final calculation, which furnishes the most satisfactory parallelism. P. Uhlich states that more perfect agreement, between the fields of force of a magnet and magnetic ore deposits, is often obtained by employing the diagram of the field of force of two unlike poles of unequal pole strength. (See Fig. 3).

To facilitate the application of this method a tracing made of Plate VIII, which represents a field of force of an ideal magnet, may be employed.

2nd Method.—The following method, depending on the determination of the angle which the prolongation of the magnetic axis of the ore deposit includes with the line drawn from the center of the magnetic axis to the point of observation, is due to Professor Robert Thalén.*



Let : AD be the plane of observation.

D the point of observation for which G and F have been determined,

SN the magnetic axis of the ore deposit,

$2l$ the length of this axis,

z the vertical distance from plane of observation to center of the magnetic axis,

x the distance AD , *i.e.*, from point for which G is a maximum to point where vertical intensity has the observed value G ,

α = the angle made by prolongation of magnetic axis with line drawn from center of magnetic axis to D , point of observation,

ϵ = length of this line.

* Jern-Kontorets Annaler, Femtiondefjerde Argängen, 1809, Sjette Häftet.

γ = the angle included at upper pole between the lines SA and SD ,

ω = the angle included at lower pole, between lines NA and ND ,

σ = the strength of the pole S or N ,

P_1 = the force exerted by S at D ,

P_2 = the force exerted by N at D ,

F_1 and G_1 = the horizontal and vertical components respectively of P_1 ,

F_2 and G_2 = the horizontal and vertical components respectively of P_2 ,

We then have :

$$P_1 = \frac{\sigma}{r^2 + (z-l)^2}$$

$$P_2 = \frac{\sigma}{r^2 + (z+l)^2}$$

$$F_1 = P_1 \sin \gamma, F_2 = P_2 \sin \omega$$

$$\sin \gamma = \frac{r}{1 + r^2 + (z-l)^2}, \sin \omega = \frac{r}{1 + r^2 + (z+l)^2}$$

$$F_1 = \frac{\sigma}{r^2 + (z-l)^2} \cdot \frac{r}{1 + r^2 + (z-l)^2}$$

$$F_2 = \frac{\sigma}{r^2 + (z+l)^2} \cdot \frac{r}{1 + r^2 + (z+l)^2}$$

If M is the moment of the magnet, we have :

$$\sigma = \frac{M}{2l}$$

$$F = F_1 - F_2 = \frac{M \cdot r}{2l} \left\{ \frac{1}{[r^2 + (z-l)^2]^{\frac{3}{2}}} - \frac{1}{[r^2 + (z+l)^2]^{\frac{3}{2}}} \right\} \quad (53)$$

$$G_1 = P_1 \cos \gamma; G_2 = P_2 \cos \omega;$$

$$\cos \gamma = \frac{z-l}{1 + r^2 + (z-l)^2}; \cos \omega = \frac{z+l}{1 + r^2 + (z+l)^2}$$

$$G_1 = \frac{\sigma}{r^2 + (z-l)^2} \cdot \frac{z-l}{1 + r^2 + (z-l)^2}$$

$$G_2 = \frac{\sigma}{r^2 + (z+l)^2} \cdot \frac{z+l}{1 + r^2 + (z+l)^2}$$

$$G = G_1 - G_2 = \frac{M}{2l} \left\{ \frac{z-l}{[r^2 + (z-l)^2]^{\frac{3}{2}}} - \frac{z+l}{[r^2 + (z+l)^2]^{\frac{3}{2}}} \right\} \quad (54)$$

$$r^2 + (z-l)^2 = c^2 + l^2 - 2cl \cos \varphi$$

$$r^2 + (z+l)^2 = c^2 + l^2 + 2cl \cos \varphi$$

If we can neglect $\frac{l^2}{c^2}$ which is a very small quantity generally:

$$[r^2 + (z-l)^2]^{-\frac{3}{2}} = \frac{1}{c^3} \left[1 + \frac{3l}{c} \cos \varphi \right]$$

$$[r^2 + (z+l)^2]^{-\frac{3}{2}} = \frac{1}{c^3} \left[1 - \frac{3l}{c} \cos \varphi \right]$$

$$F = \frac{1}{c^3} \frac{Mx}{2l} \left[1 + \frac{3l}{c} \cos \varphi - 1 + \frac{3l}{c} \cos \varphi \right] = \frac{3Mx}{c^4} \cos \varphi$$

$$z = c \cos \varphi; \quad x = c \sin \varphi$$

$$F = \frac{3M}{c^3} \cos^3 \varphi \cdot \sin \varphi \quad (55)$$

Further:

$$G = \frac{M}{2l} \left[\frac{z-l}{c^3} \left(1 + \frac{3l}{c} \cos \varphi \right) - \frac{z+l}{c^3} \left(1 - \frac{3l}{c} \cos \varphi \right) \right]$$

$$= \frac{M}{2lc^3} \left[z + \frac{3lz}{c} \cos \varphi - l - \frac{3l^2}{c} \cos \varphi - z + \frac{3lz}{c} \cos \varphi - l + \frac{3l^2}{c} \cos \varphi \right]$$

$$= \frac{M}{2lc^3} \left[\frac{6l}{c} z \cos \varphi - 2l \right] = \frac{M}{c^3} \left[3 \frac{z}{c} \cos \varphi - 1 \right]$$

$$G = \frac{M}{c^3} \left[3 \cos^2 \varphi - 1 \right]$$

$$G = \frac{M}{c^3} \cos^3 \varphi \left[3 \cos^2 \varphi - 1 \right] \quad (56)$$

$$\frac{F}{G} = \frac{3M}{c^3} \cos^4 \varphi \cdot \sin \varphi \cdot \frac{c^3}{M \cos^3 \varphi (3 \cos^2 \varphi - 1)}$$

$$= \frac{3 \cos \varphi \sin \varphi}{3 \cos^2 \varphi - 1} = \frac{3 \tan \varphi}{2 - \tan^2 \varphi}$$

$$\text{and} \quad \tan^2 \varphi + 3 \frac{G}{F} \tan \varphi = 2 \quad (57)$$

From which formula φ is obtained.

$$\tan \varphi = \sqrt{\frac{9}{4} \frac{G^2}{F^2} + 2} - \frac{3}{2} \cdot \frac{G}{F} \quad (58)$$

We have further:

$$z = \frac{x}{\tan \varphi} = x \cot \varphi \quad (59)$$

This formula is applicable only in the case of ore bodies which are vertical, or very nearly so.

The point *D*, for which *G* and *F* require to be determined, should be chosen in the line passing through G_{\max} at right angles to the strike.

CHAPTER XVII.

LABORATORY PRACTICE.

For purposes of laboratory practice in the various methods described in the foregoing report, the following experimental table will be found convenient.

The frame consists of 4 uprights of hard, well seasoned wood, 4 x 4 x 40 inches, with side pieces of same material, 2 x 6 inches, dowelled into them. (See Figs. 46 and 47). Two parallel side pieces carry the brass rails *S*, (Figs. 46 and 47) which are fastened with brass screws to the side pieces, as shown in Figs. 48 and 49.

On these rails move the castings *N N*, which are each provided with three rollers, P_1, P_2, P_3 , to obviate friction. The screws *Q* fit in slots of the rails to prevent upward displacement of the castings *N* and serve to fix the latter in any desired position on the rails. The rails are graduated into 5 centimeter divisions and the position of *N* is read from the knife edge *R*, which is in the plane passing through the center of the magnetometer.

The tube *A* which carries the magnetometer and its support is fastened rigidly to the castings *N* by the screws *O*. (See Fig. 49). The tube *A* is graduated throughout its length into centimeters and the position of the center of the tube *D*, which

carries the magnetometer, is read from the index on the bevelled side of the broken through part *K* of the support *C*. To pre-

Fig. 46

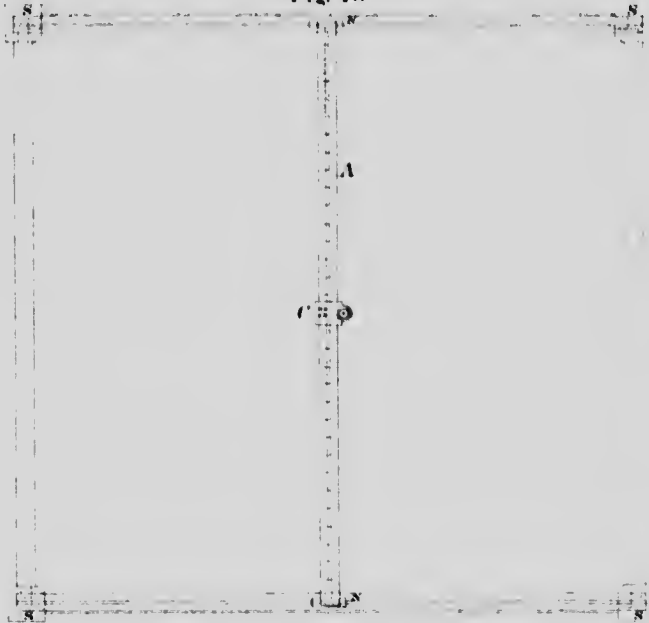
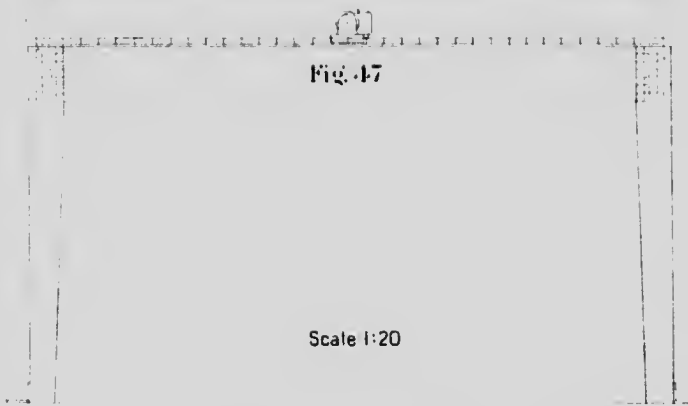

Fig. 47



Scale 1:20

vent the rotation of the support *C* on the tube *A*, the tube is provided with a key throughout its length, which fits into its

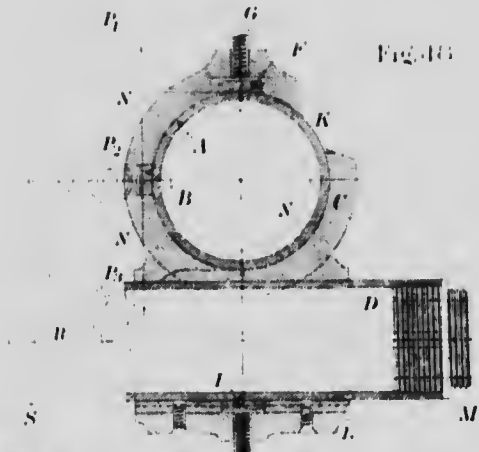

Fig. 48

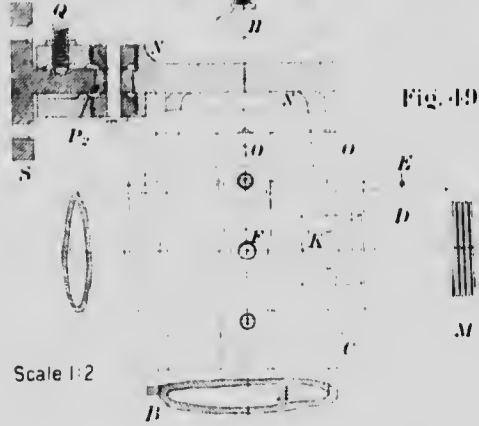

Fig. 49

Scale 1:2

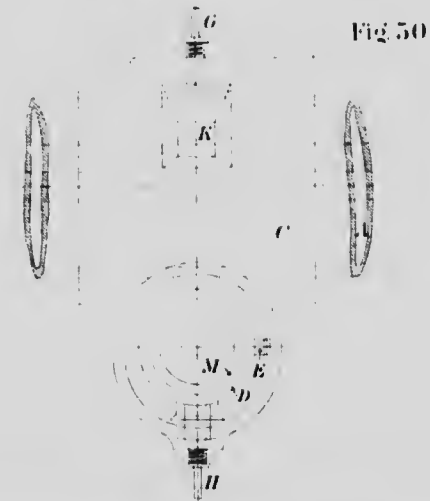

Fig. 50

sent, as shown at *B*. (Figs. 48 and 49). Screw *G* fastens the support *C* in any desired position on tube *A*.

The tube *D*, which, by means of screw plug *M*, carries the magnetometer, is graduated throughout its length into $\frac{1}{2}$ cm. divisions and is secured by screw *H*. Rotation of the tube in its support is prevented by a key *K*, fitting into its seat, as shown in Fig. 50. The length of tube *D* conveniently taken as 45 cm. In the case of examining representative ore bodies close to the plane of observation, a tube should be provided 7 centimeters in length. If other instruments are to be attached to tube *D*, appropriate screw plugs, fitting the instrument, require to be provided. The position of *D* is read at *L*. (Fig. 48).

It will be seen that by means of the graduations on the rail *S* and tube *A*, the whole field of observation represented by the interior dimensions of the experimental table may be divided into squares of $\frac{1}{2}$ decimeter on the side, and the magnetometer may be brought into positions with its center vertically above the corner of the squares. For intermediate positions the subdivisions on tube *A* may be used and those on rail *S* estimated.

The experimental table should be set up in a basement room as free from iron as possible, at least free from moveable pieces of iron, and the uprights should have a solid foundation free from contact with the floor. Brass angles may be employed to secure the uprights firmly to the floor, as shown in Fig. 47.

The ore body or bodies may best be represented by large pieces of hard cast iron or hardened steel. These should be of different shapes and dimensions, some lenticular, others thick plates with rectangular cross sections and some of irregular shape. These may be magnetized in any desirable direction by carrying a magnetizing current around them. The axis of the area enclosed by the current will constitute the magnetic axis and since both hard cast iron and steel retain magnetism after the current is withdrawn these bodies will now constitute permanent magnets, which, placed under the plane of observation of the table in any desirable position, may be examined singly

or be grouped in any manner, and their magnetic fields determined and charts of the horizontal and vertical intensity constructed. The distance of the representative ore body from the plane of observation may be regulated by supports of proper height placed beneath the magnetized bodies. To enable the observer to vary the terrain of the field, the support of the magnetometer is so arranged that it may be raised or lowered a predetermined amount for any post of observation, thus copying an agreed upon topography.

Experimentation with such a table and the construction of charts of the measurements made of the field produced by the experimental ore bodies, in groups and singly, with the plane of observation level, and at different distances from the ore bodies, and when representing a difficult terrain, will confer upon the experimenter an insight into the complex curves resulting, which cannot be attained by any amount of theoretical study. Comparing his results with the known size, disposition and depth beneath the plane of observation of his experimental ore bodies, he will soon become possessed of a sound knowledge of the variation of the field produced by the varying conditions of his experiments, which will enable him to interpret with some degree of confidence the charts constructed from measurements of actual ore bodies made in the field. Without such an experimental knowledge gained in the laboratory, and relying simply upon his theoretical knowledge of the subject, the observer will often, after having plotted his observation and drawn his curves, find himself unable to arrive at sound conclusions regarding the limit and distribution of the ore bodies in any complex case. It is for these reasons strongly recommended that mining schools which desire to take up this subject as part of their curriculum provide every facility to their students to render themselves competent, by extended laboratory work, to undertake magnetic surveys, and enable them correctly to interpret the results of their measurements.

By changing the groupings of the representative ore bodies and the assumed topography for each succeeding class, a suffi-

cient number of charts will soon be accumulated which will constitute additional valuable material for study by future classes.

APPENDIX.

THE DAHLBLOM MAGNETOMETER.

Very recently Th. Dahlblom has invented a very convenient Pocket Magnetometer* of which he has kindly sent me a description and photographs †

Description of the Magnetometer. The magnetometer consists of a compass box *A*, (see Plate A and B showing face and back of the instrument) which is attached to the support *B*, permitting revolution of the compass box about an axis passing through the pivots of the compass needle. The support *B* is provided with a box level (*a*), an arm with ring (*b*) for vertical suspension, two cylindrical axes, e_1, e_2 , and three indices, d_1, d_2, d_3 , of which d_1 and d_3 are attached to the axes, e_1, e_2 , and d_2 to the frame of the box level (*a*).

The needle (*c*) is supported in jewelled bearings. To the lower pivot of the needle one end of a spiral spring (f_1) is fastened, the other end is carried to the attachment (*g*) which permits by use of a screw the regulation of the tension of the spring. The arrest and release of the needle are effected by turning axis (*h*) which operates upon a spring.

Adjustment of the Magnetometer. The Thulin-Tilberg instrument is set up and levelled and arm *E* made to coincide accurately with the magnetic axis of the needle. The compass is removed and the axes e_1, e_2 , of the Dahlblom Magnetometer inserted in the supports. The glass cap having been removed the magnetic axis of the needle is made to coincide with the axis of the arm *E* by turning the screw of attachment (*g*) in the appropriate direction. The needle will now be in the

* Made by J. L. Rose, Upsala, Sweden.

† Letter dated Falun, Sweden, 23rd November, 1903.

‡ Spiral spring is not shown in illustration.

magnetic meridian and point to 0° on the scale of the compass box. As thus adjusted, the general resultant of the forces acting upon the needle is zero.

It may be convenient, though not necessary, to counteract the vertical intensity of the normal field by the application of a small piece of wax on the south arm of the needle.

Measurement of the Horizontal Intensity.—The compass box is turned in its support until one of the indices, say d_1 , points to 0° . The magnetometer, as a whole, is now turned until the needle accurately reads 0° . This operation brings the magnetic axis of the needle into a position parallel to the magnetic meridian of the place of observation. The support B of the magnetometer is now held firmly, while the compass box is turned in the support in one or the other direction, until

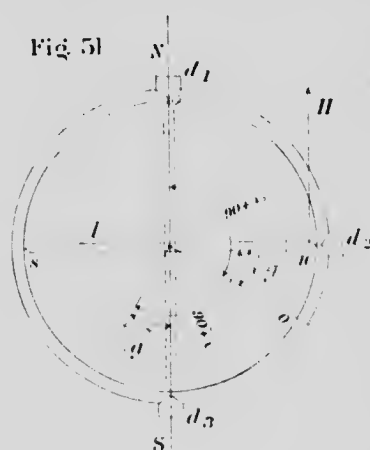

the needle is forced by the spring to occupy a position at right angles to the position when in the magnetic meridian. To effect this the compass box will require to be turned through an angle greater than 90° and the angular difference a between the rotation of the compass box and 90° will measure the tension of the spring which is counterbalanced by the horizontal intensity acting at right angles to the magnetic axis of the needle. (Fig. 51).

If M_h is the moment of rotation due to the horizontal intensity of the field, M_s the moment of rotation in the opposite direction due to the spring, we have :

$$M_h = M_s$$

$$\text{or } 2 H a l = K a^* \quad (60)$$

* K is a factor which, when multiplied by the angle of torsion, represents the moment of rotation exerted by the spring upon the compass needle. Within limits this factor may be regarded as a constant.

If, for instance, the observation is made in a normal field and angle $\alpha_0 = 25^\circ$ while in the disturbed field $\alpha_1 = 41^\circ$, we have:

$$\begin{aligned} 2 H \mu l &= K 25^\circ \\ \text{and } 2 R \mu l &= K 41^\circ \\ \text{or } H : R &= 25^\circ : 41^\circ \\ \text{and } R &= H \frac{41^\circ}{25^\circ} = 1.64 H \end{aligned}$$

In the case of a field of great intensity, to avoid either too great a tension or laxity of the spring, for which extremes K would have different values, it is better to force the needle by revolution of the compass over an angle of 30° only.

To effect the measurement of R in terms of H , under this condition, the index is set at 30° and the whole instrument turned until the needle reads 0° . The compass box is then rotated in its support until the needle points to the index. (See Fig. 52.) We shall then have, if α_1 for example equals 34° :

$$34^\circ : 25^\circ = R \sin 30^\circ : H$$

$$\text{and } R = 2 \frac{34^\circ}{25^\circ} H = 2.72 H$$

Dahlblom states that he has made comparative measurements with the Pocket Magnetometer and the Thalén-Tiberg Magnetometer, and finds that the result shows a close agreement of the measurements made with the two instruments, even when the Pocket Magnetometer was used entirely without support and simply carried by hand.

To show the comparatively slight effect of the uncertainty of the manipulation when using the Pocket Magnetometer without a support, the following illustration is given by the inventor of the instrument:

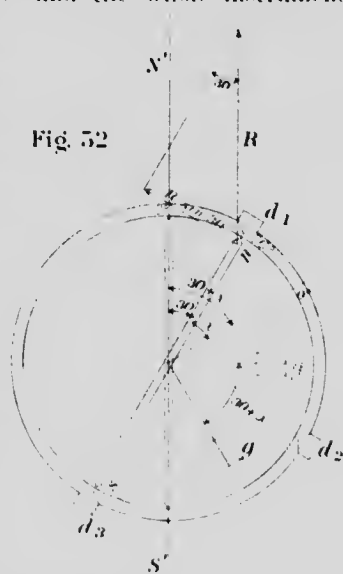

Assume (Fig. 53) that the magnetic axis of the needle is not parallel with the magnetic meridian of the place of observation, but includes with it an angle of 4° and that when the observer rotates the compass box in its support to bring the needle into a position perpendicular to the magnetic meridian, he rotates the instrument and support in the opposite direction over an angle equal to 5° . The needle will then evidently have moved not over 90° but only over 81° , and the reading will give a smaller value for R , for we have:

$$R_1 : R = \sin 81^\circ : \sin 90^\circ$$

$$R_1 = 0.988 R$$

If the errors are not, as in the example given, in the same direction, the resultant error has little influence.

When employing a deviation of 30° in the measurement of strong fields, Dahlblom expresses the opinion that by taking the average of three observations for one locality the results obtained with the Pocket Magnetometer are more accurate than those obtained from measurements made with instruments requiring a deflecting magnet.

Vertical Intensity.—If the indices d_1, d_3 point to zero and the magnetometer be turned vertical, the magnetic needle will include some angle with the horizon represented by the indices d_1, d_3 . By rotating the compass box in its support in the appropriate direction the magnetic axis of the needle may be brought to coincide with the indices d_1, d_3 . In this position the vertical component of the magnetic force of the field is perpendicular to the magnetic axis of the needle and the tension of

Fig. 53

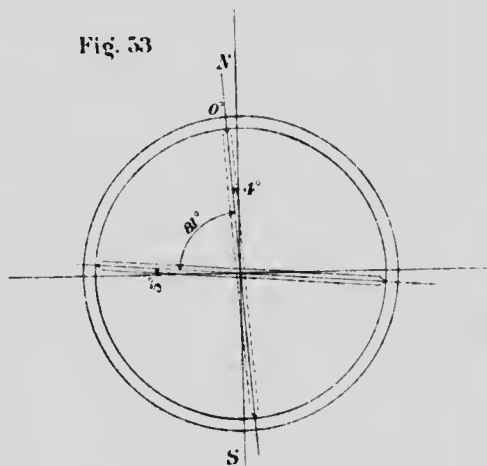

the spring counterbalances this force. The tension of the spring was adjusted so that, when the needle pointed to 0° , the effect of the spring to produce rotation was zero also; therefore, when the needle is brought by rotation of the compass box in its support into the horizontal position the amount of rotation from d_1 to the zero point measures the angle e which produces the tension of the spring just sufficient to counterbalance the vertical force of the field. This angle is read at the north end of the needle, positive intensity from 0° downwards and negative intensity from 0° upwards.

If G is the vertical component due to the magnetic ore deposit and V the vertical component due to the normal field, e and e_0 the angles due to $G + V$ and V respectively, we have:

$$2(G + V) \mu l = K e \quad (61)$$

$$2H \mu l = K a_0$$

$$G + V = \frac{e}{a_0} H$$

$$G = \frac{e}{a_0} H - V$$

$$V = \frac{e_0}{a_0} H$$

hence:
$$G = \frac{(e - e_0)}{a_0} H \quad (62)$$

If, therefore, an observer reads in the normal field $e_0 = 15^\circ$ and in a disturbed field respectively $e = 5^\circ$ and $e = 72^\circ$, then:

$$G_1 = \frac{5 - 15}{25} H = -\frac{10}{25} H = -0.40 H$$

and
$$G_2 = \frac{72 - 15}{25} H = +\frac{57}{25} H = +2.28 H$$

If the compass needle has been compensated for the vertical component of the normal field, $e_0 = 0^\circ$ and the angle observed $= e_1$

$$G = \frac{e_1}{a_0} H \quad (63)$$

In measuring the vertical component of a very strong field it is advisable to employ a deviation of only 30° from the ver-

tical. In this case, however, it is requisite, to eliminate the effect of the horizontal component, that the plane of the magnetometer be placed at right angles to the magnetic meridian. To facilitate the measurement an extra index, d_4 , should be provided and fixed at 30° from d_2 , as shown in Fig. 54.

Assume the magnetometer with its face at right angles to the magnetic meridian and the needle standing as shown by the dotted outline. (Fig. 54). The compass is now rotated in its support until the needle points to index

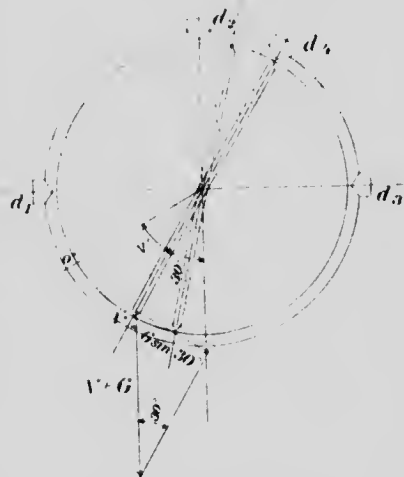

Fig. 54.

d_4 . The reading from the zero point of the graduation to the north end of the needle gives the angle ϵ , and we shall have:

$$(G \pm V) \sin 30^\circ = 2 \mu l = K \epsilon \quad (64)$$

$$H = 2 \mu l = K a_0$$

$$G \pm V = \frac{2 \epsilon'}{a_0} H$$

$$G = \frac{2 \epsilon}{a_0} H - V$$

$$V = \frac{2 \epsilon_0'}{a_0} H^*$$

$$G = \frac{2(\epsilon - \epsilon_0')}{a_0} H \quad (65)$$

The angle ϵ_0' for the normal field requires to be determined with

$$* V \sin 30^\circ = 2 \mu l = K \epsilon_0' \quad \text{and hence } V = \frac{2 \epsilon_0'}{a_0} H$$

PLATE A

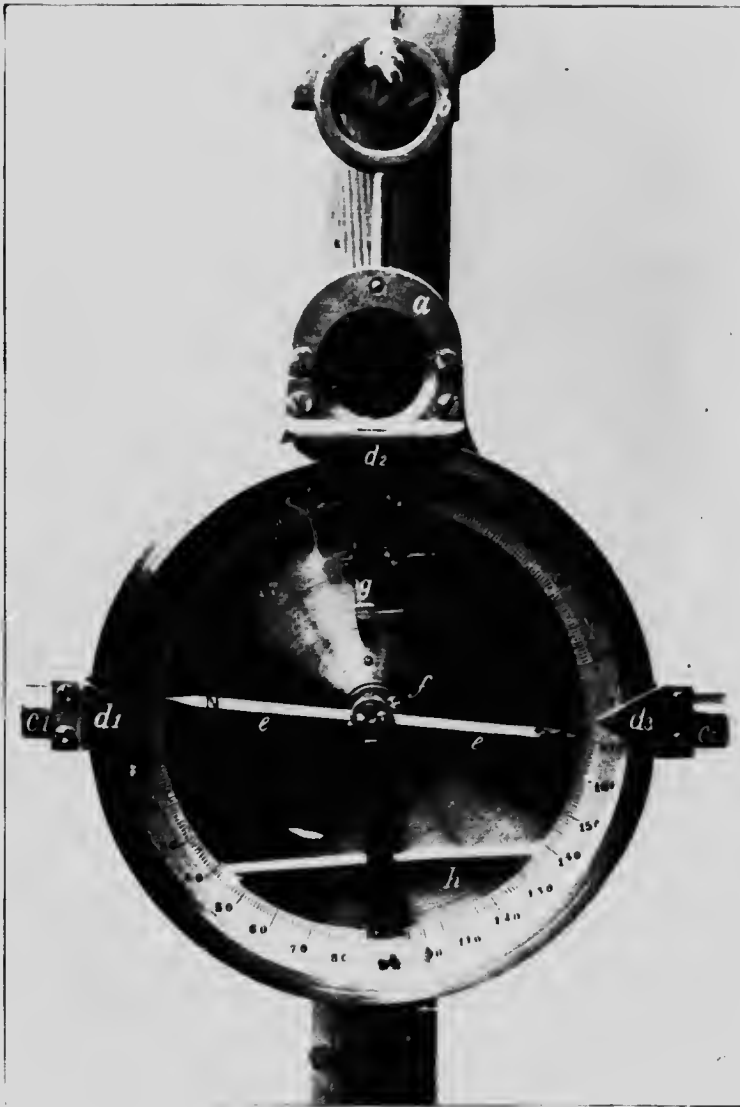

THE DAINBLOM POCKET MAGNETOMETER.
FRONT

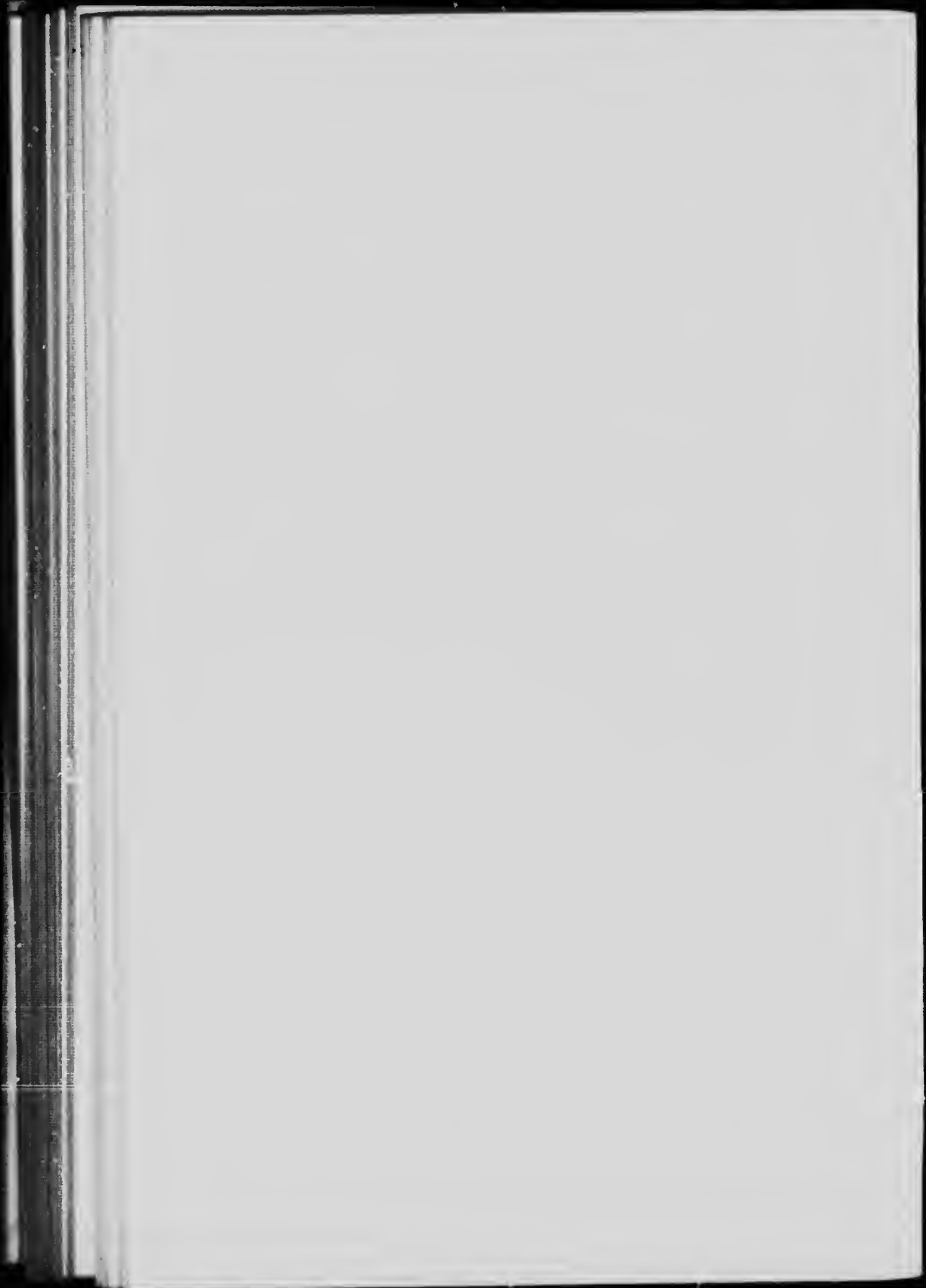
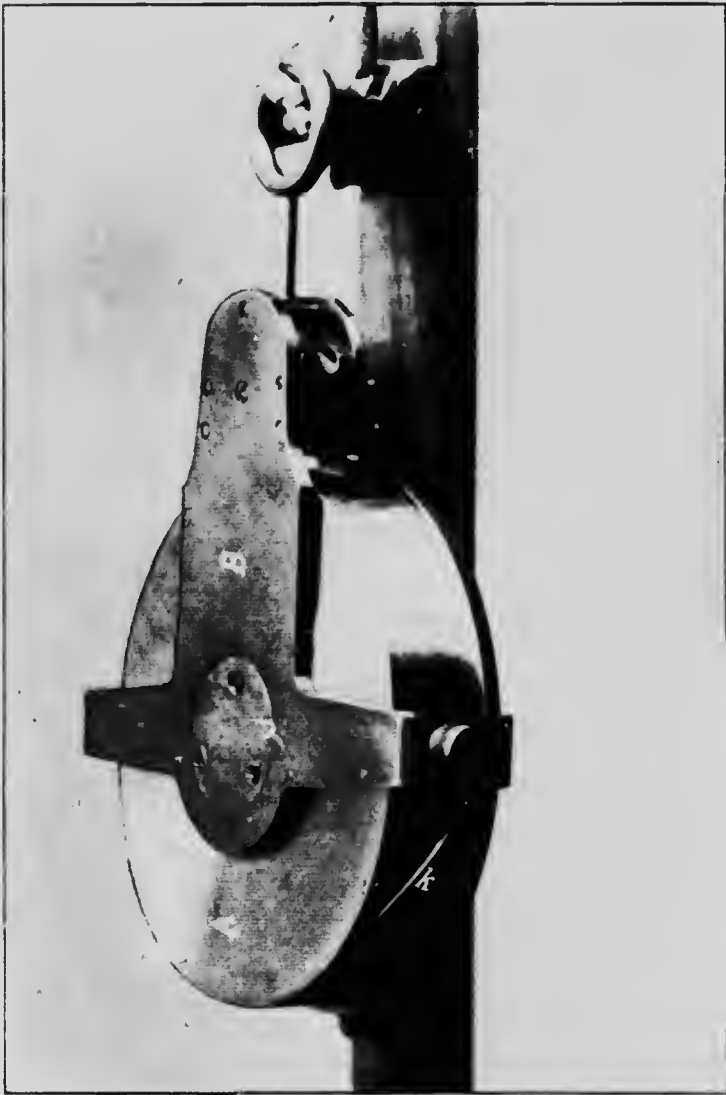

PLATE B.



THE DAHLBLOM POCKET MAGNETOMETER.
(BACK)

1871

exactitude. Thus, if $\alpha_0' = -8^\circ$ in the normal field and α in the disturbed field is found to be -32° , we have:

$$G = \frac{2(32^\circ - (-8^\circ))}{25} H = 2 \frac{40}{25} H = 3.20 H$$

The following are some of the advantages of the Dahlblom Pocket Magnetometer:

- 1st.—For not too strong fields the measurements of the vertical intensity are independent of the magnetic meridian.
- 2nd.—The magnetic forces being balanced against the tension of a spring render the long arm E and a deflecting magnet unnecessary.
- 3rd.—By rotating the compass box, when held vertical, until the needle stands horizontal in the normal field, the magnetometer may be used for prospecting, indicating by the deflection of the needle approximately the vertical force of the ore field.

TABLE I.
Table of Values of $\frac{\sin a_0}{\sin a}$

a	-1°	2°	3°	4°	5°	6°	7°	8°	9°	10°
a_0										
10°	9.95	4.97	3.32	2.49	1.90	1.66	1.42	1.25	1.11	1.00
11	10.93	5.47	3.64	2.73	2.19	1.82	1.57	1.37	1.22	1.10
12	11.90	5.96	3.97	2.98	2.39	1.99	1.71	1.49	1.33	1.20
13	12.80	6.44	4.30	3.22	2.58	2.15	1.85	1.62	1.44	1.29
14	13.86	6.93	4.62	3.47	2.78	2.31	1.98	1.74	1.55	1.39
15	14.83	7.42	4.94	3.71	2.97	2.48	2.12	1.86	1.65	1.49
16	15.79	7.90	5.27	3.95	3.16	2.64	2.26	1.93	1.70	1.59
17	16.75	8.38	5.59	4.19	3.35	2.80	2.40	2.10	1.87	1.68
18	17.71	8.85	5.90	4.43	3.55	2.96	2.54	2.22	1.97	1.78
19	18.65	9.33	6.22	4.67	3.73	3.11	2.67	2.34	2.08	1.87
20	19.60	9.80	6.53	4.90	3.92	3.27	2.81	2.46	2.19	1.97
21	20.53	10.27	6.85	5.14	4.11	3.43	2.94	2.57	2.29	2.06
22	21.46	10.73	7.16	5.37	4.30	3.58	3.07	2.69	2.39	2.16
23	22.39	11.19	7.46	5.60	4.48	3.74	3.21	2.81	2.50	2.25
24	23.30	11.65	7.77	5.83	4.67	3.89	3.34	2.92	2.60	2.34
25	24.21	12.11	8.07	6.06	4.85	4.04	3.47	3.04	2.70	2.43
26	25.12	12.56	8.38	6.28	5.03	4.19	3.60	3.15	2.80	2.52
27	26.01	13.01	8.67	6.51	5.21	4.34	3.72	3.26	2.90	2.61
28	26.90	13.45	8.97	6.73	5.39	4.49	3.85	3.37	3.00	2.70
29	27.78	13.89	9.26	6.95	5.56	4.64	3.98	3.48	3.10	2.79
30	28.65	14.33	9.55	7.17	5.74	4.78	4.10	3.59	3.20	2.88

a	11°	12°	13°	14°	15°	16°	17°	18°	19°	20°
a_0										
10°	.91	.83	.77	.72	.67	.63	.59	.56	.53	.51
11	1.00	.92	.85	.79	.74	.69	.65	.62	.59	.56
12	1.09	1.00	.92	.86	.80	.75	.71	.67	.64	.61
13	1.18	1.08	1.00	.93	.87	.82	.77	.73	.69	.66
14	1.27	1.16	1.07	1.00	.93	.88	.83	.78	.74	.71
15	1.36	1.24	1.15	1.07	1.00	.94	.88	.84	.79	.76
16	1.44	1.33	1.22	1.14	1.06	1.00	.94	.89	.85	.81
17	1.53	1.41	1.30	1.21	1.13	1.06	1.00	.95	.90	.85
18	1.62	1.49	1.37	1.28	1.19	1.12	1.06	1.00	.95	.90
19	1.71	1.57	1.45	1.35	1.26	1.18	1.11	1.05	1.00	.95
20	1.79	1.64	1.52	1.41	1.32	1.24	1.17	1.11	1.05	1.00
21	1.88	1.72	1.59	1.48	1.38	1.30	1.23	1.16	1.10	1.05
22	1.96	1.80	1.66	1.55	1.45	1.36	1.28	1.21	1.15	1.09
23	2.05	1.88	1.74	1.61	1.51	1.42	1.34	1.26	1.20	1.14
24	2.13	1.96	1.81	1.68	1.57	1.48	1.39	1.32	1.25	1.19
25	2.21	2.03	1.88	1.75	1.63	1.53	1.44	1.37	1.30	1.24
26	2.30	2.11	1.95	1.81	1.69	1.59	1.50	1.42	1.35	1.28
27	2.38	2.18	2.02	1.88	1.75	1.65	1.55	1.47	1.39	1.33
28	2.46	2.26	2.09	1.94	1.81	1.70	1.61	1.52	1.44	1.37
29	2.54	2.33	2.15	2.00	1.87	1.76	1.66	1.57	1.49	1.42
30	2.62	2.40	2.22	2.07	1.93	1.81	1.71	1.62	1.53	1.46

TABLE I.
Table of Values of $\frac{\sin \alpha \alpha_0}{\sin \alpha}$

α	$=21^\circ$	22°	23°	24°	25°	26°	27°	28°	29°	30°
α_0										
10°	.48	.46	.44	.43	.41	.40	.38	.37	.36	.35
11	.53	.51	.49	.47	.45	.43	.42	.41	.39	.38
12	.58	.55	.53	.51	.49	.47	.46	.44	.43	.42
13	.63	.60	.58	.55	.53	.51	.49	.48	.46	.45
14	.67	.65	.62	.59	.57	.55	.53	.51	.50	.48
15	.72	.69	.66	.64	.61	.59	.57	.55	.53	.52
16	.77	.74	.70	.68	.65	.63	.61	.59	.57	.55
17	.82	.78	.75	.72	.69	.67	.64	.62	.60	.58
18	.86	.82	.79	.76	.73	.70	.68	.66	.64	.62
19	.91	.87	.83	.80	.77	.74	.72	.69	.67	.65
20	.95	.91	.87	.84	.81	.78	.75	.73	.70	.68
21	1.00	.96	.92	.88	.85	.82	.79	.76	.74	.72
22	1.05	1.00	.96	.92	.89	.85	.82	.80	.77	.75
23	1.09	1.04	1.00	.96	.92	.89	.86	.83	.81	.78
24	1.13	1.09	1.04	1.00	.96	.93	.90	.87	.84	.81
25	1.18	1.13	1.08	1.04	1.00	.96	.93	.90	.87	.84
26	1.22	1.17	1.12	1.08	1.04	1.00	.97	.93	.90	.88
27	1.27	1.21	1.16	1.12	1.07	1.04	1.00	.97	.94	.91
28	1.31	1.25	1.20	1.15	1.11	1.07	1.03	1.00	.97	.94
29	1.35	1.29	1.24	1.19	1.15	1.11	1.07	1.03	1.00	.97
30	1.39	1.33	1.28	1.23	1.18	1.14	1.10	1.06	1.03	1.00

α	31°	32°	33°	34°	35°	36°	37°	38°	39°	40°
α_0										
10°	.34	.33	.32	.31	.30	.29	.29	.28	.27	.27
11	.37	.36	.35	.34	.33	.32	.32	.31	.30	.30
12	.40	.39	.38	.37	.36	.35	.34	.34	.33	.32
13	.44	.42	.41	.40	.39	.38	.37	.36	.36	.35
14	.47	.46	.44	.43	.42	.41	.40	.39	.38	.38
15	.50	.49	.47	.46	.45	.44	.43	.42	.41	.40
16	.53	.52	.51	.49	.48	.47	.46	.45	.44	.43
17	.57	.55	.54	.52	.51	.50	.49	.47	.46	.45
18	.60	.58	.57	.55	.54	.53	.51	.50	.49	.48
19	.63	.61	.60	.58	.57	.55	.54	.52	.52	.51
20	.66	.64	.63	.61	.60	.58	.57	.56	.54	.53
21	.70	.68	.66	.64	.62	.61	.60	.58	.57	.56
22	.73	.71	.69	.67	.65	.64	.62	.61	.59	.58
23	.76	.74	.72	.70	.68	.66	.65	.63	.62	.61
24	.79	.77	.75	.73	.71	.69	.68	.66	.65	.63
25	.82	.80	.78	.76	.74	.72	.70	.69	.67	.66
26	.85	.83	.80	.78	.76	.75	.73	.71	.70	.68
27	.88	.86	.83	.81	.79	.77	.75	.74	.72	.71
28	.91	.89	.86	.84	.82	.80	.78	.76	.75	.73
29	.94	.91	.89	.87	.84	.82	.81	.79	.77	.75
30	.97	.94	.92	.89	.87	.85	.83	.81	.79	.78

TABLE I.

Table of Values of $\frac{\sin \theta \sin \theta_0}{\sin \alpha}$

θ	41°	42°	43°	44°	45°	46°	47°	48°	49°	50°
θ_0										
10°	.26	.26	.25	.25	.24	.24	.24	.23	.23	.23
11	.26	.28	.28	.27	.27	.26	.26	.26	.25	.25
12	.32	.31	.30	.30	.29	.29	.28	.28	.27	.27
13	.34	.34	.33	.32	.32	.31	.31	.30	.30	.29
14	.37	.36	.35	.35	.34	.34	.33	.33	.32	.32
15	.39	.39	.38	.37	.37	.36	.35	.35	.34	.34
16	.42	.41	.40	.40	.39	.38	.38	.37	.36	.36
17	.45	.44	.43	.42	.41	.41	.40	.39	.39	.38
18	.47	.46	.45	.44	.44	.43	.42	.42	.41	.40
19	.50	.49	.48	.47	.46	.45	.44	.44	.43	.42
20	.52	.51	.50	.49	.48	.47	.47	.46	.45	.45
21	.55	.54	.53	.52	.51	.50	.49	.48	.47	.47
22	.57	.56	.55	.54	.53	.52	.51	.50	.50	.49
23	.60	.58	.57	.56	.55	.54	.53	.53	.52	.51
24	.62	.61	.60	.58	.57	.56	.56	.55	.54	.53
25	.64	.63	.62	.61	.60	.59	.58	.57	.56	.55
26	.67	.65	.64	.63	.62	.61	.60	.59	.58	.57
27	.69	.68	.67	.65	.64	.63	.62	.61	.60	.59
28	.72	.70	.69	.68	.66	.65	.64	.63	.62	.61
29	.74	.72	.71	.70	.69	.67	.66	.65	.64	.63
30	.76	.75	.73	.72	.71	.69	.68	.67	.66	.65

θ	51°	52°	53°	54°	55°	56°	57°	58°	59°	60°
θ_0										
10°	.22	.22	.22	.21	.21	.21	.21	.20	.20	.20
11	.25	.24	.24	.24	.23	.23	.23	.22	.22	.22
12	.27	.26	.26	.26	.25	.25	.25	.24	.24	.24
13	.29	.28	.28	.28	.27	.27	.27	.26	.26	.26
14	.31	.31	.30	.30	.29	.29	.29	.28	.28	.28
15	.33	.33	.32	.32	.32	.31	.31	.30	.30	.30
16	.35	.35	.34	.34	.34	.33	.33	.32	.32	.32
17	.38	.37	.37	.36	.36	.35	.35	.34	.34	.34
18	.40	.39	.38	.38	.38	.37	.37	.36	.36	.36
19	.42	.41	.41	.40	.40	.39	.39	.38	.38	.38
20	.44	.43	.43	.42	.42	.41	.41	.40	.40	.39
21	.46	.45	.45	.44	.44	.43	.43	.42	.42	.41
22	.48	.47	.47	.46	.46	.45	.45	.44	.44	.43
23	.50	.50	.49	.48	.48	.47	.47	.46	.46	.45
24	.52	.52	.51	.50	.50	.49	.48	.48	.47	.47
25	.54	.54	.53	.52	.52	.51	.50	.50	.49	.49
26	.56	.56	.55	.54	.53	.53	.52	.52	.51	.51
27	.58	.58	.57	.56	.55	.55	.54	.53	.53	.52
28	.60	.60	.59	.58	.57	.57	.56	.55	.55	.54
29	.62	.61	.61	.60	.59	.58	.58	.57	.57	.56
30	.64	.63	.63	.62	.61	.60	.60	.59	.58	.58

TABLE I.
Table of Values of $\frac{\pi \mu \mu_0}{\pi \mu \mu_0 \alpha}$

α	61°	62°	63°	64°	65°	66°	67°	68°	69°	70°
μ_0										
10°	.20	.20	.19	.19	.19	.19	.19	.19	.19	.18
11	.22	.22	.21	.21	.21	.21	.21	.21	.20	.20
12	.24	.23	.23	.23	.23	.23	.23	.22	.22	.22
13	.26	.25	.25	.25	.25	.25	.24	.24	.24	.24
14	.28	.27	.27	.27	.27	.26	.26	.26	.26	.26
15	.30	.29	.29	.29	.29	.28	.28	.28	.28	.27
16	.31	.31	.31	.31	.30	.30	.30	.30	.29	.29
17	.33	.33	.33	.32	.32	.32	.32	.31	.31	.31
18	.35	.35	.35	.34	.34	.34	.34	.33	.33	.33
19	.37	.37	.36	.36	.36	.36	.35	.35	.35	.35
20	.39	.39	.38	.38	.38	.37	.37	.37	.37	.36
21	.41	.41	.40	.40	.40	.39	.39	.39	.38	.38
22	.43	.42	.42	.42	.41	.41	.41	.40	.40	.40
23	.45	.44	.44	.43	.43	.43	.42	.42	.42	.42
24	.46	.46	.46	.45	.45	.44	.44	.44	.44	.43
25	.48	.48	.47	.47	.47	.46	.46	.46	.45	.45
26	.50	.50	.49	.49	.48	.48	.48	.47	.47	.47
27	.52	.51	.51	.50	.50	.50	.49	.49	.49	.48
28	.54	.53	.53	.52	.52	.51	.51	.51	.50	.50
29	.55	.55	.54	.54	.53	.53	.53	.52	.52	.52
30	.57	.57	.56	.56	.55	.55	.54	.54	.54	.53

α	71°	72°	73°	74°	75°	76°	77°	78°	79°	80°
μ_0										
10°	.18	.18	.18	.18	.18	.18	.18	.18	.18	.18
11	.20	.20	.20	.20	.20	.20	.19	.19	.19	.19
12	.22	.22	.22	.22	.21	.21	.21	.21	.21	.21
13	.24	.24	.23	.23	.23	.23	.23	.23	.23	.23
14	.25	.25	.25	.25	.25	.25	.25	.25	.25	.24
15	.27	.27	.27	.27	.27	.27	.26	.26	.26	.26
16	.29	.29	.29	.29	.28	.28	.28	.28	.28	.28
17	.31	.31	.30	.30	.30	.30	.30	.30	.30	.30
18	.33	.32	.32	.32	.32	.32	.32	.31	.31	.31
19	.34	.34	.34	.34	.34	.33	.33	.33	.33	.33
20	.36	.36	.36	.35	.35	.35	.35	.35	.35	.35
21	.38	.38	.37	.37	.37	.37	.37	.37	.36	.36
22	.40	.39	.39	.39	.39	.39	.38	.38	.38	.38
23	.41	.41	.41	.41	.40	.40	.40	.40	.40	.40
24	.43	.43	.42	.42	.42	.42	.42	.41	.41	.41
25	.45	.44	.44	.44	.44	.43	.43	.43	.43	.43
26	.46	.46	.46	.46	.45	.45	.45	.45	.45	.44
27	.48	.48	.47	.47	.47	.47	.46	.46	.46	.46
28	.50	.49	.49	.49	.49	.48	.48	.48	.48	.48
29	.51	.51	.51	.50	.50	.50	.50	.49	.49	.49
30	.53	.53	.52	.52	.52	.51	.51	.51	.51	.51

TABLE II.
Table of Values of $\frac{100 a_0}{100 a}$

a	1°	2°	3°	4°	5°	6°	7°	8°	9°	10°
a_0										
10°	10.10	5.05	3.36	2.52	2.01	1.68	1.44	1.25	1.11	1.00
11	11.14	5.56	3.71	2.78	2.22	1.85	1.58	1.38	1.23	1.10
12	12.18	6.09	4.06	3.11	2.47	2.02	1.73	1.51	1.34	1.20
13	13.23	6.61	4.40	3.30	2.61	2.22	1.88	1.64	1.46	1.31
14	14.28	7.14	4.76	3.57	2.85	2.37	2.03	1.77	1.57	1.41
15	15.35	7.67	5.11	3.83	3.06	2.55	2.18	1.91	1.69	1.52
16	16.43	8.21	5.47	4.10	3.28	2.73	2.33	2.04	1.81	1.63
17	17.51	8.75	5.83	4.37	3.49	2.91	2.49	2.17	1.93	1.73
18	18.61	9.30	6.20	4.65	3.71	3.09	2.65	2.31	2.05	1.84
19	19.73	9.86	6.57	4.92	3.94	3.28	2.80	2.45	2.17	1.95
20	20.85	10.42	6.94	5.20	4.16	3.46	2.96	2.59	2.30	2.06
21	21.99	10.99	7.32	5.49	4.39	3.65	3.13	2.73	2.42	2.18
22	23.15	11.57	7.71	5.78	4.62	3.84	3.29	2.87	2.55	2.29
23	24.32	12.15	8.10	6.07	4.87	4.04	3.46	3.02	2.68	2.41
24	25.51	12.75	8.49	6.37	5.09	4.24	3.63	3.17	2.81	2.52
25	26.71	13.35	8.90	6.67	5.33	4.44	3.80	3.32	2.94	2.61
26	27.94	13.97	9.31	6.97	5.57	4.64	3.97	3.47	3.08	2.77
27	29.19	14.59	9.72	7.29	5.82	4.85	4.15	3.63	3.22	2.89
28	30.46	15.23	10.15	7.60	6.08	5.06	4.33	3.78	3.36	3.01
29	31.76	15.87	10.58	7.93	6.34	5.27	4.51	3.94	3.50	3.14
30	33.08	16.53	11.02	8.26	6.60	5.49	4.70	4.11	3.64	3.27

a	11°	12°	13°	14°	15°	16°	17°	18°	19°	20°
a_0										
10°	.91	.83	.76	.71	.66	.61	.58	.54	.51	.48
11	1.00	.91	.84	.78	.72	.68	.61	.60	.56	.53
12	1.09	1.00	.92	.85	.79	.74	.69	.65	.62	.58
13	1.19	1.09	1.00	.93	.86	.80	.75	.71	.67	.63
14	1.28	1.17	1.08	1.00	.93	.87	.82	.77	.72	.68
15	1.38	1.26	1.16	1.07	1.00	.92	.88	.82	.78	.74
16	1.47	1.35	1.24	1.15	1.07	1.00	.94	.88	.83	.79
17	1.57	1.44	1.32	1.23	1.14	1.07	1.00	.94	.89	.84
18	1.67	1.53	1.41	1.30	1.21	1.13	1.06	1.00	.94	.89
19	1.77	1.62	1.49	1.38	1.28	1.20	1.13	1.06	1.00	.95
20	1.87	1.71	1.58	1.46	1.36	1.27	1.19	1.12	1.06	1.00
21	1.97	1.81	1.66	1.54	1.43	1.34	1.26	1.18	1.11	1.05
22	2.08	1.90	1.75	1.62	1.51	1.41	1.32	1.24	1.17	1.11
23	2.18	2.00	1.84	1.70	1.58	1.48	1.39	1.31	1.23	1.17
24	2.29	2.09	1.93	1.79	1.66	1.55	1.46	1.37	1.29	1.22
25	2.40	2.19	2.02	1.87	1.74	1.63	1.52	1.43	1.35	1.28
26	2.51	2.29	2.11	1.96	1.82	1.70	1.59	1.50	1.42	1.34
27	2.62	2.40	2.21	2.04	1.90	1.78	1.67	1.57	1.48	1.40
28	2.73	2.50	2.30	2.13	1.98	1.85	1.74	1.64	1.54	1.46
29	2.85	2.61	2.40	2.22	2.07	1.93	1.81	1.71	1.61	1.52
30	2.97	2.72	2.50	2.32	2.15	2.01	1.89	1.78	1.68	1.59

TABLE II.
Table of Values of $\frac{\tan a_0}{\tan a}$

a	$=21^\circ$	22°	23°	24°	25°	26°	27°	28°	29°	30°
a_0										
10°	.46	.44	.41	.40	.38	.36	.35	.33	.32	.30
11	.51	.48	.46	.44	.42	.40	.38	.37	.35	.34
12	.55	.53	.50	.48	.46	.44	.42	.40	.38	.37
13	.60	.57	.54	.52	.49	.47	.45	.43	.42	.40
14	.65	.62	.59	.56	.53	.51	.49	.47	.45	.43
15	.70	.66	.63	.60	.57	.55	.53	.50	.48	.46
16	.75	.71	.67	.64	.61	.59	.56	.54	.52	.50
17	.80	.76	.72	.69	.66	.63	.60	.57	.55	.53
18	.85	.80	.76	.73	.70	.67	.64	.61	.59	.56
19	.90	.85	.81	.77	.74	.71	.68	.65	.62	.60
20	.95	.90	.86	.82	.78	.75	.71	.68	.66	.63
21	1.00	.95	.90	.86	.82	.79	.75	.72	.69	.66
22	1.05	1.00	.95	.91	.87	.83	.79	.76	.73	.70
23	1.11	1.05	1.00	.95	.91	.87	.83	.80	.77	.73
24	1.16	1.10	1.05	1.00	.95	.91	.87	.84	.80	.77
25	1.21	1.15	1.10	1.05	1.00	.96	.91	.88	.84	.81
26	1.27	1.21	1.15	1.09	1.05	1.00	.96	.92	.88	.84
27	1.33	1.26	1.20	1.14	1.09	1.04	1.00	.96	.92	.88
28	1.38	1.32	1.25	1.19	1.14	1.09	1.04	1.00	.96	.92
29	1.44	1.37	1.31	1.24	1.19	1.14	1.09	1.04	1.00	.96
30	1.50	1.43	1.36	1.30	1.24	1.18	1.13	1.09	1.04	1.00

a	$=31^\circ$	32°	33°	34°	35°	36°	37°	38°	39°	40°
a_0										
10°	.20	.28	.27	.26	.25	.24	.23	.23	.22	.21
11	.32	.31	.30	.29	.28	.27	.26	.25	.24	.23
12	.35	.34	.33	.31	.30	.29	.28	.27	.26	.25
13	.38	.37	.36	.34	.33	.32	.31	.30	.28	.27
14	.41	.40	.38	.37	.36	.34	.33	.32	.31	.30
15	.45	.43	.41	.40	.38	.37	.36	.34	.33	.32
16	.48	.46	.44	.42	.41	.39	.38	.37	.35	.34
17	.51	.49	.47	.45	.44	.42	.41	.39	.38	.36
18	.54	.52	.50	.48	.46	.45	.43	.42	.40	.39
19	.57	.55	.53	.51	.49	.47	.46	.44	.42	.41
20	.61	.58	.56	.54	.52	.50	.48	.47	.45	.43
21	.64	.61	.59	.57	.55	.53	.51	.49	.47	.46
22	.67	.65	.62	.60	.58	.56	.54	.52	.50	.48
23	.71	.68	.65	.63	.61	.58	.56	.54	.52	.51
24	.74	.71	.69	.66	.64	.61	.59	.57	.55	.53
25	.78	.75	.72	.69	.67	.64	.62	.60	.58	.56
26	.81	.78	.75	.72	.70	.67	.65	.62	.60	.58
27	.85	.81	.78	.75	.73	.70	.68	.65	.63	.61
28	.88	.85	.82	.79	.76	.73	.71	.68	.66	.63
29	.92	.89	.85	.82	.79	.76	.74	.71	.68	.66
30	.96	.92	.89	.86	.82	.79	.77	.74	.71	.69

TABLE II.
Table of Values of $\frac{\tan a_0}{\tan a}$

a	$=41^\circ$	42°	43°	44°	45°	46°	47°	48°	49°	50°
a_0										
10°	.20	.20	.19	.18	.18	.17	.16	.16	.15	.15
11	.22	.22	.21	.20	.19	.19	.18	.17	.17	.16
12	.24	.24	.23	.22	.21	.20	.20	.19	.18	.18
13	.27	.26	.25	.24	.23	.22	.21	.21	.20	.19
14	.29	.28	.27	.26	.25	.24	.23	.22	.22	.21
15	.31	.30	.29	.28	.27	.26	.25	.24	.23	.22
16	.33	.32	.31	.30	.29	.28	.27	.26	.25	.24
17	.35	.34	.33	.32	.31	.29	.28	.27	.27	.26
18	.37	.36	.35	.34	.32	.31	.30	.29	.28	.27
19	.40	.38	.37	.36	.34	.33	.32	.31	.30	.29
20	.42	.40	.39	.38	.36	.35	.34	.33	.32	.30
21	.44	.43	.41	.40	.38	.37	.36	.35	.33	.32
22	.46	.45	.43	.42	.40	.39	.38	.36	.35	.34
23	.49	.47	.45	.44	.42	.41	.40	.38	.37	.36
24	.51	.49	.48	.46	.44	.43	.41	.40	.39	.37
25	.54	.52	.50	.48	.47	.45	.43	.42	.40	.39
26	.56	.54	.52	.50	.49	.47	.45	.44	.42	.41
27	.59	.57	.55	.53	.51	.49	.47	.46	.44	.43
28	.61	.59	.57	.55	.53	.51	.50	.48	.46	.45
29	.64	.62	.59	.57	.55	.53	.52	.50	.48	.46
30	.66	.64	.62	.60	.58	.56	.54	.52	.50	.48

a	$=51^\circ$	52°	53°	54°	55°	56°	57°	58°	59°	60°
a_0										
10°	.14	.14			.12	.12	.11	.11	.11	.10
11	.16	.15	.14	.14	.14	.13	.13	.12	.12	.11
12	.17	.17	.16	.15	.15	.14	.14	.13	.13	.12
13	.19	.18	.17	.17	.16	.16	.15	.14	.14	.13
14	.20	.19	.19	.18	.17	.17	.16	.16	.15	.14
15	.22	.21	.20	.19	.19	.18	.17	.17	.16	.15
16	.23	.22	.22	.21	.20	.19	.19	.18	.17	.17
17	.25	.24	.23	.22	.21	.21	.20	.19	.18	.18
18	.26	.25	.24	.24	.23	.22	.21	.20	.19	.19
19	.28	.27	.26	.25	.24	.23	.22	.21	.21	.20
20	.29	.28	.27	.26	.25	.25	.24	.23	.22	.21
21	.31	.30	.29	.28	.27	.26	.25	.24	.23	.22
22	.33	.32	.30	.29	.28	.27	.26	.25	.24	.23
23	.34	.33	.32		.30	.29	.28	.26	.25	.24
24	.36	.35	.34		.31	.30	.29	.28	.27	.26
25	.38	.36	.35	.34	.33	.31	.30	.29	.28	.27
26	.39	.38	.37	.35	.34	.33	.32	.30	.29	.28
27	.41	.40	.38	.37	.36	.34	.33	.32	.31	.29
28	.43	.41	.40	.39	.37	.36	.34	.33	.32	.31
29	.45	.43	.42	.40	.39	.37	.36	.35	.33	.32
30	.47	.45	.43	.42	.40	.39	.37	.36	.35	.33

TABLE II.
Table of Values of $\frac{\tan a_0}{\tan a}$

a	$=61^\circ$	62°	63°	64°	65°	66°	67°	68°	69°	70°
a_0										
10	.10	.09	.09	.09	.08	.08	.07	.07	.07	.06
11	.11	.10	.10	.09	.09	.09	.08	.08	.07	.07
12	.12	.11	.11	.10	.10	.09	.09	.09	.08	.08
13	.13	.12	.12	.11	.11	.10	.10	.09	.09	.08
14	.14	.13	.13	.12	.12	.11	.11	.10	.10	.09
15	.15	.14	.14	.13	.12	.12	.11	.11	.10	.10
16	.16	.15	.15	.14	.13	.13	.12	.12	.11	.10
17	.17	.16	.16	.15	.14	.14	.13	.12	.12	.11
18	.18	.17	.17	.16	.15	.14	.14	.13	.12	.12
19	.19	.18	.17	.17	.16	.15	.15	.14	.13	.12
20	.20	.19	.18	.18	.17	.16	.15	.15	.14	.13
21	.21	.20	.20	.19	.18	.17	.16	.15	.15	.14
22	.22	.21	.21	.20	.19	.18	.17	.16	.15	.15
23	.23	.23	.22	.21	.20	.19	.18	.17	.16	.15
24	.25	.24	.23	.22	.21	.20	.19	.18	.17	.16
25	.26	.25	.24	.23	.22	.21	.20	.19	.18	.17
26	.27	.26	.25	.24	.23	.22	.21	.20	.19	.18
27	.28	.27	.26	.25	.24	.23	.22	.21	.20	.18
28	.29	.28	.27	.26	.25	.24	.23	.21	.20	.19
29	.31	.29	.28	.27	.26	.25	.23	.22	.21	.20
30	.32	.31	.29	.28	.27	.26	.24	.23	.22	.21

a	$=71^\circ$	72°	73°	74°	75°	76°	77°	78°	79°	80°
a_0										
10	.06	.06	.05	.05	.05	.04	.04	.04	.03	.03
11	.07	.06	.06	.06	.05	.05	.04	.04	.04	.03
12	.07	.07	.06	.06	.06	.05	.05	.04	.04	.04
13	.08	.07	.07	.07	.06	.06	.05	.05	.04	.04
14	.09	.08	.08	.07	.07	.06	.06	.05	.05	.04
15	.09	.09	.08	.08	.07	.07	.06	.06	.05	.05
16	.10	.09	.09	.08	.08	.07	.07	.06	.06	.05
17	.10	.10	.09	.09	.08	.08	.07	.06	.06	.05
18	.11	.11	.10	.09	.09	.08	.07	.07	.06	.06
19	.12	.11	.10	.10	.09	.09	.08	.07	.07	.06
20	.12	.12	.11	.10	.10	.09	.08	.08	.07	.06
21	.13	.12	.12	.11	.10	.10	.09	.08	.07	.07
22	.14	.13	.12	.12	.11	.10	.09	.09	.08	.07
23	.15	.14	.13	.12	.11	.11	.10	.09	.08	.07
24	.15	.14	.14	.13	.12	.11	.10	.09	.09	.08
25	.16	.15	.14	.14	.12	.12	.11	.10	.09	.08
26	.17	.16	.15	.14	.13	.12	.11	.10	.09	.09
27	.17	.17	.16	.15	.14	.13	.12	.11	.10	.09
28	.18	.17	.16	.15	.14	.13	.12	.11	.10	.09
29	.19	.18	.17	.16	.15	.14	.13	.12	.11	.10
30	.20	.19	.18	.17	.15	.14	.13	.12	.11	.10

TABLE 41.
Table of Values of $\frac{h_{00} a_0}{h_{00} a}$

a	$=81^\circ$	82°	83°	84°	85°	86°	87°	88°	89°	90°
a_0										
10°	.03	.02	.02	.02	.01	.01	.01	.01	.00	0
11	.03	.03	.02	.02	.02	.01	.01	.01	.00	0
12	.03	.03	.03	.02	.02	.01	.01	.01	.00	0
13	.04	.03	.03	.02	.02	.02	.01	.01	.00	0
14	.04	.03	.03	.03	.02	.02	.01	.01	.00	0
15	.04	.04	.03	.03	.02	.02	.01	.01	.00	0
16	.04	.04	.03	.03	.02	.02	.01	.01	.00	0
17	.05	.04	.04	.03	.03	.02	.02	.01	.00	0
18	.05	.05	.04	.03	.03	.02	.02	.01	.00	0
19	.05	.05	.04	.04	.03	.02	.02	.01	.01	0
20	.06	.05	.04	.04	.03	.02	.02	.01	.01	0
21	.06	.05	.05	.04	.03	.03	.02	.01	.01	0
22	.06	.06	.05	.04	.03	.03	.02	.01	.01	0
23	.07	.06	.05	.04	.04	.03	.02	.01	.01	0
24	.07	.06	.05	.05	.04	.03	.02	.01	.01	0
25	.07	.07	.06	.05	.04	.03	.02	.01	.01	0
26	.08	.07	.06	.05	.04	.03	.02	.02	.01	0
27	.08	.07	.06	.05	.04	.03	.03	.02	.01	0
28	.08	.07	.06	.05	.05	.04	.03	.02	.01	0
29	.09	.08	.07	.06	.05	.04	.03	.02	.01	0
30	.09	.08	.07	.06	.05	.04	.03	.02	.01	0

TABLE III.

Table of values of $\left(\frac{1}{n}\right)^{\frac{1}{3}}$ from $n = 0.01$ to $n = 5.00$

n	$\log\left(\frac{1}{n}\right)^{\frac{1}{3}}$	$\left(\frac{1}{n}\right)^{\frac{1}{3}}$	n	$\log\left(\frac{1}{n}\right)^{\frac{1}{3}}$	$\left(\frac{1}{n}\right)^{\frac{1}{3}}$	n	$\log\left(\frac{1}{n}\right)^{\frac{1}{3}}$	$\left(\frac{1}{n}\right)^{\frac{1}{3}}$	n	$\log\left(\frac{1}{n}\right)^{\frac{1}{3}}$	$\left(\frac{1}{n}\right)^{\frac{1}{3}}$
0.00	—	∞	0.35	0.15198	1.4190	0.70	0.05163	1.1262	1.50	9.94130	0.8736
0.01	0.66667	4.6416	0.36	0.14790	1.4057	0.71	0.04958	1.1209	1.60	9.93196	0.8550
0.02	0.56632	3.6840	0.37	0.14393	1.3929	0.72	0.04756	1.1157	1.70	9.92318	0.8379
0.03	0.50763	3.2183	0.38	0.14007	1.3806	0.73	0.04556	1.1106	1.80	9.91491	0.8221
0.04	0.46598	2.9240	0.39	0.13631	1.3687	0.74	0.04359	1.1056	1.90	9.90708	0.8074
0.05	0.43368	2.7144	0.40	0.13265	1.3572	0.75	0.04165	1.1006	2.00	9.89966	0.7937
0.06	0.40728	2.5544	0.41	0.12907	1.3461	0.76	0.03973	1.0958	2.10	9.89259	0.7809
0.07	0.38497	2.4264	0.42	0.12558	1.3353	0.77	0.03784	1.0910	2.20	9.88596	0.7689
0.08	0.36564	2.3208	0.43	0.12218	1.3249	0.78	0.03597	1.0863	2.30	9.87942	0.7576
0.09	0.34859	2.2314	0.44	0.11885	1.3148	0.79	0.03412	1.0817	2.40	9.87326	0.7469
0.10	0.33333	2.1544	0.45	0.11560	1.3050	0.80	0.03230	1.0772	2.50	9.86735	0.7368
0.11	0.31954	2.0871	0.46	0.11241	1.2954	0.81	0.03051	1.0728	2.60	9.86168	0.7272
0.12	0.30694	2.0274	0.47	0.10930	1.2862	0.82	0.02873	1.0684	2.70	9.85621	0.7181
0.13	0.29535	1.9740	0.48	0.10625	1.2772	0.83	0.02697	1.0641	2.80	9.85095	0.7095
0.14	0.28462	1.9259	0.49	0.10327	1.2684	0.84	0.02524	1.0598	2.90	9.84587	0.7012
0.15	0.27464	1.8821	0.50	0.10034	1.2599	0.85	0.02353	1.0557	3.00	9.84096	0.6934
0.16	0.26529	1.8420	0.51	0.09748	1.2516	0.86	0.02183	1.0516	3.10	9.83621	0.6858
0.17	0.25659	1.8051	0.52	0.09467	1.2436	0.87	0.02016	1.0475	3.20	9.83162	0.6786
0.18	0.24824	1.7711	0.53	0.09191	1.2357	0.88	0.01851	1.0435	3.30	9.82716	0.6717
0.19	0.24042	1.7395	0.54	0.08920	1.2280	0.89	0.01687	1.0396	3.40	9.82284	0.6650
0.20	0.23299	1.7100	0.55	0.08655	1.2205	0.90	0.01525	1.0357	3.50	9.81864	0.6586
0.21	0.22593	1.6824	0.56	0.08394	1.2133	0.91	0.01365	1.0319	3.60	9.81457	0.6525
0.22	0.21919	1.6565	0.57	0.08138	1.2061	0.92	0.01207	1.0282	3.70	9.81060	0.6465
0.23	0.21276	1.6321	0.58	0.07886	1.1991	0.93	0.01051	1.0245	3.80	9.80674	0.6408
0.24	0.20660	1.6091	0.59	0.07638	1.1923	0.94	0.00896	1.0208	3.90	9.80298	0.6353
0.25	0.20068	1.5874	0.60	0.07395	1.1856	0.95	0.00743	1.0172	4.00	9.79931	0.6300
0.26	0.19501	1.5668	0.61	0.07156	1.1791	0.96	0.00591	1.0137	4.10	9.79573	0.6248
0.27	0.18955	1.5472	0.62	0.06920	1.1727	0.97	0.00441	1.0102	4.20	9.79225	0.6198
0.28	0.18428	1.5286	0.63	0.06689	1.1665	0.98	0.00292	1.0068	4.30	9.78884	0.6150
0.29	0.17920	1.5108	0.64	0.06461	1.1604	0.99	0.00145	1.0034	4.40	9.78552	0.6103
0.30	0.17429	1.4938	0.65	0.06236	1.1544	1.00	0.00000	1.0000	4.50	9.78226	0.6057
0.31	0.16955	1.4776	0.66	0.06015	1.1486	1.10	9.98620	0.9687	4.60	9.77908	0.6013
0.32	0.16495	1.4620	0.67	0.05798	1.1428	1.20	9.97361	0.9410	4.70	9.77597	0.5970
0.33	0.16050	1.4471	0.68	0.05583	1.1372	1.30	9.96202	0.9163	4.80	9.77292	0.5928
0.34	0.15617	1.4328	0.69	0.05372	1.1317	1.40	9.95129	0.8939	4.90	9.76993	0.5888
0.35	0.15198	1.4190	0.70	0.05163	1.1262	1.50	9.94130	0.8736	5.00	9.76701	0.5848

TABLE IV.
Table of Natural Tangents.

0°	.000	23°	.424	45°	1.000	67°	2.356
1°	.017	24°	.445	46°	1.035	68°	2.475
2°	.035	25°	.466	47°	1.072	69°	2.605
3°	.052	26°	.488	48°	1.111	70°	2.747
4°	.070	27°	.509	49°	1.150	71°	2.904
5°	.087	28°	.532	50°	1.192	72°	3.078
6°	.105	29°	.554	51°	1.235	73°	3.271
7°	.123	30°	.577	52°	1.280	74°	3.487
8°	.140	31°	.601	53°	1.327	75°	3.732
9°	.158	32°	.625	54°	1.376	76°	4.011
10°	.176	33°	.649	55°	1.428	77°	4.331
11°	.194	34°	.674	56°	1.482	78°	4.705
12°	.212	35°	.700	57°	1.540	79°	5.144
13°	.231	36°	.726	58°	1.600	80°	5.671
14°	.249	37°	.753	59°	1.664	81°	6.311
15°	.268	38°	.781	60°	1.732	82°	7.115
16°	.287	39°	.810	61°	1.804	83°	8.144
17°	.306	40°	.839	62°	1.881	84°	9.514
18°	.325	41°	.869	63°	1.963	85°	11.430
19°	.344	42°	.900	64°	2.050	86°	14.301
20°	.364	43°	.932	65°	2.144	87°	19.081
21°	.384	44°	.966	66°	2.246	88°	28.636
22°	.404					89°	57.290

$$\left(\frac{1}{n}\right)^2$$

.8736
 .8550
 .8379
 .8221
 .8074
 .7937
 .7809
 .7689
 .7576
 .7469
 .7368
 .7272
 .7181
 .7095
 .7012
 .6934
 .6858
 .6786
 .6717
 .6650
 .6586
 .6525
 .6465
 .6408
 .6353
 .6300
 .6248
 .6198
 .6150
 .6103
 .6057
 .6013
 .5970
 .5928
 .5888
 .5848

TABLE V.

Table for the reduction of the angles ϵ observed with the Tiberg inclinometer.*

V_n = the angle observed with the inclinometer with constant k_n

V = the angle which corresponds to the angle V_n for an inclinometer with constant 1.0 H .

V_n from 1 to 41; k_n from 0.50 H to 0.90 H .

V_n	V								
	k_n 0.50 H	k_n 0.55 H	k_n 0.60 H	k_n 0.65 H	k_n 0.70 H	k_n 0.75 H	k_n 0.80 H	k_n 0.85 H	k_n 0.90 H
1	1	1	1	1	1	1	1	1	1
2	1	1	1	1	1	1	2	2	2
3	2	2	2	2	2	2	2	3	3
4	2	2	2	3	3	3	3	3	4
5	3	3	3	3	4	4	4	4	4
6	3	3	4	4	4	4	4	5	5
7	4	4	4	5	5	5	5	6	6
8	4	4	5	5	6	6	6	7	7
9	5	5	5	6	6	7	7	8	8
10	5	5	6	7	7	8	8	9	9
11	6	6	7	7	8	8	9	10	10
12	6	7	7	8	8	9	10	10	11
13	7	7	8	9	9	10	10	11	12
14	7	8	8	9	10	11	11	12	13
15	8	8	9	10	11	11	12	13	14
16	8	9	10	11	11	12	13	14	15
17	9	10	10	11	12	13	14	15	16
18	9	10	11	12	13	14	14	15	16
19	10	11	12	13	13	14	15	16	17
20	10	11	12	15	14	15	16	17	18
21	11	12	13	14	15	16	17	18	19
22	11	13	14	15	16	17	18	19	20
23	12	13	14	15	16	17	19	20	21
24	12	14	15	16	17	18	19	21	22
25	13	14	16	17	18	19	21	22	23
26	14	15	16	18	19	20	21	22	24
27	14	16	17	18	20	21	22	23	25
28	15	16	18	19	20	22	23	24	25
29	15	17	18	20	21	22	24	25	26
30	16	18	19	21	22	23	25	26	27
31	17	18	20	21	23	24	26	27	28
32	17	19	21	22	23	25	26	28	29
33	18	20	21	23	24	26	27	29	30
34	19	20	22	24	25	27	28	30	31
35	19	21	23	24	26	27	29	31	32
36	20	22	24	25	27	28	30	32	33
37	21	23	24	26	28	29	31	33	34
38	21	23	25	27	29	30	32	33	35
39	22	24	26	28	30	31	33	34	36
40	23	25	27	29	30	32	34	35	37
41	23	26	28	29	31	33	35	36	38

* "Teknisk Tidskrift," Prof. W. Petersson, Bergsskolan, Stockholm, Sweden.

TABLE V.—Continued.

 V_n from 42 to 90; k_n from 0.50 H to 0.90 H .

V_n	V								
	k_n 0.50//	k_n 0.55//	k_n 0.60//	k_n 0.65//	k_n 0.70//	k_n 0.75//	k_n 0.80//	k_n 0.85//	k_n 0.90//
42	24	26	28	30	32	34	36	37	39
43	25	27	29	31	33	35	37	38	40
44	26	28	30	32	34	36	38	39	41
45	27	29	31	33	35	37	39	40	42
46	27	30	32	34	36	38	40	41	43
47	28	30	33	35	37	39	41	42	44
48	29	31	34	36	38	40	42	43	45
49	30	32	35	37	39	41	43	44	46
50	31	33	35	38	40	42	44	45	47
51	32	34	36	39	41	43	45	46	48
52	33	35	38	40	42	44	46	47	49
53	34	36	39	41	43	45	47	48	50
54	34	37	40	42	44	46	48	49	51
55	35	38	41	43	45	47	49	51	52
56	36	39	42	44	46	48	50	52	53
57	37	40	43	45	47	49	51	53	54
58	39	41	44	46	48	50	52	54	55
59	40	42	45	47	49	51	53	55	56
60	41	44	46	49	50	52	54	56	58
61	42	45	47	50	51	53	55	57	58
62	43	46	48	51	53	55	56	58	59
63	44	47	50	52	54	56	57	59	60
64	46	48	51	53	55	57	59	60	62
65	47	50	52	54	56	58	60	61	63
66	48	51	53	56	58	59	61	62	64
67	50	52	55	57	59	60	62	64	65
68	51	54	56	58	60	61	63	65	66
69	52	55	57	59	61	63	64	66	67
70	54	56	59	61	62	64	66	67	68
71	55	58	60	62	64	65	66	68	69
72	57	60	63	65	66	68	69	70	71
73	58	61	64	66	68	69	70	71	72
74	60	62	64	66	68	69	70	71	72
75	62	64	66	68	69	70	71	72	73
76	63	66	67	69	70	72	73	74	75
77	65	67	69	70	72	73	74	75	76
78	67	69	70	72	73	74	75	76	77
79	69	71	72	74	75	76	77	78	79
80	72	74	75	76	77	78	79	80	81
81	74	76	77	78	79	80	81	82	83
82	76	77	78	79	80	81	82	83	84
83	78	79	80	81	82	83	84	85	86
84	80	81	82	83	84	85	86	87	88
85	82	83	84	85	86	87	88	89	90
86	84	85	86	87	88	89	90	91	92
87	86	87	88	89	90	91	92	93	94
88	88	89	90	91	92	93	94	95	96
89	90	91	92	93	94	95	96	97	98
90	92	93	94	95	96	97	98	99	100

TABLE V.—Continued.

 V_n from 1 to 49; k_n from 0.95 H to 1.40 H .

V_n	V								
	k_n 0.95 H	k_n 1.05 H	k_n 1.10 H	k_n 1.15 H	k_n 1.20 H	k_n 1.25 H	k_n 1.30 H	k_n 1.35 H	k_n 1.40 H
1	1	1	1	1	1	1	1	1	1
2	2	2	2	2	2	2	2	3	3
3	3	3	3	3	3	4	4	4	4
4	4	4	4	4	5	5	5	5	6
5	5	5	5	5	6	6	6	7	7
6	5	6	7	7	7	7	7	8	8
7	6	7	8	8	8	8	9	9	10
8	7	8	9	9	10	10	10	11	11
9	8	9	10	10	11	11	12	12	12
10	9	11	11	11	12	12	13	14	14
11	10	12	12	13	13	13	14	15	15
12	11	13	13	14	15	15	16	16	17
13	12	14	14	15	16	16	17	17	18
14	13	15	15	16	17	17	18	18	19
15	14	16	16	17	18	18	19	20	21
16	15	17	18	18	19	20	20	21	22
17	16	18	19	19	20	21	22	22	23
18	17	19	20	20	22	22	23	24	24
19	18	20	21	22	23	23	24	25	26
20	19	21	22	23	24	24	26	26	27
21	20	22	23	24	25	26	27	27	28
22	21	23	24	25	26	27	28	29	30
23	22	24	25	26	27	28	29	30	31
24	23	25	26	27	28	29	30	31	32
25	24	26	27	28	29	30	31	32	33
26	25	27	28	29	30	31	32	33	34
27	26	28	29	30	31	33	34	35	36
28	27	29	30	31	33	34	35	36	37
29	28	30	31	32	34	35	36	37	38
30	29	31	32	34	35	36	37	38	39
31	30	32	33	35	36	37	38	39	40
32	31	33	35	36	37	38	39	40	41
33	32	34	36	37	38	39	40	41	42
34	33	35	37	38	39	40	41	42	43
35	34	36	38	39	40	41	42	43	44
36	35	37	38	40	41	42	43	44	45
37	36	38	40	41	42	43	44	45	46
38	37	39	41	42	43	44	45	47	47
39	38	40	42	43	44	46	46	48	48
40	39	41	43	44	45	47	47	49	50
41	40	42	44	45	46	48	48	50	51
42	41	43	45	46	47	49	49	51	52
43	42	44	46	47	48	49	50	52	53
44	43	45	47	48	49	50	51	53	53
45	44	46	48	49	50	51	52	53	54
46	45	47	49	50	51	52	53	54	55
47	46	48	50	51	52	53	54	55	56
48	47	49	51	52	53	54	55	56	57
49	48	50	52	53	54	55	56	57	58

TABLE V.—Continued.

 V_n from 50 to 90; k_n from 0.95 H to 1.40 H .

V_n	V									
	k_n	k_n	k_n	k_n	k_n	k_n	k_n	k_n	k_n	k_n
	0.95 H	1.05 H	1.10 H	1.15 H	1.20 H	1.25 H	1.30 H	1.35 H	1.40 H	
50	49	51	53	54	55	56	57	58	59	
51	50	52	54	55	56	57	58	59	60	
52	51	53	55	56	57	58	59	60	61	
53	52	54	56	57	58	59	60	61	62	
54	53	55	57	58	59	60	61	62	63	
55	54	56	58	59	60	61	62	63	64	
56	55	57	58	60	61	62	63	64	65	
57	56	58	59	61	62	63	64	65	66	
58	57	59	60	61	63	64	65	66	67	
59	58	60	61	62	63	64	65	66	67	
60	59	61	62	63	64	65	66	67	68	
61	60	62	63	64	65	66	67	68	69	
62	61	63	64	65	66	67	68	69	70	
63	62	64	65	66	67	68	69	70	71	
64	63	65	66	67	68	69	70	71	72	
65	64	66	67	68	69	70	71	72	73	
66	65	67	68	69	70	71	72	73	74	
67	66	68	69	70	71	72	73	74	75	
68	67	69	70	71	72	73	74	75	76	
69	68	70	71	72	73	74	75	76	77	
70	69	71	72	73	74	75	76	77	78	
71	70	72	73	74	75	76	77	78	79	
72	71	73	74	75	76	77	78	79	80	
73	72	74	75	76	77	78	79	80	81	
74	73	75	76	77	78	79	80	81	82	
75	74	76	77	78	79	80	81	82	83	
76	75	77	78	79	80	81	82	83	84	
77	76	78	79	80	81	82	83	84	85	
78	77	79	80	81	82	83	84	85	86	
79	78	80	81	82	83	84	85	86	87	
80	79	81	82	83	84	85	86	87	88	
81	80	82	83	84	85	86	87	88	89	
82	81	83	84	85	86	87	88	89	90	
83	82	84	85	86	87	88	89	90	91	
84	83	85	86	87	88	89	90	91	92	
85	84	86	87	88	89	90	91	92	93	
86	85	87	88	89	90	91	92	93	94	
87	86	88	89	90	91	92	93	94	95	
88	87	89	90	91	92	93	94	95	96	
89	88	90	91	92	93	94	95	96	97	
90	89	91	92	93	94	95	96	97	98	

TABLE V—Continued.

 V_n from 1 to 51, k_n from 1.45 H to 1.80 H .

V_n	V							
	k_n 1.45 H	k_n 1.50 H	k_n 1.55 H	k_n 1.60 H	k_n 1.65 H	k_n 1.70 H	k_n 1.75 H	k_n 1.80 H
1	1	1	2	2	2	2	2	2
2	3	3	3	3	3	3	3	3
3	4	4	5	5	5	5	5	5
4	6	6	6	6	6	6	6	6
5	7	8	8	8	8	9	9	9
6	9	9	9	10	10	10	10	10
7	10	10	11	11	12	12	12	12
8	11	12	12	13	13	13	14	14
9	13	14	14	14	15	15	16	16
10	14	15	15	16	16	17	17	18
11	16	16	17	17	18	19	19	19
12	17	17	18	19	19	20	20	21
13	19	19	20	20	21	21	22	22
14	20	21	21	22	22	23	23	24
15	21	22	23	23	24	25	25	26
16	22	23	24	25	25	26	26	28
17	24	24	25	26	27	28	28	29
18	25	26	27	28	28	29	29	30
19	27	27	28	29	30	30	31	31
20	28	28	29	30	31	31	32	33
21	29	30	31	32	32	33	34	34
22	30	31	32	33	34	34	35	36
23	32	32	33	34	35	36	37	37
24	33	33	35	35	36	37	38	38
25	34	35	36	37	38	39	39	40
26	35	36	37	38	39	40	41	41
27	37	38	38	39	40	41	42	43
28	38	39	40	40	41	42	43	44
29	39	40	41	42	43	43	44	45
30	40	41	42	43	44	45	46	46
31	41	42	43	44	45	46	47	47
32	42	43	44	45	46	47	48	48
33	43	44	45	46	47	48	49	49
34	44	45	46	47	48	49	50	50
35	45	46	47	48	49	50	51	52
36	47	47	48	49	50	51	52	53
37	48	48	49	50	51	52	53	54
38	49	49	50	51	52	53	54	55
39	50	51	51	52	53	54	55	56
40	51	52	52	53	54	55	56	57
41	52	53	53	54	55	56	57	58
42	53	53	54	55	56	57	58	59
43	54	54	55	56	57	58	59	59
44	54	55	56	57	58	59	60	60
45	55	56	57	58	59	60	60	61
46	56	57	58	59	60	61	61	62
47	57	58	59	60	60	61	62	62
48	58	59	60	60	61	62	63	63
49	59	60	61	61	62	63	64	64
50	60	61	62	62	63	64	64	65
51	61	62	62	63	64	64	65	66

TABLE V.—Continued.

 V_n from 52 to 90; k_n from 1.45 // to 1.80 //

V_n	V							
	k_n 1.45 //	k_n 1.50 //	k_n 1.55 //	k_n 1.60 //	k_n 1.65 //	k_n 1.70 //	k_n 1.75 //	k_n 1.80 //
52	62	62	63	64	65	65	66	68
53	63	63	64	65	66	66	67	67
54	63	64	65	66	66	67	68	67
55	64	65	66	66	66	67	68	69
56	65	66	66	67	68	68	69	69
57	66	67	67	68	68	69	70	70
58	67	67	68	69	69	70	70	71
59	68	68	69	70	70	71	71	71
60	68	69	70	71	71	71	72	72
61	69	70	71	72	72	72	73	73
62	70	71	72	73	73	73	74	74
63	71	72	73	74	74	74	75	75
64	72	73	74	75	75	75	76	76
65	73	74	75	76	76	76	77	77
66	74	75	76	77	77	77	78	78
67	75	76	77	78	78	78	79	79
68	76	77	78	79	79	79	80	80
69	77	78	79	80	80	80	81	81
70	78	79	80	81	81	81	82	82
71	79	80	81	82	82	82	83	83
72	80	81	82	83	83	83	84	84
73	81	82	83	84	84	84	85	85
74	82	83	84	85	85	85	86	86
75	83	84	85	86	86	86	87	87
76	84	85	86	87	87	87	88	88
77	85	86	87	88	88	88	89	89
78	86	87	88	89	89	89	90	90
79	87	88	89	90	90	90	91	91
80	88	89	90	91	91	91	92	92
81	89	90	91	92	92	92	93	93
82	90	91	92	93	93	93	94	94
83	91	92	93	94	94	94	95	95
84	92	93	94	95	95	95	96	96
85	93	94	95	96	96	96	97	97
86	94	95	96	97	97	97	98	98
87	95	96	97	98	98	98	99	99
88	96	97	98	99	99	99	100	100
89	97	98	99	100	100	100	101	101
90	98	99	100	101	101	101	102	102

TABLE VI.

Table of $\cot. x$ and x°

$\frac{\tan r}{\tan r_{\max}}$	$\cot. x$	x°	$\frac{\tan r}{\tan r_{\max}}$	$\cot. x$	x°	$\frac{\tan r}{\tan r_{\max}}$	$\cot. x$	x°
	∞	0,0	0,6495	1,732	30,0	0,1250	0,577	60,0
0,9999	114,589	0,5	0,6397	1,698	30,5	0,1194	0,566	60,5
0,9995	57,290	1,0	0,6298	1,664	31,0	0,1139	0,554	61,0
0,9990	38,188	1,5	0,6199	1,632	31,5	0,1086	0,543	61,5
0,9982	28,636	2,0	0,6099	1,600	32,0	0,1035	0,532	62,0
0,9971	22,904	2,5	0,5999	1,570	32,5	0,0985	0,521	62,5
0,9959	19,081	3,0	0,5899	1,540	33,0	0,0936	0,510	63,0
0,9944	16,350	3,5	0,5798	1,511	33,5	0,0888	0,499	63,5
0,9927	14,301	4,0	0,5698	1,483	34,0	0,0843	0,488	64,0
0,9908	12,706	4,5	0,5597	1,455	34,5	0,0798	0,477	64,5
0,9886	11,430	5,0	0,5497	1,428	35,0	0,0755	0,466	65,0
0,9863	10,385	5,5	0,5396	1,402	35,5	0,0713	0,456	65,5
0,9837	9,514	6,0	0,5295	1,376	36,0	0,0673	0,445	66,0
0,9808	8,777	6,5	0,5194	1,351	36,5	0,0634	0,435	66,5
0,9778	8,144	7,0	0,5094	1,327	37,0	0,0596	0,424	67,0
0,9746	7,596	7,5	0,4993	1,303	37,5	0,0560	0,414	67,5
0,9711	7,115	8,0	0,4893	1,280	38,0	0,0526	0,404	68,0
0,9674	6,691	8,5	0,4793	1,257	38,5	0,0492	0,394	68,5
0,9635	6,314	9,0	0,4694	1,235	39,0	0,0460	0,384	69,0
0,9594	5,976	9,5	0,4594	1,213	39,5	0,0430	0,374	69,5
0,9551	5,671	10,0	0,4495	1,192	40,0	0,0400	0,364	70,0
0,9506	5,396	10,5	0,4397	1,171	40,5	0,0372	0,354	70,5
0,9459	5,145	11,0	0,4299	1,150	41,0	0,0345	0,344	71,0
0,9410	4,915	11,5	0,4201	1,130	41,5	0,0319	0,335	71,5
0,9359	4,705	12,0	0,4104	1,111	42,0	0,0295	0,325	72,0
0,9306	4,511	12,5	0,4008	1,091	42,5	0,0272	0,315	72,5
0,9251	4,332	13,0	0,3912	1,072	43,0	0,0250	0,306	73,0
0,9194	4,165	13,5	0,3817	1,054	43,5	0,0229	0,296	73,5
0,9135	4,011	14,0	0,3722	1,036	44,0	0,0209	0,287	74,0
0,9075	3,867	14,5	0,3628	1,018	44,5	0,0191	0,277	74,5
0,9012	3,732	15,0	0,3536	1,000	45,0	0,0173	0,268	75,0
0,8948	3,606	15,5	0,3443	0,983	45,5	0,0157	0,259	75,5
0,8882	3,487	16,0	0,3352	0,966	46,0	0,0142	0,249	76,0
0,8815	3,376	16,5	0,3262	0,949	46,5	0,0127	0,240	76,5
0,8746	3,271	17,0	0,3172	0,932	47,0	0,0114	0,231	77,0
0,8675	3,172	17,5	0,3084	0,916	47,5	0,0101	0,222	77,5
0,8602	3,078	18,0	0,2996	0,900	48,0	0,0090	0,213	78,0
0,8528	2,989	18,5	0,2909	0,885	48,5	0,0079	0,203	78,5
0,8453	2,904	19,0	0,2824	0,869	49,0	0,0069	0,194	79,0
0,8376	2,824	19,5	0,2739	0,854	49,5	0,0060	0,185	79,5
0,8298	2,748	20,0	0,2656	0,839	50,0	0,0052	0,176	80,0
0,8218	2,675	20,5	0,2574	0,824	50,5	0,0045	0,167	80,5
0,8137	2,605	21,0	0,2492	0,810	51,0	0,0038	0,158	81,0
0,8054	2,539	21,5	0,2412	0,795	51,5	0,0032	0,149	81,5
0,7971	2,475	22,0	0,2334	0,781	52,0	0,0027	0,141	82,0
0,7886	2,414	22,5	0,2256	0,767	52,5	0,0022	0,132	82,5
0,7800	2,356	23,0	0,2180	0,754	53,0	0,0018	0,123	83,0
0,7712	2,300	23,5	0,2105	0,740	53,5	0,0015	0,114	83,5
0,7624	2,246	24,0	0,2031	0,726	54,0	0,0011	0,105	84,0
0,7535	2,194	24,5	0,1958	0,713	54,5	0,0009	0,096	84,5

TABLE VI.—Continued

$\frac{\tan r}{\tan r_{\max}}$	$\cot. r$	r°	$\frac{\tan r}{\tan r_{\max}}$	$\cot. r$	r°	$\frac{\tan r}{\tan r_{\max}}$	$\cot. r$	r°
0,7444	2,146	25,0	0,1887	0,700	55,0	0,0007	0,087	85,0
0,7353	2,097	25,5	0,1817	0,687	55,5	0,0005	0,079	85,5
0,7261	2,050	26,0	0,1749	0,674	56,0	0,0003	0,070	86,0
0,7168	2,006	26,5	0,1681	0,662	56,5	0,0002	0,061	86,5
0,7074	1,963	27,0	0,1616	0,649	57,0	0,0001	0,052	87,0
0,6979	1,921	27,5	0,1551	0,637	57,5	0,0001	0,044	87,5
0,6883	1,881	28,0	0,1488	0,625	58,0	0,0000	0,035	88,0
0,6787	1,842	28,5	0,1426	0,613	58,5	0,0000	0,026	88,5
0,6691	1,804	29,0	0,1366	0,601	59,0	0,0000	0,017	89,0
0,6593	1,767	29,5	0,1307	0,589	59,5	0,0000	0,009	89,5
0,6495	1,732	30,0	0,1250	0,577	60,0	0,0000	0,000	90,0

1870
1871
1872
1873
1874
1875
1876
1877
1878
1879
1880
1881
1882
1883
1884
1885
1886
1887
1888
1889
1890
1891
1892
1893
1894
1895
1896
1897
1898
1899
1900

INDEX.

A	PAGES
Angle of declination	14
Annual variation of terrestrial field	16
Attraction and repulsion, law of	3
Attractorily magnetic	13, 16
B	
Berg, J. Fr.	1
Bipolar magnetic axis as of	9
C	
Calibration of the Thomson-Thalen Magnetometer	63-65
Charts of magnetic intensity, information conveyed by the	74-80
" the horizontal intensity	71-72
" the vertical intensity	72-74
Compass needle in a normal terrestrial field, effect of a magnet on	18-23
Components of the total intensity of the earth's magnetism	15
Conservation of flow of force	7
Constitution of magnets, theory of	3
Construction of diagrams of magnetic fields	7
Correction of error due to defective neutralization of H' in the normal field	51-52
D	
Dahlblom, Th.	76, 86, 87
Dahlblom's modification of the sine method	37-42
" " " " Method of observation	38
" " " " Calibration of millimeter scale and construction of scale for reading k' direct	38-42
Dahlblom's Magnetometer, the	99-105
" " Description of	99
" " Adjustment of	99-100
" " Measurement of the horizontal intensity with	100-102
" " Measurement of the vertical intensity with	102-105
" " Advantages of	105
Daily variations of the terrestrial field	16
Declination	14
" angle of	14

	PAGES
Definition of magnet	3
Deflecting magnet	10, 33
Depth of a magnetic ore body, determination of the extension in.....	87-94
Description of the Swedish mining compass	65-66
" " Thalén-Tiberg Magnetometer	24-29
" " Thomson-Thalén Magnetometer.....	56-59
Destruction of magnetism.....	4
Determination of the value of K'	52-54
Diagrams of bipolar magnetic fields	9
" unipolar magnetic fields	7
" magnetic fields, construction of	7
Direction of lines of force	5
Distance of the upper pole of a magnetic ore body beneath the surface, determination of the.....	81-86
Disturbances of the earth's magnetic field.....	16
Disturbed terrestrial field of force	16-18
Dyne, definition of	6
E	
Earth's field, maximum of magnetization produced by the.....	17
" " minimum	17
" magnetic field, variations of the.....	16
" magnetism, components of the total intensity of the	15
Effect of a magnet on a compass needle in a normal terrestrial field	18-23
Equation for determination of the moment of a magnet	21
" of a line of force	12
Error due to defective neutralization of I' in the normal field, correction of the	51-52
F	
Faraday	4
Felix, A	2
Field, magnetic, variation of the earth's.....	16
" of force of an ideal and of a massive magnet.....	5
" the disturbed, the vertical intensity of.....	49-56
Fields, magnetic, construction of diagrams of	7
Flow of Force.....	7
" " conservation of.....	7
Force, direction of the lines of	5
" flow of	7
G	
Greenwich.....	14
H	
Hematite	17
Horizontal component of the earth's field for Ottawa, Ontario, value of	73

	PAGES
Horizontal intensity, chart of the	71-72
" " in a terrestrial field of force, disturbed by the presence of a magnetic ore-body, the value of	43-48

I

Inclination of needle of mining compass	67
Inclinators	1, 67
" theory of the	49-52
" sensitiveness of the	55
Inductive effect of the magnetic field upon magnetic bodies	12
Influence of magnetite as an accessory ingredient in ores or rocks	17
Information conveyed by the charts of magnetic intensity	74-80
Intensity, charts of the horizontal	71-72
" charts of the vertical	72-74
" horizontal, the value of, in a terrestrial field of force, disturbed by the presence of a magnetic ore body	43-48
" of magnetization, relation of dip to	17
" of the earth's magnetism, components of the total	15
" the vertical, of the disturbed field	49-56
Introduction	1-2
Investigation of magnetic ore deposits by magnetometric measurements	67-74
Isoclinals	14
Isodynamic lines	14
Isogonic lines	14

J

Jakobsite	13
-----------------	----

K

King, William F.	2
-----------------------	---

L

Laboratory Practice	94-99
Lamont	1
Law of attraction and repulsion	3
Line of Force, equation of a	12
Lines of Force	4
" " direction of	5
" " method of showing the	5

M

Magnet, definition of	3
" deflecting	19, 33
" effect of, on a compass needle in a normal terrestrial field	18-23
" equation for determination of the moment of a	21
Magnetic attractorily	13, 16

	PAGES
Minimum of magnetization produced by the earth's field, . . .	17
Mining compass, description of the Swedish, . . .	65-66
" " greatest inclination of needle, . . .	67
Moment of a magnet	19,21,55
" " " equation for determination of the	21

N

Neutralization of the vertical component of the earth's normal field . . .	31
" " <i>I</i> in the normal field, correction of error due to defective	51-52
Nordenstrom, G	2
Normal terrestrial field	16
North seeking polarity	9
" " pole, or north pole	3
Nyström, E	2

P

Parameter	12
Permeability	13, 16
Polarity, north seeking	9
" south seeking	9
Poles,	3
" of a magnet, situation of the	3
Pyrite	13
Pyrrhotite,	13, 16

R

Relation of dip to intensity of magnetization	17
Repulsion and attraction, law of	3
Retractorily magnetic	13, 16
Rose, J. L.	99

S

Sensitiveness of the inclinometer	55
Sine method,	23
" " Dahlblom's modification of the	37-42
" " " " " Method of observation,	38
" " " " " Calibration of millimeter scale and construction of scale for reading <i>K</i> direct	38-42
Smyth, Henry Lloyd,	17
South pole	3
" seeking polarity	9
Strength of a magnetic field at a point	6
Sundholm, H.	74
Swedish mining compass, description of the	65-66

	PAGES
T	
Tangent method.....	21, 33, 35
Terrestrial field, the disturbed.....	16-18
" " the normal.....	16
Testing and adjusting the magnetometer (Thalén-Tiberg).....	29-31
Thalén, Robert.....	1
Theory of the constitution of magnets.....	3
" " inclinator.....	49-52
" " Thomson-Thalén magnetometer.....	60-63
Thomson, Sir Wm. (Lord Kelvin).....	1
Tiberg, E.....	1
Tilas, Daniel.....	65
Total intensity of the earth's magnetism, components of the.....	15
Tube of force.....	6
U	
Uhlich, P.....	2
Unipolar magnetic fields, diagrams of.....	7
Upper pole of a magnetic ore body beneath the surface, determination of the distance of the.....	81-86
V	
Value of K, determination of the.....	52-54
" the horizontal component of the earth's field for Ottawa, Ontario.....	73
" the horizontal intensity in a terrestrial field of force, disturbed by the presence of a magnetic ore-body.....	43-48
Variations of the terrestrial field, annual.....	16
" " " " daily.....	16
" " " " due to cosmic magnetic disturbance.....	16
" " " " earth's magnetic field.....	16
Vertical intensity, charts of the.....	72-74
" " of the disturbed field, the.....	49-56
W	
Workable magnetic ore deposits.....	17
Wrede, Freiherr von.....	1

PLATE C.

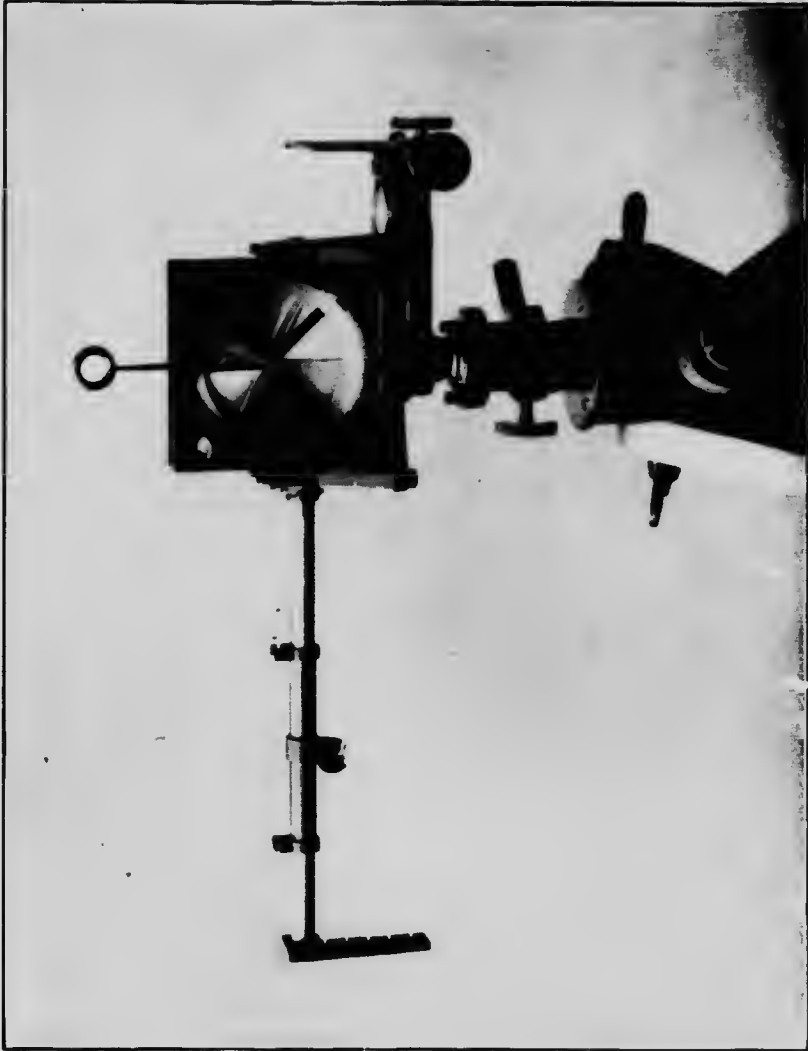

THALES-TIBERG MAGNETOMETER (SET UP AS INCLINATOR)



PLATE D.



THALÉN-TIBERG MAGNETOMETER WITH DAHBLOM'S ARM.

1870
1871
1872
1873
1874
1875
1876
1877
1878
1879
1880
1881
1882
1883
1884
1885
1886
1887
1888
1889
1890
1891
1892
1893
1894
1895
1896
1897
1898
1899
1900
1901
1902
1903
1904
1905
1906
1907
1908
1909
1910
1911
1912
1913
1914
1915
1916
1917
1918
1919
1920
1921
1922
1923
1924
1925
1926
1927
1928
1929
1930
1931
1932
1933
1934
1935
1936
1937
1938
1939
1940
1941
1942
1943
1944
1945
1946
1947
1948
1949
1950
1951
1952
1953
1954
1955
1956
1957
1958
1959
1960
1961
1962
1963
1964
1965
1966
1967
1968
1969
1970
1971
1972
1973
1974
1975
1976
1977
1978
1979
1980
1981
1982
1983
1984
1985
1986
1987
1988
1989
1990
1991
1992
1993
1994
1995
1996
1997
1998
1999
2000
2001
2002
2003
2004
2005
2006
2007
2008
2009
2010
2011
2012
2013
2014
2015
2016
2017
2018
2019
2020
2021
2022
2023
2024
2025

PLATE E.



THOMSON-THALÉN MAGNETOMETER (GLASS CAPS REMOVED).

1875
1876
1877
1878
1879
1880
1881
1882
1883
1884
1885
1886
1887
1888
1889
1890
1891
1892
1893
1894
1895
1896
1897
1898
1899
1900
1901
1902
1903
1904
1905
1906
1907
1908
1909
1910
1911
1912
1913
1914
1915
1916
1917
1918
1919
1920
1921
1922
1923
1924
1925
1926
1927
1928
1929
1930
1931
1932
1933
1934
1935
1936
1937
1938
1939
1940
1941
1942
1943
1944
1945
1946
1947
1948
1949
1950
1951
1952
1953
1954
1955
1956
1957
1958
1959
1960
1961
1962
1963
1964
1965
1966
1967
1968
1969
1970
1971
1972
1973
1974
1975
1976
1977
1978
1979
1980
1981
1982
1983
1984
1985
1986
1987
1988
1989
1990
1991
1992
1993
1994
1995
1996
1997
1998
1999
2000
2001
2002
2003
2004
2005
2006
2007
2008
2009
2010
2011
2012
2013
2014
2015
2016
2017
2018
2019
2020
2021
2022
2023
2024
2025

VERTICAL SECTION OF THE FIELD OF FORCE THE

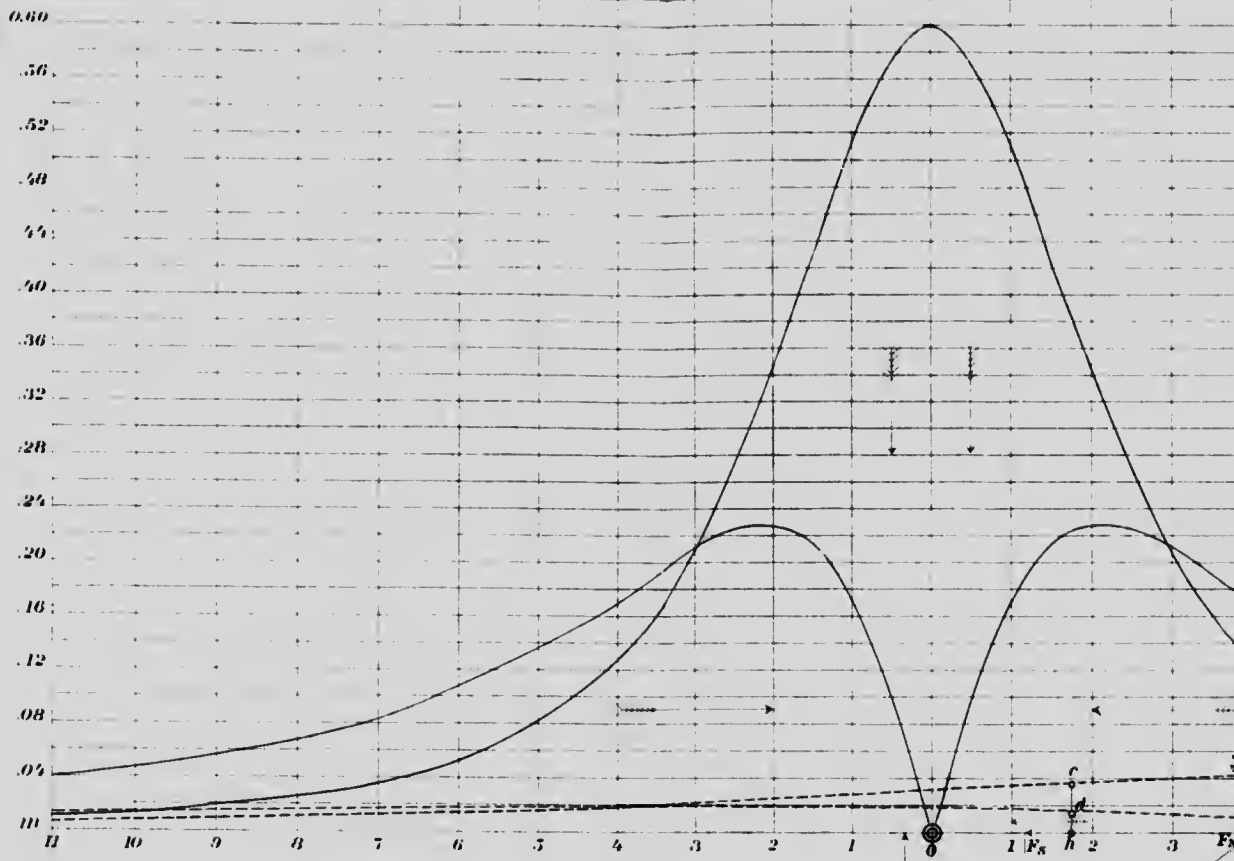
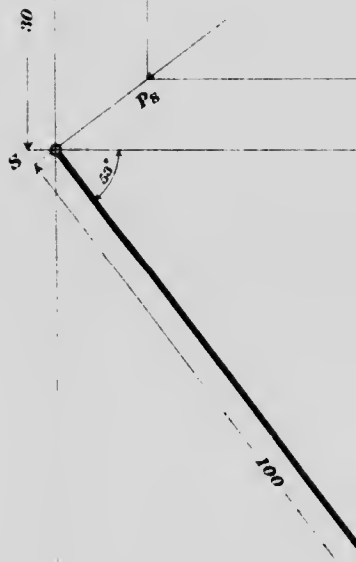
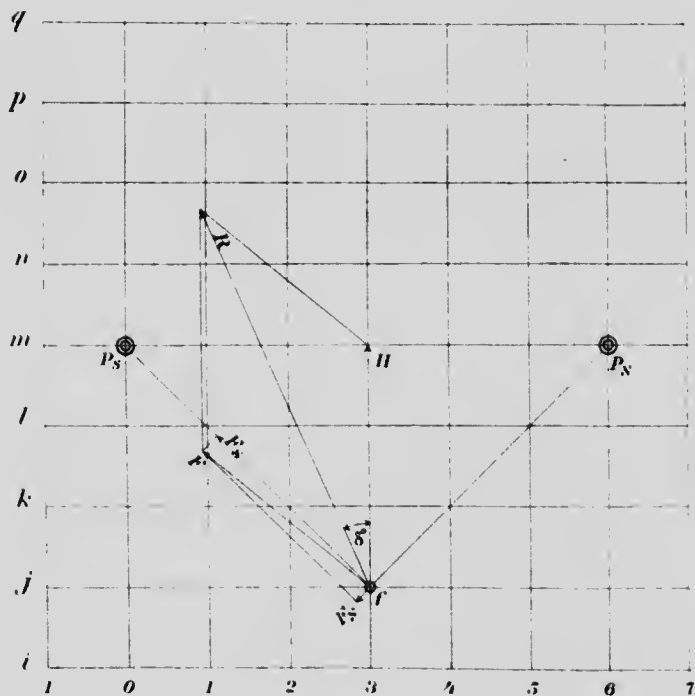
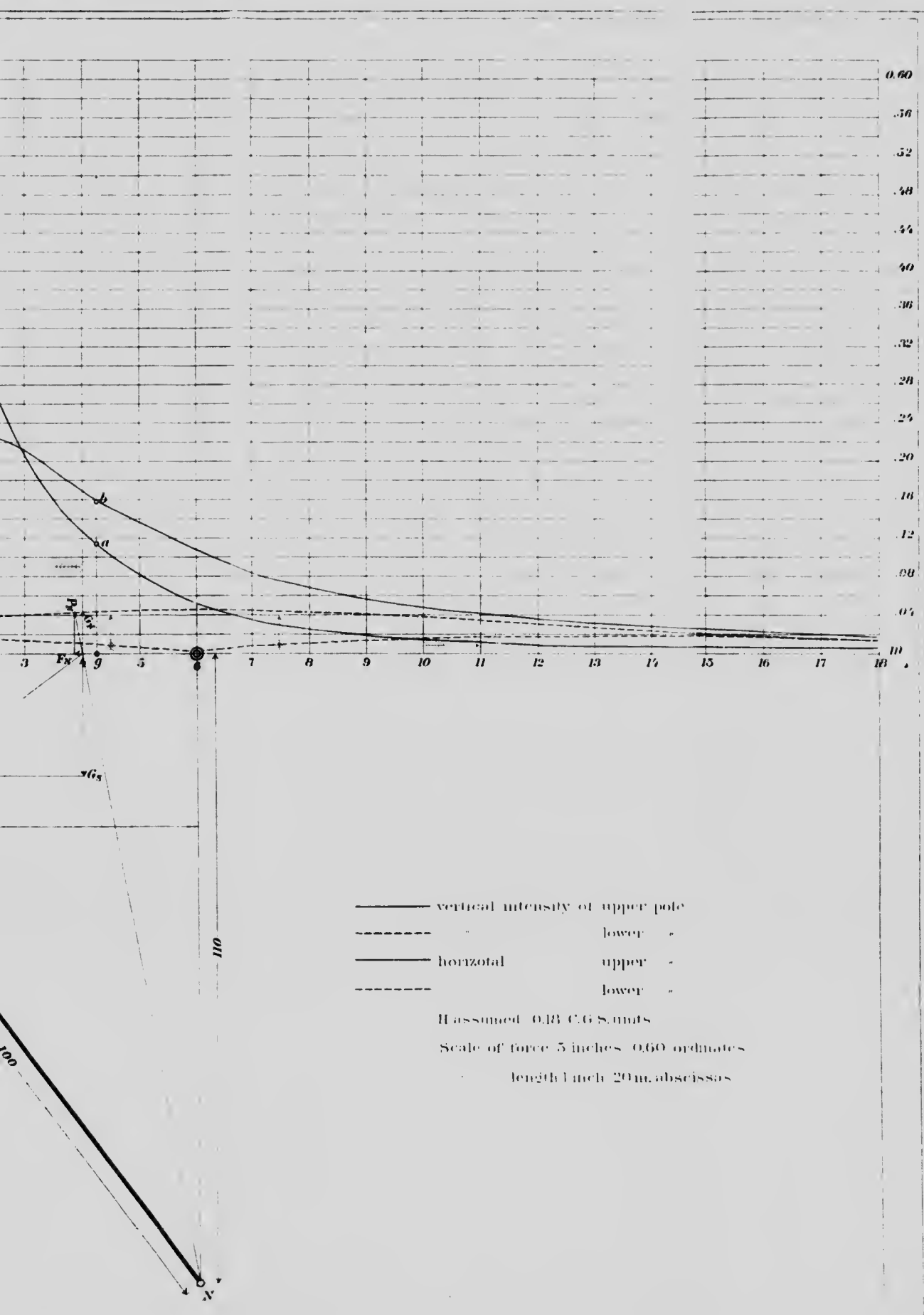

Fig 45



THROUGH THE STATION LINE M OF PLATES II AND III.

PLATE I



111
112
113
114
115
116
117
118
119
120
121
122
123
124
125
126
127
128
129
130
131
132
133
134
135
136
137
138
139
140
141
142
143
144
145
146
147
148
149
150
151
152
153
154
155
156
157
158
159
160
161
162
163
164
165
166
167
168
169
170
171
172
173
174
175
176
177
178
179
180
181
182
183
184
185
186
187
188
189
190
191
192
193
194
195
196
197
198
199
200
201
202
203
204
205
206
207
208
209
210
211
212
213
214
215
216
217
218
219
220
221
222
223
224
225
226
227
228
229
230
231
232
233
234
235
236
237
238
239
240
241
242
243
244
245
246
247
248
249
250
251
252
253
254
255
256
257
258
259
260
261
262
263
264
265
266
267
268
269
270
271
272
273
274
275
276
277
278
279
280
281
282
283
284
285
286
287
288
289
290
291
292
293
294
295
296
297
298
299
300
301
302
303
304
305
306
307
308
309
310
311
312
313
314
315
316
317
318
319
320
321
322
323
324
325
326
327
328
329
330
331
332
333
334
335
336
337
338
339
340
341
342
343
344
345
346
347
348
349
350
351
352
353
354
355
356
357
358
359
360
361
362
363
364
365
366
367
368
369
370
371
372
373
374
375
376
377
378
379
380
381
382
383
384
385
386
387
388
389
390
391
392
393
394
395
396
397
398
399
400
401
402
403
404
405
406
407
408
409
410
411
412
413
414
415
416
417
418
419
420
421
422
423
424
425
426
427
428
429
430
431
432
433
434
435
436
437
438
439
440
441
442
443
444
445
446
447
448
449
450
451
452
453
454
455
456
457
458
459
460
461
462
463
464
465
466
467
468
469
470
471
472
473
474
475
476
477
478
479
480
481
482
483
484
485
486
487
488
489
490
491
492
493
494
495
496
497
498
499
500
501
502
503
504
505
506
507
508
509
510
511
512
513
514
515
516
517
518
519
520
521
522
523
524
525
526
527
528
529
530
531
532
533
534
535
536
537
538
539
540
541
542
543
544
545
546
547
548
549
550
551
552
553
554
555
556
557
558
559
560
561
562
563
564
565
566
567
568
569
570
571
572
573
574
575
576
577
578
579
580
581
582
583
584
585
586
587
588
589
590
591
592
593
594
595
596
597
598
599
600
601
602
603
604
605
606
607
608
609
610
611
612
613
614
615
616
617
618
619
620
621
622
623
624
625
626
627
628
629
630
631
632
633
634
635
636
637
638
639
640
641
642
643
644
645
646
647
648
649
650
651
652
653
654
655
656
657
658
659
660
661
662
663
664
665
666
667
668
669
670
671
672
673
674
675
676
677
678
679
680
681
682
683
684
685
686
687
688
689
690
691
692
693
694
695
696
697
698
699
700
701
702
703
704
705
706
707
708
709
710
711
712
713
714
715
716
717
718
719
720
721
722
723
724
725
726
727
728
729
730
731
732
733
734
735
736
737
738
739
740
741
742
743
744
745
746
747
748
749
750
751
752
753
754
755
756
757
758
759
760
761
762
763
764
765
766
767
768
769
770
771
772
773
774
775
776
777
778
779
780
781
782
783
784
785
786
787
788
789
790
791
792
793
794
795
796
797
798
799
800
801
802
803
804
805
806
807
808
809
810
811
812
813
814
815
816
817
818
819
820
821
822
823
824
825
826
827
828
829
830
831
832
833
834
835
836
837
838
839
840
841
842
843
844
845
846
847
848
849
850
851
852
853
854
855
856
857
858
859
860
861
862
863
864
865
866
867
868
869
870
871
872
873
874
875
876
877
878
879
880
881
882
883
884
885
886
887
888
889
890
891
892
893
894
895
896
897
898
899
900
901
902
903
904
905
906
907
908
909
910
911
912
913
914
915
916
917
918
919
920
921
922
923
924
925
926
927
928
929
930
931
932
933
934
935
936
937
938
939
940
941
942
943
944
945
946
947
948
949
950
951
952
953
954
955
956
957
958
959
960
961
962
963
964
965
966
967
968
969
970
971
972
973
974
975
976
977
978
979
980
981
982
983
984
985
986
987
988
989
990
991
992
993
994
995
996
997
998
999
1000

INTENS

16.9	17.2
16.7	17.1
16.6	17.0
16.6	17.0
16.7	17.3
16.7	17.4

ISODYNAMIC LINES OF

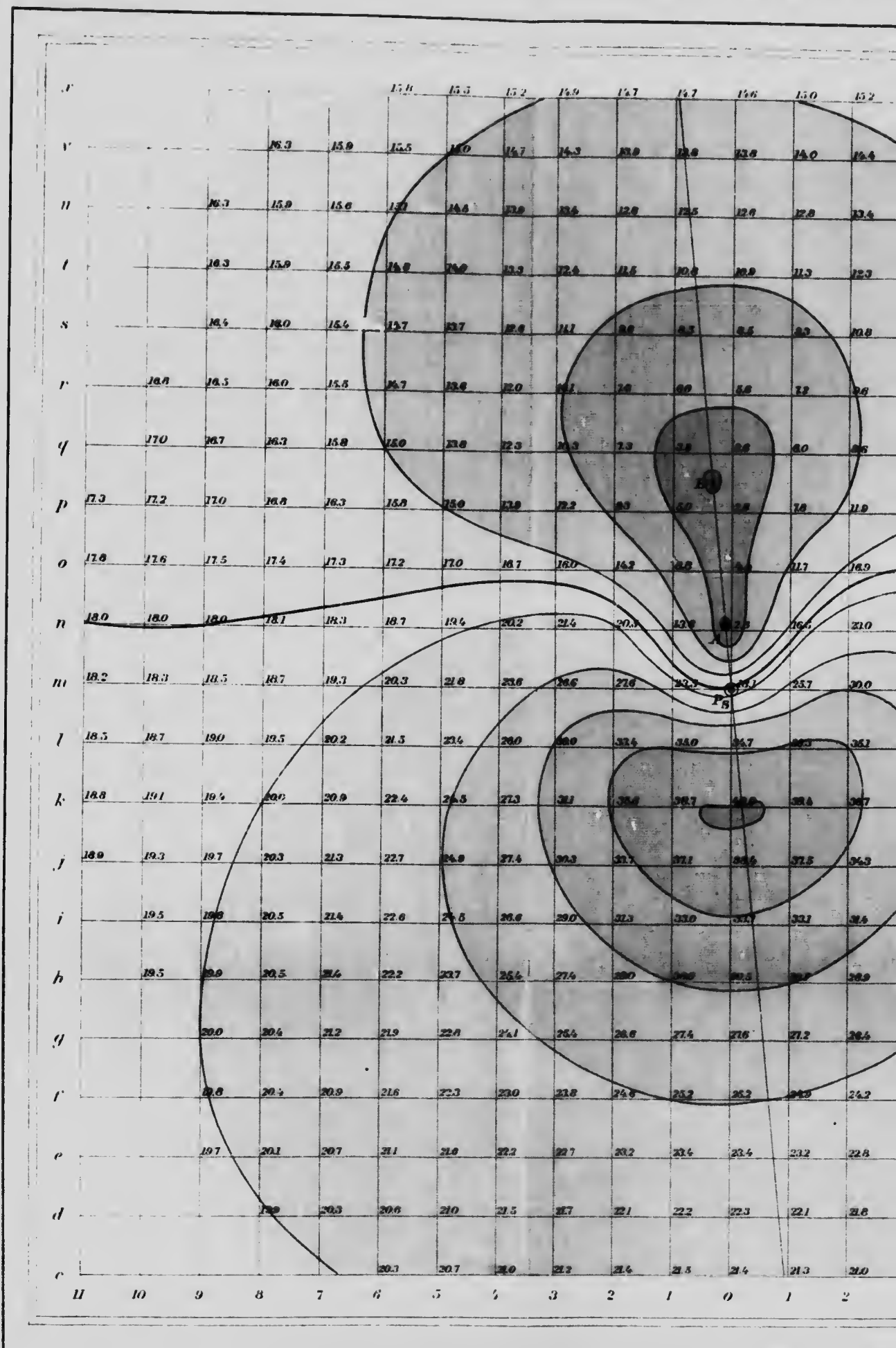

minimum R

ISOPHES OF HORIZONTAL INTENSITY R.

PLATE II

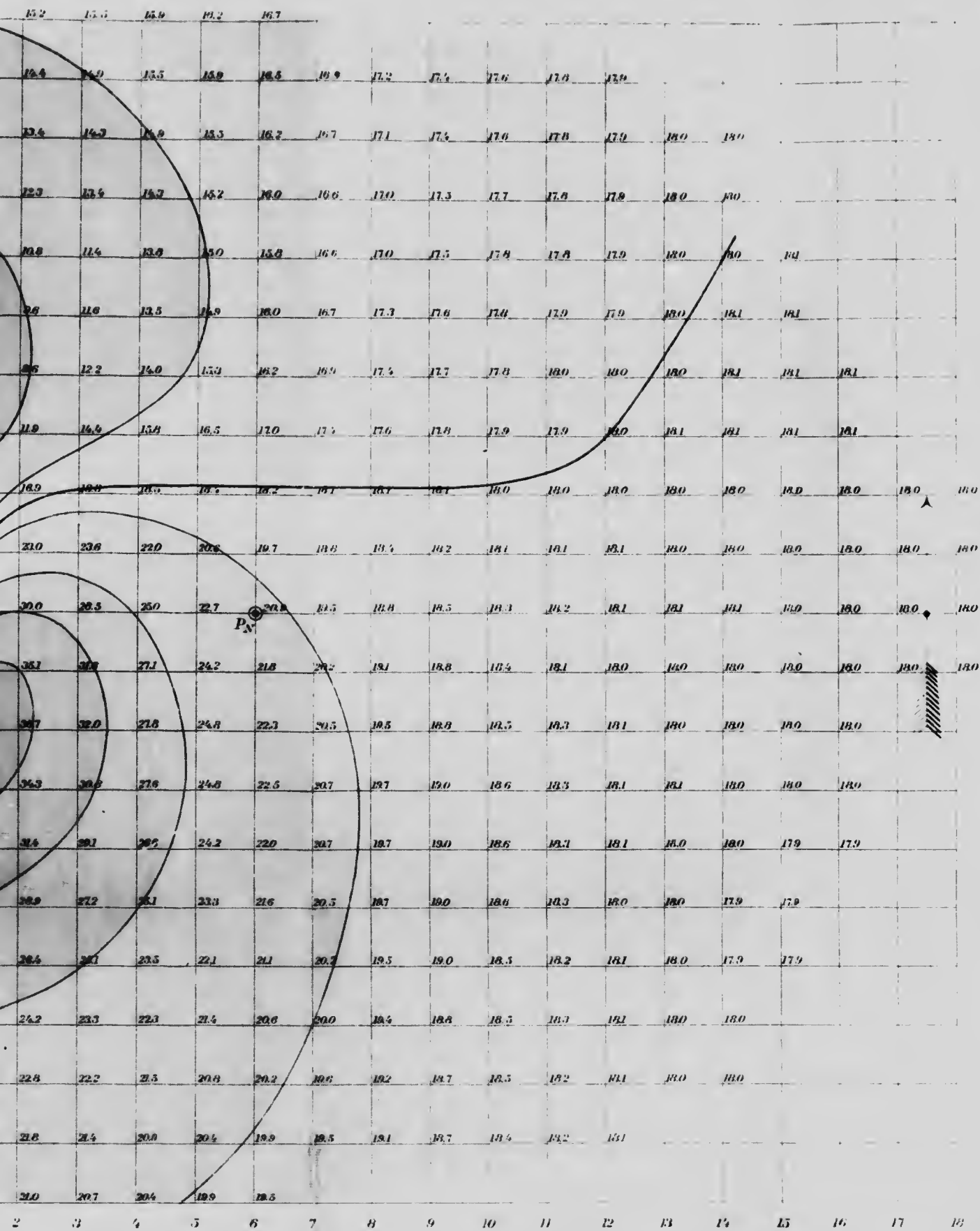

maximum R

neutral line R = 13

Scale 1 inch = 20 m.

The Mortimer Co. Ltd. Ed. 1914

1870

NTENSE

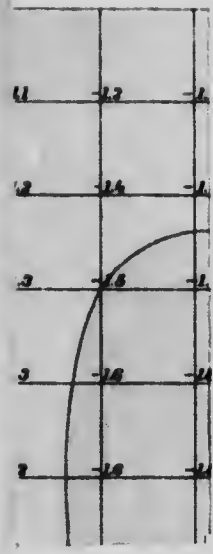

ISODYNAMIC LINES OF

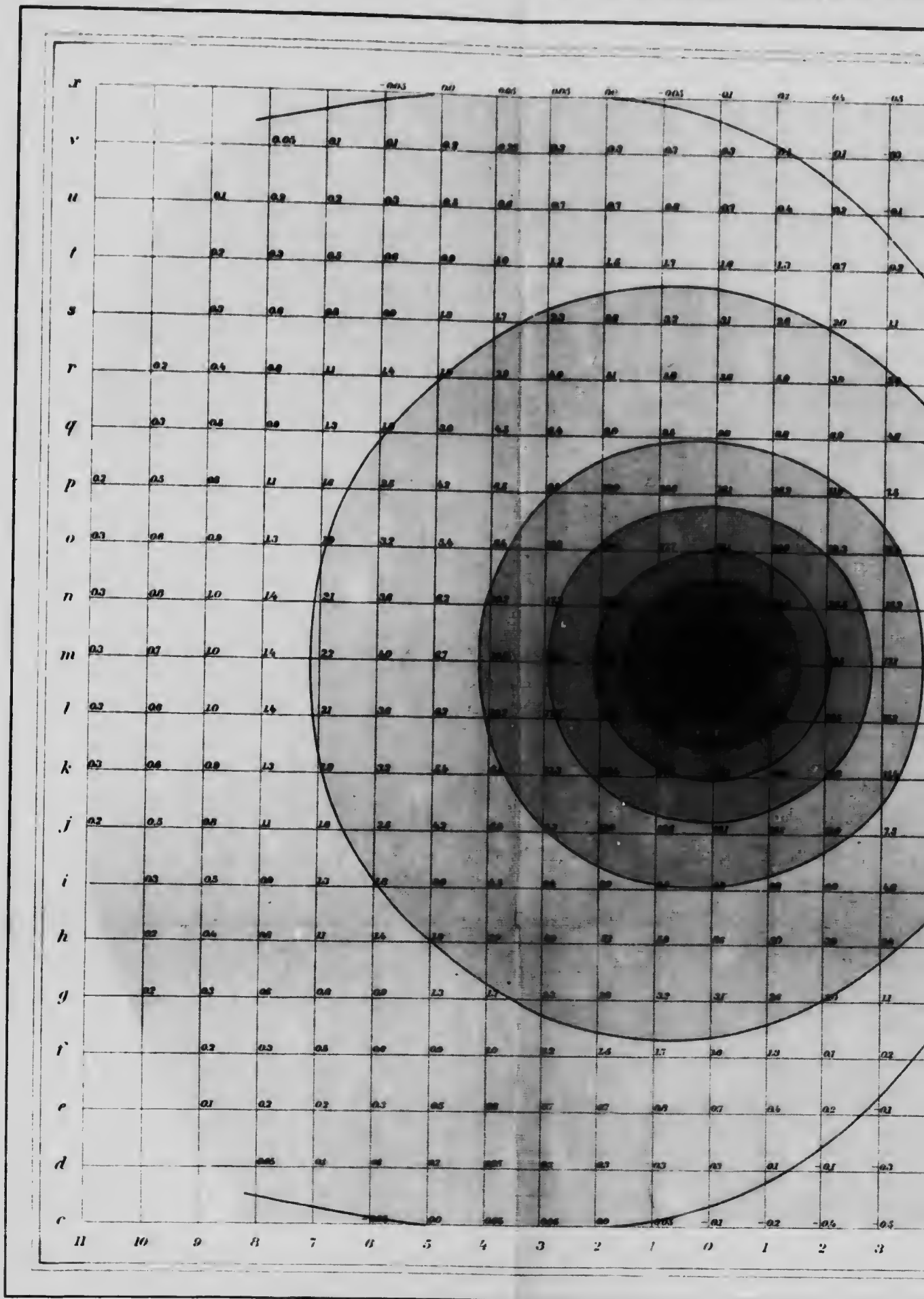

positive intensity [north pole attraction]

MAP OF VERTICAL INTENSITY G

PLATE III

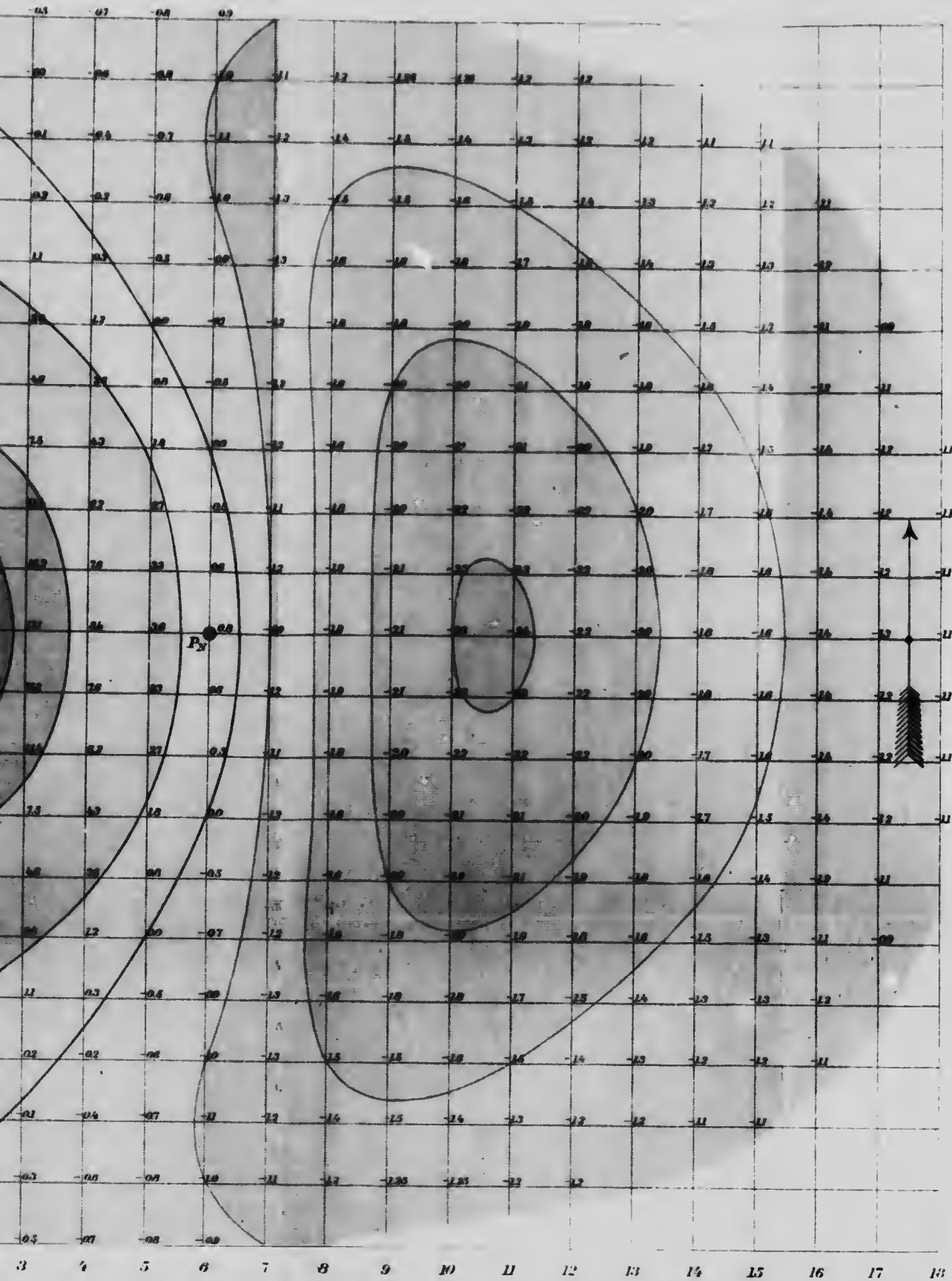

The Mortimer Co. Limited Ottawa

 negative intensity (south pole attraction)

Scale 1 inch=20 m.

Vertical text on the left margin, likely bleed-through from the reverse side of the page. The text is extremely faint and illegible.



ISOGONIC

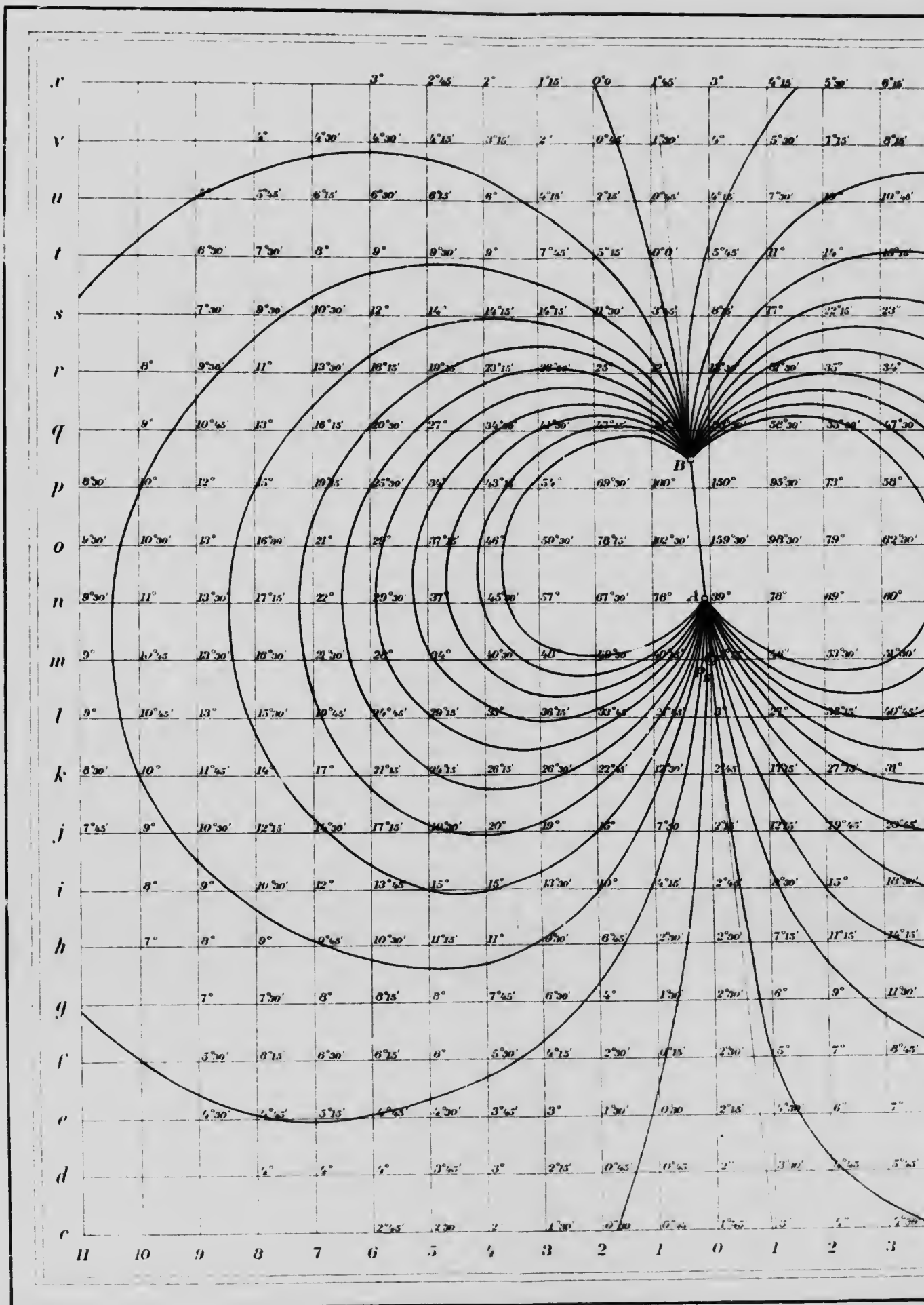

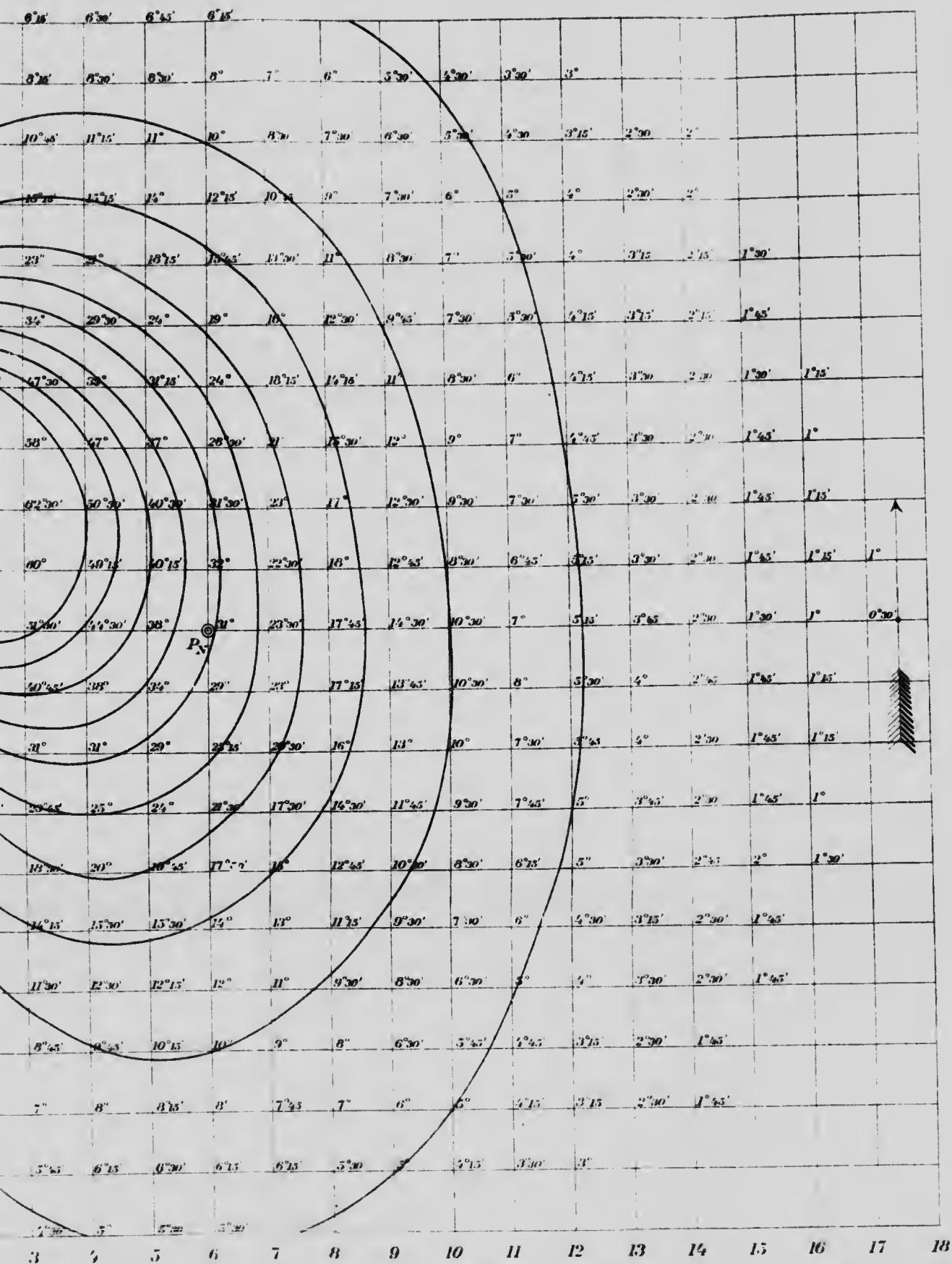

1870
1871
1872
1873
1874
1875
1876
1877
1878
1879
1880
1881
1882
1883
1884
1885
1886
1887
1888
1889
1890
1891
1892
1893
1894
1895
1896
1897
1898
1899
1900
1901
1902
1903
1904
1905
1906
1907
1908
1909
1910
1911
1912
1913
1914
1915
1916
1917
1918
1919
1920
1921
1922
1923
1924
1925
1926
1927
1928
1929
1930
1931
1932
1933
1934
1935
1936
1937
1938
1939
1940
1941
1942
1943
1944
1945
1946
1947
1948
1949
1950
1951
1952
1953
1954
1955
1956
1957
1958
1959
1960
1961
1962
1963
1964
1965
1966
1967
1968
1969
1970
1971
1972
1973
1974
1975
1976
1977
1978
1979
1980
1981
1982
1983
1984
1985
1986
1987
1988
1989
1990
1991
1992
1993
1994
1995
1996
1997
1998
1999
2000
2001
2002
2003
2004
2005
2006
2007
2008
2009
2010
2011
2012
2013
2014
2015
2016
2017
2018
2019
2020
2021
2022
2023
2024
2025

POSIT OF MAGNETITE

PLATE V

37						16
36	31	32				15
35	34	34	33	32		14
37	37	36	35	34		13
38	37	36	35	33	31	12

ISODYNAMIC LINES OF THE HORIZONTAL

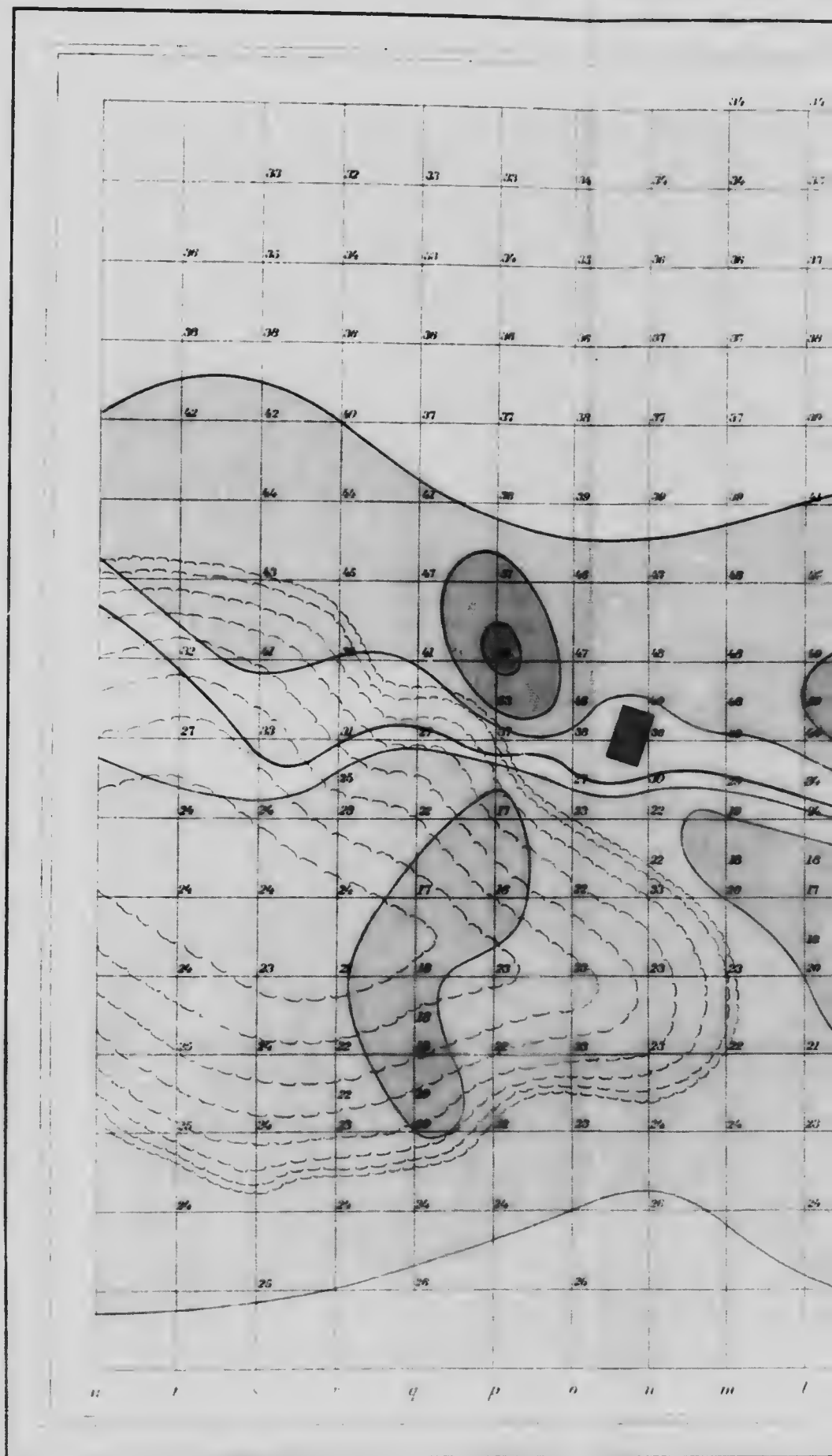

MAXIMUM

MINIMUM

HORIZONTAL INTENSITY OF A DEPOSIT OF MAGNETITE

PLATE V

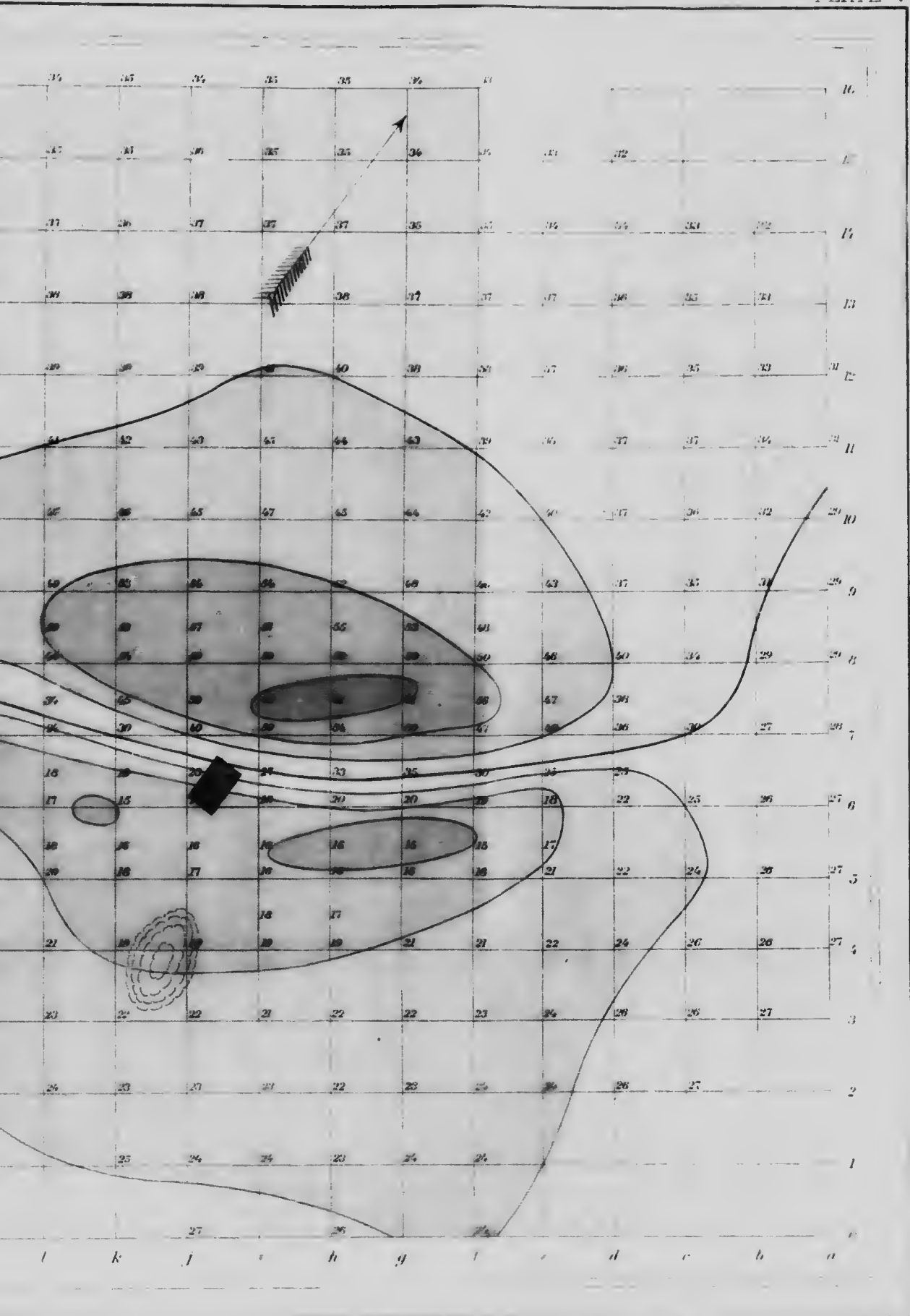

The Mortimer Co. Limited, Ottawa

neutral line

rock dump

shaft



SIT OF MAGNETTE

PLATE VI

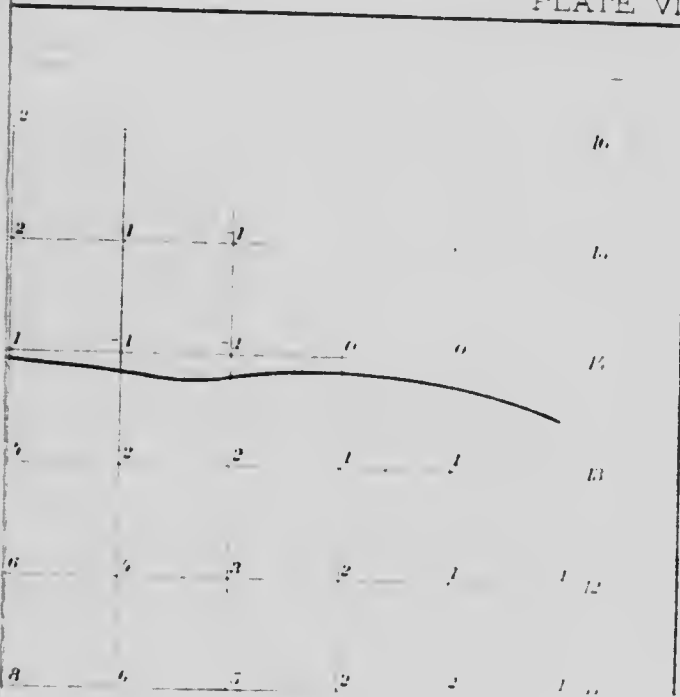

ISODYNAMIC LINES OF THE VERTICAL

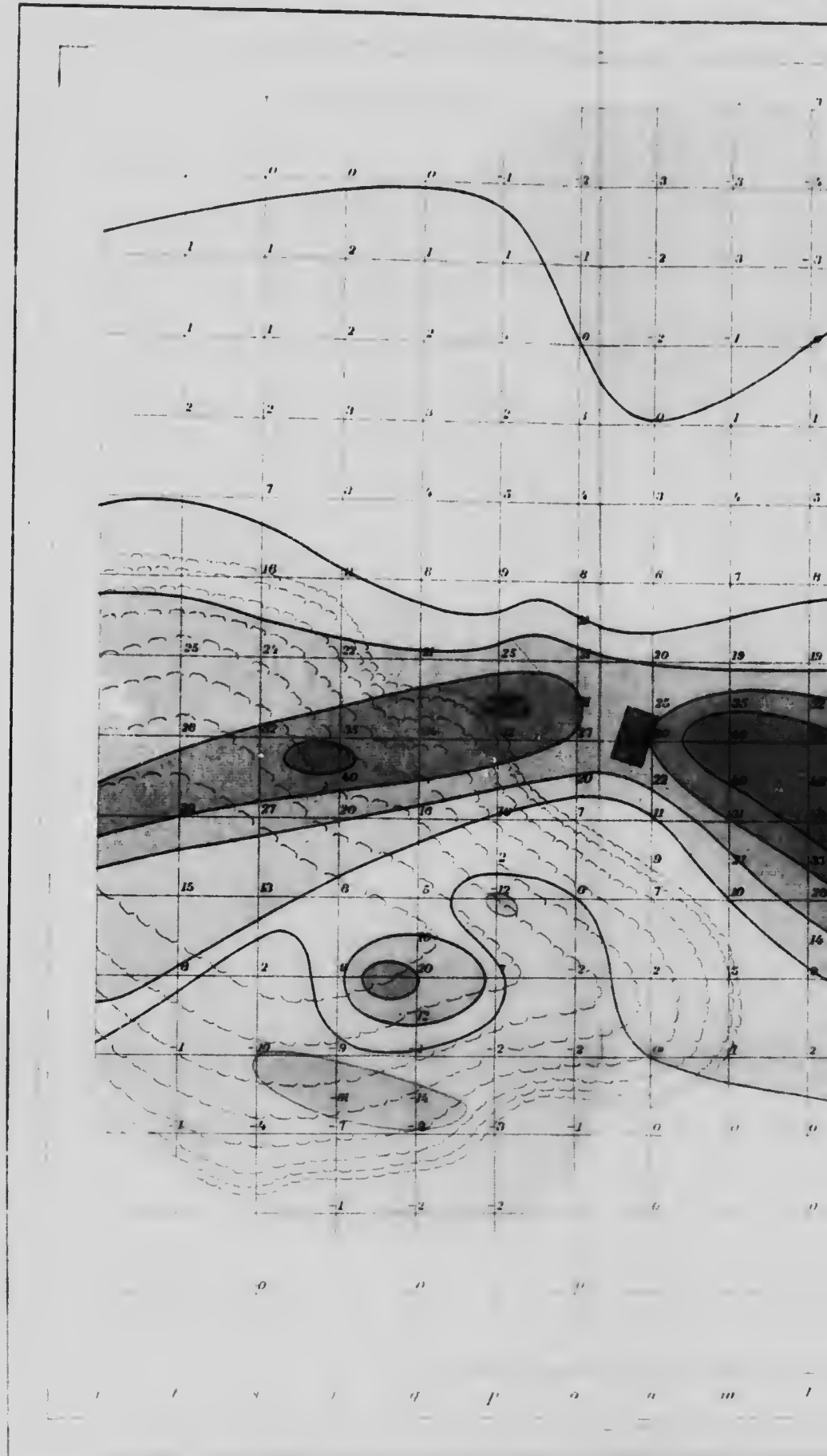

positive intensity



negative intensity

MAGNETIC INTENSITY OF A DEPOSIT OF MAGNETITE

PLATE VI

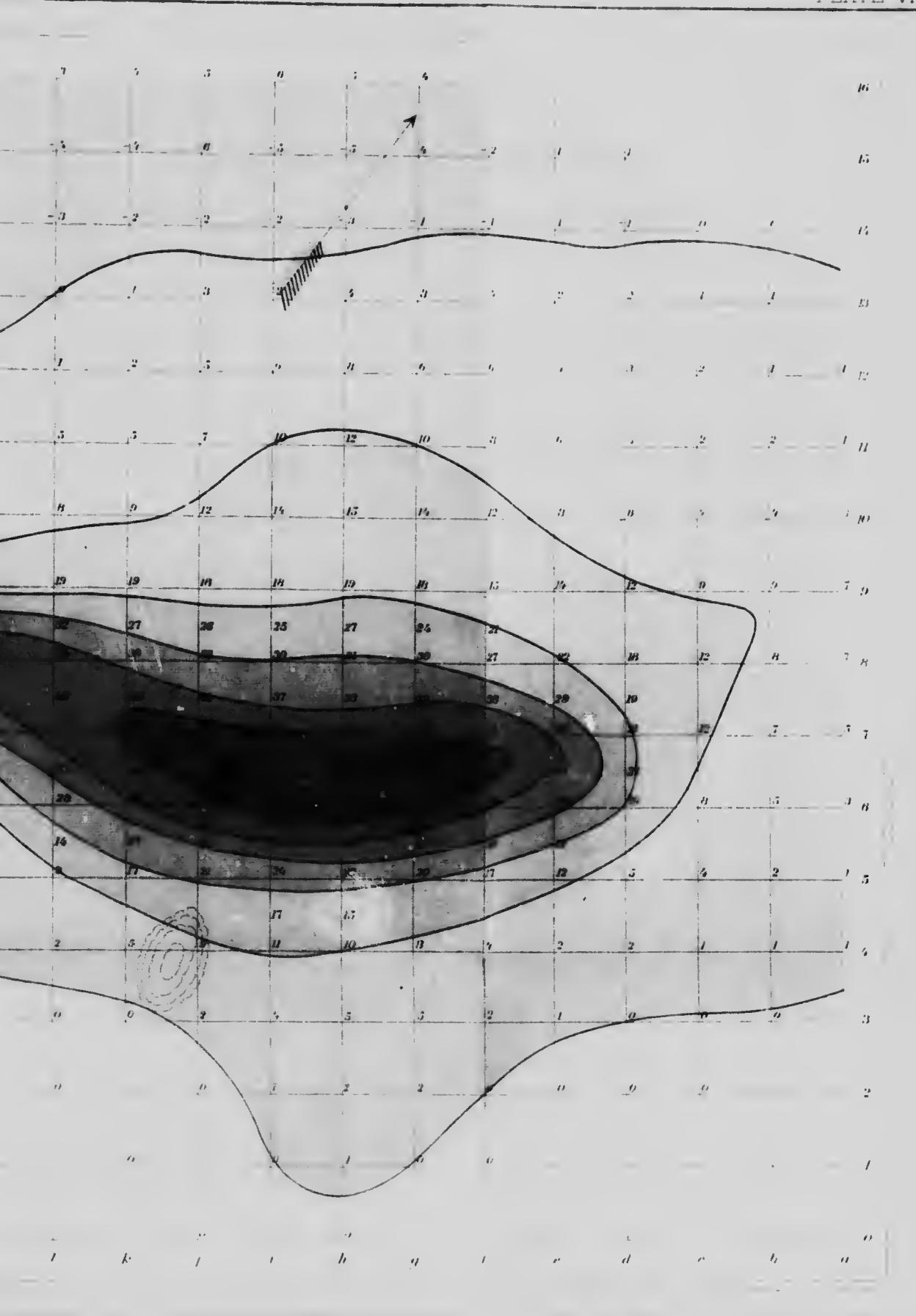

The Mortimer Co. Limited 21, 22, 23

ve intensity

rock dump



shaft

scale 1:500

K.L.H.

AL. OI





MICROCOPY RESOLUTION TEST CHART

(ANSI and ISO TEST CHART No. 2)

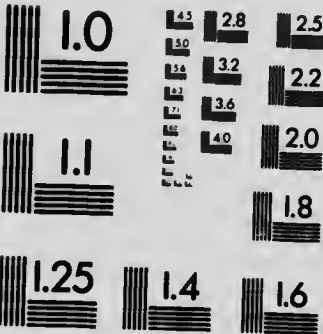

APPLIED IMAGE Inc

1653 East Main Street
Rochester, New York 14609 USA
(716) 482 - 0300 - Phone
(716) 288 - 5989 - Fax

CHART OF ISODYNAMIC LINE

VERTICAL INTENSITY

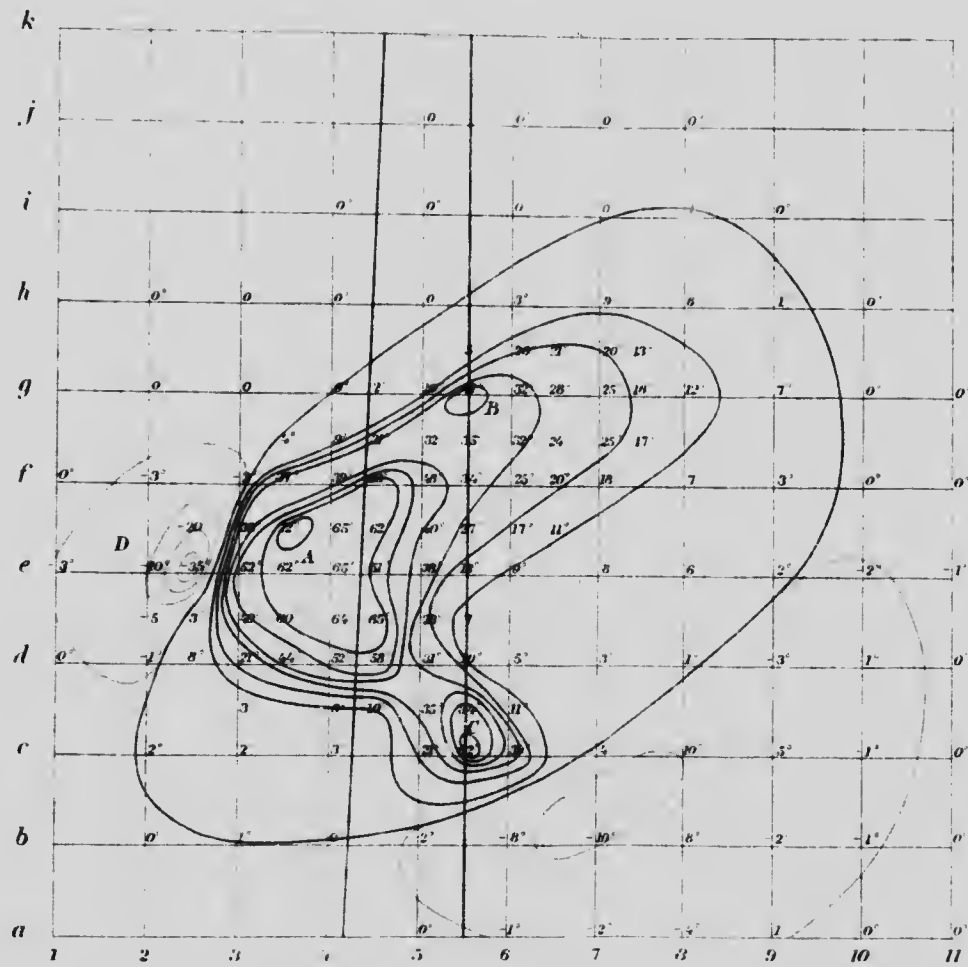

——— positive intensity upper pole
 - - - - - negative lower pole
 • K = 0.90 II

Scale 1 inch

HORIZONTAL INTENSITY

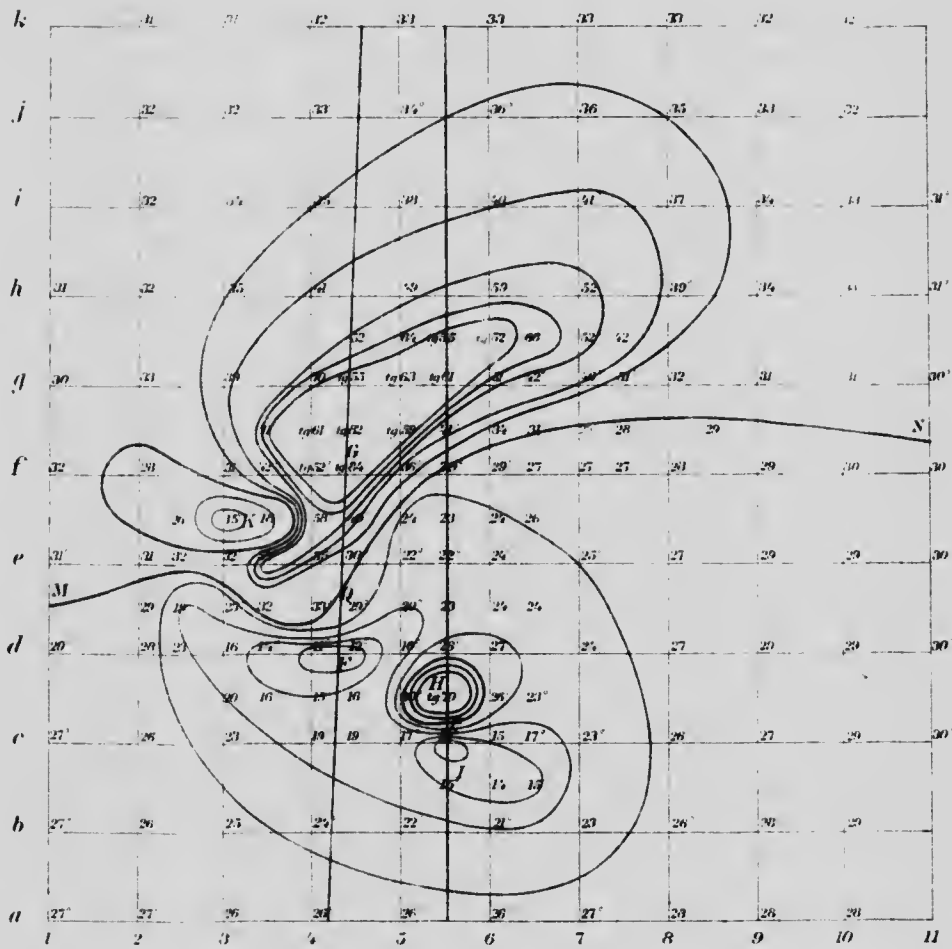

1 inch = 60 ft.

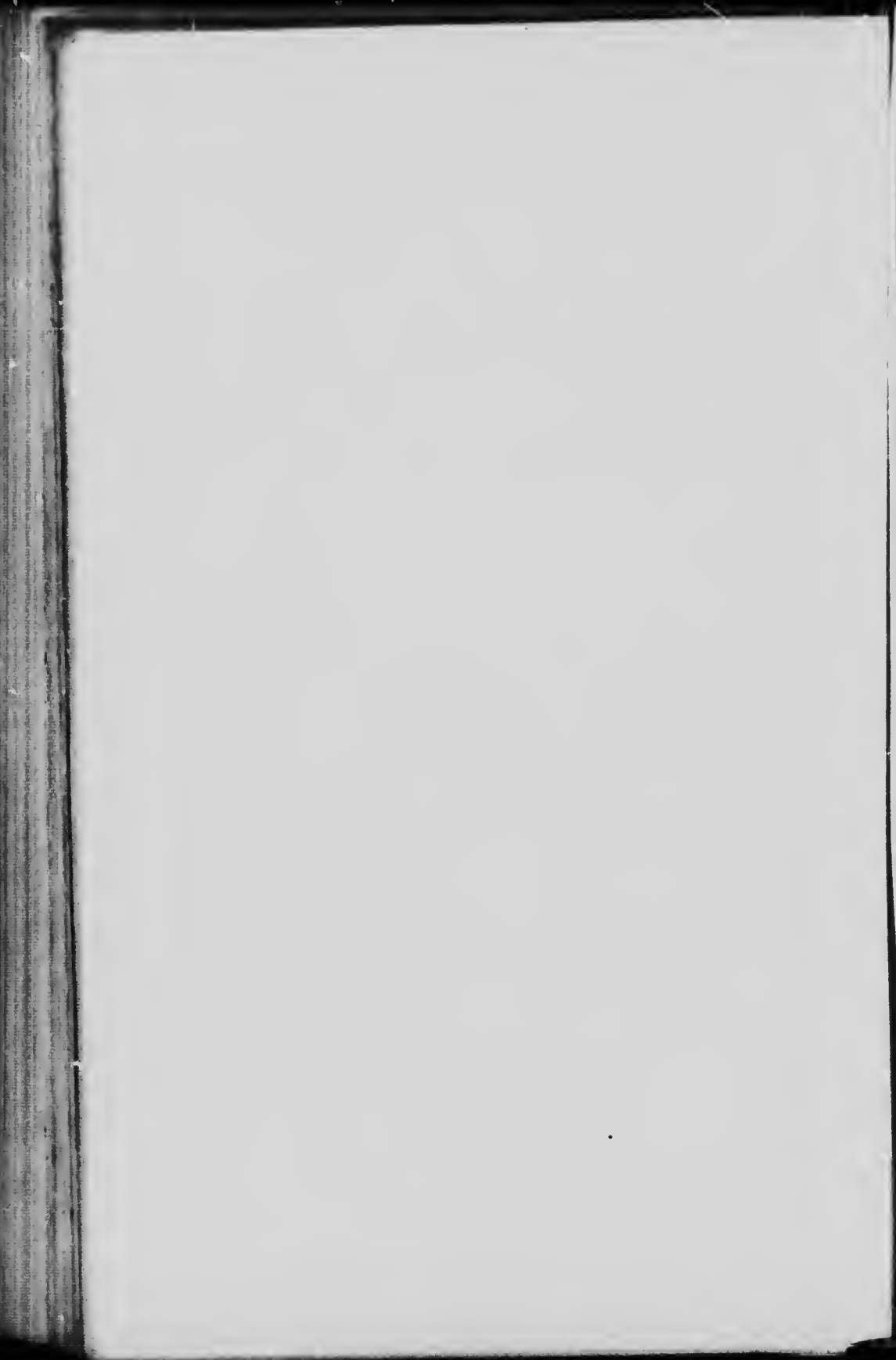
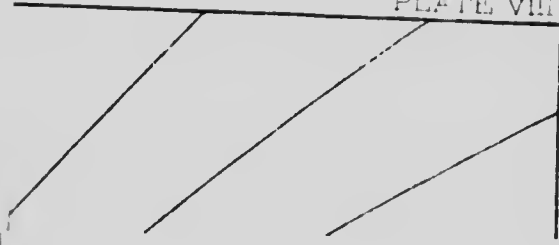
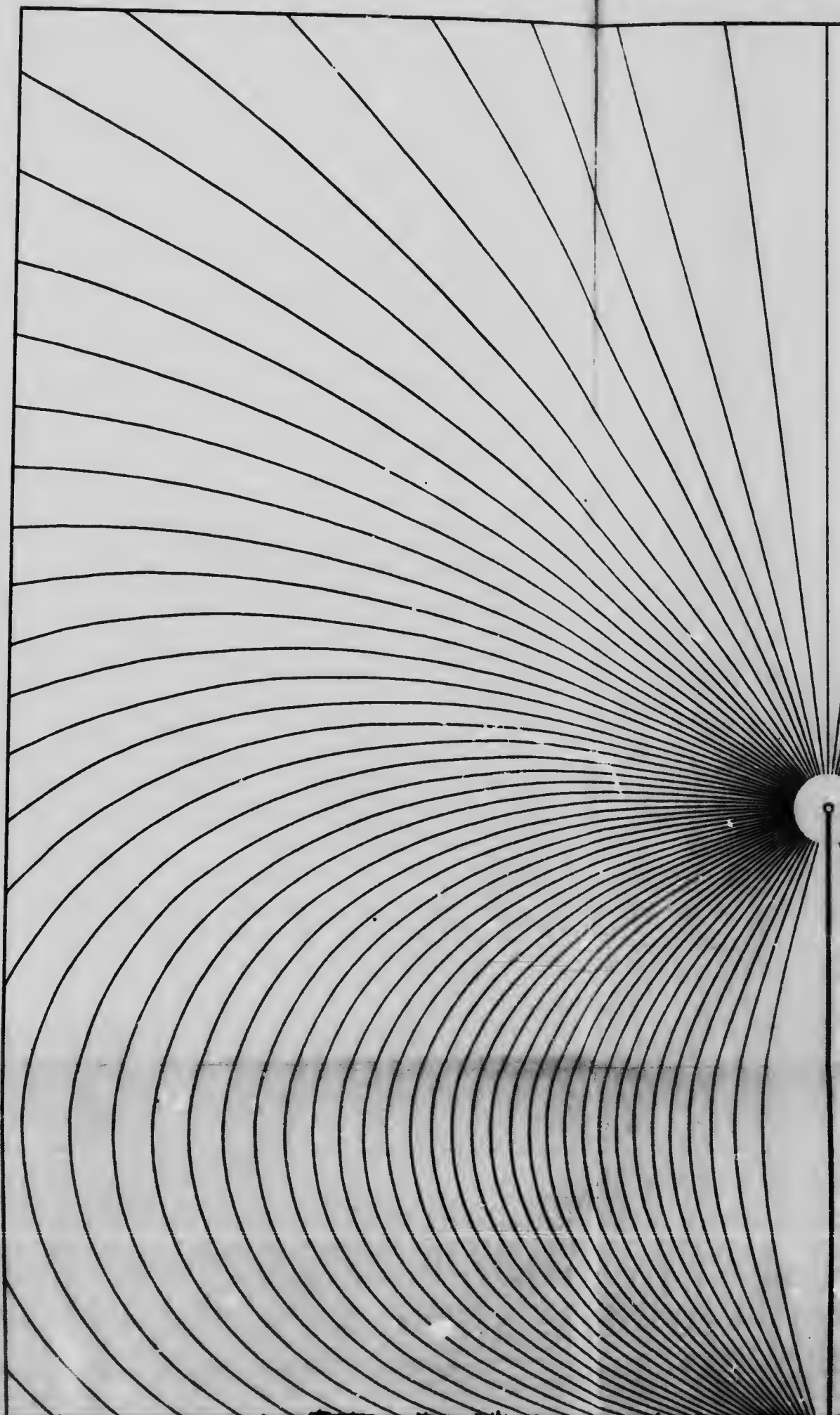

PLATE VIII



FIELD OF FORCE OF



OF AN IDEAL MAGNET

PLATE VIII

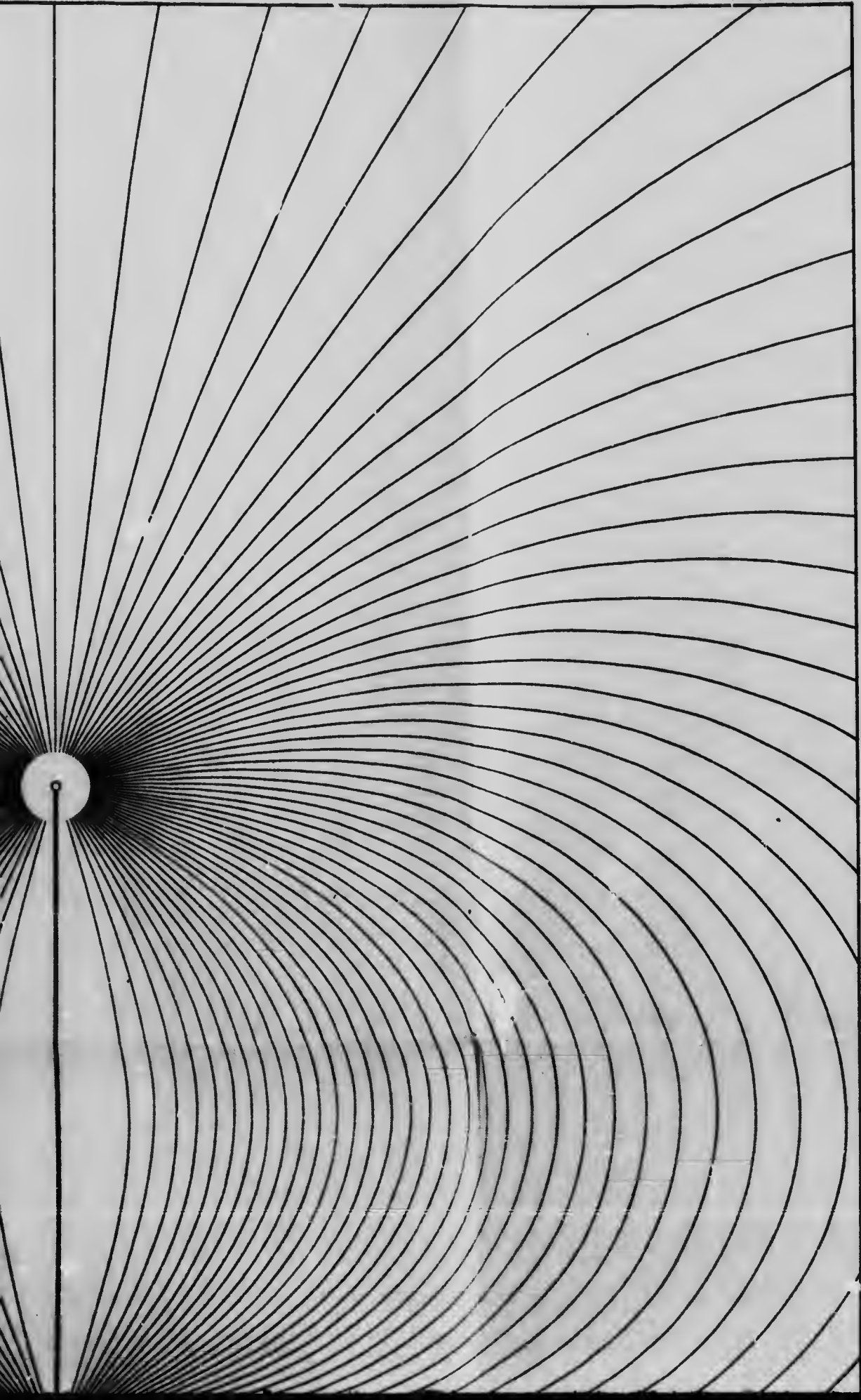

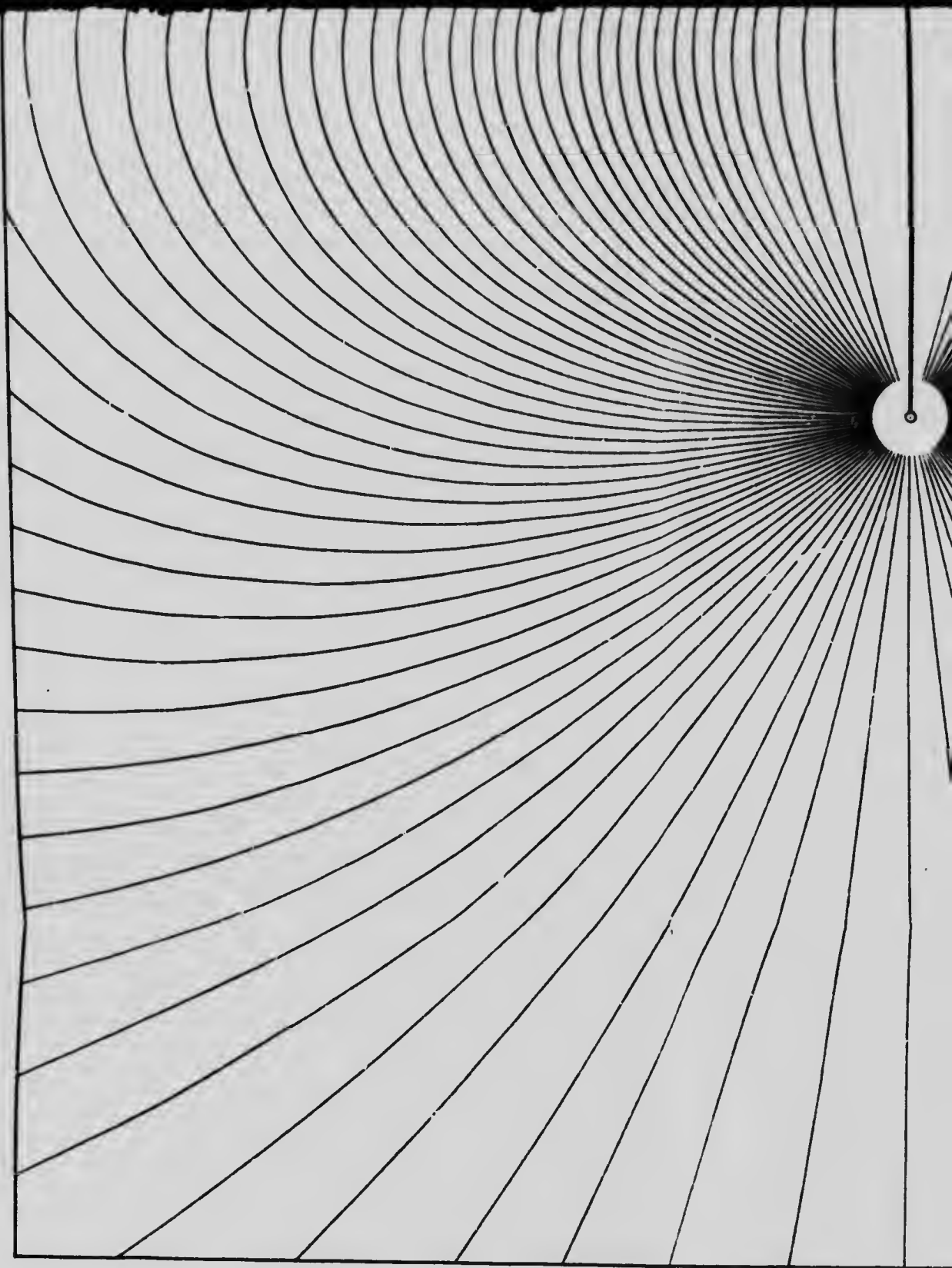

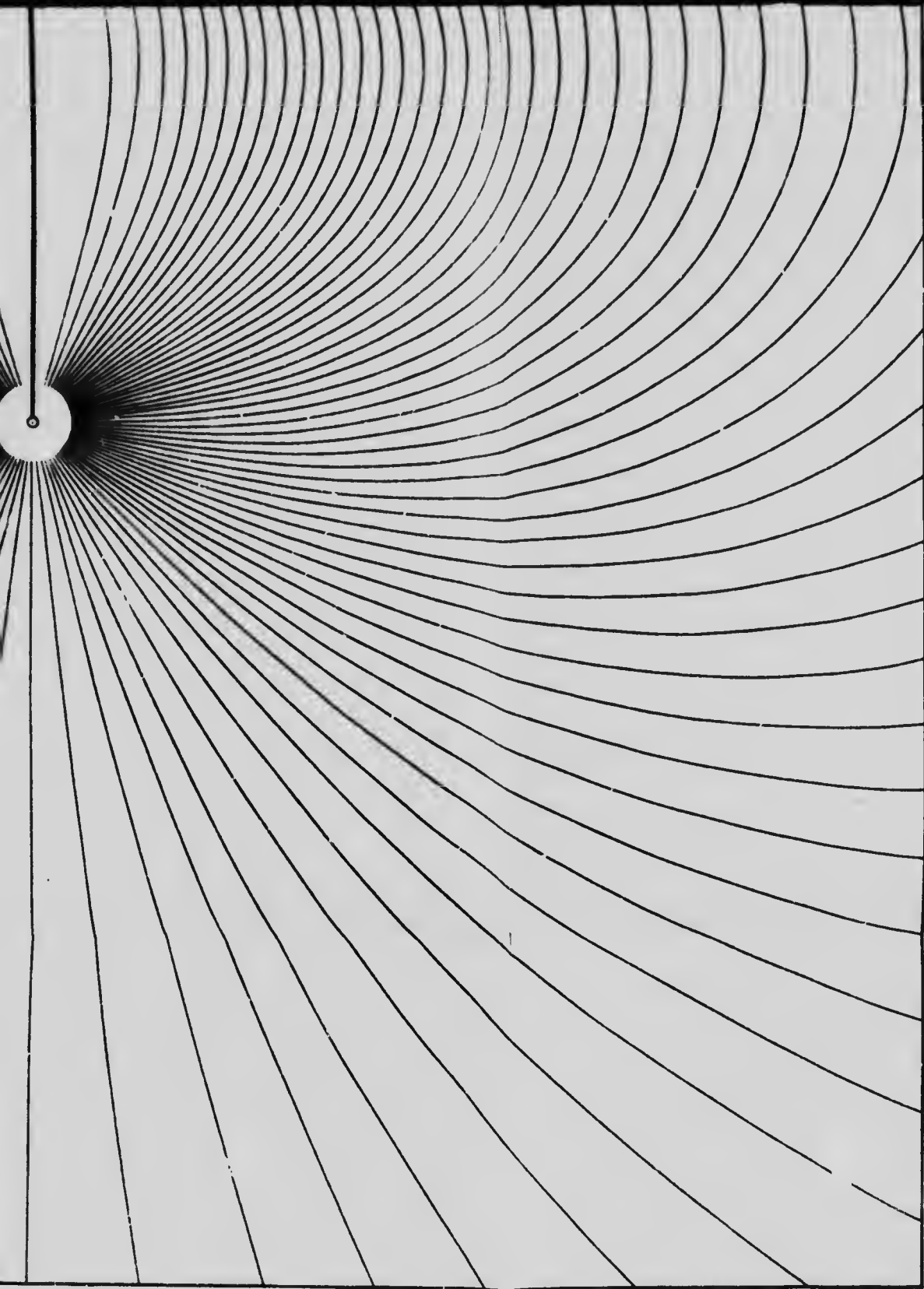

The Mortimer Co. Limited Ottawa.

