

Please read and send in as full a
discussion as possible at earliest date.

The Canadian Society of Civil Engineers.

INCORPORATED 1887.

ADVANCE PROOF—(*Subject to revision.*)

N.B.—This Society, as a body, does not hold itself responsible for the statements and opinions advanced in any of its publications.

THE USE OF ELECTRICITY ON THE LACHINE CANAL.

By L. A. HERDT. A.M. Can. Soc. C. E.

(Read before the Electrical Section, 24th March, 1904.)

The Lachine Canal is part of the large waterway which connects the great lakes with the Gulf of St. Lawrence. This waterway, comprising the mighty St. Lawrence River and the chain of lakes of the Canadian West, is, as regards the beauty of its shores, the grandeur of its scenery and the majesty of its falls, without any rival. But above all, as an inland water route, it is unsurpassed in the world for its commercial usefulness.

Having a total length of 2,400 miles, 1,000 miles from the Atlantic Ocean to Montreal, the metropole of Canada, and 1,400 miles to the head of Lake Superior, it allows free and safe navigation to large vessels up to fourteen feet draught.

The St. Lawrence River, the canals and the great lakes, have become the great artery of commerce, serving to carry the freight of the West of Canada, to Europe, besides supplying the local traffic of the cities, towns and villages lying along their shores.

Such facilities for navigation, however, were not obtained without considerable outlay of money, of time and of labor, also engineering works of the highest order. Among such works are to be included the magnificent system of canals, comprising the Lachine, Beauharnois, Cornwall, Soulanges and Welland canals. The aggre-

gate length of these canals is $70\frac{3}{4}$ miles, with a total lockage of $536\frac{1}{2}$ feet, through 54 locks.

THE LACHINE CANAL.

In the year 1903 the Lachine Canal was opened to navigation 246 days. During this time 7,365 vessels of all description passed through it, carrying over two million of tons of freight and 35,000 passengers.

432,000 tons of wheat, 218,000 tons of corn, 22,000 tons of flour, 327,000 tons of lumber, 370,000 tons of coal and half a million of tons of general cargo passed through its locks.

A few words as to the history of the construction of the Lachine Canal will not be out of place, especially as a complete history is yet to be published.

Immediately above Montreal are found the rapids of Sault St. Louis, or Lachine Rapids, which are the first obstruction to westward navigation in the St. Lawrence River. To continue the water route, as far back as 1700 the Sulpician Fathers opened up a boat canal, merely a trench, via River St. Pierre in the marshes where the Lachine Canal at present lies. The depth of water was but two and a half feet, and served for boats to carry thirty barrels of flour. The locks were six feet wide and one hundred feet long.

This was enlarged and deepened in 1821 to allow for navigation by barges drawing four feet. The locks were lengthened to one hundred and fifty feet and broadened to twenty feet.

In 1843 a ship canal was begun at a cost of two million of dollars. Five locks were built, each 2,000 feet long and nine feet of water on the sills.

The length of the Lachine Canal is eight and three quarter miles. From Lachine to Côte St. Paul, a distance of five and three-quarter miles, there are no locks, the Lachine locks being, in fact, only guard locks, the lockage is but a foot.

From Côte St. Paul to Montreal harbor, a distance of three miles, the total lockage is forty-five feet.

The Canal is spanned by six swing bridges built on piers of cut stone. These bridges are the Lachine bridges, Côte St. Paul bridge, Brewster's bridge, the Grand Trunk, Curran and Black's bridges. The last three are very heavy.

Use of the Electric Power—

In 1902 the Department of Railways and Canals decided to take advantage of the available water power on the Lachine Canal to generate electric current for the following purposes:—

- 1st. To light the canal, the locks and approaches of the bridges.
- 2nd. To electrically heat the power house and lock cabins.



Fig. 1.

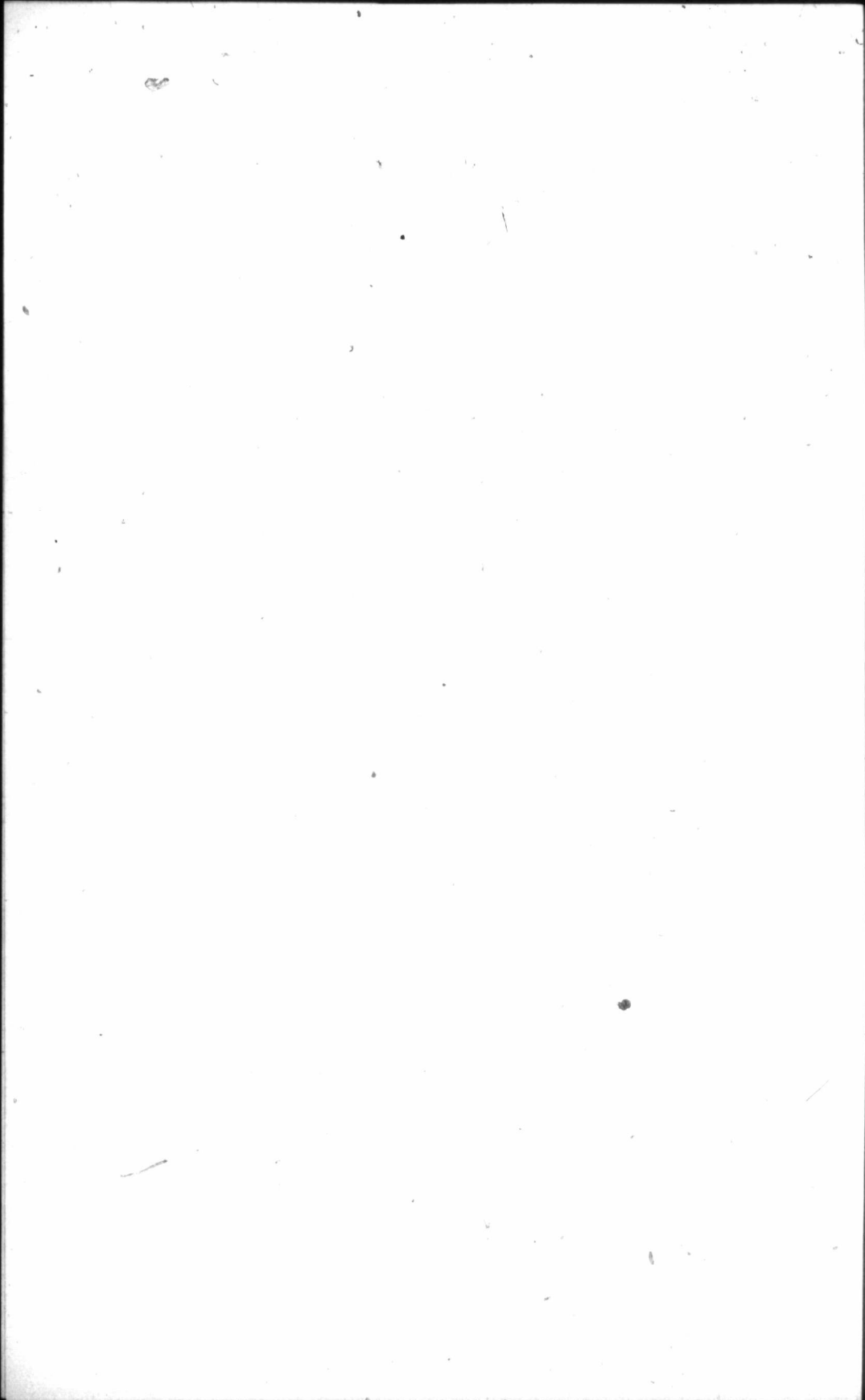

w
th
at
lig
hc
m
fr
at
Fo
op
de
fo
wi
mo
lar
ele
siz
100
Fo
Tw
He
to
no
At
a f

3rd. To open and close the lock gates, sluice valves and waste weirs.

4th. To operate the bridges spanning the canal.

To provide for these different services it was decided to provide the following equipment :—

For the lighting, 100 arc lamps, placed along the canal bank and at the locks, and approximately 100 16 c.p. incandescent lamps for lighting the power house and lock cabins.

For heating, six 6-kilowatts electric radiators, in the power house, besides a number of small heaters in the lock cabins

For the operation of the locks, twenty-four 5 H.P. Induction motors ; for the bridges, four 5 H.P. motors.

The maximum station load due to these different services is far from their aggregate sum, as the different services are not required at the same time, and as all the motors cannot operate together. For instance, it would rarely happen that all the lock gates would operate together, and further with the arrangement of machinery described below, only ~~two~~ of the motors, that is two motors out of the four, per lock, can be working at the same time.

The full capacity of the radiators would be required only in the winter months, at such time the canal is closed to navigation, the motors are not in operation and the lighting is limited to a dozen lamps which are required for the approaches to the bridges.

Proceeding from the assumption that all the purposes for which electric power is provided cannot take place at the same time, the size of the generator units was based on the following :—

100 Arc Lamps, four circuit of 25 lamps, 6.6 amps per circuit, at 2,400 volts.	63.5 K.V.A.
Four locks out of the six in operation together, that is 8 motors developing 4 H.P. each. Assuming the efficiency of motors, transformers and line at 70% and power factor 80%	42.5 K.V.A.
Two bridges out of the four in operation together, that is 2 motors developing 4 H.P. each, assuming same efficiency and power factor as above	10.5 K.V.A.
Heating of power house and lock cabins average	24 K.V.A.
A total of	140.5 K.V.A.

Two 75 K.V.A. generator units were considered amply sufficient to take care of this maximum load. During the day there would be no lighting, one generator could carry the power and heating load. At night the operation of both machines might be required but for a few hours, the night traffic being usually small.

Hydro-electric Plant—

The power house is located at Côte St. Paul, on the south side of the canal. The working head of water is about eight feet. The water is drawn from the canal through a wooden flume 15 feet by 11 feet, built in the Côte St. Paul overflow weir. Fig. 1 shows an exterior view of the power house, flume and overflow weir under construction. The power house is a fine building of pressed bricks, above a line of cut stone and concrete arches. Fig. 2 shows a back view of the power house, tail race and foundations.

Two 75 kilowatts, revolving field type A.C. 3-phase 2,400 volt, 60 cycle generators are belted to 7'-8" fly wheels. The latter are placed on two horizontal shafts geared to the vertical shafts of 125 H.P. turbines.

The two horizontal driving shafts are in line so that they can be connected by a quill, allowing either generator to be driven by either one of the turbines. Fig. 3 shows the arrangement of machinery on the generator floor.

One 7.5 kilowatt exciter is operated from a separate water wheel. It is of sufficient capacity to excite both generators when working under full load and 75% power factor. A spare exciter armature is kept in reserve.

Switchboard—

The Switchboard is of the ordinary panel board form, comprising two generator panels, one exciter panel and one feeder panel. This switchboard is placed on a gallery, eight feet above the generator floor.

The generator panels comprise the necessary indicating ammeters, voltmeters and wattmeters. Oil type switches are used. A power factor indicator and frequency meter are placed in the circuit of each generator.

The exciter panel has a D.C. voltmeter and two ammeters, one in the field of each generator, also carbon quick break knife switches for the generator fields.

The feeder panel has an ammeter and high tension oil switch in each circuit.

The lighting of the switchboards and power house is done from a small transformer in the generator circuits, but it can be thrown on the exciter circuit if required.

Arc Switchboard—

An arc switchboard is located to the left, on the second floor. Access to this board is obtained from the switchboard gallery. Four constant current transformers used for the arc lighting are placed still further to the left, inside a square brick tower, three-stories in

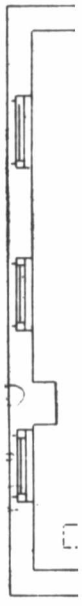

Fig. 2.

he
by
la

pl
fo

up
vo
th



Li

al
fo
fo
lan

height. The four arc light circuit, of 25 lamps each, are controlled by tubular plug switches which can be so connected that any arc lamp circuit can be connected to any one of the four transformers.

On the right of the main switchboard, on the second floor, is placed a board to control three 15 K.W. constant potential transformers for the electric radiators heating the building.

The cables from the switchboard are placed in conduits and run up against the walls of the brick tower to the top story, which is devoted to the lightning arresters and the distribution of the ends of the cables to the arms which support the transmission lines.

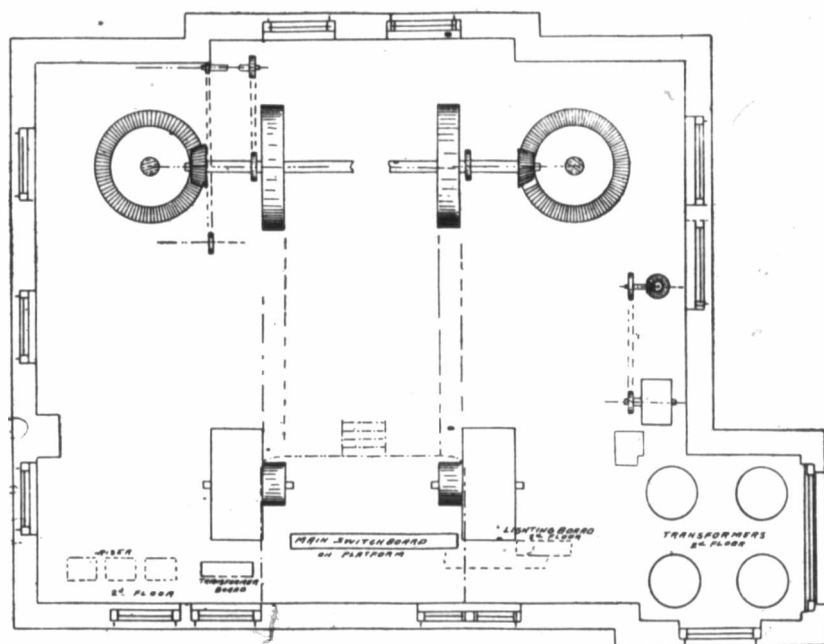

SKETCH SHOWING MACHINERY ON 1ST & 2ND FLOOR
GATE ST. PAUL POWER HOUSE

Fig. 3.

Lighting of Canal—

One hundred arc lamps, as stated previously, are distributed along the canal and at the locks for lighting. The lamps are spaced four hundred feet along the canal bank, that is a lamp on every fourth pole, these being one hundred feet apart. At bends, the lamps are spaced to give proper illumination. Eight lamps per lock

are used, giving decidedly brilliant illuminations, and secures as safe navigation at night as in the day time.

The series alternating current 6.6 ampere enclosed arc lamp is used, the regulating device being the floating coil automatic constant current transformer.

The lamps are hung twenty-two feet above the ground, from brackets. The lamps can be carboned from the ground, as a small hand reel attached to the pole eight feet from the ground allows the lamp to be brought down, through a flexible steel rope running through the tubular arc lamp bracket. This avoids spiking the poles which in lines running in open country is undesirable.

Pole Line Construction—

The pole line construction is substantial and somewhat artistic, the ornamental braces and brackets used giving it this appearance.

Cedar poles painted white are placed one hundred feet apart, and six feet from the water edge, to clear the space for the tow path. Two six pin arms are used throughout, and double arms are placed on all turns, these arms are bolted through the poles and at the ends.

On the side of the poles further away from the canal are carried the three phase 2,400 volt power circuit. One circuit runs west of the power house to Lachine locks, a distance of nearly six miles. It is made up of three No. 4 B. & S. medium drawn bare copper wire. The wires are placed in triangular form 18" from wire to wire. A circuit running east to St. Gabriel locks, a distance of two miles, is made up of three No. 6 B. & S. wire.

On the side of the poles nearest to the canal are placed the arc light circuits. Three of these, each of two No. 6 B. & S. bare copper wires, run west of the power house. Each circuit connecting twenty-five arc lamps in series. One arc light circuit runs east for the remaining twenty-five arc lamps.

The high potential lines for lighting and the 220 volt power circuits cross the canal at each lock in rubber insulated lead covered cables. These cables start from cable boxes placed on the poles, and run down the poles in iron conduit to manholes, and hence under the locks in pipe conduits. Fig. 5 shows construction of cable crossings.

The cables can be drawn in or out at any time without delay. Spare conduits and cables are in readiness to change over if any cable shows signs of break down. The cables boxes on the poles also contain lightning arresters.

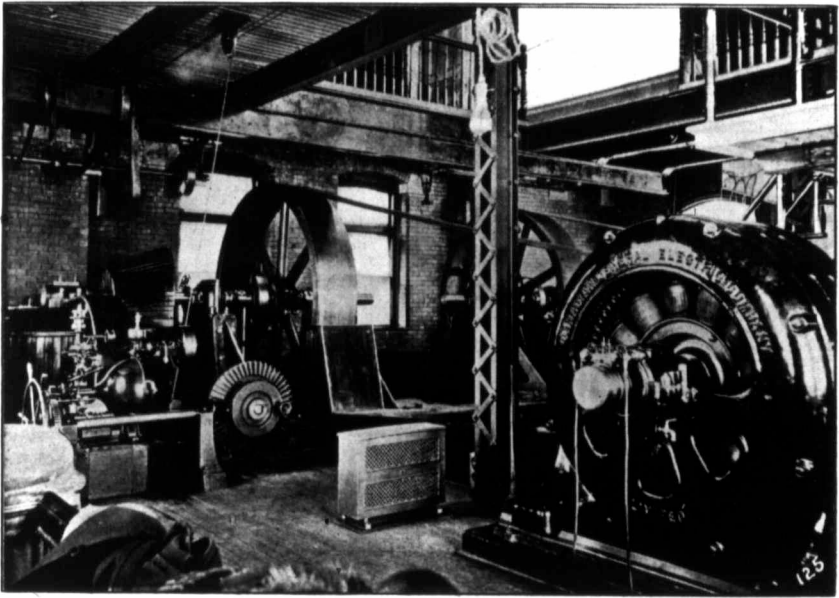
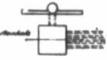

Fig. 4.

The interior of Power House.

Mat.



*Manholes & Conduit for Cable at Cote St Paul Locks
Lachine Canal*

Feb 17th, 1902.

Scale - 8 Feet = 1 Inch.

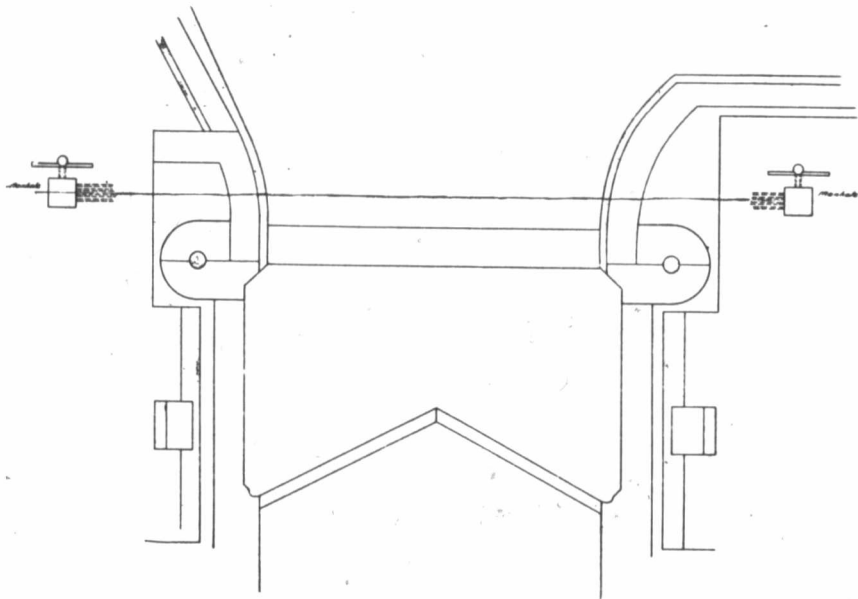
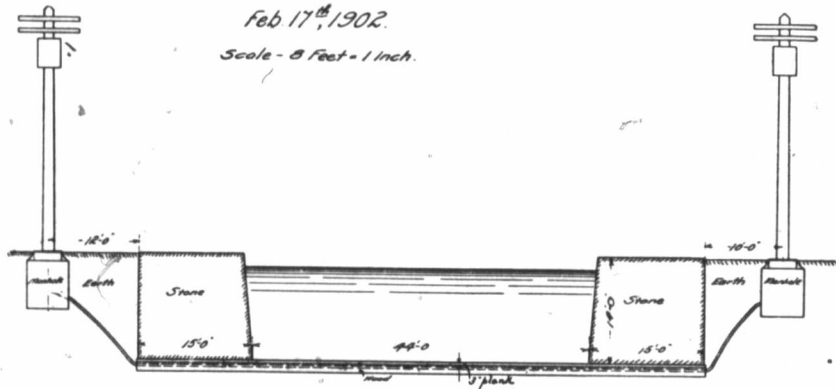

Fig. 5.

Electric Heating of Power House and Lock Cabins—

Six electric radiators each of six kilowatts capacity operating under 220 volts are placed in the power house. These radiators have been in operation during the past winter and have been found sufficient to keep the power house very comfortable even in the coldest nights that have been experienced. As the load in winter is very light, the 36 kilowatts required for heating necessitates the running of only one generator.

Three 15 kilowatts transformers, one on each leg of the three phase, 2,400 volt circuit, are placed in the power house, stepping down to 220 volts, for the radiators. A switchboard with high and low tension switches, is provided for this work.

Mechanism for Operating Lock Gates and Sluice Valves—

The old system of operating the lock gates and sluice valves by man power, does not require very long description. On the Lachine canal, four winches per lock are placed on the coping. By means of these winches, chains which open and close the gates are operated. This system is slow, over a minute and a half being required to open or close a gate; it is also expensive as it requires, to perform the work at that rate, at least two men per winch or four men per lock. The sluice valves for filling or emptying the locks are on the gates and are operated from the gate platform, through gearing, lifting vertical rods or stems attached to the valves.

Electric Power Driving—

In changing from the above method of operation to one employing electric power, the following conditions were to be fulfilled:—

1st. The coping on both sides of the gates, and the gate platform had, as far as possible, to be free of machinery.

2nd. One electric motor had to operate one gate, opening and closing, also raising and lowering the sluice valves on this gate.

3rd. A mechanism of such simplicity had to be employed, as would avoid skilled labor.

4th. Operating staff had to be reduced to one man per gate, that is two men per lock.

In order to meet these conditions, the method to be described was devised by Mr. Marceau, superintendent engineer; Mr. Parizeau of the engineer's staff; and the writer and adopted. It might be stated in passing that a number of other methods could have been used, to do the same work, which, however, would not, we think, meet the specified conditions in the same complete manner.

The whole of the driving machinery for operating one gate and its sluice valves, is placed on the gate, under the gate platform.

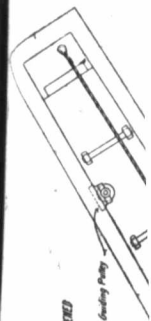

GATE ABOUT TO BE OPENED

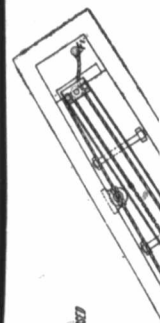

GATE ABOUT TO BE CLOSED

8

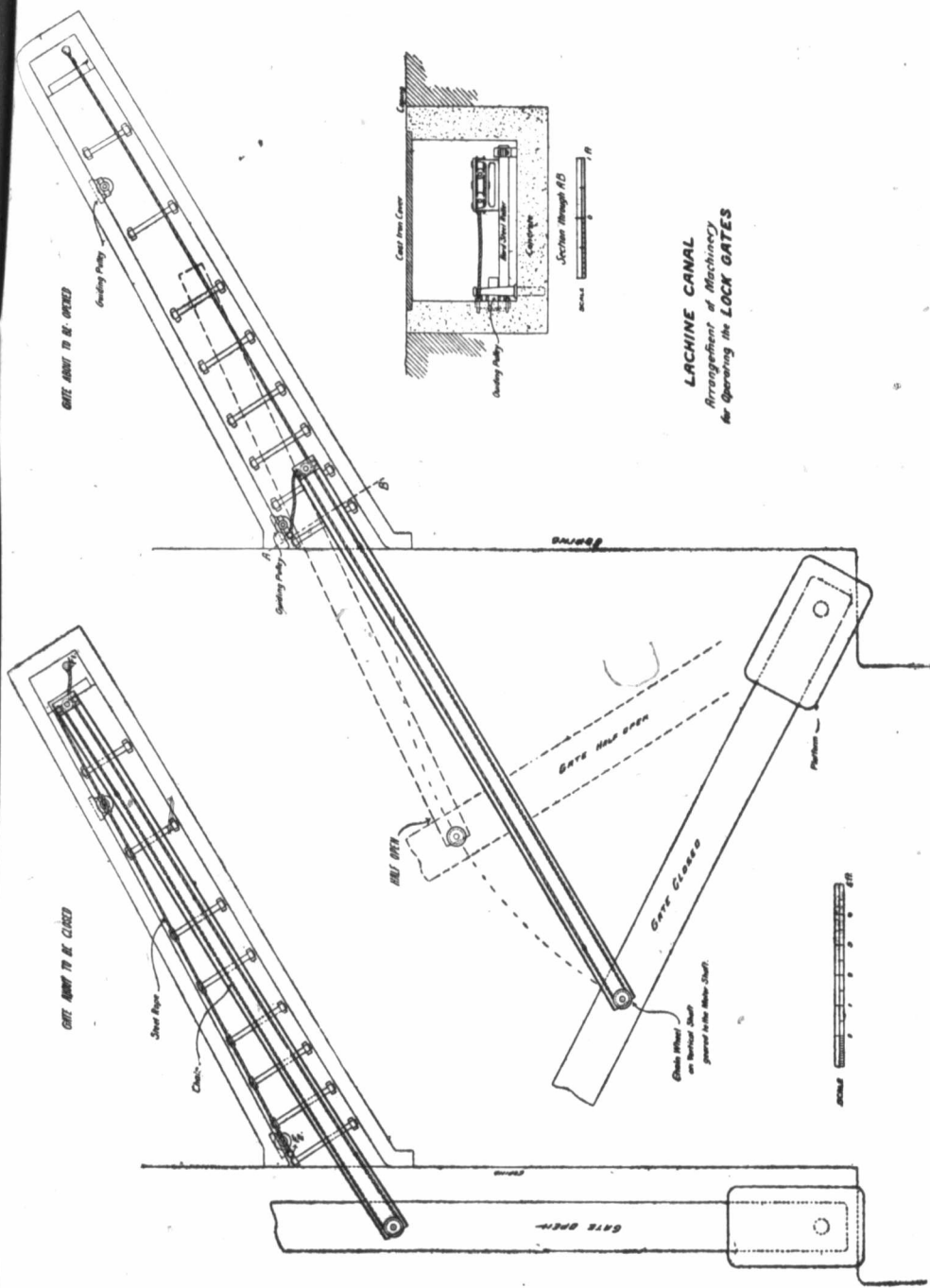

LACHINE CANAL
 Arrangement of Machinery
 for Operating the LOCK GATES

FIG. 6.

(Fig. 6.) The space there is rather limited, still it was found to be sufficient for the purpose. Power is supplied by a 5 H.P. three phase 220 volt induction motor running at 1,120 R.P.M. This motor is shown on the right hand of Fig. 6. This motor is geared to a horizontal shaft, running approximately two-thirds the way along the gate. The speed of this shaft is 300 R.P.M. A reversing switch and starter, controlling the motor, will be placed close to the handles of the clutches, which operate the machinery. Three worm gears A, B and C are placed on this shaft ; A and B to operate the two sluice valves, C to operate the lock gate.

Mechanism for Operating Sluice Valves—

Gears A and B are loose on the shaft, but can be thrown in gear through friction clutches, these gears engage brass horizontal worm wheels, which in turning, lift threaded stems or rods attached to the valves. The opening of the valves requires barely half a minute. A supplementary gearing enables the operator standing on the gate platform, to open or close the gate valves by hand if the electric power fails.

Tests made on an experimental outfit, last spring, to ascertain the power required to open and close the valves gave the following results :—

Motor running shafting only... 1,050 watts = 1.4 H.P.
 Opening sluices... 1,500 watts = 2.0 H.P.
 Time required to open valve = 30 seconds.

Mechanism for Operating the Lock Gates—

A steel worm gear C, running in oil is keyed to the horizontal driving shaft, and engages a horizontal brass worm wheel. This wheel rotates freely on a vertical shaft, which is the pivot for a U steel beam, resting on the gate on one side, and working in a cut provided in the coping at its outer end.

A friction clutch operated from the gate platform throws this wheel in gear with the vertical shaft, driving it at a speed of 15 R.P.M. A square brass casting, bored to fit this shaft and through which the latter passes, is placed in the web of the beam and holds it in place, allowing a certain amount of play whilst the gate is being moved. A chain wheel is keyed to the vertical shaft imparting motion to a chain and steel rope.

Drawing Fig. 7 shows three positions of beam with, 1st: gate open, 2nd : gate half opened ; 3rd : gate closed. The chain and rope after passing over the chain wheel run inside the web of the U beam, to guiding grooved rope wheels, placed at the outer end of the beam. The end of the rope is attached to two points in the cut made in the

copi
of t
bear
cret
wate
of th

Open

the
Who
amo
chin
chai
copi
The
thro
the

Clos

T
ed, t
now
com
the
out

In
closi
pull
very
abnc

T
in, li
tion

V
or cl
lowe
of ch

T
form
posit
toget
T
from

coping. One point F_1 is in line with the beam and at the inner end of the cut, the other point F_2 is near the edge of the coping. The beam is allowed to rest on hard steel rollers, placed on a bed of concrete slightly sloping towards the lock to carry away the surface water. An iron grating is fitted over this cut and allows inspection of the machinery at any time.

Opening the Lock Gate—

To open the lock gate, the motor is started under no load except the friction of the shaft, in the direction indicated for opening. When up to speed, the friction clutch is operated, allowing a certain amount of slipping at the start to avoid sudden strains on the machinery. The chain wheel running clockwise will pull, through the chain and rope, on the point F_1 , drawing in the beam towards the coping. The pivoting point P will describe the dotted circle shown. The outer end of the beam is guided by the rope in tension passing through the grooved pulleys until it reaches its position of rest at the end of its course. The gate is then open.

Closing the Lock Gate—

To close the gate, the direction of rotation of the motor is reversed, and thereby the rotation of the chain pulley, the rope tension is now on the point F_2 , the beam will swing slightly as the rope becomes taut, until the beams rest on the guiding pulley shown on the left in the inner portion of the cut. The beam will then move out with the gate until the latter is closed.

It must be observed that in both the opening of the gate and the closing of it, the maximum pull is required at the start, and that this pull is directly along the axis of the beam whilst opening, and at a very small angle to it, when closing, thus bending moments and abnormal frictional resistances are avoided.

The induction motor being up to speed when the clutch is thrown in, is able to develop its maximum torque. With the present reduction in gearing the pull on the chain is approximately 1,200 lbs.

With an average speed of chain of 28 feet a minute, the opening or closing of a gate will be done inside of a minute. Greater or lower speeds of operation can be obtained by a change of diameter of chain wheel.

Two operators will be required, standing respectively on the platforms of the gates. Through the friction clutches they will be in position to speed up or slow down, to allow the gates to come in well together.

Tests made with an experimental apparatus slightly different from the one described gave the following readings :—

Motor running shaft alone.. . . .	1,050 watts.. . . .	1.4 H.P.
Starting to open gate.. . . .	3,200 watts.. . . .	4.42 H.P.
Opening gate, 10 sec. from start.. . . .	2,500 watts.. . . .	3.3 H.P.
Closing gate at start, heavy wind blowing against gate.. . . .	4,200 watts.. . . .	5.6 H.P.

The induction motors are 220 volt three phase moters. To stop down the 2,400 volt of the transmission lines, three 5 K.W. transformers are placed on a pole at each lock. Lead covered cables run down the poles in iron pipes and then underground to the masonry walls of the locks to the gates at the pivoting point.

Only the lower voltage will be distributed about the locks.

4 H.P.
42 H.P.
3 H.P.
6 H.P.

To stop
V. trans-
bles run
masonry

11
12
13
14
15
16
17
18
19
20
21
22
23
24
25
26
27
28
29
30
31
32
33
34
35
36
37
38
39
40
41
42
43
44
45
46
47
48
49
50
51
52
53
54
55
56
57
58
59
60
61
62
63
64
65
66
67
68
69
70
71
72
73
74
75
76
77
78
79
80
81
82
83
84
85
86
87
88
89
90
91
92
93
94
95
96
97
98
99
100

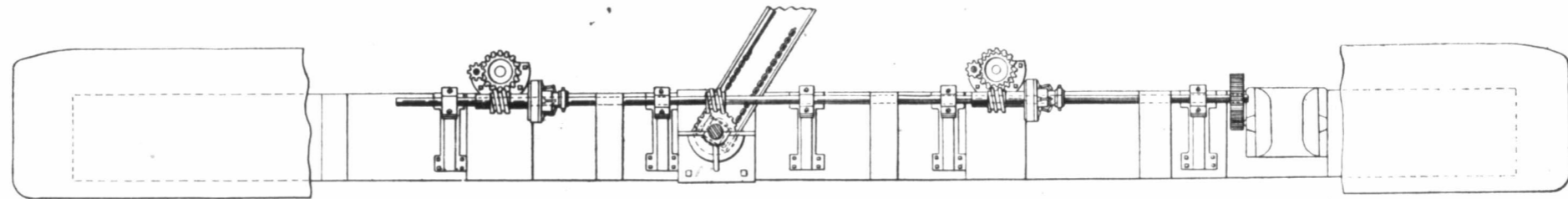

-PLAN-

LACHINE CANAL
ARRANGEMENT OF MACHINERY

FOR OPENING GATES IN SLUICE OF LOCKS

SCALE 1 INCH = 1 FOOT

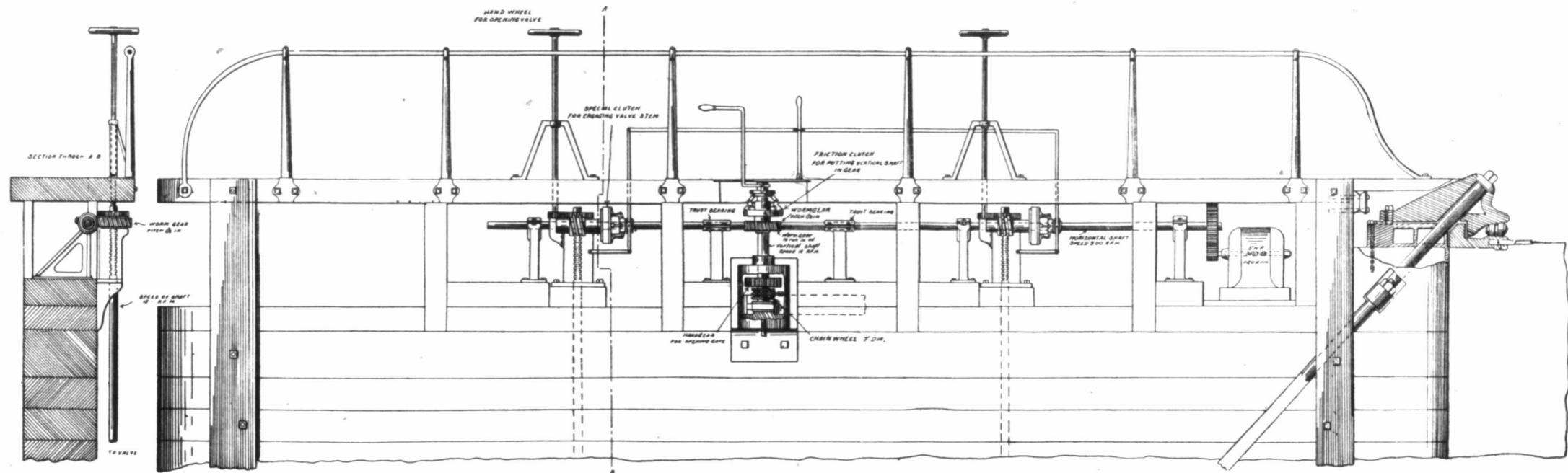
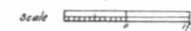

-ELEVATION-

Fig. 7.