

PUBLISHED EVERY WEEK. \$1.50 PER YEAR.

# THE FARMER'S ADVOCATE

AND HOME MAGAZINE

\*AGRICULTURE, STOCK, DAIRY, POULTRY, HORTICULTURE, VETERINARY, HOME CIRCLE.

ENTERED IN ACCORDANCE WITH THE COPYRIGHT ACT OF 1875.

Vol. XLIX.

LONDON, ONTARIO, APRIL 16, 1914.

No. 1125

## Prove the superior qualities of Purity Flour at our risk

Because we believe that PURITY is the best and most uniform flour milled—because we believe that PURITY goes farther than any other flour we say to every woman who reads this advertisement:

Go to your Grocer and buy a sack of PURITY FLOUR. Test it by actual baking and if it does not make better and more nutritious bread than any other flour you have ever used—if it does not make lighter, daintier cakes and pastry, then the Grocer will return your money.

That's the fairest way we know of doing business. Already tens of thousands of Canadian housewives have proven every claim we've made about PURITY FLOUR. Hosts of particular women declare that we are too modest in our claims—they say that PURITY is the one dependable flour. Test PURITY FLOUR for yourself. You get your money back if it does not give complete satisfaction.



# PURITY FLOUR

"MORE BREAD and BETTER BREAD" and BETTER PASTRY too.

603

Dairy and Cold Storage  
Commissioners Dec 31 14  
Dept of Agriculture

IL 9, 1914

”

m the

e made

eapest

QUAL-

RVICE,

CE is

mes the

ry fence-

osts no

han the

s. And

ECT to

akers—

mediately

a near-

house—

on 20

ands or

st, Sim-

Order

ce

ize and

u want

st here-

he num-

u want

with

order, ex-

ank draft

l check

PAGE

and your

dealer.

1c. per

ng your

QUALITY

emarkable

orders will

. Earliest

kest ship-

ved NOW

be worth

a month)

n plowing

t be done.

0.,

JOHN

Dock St.

mes St. E.



# Just Like New

A NEW wagon without a coat of paint would look no better than the old wagon you have right in your barn—it's the bright, fresh, shiny paint on the new wagon that makes it appear so attractive.

## Martin-Senour Wagon and Implement Paint

will make your old wagon "Spic and Span", and give the appearance of a new wagon, at small cost. This Paint is equally good for the Plow, the Reaper, the Binder, and all other Farm Implements that should be kept paint protected.

For every kind of painting you want to do around the farm, house, or barn, there is the right grade and shade in Martin-Senour Paints and Varnishes—just the right Finish for every purpose.

Let us tell you how to make things "Spic and Span"—write for "Farmer's Color Set" showing the various Paints and Finishes for farm service—free for the asking.



**The Martin-Senour Co.**  
Limited  
MONTREAL.

# THE AYLMEY BRONZE SPRAYER



No. 2.—Outfit A

Won highest award at St. Petersburg, Russia, over all Canadian, French and German Pumps. Also secured first place at Manchester (England), Toronto, Ottawa and Halifax.

### SPRAYER NO. 2.—OUTFIT D

Being Outfit A, ten feet of hose, with couplings attached, two Bordeaux nozzles, one brass stopcock, one Y, one long iron extension rod, without barrel. Price.....\$15.25  
Extra hose, per foot......12

For lined bamboo extension rod, in place of iron extension rod:  
Add.....\$1.50  
With barrel..... 3.00

### SPRAYER NO. 3.—OUTFIT E

Being Outfit A, two lines of hose, ten feet each, with couplings attached, four Bordeaux nozzles, two brass Y's, two brass stopcocks, and two eight-foot iron extension rods, without barrel.  
Price.....\$22.50  
With lined bamboo extension rods in place of eight-foot iron extension rods.....\$25.50  
With barrel..... 3.00

Our Catalogue gives full information as to sizes, capacity, equipment, etc. Write us for one. If your dealer can't supply you, your mail orders will receive our prompt attention.

**The Aylmer Pump & Scale Company, Limited**  
AYLMER, ONTARIO

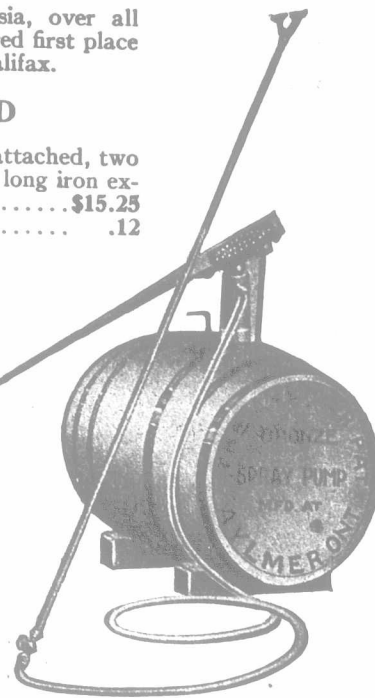

Sprayer No. 2—Outfit D

## Johnny-on-the-Spot

"Johnny-on-the-Spot" on skids or on truck, will take care of all your chores—pumping, separating cream, pulping, churning, washing, etc.

Stop wasting your time and energy in useless drudgery. Let "Johnny-on-the-Spot" do it—one of the famous Gilson "Goes Like Sixty" Line—a high quality engine at a low price. WRITE FOR CATALOGUE AND FULL PARTICULARS. ALL SIZES.

**Gilson Manufacturing Co.**  
Limited  
2409 York St., Guelph, Ontario



## Free Land for the Settler in New Ontario

Millions of acres of virgin soil, obtainable free and at a nominal cost, are calling for cultivation. Thousands of farmers have responded to the call of this fertile country, and are being made comfortable and rich Here, right at the door of Old Ontario, a home awaits you.

For full information as to terms, regulations and settlers' rates, write to

**H. A. MACDONELL**  
Director of Colonization  
Parliament Bldg., TORONTO

**HON. JAS. S. DUFF**  
Minister of Agriculture  
Parliament Bldg., TORONTO

## GOOD JOBS

YOU can become a competent chauffeur in a very short time by taking our thorough and complete Auto Course. Our instructors are specialists in their line and our equipment is most complete. Illustrated booklets will be sent free on request.

**Y.M.C.A. AUTO SCHOOL**  
281 Broadview Ave.  
Toronto, Ont.



## HAWK BICYCLES

An up-to-date High Grade Bicycle, fitted with Roller Chain, New Departure Coaster Brake and Hubs, Enamelled Wood Rims, Detachable Tyres, high grade equipment, including Mudguards, Pump and Tools, \$22.50

Send FREE 1914 Catalogue, 90 pages of Bicycles, Sundries and Repair Material. You can buy your supplies from us at Wholesale Prices.

**T. W. BOYD & SON,**  
27 Notre Dame St. West, Montreal.



**LONDON CONCRETE MACHINERY CO.**  
Dept. B, London, Ontario

## Corn That Will Grow

Canadian-grown seed corn. Your money back if not satisfied.

**J. O. DUKE, RUTHVEN, ONT.**

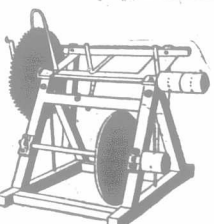

## Wood Saws

All kinds. Also pumps, grinders, etc. Write for Bulletin AC-1 and special prices.

**GILSON MFG. CO.**  
2409 York St.  
Guelph, Ont., Can.

# A Good-Crop Necessity—

## Champion Spring-Tooth Cultivator

Cultivate your soil frequently and regularly. The increase in quantity and quality of yield makes it well worth while. More than pays the cost.

When you cultivate with this CHAMPION Spring-Tooth Cultivator, you not only rid your soil of all weeds and trash, but you also leave it in proper shape to store up soil-moisture for the growing crop.

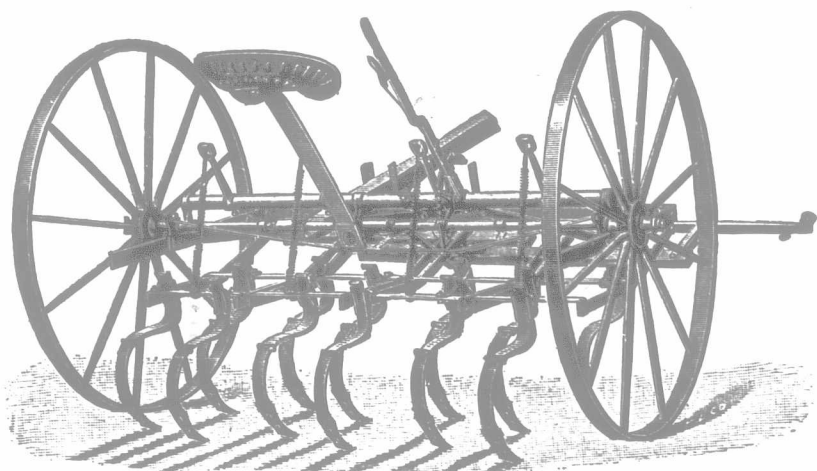

“CHAMPION” Superiority Shown at Every Point

You have only to examine the CHAMPION'S design and construction to realize that here is a Cultivator that **must** do good work. Its frame is of heavy steel—securely reinforced. Tooth-section cross-bars are RIVETTED, instead of bolted. They will never come apart.

Either 2" or 7" points may be used on the teeth. The 2" are reversible—good for double-wear. Tooth-sections are independent of each other, with a separate pressure spring to each section. One lever controls all the sections—enabling the teeth to thoroughly cultivate the most uneven soil.

### OUR COMPLETE CATALOG

Illustrates and fully describes the "Champion" in 10-12-13-16 tooth sizes—with or without grain and grass-seed boxes. See our agent or write for a copy to our nearest branch.

## The Frost & Wood Co., Limited

Smith's Falls, Montreal, St. John

SOLD IN WESTERN ONTARIO AND WESTERN CANADA BY

## Cockshutt Plow Co., Limited

Brantford, Ontario

### Make Your Own Tile

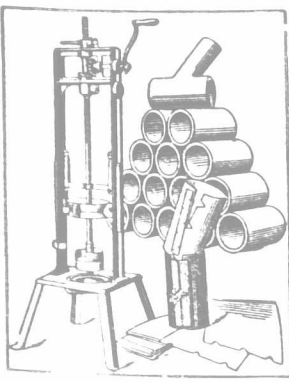

Cost  
**\$4.00 to \$6.00**  
per  
**1,000**  
Hand  
or  
Power

Send for  
Catalogue

Farmers' Cement Tile Machine Co.  
Walkerville, Ontario



### YOU NEED A FEED COOKER!

Strong, galvanized steel tank, sits right over fire. Cooks quickly. Easy on fuel. Three sizes. Write for catalog.  
The Steel Trough and Machine Co., Ltd.  
Wood, Ont.

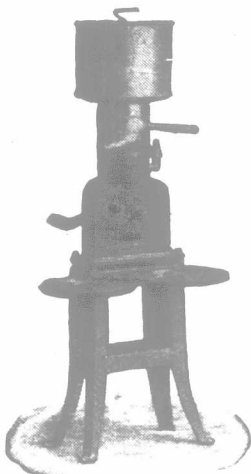

## \$15 and Upwards

Whether you have but one cow, or if you have fifty cows, we have a high-grade Cream Separator, suitable for your requirements, at a price you can afford to pay.

We send you a machine, on FREE TRIAL, any where in Ontario or Eastern Canada, and prepay the freight. Thoroughly guaranteed. LOW PRICES. EASY PAYMENTS. You take no risk whatever, for you settle for it only if satisfied.

Send for Circular "A" to-day, giving particulars of our Free Trial Offer, prices, etc. Agents wanted.

NATIONAL MACHINE CO., Brighton, Ont  
DOMO SEPARATOR, St. Hyacinthe, Que



**Pull out The stumps** With The Hercules  
All Steel, Triple Power Stump Puller  
Biggest stump pulled in five minutes or less. Clears an acre of land a day. Makes your stump land money land. 30 days' free trial—3 year guarantee. Get our new book and special low price offer now.  
Hercules Mfg. Co., 1936 22nd St., Centerville, Ia.

When writing advertisers please mention this paper

### A FARMER'S GARDEN

Helps his wife to plan her table in busy times. Saves work and worry, saves buying so much meat, gives better satisfaction to the help. A good garden will be almost impossible in your busy life without proper tools. They cost little and save much hard work.

### IRON AGE WHEEL HOES AND DRILLS

will sow, cultivate, ridge, furrow, etc., better than you can with old-fashioned tools and ten times quicker. A woman, boy or girl can do it. Can plant closer and work these hand tools while the horses rest. 38 combinations from which to choose at \$2.50 to \$12. One combined tool will do all of the work.

No. 6 Drill and Wheel Hoe



Ask your dealer to show them and write us for booklet, "Gardening With Modern Tools" and "Iron Age Farm and Garden News" both free.  
The Eastman-Wilkinson Co., Limited  
41, Symington Av., Toronto, Ont.

### Buchanan's

### Self-Compressing Long Sling



—the result of 33 years experience in making Pitching Machines. Consists of three slings and sectional pulley for drawing ends together. Easy to operate, quick to work, and exceptionally strong. We make all kinds of Pitching Machines—Swivel Carriers and Tracks, Slings, Harpoon Forks, etc. Write for catalogue.  
M. T. BUCHANAN & CO., INGLEWOOD, ONT. 2

We also manufacture Steel Cow Stalls and Positive Lock Cow Stanchions.

### No Lopsided Stones

Every CLEVELAND GRINDSTONE is absolutely even in hardness all through, and sharpens knives, axes, hoes and cutter-bar blades exactly right. Made of the only genuine Berea stone, finest in the world. Guaranteed to do satisfactory grinding, or your money back. We are the biggest grindstone makers in America. We have experts of 50 years' experience who select stones with the right grit for farm use. Let them select for you.

### CLEVELAND Grindstones

Look at the fine stone shown below! It's the CLEVELAND "EMPIRE," a sturdy grinder to run by hand or gas engine. Ball-bearing pulley. Strong frame and trough of cast iron that won't rust out. Genuine Berea stone, mounted on steel shaft, complete with 4-inch pulley. Will last a lifetime. Write for our great book, "The Grit that Grinds," and we'll give you the name of our nearest-by dealer. It will save you money. Write to  
THE CLEVELAND STONE CO.  
1127 LEAVER-NEWS BLDG., CLEVELAND, OHIO

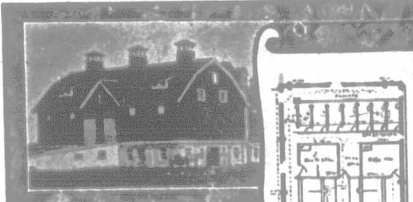

### FREE BARN PLAN SERVICE

you will save costly mistakes in building your barn, and have a much more economical layout than otherwise possible, if you will let Beatty Bros. make careful barn-plans for you. Tell us when you will build, size of barn, and number of your stock.

### Free to Any Man Who is Building or Remodelling His Barn

Our aim is to encourage the building of modern economical barns—we make no charge for our service. Valuable book "How to Build a Dairy Barn," also free. Write to-day or send coupon to:

BEATTY BROS., LIMITED,  
1311 Hill Street,  
FERGUS, ONTARIO

FREE BARN-PLAN COUPON  
All men who are planning to build or remodel a barn will receive a copy of the valuable book "How to Build a Dairy Barn" if they fill out and mail this coupon to Beatty Bros. Limited, 1311 Hill Street, Fergus, Ont. I expect to build or remodel my barn in \_\_\_\_\_ 1914, about \_\_\_\_\_  
Name \_\_\_\_\_ P.O. \_\_\_\_\_ Prov. \_\_\_\_\_

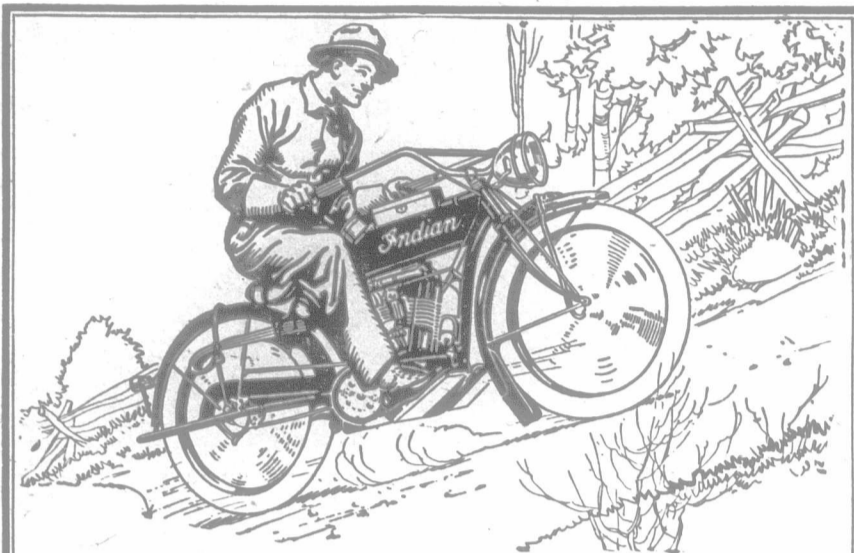

**All Roads are Level Roads  
to the  
Indian Motorcycle**

"Rushing" a hill is an unknown experience to the Indian rider. "A twist of the wrist" silently gives the command to the motor for more power. And the power is there. It responds instantly. The rider feels that peculiar "bite"—a thrilling, assuring sensation of the answering motor!—and then the speed deftly picks up—picks up—picks up—without a moment's hesitation. The steepest grade offers no trouble to the Indian-mounted man.

Rough roads, too, mean nothing to the Indian tourist. With his machine fitted with footboards and that incomparable, inimitable comfort feature, the Cradle Spring Frame, shocks and jars are dispelled. Indian riding is smooth riding, whatever the condition of the highway.

*With stupendous power—with perfected comfort devices—all roads are level roads to the Indian*

Write for the 1914 Illustrated Catalog

**HENDEE MANUFACTURING CO., 10 Mercer St., Toronto**

Main Office and Factory, Springfield, Mass., U. S. A.

(Largest Motorcycle Manufacturers in the World)

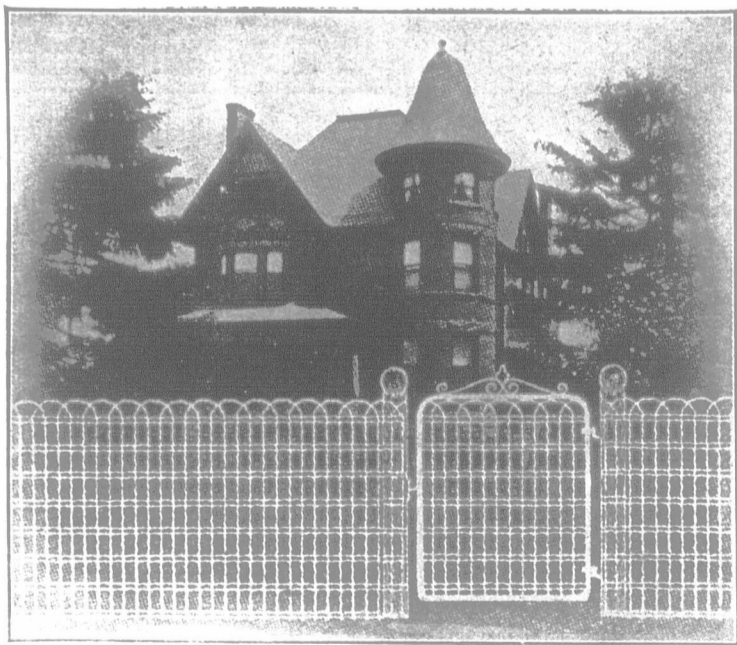

**"The Home"**

"As pretty as a picture." That's what one said of a home enclosed with "IDEAL" LAWN FENCE

And with good cause. Every garden surrounding a magnificent house was a beautiful garden. It was a garden that was a pleasure to the eye, a garden that was bathed by the glorious sunlight. "IDEAL" LAWN FENCE is a garden that has no shadow, which gives the flowers along the border the best possible chance of the sun.

With its light lawn surrounding "The Home" "IDEAL" LAWN FENCE AND GATES, not only add to the appearance of "The Home" and the value of the property, but they make "The Home" more attractive to the eye. "IDEAL" is not expensive, and can be erected by anyone. It is a fence that is both stronger and better than other fences. Write for all the facts to the McGREGOR BANWELL FENCE CO., LTD. and other "IDEAL" LAWN FENCE AND GATES.

**THE McGREGOR BANWELL FENCE CO., LTD.**  
WATERVILLE, ONTARIO



**For every kind  
of Canadian game**

There's a Dominion Shot Shell or Cartridge suited for hunting all kinds of Canadian game. Careful selection of materials, accurate loading, rigid inspection and thorough testing, are reasons why the best shooting results are obtained from the use of Dominion Ammunition. Make sure that your next hunting trip is successful. See that your dealer supplies you with Dominion Ammunition.

**The Dominion Cartridge Co., Limited**  
817 Transportation Building, Montreal

Send 10 cents (stamps or coin) for 16 beautiful colored pictures of Canadian game.

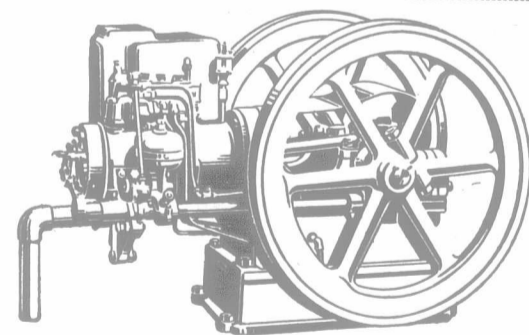

**Power Out of Cheap Oil**

By means of the Secor-Higgins Oil-Fuel System, the system that has made the Rumely Oil Pull Tractor so successful, the

**Falk Kerosene Engine**

burns cheap kerosene and distillate, and furnishes convenient, reliable power for every farm purpose.

The Falk is easy to start in any weather—once started it requires but little attention. It runs evenly on a big load or a small one and will save money on either.

In sizes from 3 to 20 horsepower, mounted on skids, trucks or stationary bases.

A smooth running all-round power-plant for threshing, husking—shredding, baling, silage cutting, spraying and sawing.

Rumely service is back of every Rumely machine—49 branches and 11,000 dealers—supplies and repair parts on short notice. Ask for Falk catalog No. 118.

- RUMELY LINES**
- Kerosene Tractors
  - Gasoline Tractors
  - Engine Plows
  - Threshing Machines
  - Corn Machines
  - Baling Presses
  - Cream Separators
  - Feed Mills
  - Stationary Engines
  - Road Machines
  - Grain Elevators
  - Steam Engines

**RUMELY PRODUCTS COMPANY**

(Incorporated)  
Toronto Power-Farming Machinery Ontario

# JOHN DEERE FARM IMPLEMENTS

John Deere reputation has been built up through the policy of putting high-class material, honest workmanship and improved design into John Deere Implements. The idea of making out of every purchaser a satisfied customer has paid. John Deere Implements have a reputation all over the world for honest value and high-grade service. When you buy a John Deere Implement you may be assured you are getting that which you want above everything else—SATISFACTION.

## CUT YOUR HAY CLEAN WITH A DRAIN VERTICAL LIFT MOWER

MADE IN 4½, 5 AND 6 FOOT CUT

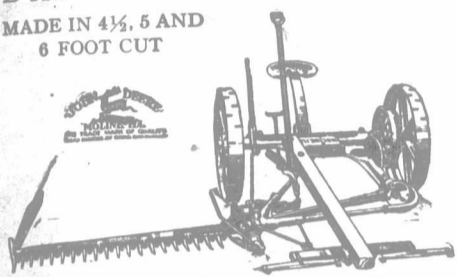

### IT CUTS THE HAY

Has the power to do high-grade work—and does it. Practically every bit of horse-power is transmitted from ground wheels to knife without waste from friction.

Keen cutting obtained by the use of compensating gears, which are arranged in pairs, each pair keeping the other in mesh so that no power is lost in transmission.

### A BOY CAN OPERATE IT

The vertical lift enables the machine to be operated easily. Steel lever with spade-handle grip conveniently located.

Large lifting spring with coils of liberal size, combining strength and flexibility. Convenient foot lever gives best service with least difficulty.

### LIGHT DRAFT

Has adjustable hitch—power of team is applied to the drag bar by draft links.

Almost entire weight of cutter bar supported by main axle by means of a large spring, eliminating ground friction.

### GREAT DURABILITY

One-piece frame—solid iron. Hard-pressed bearings. Especially shaped and tempered knife sections. Long pitman shaft does away with vibration.

### THE SPEIGHT WAGON

Careful attention is given to the construction of the Speight Wagon. Only well seasoned, carefully selected materials are used.

Hubs are barrel-shaped—that is, instead of being trimmed down as on other wagons, they are of large diameter. This eliminates pores for moisture to work in and rot the hub. Hubs are well ironed and boxed in accurately set. Wide spokes add to the strength of the wheels and give a greater bearing. This prevents spokes from sinking into the felloes.

Barrel-shaped hub permits using larger boxing, which increases the diameter of the bearing surface. This makes the wagon pull with minimum draft.

Deep oak rims, slightly oval, keep wheels from loading up when used on muddy roads.

### CLIPPED GEARS AND DUST-PROOF SKEINS

The Speight front gear is equipped with angle steel hounds. Well re-inforced rear axle and bolster are held together with clips. No bolt holes to weaken the axle or bolster. Sand and dust-proof skeins keep dirt out of the bearings and reduce draft and wear.

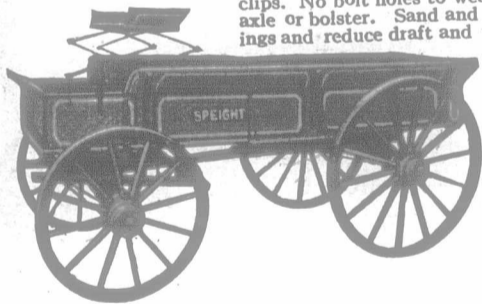

## JOHN DEERE No. 999 CORN PLANTER

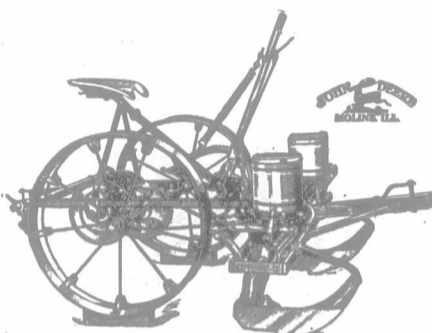

Good seed is not the only requisite of a good stand. Accuracy in your corn planter is also necessary. The more accurate your corn planter, the larger will be the yield at harvest. A planter that is not accurate is not a good planter—you can't afford to use it. In getting a corn planter insist on accuracy.

### SOMETHING ABOUT THE ACCURACY OF THE JOHN DEERE No. 999 CORN PLANTER

The "oblique-selection" drop used on the No. 999 Planter is accurate because the seed plate has a sloping wall which terminates in the cells.

The seeds lie in the bottom of the hopper in exactly the right position to enter rapidly and fill the cells.

Corn does not bridge. Cells are so shaped that seeds are easily carried along to the cut-off.

### THE REAL VARIABLE DROP PLANTER

You can plant two, three, four, five or six kernels per hill as desired, by shifting foot lever. Drilling distances are easily varied as well.

A JOHN DEERE No. 999 CORN PLANTER WILL HELP YOU RAISE A BIGGER CROP

the machine or correct in its use. Does rapid work.

Disc covers are large and can be adjusted to any desired width or angle so as to cover the seed shallow or throw up a high ridge. These covers work well on uneven land and dead furrows, up or down hill. Feed is simple and easily adjusted to insure steady flow of seed from hopper to magazine. Both feed and coverer tension regulate from the seat. No removal of bolts—simply turn a thumb screw. Fertilizer attachment can be furnished. Deposits the fertilizer where it will do the most good and will not injure the seed.

### THE ASPINWALL No. 3 DOES RAPID WORK AND DOES IT WELL.

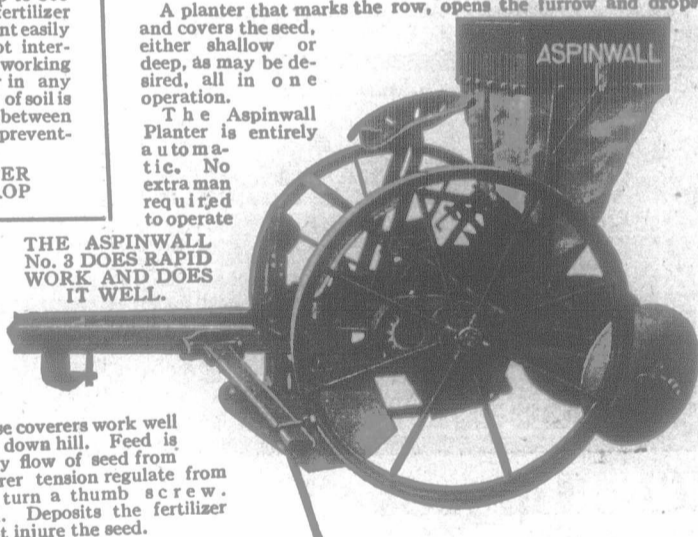

## R&V "TRIUMPH" GASOLENE ENGINE

MADE IN 1, 2, 4, 6, 8, 10 AND 12 HORSE POWER

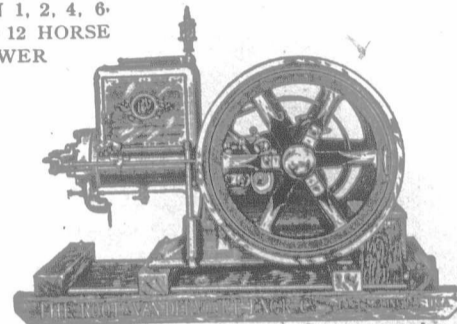

The R&V Gasolene Engine is absolutely safe to operate in or around the house or barn. It gives the most service with the least attention.

### THE EXTRA RING

There is an extra ring on the R&V "Triumph," which prevents scoring and ruining of cylinder. You will not find this feature on cheap engines.

Neat, compact, smooth running, easy to start and safe are some of the characteristics of this engine that make it pleasure to own.

The engine that lasts the longest, uses the least fuel, always develops rated horse-power and runs smoothly with least trouble, is the cheapest in the long run. The "Triumph" is just such an engine.

### OTHER R & V "TRIUMPH" HIGH-GRADE FEATURES

Cylinder detachable, making it easy and cheap to replace if ever necessary.

Die-cast babbit bearings with brass liners for taking up wear. Improved double fly-ball governor, which permits close speed regulation. Speed can be varied 30 per cent without stopping engine.

Hopper cooled. Does not require tank, pipe or fittings used on engines with other style of cooling system.

Write us for free attractive booklet—"Letting Gasolene Do It"—which shows how a Gasolene engine saves you money.

### ASPINWALL No. 3 POTATO PLANTER

A planter that marks the row, opens the furrow and drops and covers the seed, either shallow or deep, as may be desired, all in one operation.

The Aspinwall Planter is entirely automatic. No extra man required to operate.

YOUR JOHN DEERE DEALER WILL BE PLEASED TO SHOW YOU THESE IMPLEMENTS.

John Deere Plow Co., of Welland, Limited  
77-79 JARVIS STREET - - - TORONTO, ONTARIO

WE'LL BE PLEASED TO SEND YOU ANY INFORMATION ABOUT THESE MACHINES IF YOU WILL WRITE US.

## MAKE MONEY SAWING LUMBER

There's thousands of feet of high priced lumber over there in the wood-lot, waiting for you to get an "American" Portable Saw Mill, belt it up to your farm engine, and get busy in a profitable lumbering business.

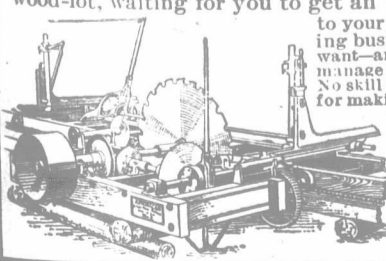

There's an "American" of just the size you want—and it's so simple, durable and easy running that you can manage it yourself, turning out the best lumber at the least cost. No skill or experience is needed. We give you full instructions for making lumber which you can use yourself or sell in the local market. If you have no timber, there's lots around you. Lumber is high and going higher. Begin now to get money when saved into lumber. Begin now to harvest your wood lot. Write for our Farm Catalog and Booklet No. 32 on farm lumbering.

AMERICAN SAW MILL MACHINERY CO.  
113 Hope Street, Hackensack, N. J.  
1387 Terminal Building, New York  
Chicago Savannah New Orleans Seattle

## 100 Standard Walking Plows

Suitable for all soils in Eastern Canada and British Columbia. No. 23, No. 30, No. 21, No. 8, No. 7, No. 5, No. 4, No. 2. The famous "Kees Centre" line to be sold at factory price.



\$10 each

Send immediately if you are to be a lucky one. Your money back if not entirely satisfactory. State kind of soil your farm is, so that we may fill the order to suit the land.

Wheels extra, 75c. each. Skimmers extra, 75c. each.  
Erie Iron Works, Limited, St. Thomas, Ont.

## Canadian National Horse Show

Toronto Armouries  
APRIL 28th to MAY 2nd, 1914  
Prize List now ready. Entries close April 18. Address:  
ALEXANDER MILN, 701 Traders Bank Building, TORONTO, ONT.  
REDUCED RAILWAY RATES



## Excelsior Life Insurance Company

ASSETS \$ 3,500,000.00  
INSURANCE IN FORCE \$19,500,000.00  
To liquidate that mortgage—to provide for old age—apply to-day for an Endowment Policy.  
EXCELSIOR CONTRACTS ARE UP-TO-DATE. DESIRABLE VACANCIES FOR AGENTS.

Head Office: TORONTO

## International Harvester Manure Spreaders

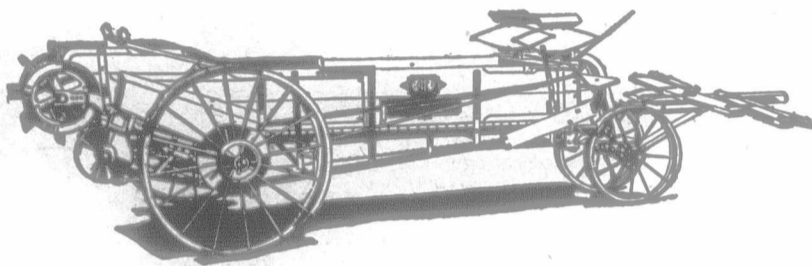

### THE I H C LINE GRAIN AND HAY MACHINES

Binders, Reapers  
Mowers, Stackers  
Bales, Stackers  
Hay Loaders  
Hay Presses

### CORN MACHINES

Planters, Pickers  
Binders, Cultivators  
Earlage Cutters  
Shellers, Shredders

### TILLAGE

Combination,  
Fog and Spring-Tooth,  
and Disk Harrows  
Cultivators

### GENERAL LINE

Oil and Gas Engines  
Oil Tractors  
Manure Spreaders  
Cream Separators  
Farm Wagons  
Motor Trucks  
Thrashers  
Grain Drills  
Feed Grinders  
Knife Grinders  
Binder Twines

**I**NTERNATIONAL Harvester manure spreaders have a score of good features in their construction. Each one is the result of careful field experiment.

An I H C spreader is low enough for easy loading, yet it has plenty of clearance underneath. The rear axle is well under the load, rear wheels have wide rims and Z-shaped lugs, insuring good traction under all conditions. Frame, wheels, and all driving parts are of steel. Apron tension is adjusted by a simple device. Winding of the beater is prevented by large diameter, and beater teeth are strong, square and chisel-pointed.

International manure spreaders are built in several styles and sizes, low or high, endless or return apron, for small farms or large. Examination will show sturdiness of construction in every detail. Repairs, if ever needed, may always be had of the local dealer.

Examine International spreaders at the dealer's. We will tell you who sells them, and we will send you interesting catalogues.



**International Harvester Company of Canada, Ltd**

At Hamilton, Ont.; London, Ont.; Montreal, P. Q.; Ottawa, Ont.;  
St. John, N. B.; Quebec, P. Q.

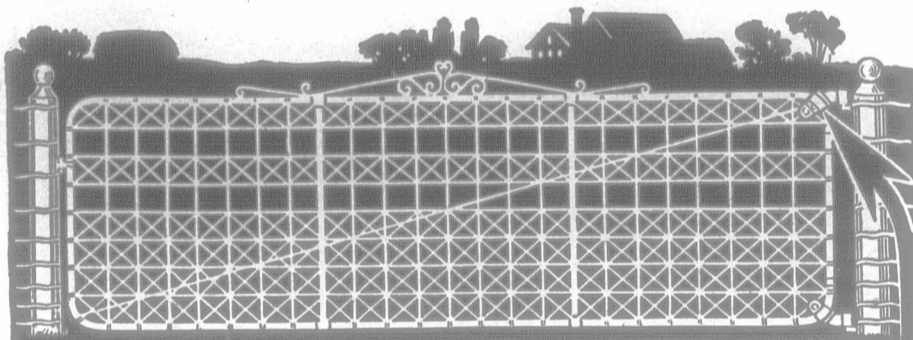

## The Improved "Ideal" Farm and Stock Gates

Possess Features That No Other Gates Have

Should the BRACE WIRE in an ordinary gate become slackened or broken, you know from experience that it cannot be tightened or replaced so as to make the gate as serviceable as when you bought it.

### OUR PATENT HINGE-CLIP

with attached BRACE TIGHTENER overcomes this disadvantage. In "IDEAL" GATES the brace wire can be adjusted or replaced in less than two minutes with an ordinary wrench and then you practically have a new gate. Our new Hinge Clip also carries the weight of the gate direct from the top hinge bolt, thus relieving the frame from any unnecessary strain.

### OUR PATENT LATCH

is supplied with all "IDEAL" GATES. It is positive and can be opened either way. Raise the thumb latch and push the gate open; when through, swing it shut—it always locks.

These new features are all covered by patents and "IDEAL" GATES are the only gates sold in Canada with these improvements, which makes the gate more serviceable and add many years to its life. A postal card will bring you our catalogue (21) which describes in detail the many advantages of "IDEAL" GATES.

**The McGregor Banwell Fence Company, Limited.**

Walkerville - Ontario

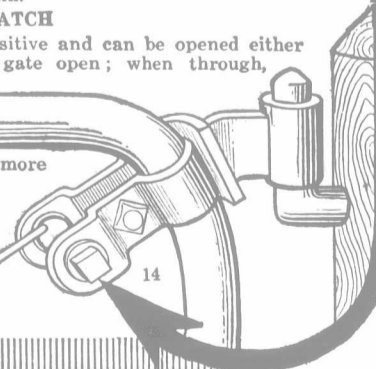

## JAMES HUTTON & Co., Manufacturer's Agents

706 Shaughnessy Building, McGill Street, - MONTREAL

Representing—

JOSEPH RODGERS & SONS, LTD., Sheffield, Cutlers to His Majesty.  
STEEL, PEECH & TOZER, Ltd., Sheffield, Steel Axles, Tyres, Spring Steel, etc., etc.  
THOS. GOLDSWORTHY & SONS, Manchester, Emery, Emery Cloth, etc.  
BERROUGHS & WATTS, LTD., London, Billiard Tables, etc.  
HOBBS JENKINS & CO., Birmingham, Fusees and Fog Signals.

## Puts the Seed Right at the Bottom of the Furrow!

In the 'LEADER' Disc Drill, the shields go well down to the bottom of the disc and deposit the seed right down in the furrow instead of simply dropping it anywhere be-

hind the disc. There are many other points of excellence in the construction of the

## "Leader" Disc Drill

Disc castings of grey iron have to be made too heavy for the strength desired. Using malleable castings we get greater strength and durability without excessive weight. Discs run on chilled bearings, lubricated from dust-proof hard oil compression cups. Booklet free.

Sold by all John Deere Plow Co. Dealers.

**The Peter Hamilton Company, Limited**  
PETERBOROUGH  
ONTARIO

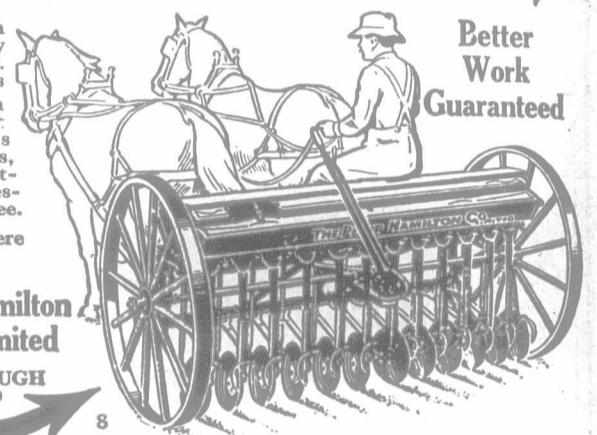

Better Work Guaranteed

Be Sure

Not Sorry

When you buy seeds you are investing not the price of the seeds only, but the value of the land for a year and the season's work as well. That makes it most important that you should buy

## EWING'S Reliable Seeds

That is the first and perhaps the most important step towards a good crop. Ewing's Seeds are clean, vigorous, healthy, true to type, and sure to grow if they get any kind of a chance. For over forty years they have been making Canadian farms and gardens famous.

Write for our handsome Illustrated Catalogue, and if your dealer hasn't Ewing's Seeds buy from us direct.

**The William Ewing Co., Limited**  
SEED MERCHANTS  
MCGILL ST., MONTREAL. 36



## A handy pump for farmers

It is a direct lift pump that can be attached to wind mills, a Fairbanks-Morse Eclipse Engine, or operated by hand.

This is one of the least expensive and most efficient of our high grade farm pumps.

Adapted for lifts from 30 to 125 feet. Altogether an ideal pump for any farm—easy to operate—will keep in good repair for years.



Send for free catalogue of pumps and water systems. If you are interested in farm engines, spraying outfits, lighting systems, power and hand tools, scales or mechanical goods of any kind, full particulars will be sent to you on request. Address Dept. 40

## The Canadian Fairbanks-Morse Co., Limited

Montreal  
Quebec  
St. John  
Ft. William



Winnipeg  
Regina  
Saskatoon  
Calgary  
Edmonton  
Vancouver  
Victoria

Canada's Departmental House for Mechanical Goods

# DE LAVAL CREAM SEPARATORS

are the cheapest  
as well as the best

LOOK AHEAD!

DON'T TRY TO SAVE \$10.00 TO-DAY IF IT MEANS A loss of 25 cents a day for all the years a cream separator may last you.

THAT'S JUST WHAT YOU WILL DO IF YOU BUY A cheap or inferior separator simply because its first price is a little less than that of the De Laval.

WHEN A PRUDENT MAN BUYS A CREAM SEPARATOR he knows that what he is really paying for is not just so much iron, steel, brass and tin, whether it is called a separator or not.



WHAT HE WANTS IS A MACHINE to perform a certain service, and he must be sure of the machine doing the work for which it is intended as thoroughly and with as little effort and care as possible on his part.

THOUSANDS OF Babcock and other tests have proved that the De Laval skims closer than any other cream separator under any conditions and particularly under the harder conditions always experienced at times.

JUST THINK what a loss of as little as 10 cents worth of cream at each skimming means to you in a

year—twice a day for 365 days—over \$70.00, and with as many as ten cows the cream losses alone from an inferior separator usually amount to more than this.

CREAMERYMEN WHO ARE DEPENDENT ON THEIR SEPARATORS for business success, have long since found out the difference between De Laval and other separators, with the result that De Laval factory separators are almost universally used the world over to-day.

DE LAVAL SEPARATORS ARE IDENTICAL IN ALL SIZES, FOR one cow or a thousand, and the differences between separators are just the same with the smallest machine and the largest. They mean as much relatively to the little as the big user.

THEN THERE IS A SAVING IN THE LABOR BECAUSE OF THE easier running and greater capacity of the De Laval over other machines and the less care required in cleaning and adjustment, worth at least 10 cents a day.

AND THERE IS THE INDISPUTABLE FACT THAT A DE LAVAL machine lasts from ten to twenty years as against an average of from two to five years in the case of other separators, or five times the average life of competitive machines.

THESE ARE THE REASONS WHY DE LAVAL SEPARATORS ARE cheapest as well as best, why thousands of other machines are yearly being replaced with De Lavals and why their use is rapidly becoming as universal on the farm as in the creamery.

IT SHOULD BE REMEMBERED, MOREOVER, THAT IF FIRST cost is a serious consideration a De Laval Separator may be bought on such liberal terms that it will actually save and pay for itself, as many thousands of them have done.

These are all facts every De Laval local agent is glad of the opportunity to prove to any prospective buyer. If you don't know the nearest De Laval agent simply write the nearest main office, as below.

DE LAVAL DAIRY SUPPLY CO., LIMITED  
MONTREAL PETERBORO WINNIPEG VANCOUVER

50,000 Branches and Local Agencies the World over

## Note that 50% More Efficient Fire-pot

Note the solid, clean fire in the Pease Fire-pot—no chance for ashes to clog—no chance for the ashes at the side to blanket the fire and prevent the heat from radiating freely from the sides of the fire-pot.

In a Pease Furnace all the heat possible given out by the coal goes directly to the heating surfaces, and every possible unit of heat is utilized.

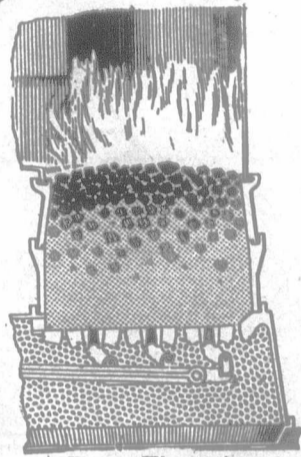

Pease Fire-pot.

## Pease "Economy" FURNACE

The "Pease" fire-pot is built in two sections—do you note that? This prevents the cracking so common with old style one piece fire-pots, due to the unequal expansion or contraction of the metal caused by the fire. It also makes it absolutely gas proof. Then in two shakes of the easy-to-work, upright shaker the fire is cleaned of ashes.

This is but one of many "Pease" advantages that will surely appeal to your sense of efficiency and economy.

Instal a new Pease "700" Series Furnace in your home just as soon as the weather gets mild, and have a healthy, warm and cosy home next winter. Don't wait until Fall—rush jobs are never satisfactory. Remember a Pease Furnace

"Pays for itself by the coal it saves."

Send for free booklet to-day.

PEASE FOUNDRY COMPANY, TORONTO, ONT.

WORKS: BRAMPTON, ONT. BRANCHES: HAMILTON, WINNIPEG AND VANCOUVER, 1920

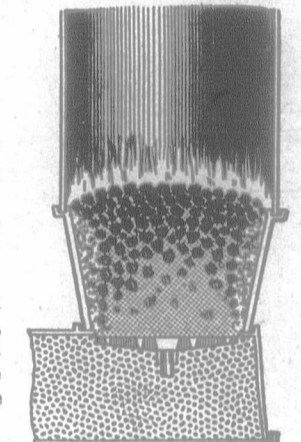

Ordinary Fire-pot.

## DIG YOUR DITCHES WITH C.X.L. Stumping Powder

Costs less than half of shovel method. Ditches four to five rods long excavated in an instant. One man can do the work. No shoveling of dirt necessary.



The accompanying cuts were taken from photographs of a ditch blown with C. X. L. Explosives at Kolapore, Ont.

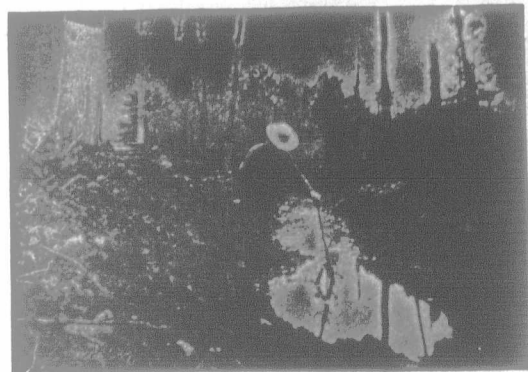

Write for our booklet to-day. It tells you how this can be accomplished.

### BLASTERS WANTED

Many farmers prefer to hire blasters. Demand exceeds the supply.

Write for information.

Canadian Explosives Limited, MONTREAL, QUEBEC VICTORIA, B. C.

Please Mention The Farmer's Advocate

# "CANADIAN"

## FARM FENCES

Big Stiff Wires of Honest Quality and Heavily Galvanized

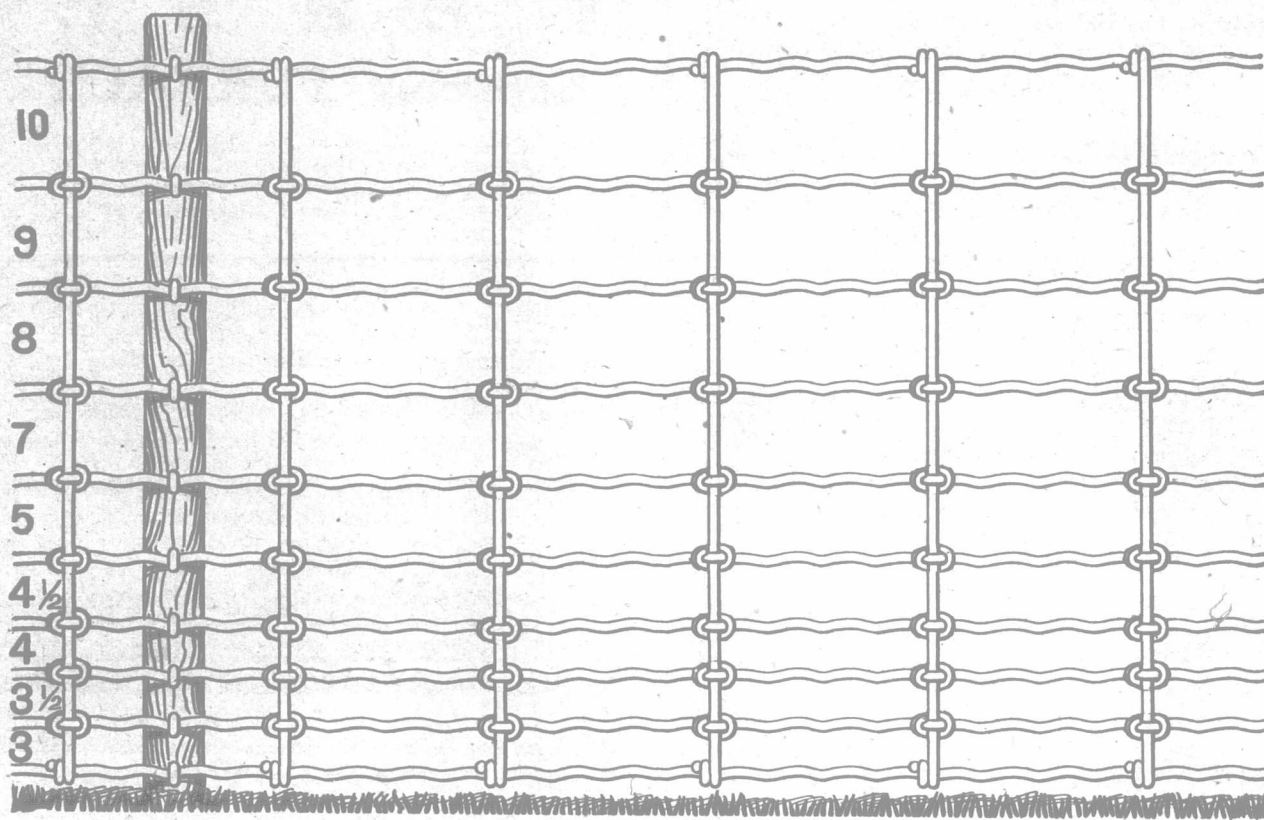

### Full Gauge No. 9 Wire Throughout

NINE OR TWELVE STAYS TO THE ROD

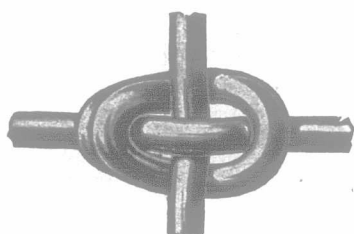

A KNOT, NOT A LOOP

Every Horizontal and Upright firmly tied together. No slipping sideways.

Manufactured by

**The Canadian Steel & Wire Co., Limited**  
HAMILTON - - CANADA





## EDITORIAL

If April snow-furries bespeak good crops, many parts of Ontario should have bumper yields this year.

It is easier to go with the crowd and throw up the hat than to share in disturbing the old and brutal way of settling international differences.

The time for seeding is here, and we have been promised a harvest as well. However, don't depend entirely upon the promise, there is always a proviso attached.

The latest and a rather likely solution of "The Boy on Farm" problem is to make farm life sufficiently interesting and attractive, that the farm girls will be found there.

If you have an old wornout horse upon the farm it would be more humane to use him doing light cultivating in the garden or cleaning the stables with the drag, than to allow the Gipsies to barter him about the country.

Some one on the forum and in the Canadian halls of national legislation with the courage, and the capacity of a John Bright in British politics would, set the pace for another great era of democratic history making.

A few don'ts for seeding—Don't mud it in. Don't sow poor seed. Don't neglect thorough soil preparation. Don't overwork the horses. Don't cultivate grass seed in too deeply. Don't sow too little seed. Don't sow too many varieties.

It is often difficult to find time in the spring rush to read and keep abreast of the rapidly-changing conditions. Rest your legs, and work your mind a short time each evening. A better balance of labor will thus be maintained, and returns in the end will be larger.

We are not prepared to say how far a breeder may develop the milking propensities of a female animal of the beef type and still retain the fleshy conformation in the progeny, but a cow that will hardly maintain her calf and nourish it sufficiently is not worthy to be named under any breed.

Co-operation, like charity, should begin at home. Agree with your neighbors to produce, one variety of grain, one variety of potatoes, one kind of stock. Have them good, and buyers will hear about you. Your business may be in the woods, but a path will be beaten to your doors.

Good grass seed may be identified by its brightness, plumpness and color, which represent maturity and vitality, and freedom from noxious weeds. When a sample of seed is produced in your own community and possesses these qualifications, nothing is to be gained by taking a chance at procuring seed from a distance.

Xerxes instructed his servant to say, each day "Master remember the Athenians." If there is a low hole in the field which delays the seeding, instruct the men to say each day, "master remember that low hole." Under these circumstances you will either get rid of the man or the unfavorable condition, and as men are scarce you will probably drain the field.

### Militiamania.

Farmers and the laboring masses of cities and towns have good reason for alarm over the concerted spread of militarism in Canada. They have only to witness the bounding up of public expenditures under "militia and defence" from \$2,650,700 in the fiscal year ending in 1905 and \$5,221,644 in the year ending in 1909 to \$10,500,665 for the current year. Nor does this sum cover pensions and the large amounts expended through the country for armories and drill halls classified as public works. This enormous and feverish increase is being made too in the face of declining public revenue. In the next place, the people hear the demand of Major-General So-and-So for compulsory military training in all the schools, public and high, and in the universities and for a staff of 9,000 trained officers, and 250,000 men for the defence of Canada, which is alleged to be "in peril of invasion"! Col. Somebody Else boasts of the numbers of cadets that will be under camp training this summer. There is bound to be resistance, passive and active, to converting the schools into recruiting agencies for the army. The armament builders are believed to have their plans under way to exploit the revenues of resources of the Dominion for equipments, many of them new today and to-morrow in the scrap heap. The men inspiring these designs are not war-loving, or blood-thirsty, and there are many high-principled and peace-preferring men in the actual service, but once fully engrafted, as the system will be, unless the people shake the leeches off, military self-interest, party politics and greed will keep the game going. Let the people be warned that if these policies and vast expenditures are condoned they will have them to the full. Because of inertia and indifference the awakening of public opinion to the dangers ahead is a tremendous undertaking, but the world's truest patriots and the best friends of humanity are ranging themselves on the side of moral principle and arbitration as against brute force. Signs are not wanting in the world of a stirring among the masses of the people that may yet make the heads of military officialdom swim. In this country regardless of party affiliations it is for the people to make their protest promptly and unmistakably known to parliamentary and legislative representatives and in the press and by their ballots turn out governments one after another until their will prevails. This is the effective cure for the malady of militiamania.

### Should Education be Withheld?

Some self-made men in the rural ridings claim that agricultural schools and colleges are educating the young men from the farm, and causing a depletion of the rural populations. Of all arguments this is, to say the least, ignoble and groundless. Canada's largest university, where agriculture is not taught at all, is congested to the doors, and asking for one million dollars to provide sufficient equipment and accommodation for the increasing influx of the youth of the country. There is a revolution rising up in the minds of young people. Instead of grasping and groping with closed eyes and out-stretched hands they desire to see the light. They feel that; "eyes have they, but they see not; they have ears, but they hear not," and desire to grasp in a broader sense the fundamental principles of life and nature.

When a correct view of the situation relating

to agricultural schools is obtained, it will be seen that all but a small percentage of the students return to the farm and those who do not, direct their efforts towards rural and agricultural improvement. If farming does not warrant or allow of developed ability or permit the mind to be so trained that it may appreciate and value the achievements and accomplishments of high minds in the literary or scientific world, it is not to be recommended to the ambitious youth. It matters not what construction is placed upon the words "achievements or accomplishments," it may mean an improved method in mixing rations for hogs, which is none the less scientific, or it may be construed to signify a well-written article upon the same discovery. Both are worthy of appreciation. The value of a college education lies in the enlightened knowledge that man has of man and the increased perception of the entire race. The dark places are made light, the rough places smooth, and on the whole the world has a different aspect to the man on the land. Education does not make men, it improves them, by broadening their field and increasing their efficiency.

### The Pulpit and the Farm.

President G. C. Creelman, of the Ontario Agricultural College, has suggested in a public address, the advantages to the ministry of rural churches, of courses at such institutions as the one over which he presides. Dr. Creelman has usually something meaty and pungent to offer from the platform and a good many will probably be disposed to say Amen to this proposal, and also to conclude that it would not hurt some of those in city pulpits to keep in closer touch with the interests of the real brain and sinew of the country. The problems of the Christian Ministry at the present day are many and serious, and Dr. Creelman would probably be the last to multiply their tasks without reason. The church like other forces in the community, has been drawn into the current of industrial, educational and social forces, resulting in the abnormal development of the city at the expense of country life and interests. The perils of this having been realized, it is the duty of the church to further the serious task of re-adjustment by precept and by example. In view of the approach of important annual gatherings of church courts and conferences the proposal is opportune. Leading church organizations are giving prominence to such issues in the social side of their activities. One of the clearest thinkers and strongest leaders among the Canadian churches has lately been presenting the case for far-reaching modifications in theological college training, so that the future ministry may be the better equipped to meet changing conditions and attitudes on the part of the people. The basic Christian truths are ever the same and unchangeable, but the human expression of them undergoes modification. The great credential of the minister, whether in town or country, is as a prophet of righteousness and heart leadership on the basis of the religious motive which in some way or other asserts itself in every life. The head of the Ontario Agricultural College has occasionally met at the summer courses for teachers, ministers full of zeal for the improvement of rural life, and the conviction was formed that these men might more effectually present this message in the terms of the daily life of those with whose occupation they need to be in intimate touch by sympathy and real knowledge.

## The Farmer's Advocate AND HOME MAGAZINE.

THE LEADING AGRICULTURAL JOURNAL IN  
THE DOMINION.

PUBLISHED WEEKLY BY  
THE WILLIAM WELD COMPANY (LIMITED).

JOHN WELD, MANAGER.

Agents for "The Farmer's Advocate and Home Journal,"  
Winnipeg, Man.

1. THE FARMER'S ADVOCATE AND HOME MAGAZINE is published every Thursday. It is impartial and independent of all cliques and parties, handsomely illustrated with original engravings, and furnishes the most practical, reliable and profitable information for farmers, dairymen, gardeners, stockmen and home-makers, of any publication in Canada.
2. TERMS OF SUBSCRIPTION.—In Canada, England, Ireland, Scotland, Newfoundland and New Zealand, \$1.50 per year, in advance; \$2.00 per year when not paid in advance. United States, \$2.50 per year; all other countries 12s.; in advance.
3. ADVERTISING RATES.—Single insertion, 25 cents per line, agate. Contract rates furnished on application.
4. THE FARMER'S ADVOCATE is sent to subscribers until an explicit order is received for its discontinuance. All payments of arrears must be made as required by law.
5. THE LAW IS, that all subscribers to newspapers are held responsible until all arrears are paid, and their paper ordered to be discontinued.
6. REMITTANCES should be made direct to us, either by Money Order, Postal Note, Express Order or Registered Letter, which will be at our risk. When made otherwise we will not be responsible.
7. THE DATE ON YOUR LABEL shows to what time your subscription is paid.
8. ANONYMOUS communications will receive no attention. In every case the "Full Name and Post-office Address Must be Given."
9. WHEN A REPLY BY MAIL IS REQUIRED to Urgent Veterinary or Legal Enquiries, \$1.00 must be enclosed.
10. LETTERS intended for publication should be written on one side of the paper only.
11. CHANGE OF ADDRESS.—Subscribers when ordering a change of address should give the old as well as the new P. O. address.
12. WE INVITE FARMERS to write us on any agricultural topic. We are always pleased to receive practical articles. For such as we consider valuable we will pay ten cents per inch printed matter. Criticisms of Articles, Suggestions How to Improve "The Farmer's Advocate and Home Magazine," Descriptions of New Grains, Roots or Vegetables not generally known, Particulars of Experiments Tried, or Improved Methods of Cultivation, are each and all welcome. Contributions sent us must not be furnished other papers until after they have appeared in our columns. Rejected matter will be returned on receipt of postage.
13. ALL COMMUNICATIONS in reference to any matter connected with this paper should be addressed as below, and not to any individual connected with the paper.

Address—THE FARMER'S ADVOCATE, or  
THE WILLIAM WELD COMPANY (LIMITED),  
LONDON, CANADA.

By aiding in the general as well as the religious betterment of his community and incidentally, making the parsonage or manse grounds and garden a pleasing example to young and old, there will be created a tone of more desirable permanence in the pastorate, and as Dr. Creelman has said, the ministers will be less disposed to be attracted by the first offer to some neighboring city or town, and younger men will be less liable to utilize the rural charge as a handy stepping stone. Special courses in relation to agriculture and rural life problems for the ministry of country churches and ministerial students might serve as a wholesome balance to a too exclusive delving in theological ash heaps, while the coming together of men of different types close to the soil and its problems would tend to promote a unity in leadership of the people delivered from unhappy divisions and out of touch with the crystallizing Christian spirit of the times. The majority of the great leaders in various walks of life come from farm homes and to have shared wisely and well in their development and in sustaining agriculture upon a high and efficient plane is a service of no small honor. On the other hand, the work of the faithful minister is one in which the wise people of the farm will heartily reciprocate.

Synthetic milk has again been discovered, this time by using a basis of casein obtained from the soy bean, but the cow is still on the job, and likely to be. We do not look for many of our dairymen selling their cows and growing soy beans extensively to supply the growing demand for milk and milk products.

### Nature's Diary.

A. B. Klugh, M.A.

One of the earliest flowers to come into bloom is the Yellow Adder's tongue. This species grows in large patches in Maple and Beech woods, the twin leaves being mottled with brown. The explanation of its occurrence in patches lies in its method of reproduction. If we dig down below the leaves and follow the thin white stem carefully for several inches we come to the corm. A corm is a modified underground stem and is like a bulb except that it is not made up of layers. When a seed of the Yellow Adder's-tongue germinates, it produces a tiny plant with a single narrow leaf and at the end of the stem, just beneath the surface of the soil a little corm, about one-fifth of an inch long and one-eighth of an inch across, is formed. During the next spring, this little corm sends out from one to five underground stems, each of which grows downward in a slanting direction. While these stems are growing the single leaf, which the plant produces in this year, is sent up above the soil. This leaf is broader than the one sent up the previous year. In the following spring, the corm sends out three or four underground stems, which grow obliquely downwards, and a corm is developed on the tip of each of these stems. While this is



Yellow Adder's-tongue.

going on one leaf appears above the ground. The corms at the end of these stems become large and the parent corm is entirely absorbed. During the fourth spring, each of these corms sends up a single leaf, and in the fifth spring, they send up two leaves and a flower-stock. In the fifth year, and in every succeeding year, as long as the plant lives, the corm gives off from one to three corms in immediate connection with itself, so that no further deepening goes on. In the following years, the plant produces a flower about every other year. This method of underground reproduction thus results in the formation of many plants from a single seed. It also explains not only the occurrence of this plant in large patches, but also the presence in these patches of so many plants with single leaves.

All our spring flowers come from corms, or underground stems of some kind, as in these stems a reserve of food is stored up ready for an early start. Flowers which spring from seed appear later in the season. The reserve food which is stored up in corms, bulbs and root-stocks is mainly in the form of starch.

This species is frequently termed "Yellow Lily," and though it belongs to the Lily Family, it is not a true Lily, as this name is correctly applied only to plants of the genus *Lilium*, while this species is an *Erythronium*. A still more erroneous name by which it is often called is "Dog-tooth Violet"—a name so wide of the mark that one can hardly see how it originated.

The flower has a three-sided ovary (which when the seeds are ripe, splits into three sections), six stamens, and a perianth made up of three petals and three sepals. The petals and sepals are both yellow and equal in size, so that they all appear to be petals, which is characteristic of flowers of the Lily Family. For this reason the petals and sepals are spoken of collectively as the perianth, meaning "around the flower" since a flower botanically need consist

only of the pistil and stamens, or in many species of only the pistil or the stamens, as these are frequently borne on separate flowers. As the season progresses, the mottled leaves of this species fade out to a plain, pale green, and by midsummer they have completely disappeared.

The Yellow Adder's-tongue does not set many seeds, but we can see that because of its vegetative method of reproduction it does not need very many to ensure the perpetuation of the species.

We find that the Maple and Beech woods contain a great many flowers in the early spring, and comparatively few later in the season. This is due to the fact that later in the season, the ground in the woods is densely shaded, so that only shade-enduring plants can live there, while in the early spring there is plenty of light. Also the hardwood bush is a comparatively dry, warm habitat in the early spring when other locations are either too damp or too much exposed.

### The Tariff and Politics.

The tariff is where Governments and oppositions turn with greatest avidity when in search of planks to strengthen their bulwarks or to form new battering rams with which to assail the forces clinging to power. It matters not what party is in power it has always a "tariff policy" and it matters not what party is in opposition it also has a "tariff policy" and these policies in Canada are not so very different in the long run. In opposition the Liberals talk freer trade but in Government fail to lower the tariff very materially. Conservatives in power or out do not talk nor do not attempt to make marked downward tariff changes in fact they favor stability of protection or an increase. During the past winter there has been considerable agitation on the part of the farmers of the West, for the removal of the duty on wheat and flour from the United States, in order that our wheat growers might have free access to the American market. There has also been considerable talk about the removal of the duty on agricultural implements entering Canada. The budget speech a few days ago showed the result of the efforts of the agriculturists. No free wheat and a lowering of five per cent. in the duties on binders and mowers, two machines out of the large numbers which the farmer must buy to equip his plant, and the duty on repairs for ditching machines has been removed. It is held that this is all the reduction that the business of manufacturing farm implements and machinery will stand and that more harm than good would come of the removal of the duty on wheat which would cause the prices at Minneapolis to level with those of Western Canada, (it being held that the wheat market in Liverpool rules the world) and would take bran and shorts out of the country where they are needed for stock feeding and worst of all would starve our transcontinental railroads. If the farmer starves the railroads the Government will feed them on subsidies anyway so they must live and grow fat. There is argument on both sides of the question of free wheat or free trade and good argument but it does seem strange that the agricultural classes who ask so strongly for lower tariff on certain articles of trade are seldom heeded to any great extent by either political party, while all political ears are erect and on the alert to hear a whisper from the manufacturing concerns or Big Interests. Several manufacturing interests are to be protected under the new schedule by higher tariffs. Among them are those concerns manufacturing wire rods from which nails and fence are made. This will likely raise the price of nails to the consumer. Wire for fencing is not severely affected by the duty because of the "draw-back" which saves the farmer from extra expense which might have been forced upon him.

We are not arguing one way or the other on the tariff question but when farmers line up and ask for something, and the manufacturers line up in direct opposition the former body gets a hearing but no action, the latter gets a hearing and almost everything else desired. It is about time for a fair division in place of the apple for the manufacturer and the core for the agriculturist. The only possible method is to renounce party politics and vote accordingly.

**Observe the Ways of Nature.**

At no other season of the year is there so much interest displayed in nature as during the spring when the green verdure is bursting from the brown and sear earth. Too many of us, especially those living closest to nature, pay very little attention to the doings which are going on round about. The man living in the country is very often least observant of nature at his very door. We smile when we think of the small boy, who when asked the definition of a caterpillar replied "an upholstered worm," and yet the boy in all probability had observed more closely the make-up of the caterpillar than many of his grown friends had done. In these days when it is almost impossible to grow fruits and crops generally without being on the alert each moment ready to combat the inroads of insect pests, it is necessary that those engaged in the work should pay close attention to the insect life with which they come in contact.

Even greater than the insect troubles are those caused by noxious weeds, and few indeed are the people living where these weeds grow and seed each year who are able to name all of them, and to recognize their seeds if they see them in a sample of grass or clover seed or in seed grain.

It is astonishing also what a small percentage of our population know anything about trees. Going through a small wood lot, in which are to be found several species of common Canadian trees, it is surprising how few of these many of our intelligent people are able to name correctly.

The greatest cause of this unfamiliarity with the every-day things of nature is due to the fact that people do not pay sufficient attention to the plants and insects which they meet almost every day during the summer months. It is a lack of observation, and right now at this season of the year, when new weeds are being sown and when the plumes of new plants are bursting through the soil, is the time to begin cultivating powers of observation, and by another spring be prepared to see and name all those trees, plants and insects which have an economical importance in the growing of farm crops in the locality in which you live. Our weekly "Nature's Diary" should help many to a better understanding of nature.

**Short-Lived Ships, Yet Costly.**

The life of a warship is very short indeed. In 1895 the battleship, Renown, was the finest and most powerful iron-clad afloat upon the high seas. At that time her value was some millions of dollars, but she was sold the other day for scrap, for the small sum of \$200,000. Ten years before the advent of super-dreadnoughts she was the pride of the British Tar and yet in one short decade her value, based on efficiency, gradually waned until she was of no more use as a fighting machine. No wonder the expenditure for military appliances increases rapidly in European countries for as soon as one ship is built or a gun completed, the manufacturers set to work to use in the next ship or gun improvements which put the former entirely out of the running and obsolete. Altogether this is what causes high expenditure. It is the great race for the most powerful navies and armaments. The super-dreadnought, at the present time, is twice as fast and twice as large as the good ship, Renown, which at the time of the late Queen Victoria's Jubilee was the wonder of the age. Who knows but that in ten years' time the dreadnought of to-day will be useful for nothing but scrap? In fact, this would seem to be the natural order of events. Millions upon millions are expended annually in replacing the older type with the newer and more formidable fighting machine. This is what we in this country should strenuously endeavor to keep clear of. If militarism once gets its grip upon the nation, its tentacles cling like those of an octopus and squeeze, and extract more of the money from the nation and deposit it in the coffers of the armament trust.

**THE HORSE.**

**How a Kicker Was Cured.**

Editor "The Farmer's Advocate":  
In one of your recent issues I saw an enquiry asking for a cure for a horse kicking in the stable. I have a seven-year-old horse that started kicking during the winter, and I have tried everything that I could think of, such as hanging a chain up behind him, strapping a short chain to his foot, tying one across the stall to keep him up, but he would kick over top of it and was finally getting worse, until he was kicking all the skin off his hind legs. At last I thought of a scheme that has fixed him. It has been about a week since I put it there, and he has not kicked as yet. This is what the remedy is:  
Procure a 3x4 scantling and put it across the stall about 3 inches above horse's rump. This keeps him from getting his hind quarters up.

Get a good strong hinge and put on one end so it may be swung back to get horse out. Nail cleats on three sides of other post and put a bolt into post at back of scantling so it will pull out. This stopped the kicking with both feet. He started again with one. To stop this I got a light chain and put it across stall about two feet from floor, so that if he happens to get over it will not hold him up. This has worked satisfactory so far.  
Elgin Co., Ont. D. D. McCALLUM.

**Experience With An Outlaw.**

Editor "The Farmer's Advocate":  
I observed an article in "The Farmer's Advocate" of March 26th, by W. H. Underwood, on "curing the kicking habit," wherein he relates some of his experiences with unruly horses, advocating the pursuing of a certain course in training or conquering such animals. While I concur in much that he has written, yet I would take objection to the application of any one rule in all cases. I therefore take the liberty of giving my individual experience with one of the worst cases of an unruly horse that has ever been encountered and conquered by myself. While my story does not—as the title might suggest—contain any thrilling adventures or escapades, yet I feel my experience might prove helpful to others finding themselves similarly situated. The term "outlaw" as used in this article does not refer to a fugitive from justice, political offender, social Ishmaelite, or Western desperado, upon whose head a price has been placed, but a class of horses who by reason of their treatment by unreasonable men have become self-assertive, incorrigible, unbreakable, so far as the employment of usual methods are concerned. Among animals as well as men the highly-sensitive, independent, intelligent natures require the most careful and judicious handling.

emotion, he stood on guard. Critical inspection was prohibited. His owner gave his history. He was an outlaw, unbroken, untameable, vicious and by reason of his evil disposition had been dubbed "Dick Turpin" after a celebrated English highwayman. Even with such a recommend I purchased him. They were to capture and assist in saddling. After some manoeuvring a rope was dropped over his head and he was secured. Covering his eyes with a piece of blanket, saddling and bridling was accomplished. My professional friend refused any further assistance. I must ride him myself. Cautiously, yet confidently I mounted. The trembling limbs and throbbing heart spoke of fear rather than viciousness. Speaking kindly, soothingly, I settled into the saddle grasping the lines firmly in my left hand, leaving the right free for any emergency. An attendant led him forth from the covered portion of the enclosure, slipped the covering from his eyes and stepped out of the way. Springing with terrific force into the air he darted forward. A succession of buck-jumps followed, and then he stopped as if waiting an attack. Still speaking quietly, I stroked his neck with my disengaged hand, taking care to avoid touching his panting sides with my heels. Presently, he rushed towards the opening, with the apparent intention of crushing my leg against the post, thus ridding himself of his burden. Without attempting to rein him, just as he was almost at the entrance, I placed my cap over his right eye, suddenly swerving and plunging forward we were in the open prairie. Here again he demonstrated his ability to buck-jump. Refusing his challenge to battle, he stood still as if in astonishment. Apparently tactics differed from my predecessors and the expected fight was not on. However, my authority was not recognized. Persuasion to advance caused preparation for battle. I wished to proceed eastward he faced westward. Past experience had taught me that with either men or animals, in seeking to secure your own way, it is policy to let them imagine they are having theirs. Therefore, I began urging him away from home. Like a flash he reared, whirled around, and as an arrow from a bow darted along the trail homeward. Feeling that even tightening of the reins might prove my undoing, I gave him his head. After running a considerable distance in the desired direction, he suddenly turned and started back upon his track at even greater speed. Now was the testing time. Would I rein him in or pursue the policy adopted? The latter idea triumphed. Speedily he slackened his pace to a walk, then stopping, reaching forward, I again stroked his neck without speaking. There was however, no perceptible change in his attitude. Dogged persistence manifested itself. Strictly adhering to former tactics I gave no indication of attempt to conquer by power. Soon he began walking slowly, turning gradually away from the trail. By gentle persuasion, I induced him to turn eastward, parallel with but not on the trail. After some hours slow travelling, we arrived at the yard and now came the question of stabling. Attempts to do so were futile and so he was picketed securely where he was.

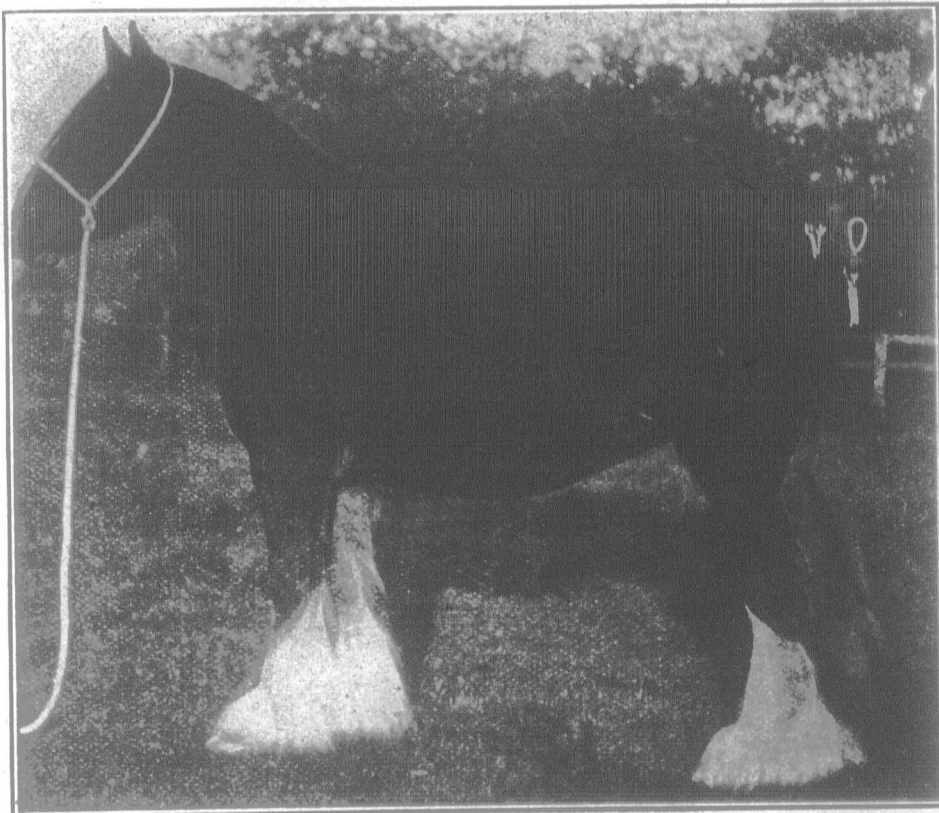

One of England's Winning Shire Mares.

The absence of judgment, tact, or willingness to study dispositions of animals, has frequently caused much trouble to owners. In Western vernacular, an "outlaw" was a pony which had successfully resisted all attempts by brute-force to make him an abject slave and was deemed dangerous. My experience with this particular pony, dates back to a time when much of our western country was still an expanse of unbroken prairie, over which bands of horses and herds of cattle roamed at leisure. My profession, at that special period made the possession of a saddle-horse imperative. My location however, was in one of the most northerly sections, where ranches were few and animals such as I required scarce. After some time, I discovered that an Irishman who combined ranching with freighting had a horse to dispose of.

Securing the services of a professional horseman, I drove out, taking a rider's outfit along. Our business being stated, orders were given to round up a bunch of ponies which after considerable trouble and noise was accomplished. The bunch containing the pony for sale was enclosed in a partially-covered corral of considerable size. When invited to make a closer examination, we found the pony standing apart from the others. His attitude suggested intense fear, alertness, defiance. With legs apart, head lowered, quivering nostrils widely distended, eyes dilated, ears flattened, while his whole body trembled with

stood perfectly still. I again stroked his neck without speaking. There was however, no perceptible change in his attitude. Dogged persistence manifested itself. Strictly adhering to former tactics I gave no indication of attempt to conquer by power. Soon he began walking slowly, turning gradually away from the trail. By gentle persuasion, I induced him to turn eastward, parallel with but not on the trail. After some hours slow travelling, we arrived at the yard and now came the question of stabling. Attempts to do so were futile and so he was picketed securely where he was.

Next morning after considerable coaxing, my efforts were successful and stabling was accomplished. Giving him a liberal supply of hay and oats I left him to soliloquise. My greatest difficulty now lay in re-saddling. Hitherto, this had been performed by lassoing and blind-folding. Force, unless really necessary, I determined to dispense with. The saddle was recognized as an instrument of torture and whenever brought near he would attempt to get away from it. Realizing that it was fear rather than wickedness which caused him to act thus, I placed the saddle on the stable floor near him. After some hours it was hung on the manger, as far removed as a double stall would allow, drawing it a little closer every time I fed and watered. A conciliatory campaign continued until his fears

Past experience had taught me that with either men or animals, in seeking to secure your own way, it is policy to let them imagine they are having theirs. Therefore, I began urging him away from home. Like a flash he reared, whirled around, and as an arrow from a bow darted along the trail homeward. Feeling that even tightening of the reins might prove my undoing, I gave him his head. After running a considerable distance in the desired direction, he suddenly turned and started back upon his track at even greater speed. Now was the testing time. Would I rein him in or pursue the policy adopted? The latter idea triumphed. Speedily he slackened his pace to a walk, then stopping, reaching forward,

were sufficiently allayed to permit him to eat his food over the saddle. During this time I had been studying the disposition, peculiarities and tastes of my pony. Handling quietly caused a recognition of my kindly intentions and at the same time, I ascertained that his pride and dignity had suffered through treatment received. Possessing the instincts of a gentleman, he had been treated like a slave. In place of giving him the position of a companion or associate they attempted to coerce him, into a hewer of wood and carrier of water. This like every liberty-loving creature he resented. Outlawry the sequel. However, he must be my assistant and burden-bearer. Procuring a light blanket, and surcingle, after considerable persuasion I secured it upon his back. Next added my gaddle bags fastened to the surcingle. Then placed my leg over his back without the saddle. By this means I discovered his objections were against the saddle not the burden. I now proceeded to saddle. Leaving the blanket secured, I quietly raised the saddle several inches above his withers and gently placed it in the position occupied by the saddle-bags. After a few attempts to rid himself of it he quietly submitted to the cinching. But while much had been accomplished by way of conquest, professional broncho-busters declared I would never mount him outside without assistance. Quietly pursuing my course the pony grew so accustomed to the saddle that it could be put on or taken off without much difficulty.

The time had arrived for the final lesson. Bright and early one long summer day before the village was astir, fully saddled and bridled Dick was led forth. After his incarceration, the fresh air seemed to act as a stimulant. Immediately he proceeded to rid himself (if possible) of the despised articles. The antics displayed were laughable but futile. He was led out to a vacant lot still continuing his vain attempts. Jumping, striking, kicking, biting, he would allow no approach. Realizing that any manifestation of force would only prolong the fight I adopted different methods. I had ascertained while studying Dick's temperament that he had a child's fondness for sweets. A supply of lump-sugar was available, I tested its powers of persuasion. While he was still sullenly and viciously opposing my propositions to mount, I extracted a lump of sugar from my pocket. Keeping a tight grasp upon the lariat, I held the enticing luxury within range of scent and vision. It acted as magic. Eyes, ears, nose, were all alert. Sullenness suddenly disappeared. Standing perfectly still he permitted me to approach and stroke his withers while he nibbled the sweet morsel, on finishing which he backed away suspiciously. Renewing my attempt again, I drew near and was able to lay my arm caressingly over his neck, meanwhile keeping the sugar in view. His head came round near to my pocket while the eye which watched every move was less defiant. This time when the sugar was demolished, Dick did not withdraw but sought for more of the coveted article. Without producing a future supply I gently patted his neck, rubbed his nose, toyed with his ears and soon leaned against the saddle, without much objection. Another lump confirmed his confidence. Laying several pieces upon the ground, I took advantage of the moment and while he was busily engaged vaulted into the saddle, quickly preparing for a struggle. Trembling violently he stood for a moment, then rearing plunged violently forward in a mad attempt to dislodge me. However, the sugar proved a greater source of attraction than I dared to imagine. Halting he returned to pick up a few remaining portions. While devouring same I quietly awaited his pleasure. Finishing he turned his head as if enquiring for more which enquiry I answered in the affirmative. Without any further attempt to unseat his rider Dick walked quietly away. He was conquered. What force failed to do kindness accomplished. The outlaw became a respectable citizen, the Ishmaelite a sociable companion. While not objecting to use of force when absolutely necessary experience leads me to believe that few horses require the rough handling formerly practiced by old-time broncho-breakers.

Essex Co., Ont. A LOVER OF HORSES.

### Starting a Balker.

A balking horse, says a writer in "The Farmer's Advocate and Home Journal," of Winnipeg, is about the most exasperating animal in creation. Whipping or other abuse only makes a horse more angry and stubborn. Whipping does no good. Try all the tricks of the jockey, and some horses refuse to move an inch. There are probably innumerable methods put forward for starting the balking horse; but one thing is certain, cruelty never pays. Kindness is more powerful than mere brute force with animals as well as with men.

Ask yourself who is really to blame for a horse being balking. Very likely the horse acquired the habit simply because some senseless driver overloaded, abused and whipped him, as a

young animal, and at a critical moment when he was doing all he could. I never knew of a balking horse that was always kindly treated and never too heavily loaded, especially when learning to work.

A few years ago, when starting a farm, I bought a horse that was known far and wide as a balking one. One fine day when I was at peace with myself and all around, I hitched him to the buggy, and turned his head towards town. He went half the way trotting right along. When he thought he had gone far enough he stopped short. I sat a while considering what to do. He seemed to expect me to use the whip, but was mistaken about that. I got out and pretended to examine the harness and fussed around

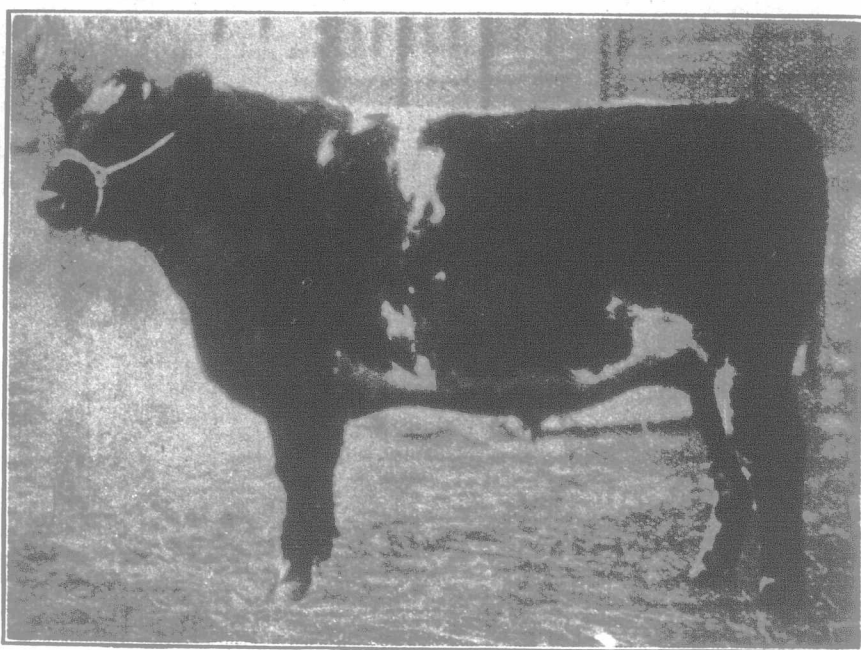

Harviestoun Twin.

Junior champion steer, at Smithfield, 1913.

a bit, then climbed in, shook the reins briskly, and gave the word of command to start. No good, not a budge. I felt like using the whip, but knew that would be useless, he had had many a taste of that already, and still was master when I bought him. I got down, pushed him back a little out of the way. I happened to have lying in the buggy a good strap. This I showed him, putting it up near his eyes. I went to the side and buckled it to his foreleg, close up to his breast, throwing the other end over his shoulder. I then raised his near foot and fixed it with the hoof almost touching his belly. This done, I found a place where I could sit down and he could see me. This was something he did not bargain for, and the novelty of stand-

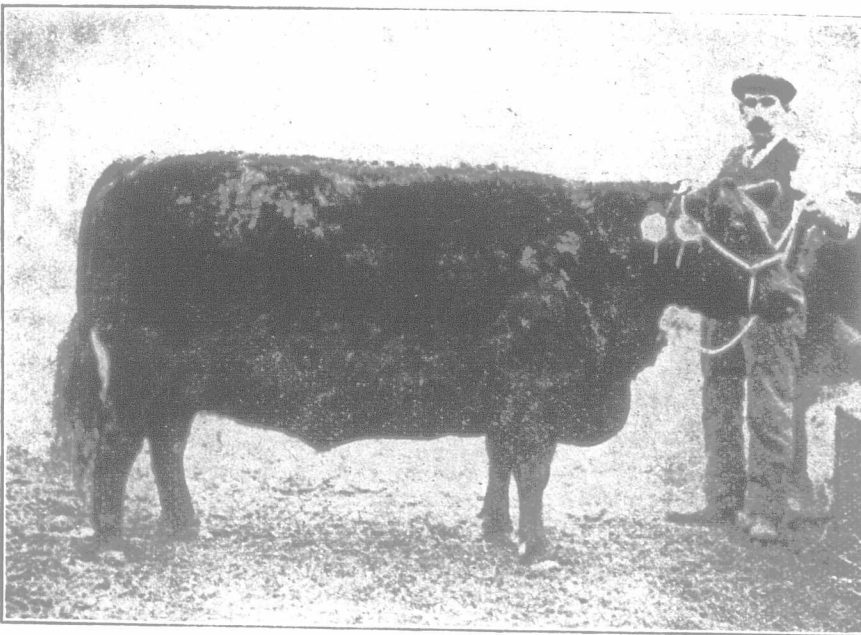

Beauty of Welbeck.

The champion beef animal of the year in Great Britain.

ing on three legs somewhat diverted his mind from the notion that caused him to stop. I think that is the chief point gained, and the most humane in handling a balking horse. When I got tired of sitting I took off the strap and showed it to him, petted him a little, and moved on at a brisker trot than before the wait. The strap became a part of the harness for a month or two, till at last the sight of it would start him on the move. A better horse for general use I never had to drive, plow, harrow, pull heavy loads, stump, anything he was asked to do but about once a month or six weeks the strap had to come in use for a while.

This is an interesting account of experience with a balker. In passing we might state that

we have seen balking horses started by filling their ears with some dry substance, as dry leaves, dead grass, or straw. This is simple and might be tried.

## LIVE STOCK.

### A Market Tip.

From time to time some interesting and valuable advice is contained in our weekly market reports. Last week our Buffalo correspondent made some statements which should, if acted upon by the cattlemen in this country prove of benefit, especially to those who contemplate marketing their finished produce on the Buffalo market.

Buffalo, as was pointed out in the lengthy description of that cattle mart, in our issue of October 9th, 1913, desires and pays a premium on light, but fairly well-finished stock. Chicago, on the other hand, is a large American market for the choicest heavy types of cattle. During recent years there has been considerable change noted in the demands of the live-stock markets on this side of the line. Toronto and Montreal, our big markets of the East, do not clamor for the heavy, export steer to the same extent as they once did. The demand is for the prime, highly-finished, lighter cattle termed "choice butcher stock." The increase in home consumption as compared with production has made an

excellent market for the lighter weights of cattle right at home.

Our Buffalo correspondent cited the case where forty nice Canadian heifers weighing an average of only 430 pounds each sold last fall on the Buffalo market as stockers at \$5.72 per hundred weight. These forty heifers were sold less than a fortnight ago on the same market weighing an average of 736 pounds each, showing a gain of 256 per head, and brought the nice price of \$8.05 per hundredweight, a margin of \$2.33 per hundredweight for the feeder. This he claims should be a tip for the Canadian breeder of feeder cattle, and for the feeder who finishes them. The point is clear, cattle should be finished at the earliest possible age. These heifers

were marketed on a day of slow sale when cattle dropped from fifteen to twenty-five cents per hundred weight all around, but they were of such choice quality and of such desirable weight that the buyers snapped them up readily early in the day. They were amongst the first lots sold. This is where the feeder has the advantage in selling, when he has a product that is sure to be in demand regardless of the upward or downward trend of the fluctuating markets upon which he is forced to depend. We are not attempting to boost Buffalo as a market centre, practically the same conditions prevail on our own big markets. Perhaps not quite as light as those mentioned, but cattle in well finish and of the well-known butcher's choice variety generally sell readily

whether the market be draggy or the demand keen.

There is another note of warning in our Buffalo correspondent's reports. It is impossible upon any occasion for anyone, no matter how well versed he is in market conditions, to prognosticate prices a month or two ahead, but the general opinion seems to be that the months of April and May, 1914, are to see a little slower sale in finished cattle than many have expected. Buyers now look for June to be the high month, and for steadier to lowering prices for the next six weeks. These are the points of greatest value to a cattle feeder.

The United States is still making a strong bid for feeder cattle from this country. They

are bought up readily, because, as stated in market reports time and again, they show good breeding, and give every indication of being the class of cattle which will make rapid gains and high economical returns for their feeders. Again we say let the Canadian breeder and raiser of stockers and feeders keep as many of these cattle as he possibly can in this country on his own farm, and finish them at an early age and market them on the highest market. There is just a danger, however, in the agitation for finishing young cattle that many will make a comparative failure by not putting an ample degree of finish on the stock before it is offered. It is a little more difficult to get high finish on a young and growing animal than it is on a mature animal, and there is no class of cattle which meets a slower sale and a lower market than the skinny, poorly-finished variety of so-called baby beef. Market toppers must be young and must show finish.

While on the subject of markets we may make some mention of the outlook for hogs, lambs and milk cows. Hogs remain high. The market held up very well over the season around about the first of April, when so many are often rushed on the market, their feeders needing the money to meet accounts coming due at that time. Lambs are also in demand. There seems to be a good outlook for both these classes.

Milkers and springers, for which there was almost an unprecedented demand during last fall and the greater part of the winter, are not now meeting with the same ready sale at high prices. The season has had the effect of slackening the demand. One thing is certain, there does not seem to be an over-supply of this class of animal of the right kind, but cows on the greater majority of farms of this country are found to freshen in larger numbers in the spring than at any other season of the year, and the flush of the grass season also insures an abundance of milk and milk products for the next few months, so that the demand naturally slackens. There is a point in this, however, for the man who raises heifers and plans selling them off as dairy cows. Highest returns undoubtedly come from having the cow freshen in the fall or early winter if she is to be sold.

Markets and marketing are fast being recognized as one of the most important parts of farm undertakings, and the closer the attention paid to this branch of the business the better will be the financial returns from the land.

### Deductions in Feeding From Observations in two Ontario Counties.

Steer feeding is a changing proposition. It is governed by the consumer, not the feeder. Farmers would become indignant if it were intimated to them that they do not control their own business, yet with the increased home demand and the consequent decrease in export stock has come a transformation of the type of steer which is being finished. Meats are expensive, consequently the buyer for the family gets a small cut, and the butcher gets a small animal to supply small cuts without waste. The three-year-old has been replaced by the two-year-old in the finishing stall, and the wheel has revolved around to the peg of younger finishing. A specialization in the dairy business and destruction of the male calves has led to a general shortage of steers, and the small margin at which feeders can be bought has forced the big stockman to only partially fill his stables. To overcome this condition, breeding cows are being maintained, and the steers must be raised in order to refill the stalls each year. Following up this gradually changing condition came the revision of the United States tariff whereby cattle were admitted duty free into the Union, and many a good steer, cow and heifer, journeyed across the line. From the town of Paisley alone 365 car loads of cattle were forwarded, and a similar number from Port Elgin during 1913. (Two shipping points in Bruce County). These were not all finished steers and cast-off cows as has been claimed by some, but many of the most promising young breeding stock left the country where it is intensely needed. Such, at the present, is the situation in the steer-feeding industry as evidenced in the counties of Bruce and Wellington.

Feeding practices have three governing factors—climatic conditions, soil characteristics and sentiment, and of these three the last we fear is the most influential. Its influence and power vary directly as it approaches prejudice. In the north part of Wellington County there are sections where the silo does not exist, because, in the words of the farmer, "the land is heavy and corn does not do well," yet north of this in Wellington and even forty miles north and west in the county of Bruce the silo again appears, and White Cap Dent, Leaming and Wisconsin No 7 are satisfactorily ensiled. Roots of course replace the silage in these districts, but the experimental work conducted at Macdonald College in feeding

roots and silage emphasizes the fact that the most economical feeding is done where roots and silage are equally mixed. In that particular instance roots were produced at a cost of \$1.85 per ton, while corn cost \$1.30 per ton to grow. Some of our most experienced feeders, from a

up his steers at from \$5.75 to \$6.00 per hundred. They were started on one-half gallon of chop, which consists of one part barley and two parts oats, along with turnips, mangels and hay. The grain ration has increased to one and one-half gallons, making an average for the winter of about one gallon per day. The roots are now almost exhausted, but bran will be substituted in their place. The cattle are sold to go on grass about the first of May at \$7.75 per hundred. Mr. Brockelbank figures that they will have gained about 250 pounds each under his ownership and feeding. In this transaction there were eight head, steers and heifers, and had they been purchased at an earlier date and grassed by the present owner, even if it necessitated renting pasturage, a larger profit could have been credited to this winter's dealings. However, in this case it was more convenient to buy later in the season, and this system of feeding is, in general, to be commended as the products of the farm are marketed in the most modern manner, while all the fertility not appropriated by the fattening animals is returned to the fields.

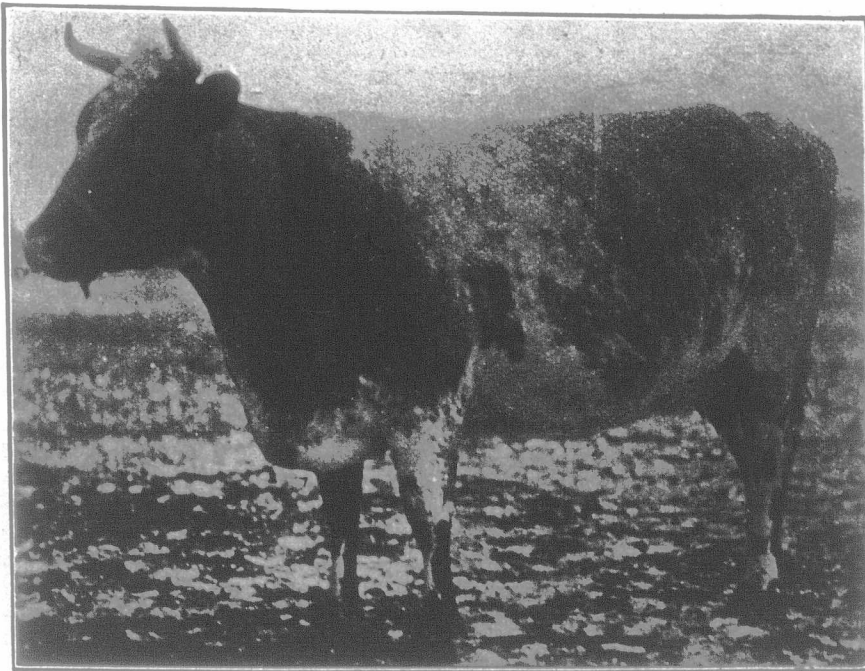

A Good Kind.

This cow, seen in Wellington County, Ont., is the kind that produces good feeders.

practical and experimental knowledge, claim that roots and silage have about the same feeding value. With a direct economical gain accruing from the practice of mixing these two roughages

propriated by the fattening animals is returned to the fields.

In the same locality and a neighbor of Mr. Brockelbank is another stockman, Geo. Mossfeld, who believes in growing beef, not making it. A good line of Shorthorn cows are maintained on the farm, and at the head of the herd is a Proud Hero-bred bull. The Scotch Shorthorn blood issuing from the herd of Wm. Duthie Collynie, Scotland, insures early maturity in the progeny, and obviates the necessity of depending upon the good, bad and indifferent type of steers that must be bought up as feeders if they are not produced on the farm where they are to be finished.

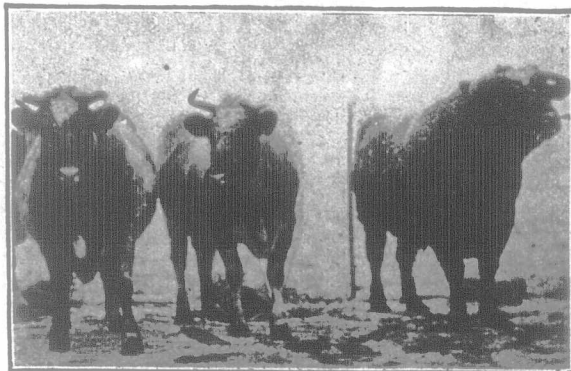

Parents.

A sire and two dams in Bruce County, that have proved themselves producers of the feeding kind.

and seeing that corn may be produced 55 cents per ton cheaper than roots, it is quite apparent that the feeders of Wellington and Bruce counties are losing profits each year through the absence of corn fields and silos.

This farm practice is forcing itself upon Canadian stockmen. With a specialized dairying business the steers are not the type to feed. If they are not valuable as breeding males they are more wisely and profitably vealed. This eliminates that class of stock from the contributors to the feed stalls and casts the obligation upon the shoulders of farmers who produce stock of the beef type. At the present time they are not supplying enough of the right kind, and to-day a few steers and heifers, two-years-old or a little over, stand where ten years ago were three times the number of well-fleshed, heavy bullocks. The young ones would be just as profitable, but the decrease in numbers is the spectacle to be lamented. Feeders assert that the dairy industry has ruined their business, as they cannot now procure the proper kind of steer to feed. It is a



They Soon Recognize a Stranger.

Four of the eight feeders that are turning farm crops into money for a Bruce County farmer.

The system of "picking up" the steers to feed still exists, and as an example of this practice may be cited the operations of H. S. Brockelbank of Bruce County. Here feeding is done on a modest, yet economical principal. About the first of last November Mr. Brockelbank bought

is a superficial and selfish way of expressing the situation. The dairyman is transacting his own business most profitably to himself, and the feeder must work out his own salvation.

The matter of stock maintained on each farm, is in part, a result of changing economic conditions, yet if the evidence and findings of modern investigations were only put into practical use, corn fields, silos and economical feeding rations would meet, to a large extent, the obstacles, presented by changing conditions. When one man's opinions are exploded through practical demonstrations on a neighbor's farm, we are prone to be guided by what we see rather than by what we hear, and basing our judgement upon the evidence presented to us, the case is strongly in favor of breeding and rearing a type of early maturing cattle for the block, and by an unbiased and unprejudiced trial establishing the silo and the most up-to-date feeding operations known to science or practice.

Come gentle Spring! ethereal mildness come!

### Docking and Castrating Lambs.

Editor "The Farmer's Advocate":

When I get ready to dock my lambs I build a fire out near the sheep pen early in the morning. I want a fire and some hot irons with which to sear the wounds. Some do not agree that docking is a good proposition. At first it seems painful and cruel, yet long ago farmers had to learn that some things appear cruel which must be done. The good of the lambs and the owner's pocketbook favor docking and castrating while the lambs are still young. A sheep's tail is a collector of filth, and a nest for blow flies and maggots. Their presence is highly objectionable in the ewe flock.

When the fire is burning well and the three small iron rods are heated to a cherry red color I am ready to start work. One man catches the lambs after they have been penned in a small place, while another holds the youngster for me to do the "de-tailing." He holds the animal with its back against his chest, and a front and hind leg in each hand. In this position the lamb is up at a convenient height, its feet are out of my way, and all things arrange themselves conveniently.

Taking a sharp knife in my right hand and the lamb's tail in my left I sever it with one downward stroke. Then the blood begins to spurt from the severed arteries in a surprising manner. On the inner side of the stub left is one large artery, and on the other side are two smaller ones. From these the blood spurts rapidly. To stop this bloodflow I take a red-hot iron from the coals and touch the throbbing arteries. This sears them and stops the blood with little pain to the lamb. It is the work of only a minute, yet it stops all the waste of blood that might otherwise sap the life of the animal.

I have tried cutting the tails off with a block, mallet and chisel, but besides requiring more helpers such a practice requires more tools, so I prefer docking the tails with a knife. Many times I have used different styles of docking pinchers. Some are heated cherry red hot, and pinched down on the tail that is being amputated. Their use, however, necessitates an extra helper to hold the tail out straight, and to hold the small board which is slipped over the tail to protect the lamb's body from the pinchers. For fast work there is always needed more than one pair of pinchers. It is very important to leave the skin longer than the bone, in order that, when the stub heals, there will be no bone sticking out unprotected. To allow for this when using the pinchers, one simply uses a snugly-fitting board. When using the mallet and block it is necessary to pull the skin back before setting the chisel on the tail and to leave plenty of skin. When simply using a knife all that is necessary is to hold the tail down in a straight line with the backbone when cutting off the tail. The skin is pushed on the back somewhat so that an end is left to slip over the bone after the stub starts to heal.

Castrating is a more serious matter. Certain I am that the average sheep owner can well afford to castrate his ram lambs. Every sheepman who pretends to work his business on money-making principles castrates his marketable ram lambs. It is no more difficult to castrate a lamb than a pig or a calf.

First I wash my hands and knife clean and wet the lamb's scrotum with disinfectant. Then I cut off the lower end, pull out the testicles and let the lamb go. I have an assistant catch the lamb and hold it so that I can keep my hands clean. He holds its back against his chest, and holds a front and hind leg in each hand. This brings it up to a convenient height, and it is in the most convenient position. Some who have trouble and lose lambs after castration often have trouble because they try to cut a lengthwise slit in the scrotum. When cutting this way they fail to cut to the end of the scrotum, and so the wound does not drain and inflammation starts. Some of the first lambs I ever castrated gave me trouble, for I cut the scrotum and then the covering of the testicle, pulling the testicle out and leaving the covering inside to collect pus and cause inflammation. This was wrong, for I should have simply cut off the end of the scrotum, and then pulled out the testicles with the covering and all the cord I could get. To keep the testicles from slipping back I cut the scrotum rather short, thus pushing the testicles so far out that they seldom slip away. In following this practice I seldom have any trouble.

Lambs should be docked and castrated while they are still under two or three weeks of age. It is far better in every way to perform the operations at this period than wait until they are mature, when the danger is in the very nature of things much greater. Statistics were kept one year at the Minnesota Experiment Station to discover the different effects these operations had when performed on lambs from ten days to two weeks old, and on lambs thirty-six days old. The operations were performed on the same day, and under exactly similar conditions. Weights were taken of all lambs treated every day for a week

or more, so as to determine how long the growth of the lambs was retarded in each case. The ten-day-old lambs lost weight for just the one day of the operations but resumed growth the next, and continued it just as though nothing had happened. On the other hand the older lambs showed no gain for from four to five days after treatment, some of them not getting on the gain, even for as long as a week. The older lambs have better developed blood vessels and organs, cell growth is less active, and they suffer a greater shock than do the younger lambs. They do not, therefore, regain their equilibrium with as great rapidity. Since these operations are necessary, it is the part of wisdom and economy to perform them at a time when growth will be as little interrupted as possible.

Johnson Co., Ill.

W. H. UNDERWOOD.

### Feeding Lambs.

In experiments carried on in Indiana with fattening lambs from the western range, it was found that the most profitable rations were those in which shelled corn, clover hay and corn silage were fed. When no silage was fed the rate of gain was satisfactory, but the cost of the gain was higher than when silage was added to the other feeds. Silage as the only roughage produced a more economical gain, but not as rapid a gain as when clover hay was also fed. The finish of the lambs fed on silage alone was not so good as that when both roughages were included in the ration. Oats were found to be too expensive to be used as a partial substitute for corn. Readers in Canada, however, must remember that corn is cheaper in Indiana than it is up here. Cottonseed meal increased the rate of gain, but did not in all cases add to the finish of the lambs, while it always added to the cost of the gains. Lambs kept in a barn made as rapid and economical gains as those in an open shed, but did not finish or sell as well.

Shearing lambs before or during fattening is a well-established practice with sheep feeders in the States. Lambs to be fed until late in the season are believed to gain more rapidly and to maintain more eager appetites than unshorn lambs. The prevalence of the practice of shearing lambs led the Station to make a trial to test its influence on fattening lambs. The trial was conducted in the spring after the regular fattening trial had been completed, and the weather had become warm. Choice western-bred stock were used, and it was found that the lambs left unshorn during the feeding period sheared heavier fleeces than those shorn when put on feed. Unshorn lambs fed a ration of shelled corn, clover hay and corn silage returned a profit of 7 cents per head more than shorn lambs fed the same ration, while on a ration of shelled corn and clover hay, the lambs shorn at the beginning of the trial returned a profit of 7 cents per head more than those not shorn until near the end of the fattening period.

The lambs where fed in the barn, as mentioned in a previous paragraph, ate very nearly one-fifth of a pound silage more daily per head than the lambs in the open shed. The total gain per lamb in the ninety days was one pound more in the lot fed in the barn. The cost of gain was 14 cents per hundred pounds greater in the open shed than in the barn. The selling value of the lambs was 25 cents per one hundred pounds in favor of the lot fed in the open shed. The additional selling value of those fed in the open shed was enough that they returned a profit of \$1.59 per lamb, as compared with \$1.41 per head from the lambs fed in the barn.

Lambs receiving no silage made slightly faster gains than those receiving both silage and hay, and very much faster gains than those receiving silage without hay. The low rate of gain with those lambs getting no hay was due to the fact that the lambs had delicate appetites at all times. The addition of silage to the hay did not affect the appetites of the lambs for gain, but greatly reduced the quantity of clover hay eaten. The average daily consumption of 1.94 pounds of silage per lamb reduced the hay eaten 1.11 pounds daily per head. The largest quantity of silage eaten by the lambs receiving both silage and hay was 2 pounds daily per head.

The grain required to make a pound of gain was greater with lambs receiving corn silage. The roughage required to make a pound of gain was 5.85 pounds of clover hay where clover hay was used alone, 5.46 pounds of corn silage where silage was used with hay, and 9.62 pounds of corn silage where silage was the sole roughage.

Lambs fed on corn silage did not finish as well as those fed clover hay, although the difference in the selling value between them and lambs fed both silage and hay was only 5 cents per hundred pounds. There was a saving in cost per hundred pounds of gain of 78 cents when silage was fed once daily, and 88 cents when it was fed twice daily. This is largely due to the fact that corn silage is a cheaper roughage than clover hay. The finish of the lambs was practically the same in the lot receiving no silage, as with those receiving silage once daily. How-

ever, where silage was fed twice daily the lambs obtained an exceptionally good finish.

It was found that with lambs getting silage alone as roughage great care was required to keep them from going off feed. The shorn lambs were found to develop keener appetites and consume somewhat more feed than unshorn lambs and also gained a little more rapidly, but as before stated did not yield as heavy fleeces. Shearing had no effect on the profit.

### Live Stock and Soil Fertility.

Editor "The Farmer's Advocate":

In any scheme to maintain or build up soil fertility, crop rotation, including the growing of legumes, is vital but not sufficient. Clovers put the soil in better physical condition, so that the plant food in it becomes quickly useful to the next crop. There is a danger then that we may mistake a more productive soil for a more fertile soil, and be inclined to give too much credit to the growing of the clover and not enough to the feeding of it to farm animals. It does not matter what crops are grown. If they are all sold away from the farm, the soil will become exhausted. Live stock must be kept. Nature has provided the cattle to go with the land, and man cannot long disobey nature's decrees.

Looked at in any way there is money in live stock; money for dairy products, money for beef, money for the annual increase, and most money of all for the next year's crop when every particle of manure is saved and applied to the land. According to figures of the United States Department of Agriculture the yield per acre of corn in Kansas dropped from 34.3 bushels in the decade 1870-79 to 21.3 in the decade 1890-99. Kansas has also grown large quantities of alfalfa, but the corn and alfalfa have both been sold away from the farms, and the decreased yields have resulted. In Illinois, which is a stock raising and stock keeping state, the yields have actually increased. It is a significant fact that the stock states show the smallest losses in crop yields. If this is true of a state will not the same principle apply to the individual farmer?

F. C. NUNNICK.

Commission of Conservation, Ottawa.

## THE FARM.

### Principle of Cold Storage.

Most progressive farmers have learned the value of the individual ice-house, yet have not realized that the most economical way of using the ice cannot be developed without a properly-constructed cold storage chamber. Creamery and co-operative cold storage chambers are getting to be quite common now under the subsidy established by the Agricultural Department. Satisfactory insulation can only be obtained through the use of double walls for the chamber, in this way providing a dead air space between the walls, as that is the best form of heat insulation. It must be dead air, so the walls must be air-tight to give satisfaction. There are many other ways of insulating, as by filling the space between walls with some so-called "non-conducting" substance such as the following, named in the order of their desirability: hair felt, slag wool, wood ashes, chopped straw, charcoal, cork, etc. The insulating properties of these substances are due largely to the fact that they enclose in the tiny spaces between their particles, small amounts of dead air which cannot escape. This air is the insulator. This is the reason why substances which cannot be packed solid are always chosen, and also why such substances should be lightly tamped into place rather than rammed hard. It should be borne in mind, however, that for cold storage work something must be chosen which does not readily absorb moisture or odors. There is no one substance which will not do this to some extent. The practice in Canada is to use either hair felt and shavings, cork and shavings or cork alone. If the building can be built with matched boards and the dead air space lined with tarred paper, the dead air space need not be filled with anything. In fact a filling would be a decided detriment.

Moisture has the property of absorbing many gases and impurities from the stores, and it is, therefore, very desirable that the air in the chamber be kept as dry as possible and that the moisture which it does contain be removed, thus purifying the air. This can only be done by providing proper circulation of the air in the storage chamber, and thus cooling the stores by circulation of the cold air in contact with them, rather than by radiation from the source of cold. Unless cooling is done by the circulation of the air, the moisture will be deposited on the stores in place of being deposited on the ice as it should be. This, of course, will undoubtedly cause some of the packed material to become tainted.

To get a good circulation it is merely necessary to appreciate the importance of the fact that cold air drops and warm air rises. All that needs to be looked out for then, is to have

the ice box above the level of the storage space, and to introduce the cold air at the bottom of the cold storage space, providing an outlet and return at the top of the chamber for the heated air to go back to be cooled and rid of its moisture. For a small chamber it will be satisfactory if the cold air is allowed to enter all along one lower edge of the chamber, and the warm air taken out the upper and diagonally opposite edge. This will make it necessary for the air to cross and circulate all through the storage space before reaching the outlet. In a larger chamber the cold air could be introduced at the center of the floor, and taken out at each of the upper edges. In a still larger room, the cold air may be introduced along two side edges at the bottom and allowed to go out through two side edges at the top. Shields or deflectors, preferably of wood painted with bath-tub enamel, should be placed so as to prevent the cold air, as it warms up, going from the inlet opening directly to the outlet opening without circulating through the room. These deflectors should slope from the bottom up, and be placed just over the cold air inlets so that as the cold air warms it will rise along the deflectors towards the outlet. Care must be taken not to place the deflectors so as to "pocket" any warm air—that is, do not make them so that any body of warm air will be caught in an upper corner, for example, and have to go downwards to escape. Deflectors are only necessary where the outlet is nearly over the inlet, and a path from one to the other does not lead through or near the center of the storage space.

Ventilation, except in very large rooms, is satisfactorily taken care of by the opening and closing of the entrance door.

The packing of stores in cold storage is a science in itself, and can only be taught by experience. The general rule is, of value, however, and will take care of most difficulties. It is to pack the stores fairly close together and leave a space between them and the walls to allow a path for the circulating air. Never pack up close to the walls.

Nova Scotia. R. P. CLARKSON.

### The New No. 72 Oats.

It is believed that there is a great future for the O. A. C. No. 72 oat in Ontario. Its character is not such that it may become a popular Canadian grain, for the abundance of straw which is produced is not desired in the Western grain-growing Provinces, but for Ontario, where a compromise is desired between a heavy yield of grain and a light production of straw this oat will no doubt replace many of the numerous varieties now being grown in Ontario. In the opinion of Prof. C. A. Zavitz, of the Ontario Agricultural College, whose department is responsible for the creation and development of this particular variety of oat, it may not have the same phenomenal success as the O. A. C. No. 21 barley; but he expects it will reduce the multiplicity of different kinds of oats and bring about a uniformity of the crop.

The origin of this oat is somewhat similar to that of the O. A. C. No. 21 barley. In the initial stages between nine and ten thousand individual grains were planted by hand, and from the crop the very best individual of this number was selected as being superior to all its contemporaries. From this one individual plant has been developed this variety of oats, which has now gone throughout Ontario.

Compared with the banner oat, which has done good service and which is still one of the very best oats that can be produced, it excels this variety in yield and quality of straw as well as yield and quality of grain. With reference to the percentage of hull, Banner possesses about 30.9 per cent; Siberian, about 29.3 per cent., and O. A. C. No. 72, 27.7 per cent. These are the averages of five years' production and trials. Compared with the Banner alone there is a difference of about 3 per cent. in percentage of hull, in favor of the new variety, which, taking it throughout the Province of Ontario, would mean \$1,000,000 in the increased value of the oat crop. Some farmers might say that it is of little value to the individual grower, but it will figure to his advantage just in that proportion which he bears to the entire production; besides there is nothing too small to be considered when labor and expenses are always creeping up.

In five year's experimental work in the plots at the College the yield of O. A. C. No. 72 has been far in excess of other varieties. The appearance in the field presents a pinkish color, which is usually quite noticeable in the ripening grain and generally shows more or less distinctly after the grain is threshed. In stooking properties it is similar to the Banner and Siberian, and about two bushels of seed per acre is recommended in seeding. As far as it has been tried it will adapt itself to the different kinds and characters of soil as well as the aforementioned varieties.

### Seeds Weeds and Creeds.

Editor "The Farmer's Advocate":

Five million bushels of seed oats, two million bushels of potatoes, and two hundred thousand bushels of seed corn will soon have been sown in Ontario. These are large amounts, and the quality of all the seed used annually is of prime importance.

A good seedbed, well drained, and as free from weeds as we can get it, is important, but the quality of seed put into it is of equal importance. Just as we cannot make a choice steer out of a scrubby feeder, no matter how well he may be fed, so we cannot expect a good crop from poor seed, even on the best of land.

The cheapest seed is not the best. Its germinating power is low, and it contains many weed seeds. It is cheaper to buy alsike or red clover seed of No. 1 grade in preference to seed of lower grade, which may be a dollar or two cheaper per bushel. The extra strength of the dearer seed and the greater freedom from weed seeds will make up the difference.

All seed sold by seed houses comes under the Seed Control Act and must be graded, but seed grown, sold and delivered by farmers on their own premises does not. We advise careful examination where seed is bought in this way and no reflection is made, because generally the ordinary farmer has not the proper means for cleaning seed well. An instance may be given where a man cleaned out four bushels of refuse and weed seeds from thirteen bushels of clover seed. He did the work as thoroughly as his mill would allow, and then thought he had clean seed. But on sending a sample to Ottawa the test showed that he had over one thousand weed seeds per ounce. His mill could not get the seed clean enough to be saleable. A really good special small-seed fanning mill will reduce the weed seeds to less than one hundred per ounce, and is not expensive, costing about thirty dollars. Two or three neighbors can easily co-operate in buying a first-class machine.

The source of seed is highly important. Western oats are usually a mixture of varieties, owing to mixing and grading before shipping. They are also liable to contain quantities of weed seeds and frosted grains, and will likely give unsatisfactory results.

With alfalfa it makes all the difference where the seed comes from. Most of it comes from southern localities in the Western States, and the crop cannot be expected to withstand our severe winters. Only the variegated kinds of alfalfa, have proved themselves hardy in Ontario. They bear variegated flowers of white, yellow or violet in many shades. Unfortunately such seed is hard to obtain and is high in price, being worth up to one dollar per pound. This price is actually being paid, whereas the common variety only brings fifteen or twenty cents. Alfalfa is a crop of growing importance, and it certainly looks as if there was money in growing the right kind of seed of this crop.

Too much of our seed corn is grown in the States, and is not suited to our short growing season. There is a big demand for Canadian-grown seed corn. The demand is far greater than the supply. Only by northern grown seed can we hope to push the corn zone further northward.

Too many varieties of potatoes are grown in Ontario, with the result that buyers cannot obtain uniform carlots. They have to go eastward to fill their orders, and this means a loss to the Ontario farmer.

Our farmers are too ready to switch from one variety of crop to another without knowing what the result will be. Generally speaking, when a certain variety of any crop gives satisfactory results under local conditions, it should not be changed until another variety is proved to be better by actual experiment. Time does not necessarily decrease the yield. At the Ontario Agricultural College thirty-three varieties of wheat, oats, barley, peas and potatoes, grown continuously for the last twenty years, give better results now than formerly, and under the same conditions of fertility and cultivation.

Permanent pasture is coming more into use in Ontario as farm labor grows scarcer. An excellent mixture, recommended by Prof. C. A. Zavitz, is as follows: orchard and meadow fescue grasses each four pounds, tall oat grass three pounds, meadow fxtail, timothy, and alsike each two pounds, alfalfa five pounds, and white clover one pound. The blue grasses will spread into this mixture naturally and will do little harm.

Good profits in seed growing can be made from small beginnings. One farmer at Almonte started with an ounce sample of a good variety of oats, obtained at the seed-judging course. He now has five hundred bushels sold at a good figure.

A father and son, who three years ago started with one pound each of O. A. C. 72 oats, have with this season over three thousand bushels at sold this season over three thousand bushels at the two dollars per bushel. This illustrates the possibilities in this line of work. Although extra

care and labor are involved the results will pay. From one oat plant in three seasons the product may easily amount to one hundred bushels.

Just before his death recently, almost the last official act of the late president of the Experimental Union, was to present Professor Zavitz with a small but carefully selected sample of home-grown alfalfa seed. He expressed the hope that it might prove of some use to the farmers of Ontario. He had tested it, believed it was good seed, and wished to pass it on. Behind that simple act lay the spirit of public service—the same spirit which prompted the inception of the Union in 1880.

There is a keener demand to-day than ever before for good Canadian-grown seed. It gives better results than any other. To the man of observant eye and careful hand who will supply this need, will come not only financial profit, but a satisfaction born of needed work well done.

Wellington Co., Ont.

S. H. HOPKINS.

### Methods Which Give Results.

Editor "The Farmer's Advocate":

You invited subscribers some time since, to give their experience in methods which had proven successful in preparing land for various spring crops. The variations in the quality of the soil in this province are so many that the methods of cultivation would require to be almost equally as various. I believe, with one of your correspondents, that the growing of red clover (and alsike) is the "sheet anchor" of successful agriculture in Ontario. It should be grown upon any and every kind of soil where it can be got to grow. When one considers the high price of stock and stock-products, and also the fact that clover, so far from impoverishing the land, enriches it, it is probably our most valuable crop.

Throughout central Ontario from Grey County to Hastings, the pea crop is, next to clover, the "easiest" on the soil, and likewise having regard to cash returns, one of the most valuable, in that respect being on a par with winter wheat, and ranking next to corn and turnips. Many have obtained from the crop of 1912 returns varying from \$25 to \$60 per acre for peas suitable for canning. On account of a flatness in the demand the returns for 1913 were not so good; nevertheless it was usually a good paying crop. The straw is excellent for sheep feed, and I would consider a mixture of peas and oats, at current prices, more valuable for fattening stock or feeding dairy cows than any other grain on the market.

The best soil for ensuring a good crop of peas seems to be a strong, dry clay, plowed after a crop of clover (preferably spring-plowing), and then disced and harrowed till it is fine and firm. Sometimes upon autumn-plowed land, it will pay to disc it three or four times. Too early sowing, I believe, is not advisable, but much depends upon whether the crop is struck by extreme heat when it is in bloom. I have seen a splendid-looking crop almost destroyed by a few hot days about the first of July. There seemed blossoms enough for thirty bushels per acre, but not more than one-third of them came to maturity. The most popular varieties of medium-sized peas in this locality are the Elephant Blue, and the Canadian Beauty. These should be sown in the latter part of April or the beginning of May at the rate of three bushels per acre. The most popular varieties of small white peas are the Golden Vine and Prince Albert. These are usually sown at the rate of two and one-quarter bushels per acre. Upon exceptionally rich soil it is not advisable to sow a variety which grows too long straw. Judging by results, I prefer, as compared with other implements, the large disc (say 18 inch) for preparatory cultivation providing the land is clean. The light gang-plow and the spring-tooth cultivator may be better if there is twitch grass. In this locality we don't usually sow peas in ground too low lying, where they are liable to be scalded by water, lying after heavy rains, and it is not advisable to sow them on any ground where there is much sow-thistle. If it is not possible to summer-fallow or grow a hoed-crop upon all the ground which is infested by this or other very bad weeds, I have managed for a few times successfully in this way: with spring-tooth cultivator as soon as the horses can, walk over the ground. This will have a tendency to start as many of the weeds as possible to grow. After cultivation let the land be in that condition till all the rest of the land is sown. Then with the twin plow or the light-gang-plow it about four to four and one-half inches deep; use the spring-tooth again, harrow and sow with oats, or if the land is rich sow mixed grain. Of course this is usually only a makeshift, intended to keep the weeds in check till the crop gets growing, and, given favorable conditions the crop will usually get too far advanced to be injured by the weeds that season. I have harvested an excellent and clean crop of mixed grain (oats and barley) upon land treated in that way, which before was badly infested

with sow-thistle. I seeded the field down with clover and timothy at the same time and had a very fine catch...

A more thorough job can be made with regard to the extermination of weeds by giving the field a deep plowing, instead of a ganging...

Referring to the pea crop again, I might mention that ground which has been in roots or corn the year before often makes excellent pea ground...

Bringing Down the Price.

Editor "The Farmer's Advocate":

It is my privilege to live in Sackville, New Brunswick, alongside the famous Tantiamar marshes, whose thousands of acres produce annually thousands of tons of the very highest qualities of timothy and clover hay...

Some of us very recently have made several trips across the continent, and have visited such centers as Winnipeg, Brandon, Moosejaw, Medicine Hat, Regina, Calgary, Edmonton, etc., and have spent some time among the farmers in the Western Provinces.

I have stated that this is a very large beef-producing center. The farmers each fatten from ten to fifty cattle each winter.

fattened the steer in the East, or the mill owner who paid 70 cents for wheat 20 years ago, and pays 70 cents for it to-day?

Westmoreland Co., N. B.

Co-operation in Pleasure.

By Peter McArthur.

Some weeks ago I received a letter from Clayton Duff, whose essays on the Canadian poets appeared in the "Home Department" during the winter. These little essays, by the way, are about the best introduction to Canadian literature that I have yet seen...

"There a sort of men, whose visages Do cream and mantle like a standing pond; And do a wilful stillness entertain...

It would be much better for us if we would let the dogs bark, and the children play—and play a little ourselves.

Perhaps we have been lectured a little too much about the greatness of our destiny as a nation, and the seriousness of the problems by which we are confronted.

No people are fonder of field sports, Christmas gambols, or practical jests. Blindman's buff, hunt-the-slipper, hot cockles, and snap-dragon are all approved English games.

lish fingers tingle. . . . Then again, cudgel-playing, quarter-staff, bull and badger baiting, cock fighting are almost the peculiar diversions of this island...

That under Heaven is blown.

All we want is to proclaim a truce with reason, and to be pleased with as little expense of thought or pretension to wisdom as possible.

After that no Canadian need be ashamed of having fun once in a while. But I am afraid that a good many of us have forgotten how, and too many young people have never learned. Many of us can remember the days when we made a baseball from a ravelled woollen sock...

If people would only begin by enjoying themselves together they would get better acquainted, be less suspicious, and more prepared to cooperate in the more serious business of life. Every school section should have its own social organization, where old and young could meet from time to time to have a care-free frolic.

Editor Th roads hear again ful in horses writte true. of so puttin bear drivin have some it is ready of the ly, bu willin motor That to the cause are a are " Provi come the us of ro roads the p the m tax o weigh who i tenan terest the o good great hill is from ditthe by he consci passiv drivin makin comm A regard the cause nowad discar do wh not o the ro numbe cities spring sold t city m the m shoulc Hur Ma form, walks, caused is wrc In grade, a pro grade as ev the sc in ver by six using atten the w be the possib same dresse face i caused lumber any l dred, very straig necess at ea In three side o inside cause tend t under ant a and p clay.



**Sensible Automobile Advice.**

Editor "The Farmer's Advocate":

The season for motor traffic along country roads is almost here. And, no doubt, we shall hear the usual tirade, in its annual occurrence, against the cars and their drivers, and the woe-ful injury they cause to highways and hedges and horses and humans. Much of what is said and written against motor cars and their drivers is true. That it is true of some motor cars and of some motor car drivers is a better way of putting it. And, of course, all the rest must bear undeserved abuse, because of the reckless driving, carelessness and arrogance of those who have made motor traffic in rural districts, to some extent, a bad-smelling nuisance. However, it is not too late to mend. Motorists should be ready to meet every request, for the consideration of the "rights" of the country people, in a kindly, business-like way. Farmers should also be willing to listen respectfully to the claims of motorists as to their privileges on country roads. That heavy cars and trucks cause serious injury to the roads is beyond question. Lighter cars cause their share of injury. Wagons and buggies are also responsible. But rural municipalities are "supposed" to provide for all wagon injury. Provision for damage by motor traffic should come from the province that issues the licenses to the users of motor vehicles. To meet the expense of road repair and also to build better roads—roads, hard and firm, with a minimum of dust—the province should, by means of license fees, tax the motorist for a "fair" share of the cost. A tax of \$1.00 per horsepower and \$1.00 per ton weight of car would not be too high for those who run motor cars to pay towards road maintenance. Motorists kick against their own interests when they kick against a moderate fee as the one suggested. The money spent to provide good roads will prevent repair bills. And a greater consideration than saving a car repair bill is the safety of life assured by roads free from holes, ruts and treacherous culverts and ditches. Motorists look to their own interests by heeding the small requests of country folk for consideration. Care exercised in meeting and passing horse-drawn vehicles, especially those driven by women, will go a long way towards making a kinder feeling for motorists in rural communities.

A large number of people have spoken to me regarding the carrying of pennants and flags on the sides of cars. These unnecessary things cause more confusion and fright among horses nowadays than does the car itself. Let them be discarded by every motorist. Let all motorists do what they can to make motoring pleasant, not only for themselves, but for every user of the roads. Farmers are buying cars in larger numbers than ever. Dealers in towns and small cities have stocked from ten to twenty cars this spring. A good proportion of them are being sold to farmers. Co-operation of farmers and city men to make better conditions, not only in the matter of good roads, but in all social affairs should be the ideal.

Huron Co., Ont.

W. G. MEDD.

**Small Concrete Walks.**

Many farmers have difficulty in keeping the forms, or screeds as they are called in small walks, straight. Crooked walks are usually caused by nailing the screeds to the pegs. This is wrong.

In laying a walk first provide for a proper grade. Be sure to slope the grade to allow for a proper fall because it is easier to slope the grade than the concrete. If there is sod cut it as evenly as possible; this will help to support the screeds and it is well to have the bed grade in sod the same width as the walk. Sometimes in very stiff soil it is possible to lay concrete by simply resting the screeds against the sod, using a peg at each end of each screed. Never attempt to lay concrete without screeds because the walk is sure to be crooked. Screeds should be the exact height of the desired walk; it is then possible to straight edge all the concrete to the same level. They should be one inch thick and dressed on one side so as to leave a smooth surface in the finished work and to prevent holes, caused by the concrete sticking to the rough lumber. Bond strip, which is to be bought at any lumber yard for about twenty cents a hundred, is about one-quarter by two inches and is very good for curves but it is too thin for straight lines. When this is used in curves it is necessary to put in more pegs and to nail one at each end and one in the centre.

In setting straight screeds drive about every three feet and put one nail in the end of the outside of each board. Do not put any pegs on the inside of the screeds because this is the chief cause of crooked walks; the pegs on the inside tend to throw out the others. Have the ground under the screeds packed hard. This is important and applies to the entire grade bed. Wet and pack the bed before laying. Drainage, in clay, must be provided for. A good material is

fairly coarse pit gravel. Obviously, where drainage is needed the bed must be deeper.

In laying the concrete first place a shovelful about every eighteen inches. This is to take the place of the inside pegs and, if packed down, will prevent the screeds from bulging. Inside pegs are out of date. This concrete should not be placed until it is time to lay the walk and the idea is to spread the concrete so as to connect a section of these braces and then to fill the centre. A light traffic walk does not require more than two inches of concrete, but it is of the utmost importance to put on a good top. Walks usually break first around the edges and such breaks are nearly always caused by too little concrete. Here, the concrete must be good, but on the rest of the walk it is not so necessary. Should the walk be on a hill start laying from the bottom and work up. This is to keep the concrete straight and to retain the water. To spread the concrete use an ordinary garden

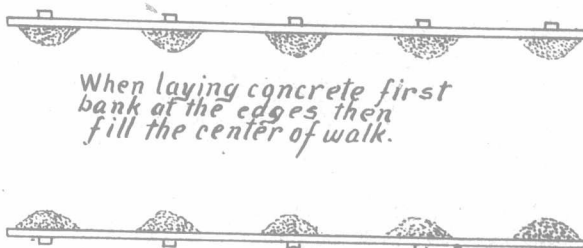

When Starting the Walk.

rake. Should the walk be against a house, float the concrete towards the outside to a slope of about one-quarter inch to the foot. This unlike the centre slope, can be done easier in the concrete than in the grade bed.

Coarse pit-run gravel is satisfactory for light traffic walks. One to six or seven, is rich enough for the rough and one to four for the top. This is rich enough to allow for any softness in the sand, although it is of the utmost importance to have sharp sand. Straightedge the concrete level by drawing a two by four down across the walk. Using a circular motion, rub the water up somewhat with the wooden float and finish with a steel trowel, if the walk is level. If on a hill, make a mark every inch or so by driving a sharpened board into the fresh concrete. Nail a stick on the side at each end so as to keep these marks straight. Expansion joints are not necessary in a light traffic walk.

Rolling the walk is good, but it is hard for the inexperienced man to do. A good roller costs about eight dollars. A walk not rolled is somewhat slippery and therefore, should not have too smooth a finish. Canvas is the best protective covering. If straw is used it should not be placed directly upon the green concrete.

The screeds should not be removed until the concrete has set three days. The best way to pull them is to use a shovel or a pick. The spaces left should be filled with gravel to the top of the walk. Usually the faster the concrete is laid the better the walk.

York Co., Ont.

CHAS. L. PITTS.

**More on the Ontario Farmers' Organization.**

Editor "The Farmer's Advocate":

In your issue of April 2nd, just to hand, I notice what appears to me to be decidedly peculiar. In the first place, I notice W. C. Good's reply to your report of the recent meeting of farmers in Toronto, which was published in your issue of March 26th, under the heading of "The United Farmers' of Ontario Launched." Mr. Good's reply is well-written, moderate and, on your part—deserved. I have always had great confidence in your paper, so was properly shocked when I read your report of March 26th—a report so full of misrepresentation, untruth (as Mr. Good has shown) and worst of all, of slurring innuendo, that it could not be passed over. As one well-known Ontario journalist wrote to me, "there is animus in it."

At the time your report appeared, I was inclined to put the blame on the reporter rather than on your paper. I thought perhaps he had been a mere callow youth, perhaps cynical and inclined to look on the world with "a jaundiced eye" and to suspect all human motives. However, the fact that in your issue of April 2nd, in which you published Mr. Good's letter, there is not one word of apology or explanation on your part, leads me to suspect that the report was published with your full knowledge and approval and that it is your deliberate intention to "knock" the new movement.

This is all the more strange, because you pro-

less devotion to the very objects for which the new movement stands. In your issue of April 2nd, in which you published Mr. Good's letter, you have first an editorial note urging co-operative buying and selling on the part of Farmers' Clubs. This is exactly what the United Farmers' Company is for, only, instead of the work being undertaken by the secretary of the local club, who of necessity must be at a disadvantage because of inexperience, we propose to supply the services of an expert central office, which will be in intimate touch with all conditions and can handle the trade to advantage, as the Grain Growers' Grain Company handles the grain trade of the Western farmers. To what do you object in this proposal? If you have any better plan we shall be glad to have it.

It may be, of course, that you think all this should be done under Government auspices. But how far do you think any Government would dare go in really establishing any effective plan of co-operation? We know, and you know, as you editorially admit in the same issue of your paper how far Governments are susceptible to the influence of "The Interests." We know also what powerful commercial interests united in an attempt to crush the Grain Growers' Company in the West. The same interests will be opposed to any effective co-operation of Ontario farmers. Can we expect any Government to risk incurring the ill will of these Interests? And do you not think it is better for farmers to show a little independence and self-help in the matter?

Then, I cannot understand why you should object to the organization of the United Farmers of Ontario. You have repeatedly urged local clubs, which this organization would promote. You have also taken part in the battle for the rights of the farmer, as you carefully point out in your editorial entitled "In the Fight for the People." Also you have had rather less effect than the proverbial fly on the wheel, as in the instance you refer to in the above mentioned editorial, where your representatives went to Ottawa on the question of the Banking Act. We all approved of your attitude and your action, but nothing came of it. The Bank Act is now rather worse than before. We may as well admit that an individual journal, or even an enlightened public opinion, if it is individualistic, can accomplish little. It is organization that counts. The Big Interests know this, and are highly organized, as your highly esteemed correspondent, Peter McArthur, has so often pointed out. In that case, what is wrong with the United Farmers of Ontario, which will federate all the local farmers' organizations into a really effective body, which would have a greater influence here than the Grain Growers' Associations have in the West, and would accomplish another potent fact—the federation of the farmers of all Canada? Ontario has always been the weak link in the chain. We hope to make it the strongest. Have you any objection?

Your report insinuates that the election of officers of the new organizations was engineered by the nominating committee. The logical conclusion from this is that there was self-interest behind it. You know of most of the men who have taken office in the new movement, and you know that they are not in any sense self-seekers. Most of them have given time, money and energy in the past, freely to the cause of the farmer, and have received nothing in return but the sense of having done their duty. In the new organization they will receive no more benefits than any private member of the organization. They are representative men from every section of the Province. Again, what is wrong with them, or of what sinister designs do you suspect them?

Speaking for myself, I will say (that I had no knowledge whatever of any move to make me the President of the United Farmers of Ontario. I was in Ottawa at the time of the election, with a delegation, to oppose the proposed renewal of the Iron Bounties. Personally I would rather have been left out of office entirely, as I know from experience what private sacrifice an office of this kind involves. However, I am grateful for the honor conferred upon me, and, because I thoroughly believe in the movement, will do all I can to forward it.

I have written the above because I felt strongly that the report in your paper was unworthy of you, unfair to the new movement and calculated to do a great deal of harm and accomplish no good purpose whatever. If you object to the purposes and aims of the organization we should at least be glad to know where you stand. If you have any criticism to make regarding the plan proposed or the methods adopted we shall be glad to have it. If you can show us how to do better we shall be still more grateful. But for the love of decency, don't be a mere knocker. Knocking is merely cheap—and mean.

If, on the other hand, as I still hope, your report does not reflect the attitude of your paper we shall be glad indeed to have the help and support of the old "Farmer's Advocate" in our

disinterested effort to uplift agriculture in the Banner Province—old Ontario.  
Simcoe Co., Ont. E. C. DRURY.

NOTE:—"The Farmer's Advocate" has or had no intention of "knocking" the organization of a central body of farmers, and it is only to dispel this belief from the minds of those who misconstrued the meaning of the report that this note is published. There was no hostile feeling or intent in our report which candidly stated facts, and pointed out the weaknesses and shortcomings as well as the strong points of the method of organization that those interested might benefit thereby to the ultimate good of the organization and Ontario farmers generally. Nowhere did our report ask for Government control; nowhere did it state that either president was instrumental in electing himself to his position; nowhere did it object to organization; nowhere did it contain misrepresentation, statements without foundation in fact, untruth and slurring innuendo. No factor working for the betterment of agricultural conditions in Canada is more ready than "The Farmer's Advocate" to lend full support to any organization which works for the welfare of the farmer and and we know that this influence is felt.

The attitude of "The Farmer's Advocate" towards this movement was very clearly expressed in the concluding paragraph of the report in our issue of March 26th, which we quote, "The United Farmers of Ontario should grow into a great movement if it gets the support of all organizations now active and many more yet to be organized. Upon these and upon the open straightforwardness of all the workings of the movement and the efficiency of the management depends the success of what we would be pleased to see the greatest movement for the good of the man on the land any part of Canada has yet witnessed. 'Equal opportunities for all' should be sufficient incentive. Let us hope that it is lived up to."  
—Editor.

### Tried Varieties Favored.

Editor "The Farmer's Advocate":

In the growing of cereal crops, much of the most important work should have been done before this time. A rich surface soil is necessary, but that depends on good general farm management, good, profitable stock, well fed; the proper care and application of farmyard manure on a proper system of rotation of crops, which will depend much on clovers and other legumes with a goodly percentage of well-cared for, hoed-crop and a sparing repetition of cereals. If then a first year clover sod, or a hoed-crop field be properly prepared in the fall, (which on our loose bottom) should not be too deep. It will only require the early preparation of a seed bed, with discs, cultivators and drags, a few inches deep into a fine tilth. The roller should only be used if necessary to make that fine tilth, but not to finish off with. If much crop is to be put in sharp drags or cultivators should be used to go over the ground to break the crust for the purpose of conserving moisture while seeding operations are progressing, and if a shower should occur, immediately after seeding, a drag should break that crust if possible before the germination of small seeds of clovers or grasses would make it injurious. Do not be carried away by every magnified advertisement or boasting neighbor praising every new variety for which a new name can be found unless you want a new disappointment; but pin your faith to good, clean, well-developed seed of a proven variety, and let it be superseded only by a variety that can do it by results under just and fair test of equal chances. We always treat oats with formaldehyde for smut, and would not wish to grow them without it.

Waterloo Co., Ont.

ANSON GROH.

### Stock Relish Sorghum.

Editor "The Farmer's Advocate":

I was very much interested in reading an article in your issue of April 2nd, on Sugar Cane. We call it sorghum and have grown more or less of it for a number of years, and our experience is almost precisely the same as that of Mr. Zavitz, only the seed will not ripen with us. All animals are very fond of it, even the pigs will eat it and require very little else. When we have more than we require for feeding green, we put the rest of it up in large shocks, say half a ton in a shock. We drive two stakes into the ground about ten feet apart, and then take a rail and drive a spike through it into the stakes at each end, and then stand the Sugar Cane up against the rail and tie it with binder twine to the rail by putting it twice around the shock and drawing it tight, so that it will not blow down. As soon as we have room in the barn we draw it in and cut it up for the cattle, and they will eat every particle of it in preference to corn harvested in the same manner.

York Co., Ont.

WM. LINTON.

## THE DAIRY.

### Milk Shortage in Western Canada

Editor "The Farmer's Advocate":

All cities in Western Canada are to-day facing a serious milk shortage. Despite the fact that dairying is urged by all agricultural institutions, ever increasing population renders the supply still extremely inadequate. There are many reasons for milk shortage, particularly in larger towns and cities. Insufficient dairy stock raising, lack of rapid transportation, and the general use of highly-perfected machinery increas-

mercialized no culinary article could be more welcome by the housewife. No sour milk, no ice, no dirty bottles, pails, or other unclean receptacle. Just milk. In the face of a milk stringency and exorbitant prices, we are offered this relief, economic and convenient.

A large and ever growing ice cream trade has developed in Western Canada, and in 1913 took the cream that would have made 6,000,000 pounds of butter.

Alta.

MAX. McD.

### Just one Mistake.

A case of "what might have been" was presented to a representative of "The Farmer's Advocate" upon a recent visit in Bruce County, Ont.

However, conditions are not so bad as this phrase indicates, for at the present time there are cows in the herd of this Bruce County farmer now giving over 85 pounds of milk, but there is an interesting story connected with the herd in so much as it frequently occurs throughout the whole country. The mistake is this—selling young heifers before they are tried and tested, and disposing of sires before their progeny has had a chance to demonstrate the worthy qualities of their parents.

During the siege of Ladysmith a young heifer calf was born on this farm, and in consequence of the time and national disturbance was named Ladysmith Betinna. Later a Holstein bull, Madonna's Calamity, was placed at the head of the herd, and several promising young heifer calves were produced as progeny of this bull. Two heifers stood side by side, but not knowing the possibilities of the individuals, the owner, disposed of one of them, but he considered at that time that he had retained the better of the two. Tracing this young animal which was sold, we follow her to the stable of one of Ontario's foremost Holstein breeders where the young female began a creditable performance, but she was subsequently sold to go to British Columbia where she has established herself as the highest-producing cow in that Province. Her name is Ladysmith Daisy. Her one-day record is 112 pounds of milk; in 7 days she produced 644.7 pounds, and in 14 consecutive days she produced 1,269.5 pounds of milk.

Rose De Kol Calamity, the stable-mate and half-sister of this record cow is still retained on the farm, but she has never been officially tested. The chances are that had she been fed with the same end in view in the R. O. P. she would have made as good a showing. In addition to this disposal of a valuable cow four other young heifers, progeny of Madonna's Calamity, were sold at about the same time. They are creditable producers as well, but they had been removed from the herd and the sire had been sent to the block before they had an opportunity of demonstrating their milking and high-producing qualities. This is a mistake, and a circumstance which frequently occurs in the management of dairy herds, but the reader must not gather from this little review of the story that the herd was demoralized, for Junetta, an eleven-year-old cow, now in the herd, is giving 85 pounds of milk per day.

All the poor dairy cows have not been taken out of the country since the removal of the United States tariff. There are too many of them left yet, but the really good ones are scarce. The only way to know the difference in the individuals is to weigh and test. Begin now.

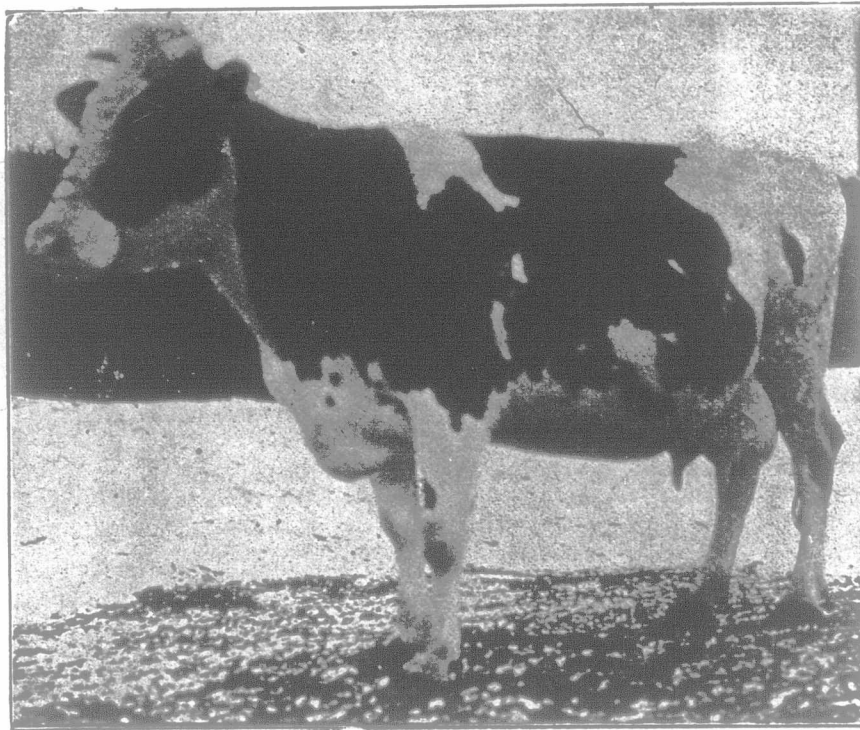

Rose De Kol Calamity.

At one time a stable mate of Ladysmith Daisy, which is now known in the West.

ing the home butter-making practice, are those most obvious.

On many Western farms to-day condensed forms of milk are used entirely, and in many towns surrounded by wheat farms, the milk supply is inadequate to supply the small rural populace. In view of the dairying possibilities of the West such conditions as those existing are most deplorable, and tend to increase the already high cost of living.

In times of milk shortage it becomes necessary for large creameries to substitute milk stocks in order to supply the demand made on them. By

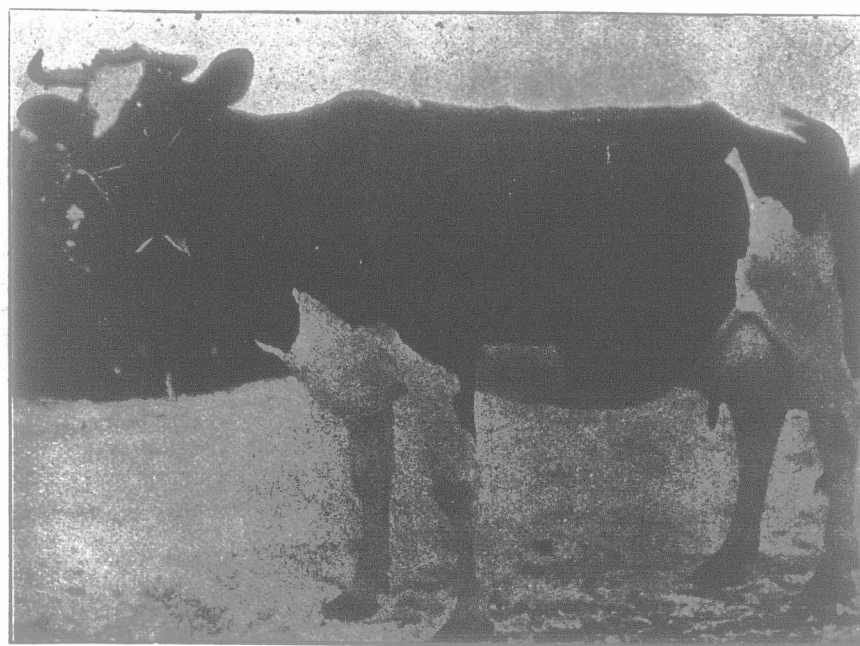

Junetta.

A cow now giving handsome returns to a Bruce County farmer.

improved scientific methods milk is dried; all the water is removed, leaving only the solids in flake-like powder. By the process of drying the nutriment of the milk is left undiluted and becomes pasteurized. In this form the milk is germ proof and easily digestible, still containing all its strength-giving and heat-producing properties. The food value of milk thus treated is absolutely unimpaired, and is now recommended even as infant diet.

Like all new productions the use of milk in this form may be lessened by prejudice. This, however, when overcome will result in a great demand for such concentrated foods. When com-

## HORTICULTURE.

### Western Fruit Combine.

Editor "The Farmer's Advocate":

Some people may imagine that because the peach situation in the West is pinching the Western growers and their customers on the prairies, that others will feel the benefit and that it will be a snap for the Eastern growers to get in and take this market. Now it will not.

I think it is a national disgrace. To our citizens it must be galling, to our government an inexcusable piece of (or price for) carelessness and tolerance, not the present Government alone but also the last, that a combine from across the line should, without question, hold the middle class of our citizens in a grip that is crushing under its weight a desire on the part of these citizens for the good and necessary things of life.

Perhaps this should be explained. There is a combine in the fruit jobbing houses of the West and here is an idea of what the situation is in some localities where they are well entrenched. How long it will be till it is general, is hard to say. This week, we were at a conference of the Okanagan United Growers, a great co-operative movement in the Okanagan, launched last year. By the way, our manager took occasion at this meeting to extend to the new Ontario co-operative a most hearty wish for their success, which we all endorsed. One of the speakers, a keen business man, a leader in the Valley in recommending that we break from the jobbers stated that he had been speaking with an independent jobber and asked him if there was actually a combine, "Well" he said, "a short time ago I asked a retailer here to give me an order for apples. He wanted to, but thought he couldn't." Finally he said "all right if you will agree to deliver them after dark." Think of it! In Canada! A blazon insult to freedom. Not because it is a foreign trading company, that is bad enough, but that within our boundaries it should be tolerated at all by our government.

This is the situation and it is only going to be solved in one of two ways; by all co-operatives that cater to the Western market working together (and working the government if need be) or else by the Government itself taking the initiative which they should. It is not the farmers who should stir up the government but the city people who are complaining of the high cost of living. Here is a chance for them to help themselves, but you can rest assured that they will not attempt it. So it is for our co-operatives if they wish a better and wider market than they now have.

British Columbia. WALTER M. WRIGHT.

### The Formalin Treatment Best.

Trials have been made at the Geneva Experimental Station to procure a remedy for scabby potatoes other than the common formalin treatment now in common use in this country. One method where formalin and crystals of potassium permanganate were used to generate a gas gave unsatisfactory results and the conclusions arrived at by the experimenters are favorable to the liquid treatment, which has been practiced commonly heretofore. Corrosive sublimate is a sure cure for scabby potatoes but it is such a deadly poison that it is not safe to recommend for general use. This elimination of other treatments throws the potato growers back upon the old-time treatment known as the formaldehyde solution, which is as follows—mix one pint of 40 per cent. formaldehyde solution (commonly called formalin) with 35 to 40 gallons of water. Soak the uncut tubers in this solution for two hours. The same solution may be used repeatedly. Treated tubers not required for planting may be used for food or fed to animals with perfect safety.

## FARM BULLETIN.

### International Peace Preparation.

Editor "The Farmer's Advocate":

I have read with great interest the articles and communications in your issues of Feb. 5th, March 5th, and 12th, viz., "Militarism in High Places," "Plowshares Into Swords," "An expensive and Burdensome Movement," "Canada's Day of Peril," and "Ready for a Scrap." While the last article is diametrically opposed to the other four, it seems to me that "Washington" was a pretty level-headed man. However, the thought which seriously occurred to me is, "How is a remedy to be accomplished?" This point seems to have been overlooked by them all.

We may criticize any measure, and probably are entitled to protest against such intolerably expensive armament systems as the ones now in vogue. The Imperial Ministry are not only do-

ing so, from what I read, but are puzzling their brains to the utmost to know how to keep them up. Can anyone say with reason that Mr. Asquith or Earl Grey are men disposed towards war? (I am assuming we are part and parcel of the British Empire). The Unionists (the opposition) are waging a bitter war with this government on the Irish Home Rule Bill. Why do they not attack them on the question of armament? Apparently they have no alternative proposition to offer them, and are too loyal to weaken their hands on such a vital matter. The "Peace-at-any-Price Propaganda" seems to be satisfactory to a very small minority indeed, as it should be. I don't know what Winston Churchill had in mind when he, indirectly through the press of Great Britain and "possibly" through the Foreign Office of the British Government, suggested to one of the greatest of military powers the adoption of some plan to reduce these enormous expenditures, but what could he do more as the head of the defence of the empire. Is he not in duty bound to see that the defences of the country are adequate, whatever that may mean? And what less can any Government do, loyal to itself and to the nation, than, first, to supply these requirements until better conditions prevail. Who would sacrifice their liberty and independence to save their "purse"? Would not their "purse" go with their independence? Who would leave their country "unarmed" before a powerful opponent "fully armed"? No honest man. Could anyone depend on such an opponent doing anything but enlarging their own boundaries? No British or other "christian or civilized" government could exist a day that was even suspected of such a policy. Two or three countries whose interests, in the eyes of their governments, gained mutual advantage and protection thereby, have agreed to arbitration "conditionally," but that does not settle the matter by any means. The only practical and efficient means "must prevent war."

There are many kinds of war. War among the shipping interests, railways, telegraph, telephone, electric light and power companies, and various other combinations. How do these fights usually end? By uniting against whom? The people. Political or national wars do not end so. They end by defeat on one side or the other, but not until bloodshed, pestilence, famine, epidemics, outrages, crimes and untold misery have devastated one, both or all of the opposing combatants. Who suffers? The people. The "long-suffering people." The intriguers come out with "laurels on their brows." Then what? The rebuilding of armaments. Well, it seems to me the intriguers have had their innings with a vengeance. Surely IT IS TIME THE PEOPLE TOOK THEIR TURN.

If the individual populations of these countries have definite aims upon each other's territories, there is no use talking peace. Who are you going to make it with? Then, in that case, have you not to prepare for war? Where do the first "whispers" of war come from? Assuredly not from the people, but from the intriguers. Under present conditions, while the people may have no such individual intentions, and hundreds of thousands of them no thought on the matter whatever, they are plunged into war before they know it, and compelled in self-defence to rush to arms. The cause may be grasping, monetary interests, political intrigue or ruling ambition, but the people have to pay the bills and undergo the suffering. It has always been so more or less in the past. How can this be prevented? By the people themselves and by them only, in the same way as they have already gained their political liberties and rights. They have won these by uniting on one thing after another until they gained what they were entitled to, often with bloodshed, truly, but that can be avoided now. Could they unite to throw off these military burdens borne by them at the present time? Without doubt, without bloodshed? Yes. How? Through their "franchise." Now the "result" of the burdens they are carrying is war, bloodshed, outrage, epidemics, famine and misery undecipherable, as the last Balkan wars have plainly shown, but the burden itself is "taxation," direct or indirect, a commercial educational and industrial necessity. This taxation is under control of the electorate, and the electorate control the governments. They (the governments) cannot go to war without money, and they cannot get the money but through the people if properly "organized." Not so when the people are "unorganized." Then they are pitchforked into war, and have to fight in self-defence and to submit to "conditions" in the end.

The greatest nations compose the so-called "European Concert," add to these the United States and Japan. These governments are all democratic or semi-democratic. They are classed in the list of civilized nations. When it comes down to "hard tacks" their "rulers" are subject to the will of the people, and in nearly every one of these countries they are "chafing" under tremendous military burdens and service.

They comprise five empires, two republics and one kingdom. Their governments have a military

organization amongst them, capable of overcoming the rest of the globe for the next century at least. But they are all in the one and same condition; they cannot get the requirements to carry on war, unless their subjects furnish them. So the people can control the situation after all. If these people are all anxious for these immense armaments, what can be done? Nothing but pay the "piper." But again fortunately they are the very reverse. In many cases they are fairly driven into the armies. No doubt they are all intent and determined on liberty with a great big L, free industry, trade, commerce, happiness and prosperity, the very reverse of war, and rightly so. Who can substantiate that they cannot get these without war? Their interests are entirely and essentially industrial and commercial.

Then will the people of these countries "co-operate" to reduce the burdens of their taxation, PREVENT THEIR HARD-EARNED MONEY BEING THROWN INTO THE SCRAPHEAP, SUPPORT A LUXURIOUS CROWD OF IDLERS AT THEIR DIFFERENT CAPITALS AND OTHER PLACES, WASTING THEIR TAXES IN USELESS WAR SCARES, AND POLITICAL INTRIGUES, SUPPORT AN ARMY OF MILITARY SNOBS, WHO, IN MANY CASES, TYRANNIZE THE VERY PEOPLE WHO FEED AND CLOTHE THEM, AND MAINTAIN IN LUXURIOUS SPLENDOR THE VERY INTRIGUERS AND SCHEMERS WHO EMBROIL THEM IN WAR, AND ITS RESULTANT EFFECTS OF BLOODSHED, FAMINE, DISEASE AND DEATH, IN ITS MOST EXCRUCIATING AND DISGUSTING CONDITIONS, NOT ONLY TO THE SOLDIERS THEMSELVES BUT TO THE PEOPLE AS WELL, TO MOTHERS, WIVES, CHILDREN AND INNOCENT BABES, AS THE LAST WAR REVEALED. If they will not "co-operate" then they must suffer and "pay" for it besides. I do not despise a soldier, but respect him as the defender of his country home and race, nor the leaders of the people who are patriots in the highest sense of the term, and are loyal citizens to their King, the Crown, and the Empire, but a system is to be abhorred, which makes it possible to plunge two or more nations into war, at the dictation or by the intriguing of one or more groups of schemers whose only direct responsibility is to shout the national anthem and patriotic slush. How can this co-operation be brought about? I say again by the "franchise." If these people can be united "for" war is it not a scientific fact or principle they can be united "against" war. I claim they can be more easily and efficiently united "against" war than "for" it. It seems to me, from reading the accounts of the last Balkan war, the least important item is the expense. It should be the aim of every member of any civilized nation, men or women, to do all they can to prevent the "spectre" of war approaching their country. Look at what is taking place in Mexico, atrocities of all kinds and descriptions, both in high and low places. Were these originated in cold blood by the people? If these people had been properly organized this could neither happen at home nor abroad, and these Mexicans, to my mind at least, would have been working along peacefully to-day if they had not been disorganized instead and distracted and brutalized by intriguing scoundrels and worse, who are living in affluence out of their miseries, posing as "patriots." Then I say let the people organize and co-operate together, in one body, with one aim, the shackling of war.

It takes more than one to make a bargain, and, as Peter McArthur says, the way to co-operate is "to co-operate." Let them organize an International Peace Association. Then let the heads of these separate branches of this association put their heads together, and I venture to say, through the simple fact of their doing so, the intriguers would find themselves on very "thin ice." But they can do more, infinitely more. Every man entitled to manhood suffrage should be a member of that association, and every woman who is interested in her family and home. Such an organization, for one purpose alone, could and would control the strongest government that could be formed in any country. No party politics could disrupt them, for they would have but one aim, "peace." Both parties and all parties would unite for "peace," and no government would dare to go to war in opposition to such a union. This country, not in part, but in whole, and I presume other countries likewise, are already organized for party politics. Let these members join this International Peace Association as well, in one body instead of two or more, and the thing is done. These party members are opposed to each other in politics only. They have no grudge or individual grievance against each other. They associate at hotels, trade and travel together, work and plan financially together, attend the same churches, and unite socially together, without a thought of partyism. Why can they not unite against war? I cannot recollect ever having discussed war with anyone who wanted it. It is the last thing the country as a whole or

individual desires to see. I once belonged to one of the militia regiments, but never heard anyone of my comrades desiring war. A few in the armies and navies, for the means of promotion, may desire it, but they are a drop of water in a rain cloud. Then surely common sense and humanity will lead people into union instead of war. All these voters have to do is to duplicate their membership into one association instead of two or more, and the moment that is done the backbone of war is broken. I read an account the other day of the German army by a writer who seemed to know what he was writing about, stating the German government were spending \$250,000,000 on the military branch of their armaments alone. This means \$5.00 for every man woman and child in the German nation or \$25.00 for every head of a family, a process simply "preparing" for bloodshed. To wipe out war altogether it would cost 50 cents instead. Surely this is worth considering.

I therefore submit the simple remedy of "co-operation," an International Society of "Peace," a living body of capable and patriotic citizens to organize the people in these different countries into a solid and undaunted "force" to resist and eliminate these OUTRAGEOUS AND SENSELESS EXPENDITURES. They can do so through their franchise, without bloodshed, and with an infinitesimal fraction of the cost of the present expenditures without the resultant sufferings of humanity. The system can be devised, the details mastered, much more easily and efficiently than the "tactics" of war.

The writer is not a "Solon" philosopher, philanthropist, anarchist, socialist, crank or dreamer, but a plain, ordinary, common-sense reader and thinker, taking, as previously stated, an interest in the public questions of the day, and the many articles and editorials on the elevation, education and uplifting of the individual for the progress, prosperity and happiness of the people generally, and is prepared to put up the first dollar towards the EMANCIPATION OF THE SLAVES OF MILITARISM.

#### A CONSTANT READER.

Nipissing District, Ont.

[Note.—In recent years the peace movement has gained a strong impetus, and hundreds of organizations have come into existence. Apart from this the Hague Tribunal, one of the most vigorous agencies in the Carnegie Endowment for International Peace, formed three years ago, to which Mr. Carnegie contributed \$10,000,000. The first aim of its Division of Intercourse and Education is to create an international organization. The most valuable agency is said to be the Conciliation Internationale, having headquarters at Paris, France, and branches in other leading countries. Our correspondent and other readers can obtain literature and general information on the subject from the Secretary of the American Association for International Conciliation, Substation 84 (407 West 117th St.,) New York City; also from The American Peace Society, Colorado Building, Washington, D. C., or The Peace Society, 31 Beacon St., Boston, Mass., or Sec. Canada Peace and Arbitration Society.—Editor.]

### Raising the Corporations Taxes in Ontario.

It is understood that the Ontario Government plans to bring in legislation this session adding considerable to the imposts on corporations which will bring into the Treasury about three-quarters of a million dollars in advance of the present revenues from companies. The tax on banking corporations is to be increased to 1-5 of 1 per cent. on paid-up capital in place of 1-10 of 1 per cent. as at present. This is to operate up to the \$6,000,000 mark with \$50 for every hundred thousand dollars in excess of this figure. Head offices are to pay \$500 tax instead of \$100 as formerly and from \$25 to \$50 for each branch office or agency in the Province. The tax on Life Insurance Companies is to be raised from 1 per cent. to 1½ per cent. on gross premiums. This will add at least \$100,000 to the revenue. Other insurance companies now paying 2-3 of one per cent. will from now on pay 1 per cent. Loan companies are to pay 1 of 1 per cent. on paid-up capital instead of a tax that now works out at about 1-12 of 1 per cent. and in no case will their tax be less than \$100. Trust companies will pay a tax of 1 per cent. calculated on the gross annual income in addition to the quarter of 1 per cent. present tax. The tax on telegraph companies has been increased from 1-10 to 1-5 of 1 per cent. on the total capital investment and telephone companies will pay ¼ of 1 per cent. instead of ¼ of 1 per cent. on paid-up capital in Ontario and in no case shall the tax be less than \$50 per year. Small local companies are dropped out entirely. Unless the tax reaches \$50 they will be immune. The tax on express companies will be \$1000 for each hundred miles of line their business covers. This is double the old rate. Gas and electric light companies are to be subject to a new tax. In addition to the present tax

of 1-10 of 1 per cent. on their paid-up capital there will be a tax of 1 per cent. on the net annual revenue. This does not cover natural gas or a municipally operated gas company. Car companies must pay a tax of ¼ of 1 per cent. on the money invested in dining, refrigerator or fruit cars in use in the Province. Race track meets are hit rather hard; the new rate being \$500 per day instead of \$200 as formerly. ¼ of 1 per cent. of the gross revenues of the railways is added to the tax on these corporations and each street railway company will pay in addition a tax of ¼ of 1 per cent. calculated on the gross earnings of the railways in the Province.

### Canadian Tariff Changes.

Among the tariff changes brought down in the recent budget speech of Hon. W. T. White are very few affecting the farmer directly. Mowing machines, harvesters, self-binders and reapers are lowered to 12½ per cent. the former tariff being 17½ per cent. but malleable castings for implements are retained at 15 and 17½ per cent. A notable factor in the changes is that parts of traction ditching machines formerly dutiable are now on the free list.

Rolled round iron wrought in the coil of iron or steel not over ¾ of an inch in diameter is changed from \$3.00 to \$2.25, \$3.50 and \$3.50 per ton when imported for manufacture of wire in the coil. For use in the manufacture of chain changed from \$3.00 to \$2.25, \$3.50 and \$3.50 per ton. Rolled iron or steel angles, beams, channels and other rolled shapes and sections of iron and steel not punched or drilled or otherwise further manufactured weighing over 120 pounds per lineal yard N.O.P. not square, flat, oval or round shapes and not being railway bars or rails are changed from \$2.00 \$2.75, and \$3.00 to \$2.00, \$3.00 and \$3.00 per ton under British preferential, intermediate and general tariff respectively.

Cassava flour for the manufacture of explosives is free.

Building stone sawn on four sides is made dutiable at 15c per hundred pounds and when further manufactured at 45c per hundred pounds instead of 20 per cent. as formerly. Galvanized hoop steel is changed from 30 per cent. to \$7.00 per ton general tariff. Wrought or seamless iron or steel tubing from 4 to 10 inches in diameter changed from 10, 12½, and 15 per cent. to 20, 30 and 30 per cent. Wrought or seamless iron or steel tubing over 10 inches in diameter changed from 10, 12½ and 15 per cent. to 10, 15 and 15 per cent. Coil chain and links 1½ inches in diameter and over changed from 5, 7½ and 10 per cent. to free, 5 and 5 per cent. Coil chain and links under 1½ inches changed from 5, 7½ and 10 per cent. to 15, 20 and 20 per cent. Malleable sprocket chain or link belting made free when used in agricultural implements, whereas it was formerly free for all purposes.

Iron or steel sections for hames and saddlery hardware are placed on the free list where formerly they paid a general tariff of \$7.00 per ton. Cork slabs, boards, planks and tiles produced from cork waste or ground cork are changed from 15, 17½ and 20 per cent. to 20, 30 and 30 per cent.

Garnetted wool waste in the white is made free. Silk in the gum or spun silk for silk thread is transferred to the free list. Buttons of vegetable ivory are changed from 22½, 30 and 35 per cent. to 5c per gross, plus 20 per cent. 5c plus 30 per cent. and 5c plus 30 per cent. Paper twine for furniture is made free. Jute canvas uncolored, not finished, is changed from the free list to 7½, 10 and 10 per cent.

Dried or evaporated bananas are free under British preferential and are taxed ¼c per pound under general and intermediate tariff.

Dessicated coconut sweetened or not per pound is raised from 3, 4 and 4c to 3, 4 and 5c. Talc which was formerly free is put in the unenumerated list and made dutiable at 15, 17½ and 20 per cent.

Caustic soda in packages not less than 25 pounds is changed from free to 1-5, 3-10c and 3-10c. When in packages of less than 25 pounds 17½, 25 and 25 per cent. instead of free.

Chloride or lime and hypo-chlorite of lime in packages not less than 25 pounds transferred from the free list and made dutiable at 10c and 15c per hundred pounds. When in packages of less than 25 pounds 17½ per cent., 25 per cent. and 25 per cent. instead of free.

Carbon electrodes of over 35 inches circumference changed from 3 to 20 per cent.

Silver lenses rate reduced from 30 per cent. to 15 per cent.

Aluminum leaf reduced from 27½ per cent. to 3 per cent.

There were several other changes but these are amongst the most important.

There were several provisions for draw-back, not important of which to the agriculturists was that on wire rods for fencing purposes.

### Thirty Millions for Ontario Roads.

The people of Ontario have been eagerly awaiting the report of the Provincial Highways Commission. This report was brought down in the Legislature last week and plans an outlay of \$30,000,000, with which it is hoped to adequately deal with highway problems in this Province. A full report of Commissioners C. A. Magrath, W. A. McLean and A. M. Rankin is now in the hands of the printers, but the Minister of Public Works, Hon. J. O. Reaume, outlined the main features of the recommendations of the commission before the House. The commission recommends that \$12,000,000 of the \$30,000,000 asked for be contributed by the Provincial Government, the counties to contribute another \$12,000,000, and the cities \$6,000,000, such obligation to be incurred gradually covering a period of fifteen years beginning in 1915 and extending to 1930.

It is suggested that a new motor tax to augment the revenue by about \$400,000 be put in force. Automobiles up to 20 H.P., the commission thinks should be taxed \$10 per car, from 21 to 30 H.P. 50c per H.P., from 31 to 40 H.P., 60c per H.P., from 41 to 56 H.P. 75c per H.P., and over 56 H.P. \$1.00 per H.P.; trucks two tons and less \$10 per car and over two tons \$5.00 per ton; motor cycles to have a uniform charge of \$4.00; chauffeurs' licenses to be \$4.00 and the tax placed upon foreign touring cars and trucks \$10.

The report places all highways in two main divisions, namely county or market roads and township roads. The county or market roads being the large division are classified into suburban, inter-urban and rural. It is the belief of the Commission that suburban roads should be maintained by the Province in co-operation with the local authorities. Cities, they think, should contribute 30 per cent. towards the cost of constructing such roads and 33 1-3 per cent. towards their maintenance; the remaining charges of construction should be divided, 30 per cent for the county and 40 per cent for the Province. Where the cost exceeds \$10,000 per mile local improvement charges should be used to meet it. Of the inter-urban roads 33 1-3 per cent. should be apportioned to the county and 66 2-3 per cent. to the Province and in maintenance 40 per cent. should be borne by the county and 60 per cent. by the Province. Projected trunk roads are exempted from the classification and are listed as suburban roads. Local roads, in the opinion of the commission should come under the control of the county councils or a permanent commission and the charge should be borne 40 per cent. by the county and 60 per cent. by the Province.

Township roads, the commission recommends, should be left in the hands of local councils. It is, however, suggested that the Province should spend \$250,000 on these roads annually for three years, apportioning \$50,000 on the basis of assessment, \$50,000 on the basis of population and \$150,000 on the basis of area, on the condition that every township spent at least \$4.00 for each dollar contributed by the Province, that proper drainage be installed, roads be dragged and statute labor abolished or commuted and a proper road organization established.

One of the largest problems in the entire work is the bringing of 42,500 miles of township roads up to a reasonably high standard and of fitting 7,500 miles of county roads to bear the heavy traffic.

Inequalities in assessments, the board believes, could be prevented by appointing an assessor for five years under the jurisdiction of a district or a qualified assessor. Some advantages are also thought to be obtained from electing a municipal council for two-year terms.

Counties now working under the Highway Improvement Act are encouraged to continue the work and the regulations will be made as elastic as possible to allow other counties to begin work. It is advised that a traffic motor survey of principal roads be taken to determine their physical condition; that a traffic census to determine the present road needs of the Province be made and an investigation be carried on during the summer into the needs of main township roads. It is also advised to carry on an investigation to outline plans of market roads for counties not now operating under the Highways Act. The organization suggested the creation of a sub-department of highways in charge of a Deputy Minister and a Chief Engineer working with the co-operation of an advisory commission. This would mean an enlargement of the present highways Branch of which Provincial Engineer, W. A. McLean is head.

The report also contains considerable information on the relation of roads to farming and the marketing of farm produce. We hope to be able to publish more of the findings in detail as soon as a complete copy is available.

**The Maritime Horse Show.**

The fifth annual Maritime Horse Show was held in the Winter Fair Building, Amherst, April 1st, 2nd and 3rd, and was a decided success. The entries were considerably larger than at any previous show, and the quality of the horses in all departments was vastly improved. Fred Richardson of Columbus, Ontario, who has judged the heavy classes for the past two years, said that he was very much surprised at the improvement in the quality especially of the Clydesdale grades. Possibly the Clydesdale and grade Clydesdales were the strongest classes in the show this year, though in point of numbers the Roadster classes led, but the quality of the Clydesdales shown by R. A. Snowball of Chatham, Logan Bros. of Amherst Point and McFarlane Bros. of Fox Harbour, made the Clydes the strong feature of the show.

Thoroughbreds were shown by Geo. Carville of St. John and Geo. M. Holmes, Amherst. Mr. Holmes' stallion "Bindemeer" and Mr. Carville's "Melsino" were good specimens of the breed. Mr. Holmes also showed the good brood mare "Anna Smith" and several fine youngsters.

Standard-breds were out in large numbers and splendid quality. "Mayor Todd", owned by Hammond Kelly of Charlottetown, P.E.I., and "Lord Hastings", owned by H. W. Ryan of North Sydney, were close contestants for first place in the aged stallion class, but were placed in the order named and "Leland F", shown by Frank C. Redding of North Sydney, won third place with "Maid's King", owned by Dr. Ronan of Antigonish, fourth. The standard-bred mares brought out eleven entries and were a breezy-looking lot, with apparently plenty of speed.

Hackneys made a very attractive showing. The aged stallions "Model Performer", owned by R. A. Snowball, and "Sidgeford Enterprise", shown by McFarlane Bros., attracted the attention of everybody by their high and true action. They were placed in the order named.

In the carriage classes, McAvity of St. John, and A. P. Elderskin of Amherst, showed Hackneys, single, double and four-in-hand, which made a most attractive exhibit all being high-class Carriage horses. Their competitors E. J. Peel of Amherst, and J. C. Purdy showed horses with more speed and not so extremely high in action perhaps a more useful road horse, but not in the same class as Carriage horses.

Percherons were not shown in large numbers, but those shown by Charles Lymes of Minudie, were of good quality, and the stallions shown by D. S. Mann and the Roderique Horse Co., of Pettitcodiac were good specimens of the breed. Several good grade Percherons were also shown in the classes for Agricultural horses and made the competitions lively for their more numerous rivals, the Clydesdales.

Clydesdales were out in force, and when we see such horses as "Baron Squire" by the noted Baron's Pride, owned by McFarlane Bros., the winner of the first prize in the aged stallions class, and "Baron Belgreddin", owned by R. A. Snowball, which took second place, along with a whole string of good ones which had to be contented with lower-places or no place at all, we certainly look for great things in the future for Maritime-Province draft stock. The Clydesdale mare "Baron's Fancy", shown by Logan Bros., and McFarlane's entry "Bess Spencer", were placed in the order named and are certainly high-class individuals of the breed fit to show in any company in Canada. In the three-year-old class, R. A. Snowball won first on "Baron's Own" and C. A. Archibald of Truro won second place. "Baron's Own" is a horse of good quality and great substance, and we look for him to make a name for himself both as a sire and in the show ring.

The three-year-old Clydesdale fillies were a particularly strong class, R. A. Snowball winning first on Miss May a filly of exceptional quality and plenty of size, C. B. Emree of Amherst, won second on the imported mare Augusta, and Logan Bros. third on "Susie of Homestead", with H. S. Pipes & Son fourth on Princess Nora.

The classes for Roadsters were the best filled in the whole show. The class for roadsters over 15 hands 2 inches had 21 entries, and those under 15-2 numbered 25 while the class for three-year-olds numbered twelve.

In the 15-2 class, A. C. Thompson of Sydney won first, J. C. Purdy, Amherst, second and W. A. Humphery, Moncton, third on high-class horses and many beautiful road horses had to go without a place.

In those under 15-2, Spurgeon Gammon of New Glasgow won first, A. P. Elderskin, Amherst second and B. C. Chapman third.

In pairs of Roadsters, Spurgeon Gammon won first, J. C. Purdy, Amherst, second, T. E. Lowther, Amherst third, and Blake Fisher, Amherst fourth.

The riding of Miss Blanchard and Miss Holmes in the ladies' saddle horses was very much admired; Miss Holmes winning first in the

saddle class, and Miss Blanchard first in the class for hunter ridden by a lady.

The attendance on the first day was good, but a regular February snowstorm the second day prevented many from attending. Friday's attendance was up to that of former years.

C. H. B.

**New Fruit Commissioner.**

Canadian fruit growers will not be surprised to learn that Donald Johnson of Forest, Ontario has been appointed to the commissionership of the New Fruit Division at Ottawa. Editorially on January 8th, 1914, the Farmer's Advocate, expressed itself in favor of a separate Fruit Division, whereas, up till recently, that department of the agricultural work has been supervised by the Dairy and Cold Storage Commissioner.

The new arrangement will give prominence and satisfaction to Canadian fruit growers as will the appointment of such a capable head of the Department as Mr. Johnson. The new Commissioner has every qualification for the office. Born 36 years ago on the Johnson farm at Forest, Mr. Johnson became active in the horticultural work at sixteen years of age and for a number of years served as foreman and head packer. Ten years ago Mr. Johnson became interested in the co-operative movement. He took a leading part in the organization of the Forest Fruit Growers' Association, (one of the first in Canada) and was



D. Johnson.

The newly-appointed Fruit Commissioner for Canada.

for six years their president and manager. He has been president of both the Co-operative Fruit Growers' of Ontario and the Ontario Fruit Growers' Association and has always been identified with any movement for the extension or improvement of the industry. Mr. Johnson has a world-wide knowledge of all phases of the fruit industry. His practical and business experience will stand him in good stead in his new office, where the results of twenty years' experience in the business will be used to the benefit of Canadian growers. The Minister of Agriculture is to be congratulated upon securing the services of such a competent man as Donald Johnson as Fruit Commissioner for Canada.

**Parliament Takes Interest in the Dairy Bill.**

A printed copy of the article "Oleo or Butter, Which?" which appeared in our last week's issue was sent to each member of the Dominion Parliament, together with a letter asking that their support be given to Hon. Mr. Burrell's Bill which has been discussed through these columns. We are glad to be able to state that the bill passed the agricultural committee without opposition and is in a fair way to complete its course through the Legislative Mill without serious objection. We are also pleased to state that we have received a large number of favorable replies to our letter from prominent members on both sides of the House.

It is reported that the Minister of Militia has leased sixty-five thousand acres of Crown Lands in Alberta for twenty-one years, to a company which will raise 15,000 horses annually. This is to raise remounts for the Canadian Militia and the British army.

**Ontario's Crop Outlook.**

The following information regarding agricultural conditions in this Province is contained in a bulletin prepared by the Ontario Department of Agriculture, based upon information furnished by a large staff of correspondents under date of April 1st:—

The new fall wheat according to the November returns, had found a good seed bed, and was then looking strong and promising. The crop is starting April in nearly the same condition in which it entered the winter, having received but little injury from the low temperatures occurring at times during January, February and March, as the fields were nicely protected by snow. A few returns describe the young plants as looking rather brown, but the bulk of correspondents regard the present appearance of the crop as most encouraging. However, the first half of April with its tendency to freeze by night and thaw by day is considered the critical time for fall wheat and clover, and that period had yet to be encountered when reports came in.

The clover crop, like fall wheat, has so far come nicely through the winter.

Notwithstanding the unusually low temperatures that were registered at times during the winter, orchards have come through in a fairly satisfactory way. Reports are frequent that peach buds have been more or less frozen, but the actual injury will not be known until the period of blossoming. So far, however, no serious loss is apprehended from root freezing. A number of the more tender bush fruits were nipped by the severe cold, but no serious harm is anticipated. Judging by the remarks of some correspondents, however, the San Jose Scale and the tent caterpillar are more to be feared by fruit raisers than occasional dips in temperature during midwinter. Scattering reports of injury to young orchard trees by field mice and rabbits were received from several counties.

The wintering of live stock caused anxiety to many farmers owing to the severe cold occurring at times, but some correspondents claim that the rather steady cold weather was much better carrying farm animals through than in the case of a so-called mild winter. Horses, with the exception of some cases of distemper, wintered well and are generally in excellent shape for spring work, although perhaps a little lean from economical feeding. Unfortunately, at present there is less demand for horses than for any other class of live stock. Cattle have also wintered well, and are remarkably free from disease. Dairy cows are described as being thin but thrifty, the result of the careful feeding demanded by the comparatively spare stores of fudder. Both fat and store cattle are in good trim generally, but are scarcer than in recent years, as the great demand in the fall for all kinds of beef cattle made a big clearing. The cattle on hand are much younger than in former years, many of them being yearlings, as most of the beef cattle are now turned off at about two years. Several correspondents state that most of the calves are now being kept on the farm, and where sold are commanding higher prices than ever before. Sheep are reported to have come through the winter in prime condition, but they are fewer in number than they should be. Swine are being marketed regularly, there being a steady and strong demand for this class of live stock. The chief incident of the winter has been the large number of hogs in many counties of the Province subject to a crippling which is described by some as a stiffening of the hind quarters, while others allude to it as a form of rheumatism. Several correspondents ascribe the trouble to injudicious feeding; others assert that the animals lacked a supply of earth or charcoal, which they believe is essential to a hog's good digestion during its winter confinement; others, again, lay the blame on cement floors and a lack of sufficient bedding during the severe weather. Young pigs have been the chief sufferers from this complaint.

The regulations governing the use of preservatives under the Adulteration of Foods Act have been amended by order-in-council to allow their use in foods for export, provided their use is consistent with the regulations of the country to which the food is exported. The use of any kind of preservative in milk is absolutely prohibited. In special foods for invalids and infants, only the following may be used as preservatives: salt, sugar, salt-petre, wood smoke, vinegar, acetic acid, spices and alcohol.

A few photographs of high-producing cows and proven sires, are fitting decorations on a dairy stable wall. Better still, if they are the photographs of some of the animals then in the stables, or of some that have been produced there. A chart containing the daily milk records of the animals also lends a business-like atmosphere to the stable.

## THE ROYAL BANK OF CANADA

Capital Authorized - \$ 25,000,000  
 Capital Paid Up - 11,560,000  
 Reserve Funds - 13,000,000  
 Total Assets - 180,000,000

HEAD OFFICE: MONTREAL

Branches throughout every Province of the Dominion of Canada.

Accounts of Farmers  
 Invited.

Sale Notes Collected.

Savings Department at all  
 Branches.

## Markets

### Toronto.

Receipts at the Union Stock-yards, West Toronto, on Monday, April 13, numbered 65 cars, comprising 1,532 cattle, 1,131 hogs, 19 sheep, and 25 calves. Good to choice cattle sold readily at firm prices, but big, rough, leggy steers, half fat, were slow sale. Choice steers, \$8.40 to \$8.60; good, \$7.50 to \$8; medium, \$7.25 to \$7.50; common, \$7 to \$7.25; choice heifers, \$7.75 to \$8; cows, \$8.50 to \$7.25; bulls, \$6 to \$8; feeders, \$7 to \$7.35; medium feeders, \$6.75 to \$7; stockers, \$5.50 to \$6.50; milkers and springers, only eight on the market, at \$62.50 to \$115, two selling at the latter price. Calves, \$6 to \$11.50. Sheep, ewes, \$6.50 to \$7.50; rams, \$5.50 to \$6.50; yearling lambs, \$8.75 to \$9.75; spring lambs, \$5 to \$10 each. Hogs, \$9.10 fed and watered; \$8.75 f. o. b. cars, and \$9.35 to \$9.40 weighed off cars.

### REVIEW OF LAST WEEK'S MARKETS

The total receipts of live stock at the City and Union Stock-yards for the past week were:

	City.	Union.	Total.
Cars	4	308	312
Cattle	49	2,847	2,896
Hogs	184	8,644	8,828
Sheep	—	904	904
Calves	—	1,522	1,522
Horses	2	232	234

The total receipts of live stock at the two markets for the corresponding week of 1913 were:

	City.	Union.	Total.
Cars	15	374	389
Cattle	159	4,855	5,014
Hogs	305	7,316	7,621
Sheep	356	273	629
Calves	160	941	1,101
Horses	—	72	72

The combined receipts of live stock at the two markets for the past week show a decrease of 77 cars and 2,118 cattle, but an increase of 1,207 hogs, 275 sheep, 421 calves, and 162 horses, compared with the corresponding week of 1913.

Receipts of live stock for the past week have been light. Trade for fat cattle was quite active, with prices, on the average, about 25c. per cwt. higher than for the previous week. Sheep, lambs, and good to choice calves, were in demand, at firm prices, while hogs were, if anything, a little cheaper, especially at the close of the week. Milkers and springers were in demand at firm prices; that is, fresh milkers and forward springers. Stockers and feeders are in demand constantly, at steady to firm prices.

Butchers.—Choice heavy steers sold up to \$8.50 for about three loads, and about six loads during the week sold at \$8.50, and seventeen fancy Easter-quality steers, 1,200 lbs. each, sold at \$8.80, which was the highest price paid during the week; choice steers and heifers, \$7.75 to \$8; good, \$7.50 to \$7.75; medium, \$7.25 to \$7.50; common, \$7 to \$7.25; choice cows, \$7 to \$7.25; good cows, \$6.50 to \$6.75; common to medium cows, \$5 to \$5.75; canners and cutters, \$3.75 to \$4.75; bulls, \$6 to \$7.50, and a few of extra choice at \$8.

Milkers and Springers.—Choice, fresh milkers, and forward springers, are in

demand, at firm prices, but common cows and late springers are slow sale. The highest price reported was \$110, but the bulk of the cows sold at \$70 to \$90 each.

Veal Calves.—Receipts have increased, but the quality of the bulk was common to medium, few of good to choice veals being offered. Choice calves sold at \$10 to \$11 per cwt.; good at \$9 to \$10; medium, \$7 to \$8.50; common, \$6 to \$7, and inferior, ill-bred Eastern calves, \$4 to \$5 per cwt.

Sheep and Lambs.—Receipts were small and prices very firm. Spring lambs are being rushed on the market, many of them before they are fit, being too young, and not fit to kill—an absolute waste. Sheep—Ewes sold at \$6.50 to \$7.50; rams, \$5.50 to \$6.50; yearling lambs, \$7.75 to \$9.75; spring lambs sold from \$5 to \$9 each.

Hogs.—Prices have declined, the market closing at \$9 to \$9.15, fed and watered; \$8.90 f. o. b. cars, and \$9.40 to \$9.50, weighed off cars.

### TORONTO HORSE MARKET.

Trade at the Union Horse Exchange, Union Stock-yards, was fairly active, over 100 horses being sold during the past week, the bulk of which went east to Quebec. One shipment went to North Bay, and several smaller shipments were made to various parts of Ontario. The local trade also was fairly good. Prices ranged as follows: Drafters, \$290 to \$240; general-purpose horses, \$175 to \$225; expressers, \$150 to \$200; drivers, \$100 to \$150; serviceably sound, \$40 to \$90 each.

### BREADSTUFFS.

Wheat.—Ontario, No. 2 red, white or mixed, 97c. to 98c., outside; \$1, track, Toronto, Manitoba, No. 1 northern, 98c., track, bay points; No. 2 northern, 96½c.; more at Goderich.

Oats.—Ontario, new, No. 2 white, 37c. to 38c., outside; 40c. to 40½c., track, Toronto, Manitoba, No. 2, 41½c.; No. 3, 40½c., lake ports.

Rye.—No. 2, 62c. to 63c., outside.

Corn.—American, No. 3 yellow, 73½c., all rail, track, Toronto.

Barley.—For malting, 54c. to 55c.; for feed, 43c. to 45c., outside.

Peas.—No. 2, 98c. to \$1.

Flour.—Ontario, ninety-per-cent. winter-wheat patents, new, \$3.80 to \$3.85, sea-board. Manitoba flour—Prices at Toronto are: First patents, \$5.60; in cotton, 10c. more; second patents, \$5.10; strong bakers', \$4.60, in jute.

### HAY AND MILLFEED.

Hay.—Baled, car lots, track, Toronto, No. 1, \$14 to \$14.50; No. 2, \$12 to \$13 per ton.

Straw.—Baled, car lots, track, Toronto, \$8.50 to \$9.

Bran.—Manitoba bran, \$25 in bags, track, Toronto; shorts, \$26; Ontario bran, \$24 in bags; shorts, \$25; middlings, \$18.25.

### COUNTRY PRODUCE.

Butter.—Receipts were liberal and prices unchanged. Creamery pound rolls, 31c. to 32c.; creamery solids, 27c. to 29c.; separator dairy, 27c. to 29c.; store lots, 24c. to 25c.

Eggs.—Receipts large; market steady, at 31c. to 32c.

Cheese.—Old, large, 15c. to 15½c.; new, 14½c. to 15c.

Honey.—Extracted, 9c.; combs, \$2.50 to \$3 per dozen sections.

Beans.—Imported, hand-picked, \$2.25 per bushel; Canadians, hand-picked, \$2.25; prime, \$2.

Potatoes.—Car lots of Ontarios, per bag, track, Toronto, 80c. to 90c.; New Brunswick Delawares, 90c. to \$1, track, Toronto.

Poultry.—Receipts light, and prices very firm. Turkeys, dressed, 22c. to 25c. per lb.; geese, 18c. to 20c. per lb.; ducks, 20c. to 22c.; chickens, 20c. to 24c. per lb.; hens, 16c. to 18c. per lb., dressed.

### Chicago.

Cattle.—Beeves, \$7.30 to \$9.50; Texas steers, \$7.30 to \$8.35; Western steers, \$5.65 to \$8.10; stockers and feeders, \$3.75 to \$8.65; calves, \$7 to \$10.50.

Hogs.—Light, \$8.70 to \$8.92½; mixed, \$8.65 to \$8.92½; heavy, \$8.45 to \$8.90; rough, \$8.45 to \$8.55; pigs, \$7.50 to \$8.60; bulk of sales, \$8.80 to \$8.87½.

Sheep and Lambs.—Sheep, native, \$5.40 to \$7; yearlings, \$5.80 to \$7.50; lambs, native, \$6.50 to \$8.15.

### Montreal.

Live Stock.—Supplies of cattle throughout the week were fairly large, although this applied more particularly to the beginning of the week, when the bulk of the butchers made their purchases for Easter requirements. The market held very firm, but towards the close of the week choice steers were quoted at 8½c., with an occasional sale at 9c., but fine stock generally sold around 8½c.; good at 7½c. to 8c.; medium, 6½c. to 7c., while lower grades ranged down to 6c. Cows and bulls ranged all the way from 4½c. up to 7c. per lb. Milch cows were available at about \$90 for choicest, and from this figure the market ranged down to \$50 each. Some spring lambs were offering for the Easter trade, and prices ranged from \$3 to \$8 each, according to size and quality. As for yearling lambs, the prices continued at 8c. to 9c., while sheep were selling at 6½c. to 7c. Calves were also in very good demand, common selling from \$3 to \$5 each, and choicest up to \$15. Hogs were about steady, Ontario selected hogs sold from 9½c. to 10c. a pound, while Manitobas brought around 9½c. to 9½c., weighed off cars.

Horses.—There was no change in this market. Horses weighing from 1,500 to 1,700 lbs., sold at \$275 to \$300 each; light draft, weighing from 1,400 to 1,500 lbs., \$225 to \$275 each; broken-down, old animals, \$75 to \$125, and choicest saddle and carriage animals, \$350 to \$400 each.

Poultry.—Turkeys were 21c. to 24c. per lb.; ducks, 16c. to 18c.; chickens, 19c. to 21c.; fowl, 16c. to 18c., and geese, 14c. to 16c.

Dressed Hogs.—Easter does not exercise any effect on the market for dressed hogs as a general thing, nor has it done so this year. Prices held steady, at 13½c. to 13½c. per lb., for fresh-killed, abattoir-dressed stock.

Potatoes.—The market continued on the easy side. Green Mountains were about 80c. per bag, ex track, in car lots, while Quebec varieties were 72c. to 75c. In a jobbing way, prices were 20c. to 25c. higher, ex store. Bags weigh 90 lbs.

Honey and Syrup.—New syrup was offered in fairly large quantities. The make is large, the weather being very favorable. The price was about 7½c. per lb. in wood, and 7½c. to 8c. in tins, making prices of tins 65c. to 70c. each for small, and \$1 for large. White clover comb honey was 15c. to 16c. per lb.; extracted, 10½c. to 11½c.; dark comb, 13c. to 14c., and strained, 7½c. to 8½c. per pound.

Eggs.—Prices of eggs were firmer last week because of the nearness of Easter, being up to 24c. to 25c. per dozen.

The market for butter was quite firm, but it is expected that prices will decline very shortly. Choice creamery, 30c. to 31c. per lb., wholesale; fine, 28c. to 29c., while second grades were 26c. to 27c. Dairy butter was firm, at 23c. to 24c. per lb. for Ontarios, and 22c. to 23c. for Manitobas.

Grain.—Oats were steady in price. No. 2 Western Canada oats were quoted at 43½c. to 44c. per bushel, ex store, in car lots; No. 3, 43c. to 43½c., and No. 2 feed, 42c. to 43c. No. 3 American yellow corn was 78c. in car lots.

Flour.—The market held firm. Manitoba first-patent flour, \$5.60 per barrel, in bags; seconds, \$5.10, and strong bakers', \$4.90. Ontario winter-wheat flour was firmer, at \$5.25 to \$5.50 for patents, and \$4.70 to \$4.90 per barrel for straight rollers, in wood.

Millfeed.—The market for millfeed was steady. Bran sold at \$23 per ton, and shorts at \$25 in bags, while middlings were \$28 including bags.

Hay.—Prices for hay were a shade on the easy side. No. 1 pressed hay, car lots, Montreal, track, was \$14.50 to \$15 per ton, while No. 2 extra good was \$13.50 to \$14, and No. 2 \$12.50 to \$13.

Seeds.—Demand for seed was good. Prices were: Timothy, \$10 to \$11.50 per 100 lbs., Montreal; red clover, \$22 to \$24 per 100 lbs., and alsike, \$20 to \$24 per 100 lbs.

Hides.—The market for hides showed no change to speak of. Beef hides, 13c., 14c. and 15c. for Nos. 3, 2 and 1, respectively; calf skins, 18c. and 20c. for Nos. 2 and 1, and lamb skins, \$1.20 to \$1.25 each, with horse hides ranging from \$1.75 for No. 2, to \$2.50 each for No. 1. Tallow sold at 1½c. to 3c. for rough, and 5c. to 6½c. for rendered.

### Buffalo.

Cattle.—Good cattle trade all week at Buffalo on shipping steers and the better kinds of butchering cattle. Eight or ten loads of Canadian steers, these ranging generally from \$7.75 to \$8.50, were taken readily. There were around forty-five to fifty cars of steers suitable for Eastern demand, and these ruled generally steady to a dime higher, top steers selling from \$8.85 to \$9.10. Choice butchering steers ranged mostly from \$7.90 to \$8.40. Medium and commoner kinds of butchering cattle ruled from 10c. to 15c. lower, bulls generally showing a decline, some medium, sausage kinds that have been selling right along from \$6.50 to \$7, selling mostly from \$6.25 to \$6.50, although some heavy, fancy bulls, ranged up to \$7.25 to \$7.75. All of the Eastern-order buyers were in the competition, and a clearance of these better-weight steers was had by 10 o'clock. The run was 180 cars, more than was expected, and ten cars in excess of the week before, but Chicago was light, and this made the demand good from New York, Boston, Pennsylvania points, and sections in the State where country killers call for the best steers. Stocker and feeder cattle ruled steady to strong, some light ones selling right along at \$7.25. Demand is very strong for these, and dehorned Canadians are wanted. They will sell readily, and bring good, strong prices. Receipts the past week at Buffalo were 180 cars, against 170 cars for the previous week, and 163 cars for the corresponding week a year ago. Quotations follow:

Heavy steers, good to choice, \$8.40 to \$9.10; heavy steers, medium to good, \$8.25 to \$8.40; butchers' steers, good to choice, \$7.75 to \$8.50; butchers' steers, medium to good, \$7.50 to \$7.75; butchers' steers, common, \$7 to \$7.25; best cows, \$6.25 to \$6.75; fair to good cows, \$5.50 to \$6; cutter cows, \$4.25 to \$4.75; canner cows, \$3.50 to \$4; good to choice, fat heifers, \$7.25 to \$7.75; fair to good heifers, \$6.50 to \$7; light and common, \$5 to \$5.50; best stockers and feeders, \$6.50 to \$7.25; fair to good, \$6 to \$6.50; common, \$5.50 to \$5.75; stock bulls, \$5.25 to \$5.50; bologna bulls, \$6.25 to \$6.75; fat bulls, \$7 to \$7.50; best milkers and springers, \$50 to \$80; common, \$30 to \$40.

Hogs.—Prices on hogs were held within a fifteen-cent grade all last week, and no time did best grades sell below \$9.30, and the top, which was Thursday, was \$9.45, heavy grades, as a rule, selling 5c. to 10c. under desirable mixed grades. Pigs, \$9.10 to \$9.25; roughs, \$8.25 to \$8.50; stags, \$7 to \$7.75. A load of Canadian hogs on Friday's market sold at \$9.30, with a few of the heaviest out. Receipts the past week 27,680 head, as against 25,280 for the previous week, and 30,400 head for the corresponding week last year.

Sheep and Lambs.—Receipts liberal first part of last week, and market mostly quarter lower. Bulk of wool lambs, \$8.40; top for clipped lambs, \$7.25; best wool yearlings, \$7.75; unshorn wethers, \$6.75 to \$7, with ewes from \$6 to \$6.50, and clipped wethers \$5.75 to \$6, with clipped ewes \$5.50 down. Lamb market reacted latter part of week, Friday, best wools selling up to \$8.75, with clip-reaching \$7.35; one load of fall clips, \$7.50. Sheep latter part of week was weaker than on Monday, wool wethers being hard to place Friday at \$6.75, while shorn wethers were slow, at \$5.75. Few springers on offer, best selling up to \$12 per cwt. Receipts for the past week, 26,400; previous week, 25,000; year ago, 31,200.

Calves.—Monday, it was mostly a \$12 market for top veals, but after the opening day prices showed a steady decline, buyers getting the best deal on Friday, at \$10.50. Cull calves were strong the fore part of the week, and for the last days of the week were considerably lower, dropping from \$9.50 on Monday to \$8.50 on Friday for the best ones. Fed calves were \$5 to \$6 generally. Supply for the past week largest of the season, 3,925 head, as against 2,759 the week before, and 3,450 a year ago.

Butter.—Creamery, prints, 28c.; creamery, prints, firsts, 27c.; dairy, choice to fancy, 24c. to 25c.; dairy, fair to good, 22c. to 23c.

Cheese.—Fancy, new, 18c. to 18½c.; good to choice, 17½c. to 18c.

Eggs.—White, fancy, 22c. to 22½c.; fancy, mixed, 21c. to 21½c.

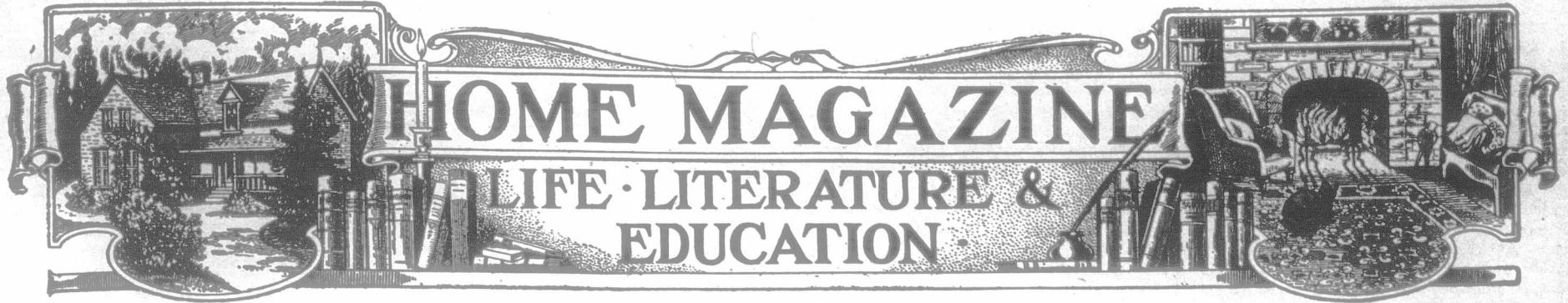

Life.

That is what we try for, hope for, and pray for:  
 That we may think more, feel more, love more, and be more:  
 That we may have life more abundantly, as He said,  
 Nothing—nothing helps in this seeking, as the sight of it—  
 The brook which is alive again,  
 The saxifrage which is alive,  
 The pussy willow, the crocus,  
 The snowdrop, the violet,  
 The bluebird, the butterfly.

The Horticultural Society and the Rural Districts.

What would a Horticultural Society do in this district?—that is a question which might very pertinently suggest itself, at this time of year, to every lover of trees, vines and flowers, beautiful vistas, and attractive homes.

It may as well be admitted at the outset that Canada is not as beautiful as she might be, as she should be. Take a long motoring trip through the country if you want to realize that fact. True (we speak of the eastern and middle provinces), there is every advantage of contour and diversification, mountain here and hill there, rolling slope and deep valley and sudden glen, river and lake, and murmuring streamlet, but, like the fair Indian summer, these very charms, to the thoughtful, suggest also the thought of their evanescence. It is only too true that the rapid and thoughtless deforestation of every spot where timber good enough for the selling is to be had, is speedily clearing the fairest vistas of their chief beauty, and, as everyone who has studied forestry knows, with the passing of the trees the rivers are diminishing in size, the brooks are disappearing, and the whole country is suffering, more or less, from the sudden extremes and all too general aridity thus artificially introduced.

"Hoots!" says the too-practical man, "who is going to spare the woods for the sake of a lot of æsthetic nonsense? I've got to have the money, so my woodland goes!"

He forgets, poor man, that from the merely economic standpoint, he commits a blunder when he wastefully sacrifices his woodlot. Timber is truly worth money nowadays, and the saving folk of Europe have long since found out that woodlots may be made to yield a continuous harvest. Trees are, it is true, cut down and sold, but the undergrowth is carefully protected, the cattle are excluded, and, in some places laws have been passed compelling every man who cuts down one tree to plant two in its stead.

It is notorious, too, that where trees have too woefully disappeared, windstorms are more destructive and spring floods are inevitable. From the treeless slopes, where no network of roots interposes to hold back the melting snow, brown rivulets flow, carrying with them soil, fertilizer, the very "good" of the land, to deposit it, perhaps in some marshy delta at the river-mouth, perhaps as a rich alluvial border to some other man's farm. . . Yes, assuredly, the man who ruthlessly sacrifices all the trees on his farm may very well be in the position of the man who killed the goose that laid the golden eggs. With no regard for æsthetics, he reveals also that he has none for economics.

But to return—as you whiz through the country in your motor-car, or, still better, amble along with your old brown nag—if anyone ever does amble nowadays—you see that the landscape fails in beauty, not only because of the sacrifice

of its natural charms, but also because positively no really constructive work of any kind is being done on nine-tenths of the farms. . . . There they slide past, mile after mile of them—just money-grubbing spots for all to the contrary that is expressed by anything connected with them. The houses are tidy, for the most part, and comfortable; there is a prosperous "well-liking" look everywhere; but with that the story ends. You look in vain almost for the artistic touch, either in architecture or in planting. You search without reward for some indication of individuality, some expression of the thought of the inhabitants in these their habitations. "Is there no thought!" you exclaim, "or do the people not care?"—and then you know you have been impatient, perhaps without reason, for these are very busy folk, and they are educating their children, and—

than a house. Embower a fine house with vines and surround it with shrubbery and the thing is done. Do the same thing with the shabby little house and the thing is also done. If money is short, there are always our own fields and woodlands and stream-sides to furnish supplies, wild clematis and bitter-sweet, hard maples and beeches, evergreens for the windbreak, and June-berry and wild cherry to give a mist of white bloom in season.

But, to come back to the question with which we started, there is probably no agency which will inspire the improvement of a whole neighborhood as will the formation of a Horticultural Society—a fact which almost every city and town, in Ontario at least, has found out. It only remains for the rural districts to follow.

Every spring and fall roots or seeds are sent to members—always the choicest

landscape gardening and kindred subjects through the Association, and the inevitability of imbibing hints from other members at each gathering, and the advantage of having an organized society in each neighborhood must be apparent.

Organization is found of use in almost every branch of life; why not in this? "United we stand," and, united the Horticultural Societies of Ontario have done much that would not otherwise have been done towards destroying the ugly and setting up the beautiful. Where they are active warfare has been made on unsightly dumps and disfiguring advertising, on weed-filled vacant lots and bad—if ever so sincere—planting; while flower-borders, window-boxes, children's gardens and parks have appeared where none ever were before. A feature of especial interest has been the flower-shows, held, as a rule, three times during each summer, a source alike of inspiration and instruction, and a sheer delight to all lovers of flowers.

Should the rural districts join hands with these city societies, what might not be done towards making Canada the beautiful Canada she may be?

Let us not be altogether material. Let us respect and at least follow afar off the Oriental who says—and, he it remembered, a country's proverbs reveal somewhat the character of its people—"If you have two loaves of bread, sell one and buy a lily to feed your soul."

Little Trips Among the Eminent.

Canadian History Series. FRONTENAC.

[After an inevitable delay, owing to the preponderance of garden articles at this time of year, our Canadian History Series may again be resumed. In the following sketch acknowledgments are due to Parkman's "Count Frontenac" and Agnes Maule Machar's "Story of Old Kingston."]

"The most remarkable man who ever represented the crown of France in the New World," so Parkman designates Louis de Buade, Count de Frontenac, Governor of Canada from 1672 to 1682, and again, when it was found necessary to recall his iron hand, from 1689 to 1698.

Count Frontenac came of an ancient and noble race, and inherited all the pride of his family, albeit, judging from the letters of Mlle. de Montpensier, grand-daughter of Henry IV., he had little else to inherit. Speaking of a visit to his estate of Isle Savary, she tells, it is true, of his gardens, fountains and ponds, in which he took great interest, but she also ridicules, somewhat, his plans for improvement, which, she thinks, much too ambitious for a man of his slender means.

Rather scathing she is of the imperious, dignified, handsome Count for again she takes opportunity to tell of how "while he was at St. Fargeau he kept open table and many of my people went to dine with him, for he affected to hold court and acted as if everybody owed duty to him." She pitied Madame de Frontenac for having such a husband, and, indeed, judging from the exhibitions of irascibility and imperiousness displayed by the gentleman all through his life, her pity may not have been misplaced. Madame de Frontenac, however, was not one to submit herself tamely to many irritations, and not long after her marriage she left her husband to attach herself to the train of Mlle. de Montpensier. Scidom again did she go back to him, although she appears to have corresponded with him throughout his lifetime, and exerted her influence among the ministers (for her

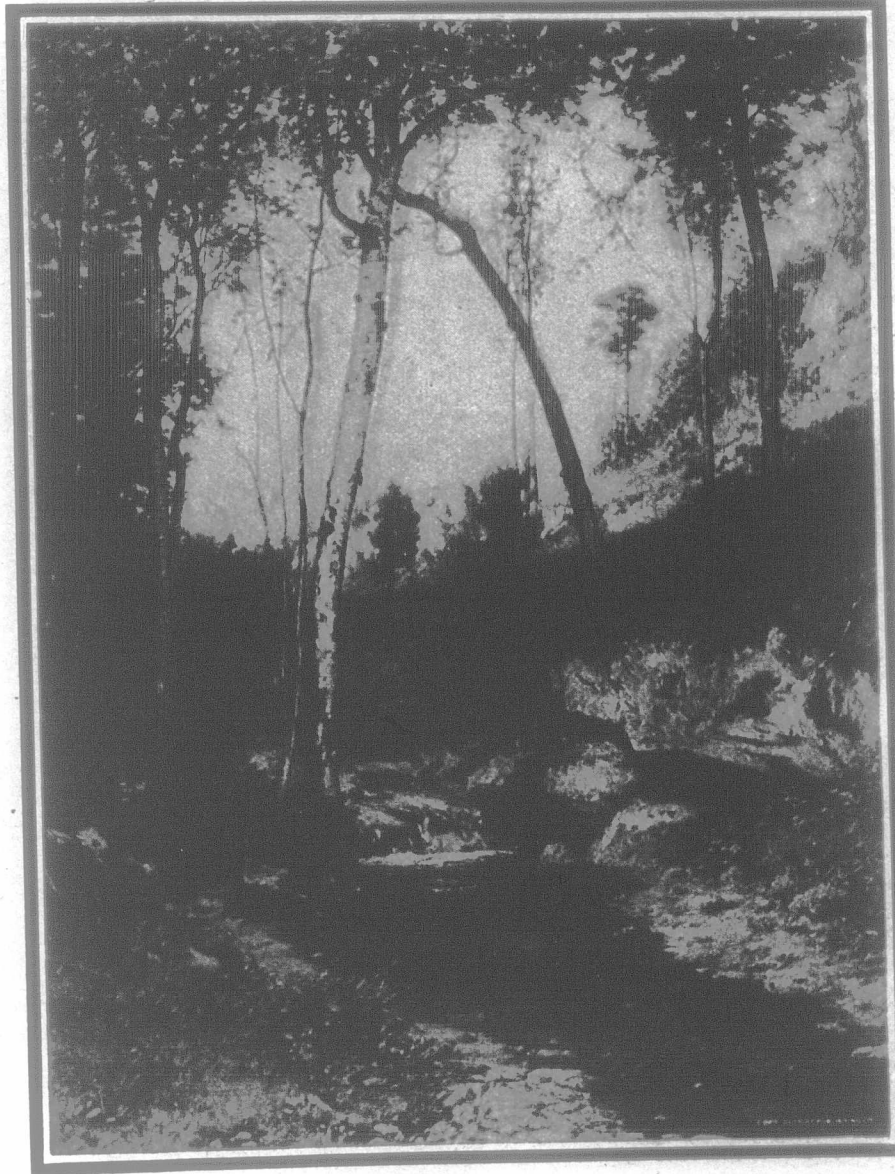

A Mountain Brook.

From a painting by Alexander H. Wyant, N. A., in the Albright Art Gallery, Buffalo. From Thistle Print Copyright Detroit Pub. Co.

Educating their children? Ah, then they are neglecting a very important part of it, for not least in the education of any human being is a love of the beautiful. To love the beautiful—the trees, the vines, the shrubs, the flowers, the bird-songs, the blue cloud-flecked skies, the fields of waving grain and wood-borders aflame with golden-rod—to love all these is a long step towards loving all goodness and truth.

After all, it costs so comparatively little to have a home, at least externally, rather

beauty and wit made her ever a favorite in the social circles of Paris) to promote his interests.

Finally, in 1672, "having lived much in society, and being completely ruined," as Saint Simon has recorded, Frontenac was glad enough to take the position of Governor and Lieutenant-General for the King in all New France, a post for which his prowess under the Prince of Orange in Holland and in subsequent wars in France had left him well enough fitted; and so, at the age of fifty-two, it became his lot "to exchange the splendors of St. Germain and the dawning glories of Versailles for a stern, gray rock, haunted by sombre priests, rugged merchants, and traders, blanketed Indians, and wild bush-rangers."

A less venturesome spirit might have quailed before the mighty task of governing this vast wild land, of which Quebec was the gateway, but, notwithstanding his faults, Frontenac had been cast in heroic mould, and so his first impressions of the "stern gray rock" were favorable enough. "I never saw anything more superb than the position of this town," he wrote enthusiastically to France. "It could not be better situated as the future capital of a great empire."

"A great empire"—it was the same rosy vision that was luring La Salle to adventure, triumph, defeat, and death, for, it is to be remembered, it was during the administration of Count Frontenac as Governor of Canada that La Salle made his famous ventures to the great rivers of the West.

#### FRONTENAC AT QUEBEC.

Fond of pomp and ceremony, and feeling, no doubt, almost emperor in this land so far from the court of France, Frontenac's first act was to call a meeting of the people, whom he addressed with all his fine powers of oratory, concluding the occasion by having all solemnly take the oath of allegiance in the church of the Jesuits. Next, he proceeded to give the city a municipal government, modelled on that of some of the cities of France, and, with great perspicacity, he proposed having a meeting of the people every six months to discuss measures for the welfare of Canada. The French minister, Colbert, however, wrote him that this was not to be thought of, as arbitrary measures were the only security in so new a land, and so the first golden opportunity for understanding and sympathy was lost.

At the next turn, we find the new Governor at odds with almost everyone with whom he had to do. He would brook no opposition, and so swords were crossed first with the intendant, often over foolish matters of precedence in the council meetings, then with the bishop, and with the Jesuits in general, whom he accused of aiming too much at temporal power. From the beginning, indeed, he gave his support to the Recollets, who distressed him by no such ambitions.

His bitterest enemies were, however, the merchants, who watched his ventures in the fur trade and the privileges that he permitted to his friends with an uneasy eye, and whose grievances reached a climax with the establishment of the fort so long known by his name, Fort Frontenac, the site of which is now occupied by the flourishing city of Kingston.

#### FORT FRONTENAC ESTABLISHED.

The idea of establishing a fort at the eastern end of Lake Ontario to serve the double purpose of holding the Iroquois in check and controlling the fur trade from the upper lakes, was not original with Frontenac. The preceding Governor, De Courcelles, had thought of it, and had made plans for it. Frontenac, however, at once saw the strategic value of such a post, and, with characteristic energy, set about its realization. The fur trade, for the present, must be the chief source of wealth for the French; the establishment of an empire could only be forwarded by founding posts ever farther and farther towards the interior; the Iroquois he recognized as the great menace to every plan that could be devised, the great dragon upon which he must set his foot, and, indeed, so successful was he in this last, that after his time the great confederacy of tribes to the south of Lakes Erie and Ontario practically ceased to be the unceasing terror of French Canada.

His success with the Indians, however, was not confined to his power to crush and destroy. From the very beginning there seemed to be in him a chord that responded to the moods and visions of the red man,—in this polished courtier a streak of the native Indian himself. He knew instinctively how to impress the primitive yet by no means dull mind of the bronzed warriors who came to treat or to trade. He knew how to endear himself to his dusky "children," and those whom he made his allies adored

him. On the other hand, he could be stern with an enemy as was the enemy himself, haughty, implacable, so that even in time of war the great Five Tribes respected and stood in awe of the great Onontio, the French "father."

Such a man as this could not establish a fort in the very heart of the land of the aborigines by dint of mere force, gray, prosaic, unimpressive. His imagination saw the value of the parade and ceremony so dear to the hearts of the rovers of the woods, and so he determined that the establishment of Fort Frontenac should be accomplished by a display that would be talked of far and near in the sunlit dusks of the vast forest land.

It was advisable, too, that the fort be built with the consent of the Iroquois, as well as of the tribes who were allies of the French, and so, as recounted in a previous issue (Feb. 5th), La Salle was sent to summon representatives from all the tribes to meet at Cataragui. At the appointed time, as has also been told, Frontenac advanced up the St. Lawrence in fine array, with 120 canoes guarding the two gaily-painted flat-boats in which he and his staff, in all their glory of regalia and gold-laced uniforms advanced to the place of meeting.

Just where the spot upon which the Council was held was, has been somewhat a matter of dispute, but as Miss Machar (in "Story of Old Kingston") very well points out, it could not have been very close to the site of Fort Frontenac, since, even while the conference was proceeding, Frontenac's engineer was busy tracing out the plan for the fort. Missauga Point, she thinks, may have been the place.

At all events, all details of the Council itself have been preserved, and so we may easily picture the scene for ourselves. It was the 13th of July, 1673. "A double line of soldiers under arms," says Miss Machar, "formed a living lane from the Governor's tent to the Iroquois camp, to impress the deputies who marched, with grave and dignified mien, to the place of conference—an area carpeted with sail cloth before Frontenac's tent, where burned the orthodox campfire. . . . Here the envoys in their robes of state were duly presented to the Governor and his suite, imposing in their brilliant, gold-laced uniforms and aristocratic bearing. . . . After the first salutations, there followed, according to Indian custom, a period of silence, while

the chiefs squatted on the canvas carpet, smoking their pipes with imperturbable serenity. At length the conference was opened by a speech from the Chief Garakontie, known to be friendly to the French, expressing with profuse compliments the pleasure and respect with which the new Onontio was welcomed among them, on behalf of the five Iroquois nations for whom he undertook to speak."

In return, Frontenac spoke at length, addressing his audience as "children," telling them that his mind was full of peace, and concluding all with a great feast and endless presents of raisins, trinkets, and prunes. As a result, permission was given for erection of the fort, although not until some assurance had been advanced of the prices that would be given for furs brought to it, and immediately the work was put under way, before the very eyes of the Indians, who were astounded to see the rapidity with which trees were felled, logs hauled, and walls and bastions piled in place.

\* \* \* \*

The fort was built, and a garrison placed in charge, but the first enemies against whom it had to contend were not Indians. News of it caused immediate consternation among the merchants, who had not been taken into the Governor's confidence, and who feared this new step might be a hindrance, more or less, on their free-and-easy methods in the fur trade, and chief among the objectors was Perrot, the Governor of Montreal, who, surrounded by a company of "disbanded soldiers, fur traders and forest adventurers, the best fighters in Canada," held a sort of savage court beneath the shadow of Mount Royal. Perrot was put in no better humor when Frontenac, following the instructions of the King, proceeded to arrest his *coureurs de bois*, rangers of the woods who traded everywhere with the Indians. As a consequence, he defied the Governor-General, was landed as a prisoner in the Chateau St. Louis, and finally shipped to France, where the whole matter was referred to the King. As a result, Perrot spent a short time in the Bastille, then was liberated and sent back to Montreal, while letters of advice were written to Frontenac by His Majesty and Colbert.

Few of the merchants, however, were so above-board as Perrot. Most of them contented themselves with keeping a wary eye on Frontenac and La Salle, blocking them at every turn, and circulating evil reports against them in France.

Frontenac, meanwhile, conscious of "cabal and intrigue" to which he refers in his letters, defended himself against the charges as best he could, wrote letters to the King and Colbert, quarrelled all the more with the intendant, Duchesneau, with the attorney-general, the bishop, and the Jesuit clergy, and, it appears, took more advantage of trade on his own account than was necessary.

Each faction, indeed, accused the other of sending furs to the English settlements, and so defrauding the revenue. The letters of the King to Frontenac grew continually sharper, and at last, in the autumn of 1682, both Frontenac and Duchesneau were abruptly recalled to France.

Shortly before his recall, Frontenac had written to the King, "I most humbly supplicate you to consider that for ten years I have maintained all these savages in an obedient, quiet and peaceful temper only by a little address and management."

The claim was true, yet had Frontenac's connection with Canada ended at this point, he would have passed into oblivion as a Governor of no especial merit, who, by his tempers and autocracy, had only succeeded in bringing, as Duchesneau wrote to Seignelay, "disorder everywhere," and who had committed the grave blunder of permitting the sale of brandy to the Indians. The situation was yet to arise which would require his tact and his firm hand to bring order into most grave disorder, due to those same savage tribes whom he had managed by "a little address and management"; which was to give him opportunity to reveal himself as a statesman, ruthless but capable; which was to cause him to be proclaimed as "father and saviour of the country."

Frontenac had his faults, and grave ones, yet, looking back over the perspective of the years, it appears not too



A Home, Not a House.



GOODS SATISFACTORY TO YOU OR MONEY REFUNDED, INCLUDING SHIPPING CHARGES. NO EXCEPTIONS

# EATON'S

FREE DELIVERY WE PREPAY SHIPPING CHARGES ON 10.00 ORDERS AND OVER

## WEEKLY MAIL ORDER BARGAINS

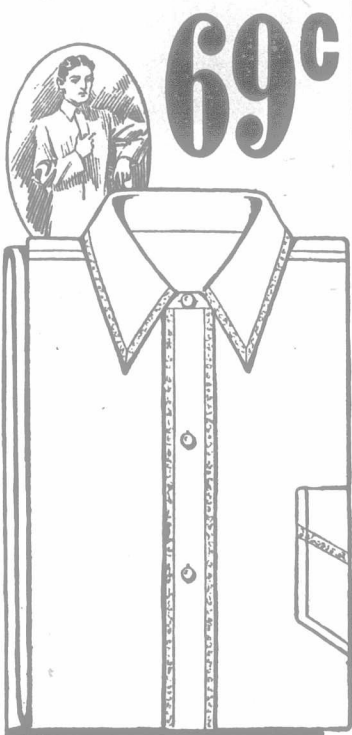

69c

**DON'T MISS THIS OFFER**  
**Fine Quality Nightgown**

40-A85. Do not delay in ordering one of these Men's High-grade White Flannelette Night Robes, made from a fine quality flannelette, good weight, with collar attached, pocket, neatly trimmed, pearl buttons, double-stitched seams. These will go with a rush. There is only a limited quantity for this Sale, so order early, and thus share in this remarkable value while they last. In White only. Sizes 14, 15, 16, 17, 18, 19. Clearing at bargain price... **69c**

### STEREOSCOPE

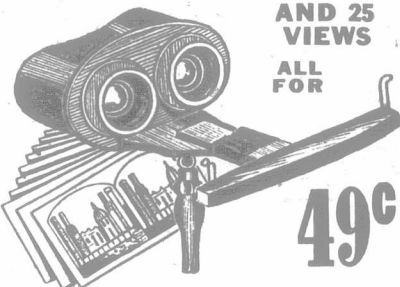

AND 25 VIEWS ALL FOR

49c

### SHARE IN THIS BIG VALUE

32-A03. This instrument can be adjusted either for stereoscopic views or photographs and other pictures by simply reversing the lenses. It also has a dark chamber feature. The Stereo-Graphoscope excludes all the light. It has a birch frame, large metal-mounted lens, patent folding handle, figured mahogany hood, brass trimming and 25 views. Selected stock. All for... **49c**

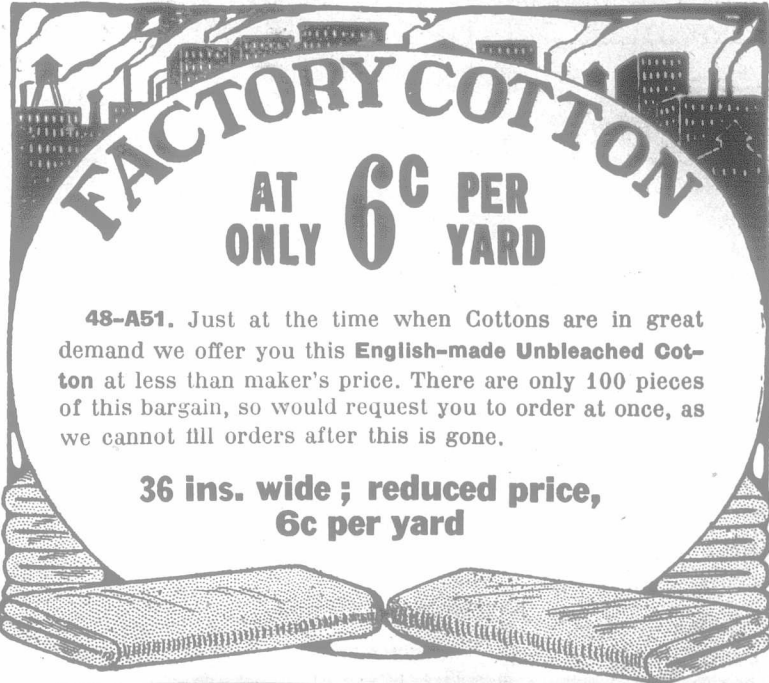

48-A51. Just at the time when Cottons are in great demand we offer you this English-made Unbleached Cotton at less than maker's price. There are only 100 pieces of this bargain, so would request you to order at once, as we cannot fill orders after this is gone.

36 ins. wide; reduced price, 6c per yard

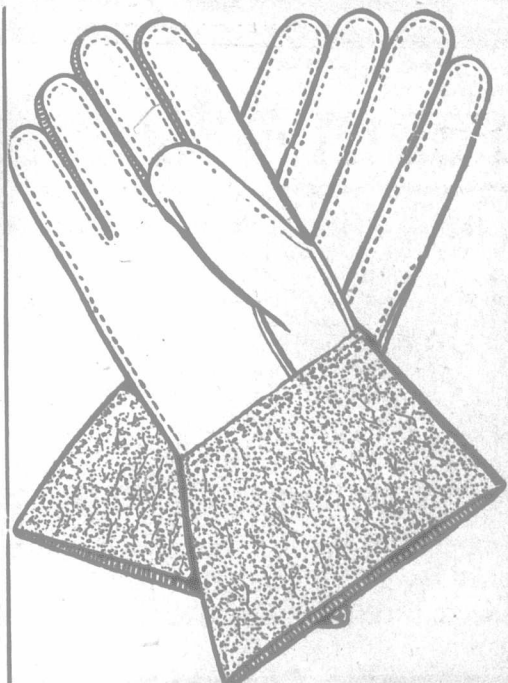

**ORDER A PAIR NOW 29c**  
**A GREAT VALUE SAVING**

20-A10. Men's "Asbestos Tan" Railroader's Gauntlet Gloves, unlined, outseams and 4-inch cuff, strong and durable, fire and waterproof. Do not miss this opportunity. Medium and large sizes. To clear, per pair... **29c**

### OUR BIG CLOTHING SPECIAL

**MEN'S TWEED OR SERGE SUITS 5.00**



44-A23. A Durable Tweed Suit for a working man, or it even looks good enough to wear as a second suit to save your better clothes. They have been made up in our own factory from good sturdy imported tweeds, in a variety of patterns, greys and browns, with neat striped effects, tailored in a stylish single-breasted three-button sack model. Vest closes with five buttons; trousers with three pockets; serviceable body linings throughout. Sizes 36 to 44-inch chest; 33 to 42-inch waist; 30 to 33-inch leg. Only... **5.00**

44-A75. Navy Blue Mill-finished English Serge Suit. Coat is cut in the single-breasted style, three-button model, popular spring wear, twilled Italian body lining; six-button vest. Sizes to fit 36 to 44-inch chest, 32 to 42 waist measure, 30 to 33 leg measure. If you come within these sizes you can share in this big bargain. State size clearly. Only... **5.00**

### A Bargain in Boys' Suits

44-A12. Just 200 Boys' Two-piece Brown Tweed Suits to go at almost half price, Norfolk style, box-pleated back and front, knee pants, grand wearing material. Sizes 24 to 27 chest. A great bargain at... **1.65**

### 1.69 Buys This All-Wool Skirt



32-A640. A surplus quantity of All-wool Cheviot Skirting — too heavy to put into summer styles, but just the thing for now; also a factory opportunity to employ spare time, and you have the reasons for this startling offer. The skirt is in a plain, thoroughly tailored, five-gored style, and measures the easy-walking 60-inch sweep around the lower hem. Choice of thirty different sizes. Waistbands 22, 23, 24, 25, 26, 27 ins. Lengths (front) 37, 38, 39, 40, 41 inches. Navy. Only. Each... **1.69**

THE T. EATON CO LIMITED TORONTO CANADA

doubtful that the apparent failure of his first administration was due not so much to his personal blunders as to the fact that he was, to no inconsiderable extent, the victim of an organized attack. (To be continued.)

## Hope's Quiet Hour.

**The Necessity of Choice.**  
If it seem evil unto you to serve the LORD, choose you this day whom ye will

serve . . . . but as for me and my house, we will serve the LORD.—Josh. 24 : 15.

"I have a life with Christ to live; But, ere I live it, must I wait Till learning can clear answer give Of this and that book's date? I have a life in Christ to live; I have a death in Christ to die; And must I wait till Science give All doubts a full reply?"

"Nay, rather while the sea of doubt Is raging wildly round about, Questioning of life and death and sin, Let me but creep within

Thy fold, O Christ, and at Thy feet Take but the lowest seat, And hear Thine awful voice repeat, In greatest accents, heavenly sweet: 'Come unto Me and rest; Believe Me and be blest.'"

Elijah said long ago to God's chosen people: "How long halt ye between two opinions: if the LORD be God, follow Him; but if Baal, then follow him." He asked the question sadly but pre-emptorily. It was not an idle question, but one that demanded an answer. Yet "the people answered him not a word." When, Joshua put the same question, laid the necessity of a decided choice before

the people, their answer was prompt and determined: "We will serve the LORD." They were warned of the solemnity of their decision, of the necessity laid upon them to translate words into deeds. Those who ranged themselves on the Lord's side must really spend their lives, in serving Him and refuse to serve other gods.

Many things have changed since then, but the relation between man and God is exactly the same as it was. We find ourselves in this world, with eternity ahead of us, and we must make the great choice. It is impossible to escape the tremendous responsibility of human life. To commit suicide is an impossi-

Give Me a  
Chance to PROVE  
My Flour



## Cream of the West Flour

the hard wheat flour guaranteed for bread

For several months we have been selling flour direct from our mills to the farmers of Ontario. Have you taken advantage of our splendid offer? If not, you will find it profitable to do so now. Read our prices:

### GUARANTEED FLOURS.

	Per 98-lb bag.
Cream of the West Flour [for bread].....	\$ 2 90
Queen City Flour [blended for all purposes]..	2 50
Monarch Flour [makes delicious pastry] .....	2 50

### CEREALS.

Cream of the West Wheatlets [per 6-lb. bag].	25
Norwegian Rolled Oats [per 90-lb. bag].....	2 50
Family Cornmeal [per 98-lb. bag].....	2 25

### FEEDS.

	Per 100-lb bag.
"Bullrush" Bran.....	\$ 1 30
"Bullrush" Middlings.....	1 35
Extra White Middlings.....	1 45
"Tower" Feed Flour.....	1 60
"Gem" Feed Flour.....	1 75
Whole Manitoba Oats.....	1 50
"Bullrush" Crushed Oats.....	1 55
Manitoba Feed Barley.....	1 35
Barley Meal.....	1 40
Oil Cake Meal (old process, ground fine)....	1 70
Chopped Oats.....	1 55

Prices on Ton Lots: We cannot make any reduction on above prices, even if you purchase five or ten tons. The only reduction from the above prices would be on carload orders.

Terms Cash With Order: Orders may be assorted as desired. On shipments up to five bags, buyer pays freight charges. On shipments over five bags, we will prepay freight to any station in Ontario, east of Sudbury and south of North Bay. West of Sudbury and New Ontario, add 15 cents per bag. Prices are subject to market changes

## Any One of These Books Free When You Buy Three Bags of Flour

The Dominion Cook Book has 1,000 recipes and large medicinal department. The books by Ralph Connor, Marian Keith and J. J. Bell are full of absorbing interest. Start now to build up your library with these books. You may choose a new book each time you buy three bags of guaranteed flour from us (any brand). If you buy 6 bags, you get two books and so on. Enclose 10 cents for each book to cover postage. To get a book remember that at least three bags must be flour.

**Dominion Cook Book**  
Books by Ralph Connor:  
Black Rock  
Sky Pilot  
Man From Glengarry  
Glengarry School Days  
The Prospector  
The Foreigner

Books by Marian Keith:

Duncan Polite  
Treasure Valley  
'Lisbeth of the Dale

Whither Thou Goest  
By J. J. Bell

**The Campbell Flour Mills Company, Ltd.**  
(WEST) TORONTO, ONTARIO

bility. We may kill the body—we cannot kill ourselves.

We must choose—for to refuse to serve God is to serve ourselves or the world or Satan. An agnostic is a man who professes to know nothing about God. He tries to shelter himself behind ignorance. But ignorance is a self-chosen evil—unless the agnostic has sought with all his might for the truth, never ceasing the search until he has found it. It has been said: "It is a very solemn thing to be a Christian, but it is a far more solemn thing not to be one."

Let us look again at the verses with which I began. We find the necessity laid upon us of living and dying. We have no choice given us about these things. Dare we wait until all difficulties about the Bible and Science have been made clear, before we decide whom we will serve? Our lives are drawing every day nearer the mysterious change which we call "Death." The difficulties which stand in the way of faith are not likely to be all cleared away in our time. Can we afford to waste our lives in waiting?...

There was a man once who openly took this attitude towards the Christian religion. He was a man of great learning, but that did not help him much in making a decision. He stood aside, refusing to make a choice,—and missed his chance. His advice was to let the Christian Church alone, "for," he said, "if this counsel or this work be of men, it will come to nought: But if it be of God, ye cannot overthrow it; lest haply ye be found even to fight against God."

Well—according to his own theory—it has proved itself to be "of God"; for all the awful fury of persecution, and all the freezing blight of fashionable and luxurious modern Christianity have not overthrown the Church of Christ. It has grown mightily, and spread into country after country, bringing civilization in its train. But what of Gamaliel, who stood aside to see what would happen! His famous pupil, Saul of Tarsus, made his choice enthusiastically, and served his chosen Master gloriously. Dare we stand beside Gamaliel and wait?

Need we wait? Has not Christ proved His claim to be the Light of the world? Is not His Name the greatest earth has ever known? We date every event in history from His birth—A. D. or B. C.—millions of dollars are poured out annually in His service, vast multitudes of men and women are praying to Him and working for Him every day. The sick and the sorrowful look to Him for strength and gladness—and find what they really seek.

Some men stand aloof and say contemptuously that they know plenty of Christians who are selfish and grasping, who grind down the poor and use dishonest means for their own worldly advancement. How shallow such reasoning is. Ask them boldly whether the men they despise are really Christians, really following in the steps of JESUS; or whether they are unlawfully calling themselves by His Name.

If you want a rule of life to follow which is the highest you can see, study the demands of our Master. He insists on absolute purity of thought, on love and forgiveness which nothing can kill, on daily self-denial, and the much-needed virtue of a trust in God which leaves no room for nerve-racking worry. Then His example was one of everyday service and prayer, of patience under insult and agony, of self-forgetful thoughtfulness for others, of trust in the Father's love even when He felt deserted by God and man. When we have obeyed His Commands, and lived as beautifully as He did, it will be time enough to begin looking for a nobler Leader.

Remember that it is not enough to serve Christ secretly. The choice must be definite, and the people who know us must see clearly which side we are on. Think of those solemn words spoken by Christ as a time when open confession often meant scorn, contempt, and loss of worldly goods—soon after that time it meant torture and death. He said: "Whosoever therefore shall confess Me before men, him will I confess also before My Father which is in heaven. But whosoever shall deny Me before men, him will I also deny before My Father which is in heaven."

If our neighbors can't tell which side

we are on, our confession of Christ as our Master must be very weak and undecided. They will judge of us more by our actions than by any wordy profession of religion.

A boy—who thought he was a Christian—was disappointed because the other boys would not listen to his religious talk. A friend asked if he ever prayed to God about his games. He said that he did—that he prayed that he might win. The friend asked him if he never prayed that another boy might win in a game of marbles. "Why, no," he replied, wonderingly, "of course I want to get as many marbles as I can." The friend suggested that it was no wonder the boys were not attracted by that kind of Christianity. The desire to get all the worldly success possible for one's self, careless about the success or pleasure of other people, may be human enough, but it is a very unfair representation of the spirit of Christ.

We must make our choice and prove by our everyday actions that it is not a sham—a mere wordy profession of Christianity. St. John—the Apostle of love—warns us not to love merely in word and tongue, "but in deed and in truth."

The other day I received a donation from one of our readers in the West, with the request that it might be used to provide reading matter for some "shut-in." It has been spent on books, which have been already lent to several sick people, and will be passed on to others. That is a very practical way of showing love to Christ "in deed and in truth."

Perhaps you are not sure—not quite sure, as yet—that JESUS is God. At least, you can be quite sure that you are not wasting your life if you are living as He requires. If you are in doubt about the great choice, don't stand aside and wait for developments, as Gamaliel did. Seek, and you shall find the Light, set yourself earnestly to do the will of God, and you shall know Him Who is the Truth (St. John vii: 17). Use the light you have.

"For deep in many a brave, though bleeding heart,

There lurks a yearning for the Healer's face—

A yearning to be free from hint and guess,

To take the blessings Christ is fain to give:

To all who dare not with their conscience strive,

To all who burn for this most dear success,

Faith shall be born!"

DORA FARNCOMB.

## News of the Week

Cy Warman, author and poet, who died in Chicago, was buried on April 9th, at London, Ont.

Norman Angell, author of "The Great Illusion," lectured last week upon the subject of international peace before the International Polity Club, in Convocation Hall, Toronto. At the close of the lecture, two volumes of Aylmer Maude's "Life of Tolstoi" were presented to him.

The Dowager-Empress of Japan, widow of the late Emperor Mutsuhito, died on April 9th.

Heavy losses to American and German refineries as a result of bombardment of Tampico by Mexican soldiers are reported. The Federals were routed in a desperate fight at San Pedro de Los Colomas, on April 9th.

On April 9th, British Consul Myles, at El Paso, went to Juarez to protest to Gen. Carranza against the confiscation of British mining property at Tampico. He declares that the call was unofficial, but it has been interpreted by the Carranza Government as a virtual recognition of it by Great Britain.



## A Concrete Root Cellar

is one of the farmer's greatest money makers. It makes money by keeping produce in good condition until it can be taken to market, or until better prices can be obtained. It maintains a cool, even temperature that

### Keeps Produce Perfect

A concrete root cellar is always dry, clean and sanitary. It is proof against heat, cold, water, fire and rats. Although the greater part of it is under ground, it cannot crumble or rot away. It is permanent and needs no repairs

Tell us to send you this handsomely-illustrated free book, "What the Farmer Can Do With Concrete." - It contains the fullest information about concrete root cellars and other farm buildings that never wear out, and shows how you can build them at a small cost.

Farmers' Information Bureau

**Canada Cement Company Limited**

564 Herald Building, Montreal

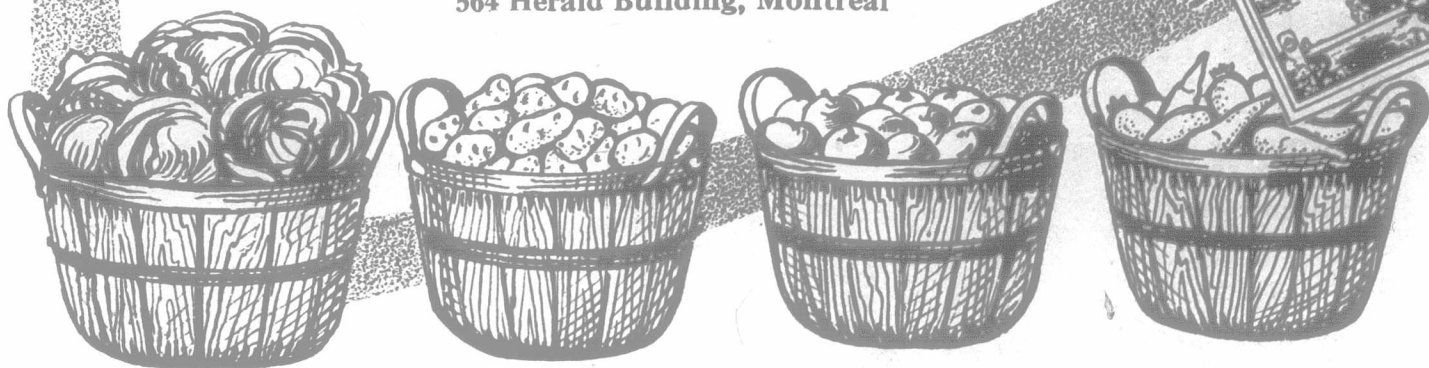

You Can Solve the Problem of raising young calves ECONOMICALLY by using

Gardiner's Calf Meal

THE PERFECT CREAM SUBSTITUTE

along with your separated milk, this is no experiment but has been proven successful by thousands of our customers.

The good reports from the users of our Calf Meal which are coming to us every day are our best guarantee as to the value of our Calf Meal for raising calves.

Why not give it a trial? If your dealer does not handle our meal write direct for our Special offer of a Trial Sack of 100-lbs. prepaid to your nearest station.

Save the Young Chick

One of the greatest sources of revenue in poultry raising is to be able to bring the maximum number of young chicks from the hatch unto full maturity. This can be done by feeding

Gardiner's Baby Chick Food

to the baby chicks for the first few weeks until they are old enough to take larger grain when they may be fed our Chick Food.

Our BABY CHICK FOOD is a special preparation for the baby chicks made from the finest of cereals carefully prepared in the right proportions and partially predigested, making it an exceptionally good food for bringing the young chicks past the critical period of the first few weeks.

You don't feed a baby like a man, neither should you feed a Baby Chick like a full grown hen.

Put up in 25-ct. packages or in 25-lb., 50-lb. and 100-lb. bags. Ask for our special prices of assorted orders of 500 lbs. of our Calf Meal and Poultry Foods. Manufactured by

GARDINER BROS., Sarnia, Ont.

Advertisement for Ramsay's Ready Mixed Paint featuring a calendar for March, April, and May, and an image of a paint can.

Biggest Thing on the Calendar for Spring

A Reliable Name on a sealed can is everywhere the Modern Guarantee of Quality

And now for the Spring clean-up. You will find Ramsay's Paint the lustiest helper you ever employed.

For every purpose there is a special Ramsay finish, and in every can of Ramsay's Paint there is the ideal combination of honest, time-tried materials and modern scientific methods of machine mixing.

The local Ramsay dealer will give you splendid service and suggestions, or write direct to the factory for interesting paint literature that will help you solve your paint problems.

A. RAMSAY & SON CO (Established 1842) MONTREAL, Que.

Black Cat Batteries

cost less last longest WHY? Because they have NINE LIVES!

They outlast all other batteries. Made in Canada by the oldest, largest and most reliable Battery Factory in the Dominion

CANADIAN CARBON CO. Limited 96 West King Street TORONTO

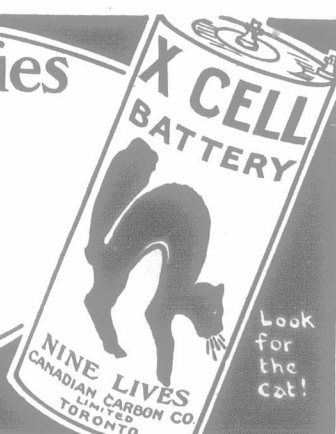

The Ingle Nook.

[Rules for correspondence in this and other Departments: (1) Kindly write on one side of paper only. (2) Always send name and address with communications. If pen name is also given, the real name will not be published. (3) When enclosing a letter to be forwarded to anyone, place it in stamped envelope ready to be sent on. (4) Allow one month in this department for answers to questions to appear.]

Dear Ingle Nook Friends,—Didn't my fine spring "spiel" of last week end in a rather ludicrous anti-climax? Ugh! As I came down this morning everyone was running to keep warm, furs were out, and it looked as though winter were in full advance rather than in flying retreat to boreal regions—to make way for the bluebirds!!! Of course, by the time this reaches you you may be sizzling.—Moral: Don't write about the weather a week before.

Nevertheless the refrain is still ringing in my ears,

'Let us go, go, go away from here! On the other side the world we're overdue, 'Send your road is clear before' you When the old spring-fret comes o'er you, And the Red Gods call for you.'

Have you ever thought of it, dear Ingle Nook friend,—of the many, many roads there are, some closed, perhaps, yet some open, and many more to be opened if we will only set the key to the toll-gates? Your road may not, perhaps, lead you to "wood-smoke at twilight," to the land of the "blackened timbers," the "racing stream," and "a silent, smoky Indian that we know."

If I could I think I should want to be an apostle of joy. The older I grow the less patience I have with the old Puritanical notions of self-harrowing and fear of happiness. Why when you are joyful you are at your best; you are doing your best work; you are radiating sunshine into a world which, heaven knows, needs it badly enough.

Personal sorrows come to us, too, often sorrows of our own making, occasionally those that are thrust upon us through accident or someone else's shortcomings. They leave their sting, and not always is it possible for us to turn them into the incense of holy places. But, after all, the great crashes do not come often. The most of life is an opportunity for joy, and upon our own heads be it if through laziness, or stupidity or warped vision we turn the long level reaches into places for marking time and doleful whimpering.

How much better to feel that we are on an open road leading to all sorts of wonderful revelations and interesting mysteries.

"Afoot and light-hearted I take to the open road, Healthy, free, the world before me, The long brown path before me, leading wherever I choose.

"Henceforth I ask not good-fortune—I am good-fortune, Henceforth I whimper no more, postpone no more, need nothing. Strong and content, I travel the open road."

But the revelations and mysteries do not come to those of us who simply sit about or keep ourselves busied eternally with just the muck of things. We need to get the vision somehow, the vision which will make us see "every common bush afire with God" where, perhaps, "the rest sit round and eat blackberries." We have to make the effort if we are to advance, if we are to taste the delight of feeling that we are advancing, now slowly, and again by leaps and bounds. Dear friend, are you just a bit tired of

things? Have you the feeling "Let us go, go, go away from here," but are you tied down, tied down hand and foot by home duties that sometimes seem irksome because so monotonous? But has it never struck you that the emancipation may be right in your own hands? After all it is just emancipation that we all want—and where can we find it but in our own minds?

You may literally "go away from here;" you may travel abroad, enjoy yourself immensely, come home broadened somewhat and with many pleasant memories, yet in a few months be as much in the doleful dumps as ever; but once you have set out on the open road of the mind, you can't mark time, you can't feel stupid, you can't eternally whine.

It isn't drudgery to wash dishes, or to scrub floors, or to sweep and dust, is it?—if all the time you are lifting a song of bright thoughts inside of your little head, or puzzling out something interesting. Think of it—your mind is almost everything; now isn't it? If it is all right everything is all right. And if you haven't time to develop it you ought to make time. Almost everyone can do that by eliminating non-essentials.

Now I know some of you are saying, "Hurrah! My sentiments to a dot!"—But please don't any of you gasp a dying gasp and say, "oh this is all very well for some people, but it isn't for common folk like us."—There aren't any common folk. Folk are never common or ordinary unless they let themselves be so.

And don't sit long with a perplexed frown on your brow wondering just how one is to begin.

Of course I'm coming to books, and dear friends don't become impatient with me. If I talk books, books, and yet more books, believe me it is because I know so well what they have been to me. They may be just as much to you—as many of you have found out. Why should they not be? They make you think,—they make you THINK; don't forget that.

Get books, but find out what are the right books. Perhaps you distrust your judgment; but surely you have some trained friend—some educated friend, trained in books—who can help you a little until you have found your feet. Perhaps at first your pastor or your priest can help you; a little later you will need no help, for you will be your own arbiter in the matter. I only hope that your clergyman or your teacher is a true booklover, gifted with the literary sense, broad-minded and a student. Not all measure up to the mark.

I should like right here to plunge into telling about some books, recommended to myself lately by just such guides, which have meant much to me, but my space is at an end. Next time, perhaps, you will care to hear.—Junia.

THE LAW COURSE.

Dear Junia,—I am coming, like many another, to your corner for information. I am attending a Collegiate Institute just now, but intend to take up a course in law. I know that there are very few lady lawyers, but I think I will like it very much.

Could you give me any information as to this course? How old would I have to be to go to Osgoode Hall? I intend to finish my four years in Collegiate before doing anything else. I am asking a great deal of you, dear Junia, but I hope you will be able to answer me. Thanking you in advance.

A LAW ASPIRANT.

Write to the Registrar of Toronto University for all information in regard to this course.

LETTER FROM A "CHATTER."

Dear Junia,—Do you know the pleasurable feeling that comes in receiving something you have long been looking for but did not really expect to get? From time to time, you have expressed yourself in a small way, on woman suffrage, and I always thought, "Oh I do wish she would sit down and write us what is really her heart thought on the subject." Well it came at last in March 12th Advocate, and thank you very much. I think your position is the position of most of the thinking women of to-

### The Book That Saved These Ladies Over \$200 Is Yours Free

Mrs. James Cameron writes:



Pink Charmeuse Dyed Dark Blue

"My husband and I were invited to a large ball last week. I was at my wits' end to know what to wear. I had a pink charmeuse gown which was so badly faded that I did not see how I could wear it, and had made up my mind I would have to buy a new gown for the occasion, although we really could not spare the money conveniently. In looking over the advertisements in the Magazine I saw your advertisement offering to send THE DIAMOND DYE ANNUAL AND DIRECTION BOOK FREE. I wrote you for a copy and received it by return mail. At the drug store on the corner I bought a package of DIAMOND DYES for Wool or Silk and recolored my charmeuse a dark blue. I made some alterations to it and trimmed it with Bulgarian trimming. It was a great success and since dyeing it I have dyed many other articles with DIAMOND DYES. I have counted up and find that the one cent postal card I sent you for your book has saved me at least a hundred dollars. If I had bought the things it made as good as new, they would have cost that much money."

KATHERINE CAMERON. (Mrs. James Cameron)

P.S.—My husband says I was the belle of the ball in the charmeuse gown. I send you my photograph in it. You may publish it if you like.

### Diamond Dyes

"A child can use them"

Simply dissolve the dye and boil the material in the colored water.

Miss Joan Wilson writes:

"Enclosed is a photograph of myself in a cloth suit I dyed according to directions which I read in your DIAMOND DYE ANNUAL AND DIRECTION BOOK. It was originally a gray and I dyed it a beautiful deep brown. I also dyed an agrette, which was white, to match the gown. I did not need the book to dye this suit, for the directions on the envelope of the DIAMOND DYES I bought told me all I needed to know, and their use is so simple. Still I found the book very valuable for it told me of many things that could be dyed. It has, I believe, saved me \$100, or more, by making good materials of poor color available for use in new and stylish hues."



Gray Suit Dyed Brown

JOAN WILSON.

NOTE.—In a second letter Miss Wilson writes: "You have my full permission to use the photograph I sent you in your advertising."

#### Truth About Dyes for Home Use

There are two classes of fabrics—Animal Fibre Fabrics and Vegetable Fibre Fabrics.

Wool and Silk are animal fibre fabrics. Cotton and Linen are vegetable fibre fabrics. "Union" or "Mixed" goods are usually 60% to 80% Cotton—so must be treated as vegetable fibre fabrics.

It is a chemical impossibility to get perfect color results on all classes of fabrics with any dye that claims to color animal fibre fabrics and vegetable fibre fabrics equally well in one bath.

We manufacture two classes of Diamond Dyes, namely—Diamond Dyes for Wool or Silk to color Animal Fibre Fabrics, and Diamond Dyes for Cotton, Linen or Mixed Goods to color Vegetable Fibre Fabrics, so that you may obtain the Very Best results on EVERY fabric.

Diamond Dyes Sell at 10 Cents Per Package. Valuable Book and Samples Free.

Send us your dealer's name and address—tell us whether or not he sells Diamond Dyes. We will then send you that famous book of helps, the Diamond Dye Annual and Direction Book, also 36 samples of Dyed Cloth—Free.

THE WELLS & RICHARDSON CO., LIMITED 200 Mountain Street, Montreal, Canada.

day. The first thought on the question is that of disapproval, among farmer women especially. In their happy, independent homes they think everything must be all right. The men take care of the outside world, ours is the inside world—the home. But just stop. Again, and again, and again, we hear the call from the outside. "Wake up sisters! All is not well." We perhaps stop and listen, and think a moment, and then the matter is dropped. But still further comes, the cry. Then, it may be, something comes into our own life, or into our friend's life, a girl gone astray, or a boy ruined through drinking or cigarette smoking, or some of the thousand and one things that are happening every day and we say, "Why is this evil allowed?" and we are roused to do more thinking. Are the men doing the outside world's work as they should? There is no doubt but what it is their duty and their proper sphere, but they have certainly failed to fulfil all of their duty.

I have always in the bottom of my heart favored woman's suffrage. While women are different from men, they are not inferior any more than mind is inferior to brute force. While it is woman's nature to look up to man as a superior, and it is usually the man's nature to foster that feeling, he for some reason or other is not able always to hold his position. This is emphasized more since woman has awakened to the fact that she has a mind as well as he. Women have been developing far more rapidly in the past hundred years than man has,—I do not mean our geniuses, but our average ever-day man. Compare him with the man of a hundred years ago, and our women of to-day with the woman of a hundred years ago. Perhaps the men are just waiting for her to catch up, and take her proper place at their side as their equal. If so, when she does reach that plane, the man will gain far more than she, as she will be the balancing power between the moral and material forces.

Now, as to our English sisters. To my mind we are not in a position to judge. We think they might have found some other way to accomplish their ends, but we are not there and we do not know it all. These women have been there all their life; they, perhaps, have thought out all the different plans, and are acting according to their best judgment.

I was so interested in your print of Mrs. Pankhurst's face. How different from the pictures of her marching off between policemen! A woman with such a face could not be vicious or coarse or low. There is mind and soul looking out from those eyes. We must not judge her too hastily.

MRS. J. W.

#### POLISHING WINDOWS.

Dear Junia,—I have never written to your Ingle Nook before, but as I was writing to the "Advocate" I thought I would put in a note to you. I find many very helpful things in your Nook, and I saw in it a method for polishing windows some time ago. Well, as I have a simpler one I will pass it on to you. It may help some busy housewife in housecleaning time. Just secure a piece of chamois at a drug store (I got mine two years ago for 15 cents), and when washing windows just wash them once with it, then rinse it again out of clean water and wipe the windows off with it. In a few seconds Easter. Simcoe Co., Ont. "BUSY BIRD."

#### WEDDING QUERIES.

Dear Sirs,—Would you please give in your Advocate a few good suggestions for a wedding in the month of February?

Would it be suitable to have Valentine decorations after the 14th of month, or what would be most suitable for the occasion?

Would you have a number of small tables or one long one in centre of large room for guests of one hundred? Tell how to decorate tables, about eatables. What kind of meats, and salads?

How many cut cakes or layer cakes would be necessary? What kind of fruits and raw fruit would be best? How many oranges and candy? How many courses would be best to have?

### "Canada's Biggest Piano Value"

THINK for a moment! The money you are going to pay for that piano is genuine 100 cents to the dollar money. No other kind will do. Make absolutely certain of 100% efficient piano. Buy a



Style 70.—Colonial

### Sherlock-Manning 20th Century Piano

and you buy "Canada's Biggest Piano Value"—an instrument conceded to be second to none in lasting tonal qualities and durability.

Another important consideration: The Sherlock-Manning can be delivered right to you at a saving of \$100.00, owing to our 20th century way of doing business.

Ask for the proofs of this statement. We'll mail them to you along with our latest art Catalogue. 41

SHERLOCK - MANNING PIANO CO. LONDON (No street address necessary) CANADA

MAIL THIS COUPON NOW

MESSRS. CATESBYS, LTD. (of London) Dept. "A," 119 West Wellington St., Toronto, Ont.

Please send me your new season's Style Book and 72 pattern pieces of cloth. I am thinking of buying a suit—overcoat.

Full Name.....

Full Address.....

\*If you only want overcoat patterns, cross out the word "suit." If you only want suitings, cross out "overcoat." London Farmer's Advocate. Coupon No. 2.

### We Want Every Reader of The London Farmer's Advocate to Sign and Mail This Coupon

Mail it and get a free set of Catesbys' suit or overcoat patterns, and be convinced that it is possible to buy a better suit in London, England, for \$13.25 than could be bought in Canada for \$25.00.

You've heard that clothing is much cheaper and better in England—you know that English fabrics are the finest in the world.

Think, then, of the advantages of securing a suit made of the best English woollens, cut in the latest Canadian, New York or London style (whichever you prefer), and tailored to your individual measure, delivered to your door all duty and carriage charges prepaid, for about half what you would have to pay if you bought it in Canada.

Isn't it worth while, then, to get our patterns and see what there is in this offer? You can't lose anything by it, but you may save a whole lot.

All you need do is to fill in the coupon and mail it to our Toronto office. By return we'll send our latest Style Book, 72 pattern pieces of fine English suitings, a letter explaining our system of doing business, and a self-measurement chart that is so simple you can't go wrong in taking your own measure.

We will also send you testimonials from Canadians who at first were as sceptical as you are, but who are now satisfied and regular patrons.

WRITE NOW. If you don't want to cut this paper, send us a post card or letter. We'll mail book and patterns anyway. But to get them you must mention London Farmer's Advocate.



### CATESBYS, LTD.

(Of Tottenham Court Road, London, England)

119 West Wellington Street

TORONTO

The "CARRINGTON." A very dressy model; full three-button double-breasted style, in tweeds or fine blue serge, \$13.25, all duty and carriage charges paid right to your door.



### Do You Need Furniture?

We can help you to a most economical purchase by our direct-from-factory plan of selling furniture. Write for our large, free

### PHOTO ILLUSTRATED Catalogue No. 7

Hundreds of pieces of the best selected furniture and home furnishings priced at just what they will cost you at any station in Ontario.

ADAMS FURNITURE CO., Ltd

Canada's Largest Home Furnishers TORONTO

# From Factory To You

# \$32.00 Per Ton

F. O. B. Dundas, Ontario

THIS is the kind of opportunity you get once in a long time. In order to introduce Caldwell's Dairy Meal we have decided to sell direct it to farmers at wholesale prices.

You need only read the list of ingredients and the Government-guaranteed analysis to realize that this meal is the production of an experienced dairy expert.

## CALDWELL'S DAIRY MEAL

<b>Guaranteed Ingredients</b>	<b>Guaranteed Analysis</b>
Cotton Seed Meal, Gluten Feed, Malt Sprouts, Dried Grains, Chopped Barley, Clover Meal, Molasses Meal.	Protein - - - 20%
	Fat - - - 6%
	Fibre - - - 10%

COMPARE the price we quote with the price of any feed on the market for the production of milk—then remember that this is a fully-balanced ration, made from carefully-selected materials, thoroughly re-cleaned and guaranteed to contain no mill sweepings, oat hulls or other low-grade fillers. The correct and necessary feeding elements have been incorporated in proper proportions to ensure a complete balanced ration in a most easily digestible form. Write for booklet.

**The Caldwell Feed Co., Limited**  
DUNDAS, ONTARIO

USE THIS COUPON

The Caldwell Feed Co., Ltd., Dundas, Ont.

Send me.....ton of your CALDWELL'S DAIRY MEAL.

Enclosed is.....to pay for same.  
(Use P. O. Order, Express Order or Bank Money Order.)

Name.....

Address.....

Nearest Railway Station.....



## HAYING TOOLS

FROM FACTORY TO FARM

Satisfaction Guaranteed Or We Refund Your Money

Hay Carriers For Wood, Steel or Rod Tracks	\$4.50	Slat Slings 5-ft. Set	6.25
Forks - - - - -	\$2.10	Shir Pulley - - -	1.75
Steel Track, per ft. -	.10	Pulleys ea. - - -	.25
Track Couplings, ea. -	.10	Floor Hooks 3/4" ea.	.08
Track Bumpers, ea. -	.10	Hitch Hook, ea. - -	.20
Sling Lifter - - - -	1.40	Pulley Hoister, ea. -	.15
Short Slings 2-Rope Set - - - - -	2.60	Hanger, Steel Track	.07
Short Slings 3-Rope Set - - - - -	3.50	Hanger, Wood Track	.07
Slat Slings 4-ft. Set	5.50	Brackets - - - -	.06
		Bracket Nails, lb. - -	.06

FREIGHT PAID IN ONTARIO

**R. DILLON & SON,** 110 MILL STREET Oshawa, ONT.  
ALSO LITTER CARRIERS, STALLS, STANCHIONS, ETC.

About bride's cake.—How should it be cut and served, and by whom?  
Is it fashionable or not to have bridesmaids and grooms-men or flower girls?  
What would be nice for bride's dress, and bridesmaid's dress, for fair and dark people?  
What amusements during the evening?  
About what time in the afternoon would be fashionable to get married?  
What time should they dine?  
I think probably this is all at present. Hoping to see this in Advocate as early as possible.  
Wellington Co., Ont. MARY.

My dear Mary, you have certainly arrived in good time. For next, February! Whew! I rubbed my eyes to see if possibly your letter had not been belated and last February was meant, but no, there it was in black and white,—March 14th!

If the wedding is to be very soon after Feb. 14th Valentine decorations would be quite in place, but, of course, they would be much more appropriate for that very day. Pink flowers, pink tulle, and the tiny pink hearts that may be bought all ready for use—do not these suggest to your artistic soul a dozen different arrangements? As a rule white flowers are preferred for the bride's table.

With one hundred guests you will find it much more convenient to have a number of small tables, unless, indeed, you prefer to have a buffet luncheon, where the guests eat standing up or any old way, the gentlemen helping to serve the ladies. I hate the "things" myself.

Hot meats are becoming more and more of the past at weddings, cold meats, salads and dainty sandwiches taking their place. Fowl and sliced tongue are always liked.

But as to quantities,—see here, Mary dear, I am an editor, not a caterer. Besides I don't know how much the people up in your part of the country eat. Let me out of it, won't you?—and get someone nearer home to do the necessary "figuring." I never was any good at mathematics anyway.

## Alfred A. Gilmore

ARCHITECT

Preston :: Ontario

SPECIALIZING IN

Sanitary Dairy and Stock Barns

Exhibition Buildings

Rinks and General Farm Buildings

Write for Literature and Testimonials

## GRAND TRUNK RAILWAY SYSTEM

### Homeseekers' Excursions

Round trip tickets to points in Manitoba, Alberta and Saskatchewan via Chicago, St. Paul or Duluth, on sale each TUESDAY until October 27, inclusive, at low fares.

Through Pullman Tourist Sleepers to WINNIPEG on above dates, leaving Toronto 11 p.m. No change of cars. Return Limit, Two Months

### SETTLERS' FARES

(One-way second-class)  
From stations in Ontario, Kingston, Renfrew and west to points in Alberta and Saskatchewan, each TUESDAY during April.

The Grand Trunk Pacific Railway is the shortest and quickest route between Winnipeg, Saskatoon and Edmonton, with excellent through service to Regina. Trains now running into Calgary.

Berth reservations and particulars at all Grand Trunk ticket offices or write C. E. HORNING, D.P.A., Toronto, Ont.

Regenerated Banner Oats grown in first prize standing crop the last two years. Per bus. 60c., bags 30c. Geo. D. Fletcher, R. R. No. 2 Phone Erin

## Silos! Silos! Silos!

FACTORY TO FARMER

A better silo for less money. Send for price list and cuts.

FARMERS' SILO MANUFACTURERS, Markham, Ontario

## Bargain on Clydesdale Stallion

For quick sale. Grandview Baron, No. 11011; four years old; took 1st prize at Guelph when a colt and a number of other shows; enrolled, 2842; form 1, inspected; bay, white face and legs. The owners have sold their farm and he must be sold. Liberal terms to good customer. Weighs about 1,900 lbs. MAIR BROTHERS, Aurora, Ont.

Please mention "The Farmer's Advocate."

Mail This Coupon NOW

London Feather Co., Ltd. 144 Yonge St. TORONTO, ONT.

Send me your latest Plume and Hat Catalogues. I am thinking of buying a hat or some new plumes, or of getting my old plumes re-dyed and made over.

NAME..... ADDRESS..... London Farmer's Advocate.

Get Two Millinery Catalogues Free

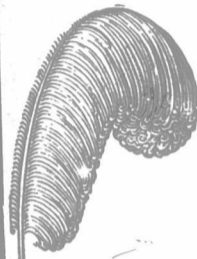

One is a catalogue of newest styles in hats, illustrating 20 up-to-date models; the other is a catalogue of plumes, the like of which, for style and value, you never saw before.

This handsome plume, fully 18 ins. long, French curled and fastened on your local milliner would charge \$6.50 for, in either Black or White, I should be glad to send you, \$3.95 from us.

Both are full of typical London Feather millinery bargains. For remember, when you buy from us you save all middlemen's profits. Our prices are 50% to 75% less than local dealers.

Send Old Ostrich Plumes To Us To Be Made Over

We make them into fashionable novelties, from 75c. up. You take no risk, because if our price is not satisfactory we return your feathers at our expense. You had better sign and return the above coupon at once.

London Feather Co., Limited Dept. F 144 Yonge Street TORONTO, ONT.

As to courses, why that must depend on how much trouble and expense you wish to assume. If you wish to make a great fuss you might undertake something like the following:

- Consomme in cups, or grape-fruit cocktail. Oyster Patties. Olives. Salted Nuts. Boned Turkey. Tongue in Aspic Jelly. Lobster Salad. Chicken Salad. Nut Sandwiches. Candied Fruit. Small Cakes. Orange Ice. Fruit Cake. Lemon Ice. Coffee. Chocolate.

Personally I think such a menu all nonsense. One can do very nicely, and without menace to anyone's digestion, with a much simpler and daintier preparation, e. g.,

- Grape-fruit in Cups. Oyster or Chicken Pates. Sliced Turkey. Sliced Tongue. Waldorf Salad. Ice-cream or Fruit Salad. Cake. FRUIT. NUTS. Coffee. Tea.

Of course, you may add salted almonds, pickles, olives and bonbons at your sweet will.

The chief thing to remember is to be sensible about the whole affair. As soon as one begins to "show off" one is vulgar. Simplicity and daintiness should be the aim rather than great expenditure or elaborateness.

As a rule the bride puts the first knife-cut into the cake, using a knife tied with white ribbon. Someone then finishes the cutting, and the pieces are distributed to the various tables. Sometimes still the old fashion of having a decorated bride's cake on the bride's table is still adhered to, by way of ornament pro tem, but to be taken to the bride's home later; of course similar cake is served at the time. Often, however, this is not done, and, instead, a pile of dainty white boxes containing wedding cake is left in the hall, and each guest is supposed to take one, for good luck, on leaving.

It is quite in order to have bridesmaids, best man and all the rest at a wedding, especially a church wedding. Many, however, prefer to go "un-attended."

The bride's dress should, of course, be white,—white satin, embroidered mull, etc., according to her means, and the use to which the gown is afterwards to be put. The bridesmaids may wear dresses of any pretty material in light, dainty coloring, and the effect is prettiest if all are made alike. The colors should, of course, harmonise. It would be awful, for instance, to see two or three shades of pink screaming at one another beside the white-robed bride. Methinks it would take away no little of the solemnity of the service.

Amusements will not be necessary. And don't try to be "fashionable." Have the wedding at the time that it suits best for convenience. The wedding-breakfast comes after the bride and groom have had ample time to receive their friends, and respond to their congratulations and best wishes.

COMPLEXION QUERIES.

Dear Junia,—May a stranger enter your Ingle Nook for some help? Will you kindly tell in "The Farmer's Advocate" first:

- What will remove blackheads? What will remove hair from the face without injuring the skin? Will you give some hints on health, how to be a healthy, happy, rosy-cheeked girl? What will give me a clear skin, free from pimples?

I have heard olive oil or cod-liver oil, I forgot which, was said to be good in clearing the complexion. Will you recommend this?

SUNFLOWER. Elgin Co., Ont. To remove blackheads wash the face well every night with plenty of warm water, good soap, and a complexion brush, then apply a good cream, which must, of course, be washed off in the morning. Apply once a day until the spots disappear the following lotion: Boracic acid 1/2 dram; spirits of rosemary 1 ounce; water 3 ounces. Rub in well.

\$60 A WEEK AND EXPENSES

to any Canadian man or woman with red blood in their veins. I want representatives in every part of the country for the best, most honest, and most efficient proposition ever offered. No experience needed.

It solves the bathing problem. No plumbing, no waterworks required. A boon alike to country and city dweller. Full length bath in any room. Folds in small roll, handy as an umbrella. Now, I want YOU to handle your county. Demonstrating tubs on liberal plan. I'm positive you can make more money in a week than you ever made in a month before.

Two Sales a Day—\$300 Dollars a Month

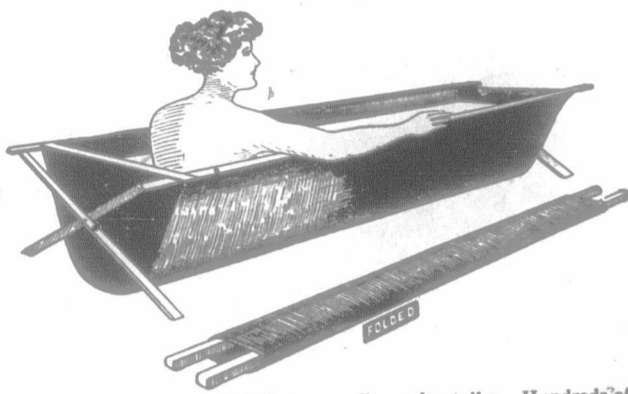

That's what you should get every month. Needed in every home—badly wanted—eagerly bought. Take the orders right and left. Quick sales, immense profits. Look at these men. Smith, Ohio, got 18 orders first week; Myers, Wis., \$250 profit first month; Newton, California, \$60 in three days. You should do as well. The work is very easy, pleasant, permanent, fascinating. It means a business of your own.

Demonstrating Tub Furnished

I grant you credit—back you up—help you with live, appealing sales talks. Hundreds of delighted buyers and sales agents bear testimony to the value of my folding bath tub and to the squareness of my business methods. Write to-day for full details. Send no money. Just hustle a postcard for free Tub offer.

C. A. RUKAMP, General Manager.

The Robinson Cabinet Mfg. Co. Walkerville, Ont. 129 Sandwich Street

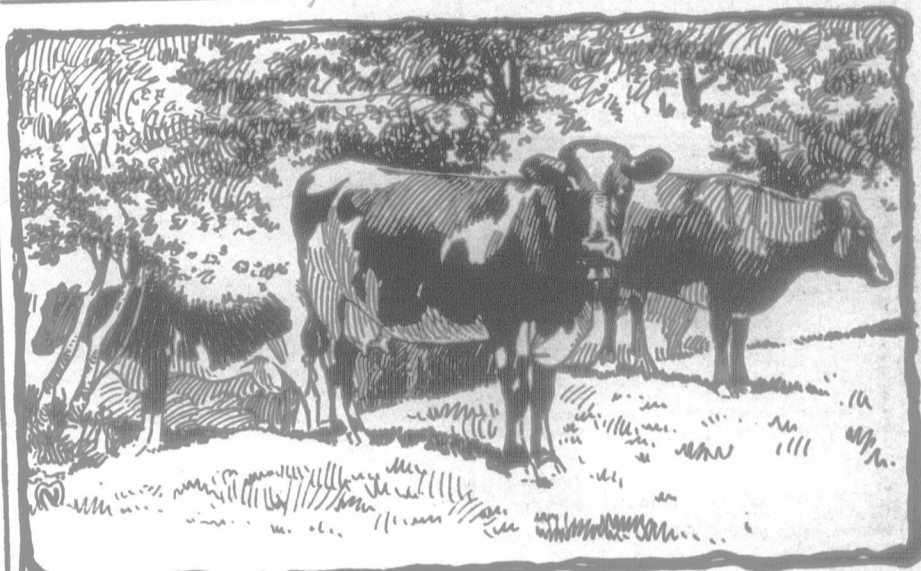

Pick out your California Farm this Spring

Look into the money-making possibilities of dairying, poultry-raising and fruit-growing in the San Joaquin Valley—heart of Golden California—now. This year will see thousands of homeseekers in California. Your foresight should lead you to anticipate this influx.

Here is a wonderfully fertile valley whose deep, rich soil, all-the-year-round growing climate and irrigation facilities make it a food factory that produces a great range of crops in bountiful measure. Its location gives it ready access to markets eager for all that can be produced.

It is already a well-developed country. People here get together and cooperate to save and to make money for each other.

I am here to help you to locate to advantage. I am not selling land—but I can point out the land best adapted to various crops. I can save you time and travel. I want to secure ambitious, progressive farmers to cultivate these prolific acres along the Santa Fe.

Write for our free books, "San Joaquin Valley," "Dairying" and "Poultry." Read what they tell of the reasons why this country is good—of people who have made successes, and how—of results which you can get if you have only the necessary energy and ambition.

I would like you to read what the farmers already here have to say in regard to what has been done by them to win fortune in this land of big returns.

Send coupon, or your name and address on a postal, saying "San Joaquin Valley." This will bring the books promptly and any additional information desired. Write to-day.

C. L. Seagraves, Genl. Colonization Agent, A. T. & S. F. Ry., 2262 Railway Exchange, Chicago. Please send me free copies of your three books on farming in the San Joaquin Valley, California.

Melotte Cream Separator



Increases the butter yield 25% besides improving the quality.

Saves time and labour, space and utensils.

A MILLION IN USE

You Can't Afford To Be Without a "MELOTTE"

THE "MELOTTE" BOWL

Unlike the top-heavy bowl in other makes the "Melotte" bowl hangs free on a ball-bearing spindle, hence the easy running of the machine and its consequent long life.



Write For Catalogue "G"

R. A. LISTER & CO., Limited 50-60 Stewart St. TORONTO, ONT. WINNIPEG, ST. JOHN, N.B.

Please mention "The Farmer's Advocate."

When writing advertisers mention "The Advocate."

**HOW 'PRO-FAT' INCREASES YOUR DAIRY PRODUCTS**

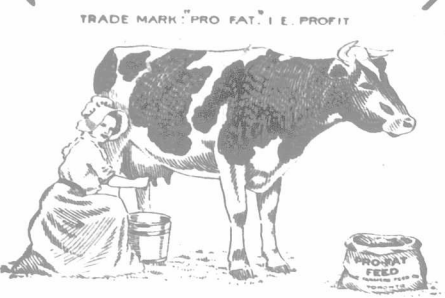

FEED DRIED BREWERS GRAINS AND WATCH THE MILK FLOW INCREASE

PRO-FAT makes your cows produce a larger quantity and better quality milk. PRO-FAT is a scientifically prepared food, made of dried brewers' grains, rich and nourishing. As a milk producer it is giving wonderful results. Leading dairymen, men who have experimented and tested various feeds, stand by and recommend PRO-FAT as the most wholesome body-building and milk-producing food.

Write for sample and booklet, which will give you still more information and show you how to increase your dairy profits.

**The Farmers' Feed Co., Ltd.**  
108 Don Esplanade, Toronto

**Early Seed Potatoes**

- Irish Cobblers, one of the best early sorts per bag... \$1.50
- Early Harvest, nice white stock, a favorite, per bag... 2.50
- Early Ohio, stock limited, per bag... 1.50
- Early Sensation, per bag... 1.50
- Early Pink Eye, per bag... 1.25
- Davies Warrior, late, new, per bag... 2.00

Other late varieties: Carmen, Delaware, Green Mountain, Nox Alls. Any of above late varieties \$1.35 per bag. No charge for potato sacks. F.O.B. Guelph.

- Seed Peas, Early Centennial, \$1.35 per bus., Lakefield White, \$1.35 per bus.
- Seed Corn, Shelled, White Cap Yellow Dent \$1.35, Leaming \$1.35 bus. Mammoth Cuban \$1.40 bus. Gate Post Yellow \$1.40 bus. Wisconsin No. 7 \$1.50. Southern Sweet \$1.35 bus., Comptons Early \$1.65 bus., Long Fellow \$1.65 bus.,

F. O. B. Guelph. Bags extra 25c. each. Corn shipments about May 1st to 15th.

**HEWER SEED CO.,**  
90 Macdonnell Street, East, GUELPH, ONT.

**The "New Century" SMILE**

It is worn by every housewife who uses one of these washers. The reason is quickly found for the New Century makes washing easy. It removes the hard rubbing and does the work more thoroughly than any other way. The New Century Hand Washer works quickly and easily. It gushes the water through the fabric, leaving it sweet and clean in a few minutes. It cannot injure the finest garment you possess. The product of twenty-five years experience in making washers, the New Century is without an equal. Patented features make it the leading hand washer. Examine it at your dealer's or send to us for information.

**CUMMER-DOWSWELL Limited**  
Hamilton, Ontario

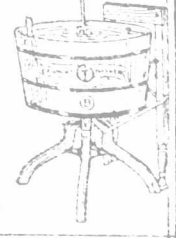

It is impossible for anyone but a specialist—and a very good one at that—to remove hair from the skin.

How to be "a healthy, happy, rosy-cheeked girl"?—That's a fairish order, isn't it, Sunflower? But your name is one of good omen. How could a sunflower be other than robust and cheery. Hm-m-m, let us see: To be healthy you must obey all the laws that make for good health, take plenty of open-air exercise, plenty of sleep, eat good, nourishing food, breathe fresh air night and day, think pleasant things, and never, never, never fall into a "bad temper." When you have good health you are likely to find that the "rosy cheeks," or, at least, a good, healthy color, will follow. Health will help to bring happiness, but to be really happy you must find something interesting and useful to do. Keep busy, keep interested, find out worth while things in life. . . . Now, how is that for a prescription?

Sometimes pimples are caused by some internal condition of the body. In that case it is necessary to consult a physician. If, however, they are confined to the skin something may be done by way of home remedy. The first step is frequent bathing,—a bath every day, with plentiful use of a good, mild soap, and a fresh brush. Especially is it necessary to wash the affected parts well before going to bed. After washing one of the following lotions may be applied: (1) Alcohol 3 ounces, salicylic acid 1 drachm. Good also for removing blackheads.

An old-fashioned remedy for pimples which you may try—it is sure to be harmless at least—is red clover tea. Put a good pinch of dried red clover, leaves and blossoms, into a jar and pour over  $\frac{1}{2}$  pint boiling water. Let stand over night. The dose is a small wine-glassful taken three or four times a day.

Olive oil is sometimes used as a skin-food, for dry, harsh skin, but it is scarcely as satisfactory, as some of the good cold creams. If you take enough cod-liver oil internally it will make you plump. Now, Sunflower, I hope you will be more beautiful than ever.

**The Scrap-Bag.**

A RAIN BARREL HINT.

If you have a house guiltless of cistern or plumbing, and are dependent upon rain barrels for your soft water supply you will find the following plan of value. Place the barrel on a high stand, and have a faucet attached to the lower part of it. Next procure a long piece of rubber hose with a faucet attached. The hose, as you may see, may be passed into the house through an open window, or may be used, if faucets be also attached to the wash-tubs, for watering the back-yard garden.

**TO WHITEN YELLOW LINEN.**

To whiten linen that has become yellow from lying away, wash and rub soap all over and without wringing put it in the sun. When dry, wet thoroughly and repeat the process. A day or two of this will make the linen as white as when new.

**TO CLEAN A WOOL SWEATER.**

Shake out all the dust, then drop the sweater in warm water and stir it about. Press out a little and remove to a vessel of clean, warm soapy water, to which a teaspoonful of borax has been added. Gently souse the sweater up and down, and if there are any greasy spots rub soap on your hands and manipulate the sweater, but do not rub soap directly on the wool. Rinse in three clear, warm waters, and add a few drops of blueing to the final water. Press the water out, then place the sweater in a pillow-case and leave over the tub, suspended by the four corners, for three days. Finally spread it on a sheet in the sunshine, and leave a day or two until dry. If you hang a sweater on the line it will be sure to go out of shape.

**TO "SET" COLOR.**

When green, blue, mauve or purple is the dominant note soak the things before washing for at least ten minutes in alum water, using an ounce of alum to

a gallon of water. For pinks, browns, brown-reds and tans, use sugar-of-lead in the same proportion. Black goods, black-and-white, gray and very dark purple need to be soaked in strong salt water, or have some turpentine put in the wash water. Salt or turpentine put in the rinsing water will help to retain almost any color, if nothing better be on hand. It should be remembered, however, that sunshine on wet goods will bleach out almost anything colored, so that prints, etc., should be dried in the shade, and as quickly as possible. It is also necessary to rinse out soap very thoroughly. If the garments are not too much soiled wheat bran tied in a cheese-cloth bag will be found an excellent substitute for soap.

**RE-COVERING AN UMBRELLA.**

It pays to have new tops put on umbrellas whose handles and framework are good. In almost every town or city there are men who will do this work excellently, providing the material, for from \$1.00 up. Cheaper frames may be re-covered at home, and made quite presentable enough for knocking-about wear or for the children to carry to school. Remove the old cover and metal cap, and rip out a section for a pattern. Press this evenly and lay it on satine or gloria with the lower edge to the selvage, then cut out carefully. Put the sections together with French seams, then fasten to the frame and replace the metal cap.

**SPRING "GREENS."**

Among the weeds recommended by the Ladies' Home Journal (Philadelphia) for spring greens, in addition to the well-known lamb's quarters or wild spinach, are milkweed cut for cooking when about a foot high, young dandelion leaves, young leaves of the common yellow or brown dock, common round-leaved mallow, young shoots of hops. It is also stated that the colored portion of red clover blossoms makes a very nutritious salad when mixed with salad dressing.

**Seasonable Cookery.**

Orange Sauce.—Beat the whites of 3 eggs stiff and gradually add 1 cup powdered sugar, beating all the time. Next add gradually the juice and grated rind of 2 oranges and the juice of one lemon.

Lemon Cream Rice.—Pick over  $\frac{1}{2}$  cup rice, cover with cold water and let soak over night. Drain, put in a double boiler, add 3 cups rich milk and cook until rice is soft. Add  $\frac{1}{2}$  cup sugar, grated rind of  $\frac{1}{2}$  of a lemon, 1 and one-third tablespoons lemon juice,  $\frac{1}{2}$  teaspoon salt, and yolks of 2 eggs, slightly beaten. Cook for 5 minutes, turn into a slightly buttered pudding dish, and cool. Beat the whites of the eggs until stiff, and add 2 tablespoons powdered sugar gradually, then add  $\frac{1}{2}$  teaspoon lemon extract. Spread top of pudding with the mixture and brown in the oven.—Woman's Home Companion.

Potato Croquettes.—Heat 1 cup mashed potato and add a tablespoonful of hot milk. Beat very light and season with pepper, celery, salt, and half a teaspoon chopped parsley. Set away to cool, then mould into croquettes, dip in beaten egg then in crumbs, and fry. Salmon Croquettes.—To 1  $\frac{1}{2}$  cups cold flaked salmon add 1 teaspoon lemon juice and salt and pepper to season. Next add 1 cup thick white sauce made of milk thickened with a little butter and flour mixed together. Spread on a plate to cool. Shape into croquettes, dip in crumbs, then into egg and crumbs again; let get cold, fry in deep fat and drain.

Date Cookies.—Stone and chop 1 large cup of dates. Cream together two-thirds cup butter and 1 cup sugar and add to the dates. Next add a pinch of salt,  $\frac{1}{2}$  teaspoon cinnamon,  $\frac{1}{2}$  teaspoon of nutmeg and  $\frac{1}{2}$  cup milk. Add a little flour, then 2 teaspoons baking-powder, then enough flour to make into a dough. Roll out about 1 inch thick and bake in a quick oven.

Banana Salad.—Peel some fine bananas and cut them into pieces 3 inches long. Roll them in chopped peanuts and lay on lettuce. Add a little salad dressing.

Spiced Prunes.—Wash 2 lbs. prunes. Roll down 1 pint vinegar and 3 lbs. sugar with some whole spices till it is

**An Income For the Farmer's Wife**



THE wife of every farmer should have her own income and her own bank account.

And it does not matter how busy you are in the home, or how little time you have to devote to the raising of poultry we can show you how you can make a good income and build up a substantial bank account by poultry raising the Peerless Way.

We can show you how to be independent of the money your husband gets for his crops and other farm produce, so that when you wish to buy clothes, or take a shopping trip to town, you can just stop at the bank and draw all the money you will require.

**The Peerless Way Makes Poultry Pay**

If you know the right way to raise and keep poultry it requires very little outlay or money, and takes but very little of your time. The right way is the Peerless Way, that is, by hatching the eggs in a Peerless Incubator and rearing chickens in a Peerless Brooder.

Bowsman River, Man. "I bought a Peerless machine from a friend. It was the first machine I ever have seen. I brought out three hatches; the first hatch I got 137 chicks from 196 eggs, second hatch I got 143 chicks from 204 eggs, and the third hatch I got 124 chicks from 210 eggs. I intend starting another hatch this week. I like my machine fine and would not be without one again. Yours very truly, (Sgd) Mrs. Sol. Richet."

We have prepared a book for you entitled "Money In Eggs," if you would be interested in learning how other women like you are making independent incomes from the sale of eggs and plump chickens. Experience is not essential. We are practical poultry raisers ourselves and will furnish you all the information necessary to make your chickens pay you handsome profits.

Fill in and send this coupon now for full particulars.

Lee Manfg. Co. Ltd., Pembroke, Ont.

Please send me the booklet "Money in Eggs."

Name.....

Address.....

**LEE MANUFACTURING CO. LTD.**  
106 PEMBROKE ROAD  
**PEMBROKE ONTARIO CANADA**



syrupy. Add the prunes and simmer very gently until they are soft. Dip them out, add a little juice and set aside, then put in more prunes if needed.

## The Beaver Circle

Our Senior Beavers.

[For all pupils from Senior Third to Continuation Classes, inclusive.]

### Senior Beavers' Letter Box.

Dear Puck and Beavers,—I thought I would write a letter to your charming Circle. I have been a silent but interested reader ever since I learned to read. I can't go to school when the weather isn't fine, as I have three miles to walk. I like to read books. Some of the books I have read are, "The Elsie Book," "Nellie's Memories," and "Black Beauty." I am very sorry about Gladys Le Dunn, who had such a sad Xmas. I like skating and sleigh-riding. I am in the Senior Fourth Class at school. I like my teacher; her name is Miss Simpson. I am going to try the Entrance examination in June. My sister is going to try, too. Well, good-bye for this time. Your little Beaver friend,  
 BESSIE BELL (Book Sr. IV)  
 Kingston, Ont.

Dear Puck and Beavers,—I have just finished reading some of the letters in the Beaver Circle. My father has taken "The Farmer's Advocate" ever since I can remember. We all enjoy it very much. I go to school every day, and like it very well. My teacher's name is Miss Hogg, from Wingham. We all like her very well. I have one sister; her name is Mary. She is eight years old, and will be nine on the 21st of this month (written in February). She expects to have a birthday party.

Say, Puck, your Circle is such a charming one, may I join? I just love reading the letters the Beavers write. I suppose all of the Beavers are like me—they like reading. I have read "Black-creek Stopping House," "Sowing Seeds to Danny," "Bobbie, General Manager," and am reading "Treasure Island" now. Well, I will close, wishing the Beaver Circle every success.

Will some of the Senior Beavers kindly write to me?  
 MABEL WAGG (age 12, Jr. IV).  
 Claremont, Ont.

## The Ivory Snuff Box.

By Arnold Fredericks.

(Copyrighted.)

Chapter XI.

A CLEVER STRATAGEM.

Richard Duvall, alone in Dr. Hartmann's outer office, had not long to wait. He had hardly succeeded in throwing off the agitation which the unexpected sight of Grace had caused him, when the door from the hall was opened, and Grace admitted Seltz to the room.

The latter glanced at Duvall with a curious look, but said nothing. Grace withdrew, closing the door quietly after her. The detective went up to the newcomer and addressed him in a low tone. "You are Oscar Seltz, from London?" he asked bluntly.

The man appeared greatly taken back. "Yes," he said haltingly. "I wish to see Dr. Hartmann."

"About the snuff-box, of course?"

Again the man started.

"Who are you?" he asked, suddenly suspicious.

"I am Dr. Hartmann's assistant. He had been waiting for you. You have the box with you, of course?"

The man felt carefully in his pocket, and presently drew out a small object done up in paper.

"Yes, I have it. The price was to be twenty-five hundred francs."

"That is correct," remarked the detective. "Give it to me."

Seltz drew back his hand.

"I want the money first, and I cannot deliver it to any one but Dr. Hartmann."

"Dr. Hartmann is in the next room," said Duvall with a pleasant smile. "He has the money all ready for you. I will call him. But first, let me see if you

# CALDWELL'S Cream Substitute CALF-MEAL



is the next best thing to whole milk for vealing up or raising calves and it is guaranteed as such to the Canadian Government. You can raise as healthy calves on it as any man would desire and at a big saving in cost. Ask your Feedman about it, or write us for the proofs.

THE CALDWELL FEED CO., LTD., DUNDAS ONT.

## POULTRY AND EGGS

Condensed advertisements will be inserted under this heading at three cents per word each insertion. Each initial counts for one word and figures for two words. Names and addresses are counted. Cash must always accompany the order for any advertisement under this heading. Parties having good pure-bred poultry and eggs for sale will find plenty of customers by using our advertising columns. No advertisements inserted for less than 10 cents.

**A DOLLAR** for fifteen Barred Rock eggs; Ontario Agricultural College laying strain. Mrs. Berry, Route 6, Guelph.

**ANCONAS**, Single and Rose Comb Sicilian Buttercups; unexcelled strains; eggs \$2 up. A. C. Apps, Brantford, Ontario.

**AM** selling White Wyandotte and White Leghorn eggs at \$1 per 15, \$4 per 100. Day-old chicks \$6 per 50, \$10 per 100. Safe delivery guaranteed. W. R. Kaiser, Lansdowne, Ont.

**AMERICA'S** greatest laying strain of White Wyandottes; winners at the principal egg-laying competitions; hatching eggs two, three and four dollars per setting. McLeod Bros., Beulah Farm, Stony Creek, Ont.

**ANCONAS**—Hen hatchery, free range, healthy, hardy, vigorous, develop early, lay at 4 1/2 months. Eggs, \$1.00 per 15; \$4.00 per 100. W. E. Williams, Clonaboye, Ont.

**BUFF** Leghorns, Buff Orpington eggs. Circular free. J. E. Griffin, Dunville, Ont.

**BARRED** Rock eggs from well-bred, healthy, heavy-laying, prize-winning birds. Dollar for fifteen; two fifty for forty-five. Chas. Hiliker, Norwich, Ont.

**BARRED** Rocks—Winter egg machines—Eggs from special mating of my choicest purebred birds \$1.50 per fifteen. Earl Bedal, Box C, Brighton, Ont.

**BUFF** Orpingtons—First pen all prize-winners. Second pen headed by first cock bird, Brantford; \$2 and \$1.25 per 15. G. W. Hawkins, Plattsville, Ont.

**BRED-TO-LAY** Barred Rocks—Eggs for hatchery \$1.25 per setting or \$4 100. W. R. N. Sharpe, Ida, Ont.

**BARRED** Rock and White Leghorn—All imported stock; bred for heavy winter layers; eggs \$1 a setting and \$5 a 100. Write for photo of finest plant in Canada. A. C. Baeker, owner, Huron Specialty Farm, Brussels, Ont.

**BARRED** Rocks, R. I. Reds, White Wyandottes, S. C. Brown and White Leghorns. Eggs \$1 per 15. Wm. Bunn, Denfield, Ont.

**CARLUKE** Poultry Yards Exhibition and laying strain Barred Plymouth Rocks. Have won the Championship and Medal, Canadian National, Toronto, 1903-1910-1911-1912-1913; which stamps their superiority in the most decisive manner, winning from amongst the principle breeders of Canada. We bred our winners and can sell you eggs that will enable you to do the same. If you want eggs write for prices. G. Morton & Son, R. 4, Box 130, Hamilton, Ont.

**DUCKS**—Records exist where Indian Runner ducks have produced 300 to 320 eggs in 365 days. True Indian Runner ducks, trio \$10, baby ducks 75 cts. each. Fertile eggs, \$2, \$3 and \$5 per setting. Mrs. E. C. Cutley, Weston, Ontario.

**EGGS**—Choice Exhibition, Barred Rocks, fine barred, dollar per fifteen. Bred to lay strain, one dollar per fifteen. Miss Z. Barbour, Erin, Ontario.

**EGGS** from 170-egg White Wyandotte hens, mated to Beulah Farm males, \$1.00 per 15. Dr. Nicolle, Maynooth, Ont.

**EGGS** from my exhibition Barred Rocks should improve your flock. Only \$3 per setting. A few choice cockerels \$3 each. J. A. Betzner, Aldershot, Ont.

**EGGS** from choicest matings of an extra heavy laying strain of S. C. Black Minorcas, an exhibition mating of S. C. Black Minorcas, all prize-winners; also choice White Wyandottes. We can satisfy you with quality and price. Write: Peterson Bros., Norwich, Ont.

**EGGS** from Barred White and Columbian Rocks Black and White Leghorns, Black Wyandottes, Black Minorcas, \$2.00 per 15. Collard & Rose, Southend, Ont.

**EGGS** for sale from prize-winning Rouen, Pekin and Buff Orpington ducks, \$2.50 per setting. S. J. Cox, Coiborne, Ont.

**FOR SALE**—Golden Laced Wyandotte Cock; Black and Silver Laced Wyandotte Cockerels, and Golden and Silver Laced Wyandotte Cocks, eggs from both varieties. Peter Daley, Box 12, Seaforth, Ont.

**FOR SALE**—Single-comb Brown Leghorn eggs, from imported stock; bred to prize cockerels, and grand layers; price \$1 per 15, or \$2 for 45. W. C. Shearer, Bright, Ont.

**HATCHING** eggs—Barred Rocks, Campines, Anconas, "egg machines." Catalogue free. John A. Nash, London, Ont.

**HIGH-CLASS** Barred Rocks—Barred to the skin; great laying strain; very large fowl; a hen two years old weighed 13 pounds; cockerels eight months old weigh nine pounds. Eggs for hatching, \$1 per 15. R. A. Cowan, Lisgar, Ont.

**HATCHING EGGS** from Rose Comb, Rhode Island Reds, White Wyandottes, Single Comb White Leghorns, heavy laying strains, One Dollar per fifteen. Wesley Shanklin, Ilderton, Ont.

**INDIAN** Runner eggs, dollar per ten. White Wyandottes, specially fifteen years. W. D. Monkman, Newmarket, Ont.

**IF** you want winter eggs, buy King's bred-to-lay Single Comb Brown Leghorns. Large layers of large eggs, averaged seventy-one eggs in ninety winter days, January, February, March. Choice eggs, \$1 per fifteen, \$5 hundred. Harshbarger's world-famous-wonder laying strain, Indian Runner Ducks with records of 280 eggs per year. Pure white eggs \$2 thirteen, \$10 hundred. High class Silver and Golden Wyandottes, winners at Canada's greatest show. T. A. King, Milton, Ont.

**MAMMOTH** Bronze Turkeys, fine heavy birds bred from prize stock. R. G. Rose, Glanworth, Ont.

**PEACHGROVE FARM**—Grand laying Indian Runner ducks, Eggs \$1.50 per fifteen. Frank Bainard, Glanworth, Ont.

**MY** Barred Rocks won first at Toronto, London and Hamilton. Cockerels and hatching eggs for sale. Leslie Kerns, Freeman, Ont.

**ONE** S. C. Rhode Island Red and one S. C. Black Minorca cockerels. Eggs from the same varieties also S. C. White Leghorns and White Wyandottes. Powell Bros., Elizabethtown, Ont.

**PURE-BRED** Barred Rocks—Eggs for hatching, one dollar per fifteen. Exhibition matings, three dollars per fifteen. Jas. E. Metcalfe, R. R. No. 2, Walkerton, Ont.

**PUREBRED** Barred Rock and R. I. Red eggs, \$1.50 per fifteen. F. H. Young, Box 153,aledonia, Ont.

**ROSE-COMB** Buff Leghorns—\$2 setting; prize-winning stock. Chas. Kingsbury, Pt. Credit, B. R. Paris, Ont.

**SINGLE-COMB** White Leghorn Eggs that hatch: dollar setting; five dollars hundred. E. W. B. rt. Paris, Ont.

**THOROUGHBRED** Indian Runner Ducks—Eggs one-twenty-five per ten. Barred Rock, Black Minorca (rose and single comb) and Houdan eggs for hatching, two dollars per fifteen. Sunnyside Poultry Yards, Highgate, Ont.

**UNFERTILE** Eggs replaced free and safe delivery guaranteed. Eggs from high standard bred-to-lay Barred Rocks, White Wyandottes, Buff Leghorns, \$1.25 fifteen; large vigorous stock; extra heavy layers; pullets laying at 5 months old. Write for free catalogue which gives full particulars. Satisfaction or money refunded. Charles Watson, London, Ont.

**WHITE** Wyandottes—Champions eight years at New York State Fair. Big, vigorous cockerels, \$2, \$3 and \$5 each. Pullets, \$2 and \$3. Eggs, \$3 per setting. Send for free catalogue. John S. Martin, Drawer R, Port Dover, Ont.

**WHITE** Wyandotte eggs for hatching from good, vigorous stock. Special matings, \$3 per fifteen; utility mating, \$2 per fifteen. W. T. Milie, Walkerton, Ont.

**WHITE** Wyandotte eggs from strong hardy stock, bred to win in the laying pen and show room and on the table, \$2 per sitting. This is the opportunity you have been looking for. W. B. Powell, Galt, Ontario.

**WHITE** Wyandotte eggs from my Championship male and other matings; heavy laying strain. H. Rundle, Brighton, Ont.

**WHITE** Wyandottes—Pure Regal strain; bred from Rochester, N. Y. cup winners. Her man Claus, Shannonville, Ont.

**WHITE** Wyandottes exclusively—Eggs \$1 per 15. Good hatch guaranteed. Thos. F. Pirie, R. R. No. 3, Ingersoll, Ont.

**WHITE** Wyandotte eggs—Pure Regal strain; extra good layers; one dollar for 15. Allan McPhail, Galt, Ont.

**WHITE** Wyandottes', R. C. Reds', White Rocks' and Buff Leghorns' eggs \$2 per 15. S. C. White Leghorn eggs \$1 per 15. Indian Runner Duck eggs \$1.50 per 15. C. S. Wilson, Tambling's Corners, London, Ont.

**WHITE** Wyandotte Eggs from specially selected vigorous stock, laying strain. \$2.00 per setting. Weldwood Farm, London, Ont.

**Lochabar** POULTRY YARDS is prepared to fill orders for eggs from selected birds of the following varieties: Barred P. Rock eggs, \$1 per 15; M. Bronze turkey eggs, 40c. each, \$3.50 per nine. D. A. GRAHAM, R. R. No. 3, Wilmont, Ont.

**S. C. White Leghorns**—Great laying and prize winning strains, eggs \$1 per 15, a hatch guaranteed \$4 per 100. GEO. D. FLETCHER, R. R. No. 2, Erin, Ontario 'Phone Erin.

## SHOEMAKER'S BOOK on POULTRY

and Almanac for 1914 has 224 pages with many colored plates of fowls true to life. It tells all about chickens, their prices, their care, diseases and remedies. All about incubators, their prices and their operation. All about poultry houses and how to build them. It's an encyclopedia of chicken-om. You need it. Only 15c. G. C. SHOEMAKER, Box 990, Prospect, Ill.

## WANT TO BUY

Advertisements will be inserted under this heading, such as Farm Properties, Help and Situations Wanted and Pet Stock.

**TERMS**—Three cents per word each insertion. Each initial counts for one word and figures for two words. Names and addresses are counted. Cash must always accompany the order. No advertisement inserted for less than 50 cents.

**FOR SALE**—25 acre farm with house and barn also 75 acre farm to rent with buildings. Apply Wm. Barker, Princeton, Ont.

**FOR SALE**—Near Melita, in Southwestern Manitoba, a first-class farm of 640 acres; 450 acres under cultivation; buildings worth \$6,000.00; good frame house, large barn, sheds, granaries, etc. Plenty of good water. Pine Grove of trees around the buildings. School on the farm. Will take a small farm (25 or 50 acres) in Southwestern Ontario on the deal, \$32,000 per acre. Address M. L. C., Box 184, Melita, Manitoba.

**FARM FOR SALE**, 50 acres near Grimsby, Ont. mostly well timbered, a bargain for quick sale, suitable land for fruit. Address Beamsley, Box 9.

**I HAVE** a large number of housekeepers and good domestics requiring advanced passage to Canada. I personally guarantee each person remaining in situation until fare repaid. Hughes, 3 New Street, Birmingham, England.

**PURE BRED** Scotch Collie pups, \$10 each with full pedigree for registration. S. J. Cox, Colborne, Ont.

**FOR SALE**—Purebred Scotch Collies; color sable and white; rough coat; 10 champions in five generations. A. B. Van Blarcom Morganston, Ont.

**SEND** for wholesale catalogue to Lancashire's Cheapest Drapery Warehouse, and learn how to increase income. Make money selling British goods, tablings, towellings, ready-mades, dress materials, ladies' overalls, pinafore muslins. Cochran's Warehouse, Victoria Bridge, Manchester, England.

**WANTED**—Persons to grow mushrooms for us at home. From \$15 per week upwards can be made by using waste space in yards of gardens. Illustrated booklet sent free. Address Montreal Supply Company, Montreal.

**WANTED**—Experienced Farm Hand, good milker, furnished home free. State wages expected, experience, age, number in family. Address: Box A, Farmer's Advocate, London, Ont.

## Cream Wanted

We pay express charges on cream from any express office within 200 miles of Ottawa. We also supply cans. Sweet or sour cream accepted. Write for particulars to

**Valley Creamery of Ottawa, Limited, Ottawa, Ontario**

### Two First-Class Milkers Wanted

Wages \$28.00 Per Month and Board, Steady Employment. Apply, **Eringdale Farms Limited, 18 Miles West of Toronto, Eringdale, Ontario.**

## FOR SALE

Power Spramotor (London make), slightly used. **T. S. SHANTZ, Baden, Ont.**

**FOR SALE**—Splendid Bay Stallion, registered "Joe Larabee," sound, in good condition, first class foal getter. Address: **Dr. J. A. Ste. Marie, Hull, Quebec**

**FOR SALE**—Choice Registered Berkshire Sows, bred, dam 1st prize Western Fair; also a 5-year-old Percheron suitable for brood mare. **JOHN W. GOULTER, No. 7, St. Thomas, Ont. Traction Station 35**

**CREAM**—Toronto consumes the milk and cream from over 16,000 cows and the butter production of over 70,000 cows, we need your cream and expect to pay well for it, drop a card.

**The Toronto Creamery Co., Ltd., Toronto**

## me

## Wife



farmer should and her own

how busy you little time you ofing of poultry you can make a o a substantial ry raising the

to be independ- sband gets for roduce, so that uly clothes, or g trip to town, ust stop at the and draw all e money you ill require.

erless Takes Pay

ne. The way, that is, in a Peerless chickens in a

River, Man. machine from at machine I ht out three I got 137 d hatch 1 eggs, and the cks from 210 uther hatch

e and would

ol. Richet."

nk for you en- ggs," if you learning how re making in- the sale of ns. Experi- are practical and will fur- on necessary pay you hand-

oupon alars.

oke, Ont. elict "Money in

.....

.....

.....

.....

.....

.....

.....

.....

.....

.....

.....

.....

.....

.....

.....

.....

.....

.....

.....



**HARAB FERTILIZERS**  
Grow Bigger Crops

*Progressive Jones Says:*

**“Watch for this Sign”**

If you want to get right on the fertilizer question, friend, take my advice and visit the nearest agency for

# Harab FERTILIZERS

You will know the Harab agency by the sign shown above. It will be found over the door of our dealer in your nearest town or village. Every agent is thoroughly posted about profitable fertilizing. I say here—that fertilizing the Harab way is like sowing pennies to harvest dollars, for it not only gingers up the present profits by providing a bigger crop—but also nourishes the soil for future dividends.

Every one of the Harab Fertilizers is a proven success—one of them is the right fertilizer for your soil and for the crop you wish to raise. Harab experts will give your enquiry individual attention. By their aid your proper fertilizer is easily selected.

The Harris Abattoir Company have an interesting booklet of information about their twenty-five successful fertilizers. Just write for a copy to-day—and keep a weather eye open for the Harab sign—visit the Harab agency.



*Yours for bumper crops,  
Progressive Jones*

Fertilizer Department  
**The Harris Abattoir Co., Limited**  
Toronto

have really secured what we want.” He held out his hand.

“Don’t be afraid,” he said. “I shall not leave the room. The box will not be out of your sight.”

Seltz appeared to consider the matter for a brief moment, but the detective’s manner reassured him. He extended the package toward Duvall.

“It is there, all right,” he laughed softly. “And a hard time I had getting it.”

Without making any comment, Duvall took the package, quickly tore off the coarse paper wrappings, and saw inside a small, round, ivory box, its top ornamented with a number of small pearls, arranged in a circular design about its circumference. He glanced swiftly at it, crushed the paper into his pocket, then started toward the door at the rear.

“Where are you going?” demanded Seltz harshly, his hand going toward his pocket, as though for a weapon.

“To call the doctor, my man,” Duvall replied. “Don’t excite yourself. He will be here in a moment with your money.”

Without a moment’s hesitation he crossed to the study door and tapped lightly upon it. As he did so, his back was toward Seltz, hence the latter did not see the swift movement by which he conveyed the snuff-box to the pocket of his waistcoat.

When after a few moments delay Dr. Hartmann appeared on the threshold, Duvall’s hands were both quite empty.

As the doctor entered the room, the detective gave a quick nod toward Seltz.

“My man,” he remarked in a low tone. “He seems to be rather bad this morning.” Then aloud: “Oscar, this is Dr. Hartmann.”

Seltz bowed, then stood uncomfortably, shifting his weight from one foot to the other as the doctor bent upon him a searching glance.

“Sit down, my good fellow?” the latter presently remarked, as he took a chair.

“I—I don’t think I had better, sir,” he stammered. “I am in somewhat of a hurry—”

The doctor interrupted him in a soothing voice. “There, there. Sit down. I want to talk to you.”

Seltz glanced helplessly toward Duvall, apparently somewhat confused by the reception which Dr. Hartmann had accorded him. It was not entirely what he had expected.

“I have explained everything to the doctor,” remarked Duvall hastily. “He understands about the money you had requested.” He looked significantly at Dr. Hartmann.

“Then I hope the matter can be settled at once,” said Seltz, apparently much relieved. He made no movement to sit down, but continued to look expectantly at Dr. Hartmann.

The latter nodded in a grave and reassuring way.

“Give yourself no uneasiness, my man. Everything will be satisfactorily arranged. Meanwhile, sit down, if you please, and tell me something about yourself. I understand you have been greatly worried of late. Not quite yourself—let us say.”

Seltz looked at him in blank amazement.

“I haven’t been worried by anything, except the business which brought me here. I want my money—”

“Exactly, exactly,” the doctor assented in a soothing voice. “You shall have your money in due time. I promise you that. But first sit down and let us have a little chat.”

Seltz sat down helplessly. Apparently he was at a loss as to just what to say next. The doctor had told him that the money he expected would be forthcoming. He resigned himself in patience to await the latter’s pleasure. For a moment he glanced at Duvall, however.

“You should not have taken it from me,” he said peevishly.

Duvall looked quickly at Dr. Hartmann. The latter at once spoke up.

“Give the matter no further thought, my man,” he said gravely. “I will see that you are fairly treated. But before you go ahead, I want you to tell me more about yourself—your life—your amusements—”

“What the devil have my amusements got to do with the matter?” exclaimed



## An Inexpensive Durable Roof

—a roof that is easy to lay, that looks well, that is suitable for any class of building, is fireproof and is *guaranteed*.

# SAMSON ROOFING

fills every one of these requirements. The felt body of Samson Roofing is *thoroughly* saturated with the waterproofing compound. It is upon this thoroughness of saturation that the life of a roofing depends. Its surface is hard and absolutely unaffected by any weather conditions, and cannot be ignited by sparks or burning brands. The cost of Samson Roofing is much less than shingles, slate, tin, etc., and very little labor is required to lay it.

With your order for roofing we supply complete directions for applying, and a supply of nails, and lap-cement for cementing the joints.

We have prepared an interesting booklet “The Roofing of Farm Buildings” which should be in the hands of everyone who thinks of building. It is yours for the asking. 5

Ask your dealer for Samson Brand.  
**H. S. HOWLAND, SONS & CO. Limited**  
142 Front St. West, Toronto

**FROM LONDON ENGLAND**

# SUITS \$4.50<sup>c</sup> DELIVERED FREE

**\$1,000 IF UNTRUE WE SEND A GENTS SUIT DUTY & CARRIAGE PAID FOR \$4 50.**



This marvellous but perfectly honest offer of a Gents 3 piece suit, delivered free (nothing more to pay) for \$4.50 (backed up by testimonials from the British Police) has never been equalled in Canada. The biggest advertising offer made! Our Suits have reached every Village in Great Britain. Our name is known and respected in every corner. Our Postal business is enormous. Now, Sir, we are going to make that same big business in Canada. **WE’LL DO IT AT ALL COSTS!** Honest dealing and rock bottom prices **MUST** win through.

We want your Trial Order, simply as an advertisement for us in your locality. We want you to talk about us to your friends so we offer a Gents stylish well-fitting London-cut made-to-measure 3-piece sample suit in genuine fine-quality English Tweeds and Blues, direct from London to you, for \$4.50, absolutely free of further charge. Our styles, materials, cut and finish are absolutely unobtainable. Raincoats from \$6.50.

**MAIL CARD TO TORONTO FOR FREE SAMPLES.**

Send postal card for free Cloth Cuttings, fashions, and easy self-measure charts. They cost you nothing. We send also higher price samples.

**ADDRESS FOR SAMPLES: H. THOMAS & CO. (Dept. 17)**  
Dominion Bank Building, Cor. College and Spadina, Toronto, Ont.

ORDERS & PAYMENTS ONLY TO:—

**H. THOMAS & CO. 142, GRAY’S INN ROAD, LONDON, W.C. ENGLAND.**

## ELECTRIC STEEL WHEELS

WITH GROOVED TIRES

\$18.00 per set, f.o.b. Toronto 28-inch and 32-inch diameter 4x3/8 tire. Write for catalogue.

NORMAN S. KNOX, 47 Wellington Street East, Toronto, Ont.



ELECTRIC WHEEL COMPANY, 8 Elm Street, Quincy, Illinois.

## HOLSTEINS.—D. B. TRACY, Cobourg, Ont.

We have a choice lot of bull calves with strong backing and from dams with records of 18 to 24 lbs. Just the kind you are looking for. Write for extended pedigree or still better, come to see us. Prices very reasonable.

# SEED OATS

If you require any, you take no risk in ordering these. They are good and clean—no weed seeds. Our stock is changing rapidly these days. Donot delay another-day in ordering.

O.A.C. No. 72, at \$2.75 bush., bags free.  
American Banner at 75c. bush., bags free.  
Sensation, at 75c. bush., bags free.  
Registered Siberian, at \$1.00 bush., bags free.  
Black Victor at 80c. bush., bags free.  
Daubeney, at 75c. bush., bags free.

Our Sensation Oats are the finest looking sample we have in stock—test 42 lbs. to the bush. The Registered Siberian we think the best bargain. O.A.C. No. 72 are going fast. Would advise haste in sending in your order. For prices on Barley, Clovers and Timothy, Seed Corn, Mangels and Turnips, see our ad. on page 717 issue April 9 of this paper.

**Geo. Keith & Sons**  
Seed Merchants Since 1866  
124 King St. E. TORONTO

**Strawberry Plants**—Most profitable under ideal conditions. 125 for \$1.00 post paid.  
**SILVERWOOD FRUIT FARM**  
W. J. Galbraith, Phepston, Ont

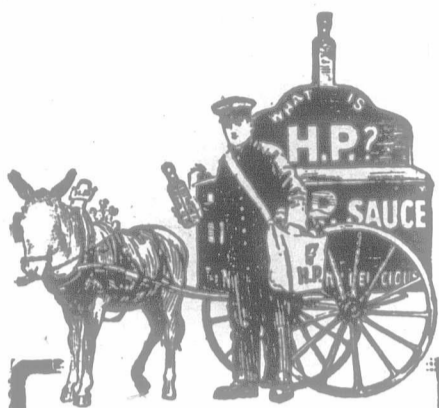

Did you get your sample of H.P., the new sauce from England?

Everybody is simply delighted, and all the Stores here are selling H.P. freely.

Wouldn't it be worth your while to buy a bottle of the

One and Only

**H.P. SAUCE**



Endorsed by Beginners and Experts

**Prairie State Incubators Are Guaranteed**

to be absolutely as represented, or your money will be refunded upon the return of incubator in good order.

The best possible evidence of their efficiency is contained in the fact that Canadian Agricultural Colleges are successfully using Prairie State Incubators in their practical and demonstrative work. Write them for their results. Hundreds of others, both beginners and experts, have told us of the excellent results they obtained in hatching strong, healthy chicks that have lived.

Send for this FREE BOOK, "How to Hatch Chicks that Live." It gives reasons why the Prairie State is better, shows the best kind of Hoyer, tells how to build brooders, the kind of feed to use, and how you can obtain the experience of others. Write for it to-day.

We offer the best cash market in Canada for eggs and poultry. Ask for quotations.

Gunn, Langlois & Co., Limited  
61 St. Vincent St., Montreal

**Baby Chicks**

Order your baby chicks now from our splendid laying strain of single-comb White Leghorns.

UTILITY POULTRY FARM  
T. G. Delamere, Prop. STRATFORD, ONT

Strawberry Plants—Williams' Improved Parson's Beauty, Splendid Sample; Fountain, Steven's Champion and other leading varieties. If interested, write for our catalogue and price list. W. WALKER, Port Burwell.

Seltz, his voice trembling with anger. "I tell you I want my money!"

"And I tell you you shall have it. But now, I insist that you let the matter drop for the present and answer my questions, otherwise I can do nothing to help you."

The remark quieted Seltz somewhat.

He was, after all, in a peculiar position. The snuff-box was gone. He cursed his stupidity in having let it pass out of his possession before the price agreed upon for its delivery had been forthcoming. That Dr. Hartman did not question the payment of the money, however, was reassuring.

He determined to answer as well as he could whatever questions the doctor might see fit to ask him. The latter continued to examine his supposed patient with a shrewdly professional air.

"How old are you, my man?" he suddenly inquired.

"Thirty-six."

"Do you drink?"

"Yes—I—I drink occasionally."

"Use any drugs?"

"No."

"Appetite good?"

"Yes."

"Sleep well?"

"Yes; pretty well."

"Have you had any shock recently? Has anything happened to make you nervous or excitable?"

Seltz glanced nervously from Duvall to the doctor and back again. What, he wondered, was the purpose of this examination? Was Dr. Hartmann trying to lead him into damaging admissions concerning the method he had employed to secure the snuff-box? He scowled, then suddenly spoke.

"It's none of your affair, is it if I have?"

"Oscar!" said Duvall, in a tone of remonstrance. "Don't speak to the doctor in that way."

"Oscar!" The man turned on the detective angrily. "Look here—you took that—that—" he hesitated, fearful that some trap had been set for him—"that article away from me. Now, see that I get my money."

The doctor glanced at Duvall. "He seems to be possessed with the one idea," he remarked softly, then turned to Seltz again.

"My good man, I have already assured you that Mr. Brooks and myself will see that you get your money. What more do you want?"

"I want the money," Seltz cried, losing his patience, "and I want it quick."

He sprang from his chair, and his hand shot toward his pocket, whence it reappeared in a moment with a revolver.

"No more of this nonsense, now. I want the cash."

The doctor, who had also sprung to his feet, started toward the angry barber with outstretched hands. Seltz whirled on him, the revolver pointed directly at Hartmann's head.

"Keep off," he cried.

In his excitement he had forgotten Duvall, who at once seized him from behind.

"Look out, doctor," he cried, as he threw his arm about the fellow's neck and slowly throttled him.

"He's gone quite insane—dangerous—take away the revolver."

As he spoke, he tightened his arm about Seltz's throat until the latter gasped for breath. The revolver fell from his nervous grasp. He clutched at the detective's arm and tried to tear it from his throat, all the while groaning and spluttering at a great rate.

"Hopelessly insane, I fear," said the doctor, as he picked up the fallen revolver. "You had best take him away at once."

"But, doctor, I can't do anything with him in this violent state. Can't you give him something to quiet him?"

"Nothing but a hypodermic. He wouldn't swallow a drug, I fear."

"Then give him a hypodermic at once. I've got to get him away from here somehow."

He tightened his hold on Seltz's throat as the latter struggled furiously, trying his best to get away. Luckily for Duvall, his adversary was a man of only moderate strength, but he struggled like the madman the doctor supposed him to be, trying in vain to speak. The detective's arm, however, tightly wound about his throat, effectually prevented his cries from becoming intelligible.

**Easy Dyeing at Home**

Faded dresses—soiled blouses—dingy curtains—ribbons, silk gloves, satin slippers, feathers, feather boas, parasols, cushion tops—all can be made fresh and beautiful again with



**MAYPOLE SOAP**



It cleanses and dyes to rich, glowing colors at one operation. No muss.

No stained hands or kettles. No streaks. Just satisfaction. 24 colors to select from. Colors 10c, Black 15c, at all dealers, or postpaid with free Booklet on "How to Dye" from

FRANK L. BENEDICT & CO. MONTREAL 76

**Direct From Factory to You**

Save \$5 to \$40 on any bed you buy

We sell you any grade and design of bed you need, at factory figures. No other Bed Company in Canada will do this.

Think of anyone selling you a brass or steel bed at a lower price than furniture stores pay. That's exactly what we do.

Write for our free, illustrated catalogue of brass and enamelled steel beds, cribs—also springs, mattresses, couches, divans and costumers. Choose the article you need, in the style you prefer, pay us lowest factory price and we deliver the goods right to your station, bright, new and carefully packed—FREIGHT PREPAID.

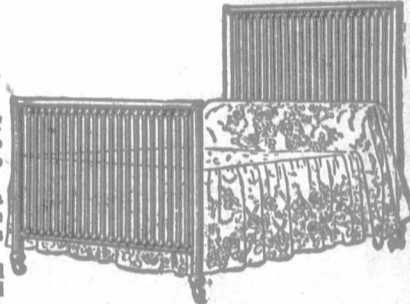

**30 DAYS TRIAL—360 DAYS APPROVAL TEST**

We give you thirty days' free trial of any article you buy. If you are not completely satisfied, return the goods at our expense and we refund your money. We give you 360 days as a thorough test period so that you can try out your purchase on every point. During that time, if you find any defect in material or workmanship, we guarantee to make it right or refund your money. Hundreds of families have bought beds from us on this money-saving system. No need to pay double for beds. Our prices will astonish you. WE PAY FREIGHT

fect in material or workmanship, we guarantee to make it right or refund your money. Hundreds of families have bought beds from us on this money-saving system. No need to pay double for beds. Our prices will astonish you. WE PAY FREIGHT

Write today for free Catalogue

**Quality Beds, Limited**  
Manufacturers, 115 Main St. Welland, Ont.

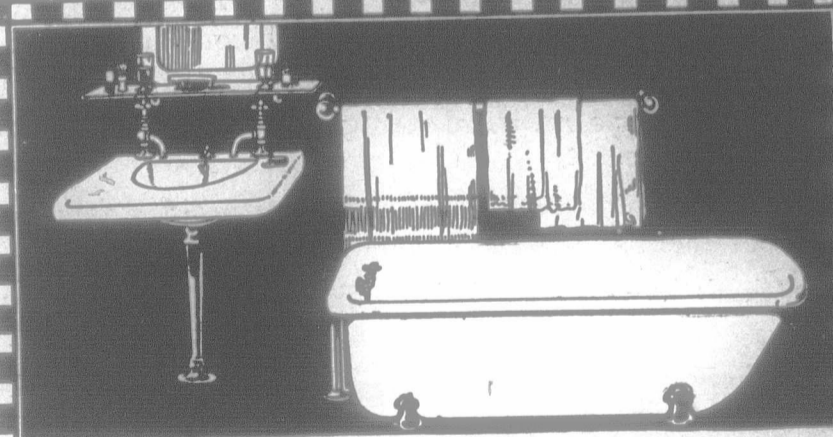

**In The Bathroom—**

on the bathtub, wash-basin, linoleum, woodwork, mirrors, lavatories and all metal fixings, use Panshine. It is perfectly wholesome, has no disagreeable smell and leaves nothing but absolute cleanliness behind it.



**PANSHINE**

A pure, white, clean powder that doesn't scratch and positively will not harm the hands.

Large Sifter 10c. At all Grocers

**Best Tea At Its Best**

**"SALADA" TEA is always the same, no matter when or where you buy it.**

**"SALADA"**

is the choicest tea—green, black or mixed—from the finest tea-growing country in the world—Ceylon, with its exquisite flavor and freshness protected by the sealed lead packages.

**POLICIES**

**The Woodbine Disaster**

*Claimed as one victim at least, a young man who had wisdom enough to call in the service of a sound Life Insurance Company to carry the risk of just such a contingency.*

*Are those looking to you for support sufficiently protected against the many dangers that surround high and low alike.*

LIFE RATE ENDOWMENT POLICIES MEET ALL CIRCUMSTANCES  
Issued only by the

**London Life Insurance Company**  
London - - - - - Canada

**"GOOD IS GOLD"**

"I'm so sorry, doctor," Duvall went on, as Hartmann prepared his hypodermic needle, and, approaching the struggling man, took hold of one of his arms and bared it with a quick motion. "I wouldn't have subjected you to all this annoyance for anything. The poor fellow has been getting worse for days, but I had no idea, when he left me this morning, that he would be like this."

"It frequently happens," the doctor remarked, as he pressed the syringe into the man's forearm and then withdrew it quickly. "There—he'll soon be all right now. Just hold him there for a few moments longer, Mr. Brooks, and he'll be sleeping like a child."

Even as he spoke, the struggles of the man in Duvall's arms became less violent; his efforts to cry out less vigorous.

"It's a sad case," the detective remarked. "I am very much afraid that he must be sent to an asylum."

"Undoubtedly the best place for him, my dear sir," remarked Hartmann dryly. "I see your cab is waiting outside. As soon as the man is quiet I will have one of my attendants help you carry him to it."

He went over to Seltz, who was now struggling faintly, and felt his pulse. "He is quite harmless now," he observed, looking keenly into the man's face. "I will call one of my men." He went to the wall and pressed an electric button.

Duvall allowed the limp body of the barber to slip softly into a chair. "Poor Oscar," he said musingly, looking down at the huddled-up figure. "What a pity. Such a faithful fellow, too." He turned to Hartmann. "I feel almost as though I had lost an old friend."

The doctor smiled. "Rather a dangerous one, I should say," he remarked, as he glanced at the revolver on the table. "You will want this, I suppose."



**QUALITY AND EFFICIENCY**

ARE MAIN ESSENTIALS IN A PIANO

YOU GET THESE IN A

**BELL PIANO**

We take the time and pains to build them right.

There are many good features in the BELL never found in other makes.

Information in our (free) catalogue No. 40. Send for it.

**THE BELL PIANO & ORGAN COMPANY, LIMITED**

GUELPH - - - - - ONTARIO

**O.A.C. No. 21 Barley 80c. Bush.**  
Beautiful sample grown after roots and corn. We fill orders for same parties year after year. Good bags 30c. John Elder & Sons, Hensall, Ont.

**WHEN YOU DECIDE TO BUILD---  
BUILD A STEEL TRUSS BARN**

It is the only barn that is made to your order.

You tell us the size you want and we furnish all the materials from the foundation up—including lumber, hardware, doors, metal covering.

You get a barn that is fire proof and lightning proof. Your stock and grains will always be safe.

You get 25 per cent. more storage space than you would in a similar sized wood barn.

You get a building which can be erected in a few days by a small crew of men.

You don't have to spend time and money in getting out heavy timbers. You don't have to board a large crew of men half the summer.

Send for our free barn book. It will tell you all about the Steel Truss barn and show you a few pictures of buildings erected.

We can refer you to many farmers who have erected this type of barn during the year—they are all pleased with it. Read the letter here.

**It Paid Mr. Roth to Investigate**

Shakespeare, July 17th, 1913.

Dear Sirs:—

I built an Acorn Barn 50 x 72 and am sending you a photograph, and would advise any farmer to do away with heavy timbers and use the steel frame with metal roof and sides. Five carpenters, four neighbors and myself erected the barn frame in half a day and it saved me at least \$125.00.

There are no cross timbers or girts in the way, making it easy to unload grain. I lined up my granary with metal and it is perfectly tight.

NICK. ROTH.

USE THE COUPON TO-DAY

**The Metal Shingle & Siding Co., Limited**  
Head Office: PRESTON, ONTARIO

COUPON

The METAL SHINGLE & SIDING CO., Ltd.  
PRESTON, ONTARIO

Please send me a free copy of The Steel Truss Barn.

Name.....

Address.....

FACTORIES AT

MONTREAL  
TORONTO  
PRESTON  
WINNIPEG  
SASKATOON  
EDMONTON  
REGINA  
CALGARY

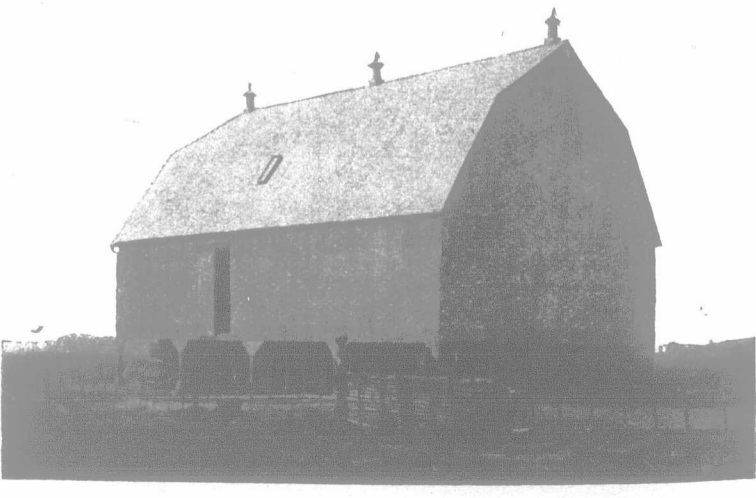

**Wonderful Cloth—Won't Tear  
—Won't Wear Out—Absolutely  
Holeproof.**

A sensational discovery that should prove a boon to all readers has been made by a well-known English clothing company. They have discovered a really remarkable cloth that will not tear, will not wear out, in fact is absolutely holeproof, and yet looks exactly as the very finest tweeds and serges. It is made in all the most up-to-date designs and is most suitable for farm or rough wear or office and best wear.

Just to introduce this remarkable

cloth to the notice of our readers, the offer is made of a pair of well-fitting smartly-cut Gents' trousers for the rock bottom price of \$1.80; walking, riding or cycling Breeches for 2 Dollars, or a well-cut Gents' Suit, right-up-to-the-minute in fashion for \$5.50; and with every garment the firm will send a printed guarantee plainly stating that if the smallest hole appears within 6 months, another will be given absolutely free of cost. The prices quoted include both Postage and Duty, so that customers have nothing more to pay on delivery.

See advertisement below and write for patterns. They cost nothing.

**WONT WEAR OUT  
SUITS 5 50**

**MARVELLOUS DISCOVERY WILL  
SAVE YOU DOLLARS!  
IF YOU WEAR SMALLEST HOLE  
(AS OUR GUARANTEE) WE REPLACE FREE!**

**A Sensational Discovery! Save you Dollars! A really remarkable cloth, that will not tear, or wear out, absolutely Holeproof, looks exactly as finest tweeds and serges, made in all the most up-to-date designs and suitable for farm and rough wear or office and best wear.**

**TROUSERS, \$1.80. BREECHES, \$2.  
(5 PAIRS, \$4.50) DUTY & POST PAID (5 PAIRS, \$6.50)**  
Just to introduce this remarkable cloth we offer a pair of well-fitting smartly-cut Gents' Trousers for only \$1.80, Breeches \$2. or well-cut right-up-to-the-minute in fashion for \$5.50 all Duty and Post Paid. With every garment we send a printed guarantee plainly stating that if the smallest hole appears in 6 months (NO MATTER HOW HARD YOU WEAR IT) another given absolutely free. We pay all charges, Post and Duty. You have no more to pay.

**FREE SAMPLES:** Send merely 3 Cent stamp for grand free patterns, measure chart and fashion, to our Toronto office, THE HOLEPROOF CLOTHING CO. (Dept. 1), 175 HURON STREET, TORONTO, ONT., or send \$2.50 for sample pair of Trousers (5 pairs \$4.50), with waist and leg measure and colour, direct to England. Don't send money to Toronto.

**THE HOLEPROOF CLOTHING CO. 54, THEOBALDS ROAD, LONDON, W.C., ENG.**



Duvall took the revolver and thrust it into his pocket.

"Might as well take it along, I suppose, doctor. Now about my bill—do I owe you anything in addition to the fee I paid you on my arrival?"

He felt for his pocketbook.

"Nothing my dear sir." The doctor smiled. "I feel that in accepting your fee I am robbing you." He drew the note from his pocket, but Duvall waved it aside.

"I insist, my dear sir. You have given me your valuable time at least, even if you could do this poor fellow no good."

He passed as an attendant in a gray uniform entered the room.

"Max," said the doctor, addressing the man. "Help this gentleman to put his friend into the cab."

The man came forward, and with Duvall's help picked up the limp figure of Seltz, who was now sleeping soundly. In a few moments they had transferred him to the cab outside.

As they left the house Duvall saw Grace standing near the door, her face pale, her eyes seeking his. He avoided her glances, making no sign that he recognized her.

The doctor, somewhat annoyed, requested her with elaborate but firm politeness to withdraw. She did so, without looking back, but her heart was beating until it shook her whole body, and she longed to run to her husband and drive off with him, in spite of the doctor's presence.

Somehow she felt that the necessity which had kept her a prisoner in this house no longer existed; that Richard had succeeded in recovering the ivory snuff-box and would soon send her word to join him, so that they might return to Paris together. She went to her room, ordered some luncheon brought to her, and sat down to await his message.

Meanwhile Duvall, with Seltz beside him, drove rapidly away from the house, his arm about the man's unconscious

**We Specialize in the  
Treatment of**

**PIMPLES  
BLOTCHES  
BLACKHEADS**

and other skin troubles, and assure satisfactory results. We give treatments in our offices, and have home treatments for those who cannot come to us. Consultation free at office or by mail. 21 years' experience and success in the treatment of the above and other skin, scalp, hair and complexional troubles, including

**SUPERFLUOUS HAIR**

Moles, Warts, Red Veins, etc., these by our reliable and antiseptic method of electrolysis. Only expert operators employed, and satisfaction assured in each case. Booklet "F" and sample of toilet cream sent on request.

**HISCOTT INSTITUTE  
61 COLLEGE STREET, TORONTO  
Established 1892**

Send for wholesale Catalogue to

**LANCASHIRE'S CHEAPEST  
DRAPERY WAREHOUSE**

and learn how to increase income. Make money selling British goods; Tablings, Towellings, Ready-mades, Dress Materials, Ladies' Overalls, Pinafore Muslins.

**COCHRANE'S WAREHOUSE,  
Victoria Bridge, Manchester, England**

**LOOK OUT FOR THE  
Imperial Life**

**ASSURANCE COMPANY'S**  
big advertisement, which is due to appear in next week's issue, entitled "Until Death do us Part."

**"READY-MADE" BUILDINGS**

"Ready-Made" buildings have solved the problem. No more do you have to leave your implements out in the storms.

You can now get a building all ready cut to your measure and delivered at your station. You haul it home, and with the help of the hired man you can set it up in a couple of days.

All the timber is cut and marked. You nail or bolt it in place. Then you nail on the covering--which is cut to size and marked.

You have no large carpenter bills--we do most of the work in our factory. All you have to do is set the building up.

We make buildings for all purposes. Write to-day for our free booklet.

Fill out the coupon.

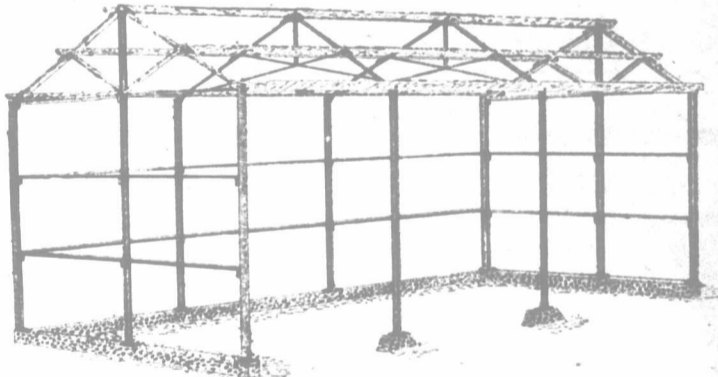
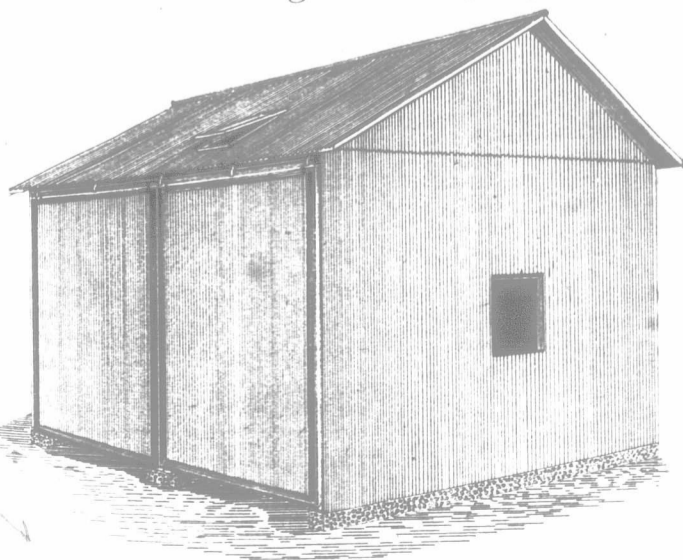

An example of one of our smaller "Ready-Mades."

Note the fine appearance. The Corrugated Iron, being cut and fitted especially for this building, gives no chance for mistakes or botching jobs in erection. The entire front can be opened, as the doors slide past each other. Plenty of light is furnished by the Acorn roof and side windows. This class of building is lightning-proof, fire-proof, rust-proof and practically wearout-proof.

Strong steel frame work of "Ready-Mades" will last forever and always keep the building true and straight, never allowing it to sag at the roof or cave in at the sides and ends. It will make the building stand up under any kind of a roof load, and will resist all wind pressure. All joints are strongly rivetted and bolted, and will not come apart.

**The Metal Shingle & Siding Co., Limited**  
PRESTON, ONTARIO

FACTORIES AT:

- MONTREAL
- TORONTO
- PRESTON
- WINNIPEG
- SASKATOON
- EDMONTON
- REGINA
- CALGARY

COUPON

**The METAL SHINGLE & SIDING CO., Ltd.**  
PRESTON, ONTARIO

Please send your free booklet, "Ready-Made Buildings."

Name .....

Address .....

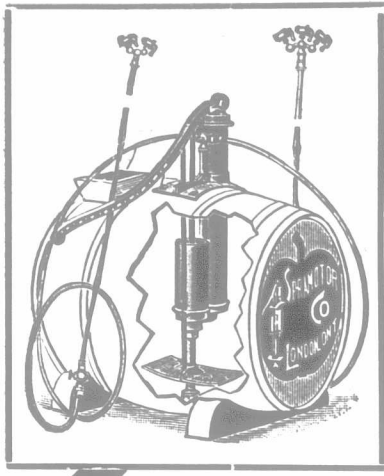

**Bigger Crops of Better Quality? That's What A Spramotor Will Get For You**

Compared with what it will do for you, year after year, a Spramotor's initial cost is trifling indeed.

We can prove to your complete satisfaction that you can increase fruit yields fully 80 per cent. with a Spramotor. Also that it has brought 400 bushels of potatoes to the acre, from land that formerly yielded practically nothing.

There is a big difference between the Spramotor and any other spraying machine made. We have been over twenty years in this one line, to the exclusion of everything else. Over twenty patents have been granted covering tested features that you can get on no other machine made. During our long experience, we have discovered what to use, and what to avoid in the manufacture of Spramotors. We have also overcome some seemingly impossible obstacles, and found the solution to many difficult problems. To-day, the man who buys a Spramotor gets the utmost in spraying efficiency.

These are the reasons why Spramotors have won over a hundred First Awards and Gold Medals, in different parts of the world, and why the Canadian Government, the State and Federal Governments of the United States, and the leading Agricultural Colleges and Universities in America use our machine.

You owe to yourself to know all about the Spramotor before investing in any spraying machine. We cannot tell all its points of superiority in one advertisement, or in twenty. Take advantage of the following offer.

**FREE** Write us a short letter, giving some idea of your spraying needs, and we will send you a copy of our valuable illustrated work on Crop Diseases, also full particulars of a Spramotor that will do your work to best advantage at lowest cost.

**B. H. HEARD SPRAMOTOR**  
1735 KING STREET LONDON, CANADA

**Beautify and Protect Your Property**

Peerless Ornamental Fencing accomplishes two great purposes. It beautifies your premises by giving them that symmetrical, pleasing, orderly appearance, and it protects them by furnishing rigid, effective resistance against marauding animals, etc.

**Peerless Ornamental Fencing** is made of strong, stiff, galvanized wire that will not sag. In addition to galvanizing, every strand is given a coating of zinc enamel paint, thus forming the best possible insurance against rust. Peerless ornamental fence is made in several styles. It's easy to erect and holds its shape for years.

Send for free catalog. If interested, ask about our farm and poultry fencing. Agents nearly everywhere. Agents wanted in open territory.

Banwell Hoxie Wire Fence Co., Ltd.  
Winnipeg, Man.—Hamilton, Ont.



**This is THE FAMOUS LITTLE WETTLAUER POWER MIXER**

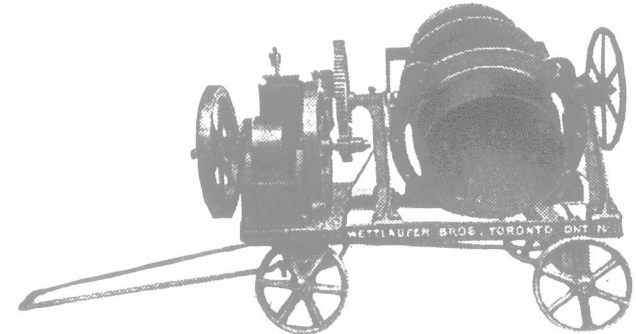

The Wetlaufer Concrete Mixer is especially adapted for all Farm Concrete Work—Brick, Block, Barn Floors, Foundations and Silo building. The Wetlaufer Concrete Mixer mixes quickly and thoroughly, and Government test has proven that it makes a concrete that is absolutely impossible to make by hand. This Mixer will save you money on your own Cement work and You Can Earn Money by doing work for your neighbors.

Send for catalogue to Farm Dept. W. 3.  
WETTLAUER BROS. 178 SPADINA AVE. TORONTO, ONTARIO

**For Sale CLYDESDALE STALLIONS For Sale**

Owing to death of the owner this strictly high class quality stallion, Cattaneo Imp. [12005], is for sale. Black, white legs and face, rising 5 yrs., by the C.C.C. Oyam!, dam by Royal Gartley's Heir. This is one of the highest and best quality stallions in Canada, will be sold cheap.  
GIDEON BROWNSBERGER MARKHAM, ONT.

figure. At the gate of the park he saw another cab waiting, and in a moment perceived that it contained Dufrenne, who, in accordance with his instructions, had been following Seltz.

Duvall nodded to him, then pointed silently down the street. Dufrenne at once ordered his driver to follow. In a short time they had reached the Hotel Metropole, and Seltz, with the assistance of two of the porters, had been carried upstairs and placed on the bed.

Duvall explained to the manager of the hotel that the man was a friend of his who had been taken ill and needed to sleep for a few hours. He also engaged the adjoining room, and thither he and Dufrenne presently repaired to examine the snuff-box which, until now, had been reposing safely in the detective's waistcoat pocket.

He drew it out, when they were alone, and silently handed it to Dufrenne. The little old Frenchman took one look at it, then threw up his hands with a cry of joy.

"It is the ambassador's snuff-box! Heaven be praised," he cried, as the tears coursed down his withered cheeks.

(To be continued.)

**Remarkable Challenge.**

**ENGLISH CLOTHING FIRM OFFERS MAN'S SUIT FOR \$4.50**

A well-known English clothing company, H. Thomas & Co., 142 Grays Inn Road, London, W. C., Eng., seems bound to become as highly popular in the Dominion as they are in Great Britain. Everybody knows H. Thomas & Co. in England for the remarkable prices they quote in Gents' wear. On page 774 readers should note the firm's advertisement, "Gents' Suit (Jacket, Vest and Trousers), \$4.50 delivered free to you no more to pay." Look up the advertisement on page 774, and write for free patterns and fashions to their Toronto branch.

**Seed Commissioner's Report.**

The report of the Seed Commissioner, Geo. H. Clark, covering the period from March, 1911, to August 31, 1913, has just been issued. It contains some valuable information, under the headings of Seed Growing, Seed Testing, and Seed Inspection. Among other things, it is pointed out that two degrees of frost, when oats are in the milk stage, in most cases, renders them of no value for seeding purposes, even though the frosted heads may fill and yield oats of heavy weight per measured bushel. An interesting item is also found in the report on alfalfa. Of 353 samples of seed tested at Ottawa last season, it was believed that not more than half a dozen were of Canadian origin. While more than one-third of the total number contained weed seeds which occur only in alfalfa produced in Europe, the remainder of the seeds came from the Western and Middle Western States, probably from Montana and Utah. Very little alfalfa seed is produced in Wisconsin and Minnesota, and practically none of it is to be had in Canada. This report, which is a concise summary of the work of the Seed Branch for the period indicated, is available to all who apply for it to the Publications Branch, Department of Agriculture, Ottawa, Ont.

The Farmers' Gazette, England, March 28th, states: "A four-year-old cow, the property of Michael O'Brien, Scart, near Bansa, gave birth to three bull calves recently. The cow and her three offsprings are in robust health. A Kerry cow, belonging to the same owner, had twin calves five times. She gave birth to ten calves in five years. Only one of the calves died, the remainder bringing average prices when yearlings; and a ewe, the property of John Murphy, Kellystown, Adamstown, Co. Westford, has had no less than seventeen lambs in four years—four in 1911, four in 1912, five in 1913, and four this year. Mr. Murphy had another ewe of the same breed, which had ten lambs in three years.

**FARM STOCK PUMP**

**\$5.25**  
FREIGHT PAID. 3 INCH CYLINDER. 7 FEET PIPE FREE.

Our big bargain in farm pumps. Over a dozen other styles to choose from. All sold at our low-expense profit on actual foundry prices. Write for catalogue to-day.

**WE FIT PUMPS COMPLETE**  
We can supply pumps for any depth of well, all complete with pipe, threaded and fitted with couplings ready to instal.

Send depth of your well and height of water in dry season. We will tell you exact cost of pump complete, ready to instal. FREIGHT PAID TO YOUR STATION. WRITE TO-DAY!  
*The Halliday Company Limited*  
FORMERLY STANLEY MILLS & CO.  
HAMILTON ESTAB 1855 CANADA

**SOW SIMMERS**

ESTAB'D 1856

Used by successful planters for over half a century

Our large and beautifully illustrated CATALOGUE FREE

J. A. SIMMERS, Limited TORONTO, ONT.

**SEEDS**

**Lots of Luscious TOMATOES**  
To raise the largest and best quality and most profitable crop of Tomatoes and "garden truck" use **DAVIES Special Mixed FERTILIZERS**. Send for free booklet. The **Wm. DAVIES Limited** WEST TORONTO, ONT.

**Prove It Yourself Without Cost**

I will send you a "1900" Gravity Washer for 30 days

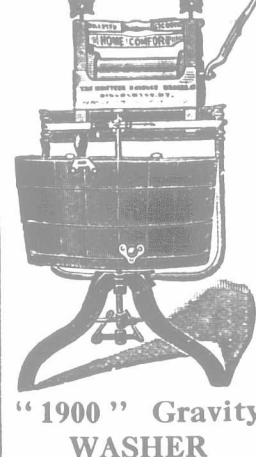

**FREE TRIAL**  
—not a cent of cost to you—I pay freight. Everybody who has used this washer says it is the "best ever." Write me to-day personally for booklet and particulars.

**H. H. Morris**  
Manager "1900" Washer Co.  
355 Yonge St. Toronto, Can.

**FOR SALE—SEED CORN**

Many varieties; also Feed Corn. Apply to **Edward Tellier, St. Joachim, Ontario**

Please mention "The Farmer's Advocate."

**K PUMP**  
**5.25**  
**FREE.**  
 bargain in farm  
 a dozen other  
 e from. All sold  
 pense profit on  
 y prices. Write  
 to-day.  
**PUMPS**  
**PIETE**  
 ly pumps for any  
 all complete with  
 and fitted with  
 y to instal.  
 height of water,  
 on exact cost of  
 al.  
**OUR STATION.**  
**117**  
*any Limited*  
**MILLS & Co**  
**CANADA**



It certainly  
 does pay  
 to use.

**Windsor  
 Dairy Salt**

116

**GALVANIZED  
 STEEL TANKS**

91 to 1,218 gallons

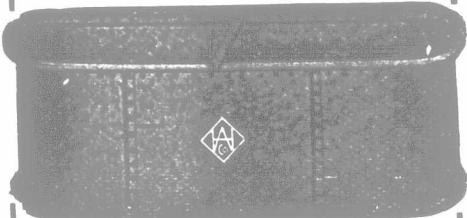

Our trade mark appears on all our tanks, guaranteeing the quality and workmanship.

If your dealer does not handle the H.-A. Co.'s, write for catalogue No. 24, showing over 700 different styles and sizes for ALL purposes.

**THE HELLER-ALLER CO.**  
 Windsor Ontario

**Alaska Peas**

We have for sale 800 bushels of first-class Alaska Seed Peas. Will sell any quantity at the closest prices.

**The Title & Trust Co.**

Liquidator  
 61 Yonge St. TORONTO

**Make your Will now**

It is not right for you to neglect this solemn duty to your family or those dependent on you. You can make a perfect legal, incontestable will in your own home. Get a **"CODE" WILL FORM** with complete instructions to-day at your book-sellers or stationers for **25c.** or direct from **THE COPP CLARK CO. Limited** 909 Wellington St. West, Toronto

Please mention "The Farmer's Advocate."

**Questions and Answers**

1st—Questions asked by bona-fide subscribers to "The Farmer's Advocate" are answered in this department free.

2nd—Questions should be clearly stated and plainly written, on one side of the paper only, and must be accompanied by the full name and address of the writer.

3rd—In veterinary questions; the symptoms especially must be fully and clearly stated, otherwise satisfactory replies cannot be given.

4th—When a reply by mail is required to urgent veterinary or legal enquiries, \$1.00 must be enclosed.

**Miscellaneous.**

**Settling for House.**

A bought a house from B; A did not pay for it in full at that time; B took mortgage on it; A agreed to pay B the balance in two instalments; B moved 60 miles from the locality; B would not come to collect his money. The first payment, A sent to him. Now, the last payment will be soon due. Is B obliged to come and collect his money and give A the clear deeds, or has A to go to B?

A FARMER.

Ans.—The money can be safely sent to B, who is obliged to send the note or lien to A, or destroy it. Bank draft, marked cheque, or money order, would be safe.

**Gossip.**

**A. B. & T. W. DOUGLAS' SHORTHORNS AND CLYDESDALES.**

About one mile north, and overlooking the pretty and prosperous town of Strathroy, a town almost midway between Sarnia and the city of London, lies the stock farms of A. B. & T. W. Douglas, breeders of Shorthorn cattle and Clydesdale horses, where we find about sixty head of Shorthorns have come through the winter in nice condition. The present head of the herd is Clansman =87809=, a smooth, stylish bull, about two years old, that looks like making a big, massive fellow. He was bred by H. Cargill & Son, Cargill, Ont., is sired by Lancaster Royal 2nd =83586=, dam Clara 57th =34121= (imp.), and by the appearance of the dozen or more calves from him, he is likely to make a good name for himself. The older calves and young bulls and heifers are by His Grace =69740= (imp.), bred by David Anderson, Aberdeenshire, Scotland, and by the lot of young things to be seen in the herd, he has left a good impression. Among the older matrons, the daughters and grand-daughters of that grand old cow, Graceful 8th (imp.), are the most numerous, and are the dams of quite a number of the young things offered for sale at the present time. Although the demand for young bulls has been excellent, Ravena King =92171=, a red roan, seventeen months old, still remains in the herd. He is a thick, massive bull, of good quality, and in breeding good enough to be a first-class herd bull, sired by His Grace (imp.), and a grandson of Graceful 8th (imp.). There are also quite a number of well-grown calves that will soon be ready for service. The offering also includes a few choice heifers recently bred, but safe in calf. The Clydesdales, although not large in numbers, are of the right sort. There are two excellent brood mares, Ursula [11611] (imp.), not large, but of the right quality; has been a regular breeder of nice things. Her mate, Audrey [20432], from imported sire and dam, is somewhat larger, but of the same good quality, and is proving an excellent breeder, as she is the dam of that grand young stallion, Stately Victor [15025], also offered for sale. He is rising three years old, a dark brown, nicely marked with white. He looks like making a ton horse, with the best of legs and feet, and has every appearance of being both a show and stock horse. Four nice fillies also adorn the stable. See the advertisement on another page and write them. Anything on the farm is for sale, and will be priced right.

T. H. Hassard, the well-known horse-man of Markham, Ont., writes: "I still have on hand eight Clydesdale stallions and five Percheron stallions, all extra good horses, and in fine condition for a heavy season. Parties wanting something special of other breed would do well to pay a visit to my stables. In order to clean up, I will sell them at very low prices."

**Modern Conditions  
 Demand Modern Methods!**

There is as keen competition to-day in the farming business as in any other. Keep up with the progressive fellows by adopting modern methods. No dairyman or farmer can mix feeds himself that will even approach the tried and tested Caldwell products, even by spending double what they would cost him. For instance:

**CALDWELL'S  
 CREAM  
 SUBSTITUTE Calf Meal**

contains Linseed (NOTE: not Cotton Seed), Wheat, Oat, Corn, Locust Bean, Pea and Molasses Meal in correct proportions to ensure the best results. These ingredients are guaranteed to the Government, and by analysis provide the following: Protein 19 to 20%, Fat 7 to 8%, Fibre 5%. Providing, as it does, almost the identical nutritive elements found in whole milk, Caldwell's Calf Meal enables you to sell your milk and raise just as good calves without it. As a feed for use during the process of "wealing-up" it is without an equal for results.

**CALDWELL'S  
 Dairy Meal**

is a high protein, carefully-balanced cow ration for the production of milk. It is prepared from selected materials, carefully re-cleaned, and contains no mill sweepings, oat hulls or other cheap "fillers." Government-guaranteed—the same as all Caldwell products. Analysis proves that it furnishes Protein 20%, Fat 6.3%, Fibre 10%. All the beneficial elements contained in Caldwell's Dairy Meal are presented in their most easily-digested form. It will increase the milk flow and keep your cows in prime condition.

**CALDWELL'S  
 Molasses Meal**

is the unequalled upbuilder of horses, cattle, sheep and hogs. It contains 84% of PURE CANE MOLASSES (NOTE: not Beet Molasses) and 16% Edible Moss. These two ingredients contain food elements that are not present in the most expensive straight diet of cereals you can use. Caldwell's Molasses Meal is mixed with the ordinary feed, and renders it more palatable and easier to digest. It not only cuts down feed bills, but makes ordinary feed far more beneficial to stock, keeping your animals in perfect condition the year 'round. It has unique anti-septic and digestive properties that will cause a prompt improvement in the animals fed with it. Try Caldwell's Molasses Meal and see whether it does not give you better results and save you money as well.

N.B.—If your dealer cannot supply you with Caldwell's, write us direct. Send for free booklets on any or all of the above feeds.

**The CALDWELL FEED CO., Limited**  
 DUNDAS, ONTARIO

**THE PREMIER  
 CREAM SEPARATOR**

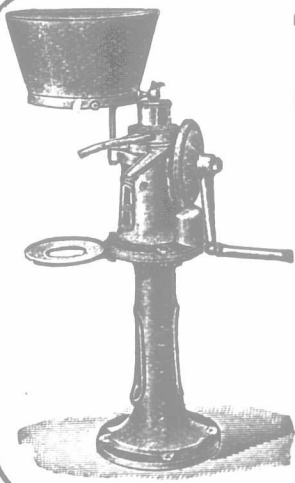

The machine to purchase if you are looking for more profit from your dairy, with less labor. It secures more and better cream from your milk. It is easy to turn and easy to clean, and once set up requires no adjustment. Highly finished throughout and built to last. Catalogue "A," 1914, containing information of interest to you, will be sent free on application to

**The Premier Cream Separator Co.**  
 Winnipeg Toronto St. John, N.B.

**Bell Portable Sawmills.**

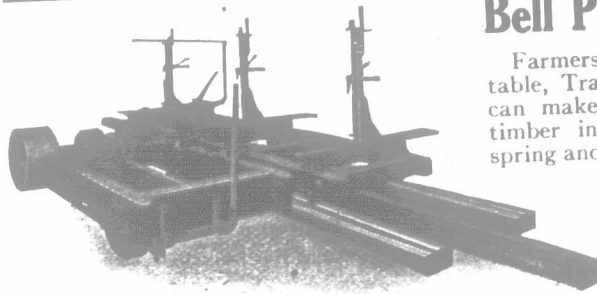

Farmers or threshers who have Portable, Traction or Gasoline Engines, can make good money sawing fallen timber in their locality during the spring and summer months with one of our sawmills. Prices from \$260 up. Also engines, new and rebuilt.

**The ROBT. BELL  
 E. & T. CO., Limited**  
 Seaforth, Ont.

# Hupmobile

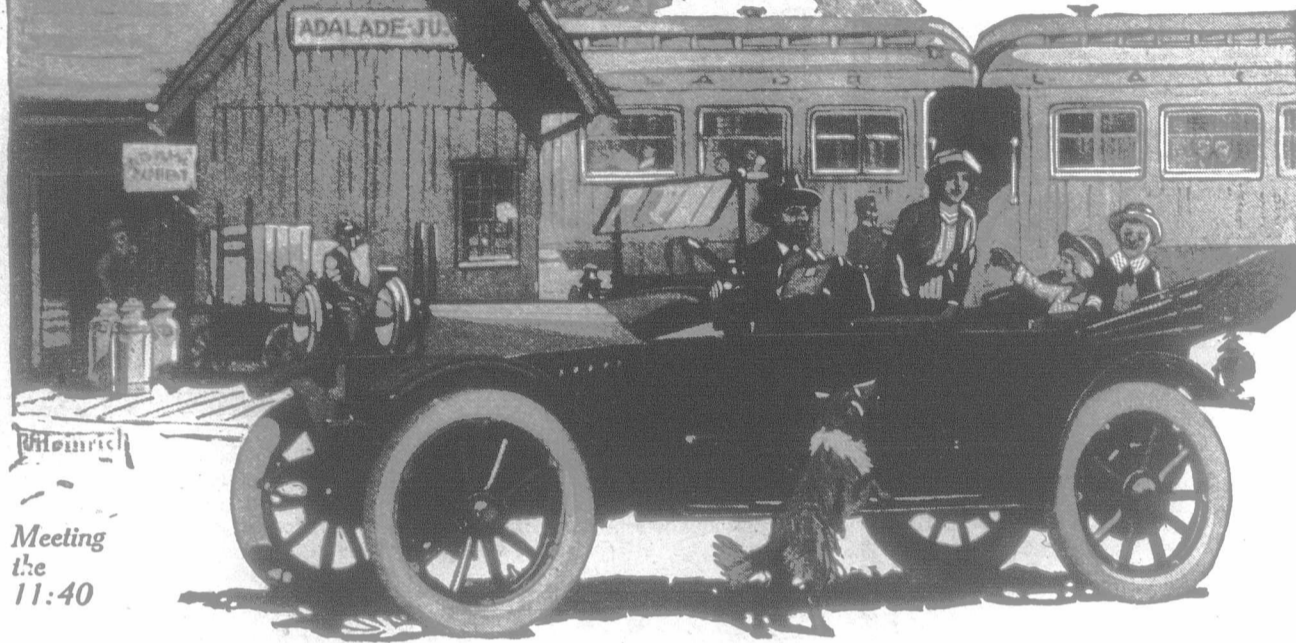

Meeting  
the  
11:40

Touring Car, regular equipment, \$1230, f.o.b. Windsor. With electric lighting and starting, demountable rims, over-size tires, tire carrier, \$1380, f.o.b. Windsor.

## The Car for the Farmer's Family

"The Hupmobile is the cheapest and most satisfactory in the end."

So wrote a big western corporation, using motor cars in its business, to another corporation that had heard of Hupmobile economy and made inquiry.

The first corporation had bought another make of car—a number of them—but they are now displaced by Hupmobiles.

The reason is one year's record of Hupmobile costs.

The company found that the Hupmobile, in 12 months, cost but 4½ cents per mile traveled—and this included not only oil and gas, cleaning, storage, mechanic's time, but one cent per mile for depreciation!

So in came Hupmobiles to the service of this great, rich corporation and went the other cars which could not show Hupmobile low cost of operation and maintenance.

Isn't that the sort of real, definite economy record you want to hear? Here's another, dealing with another phase of motor car upkeep—repair cost.

Here at the factory we know, to the last penny, the amount of Hupmobile repair parts sold during the last five years.

These records show the average cost per mile to the Hupmobile owner for repairs, based on 5,000 miles yearly, to be 2.7 mills—barely more than one-fifth of a cent.

This cost shrinks to 1.9 mills per mile at 7,000 miles per year; and at 10,000 miles per year it comes down to 1.4 mills per mile. There is the true story of Hupmobile economy.

There is the real reason why the Hupmobile has loyal, staunch friends on the farms, in the towns and cities—all over the world.

Many a Hupmobile owner has never bought a spare part; hundreds have had occasion to replace worn parts only, not broken or defective ones.

And that is true motor car economy—not merely good mileage on gas and oil and tires, which, of course, Hupmobile gives.

Try to buy a second-hand Hupmobile and you will be surprised at the price named by the owner—it seems high for a second-hand car.

Yet it is a well-known fact that the Hupmobile stands better in the second-hand market than almost any other car.

Reason—the light, strong construction, the good, sound materials it seems almost impossible to wear out, the sweet, smooth-running long-stroke motor; and the extremely low rate of depreciation.

You want a car, not only of low first cost but low after cost?

"The Hupmobile is the cheapest and most satisfactory in the end."

A powerful corporation speaks to you out of its experience with other cars and with the Hupmobile.

Isn't that enough for you?

### Hupp Motor Car Company, Desk N, Windsor, Ont.

Center control—either side front entrance. Vibrationless steering wheel. Short turning radius 40 ft. "Lively" motor—quick response to throttle. Little of customary

motor vibration. Dash control of hot and cold air to carburetor. Simple carburetor—no delicate adjustments necessary. Certain clutch action. Simple, infallible oil-

ing system. Rain vision, ventilating windshield. Quickly adjustable side curtains. Low center of gravity—good looks, easy riding, few skids, no turning over.

Gasoline tank under cowl, nearly over carburetor, assuring constant flow of gas. Improved tire carrier. Rainshield on magneto. All moving parts enclosed. "Streamline" body—

only now being adopted by highest priced cars. Accessibility and lightness in weight of starting system. Four spare fuses in fuse box cover.

## Prove the "BISSELL" by Its Work

Do the gangs on your Harrow crowd together and raise out of the ground if it is hard? They won't do this on the "Bissell." The "Bissell" is so designed that THE GANGS CAN'T CROWD OR BUMP together no matter how hard the ground may be.

Tough soil won't stick the "Bissell." It stays right down to its work and pulverizes the ground thoroughly.

We ask you to take a "Bissell" out into the field and test it beside other Harrows. Then you

will HAVE PROOF that it is A SUCCESS ON HARD LAND—THAT IT PULVERIZES THE BEST—and that it is the lightest draught.

Post yourself fully on Harrows before buying. We put our name on every Harrow so that you will know it is genuine. Ask your local dealer, or write to Dept. W for free Catalogue.

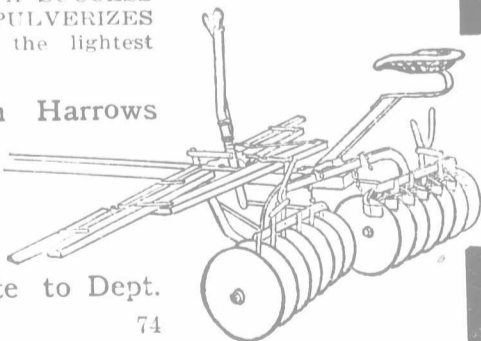

### T. E. Bissell Company, Limited, Elora, Ont.

JNO. DEERE PLOW CO., Ltd., 77 Jarvis St., Toronto, Selling Agents for Ontario and Quebec

### Farmers of Ontario!

Are you requiring help this Spring? Parties of young men and boys are now coming forward. For full particulars apply

BOYS' FARMER LEAGUE,  
DRAWER 126, WINONA, ONTARIO

Seed Potatoes Hustler and Noxall, two new, white late varieties; eating quality first-class; immense yielders; price on application. Also White Rock eggs for hatching; one dollar per fifteen.  
W.M. HOUSBERGER - Jordan, Ontario

WE WILL GLADLY GIVE INFORMATION REGARDING THE USE OF

## Lime

on your soil. The soil must be sweet to produce good crops. Where sorrel, horse tail, moss, etc., appear, the soil is sour, and you cannot expect the maximum yield of hay, cereal or fruit without correcting this acid condition. Lime Carbonate (Caledonia Marl) will do this. In many instances it has more than doubled the yield. We furnish blue litmus paper free with directions for testing your soil. Write us for further information. Agents wanted.

INTERNATIONAL AGRICULTURAL CORPORATION  
Caledonia Marl Branch 827 Marine Bank Buildings, Buffalo, N.Y.

When writing advertisers, please mention "The Farmer's Advocate."

### Questions and Answers. Miscellaneous.

#### Itchy Legs.

I have a mare eight years old. She has had an itch on her hind legs for the past two years. When shod, she cuts herself with shoes while itching. Please give me a remedy.

A SUBSCRIBER.

Ans.—If this mare is not in foal, would advise you to purge first with 8 to 10 drams aloes and 2 drams ginger. Make a solution of corrosive sublimate, 30 grains to a quart of water, and rub well into the legs twice daily. Give her one ounce of Fowler's solution of arsenic night and morning on her grain, or in a pint of water as a drench every alternate week as long as necessary. In animals rather inclined to be coarse in quality, it is a common trouble, but it may be allayed by regular feeds of a laxative nature, and otherwise good care.

#### Hedge—Variety of Oats.

1. I intend planting a short piece of hedge for fence. I have a neighbor that is going to cut down his hedge. Would it be advisable to take those plants? Do you think they would grow, and what time should I dig and plant them?

2. Is the New Century oats a good variety? Do you think it is as good oat as the Banner.

Ans.—1. The question does not state the kind of hedge it is. In all probability, better results would be obtained from getting new trees, as those discarded from the old hedge would likely be too large. Set them early in the spring, or if cedar, June is a good time.

2. The New Century is a fair variety of oats, but not as good an all-round oat as the Banner.

#### Wild Radish—Sweet Clover.

1. Please tell me, through your paper, the name of the seeds inclosed, and something about the plant. I got them in some seed oats I bought.

2. Please give me any information you can regarding white sweet clover. Can it be cut once for hay and left to go to seed the same year, as red clover, or is it like alsike? J. A. B.

Ans.—1. They are the seed of wild radish, an annual and winter annual plant. It should be hand-pulled when it first appears, and when it becomes prevalent, a short rotation of crops should be followed, where hoed crops form an important part.

2. Sweet clover is like red clover in nature. It should furnish a crop of hay and seed in one season. There has been much written regarding sweet clover in recent numbers of this journal.

#### Barrenness—Varieties of Peaches.

1. I have a two-year-old heifer that comes in heat every two weeks. Have bred her twice, but she is not in calf.

2. What causes her to come in heat every two weeks?

3. Is there any probability of her breeding? If not, can anything be done to make her breed?

4. Can peaches be grown successfully in Middlesex, and what are the most suitable varieties? C. R. W.

Ans.—1 and 2. This is due, no doubt, to an unhealthy condition of the ovaries, which is hard to remedy.

3. The chances are against conception, but the following treatment may correct matters: Mix an ordinary two-cent cake of yeast to a paste with a little warm water, and allow it to stand for twelve hours in a moderately warm place, then stir in one pint of freshly-boiled, lukewarm water, and allow it to stand for eight or twelve hours. The mixture will then be ready for use. After flushing out the passage with warm water, inject the entire solution of the yeast-cake into the vagina with a large syringe. Make the solution when the animal is first coming into heat, and make the injection from one-half to one hour before breeding. This treatment is not infallible, but favorable reports are often heard concerning it.

4. Peaches are being grown in Middlesex County with a moderate degree of success. The best commercial varieties are Yellow St. John, Fitzgerald, Elberta and Lemon Free. Carman is a good white variety.



**DR. HESS  
Instant  
Louse Killer**

*Kills Lice on Poultry  
and Farm Stock*

It kills them *instantly*—as soon as it gets to them—that's why it's called *Instant*. It also destroys bugs on cucumber, squash and melon vines, cabbage worms, slugs on rose bushes, etc. See the name "Instant" on the can—that's the louse killer formulated by Dr. Hess (M. D., D. V. S.). Sifting-top cans. 1 lb. 35c; 3 lbs. 85c. (duty paid). If not at your dealer's, write

Dr. Hess & Clark  
Ashland  
Ohio



**BEST ON EARTH**

**WATCH FOR THE  
TRADE MARK  
AND  
KNOW WHAT YOU GET  
FREEMAN'S  
FERTILIZERS**

**A SPECIAL FORMULA FOR  
EVERY REQUIREMENT.**

**Do not buy a "A Pig in a Poke."**

Send for booklet showing just what Fertilizer you should use and the exact composition of it. Your copy will be sent for a post card.

**The W. A. FREEMAN CO., Ltd.**  
222 HUNTER ST. E.  
HAMILTON, ONTARIO.

**R.M.S.P.**

**FORTNIGHTLY SAILINGS**

— BY —  
**TWIN-SCREW  
MAIL STEAMERS**  
FROM  
**St. John (N.B.)  
AND  
Halifax (N.S.)**

**SPECIAL FACILITIES  
FOR TOURISTS**

For Illustrated Folders, Rates, etc., apply to the Agents of The Royal Mail Steam Packet Company; or in HALIFAX (N.S.) to PICKFORD & BLACK, Ltd.

**RAW FURS**

Trappers are finding out that the Manufacturer is the only place to send their furs. No large newspaper price lists with one dozen sorts for each kind; just a fair deal every time is bringing us greatly increased shipments. Large prices on paper is no good to you, boys. Write for shipping tags and price list free.

**C. H. ROGERS**  
Dept. B. Walkerton, Ont.

Please mention "The Farmer's Advocate."

**Questions and Answers.  
Miscellaneous.**

**Removal of Car.**

A buys a farm from B. Can B, on vacating premises, remove and take away the slings' car from steel track, he having to loosen bolts to remove stop-block to permit of car being taken off?

A. QUERY.

Ans.—The car is, properly speaking, one of the implements of the farm, and provided you can remove the car without in any way destroying the permanent fixtures of the barn, you are entitled to it. However, it is a technical point which we cannot answer from our present understanding of the case, whether you would be allowed to loosen the bolts and meddle with the stop-block or not. Most cars are so constructed that by loosening a few nuts at the top of the car you would be able to remove it without taking off the stop-blocks. Cars of this type could be taken off.

**Silo Foundation—Injustice to Buyer.**

1. I would like to ask you for the best method of putting in a foundation for a stave silo 12 x 30 feet. The ground is a sandy loam, with the quicksand coming to within three or four feet from the surface of the ground. Also, how should a drain be put into it?

2. Some time ago I purchased from one of the largest breeders of Tamworths in Canada, a pair of fine sows, and paid a handsome price for them. When I received their pedigree I noticed they were full sisters, farrowed by the same dam, and sired by the same sire. I also noticed that there is only fourteen weeks' difference in their ages. Now, can this be possible? Or has there been some mistake in the papers? If so, what is my best plan to have this mistake rectified? I informed the breeder of the circumstances, but he has not given me any satisfaction yet as to how this could happen.

BEGINNER.

Ans.—1. In the first place, make marks representing the inside circumference and outside circumference of the wall. The wall should be about twelve to fifteen inches thick. With these marks made, remove the earth between these two lines to a depth below the frost-line. It might be well to have your tile laid below this line, and prior to the time of excavating. If it is once drained, the trouble from quicksand is dispensed with. Having removed the soil from the inside of these two lines, fill with concrete made, preferably, of one part cement, three parts sand, and five parts broken stone. The broken stone may be of all sizes, up to pieces that will pass through a two-inch ring. Washed gravel, broken brick, or screened cinders may be used in place of broken stone. If the gravel contains sand, the amount contained should be estimated by screening. The proportions of gravel and sand should be then adjusted to conform, approximately, to the above formula. After the depth is filled to the surface of the ground, place forms to retain the concrete in this form is within one inch of the top, finish with mortar made by mixing one part of cement to three parts sand, and strike off level with the top edges of the form. Eye-bolts or stays may be sunk in the cement to which uprights in the silo may be fastened and secured. The bottom of the silo should be about four inches thick, and sloping to the center. An opening should be made in the center connecting with the tile drain. The concrete floor should be made of concrete similar to that used in the foundation, and surfaced with mortar made of three parts sand to one part cement.

2. If these two sows were full sisters under the conditions you explained, it is a very singular case indeed. However, we would not like to say that there could not be abnormal conditions under which it would be possible. However, the proper procedure for you to follow would be to communicate in a business-like way with the breeder from whom you purchased. If you cannot obtain a satisfactory explanation from him, write the Accountant, Live-stock Records, Ottawa, who possibly could clear the matter up for you. Failing this, it is a matter for the solicitor.

**An Investment—  
Not an Expense**

**A MASSEY-HARRIS SPREADER** on your farm will enable you to apply the manure when it will do the most good, even if help is scarce, for it is a great labor and time saver.

It spreads manure over more acres, because it is so thoroughly pulverized that all of it is available as plant food and need not be applied so thickly as would be necessary with hand spreading.

It makes possible the top dressing of field crops, which is usually the most effective method—the first rain carrying the fertilizing elements down into the soil.

On meadows and pasture lands it makes it possible to apply the manure so as to be of the greatest possible benefit—renewing the fertility without losing the use of the land for a time.

**The Spiral Beater  
Ensures  
Even Spreading**

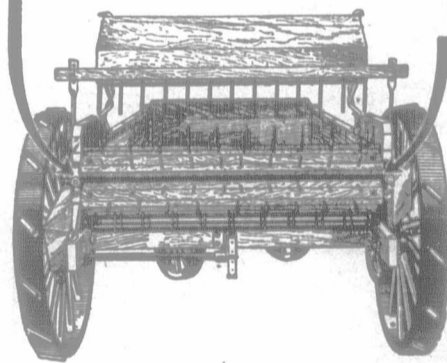

Free Booklet on Soil Fertility and the advantages of using this Spreader from any of our Agents or by mail.

**Massey-Harris Co.,  
Limited.**

Head Offices—TORONTO, CANADA

Branches at—  
Montreal, Moncton, Winnipeg,  
Regina, Saskatoon, Swift Current,  
Calgary, Yorkton, Edmonton.

Agencies Everywhere

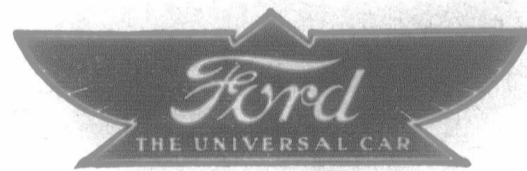

The Ford—the Lightest, Surest,  
Most Economical—the very essence  
of automobiling—and all Canadian.

Model T \$600  
Runabout  
f. o. b., Ford,  
Ontario

Get particulars from Ford Motor Company of Canada, Limited, Ford (formerly Walkerville), Ont.

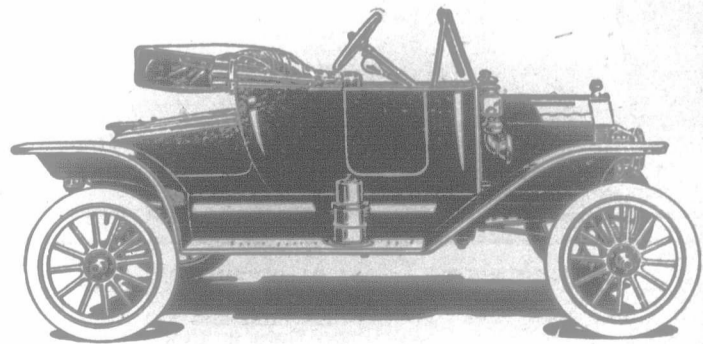



**PRATTS Poultry Remedies**

- Pratts Poultry Regulator, 25c to \$1
- Pratts Baby Chick Food, 25c to \$1.75
- Pratts Liquid Lice Killer, 50c qt. \$1 on gal.
- Pratts Powdered Lice Killer, 25c-50c.
- Pratts Roup Cure, 25c-50c
- Pratts White Diarrhoea Remedy, 25c-50c
- Pratts Poultry Disinfectant, \$1.50 gal.
- Pratts Cholera Remedy, 25c-50c
- Pratts Head Lice Ointment, 25c
- Pratts Gape Remedy, 25c-50c
- Pratts Bronchitis Remedy, 25c-50c
- Pratts Condition Tablets, 25c-50c
- Pratts Sore Head Remedy, 25c-50c
- Pratts Scaly Leg Remedy, 25c-50c



**Raise The Little Chicks**

Don't lose sight of the fact that the youngsters of to-day are the producers of to-morrow. Raising them is a simple matter if correct methods are followed. The unnecessarily heavy death rate in baby chicks is largely due to improper feeding.

**Pratts Baby Chick Food**

is a scientific ration for the successful raising of young chicks. Fed for the first three weeks, it lays the foundation for vigorous health, furnishing the same elements of nutrition, in the same proportions, as supplied by the mother hen. Pratts Baby Chick Food is not a cure-all, but it does prevent disease by building bone and muscle and imparting the stamina necessary to resist intestinal disorders and other ailments common to the newly hatched. Order a package TO-DAY.

"Your Money Back If It Fails."

At your dealer's, 14-lb. bag, \$1.00; 6 1/2-lb. pkg., 50c.; 3-lb. pkg., 25c.

**PRATT FOOD CO. of Canada, Limited TORONTO**

Fill in and mail this coupon together with 10c. in stamps to cover postage, wrapping, etc., and we will mail you a copy of "The Poultryman's Handbook," 100 pages, profusely illustrated.

**Coupon "A. 1"**

Send me your 160-page Poultry Book. Enclosed find 10c. in stamps.

Name .....  
Address ..... P-5

**Your Buildings are Safe**  
And well protected from the storms and weather elements if they are protected with our high-grade

**Roofings and Sidings**

Preston Safe Lock Shingles on the roof are a safeguard against damage by lightning. We give a written guarantee.

Acorn Sheets are strong, rigid and easy to erect. They are absolutely weatherproof. Acorn sheets are highest quality and full weight. Our book "Steel Fireproofing 65" is now ready. Send for a copy, which will give you some good information on buildings.

**The METAL SHINGLE & SIDING CO., Ltd.**  
Preston Montreal Saskatoon Calgary  
Associated with The A. B. ORMSBY CO., Limited  
Toronto Winnipeg  
ADDRESS YOUR NEAREST OFFICE E.O.S.

**Everything--From a Berry Bush to**

a shade tree. Fruit, Ornamental and Evergreen trees, Shrubs, Roses, Grape Vines in great variety. Send for our priced catalogue, it's been our agent by mail over 30 years. No experiment when ordering at the Central Nurseries direct. Prices right, so are the offers. Get busy while we are in good variety--choice seed potatoes, etc.

A. G. Hull & Son, St. Catharines, Ontario

**Questions and Answers. Miscellaneous.**

**Coons.**

In last week's issue of "The Farmer's Advocate," I noticed a few questions about coons. Having raised coons on several occasions, I am in a position to answer the questions. Last spring mine mated on the sixth of April, and had their young on the eighth of June; three in number. They were over three weeks old before they opened their eyes. They will need to be fed some bread and milk after they are about three months old. The male must be put into a separate place a month before the young arrive or there will be war. H. M.

**Lump on Jaw.**

1. Have a calf about a month old that has a large swelling on the side of its jaw. I used a caustic to burn its horns, and I don't know whether it had anything to do with the swelling or not. I am feeding skim milk with a little linseed meal in it, and give it whole oats. Tell me how to cure it.

2. Would like to know the analysis of poultry food, as to protein and fat.

Ans.—1. Treating the horns would not cause the trouble, which is likely lump jaw. Look up answers to similar questions in recent issues.

2. Write the manufacturers, London, Ont.

**A Host of Queries.**

1. I intend pasturing some thirty or thirty-five hogs this summer on peas and oats for early pasture, and rape for later. Would the rape be much better sown in drills? I would think broadcast would be as good if extra labor were taken into consideration, as ground is perfectly clean.

2. Will three acres be sufficient to finish them without feeding grain?

3. Would it be advisable to sub-fence the rape and feed, or pasture one plot at a time?

4. Would a three-foot wire fence be high enough for fencing hogs?

5. Would it be more profitable in your estimation to feed grain with pasture?

6. Last spring we had some trouble with young calves dying with white scours, and discovered a simple but sure cure, which might benefit some of your readers. Drench with about half a tea-cupful of best whiskey or brandy, and if no better in twelve hours, repeat, and enlarge the dose to three-quarters.

7. How many pounds of clover and timothy do you recommend sowing for mixed hay?

8. Could you give me a prescription for tanning hides?

9. Would you advise crossing Yorkshire sows with Berkshire hogs, or using Yorkshire hogs? Do Tamworth and Berkshire, or Tamworth and Yorkshire, make the better cross? FARMER.

Ans.—1. Rape grows ranker sown in drills, and might produce more feed. The chief reason for sowing it in drills, however, is to kill weeds.

2. We do not think you can finish them satisfactorily without some grain. Fed in conjunction with a grain ration, three acres would be sufficient.

3. Sub-fence if practicable.

4. Yes; but a little higher would be safer.

5. Yes.

6. This would not cure the contagious form of scours.

7. Sow plenty of seed. Not less than eight to ten pounds of clover, and four or five pounds of timothy.

8. Again, we advise against home tanning. Soak hides three days in soft water. Scrape off all flesh. When clean, place in a tan composed of equal parts alum and salt dissolved in hot water (7 lbs. of alum and salt to 12 lbs. water). Leave in two days. Hang up and scrape. Put back in brine two days. Hang up again to dry. Oil and lay away to dry.

9. Many successful pig feeders favor crossing Berkshire boars on Yorkshire sows. Yorkshire sows are sometimes thought to be a little more prolific than Berkshires, and the cross makes good feeding pigs. As a general thing, we do not favor crossing of breeds. Would rather cross Berkshires and Tamworths than Yorkshires and Tamworths.

**WOOD FORK OR STEEL OR SLING TRACK OR SLING OUTFITS**

**PUT UP YOUR OWN HAYING OUTFIT SAVE BIG MONEY**

**HUNDREDS HAVE DONE IT SO CAN YOU**

Do not go through another haying season without one of our labor saving outfits. You can put in your own outfit and save half price or more. We furnish everything complete. Send size of your barn and height from floor to peak. Also say whether you use end or centre driveway for unloading. We will then tell you exact cost of outfit, all complete.

**COMPLETE HAYING OUTFITS \$12.50 AS LOW AS**  
FREIGHT PAID ONTARIO AND EAST

**BEST FOUR STRAND MANILA**

**NEW LOW PRICES ON ROPE**

We furnish nothing but the best four strand Pure Manila Rope with our outfits. Do not be misled by prices on other rope not pure manila.

Best 4 Strand Pure Manila Rope, 3/4", per 100 feet, \$2.90.  
Best 4 Strand Pure Manila Rope, 7/8", per 100 feet, \$4.85.  
Best 4 Strand Pure Manila Rope, 1", per 100 feet, \$5.75.

Everything first class. Write for catalogue to-day, and tell us what kind of outfit you prefer.

**CATALOGUES AND INFORMATION FREE**

*The Halliday Company Limited*  
FORMERLY STANLEY MILLS & CO.  
**HAMILTON ESTAB. 1888. CANADA**

**Ploughs—Wilkinson**

TRADE MARK REGISTERED

U.S.S. Soft Centre Steel Moldboards, highly tempered and guaranteed to clean in any soil. Steel beams, steel landsides and high carbon steel coulters. Each plough is fitted especially with its own pair of handles—rock elm, long and heavy and thoroughly braced. The long body makes it a very steady running plough. Shares of all widths—specials for stony or clay land. The plough shown turns a beautiful furrow, with minimum draft and narrow furrow at finish. Ask for catalogue.

The Bateman - Wilkinson Co., Limited  
411 Spadina Ave., Toronto, Canada.

No. 3  
Sod or General Purpose Plough. 25 styles to choose from.

**MAIL CONTRACT**

SEALED TENDERS addressed to the Postmaster General will be received at Ottawa until noon, on Friday, the 8th day of May, 1914, for the conveyance of His Majesty's Mails on a proposed Contract for four years, six times per week each way, between Big Point and Chatham (Chatham No. 1 Rural Route) from the 1st day of July, 1914, next.

Printed notices containing further information as to conditions of proposed Contract may be seen and blank forms of Tender may be obtained at the Post Offices of Big Point, Dubuque, Painscourt and Chatham, and at the Office of the Post Office Inspector at London.

Post Office Department, } G. C. ANDERSON,  
Mail Service Branch, } Superintendent.  
Ottawa, 26th March, 1914.

**An Easy Way to Earn \$5.00**

Send us a picture suitable for advertising—one showing a **WATEROUS PORTABLE SAWMILL** in actual use—and we will send you a five dollar bill. The picture must show a Waterous Portable Sawmill, must be clear and must be accompanied by a description covering the essential facts. The picture should measure not less than 4" x 5" and be printed on glossy paper.

We reserve the right to accept or reject pictures according to our own judgment of their value.

Address—Advertising Department, **WATEROUS ENGINE WORKS CO.,** Brantford, Ontario

**"And remember,  
John  
use nothing but,  
Brandram's  
B.B. Genuine  
White Lead  
on that job."**



Brandram's B. B. Genuine White Lead is the one safe white lead to use because it is corroded by the famous Brandram process, which makes it penetrate further into the wood on account of its wonderful smoothness and fineness. It can be depended upon to protect the wood longer against deterioration than lead made by any other process.



Brandram's B. B. Genuine White Lead has for over 100 years been accepted as the standard of values in white lead. If the world's verdict of superior quality is good enough for you, buy Brandram's.

Write for booklet, or ask your dealer.



**BRANDRAM-HENDERSON LIMITED**  
Montreal Halifax St. John Toronto Winnipeg

**Efficiency of Lightning Rods**

Lightning Rods, when properly installed, will prevent your Building being struck in about 945 times out of one thousand. There are statistics to prove this. And in the other 55 cases will carry the bolt harmlessly into the ground.

We know that electricity will follow a copper cable instead of a wooden beam, or boards, to the ground (where its trying to get). You know lightning strikes the higher points on a building, the tall trees in a bush.

If you have points above your building for it to strike; if it is going to hit the building, and a conductor to carry it to the moisture in the ground—why isn't it reasonable to suppose that it will work?

And it does work. Prof. Day says: "Lightning Rods, properly installed, are almost absolute protection. Out of every Thousand Dollars worth of damage done to unrodded buildings by lightning \$999 would be saved if those buildings were properly rodded"—and he proved it at the Winter Fair in Guelph last December—proved it beyond a doubt.

And no building with Universal Rods on has ever been damaged. If you would like to see our rod drop a card for sample.

**THE UNIVERSAL LIGHTNING ROD COMPANY  
HESPELER, ONTARIO**

**"ROSS"  
CADET  
RIFLE**



**EVERY FARMER NEEDS  
A GOOD RIFLE**

The ROSS Sporting Models, 303 and 280, are absolutely the best made, but for those who have no use for such high power arms, the new ROSS 22 Model, which we call "Cadet," because the Government has adopted it officially for Cadet Corps, is a splendid all-round rifle.

Strong and well-balanced, its barrel is accurate and its novel sights—a protected foresight and peep rear sight, are wonderfully easy to line on either bulls-eye or game. This rifle uses either 22 short, long or 22 long rifle.

Its action is safe and quick. Easy to clean. The best rifle to teach boys how to shoot. If your dealer cannot supply you, write direct for illustrated catalogue to

**THE ROSS RIFLE COMPANY, Quebec**

When writing advertisers mention "The Advocate."

**The Value of Butter-Fat as a Food.**

Editor "The Farmer's Advocate": Experiments in the feeding of animals are constantly proving that among artificial foods there is no substitute which is so valuable as the food which nature has provided for them. Recently two investigators, Professor T. B. Osborne and Professor L. B. Mendel, of the Connecticut Agricultural Experiment Station, and the Sheffield Laboratory of Physiological Chemistry in Yale University, have been studying conjointly the importance of butter-fat in the food of young animals. Their experiments with rats show that the young can be raised up to a certain size, about two-thirds of that of the adult, upon a "protein-free milk" diet, with or without lard as a substitute for butter-fat. But at this point growth ceases, and is only resumed when butter-fat is added to the diet. This shows the need which young animals have for a particular kind of fat when they are growing. Life can be maintained in both young and adult rats for a long period upon a "protein-free milk" diet, but growth inevitably ceases if the butter-fat is withheld. No substitute, such as lard, will take the place of this.

Artificial foods, which in their general composition very closely resemble milk foods, have the same injurious effect upon the growth of rats. When centrifugated milk, to which is added lard and starch in the proper amounts, is used as a food, the young rats grow to a larger size than those brought up on a "protein-free milk" diet, but do not reach the normal adult size before growth is checked. This longer period of growth is probably due to the very small per cent. of butter-fat which does not separate out from the milk when it is centrifugated.

By an analysis of butter-fat into its component parts, it was found that the essential substance for growth is contained in the fatty acids of the butter-fat, and not in the dry matter or soluble substances of the milk which are also present in the butter-fat to a small degree. It is not known just what the nature of this substance is, but obviously it is due to the method of production. The fat in milk is the product of a highly specialized organ of the body, the mammary gland, and is designed for the nourishment of the young. Other fats are stored up in cells all over the body, and while they may be called upon to maintain life when food is scarce, they do not contain the growth-producing elements. The investigators point out, however, that growth will not be produced by butter-fat alone, but that the proper proportion of protein and inorganic salts in the diet must also be maintained.

Maine. MAUD DEWITT PEARL.

**Questions and Answers.  
Miscellaneous.**

**To Cure a Cribber.**

I have taken your paper for a number of years, and found it one of Canada's best papers. Would you please print in your columns a cure for a cribbing horse? We have had a strap on him for about six months, but it doesn't do any good.

AN OLD SUBSCRIBER.

Ans.—Cribbing is a vice difficult to check. In the early stages it can sometimes be checked by working the horse and keeping him in a box stall without mangers, racks, etc., where he will be likely to catch his teeth. The strap is only effectual when on. Smearing the manger with aloes, or other bitter or foul-smelling substances is also recommended. A revolving roller of hard wood on the front of the manger is successfully used by some. The horse bites on the roller and his teeth slip off.

**"CONSTRUCTIVE AGRICULTURE."**

Peter Tumbledown's city cousin visited him last summer. After dinner the cousin walked about Peter's farm; but the longer the city man walked the longer grew his face.

After staring at some scraggy cows, he returned to the house and remarked to Peter:

"I notice you've started to build cows here."

Peter looked puzzled.

"Well," explained the cousin, "you have the frames up, haven't you?"



**The General says:-**

Every building on your farm will be a better, more valuable building if you give it a **Certain-teed** roof! The label on

**Certain-teed  
ROOFING**

guarantees 15 years' service. No "test" for toughness, pliability or anything else can give you advance knowledge of how long a roof will last. Roofs don't wear out—they dry out. Let the three biggest mills in the world guarantee the roofing you buy.

Your dealer can furnish **Certain-teed** Roofing in rolls and shingles—made by the General Roofing Mfg. Co., world's largest roofing manufacturers, East St. Louis, Ill., Marseilles, Ill., York, Pa.

We are sole Agents in Ontario for

**Certain-teed**

**RED RING ROOFING**

See your dealer—if he does not handle **RED RING Certain-teed Roofing**, and Standard Wall Board, write us for samples and prices.

**"Standard" Wall Board**

is damp proof, will not warp, is sanitary and is cheaper than lath and plaster.

**The Standard Paper Co., Ltd.**  
109-111 George Street,  
TORONTO, ONT

**Caked Udders Cured  
in 24 Hours by**

**Douglas' Egyptian Liniment**

Here is the opinion of Mr. Robert Harkness, a leading resident of Tamworth, Ont.:

"Having had wonderful success with Douglas' Egyptian Liniment on my stock, I feel it my duty to write you.

Our cattle were troubled with caked udders, so bad, in fact, that we thought they would lose the use of them. We applied the Liniment but twice, and in 24 hours we could milk without any trouble.

When anything goes wrong in our home or stables, this excellent Liniment is always called for, and never fails to give instant relief.

I hope this letter will catch the eye of those whose cattle are suffering from caked udders."

Besides quickly curing this trouble, Douglas' Egyptian Liniment has proved its worth in both human and animal disorders, such as rheumatism, sciatica, neuralgia, sprains, burns and inflammations. It has healed, without blood poisoning or other complications, serious wounds, sores and bruises.

Twenty-five cents at all dealers. Free sample on request.

**DOUGLAS & CO.**  
Napanea Ontario

**What Every Dairyman Needs**

A clip to hold the cow's tail while milking. Handy and easy to use. Saves the milker many a nasty blow in the face from the cow's tail while milking. Sent post paid to any address, with full instructions as to how to use them, upon receipt of 50c (fifty cents). Address:

**R. A. CHAMBERLIN**  
83 Bayswater Ave. Ottawa, Ontario

**Registered Tamworths** For Sale—A choice young heifer just ready for service and a few nice young sows 3 months old, satisfaction guaranteed. Can ship by G.T.R. or C.N.O.R. **POWELL BROS.,** Elizabethville, Ont.

**ORK  
SLING  
OUTFITS**



**DONE IT  
U**

haying season outfits. You save half price when complete. Sent from floor to floor or centre will then tell you

**ITS \$12.50  
AND EAST**

**MANILA**

**ON ROPE**

best four strand outfits. Do not be not pure manilla. Rope, 3/4", 90. Rope, 1/2", 85. Rope, 1", 75. Write for catalogue and of outfit you

**MATION FREE**

**any Limited  
MILLS & C.  
CANADA**



**TRADE MARK**

**Wilkinson**

REGISTERED boards, highly clean in any soil. and in carbon be used either is fitted especially—rock elm, ed. The long body ough. Shares of all land. The plough with minimum draft ask for catalogue. Wilkinson Co., 1000 Wellington Ave., Toronto, Ontario, Canada.

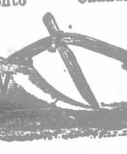

**TRACT**

used to the Postmaster at Ottawa until May, 1914, for the Mails on a proposed times per week each Chatham (Chatham 1st day of July, 1914.

further information Contract may be seen may be obtained at the Post Office In- Superintendent.

**Earn \$5.00**

suitable for showing a **BLE SAWMILL** and you a five dollar a Waterous Portable must be accompanied essential facts. The less than 4" x 5" and

cept or reject pictures ment of their value. **NE WORKS CO.,** Ontario

## A TREATISE on the Horse— FREE!

We offer you free this book that tells you all about horse diseases and how to cure them. Call for it at your local druggist or write us.

### KENDALL'S SPAVIN CURE

is invaluable. It cures Spavin, Curb, Splint, Ringbone or any other lameness, quickly and safely at small expense. Read what Leo Gulligan, of Ennismore, Ont., says: "I used your Spavin Cure on a horse that had Ringbone, and it cured him in four weeks time."

Kendall's Spavin Cure is sold at the uniform price of \$1 a bottle, 5 for \$5. If you cannot get it or our free book at your local druggist, write us.

Dr. B. J. KENDALL COMPANY  
Enosburg Falls, Vermont 81

### BITTER LICK MEDICATED Salt Brick

#### Great Conditioner & Worm Destroyer

Bitter Lick is a compressed salt brick, medicated with roots, herbs, etc., in such proportion as will keep horses in excellent condition and free from worms. Bitter Lick keeps the appetite keen; all horses like it; tones the digestion and prevents colic. It has no cheap filler and takes the place of worm and condition powders, etc., keeps horses healthy for only 10¢ a week.

Ask your dealer or write for booklet.  
STEELE, BRIDGES & CO., Ltd., WHARFERS, MAR.  
Wm. Cooper & Nephews, Toronto, Ont.

## HICKMAN & SCRUBY

Court Lodge, Egerton, Kent, England  
Exporters of Pedigree Live Stock  
of all descriptions.

We are the only firm in Great Britain who make this their sole business, and therefore offer advantages not obtained elsewhere. When our Mr. A. J. Hickman started this business seven years ago, he did not know a single foreign breeder. This year we have exported more stock to order than any other firm in Great Britain. This is a fact which talks. The frequency with which we buy stock from English breeders means that we can do business with them on more favourable terms than can be done by anyone else. No one should import draft horses, beef or dairy strains of cattle, or mutton breeds of sheep, without first getting full particulars from us. Highest references on application.

### NOTICE TO HORSE IMPORTERS GERALD POWELL

Commission Agent and Interpreter  
Nogent Le Rotrou, France

Will meet Importers at any port in France or Belgium and assist them to buy Percheron, Belgians, French Coach horses. All information about shipping, banking, and pedigrees. Many years' experience; best references; correspondence solicited. P.S.—Nogent is in the heart of the Perche horse district.

### Notice to Importers C. CHABOUDEZ & SON

205 rue La Fayette, PARIS, FRANCE  
If you want to buy Percheron Horses and Mares, I will save you time and money and all trouble with papers and shipment. Will meet Importers at any landing port. I am acquainted with all breeders and farmers. 30 years' experience. Best reference. Correspondence solicited.

FOR SALE—THREE CHOICE

### Imported Clydesdale Stallions

of the best breeding right in every way and splendid stock getters. Wm. MEHAREY,  
RUSSELL, ONTARIO

### WOODLAND FARM CLYDESDALE AND HACKNEY

Horses, Shetland Ponies, Brown Swiss Cattle. Some nice young Hackneys and Shetlands for sale. Stallions, Mares and Geldings.  
Ralph Ballagh & Son, Guelph, Ontario

Clydesdales, Imp., Stallions & Fillies  
Stallions, prize-winners of highest quality, character and breeding; Fillies prize-winners in foal, also stock bull, Crown Imperial 86997, a high class bull.  
GOODFELLOW BROS.  
R.R. No. 3, Bolton. L.-D. Phone.

**New Easier Better Spraying**

Write For Free Book How to save money, labor, time. Banish blight, disease and insects from orchards, etc. Use Brown's Auto Spray. Style shown has 4 gal. capacity—non-clogging Auto Pop Nozzle. 40 other styles and sizes—hand and power outfits.

E. C. Brown Co., 67 Bay St., Rochester, N.Y.

Please mention "The Farmer's Advocate."

## Gossip.

### ELMDALE HOLSTEINS.

The noted Elmdale herd of Holsteins, owned by R. Lawless, of Thorold, Ont., in its many years successful history, was probably never so uniform as now, nor never so rich in the blood of the American champions of the breed. The herd, as at present, are practically all young, among which very little official testing has been done, but the long list of official records in their ancestry, their splendid type and udder development, is all the evidence required to show their ability to make a big showing when given an opportunity. With their rich ancestral breeding, and they bred to the great bull now at the head of the herd, they present a mighty alluring proposition to anyone wanting a young cow or heifer or two. This grandly-bred bull is Correct Change, a son of Changeling Butter Boy, with 50 A. R. O. daughters. His full sister, Ready Change, gave 110 lbs. milk in one day; 31.16 lbs. butter in seven days. His dam, Changeling, gave 100 lbs. milk in one day; 29.23 lbs. butter in seven days; his sire, Pontiac Butter Boy, has 57 A. R. O. daughters, and 10 A. R. O. sons. He is a brother of the dams of Pontiac Rag Apple, 31.26; Pontiac Clothilde De Kol 2nd, 37.21; Pontiac Jewel, 30.74; Pontiac Artis, 31.17, and many others of equal fame. The dam of Correct Change was Tidy Abbecker Princess Bettina, seven-day record, 30.13 lbs.; thirty-day record, 113.74 lbs. Her sire, Tidy Abbecker Prince, has 34 A. R. O. daughters, two of them over 30 lbs., and he is a son of the great Tidy Abbecker, 27.29 lbs., who has five A. R. O. daughters, two of them over 28 lbs. each. Descendants of Tidy Abbecker are among the most sought for strains of Holsteins to-day in the United States, for none other has shown a more uniform heavy production, nor a higher average test. The service of this intensely-bred bull is open to the public for a limited number of selected cows, at the very moderate fee of \$25, and richly-bred heifers in calf to him are for sale in the herd.

### JERSEYS AT DON FARM.

The noted show and prizewinning herd of Jersey dairy cattle owned by D. Duncan & Son, R. R. No. 1, Todmorden, Ont., was visited by a representative of this paper a few days ago, and, as usual, was found in the nicest kind of condition. With their nicely-balanced and well-developed udders, they look every inch the big-producing and high-class show herd that has given them the reputation of one of the best Jersey herds in the country. Forty-five to fifty pounds of milk per day, and a persistency of flow that carries them to success in every R. O. P. test in which they have ever been entered, is a standard maintained in the herd for many years. Mention of a few that are dams of young bulls for sale will demonstrate the capacity of the herd as a whole. Lady Primrose, 49 lbs. a day, a show cow, has a September bull calf by the intensely-bred bull, Eminent Royal Fern. Art Sweet Rose will give 45 lbs. a day for months, and has a yearling bull by the great sire and high official-backed bull, Fontaine Boyle. Fanny's Favorite, a 40-lb.-a-day cow, has been in milk a year, and is now giving 23 lbs. a day. She has a daughter of the old stock bull, Fontaine's Boyle, and has a yearling bull by Eminent Royal Fern. Another very persistent milker that for some months after freshening gives 45 lbs. a day, is Golden Duchess of Don. Out of her is an eighteen-months-old bull, by Fontaine Boyle. Another yearling bull is out of Daisy Bell of Don. She is a daughter of the noted champion, Blue Blood of Dentonia, and as a two-year-old gave 38 lbs. a day, testing 6-per-cent. fat. Her yearling bull is by Fontaine Boyle. Lady Primrose, the well-known Canadian champion, and dam of the September bull calf first mentioned, is looking her best and milking very heavily. Another particularly choice cow is Bessie of Don, three years old, giving 40 lbs. a day. She is a daughter of Fontaine Boyle. There are also a large number of heifers from calves up, daughters of the two great stock bulls that are full of quality for the show-ring or official producing blood for breeding purposes. Write the Messrs. Duncan your wants.

It Won't Rub Off

VISIT the finest hotels, the costliest homes, and you will find Alabastined walls. Alabastine is used in these palatial places, not because it is the most expensive wall-decoration, but because it is the most artistic and effective. An Alabastined wall is a delight to the eye—so soft, velvety and beautiful. It will not rub off or fade. Alabastine is cement, and hardens with age. Its beauty is permanent. It is the most sanitary and inexpensive wall coating known. Alabastined walls are now the general vogue, in cottage and mansion alike. Wall Paper is out of fashion. The sales of Alabastine in Canada have doubled in two years.

## CHURCH'S Alabastine

COLD WATER

None Genuine without Little Church on Label



**FREE STENCILS**

To still further popularize Alabastine and again double its sales, we have organized a Decorative Department, and are prepared to offer FREE COLOR SCHEMES and FREE STENCILS to users of Alabastine. Write today for particulars. Our advice is free. Let us help you to beautify your home at a moderate cost.

Please send free particulars of your Color Scheme and Free Stencil offer to

Name.....

Street.....

City..... Prov.....

The Alabastine Co., Ltd., 31 Willow St., Paris, Ont.

## Insure Your Horses

against Death through Disease or Accident, Fire and Lightning. We issue the most liberal policies free from vexatious conditions and offer indisputable guarantee of solvency and square dealing.

We insure: Stallions, Track Horses, Draft Horses, In-Foal Mares, with or without insurance on the Foal; Cattle, Castration and Transit Risks, etc.

### All kinds of Animals Insurance

Write us for further information and address of nearest agent.

## THE GENERAL ANIMALS INSURANCE COMPANY OF CANADA

Head Office: MONTREAL, Que.

## FREE-FARM ACCOUNT BOOK

Bickmore's Farm Account Book will be sent free to any farmer who will tell us who and where he is. This book is arranged to keep all accounts in simple form—more simple and certainly more practical than trying to remember them; shows what to charge against crop production; has a laborers' time record; and section for personal accounts. 64 pages, for ink or pencil. Not a cheap affair. Its quality is in keeping with BICKMORE'S GALL CURE, a soothing, healing salve, the old-time reliable horse remedy. Horses are now too valuable and too high priced to take chances of losing their services. Bickmore's Gall Cure heals and cures Harness and Saddle Galls; Rope Burns, Cuts, Scratches, Grease Heel, etc. You don't have to lay the horse off. Bickmore's cures while the horse works. Great thing for sore tests in cows. The work-horse trade mark on every box. None genuine without it. Be sure to ask for Bickmore's Gall Cure when you go to buy and do not take a substitute. Farm Account Book is ready. Send today.

WINGATE CHEMICAL CO., Canadian Distr's, 8890 Notre Dame St. W., Montreal, Can.

### TOPPERS IN CLYDESDALES AND PERCHERONS

I have just landed a big importation of Clydesdales and Percherons, if you want a big ton stallion with the best of quality, come and see me, I can show you the best lot of stallions you ever saw.

T. D. ELLIOTT

BOLTON, ONTARIO

### Clydesdales & Shires

If you want Stallions, Fillies or Foals of the above breeds, personally selected from A. and W. Montgomery's Clydesdale Stud and the Bramhope Shire Stud, Cheshire, and home-bred of the most fashionable strain, see and select from the large stock now offered. Prices and terms will please. D. McEachran, Ormsby Grange, Ormstown, Que.

### STALLIONS & FILLIES

For this season's trade we have Clyde Stallions and Fillies that were up to championship honors in Scotland, and the same honors in Canada. Breeding characters, quality and action unsurpassed. Visit our barns if you want the best.

ROBERT NESS & SON

HOWICK, QUE.

### IMPORTED BELGIAN AND PERCHERON STALLIONS

Just landed, a choice lot of young stallions of the best breeding, with size and quality. Several winners in Europe. For sale at Hunters' Stables, 106 Nelson St. (near Rideau), Phone Rideau 671. Ottawa, Ont. A visit solicited. H. E. Martinette, Proprietor, 52 Sweetland Ave., Ottawa.

### Mount Victoria Clydes and Hackneys

When in need of a high-class Clydesdale stallion or filly, or something that has won and can win again in Hackney stallions or fillies, visit our barns at Hudson Heights, Quebec. T. B. MACAULAY, Proprietor. Hudson Heights, Que. E. WATSON, Manager.

# No More Sore Shoulders



You want a sweat pad Mr. Farmer, that will not only give you superior wearing qualities, but one that will avoid for you all troubles caused by gall sores.

VENTIPLEX pads cure and prevent galls and sores by the very principle on which they are constructed, being made of a soft woollen fabric which is porous and absolutely non-poisonous (acting on perspiration as a blotter on ink) thus keeping the horse's shoulders dry and well at all times. VENTIPLEX pads can be cleaned when dirty and wearing qualities are unequalled.

Your absolute satisfaction is our guarantee. See "VENTIPLEX" at your dealers or if he can't supply you, write us.

Booklet free, address Dept. C. Burlington - Windsor Blanket Co., [Ltd., TORONTO, ONT.

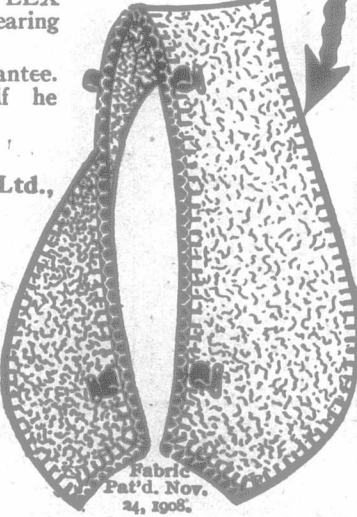

## Percheron Stallions

The premier show herd of Canada. All ages, blacks and greys, weights from 1800 to 2150 lbs. Write for the greatest illustrated horse catalogue in Canada

HODGKINSON & TISDALE, BEAVERTON, ONT. G.T.R and C.N.R. Railroads, Bell 'phone, No. 18.

## SEE OUR CLYDESDALES

A choice lot of Stallions and Mares are in our stables at the present time. They are the big kind with the best of quality and in the pink of condition. Write us for particulars, and we will be pleased to meet you at any of the Stations mentioned.

SMITH & RICHARDSON Columbus P. O. Myrtle, C.P.R.; Brooklin, G.T.R.; Oshawa, C.N.R. Long-distance 'Phone.

### Percheron, Clydesdale and Shire Stallions, Mares and Fillies

Belgian, Hackney, French Coach, and Standard Bred Stallions. We have a better bunch of stallions and mares in our barns at present than ever before, and are in a position to sell cheaper than any other man in the business. We raise our own feed, do our own buying and selling. No commission agents to share profits with. We have nice, big stylish blacks and greys, with right kind of bone and feet and good, straight, true action. Every stallion guaranteed a foal getter. Every mare a breeder. List of prizes won: Sherbrooke and Ottawa on 16 head, 15 firsts, 6 seconds, 4 thirds, 3 fourths and 6 championships. This speaks stronger than words as to the quality of our stock. J. E. ARNOLD, GRENVILLE, QUEBEC. Grenville is midway between Montreal and Ottawa C. P. R. and C. N. R. Three trains run daily from each of these cities.

Imp. CLYDESDALES and PERCHERONS Imp. The Season is advancing, select your horse now. I can show you Clydesdale Stallions with size, quality, and breeding, second to none in Canada for about half the usual price, and the same in Percherons. T. J. Berry, Hensall, Ont., G.T.R., 'Phone.

Imported CLYDESDALE Stallions Yes, they are here, our 1914 importation, and if you want a big young stallion with the best legs, ankles, feet, action, breeding and character you ever saw at a price a poor man can pay, come and see our lot. BARBER BROS. Gatineau Pt., Quebec.

BREEDING AND QUALITY There never was a better bred lot imported, and their standard of character and quality is the highest and my price the lowest. Clydesdales G. A. Brodie, Newmarket, Ont. L.-D. Bell 'Phone

STALLIONS AND FILLIES Imported and Canadian-bred. With over 25 head to select from, I can supply, in either imported or Canadian-bred, brood mares, fillies, stallions and colts. Let me know your wants. L.-D. 'phone. R. B. Pinkerton, Essex, Ontario.

CLYDESDALES, IMPORTED STALLIONS AND FILLIES In the modern Clydesdale there must be big size, draft character, quality at the ground, and straight clean action. Come and see what I have with the above requisites in both Stallions and Fillies, also one French Coach Stallion. JAMES TORRANCE, MARKHAM, ONT., G. T. R.; LOCUST HILL, C. P. R.

Imp. Stallions CLYDESDALES Fillies Imp. To the Clydesdale men of Canada we wish to say we have some of the best show material in this country. More size, more style, more quality, more character and better breeding than ever before, in both stallions and fillies. JOHN A. BOAG & SON, Queensville, Ont. Electric cars every hour.

### Questions and Answers. Veterinary.

**Fatality in Sow.** Sow farrowed nine pigs on February 12th last. At five weeks old the pigs not doing well I took all but two from the sow. Next day, one of these having been hurt, we took it to the house. In the afternoon the sow went to her bed as usual, and at 4 o'clock was nursing the pig, and at 6 o'clock she was dead. A post-mortem revealed two patches about the size of quarters of a dollar on her lungs, and one-half of the liver was diseased. G. R. Ans.—She had tuberculosis, for which nothing could have been done. V.

**Canine Distemper.** Female Fox Terrier took sick on Sunday night. She held her head back, tried to yawn, but could not open her mouth wide. On Monday she would thrust both feet into her mouth as if suffering from tooth ache. She seemed to have a cold. On Tuesday the cold seemed worse, and she was not able to bark. On Wednesday she could not close her mouth, and vomited a greenish fluid. She seemed hungry and thirsty, but could not swallow. On Thursday she was blind in one eye, and was getting worse in every way. I gave her castor oil and Electric oil, and rubbed her neck with turpentine and duck oil. Thursday night she went to sleep. On Friday she slept most of the time, but got up twice and tried to drink, but was unable to swallow. She died on Friday night. A. M.

Ans.—This was an attack of canine distemper, which involved the brain in the early stages, which accounts for the inability to use the mouth properly, to bark or swallow. Such cases usually end fatally. A veterinarian might have been able to treat successfully by the use of antitoxins, especially prepared for the treatment of this disease. V.

### Gossip.

**"THISTLE HA" FARM.** One of the oldest stock farms in the Dominion, and one well known wherever Shorthorn cattle and Shropshire sheep are popular, the "Thistle Ha" Farm, for considerably over half a century, has been the recognized home of the highest standard in Shorthorns and Shropshires. John Miller, Sr., the former owner of this noted farm, and the pioneer importer and breeder of Shorthorns in Canada, at his decease, left a fame for himself and "Thistle Ha" equalled by few men this continent has known, and in the present owner, John Miller, a worthy son of a noble sire, he left one fully qualified to continue his life's work on the same high standard and honorable method that characterized the name-making of this famous farm. Pure Scotch, imported and Canadian-bred, the Shorthorn herd of to-day is up to a high standard in excessive fleshing qualities, representing on blood lines such famous tribes as the Cruickshank Village, Lady Joyce, Lady Madge, Cruickshank Bessie and Clementinas, the get of such noted sires as Imp. Diamond Cross; the \$1,425 bull, Langford Eclipse (imp.); Royal Prince (imp.), and the great sire, Uppermill Omega (imp.). Among the heifers are much choice show material, low, thick, with splendid quality and breed character. In young bulls there is only one left, a red, ten months old, sired by the Broadhocks bull, Imp. Diamond Cross, out of a Village dam, by Imp. Langford Eclipse. This is right royal breeding, and his splendid type shows it. A solid red, he has all the appearance of a coming show bull of a high standard. The quality of the large flock of Shropshires was never higher than now, totalling about an even 100. The large importation of last year are now lambing, and the 40-odd now growing nicely are a most uniform lot. The sex complexion of the flock are, 21 of last year's importation, shearing ewes; 30 Canadian-bred shearing ewes, bred from imported stock; 30 shearing rams Canadian-bred; 5 imported rams rising two years; balance imported ewes. Parties wanting Shropshires of the highest standard of the breed can get their wants supplied in this flock.

### Horse Owners! Use GOMBAULT'S Caustic Balsam

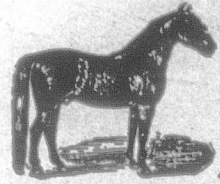

A Safe, Speedy, and Positive Cure. The safest, Best BLISTER ever used. Takes the place of all liniments for mild or severe action. Removes all Bunches or Blemishes from Horses and Cattle. SUPERSEDES ALL CAUTERY OR FIRING. Impossible to produce cure or blemish. Every bottle sold is warranted to give satisfaction. Price \$1.50 per bottle. Sold by druggists, or sent by express, charges paid, with full directions for its use. Send for descriptive circulars. The Lawrence-Williams Co., Toronto, Ont.

### SAVE-THE-HORSE

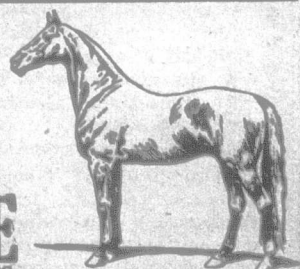

TRADE MARK REG. GO RIGHT AT IT! Cure The Horse While He Works. This remedy is positive. It is the humane treatment for sore, lame and blemished horses. It goes through and through both bone and tissue—it works inside, not outside. And Produces a Cure That Withstands Every Test. No Scar or Loss of Hair. Horse can work as usual. J. M. Green & Sons, Limited, City Planning Mills, St. Thomas, Ontario, writes: Troy Chemical Co., Toronto, Ont., send one bottle of Save-The-Horse. We used a bottle on a large bone swelling on inside right hind leg of a horse, with great results. Mr. John Louth of Hamilton, Ont., writes: I had a horse with a splint and cured him with nine applications of Save-The-Horse. Mr. Gordon J. Gillula of South Burston, Ont., writes: Regarding to the ring bone, I am well pleased, it has cured all lameness and the enlargement is reducing all the time.

We Originated the plan of treating Contract to Return Money if Remedy Fails on any case of SPAVIN, Ringbone, Thorpin and ALL Shoulder, Knee, Ankle, Hoof and Tendon Disease. WRITE, and we will send—Book, Sample, Contract and Advice—ALL FREE to Horse Owners and Managers only.

TROY CHEMICAL CO., 148 Von Horn Street, Toronto, Ont. (Also Binghamton, N. Y.) Druggists sell Save-The-Horse With Contract, or we send it by Parcel Post, Express Prepaid

### Horse and Cattle Breeders



ARTIFICIAL IMPREGNATORS With which we guarantee you can get 7 to 6 mares in foal from each service of your stallion or jack; impregnate irregular-breeding and so-called barren mares and cows, and increase your profits from your breeding operations. Prices, \$5 to \$5.00.

BREEDERS SUPPLIES A full line of Stallion Brides, Shields, Supports, Invigorating Tonic, Tooth Cutters, Forceps, Files, Floats, Extractors, Breeding Hobbles, Dehorers, Castrating Knives, Emasculators, Trocars, Syringes, Abortion Preventive, Stallion Service Books, etc. Write for our free 68-page Catalog and Price List which illustrates, describes and prices the above mentioned articles and dozens of other Breeders and Stock Owners Supplies. You can get first quality goods in this line from us at lower prices than you can get them from anyone else. BREEDERS SUPPLY CO., Dept. 3, Cleveland, Ohio, U.S.A.

### Become More Proficient and Increase Your Profits

### ABSORBINE

TRADE MARK REG. U.S. PAT. OFF. Removes Bursal Enlargements, Thickened, Swollen Tissues, Curbs, Filled Tendons, Soreness from any Bruise or Strain; Stops Spavin Lameness. Always pain. Does not blister, remove the hair or lay up the horse. \$2.00 a bottle, delivered. Book 1 K free. ABSORBINE, JR., the antiseptic liniment for manking. For Synovitis, Strains, Gouty or Rheumatic deposits, Swollen, Painful Varicose Veins. Will tell you more if you write. \$1 and \$2 per bottle at dealers or delivered. Manufactured only by W. F. YOUNG, P.O. Box 258, Lyman's Bldg., Montreal, Can.

### CANADIAN-BRED CLYDESDALE STALLIONS AND HOLSTEIN BULLS

One stallion; rising 3 years, a show horse; 3 stallions rising 2 years and 2 rising one year. Would trade one or two for Holsteins. Five bulls, under 7 months, from P.O.P. and R.O.M. dams, milking up to 84 lbs. per day and 16,000 lbs. in 11 months. A few points.

R. M. HOLTBY R.R. No. 4, Port Perry, Ont.; Manchester, G.T.R., and Myrtle, C.P.R. Bell 'Phone.



**No More Paint Trouble!**  
**Amatite ROOFING**

THE mineral surface of Amatite does away with the need of painting. Ordinary ready-roofing you know, needs painting about every two years.

The practical farmer counts maintenance with first cost in determining the value of a roof-covering, and he knows that two or three paintings cost as much as a new roofing.

Amatite costs no more than other roofings and the up-keep cost is nothing.

A helpful booklet—together with a sample of Amatite—is yours for the asking. Write today.

The Paterson Mfg. Co., Limited  
Montreal Toronto Winnipeg  
Vancouver St. John, N. B.  
Halifax, N. S. Sydney, N. S.

**FORTY YEARS REPUTATION**

is something that is of incalculable value.  
It is plain that we have to be just as careful of the quality of our goods now, to keep up that reputation, as we have been in building it.  
And that is your surest guarantee of the uniform excellence of—

**GUNNS SHUR CROP FERTILIZER**

We have an interesting book about fertilizers—it is yours for the asking.

Gunns Limited, West Toronto

**15.95 AND UPWARD ON TRIAL.**

**AMERICAN CREAM SEPARATOR**

A SOLID PROPOSITION, to send fully guaranteed, a new, well made, easy running, perfect skimming separator for \$15.95. Skims warm or cold milk; making heavy or light cream.

Absolutely on Approval.

The bowl is a sanitary marvel, easily cleaned. Different from this picture, which illustrates our large capacity machines. Shipments made promptly from WINNIPEG, MAN., TORONTO, ONT., and ST. JOHN, N. B. Whether your dairy is large or small, write for our handsome free catalog. Address: Box 1200

**AMERICAN SEPARATOR CO. BAINBRIDGE, N. Y.**

**CHURCH BELLS CHIMES AND PEALS**

MEMORIAL BELLS A SPECIALTY FULLY WARRANTED

**McSHANE BELL FOUNDRY CO., BALTIMORE, Md., U. S. A.**

Established 1856

**DR. BELL'S** Veterinary Medical Wonder. 10,000 \$1.00 bottles FREE to horsemen who will give The Wonder a fair trial. Guaranteed to cure Inflammation, Colic, Croup, Coughs, Distemper, Fevers, etc. Agents wanted.

**DR. BELL, V. S., Kingston, Ont.**

**Gossip.**

**SUNNYSIDE CHESTER WHITES.**  
W. E. Wright & Son, of Glanworth, Ont., are again to the front this spring with an extra nice offering of young boars and sows, bred from their well-known herd of Toronto, London and Guelph prizewinners and champions. For many years past this herd has maintained their place for high-class quality and type as second to no other herd in Canada, and what is of particular interest to intending purchasers of Chester White swine, is the fact that W. E. Wright & Son, from the thousands of pigs they have shipped from one end of Canada to the other, have never been credited with misrepresentation, nor shipping an inferior animal. Write your wants, and trust them to do the right thing.

**HAMILTON FARM HOLSTEINS.**  
About three miles from either Niagara Falls or Thorold, on the Niagara Falls-Thorold Electric Railway, lies the 1,000-acre stock farm known as the Hamilton Farm, and owned by F. Hamilton, of St. Catharines, Ont. This is one of the many large stock farms in Canada, owned and operated by business men on business principles. A few years ago, when the idea of operating this farm himself became a settled matter in the mind of Mr. Hamilton, he decided on milk production as his source of revenue for operating expenses, and after mature deliberation, was convinced that Holsteins were best adapted to his needs, as they were not only heavy producers of milk, but the breed's ever-increasing popularity created an active demand for the herd's natural annual increase, at remunerative prices, thus, in a sense, doubling the annual revenue over what would be received from a grade herd. The founding of this great herd, of upwards of a hundred head as it is at present, was where business ability showed itself over haphazard methods. Richly-bred animals, with high official-record backing, coupled with individual merit, was the order of purchase, and the remarkable uniformity and levelness of line, typical wedge-shaped type, with large, well-balanced udders so universal in the long rows of cows as they are lined up in the commodious stables, is of a standard seldom seen. A few of the sire's represented in the herd are, Prince Beauty Pietertje Hartog, with forty A. R. O. daughters; Bonheur Statesman, with sixteen A. R. O. daughters; Prince Posch Calamity, with seventeen daughters and five sons in the R. O. M.; King Lyons Colantha, whose six nearest dams' records average 27.98 lbs.; Sir Lyons Hengerveld Segis, a son of the great King Segis, and out of a 33.31-lb. dam; Count Hengerveld Payne De Kol, whose sire has over 100 daughters in the list, eight of them over 30 lbs. each; Correct Change, whose sire has over forty A. R. O. daughters and who is full of 100-lb.-a-day blood, and many others of equal breeding. Official records of the herd range from 16.78 for junior two-year-olds; 23.03 for senior two-year-olds; 19.46 for three-year-olds, to 27 lbs. for adults, and count among their number Canadian champions at leading shows. The principal sire in use is Prince Hengerveld of the Pontiacs, a grandson of the great Pontiac Korndyke, and a son of the famous sire, King of the Pontiacs. His dam is a daughter of Pietertje Hengerveld Count De Kol, with ninety-eight A. R. O. daughters, thirteen of them over 100 lbs. a day milk production. Assisting this great bull in service is Sir Korndyke Topsy De Kol, a son of Pontiac Korndyke Hengerveld De Kol, a full brother to King of the Pontiacs. His dam is a 23-lb. daughter of Korndyke Queen De Kol's Prince, with fifty-four A. R. O. daughters. Richly-bred young stock are always for sale.

A Canadian, wishing to know his fate at once, telegraphed a proposal of marriage to the lady of his choice. After spending the entire day at the telegraph office, he was finally rewarded late in the evening by an affirmative answer. "If I were you," suggested the operator, "I'd think twice before I'd marry a girl that kept me waiting all day for my answer."  
"No, no," retorted the man. "The girl who waits for the night rates is the girl for me."

**International Harvester Cream Separators**

**THE I H C LINE GRAIN AND HAY MACHINES**  
Binders, Reapers  
Headers, Mowers  
Rakes, Stackers  
Hay Loaders  
Hay Presses  
**CORN MACHINES**  
Planters, Pickers  
Binders, Cultivators  
Earling Cutters  
Shellers, Shredgers  
**TILLAGE**  
Combination,  
Fog and Spring-Tooth,  
and Disk Harrows  
Calibrators  
**GENERAL LINE**  
Oil and Gas Engines  
Oil Tractors  
Manure Spreaders  
Cream Separators  
Farm Wagons  
Motor Trucks  
Thrashers  
Grain Drills  
Feed Grinders  
Knife Grinders  
Binder Twine

**PIGS and calves thrive and grow fat when fed with warm, skim milk. You cannot get warm skim milk to feed them unless there is a cream separator on your farm. There is money enough in this one advantage to pay for a cream separator the first year. This is specially true if you buy a close skimming, durable International Harvester cream separator—Lily, Bluebell or Dairymaid.**

These separators have all the points which make cream separators good. They have the balanced bowl, the self-adjusting neck bearing, the tool steel spindles, the bronze bushings, the spiral gears, the low supply can, the high skim milk spout, and the open, sanitary base, without which no separator can be satisfactory.

Some dealer near you handles I H C separators. If you do not know, write us and we will tell you who he is. We will also send you our cream separator book which tells you why it pays so well to buy an I H C separator.

**International Harvester Company of Canada, Ltd**  
At Hamilton, Ont.; London, Ont.; Montreal, P. Q.; Ottawa, Ont.;  
St. John, N. B.; Quebec, P. Q.

**Raise Better Calves at Less Expense, with**

**Royal Purple CALF MEAL**

It is no longer necessary or even advisable to give your whole milk to calves. Use ROYAL PURPLE Calf Meal and get the good price for your whole milk that it will bring. ROYAL PURPLE Calf Meal is entirely different from most others, because it is partly pre-digested. The ingredients which are hard to digest are roasted to render them easy of assimilation by the calves. The roasting also causes the grains to shrink over one-third, so that in using ROYAL PURPLE Calf Meal you are using a concentrated meal, containing pound for pound, more value than others. Equal to new milk at 5 cents a gallon.

or write us direct. Also inquire about our club plan, whereby you can secure 100 pounds of ROYAL PURPLE Calf Meal for best cost raised in your district.

**ROYAL PURPLE CHICK MEAL** Solves the problem of what to feed young chicks to get best results. ROYAL PURPLE Chick Meal is just right, neither too coarse nor too fine. The ingredients hard to digest are partly roasted. No losses of chicks through indigestion when you use this splendid meal. If your dealer hasn't it, write us direct. Fifty per cent of the young chicks that die do so from indigestion due to improper feeding.

To raise fowl successfully you should have our poultry remedies, especially our Roup Cure. There is no reason why you should lose any of your young chicks or turkeys from disease. We will send, absolutely free, one of our 80-page booklets on the common diseases of stock and poultry and how to treat them.

**SPECIAL \$50 PRIZE OFFER.**  
We offer \$50 cash prize for the best calf raised in Ontario on our ROYAL PURPLE Meal, weight for age, shipped to us for the Toronto Exhibition. This calf will be shown in our exhibit, and after the exhibition is over will be returned to the successful contestant. Ask your dealer for full particulars.

We will send 100 lbs. Calf Meal Freight Paid for \$4.25

**W. A. Jenkins Mfg. Co. London, Canada**

**Elm Park Aberdeen-Angus and Clydes**

We have for sale a few two-year-old heifers by imported bulls and out of imp. cows bred to good bulls. We also have 3 three-year-old Clydesdale fillies, 2 two-year-old fillies and 2 yearling stallions. Five of them out of Lord Charming mares by King Seal, imp. Address: JAMES BOWMAN, Elm Park, Guelph.

**"THE AULD HERD"**

We have a select lot of females of all ages, and of the best Scotch families for sale. Also a March bull calf, red, little white, an Orange Blossom by Broadhooks Ringleader.

**A. F. & G. AULD, Eden Mills, P.O. Guelph or Rockwood Stations**

**R. O. P. SHORTHORNS - R. O. P. JERSEYS**

For the first time we are offering for sale Shorthorn cows and heifers, and Jersey cows and heifers with official R. O. P. records, with their official records is high-class individuality.

**G. A. JACKSON, DOWNSVIEW POST OFFICE. WESTON STATION.**

**Maple Grange Shorthorns**

Pure Scotch and Scotch topped. Breeding unsurpassed. A nice selection in young bulls, and a limited number of thick, mossy heifers.

**R. J. DOYLE, Owen Sound, Ont.**

Questions and Answers. Miscellaneous.

Lines and Eveners for Three Horses.

Will you please publish in your valuable paper a cut showing a three-horse evener, suitable for plow or disk harrow. Also the lines for driving three horses. D. H. C.

Ans.—For about the hundredth time we are reproducing illustrations of these devices. Readers should keep their papers and have them for reference.



Lines for a three-horse team.

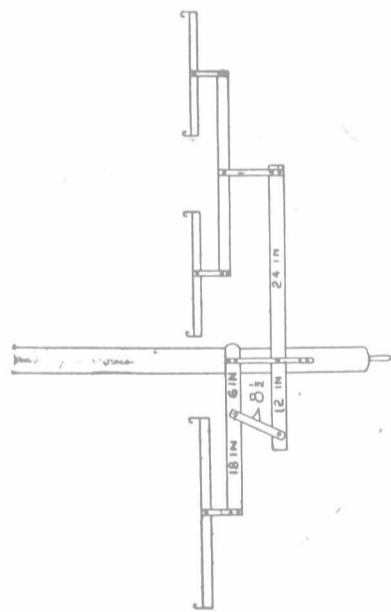

Three horse eveners.

Selling Good Cows Cheap.

The following is a sample of what is discovered by the simple weighing of milk and testing of samples. A four-year-old cow gave in one month 920 pounds of milk containing 35 pounds of fat. In the same herd, a five-year-old gave only 830 pounds of milk and 19 pounds of fat.

This further fact is interesting: This particular cow was sold by a man absolutely ignorant of her value or dairy capacity. The present owner, through keeping individual records, knows her better, and would not sell her for less than thirty dollars more than he paid for her.

Another fact is worth careful attention: The total of the herd yield for a day or a month will never reveal these good individuals. What the owner needs to know for certain is obtained only from a record of each cow he keeps. You can save labor and good feed by following them on cows that you know are worth keeping; you will then be in a position to keep your best cows, and will not lose money by selling good cows cheap. C. F. W.

# Planet Jr.



**No. 16** Planet Jr. Single Wheel Hoe, Cultivator, Rake and Plow

The highest type of Single Wheel Hoe made. It is light, handy, and adapted to almost every garden use. Has leaf guard for close work, and a durable steel frame. Light enough for a woman to use.

The up-to-the-minute time and labor savers in field and garden. Planet Jr implements are the product of more than 40 years' experience of a practical farmer and manufacturer. Get them for scientific work and big results. \$2 to \$100. **FREE** Our new 72-page illustrated catalogue contains valuable advice about tools for each kind of cultivation. Write postal today.

**S. L. ALLEN & CO**  
Box 1108F Philadelphia  
Write for the name of our nearest agency



**No. 11** Planet Jr. Double Wheel Hoe, Cultivator, Plow and Rake

The greatest cultivating tool in the world for the grower of garden crops from drilled seeds. The plow opens furrows for manure, seed, etc., and can be reversed for covering. Crops can be worked both sides at once until 20 inches high. Steel frame. Just the tool for the onion-grower.



**No. 25** Planet Jr. Combined Hill and Drill Seeder, Double Wheel Hoe, Cultivator and Plow

A capital implement for large-scale gardening especially. It has automatic feed-stopper, seed index, and complete cultivating attachments. The hoes are of a special patented form which run close to row without danger to leaves or roots. Steel frame. Two acres a day can be easily worked with this tool.



**No. 8** Planet Jr. Horse Hoe and Cultivator

The best-known cultivating implement made. It is so strongly built that it withstands incredible strain, yet it is light and easy to handle. Has new steel wheel which prevents clogging with stones and other trash. Cultivates to any depth and adjusts to any width. Opens and closes furrow, and hoes right up to plants without danger of injuring them.



**Fire-Fly Garden Plow**

Especially useful to owners of small gardens, and to chicken-raisers for plowing up scratching yards. Its light weight makes it easy for women or children to use also. Enables the owner of a family garden to do all the work in spare minutes.

## Home-grown and Tested Seeds

Remember: BEST SEEDS—BEST CROPS

SPECIAL OFFER! Order Our Famous Special Collections:

Farm Garden Collection D.—31 selected varieties, \$1 postpaid. One packet each of Beans (wax), Beans (green podded), Corn (early sugar), Peas (early garden), Beets (early round), Cabbage (early), Carrot (garden), Cauliflower, Cucumber, Lettuce (early head), Lettuce (curled), Onion (large yellow), Musk Melon (early), Parsnip, Parsley (curled), Pumpkin (sugar), Radish (French Breakfast), Radish (White Icicle), Tomato (early), Turnip (table variety), Marjoram, Sage, Savory, Spinach, Thyme, Mangel ("Our Ideal") and five selected Flower Seeds including Aster.

Trial Collection E.—17 selected varieties, 50c. postpaid.  
Children's Collection F.—13 selected varieties 25c. postpaid.

### Ontario Seed Company Successors, Waterloo, Ontario

Our Hurst Sprayers are the best. Ask for Catalogue

### SHORTHORNS

I have ten young Shorthorn bulls, some fit for service now. Part of them are bred, and made so that they are fit to head the best herds in any country, some of them are of the thick, straight, good-feeding kind, that will produce money-making cattle; some of them are bred from the best-milking Shorthorns, and the prices of all are moderate. I have SHROPSHIRE and COTSWOLD rams and ewes of all valuable ages. Write for what you want. **Robert Miller, Stouffville, Ont.** I can suit you in quality and price.

### Shorthorn Bulls FOR SALE

From one up to one hundred head of Shorthorn bulls for sale ranging from 6 months up to 3 years old. Car loads a specialty. Ship to any place in Canada or U. S. **T. L. MERCER, MARKDALE, ONTARIO**

### SALEM SHORTHORNS

Herd headed by Gainford Ideal, and Gainford Perfection, sons of the great Gainford Marquis. We are generally in shape to supply your wants in either sex. **J. A. WATT, Elora, G. T. R., C. P. R.** Telephone and Telegraph.

### Sprucedale Stock Farm

We are now booking orders for LEICESTER LAMBS of either sex. **A. Watson & Sons, St Thomas, Ont.** Breeders of Clydesdales and Hackneys. Holstein Cattle and Yorkshire Swine

### Glenallen Shorthorns

We have some of the best young bulls we ever bred, Scotch or Booth breeding, low, thick, mellow fellows of high quality, also some heifers. **GLENALLEN FARM, ALLANDALE, ONTARIO.** R. Moore, Manager.

### Shorthorns and Clydesdales

5 bulls of serviceable age, choice quality some of them herd headers, sired by His Grace (Imp.) = 69740 = and a number of cows and heifers. One stallion rising 3-year-old. A big, good-quality horse; also four choice fillies. All from imported stock. **A. B. & T. W. DOUGLAS, STRATHROY, ONT. L. D. phone.**

### SHORTHORNS

Our present offering consists of Nonpareil Lord = 87184 = Dam Imp. Dalmeny Nonpareil 6th. 7 young bulls from 6 to 12 months old. 15 cows and heifers of choicest quality and breeding. **A. J. HOWDEN & CO., COLUMBUS, ONTARIO.** Myrtle. C. P. R. and G. T. R. Long-distance phone.

### Springhurst Shorthorns

Shorthorn cattle have come to their own; the demand and prices are rapidly increasing; now is the time to strengthen your herd. I have over a dozen heifers, from 10 months to two years of age, for sale; every one of them a show heifer, and some of them very choice. Bred in my great prize-winning strains. Only one bull left—a red, 18 months old. **HARRY SMITH, EXETER STN. HAY P. O.**

### Potato Profits

depend largely on how the crop is planted. Every skipped hill is a loss in time, fertilizer and soil. Every double wastes valuable seed. It means \$5 to \$30 per acre extra profit if all hills are planted, one piece in each. That is why

## IRON AGE 100 Per Cent Planters

often pay for themselves in one season on small acreage. They also plant straight, at right depth, 12 to 24 inches apart. With or without fertilizer distributor. Ask your dealer to show you this Planter and write us for booklet, "100 Per Cent Potato Planting" and copy of Iron Age Farm and Garden News.

The Bateman-Wilkinson Co., Ltd. 415 Bymington Ave., Toronto, Ont.

### HEREFORD BULLS

FROM IMPORTED STOCK  
Six heifers, one bull.  
**A. S. HUNTER & SON, Warrham, Ont.**

### Good Shorthorn Bulls

not all sold. I have 2 roams, 17 and 12 months respectively; a dark red, 12 months; a white, 11 months; a red roan, 10 months; all straight, smooth, wide, fleshy, strong-boned bulls, showing breed character; some from heavy-milking dams; also five yearling heifers. Priced on easy terms for quick sale.  
**STEWART M. GRAHAM, Lindsay, Ontario**

### THE MANOR Shorthorns and Lincolns

Bulls and rams all sold; a few females for sale. Inspection solicited.  
**J. T. GIBSON :: Denfield, Ontario**

## Scratches and Stocking

—Are prevalent in cold weather irregular work and overfed induces both. A system tonic and blood purifier, such as Fleming's Tonic Heave Remedy will prevent these troubles and when developed, with Fleming's Veterinary Healing Oil quickly cure them. Per. Box \$1.00

Fleming's Tonic Heave Remedy

Write us for a Free Copy FLEMING'S VEST POCKET VETERINARY ADVISER

FLEMING BROS., Chemists 75 Church St. Toronto

## Calves Without Milk

### BLATCHFORD'S CALF MEAL

The Complete Milk Substitute

The result of over 100 years' experience with calf-raisers. The only Calf Meal made in an exclusive Calf Meal Factory. As rich as new milk at less than half the cost. Makes rapid growth. Stops scouring. Three calves can be raised on it at the cost of one. Get Bulletin, "How to Raise Calves Cheaply and Successfully Without Milk" by sending a postcard to

Steele, Briggs Seed Co., Toronto Ontario



## Hay & Straw

All kinds bought outright or handled on Commission. Write at once stating grade, quality, quantity and when you could make shipment.

CRAMPSEY & KELLY, Dovercourt Road, TORONTO, ONT.

## SHORTHORNS

Bulls all sold, choice females for sale. 1 yearling Clyde stallion, 1 weanling Clyde stallion, big, best quality and breeding.

John Clancy, Manager, Cargill Limited, Cargill, Ont., Proprietors.

## GLENGOW SHORTHORNS

Still have a few choice bull calves, and several real nice heifers of different ages.

WM. SMITH, Columbus, Ont.

## Woodholme Shorthorns

I have a few more Scotch Bulls, of the low set thick kind, breeding unsurpassed, left for sale; among others a 10 month's, out of Imp. sire and dam, a herd header of the right kind. Write me your wants

G. M. Forsyth, North Claremont, Ont.

## FLETCHER'S SHORTHORNS

Present offering 6 choice bulls, suitable for high-class herd headers, 6 to 11 months, and females all ages. Present stock bull "Royal Bruce" (Imp.) = 55038 = George D. Fletcher, R. R. No. 2, Erin, Ont. Erin Station, C.P.R. Long Distance Phone

## "OAKLAND" SHORTHORNS

50 head of good individuals to select from, 26 breeding females, headed by a fine roan 1st prize and sweepstakes bull. Just three bulls fit for service, all of high quality, and priced to sell. Dual-purpose a specialty.

John Elder & Sons, Hensall, Ontario

## Spring Valley Shorthorns

Herd headed by the two great breeding bulls, Newton Ringleader (Imp.) 73783, and Nonpariel Ramsden 83422. Can supply a few of either sex.

KYLE BROS., Drumbo, Ontario Phone and Telegraph via Ayr.

## Shorthorns "Trout Creek Wonder"

at the head of the herd which numbers about 40 head. Heifers and bulls of the best quality for sale at reasonable prices.

Duncan Brown & Sons, RR 2, Shedden

## Shorthorns and Swine

—Have some choice young bulls for sale; also cows and heifers of show material, some with calves at foot. Also choice Yorkshire sows.

ANDREW GROFF, R. R. No. 1, Elora, Ont.

### Questions and Answers. Miscellaneous.

#### Sawing Logs.

If a farmer draws in logs to a saw-mill to get them sawed into lumber at so much per thousand, and pay the mill-man, say, \$4 for sawing one thousand feet, can he draw the slabs home, or can the mill-man cut the slabs up and sell them for wood? J. A. B.

Ans.—According to usual custom, the man who does the sawing gets the slabs.

#### Draining Clay.

I have fifty acres about one and a half miles east of Beamsville; very hard clay, with perhaps about twelve inches loam on top, very flat, which I would like underdrained. The tenant on the farm tells me that they will not drain in the soil on account of its clay nature, but I am told in some parts they are using cedar plank put up edgewise, leaving bottom of drain soil. Could you give me any information about this kind of a drain, as there is not much fall to carry off the water. The plank could be put within eighteen inches of the surface all right. G. H. H.

Ans.—In very heavy clay soil, it is advisable to place the drains not more than 50 or 60 feet apart, and do not put them in too deep. Not more than 2½ feet, and perhaps 2 feet in some places. Tile would be, in the end, more satisfactory than cedar, and would not be as costly.

#### Lawn Alfalfa and Unthrifty Cow.

1. Can you advise me what to do for a lawn where the grass is nearly choked out by moss?

2. Is it best to pasture a newly-seeded field of alfalfa or cut it for hay?

3. What would be best in the line of medicine to give a cow I am fattening that seems not to be gaining, keeps poor and unthrifty, does not gain like the others that get the same food, and oblige? D. P.

Ans.—1. Moss gets into a lawn sometimes by reason of the fact that the lawn is over-watered, but in your case we do not suppose that this is so. It might be advisable to plough up the lawn and reseed it.

2. It is not generally conceded to be good practice to pasture alfalfa, at least not very closely, better results generally come from cutting it for hay.

3. Are you sure your cow is healthy and is not troubled with lice? Give her a little oil-cake meal along with the other feed. It may be that her system needs a cleaning out. If you think it necessary give a dose of Epsom salts.

#### Scours.

I have had trouble with my calves. As soon as they are born they start to scour, and we have tried several cures but with no relief. They die in two or three days; the third one is sick now. We have no hopes of raising any, as they are dying as they come. We were thinking it might be in the feed, that the cows are getting. They are fed on silage, good oat straw, and oat chop. Please advise in your paper what is the trouble, and what to do.

A SUBSCRIBER.

Ans.—This is a case of contagious scours. The germs causing the disease gain entrance to the system through the torn and raw surface of the new-born calf's navel string. It affects calves from a few hours old to a few days old, but in some cases they live for several days, and after the illness eventually die of pneumonia. The disease is very often coincident with an outbreak of contagious abortion. The germs thrive in the absence of light and in moisture. Wash the navel of each newly-born calf in a solution of 1 part formalin to 10 of water. Give internally a little formalin in milk. For this, dissolve one-half ounce of formalin in 15½ ounces of water and add one teaspoonful of this liquid to each pound of milk fed the calf. Keep everything clean.

Jim—You get plenty of cream at your boarding-house?

John—And such milk. I say, cream isn't in it!

## Get The Best Fence At The Lowest Prices DIRECT FROM PAGE (FREIGHT PREPAID)

### HEAVY FENCE

No. of bars.	Height inches.	Uprights apart.	No. 9 Page Wire Throughout in 20, 30 and 40 Rod Rolls, Freight Paid.	PRICES		
				Spacing of Horizontals in Inches.	Old Ont. per rod.	New Ont. and Que. Prov.
4	30	22	10, 10, 10	\$0.16	\$0.18	\$0.19
5	37	22	8, 9, 10, 10	.18	.20	.21
6	40	22	6½, 7, 8½, 9, 9	.21	.23	.24
7	40	22	5, 5½, 7, 7, 7½, 8	.23	.25	.26
7	48	22	5, 6½, 7½, 9, 10, 10	.23	.25	.26
8	42	22	6, 6, 6, 6, 6, 6, 6	.26	.28	.29
8	42	16½	6, 6, 6, 6, 6, 6, 6	.28	.30	.31
8	47	22	4, 5, 5½, 7, 8½, 9, 9	.26	.28	.29
8	47	16½	4, 5, 5½, 7, 8½, 9, 9	.29		
9	48	22	6, 6, 6, 6, 6, 6, 6	.29	.31	.32
9	48	16½	6, 6, 6, 6, 6, 6, 6	.31	.33	
9	51	22	4, 4, 5, 5½, 7, 8½, 9, 9	.29	.31	
9	51	16½	4, 4, 5, 5½, 7, 8½, 9, 9	.31		
10	48	22	3, 3, 3, 4, 5½, 7, 7, 7½, 8	.31	.33	
10	48	16½	3, 3, 3, 4, 5½, 7, 7, 7½, 8	.33		
10	51	16½	3, 3, 3, 4, 5½, 7, 8½, 9, 9	.33		
10	51	22	3, 3, 3, 4, 5½, 7, 8½, 9, 9	.31	.33	
11	55	16½	3, 3, 3, 3, 4, 5½, 7, 8½, 9, 9	.36		

### MEDIUM WEIGHT FENCE

No. 9 Top and Bottom, and No. 12 High Carbon Horizontals between; No. 12 Uprights; No. 11 Locks (Maritime Provinces prices of Medium Weight and Special Poultry Fences include painting.)

5	36	16½	8, 8, 10, 10	\$0.18	\$0.19	\$0.22
6	36	16½	6, 7, 7, 8, 8	.20	.21	.24
6	42	16½	7, 7, 8, 10, 10	.20	.21	.24
7	42	16½	6, 6, 7, 7, 8, 8	.22	.24	.27
7	26	8	3, 3, 4, 5, 5, 6	.23	.25	.28
8	48	16½	4, 5, 6, 7, 8, 9, 9	.26	.28	.31
9	36	12	3, 3, 3, 4, 5, 6, 6, 6	.27	.29	.32
9	50	16½	3, 4, 5, 6, 7, 8, 9, 9	.28	.30	.33
10	54	16½	3, 3, 4, 5, 6, 7, 8, 9, 9	.30	.32	.35

### SPECIAL POULTRY FENCING

No. 9 Top and Bottom. Intermediates No. 13. Uprights 8 inches apart.

18	48	8	Close bars	\$0.42	\$0.44	\$0.46
20	60	8	Close bars	.47	.49	.52

### PAGE "RAILROAD" GATES

48	10-ft. op'ng	\$3.80	\$4.00	\$4.00
48	12-ft. op'ng	4.00	4.20	4.20
48	13-ft. op'ng	4.25	4.45	4.45
48	14-ft. op'ng	4.50	4.75	4.75

WALK GATE, 48 in. high, 3½ ft. opening . . . . . 2.35 2.35 2.35  
 STAPLES, 25-lb. box . . . . . .75 .80 .85  
 BRACE WIRE, 25-lb. rolls . . . . . .70 .75 .80  
 STRETCHING TOOLS, Complete outfit . . . . . 8.00 8.50 9.00

### PAGE WIRE FENCE CO., LTD.

Mail Your Order with Cash Money Order, Express Order, or Personal Check to our nearest branch.

TORONTO 1140 King St., W.  
 ST. JOHN 42 Dock St.  
 MONTREAL 508 Notre Dame St., W.  
 WALKERVILLE 88 Church St.  
 WINNIPEG  
 A. J. McMillan, 101 James St., E.

WRITE FOR 80-PAGE FREE CATALOG

## "PAGE FENCES WEAR BEST"

## Shorthorns & Clydesdales

We have seven yearling bulls and seven bull calves from 7 to 12 months. All reds and roans, and of choice breeding. We have some extra good imported mares, for sale also some foals. If interested write for catalogue of their breeding.

W. G. PETTIT & SONS, Burlington Junction, G. T. R. FREEMAN, ONTARIO Bell Phone.

## 100 SHORTHORNS IN OUR HERD 100

Our 1913 crop of 22 bulls are all sold, we have 20 extra bull calves coming on for the fall trade. For Sale—25 heifers and young cows; these old enough are bred to Right Sort (Imp.), or Raphael (Imp.), both prize winners at Toronto last fall.

MITCHELL BROS. Farm ¼ mile from Burlington Junction. BURLINGTON, ONT

## Poplar Shorthorns

We have the best lot of young bulls for sale this spring we have ever bred, reds and roans, 10 to 18 months of age, Butterflies, Roan Ladies, Lavenders and Lovelies, all sired by the great Uppermill Omega Imp. Strictly high-class herd headers

MILLER BROS. CLAREMONT STATION, C.P.R. BROUGHAM, ONT.

## SHORTHORN BULLS FOR SALE

Eight head, from 10 to 18 months, bred from cows which are from imported duns and sired by choice bred bulls. Prices are not high, as I need the space for stabling cattle. Shropshire and Cotswold ewes bred to imported rams.

BLAIRGOWRIE FARM JOHN MILLER, JR., Ashburn, Ontario

## Willow Bank Stock Farm Shorthorns and Leicester Sheep.

Herd established 1855; Bock 1848. The imported Guickshank Butterfly Roan Chief = 69865 = heads the herd. Young stock of both sexes to offer. Also an extra good lot of Leicester sheep of either sex; some from imported sires and dams.

James Douglas, Caledonia, Ontario

## Brampton Jerseys

We are doing the largest business we ever did, chiefly with our old customers. Young bulls and heifers from sires with tested daughters. Several imported cows and bulls for sale. Canada's Greatest Jersey Herd

B. H. Bull & Son, Brampton, Ont.





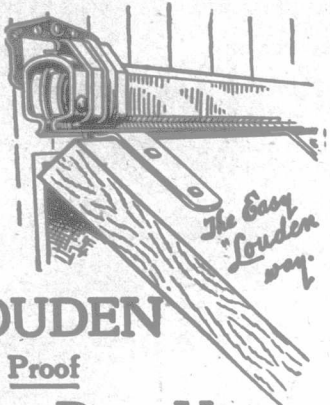

**Get this LOUDEN Bird Proof Barn Door Hanger**

and have the barn door hang and run right for all time. This is positively the finest Barn Door Hanger on the market. As its name implies birds cannot build in the track. The track is hollow with closed ends. No ice or snow in winter or trash in summer can possibly get in to clog it. Runs on two strongly braced trolley wheels always smooth and easy running. Hinged so as to make it flexible and to allow the door to swing outwards and upwards if occasion requires.

**Ask for the Louden Line**

—over 47 years of experience and practical experiments go to make Louden goods efficient and reliable. We make

**"Everything for the Barn"**

including Cow Stalls, Stanchions, Litter and Feed Cans, Hay Forks and Slings.

Write for our new Catalogue.

**The LOUDEN MACHINERY CO.**  
Dept. 41 - GUELPH, Ont. 4

**EVENTUALLY—WHY NOT NOW?**

USE  
**Rice's Pure Salt**  
IT WILL PAY YOU  
NORTH AMERICAN CHEMICAL CO., LTD.  
Clinton, Ontario

**CATTLE AND SHEEP LABELS**

Size	Price dos.	Fifty tags
Cattle . . . . .	75c.	\$2.00
Light Cattle	60c.	1.50
Sheep or hog	40c.	1.00

No postage or duty to pay. Cattle sizes with name and address and numbers; sheep or hog size, name and numbers. Get your neighbors to order with you and get better rate. Circular and sample mailed free.

**F. G. James, Bowmanville, Ontario**

**Alloway Lodge Stock Farm**  
Aberdeen-Angus Cattle  
Southdown Sheep  
Collie Dogs

Four litters sired by Imp. Holyrood Marquis are expected shortly, three of them from imported Mitches. Order now if you wish to secure a choice pup.

**ROBT. McEWEN,**  
Near London - Byron, Ontario

**OXFORD DOWN SHEEP**

We have the champion Oxford Flock of America. Winners at Chicago International, Toronto, London, Winnipeg, Regina, Brandon and Saskatoon Fairs. Present offering: 100 ram and ewe lambs, and 50 yearling ewes by imported rams. Consult us before buying.

**Peter Arkell & Sons, Teeswater, Ont.**

**TAMWORTHS**

We are now booking orders for Spring pigs, also can supply White Wyandotte settings \$1.00 per 13.

**Herbert German : St. George, Ontario**

**MORRISTON SHORTHORNS & TAMWORTHS**

Bred from the prize-winning herds of England. Have twelve young sows bred to farrow in June, dandies, and twenty young boars fit for service; also some choice cows and heifers of the best milking strain.

**CHAS. CURRIE, Morriston, Ont.**

**TAMWORTHS**—Some choice young sows, bred, for April and May farrow; also a few boars. Write for particulars.

**JOHN W. TODD**  
R. R. No. 1 - Corinth, Ontario

**Cloverdale Large English Berkshires**

No matter what your needs in Berkshires may be see Lang the live Berkshire man. He is always prepared to furnish anything in Berkshires. Write or come and inspect.

**C. J. LANG,**  
Hampton, Ont., Durham Co.

**Hampshire Swine**

I have a choice lot of Hampshire belted hogs for sale. Will be pleased to hear from you, and give you description and prices.

**J. H. Rutherford, Box 62, Caledon East, Ont.**

**Sunnyside, Chester Whites**

Last fall and winter shows, champions, male and female, as well as many lesser winners, are now breeding in our herd; young stock, both sexes, any age.

**W. L. Wright & Son, Glanworth, Ont.**

**Questions and Answers, Miscellaneous.**

**Repairing Cracked Troughs.**  
How can I repair cracks in a large cement water trough used out of doors for cattle only in summer; damage has been done by frost?  
**E. I. T.**

**Ans.**—We have had no experience in repairing cement troughs which have been cracked by frost. The cracks, we suppose are not very wide, and it would likely be impossible to fill them with cement again, so that it will set and prevent leaking. The trouble might be gotten over by putting a lining in the trough of an inch or so more of cement, but we do not know that this would be the best method. Any of our readers who have experience in repairing cement troughs damaged in this way would do us a favor by sending their methods of repairing to this office.

**Whitewash.**  
Kindly publish at an early date a good whitewash for outdoor purposes.  
**A. Mc.**

**Ans.**—Take half a bushel of unslaked lime, slake with warm water, cover it during the process to keep in the steam. Strain the liquid through a fine sieve or strainer. Add a peck of salt previously well dissolved in warm water, three pounds of ground rice boiled to a thin paste and stir in boiling hot, half a pound of powdered Spanish whiting and a pound of glue, which has been previously dissolved in warm water, and add five gallons hot water to the mixture. Stir well and let it stand for a few days covered up from the dirt. It should be put on hot. A pint of the mixture will cover a square yard properly applied. Small brushes are best for the application.

**Cropping Black Muck.**  
I have a piece of swamp land which has been underdrained and ploughed twice, but hasn't been cropped, composed of a deep, black muck, mostly decayed wood and vegetation. I wish to find out what would be best to grow on this.

1. Would it be suitable for fodder corn?
  2. Would it be suitable for potatoes? If not what does it lack?
  3. Are there any proven cases where cows have developed pneumonia from eating sour silage?
- E. V.**
- Ans.**—1. We have seen land of this kind produce very satisfactory crops of fodder corn. In fact if this land is not too wet this would be as good a crop as any to put on it.
2. Potatoes would likely do very well on this class of soil. There might be a tendency for too great a growth of top and if it lacked anything it would be potash. Such land should be excellent for garden and truck crops and such crops as celery.
3. Not that we have heard of.

**Silo Queries.**

1. How much gravel and cement is required to build a silo, 14 feet in diameter and 35 feet high?
2. How thick does foundation and wall need to be?
3. What proportion of cement and gravel is used?
4. What is best for reinforcing, and how far apart are they put?
5. How is the best way to scaffold for building silo?
6. How is concrete roof made for a silo?
7. Do you think cement blocks make a better silo than a solid wall?

**SUBSCRIBER.**

**Ans.**—1. To complete the work and make a first-class job about 45 barrels of cement, and from ten to twelve cords of gravel.

2. Foundation about 15 to 18 inches thick, and for silo 10 inches at the ground, sloping to six inches at the top.

3. Foundation about one to ten, the bulk of the wall one to eight.

4. Three-eighths inch annealed wire is good, about two bands to each curving in building.

5. Use long poles (tamarack is good) planted three feet in ground and six inches through.

6. See an article on page 591 March 26th issue. All that is necessary is plenty of reinforcing.

7. No.



**The Roofing Question**

**SETTLE it once and for all.** You don't want to have it coming up periodically—then why not decide on **Galt Steel Shingles**, and make a permanent job? The best service you can hope for from a roof of the ordinary, present-day wood shingles is from 10 to 15 years. **Galt Steel Shingles** will last a lifetime. Such a roof cannot burn, rust or decay, assuring permanent satisfaction and freedom from repairs. Write for literature and information on the roofing question. We will gladly furnish full particulars on request. Simply write the one word "Roofing" on a postcard, together with your name and address.

**THE GALT ART METAL CO., Limited**  
150 Stone Road, Galt, Ontario.  
Cor. Richard and Pine Sts., Winnipeg, Man.

**One-Horse Spring Tooth Cultivator**

**HAS NO EQUAL.**

Read the following testimonial:

The One-Horse Spring Tooth Cultivator I got from you will equal two others in cleaning out berry bushes

**J. INGRAM, Union, Ont.**

If there is not an agent in your locality handling the One-Horse Spring Tooth Cultivator, write us to-day. Pleased to give you prices and particulars.

**The Hall Zryd Foundry Co., Limited**  
HESPELER, - ONTARIO  
MAKERS OF PILOT STOVES, RANGES and FURNACES

**Special Offering of SHROPSHIRE EWES**—40 imported shearing ewes and 40 home-bred ewes have been bred to choice imp. rams. One crop of lambs should nearly pay for them at prices asked. Also some good ewe lambs at a low price.

**JOHN MILLER, Brougham, Ont.**  
Claremont Stn., C.P.R., 3 miles. Pickering Stn., C.T.R., 7 miles.

**NEWCASTLE TAMWORTHS, SHORTHORNS AND CLYDESDALES**

Present offering: boars and sows all ages. Sows bred, boars ready for service, full of imported blood and show ring quality; I think the best I ever bred, also younger ones of both sexes. A few nice bulls 4 to 8 months old. Heifers carrying their first calves and others with calves at foot, of splendid milking strains. Two or three nice fillies and mares that are bred to imp. stallions, all registered, prices right.

**A. A. COLWILL, Newcastle, Ont.** L.-D. Phone

**CHAMPION HAMPSHIRE SWINE**

We have the Champion Herd of Canada. We import more Hogs every year than all others combined; at all times we can supply either sex of any age desired. Write us.

**HASTINGS BROS., Crosshill P.O., Newton G. T. R., Linwood C. P. R.**

**Berkshires** choice selection.  
**S. DOLSON & SON** - Norval Station, Ont.

**Sunnybrook Yorkshires and Holsteins**

In Yorkshires we can supply either sex from a few weeks old up to breeding age, sired by our champion boar Eldon Duke (32228), and out of prize-winning sows. Also richly-bred Holstein cattle of all ages.

**WM. MANNING & SONS, WOODVILLE, ONTARIO.**  
Grasshill Sta., C. P. R. and G. T. R.

**Cloverdale Large English Berkshires**

No matter what your needs in Berkshires may be, see Lang the live Berkshire man. He is always prepared to furnish anything in Berkshires. Write or come and inspect.

**C. J. LANG,**  
Hampton, Ont., Durham Co.

**Duroc-Jersey Swine** Twenty-five sows bred for fall farrow; a few boars ready for service; also one Jersey bull, 11 months, and two bulls, 6 months old, out of high-producing dams.

**MAC CAMPBELL & SON, Northwood, Ont.**

**ELMHURST LARGE ENGLISH BERKSHIRES**

From our recent importation of sows, together with the stock boar Suddon Torredon we can supply select breeding stock, all ages. Satisfaction and safe delivery guaranteed.

**H. M. VANDERLIP, Breeder and Importer, Cainsville, P.O., Langford Station on Brantford and Hamilton Radial.**

**Large White Yorkshires**

Have a choice lot of sows in pig. Boars ready for service and young pigs of both sexes supplied not akin to best British herds. Write or call **H. J. DAVIS, Woodstock, Ont.**

Long-distance 'phone. **C. P. R. and G. T. R.**

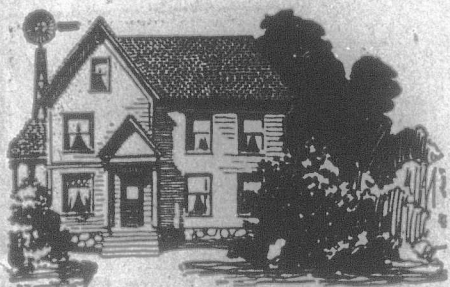

### The best paint for your house

Paint-making is more than mixing some pigments and liquid with a paddle. This explains why you can give best protection to your house if you use scientifically prepared paint.

Real paint—the kind you want—is made scientifically, in a way that calls for expert paint-makers, scientific selection of materials, accurate proportions, immense grinding and mixing machinery and other factory equipment. No hand-mixed paint can begin to compare with



Careful tests have shown that good wearing and protecting qualities of paint depend upon the fineness of the grinding as well as upon the accurate proportions of the materials, and their high quality. "High Standard" is made of the choicest materials and in the exact proportion that years of exposure tests have proved to give best results. No one can approach this in home-made paint.

For interior walls and ceilings use Lowe Brothers Mellotone—the beautiful finish that is washable, fadeless and does not easily scratch or mar. Adapted to every room in the house.

Have the best looking house in your neighborhood. Ask your local "High Standard" dealer-agent to give you paint information and color combinations for exteriors, interior walls, floors, woodwork, etc.

**Valuable Books—Free** Experts have prepared some valuable books—"Homes Attractive from Gate to Garage," and "Mellotone Your Walls." These with special color cards showing how to secure good results with your barns, implements, vehicles, sent free upon request. Write today.

**Lowe Bros., Limited**  
261 to 267 Sorauren Ave.,  
Toronto, Canada.

### CUNARD LINE

Canadian Service  
New Magnificent Steamers.  
ANDANIA ALAUNIA  
ASCANIA AUSONIA

One Class (II) Cabin. Low Rates.  
IMMIGRATION DEPARTMENT  
FARM HELP SUPPLIED  
No Charge Made.

Write immediately, stating whether married couples, families or single persons wanted; also if experienced, partly experienced or inexperienced help required.

State wages and conditions. Regulation forms supplied upon application. Utmost care given to selection. Apply:

The Cunard Steamship Co., Ltd.  
114 King Street West, Toronto.

### THE IMPERIAL BAG HOLDER



enables one man to do the work of two in filling bags. Does the work better in every way, does it quicker, thus it

#### SAVES YOU MONEY

It is portable, adjustable, holds any size bag securely, yet will not tear it. Price only \$3 each. Send today or ask your dealer.

THE IMPERIAL BAG HOLDER COMPANY  
Lucknow, Ontario

Splendid proposition for agents.  
1249

## Ventilation In Your Barn



Pedlar's  
"Superior" Barn  
Ventilator



Too many farmers are content to overlook the important question of proper ventilation in their barns, yet nothing is more essential to the health of their live stock and the preservation of their crops and buildings.

### Pedlar's "Superior" Barn Ventilator

is especially adapted for ventilating barns and large buildings.

It provides a constant upward current without any down draught, working continuously and most efficiently. It is priced much lower than other ventilators not nearly so satisfactory. Fully protected from the bird nuisance.

Get our Folder on "Barn Ventilation."

For Roofing your Barns, the big "George" Shingle (24 in. x 24 in.), with its positive four-side interlocking device, affords ideal protection against fire, wind, snow, and rain.

And for your dwellings and out-houses the "Oshawa" Shingle (16 in. x 20 in.), of identical quality and design, is equally effective. Get our Shingle booklet.

Best grade Corrugated Siding, and a variety of Sheet Metal products always in stock at all our branches.

Write nearest address for Catalogue 22 L. F.

### THE PEDLAR PEOPLE, Limited

86 King St., London, Ont.  
HEAD OFFICE AND WORKS: OSHAWA, ONT.  
Large and varied stocks always carried at

Established 1861.

Toronto, Ottawa, Montreal, Winnipeg, London, Chatham,  
St. John, Quebec, Sydney, Halifax, Calgary, Vancouver.



G. A. Pedlar

9B

## WE STAND BEHIND OUR ENGINE

Every "NEW-WAY" Air-Cooled Engine is guaranteed to cool and deliver its rated power in any climate for any length of time.

Give it the ordinary care necessary to any piece of machinery---overheat it---and you will get your money back and big interest.

### THE "New-Way"

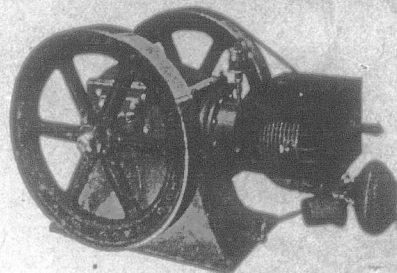

Ordinary care on our engine means less care than is necessary on ordinary, or water-cooled engines.

No Freeze-ups.  
No Water.  
No Bursted Hoppers or Pipes.  
No Oil Holes.  
No forgotten bearings.

A SELF-CONTAINED, SELF-OILED, SELF-OPERATED, ECONOMICAL, HEAVY DUTY, DIRECT COOLED ENGINE

Don't even think of buying an engine until you have seen the "NEW-WAY" in operation.

WRITE FOR CATALOGUE DC 12 WHICH TELLS HOW TO MAKE MONEY.

The "NEW-WAY" Motor Company of Canada, Ltd., Welland, Ont.

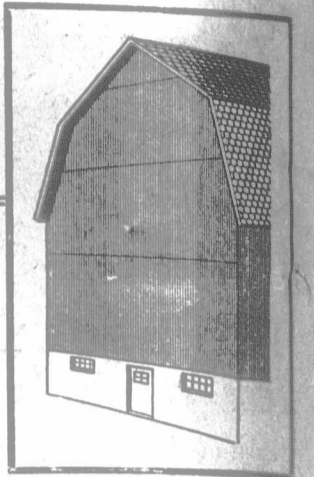
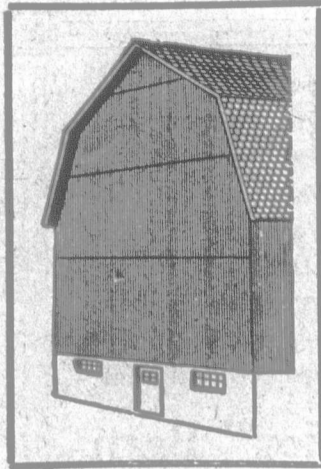

# Just One Way to BUILD YOUR BARN

if You Want the Best Barn You Can Build

## THE "METALLIC" WAY

of Barn Building means "Eastlake" Steel Shingles for the Roof, and "Metallic" Corrugated Iron for the Sides. We want every Farmer who reads this announcement to write us (use the coupon below) and get the cost of "Metallic" Materials for Barns.

We make strong claims for our Materials. "Over 30 years' service and still giving service" is one. "Fire-proof," "Lightning-proof" and "Storm-proof" are others. We want you to make sure for yourself that "Metallic" Materials are the Materials for your Barn.

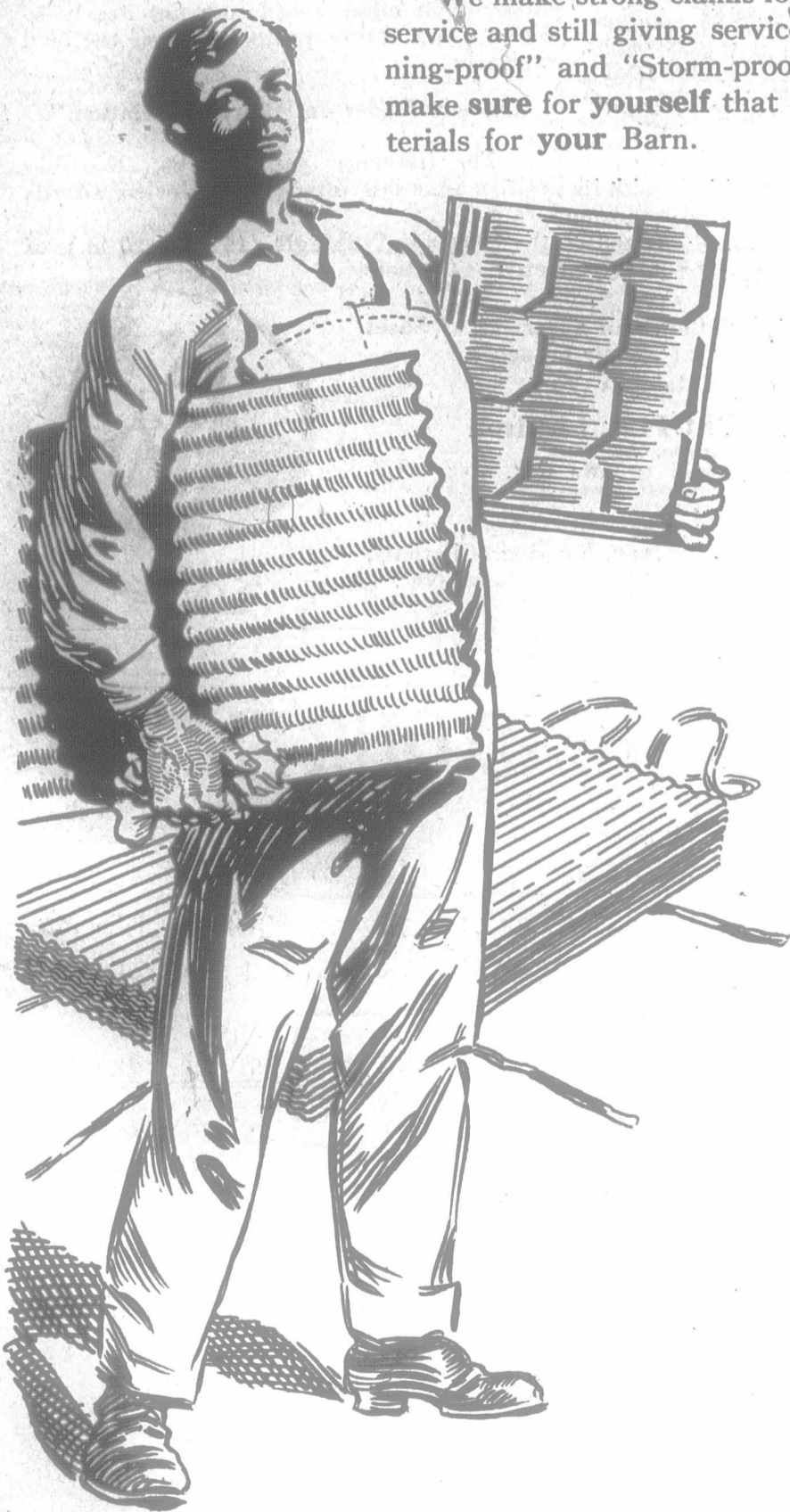

### "Eastlake" Steel Shingles

(The Thirty Year Barn Roofing.)  
and

### "Metallic" Corrugated Iron

(Staunch as Armour Plate.)

**"EASTLAKE" STEEL SHINGLES.**—The patent Counter-sunk Cleats and Telescopic Side Locks make it absolutely easy to lay "Eastlake" Shingles. The Side-lock provides a large and commodious concealed gutter. Perfect rain shedding. The Countersunk Cleats hold the butt of the next higher "Eastlake" Shingle tightly against the Shingle below. An "Eastlake" Shingle covers the area of 15 ordinary wood shingles and is attached by only 4 nails, saving the driving of 26 nails. The Metal in "Eastlake" Steel Shingles is the best we can obtain and they are galvanized by a special process—and the galvanizing is applied on both sides.

**"METALLIC" CORRUGATED IRON.**—Means the difference between ordinary Corrugated Iron and superior Corrugated Iron. To put ordinary Corrugated Iron on the sides of an "Eastlake" roofed barn is to finish a good job badly. Deeper Corrugations made one at a time mean better Corrugated Iron, the easiest to lay accurately and the most durable you can obtain.

**"Halitus" Ventilators.**—Let all the bad air out and the good air in—indispensable in a well made barn.

**"Acheson" Barn Roof Lights.**—A "Metallic" roof light with great advantages—easily laid and strong to withstand storms.

**GET THIS FREE BOOK ON BARN BUILDING.**

To The METALLIC ROOFING CO. Limited  
TORONTO, ONTARIO

Dear Sirs,  
Please send me the "Eastlake" Metallic Shingle Book (Free) telling me how to build a barn the "Metallic" way.

I enclose rough sketch and dimensions of the barn I would like to build—please let me know the cost of "Eastlake" Steel Shingles for the roof, "Metallic" Corrugated Iron for the sides.

"Halitus" Ventilators, "Acheson" Barn Roof Lights, (for Light and Ventilation).

Quote price laid down at .....  
Railway Station.

Name .....

Address .....



THE  
**Metallic Roofing Co.**

MANUFACTURERS  
ESTABLISHED  
1884

LIMITED  
TORONTO