

Technical and Bibliographic Notes / Notes techniques et bibliographiques

The Institute has attempted to obtain the best original copy available for filming. Features of this copy which may be bibliographically unique, which may alter any of the images in the reproduction, or which may significantly change the usual method of filming, are checked below.

L'Institut a microfilmé le meilleur exemplaire qu'il lui a été possible de se procurer. Les détails de cet exemplaire qui sont peut-être uniques du point de vue bibliographique, qui peuvent modifier une image reproduite, ou qui peuvent exiger une modification dans la méthode normale de filmage sont indiqués ci-dessous.

- Coloured covers/
Couverture de couleur
- Covers damaged/
Couverture endommagée
- Covers restored and/or laminated/
Couverture restaurée et/ou pelliculée
- Cover title missing/
Le titre de couverture manque
- Coloured maps/
Cartes géographiques en couleur
- Coloured ink (i.e. other than blue or black)/
Encre de couleur (i.e. autre que bleue ou noire)
- Coloured plates and/or illustrations/
Planches et/ou illustrations en couleur
- Bound with other material/
Relié avec d'autres documents
- Tight binding may cause shadows or distortion along interior margin/
La reliure serrée peut causer de l'ombre ou de la distorsion le long de la marge intérieure
- Blank leaves added during restoration may appear within the text. Whenever possible, these have been omitted from filming/
Il se peut que certaines pages blanches ajoutées lors d'une restauration apparaissent dans le texte, mais, lorsque cela était possible, ces pages n'ont pas été filmées.

- Coloured pages/
Pages de couleur
- Pages damaged/
Pages endommagées
- Pages restored and/or laminated/
Pages restaurées et/ou pelliculées
- Pages discoloured, stained or foxed/
Pages décolorées, tachetées ou piquées
- Pages detached/
Pages détachées
- Showthrough/
Transparence
- Quality of print varies/
Qualité inégale de l'impression
- Continuous pagination/
Pagination continue
- Includes index(es)/
Comprend un (des) index

Title on header taken from: /
Le titre de l'en-tête provient:

- Title page of issue/
Page de titre de la livraison
- Caption of issue/
Titre de départ de la livraison
- Masthead/
Générique (périodiques) de la livraison

- Additional comments: / Various pagings.
Commentaires supplémentaires:

This item is filmed at the reduction ratio checked below /
Ce document est filmé au taux de réduction indiqué ci-dessous.

10X	14X	18X	22X	26X	30X
<input type="checkbox"/>	<input type="checkbox"/>	<input type="checkbox"/>	<input type="checkbox"/>	<input checked="" type="checkbox"/>	<input type="checkbox"/>
12X	16X	20X	24X	28X	32X

The Canadian Patent Office

RECORD



Vol. V.—No. 9.

SEPTEMBER, 1877.

Price in Canada \$2.00 per An
United States - \$2.50

CONTENTS.

INVENTIONS PATENTED	131
INDEX OF INVENTIONS	CXLI
INDEX OF PATENTEES	CXLII
ILLUSTRATIONS	141

INVENTIONS PATENTED.

No. 7673. Improvement in Halter Fastenings.

(*Perfectionnement des ferrures de lieurs.*)

John C. Dillon, Amherst, Mass., U. S., 18th July, 1877, for 5 years.

Claim.—1st. The crescent-shaped coupler A, both with the shank S projecting laterally from its outer perimeter and perpendicularly from its inner perimeter for use with a ring or rings; 2nd. The coupling ring C bent upward on the chord of its arc and adapted for use with the coupler A; 3rd. The combination of the straight shank coupler A, the long link B and a plain ring C, or the coupling ring C bent upward on the chord of its arc; 4th. The combination of the coupler A having a shank perpendicular to its periphery and a plain ring C.

No. 7674. Improvements on Shoe Lasts.

(*Perfectionnements aux formes de chaussures.*)

Samuel J. Parsons, (Assignee of John T. Pooley, Benton, N. B., 18th July, 1877, for 5 years.

Claim.—In combination with the last A having locking plate E, the block B having hooked plate I, barbed crank detent L, locking with opposite edges of the plate E and a spring N.

No. 7675. System for Regulating the Continual Supply of Purified Water and Continual Discharge of Refuse Water.

(*Système de règlement de l'alimentation continue de l'eau pure, et de l'écoulement continu des eaux sales.*)

Harry R. Newton, London, Eng., 18th July, 1877, for 5 years.

Claim.—1st. The locking apparatus for regulating a constant measured small or large supply of filtered water to be delivered into existing cisterns or other reservoirs or by a new system, into closed tanks; 2nd. The use and application of the apparatus for the combined sanitary objects, for supplying and regulating water, filtered or unfiltered, to houses and in locking or fastening apparatus therefor, and for discharging and separating waste and surface waters from houses and lands, and in the construction of drains, sewers, and connections therefor, parts of all of which methods of construction and apparatus are applicable to other useful purposes.

No. 7676. Method of Cutting Stone.

(*Méthode de tailler la pierre.*)

Benjamin C. Tilghman, Philadelphia, Pa., U. S., 25th July, 1877 (Re-issue of Patent No. 2929), for 10 years and 6 months.

Claim.—1st. The use of grains or globules made of iron or cast iron or steel, or their alloys subdivided while melted in the process of cutting, sawing, boring and grinding stone, glass, pottery and similar hard substances; 2nd. The use of grains or globules made of iron or cast iron or steel, or their alloys, subdivided while melted, and of rounded or spheroidal shape so as to operate, by a rolling or crushing, in the process of cutting, sawing, boring and grinding stone, glass, pottery and similar hard substances; 3rd. The use of grains or globules made of iron or cast iron or steel, or their alloys, and still hardened by cooling from a melted state, in the process of cutting, sawing, boring and grinding stone, glass, pottery and similar hard substances; 4th. The use of alkaline water in cutting, sawing, boring and grinding of stone, glass, pottery and similar hard substances by grains or globules of iron or cast iron, or steel, or their alloys; 5th. The use of notched blades for frame saws in sawing stone and similar hard substances with grains or globules of iron or cast iron, or steel, or their alloys.

No. 7677. Improvements on the Manufacture of Gas.

(*Perfectionnements dans la production du gaz.*)

Myron H. Strong, Brooklyn, N. Y., U. S., 25th July, 1877, for 5 years.

Claim.—1st. Heating steam to a high temperature and bringing the steam into contact with carbonaceous material, supplied gradually or in detail into a retort and passing the two together down through the heated retort, and then completing the process and fixing the resulting gases by passing such gases through a bed of incandescent carbon; 2nd. The compound retort with two vertical chambers a b separated by a partition wall c, and the whole enclosed in one casing, the retort a having a filling of fire-brick or similar material, in combination with means for supplying steam at the lower end of the chamber a and for supplying carbon gradually or in detail at the upper ends of the chamber b, and a fire bed at the bottom of such chamber b; 3rd. The retort b having a fire bed f at the bottom, the super-heating retort a and the carburating chamber r, in combination with the steam supply pipe m, the connection from the retort a to the retort b, the gradual fuel supply apparatus at the top of the chambers b, the enclosing casing and the gas delivery tube connected to the third chamber and the fire bed.

No. 7678. Improvements in Tobacco Cutters.

(*Perfectionnements aux coupe-tabac.*)

Michael McMillan, Hamilton, Ont., 25th July, 1877, for 5 years.

Claim.—1st. The combination with the bed plate A, the knife frame C and provided with vertical slots F F, friction roller K; 2nd. In combination with a tobacco cutter of the slot H in the knife G into which the roller K operates for removing the knife horizontally, the said knife operated by an L shaped handle attached; 3rd. In combination with a tobacco cutter, of the spring L, gang N, projection O, lead plate P.

No. 7679. Improvements on Carpet Sweepers.

(*Perfectionnements aux balayuses de tapisserie.*)

Alonso S. Hinkley, Buffalo, N. Y., U. S., (Assignee of Jonas Hinkley), 25th July, 1877, for 5 years.

Claim.—1st. The side pressure wheels E E E E and F F, in combination with the shafts E₁ E₂ E₃ E₄ and F₁ F₂, springs X X and brush R when used in the manner specified; 2nd. The self-adjusting brush pan G, in combination with the brush R and box A, when operating together; 3rd. The ribs z and leather facing V U, in combination with the loose pan G, carrying the brush R; 4th. The pan G when composed of the heads J J, sides S S, bottom G Q and circular pieces T T, in combination substantially as set forth; 5th. The brush R, leather washers V V, heads I J having opening L and circular pieces T T in combination substantially as set forth; 6th. The box A handle C, wheels E E E E and F F, pan G and brush R, in combination substantially as specified.

No. 7680. Improvements on Turbine Wheels.

(*Perfectionnements aux turbines hydrauliques.*)

Titus H. Russell and Samuel E. McCully, Windsor Mills, Que., 25th July, 1877, for 5 years.

Claim.—1st. The wheel case A and gate 3, constructed with upwardly tapering peripheral walls, the latter adjustable vertically, said gate having water tight contact with peripheral walls of shell; 2nd. In combination with the wheel case A, the rotative cam ring 7 for adjusting the altitude of the gate; 3rd. The combination with the case A, and gate 3 having lugs 11, of the cam ring 7 and outer ring 14, for adjusting the gate rotatively and vertically; 4th. The head block 25 having an adjusting screw 24, in combination with the spindle 20, collar 26 and chamfered shaft 19, for compensating frictional wear of the step 22; 5th. In combination with the gate 3 the winged chutes 18, having self-adjusting action pivoted between the flanges 2 of the shell A; 6th. The wheel C constructed with a peripheral concavity 5 at its base below the entrance of the buckets 4 to form curvilinear throats; 7th. The step 23 composed of two pieces, one of soft and the other of the hardest steel for diminishing friction.

No. 7681. Improvements on Oil Cans.

(*Perfectionnements aux bidons à huile.*)

John Graves, New York, U. S., 25th July, 1877, for 5 years.

Claim.—1st. A case for packing oil cans for transportation, consisting of an inner section A₁ attached by top cross strips to can of a detachable outer

section A² and of a lid B; 2nd. The combination of the case A having guide slots and pivot hooks C with side trunnions of the can to support the same in raised position (tilting); 3rd. The combination of the can D, having side trunnions, outer section A² having side slots and pivot hooks C, inner section A¹ attached to can, and lid B having staples for entrance of locking hooks to secure case firmly to can.

No. 7682. Improvements on Car-Couplings.
(*Perfectionnements aux attelages de wagons.*)

James M. Keen, Digby, N. S., 25th July, 1877, for 15 years.

Claim.—1st. The draw head A having neck d and slot b c. 2nd. The improved coupling pin consisting of body B, having button C and bevelled flange D; 3rd. The draw head A having neck d and slot b c, in combination with the coupling pin B having button C and bevelled flange D.

No. 7683. Improvements in Horse-powers.
(*Perfectionnements aux moteurs.*)

Thomas E. Adams, North Evans, N.Y., U.S., 25th July, 1877, for 15 years.

Claim.—1st. The combination of the upright shaft A, of the band wheel B made vertically adjustable thereon so as to be lowered to the floor or ground; 2nd. The wheel B provided with one or more spaces H for the draft animals and having the draft staples g arranged, one in the rim c and one in the brace f, in a line drawn through, the centre respectively of the wheel and spaces H so as to apply the draft; 3rd. The combination with the wheel B, provided with one or more spaces H, of the U shaped pusher or draft device K arranged upon the wheel and secured with its forward ends respectively to the rim and brace of the wheel, at or near the middle of the space H; 4th. The combination with the wheel B provided with square hub d and space H for the draft animals, of the flat shaft A and wedges b.

No. 7684. Improvements on Car Axle Boxes.
(*Perfectionnements aux boîtes d'essieux de wagons.*)

Alexander Calder, London, Ont., 25th July, 1877, for 5 years.

Claim.—1st. In combination with the box A having extensions B B for seating rubber springs, the spiral spring C and stop block D; 2nd. The friction saddle E, grooved longitudinally to receive the journal K and having pivotal and rocking motion within the box A; 3rd. The working of the box A together with the extensions B B and spiral spring C without friction pedestals on the side of the box as is usual in street and railway cars; 4th. The combination of the box A in conjunction with the extensions B B and rubber springs thereon together with the spiral spring C and stop block D, and saddle of brass or other suitable metal grooved longitudinally to receive the journal K.

No. 7685. Galvanic Sheathing for Ships.
(*Blindage galvanique de navires.*)

Joseph Betteley, London, Eng., 25th July, 1877, for 5 years.

Claim.—1st. The galvanic sheathing composed of one half surface quantity of iron to that of zinc; 2nd. The employment of paper, felt, or other fibrous body, between iron and zinc used as a sheathing for ships for producing a galvanic action in sea water.

No. 7686. Improvements on Hame Fasteners.
(*Perfectionnements aux attache-attelles.*)

George Jeffrey, Bramford, Ont., 25th July, 1877, for 5 years.

Claim.—The bar C provided with the ridge m when so arranged as to shut into the slotted bar B, and in connection with the latter to swing its inner end through the bar A, and so moving m side the line of draught as to make itself self-locking.

No. 7687. Improvements in Fire Escapes.
(*Perfectionnements aux appareils de sauvetage d'incendie.*)

Sarah L. McKee and Benjamin F. McKee, (Assignees of George W. McKee) Brooklyn, N.Y., U.S., 27th July, 1877, for 5 years.

Claim.—1st. A metal tube G sliding on a rope as a means of escape from fire; 2nd. A metal tube G provided with eccentric H, brake K attached and operated conjointly by links L, L, for braking or locking the device on the rope; 3rd. In combination with the tube G, of the lower metal tube P and provided with lever brakes R R, rods or chains T T, rollers e e, rods or chains W W, foot board V, seat U; 4th. In combination with the tubes G of the ring N and belt O; 5th. In combination with the tube G of the hand brake M; 6th. The combination of the hooked brackets A, metallic tubes G P with their brakes H K M R R, belt O, seat U, rods or chains T T, Q Q, pulleys e e, chains W W, foot board V, cord X and pulleys h, all constructed to form a fire escape; 7th. In combination with the fire escape the sack Y attached to hooks f f of the rods or chains T T.

No. 7688. Improvements on Paddle Propellers.
(*Perfectionnements aux propulseurs a aubes.*)

William Davenport, Philadelphia, Pa., U.S., 27th July, 1877, for 5 years.

Claim.—Two or more parallel cranks having vertical paddles B suspended from one shaft and braced from the other.

No. 7689. Improvements on Force Pumps and Fire Engines.
(*Perfectionnements aux pompes foulantes et aux machines a incendie.*)

Walter Scott, Richmond, Que., 27th July, 1877, for 5 years.

Claim.—1st. The cylinder a, piston b, passages c d g, valves e h in combination with box k, passage n and valves h m; 2nd. The combination of the piston rod q, yoke r, links s t and lever p.

No. 7690. Improvements on Button Machines.
(*Perfectionnements aux machines a boutons.*)

Charles Radcliffe, Newark, N. J., U. S., 27th July, 1877, for 5 years.

Claim.—1st. The combination of a hopper F, tube E and vibrating brush f; 2nd. The tilting hopper H arranged with a depression in and extending across the bottom for receiving and arranging simultaneously a series of metal faces for buttons or similar articles; 3rd. The combination of a hopper F, vertical tube E, vibrating brush f and the revolving plate; 4th. The combination of the tilting hopper with its slot like depression, the reciprocating bar K and the revolving plate; 5th. The combination of the revolving plate and revolving brush and guide for conducting articles to be stamped or punched, to depressions in the edge of said revolving plate; 6th. The combination of the tilting hopper, revolving plate, rotating brush and guide; 7th. The combination of the hopper F, the tilting hopper H and revolving plate; 8th. The combination of the hopper F, vibrating brush f, tilting hopper H, vibrating brush l, reciprocating bar K and revolving plate; 9th. The combination of the tilting hopper, reciprocating bar, revolving plate and one or more punches; 10th. The combination of the tilting hopper, reciprocating bar, revolving plate, revolving brush, and one or more punches; 11th. The combination of the hopper F, tilting hopper H, revolving plate, revolving brush and one or more punches; 12th. The combination of one or more vertical tubes for conveying fillings or faces, the revolving plate and one or more punches; 13th. The combination of the vibrating brush f, reciprocating bar K and punches, all operated from the same sliding frame; 14th. The combination of the tilting hopper and reciprocating bar operated by the same cam wheel.

No. 7691. Apparatus and Process for the Separation and Treatment of Oils.
(*Appareil et procede de separation et de traitement des huiles.*)

Hermann Frasch, Philadelphia, Pa., U. S., 27th July, 1877, for 5 years.

Claim.—1st. Causing the oils to pass in thin films over pipes or other heated surfaces, and at the same time exposing them to a confined draft of air; 2nd. Causing the oils to pass in thin films, over heated pipes or other surfaces in contact with an air draft in an air flue, and passing the said draft and separated light oils afterward through suitable condensers and receivers; 3rd. A series of horizontal heating pipes, whose lower edges are respectively provided with serrated drip plates, and a feed pipe, the same being relatively arranged within an air flue having a draft opening at either extremity whereby the liquid under treatment may be subjected to a confined draft of external air; 4th. The combination with a vertical series of horizontal heating pipes, the latter constructed with drip plates, of an upper feed pipe constructed to draw into the liquid over the length of the said series of pipes and an air flue having a draft opening at either extremity within which latter the former parts are exposed to a vertical draft of air; 5th. The combination with the serrated pipes A, the feed pipe C and the air flue D of one or more condensers and receivers P.

No. 7692. Improvements in Cigars.
(*Perfectionnements dans les cigares.*)

James H. Campfield, Ottawa, Ill., U. S., 27th July, 1877, for 5 years.

Claim.—A cigar provided near its mouth end with a porous substance saturated with tannic acid.

No. 7693. Machine for Making Horse Shoe Nails.
(*Machine a fabriquer le clou a cheval.*)

James D. Sumner, Lexington, Mass., U.S., 27th July, 1877, for 5 years.

Claim.—1st. The moveable stamper l, in combination with the stationary blocks or dies m n and the projections n m on the block m, or vice versa; 2nd. In combination with the moveable stamper l and its stationary dies m n of the movable punch or punches f with its stationary die t; 3rd. In combination with the moveable stamper l, its stationary dies or blocks m n, the movable punch or punches f and die t, of an intermittent feeding mechanism; 4th. The combination of the moveable stamper l and dies m n with the intermittent feeding mechanism, and the oscillating tunnel y z, with its adjusting screws 3 4 4, movable cover l, and spring 5 5 6; 5th. In combination with the stationary dies m n, projections n m, the adjustable guides q q with their regulating screws p p s s; 6th. In combination with the movable punch or punches f, its stationary die t, guide pieces u u with their lips or projections e e and regulating screws w w.

No. 7694. Improvement on Rigging Ratlines.
(*Perfectionnement des enfile-harts de hauts.*)

John C. Knowlton, Rockport, Mass., U.S., 27th July, 1877 for 5 years.

Claim.—1st. The combination of the clasp A, bolt D and nut E, with the hook F all constructed and adapted to operate with relation to the shroud and ratlin; 2nd. The combination of the clasp, bolt, nut and hook adapted to secure the middle of the ratlin to the central shroud with the clasp, bolt, nut and thimble applied to the outer shrouds and the eyes of the ratlin ends.

No. 7695. Improvements in Organ Stop Actions.
(*Perfectionnements aux jeux d'orgues.*)

John A. Kydd, Bowmanville, Ont., 27th July, 1877, for 5 years.

Claim.—1st. The stop levers J connected to the notes H by the rods G resting upon the hinged plates E, provided with the arms D and connected to the pivoted lever B by the rods C C, in combination with the key pedal A; 2nd. The hinged plates E provided with the vertical lanced plates F b tating against the end boards N, in combination with the springs I; 3rd. The plates K hinged to the top of the instrument and provided with arms L resting upon the stop levers J, in combination with the stops M.

No. 7696. Improvements on Pea Harvesters.
(*Perfectionnements aux moissonneuses a pois.*)

William Boyd and William Bentley, Strathroy, Ont., 27th July 1877 for 5 years.

Claim.—1st. The rakes A, B, frames C D outer frame F chains G J standards H K, main bar I, tongues P Q bar R standards S U and lever T in combination with wheels L M and studs N O; 2nd. In combination with the above, the foot board V and chains X N.

No. 7697. Improvements in Mill Stone Dress.*(Perfectionnements dans le rhabillage des meules.)*

Robert S. Williams, Milwaukee, Wis., U.S., 27th July, 1877, for 5 years.

Claim.—The tangential furrows A upon the bosom of the stone and connecting with the radial furrows upon the skirt.**No. 7698. Apparatus for Cleansing the Hulls of Vessels Afloat.***(Appareil pour nettoyer les coques de vaisseaux à flot.)*

Henry J. Cole, London, England, 1st August, 1877, for 5 years.

Claim.—1st. The combination of appliances shown in figures 1 2 3 4; 2nd. The combination of appliances shown in Figures 6 7 8; 3rd. The apparatus shown in Figures 13, 14; 4th. Fitting two vancanson or ladder chains B B, upon or against a vessel, to rotate a drum brush, when said brush is drawn up or down, or to and fro; 5th. Constructing cylindrical brushes with intervening metal strips, or blades in spiral order; 6th. Fitting or attaching springs in cylindrical brushes made in sections or without metal blades.**No. 7699. Raising and Transplanting Plants.***(Culture et déplacement des arbres.)*

Conrad Loskamp, Newburgh, N.Y., U.S., 1st August, 1877, for 5 years.

Claim.—1st. The method of raising and transplanting plants which consists in planting roots, seeds, &c., in earth contained in a series of paper bags, moistening the earth in the bags simultaneously by water supplied centrally thereto, hastening germination, forcing the growth of the plants and preventing injury to the bags by the circulation of warm air about the outside of the bags, and finally transplanting the plants with the bags and earth about the roots; 2nd. The combination of a rack for holding and separating the bags, an open bottomed frame in which the rack is supported, and water holders or receptacles for supplying water centrally to the earth in the bags; 3rd. The frame constructed with an open end, an open bottom and a closed top provided with the series of water holders.**No. 7700. Improvements on Churns.***(Perfectionnements aux barattes.)*

William H. Conyer, Agnews' Mills, Elizabeth Fite, Alleghany, and Jacob J. Speck, Pittsburgh, Pa., U.S., 1st August, 1877, for 5 years.

Claim.—1st. The combination of discs with a partition board, of a reversible compartment churn for collecting the butter globules and spreading the air; 2nd. The combination of swinging balls or frames with a reversible churn barrel and a supporting frame; 3rd. The combination of spring holders with a reversible or journalled churn barrel and supporting frame; 4th. The combination of the frame A having journal boxes B, swinging balls E and spring holders F, to operate in connection with a reversible or journalled churn barrel D.**No. 7701. Improvement in Dredging and Derrick Machines.***(Perfectionnements dans les dragues et les chèvres.)*

Ralph R. Osgood, Troy, N.Y., U.S., 1st August, 1877, for 5 years.

Claim.—1st. A turn-table with one or more vertical guide sheaves and two or more horizontal guide sheaves, in combination with a hinged or pivoted boom and its hoisting chain, or its equivalent; 2nd. One or more hoisting chains, in combination with the dipper or load boom, turn-table guide, sheaves and moving power; 3rd. The step with an annular groove on its upper surface, in combination with a turn-table, annular flange corresponding with groove in step, ring or segments firmly secured to step and over annular flange of the turn-table; 4th. The turn-table, boom and hoisting chain, in combination with the boom chain and stop chain; 5th. The combination of boom F, turn-table D, sheaves P Q R, step B, hoisting chain M, boom chain I, stop chain J.**No. 7702. Improvements in Car Couplings.***(Perfectionnements dans les attelages de wagons.)*

William Craig, Nunda, N.Y., U.S., (Assignee of Benning Rowell), 1st August, 1877, for 5 years.

Claim.—The combination of the lever and pivoted V shaped pawl, the T rock shaft, the ratchet or toothed link fixed on the end thereof, and the coupling pin and draw head.**No. 7703. Improvements in Keys for Locks.***(Perfectionnements aux clés de serrures.)*

Richard A. Abbott and Myron W. Parrish, Jackson, Mich., U.S., 1st August, 1877, for 5 years.

Claim.—The combination of a thumb screw or nut with a door or other key.**No. 7704. Improvements on Water Purifiers.***(Perfectionnements aux filtres à eau.)*

James Foley, Montreal Que., 1st August, 1877, for 5 years.

Claim.—1st. A water purifier to connect with water service pipes having a group of tubes *a a* 2 3, connectedly arranged within bands N or a casing L; 2nd. A water purifier constructed of a group of tubes *a a* 1 2 3 having trap screws or ports *d*, perforated diaphragms *c c* 1 and connected near top and bottom alternately by pipe connections or eyelets *b b* 1 2 and inlet and outlet pipes *f f* 3, valved for circulating the flow alternately upward and downward, or vice versa; 3rd. A water purifier constructed of a group of tubes *a a* 1 2 3 coupled together near top and bottom alternately by pipes or eyelets *b b* 1 2 to give an upward and downward flow through the filtering medium in said tubes; 4th. A water purifier consisting of a group of filtering tubes *a a* 1 2 3 connected alternately at top and bottom, having inlet and outlet pipes *f f* 3 connected by pipe G for reversing the circulation; 5th. A water purifier composed of a group, or purifying tubes *a a* 2 3 alternately connected, and a cooling chamber above the same having within a coil pipe I for storage of ice for cooling the flow of purified water.**No. 7705. Improvement in Combined Covers and Blotters.***(Perfectionnement dans les couvercles-buvards.)*

Jesse W. Payson, Hyde Park, Mass., and William M. Scribner, Chicago, Ill., U.S., 1st August, 1877, for 5 years.

Claim.—1st. A combined blotter and cover formed of one continuous strip of bibulous paper and folded in form; 2nd. A combining blotter and cover folded in form and having protection strips or bands at the folds; 3rd. The combination of the back pieces A A and flaps B B, either or both of bibulous paper, with strips C C C; 4th. In any combined blotter and cover having folded pieces or flaps, the lines D D drawn on the meeting faces of such flaps.**No. 7706. A Barrel. (Un baril.)**

James Tomlinson, Goderich, Ont., 2nd August, 1877, (Extension of Patent No. 4023), for 5 years.

No. 7707. A Barrel. (Un baril.)

James Tomlinson, Goderich, Ont., 2nd August, 1877, (Extension of Patent No. 4023), for 5 years.

No. 7708. Composition for Sheep and Cattle Wash.*Composé pour le lavage des moutons et bêtes à cornes.)*

William Clark, South Dumfries, Ont., 3rd August, 1877, (Extension of Patent No. 1573), for 5 years.

Claim.—The combination of spirits of tar, the best whale-oil, hellebore, tobacco juice, powdered soda, and soft soap in the proportions and in the manner specified.**No. 7709. Improvement on Curtain Fixtures.***(Perfectionnement des ajustages de rideaux.)*

Nathan Campbell, Rochester, N.Y., U.S., 9th August, 1877, for 5 years.

Claim.—1st. The lever B constructed with the pawl *f* and extending outside of and around the ratchet C, in combination with a bracket having a bearing *d*; 2nd. The ratchet C constructed with four plane sides *a a a a* and hooked teeth *b b b b*; 3rd. The bit G and socket *j*, the socket constructed shorter than the bit and having the depression X in the back to contain the bit; 4th. The bracket A constructed with the open slot Z in its foot, near the top, leaving a wide bearing at its bottom.**No. 7710. Improvements on Concrete Pavement.***(Perfectionnements du pavage en béton.)*

Cyrus M. Warren, Brookline, Mass., U.S., 9th August, 1877, for 5 years.

Claim.—A foundation of concrete prepared with or containing coal tar or coal tar pitch and a surface layer of concrete made with a compound of native bitumen or rosin, and the heavy oil or residuum of petroleum or equivalent non-volatile and non-drying material, or an equivalent surface layer made of other bituminous material.**No. 7711. Improvement in Photographic Printing Frames.***(Perfectionnement des châsses à impressions photographiques.)*

Louise Ray, Peoria, Ill., U.S., (Assignee of Thomas L. Ray), 9th August, 1877, for 5 years.

Claim.—1st. In the process of printing an indefinite number of sun pictures from negatives of different intensity at one time and at the same exposure to light; 2nd. The method of securing the equal printing of pictures in printing, that is: by retarding the light on all of the least intense negatives or increasing the light on all of the most intense, or by retarding the light on the least intense and increasing the light on the most intense by means of equalizing media and condensing lenses; 3rd. The method of printing one picture from each negative in the printing frame on a continuous piece of sensitive paper, and having an indefinite number of pieces of sensitive paper between the negatives just the size of the picture already printed; 4th. The method of pressing the sensitive paper in contact with negative in the printing frame by means of the flexible strip P with block L and spring S₃ and the cover K; 5th. The printing of an indefinite number of pictures, at one time and in the same frame, of different persons, or from negatives of the same intensity taken on separate glasses, when said pictures are finished on separate cards.**No. 7712. Manufacture of Brooms and Brushes.***(Fabrication des balais et des pinceaux.)*

Thomas Jesson, Galway, and Thomas Duggan, Glasnevin, Ireland, 9th August, 1877, for 5 years.

Claim.—1st. The process of making brushes by laying across a box D the bristles *a*, or their equivalent, wrapping the same with wires or rods *f* and forcing the bristles or their equivalent, so bound, into a hollow brush, stock or head; 2nd. The novel combination in a machine for making brushes, of a table or bench J having an opening or space, a portable box or casing D and a pusher P; 3rd. The portable box composed of transversely connected sections D in conjunction with parallel rollers 1 2 and end pins 3 4 5 6, with or without a hinged drop bottom; 4th. The employment of iron wires or rods *f* and pins *t*, in combination with the material *a* arranged and fastened; 5th. The employment in combination with the brush stock F, fig. 12, of the wires *i* and eyes or hooks *l*, for fastening the bristles or their equivalent *a* in the said stock.

No. 7713. Improvement on Extension Chandeliers. (*Perfectionnement des candélabres à rallonge.*)

Wolcott A. Hull, Meriden, Ct., U.S., (Assignee of John T. Bruen), 9th August, 1877, for 5 years.

Claim.—1st. The combination with the movable portion of a chandelier and its fixed suspending tube, of an internal screw and nut, the one turning upon the other, and an automatic stop device operating to prevent such turning of the screw or nut and thereby to stop the descent of the chandelier; 2nd. The combination of the internally threaded suspending tube B provided with a projection b, the slotted sliding tube T attached to the chandelier, the box P, the screw or twisted rod A, the cylinder d attached to said screw and containing the seat h, the stop i, the spring k which acts upon said stop and the button m; 3rd. The combination of the supporting screw A, the suspending tube B and springs E.

No. 7714. Attachment for Threshing Machines. (*Disposition aux machines à battre.*)

John Abell, Woodbridge, Ont., 9th August, 1877, for 5 years.

Claim.—The plate A provided with a concave serrated face, in combination with the cylinder and carrier belt of a threshing machine.

No. 7715. Improvements on Boxes for Shafting.

(*Perfectionnements aux boîtes d'arbres de couche.*)

Joseph Tomlinson, Black Hawk, Col., U.S., 9th August, 1877, for 5 years.

Claim.—The combination, in the journal box, of the upper bearings g g, pad k between such bearings, the lower bearings c c and pad k between said bearings, the oil chamber b, in the bottom of the shell a, and the spring cut off plates m n in the recesses at the ends of the boxes; 2nd. The combination, in the journal box, of the oil chamber b, spring pad k between the bearings c c and the spring cut off plates m n and their recesses at the ends of the journal box.

No. 7716. Apparatus for Self-Adjusting Saddle Girths.

(*Appareil automatique à serrer les sangles des selles.*)

Alois Steinback, Vienna, Austria, 9th August, 1877, for 5 years.

Claim.—The springs f f and pawl, in combination or not with the buckles a and b.

No. 7717. Improvement in Cheese-Presses.

(*Perfectionnement dans les presses à fromage.*)

Arad S. Beach, Groton, N. Y., U. S., 9th August, 1877, for 5 years.

Claim.—1st. A cheese press adapted to receive and press a series of cheeses end to end, and having its holder frame composed of or provided with a receptacle for the proper collection and discharge of the expressed liquid; 2nd. In combination with a frame work and suitable platens between which to compress the interposed gang of cheeses, two or more drawing screw shafts or their equivalents; 3rd. In combination with a press adapted to press a series of cheeses with hoops arranged end to end, one or more sliding holder boards I, or their equivalents, and means of holding said board or boards in place vertically; 4th. In combination with the box or body A of the press suitable ways to w, or their equivalents, upon which to rest and slide the hoops in the operations of putting in, pressing and removing the cheeses; 5th. The combination with a system of gears, for operating a series of press screw shafts, of a hand lever and reversible pawl or finger j, or its equivalent.

No. 7718. Improvements in Reaping Machines.

(*Perfectionnements aux moissonneuses.*)

John Abell, Woodbridge, Ont., 9th August, 1877, for 5 years.

Claim.—1st. The single plate driving wheel A having a convex concave section and provided with the circular rack A₂. 2nd. The combination with the wheel A having a convex concave section and shaft A₁ of the similarly curved frame plate B; 3rd. In combination with the wheel A provided with the inner circular toothed rack A₂, the bevel wheel C, upright shaft C₁ and frame B, 4th. The combination with the shaft C₁ and toothed wheel C₂ of the toothed wheel D and crank shaft D₁; 5th. The wheel C₂ with half-clutch and shaft C₁, in combination with the clutch C₃ and clutch lever C₄; 6th. The frame B loosely mounted on the shaft A₁ and provided with the guide rods B₁, in combination with the bracket E of the cutter bar E₁; 7th. The combination of the wheel A, frame B, with guide rods B₁, with the bracket E of the table of a reaping machine; 8th. The ratchet lever F pivoted on frame B, differential wheel F₂, chains F₃ G and outside wheel G₁, in combination with the table of a reaping machine; 9th. The wheel A, frame B, outside wheel G₁ with their operating connections, in combination with the table of a reaping machine and its connections; 10th. The outside wheel G₃ mounted on the pivoted quadrant arm G₂, in combination with the perforated guide plate H; 11th. The frame B arranged to work at a fixed level with attached crank driving wheel D, in combination with the crank shaft D₁, the said crank shaft being arranged to adjust itself to the level of the table to which it is attached; 12th. The frame B with bracket piece I, in combination with the spring lever J and pole J₁; 13th. The rake head plate L₂ provided with adjustable clutch R₁, in combination with the cam wheel R; 14th. The toothed cam wheel R, in combination with the toothed bevel cam wheel R₂; 15th. The cam wheels R R₂, in combination with the rod V₂, bracket V₁, lever V and pivoted guide blocks T T₁; 16th. The block V₁ in combination with the rod V₂ and cam wheels R R₂; 17th. The rakes P with brackets W, in combination with the hinged arms P₁ with pin X, 18th. The bracket W in combination with the spring latch X₁; 19th. The rakes P with spring latch X and lug W₁, in combination with the pivoted guide blocks T T₁, with the stop block T₂ and cam T₃; 20th. The combination of the rakes P and attachment pivoted blocks T T₁, lever V, rod V₂ and cam wheels R R₂; 21st. The combination with the rake arm P, bracket W and pin X, of the washer Y, pin p and spring Y₁; 22nd. A six rake reaper formed by the addition of an extension web with raised rim to the rake head plate and an increased circle on which the rake arms hinge.

No. 7719. Improvement on a Waggon Box.

(*Perfectionnement des caisses de voitures.*)

Edwin R. Lang, Langford, Ont., 9th August, 1877, for 5 years.

Claim.—1st. The irons E F G, 2nd. The application of the irons to waggon boxes.

No. 7720. Improvements in Churn Dashers.

(*Perfectionnements aux bolles-beurre.*)

John Ferguson and Alexander Ferguson, London, Ont., 9th August 1877 for 5 years.

Claim.—1st. The combination of three or more rings or sets of chambers A B C, set half an inch apart by means of the projecting inside shafts a b c with the removable cover d; 2nd. The combination of the inside shafts a b c, the wings of the inside shafts D E F G, the rings A B C and the inside flanges i; 3rd. The combination of the coupling bolt e, the bolt head f, the cavity m in the inside shaft of the lower ring A, the screw g and the socket h.

No. 7721. Improvements on Steam Boilers.

(*Perfectionnements aux chaudières à vapeur.*)

Henry S. Coleman, Chelmsford, Eng., 9th August, 1877, for 5 years.

Claim.—The combination with a double boiler of circulation tubes forming downward continuations of each alternate connecting tube, said circulation tubes extending to within a few inches of the bottom of the lower shell for the purpose of determining a circulation of the water.

No. 7722. Improvements on Land Rollers.

(*Perfectionnements aux rouleaux d'agriculture.*)

James S. Palmer, Brantford, Ont., 9th August, 1877, for 5 years.

Claim.—1st. A land roller having tapering or cone-shaped rolls B, 2nd. A land roller constructed of conical rollers B having tapering flanges C on an axle tree A, provided with a draft tongue E.

No. 7723. Improvements on Compound Reflectors.

(*Perfectionnements aux réflecteurs composés.*)

Faung I. Senour, Pittsburgh, Pa., U. S., 9th August, 1877, for 5 years.

Claim.—1st. The combination of the center conical or bell-shaped reflector and the exterior reflector arranged concentrically with and at the base of the inner reflector and a suitable distance from the same; 2nd. The adjustable collar G with skeleton frame I containing the reflectors J L and suspended on the gas fixture by a set screw or other suitable device; 3rd. The combination of an oil font and burners supported on the reflector frame with the reflectors.

No. 7724. Improvement in Watch Movements. (*Perfectionnement dans les mouvements des montres.*)

Charles S. Mosely, Elgin, Ill., U. S., 9th August, 1877, for 15 years.

Claim.—1st. A watch movement having the barrel placed midway between the figures denoting twelve and three o'clock on the dial with a bridge projecting from the barrel on either side to and beyond the two figures respectively; 2nd. Two sets of cavities and holes counter parts one of the other, arranged on each side of the barrel; 3rd. A barrel and main winding wheel combined with a bridge having openings on each side of the barrel, and winding wheel with a single operative intermediate wheel.

No. 7725. Improvements on Stove-pipe Shelves.

(*Perfectionnements aux tablettes à tuyau de poêle.*)

Charles Allen, Waterloo, Que., 9th August, 1877, for 5 years.

Claim.—1st. The combination of the pipe b, flange c, ring d, with the arms g and plate f; 2nd. The combination of the pipe b, ring d and plate f supported thereby with the bolts g, flanges i and shelf or shelves h; 3rd. The combination of the pipe b, shelves f h, with the flange k and peripheral casing l m.

No. 7726. Improvements on a Drying House.

(*Perfectionnements aux sécheresses.*)

Samuel W. Craven, Cobden, Ill., U. S., 9th August, 1877, for 5 years.

Claim.—1st. The combination with the frames D having grooved side bars b of the pivoted gravitating catches O; 2nd. The combination with the dry house having the stationary pivoted gravitating catches E, of the sliding frame D having similar catches O; 3rd. The dry house separated from its furnace by a metallic diaphragm b; 4th. The combination with the stationary pivoted gravitating catches E and the vertically movable frame D having similar catches O, of the rock shaft G, cams or eccentrics F and chains H.

No. 7727. Improvements in Cooking and Heating Stoves.

(*Perfectionnements dans les poêles de cuisine et de chauffage.*)

Charles A. Hazalin, Albany, N. Y., U. S., 9th August, 1877, for 5 years.

Claim.—1st. A cooking or heating stove provided with a permanent projection c₁ of the front plate C, a fire box having an adjustable front plate F for extending the upper surface of the burning fuel into said projection within the exterior casing of the stove and beyond the area of the grate E, for the purposes of broiling, radiation or illumination; 2nd. The permanent projection c₁ of the front plate C, in combination with the inclined front plate F of the fire box extending thereinto; 3rd. The combination with the projection c₁ of the front plate C having the groove c₂ of the end piece c₃ having the shoulders c₄; 4th. The combination of the adjustable front plate F with the damper G; 5th. The damper G and door D; 6th. The combination with the projection c₁ of the front plate C provided with the means for holding the gridiron L of the hearth plate K arranged in relation to the gridiron.

No. 7728. Improvements on Lamp Stands.*(Perfectionnements aux pieds de lampes.)*

John Forster, Coal Valley, Ill., U. S., 9th August, 1877, for 5 years.

Claim.—A socket base A with swinging oil cup stand E, and of an upright standard B with adjustable stand C and collar D for the lamp, and a pin cushion F at the top.

No. 7729. Improvements on Horse Rakes.*(Perfectionnements aux râteliers à cheval.)*

John B. Armstrong, Guelph, Ont., 9th August, 1877, for 5 years.

Claim.—An elastic steel horse rake tooth B, tapered twenty-four inches, more or less from the point B₁, for the purpose of permitting the said tooth to pass over obstructions with the least possible resistance and without injury to the said tooth B.

No. 7730. Improvements on Sinks and Water Closets.*(Perfectionnements aux ériers et cabinets d'aisance.)*

George Jennings, London, Eng., 9th August, 1877, for 5 years.

Claim.—1st. The construction of sinks, also the arrangement of outlet valve and overflow consisting of a valve with hollow stem S having a handle S₁, projecting webs S₂ and overflow aperture S₃ applicable for bath, lavatories, sinks and other receptacles for waste water; 2nd. The water closet with overflow A from chamber B (in which the stem C of the closet valve is located) into the trap D which is below the pan E of the closet; 3rd. The construction of closet without any trap between the closet valve H and soil pipe, but with a trap D at the lower end of overflow A and with a shield I projecting downwards from the valve seat H to below the outlet from the trap D; 4th. Forming valve apparatus used for supplying water to water closets with two delivery passages a b; 5th. The construction of valve apparatus with valve c, diaphragm g, chamber h, passage i closed by small valve k and passage m fitted with valve or tap n for controlling the supply of water to water closets; 6th. Forming the pans of water closets with rib B opposite to outlet C.

No. 7731. Improvements on the Preservation of Food.*(Perfectionnements dans la conservation des substances alimentaires.)*

Pierre P. E. M. Koch, Antwerp, Belgium, 9th August, 1877, for 5 years.

Claim.—1st. The preservation in the natural state of articles of food and in general of matters which are subject to change, fermentation or corruption, by simple immersion of the matters to be preserved in an antiseptic solution, followed by their exposure in a close apparatus to the pressure of a gas, and placing them afterwards in packages of suitable nature from which the air is removed or replaced by a gas or by a fatty matter, or preserving without special package, either on sea or land, in receivers of any dimensions suitable to afford protection from the air; 2nd. The preservation in a similar manner of the same substances in a salt state (either dry or wet); 3rd. Their preservation in the smoked state by the same method; 4th. The preservation of substances in the boiled or cooked state by the operation of vacuum obtained mechanically in packages which contain these substances (either in a natural state or already to some extent cooked), and by their subsequent exposure in close vessels to the action of steam which effects or completes the cooking.

No. 7732. Process and Apparatus for Reducing Cereals into Flour.*(Procédé et appareil pour convertir les céréales en farine.)*

Van Buren Ryerson, New York, U.S., 9th August, 1877, for 15 years.

Claim.—1st. The combination of a circular case, the interior periphery of which is provided with a succession of abrupt faces, with a revolving disk having radial beaters and provided with sections of rims having also a succession of abrupt faces; 2nd. The combination with the circular case of a milling machine of a revolving disk having radial beaters and provided with sections of a rim; 3rd. The combination of machinery for reducing cereals to flour with suitable machinery for bolting flour, whereby the flour is discharged from the mill under blast pressure directly into the bolt.

No. 7733. Improvements on Flower Stands.*(Perfectionnements aux jardinières.)*

Peter McNeil, Kincardine, Ont., 9th August, 1877, for 5 years.

Claim.—1st. The arrangement of a series of tables or shelves revolving either way round a jointed centre shaft t u; 2nd. The stand on casters w forming the lower part u of a centre shaft into a socket in which an upper part t of said shaft is fixed by means of dowel pins; 3rd. The combination of the water tank e, the indicator f, the tap g on the tank, the hose h, the spring tap or nozzle i, the removable perforated top j of the tank e, the thumb screw k and the nut l, together with the square cavity to receive said nut l and the hose rest o and the flange g; 4th. The arrangement of the movable guard m round each table or shelf, the metal supports n for the same and the bearers pp; 5th. The combination of a stand or casters w, the collar r, the revolving table a and the stationary lamp stand s.

No. 7734. Straw Carrier Bracket for Threshing Machines.*(Console de toile sans fin de machines à battre.)*

John Abell, Woodbridge, Ont., 9th August, 1877, for 5 years.

Claim.—Two oppositely placed and adjustable pivot joints on which the driving pulley head may be adjusted to any angle required.

No. 7735. Spark Arrester. (Arrête-flammèche.)

Charles H. Waterous, Jr., Brantford, Ont., (Assignee of Robert B. D. June and Oratus S. French, Fremont, Ohio, U. S.), 9th August, 1877, for 5 years.

Claim.—1st. The basin or water reservoir B and flue C made or cast in one piece, in combination with the base A; 2nd. The base A consisting of one piece of metal, in combination with the water reservoir or basin B and the inverted cone E, for the purpose of deflecting the sparks into the water contained in the reservoir or basin B and flue C; 3rd. The perforated plates I and J constructed and arranged in relation to each other and in combination with the reservoir B.

No. 7736. Clothes Washing Machine.*(Machine à laver le linge.)*

James R. Bower, Shelburne, N. S., 9th August, 1877, for 5 years.

Claim.—1st. The construction of the washer R with the bars A A; 2nd. The combination of the washer R and the bars A A with the corrugated zinc bottom L; 3rd. The general shape and construction of the machine.

No. 7737. Snow Plough and Track Clearer.*(Charrue à neige et chasse-pierre.)*

Jens T. Jensen, Oskaloosa, Iowa, U. S., 9th August, 1877, for 5 years.

Claim.—The turn-bale B carrying the plough C, elevator D and discharge, all mounted upon the truck A.

No. 7738. Process of Manufacturing Lined Felts. (Procédé de fabrication des feutres doublés.)

Thomas Samuel, Montreal, Que., 9th August, 1877, for 5 years.

Claim.—Combining an outer and inner layer of felted materials by means of a suitable cement applied to the respective fabric, while still in the web or piece, one layer thus forming a lining to the other and both so firmly attached together that one process of cutting and shaping suffices for both outer material and lining.

No. 7739. Automatic Gas Lighter.*(Allumoir à gaz automatique.)*

Kasimir Vogel, Chelsea, James Bartlett and Charles C. Moulton, Boston, Mass., U.S., 9th August, 1877, for 5 years.

Claim.—1st. The combination of a clock movement, a gas cock and its burner with an igniting device with mechanism for actuating the same, all so combined and arranged as to be regulated by such clock movement and a compensating device by which such opening and closing of the gas cock and igniting the gas shall be automatically adjusted to the varying length of days and nights; 2nd. The combination of cams w x, pinion r, segment lever u, gear s with its sliding block t, gear r with its pinion v, gear m and pin p; 3rd. In combination with cams w x, lever z with its toothed arms 1 2 and cam 3 connected with the transmitting shaft 4; 4th. In combination with a gas burner, the two fuse chambers 11 11 with the two feeding pawls 13 13, the two igniting fingers 14 14, and the gas opening devices, all connected with a single actuated mechanism; 5th. In combination with a gas burner the pivoted tilting stirrup 17, spring 18, sliding collar 15 and cap 21.

No. 7740. Improvements on Ice Houses.*(Perfectionnements aux glaciers.)*

Joseph E. Baril, Montreal, Que., 9th August, 1877, for 5 years.

Resumé.—La propriété d'une glacière à double courant d'air o Y o Y o Y o Y, isolant l'air chaud d'avec l'air froid pour préserver les viandes de la saueur qu'elles prennent dans les glaciers ordinaires et qui consiste dans les pièces suivantes: Plancher ou plafond en plan incliné F avec poutrelles f et sous-poutrelles d qui forment la contre-chambre sous plafond W ou réservoir d'air chaud; les arcs-boutants cr, les tringlettes d, porte-crochets a, la cloison latérale G faite en doubles parois pour en rendre la surface intérieure du couloir P complètement anti-condensatrice; ce saidit couloir P, pour le passage du courant d'air chaud Yo les couloirs longitudinaux q et q₁ pour le passage de l'air froid o Y, Yo, les cloisons J postiches ou non, les claire-voies v composées des planches m sur lesquelles sont clouées les tringlettes h et la coupe en double biseau des dites tringlettes; les traverses K et leur pente vers le tuyau x; les planches N formant les rebords longitudinaux du réservoir ou récipient à glace L (et qui est en tôle galvanisée), avec leur inclinaison vers l'intérieur du dit récipient, et que la dite tôle vient recouvrir, et l'application du dit récipient L, tel que placé dans la chambre haute E de la glacière, ainsi que cette chambre E elle-même.

No. 7741. Stove-pipe Elbow Machine.*(Machine à coudes de tuyaux de poêles.)*

Charles H. Amann, Columbus, Ohio, U.S., 9th August, 1877, for 5 years.

Claim.—1st. The anvil wheel B consisting of an exterior right cylindrical part i, and an inner part t of the form of a conical frustum, with its larger base next the part i and of larger diameter than the same, in combination with the hammer wheel B₁ consisting of an outer right cylindrical part j and an inner conical part j₁ of less diameter and forming a re-entrant angle with part j; 2nd. In a pipe jointing machine the combination with the shafts A A₁ and wheel B₁ having the exterior right cylindrical portion J, the conical portion J₁ and the re-entrant angle between, of the anvil wheel B having the exterior cylinder i, the salient part t and the stop flange m, arranged in contact with the inner face of the wheel B₁ and adapted to form a bead on a pipe edge with an oblique flange Q; 3rd. The combination with an anvil wheel, applied upon a shaft rotating in fixed bearings and a hammer wheel on a shaft having movable bearings, of a pressure cam, a lever and a treadle for applying the pressure; 4th. The shaft loosely applied in its bearings at one end and suspended in a vertically movable sash at the other, a connecting rod, a rock cam and an actuating treadle combined; 5th. The spring S in combination with a cam, a lever and a vertically vibrating shaft A₁ having hammer wheel B₁, and a shaft A having anvil wheel B; 6th. The combination with the wheel I having a slightly rounded periphery of the peripherally grooved clamping wheel I₁; 7th. The wheel I₁ having the tapering or bevelled edges p₁ and peripheral grooved p in combination with an anvil wheel I having a slightly rounded periphery.

No. 7742. Machine for Painting Cylindrical Bodies.*(Machine pour peindre les objets cylindriques.)*

Charles T. Brandon, Toronto, Ont., 9th August, 1877, for 5 years.

Claim.—1st. The shaft D D provided with the alternately placed discs F, of regular or irregular widths and placed at regular or irregular distances apart; 2nd. In combination with the shafts D D provided with the alternately placed discs E, the adjustable tables G G and independent colour pans F; 3rd. The combination with the discs E of the colour scrapers K; 4th. The combination with the tables G G provided with the wedge blocks g, of the wedges I I and operating screws H H; 5th. The frame A, shafts D D with alternately arranged colour discs scrapers K, pans F and adjustable table, all combined and arranged to form a machine for painting cylindrical bodies such as broom handles, croquet pins, &c.

No. 7743. Improvements on Hydrants.*(Perfectionnements aux bornes-fontaines.)*

William Todd and Sullivan C. Andrews, Portland, Maine, U.S., 9th August, 1877, for 5 years.

Claim.—1st. The combination with a main and service pipe of a hydrant, &c., of a sliding gate at the main and of a drain valve at the open vertical part of the connecting pipe, the gate and valve being operated simultaneously so that when one is closed the other is open, and vice versa; 2nd. The combination with the main pipe and connecting pipe having guide casing, of a sliding gate operated to open or close the main, by crank shaft and pivot rod connection with the post of the hydrant; 3rd. The combination of the post connecting rod and crank shaft having lug with the drain valve and operating bell crank lever.

No. 7744. Improvements in Mowing Machines.*(Perfectionnements aux faucheuses.)*

William N. Whitely, Springfield, Mass., U.S., 9th August, 1877, for 15 years.

Claim.—1st. The combination of the differential and oscillating gear C C, for driving the cutters, the lifting lever F for elevating the cutting apparatus into an upright position, and the tilting lever H for elevating and depressing the points of the guard fingers; 2nd. The combination of two independent driving and supporting wheels with an adjustable frame M mounted between and carried by said wheels, the differential oscillating gear and the tilting apparatus for tilting the cutters; 3rd. The combination of two independent driving and supporting wheels and the adjustable frame M with the differential oscillating gear, for driving the cutters and the foot lever K and automatic lock K, device carrying the front of adjustable frame and cutting apparatus; 4th. The combination of the adjustable frame M slotted to permit the tilting of the cutting apparatus; 5th. The combination of the slotted adjustable frame M and main shoe carrying the cutting apparatus with the lever H, mounted upon the adjustable frame and connected to the rear of the shoe pin I to tilt or rock the guards up and down; 6th. The combination of the differential and oscillating gear for driving the cutters, the lifting lever F for lifting the cutting apparatus into an upright position, and the foot lever K for carrying the cutting apparatus and front of the adjustable frame M above the ground and the tilting device; 7th. The tilting device mounted upon the adjustable frame M and in the aperture of the driving arm D; 8th. The combination of the lifting lever and tilting lever, notched quadrant plates F; 9th. The connection of the driving arm to the differential oscillating gear by means of lugs C radiating from the centre of said oscillating gear; 10th. The combination of a cutting apparatus driven by differentially oscillating gearing and that can be operated, either in a horizontal or vertical position, while the machine is in motion, and at the same time capable of being tilted to point the guards up and down; 11th. The combination of the adjustable frame M, the hinged or jointed cutting apparatus A hinged or jointed to said adjustable frame; said hinged joint provided with suitable means for tilting or rocking the guards up and down, hinged pole and foot lever mounted upon said pole and connected to the adjustable frame in such manner that the operator can lift the front of said adjustable frame and carry the weight upon the pole; 12th. The combination of two driving and supporting wheels, the adjustable frame M, the differential oscillating gear for driving the knife, the lifting lever to turn the cutting apparatus into an upright position, the tilting apparatus for rocking the points of the guards up and down, and the foot lever to lift the front end of said adjustable frame with the cutting apparatus; 13th. The foot lever K and automatic locking device K', the lifting levers F H with automatic locking device connected to the adjustable frame M in such manner that the operator can lift either end of the cutting apparatus independently and simultaneously and carry the weight upon the pole; 14th. The sliding whiffletrees N and the draught rod O, connected to draw from the centre of the whiffletree pivot direct.

No. 7745. Improvements on Floating Water Wheels and Pumps.*(Perfectionnements aux roues hydrauliques et aux pompes flottantes.)*

Claiborne Harris, Victoria, B.C., 9th August, 1877, for 5 years.

Claim.—1st. The combination of the floating raft, pontoon or boat A with either one or two undershot water wheels B, or any other kind of water wheel; 2nd. The combination of the floating raft, pontoon or boat A, the undershot water wheel or any other kind of water wheel B, the spur wheel C, the pinion D, crank E, connecting rod F, with the double-acting pump I having one or two suction pipes L L and the discharge pipe M or with two pumps.

No. 7746. Stall for Carrying Horses at Sea.*(Stalle pour transporter les chevaux par mer.)*

James Arless, Montreal, Que., 9th August, 1877, (Extension of Patent No. 6856), for 5 years.

No. 7747. Improvement on Brick Machines.*(Perfectionnements des machines à briques.)*

Daniel Davis, London, Ont., 11th August, 1877, (Extension of Patent No. 1591), for 5 years.

Claim.—The application of the press E in combination with the press bar Q, crank N, bevelled pinion L and large bevel wheel C in the application of roller O, in combination with levers P, crank K, in connection with long lever R, crank I and bevelled pinion M, and the manner in which craper G forces the tempered and ground clay into press E.

No. 7748. Sad Iron Heater.*(Chauffeferre de fers à repasser.)*

William H. Haylock, Jonesville, N.Y., U.S., 11th August, 1877, for 5 years.

Claim.—1st. The combination in a heater for sad irons, &c., with the burner and chimney C having seat Cr, of an interchangeable top B having angular corner pieces a; 2nd. The combination of the supporting arms A and burners D with inverted conical lamp chimney C C' and interchangeable top B resting by angular corner pieces on the chimney and arms and having side spaces for exit of heat; 3rd. The oil receptacle E' having a box or casing E filled with a suitable non-conductor of heat, in combination with detachable wick tubes.

No. 7749. Improvements on Syrups, Mineral Waters, &c.*(Perfectionnements aux sirops, eaux minérales, etc.)*

Horace L. Bowker, Boston, Mass., U.S., 11th August, 1877, for 5 years.

Claim.—The combination of saponin extracted from vegetable products with syrups, mineral waters, ciders, beers, ales, etc., or other liquids containing carbonic acid gas, whether natural or artificial.

No. 7750. Machine for Addressing Newspapers.*(Machine à adresser les papiers-nouvelles.)*

Alexander Dick, Buffalo, N.Y., U.S., 11th August, 1877, for 5 years.

Claim.—1st. A mailing machine formed by the combination of the body A D and the inserted and attached parts, viz.: reel guage, web guides d d, web depressing roller C, paste roller O, paste check bearings and bracket wire H I, double wire paste regulator f, slideway M with springs r and brackets t, feeding roller R, belt B, propelling roller Z, handle X with pivoted double wire reel guard h h, pitman Y with thumb screw S, stamping cutter K and fixed cutter P, when the construction and combination of all the various parts singly and relatively are in the manner described; 2nd. The guage wires d d having the loops w w; 3rd. The combination of roller E having pivoted bearings with the paste roller O; 4th. The combination of paste check bearings and bracket wire H I; 5th. In combination with the paste roller O and slideway M the hinged double wire paste regulator f; 6th. In combination with the feeding roller R, the slideway M having the spring r and brackets t; 7th. The handle X having the pivoted double wire reel guard h h and the guide attachment F; 8th. In combination with the handle X and cutter stamp K, the pitman Y with swivelled thumb screw S; 9th. In combination with the belt B feeding roller R and slideway M, the propelling wheel Z; 10th. In combination with the slideway M the feeding roller R; 11th. In combination with the stationary blade P, the stamping blade K having its eye to receive the attaching bolt formed by turning over a part of itself into the form of a tube; 12th. In combination with the cutters K and P and the socket v and the ear L, the nut u having the double function described.

No. 7751. Improvements on Road Scrapers.*(Perfectionnements aux éboueurs de chemins.)*

David Clark, Windsor, Ont., (Assignee of A. Maybee, Maybee, Mich., U.S.), 11th August, 1877, for 5 years.

Claim.—1st. The shoe A constructed with serrated cutting edges H; 2nd. The shoe A constructed with vertical cutting edges I and having a pivoted bale F provided with lower cutting edges J.

No. 7752. Hay Elevating Device.*(Elevateur à foin.)*

George A. Dickson, Shortsville, N.Y., U.S., 11th August, 1877, for 5 years.

Claim.—1st. A pulley block A provided with pivoted hooked bars or arms C C, their upper ends connected together by a toggle joint D with or without a projecting central pin f; 2nd. The pulley block A provided with pulley B, pivoted hooked arms C C connected together by the toggle joint D, in combination with the pivoted lever E; 3rd. The spear shaped catch G formed by the two hinged or pivoted bars G (G having projecting shoulders g g, in combination with the pulley block A provided with pivoted hooked arms C C, toggle joint D and pivoted lever E; 4th. The spear-shaped catch G with hooked ends or projecting shoulders g g and provided with a haap J and recess h for holding the sling rope I, in combination with a pulley block A provided with pulley B, pivoted hooked arms C C, toggle joint D and pivoted lever E.

No. 7753. Device for Converting Reciprocating into Rotary Motion.*(Appareil à convertir le mouvement de va-et-vient en mouvement rotatoire.)*

Absalon G. Smyth, Hamilton, Ont., and John Smyth, Brantford, Ont., 11th August, 1877, for 5 years.

Claim.—1st. One or more automatic locking devices constructed so as to allow a wheel to revolve on its axle in one direction only, in combination with two gear wheels when placed upon separate shafts, or their equivalents, so as to receive the rack N between said wheels and engage both for the purpose of converting reciprocating motion into rotary; 2nd. The rack N provided with cogs placed upon two sides facing opposite directions, in combination with one or more automatic locking devices constructed so as to allow a wheel to revolve on its axle in one direction only for the purpose of con-

verting reciprocating motion into rotary; 3rd. The block I constructed and arranged so as to support and retain in position one or more wheels for the purpose of converting reciprocating motion into rotary; 4th. One or more wheels F F, in combination with one or more automatic locking devices and one or more wheels J J; 5th. The combination and arrangement of one or, more locking devices and one or more shafts G G; 6th. The block I attached to and used in combination with pin E.

No. 7754. Broom Holder. (*Porte-balai.*)

Henry M. Wells and Thomas R. Fuller, Toronto, Ont., 11th August, 1877 for 5 years.

Claim.—1st. The pierced rubber E, irrespective of any particular form in which it is pierced, as secured by the clamping piece D and the arms C C, in combination with a rack or other fixture A; 2nd. A broom holder constructed with pierced rubber E, the rubber E in one or more pieces thereof; 3rd. A broom holder constructed with pierced rubber E in one or more pieces thereof, the application of the same to the holding of the within specified and other such articles.

No. 7755. Improvements on Gas Pipe Fencing.

(*Perfectionnements aux clôtures en tuyaux de gaz.*)

William S. Hobs, London, Ont., 11th August, 1877, for 5 years.

Claim.—1st. The T-side outlet K, cross couplings F F, and double T couplings G G, in combination with lengths of gas pipe B C D E and bolt J; 2nd. In combination with the elbow couplings I I and length of gas H with post L provided with screw foot M and flange N and movable T-couplings O O.

No. 7756. Improvements on Ear Slippers.

(*Perfectionnements aux oreillers.*)

Isaac B. Kleinert, New York, U.S., 11th August, 1877, for 5 years.

Claim.—An outer piece of the desired size and form to cover the ear and an inner or fastening piece, which latter is arc-shaped and secured to the outer piece above the middle portion of the same.

No. 7757. Improvements on Seeding Machines.

(*Perfectionnements aux semailles.*)

John Westlick, Bethany, Ont., 11th August, 1877, for 5 years.

Claim.—1st. The adjustable guard G secured in the draw bar A of a seeding or other such machine; 2nd. The spring E as applied to a seeding or other such machine; 3rd. The combination with the guard G of the draw bar A, tooth B, arm *b*, links C D, stop *e* and spring E; 4th. The combination with the guard G of the draw bar A and tooth B.

No. 7758. Improvements in Food.

(*Perfectionnements dans les composés alimentaires*)

James D. Cragin, Melrose, Mass., U.S., 11th August, 1877, for 5 years.

Claim.—Freshly drawn blood, common salt, pulverized sage, pepper, all-spice, pluck and oatmeal.

No. 7759. Process for Preserving Fruit and Vegetables.

(*Procedé de conservation des fruits et des légumes.*)

Lyman Bradley, Buffalo, N.Y., U.S., 11th August, 1877, for 5 years.

Claim.—The process of treating various fruits and vegetables for the purpose of preserving them in a raw or uncooked state by first impregnating them with sulphurous acid gas, and then filling the barrels or other vessels in which they are afterwards placed with cold water so as to submerge the articles therein.

No. 7760. Improvements in Pipe Core Barrels.

(*Perfectionnements aux noyaux de tuyaux.*)

George Bisset, Jr., and William H. Knight, Quebec, Que., 11th August, 1877, for 5 years.

Claim.—1st. A cylinder formed in segments as a core barrel L L; 2nd. The adjusting pyramidal or cone-shaped blocks H H; 3rd. The adjusting bolts R R; 4th. The mode of applying the bolts through the intervention of the diaphragm M.

No. 7761. Improvements on Thill Couplings.

(*Perfectionnements aux ajustages de limonnières.*)

Alexander P. Ladd, St. Lawrence, N. Y., U.S., 11th August, 1877, for 5 years.

Claim.—1st. In combination with the thill iron A and coupling iron C, the coupling pin D having a crank *a*, elbow *b*, a curved elongation E integrally formed therewith to lock with the irons A C for preventing an endwise movement of the pin D; 2nd. The bow spring F in combination with the clip B and thill iron A to prevent rattling.

No. 7762. Improvements on Washing Machines.

(*Perfectionnements aux machines à laver.*)

Alexander P. Ladd, St. Lawrence, N. Y., U.S., 11th August, 1877, for 5 years.

Claim.—The clothes' carrier or hollow cylinder provided with ribs or beaters D, rounded or blunt on their inner surfaces, for rubbing the clothes and having sharp edges set radially outward so as to direct the currents of water inward, upon and through the clothes, and acting equally well when the stroke or motion of the machine is raised.

No. 7763. Improvements on Refrigerators.

(*Perfectionnements aux réfrigérants.*)

John O. Beck, Laporte, Ind., U.S., 11th August, 1877, for 5 years.

Claim.—The combination of the two chambers *h l*, ice rack *d* and doors *c*, the chambers *h* being located in front of the one *l* and having for its ceiling a portion of the bottom of the ice rack, and elsewhere being open at the top.

No. 7764. Improvements on Spikes.

(*Perfectionnements aux clous barbelés.*)

Edwin R. Whitney, Magog, Que., 11th August, 1877, for 5 years.

Claim.—A spike having a series of indentations in its shank B, the rectangular edges of the shank being unbroken by said indentations.

No. 7765. Improvements on Carriage Clips.

(*Perfectionnements aux brabans de voitures.*)

James Woods, Strathroy, Ont., 11th August, 1877, for 5 years.

Claim.—1st. The iron clips F F with journal boxes G G, bars *a* and tie rods *b b*; 2nd. The clips F F, bar *a*, the rods *b b* and journal boxes G G, in combination with side bars C C, springs D D and spring eveners E E.

No. 7766. Improvements in Clapboarding.

(*Perfectionnements dans le lambrissage à clin.*)

Eli Barrett, Cobourg, Ont., 11th August, 1877, for 5 years.

Claim.—The use of the boards planed and fitted.

No. 7767. Apparatus for Recovering Waste Alkalies.

(*Appareil de revivification des alkalis perdus.*)

John W. Dixon, West Manayunk, Pa., U.S., and John A. Fisher, Dundas, Ont., 11th August, 1877, for 5 years.

Claim.—1st. The combination of a digester A, the evaporating vessel B connected by a pipe C, the auxiliary evaporating pan E, the incinerating hearth H and a furnace I; 2nd. The combination of a furnace I, heat passage K, evaporating pan B over the passage K, coil of pipe L placed in said passage and having upon it a pump M to circulate the liquor from the evaporating pan B through the oil and back to the said pan B, whereby one furnace is used to heat the evaporating pan and the coil containing the liquor in circulation; 3rd. The combination of a furnace I, incinerating hearth H in the heat passage K, evaporating pan B over the passage K, coil of pipe L placed in said passage and having upon it a pump M to circulate the liquor through the coil from and to the evaporating pan B, whereby the united heat from the furnace E and the hearth H through passage K heats both the evaporating pan B and the coil L containing the liquor in circulation; 4th. The combination of the furnace I having incinerating hearth H in heat passages K, an auxiliary evaporating pan E discharging on said hearth and receiving the contents of an evaporating pan B on top of said passage, and a coil L within said passage having a pump M to circulate the contents of pan B through said coil, whereby the process of reclaiming the alkaline salts is performed by continuous operation.

No. 7768. Machine for Setting the Edges of Boots and Shoes.

(*Machine à polir la coupe des semelles de chaussures.*)

George H. P. Flagg, (Assignee of George A. Fullerton), Boston, Mass., U.S., 11th August, 1877, for 5 years.

Claim.—1st. The device for sustaining the tool consisting of the pin K and spring *l*; 2nd. The tool holder K provided with one or more pins *k k* and mounted upon the journal or boss *h*, in combination with catch *m* and plunger *n*; 3rd. The tool M formed with a hollow shaft *p* and with a notch *q* on the shaft, adapted to operate in combination with the spring *l*.

No. 7769. Improvements in Churn Powers.

(*Perfectionnements aux moteurs de barattes.*)

Samuel Weaver, Buchanan, Mich., U.S., 11th August, 1877, for 5 years.

Claim.—The combination of a hanger or its equivalent by which the churning machine is elevated with a weight from which is derived the power or driving mechanism.

No. 7770. Apparatus for the Purification of Gas.

(*Appareil de lavage du gaz.*)

Thomas N. Kirkham, David Hulett, Samuel Chandler, Jr., and Josiah Chandler, London, Eng., 11th August, 1877, for 5 years.

Claim.—The improved washer or scrubber.

No. 7771. Improvements on Harrows.

(*Perfectionnements aux herbes.*)

Benjamin Wetherbie, St. Eleanor's, P.E.I., 11th August, 1877, for 5 years.

Claim.—1st. The combination of the shears F and G, the latter having wings *b* of less curvature and projection than the wings *a* of the former, and bolted to the frame A, whereby they travel within their path; 2nd. The frame A provided with harrow shears F G H subdivided by a hinged joint E.

No. 7772. Dough Raising Apparatus.

(*Appareil à faire lever la pâte.*)

William Skillen and Rebecca L. Skillen, Parnassus, Pa., U.S., 15th August, 1877, for 5 years.

Claim.—1st. The combination of the closet or box A provided with the perforated partitions *a* and the heated brick or like body suspended therein; 2nd. The closet or box provided with perforated partitions, one of which forms a slide or drawer *a*; 3rd. The dough raising apparatus having the detachable reversible hinged cover B.

No. 7773. Improvements in Syringes.*(Perfectionnements aux seringues.)*

John S. Parsons and Joseph H. Yundt, Indianapolis, Ind., U. S., 15th August, 1877, for 5 years.

Claim.—1st. The outer tube A of a syringe formed with its rear end contracted and provided with a screw thread in which operates the screw threaded end C of the inner tube B; 2nd. The inner tapering tube B provided at the large or nozzle end with guides K K K to guide said inner tube B in the centre of tube A; 3rd. The inner tube B provided with a screw thread at small end C and adapted to be operated for adjustment in length by screw thread in the contracted end L of the outer tube A; 4th. The outer tube A provided with an induction tube G at or near its rear contracted end L; 5th. The outer tube A provided with a bulb F; 6th. The inner tube B formed tapering so as to leave a very narrow annular space at the nozzle between it and the outer tube A, and extending beyond the contracted end L of the outer case A with a screw thread or its equivalent in such a manner as to allow the inner tube to be made adjustable endwise and to allow fluids to pass out of the syringe at the nozzle into the recess in which the syringe is inserted and to discharge said fluids through the interior of the inner tube B; 7th. A syringe composed of the outer tube A having a contracted or reduced end L, the inner tapering tube B provided with lugs K K K at or near its nozzle or large end, and further provided with a screw thread C at its small end, the lock nut D, washer E and induction tube G.

No. 7774. Rolls for Making Horse Shoe Blanks.*(Moquettes pour faire les ébauches des fers à cheval.)*

Harvey K. Plagler and Theodore S. Very, Boston, Mass., U. S., (Assignees of Hazeu J. Batchelder), 15th August, 1877, for 5 years.

Claim.—1st. A pair of rolls A B having punches P P adapted to enter a bar from opposite sides and form coinciding cavities; 2nd. A pair of rolls A B having punches P P, which are adapted to enter a bar of iron from opposite sides and form coinciding cavities which are inclined transversely of the bar; 3rd. The roll A having the shape of a conic frustum and provided with the die D or its equivalents and punches P, said die and punches being oblique to the surface of the roll A along its transverse section; 4th. The roll B having the die or enlargement E and punches P, combined with the roll A having punches P; 5th. The roll B having its periphery reduced on one side, in combination with the roll A; 6th. The roll B having the enlargement E, in combination with the roll A; 7th. The roll B having punches P, enlargement E and reduction R, combined with the roll A; 8th. A bar or blank provided with coinciding cavities on its opposite sides.

No. 7775. Improvements on Drills for Metal.*(Perfectionnements aux forêts à métaux.)*

James P. Thompson, Milwaukee, Wis., U. S., 18th August, 1877, for 5 years.

Claim.—1st. An improved drill bit having three longitudinal or spiral flanges whose sides are in cross section of the shape shown *d e*, the said flanges being connected by a central core and being parallel to each other; 2nd. A twist or spiral drill constructed with the annular grinding line D upon the shank A at right angles to the longitudinal centre of the drill.

No. 7776. Improvements on Butter Workers.*(Perfectionnements aux appareils à apprêter le beurre.)*

Eugène Dansereau, Verchères, Que., 18th August, 1877, for 5 years.

Claim.—The combination of the table A, lever B, pin C and eyebolt D.

No. 7777. Improvements in Ploughs.*(Perfectionnements dans les charrues.)*

Napoléon F. Patenaude, Sorel, Que., 18th August, 1877, for 5 years.

Claim.—1st. The contour form given to the mould board A; 2nd. The construction of the skeleton B (otherwise called land side) in two metal plates, the outer plate being of steel; 3rd. The unattached sole in combination with slotted lugs and the method of raising or depressing the sole by means of screws.

No. 7778. Improvements in Dredging Machines.*(Perfectionnements aux machines à draguer.)*

Charles O. Davis, Portland, Me., U. S., 18th August, 1877, for 5 years.

Claim.—1st. The combination with the rigid swinging crane A of the horizontal friction wheel D and a device for clamping said wheel; 2nd. The combination in dredging machinery of the chain M and the vertical rods or shafts that operate the buckets for holding the buckets down; 3rd. The combination of the chain J, slotted piece h, frame H, bars j and buckets G G and chain L; 4th. The combination of the chain J, the slotted piece h, frame H, chain L, sheaves m r, rods F, bars j and buckets G G; 5th. The combination of the tubular shafts E, rods F and buckets of a dredging machine; 6th. The combination of the shafts E, rods F, slotted piece h, bars j, buckets G G, frame H, guides D, chains J L M and crane A.

No. 7779. Improvements on Fare Registers.*(Perfectionnements aux registres des billets de passage.)*

William H. Hornum, New York, U. S., 18th August, 1877, for 5 years.

Claim.—1st. The combination in a fare register of a pawl and ratchet for preventing the registering mechanism from being turned backward, a registering mechanism, an alarm mechanism, a prime-mover common to both and a locking latch for preventing the alarm from being sounded while the registering mechanism is free to be turned to zero; 2nd. The combination in a fare register of a single trip register, a general register, a prime mover common to both, a pawl and ratchet for preventing the single trip register from being turned back, and a locking latch for preventing the general register from being moved while the single trip register is free to be turned to zero; 3rd. The combination in a fare register of a single trip register, a general register, an alarm, a prime mover common to all three, a pawl and ratchet for preventing the single trip register from being turned back, and a locking latch for preventing the general register and the alarm from being moved while the single trip register is free to be turned to zero; 4th. The combination with the locking latch, the alarm mechanism and the registering mechanism of a pawl for locking the latch of a projection cam or toe on

any part of the registering mechanism for releasing the locking latch automatically when the registering mechanism has been turned to zero; 5th. The combination in a fare register with a registering mechanism and alarm, a prime mover common to both, a locking latch, a pawl for retaining said locking latch, and a tooth of projection for releasing the locking latch of a zero stop to arrest the registering mechanism at the moment the locking slide is released; 6th. The combination in a fare register of a solid protector with the alarm bell or gong and with the sound openings in the sides of the case, said protector being provided with an opening in its top; 7th. The combination in a fare register of a registering mechanism, an alarm, a prime mover common to both and a dial K, indicating the number of times the register has turned to zero.

No. 7780. Trimmer and Braid Guide Attachment for Sewing Machines.*(Lames de machines à coudre.)*

Eleanor C. Sproul and Samuel S. Rickman, Hamilton, Ont., 18th August, 1877, for 5 years.

Claim.—1st. In combination with a sewing machine of the plate E, constructed with folder f, braider l j, cloth holder k and slots g m; 2nd. In combination with the plate E of the plate D, constructed with folder n and slots g corresponding with slots g of the plate E; 3rd. In combination with a sewing machine, of the plates E and D constructed and operated for braiding, hemming, tucking and binding.

No. 7781. Improvement in Lamps.*(Perfectionnement des lampes.)*

Abner Burbank, Ethan A. Chase and Douglas Hovey, Rochester, N. Y., U. S., 18th August, 1877, for 5 years.

Claim.—1st. An air injecting lamp constructed with air pipes A₁ enclosing the oil receptacle B, branch pipes A₂ A₂ provided with the injectors a a, and oil pipes D D connected at one end with the receiver C and at the other with the burners E E; 2nd. The combination with the transparent receptacle B constructed with the narrow neck d, of the shallow receiver C contracted at its top so as to embrace only the neck, leaving the whole body of the receptacle exposed; 3rd. The combination with the receptacle B and air pipes A₁ A₁ of the holder I; 4th. The combination with the burner E₁ and injecting tube or opening g, of the deflector p and screens h h.

No. 7782. Improvements on Car-Couplings.*(Perfectionnements aux attelages de wagons.)*

Charles Dobbs and Samuel L. Robinson, Millwood, Texas, U. S., 18th August, 1877, for 5 years.

Claim.—The combination of the projection c on top of the front end of the head d, flanges g, hooks e and bolts t, the head being cut away between the projection c and flanges g, so that the links or hooks can slip off sideways.

No. 7783. Steam Boiler Injector.*(Injecteur de chaudière à vapeur.)*

William T. Messenger, Boston, Mass., U. S., 18th August, 1877, for 5 years.

Claim.—1st. The movable and stationary nozzles provided with means of guiding the movable one rectilinearly and with an adjusting screw or screws; 2nd. The pump barrel and its valve case formed or made in one entire piece; 3rd. The pump educt and the chambered rear nozzle receiver formed or made in one entire piece; 4th. The movable nozzle provided with a valve and open chamber and notched head, in combination with an operative screw provided with a head neck and shoulder, and applied to the nozzle and case cap.

No. 7784. Improvements in Tobacco Pipes.*(Perfectionnements dans les pipes de tabac.)*

Samuel R. Dummer, Jersey, N. J., U. S., 18th August, 1877, for 5 years.

Claim.—1st. The bowl of a smoking pipe made wholly of tobacco or of tobacco mixed with the ingredients named or their equivalents, to prevent the two ready combustion of the bowl; 2nd. The combination of a screw-threaded socket provided with wing or wings a to hold it in place, and the bowl of a smoking pipe, the socket being of different material from the bowl.

No. 7785. Improvements on Ice Creepers.*(Perfectionnements aux crampons à glace.)*

Thomas Gunsalus, West Troy, N. Y., U. S., 18th August, 1877, for 5 years.

Claim.—The body A, screw B, concave arms a having sharp edges b and central spur c, the latter projecting beyond the edges b, constructed and arranged as described.

No. 7786. Punching and Shearing Machine.*(Machine à poinçonner et découper.)*

Moritz Gluck, New York, U. S., 18th August, 1877, for 5 years.

Claim.—1st. The compound levers B C D, combined together in the frame A, in which are fixed their fulcrums b c d, the whole series of the said levers being coupled together by the cog gearing b c c d; 2nd. The cutting knife E, in combination with the compound levers B C and D; 3rd. The guard plate F attached to the side of the bed plate A, by the screw f; 4th. The gauge G G; 5th. The punch stock H, in combination with the compound levers B C D; 6th. The adjustable attachment for the guide I to the bed plate by means of the bolts t and slots a; 7th. The adjustable punch die k formed with adjusting slots k and adjustably attached to the bed plate A by means of the bolts L and the said adjusting slots k, and the bed plate slots a² so as to centre the said die plate to the punch.

No. 7787. Improvements on Rotary Churns.*(Perfectionnements aux barattes rotatoires.)*

James Burbank, (Assignee of Maxime Caissé), Danville, Que., 18th August, 1877, for 5 years.

Claim.—The combination of the pipe P P passing through the hollow gudgeon G and the arm or stay A.

No. 7788. Improvements on Potato Diggers.*(Perfectionnements aux arrache-patates.)*

Lewis A. Aspinwall, London, England, 18th August, 1877, for 5 years.

Claim.—1st. The employment of the flat separator I; 2nd. The employment of the flat separator I and supported at one side; 3rd. The separator I in combination with the spade D.

No. 7789. Improvements on Electric Telephony.*(Perfectionnements à la téléphonie électrique.)*

Alexander G. Bell, Boston, Mass., U.S., 22nd August, 1877, for 5 years.

Claim.—1st. The union upon and by means of an electric circuit of two or more instruments, so that if motion of any kind or form be produced in any way in the armature of any one of the said instruments, the armatures of all the other instruments upon the same circuit will be moved in like manner and form, and if such motion be produced in the former by sound, like sound will be produced by the motion of the latter; 2nd. A system of electric telegraphy or telephony consisting of transmitting and receiving instruments united upon an electric circuit, the production in the armature of each receiving instrument of any given motion by subjecting said armature to an attraction varying in intensity; however such variation may be produced in the magnet or the production of any given sound or sounds from the armature of the receiving instrument, by subjecting said armature to an attraction varying in intensity in such manner as to throw the armature into that form of vibration which characterizes the given sound or sounds; 3rd. The combination with an electro-magnet of a plate of iron or steel, or other material capable of inductive action, which can be thrown into vibration by the movement of surrounding air or by the attraction of a magnet; 4th. The combination with a plate and an electro-magnet, of means whereby the relative position of the two may be adjusted so that without touching they may be set as closely together as possible; 5th. The formation, in an electric telephone, of a magnet with a coil upon the end or ends of the magnet nearest the plate; 6th. The combination with an electric-telephone of a sounding box; 7th. In combination with an electric-telephone, the employment of a speaking or hearing tube for conveying sounds to or from the telephone; 8th. In a system of electric telephony, the combination of a permanent magnet and a plate of iron or steel, or other material capable of inductive action, with coils placed upon the end or ends of said magnet nearest the plate; 9th. In a telephone, the magnet being arranged within the handle portion.

No. 7790. Window Screen.*(Ecran de fenêtre.)*

James C. Walker, John H. Ryal and James W. Corry, Detroit, Mich., U.S., 22nd August, 1877, for 5 years.

Claim.—The combination of the hollow automatic roller having telescopic extension piece E, sockets b b with dove-tailed grooves a a, side plates C C, rod D, screen F, metallic strips H having openings CC, sash in combination with screen having hooks d d and metallic strips I.

No. 7791. Improvement in Fanning Mills.*(Perfectionnement dans les tarrares.)*

Andrew W. Kendrick and Charles T. Kendrick, Brooklyn, N.Y., U.S., 22nd August, 1877, for 5 years.

Claim.—1st. The wheel Q and pins R, in combination with the cam guides Z and lever T, for giving motion to the screens of grain and seed separators; 2nd. The adjustable horizontally vibrating lever W pierced with holes in a line crossing its centre provided with the embedded nut, the U-formed clevis X and the bolt T; 3rd. The combination of the wheel Q provided with perforations R, the lever provided with cam track L, the lever provided with perforations R, embedded nut, clevis X and bolt Y, the adjustable connecting rod N provided with the thread and thumb nuts, and the screens C and x; 4th. The adjustable and removable supporting block E, formed with grooves to receive and support the screens, and the slot for the reception of a fastening bolt provided with a thumb nut; 5th. The combination with the screen frames of the horizontally vibrating lever W having the perforations, the embedded nut, the U-formed clevis X rigidly attached to its under side and having its upper part fitting over the screen frame to confine it from vertical motion, the parts being pivotally connected by bolt Y; 6th. The combination with the projecting screen supports d of an adjustable inclined screen or screens C and x having an offset or shoulder at each side plated with iron adapted to strike said blocks in the motion of screens; 7th. The combination of the projecting screen supports d, the screen or screens having the shoulders or offsets at the sides plated with iron, the adjustable horizontally vibrating lever W provided with the perforations, the embedded nut, the rigid clevis and the pivot bolt; 8th. The flexible hanger made of three pieces of strap or sheet metal connected rigidly together in Y-form and having the upper end of the Y rigidly secured to the casing of the mill and the lower end to the shoe; 9th. The adjustable and reversible screening box L provided with the pivoted cleats P at its sides and a smooth imperforate bottom adapted for use as a chess board; 10th. The adjustable chess board and deflector M provided with guard or fender Mr and pivoted cleats P; 11th. The fan doors or valves r constructed in sections hinged together, one section being supported upon the other and adapted to open laterally; 12th. The portion disc O of the fan arranged to fit accurately within the drum and divided into two air compartments while allowing the free rotation of the fan; 13th. The combination with the partition disc O slotted to receive and carry the fan wings, of the fan wings A convex in cross section in the direction of rotation; 14th. The detachable doubly inclined spout N covered with coarse wire net work and provided with arms B secured to the spout above the net work and serving both as a means of attachment to the nest of screens and as fenders for guiding off the coarse impurities; 15th. The adjustable supporting screws S for steadying and bevelling the mill formed with a conical point and annular shoulder or offset.

No. 7792. Instrument for Drawing Ships' Lines.*(Instrument pour tirer les lignes des navires.)*

Robert D. Duthie, Aberdeen, Scotland, 22nd August, 1877, for 5 years.

Claim.—The construction and use of an improved draughting board supported on brackets and fitted with horizontal slide bar and slide and vertical tracing slide or bar.

No. 7793. Improvements on Steering Apparatus.*(Perfectionnements aux appareils à gouverner.)*

Charles H. Herson, Lord's Cove, N.B., 22nd August, 1877, for 5 years.

Claim.—The combination with the rudder post B of the platform E, tiller F having bifurcated stems I, steering wheel J having screw core hub J, and screw rod L secured fixedly at the ends whereby, by the movement of the wheel, the steersman's position coincides with the movement of the rudder.

No. 7794. Machine for Separating and Scouring Wheat.*(Machine à séparer et nettoyer le blé.)*

Hiram J. Livergood, Brantford, Ont., 22nd August, 1877, for 5 years.

Claim.—1st. The suction fan B so constructed that it sucks from both sides at once; 2nd. The back suction leg H H fastened to a perpendicular fan case and also to the frame of machine, in combination with a combined separator and scourer, also in combination with a horizontal scouring cylinder; 3rd. The manner of constructing the shoe C C, the way to oat sieves N N and return boards P P, all as arranged in shoe, the carrier boards O O which convey the wheat to the cockle sieves, the manner of setting the cockle sieves at reverse angles to what the oat sieves stand; 4th. The manner of constructing the scouring cylinder D D of staves or sections, these staves are cast with teeth on them, also have a rib bolted to them in a spiral form; these staves fit in recess in the heads, also use of beaters in combination with an adjustable brush, J is the compressing links for the purpose of setting the brushes to the scouring case or from it, this is done by a bolt at the end of the scouring cylinder; 5th. The wire cloth scouring case E E, the manner in which it is constructed of a flat warp and a round filling, the fillings are not crimp as the wire cloth is usually made in combination with a horizontal scourer; 6th. The manner of passing current of air underneath the scouring case E and between the outer case to the suction leg I independent of the scouring of the wheat; 7th. The suction leg I standing in a perpendicular position and fastened to a perpendicular fan case so arranged that the wheat is thrown directly from the scouring cylinder into the bottom of the suction leg I; 8th. The manner of setting the suction leg I so that it joins one end of the scouring cylinder D and forms a suction directly under and all around the outside of the scouring case for the purpose of suction, the fuses and dirt after being scoured off the wheat; 9th. The manner of constructing the double crank or eccentric motion for driving the shoe, in combination with a combined separator and scourer.

No. 7795. Improvements in Fire-proof Safes.*(Perfectionnements aux coffres-forts.)*

Thomas Fuller, Montreal, Que., 22nd August, 1877, for 5 years.

Claim.—The space between the outer and inner walls filled in, either wholly or partially, with blast furnace slag or any preparation thereof.

No. 7796. Stone Sawing Machine.*(Machine à scier la pierre.)*

William C. Hoffman, Toledo, Ohio, U.S., 22nd August, 1877, for 5 years.

Claim.—1st. In combination with the saws O the bars P P, each provided with a vertical and a horizontal groove p p' respectively and a slot p₁ at one end of said groove p₁, the blocks Q inserted within said groove p between and upon each side of said saws and the tightening wedge q fitted into said slot; 2nd. In combination with the rails L of the saw frame provided each upon its lower side with a V-shaped bar U, the blocks D arranged to slide vertically within the opening e within the main frame and having upon its inner face a journaled roller K that has a V-shaped peripheral groove and the lug d₁ which projects over said rail; 3rd. In combination with the saw frame the vertically moving blocks D having the horizontal space d₂, the nut E fitted into said space, the vertical screws G, the shafts H and I and the mitre gears h h' g g' i; 4th. In combination with the raising and lowering mechanism described, the gear wheels R S, the pinion S and V, the bar T provided with the stud t, the stud U, the cone pulley V, the bar w having the hooked projection w and the pin or stud u secured within and projecting from the main frame; 5th. In combination with the raising and lowering mechanism, the pulleys X journaled upon the shaft H, and the clutch Y secured upon said shaft between said pulleys; 6th. The machine constructed and arranged to operate in the manner shown.

No. 7797 Improvements in Dough Troughs.*(Perfectionnements aux huches à pétrir.)*

John W. Martin and George Burgert, Alliance, Ohio, U.S., 22nd August, 1877, for 5 years.

Claim.—1st. The combination of the exterior and interior vessel; 2nd. The supports or ribs D on either exterior or interior vessel for the purpose of firmly supporting interior vessel, thus making one solid vessel; 3rd. The space between the vessel with opening for admitting water, and two or more small holes or vents in flange for escape of steam and draining.

No. 7798. Metal Can Seaming Machine.*(Machine à faire les coutures des boîtes métalliques.)*

Francis R. Walsh and Francis A. Bowen, Chicago, Ill., U.S., 22nd August, 1877, for 5 years.

Claim.—1st. The combination with the lever K of the disc K₁ carrying the seaming rollers L M N; 2nd. The combination with the disc K carrying the seaming rollers L M N and provided with the notches h i j, of the pawl o and spring m, for adjusting and holding the disc; 3rd. The combination with the lever S carrying the roller r, of the spring catch n; 4th. The combination with the disc k₂ carrying the rollers L M N, of the lever S carrying the roller r.

No. 7799. Improvements in Window Ventilators.*(Perfectionnements aux ventilateurs de croisées.)*

Chris Clushman and Charles Porter, Hamilton, Ont., 22nd August, 1877, for 5 years.

Claim.—The pane of glass A having circular or other shaped holes B B with an adjustable glass cover C to correspond, and pivoted to the said pane of glass by pin E secured by nuts D D.

No. 7800. Improvements on Milk Coolers.*(Perfectionnements aux rafraichissoirs à lait.)*

Orrin J. Stiockles, Canton, N.Y., U.S., 22nd August, 1877, for 5 years.

Claim.—The combination of the concentric pans A B, the latter having a central bottomless chamber F to contain ice.

No. 7801. Improvements on Cattle Stanchions.*(Perfectionnements aux étaies à bétail.)*

Zalmon W. Smith, Addison, N.Y., U.S., 30th August, 1877, for 5 years.

Claim.—1st. The lower stanchion pivot a provided with semi-peripheral groove and having a locking device; 2nd. The combination with pivoted sections C C of the weighted link d working in slot d₁, the latch f sliding in the inclined slot f₁ and the stop pin f₂.

List of Patents Issued up to 14th September, 1877, but not yet officially published in the Patent Office Record.

- No. 7802. G. Elmslie, Toronto, Ont., "Car Wheel," (Extension of Patent No. 7628), 30th August, 1877.
 No. 7803. T. Wilson, Richmond Mill, Ont., "Fanning Mill," (Extension of Patent No. 1641), 31st August, 1877.
 No. 7804. H. Albrecht, Philadelphia, Pa., U.S.A., (Assignee of J. F. Burrow), and John Solter, Baltimore, Md., U.S.A., "Plating Machine," 28th August, 1877.
 No. 7805. F. X. Rousseau, Montreal, Que., "Trap and Ventilator," 29th August, 1877.
 No. 7806. W. E. S. Baker, (Assignee of J. H. Lewars and C. Klontz, Philadelphia, Pa., U.S.A.), "Lump Collar," 29th August, 1877.
 No. 7807. J. E. Minshall, Middletown, N.Y., U.S.A., "Tube Expander," 29th August, 1877.
 No. 7808. N. W. Spaulding, San Francisco, Cal., U.S.A., "Saw Teeth," 29th August, 1877.
 No. 7809. E. Stovel, Guelph, Ont., "Pump," 29th August, 1877.
 No. 7810. H. B. Evans, Saint Charles, Miss., U.S.A., "Brick Kiln," 29th August, 1877.
 No. 7811. E. P. Terrell, Bellefontaine, Ohio, U.S.A., "Saw Grinder," 29th August, 1877.
 No. 7812. F. R. Hawkins, Tilsontown, Ont., "Grain Cleaner and Separator," 29th August, 1877.
 No. 7813. J. M. Lichtler, Luray, Va., U.S.A., "Machine for Stuffing Horse Collars," 29th August, 1877.
 No. 7814. J. B. Goff, Canadoc, Ont., "Portable Fence," 29th August, 1877.
 No. 7815. D. D. Wright, Oakville, Ont., "Car Coupler," 29th August, 1877.
 No. 7816. J. Foley, Montreal, Que., "Water Purifier," 29th August, 1877.
 No. 7817. W. Craig, J. S. McMurray, and F. R. Fuller, Toronto, Ont., "Bang Making Machine," 29th August, 1877.
 No. 7818. H. Harrington, Hammondsport, Ont., "Moveable Fence," 29th August, 1877.
 No. 7819. T. E. King, Rockville, Conn., U.S.A., "Spool Stamping Machine," 29th August, 1877.
 No. 7820. J. M. Simpson, Oshkosh, Wis., U.S.A., W. Ault, Toronto, Ont., "Steam Engine," 29th August, 1877.
 No. 7821. B. Horsley, Middletown, N.Y., U.S.A., (Assignee of F. E. Schurz, Middletown, N.Y.), "Art of Binding Books," 29th August, 1877.
 No. 7822. S. Caddick, P. mabrook, Maine, U.S.A., "Puddling and Heating Furnace," 29th August, 1877.
 No. 7823. S. L. Worth, and J. H. Pontifex, Oxford Street, Middlesex Co., England, "Mode of Ventilating Water proof Garments," 29th August, 1877.
 No. 7824. W. H. Forbes, Baltimore, Md., U.S.A., "Porth-hole Protector," 29th August, 1877.
 No. 7825. D. Scott, Olney, Ill., U.S.A., "Barrel Stand," 29th August, 1877.
 No. 7826. W. H. Stafford, and S. S. Cook, Woonsocket, R.I., U.S.A., "Tape Clip," 29th August, 1877.
 No. 7827. O. Lingensfelder, and H. R. Morris, Merrickville, Ont., "Blocking and Ironing Shirt Bosom Board," 29th August, 1877.
 No. 7828. J. Foley, Montreal, Que., "Water Filter," 29th August, 1877.
 No. 7829. C. H. Victory, and A. P. Adams, Albany, N.Y., U.S.A., "Snow Shovel," 29th August, 1877.
 No. 7830. H. W. Putnam, Bennington, Vt., U.S.A., "Barbed Fence Wire Making Machine," 29th August, 1877.
 No. 7831. G. Pyc, St. John, N.B., "Harvester," (Extension of Patent No. 3890), 1st September, 1877.
 No. 7832. G. Pyc, St. John, N.B., "Harvester," (Extension of Patent No. 3891), 1st September, 1877.
 No. 7833. C. A. Bissel, St. John's, Que., "Hose Coupling," 30th August, 1877.
 No. 7834. T. A. Bissel, Detroit, Mich., U.S.A., "Car Axle Box," 30th August, 1877.
 No. 7835. F. Jarek, Erie, Pa., U.S.A., "Shut-off Box for Gas and Water Pipes," 3rd September, 1877.
 No. 7836. J. A. Fordon, Bay City, Michigan, and J. E. Thomas, West Bay City, Michigan, U.S.A., "Boiler Cleaner," 3rd September, 1877.
 No. 7837. W. H. Palmer, Warren, Pa., U.S.A., and H. F. Roesser, Buffalo, N.Y., U.S.A., "Spring Bed Bottom," 3rd September, 1877.
 No. 7838. J. Demack, Easton, Ont., "Churn," 3rd September, 1877.
 No. 7839. D. T. Shaw, New York, U.S.A., "Riding and Driving Reins," 3rd September, 1877.
 No. 7840. P. Payette and T. A. Cook, Toronto, Ont., "Bread Knife," 3rd September, 1877.
 No. 7841. J. P. Patten, Yarmouth, N.S., "Self-supporting Style of Fire-proof Buildings," 3rd September, 1877.
 No. 7842. J. F. Greene, Brooklyn, N.Y., U.S.A., "Fibre Manufacture," 3rd September, 1877.
 No. 7843. G. S. Wolf, Philadelphia, Pa., U.S.A., "Coloring Composition," 3rd September, 1877.
 No. 7844. C. Nysewander, New Carlisle, D. Nysewander, Jr., Springfield, and J. Nysewander, New Carlisle, (Assignees of D. Nysewander, Springfield, Ohio, U.S.A.), "Windmill," 3rd September, 1877.
 No. 7845. R. Doty, and J. Doty, Wellsville, N.Y., U.S.A., "Wagon Spring Attachment," 3rd September, 1877.
 No. 7846. C. D. Pierce, Philadelphia, Pa., U.S.A., "Earth Auger," 3rd September, 1877.
 No. 7847. A. M. Goldschmidt, Preston, Ont., "Invalid Chair and Lounge," 3rd September, 1877.
 No. 7848. P. Lord, St. John's, Que., "Fire Escape Ladder," 3rd Sept., 1877.
 No. 7849. J. W. Rogers, Salem, Mass., U.S.A., "Sole Buffing Machine," 3rd September, 1877.
 No. 7850. H. F. Bush, and M. L. Bush, Douglassville, Pa., U.S.A., "Attachment to Grindstones for Sharpening the Knives of Mowing and Reaping Machines," 3rd September, 1877.
 No. 7851. R. G. Leckie, Actonville, Que., "Revolving Roasting Furnace," 3rd September, 1877.
 No. 7852. G. F. Deacon, Liverpool, England, "Tramway," 3rd Sept., 1877.
 No. 7853. T. Mann, Portland, Multnomah, Oregon, U.S.A., "Brick and Mortar Elevator," 3rd September, 1877.
 No. 7854. P. E. Rudel, Grand Rapids, Mich., U.S.A., "Wreiger and Wash Bench Combined," 3rd September, 1877.
 No. 7855. Wm. Foote, Fillmore, N.Y., U.S.A., "Vehicle Spring," 3rd September, 1877.
 No. 7856. R. B. Hamar, Eden, Me., U.S.A., "Door Threshold," 3rd September, 1877.
 No. 7857. J. Keller, Chatham, Ont., "Tea Kettle," 4th September, 1877.
 No. 7858. H. W. Coulter, South Cayuga, Ont., "Clothes Dryer," 4th September, 1877.
 No. 7859. Wm. Pettis, Port Greville, N.S., "Churn," 4th September, 1877.
 No. 7860. J. Wright, Toronto, Ont., "Door Bolt," 4th September, 1877.
 No. 7861. S. L. Gould, Gardiner, Me., U.S.A., "Pulp Engine," 4th September, 1877.
 No. 7862. W. Clubine, Goodwood, Ont., "Anti-pressure Steam Engine Valve," 4th September, 1877.
 No. 7863. Jos. Aski z, Elida, Ohio, U. S. A., "Glass Burial Case," 4th September, 1877.
 No. 7864. S. Heushall, Philadelphia, Pa., U.S.A., "Machinery for Manufacturing Boots and Shoes," 4th September, 1877.
 No. 7865. J. F. Starr, Jr., Cannden, N. J., U. S. A., "Sheet Metal Pipe," 4th September, 1877.
 No. 7866. A. B. Coleman, Lyndenville, N. Y., U. S. A., "Harness," 4th September, 1877.
 No. 7867. R. G. Leckie, Acton Vale, Que., "Method of Separating Sulphur from its Ores," 4th September, 1877.
 No. 7868. J. F. Golden, Toronto, Ont., "Railroad Switch Shifter," 4th September, 1877.
 No. 7869. M. Van Buren Center, Mount Albert, Ont., "Stamp Extractor," 4th September, 1877.
 No. 7870. J. Forbes, Dartmouth, N.S., "Electrical Apparatus for Insulating Overstrain or Weakness in Roofs, Bridges, &c.," 4th September, 1877.
 No. 7871. P. O. Jenkins, Gilman, Ill., U. S. A., "Lime Heating Stove," 4th September, 1877.
 No. 7872. N. K. Joyce, Brooklyn, N.Y., U.S.A., "Air Register," 4th September, 1877.
 No. 7873. A. Fickett, Rochester, N.Y., U.S.A., "Wood Pulping Engine," 6th September, 1877.
 No. 7874. J. A. Fox, Newfaun, N.Y., U.S.A., "Wagon Jack," 12th September, 1877.
 No. 7875. P. H. Lee, Binghamton, N. Y., U. S. A., "Ventilating Undergarment," 12th September, 1877.
 No. 7876. "The Neptune Fog Horn Company of Quebec, Que., (Assignee of G. S. Gaudin, Montreal, Que.), "Fog Signal," 12th September, 1877.
 No. 7877. W. R. Brandon and H. Wheeler, Walsingham, Ont., "Stamp Extractor," 12th September, 1877.
 No. 7878. M. W. Griffiths, Middle Granville, N. Y., U. S. A., "Line Printer," 12th September, 1877.
 No. 7879. W. Jones, Oshawa, Ont., "Blind Hinge," 12th September, 1877.
 No. 7880. R. B. Sheldon, Shortsville, N.Y., U. S. A., "Lock and Spring Attachment for Seed Sowing Machines," 12th September, 1877.
 No. 7881. N. Van Allen, Chicago, Ill., U.S.A., "Braces and Suspenders," 12th September, 1877.
 No. 7882. C. K. Marshall, Vicksburg, Miss., U.S.A., "Letter Envelope," 12th September, 1877.
 No. 7883. W. Bristol, Madoc, Ont., "Shifting & Folding Vehicle Seat," 12th September, 1877.
 No. 7884. C. La Dow, Albany, N.Y., U.S.A., "Harrow Cultivator," 12th September, 1877.
 No. 7885. C. S. Anthony and J. Manheim, Taunton, Mass., U.S.A., "Devices for Preventing the Accumulation of Frost and Steam upon Store Windows," 12th September, 1877.
 No. 7886. R. Roberts, St. Joseph, Mo., U.S.A., "Cigar Making Machine," 12th September, 1877.
 No. 7887. C. K. Marshall, Vicksburg, Miss., U. S. A., "Postal Card," 12th September, 1877.
 No. 7888. E. Sanders, Yarmouth, N.S., "Double Action Ship's Pump," 12th September, 1877.
 No. 7889. L. B. Herrien, Galesburg, Ill., U. S. A., "Plating Machine," 12th September, 1877.
 No. 7890. J. P. Edwards, Annapolis, N.S., "Car Coupler," 12th September, 1877.
 No. 7891. G. W. Copeland, Malden, Mass., U.S.A., (Assignee of L. Woodward and M. Brock, Boston, Mass., U.S.A.), "Lasting Machine for Boots and Shoes," 12th September, 1877.
 No. 7892. Jno. Beaudet, Cambridge, Mass., U.S.A., "Hinge," 12th September, 1877.
 No. 7893. J. Labelle, Sault-aux-Récollets, Que., "Pont Bug Gun," 12th September, 1877.
 No. 7894. Jas. Flower, Detroit, Mich., U.S.A., "Tap and Die," 12th September, 1877.
 No. 7895. F. Keenan, Brownville, N. Y., U. S. A., "Rock Drilling Machine," 12th September, 1877.
 No. 7896. B. W. Brown, (Assignee of W. K. Lewis, Boston, Mass., U.S.A.), "Method of Putting up Baked Beans," 12th September, 1877.
 No. 7897. J. Postwick, Buffalo, N. Y., U.S.A., "Bed Bottom," 12th September, 1877.
 No. 7898. M. L. King, Oblong, Ill., U.S.A., "Water Power Apparatus," 12th September, 1877.
 No. 7899. Jas. Flower, Detroit, Mich., U.S.A., "Chuck for Working Pipe Fittings," 12th September, 1877.
 No. 7900. W. E. Wilcox and L. A. Kelsey, Cleveland, Ohio, U.S.A., "Railway Journal Box," 12th September, 1877.
 No. 7901. James C. Wilson, Montreal, Que., (Assignee of L. D. Bowser, Boston, Mass., U.S.A.), "Squire Bottom Bag," (Extension of Patent No. 1944), 12th September, 1877.
 No. 7902. L. S. Robbins, N. Y., U.S.A., "Preserving and Vulcanizing Wood Process," 12th September, 1877.
 No. 7903. E. R. Lange, Langford, Ont., "Wagon Cramp," (Extension of Patent No. 7719), 13th September, 1877.
 No. 7904. G. Boulter, Montreal, Que., "Improved Moccasin," 13th September, 1877.
 No. 7905. Jno. Abell, Woodbridge, Ont., "Tilting and Locking Lever for Rake Heads," 13th September, 1877.
 No. 7906. C. N. Fowler, Youngstown, Ohio, U.S.A., "Pessaries," 13th September, 1877.
 No. 7907. J. H. Corrin, Bruce Mines, Ont., "Combined Sofa and Bed," 13th September, 1877.
 No. 7908. H. Wright, Danmariscotta, Me., U.S.A., "Match Splints Machine," 13th September, 1877.
 No. 7909. L. Leathers, Oakland, Cal., U. S. A., "Artificial Stone" (Extension of Patent No. 7552), 13th September, 1877.
 No. 7910. L. Leathers, Oakland, Cal., U. S. A., "Artificial Stone" (Extension of Patent No. 7553), 14th September, 1877.

INDEX OF INVENTIONS.

Addressing newspapers, A. Dick	7750
Alkalies, recovering, J. W. Dixon et al.	7767
Asale boxes, A. Calder	7681
Barrel, J. Tomlinson	7707
Blotters and covers, J. W. Payson et al.	7705
Boots and shoes, G. H. P. Flagg	7768
Brek machine, D. Davis	7717
Broom holder, H. M. Wells et al.	7751
Brooms and brushes, T. Jesson et al.	7712
Butter workers, E. Jansereau	7776
" machines, C. Radcliffe	7690
Can seaming, F. A. Walsh et al.	7798
Cans, oil, J. Graves	7681
Car-couplings, C. Dobbs et al.	7782
" " J. M. Keen	7682
" " W. Craig	7762
Carpet sweepers, A. S. Hinkley	7679
Carriage clips, J. Wood	7765
Cattle stanchions, Z. W. Smith	7801
" wash, W. Clark	7708
Chandeller, extension, W. A. Hull	7713
Cheese presses, A. S. Beach	7717
Churn dashers, J. and A. Ferguson	7720
" powers, S. Weaver	7769
Churns, W. H. Conner	7700
" rotary, J. Burbank	7787
Cigars, J. H. Campfield	7692
Clap boarding, E. Barrett	7766
Cooking stoves, C. A. Hamelin	7727
Covers and blotters, J. W. Payson	7705
Curtain fixtures, N. Campbell	7703
Derrick machines, R. R. Osgood	7701
Dough raising, W. and R. L. Skillen	7772
Drawing instrument, R. Duthie	7792
Dredging machines, C. O. Davis	7778
" " R. P. Osgood	7701
Drills, metal, J. P. Thompson	7775
Drying house, S. W. Craven	7726
Ear slippers, I. B. Kleimert	7756
Electric telephony, A. G. Bell	7783
Engines, fire, W. Scott	7689
Fanning mills, A. W. and C. T. Kendrick	7791
Fare registers, W. H. Hornum	7779
Felts, lined, T. Samiel	7758
Fencing, gas pipe, W. C. Hobs	7755
Fire escapes, S. L. and B. F. McKee	7687
" proof safes, T. Fuller	7795
Flour, Van R. Ryerson	7732
Flower stands, P. McNeill	7733
Fool, J. T. Cragin	7758
" preservation, P. P. E. M. Koch	7731
Fruits, preserving, L. Bradley	7759
Gas lighter, K. Vogel et al.	7739
" manufacture, M. H. Strong	7677
" purification, T. N. Kirkham et al.	7770
Halter fastenings, J. C. Dillon	7673
Hame fasteners, G. Jeffrey	7686
Harrows, B. Wetherbie	7771
Harvesters, pea, W. Boyd et al.	7696
Hay elevating, G. A. Dickson	7752
Heater, sad iron, W. H. Haylock	7748
Heating stoves, C. A. Hamelin	7727
Hose nails, J. D. Sumner	7693
" powers, T. E. Adams	7683
" shoe blanks, H. K. Flagler et al.	7774
Horses, stall for, J. Arless	7746
Hydrants, W. Todd et al.	7715
Ice creepers, T. Gunsalus	7755
" houses, J. E. Baril	7740
Injector, steam boiler, W. T. Messinger	7783
Iron heater, sad, W. H. Haylock	7748
Lamp stands, J. Forster	7728
Lamps, A. Burbank et al.	7781
Locks, keys for, R. A. Abbott et al.	7703
Milk coolers, O. J. Stuckies	7800

Mill-stone dress, R. S. Williams	7697
Motion converting, A. G. Smyth et al.	7753
Mowing machines, W. N. Whitely	7744
Nails, horse, J. D. Sumner	7693
News-papers, addressing, A. Dick	7750
Oil cans, J. Graves	7681
" treatment of, H. Frasch	7691
Organ stop actions, J. H. Kydd	7695
Painting cylindrical bodies, C. T. Brandon	7742
Pavement, concrete, C. M. Warren	7710
Photographic printing frames, L. Ray	7711
Pipe core barrels, G. Bisset, jr., et al.	7763
Pipes, tobacco, S. R. Dummer	7784
Plants, raising, C. Lo-kamp	7699
Plough, snow, J. T. Jensen	7737
Ploughs, N. F. Patenande	7777
Potato-diggers, L. A. Aspinwall	7788
Propellers, paddle, W. Davenport	7688
Pumps, floating, C. Harris	7745
" force, W. Scott	7689
Punching machine, M. Gluc	7786
Rakes, horse, J. B. Armstrong	7729
Rattus, rigging, J. C. Knowlton	7694
Reaping machines, J. Abell	7718
Reflectors, compound, F. L. Senour	7723
Refrigerators, J. O. Beck	7761
Registers, fare, W. H. Hornum	7779
Road scrapers, D. Clarke	7751
Rollers, land, J. S. Palmer	7722
Saddle girths, A. Steinback	7716
Safes, fire proof, T. Fuller	7795
Screen, window, J. C. Walker et al.	7790
Seeding machines, J. Westlick	7757
Sewing " E. C. Sproul et al.	7780
Shafting boxes, J. Tomlinson	7715
Shearing machine, M. Gluc	7786
Sheep wash, W. Clark	7708
Shelves, stove pipe, C. Allen	7725
Ships lines, drawing, R. Duthie	7792
" rattus, J. C. Knowlton	7694
" sheating, J. Bettely	7685
Shoe lasts, S. J. Parsons	7674
Sinks and water closets, G. Jennings	7730
Spark arrester, C. H. Waterous, jr.	7785
Spikes, E. R. Whitney	7761
Stall for horses, J. Arless	7746
Steam boiler injector, W. T. Messinger	7783
" boilers, H. S. Coleman	7721
Steering apparatus, C. H. Heron	7793
Stone cutting, B. C. Tughman	7676
" sawing, W. C. Huffman	7796
Stove-pipe elbow, C. H. Amann	7711
Stoves, cooking and heating, C. A. Hamelin	7727
Syringes, J. S. Parsons et al.	7773
Syrups, mineral water, H. L. Bowker	7749
Telephony, electric, A. G. Bell	7789
Tbill couplings, A. P. Ladd	7761
Threshing machines, J. Abell	7714
Tobacco-cutters, M. McGinn	7678
Troughs, dough, J. W. Martin et al.	7797
Turbine wheel, T. H. Russell et al.	7680
Vegetables, preserving, L. Bradley	7759
Ventilators, window, D. Clushman et al.	7799
Vessels cleansing, H. J. Cole	7698
Wagon box, E. P. Langs	7719
Wash, sheep and cattle, W. Clark	7708
Washing machine, J. R. Bower	7736
" machines, A. P. Ladd	7762
Watch movements, C. S. Mosely	7721
Water closets and sinks, G. Jennings	7730
" purifiers, J. Foley	7704
" supply, H. R. Newton	7745
" wheels, C. Harris	7719
" and syrups, mineral, R. H. Bowker	7719
Wheat scouring, H. J. Livergood	7794
Wheels, turbine, T. H. Russell et al.	7680
Window screen, J. C. Walker et al.	7700
" ventilators, C. Clusham et al.	7799

INDEX OF PATENTEES.

Abbott, R. A., et al, keys for locks..... 7703
 Abell, J., reaping machines..... 7718
 " " threshing " 7714, 7731
 Adams, T. E., horse powers..... 7683
 Allen C., stove-pipe shelves..... 7725
 Amann, C. H., " elbow..... 7741
 Andrews, S. C., et al., hydrants..... 7713
 Arless, J., stall for horses at sea..... 7746
 Armstrong, J. B., horse rake..... 7729
 Aspinwall, L. A., potato diggers..... 7788
 Baril, J. B., ice houses..... 7710
 Barrett, E., clapboarding..... 7786
 Bartlett, J., et al., gas lighter..... 7739
 Batchelder, H. J., horse shoe blanks..... 7774
 Beach, A. S., cheese presses..... 7717
 Beck, J. O., refrigerators..... 7763
 Bell, A. G., electric-telephony..... 7789
 Bentley, W., et al., pea harvesters..... 7696
 Bettley, J., silps's sheating..... 7685
 Bisset, G., Jr., et al., pipe core barrels..... 7760
 Bowen, F. A., et al., can seaming..... 7798
 Bower, J. R., washing machine..... 7735
 Bowkers, R. H., syrup and mineral waters..... 7749
 Boyd, W., et al., pea harvesters..... 7696
 Bradley, L., presrying irats..... 7759
 Brandon, C. T., painting cylindrical bodies..... 7712
 Bruen, J. T., extension chandelier..... 7713
 Burbank, A., et al., lamps..... 7781
 " J., rotary et urns..... 7787
 Burgert, G., et al., dough trough..... 7797
 Caisse, M., rotary churns..... 7787
 Calder, A., axle boxes..... 7681
 Campbell, N., curtain fixtures..... 7709
 Campfield, J. H., cigars..... 7692
 Chandler, S., Jr., and J., et al., gas purification..... 7770
 Chase, E. A., et al., lamps..... 7781
 Clark, W., sheep wash..... 7708
 Clarke, D., road scrapers..... 7751
 Clushman, C., et al., window ventilators..... 7799
 Cole, H. J., cleansing vessels..... 7698
 Coleman, H. S., steam boiler..... 7721
 Cover, W. H., et al, churns..... 7790
 Corry, J. W., et al., window screen..... 7790
 Cragin, J. T., food..... 7758
 Craig, W., ear-couplings..... 7792
 Craven, S. W., drying house..... 7726
 Dansereau, E., butter workers..... 7776
 Davenport, " , paddle propellers..... 7688
 Davis, C. O., dredging machines..... 7778
 " D., brick " 7717
 Dick, A., addressing newspapers..... 7750
 Dickson, G. A., hay elevating..... 7752
 Dillon, J. C., halter fastenings..... 7673
 Dixon, J. W., et al., recovering alkalies..... 7767
 Dobbs, C., et al., car couplings..... 7782
 Duggan, T., et al., brooms and brushes..... 7712
 Dummer, S. R., tobacco pipes..... 7784
 Duthie, R., drawing ships' lines..... 7792
 Ferguson, J. and A., churn dashers..... 7720
 Elsher, J. A., et al., recovering alkalies..... 7767
 Ette, E., et al., churns..... 7700
 Flagg, G. H. P., boots and shoes..... 7768
 Flagler, H. K., et al., horse shoe blanks..... 7774
 Foley, J., water purifiers..... 7704
 Foster, J., lamp stands..... 7728
 Frasch, H., treatment of oils..... 7691
 French, O. S., et al., spark arrester..... 7735
 Fuller, T., fire-proof safes..... 7795
 " T. R., et al., broom holder..... 7754
 Fullerton, G. A., boots and shoes..... 7768
 Gluck, M., punching machine..... 7786
 Graves, J., oil cans..... 7681
 Gunsalus, T., ice creepers..... 7785
 Hamlin, C. A., cooking and heating stoves..... 7727
 Harris C., water wheels..... 7745
 Haylock, W. H., sad iron heater..... 7748
 Herson, C. H., steering apparatus..... 7793
 Hinkley, A. S., carpet sweepers..... 7679
 Hobs, W. C., gas pipe fencing..... 7765

Hornum, W. H., fare registers..... 7779
 Hovey, D., et al., lamps..... 7781
 Hoffman, W. C., stone sawing..... 7796
 Hulcutt, D., et al., gas purification..... 7779
 Hull, W. A., extension chandelier..... 7713
 Jeffrey, G., hame fasteners..... 7686
 Jennings, G., sinks and water closets..... 7730
 Jensen, J. T., snow plough..... 7717
 Jesson, T., et al., brooms and brushes..... 7712
 June, R. B. D., et al., spark arrester..... 7797
 Keen, J. M., ear-couplings..... 7682
 Kendrick, A. W. and C. T., fanning mills..... 7791
 Kirkham, T. N., et al., gas purification..... 7770
 Kleinert, I. B., ear slippers..... 7756
 Knight, W. H., et al., pipe core barrels..... 7789
 Knowlton, J. C., rigging rattins..... 7694
 Koch, P. P. E. M., food preservation..... 7711
 Koydd, J. H., organ stop actions..... 7695
 Ladd, A. P., thill couplings..... 7761
 " " washing machines..... 7792
 Langa, E. P., waggon box..... 7719
 Livergood, H. A., scouring wheat..... 7791
 Loskamp, C., raising plants..... 7699
 McCully, S. E., et al., turbine wheels..... 7680
 McGinn, M., tobacco-cutters..... 7678
 McKee, S. L. and B. F., fire escapes..... 7687
 McNeill, P., flower-stands..... 7753
 Martin, J. W., et al., dough troughs..... 7797
 Maybee, A., road scrapers..... 7751
 Messinger, W. T., steam boiler injector..... 7758
 Mosely, C. S., watch movements..... 7721
 Moulton, C. C., et al., gas lighter..... 7789
 Newton, H. R., water supply..... 7675
 Osgood, H. R., dredging machines..... 7701
 Palmer, J. S., hand rollers..... 7732
 Parrish, M. W., keys for locks..... 7763
 Parsons, J. S., et al., syringes..... 7773
 " S. J., shoe lasts..... 7671
 Patenaude, N. F., ploughs..... 7777
 Poole, J. T., shoe lasts..... 7671
 Porter, C., et al., window ventilators..... 7798
 Radeffle, C., button machines..... 7690
 Ray, L., photographic printing frames..... 7711
 Rickman, S. S., et al., sewing machines..... 7780
 Robinson, S. L., et al., ear couplings..... 7782
 Rowell, B., " " 7792
 Russell, T. H., et al., turbine wheels..... 7680
 Ryah, J. H., et al., window screen..... 7799
 Ryerson, Van B., flour..... 7782
 Samuel, T., lined felts..... 7783
 Scott, W., pumps and engines..... 7699
 Senour, F. L., compound reflectors..... 7723
 Skillen, W. and R. L., dough raising..... 7772
 Smith, J., et al., converting motion..... 7753
 " Z. W., cattle stanchions..... 7801
 Smyth, A. G., et al., converting motion..... 7733
 Speck, J. J., et al., churns..... 7700
 Sproul, E. C., et al., sewing machines..... 7780
 Steinbeck, A., saddle girths..... 7716
 Stickles, O. J., milk coolers..... 7800
 Strong, M. H., gas manufacture..... 7677
 Sumner, J. D., horse nails..... 7698
 Thompson, J. P., metal drills..... 7775
 Tilghman, B. C., stone cutting..... 7676
 Todd, W., et al., hydrants..... 7718
 Tomlinson, J., barrel..... 7706, 7707
 " " shafting boxes..... 7715
 Very, T. S., et al, horse shoe blanks..... 7774
 Vogel, K., et al., gas lighter..... 7789
 Walker, J. C., et al, window screens..... 7799
 Walsh, F. A., et al., can seaming..... 7798
 Warren, C. M., concrete pavement..... 7710
 Waterous, C. H., Jr., spark arrester..... 7785
 Weaver, S., churn powers..... 7769
 Wells, H. M., et al., broom holder..... 7754
 Westlick, J., seedling machines..... 7757
 Wetherbie, B., harrows..... 7771
 Whitley, W. N., mowing machines..... 7744
 Whitney, E. K., spikes..... 7761
 Williams, R. S., millstone dress..... 7697
 Woods, J., carriage clip..... 7765
 Yundt, J. H., et al., syringes..... 7778

THE
CANADIAN PATENT OFFICE RECORD.

ILLUSTRATIONS.

Vol. V.

SEPTEMBER, 1877.

No. 9.

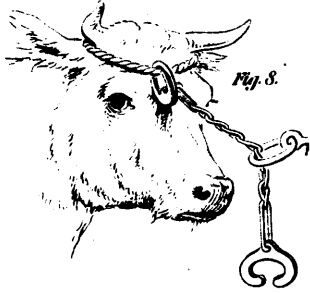

7673 Dillon's Improvement in Halter Fastenings.

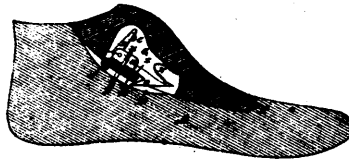

7674 Poole's Improvements on Shoe Lasts.

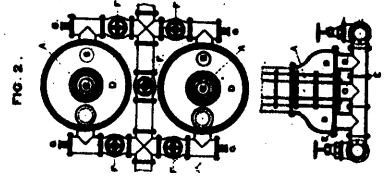

7675 Newton's System for Regulating the Continual Supply of Purified Water and Continual Discharge of Refuse Water.

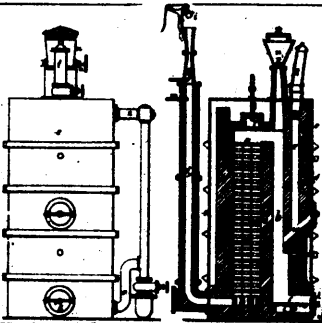

7677 Strong's Improvements on the Manufacture of Gas.

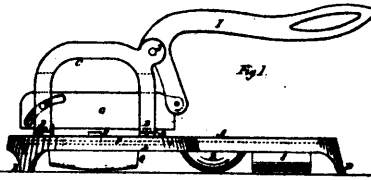

7678 McGin's Improvements in Tobacco Cutters.



7679 Hinkley's Improvements on Carpet Sweepers.

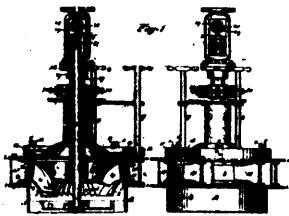

7680 Russell & McCully's Improvements on Turbine Wheels.

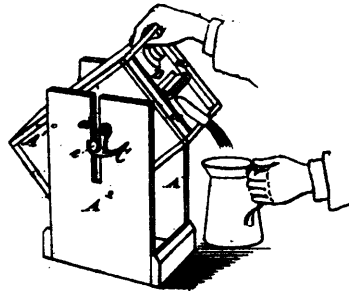

7681 Graves' Improvements on Oil Cans.

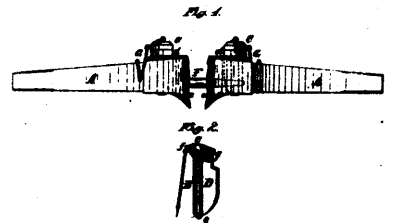

7682 Keen's Improvements on Car-Couplings.

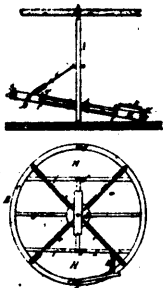

7683 Adams' Improvements in Horse-powers.

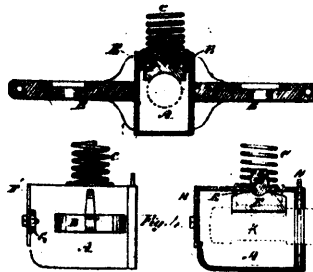

7684 Calder's Improvements on Car Axle Boxes.



7686 Jeffrey's Improvements on Hame Fasteners.



7687 McKee's Improvements in Fire Escapes.

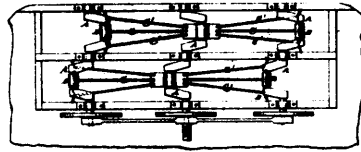

7688 Davenport's Improvements on Paddle Propellers

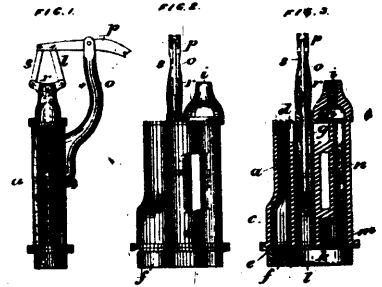

7689 Scott's Improvements on Force Pumps and Fire Engines.

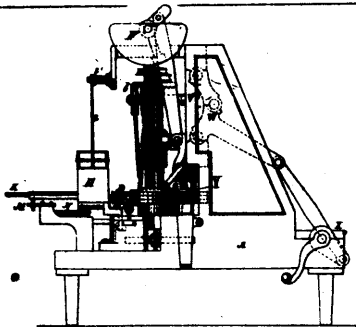

7690 Radcliffe's Improvements on Button Machines.

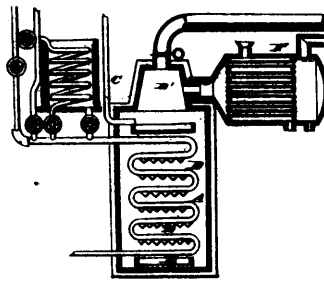

7691 Frasch's Apparatus and Process for the Separation and Treatment of Oils.

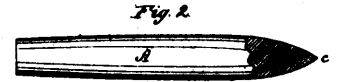
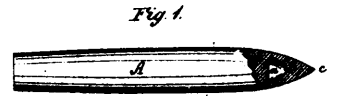

7692 Campfield's Improvements in Cigars.

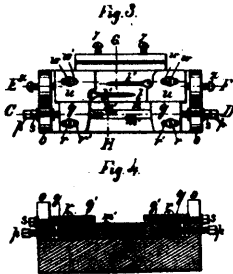

7693 Sumner's Machine for Making Horse Shoe Nails.



7694 Knowlton's Improvement on Rigging Ratlins.

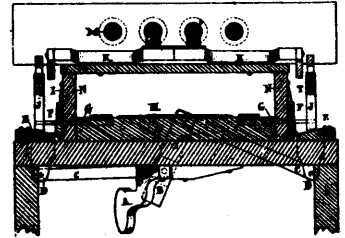

7695 Kydd's Improvements in Organ Stop Actions.

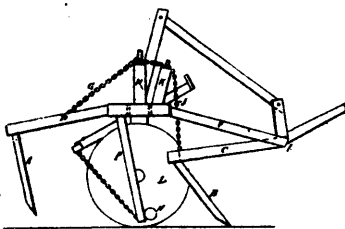

7696 Boyd & Bentley's Improvements on Pea Harvesters.

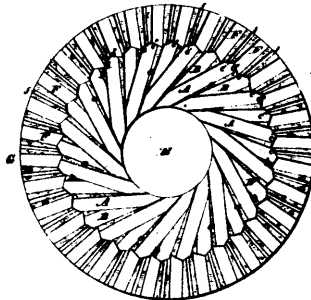

7697 Williams' Improvements in Mill Stone Dress.

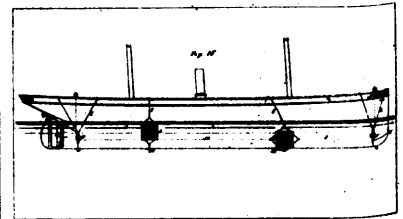

7698 Cole's Apparatus for Cleansing the Hulls of Vessels Afloat.

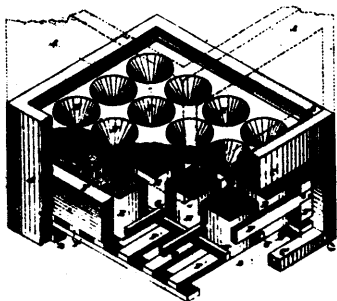

7699 Lockamp's Raising and Transplanting Plants.

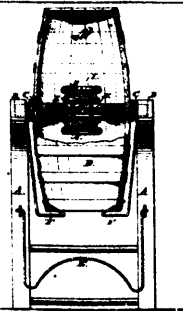

7700 Convers' Improvements on Churns.

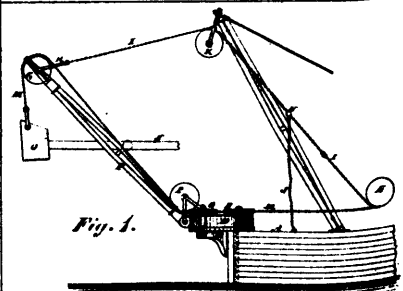

7701 Osgood's Improvement in Dredging and Derrick Machines.

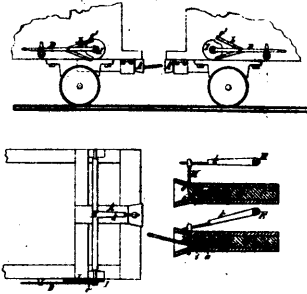

7702 Rowell's Improvements in Car Couplings.

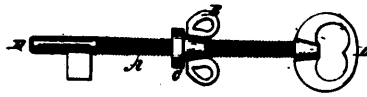

7703 Abbott & Parrish's Improvements in Keys for Locks.

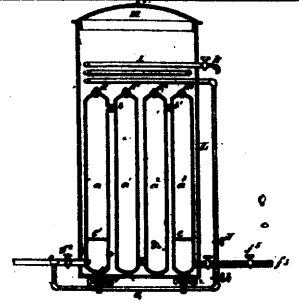

7704 Foley's Improvements on Water Purifiers.

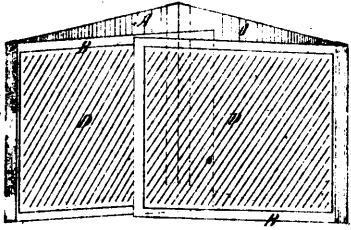

7705 Payson & Scribner's Improvement in Combined Covers and Blotters.

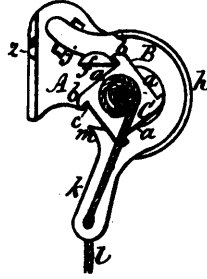

7709 Campbell's Improvement on Curtain Fixtures.

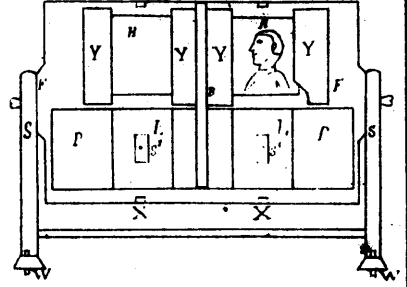

7711 Ray's Improvement in Photographic Printing Frames.

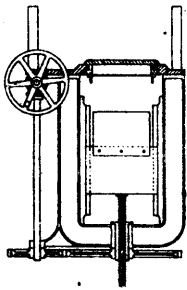

7712 Jesson & Duggan's Manufacture of Brooms and Brushes.

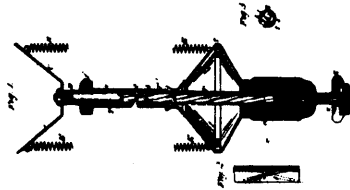

7713 Bruen's Improvement on Extension Chandeliers.

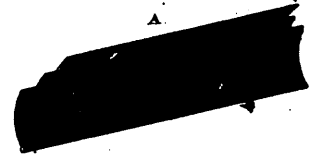

7714 Abell's Attachment for Threshing Machines.

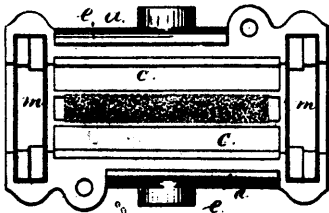

7715 Tomlinson's Improvements on Boxes for Shafting.

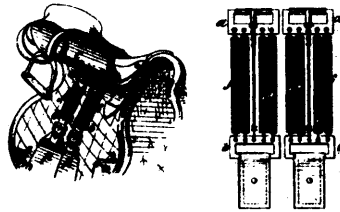

7716 Steinback's Apparatus for Self-Adjusting Saddle Girths.

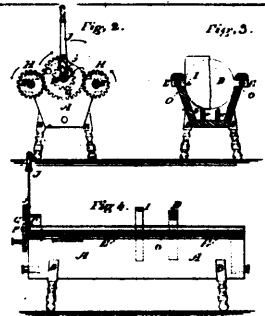

7717 Beach's Improvement in Cheese-Presses.

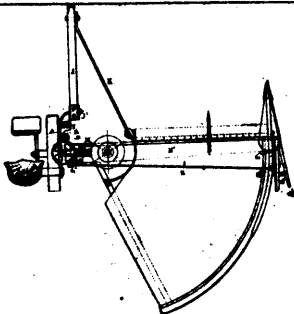

7718 Abell's Improvements in Reaping Machines.

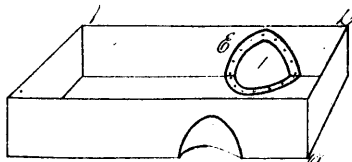

7719 Langs' Improvement on a Waggon Box.

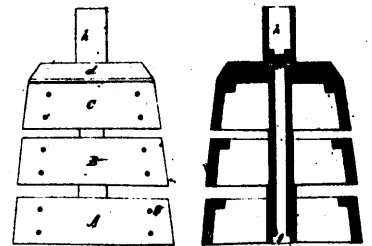

7720 Ferguson's Improvements in Churn Dashers.

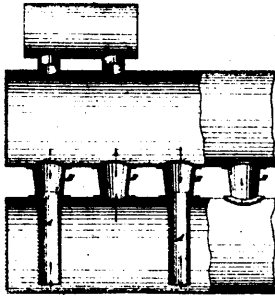

7721 Coleman's Improvements on Steam Boilers.

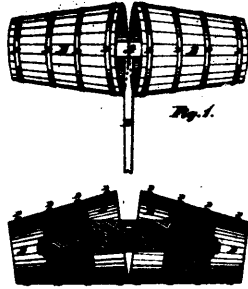

7722 Palmer's Improvements on Land Rollers.

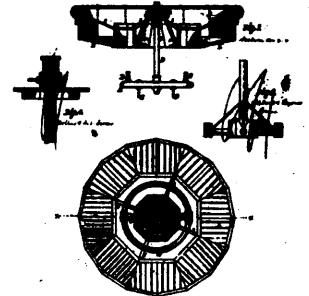

7723 Senour's Improvements on Compound Reflectors.

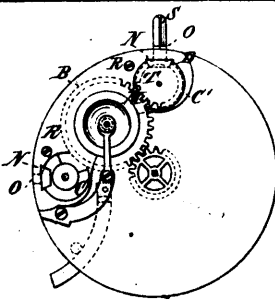

7724 Mosely's Improvement in Watch Movements.

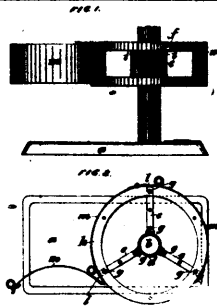

7725 Allen's Improvements on Stove-pipe Shelves.

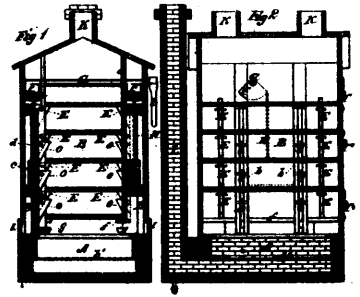

7726 Craven's Improvements on a Drying House.

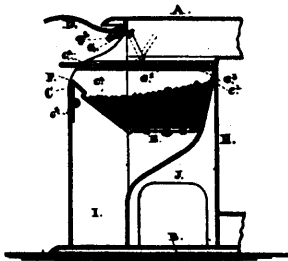

7727 Hamlin's Improvements in Cooking and Heating Stoves.

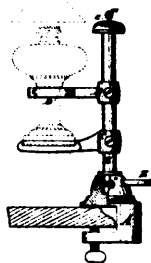

7728 Forster's Improvements on Lamp Stands.

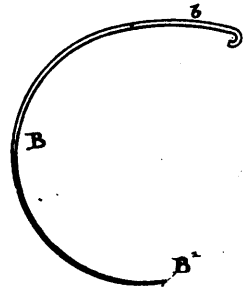

7729 Armstrong's Improvements on Horse Rakes.

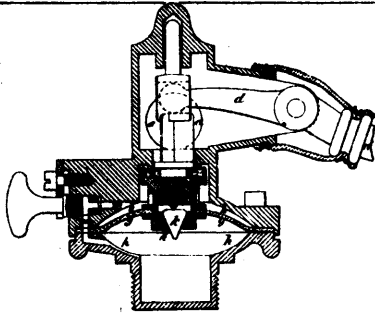

7730 Jennings's Improvements on Sinks and Water-Closets.

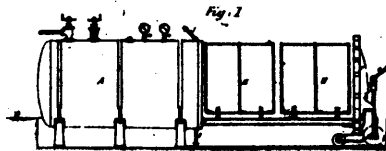

7731 Koch's Improvements on the Preservation of Food.

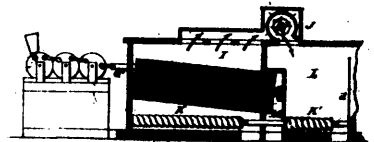

7732 Ryerson's Process and Apparatus for Reducing Cereals into Flour.

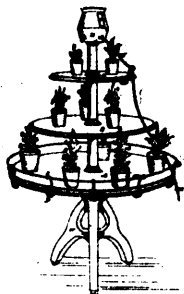

7733 McNeil's Improvements on Flower Stands.

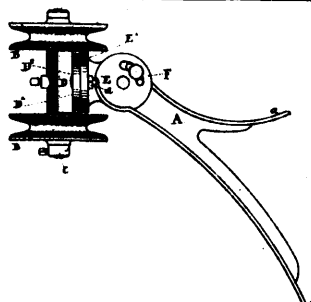

7734 Abell's Straw Carrier Bracket for Threshing Machines.

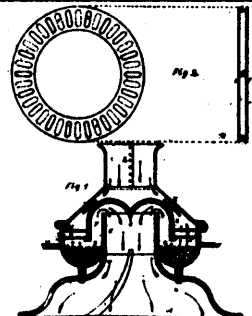

7735 June & French's Spark Arrester.

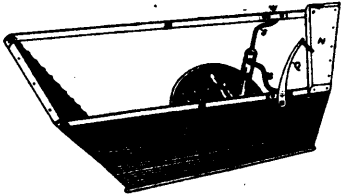

7736 Bower's Clothes Washing Machine.

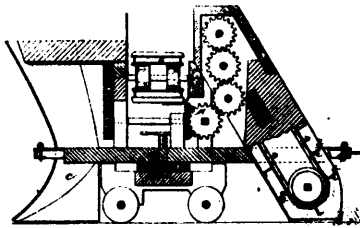

7737 Jensen's Snow Plough and Track Clearer.

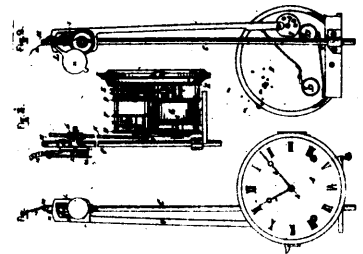

7739 Vogel, Bartlett & Moulton's Automatic Gas Lighter.

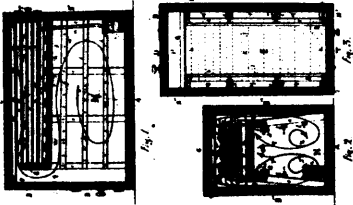

7740 Baril's Improvements on Ice Houses.

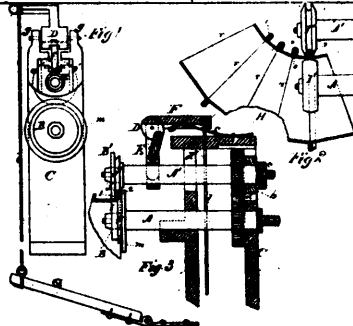

7741 Amana's Stove-pipe Elbow Machine.

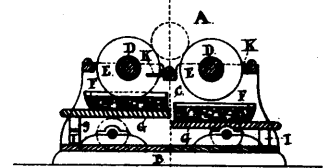

7742 Brandon's Machine for Painting Cylindrical Bodies.

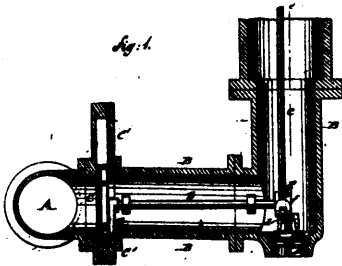

7743 Todd & Andrews' Improvements on Hydrants.

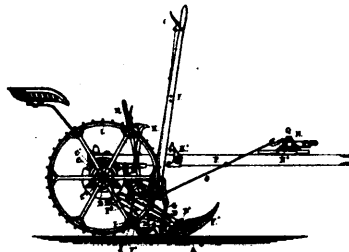

7744 Whitely's Improvements in Mowing Machines.

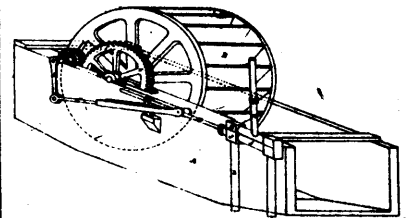

7745 Harris' Improvements on Floating Water Wheels and Pumps.

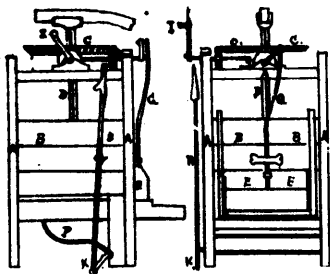

7747 Davis' Improvement on Brick Machines.

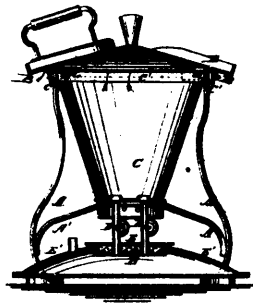

7748 Haylock's Sad Iron Heater.

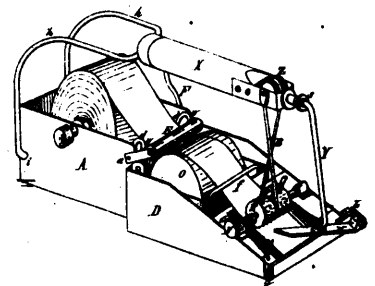

7750 Dick's Machine for Addressing Newspapers.

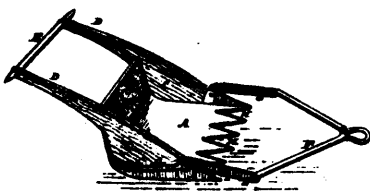

7751 Maybee's Improvements on Road Scrapers.

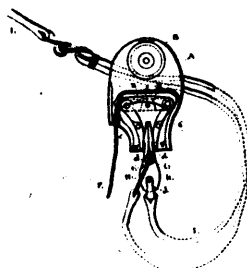

7752 Dickson's Hay Elevating Device.

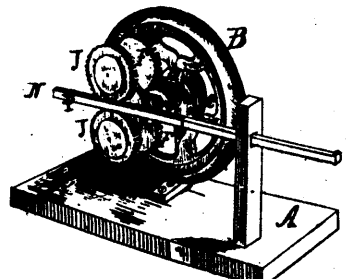

7753 Smyth's Device for Converting Reciprocating into Rotary Motion

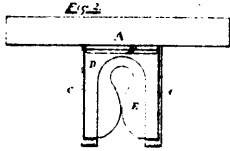
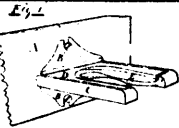

7754 Wells & Fuller's Broom Holder.

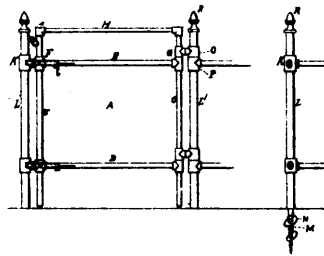

7755 Hobs' Improvements on Gas Pipe Fencing.

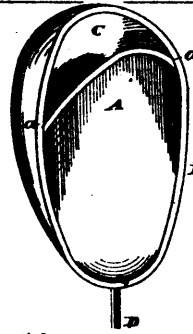

7756 Kleinert's Improvements on Ear Slippers.

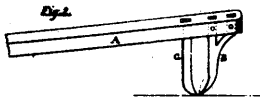
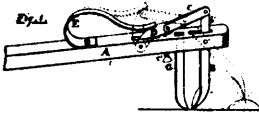

7757 Westhick's Improvements on Seeding Machines.

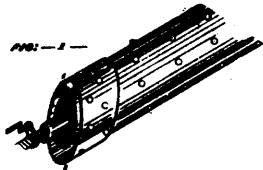

7760 Bisset & Knight's Improvements in Pipe Core Barrels

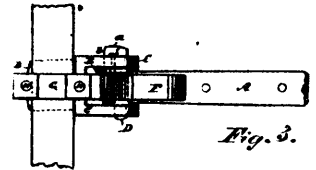
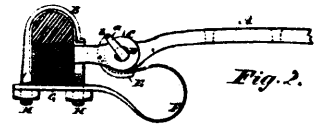

7761 Ladd's Improvements on Thill Couplings.

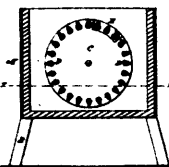
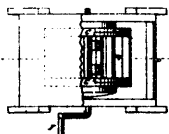

7762 Ladd's Improvements on Washing Machines

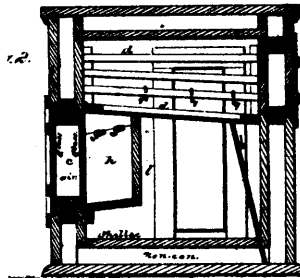

7763 Beck's Improvements on Refrigerators.

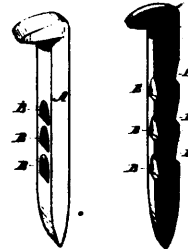
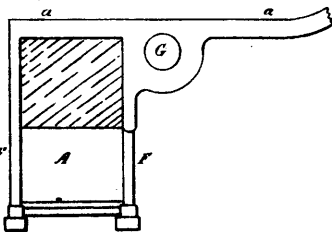

Fig. 1.



Fig. 2.

7764 Whitney's Improvements on Spikes.



7765 Woods' Improvements on Carriage Clips.



7766 Barrett's Improvements in Clapboarding.

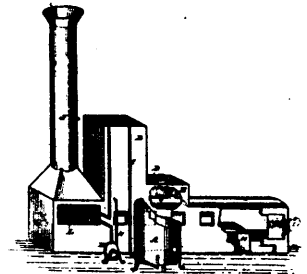

7767 Dixon & Fisher's Apparatus for Recovering Waste Alkalies.

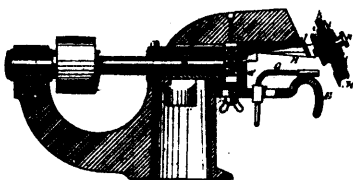

7768 Fullerton's Machine for Setting the Edges of Boots and Shoes.

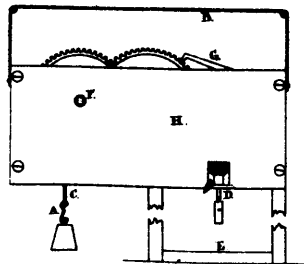

7769 Weaver's Improvements in Churn Powers.

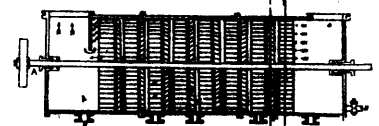

7770 Kirkham, Hulett & Chandler's Apparatus for the Purification of Gas.

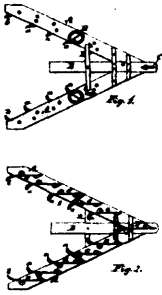

7771 Wetherbie's Improvements on Harrows.

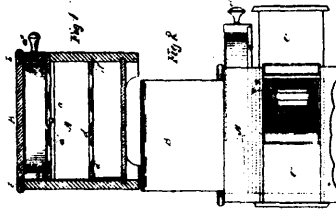

7772 Skillen's Dough Raising Apparatus.

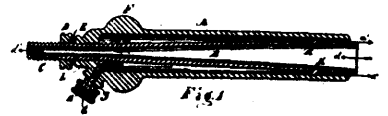

7773 Parsons & Yundt's Improvements in Syringes.

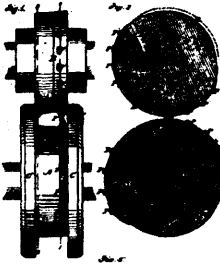

7774 Batchelder's Rolls for Making Horse Shoe Blanks.

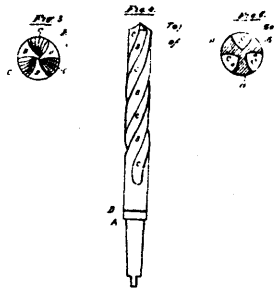

7775 Thompson's Improvements on Drills for Metal.

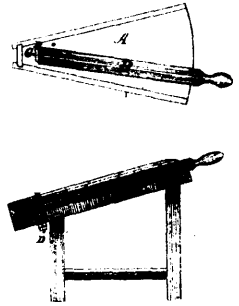

7776 Dansereau's Improvements on Butter Workers.

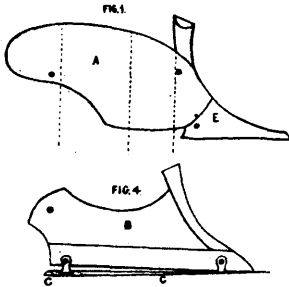

7777 Patenaude's Improvements in Ploughs.

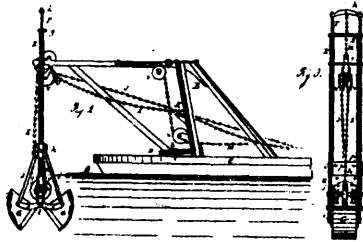

7778 Davis' Improvements in Dredging Machines.

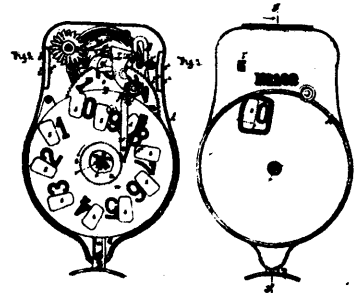

7779 Hornum's Improvements on Fare Registers.

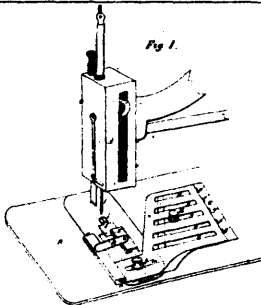

7780 Sproul & Rickman's Trimmer and Braid Guide Attachment for Sewing Machines.

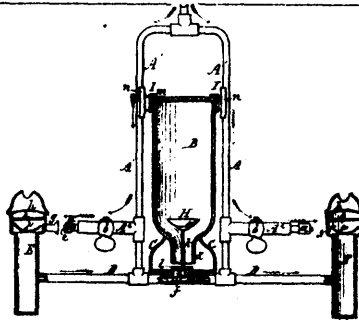

7781 Burbank, Chere & Hovey's Improvement in Lamps.

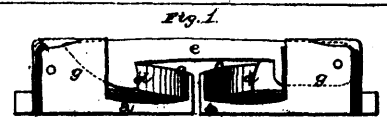

7782 Dobbs & Robinson's Improvements on Car-Couplings.

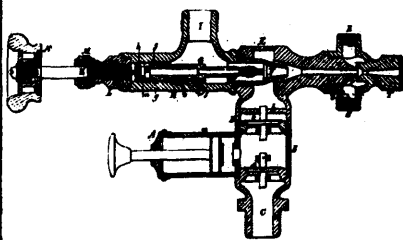
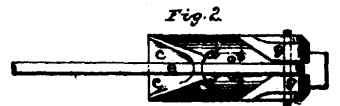

7783 Messinger's Steam Boiler Injector.

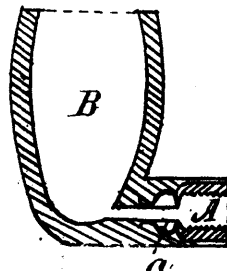

7784 Dummer's Improvements in Tobacco Pipes.

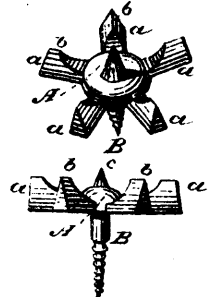

7785 Gunsalus' Improvements on Ice Creepers.

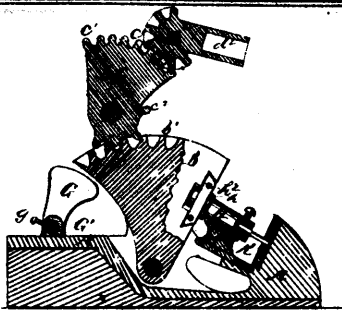

7786 Gluck's Punching and Shearing Machine.

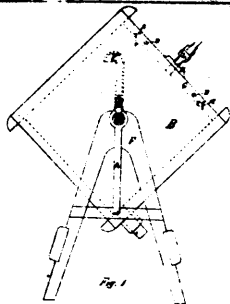

7787 Caissé's Improvements on Rotary Churns.

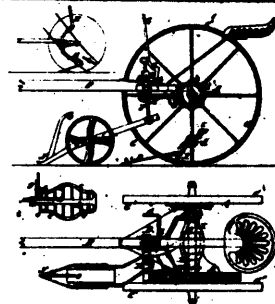

7788 Aspinwall's Improvements on Potato Diggers.

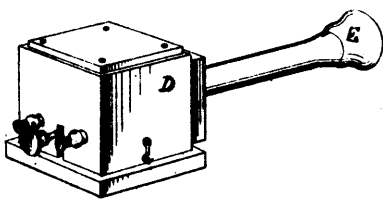

7789 Bell's Improvements on Electric Telephony.

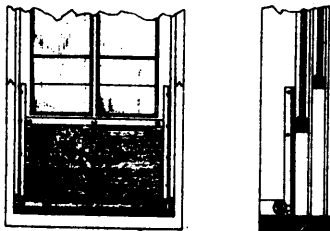

7790 Walker, Ryal & Corry's Window Screen.

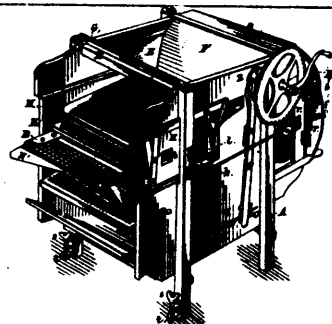

7791 Kendrick's Improvement in Fanning Mills.

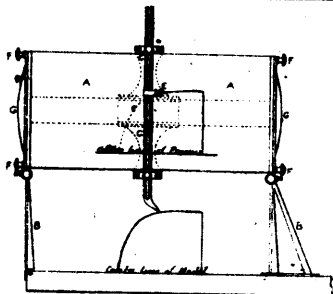

7792 Duthie's Instrument for Drawing Ships' Lines.

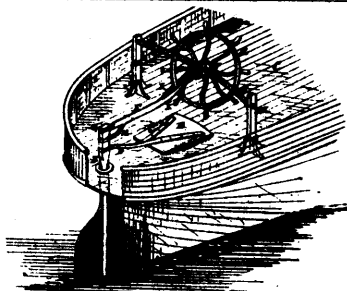

7793 Herson's Improvements on Steering Apparatus.

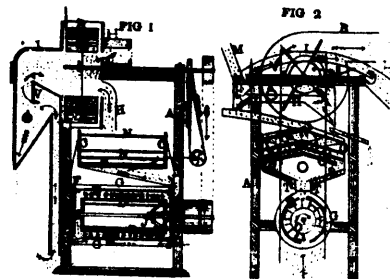

7794 Livergood's Machine for Separating and Scouring Wheat.

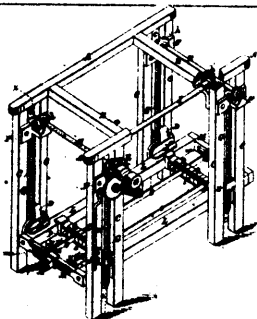

7796 Hoffman's Stone Sawing Machine.

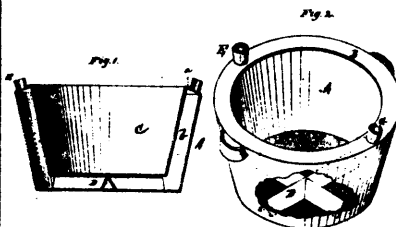

7797 Martin & Burgert's Improvements in Dough Troughs.

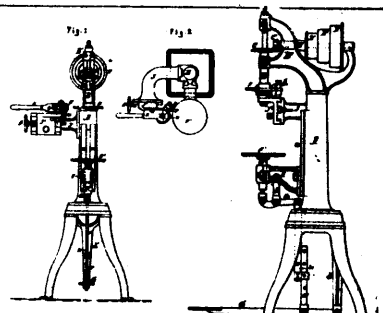

7798 Walsh & Bowen's Metal Can Seaming Machine.

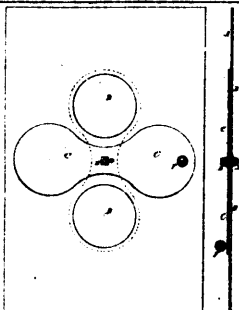

7799 Clushman & Porter's Improvements in Window Ventilators.

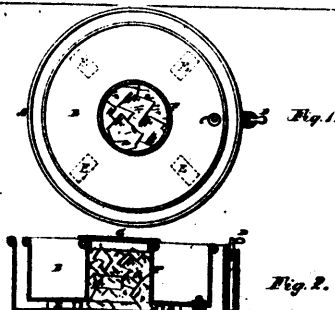

7800 Stickles' Improvements on Milk Coolers.

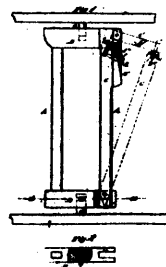

7801 Smith's Improvements on Cattle Stanchions.