

**PAGES
MISSING**

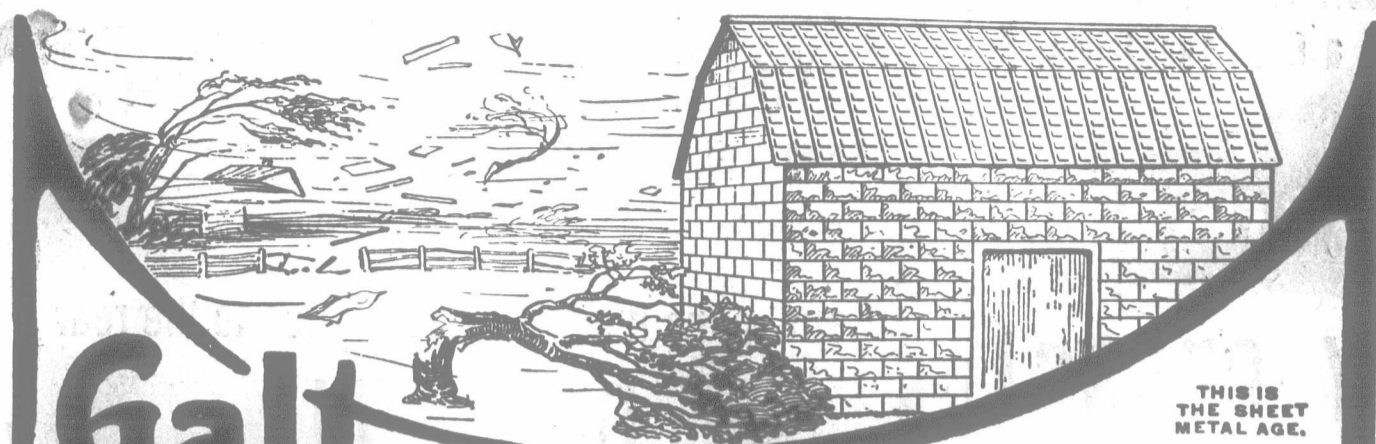

Galt Steel Siding

THIS IS THE SHEET METAL AGE.

A building roofed with Galt "Sure-grip" Shingles, and with its sides protected with Galt Steel Siding, will come through a hurricane unharmed, while other buildings will be badly shattered, if not demolished. Galt "Sure-grip" Shingles are locked together so securely and lie so closely to the roof that they leave no opening for the wind to get under and rip them off.

Galt Steel Sidings are wind-proof, too. They don't shrink; leaving cracks for the wind to sneak in, as does lumber, particularly the unseasoned kind which no gets nowadays.

Warmer than wood—and at no greater cost. Fire, wind, water and frost proof. Galvanized or painted. Handsome as brick or stone.

Complete information in our Free Illustrated Catalogue.

THE GALT ART METAL COMPANY, Limited, Galt, Ontario.

STEVENS

FINDS ITS MARK LIKE THE EYE OF A HAWK



Little Scout, : \$2.25
Stevens-Minyard, Jr., \$3
Crack Shot, : : \$4
Little Krag, : : \$5
Favorite No. 17, : \$6

Our Catalog Is Sent Free

Write for this 120-page book, telling all about "Stevens" rifles, shotguns and pistols, different parts, care of rifles, pointers on ammunition, how to choose a rifle, and much other interesting and valuable information. Send four cents in stamps for postage.

For six cents in stamps we will send our beautiful lithographed hanger.

Be sure to get "Stevens." If your dealer should not be able to supply you, write direct to us.

J. STEVENS ARMS & TOOL CO.
30 Pine Street
Chicago Falls, Mass., U. S. A.

STUDY AT HOME

We teach you by mail, in your spare time. If you can read and write, we can help you.

Courses in Bookkeeping, Shorthand, Penmanship, Arithmetic, Complete Commercial, Agriculture, Stock Raising, Poultry Raising, Electrical Engineering, Steam Engineering, Mechanical Drawing, Civil Service, Public School Course, High School Course, High School Entrance, Matriculation, Teachers' Certificates (any Province), Social English, Spelling, Composition, or any subject. Full information on request. Clip out and send this ad.

THE HOME CORRESPONDENCE SCHOOL OF CANADA, LIMITED

Dept. B, Toronto, Canada.
In consultation with the Canadian Correspondence College, Limited.

WINDMILLS

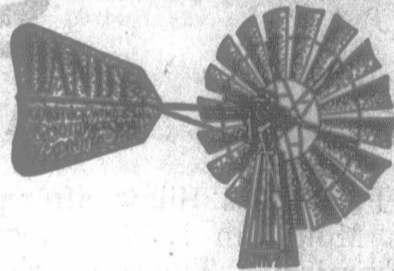

Grain Grinders, Tanks, Water Boxes and Foundry Supplies. Write for our free catalogue. Estimates cheerfully given.

WOODSTOCK WIND MOTOR CO., Limited,
Woodstock, Ont.



BOYS FOR FARM HELP

The managers of Dr. Bernardo's Homes invite applications from farmers, or others, for the boys who are arriving periodically from England to be placed in this country. The young immigrants are mostly between 12 and 15 years of age; all will have passed through a period of training in Dr. Bernardo's English Institutions, and will have been carefully selected with a view to their moral and physical suitability for Canadian life. Full particulars as to the terms and conditions upon which the boys are placed may be obtained upon application to Mr. Alfred B. Owen, Agent, Dr. Bernardo's Homes, 24 Farley Ave., Toronto.

EVERY FARMER NEEDS

Just as good a yield from his farm as possible. Therefore, before sowing, make sure of your seeds—buy them from a trustworthy source—get

EWING'S RELIABLE SEEDS

In the ground they are the most reliable seeds obtainable—they are seeds that give results—that make your harvest come up to your expectations, as only the best can.

WRITE FOR OUR '07 CATALOGUE—it explains.

WM. EWING & CO., Seedmen, 142-146 McGill St. MONTREAL.

WET WEATHER WORK IS HEALTHFUL AND PLEASANT IF YOU WEAR TOWER'S FISH BRAND WATERPROOF OILED CLOTHING



WATERPROOF OILED CLOTHING
BLACK OR YELLOW

Perfect Protection
Longest Service
Low in Price

Sold Everywhere

Alberta Fall Wheat Lands

The wheat lands of Southern Alberta are recognized as the best in Western Canada, and the HIGH RIVER DISTRICT is unexcelled. WE HOLD some of THE VERY BEST LANDS in this vicinity. If you are interested, write us.

THE HIGH RIVER REALTY COMPANY
P. O. Box 930. High River, Alta.



Fourteen Years Selling Direct

We are the only manufacturers of Vehicles and Harness in Canada selling direct to the consumer, and have been doing business in this way for 14 years. We have no agents, but ship everywhere for examination. You are out nothing if not satisfied. Our prices represent the cost of making plus one profit.

Wharfedale Farm, Newcastle, Ont., Jan. 14, 1907.
International Carriage Co., Brighton, Ont.:

Sirs.—Before writing to you about the wagon, Mikado buggy, and bob'sleigh, which you shipped to me in the fall, I wanted to thoroughly test them. Their appearance was fine, and I wished to see if they were as good as they looked. I am glad to say they are, and people who have asked me the prices of the sleighs and buggy have been astonished at the moderate prices named.

If I see anyone around thinking of buying a new carriage or wagon I will direct them where to go. Yours truly,
A. T. ARNOLD-FORSTER.

Our large FREE catalogue shows complete line and gives prices. Send for it to-day.

International Carriage Co.,
BRIGHTON, ONTARIO.

Advertise in the Farmer's Advocate.

Everything Substantial Must Have a Good Foundation.

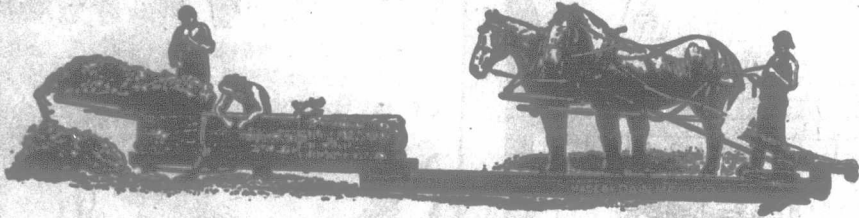

THE DAIN HAY PRESS

has a good foundation. The frame is channel steel solidly riveted together.

The Dain Press will do more tons per day than any other press, notwithstanding what irresponsible opposition agents say.

The Dain Press will make heavier bales, and not strain, get out of order or break.

You can't afford to make the mistake of buying any other machine.

Great Capacity. Great Durability.
The two qualities most desired in Hay Presses, and found only in the Dain.

Write in to-day. Catalogue for the asking.

THE DAIN MFG. CO., PRESTON, ONT.

The Fairchild Co., Winnipeg, Man.,
Western Agents.

You Never Can Make Butter With the Butter Fat that's Lost

Either in the skim milk or on account of churning thin watery cream.

Cans, pans and cheap machines to the rear

DE LAVAL CREAM SEPARATORS

ARE BEST.

173-177 William Street,

MONTREAL.

"GOES LIKE SIXTY"

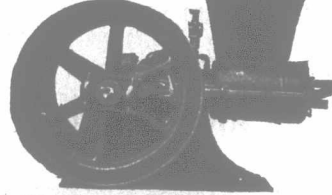

For \$150.00 To introduce our famous
**GILSON
GASOLINE ENGINES**

Strong enough to saw wood, grind feed, and run all kinds of machinery. **FROST PROOF.** Starts readily in coldest weather. Write for catalogue—all sizes. **FREE TRIAL.**
GILSON MFG. CO., G. Park St., Pt. Washington, Wis.

When Writing Advertisers Kindly Mention this Paper.

Last Mountain Valley Lands

We own thousands of acres of **Choice Selected Land** in this district, which is in the heart of the

GREAT WHEAT PLAINS

OF

SASKATCHEWAN

Ample **TIMBER** for All Purposes

Prof. Thos. Shaw, after personal inspection, writes: "This rich and beautiful farming section lying in the vicinity of Last Mountain Lake, embraces one of the finest areas in the Northwest. The land is undulating in this region, mostly open prairie. The soil is rich black vegetable loam, from one to two feet deep, and is underlaid with a clay subsoil. Frost, to injure the wheat, is virtually unknown. Being thus favored so highly by nature, it is not surprising that the production of wheat in this region is phenomenally high; in several instances forty to forty-five bushels per acre have been reaped. Oats, Barley, Flax and all small grains yield relatively as good as those of wheat. Potatoes grow most luxuriantly. Two or three years ago there were not more than thirty-five settlers in the entire area; now there are over a thousand, and others rapidly coming in."

Send 25c. for our beautiful new photographic souvenir, entitled "The Lake and Lands of Last Mountain Valley," which is not only a work of art, but a book of authentic information. We will also send Atlas of Canada, Maps, etc.

Wm. Pearson Co., Limited,
304 NORTHERN BANK BUILDING, WINNIPEG.

"PAGE FENCES — WEAR BEST"

Made of High Carbon Wire,—we'll prove it to you. COILED—not crimped. This makes it still stronger in service. It stays taut. Painted WHITE over heavy

THE PAGE WIRE FENCE COMPANY, LIMITED,



galvanizing—rust proof. Experienced dealers to erect it. Leads all in sales
209—as in merit. Get illustrated booklet and 1907 prices before buying.
Walkerville, Toronto, Montreal, St. John, Winnipeg

The Farmer's Advocate and Home Magazine

"Persevere and Succeed."

Established 1866.

Vol. XLII.

LONDON, ONTARIO, FEBRUARY 28, 1907.

No. 753

EDITORIAL.

Experience in Cow-testing.

With this number we place before our readers a few of the hundred or more letters recently to hand on the subject of individual milk records. They are printed, without selection, just as they came to hand in reply to a letter of inquiry, and their almost unanimous and, in many cases, enthusiastic endorsement of the wisdom of keeping accurate account of the work of individual cows may well cause dairymen to pause and think hard. Of course, our letter was addressed only to men who, we were advised, were or had been keeping records, and it is to be expected the opinions of most of these would be much more generally favorable than a verdict obtained by a hit-and-miss census. It is true there are many good dairymen who have never made a practice of weighing their milk at all. They either have never thought of it, or else have dismissed the proposition with the mental comment that help was too scarce and milk records too much bother. This latter objection is, to our mind, most effectively answered by our correspondents, nearly all of whom state that the time required to keep milk records is inconsiderable, while the greater care in milking, feeding and attention results in a substantial increase in milk yield that handsomely repays the trouble of weighing the milk and keeping the records. Several mention that the hired man has become as much interested in the records as they themselves. So far from making the milking irksome, records give the men a new pleasure in their work.

We grant that some men will take an interest in the records when the idea is new and the cows increasing in response to the stimulus of improved feed and care, but will find their interest waning when the record becomes an old story and the cows have reached a stage whence further increase is not easy. The wide-awake dairyman, however, will not allow himself to lag. Once started, he will become so seized of its advantages that he will feel he cannot afford to stop keeping records. He will continue, not merely for the sake of maintaining his milk flow, but in the ever-absorbing ambition to weed out his poor cows and ascertain the good ones by several years' continuous records—for let us warn most emphatically against drawing final conclusions from one year's results. Many a cow does well one season, but falls short the next, and many heifers are slow in reaching their best producing capacity. It is the average of several years' performance that counts.

Among our correspondents are those who have kept records four, five and six years continuously, and these evince no thought of discontinuing. Their testimony is worth heeding. Even men who see little use in milk records must admit that those who have tried it are best qualified to judge. Their evidence is that the scales have no end of surprises in store, even for the best of herdsmen. In fact, records are worth most to the up-to-date dairymen. These men make more intelligent use of their records, learning more readily what lessons the figures convey. Not the least of its advantages is that record-keeping, in the case of dairy cows, fixes the habit of close observation, and shows the wisdom of applying similar rules to all the operations of the farm. Its benefits are cumulative.

The milk record is the basis of dairy-herd improvement. It points the way to progress in breeding, weeding and feeding—that trinity of effective purpose. Now is the time to start. A line to Prof. J. H. Grisdale, Agriculturist, Central Experimental Farm, Ottawa, will bring

blank ruled forms very well suited to the purpose. A trifling expense for a spring balance will complete the outfit, and a creameryman or some neighbor will generally be found willing to make occasional Babcock tests.

Pessimistic, but Wholesome.

The recent retiring presidential address of Mr. P. Howland, before the Toronto Board of Trade, contained a number of observations, the timeliness, candor and sanity of which will commend themselves to the farming community, as they should to business men generally. Notwithstanding the large deposits in the banks, indicating the thrift and saving of the people, he pointed out that bankers are finding it difficult to keep their reserves in safe proportion to their liabilities and find means to meet the constantly-increasing demands of their customers and the very speculative disposition of the times. Mr. Howland, therefore, felt warranted in presaging a probable period of dear money, a tendency upon which our readers who contemplate increasing their liabilities for land or improvements would do well to keep an eye.

The old maxim read, "In time of peace prepare for war." Mr. Howland, we gather, would translate this, in time of prosperity prepare for the inevitable cycle of depression, and so defer and minimize its advent. Railway construction, immigration, unusually good crops and high prices for all commodities, including labor, Mr. Howland diagnosed as the causes of the "good times" prevailing. The producers of beef, dairy products, bacon, poultry and like articles, will hardly concur with Mr. Howland that the prices are about at the inflation point, because, by keeping tab on taxes, cost of fodder, and sundry items in the cost of production, they will probably conclude that their margin is certainly not inflated. On this very point, as competent and careful an observer as Mr. Wm. Duthie, of Collynie, Scotland, in a lecture, after his tour of Canada last year, declared that "the great drawback to successful farming in Canada was the comparatively poor prices which the farmer got for what he raised and sold, together with the high prices he had to pay for what he had to buy.

The law of averages will, he argued, bring about the lean years, and that condition will be hastened by the extraordinarily large expenditures, national, provincial, municipal and individual, against which he properly sounded a note of warning. These expenditures involve a large burden of interest, and it is not surprising, therefore, to learn, as lately announced by the official reports of a leading financial agency, that the vast bulk of all the business failures in the country are due to want of sufficient initial capital, which is especially dangerous in a speculative period.

He condemned Government bonuses as one of the worst forms of class legislation. The extent to which these are growing is shown by a late statement of the Minister of Customs to Parliament, showing that to date over \$8,000,000 had been paid out in this way, including \$998,000 to the Soo Company, \$1,416,469 to the Nova Scotia Steel Company, and \$3,466,519 to the Dominion Steel Co. While these bonuses may not, like a high tariff, directly operate to increase prices, they must, in the end, come out of the pockets of the people, who are led to believe that without the presence of these artificially-stimulated industries we should be at the mercy of some big American trust. We do well not to place undue emphasis upon the advantage of a whistle that may cost us dear.

Referring to the deplorable revelations in com-

mercial, financial, insurance and political affairs during the past year, characteristic of a buoyant, speculative era, Mr. Howland contended that these things were doubtless fostered by paternalism, whether taking the form of protection by customs duties or bonuses, sumptuary laws that tend to make the individual lean on Government help for his profits and his wage, thus weakening self-reliance and independence; but we think that no student of modern economics can shut his eyes to the socialistic evolution in relation to public control of public utilities and the care of the individual by the state, through which the world is just now passing.

In conclusion, Mr. Howland designated a weakness in the Canadian Railway Commission in failing effectually to deal with rates, rate combinations and discriminations, while spending so much time on the less-important details of railways crossing each others' tracks, while the interests of the shippers and the people generally were suffering.

Let us Know What we are Feeding.

The Ontario Experimental Union, a body composed chiefly of students and ex-students of the Ontario Agricultural College, has at four of its annual meetings discussed the advisability of a Federal law providing for an official system of inspection and analysis of concentrated feeding-stuffs, such as gluten feed, oil meal, and the dozens or hundreds of other by-products in the manufacture of starch, glucose and other articles derived from the cereal grains. The law desired would, further, compel the manufacturer or vendor of these commercial feedstuffs to attach to each package or parcel a tag bearing a guarantee of the percentage of protein and fat contained in the feed, or, if sold in bulk, to produce on demand a guarantee of the percentages of the two constituents mentioned.

Legislation to similar purpose has been enacted in many States by the American Republic, where bulletins are regularly issued by the State Experiment Stations giving the results of analyses of all the brands of feedstuffs sold in each particular State. In Canada, a plan similar to the one outlined above has long been in force with regard to commercial fertilizers, and the ever-increasing number of milling by-products renders a law necessary to regulate the commerce in them.

Two reasons demand such a law. In the first place, the very large and increasing number of these feeds makes a study of their composition confusing, even to an agricultural chemist. It is practically impossible for anyone to learn and keep in mind anything like an accurate knowledge of their average composition. In the second place, even if one could possess himself of such information, it would be of little use, because analysis shows a wide range in the composition of similar products from different mills. For instance, analyses of gluten meal at the O. A. C. have shown a variation in the content of crude protein from 15 or 16 up to 34.9 per cent, and differences of considerable consequence occur in most of the other commercial concentrates also. As a rule, these commercial feedstuffs are valuable; some are richer than any of our staple grains. But, in order to buy and use them wisely, one must know how the particular brands in which he proposes to invest compare with staple feeds in the total amount of nutriment contained. Not less important is it to know of what nature the nutriment is, whether rich in protein, as are bran, oil meal and peas, therefore adapted to produce growth and milk; or whether it is more of a purely fattening property, like corn. If a

THE FARMER'S ADVOCATE AND HOME MAGAZINE

THE LEADING AGRICULTURAL JOURNAL IN THE
DOMINION.

PUBLISHED WEEKLY BY
THE WILLIAM WELD COMPANY (LIMITED).

JOHN WELD, MANAGER.

AGENTS FOR THE FARMER'S ADVOCATE AND HOME JOURNAL,
WINNIPEG, MAN.

LONDON (ENGLAND) OFFICE:
W. W. CHAPMAN, Agent, Mowbray House, Norfolk Street,
London, W. C., England.

- 1. **THE FARMER'S ADVOCATE AND HOME MAGAZINE** is published every Thursday. (32 issues per year.) It is impartial and independent of all cliques or parties, handsomely illustrated with original engravings, and furnishes the most practical, reliable and profitable information for farmers, dairymen, gardeners, stockmen and home-makers, of any publication in Canada.
- 2. **TERMS OF SUBSCRIPTION.**—In Canada, United States, England, Ireland and Scotland, \$1.50 per year, in advance; \$2.00 when not paid in advance. All other countries, 12s.
- 3. **ADVERTISING RATES.**—Single insertion, 30 cents per line, agate. Contract rates furnished on application.
- 4. **THE FARMER'S ADVOCATE** is sent to subscribers until an explicit order is received for its discontinuance. All payments of arrears must be made as required by law.
- 5. **THE LAW IS**, that all subscribers to newspapers are held responsible until all arrears are paid and their paper ordered to be discontinued.
- 6. **REMITTANCES** should be made direct to this office, either by Money Order or Registered Letter, which will be at our risk. When made otherwise we will not be responsible.
- 7. **THE DATE ON YOUR LABEL** shows to what time your subscription is paid.
- 8. **ANONYMOUS** communications and questions will receive no attention. In every case the FULL NAME and POST-OFFICE ADDRESS MUST BE GIVEN.
- 9. **WHEN A REPLY BY MAIL IS REQUIRED** to Urgent Veterinary or Legal Inquiries, \$1 must be enclosed.
- 10. **LETTERS** intended for publication should be written on one side of the paper only.
- 11. **CHANGE OF ADDRESS.**—Subscribers when ordering a change of address should give the old as well as the new P. O. address.
- 12. **WE INVITE FARMERS** to write us on any agricultural topic. We are always pleased to receive practical articles. For such as we consider valuable we will pay ten cents per inch printed matter. Criticisms of Articles, Suggestions How to Improve THE FARMER'S ADVOCATE AND HOME MAGAZINE, Descriptions of New Grains, Roots or Vegetables not generally known, Particulars of Experiments Tried, or Improved Methods of Cultivation, are each and all welcome. Contributions sent us must not be furnished other papers until after they have appeared in our columns. Rejected matter will be returned on receipt of postage.
- 13. **ALL COMMUNICATIONS** in reference to any matter connected with this paper should be addressed as below, and not to any individual connected with the paper.

Address—THE FARMER'S ADVOCATE, or
THE WILLIAM WELD COMPANY (LIMITED),
LONDON, CANADA.

dairyman has abundance of corn silage and straw, and perhaps some corn and barley meal, but very little clover, oats or bran, he would be pretty near throwing his money away to invest in a concentrate that did not contain plenty of protein. Conversely, it would be unnecessarily expensive for a man feeding steers clover or alfalfa hay to spend much money on highly-nitrogenous concentrates, as the steers would receive enough protein in their hay. If all our concentrates were guaranteed to possess, within reasonable limits, a certain quantity of protein and a certain quantity of fat, the intelligent feeder could form a good idea what one or more of them he should purchase to best advantage to supplement his home-grown feeds. Until this is done, our feeders must be groping in the dusk when they undertake to utilize these feeds.

At the meeting of the Experimental Union last December the subject of legislative control of feeding-stuffs was again presented in a short paper, and a resolution passed calling upon the Dominion Government to enact the necessary legislation. Through the co-operation of Mr. Putnam, Superintendent of Farmers' Institutes, the resolution has been circulated as a petition at the Farmers' Institutes this winter, and will then be forwarded to the Dominion Government. The substance of the petition will be found in another column. Read it and think it over. The cause is well worthy of your support.

Best Investment He Ever Made.

In renewing my subscription and sending one new subscriber, I wish to say I am very much pleased with your journal. I feel it is the best investment I have ever made. I am going to try to get all my friends to subscribe for it. All I regret is I did not take it sooner, as I feel I would be far more up-to-date on my farm.

Wright Co., Que.

D. J. WOODS.

Our Maritime Letter.

It is pleasing to know that the Maritime Agricultural College at Truro, whilst not overcrowded, is receiving a much more general support than ever. We were there the other day, on our way home from Ontario and the hopefulness which pervaded the teaching staff was in striking contrast with other years. Of course, Guelph wasn't built in a day any more than Rome, nor will Truro in many years measure up to the proportions of its Ontario prototype. Still, there the ordinary signs of adaptability to conditions, and the recognition which comes of satisfied examination now seem to be hers. The Maritime Provinces as a whole, are not a very large area for a college of this nature; and then it must be remembered that apart from Prince Edward Island, the sea divisions of our Dominion have not been devoting themselves very seriously to farming. If the normal progress can then be verified in Truro there is no reason to fear for its future.

According to the college register, this year sees New Brunswick patronizing the institution much more generously than ever. The Government pay the transportation expenses of the pupils and they are enrolled for the short and long courses alike. New Brunswick, when its rich forest lands are exploited—and may that day be remote—can doubtless turn great areas to agriculture. The soil of the northern section will be light for the most part, but carefully handled it will give paying returns. Indeed, several farming communities are already launched out into agriculture, almost entirely, and they are flourishing. The adjacent lumbering centers of course afford a strong market for field products. In general the farmers of New Brunswick are paying greater attention than ever to their work, and since it would be little short of foolishness for their rulers to attempt to start a college of their own, their sons will more and more as the years evolve, frequent the halls of Truro.

Prince Edward Island is peculiarly situated. Her communication is so defective that no cut-and-dried policy can be followed. None of her students are encountered at the college this year. The winter came in so suddenly, so severely, and so unexpectedly, that the disposition to take the trip over the straits to agricultural classes was completely knocked out of us, in the anxieties which surround the urgent foddering of the cattle, the supplying of fuel and the other hundred and one things always awaiting the last favorable moment. And the youth of the country is now largely in other lands. Last year the Government sent pupils to Truro on the ordinary lay—free transportation—this year it has done nothing. Selected on any other basis than the political, this sending of young men to the Agricultural School of the provinces is about as good a thing as the country could do for its advancement. Our Government is now doing very little for agriculture; it is drawing everything from it. The old Provincial Farm has gone by the board and in its stead the Local Administration is to donate to the Federal Department of Agriculture the site for an experimental station. A grant for the purpose of this work will be put through at Ottawa this session.

If the new experimental farm does not serve agriculture in the Island better than Nappan has done the larger constituency, there is little need of rejoicing. But, it should. We confess to a sort of shock to our hopefulness, when in Nova Scotia the other day. We were dilating on the good to be done us by our prospective station, when a leader in the agricultural army stumped us with this: "Now, Father Burke, after all, what have the experimental farms done in the way of experimentation? Simply nothing." We thought of some wheat accommodations, and stated them. "And what have they amounted to?" came back quickly. We really didn't know. But surely all this care and money must have produced some scientific results to which Canadian agriculture can proudly turn. And surely it would be well to know them, if those stations are to be maintained and the money expended on them justified before the country. They cover the whole range of husbandry. Have they improved the nation's stock? Have they bettered its seeds? Have they developed its fruits? Has sane instruction

gone out from them? We always thought so; but when the proofs are demanded at short notice it is not so easy to reply.

Anyway, it were well for the farming community to discuss the pros and cons of experiment station work. And just here the question arises, "Who is heading the agricultural movements of Canada at the moment?" We all know that a supreme head is necessary to direct the work intelligently. Dr. Robertson was Commissioner of Agriculture. He looked abroad from the watchtower of the nation, and saw much more, all will admit, than we citizens at the gates. But he has not been succeeded. The aggressive side of our agriculture, so to speak, misses him very much. There is evidently a want somewhere. And agriculture is important enough in the national economy to have it quickly filled.

But we were speaking of the Maritime College, and rejoicing at its success. "Next year the Newfoundland Government will send students here," we were told. This is right. It must be made the fountainhead of this Atlantic seaside. Equipped and extended, it must meet all the requirements of the case. Our new Island farm will serve as a station to it.

A. E. BURKE.

Making One "Vet." a Year.

The Ontario University Commission has, we understand, so far advanced its work in regard to veterinary education, that practically all that remains undone is to adjust the financial terms upon which the Veterinary College will be taken over and affiliated with the Provincial University, so that its course may be lengthened and its status raised, whereby the whole profession will be benefited, and, indirectly, the live-stock interests of the country. The College has annually been turning out a long list of graduates, all duly qualified as practitioners, probably far more than the actual needs of the case require; but in spite of this, the Ontario Legislature must needs go into the petty political business of making "vets." by act of Parliament, at the rate of about one a year. Last year a blacksmith was graduated, and now, we understand, an attempt is on foot to grant the title "V. S." to another unqualified man. We have protested before against the Legislature thus usurping the functions of educational institutions, and now do so again, with the suggestion that members of that body should, for the future well-being of the veterinary profession, put their feet down once and for all upon such proposals, and in their own interests as well, by discouraging analogous appeals from other quarters. The more they pander to the people in this way, the more they will be deluged with similar requests to do for every Tom, Dick and Harry what Tom, Dick and Harry are well able to do for themselves.

HORSES.

Our Scottish Letter.

After a period of enforced silence, due to the effects of the railway disaster at Arbroath, on 28th December, in which I was unfortunately involved, I now resume correspondence with my friends in Canada. I had a very narrow escape from sudden death, being in the part of the train which suffered most. Apart from somewhat numerous cuts and bruises in the head and limbs, I fortunately escaped without broken bones.

The chief events of January have not been such as would likely have interested deeply Canadian readers. The weather has been wintry, and, therefore, seasonable. We have had a deal of frost and snow, with one mild week—that from the twelfth to the nineteenth of the month. The variations during the rest of the first month of 1907 have been amazing, and the heavy snows and intermittent frosts have been rather hard on sheep, while of necessity there has been a somewhat severe consumption of straw. Flockmasters do not like to feed hay to the sheep if they can possibly avoid doing so. It teaches the sheep a bad habit, and, as in the case of human beings, such habits are very difficult to get rid of.

CLYDESDALES FOR CANADA.

The month has borne witness to the keenness of the demand for Clydesdales in Canada. Scarcely a week has passed without shipments being made, and at present not a few buyers are going the rounds and picking up fillies chiefly for export to the Northwest. To encourage the breeders who are such hearty supporters of the breed, the Clydesdale Horse Society recently donated six gold medals for competition at the fair to be held during the ensuing season at Winnipeg, Regina and New Westminster. An application

has also recently been received from Brandon. The Vice-President of the Brandon Association, Mr. McPhail, is at present with us here. He was at the Scottish Stallion Show on Wednesday, where we had also with us gentlemen from Sweden, the Argentine, and other parts of the world.

THE GLASGOW STALLION SHOW.

The show of Clydesdale stallions, held in Glasgow on February 6th, was chiefly remarkable for the splendid quality and substance of several old stallions which entered the lists. Of these the oldest was Mr. Wm. Taylor's Sir Simon 10465, now eleven years old. This great horse had the Glasgow premium when he was a three-year-old. He was shown wonderfully fresh and fit, and was well in for the same honor a second time. He was bred at Knockdon by Mr. Alex. Cross, and was got by the celebrated Sir Everard 5353, whose blood now dominates the Clydesdale world through Baron's Pride, Sir Hugo, and other breeding horses. Another noted old horse was Baron Kitchener 10499, one year younger than Sir Simon, and more successful on this occasion. This noted son of Baron's Pride was bred near Glenbue, and was out of a mare by Sirdar 4714, a son of Darnley, which Colonel Holloway exported many years ago. Baron Kitchener was first owned by the Messrs. Montgomery, who showed him very successfully as a yearling and two-year-old. They then sold him to Mr. Herbert Webster, a Dunham gentleman, and in his hands he was also successful. For some years past he has been owned by Mr. Matthew Marshall, Stranraer, and for him he was last year third at this February show. He bettered his position to some purpose this year, being placed first in a strong class, and winning also the Cawdor challenge cup against all comers, save the young horse, Oyama, which, having won it last year, was debarred from competing for it a second time. Baron Kitchener is a grand specimen of the breed, showing plenty weight and cart-horse substance and character. There was no question of his right to win both the first prize in the open class and the challenge cup. After him in the class came a four-year-old horse, Mr. Stephen Mitchell's British Chief 12500 (a son of Baron's Chief, by Baron's Pride), whose present owner paid 750 gs. for him in October last. This is a very handsome, big horse, not faultless in his action in front, but taken altogether, a right good specimen of the breed. The third horse, Mr. W. S. Park's Royal Chattan 11489, is rising seven years old, and another splendid wearer. He was first at this show and champion at the Highland in 1905, and this week not only secured the Glasgow district premium a second time, but his son, Clan Forbes 12913, which is his facsimile, and also owned by Mr. Park, secured the junior premium. Royal Chattan is a horse with magnificent action. He was bred by Mr. John Findlay, Springhill, Bailliestar, and a very large number of fillies got by him, and by his sire, Clan Chattan 10527, also a Glasgow premium horse, were exported to Canada last year. His dam was got by the celebrated sire, Baron's Pride, whose descendants fairly dominated this show. Old Sir Simon was fourth, and the fifth and sixth horses were big, gay, handsome sons of Hiawatha 10067, whose stock for several years secured the leading honors at this gathering.

The leading three-year-old, as already indicated, was Mr. James Kilpatrick's beautiful quality horse, Oyama 13118. Last year he won in the two-year-old class, and carried off the Cawdor challenge cup against all comers. This year he not only won his class, but carried off the Brydon 100 gs. challenge shield. The difference between this trophy and the Cawdor cup is that horses competing for it must be up to a given height, and pass a veterinary examination on the ground as sound. Oyama is got by Baronson, a son of Baron's Pride, which promises to be an extra good breeding horse. Oyama is a quality Clydesdale, and probably Canadian judges would not think so highly of him as do Scotsmen. He has faultless feet and pasterns, and bones like ivory. Next to him stood the Hiawatha horse, the Undaunted Prince 13233, owned by Mr. John Pollock, Langside, the owner of Hiawatha. This young horse was last year champion at both the Ayr and Glasgow summer shows. He moves like a motor car, and never seems to have enough of it. His feet and ankles are not so sharply defined as are those of Oyama, and Mr. Wm. Taylor's Sir Spencer 13211, which was placed third, also excels him in this particular. This is an extra good type of cart horse. He stood second to Oyama at this February show a year ago, and is a very solid, massive cart horse, with true cart-horse action. His sire was Sir Hugo, a son of Sir Everard, which breeds exceptionally good weighty stock. Following him in fourth place came Mr. W. S. Park's Clan Forbes 12913, to which reference has already been made, and the fifth, sixth and seventh horses were, in order, Rowallan 13159, Crusoe 13428, and Pacific 13119. Rowallan and Pacific are both owned by Mr. William Renwick, Meadowfield, Corstorphine, and Crusoe is owned by Mr. Wm. Dunlop, Dunure Mains, Ayr.

The first-prize two-year-old was Johnston Victor 13540, and the first-prize yearling or foal, Mr. Guild's Sam Black, by Baron o' Dee. It was pre-eminently as I have said, a "Baron's Pride" event. The first-prize aged horse, Baron Kitchener, is his son, and the first-prize three-year-old, two-year-old and yearling colts are got by as many sons of his, viz., Baronson, Balmedie Queen's Guard, and Baron o' Dee. Previous to the

show 85 stallions had been hired for service in 1907, and of them the first to be hired was Baronson, which was let at the show of 1906 for service in the season of 1907. Of the 85 not less than 42 are owned by Messrs. A. & W. Montgomery, Netherhall and Banks, Kirkcudbright. After them comes Mr. James Kilpatrick, Craigie Mains, Kilmarnock, who has a dozen hired. Including the two Glasgow premium horses, Royal Chattan and Clan Forbes, both owned by Mr. W. S. Park, Hatton, Bishopton, 14 horses were hired at the show on February 6th, inst. So far I have not heard of any engagement being yet made for 1908. Of the winners at the show this week, three were sons of Hiawatha, two of Baronson, two of Sir Hugo, two of Baron o' Buchlyvie, and there were one each by Baron's Pride, Baron's Chief, Sir Everard, Clan Chattan, Shapely Prince, Baron Ruby, Marcellus, Balmedie's Queen's Guard, Baron o' Dee, Sir Humphrey, Lothian Again, Lord Fauntleroy, Sir Ronald, Carthusian, Royal Chattan, Montrave Magnus and Revelanta.

"SCOTLAND YET."

Some Famous English Shires.

Specially written for "The Farmer's Advocate," and illustrated with photos, by G. H. Parsons.

It is very doubtful if there is any branch of British farming, at the present time, that is on a sounder or more paying basis than Shire-horse breeding. After one or two seasons of remarkable prices, things have certainly toned down a little, but they are looking up again, and the market for big, sound, weighty horses suitable for town work, is as good as ever it was. There is no secret in the fact that the motor, for heavy haulage, has not been quite the success that was anticipated, and the day when the Shire will be dispensed with is further distant than ever. One very pleasing feature in connection with this widely-known draft breed is that the tenant farmer and small breeder has played such a prominent part in its upbuilding. Many a London champion or Royal winner claims a tenant farmer, perhaps in a

very humble position, as its breeder; and although the Shire Horse Society is materially assisted by almost all the leading nobility, from the King downwards, it cannot in any way be stated that, like some breeds, a monopoly is held by the wealthy classes. A more important fact than this is that there are many agriculturists in England to-day in a very prosperous condition who would have been bankrupt had it not been for Shire-horse breeding. The various societies, composed of farmers and other interested parties, who have clubbed together for the purpose of securing good stallions at a nominal fee in their respective districts, have done an inestimable amount of good. A speaking proof of this is that it is quite a common occurrence for a foal of only a few months old to change hands for three figures.

That there are endless possibilities in the export trade, particularly with Canada, is a fact to which British Shire breeders are awakening. The patriotic and broad-minded spirit which prompted H. M. the King and Lord Rothschild to send out some of the pick of their studs, should do much to further the interests of this breed on both sides of the water. However, one must not be disappointed if the export trade fails to develop with mushroomlike suddenness, as a good many very inferior-class horses have been sent abroad that have caused a misrepresentation of the merits of the Shire that only time and the introduction of typical, weighty horses can outlive.

Many Canadian breeders interested in the Shire will doubtless find instruction in studying the accompanying series of portraits of some of the leading British stock and show horses, which reveal the type and characteristics with more force and accuracy than words. One point which must not be overlooked is that two of the stallions, Markeaton Royal Harold and Buscot Harold, to

wit, were photographed as aged horses quite recently, and the remarkable freshness which they display, after long and arduous careers, speaks volumes for the wearing qualities of the breed.

We commence our series with Bury Victor Chief 11105, whose name is probably as widely known in Canada as in England. He is a black, with conspicuous white markings, foaled in 1889. His sire was Prince Victor, and he was bred by Mr. J. Rowell, in Huntingdonshire. He passed into the hands of Mr. Joseph Wainwright, of Great Rocks, Buxton, for over a thousand pounds, a price which created a good deal of comment at the time. It turned out a good investment, however, as he secured for his owner the highest honors



Buscot Harold (16576), at 10 Years Old.

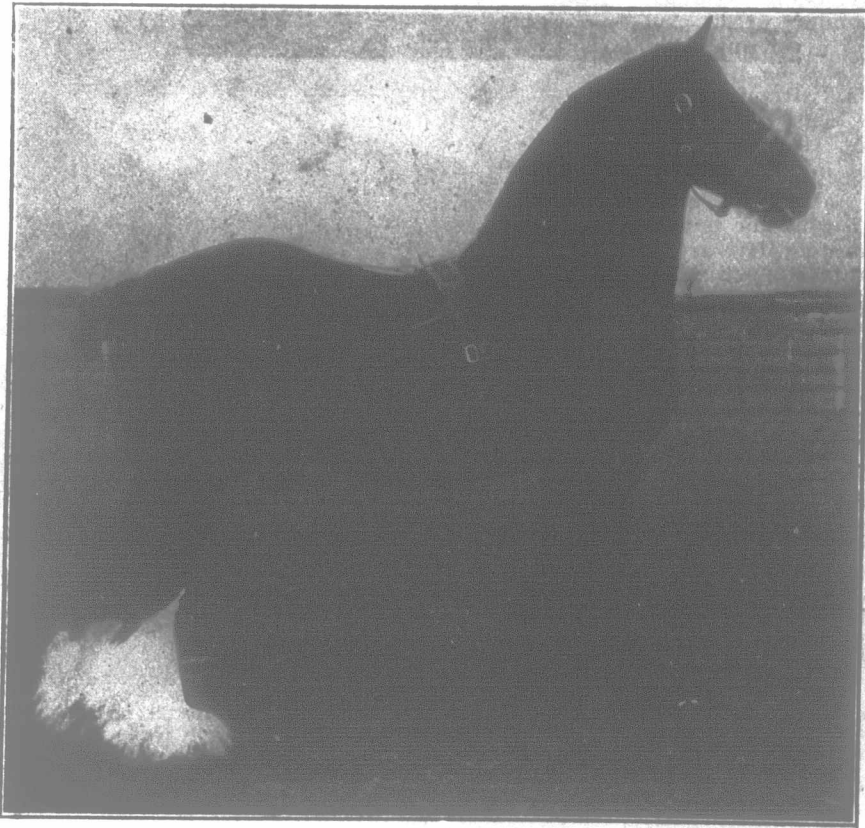

Markeaton Royal Harold (15225), 13 Years Old.

To Stimulate Growth of Horse Hair.

Editor "The Farmer's Advocate":

I saw in "The Farmer's Advocate" of Feb. 7th an inquiry as to what would make hair grow on horses' legs denuded by overblistering. I used on a valuable mare in the Old Country one-half pint of raw linseed oil, one-half pint of coal oil, and about 4 tablepoons of sulphur, mixed, and rubbed it on the bare place of the horse once a day, and it answered first-class. This is what they use on the stud farms in the Old Country. I trust this will be of some use to "The Farmer's Advocate" readers.

J. H. M.

York Co., Ont.

the Shire world can bestow, including the championship twice at the London Shire Shows, and made a considerable reputation as a sire. Numerous winners claim this grand old favorite for their sire, prominent amongst whom may be mentioned Victor's Queen, Rock's Chief, a London reserve champion, and Rock's Commander. When we saw the old horse he was well on in his 'teens, but although time had left its mark, he came out of his box with the fire and vitality of a youngster, and his grand bone, good feet and fine-quality feather left a lasting impression of what a cart stallion should be.

Mention of the name of Markeaton Royal Harold 15225 calls to mind the sweeping victory secured by his owner, Sir Alex. Henderson, at the Shire Show in 1898, when Buscot Harold, his sire, Markeaton Royal Harold, his dam, Aurea, and Lockinge Loriet, a mare from the same stud, made a clean sweep of the six championships. Markeaton Royal Harold is a striking example of the famous "Harold" cross with "Premier" mares, his sire being Mr. Duncombe's renowned horse, and his dam, Sensible, by Premier, an own sister to a host of great stock horses, amongst which are Chancellor, Hydrometer, Northwood and Calwich Topsman. Markeaton Royal Harold 15225 is a bay, foaled in 1893, and a more imposing-looking horse could not be found. He combines weight and activity, with beautiful flat bone, grandly-turned joints and good-wearing bone. As he steps out of his yard, with head majestically aloft and mane flowing in the breeze, one can picture what a sight it would have been to see a horse of this stamp carrying a knight in glittering armor forth from some ancient castle to do battle for his king in the days of chivalry and romance. But the more peaceful calling of winning honors in the show-ring was his lot, and his prize record is an excellent one, besides being the sire of a very large number of winners, the most famous of which is, of course, the subject of our next notice.

Buscot Harold 16576.—This horse is unique as far as his breeding is concerned, being the progeny of two London champions, Markeaton Royal Harold and the great prizewinning mare Aurea, by Thornton Premier. He is a beautiful bay, foaled in 1896, and bred by his owner, Sir Alex. Henderson. Sound judges of the Shire regard Buscot Harold as one of the greatest specimens the breed ever produced, and they are not far wrong. His grand crest, powerful quarters and well-moulded limbs show to advantage in the accompanying photo, which, it should be mentioned, was taken at the end of last season, during which he served 100 mares. The fact of him being put fourth on his first appearance in the show-ring, does not count as a true record of his merits, for, being fresh to the sights and sounds of the London arena, he gave a very poor show, but he was never put back again, as his prize record shows, and he was the first horse to lower the colors of his sire, winning first and champion at the Shire Show, London, in 1898, 1899 and 1900. Buscot Harold is the sire of many winners, and was let for £1,000 for one season.

In Tatton Friar, we come to a younger horse, and one of a totally different stamp. His great characteristic is weight, and in this respect he is probably without a rival in the country. A dark brown, with white markings, bred by Mr. J. Ball, Chester, owned by Earl Egerton, of Tatton, Knutsford, Cheshire, and foaled in 1900, he is by Conquering Harold, out of Sandycroft Rose, by The Friar. In 1904 he came out at London and ran a neck-and-neck race with Birdsall Menestrel for the class honors. He then won the £50 Gold Cup at the Royal Lancashire, and was second at the Yorkshire. In 1905 Tatton Friar again won the Royal Lancashire Gold Cup, and at the beginning of this year experienced very hard luck in not getting the championship at the Shire Show, London, for it was only after a long struggle that he gave in to Present King II., and in many opinions the verdict should have gone in his favor. This horse seems to have a very bright future before him as a sire; his stock are coming out well, and win in the show-ring among the best of company.

The last of the stallions dealt with has probably been seen in the flesh by many Canadians who peruse these pages. This is Girtton Charmer 20515, which was included in Lord Rothschild's exhibit at Toronto last September. He is a brown, foaled in 1901, sired by Normaer of Batsford, dam Southgate Charm, by Harold. This horse is rather a different type to what is commonly seen in the show-ring. He does not carry quite such a profusion of feather as is prevalent to-day, but, nevertheless, he is a sire of sterling merit, and every inch a cart horse of the weightiest class. A complete list of Girtton Charmer's honors, did space permit, would doubtless be of interest. Suffice it to say he was first and reserve junior champion at London Shire Show in 1903, first and junior champion at Shire Show in 1904, and first and supreme champion at Shire Show in 1905.

We now come to the females, on whom so much

of a stud's success depends, for, without a good and, above all things, sound mare, it is useless to attempt breeding.

Princess Beryl fills the eye as an ideal Shire brood mare. She is a tremendous animal, showing wonderful quality, with a roomy body, carried on magnificent limbs. Her pasterns are good, feet strong and open, while the quality of her feather is perfect. She is a member of the famous Tring Park stud, owned by Lord Rothschild, was bred by Sir Henry Ewart, and is a black nine-year-old daughter of Prince Harold and Jewel, by Electric. Many honors have fallen to her share, including (1904) fifth Shire Show, London, in strong class; first and champion, Shire Horse Show, London, 1905; and first and reserve champion, Shire Show, London, 1906.

Sussex Blue Gown is a gray six-year-old, by Nailstone Cœur de Lion 16269, dam Sussex Blue Bell, by Victorious. She was bred by Mr. T. Luckin, and is a considerable prizewinner, her

cellent mover, with an abundance of flat bone and good feather.

Combermere Abbess is a black-brown yearling filly, sire Tatton Friar, dam Moor's Star, by Regent II. She was bred by that enterprising young breeder, Mr. Noel Forwood, of Whitechurch, Salop, and is owned by Mr. Egerton Orme, Ash, Etwale, Derby. This filly is quite one of the best of her age seen out for some time, combining size, weight and quality, whilst in the all-important points of feet, joints and feather, she bears the closest scrutiny. Her prize-list is a very considerable one for so young an animal, including first in open and local classes at Royal Show, Derby, 1906.

No Act Required.

Editor "The Farmer's Advocate":

There is no doubt our Government is anxious to help the horse-breeding industry of this country in some way, and there is also no doubt that this anxiety is being used by importers and stallion owners to further their own interests, by having an inspection and license act, also a lien act, placed upon our statute books. Now, how can such an act improve the quality of the horses in this country? The stallions are not entirely at fault, as these men would have us believe. They are, as a politician would say, drawing a herring across the trail. Of course, if they can prove the stallions are entirely at fault, then there may be some excuse for legislative interference; and this I don't think they are able to do, because in every community we have very many farmers patronizing the same stallion, with very different results, be he ever so good. In every community we have and always have had three classes of mares—good, bad and indifferent—which, when all are bred, must produce a lot of inferior stock from any stallion, and under a license act results would be the same.

Then, again, we have the different breeds of light and heavy horses crossed back and forth to such an extent that it would be strange if present results were not attained. And, again, we have the good-natured, slick-tongued "come-and-have-a-drink-boys" groom, who has as much influence in the production of scrub stock as the much-dreaded scrub horse; and these same conditions must obtain under any circumstances, so that it really seems a case for education more than coercion. Teach the great importance of line-breeding, and induce farmers to quit this eternal crossing of the different breeds of light and heavy horses, for to this, more than to any other cause may be attributed our present supply of inferior stock. The inferior stallions, as a rule, do not receive the amount of patronage that these people would lead one to believe, or they would not be compelled to do business at a fee of four or five dollars or less.

Stallion owners tell us they cannot pay prices high enough to secure the best stallions. This may be, and still we know of many syndicates which did pay long prices for what were supposed to be the best and which proved a total failure as stock horses, showing that long prices did not ensure farmers a uniform progeny.

Breeding, as carried on by the farmers of to-day, is more in the nature of a side line than a regular business or industry, as farmers require a great number of horses for both road and farm work. These they believe they can produce more cheaply than they can be purchased. Then, it is up to each farmer to use whatever breed of stallion he believes will produce stock suitable for his own requirements, be he registered or not.

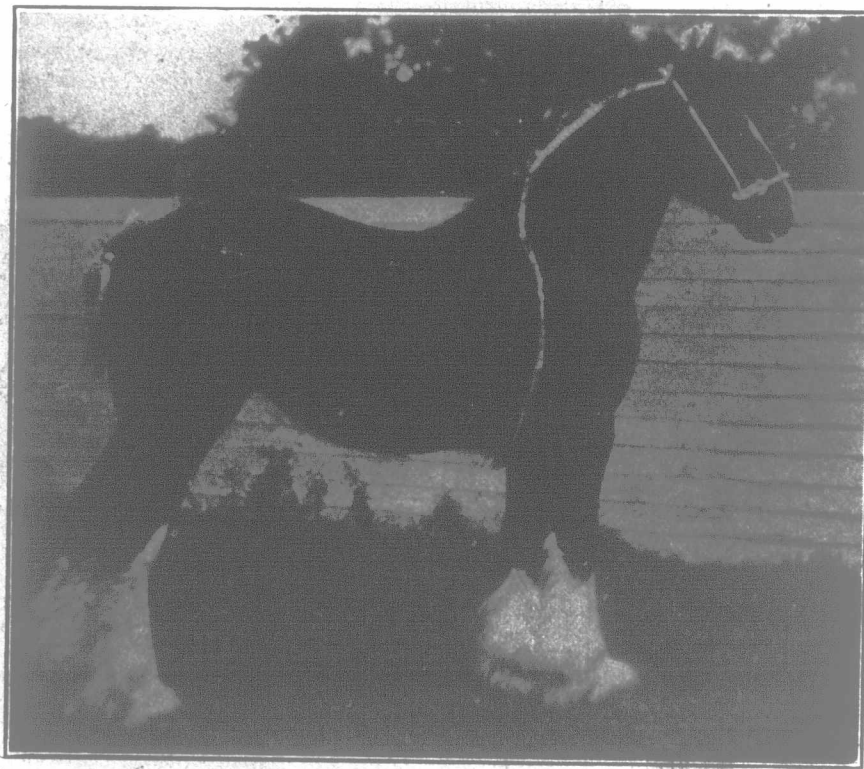

Combermere Abbess.

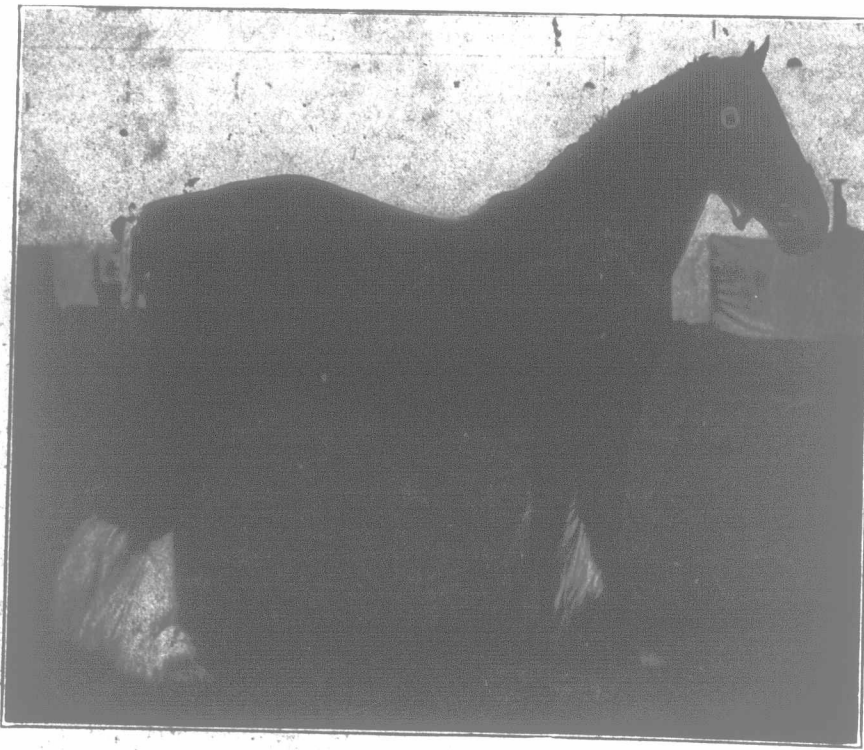

King Forest, in His Yearling Form.

victories including first and champion at Shire Show, London, 1906. She was sold for 516 gs. to Earl Beauchamp, Madresfield, Malvern, after the Shire Show. Sussex Blue Gown is a grand, upstanding mare, of very striking appearance, with immense bone and substance, which generally carry her to the fore in the show-ring; but in spite of these, she hardly displays the sweet feminine character one likes to find in a brood mare.

Our series concludes with two very successful youngsters, which give an excellent idea of what a Shire colt should be. Mr. F. E. Muntz's King Forest is a two-year-old son of the renowned stock-getter, Lockinge Forest King 18867, out of Lockinge Dimple. In 1905 he was unbeaten at the foal shows; in 1906 he was second to a colt by the same sire at the Shire Show, London, and since then he has won first at the Royal and several other shows. He is a beautiful colt, brimful of quality, an ex-

The unregistered sire can stand at home at a low fee, and cut well into the trade in that section, so that a mere inspection and license to travel would not cover the whole difficulty. They say we have a lot of unsound stallions; we certainly have some, but farmers are not compelled to patronize them, even under the present system. A stallion does not travel far before all his faults are known by those who need to know them, because we have many men in every community both able and willing to advise all customers as to any weak spots in this or that stallion.

Then, what about all the unsound mares which are bred every year? Will an inspection act stop this cause of trouble? Decidedly not. It looks as though importers and dealers in stallions have found farmers wary of the syndicate business, and are adopting this method to enlarge their field of labor—a kind of protection at the farmer's expense, as their aim certainly is to limit competition, and thereby be enabled to put up the price of fees to whatever extent they might see fit, without any corresponding benefit to the farmer.

As the lien act has little or nothing to do with the improvement of horse-breeding, little need be said in regard to it, any more than it is also entirely in the interest of the stallion owner, and, whether he, as a creditor, would be entitled to the advantage which such an act would give to him, is open to question, inasmuch as he has the same law to collect a debt with as any other creditor. Many stallion owners are entirely to blame for many of the losses of which they complain, in the many outlandish risks they take and the bargains they offer in the shape of a galloping foal, a foal ten days old, a living foal, a foal without white markings, or no pay. Then, again, he deals with everyone, irrespective of ability to pay, and, when he loses, howls for a special act in his favor. I see no reason for any lien act, and I have been in the stallion business for the last twenty-seven years.

At first sight the inspection act looks very simple, but, upon closer examination, we find many more difficulties than at first appear upon the surface, and until some better scheme is devised, the whole question should be shelved.

Peel Co., Ont.

W. C. BROWN.

LIVE STOCK.

Cures for Ringworm.

Many inquiries are made at this season of the year for a remedy for ringworm on cattle. The disease is caused by a vegetable parasite, and shows itself generally on the eyelids or other parts of the head, or on the neck, and is liable to spread over all parts of the body. It may be known by the loss of the hair on the part affected and the formation of a white scale or scurf which spreads to larger surface, and to other cattle in the same stable, and is supposed to lurk in the walls and partitions of the stable. Numerous remedies are prescribed by veterinary authorities, such as tincture of iodine, nitrate of mercury ointment, acetic acid, coal-tar preparations, etc., but a simple and sure cure is sulphur ointment, made by mixing powdered sulphur in oil, lard or grease of any kind, well rubbed into the affected part. The cure will be more quickly and effectually completed if the scales are first softened by washing with warm soapsuds, and partially or wholly removed by gentle scraping with the finger nails. A little coal oil in the mixture applied will also make the cure more certain, though we have known very satisfactory cures from the use of sulphur and lard, repeated once or twice after a lapse of two or three days.

Handling a Vicious Bull.

If a bull has once shown the least disposition to be vicious, he should never again be taken out of his stall without a ring in his nose and a staff of first-class tough wood, with a strong, safe, spring snap, or, better, a jointed connection with a turn-screw, as spring snaps are liable to get out of order. Indeed, it is not absolutely safe to trust even a mild-tempered bull that has never shown a tendency to be cross, as many cases have occurred where such an animal has suddenly and surprisingly turned vicious, owing to some unknown cause, and done his caretaker to death. A very vicious bull cannot be safely taken out, even with a staff, and the simply safe way to handle such is to blindfold him by securely fastening a sack or something of the kind on his head so that he cannot see either in front or sideways. This device is equally effective in quieting an excited or nervous cow, heifer or steer that one wishes to lead. The writer recalls the case of a nervous heifer, shipped alone in a freight car, being so excited on arrival at her destination that it was impossible to untie her in the car, as she would jump at a person, and would have impaled him upon her horns. A horse blanket was thrown over her head, then a sack fastened over her eyes, and she was led out quietly and tied behind a wagon, where she followed as quietly as could be desired.

The Dog and Sheep Problems in Nova Scotia.

Editor "The Farmer's Advocate":

The subject of the protection of sheep from the ravages of dogs is of even more importance to the farmers of Nova Scotia than those of almost any other part of the Dominion. We have large areas of lands, essentially adapted to sheep. The climate is temperate and moist. Roots and fine, succulent grass, when given a chance, grow to perfection. We have little trouble with contagious disease, and, moreover, the quality of wool and mutton produced under these conditions is unexcelled.

At the same time, Nova Scotia is not essentially an agricultural country in the sense that Ontario is, and it is difficult to create a large public sentiment in favor of measures to exterminate worthless dogs, and thus give the valuable sheep a chance. Our present statutes in regard to the protection of sheep are almost identical with those of the second part of the Ontario law, being, briefly, to the effect that anyone may shoot a dog (a) when actually worrying, (b) when terrifying or giving tongue to sheep, and (c) when found on a farm on which sheep are kept between sunset and sunrise, unless the dog is the property of the neighbor whose farm adjoins. Further provision is made by which, on resort to Common Law, a man can secure damages for sheep destroyed from the owner of the dog that has done the damage, provided, of course, that he is known.

At the present time there is a strong agitation in Nova Scotia to add to this law and make it more effective. A committee, of which the writer was chairman, was appointed, and we have gone carefully into the question. Our greatest difficulty, by way of having a measure passed to tax dogs, lies in the objection taken to a universal law by the inhabitants of incorporated towns and cities. We are strongly of the opinion that a



Border-Leicester Yearling Ram.

Winner of numerous prizes in Scotland in 1906.

compulsory law for all unincorporated municipalities be passed, putting a \$1.00 tax on dogs and \$3.00 on bitches. We would like to see the incorporation laws so amended that this law would be made compulsory in the incorporated municipalities. But, provided the opposition to this were too strong, we would be temporarily satisfied with a measure which could be subsequently amended, making this tax compulsory in the unincorporated municipalities. Were it possible to have this measure carried for incorporated towns and cities, I would be inclined to borrow a clause from the optional New Brunswick law, according to which 15 per cent. of the dog taxes collected in the incorporated towns and cities should be pooled with the whole tax collected from the unincorporated municipalities. This would constitute the fund from which losses could be paid in the case where damage is done to sheep by dogs, the owner or owners of which are not known.

In regard to the steps to be taken in order to secure compensation for sheep destroyed under the above-mentioned circumstances, we would suggest that the owner of any sheep or lamb killed or injured by any dog, the owner or keeper of which is not known, may, within five days after the killing or injury is known, go before a magistrate to secure a judgment for compensation for the killing or injury; and if the magistrate, after due examination, is satisfied that the aggrieved party has made diligent search and inquiry to ascertain the owner or keeper of such dog, and that such owner or keeper cannot be found, he shall award to the aggrieved party a judgment for compensation of a sum not exceeding two-thirds of the amount of the damage sustained by him; and the said justice shall forward to the clerk of the municipality his finding in the matter, and the said clerk shall bring it before the council at its first meeting, and, if in their judgment the award is fair and equitable, then the said council shall instruct the treasurer to pay the sum forthwith, or an amount that they may deem fair.

Since writing the above, it appears to me that,

in accordance with the recommendation made at the Dominion Sheep-breeders' annual meeting at Toronto, the clause requiring not more than two-thirds compensation should be changed to read, "not less than two-thirds."

If it were clearly represented to the writer that it were better to make this law, as it is now in Ontario, optional with the various municipalities, I would be inclined to recommend that such a law can be repealed for only one year, and must be annually repealed by the municipal council in order to remain non-effective. Such an amendment would be effective, at least, in regularly calling to the attention of the municipal councillors the importance of the measure, and would, moreover, prove a strong incentive to the working up of a growing sentiment in favor of this law, so essential to the welfare of the sheep industry.

In conclusion, I am pleased that this matter is to be fully discussed in the columns of your paper. While each Province must have laws adapted to its own conditions, yet the common principles of the law cannot be very different. Provided the discussion is as full as I hope it will be, I would like to make arrangements by which I can have placed in the hands of all our local legislators copies of your paper in which the discussion occurs.

M. CUMMING, Principal.

Nova Scotia Agricultural College.

Waters from Barrels in Stable.

Editor "The Farmer's Advocate":

In our system of watering stock, the water is pumped from a drilled well, located just outside the stable wall, by a power windmill. A belt from the line shaft operates a pumping jack in the stable, and from that a jerk-rod and angle drives the pump. The water is driven through a pipe under the stable wall and up into a wooden tank, holding 925 gallons, in the barn above. From this tank, three lines of inch pipe lead to three barrels, and as our cattle are all in loose pens, except the cows, the cattle from two pens drink out of each barrel. As water is always kept in the barrels, they drink when they please. The cows are watered twice a day in pails, the water being dipped from one of these barrels which is at the edge of the feed alley in front of them. With three or four pails, the cows can be watered in 10 to 15 minutes. The horses are watered from one of the other barrels which is beside their feed alley. One of the lines of pipe is extended out at the top of the stable wall, and below is a large trough. This is used only in summer, and is very convenient for horses and cows. These lines of pipe are all overhead in the stable, and have a fall from the tank, so that when the weather is very frosty the pipes may be drained by shutting off the water at the tank and opening the globe valves at the barrels.

We have had this system in operation for seven years, and the cost has been about as follows: Drilling and casing well, 110 feet, 5-inch casing, \$160; iron pump, \$9; tank, \$10; pump jack, jerk-rod, etc., \$3.50; piping all around, check valves, etc., \$12.50; four Globe valves, \$3.80. Besides the foregoing cost, there were the barrels, which were machine-oil empties, and the trough. Measurements were taken, and the pipes were all cut and threaded at the shop, and we put them together ourselves.

The advantages of this system are: Cheapness to instal, the ease with which pipes can be reached when blocked up, facility with which barrels can be cleaned out if they become dirty or slimy, and the convenience and great saving of time over having to let stock out to water. The chief disadvantage we have so far found is that barrels are apt to overflow if not watched when filling. Considering cost of installing and ease of cleaning, I have not seen any plan I like better.

Huron Co., Ont.

Importance of Ventilation Not Discounted.

Editor "The Farmer's Advocate":

I am in receipt of a copy of "The Farmer's Advocate," containing editorial reference to and a review of our bulletin on "Stable Ventilation." The caution and the urgent advice given in your editorial is altogether appropriate, and I think it very wisely done. We realize that this is a somewhat dangerous subject, or at least one very difficult to publish without doing a great deal of harm. Please bear in mind that we are endeavoring to make very plain that there is no reason to doubt the general necessity of ventilation, and that if future work supports the work which we have done this far, ventilation will still be as important as it ever was; but that we may have been very badly mistaken in the past concerning some points in the explanation of the necessity, and that some things which have been considered very important are perhaps not seriously important at all.

The second bulletin in this series will probably be out during the early spring.

M. H. REYNOLDS, Veterinarian.
Minnesota Agricultural Experiment Station.

Petition for Feedingstuffs Legislation.

The subjoined resolution, endorsed at the Ontario Experimental Union, at Guelph, December last, has been circulated this winter as a petition through the Ontario Farmers' Institutes. The law it asks for is badly needed, and will be more and more necessary with each succeeding year. If you have had no opportunity to sign the petition, clip out this copy and mail with your address to the Department of Inland Revenue, Ottawa. It would be well for Provinces other than Ontario to be heard from, as the legislation needed will be national in scope and application.

As the paper with which the resolution was presented says, a casual review of these concentrated commercial feedingstuffs, with reference to the percentages of protein and fat, will suffice to assure those informed on the subject that in most instances the feeding values and prices of these feeds are not in accord. In fact, at the present time feed is retailed at so much per ton, whether it is rich in protein and well suited to supplement our ordinary farm feeds, or whether it is a starchy feed, and, therefore, of much less value (as a general thing) in compounding suitable rations for cattle. Such being the case, special care in the purchase of feeds and some knowledge of their chemical composition will be found of great value in selecting the feeds that will produce the greatest profit. Economical purchase does not imply the purchase of the lowest-priced foods. Many of the waste products of our mills are not altogether worthless, but it is important that the purchasers should know what they are and what relation they bear to standard feeds (bran, shorts, etc.).

In view of these facts, and in view of the further fact that the committee appointed previously to deal with this matter did not deem it practicable to establish limits of variation, the resolution was framed as follows:

"Whereas on three previous occasions the subject of commercial feedingstuffs has been before this Association, and two separate petitions have been presented to the Government asking that some means be devised whereby the purchasers of mill by-products might be able to judge of their nutritive value; and whereas the Government has complied with these requests in so far as to order a collection and analysis of most of the by-products of the mill; and whereas the analyses show that the composition of wheat bran, shorts, the whole grains, or meal obtained by grinding any single grain, is fairly constant, but that the composition of other commercial feeds varies widely; and whereas bran and shorts constitute the whole output in the way of by-products of many small mill owners throughout the country, and there being no purpose to be served in requiring these men either to employ a chemist or to have analyses made of these by-products of constant composition; and whereas the adulteration of these by-products is fully covered by the Adulteration of Foods Act (R. S. V., Chapter 24 and 26); and whereas the Committee do not deem it practicable to establish standards or limits of variation for by-products, therefore be it resolved: (1) That the terms "bran," "shorts," or "middlings," when used without further description, shall be construed to mean by-products derived solely from wheat in the ordinary processes of milling, and the products so described shall be free from oat hulls, barley hulls, buckwheat hulls, ground weed seeds, or other substances not derived directly from wheat in the process of milling, and that feedingstuffs containing products not derived from wheat in the process of milling, and sold under the name of "bran," "shorts" or "middlings," without further qualifications or description, shall be regarded as adulterated feeds; (2) that other milling by-products which are not derived from wheat, but which may be properly described as "bran," "shorts" or "middlings," shall not be offered for sale without prefixing the name of the grain from which they are derived to the terms "bran," "shorts" or "middlings," such as, for example, corn bran, pea bran, buckwheat bran, buckwheat shorts, buckwheat middlings, etc.; (3) that it is not advisable to require any formula for the composition of wheat bran, shorts, the whole grains, or meal obtained by grinding any single grain; (4) that in the case of other feedingstuffs, each manufacturer or vendor should be required to label each bag or package with the percentage of protein and fat, or, if sold in bulk, that the manufacturer or vendor shall be compelled, on demand, to give a written guarantee of the percentage of protein and fat; and, further, if the product offered for sale as a concentrated feedingstuff is a mixture containing weed seeds, milling by-products, or any by-product derived from the manufacture of starch, cereal foods, split peas, or other manufactured products, the manufacturer or vendor shall be required to furnish a statement showing the kinds of by-products contained in the mixture, and the percentage by weight of each by-product in the mixture; (5) that the Government be urged, in the interests of feeders of live stock, to take such action as indicated in (4); (6) that a copy of this resolution be submitted at farmers'

Institute meetings for the signature of members, and when these signatures are secured, this resolution be construed as a petition to the Government for the action outlined in No. (4); (7) that a copy of this resolution be forwarded to the Minister of Inland Revenue forthwith, and that the signatures be forwarded as soon as obtained.

Would Like to Hear from Sandy Fraser on the Dog Question.

Editor "The Farmer's Advocate":

Articles have been appearing in your recent issues on dog taxation for the protection of sheep. As it is very difficult to draw the line for the shooting system, the next best resort is taxation. Dogs do a considerable amount of harm in this county to the sheep industry, driving many farmers out of sheep-raising altogether. Whether there are more dogs than sheep in the County of Russell, I will leave for someone else to answer, but in the Township of Cumberland, where I live, from personal observation, I would be inclined to think there are more dogs than sheep. A great many of the sheep-killing dogs are the half-starved curs, of which so many are met in villages and towns, mostly all depending on the refuse from the village butcher shop and the farmer's sheep. A good many of the sheep-killers, also, are dogs where two, three, four, or more, are kept in one place. The dogs eat of the crumbs that fall from their master's table, and if a man keeps three or four, the chances are enough crumbs will not fall, and the dog is led to rambling in search for food, and thence to sheep-killing. Fortunately, in their rambles, they sometimes treat themselves to a fox bait, which generally puts an end to their unprofitable career. If there was a good strict dog tax, at the following figures, I think sheep-killing dogs would soon be a thing of the past, and our most profitable farm animals would have a chance to show their real value to farmers: Where one dog is kept, \$3.00; where two are kept by the one man, \$5.00 for the second dog, and then add \$5.00 for each additional dog. Let this tax be collected with the yearly taxes and go into the township treasury, to be used, as far as necessary, for the insurance of sheep against the ravages of dogs, and let the injured sheepman apply here for redress. Under such a tax useless scrub dogs would soon disappear, while the good dogs, if there are such, would be retained. As to dog taxes being kept as a separate fund, as advocated by H. Misner, I have known these separate taxes to be rendered ineffective. It was in the following way: The dog, at the time his owner paid his tax, was to receive a mark or brand, and the magistrate or constable received authority to shoot any dogs not so marked, but, through tender-heartedness, or some other cause of which I am not aware, he failed to do so. If men like R. S. Holdsworth were chosen to look after the dogs, this law would likely have proved more effectual.

Wishing your paper all success, I hope we may hear from Sandy Fraser on this subject. I would also like to know if J. E. M., Glengarry Co., doubts the economy of dogs, as well as manure spreaders?

Russell Co., Ont.

An Inexpensive Watering System.

Editor "The Farmer's Advocate":

In reply to your printed inquiry about how stock is watered, it might be worth while to describe our present system. We feed fattening steers, loose, in large basement stables. The well is just outside the shed, at the end of the barn. For some time I pumped the water with a common iron-top stock pump. Last fall I had a windmill erected on a mast fastened to the end of the barn, and connected over the well by means of jerk-rods and elbows. A steel tower would have been better in some respects, but more expensive. It is simply attached to the pump I had. I then built a cement trough, holding about twenty barrels, just inside the shed. The water is conveyed from pump to trough by a common open trough, with slight fall. For sake of cleanliness, the cement trough is covered with plank two feet above top of trough. Here the cattle may come to drink at will. A regulator of the plank-float kind shuts off the mill when the water gets so high in the trough. These floats are supposed to start the mill as well, but I find it safer to start the mill myself, weighting it so it will be sure to stop. The cost of the mill (which has an 8-foot wheel), erection included, was \$50. The mast was a car sill, which I furnished at small cost. The trough we made ourselves, using the cement basement for one side and one end. The remaining sides are 6 inches thick, and of Portland cement, mixed 1 to 9. Last of all, it was well washed with pure cement. Its whole cost would not exceed \$5.00. For my requirements, this outfit answers every purpose. It was not expensive, and seems durable.

Elgin Co., Ont.

H. C. TEEPLE.

The Lambing Season.

As the lambing season on most farms where sheep are kept in Canada commences early in March, a few hints on the care of the ewes and lambs may prove helpful to those who are inexperienced in the management of a flock. The ewes should be getting a little grain ration about this time, such as a pint to a quart each daily of oats, and if the same quantity of bran is added, all the better, to provide milk for the lambs when they come, and to give the mother strength to meet the demands of maternity. The pen should be made comfortable by closing any cracks in the walls to keep out frost and stop cold draughts. It is a good plan to have a few low, light hurdles provided, say four to six feet long and two feet six inches high, with which to improvise pens for confining individual ewes having twins or weak lambs for a day or two, till the lambs learn to help themselves. Two of these hurdles in a corner, tied at top and bottom with rope or strong twine to staples in the wall or to the hay rack, make a handy little pen, in which the ewe may be given a bran mash or a warm drink, and, if necessary, held while the lambs are suckled. It is not wise to keep the ewe thus confined more than two or three days, as there is danger of her being overfed when giving her a portion alone, causing indigestion or an oversupply of milk. Both she and the lambs will be better for moving around for exercise, and the ewe will feed better hustling with others for her portion. The careful shepherd will visit the flock before retiring for the night, to see if there are indications of an increase before morning, and if there are, he will not mind missing a few hours' sleep in order to be on hand to care for the little strangers, if need be, and to see them comfortably started in life. Lambs are often lost by neglecting to see that they get a fair start, and it is not a pleasant reflection that they might have been saved by a little sacrifice of comfort on the part of the caretaker.

It is seldom necessary to interfere with a ewe in labor; nature generally works out its own salvation better than can be done by meddling, but in cases where the labor is unduly prolonged, say two hours or more, examination should be made to find whether the presentation is normal, and if not, it should be made so by introducing the hand, first dipped in hot water and oiled. Then, force should not be used, but time given for nature to do the work, and if help be needed, it should be gentle, and only simultaneously with the natural throes or pains of the mother. If the presentation be found to be hind feet first, no attempt should be made to turn it, but the lamb should be taken away as it is presented. In a case where severe difficulty has been met in lambing, a weak solution of carbolic acid in warm water, poured from a quart bottle into the vagina, will serve a good purpose in avoiding inflammation and the eversion of the uterus, which is liable to occur after such an ordeal. In a case where this trouble does occur, the protruding mass should be carefully washed with warm water, with a little carbolic acid in it, and replaced with the hand, and the ewe kept confined in a narrow pen with her hind end higher than her front. Tying a few strands of wool across the opening of the vulva will also tend to prevent a repetition of the eversion, or a network truss, with strings tied to a strap around the ewe's neck, may be necessary in a very bad case.

If the lamb be not strong enough in an hour after birth to stand up and suck, the ewe should be gently laid on one side, and the teat, after milking out a little, placed in the lamb's mouth. When, if it has any ambition, it will help itself. It is not wise to force a lamb to take too much milk at first; nature's way is little and often. An overdose is apt to cause either indigestion or diarrhoea, or both.

In a case where a ewe has twins, and not enough milk to sustain them, it is better to hold a ewe that has more than enough for her lamb and let the youngster get a little from that supply, than to resort to feeding cow's milk; but if the latter must be used, let it be from a fresh cow and always from the same cow, fed warm, a little at a time from a bottle with a rubber nipple.

When the lambs are two weeks old, if they are grades, and the males intended for the butcher, they should be castrated, and the tails of all docked. This is best done by cutting up from the under side of the tail with a sharp jackknife against the thumb, at the second or third joint of the tail from the root. In a case of prolonged bleeding, tie a soft cord around the stump for a few hours, which will stop the bleeding. When lambs are three or four weeks old, give them a separate rack and trough, with a "creep" through which they can pass and the ewes cannot, and feed them sweet clover hay, chopped oats and bran, and sliced roots, renewed every day, and they will grow fast and make less severe demand on their dams.

Watering and Water Tanks.

Editor "The Farmer's Advocate":

In reply to your queries as to watering stock in winter, I may say that two years ago I put water basins in one cattle stable (for about 30 cattle), at a cost of about \$45. From my experience so far, I do not think I ever made a more profitable investment, although certain disadvantages attach to this system. The disadvantages might be enumerated as follows: (1) The risk of not giving the cattle sufficient exercise; (2) the risk of the water pipes freezing in the stable; (3) uncleanness caused by the cattle spilling the water into the mangers. With a little care, all these disadvantages may be successfully minimized. The advantages I would state thus: (1) A great saving of time; (2) warmer water for the cattle to drink, as a rule; (3) avoidance of turning cows out on stormy days; (4) ease in teaching calves to drink; (5) letting the cattle drink when they want it, and as often as they want it.

There are various schemes of stable watering, more or less good. The best is that which is cleanest. Some farmers have lids on the basins, which the cows lift when they want to drink. My basins are fastened in the partitions between the stalls. I find them clean enough, except in the case of some cows that will lap continually, and thus spill the water.

In your editorial you speak of having a trough in a protected place, and pumping fresh water into it daily. This, I think, is an excellent plan for young stock, though they will be drinking ice water almost invariably, owing to formation of ice in the trough, and the virtual impossibility of being on hand to pump fresh water just when the cattle want to drink. However, this is not a very important matter. I water about a dozen yearlings at a cement trough in the barnyard, which is covered with a lid most of the time.

Notwithstanding its being in a protected place and being covered, the water in it freezes considerably in ordinarily cold winter weather. I do not think it a bad plan to turn cattle out regularly, although there are days—for example, when it is raining, or when a wet snow is falling—when it would be both healthful and convenient to water them inside.

As far as stable temperature is concerned, I aim to keep it only just above the freezing-point. Ordinarily, one can thus get good ventilation, but in extremely cold weather, with solid-stone walls, it is rather difficult to get sufficient ventilation without having the temperature fall below the freezing-point. Hence the desirability of having a non-conducting wall.

Your warning as to pampering stock is a timely one, and I have often thought that if one had a large, open shed, provided with racks for hay, and with a water-trough, and with access to a straw stack, and if the shed could be roughly closed in when the weather is stormy—that, with such accommodation, young, thrifty stock would be in almost ideal winter quarters. But, of course, there is the difficulty in feeding roots, and more or less fighting for the feed, unless the cattle are dehorned. On the whole, considering the convenience of feeding and the like, the stable is to be preferred, and, if farmers would be a little more careful to provide light, fresh air and exercise, many of the admitted disadvantages and dangers of stabling would be avoided.

Referring to Mr. Lummis' scheme for ventilating stables, it might be pointed out that the canvas would likely soon be rendered impervious to air by a heavy deposit of moisture or hoarfrost upon it.

As for cement tanks, I built one three years ago, 3 1/2 feet deep and 9 feet in diameter, at very small cost, and it has been entirely satisfactory ever since. This tank is outside any building and partly in the ground, partly banked up with earth. I use it as a reservoir only, and have a float in it, which, attached to a stick that comes up through the cover, tells me how much water there is in it. I have also a cement water trough, two years old, that has given complete satisfaction. Wherever the foundation is good, cement is decidedly "the thing" for troughs and tanks." Brant Co., Ont. W. C. GOOD.

"Horses in Stock-yards market," says a Chicago exchange, "are selling at sky-high prices. It is a pronounced case of scarcity, despite prediction for several years past that colt crops were being raised that eventually would knock a large hole in the bottom of the market. Even that much-heralded hoodoo of His Equine Majesty, the chug wagon, has failed to make good in putting him out of business."

THE FARM.

A General-purpose Barn.

Most of the barns illustrated of late in "The Farmer's Advocate" have been specially used for dairy cattle. We have been asked to publish that of Mr. W. A. Clarke, West Middlesex, designed and used chiefly for beef cattle, but containing features well adapted to dairying or general purposes on a 100 to 200 acre farm. As it stands, it appears to be the product of sixteen years' evolution, new ideas being incorporated from time to time as improvements were suggested by experience. The silo and root-house are yet to

used as a steer pen, and is a handy place to throw the horse manure; making bedding for the cattle if for any reason it is not convenient to put into the yard where cattle, horse and hog manure is usually mixed, unless taken direct to the fields. The sheep and hen house is 18 x 30 feet, with 16-foot posts. The hogpen, 23 x 20 feet, 8 feet high, is under the straw compartment, 19 feet high, and the straw stack in the rear appears to be an ideal feature, very convenient for supplying bedding to all the stock. In the 40 x 60 building, this season there have been comfortably housed 32 steers, 5 cows, 6 horses and a pen of calves. There is also accommodation for a couple of colts, 20 head

All the cattle are fed in stanchions, but are, with the exception of the cows, only confined when feeding. Water is not kept before them. A row can be fastened or loosened at once with a lever.

All the floors, except for implements, sheep and hens, which are of earth, are cemented and laid level, except cow stalls, no manure running away. Seven-foot roller doors in cattle, sheep (or steer) and hog pens, facilitate rapid cleaning, with two-horse wagon or sleigh, daily, except Sundays, and removal direct to fields. Swing or roller gates take the place of rigid, dark partitions. Water is pumped by an 8-foot windmill on 40-foot steel tower to supply tank, which feeds six troughs inside and two outside, kept open all winter. Ventilation is obtained by tiles through walls, chutes, trapdoors and sliding windows. Grain for market or chopping is dropped on wagon or sleigh at end of granary passage; returning, the load is driven on barn floor above and chop is dumped into granary bins which feed into double chop bins in stables or hogpens. Pen "A" holds 9 calves or 8 yearlings; or a gate 9 feet can be hung to make a box stall for cow and calf. The pens "B" and "C" hold comfortably 15 steers, loose, each of 1,000 to 1,200 lbs. The foregoing notes with the accompanying plans, will give our readers the salient features of Mr. Clarke's stabling. In most cases men work out details to suit their own conditions. With such a handy barn the owner feels justified in claiming that one man, if need be, can do all the work and still have time to talk to his friends or hold the baby.

Harrying the Editors to the Grave.

Editor "The Farmer's Advocate":

I will add one more hand to the many that must be dragging you to an early grave. I feel constrained to write simply to relieve my feelings. I might say that no other paper that I have seen is doing the great work of "The Farmer's Advocate" in encouraging farmers and others to express their ideas suitably. I see by Mr. Baty's letter, page 204, issue Feb. 7th, that he seems to imply there is no advantage with a hollow wall over a solid one, provided there is fair ventilation. If by some system perfect ventilation could be obtained, then it is true there would not be the demand for hollow walls, as there would not be the dampness to adhere and freeze to the solid ones. Now, it is true, if the walls be air-tight, no number of air-spaces would save the inmates from suffocation, but the advantage is they keep the stable drier, as it stands to reason that solid walls which are coated half an inch with frost must have a different effect on the atmosphere inside than the absolutely dry wall. The question naturally arises, How can a hollow wall best be

built? The only hollow wall in this district at present is the big brick. And I can say from observation that, while the doors and concrete part to our basement are nearly always damp or coated with frost, the brick, save where it joins the other material, is always dry. The fault with the brick is that they are made perfectly flat, not with a groove on the top like small brick, the mortar, accordingly, having no hold, so that I have known a horse to have kicked one right out of a wall. This should be easily remedied by the makers. But why cannot concrete walls be built hollow? An ingenious neighbor has declared his intention of building a wall for his henhouse by filling up the center with empty salmon and tomato cans. But as it is too late to induce the Government to subsidize the canning industry sufficiently to provide cans to go around, we must think of some other plan. Others talk of using tile, laying row after row on top of one another, but this would take a great many tile. Why cannot one build a wall by

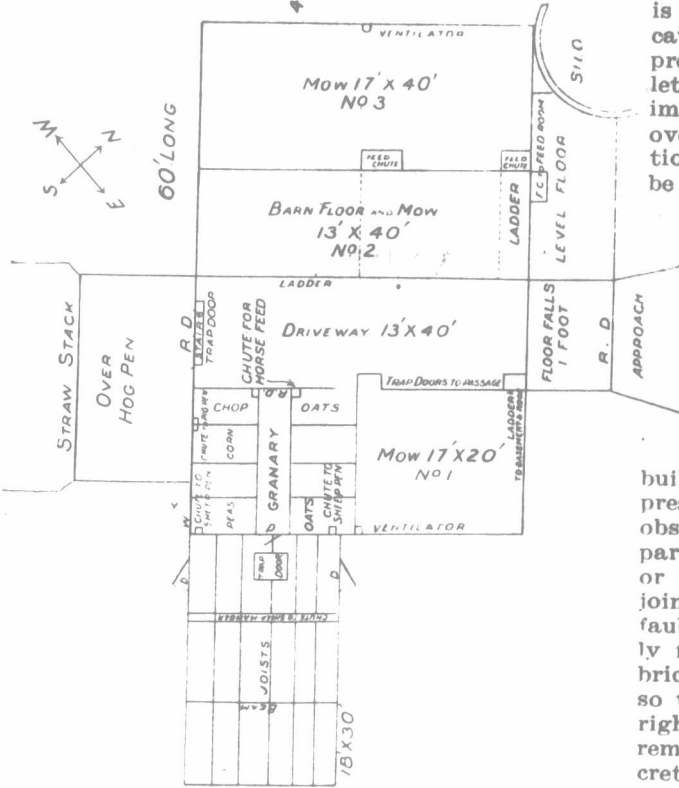
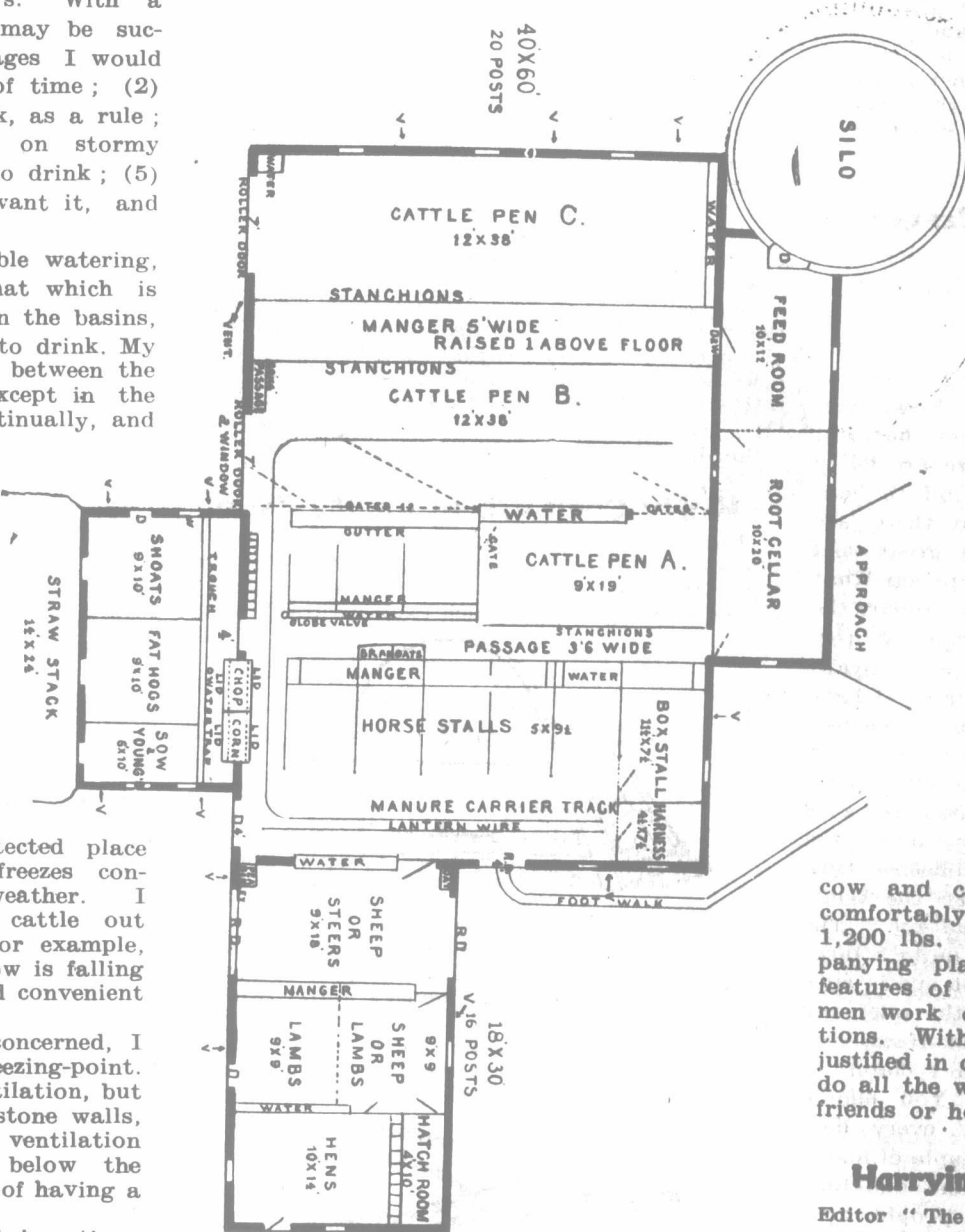

be erected. Our engravers have not shown the carriage, implement and ice house, 20 x 35 feet, with 14-foot posts, situated some 90 feet in a north-easterly direction from the main barn, and to the left of the gravelled driveway passing the residence, "Maple Villa," which faces the King's highway.

The compartment marked for sheep on plan is

using $\frac{1}{2}$ -inch boards in center of wall, and wedging, say, 2 inches apart, raising boards as outside plank are raised, thus securing a $3\frac{1}{2}$ -inch dead-air space? The wall might be strapped together by laying in bolts or pieces of iron, or by leaving ends of boards some distance apart and filling up space with concrete.

Middlesex Co., Ont.

[Note.—Could our friend see the pile of correspondence on our tables, and the still larger budget in the printers' hands, he might well fear for our health and mental balance. However, letters from subscribers do more than anything else to make the paper interesting, and the journalistic mind is schooled to maintain its poise amidst distraction. Besides, it is said to be easy to labor for those you love, and as we entertain the most benevolent feelings for all the many thousand readers of "The Farmer's Advocate," ours is a labor of love. Let the letters come. We'll take care of them somehow.—Editor.]

Care and Management of Manure.

Editor "The Farmer's Advocate":

This subject has been pretty well discussed in "The Farmer's Advocate," but I think it will help some people to get more opinions on it. The majority of writers claim that drawing direct to the field in winter is the best way. Now, you cannot lay down any hard-and-fast rules that will suit every part of the country. There are parts of Ontario where it does the land good to haul out and spread manure in winter, but there are other sections where it would do a great deal more good to draw and apply in the spring. What I wish to write about most is how to prepare the manure before drawing to the field. Some writers claim you cannot leave manure in a barnyard without great loss. I will give my plan. I have a boat, made of common plank, about seven feet long, and wide enough to go out the doors; a stout iron rod hooks the whiffletree to either end. As my barn was remodelled, the passages were not wide enough to turn round, so we drive the horse in with boat, then unhook whiffletree, turn the horse round, and he walks over the boat; hook on your whiffletree, then load up. The beauty of this plan is, you can form quite a large pile in the barnyard, and it will not spoil with heating. We drive the boat onto the pile and scatter the manure evenly over the surface, say, about six or eight inches deep; then I claim to get the best results from manure. You should mix the different kinds together, say, every day. We draw from the cattle manure a couple of loads, one load from the horse manure, and one load from the hogs. I believe very few people have any idea how much better results will be got from mixing it in this manner. Someone may say it will heat too much, but my experience is that, by driving onto the pile and allowing the stock to tramp on it, it will only get one light heat, which I want it to get. I do not like to see the wagon going out with a lot of dry straw on it. One very great improvement in handling manure is having the grain threshed with a machine with cutting-box attachment. You can load it a great deal easier, and then when you come to spreading, you have no trouble to make a good job. When I draw out my manure, it depends a good deal what I am going to grow on the land. If I am going to grow mangels, I would put it on in the fall, and if I wanted to sow fall wheat, I would like a top-dressing of manure. Then, for other roots and corn, if I had time I would put it on in spring; but I do not deny that I practice a certain amount of winter-manuring, though the only advantage I see in it is to get the work done in a slack time. Suppose your root field is a long way from the barnyard—of course, to grow roots or corn successfully, you must prepare the land and sow in proper time, which you might not be able to do if you had a large quantity of manure to draw at that time. My system of farming is to feed everything I grow on the farm, with the exception of fall wheat, and if it is not a good price, it will pay to feed it. In fact, I would rather buy grain or corn to feed than to sell it. When we consider the grand prices the Ontario farmers are getting for dairy products, hogs and horses, as well as cattle fed in winter, if they do not prosper it is their own fault. But, Mr. Editor, there is nothing, to my mind, they will have to thank more than your valuable paper. A great deal of credit is given to Institute meetings, and they are all right, but it seems to me that there is about as much information in every issue of "The Farmer's Advocate" as in any Institute meeting I have attended. Thanking you for so much space,

Perth Co., Ont. THOS. DICKSON.

Twenty-share Beef Ring.

Editor "The Farmer's Advocate":

Having noticed in "The Farmer's Advocate" of Feb. 7th an inquiry re a 20-member beef ring, regulations and chart, I would say such a ring has been in successful operation in this neighborhood for about fourteen years. The chart is as follows:

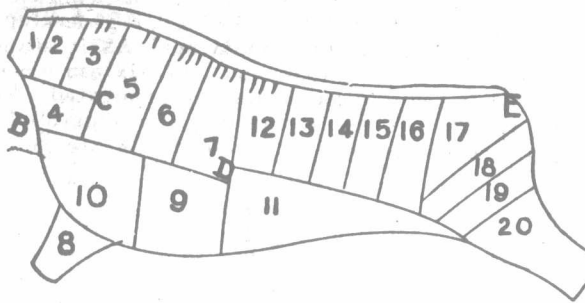

The numbers that go together are as follows: 1 and 18, 2 and 16, 3 and 12, 4 and 13, 5 and 17, 6 and 20, 7 and 11, 8 and 15, 9 and 14, 10 and 19. The butcher usually gets, in this ring, \$2.00 for killing and cutting up. That part of it is just as the butcher and patrons agree. No difference is made between stall-fed and grass cattle. I have been butcher for five years, and try to give the patrons a piece of steak and a small chunk of suet. The patron that has a quite steaky piece for his share, does not get much steak. We settle up at 10 cents per pound; this keeps up the quality.

South Ontario, Ont.

Handy Contrivance for the Farm.

Upon how many farms does one still see the old practice of moistening the grindstone by pouring water on from dipper or basin. Fig. 1 shows a handy device which explains itself, simply

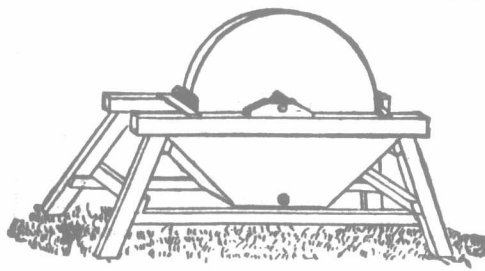

Fig. 1.

a tank for holding the water, so fixed that the stone becomes wet at every turn. A plug at bottom will let out the unused water when the tool is sharpened.

Fig. 2 shows a bag-tie which, if properly adjusted, will not slip. Take a strong cord about 18 inches long and double it as shown, passing

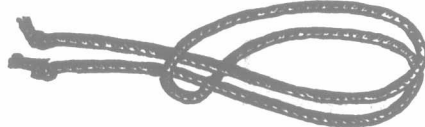

Fig. 2.

the ends through. Now slip the mouth of the bag through the loop and pull as tightly as possible; then take an end of the string in each hand and pull again in opposite directions. Pass the string completely around, make a knot and double or single bow-knot, and the work is done.—[Geo. Martin, in Farm Appliances.]

Farm Fence Law.

Editor "The Farmer's Advocate":

In your issue of Jan. 31st, Mr. Pratt, of Simcoe Co., has a letter in reference to our farm fences. I think, with him, that this is one of the most important subjects that we have to deal with. As I understand the law, it is that those who keep stock must take care of them. I cannot understand why they do not, unless it is because nearly every township and county in Ontario have special by-laws in regard to lawful fences, and very few know just what the law is in this matter. Now, I consider that the law, as above stated, is just and fair to all, and why it is ignored, I would like to know. You say that there are special statutory provisions for the unorganized districts of Ontario, but I would like to know why there are such. We are commanded not to steal, and I think it is quite as bad to send our cattle to steal; and that is what quite a number of settlers have done in the said unorganized districts. I think that where settlers are beginning to clear land to make farms of, they ought to begin right at first, and this would save a great amount of time and trouble in the future. It is very unjust for a new settler just beginning to clear land to make a home for himself to have to fence against all the cattle that may be ranging around miles away from their owner's place. I have been a reader of "The Farmer's Advocate" for over twenty years, and I have gained considerable information from your columns. I hope this subject will be fairly discussed.

Parry Sound. JAMES S. MILLER.

An Elgin Co. Ventilation and Watering System.

Editor "The Farmer's Advocate":

Having been a reader of your paper for a number of years, and often benefited by others' experience, I will try to answer your questions in regard to watering stock in winter in a way that might be helpful to some person. Having had a number of years' experience of watering outside, and the last two years of watering inside, I am satisfied the only place to water cattle is inside, both for convenience and profit, if you have the proper system. I will try to give the advantages of inside watering. In the first place, we will deal with milk cows. This winter I turned my cows out sometimes and fed them cornstalks, to avoid having the stubs in the mangers. The result was that if the day was not exceptionally mild my cows just shrank one quarter in their milk by being out long enough to eat one feed. Again, most farmers do not have cattle all of the same kind; they will have a few steers and some cows, and, it may be, some calves. In watering outside, these are certain to get mixed sometimes, and the stronger ones, which are being heavily fed, will boss the others with no mercy, and as it is more or less icy in the winter, your losses sometimes may be quite heavy in watering outside. I might say, in nine years I had three cows get their hips knocked down and one slightly ruptured, and have neighbors who were more unfortunate. In watering inside, there are three things a person wants to overcome—frost, keeping feed out of the water basins, and water out of the mangers. Now, in dealing with the frost, I will have to touch on the question of ventilation, which is probably getting already wearisome to some of your readers. With ventilation, we have to take pure air in some place and send the foul air out at another. I will try to explain my system. To get the foul air out, I use ventilators made of 12-inch pine boards, nailed together tight, running from the ceiling above the cattle to the roof, and above the roof, galvanized metal. By having these running alongside a purline post, they are no bother. You will require one for about every eight head of matured cattle in clear weather. On close or sultry days this would not be sufficient. I have two chutes for feed, one at each end of the feed alley, which is in the center of the barn, running from end to end. These are 38 inches square, made of matched hemlock, and run to within six feet of the peak, with a lid on top, with doors hung on hinges at the top, and swinging in all the way up. These doors are four feet in length, and the space between each door is three feet, using the doors always level with my feed. By having a wood screw directly over chute and a ring fastened in cement floor below, this furnishes a complete place to run your hay rope. I have a door at bottom of chute which swings down when I want to use it for feeding or ventilation, and we keep it closed at other times. Now, to take the fresh air in, I will give you something that I think is new to a good many, and works well. Behind my cattle I have between nine and ten feet from wall to drop where cattle stand, with $1\frac{1}{2}$ inches of fall from wall to drop on the whole run, and an extra 2 inches of fall in the last 2 feet next to the drop, and 9-in. drop. This allows driving right through with a wagon and taking manure to the field with ease. At the wall behind cattle, I have tile placed in the wall about 30 inches above the floor on inside, and 10 inches lower on the outside. By placing them in this way, it will take more than one tile to reach through the wall, but you will have no draught on your cattle, the current being upwards, and not noticed two feet from the wall. It will be warmed before reaching your water basins. Your pure air is beneath the foul air, and the temperature will be about uniform throughout the whole stable. The tile should be four-inch, and placed about four feet from center to center on both sides.

To keep the feed out of your water basins, don't place your basins over your mangers; place them in the partition between the cows, directly back of manger, rounding out a hole in partition above the basin. Then, by using a good-sized basin (a very important point), one basin will answer for two cattle, if tied, and two box stalls, if running loose. By having them placed in this way, they will have to back slightly to drink, and they will clear their mouth in doing it; also, when they take their nose out of the water basin, it will drip off outside of the manger. Since putting in the water in my barn, I have been in several barns where they have water in front of their cattle, and I have not been in one single barn outside of my own where there was not more or less lapping the water out into the mangers and stalls. I have seen the attendants bailing it out in some cases, and some throwing it out with wet feed. I have had over 50 head in the stable this habit. It is contracted by the cattle not being able to get the water readily as they want it. To overcome this, have your main pipe that runs in front of your cattle a good-sized one, The

Watering

paper for a... questions in... a way that... having had a... ring outside... inside, I am... tile is inside... you have the... advantages... we will... turned my... stalls, to... The re-... exceptionally... ter in their... at one feed... le all of the... rs and some... In watering... l sometimes... ing heavily... y, and as it... losses some-... outside. I... e cows get... ightly rup-... more unfor-... three things... eeping feed... out of the... frost, I will... ventilation... arisome to... on, we have... and the foul... explain my... use ventila-... together... the cattle... sized metal... arline post... re one for... tle in clear... would not... eed, one at... the center... These are... lock, and... n a lid on... top, and... doors are... ween each... ways level... ew directly... ment floor... o run your... of chute... use it for... closed at... air in, I... new to a... my cattle... n wall to... es of fall... and an... ext to the... ing right... to the... le, I have... above the... the out-... will take... wall, but... the cur-... feet from... hing your... the foul... uniform... should be... eed from... r basins... rs; place... directly... partition... ood-sized... sin will... ox stalls... d in this... o drink... it; also... er basin... ince put-... n in sev-... front of... ne single... not more... mangers... ailing it... out with... e stable... formed... tle not... ey want... pe that... ne, The

stem that leads up to your basin need not be over 1/2-inch pipe, but have your main pipe large, because they will all drink directly after eating, and, all being fed at the same time, there will be a large number drinking at once, and low water in the basins starts them to lapping it out. Set your float so the basins are nearly full. Don't keep the valve in the bottom of basin screwed down too tight; let the water in pretty freely, and watch your tie chains so they work freely up and down, and you will not be bothered much with lapping cattle.

In regard to the cost, I had a tank house, with storage tank in it, previous to putting the water in the barn. This was situated some distance from the barn. The piping and digging the trench (which was five feet deep) from elevated tank to barn was \$25. The fixtures inside the barn—17 basins, 1 float and reservoir for the tied cattle, and 2 basins, reservoir and float for box stalls, with pipes and everything complete—cost \$101.15. D. C.

Elgin Co., Ont.

Basement Stables.

Editor "The Farmer's Advocate":

I have read the pros and cons of the basement stable with a good deal of interest, but my mind has not changed, in one particular, at least, and that is that, to combine comfort and convenience, the stable must be underneath the barns, instead of in annexes, etc. But in no case should they be built in the side of a bank; they should be all above ground. As to what to build the basement of, largely depends upon the convenience of the different materials, whether it be lumber, brick, stone, solid cement, or hollow cement blocks. Personally, I have no fault to find with frame stabling (well built), except that it is perishable. My stabling for the last 25 years was frame, and quite comfortable, but as I have not enough room, I am building a basement, 40 x 84 feet, the coming spring with hollow cement blocks. My sheep and hog pens are double-boarded with tar paper between, and young lambs are being dropped during the coldest weather without loss. If one can judge from the discussion, there has been more reason to fault the manner in which stables have been constructed than in the kind of material used. The fact has but recently dawned upon us that we should give our stock more light and ventilation. The latter seems to be a more difficult condition to solve; that is, at a price that the average farmer would be justified in expending, and I am not quite sure that some of the cheaper methods, such as tile through the walls, etc., will not give good satisfaction, if judgment is used in regulating them according to the weather. I had the opportunity, when travelling in the interests of your valuable paper, of seeing a great many of the leading stock-breeders' stables throughout this Dominion, and there were very few of them lighted to suit me, and some of them which had a reasonable amount of light had it practically shut out of the stable proper by high box-stall partitions, etc. Woven wire (fencing material) would answer the purpose just as well for the upper part of the partition, and would not darken the stable to any extent. I would say to those who have dark stables—and I think this will apply to the majority—just chisel out a few good-sized holes through the walls, and put in all the extra windows you can, and I venture to say the trouble that has been experienced in the past with vermin on the stock and dampness in the stables will disappear to a great extent. Let me also warn those about to build or remodel not to build too wide. If you do, it is almost impossible to get light enough into the center of the stable. I think 40 feet is as wide as can be lighted properly, and it is also plenty wide enough to mow away hay or grain above from a single hay-fork track.

You asked in a late issue for experience from those that have walls built with hollow cement blocks. While mine is not yet built, my brother put up two barns last summer, each 36 x 50 feet, in the shape of an ell, and although his stock does not more than half fill it, it has no sign of frost on the walls, nor have the mangels frozen any in a box stall without covering. It is necessary, however, to have a careful hand make the blocks. I don't think one could sledge one of my blocks to pieces, yet I am told that a neighbor's, procured from another maker, fell to pieces during the soft spell in January. I think this topic has brought out a good many points that will be of lasting benefit to the farmer, thanks to "The Farmer's Advocate." R. H. HARDING.

Middlesex Co., Ont.

Wireworm Experience Asked For.

In renewing my subscription to "The Farmers' Advocate," I am glad to be able to say that I think it a model farmer's paper, and it is improving all the time. The Christmas Number was grand. I would like to see some readers discuss their experience with wireworms, as they are a pest in this locality. Wishing you great success. T. HUGHES.

Grey Co., Ont.

Practical Farm Drainage.

About a year and a half ago, at the suggestion of Prof. Reynolds, the Minister of Agriculture authorized the Department of Physics at the O. A. C. to send out representatives among the farmers to give advice on drainage to those requesting it. The response to this offer of assistance has been very gratifying, indeed. During the autumn of 1905 and the whole open season of 1906 many farms have been visited and surveyed, completely or in part, and the owners furnished with maps showing them the elevations of the different parts of their farms, the slope of the land, the proper outlets, and the best plan for draining the various slopes. But, with all this information at hand, they have still to construct their drains. We found various methods in use. Some had been digging by the water test—the grade was right when the water would run—

A HOMEMADE DRAINAGE LEVEL.

The first requisite is a level adapted to showing the difference in elevation between two points. Figure 1 represents a homemade drainage level. It consists of:

- (1) An upright piece of wood, 5.5 feet high, 3 inches wide, and 1.5 inches thick, sharpened at the bottom, and with a slot 2.5 feet long beginning within 6 inches of the top.
(2) A cross-piece, bolted to the upright by a bolt through the slot; washers at head and nut. The cross-piece may be rotated about its center.
(3) A long carpenter's level, with straight top, sitting on the cross-piece, held loosely in position by two buttons.
(4) Two wood screws, with thumb-head, passing through the cross-piece and touching the bottom of the level.

When the instrument is to be used, the upright is sunk firmly into the ground as nearly perpendicular as possible. The level is levelled roughly by tilting the cross-piece, and then the thumb-screws are used for more accurate adjustment; either end of the level may be raised as little as needed by the screw at that end. The photograph shows the level in use. It requires two men to operate, A to sight, B to carry the measuring pole or staff and note the fall or rise from one place to another.

DETERMINING THE FALL OVER THE DITCH.

When the location of the ditch has been decided on, it should be staked out with three or four stakes six or eight feet high, to plow by when digging is begun. They will be removed when the first furrow is plowed. Then the length of the drain should be determined. If a 66-foot tape is used in measuring, a short stake, say 3 feet long, should be set up every 66 feet along the ditch, but these should be set three or four feet to one side of the ditch, so that they will not be disturbed by the plow; they will be needed later. If a 100-foot tape is used, these stakes would be placed 100 feet apart. We shall use the 100-foot tape. For convenience the stakes may be numbered 0, 100, 200, 300, etc., stake 0 being at the outlet, stake 100 being 100 feet from the outlet, stake 200 being 200 feet from the outlet, etc. Measurements are usually begun at the outlet.

When the drain is staked, we are ready to determine the fall. The level is set up half way between stake 0 and stake 100, and levelled, the cross-piece being in line with the stakes. B stands the staff at stake 0 and places his pencil across the staff, and A sights over the level, directing B to raise or lower the pencil until it is in line with the level. B notes the height of the pencil on the staff, say 4 feet 10 inches, for illustration, and then moves the staff to the next stake, number 100, the level remaining in the same position. A now sights forward to the staff, and B places the pencil the proper height, say 4 feet 4 inches.

Figure 2 represents the operations thus far. It is easily seen that the difference between the two readings, 4 feet 10 inches and 4 feet 4 inches, i.e., 6 inches is the fall from stake 100 to stake 0. The level may now be moved half way between stake 100 and stake 200, the staff remaining at stake 100, and the fall from 200 to 100 determined, as in the first case. This is continued the full length of the drain. All the separate falls are added together for the total fall.

The average fall per 100 feet may now be determined, e.g., if the drain is 800 feet long, and the total fall is 24 inches, then the fall per 100 feet is 24 ÷ 8 = 3 inches. If the ditch is to be the same depth at both ends, the grade of the ditch bottom will be 3 in. in 100 ft. If this is not steep enough, more fall may be gained by putting the ditch deeper at the outlet; e.g., if it were made 8 inches deeper at the outlet than at the source, then the grade of the ditch bottom would be 4 inches in 100 feet.

WM. H. DAY, Professor of Physics, Ontario Agricultural College.

Advantages of the Rural Telephone.

Editor "The Farmer's Advocate":

Since the early days of the reaper and thresher there has probably been no one device brought out of such incalculable assistance to the farmer as the telephone. With the many inventions which have come to help the farmer in his work, and the prospect at no distant day of having free mail delivery, the agriculturist and his family certainly bid fair in this twentieth century of progress to enjoy the privileges to which they have been so long entitled. Of greater use than many of the things mentioned, and actually capable of greater service to the farmer, is the telephone. Have you ever stopped to think how many hours out of every week can be saved to the farmer and his family by the assistance of the telephone? No other single convenience can be obtained for so small an outlay, considering the numerous advantages it affords. In spite of this fact, some farmers are even yet undecided as to the wisdom of having farm telephones. They fear that it is a needless waste of hard-earned money; but the farmer who has had a telephone for a year or longer knows why so many farm lines are being built. In many parts of our country the rural



A homemade drainage level.

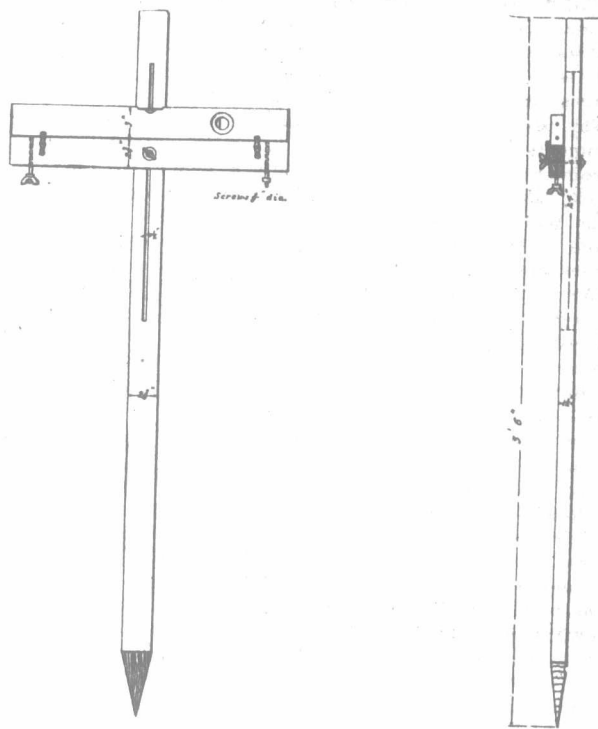

Fig. 1.

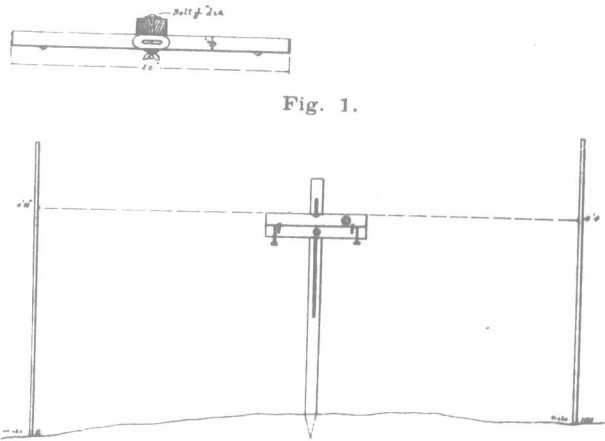

Fig. 2.

telephone has come to be recognized as a necessity. Time in this age is an important item to the farmer, as much so perhaps as to the business man in town. The telephone is the connecting link between city, town and country. It puts the farmer next door to everybody. Its practical advantages cannot well be overestimated, and where once installed it is never taken out.

INTERESTED FARMER.

Oxford Co., Ont.

Top-dressing on Clay.

Editor "The Farmer's Advocate":

Your correspondent, "Young Farmer," Feb. 7th issue, finds clay land much harder to plow where it had been top-dressed. It seems to me this is only what we may expect. There is a great cry at present to put all the manure on top of the land. But should it be used in this way with all classes of soil? Would it not be better to put all manure into the land when we are farming clay? It must be handled vastly different from sand.

The growing plant requires light, moisture and warmth; all of these combined, and none in excess. If moisture is excessive, air, which conveys warmth, cannot enter. Water and air cannot occupy the same space at the same time.

Now, the secret of success with clay land is to till in such a manner as to secure proper drainage, and at the same time conserving all necessary moisture. We must do all possible to bring it to a pulverized (mellow) condition. If superabundant water cannot dry or drain quickly, the land will become baked, sour, cold and, withal, unproductive. It also hardens so as to give greater resistance to farming implements. So, if we would procure the best from clay, we must aim at getting the ground open. There is nothing better for improving a clay field than plowing under a heavy green crop. For this, clover, of course, is the best of all, but timothy, rye or buckwheat are all valuable for improving the friability of clay; but these are not as rich, and cannot add to the fertility as does clover. Even a crop of thistles nearly matured is excellent, if a farmer is so unfortunate as to have a crop of this kind.

Then, it seems to me that if we would do the best by clay land, we would apply the manure in as coarse a state as possible, and apply as fresh from the stables as circumstances will permit on ground to be plowed. The plowing should not be deep enough to bury forever the manure. However, if covered, say, 5 inches deep, there would not be much danger of its wasting, as clay, over clay subsoil, is not apt to leach.

I have in mind a piece of ground which received a copious application of straw many years ago—simply clear, coarse straw—and the good effects of that application can be seen to this day. This ground is mellow, and produces abundantly. In fact, fertile clay always produces abundantly, if the drainage and tillage are adequate. It not only produces heavier crops, but of much superior quality to those grown on sand.

Wentworth Co., Ont.

[Note.—We shall hope to hear from others as to the soundness or otherwise of this doctrine as the result of experience with clay land.—Editor.]

Windmill for Pumping a Splendid Investment.

Editor "The Farmer's Advocate":

In reply to the questions asked in issue of Feb. 7th, re the watering of stock in winter, I would answer from my own experience as follows: Four years ago I purchased a windmill and attachments, costing me, when completed, \$250, and it has given first-class service. As to its advantages, they are many. In the first place, when I am in a hurry I can turn the tap and let the supply tank fill the drinking tank while I am doing other chores, instead of carrying out a kettle of hot water to thaw out an old, rickety pump, and then jerking my arms out of joint trying to pump water as fast as a lot of thirsty cattle can drink it. Then, in my feed room I turn another tap, and while I am putting chop or shorts into my swill barrel the water is running in and mixing with the feed, so that by the time I have the feed all in it is partially soaked and all ready to mix. Then, again, at the house, all my wife has to do when she wants water is to set the pail under a tap in the house, and while the pail is filling she can go about her other work. Taking all into consideration, and multiplying it several times a day for 365 days to the year, a vast amount of time and hard labor is saved. That is an unknown thing, as far as pumping water is concerned, if you have a good mill. I have heard men say, when they heard what my outfit cost, "Oh, I can pump a lot of water for \$250." Well, it may be they could, but how much could they pump for \$7 or \$8 interest on that amount, where they have it locked up in a bank drawing 3 per cent. interest? I know of men pumping water by hand for 20 or 30 head of cattle and horses, and as many hogs, to say nothing about the many pails for various other purposes, and

if one were to go and try to hire them to pump the same amount during the year for \$8 interest and a slice off the capital, they would be insulted. The only disadvantage I see is, during a continued streak of cold weather, if the wind does not blow enough to pump some water into the supply tank, the water that is in it gets rather cold for the stock. However, as there is hardly ever a day the wind does not blow some, it does not often get too cold; but if it does, I turn the tap and pump some by hand while the tap is running, thus mixing the water coming from the well with that coming from the tank. I have my drinking tank placed in the north-west corner of my yard, so that for a few hours in the day the sun shines directly on it, and the cattle seem to drink more readily than if it were in a colder place. I think anyone who keeps over 20 head of stock, if he views the situation from a business standpoint, and considers life worth living, would not be without a good windmill and attachments. I know mine cost quite a sum of money, but if a man would double the amount and offer it to me to do away with my mill and pump by hand, I would not consider it.

ALF. E. BROWN.

Kent Co., Ont.

Roads and Beef Rings.

In this locality mild winter weather still prevails. Sleighing is good enough on some portions of the road, but on others, owing to the high winds which accompany the snow, it is nearly all blown off where the road is graded high. What, with high grading and wire fences, the roads are so bare in places that it is impossible to get along with any decent-sized load. In other places it is a foot deep. This is an example of our system, or rather lack of system, of making roads. The condition of the roads is really of more importance in winter than in summer, as that is the time the heaviest teaming is done—or would be done if we had good sleighing. One thing noticeable is that those portions which have a hedge fence or row of trees on the windward side hold the snow fairly well. Why should not the Legislature compel the township councils to keep the roads in proper condition? It would mean thousands of dollars profit to the Province, as the interference with business on account of the bad roads, especially in winter, means an enormous loss. With good sleighing teaming could easily be done for half what it now costs. As a remedy for this defect, the writer would suggest three plans: First, that men be employed to shovel snow on to the highly-graded portions; or, secondly, that trees be planted on the windward side to break the wind somewhat, and precipitate the snow on the road; or, thirdly, that all the open ditches be tiled so that loads could take the side if necessary, and this thorough drainage would lessen the necessity for such high grading. If ice would not "bear" on the creeks, the approaches to the bridges should be flanked with a fairly tight board fence to precipitate the snow. In any case, some person or persons should be appointed who could be held directly responsible for keeping the roads in better condition for traffic. As it is now, what is everybody's business is nobody's. The commuting of the statute labor shifts the responsibility to a group of persons whose chief care is to do only enough to secure a certain percentage of votes, and to do that work in that section in which the votes are most needed. Where pathmasters are retained they are hampered by lack of authority, and if councillors will not and pathmasters cannot, the poor public are placed between two stools, and thus are sure to reach the ground. We are badly in need of some system which will place all our leading roads in a more uniform condition, and the better that condition can be made the more desirable, but above all let us have more uniformity.

You ask for information of the workings of a beef ring. As it was my privilege to have something to do with one last summer, I will try to give some reliable information about it. The "ring" was composed of sixteen responsible members, who each agreed to provide one animal during the season for slaughter, said animal to be a heifer or steer not more than two years old, and to dress not less than three hundred or more than five hundred pounds of beef, exclusive of the head, heart, liver, feet, tail, etc., and fat of internal organs, which was separated by the butcher, and all reverted to the owner of the animal, including also the hide. No distinction was made between stalled or grass animals, as the syndicate did not get into operation before July. The butcher charged \$2.50 per animal, and provided everything for his work, and had to divide the carcass according to a chart given in an issue of "The Farmer's Advocate," each member getting a different cut from the week previous. It is exact and tedious work weighing (as it were) the animal first and cutting it to an exact proportion afterwards, and while the price may seem high, I am very sure that same butcher would not do it for one cent less another year. The beef was valued at 6¢ per pound, i.e., the average weight of the beef of the sixteen animals was taken, and all those who had provided animals exceeding the average were paid 6¢ per pound for the amount, and those who were below the average had to make up the deficiency at the same price. Some who couldn't use their full share subdivided it to others, so that there were over thirty who benefited, and all seemed pleased.

Perth Co., Ont.

J. H. BURNS.

Seed Fairs.

For those who realize the importance that should be attached to the improvement of farm crops by the use of good pure seed, it is hard to believe that in this progressive age and in this progressive province of Ontario so few seed fairs have been held. The outlook for the future, however, is much more promising, and in the course of two or three years we hope to see a successful seed fair organized in every county, at least, in our Province. A glance at the last report of the Bureau of Industries shows that about 9,000,000 acres were in field crops, hay and clover in 1905, with a total crop valuation of about \$143,000,000, or an average of \$16 per acre. In round numbers, 796,000 acres were sown with fall wheat, 190,000 acres to spring wheat, 773,000 with barley, 2,600,000 to oats, 375,000 to peas, 101,000 to rye, 101,000 to buckwheat, and the remainder, about 4,000,000, was hay, clover and hoe crops. Allowing that 5,000,000 acres be sown with the common cereals, excepting corn, if 5 bushels of an increase could be made per acre through the use of better-cleaned seed than is ordinarily used by the commercial farmer—and this, I believe, would be a moderate estimate—the result would be 25,000,000 bushels of grain, which, at market prices, would yield a good profit in the business. Such a result would be possible if every four bushels from the bin were cleaned to three bushels for seed purposes. A seed fair should be very useful in finding a market for the disposal of good seed grain. They bring the buyer and seller together where bargains may be made at the least possible trouble and expense.

In nearly every locality there are some enterprising farmers who realize that the use of good plump seed for seeding means 5 to 20 bushels increase per acre, as compared with the results from the use of inferior seed.

Comparing the results from the use of good seed with the extra cost of preparing it, the extra expense per acre is a mere bagatelle. A seed fair would enable those who are inclined to object to paying more than market prices for seed to see the value of good clean seed, such as would meet the requirements of the Seed Control Act. The expert who visits the fair to do the judging is also prepared to give a lecture on seed-improvement and conduct a grain-judging class, which will be most helpful to those who will attend.

The Seed Branch of the Dominion Department of Agriculture, in co-operation with the Provincial Department of Agriculture, is prepared to furnish the judge and lecturer free of charge, as well as to publish and mail the prize-list and programme for such fairs. In doing this, however, all seeds exhibited shall be representative of the amount of such seed offered for sale by the exhibitor, and must meet the requirements of the Seed Control Act. In order to safeguard the purchaser of seeds against misrepresentation of goods, the secretary, or such other officer as may be appointed, shall take a sample of all seeds offered for sale, and in case of any dispute between buyer and seller, shall have power to arbitrate in the same. These seed fairs will afford those members of the Canadian Seed-growers' Association an opportunity for showing what can be done by selection, as well as give them a good chance to dispose of surplus stock.

Seed fairs should encourage the better use of the fanning mill for selection. Too much seed grain is only put through the fanning mill once, instead of three or four times, as is necessary to get all the light and small seeds thoroughly screened out. Many of the grain dealers and millers are taking grain as it comes from the cleaner, which encourages the neglect of the use of fanning mills altogether. It would be a great calamity to farmers if the general use of the fanning mill were neglected in preparing seed grain, unless they would buy all their seed grain from other farmers or dealers who make a business of preparing seeds. It is to be hoped that farmers living in the vicinity of a seed fair this spring will take full advantage of their opportunities.

T. G. RAYNOR.

A Faker Convicted.

William Ernest Taylor, a young Englishman, arrested at Queenston on a charge of fraud in conducting a fake circular-addressing agency, has been convicted before P. M. Cruickshank, Niagara Falls, Feb. 20th, and remanded for sentence. Taylor swindled a number of Toronto people out of a dollar apiece by promising them employment in addressing circulars, at 50 cents to \$3.00 per day. The dollar he charged was for enrollment and supplies, but none of his victims got anything for their money. The game is a successful swindling concern in England, and corresponds with similar schemes against which the public were warned editorially in "The Farmer's Advocate" of Feb. 14th.

THE DAIRY.

Dairying Again Popular in Prince Edward Island.

We have had a comparatively fine winter here, and travelling has been pretty good. The fields are fairly well covered with snow. Most of the dairy companies have held their annual meetings, and are now preparing for another year's business. Patrons are well satisfied with last year's returns, and feel hopeful for the future. Dairying is becoming more popular again, and most factories report considerable increase in the output of last season. Last summer was the hottest season experienced here since the cheese-factory business was inaugurated, and some cheese of the July make were heated in the factories, occasioning considerable loss. Many of our curing-rooms attained a temperature as high as 80 degrees F. in July. To guard against a repetition of this, many of the dairy companies will put in ice to use in keeping the temperature down in the hotter months. Our climate is cool here, except in July and the first part of August. The butter business is increasing. Some of the dairy stations that formerly made only cheese are now making butter exclusively. Skim milk is valued highly for raising calves and pigs, and many think they get larger returns from their cows at the creamery than at the cheese factory. We think that the cream-gathering creamery will be in evidence here in the near future. It is costing nearly twice as much to get milk drawn to the dairy stations as it did ten years ago. It now costs as high as ten cents per hundred pounds at many of the factories. This raises the cost of making cheese and butter very considerably. The whole cost of making this year at the factory with which I am connected was \$2.35 per hundred, and that figure will be near the average for the Island. There have not been many hand separators placed here yet, but, according as we turn our attention to buttermaking in factories, they must come. Many patrons are favoring the idea of making butter in the colder months of June and October, and turning out cheese the three warmer months. I think this would be a good plan to adopt, as it would work in well with our bacon business. The average of milk supplied per cow at one of our largest cheese factories, whose statement is before me, is only a little over 2,000 pounds for the five months of the cheese season. This ought to be at least doubled, and might be with very little effort on part of the patron in weeding out the poor cows and replacing them with better ones, and providing sufficient succulent feed for them all through the dairy season. But many of the factory patrons depend entirely on their pastures for the production of milk, and the result is a serious falling off of the supply after July. The success of dairying here depends more on growing abundance of feed to supplement the pastures than on any other one thing. A series of dairy meetings will be held here this month in charge of Mr. Whitley, of the Dairy Commissioner's Staff. A series of seed-judging meetings begins to-day, conducted by Prof. Klinck, of Ste. Anne de Bellevue, Que. Our Dairymen's Association will also meet this month.

P. E. Island.

How Cattle are Watered.

Editor "The Farmer's Advocate":
Our cattle are watered at a trough in sheltered barnyard outside of stable once every day, when it is not too cold to turn them out. They are all watered at noon, and the milking cows also get watered with pails, which are filled at the float-box in passage in front of cows, just before their evening meal. All the cattle are watered with the pails on very stormy days. Water is stored in a cement tank buried in approach to barn doors. Water is always warmer than if taken from a tank outside or up in the barn. As to cost of system, our power windmill (which also pulps the turnips), with suction force-pump, in dry well in stable; piping from well 30 feet distant, piping to tap in horse stable and to float-box for cows, complete, with valves, taps, etc., cost \$170.00, and has been in use four months. We dug the well ourselves, and put in a cement curb costing \$20.00.

The advantages are: Plenty of water at all times for everything; water convenient for mixing pig feed; cattle can be watered by lamplight, if necessary.

Disadvantages: Sometimes the cattle upset the pails when watered indoors.

For indoor watering, Dickson Bros., Walton, have galvanized troughs under manger-board in passage, with a little door at each beast's head, to be opened twice each day, before noon and night feeding. This is the best thing I have seen for cattle tied up, as ours always are. I have never seen bowls which gave thorough satisfaction, although I have examined several such systems.

Huron Co., Ont.

T. R. BENNETT.

An Oxford County Dairyman's Barn and Herd.

Editor "The Farmer's Advocate":

I have been very much interested in the discussion which has been carried on in your paper re stone-basement stables. In reply to your inquiry as to how my herd was handled that was entered in the dairy-herd competition, under the auspices of the Western Dairymen's Association, I may say that I have taken the liberty to draw a plan of my stables to let you see how they are constructed. The walls are of stone, and plastered on the inside to have them white and smooth. Have never been troubled with damp walls or ceiling, of which a number of writers complain. Had fifteen years' experience with double-boarded stables, and found them very damp after a spell of cold weather. There is a complete water system throughout the stable, each pair of cattle having a basin to drink from which is kept filled, being regulated by a float in the water-box.

One year ago I installed a litter carrier for the purpose of cleaning the stables; it is a great improvement on the old wheelbarrow plan. The woodwork of the stable is planed ash and hemlock, and the floors are all cement except the root-house. The windows are large, each containing four panes 15 x 20 in.; there are twenty windows in all. This furnishes a good supply of sunlight, which is very necessary for all kinds of stock. My farm contains 100 acres, and the breed of cows is Holstein, six pure-bred, and the rest Holstein grades. I keep from 12 to 15 cows; have three or four freshen in October and go dry in July. The cows' average milk yield for seven months was 6,691 pounds each. The average amount of money per cow was \$60.48. I was charged 45 cents per hundred for drawing,

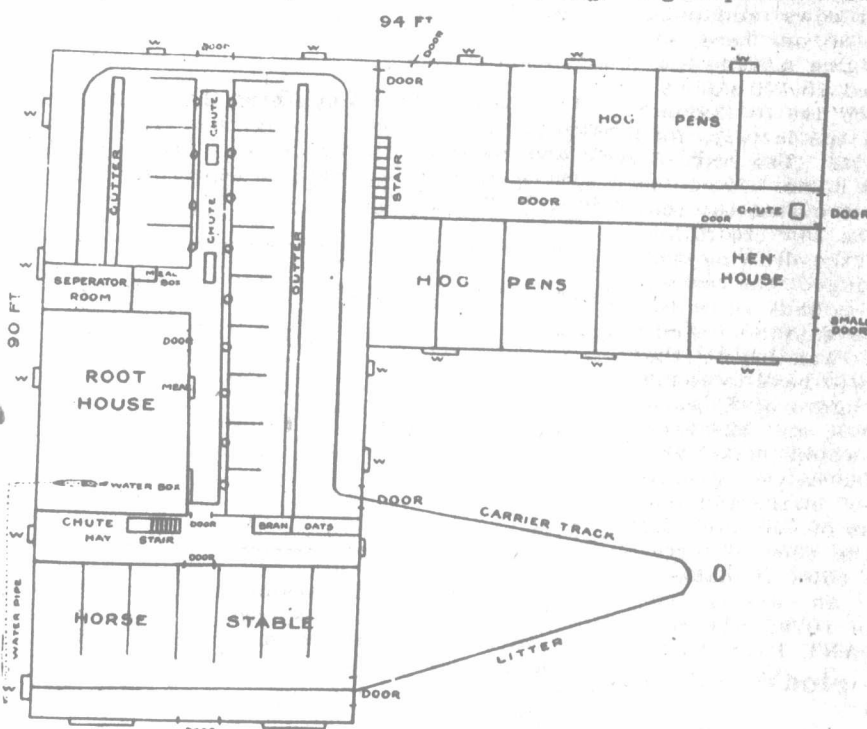

W. E. Thomson's Dairy Barn.

while the winner of the prize drew his own milk. Had I been charged the same as he, the average per cow would have been \$63.15.

During the months of July and August I fed one and one-half tons of bran and a small amount of oat chop, and then green corn. In the winter I feed the cows on straw, cut corn and roots until they freshen, then I add a meal ration. About the first of April I start to feed hay. In the past I have not weighed my milk to any extent, but am doing so at present, and intend to continue. In building up my herd, I have paid special attention to the breeding, raising heifers from the very best cows, and using as good a sire as could be had. During the winter have fed all young heifers well. All heifers freshen about January, which gives them a long milking period for the first year. Since putting in the water basins, the cows have done very much better. Last winter they were out only once, and so far have seen no bad effects from being kept confined. During the summer months we are very particular to have the milking done about the same time morning and evening.

For the past year the aggregate returns for fifteen cows was \$1,240, the average cash returns being \$82.66 2-3. In these figures there has been no estimate of whey which was fed to hogs during the summer. During the winter months the milk is separated at the barn, and the skim milk fed while warm to calves and small pigs. There seems to be no other industry about the farm which brings in as good returns as the cows and hogs when properly handled. I keep from 50 to 60 hogs the year round. The total receipts for hogs sold for the last three years have been about \$1,000 per year. I buy millfeed and corn to mix with other grain, such as oats and barley.

Oxford Co., Ont.

W. E. THOMSON.

Milk Records Reduced Dairying to Business Basis.

Editor "The Farmer's Advocate":

The question of "keeping records" of cows is engaging widespread attention. No one can claim to be an up-to-date dairyman who does not keep individual records of his herd. No matter how well cows may have been cared for, there will be improvement just as soon as a proper system of keeping records is adopted, and a new and increasing interest is created. The owner sees, as he never did previously, the wonderful capabilities of his good cows and the uselessness of his poor ones. He sees how responsive his cows are to the smallest influence, and he delights in studying their individual characteristics; and, once started, he does not go back to his former methods.

Our experience has had this effect, and we are anxious to have formed here a cow-testing association. We have had Mr. Whitley and Mr. Heseltine, of the Dairy Department, Ottawa, here, and expect to have organization completed in a few weeks.

We have cement floors, without any wood for partitions or mangers, as we desire to have the floor as clear as possible in order that it can be washed off again. Wood always will absorb the liquids and hold the odors, and we cannot see how any dairy can be perfectly clean with wood floor, partitions and mangers. We have gas pipe for partitions, cement trough for feeding and watering, and steel stanchions. With lots of light and the King system of ventilation, we claim it is possible to keep our stables clean and healthful. The dairy room is completely shut off from stable proper by solid stone partition.

Business engagements prevented us from giving a personal supervision to our dairy, which consists of between 40 and 50 cows, and we were at a loss always to know what the cows were doing until we began the record-keeping some 10 months ago. We had a straight spring scale, which cost \$1.25, conveniently hung behind the cows, and it took only a few seconds for each milker to hang his pail thereon and mark amount on sheet. We thus had the weight of each milking of each cow. We then tested the milk, and were able soon to know what each cow was doing. In these 10 months we discovered 10 cows it were better for us to sell, which we did. They were not producing enough to pay for their keep and labor required to attend to them, and we were able to dispose of those that were the poorest ones, the records giving us positive information. Again, we found that the milkers took renewed interest in their work; they milked cleaner, trying to get as much and more milk each successive milking; they watched the record sheets, and realized, as they did not before, how responsive the cows were to good care and proper feeding, as well as to careless handling, bad milking, irregular feeding and milking, or neglect of any kind. We were able, further, to tell what our dairy was doing. We could see where the gains could be increased and the losses prevented, and were able to put its management on a business basis. Then, lastly, but not least, we are impressed with the desirability of making each new record exceed the last, thus making us determined to improve our herd each year, and further encourage and assist others to do likewise.

Halton Co., Ont.

"MOUNT DAIRY."

The Turnip Flavor.

Editor "The Farmer's Advocate":

Enclosed please find my subscription to your very valuable paper for another year. We all enjoy reading so fine a farm journal.

In a recent issue I saw an inquiry as to how turnips could be fed so as not to taint the butter. If your inquirer would feed his turnips just after milking, and let his cows go 12 hours before milking again, he would not find the flavor in the butter; but he must not feed turnips more than once a day so as to be able to do that. I feed that way, and have no trouble.

Carleton Co., Ont.

WM. A. WALLACE.

At the risk of wearying some of our readers, we continue to publish letters received from subscribers who have adopted the system of keeping individual records of the milk production of their cows. The responses have assumed the character of an avalanche.

Does It Pay To Keep Individual Milk Records ?

Nine Cows Averaged \$91.11.

Editor "The Farmer's Advocate":

Since keeping individual milk records of our cows, we have raised our standard from 6,000 to over 8,000 in four years' time, and can see no reason why the 10,000-pound mark can not be reached. A cow is only a boarder on a farmer at the 6,000-pound mark, and should be put off for beef, not to some other man to lose money on. How can we tell which cow is paying us and which is not? Simply get one of these little spring-balance scales and weigh each cow's milk every time you milk her for one season, then you will know. A man may say he is taking as good care of his herd as he knows how, so where would the weighing of his milk pay him? It would pay him big money by raising the standard of his cows. It does not take long to weigh the milk. Have your scales hanging so they are handy, and also have your blank forms so you can mark each cow's milk down without losing any time. It takes us about five minutes to weigh the milk from nine cows each day, so you can see it does not require much time. We started weighing our milk four years ago, simply to see which cow was paying us and which cow was not, and we soon learned that it paid us to weigh. I might say, when we started to weigh our milk, four years ago, we had twelve cows, and their average was 6,660 pounds each, and last year we had nine cows, and their average for the season of ten months was 8,385 pounds each. We have changed our herd by culling out the poor cows and putting better cows in their places, so our herd of nine cows is a young herd, averaging a little less than five years each. We received 75,470 pounds of milk from our cows from March 1st to December 31st, sent 68,002 pounds to the factory for cheese, and received \$555.19 for it. The rest of the milk was made into butter at home. We sold \$52.67 worth of butter, and used butter to the amount of \$26.40. In giving the cow credit for all of her milk, we must count the drawing of the milk to the factory and the making of the cheese, which cost us \$1.60 per 1,000 pounds of milk, which, all told, would amount to \$100.80. And, by the way, some of the milk was fed to the calves in the spring, so that we will have to count them. Putting them at a low figure of \$5 each for the seven grade Holstein calves, and \$25 each for the two pure-bred calves, would make \$85 for the calves. Our grade heifer calves (five in number) were sold at the time of birth, and our bull calves for veal at four weeks of age, and the two pure-bred were valued at the time of birth. So, counting in all from the nine cows, it makes a grand total of \$820.06, or an average of \$91.11 7-9 each for the season of 10 months ending the year 1906. CONSTANT READER.
Brant Co., Ont.

Has Taken up Milk Records Again.

Editor "The Farmer's Advocate":

We started keeping individual milk records seven years ago, but discontinued it after a year and a half. We began again last year, and will adopt the Babcock test this year. The time it takes per day is so very short that it is not to be compared with the satisfaction of the results in finding out which are the best cows. It also raises a kind of friendly competition among the milkers to know whose cows are giving the most milk. It is the only method by which we are enabled to find out what cows are paying their way. Some, of course, we know without weighing, are profitable, and others are not; but to find out which are the ones between the best and the poorest, testing is the only sure way.

It has enabled us to raise our standard from an average of 5,000 pounds of milk in nine months, in 1899, to over 8,000 pounds in nine months in 1906, as the following records will show. The cows are pure-bred and grade Holsteins, indicated by the letters P and G: P—Lena, 11,667 pounds from 1st of April to 31st December, 1906, nine months; G—Nell, 11,062 pounds from 1st of April to 15th December, 1906, eight and a half months; P—Clara, 10,420 pounds from 1st of May to 31st December, 1906, eight months; G—Alice, 6,040 pounds from 1st April to 30th November, eight months; G—Pride, 5,261 pounds from 1st April to 30th November, 1906, eight months; G—Spot, 4,879 pounds from 1st April to 30th November, 1906, eight months. These figures include the three best cows and three poorest cows in the herd. Needless to say, the three latter cows go to the block.

No matter how good care a man is taking of his herd, I think he should keep a record of each cow's milk. He is then able to compare his cows at the end of the year, and know just exactly what the herd is doing. GEO. CARLAW.
East Northumberland, Ont.

A Grist of Letters from Those Who Have Tried.

Has Kept Milk Records for 16 Years.

Editor "The Farmer's Advocate":

I have been keeping daily milk records of my herd for about 16 or 18 years. I started the record because I wanted to make my dairying a commercial success. In this I was largely assisted in knowing just what returns I got from each cow daily, monthly and annually. In no other way could I tell whether a certain cow was yielding me a profit or not. It takes perhaps two minutes to each cow at each milking—no more, perhaps not quite that. Now, if there is any sudden fluctuation in the flow of milk, I can at once look for the cause, and thus learn whether the cause was something to avoid in future or continue to practice. It has told me that some of my cows were large producers and money-makers, while others were small producers and money-losers to me.

I enclose you one of the books that we use in the stable. A lead pencil is used there to mark the records:

January, 190.....			
Date.	Amount of Milk.		Total.
	Morn.	Eve.	
1			
2			
31			

This book is brought into the house every Saturday night, when I copy these records with pen and ink into a bound book, a leaf from which I also enclose, which book is kept convenient for reference at any time:

Name No. Dropped.....
Served by.....
Calved

Day.	January.	February.	December.
1			
2			
31			
Total			

You will notice it contains the date of service, time of calving, etc., as well as the complete daily, monthly and annual milk returns. So long as I keep cows, I shall undoubtedly keep a record of their milk flow, too. A. A. WRIGHT.
Renfrew Co., Ont.

Figures Certain to Show Surprises.

Editor "The Farmer's Advocate":

I have been keeping a record of my cows for four years. It takes only two minutes per day per cow to weigh milk and record it on a sheet just above the scales, and by the use of a Babcock tester I know just what my cows are making. I suppose the main reason I started was not wanting to work in the dark. One thing I learned by keeping this record was, I found I had several cows that were no more than paying for their keep, and I was throwing my labor away. Now my old stock is well weeded, and I am raising young stock from good cows. My herd of 25 cows, including 6 heifers with their first calves, averaged 5,600 pounds of milk, from which I manufactured 6,030 pounds butter. A dairyman may take as good care of his herd as possible, and may think he has only good cows, but just let him keep a record of each cow and test her milk, even once every two months, and he will find he has some boarders. GEO. STOKES.
West Ontario Co., Ont.

Good Exercise in Addition for the Children.

Editor "The Farmer's Advocate":

I have been keeping individual milk records for two years. Two minutes per day for a herd of sixteen cows is all the time required to set down weights. I make out sheets in evening for a month at a time. It is good practice for the young people to add them up. I have learned by them which are my best cows, and have turned off half a dozen poor ones to the butcher since starting. I consider it pays well, and is a benefit to any man keeping a dozen or more cows. H. R. NIXON.

45 Seconds a Day per Cow.

Editor "The Farmer's Advocate":

I have been keeping daily records since Feb. 1st, 1905, or a few days over two years. I have been taking note of the time it requires to keep records, and I find that it only takes 10 seconds at most per cow to weigh each milking, and about the same time to record it on the daily sheet. It does not take over 45 seconds per cow per day, besides the few minutes at the end of the week to add up the week's milk. I consider it time well spent. I was induced to commence through listening to the discussions at the dairy convention at Stratford in 1905, more particularly by the address given by Mr. Grisdale, Agriculturist, Experimental Farm, Ottawa.

I have learned it is the only way I (or anyone) can tell what amount of milk cows will give during the year, and whether they are kept at a profit or loss. Since keeping records, I find that I have two cows that have to go to the block, yet one gave last year 4,890 pounds of milk, which I think too low a yield for profit. I have cows that last year gave me over 7,000 pounds of milk, and a heifer (her first calf) gave 6,685 pounds. By these figures, it is easy to see which cows pay to keep and the ones to put off. My cows are high-grade Shorthorns. I have been breeding to pure-bred bulls for the past 35 years, with the exception of two years, and these years to a high-grade Shorthorn bull. I find that keeping records pays the man who takes good care of his herd, for he then knows if he is getting milk in return for his feed and care given them, and there is no guesswork about it, as he has the figures to prove it. Now that I have had two years' experience, would not think of doing without them. South Perth, Ont. J. BAXTER.

The Farmer's Advocate Interested Him in Milk Records.

Editor "The Farmer's Advocate":

I kept individual records a part of summer in 1905, and in 1906 from March 21st, when the first cow calved, until December 24th, when we let the last one go dry. I find that by keeping milk records we milk more regularly and feed better; the hired help takes very nearly as much interest in the milking as I do myself, and I find that when a milk record is kept we are bound to keep up the flow by feeding a little bran, etc., when the pasture gets dry. I think it is one of the best ways to ascertain the boarders and weed them out as soon as possible, and fill their place with better cows. As far as time is concerned, I do not think it takes one minute per cow per day when you have everything handy.

"The Farmer's Advocate" started me keeping individual milk records, and, with the little experience I have had with it, I intend to keep it up for the dollars and cents that are in it, which will well repay me for time spent. I weeded out three of my cows this fall which I thought were not too bad before I kept a record of them.

My herd was composed of twelve cows—grades of all kinds. My best cow calved July 2nd; another that calved for the second time at the age of 26 months 10 days, and was such a poor milk-er that I let her go dry on the 27th September; had only six calved first of May, and it was the 21st when the rest had all calved. The average was 227 days for each cow. They gave me 55,245 pounds milk, which makes an average of 4,603 pounds each, or 20 725-2723 pounds a day. It is a small average, indeed, but I intend to improve it, and with the help of "The Farmer's Advocate," Farmers' Institute and Central Experimental Farm reports, a farmer has a good chance to improve on the old methods. Before I close I must say that if you can start a farmer keeping individual milk records, he will soon try to find out what is the best feed, how much he should feed, etc., and would sell his potatoes at 50c a bag and buy bran at \$20 a ton rather than feed the potatoes to his cows. Prescott Co., Ont. E. P. LABROSSE.

Believes in Milk Records for the Dairyman.

Editor "The Farmer's Advocate":

I have not kept milk records for the past four or five years. The real reason why we stopped was that our spring balance broke, and I have never procured another. The actual weighing does not take long; it is the adding up the totals at end of each month that is irksome. The records add quite an interest to the milking, apart from any other benefit, and are an incentive to careful and clean (I mean thorough) milking. They would benefit the man who is aiming for milk alone considerably more than one who is raising dual-purpose cows, as I am. In this district milk is secondary to beef, as a rule. N. Wellington, Ont. ALFRED HUTCHISON.

Will Procure a Pure-bred Bull.

Editor "The Farmer's Advocate": We have been keeping cow records for twenty-one months. The time required is about 1 1/2 minutes per day per cow.

Figures would be of little interest, as our records have been kept only one year and nine months, so we have not had time to make necessary improvement in our herd, but a pure-bred sire will be got in the near future.

Milk records are a decided benefit to a man who takes good care of his herd, for some cows yield heavily when they freshen but do not keep up flow as steadily as others which give a somewhat less flow; so, in the end, the cow considered to be one of the best may not prove to be so.

Labelle, Que. JOHN NEWTON.

Requires Little Time to Keep Milk Records.

Editor "The Farmer's Advocate": I am an amateur at keeping individual milk records, having never kept them for more than four months at a time.

I started because I knew our cows were not doing nearly what they should; that the only way to improve was to keep culling out the poor ones, and that the surest way to find them out was by using scales. Five of our 1906 herd will never board with us again.

Milk Records for a Dual-purpose Herd.

Editor "The Farmer's Advocate": I have been keeping individual milk records for rather more than a year, and find that one minute per cow per day is sufficient to weigh and mark down weight of milk.

I started the records to find out how my cows compared with the herds at the experimental farms, and to learn the comparative value of each cow in the herd, with the object of building up a first-class dairy herd, at the same time raising calves of good beef type.

One thing I have learned is that cows will shrink badly if left out of doors when the weather is cold or wet in the autumn, even though the pasture is good. During the two seasons that I have weighed the milk, my cows have given more in December and January than they did in the last half of November, notwithstanding they have been longer in milk.

It will pay the dairyman to weigh his milk, even should he be giving his cows the best care that he knows how, as he will then be able to care for them more intelligently, and to cull out the unprofitable ones.

North Middlesex Co., Ont. MOSES PIERCE.

Pays to Keep the Record of a Single Cow

Editor "The Farmer's Advocate": This is the second year we have kept milk records. We keep only one registered Ayrshire, disposing of calves. Five minutes daily will keep record.

It was more economical to buy milk or keep a cow, and find I get a greatly increased flow and better milk, as the moment the flow slackens it is detected and food can be changed. This summer, as soon as pasture commenced to dry, records showed decrease in flow, though to the eye pasture appeared ample.

The yield of my cow from July 11th, 1905, to April 16th, 1906, was 7,634 pounds of milk.

Quebec Co., P. Q. C. R. WHITEHEAD.

Milk Records Unnecessary.

Editor "The Farmer's Advocate": We keep an average of twenty cows, grade Shorthorns and Ayrshires, send our milk to the cheese factory for 5 1/2 months each summer, and the balance of the year we churn.

We conducted an individual test one season for quantity (not quality, as we do not get paid by the test). We judged our cows before commencing the test, and we found, after adding the season's work, we had judged them correctly in nearly every instance.

In the first place, we have from three to six heifers every year two and three years old. Two of these can often be milked into one pail, thus saving an extra walk to the milk-stand. Again, it takes at least three years to prove the value of a young cow. We have had heifers do well at first, and turn out only second-class cows.

"The Farmer's Advocate" is always a welcome visitor with us. Your editorial, "The June-condition Fad," is well deserving of a place in your valuable paper.

N. Wellington Co., Ont. JOHN BANKS.

Herd Record of Grade Shorthorns.

Following is a statement of returns from the grade Shorthorn herd (22 cows) of Mr. Wm. Hutchison, Oxford Co., Ont., received from the Princeton Creamery:

Table with columns for months (1906-April to 1907-January), amounts, and averages. Total: \$1,856.94 = \$61.68

Some of Mr. Hutchison's herd are heifers. He also sold \$1,700 worth of hogs during the ten months. Princeton Creamery paid an average of 99 cents per 100 pounds of milk for the cheese season.

[Note.—We should be pleased to receive from patrons of other creameries and cheese factories a statement of the returns made by their herds during the past season, also including statement of any special supplies of foods used to supplement pasture in summer or in stable during late fall and winter.—Editor.]

Difficult, but Good.

Editor "The Farmer's Advocate": I have been keeping individual milk records for a period of five months, but owing to certain unfavorable conditions which existed in my herd, my records are not complete.

I might say I think the testing and grading up to a good herd the most difficult problem about dairying.

Milk Records the Coming Thing.

Editor "The Farmer's Advocate": I have only just done enough keeping milk records to convince me that it is a most important matter in connection with our dairy industry, and one likely to be considered this coming season by many of the foremost dairymen of this Province.

J. J. PARSONS.

Six Years' Experience with Milk Scales.

Editor "The Farmer's Advocate": Successful business and bookkeeping generally are very closely associated.

Having kept records of our cows' milk for over six years, I am fully convinced of their value, or I should not have continued so long. The suggestion to commence came from a circular from Ottawa, with the offer to furnish blank papers for keeping the same.

Some of the benefits of keeping records: You become better acquainted with the value of your cows. Before commencing, a certain cow was placed by me as ranking third or fourth in point of milk production, and, of course, in value.

After keeping a record of two years, she proved to stand at the head of the herd. If a variation is noticed, especially if the yield is lowered, inquiry is at once made as to the cause. Cold and chills, lack of sufficient food or water, fright by dogs or horses, improper milking, change of milkers, change of order of milking and of feeding, and irregularity in hours of milking—the effects of all of these have been proved, and some very markedly so, to our satisfaction.

It's the Whole Year's Production that Counts.

Editor "The Farmer's Advocate": We started testing our cows only a year ago, thinking that the only way of finding out which were really our best, as anyone may milk all their own cows themselves and at the end of the season not know which gave the most milk, if they did not weigh; consequently would not know which to maintain in their herd.

The annual statement for 1906 of the North Oxford Cheese and Butter Factory, a copy of which is sent us by the secretary, Andrew Dunn, illustrates the amount of cash which a good institution like this distributes annually in a district. In actual money, the patrons received \$43,050.67, besides cheese valued at \$481.49 and butter at \$464.25.

The annual statement for 1906 of the North Oxford Cheese and Butter Factory, a copy of which is sent us by the secretary, Andrew Dunn, illustrates the amount of cash which a good institution like this distributes annually in a district. In actual money, the patrons received \$43,050.67, besides cheese valued at \$481.49 and butter at \$464.25.

GARDEN  ORCHARD.

"Number One."

III.

Another advantage resulting from thorough pruning is that of reducing the amount of fruit which may set on each tree and throwing more strength into those specimens which are allowed to remain, thereby making them the more likely to become "Number One" from the blossom right on to the perfect fruit; the thinning part of the work is being done at the same time as is the pruning. Nor is this all. We must not forget that every blossom cut off and thus prevented from developing means, not only that much of the strength of the tree saved (it costs it a heavy strain to bring forth its bloom—flowers are heavy feeders), but it means that there are a host of reproducing germs removed from it. These are what tax its strength; the production of the fruit-flesh is indeed a very small matter in comparison. Thus, if by any means we can concentrate into about one-quarter of what would otherwise be the number of units (or specimens of fruit) on a tree, we at once cut off that much of draft on the land food which it requires to perfect the seeds or pits therein contained. This alone ought to be in itself sufficient incentive for doing a thoroughly good job in this line. Manure is not sufficiently abundant to allow of its being thrown away on useless trash; wood ashes are not now so easily secured as they were 15 years ago; the farm calls for a return of that part of the crop which properly belongs to it. It grows these grain, hay and root crops on shares, the straw or refuse being its proper share. Consequently, every orchardist should view these surplus specimens as sap-suckers and bleeders which are an out-and-out detriment to the tree, a robber of the fertility of the soil, and worse than unprofitable to himself, even if cider be a good price.

The pruning well done, clears the way for thorough spraying. This is one of the most important of all the various duties which are coupled with the work of the orchardist. All the others may be indeed well executed, and yet their whole usefulness be wasted by failure to spray. If you have taken the trouble to notice what was said in this line in the extracts given in my first letter, as well as to learn the verdicts of numbers of others who have tried this means of improving their crops, you will doubtless find that there is in this a vital question for yourself. The codling moth, canker worm, tent caterpillar, tussock moth, aphides of different kinds, oyster-shell bark-louse, San Jose scale, Forbes scale, oleander scale, black scab, black and brown rots, shot-hole fungus, leaf blights of various kinds, are among the many things which infest different fruits, etc., and for which spray mixtures are used. While the trees are dormant, some of these are attended to; others come on later, and the spraying often has to be done when the trees are covered with foliage. It does not require a very keen eye to see that this work can be far more easily done on properly-pruned trees than is at all possible to do where their tops are a veritable thicket. Moreover, the properly-pruned trees will require less time and mixture spent on them than the others. This again means a double saving on this score alone, and with far better chances for something returning that will pay for all that has been spent on this account. Where the orchards have been well pruned, I have seen first-class work done with a Spar. When this is used, there is no stopping at each tree, but the outfit is driven from one end to the other of each row without even a halt. When this style of nozzle arrangement is used, the operators take advantage of the wind and use it as a means of carrying the spray into and through the tree-tops. I have seen it drift across to the fourth row and deposit quite a coating on each one. In this way there is a great saving of time in doing the work, and also a saving of material which would otherwise be wasted on the ground. When all the trees have been sprayed with the wind from the southwest, then watch for the change to the northeast, and at once jump into it again. If no chance of this kind presents itself and there comes a calm spell, if it is taken advantage of, and, by the use of extension rods, the work goes on. You can easily see that there is economy in each and every step in this way of handling an orchard, that what would otherwise go to waste is turned to your profit account, that thorough pruning effects a saving when it is time to spray, by causing a less amount of mixture and time to be taken up by it, and a more thorough job done. (In the work of spraying, the economy in both of these and in the amount of help required to perform it, is much greater when a power sprayer is used than if it is done with hand pumps.) Briefly stated, the gains are: First, the tree-heads spaced out so that sunlight can percolate through them evenly; second, the tree relieved of a lot of unnecessary taxation and burden; third, more strength thrown into a less number of units;

fourth, a useless waste of fertility saved; fifth, this waste given to the fruit which is allowed to remain, thus forcing it to become larger and of better quality; sixth, faster time made in spraying; seventh, more thoroughly effective work accomplished in the spraying; eighth, the greater quantity turned into "Number One"—probably 90 to 100 per cent. I have seen this practice turn Lombard plums, Crosby peaches and other overloaders, which are nearly always small, into a size which placed them in the "Fancy" and "Choice" grades, and their quality did the rest at securing the tiptop prices.

Try it. Begin NOW, and you will soon have forgotten that old whim about the apple orchard being one which will not pay for the work spent on it. Get to work right; begin right; divide it up between all the essentials, instead of throwing all your energies into cultivation or any other one thing alone; put your trees in proper shape and give them a chance to recover from the lack of proper care in the past, and you will soon be on the right track to overtake "Number One," and will have a product which will attract not only the buyers, but also fat prices for it, and your orchard will soon turn out sufficient cash to enable you to buy carloads of manure, etc., to feed up what you will very likely term as one of your best friends. W. H. BRAND.
Lincoln Co., Ont.

How a New Brunswick Orchard was Started.

Editor "The Farmer's Advocate":

The printed questions in your issue of January 31st are questions I had to decide on four years ago, and the enclosed photo (see cut) partially answers nearly all of them. I have about six acres of young orchard, and three more to go out



Starting a New Brunswick Orchard.

this spring. The varieties are Gano and McIntosh, and this year's setting will be either Stark or some hardy sort to top-graft to Bishop Pippin. I decided when the trees were set to head them at three feet and cultivate. Although the low head and much looks very tempting, yet, as far as I know, this system has not been practiced to any extent, in New Brunswick, anyway, and we do know that good cultivation will make trees grow and bear good fruit. My experience only has to do with apple trees, and my system has been as follows: In the spring I take a good strong horse, with man to lead, and plow under a rather heavy coating of manure; use a short, padded whiffletree; back-furrow to the trees; if one is careful, the back-furrows can be made to meet. Last year was the third year from setting, and I plowed three furrows on each side; this year I will plow five. Instead of harrowing, I levelled the ground with a hoe. I could not work either a harrow or horse cultivator. The man, a good hoer, did the five acres of trees in less than a day. Of course, the soil was very mellow and light. Then we set out tomatoes and cabbage in this strip, applying to each plant two handfuls of mixed fertilizer and hardwood ashes. I then kept the strip on each side of the trees cultivated with a one-horse cultivator, and hand-hoed between the plants. My trees made all the growth they should, and the returns from the tomatoes and cabbage were very satisfactory, and one cultivation did both; moreover, I intend to keep on with this practice.

As I said before, undoubtedly the low head—by low head, I mean from one to two feet—is much easier to spray and pick than a high head, but I cannot see how we can cultivate such with

our ordinary farm machinery. In conclusion, I will say that I can recommend anyone to follow the system I am using for good results. York Co., N. B. S. B. HATHEWAY.

Another New Brunswicker's Orchard Practice.

Editor "The Farmer's Advocate":

My experience in heading fruit trees is confined to the apple. In starting an orchard of apple trees, my aim is to form a tree that will not prevent a team from working within six feet of the grown tree without doing it serious injury when not loaded with fruit. To accomplish this purpose, each variety needs heading to suit its habit of growth. The Transparent, Spy and Wagner, with others of like growth, could be headed two and a half or three feet from the ground, while those of a spreading growth, like Alexander, Golden Russet, etc., would require from four to five feet of trunk to accomplish the same purpose.

In reply to question 2, as to what height I would advise a farmer to head his trees, I should say from two and a half to five feet, to suit growth of variety.

The advantages of low-heading are that it makes picking easier, and reduces loss from high winds.

The objections are: Many varieties, when loaded with fruit, would have the lower tier of branches lying on the ground. Such fruit would not get color or flavor, and would be eaten by wireworms and slugs, making the fruit useless for sale. This could be avoided by propping up the limbs, if very carefully done.

Our system would, perhaps, be condemned by the advocates of clean cultivation, consisting, as it does, of a strip of sod under the tree, with the rest of the land under cultivation, keeping the cultivated space as wide and the sod as narrow as possible, by plowing very shallow in early spring, following often enough with the disk and smoothing harrows to keep the surface mellow and clean till first of July, when crimson and red clover are sown, to occupy the ground till the following spring. Our orchard, being located on a side-hill, and planted 15 x 30 feet, made this seem necessary; now that we are removing every other tree, cross cultivation will be practiced to some extent. An extension disk has not yet been used, but will be later. J. C. GILMAN.
York Co., N. B.

High and Low Headed Fruit Trees.

Editor "The Farmer's Advocate":

The question as to what height young trees should be headed is one about which there is, and I suppose always will be, a difference of opinion. There are very good reasons given for both systems, and the question is which is the best and most advisable. In many cases the heads are already formed in the tree as it comes from the nursery, to such an extent that it is difficult to make them any higher or lower. Then there are some varieties that have a low spreading and drooping habit of growth, while others have an upright habit, and the object of the pruner is to try to keep up those of a spreading habit and encourage an upward growth, and in the case of those of an upright habit to spread them a little.

The advantages of a low-headed tree are: First, that they are not so liable to sunscald, and they are not so liable to injury from high winds or having the fruit blown off. It is easier to pick the fruit and to spray the tree. The main objection to the low head is the difficulty of cultivation. In the case of apple trees, even with the use of extension tools, it is almost impossible to cultivate under the tree.

In the case of the standard or high-headed tree, with the use of the single or one-horse orchard plow, with a wide extension reversible clevis, and an extension disk harrow, cultivation can be easily carried on right up to the trunk of the tree.

But with many varieties in standard trees it is a difficult matter to keep the trees up to the desired height, and requires a constant upward training; and when fruiting begins the limbs will bend down so low that when the fruit is half grown, or a little more, no further cultivation can be done close to the tree; and, further, when once the limbs have been bent low by the weight of fruit, there is a tendency to remain in that position, so that to keep them up to the desired height, that a horse can walk under them in cultivating, one would require to start the head at not less than four feet, and then with some varieties, and, in fact, with most of them, there would be considerable lopping off of lower branches. Probably the medium between the dwarf and the high standard would be the most preferable for most sections of the country—what is called half standards, with the heads started about two and a half feet high. For the first few years it would not be a difficult matter to get pretty close to the trees. As they grow older they might be mulched heavily, as far out as the branches extend, or as far as the extension tools would reach to, and thus keep the moisture where it is needed during summer, and in localities where there is not much snow, afford protection to the roots during the winter.

In localities where San Jose scale exists it has

been found that it is a difficult matter to control the scale on very high trees, on account of the difficulty of applying the spraying mixtures to the central higher parts of the trees; and the heading or cutting back of high trees is advised in infested districts.

On the other hand, the fruit on the high standard tree, while more exposed to wind storms, is at the same time usually better colored, better flavored and cleaner, on account of the air and sunshine getting free access to it. In any case, plenty of space between the trees should be allowed. A free circulation of air and sunlight all around and under the tree as well as through the branches, is essential to productiveness and good quality in the fruit.

The trouble of sunscald, so prevalent in some localities, is easily prevented, and at a very trifling cost, by either using the common building paper, tying it around the trunks in the late fall and leaving it there until late in the spring; it also protects the young trees from mice. A still better thing is strips of veneer from a basket factory. They can be got of the requisite length as ordered, and at a trifling cost, and can be quickly and easily put on, and are a perfect preventive from sunscald and field mice.

The question of high or low heading of trees should be largely one of locality. In localities subject to severe gales in autumn, and in sections infested or likely to be infested with San Jose scale, half standards or low-headed trees would be preferable; while in other sections not so affected the standard, on account of the reasons stated, would be preferable. Simcoe Co., Ont. G. C. CASTON.

American Pomological Society Meeting.

The thirtieth biennial meeting of the American Pomological Society will be held in the convention hall on the grounds of the Jamestown Exposition, in conjunction with the Society for Horticultural Science, September 25 and 26, 1907. A number of important matters will come before the Society at this time. Reports on the grading and inspection of fruits for home distribution and export purposes are due, and the members of the committee having this matter in hand have been working earnestly. The committee on judging and score-cards will add to the excellent reports already presented, and include a number of fruits not yet dealt with. The history of fruit-growing in one of the oldest sections of the country carries with it many important lessons, and will be presented by competent authorities. Various matters bearing upon the technical phases of fruit-growing will be presented and discussed. It is not the intention of the Executive to hold three sessions each day, but rather to confine the work to morning and afternoon sessions, allowing the evening to be free for such other recreations or duties as may offer themselves. There will be ample facilities for holding the meetings and making a creditable exhibit. The sessions will be held in the convention hall, and the exhibit will be staged in the interior court of the States' Exhibit Building.

The Society for Horticultural Science (Dean L. H. Bailey, of the Cornell College of Agriculture, Ithaca, N. Y., president, and Prof. V. A. Clark, of the Arizona Experiment Station, Tucson, secretary) will meet in joint session with the American Pomological Society this year. This general announcement is made under the authority of the Executive Committee, Captain C. L. Watrous, Des Moines, Ia., chairman; L. A. Goodman, 4000 Warwick Boulevard, Kansas City, Mo., president of the Society; and John Craig, Ithaca, N. Y., secretary.

Improving an Essex County Farm.

Editor "The Farmer's Advocate":

S. Benetian, Essex Co., writes: "I own a farm on the Canadian side of Detroit River, below Sandwich Town—twenty-five acres, black, sandy soil, best of all for garden stuff. In fact, it is in the center of the radish belt. It has been neglected a year, and needs to be improved. Would you advise me as to the best of fertilizers and least expensive methods.

"I can secure Canadian tobacco-stems. Would it be advisable to have that scattered on my land? I can also secure manure from the farmers, but the hauling would come very high. What product should I attempt to raise most for the first year, the soil being in somewhat of a poor condition? Could tobacco be raised, or potatoes?

"I also wish to plant a small orchard on this farm. Would the patch need to be fertilized? Would tobacco-stems be good there?

"Should I attempt to underdrain my farm? Would this do away, to some extent, with the need of fertilizers?"

In the first place, whether the soil should be underdrained or not, is a matter which you can best determine yourself. If the land is in need of underdraining, it would certainly pay to attend to this first, for on undrained soil we never get the full benefit either of cultivation or fertilizers applied.

The best method of restoring fertility and bringing the soil back into good tilth will depend somewhat upon the kind of crops it is desired to grow upon it. Probably the quickest way to add

fertility to the soil would be to grow a heavy crop of some leguminous plant, such as clover, lucerne (alfalfa), or hairy vetch, and plow this under when it reaches its maximum growth. This would add a large amount of vegetable matter, and make the soil more friable and retentive of plant food. If, in addition to this green-manuring, a good top-dressing of unleached wood ashes could be applied, say at the rate of five or six tons per acre, this would add largely to the potash and phosphoric-acid content of the soil. The leguminous cover crop should furnish all the nitrogen necessary; in fact, it is often stated that the cheapest source of the chief elements of plant food in the soil are clover seed and wood ashes. There is no doubt that barnyard manure is one of the most valuable general fertilizers, but the profits to be derived from it, of course, depend largely upon cost of procuring and applying it. Tobacco-stems are particularly rich in potash, and if they can be obtained conveniently, might be applied profitably. None of these applications, however, benefit the soil as much as the turning under of a good crop of clover or other legume. Commercial fertilizers, as a rule, are too expensive to be applied in a general way without first making a small test to find out what results they will give upon the particular soil or crop to which they are to be applied.

With regard to the crops which can be most profitably grown on the soil, this is one which depends largely upon locality and the demands of the market, and you can probably determine this better than anyone else. I may say, however, that tobacco and potatoes are both exhaustive crops upon soil fertility, and where such crops are grown, a rotation of crops should be adopted in which clover, vetch, or some other crop, can be grown at least every four or five years, and will add humus to the soil. O. A. C., Guelph, Ont. H. L. HUTT.

Growing Early Tomatoes.

Editor "The Farmer's Advocate":

I grow early tomatoes by starting them in a hotbed the last week in March, and plant out about May 24th. Have had tomatoes ripe July 20th. To make the hotbed, I dig out 15 inches of dirt, then put in horse manure, tramping it solid. Next apply about 3 inches of fine rich earth on top, and plant the seeds in rows from two or three inches apart. AMATEUR. Durham Co., Ont.

POULTRY.

Feeding for Egg Production.

Editor "The Farmer's Advocate":

I see in your issue of Feb. 7th, Mr. Jas. Nicholson, of Bruce Co., asks me to write an article telling more about the management of my hens to obtain such good results. I have no secrets to harbor, and yet it may be a difficult matter to impart to others the knowledge (if knowledge we can call it) I have acquired, so that they in turn may become better qualified to meet the difficulties they have before them. I have studied hens a long time, and there is much for me to learn about them yet. However, I will do the best I can. But let me say that I cannot tell another how to feed in a satisfactory manner. I do not always feed the same way without variation. I feed for results, and to do so, one must watch his birds, the same as one must watch his cattle or hogs to feed to the best advantage. The secret is to feed as well as possible, and yet not overfeed. Also, one must have some slight knowledge of the nature of different articles of food within reach; that is, he should know if a certain food will produce fat or muscle, or both. If my birds are not laying to suit me, I study their condition. Are they becoming too fat, or are they getting insufficient food, or are the weather conditions the cause? Whatever I conclude the cause to be, I try to remove it. Must I decrease feed or increase exercise? With my birds, I have to guard against their becoming too fat.

But there are certain conditions to be sought after, and if these conditions are right, the chances are favorable for any person to have fair results. I think all will agree there are three essentials to the getting of eggs satisfactorily. These are stock, housing and feeding.

In the first place, the stock must have the laying qualities bred into them. Then they must be housed in suitable quarters, and there is much difference of opinion as to what quarters are suitable. And we must feed our birds as their natures require, or they cannot please the owner with returns. I might have added the rearing of the pullet from hatching to laying—a very important matter. I always try to make them work for some of their food from the start, and I never try to fatten the cockerels fit for good market birds while they are running with the pullets. If I did, the latter would become too fat for future usefulness. I have trap-nested a good many hens, and my experience is that a

pullet getting too fat before commencing to lay, or delayed by any cause from getting started to lay when matured, never made a high record afterwards. Therefore, I do not favor pushing the pullets with highly-stimulating egg rations until they are well grown. The constitution is superior in the well-grown, bony bird, and without a good strong constitution, they cannot stand the strain of laying 200 and upwards of eggs in one year.

In regard to stock, I would say that my pullets were bred to lay. Their mother had laid 229 eggs in a year, and their sire was from the best laying strain I could obtain at that time. While I am willing to tell how I feed, I want to point out that the ordinarily-bred flock cannot be expected to do just as well.

Prof. Gowell, of Maine Experiment Station, has achieved world-wide fame with the laying records of his flock of Barred Rocks. He has only a half dozen hens which have equalled my hen "Pearl"—237 eggs—while his flock for year averages 150 each. My ten pullets of "Queen" laid, from December 2nd, 1905, to September 11th, 1906, 150 each. On the latter date three had to be removed to make room for pullets to be trap-nested. The remaining seven averaged 190 2-7 in the year! Now, 110 eggs is a very fair average from a flock not specially bred for eggs. In fact, the hens at the Ottawa Experiment Station are reported, on two occasions, some years ago, to yield not more than six dozens each, and there were a good many breeds represented. So I say that no one should be discouraged if these extra good results are not obtained. We just have to breed and feed the best we can, and strive to improve as we grow older. So much for breed.

Now, another point is the housing. I am not sure what is the best style of house, but am positive that for my breed of hens the open-front is a good house. Mr. Nicholson mentions windows in both the south and east. This will cause a draft, which is most detrimental. My house, in which these records were made, is of rough boards and tar paper. The floor is two-ply, with paper between the two thicknesses, and the joints are broken. Then, the roof is sheathed, tar-papered, over which are shingles. The sides are rough inch boards, not matched, one thickness, and double tar-papered on outside. The paper on roof laps down over ends of sheathing, so that the three sides are completely sealed. The south side has two frames, 3½ feet by 5 feet, each with factory cotton stretched across. These are hinged at the top to plate, and are lifted every morning and hung to ceiling, where they remain all day. There is only wire netting between the hens and outdoors. One window of glass is between these frames. It is about 2 x 4, and was calculated to make light on stormy days when the curtains could remain down; but the pen was too dark, so the curtains are up every day. There is no pretense or attempt at making the south side tight. The other three sides are wind-proof. The pen is 4½ feet high at back, and 7 feet at front. When zero weather is on, I drop a loose curtain of coarse jute sacking over the front of roost, but not when at all mild. The roosts are at the back of the pen. There is a dropping-board, which I clean every morning, unless frozen. Having a hoe and an old basket handy, it is a short job, and worth while. Nests and grit boxes are up on platforms hung to wall, so the whole floor-space is available for scratching. There is no frost or dampness on walls, and I am well pleased with this style of house for the birds' health and vigor, cheapness of construction and convenience to the caretaker. If I had a little more glass, so the curtains could be closed when extremely cold, the male birds' combs could be saved. The hens do not freeze at all.

As to feeding, I gave about one-half pint of grain scattered in litter at daylight, 10 a. m. and 1 p. m., and about 3 pints at 4 p. m., to 25 hens. The grain was wheat, barley, oats, cracked corn and buckwheat—the major portion wheat. These grains are not mixed and fed together; one at a time, and a change each feeding. Mangels hung within reach mornings. The last thing at night they got a sufficient mash to round their crops up. Mash composed of kitchen wastes, dry clover leaves, bran, shorts and chop, with a little oil-cake meal, mixed with boiled potatoes and peelings while hot. This mash varied. The aim was to fill the crops, and as cheaply as possible. When the weather was mild, a very little chop, barley or corn, but when cold the proportion of chop was increased and the bran decreased. Also, each night about one-half ounce of cut meat scraps from the butcher shop to each hen. I have no bone mill. The ground bone would suit me better than meat. I believe in giving the bone or meat and vegetables every day, no matter how little there is. Have no use for the twice-a-week or the every-other-day system for these foods, as some write and talk. We must, in handling the hen under artificial conditions, come as nearly as possible to natural conditions. We do not see her going about gathering a supply of worms and bugs two days of the week, and filling up on grass the other days. But, on the other hand, it is a

Continued on page 349.

A Good Homemade Brooder.

A subscriber has requested from E. H. Morgan, Missisquoi, P. Q., particulars about how he built the brooder mentioned in his letter published in "The Farmer's Advocate" of January 17th. In reply, Mr. Morgan informs us that he took the plan out of Bulletin 7, issued by the Experimental Farm. We presume he means Bulletin 7, issued

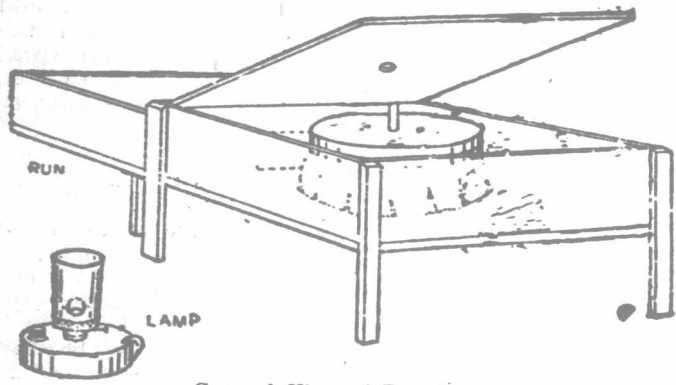

General View of Brooder.

by the Poultry Division of the Live-stock Commissioner's Branch of the Dominion Department of Agriculture. An illustrated description of this brooder was given by F. C. Elford in an article in this paper last spring. We republish it for the benefit of those interested. Mr. Morgan says that, as he figures, it cost him just \$2.25, not counting the work, which he considers 50 cents would cover. He used about 28 feet of lumber, at 2 cents per foot; the burner and collar he took off an old broken lamp—it would have cost about 10 cents to purchase. The itemized cost is: Lumber, 56 cents; galvanized iron, 75 cents; tinsmith work, 80 cents; 2 yards of cotton, 10 cents; and nails, 4 cents. He says he has had fine success with it.

Mr. Elford wrote of the brooder as follows:

THE BROODER.

"For brooding, many use the old hen, and when every precaution is used against vermin good results are obtained. Satisfactory arrangements for brooding are absolutely necessary, however, when artificial incubation is adopted. Even where it is intended to use the hen, artificial brooders should be provided, as hens are not always to be relied on. There are many good brooders on the market. A brooder should be dry, with plenty of heat overhead and good ventilation. Young chicks, as well as old ones, require plenty of fresh air. The young chicks need a high temperature beneath the hover—a place where the chick may doze for several days. A covering of clover leaves or similar material makes a good litter in which the feed may be fed.

"For ordinary farm conditions, the individual brooder and colony house is very advantageous. The brooder inside of a colony house is easier to operate in changeable weather; the colony house forms a runway for the young chicks and protection from the wet, and, when the brooder is taken out, allows a good place to house the growing chicks till marketed or put into winter quarters. A description of how the brooders and colony houses used at the Dominion Government's Poultry Illustration Stations are made, might be of benefit to those intending to construct such for their own use.

CONSTRUCTION.

"The brooder is warmed by means of a lamp; the fumes of the lamp are not permitted to enter the chick compartment. Warm fresh air continually flows into the brooder and ventilates it. The management of the brooder is simple. It should be placed in the movable house, or in a vacant room or pen. It is not intended for outdoor use. The brooder can be satisfactorily constructed at home; the heater and lamp can be made by any tinsmith; the cost of the complete brooder is small.

"Box.—The box that forms the brooder is 34 inches square and 8 inches deep, inside measurements. It is made of 1/2-inch lumber, planed on both sides. A 5 x 10-inch chick door should be sawed in one of the sides of the box; the chick door should be hinged at the top. The floor is 1/2-inch matched lumber. At center of the floor a round hole (diameter 6 1/2 inches) should be sawed. The heater is placed in this opening, and rests on a galvanized-iron rim (inside

diameter 5 1/2 inches). Four legs, 1/2 by 2 inch, should be attached to the box; they should project 8 1/2 inches below it. The roof is a light wooden frame, covered on both sides with heavy cotton. It should fit inside the box level with the top, and be supported on 1/2-inch cleats. The roof frame is 34 inches square and 1 inch deep, outside dimensions. A 2-inch hole is required in the cotton for the upper smoke pipe of the heater.

"Run.—The run is 2 by 3 feet. It should be hinged to the front of the brooder on a level with the brooder floor. A three-section hinged frame, 6 inches high, should be placed around the outside of the run to confine the chicks for the first few days. The floor of the run can then be lowered to the ground, and will form a runway into the brooder.

"Lamp.—Dimensions: Diameter of the oil fount, 7 1/2 inches; depth, 2 inches; total height of lamp (including chimney), 8 inches. There should be a small handle on the oil fount, and a screw cap for filling with oil. A large-size burner can be used, or a special water-cooled burner. The burner screws into an ordinary lamp collar, soldered to the oil

fount. The iron chimney is about 5 inches high; the diameter of the top chimney is 2 1/2 inches; the bottom diameter is 3 inches. A 1 1/2-inch hole should be punched in the chimney, and covered inside with mica, in order to see the flame. The top of the chimney is placed over the lower smoke pipe.

"Heater.—The heater is complete in itself, and can be successfully operated in a box of any

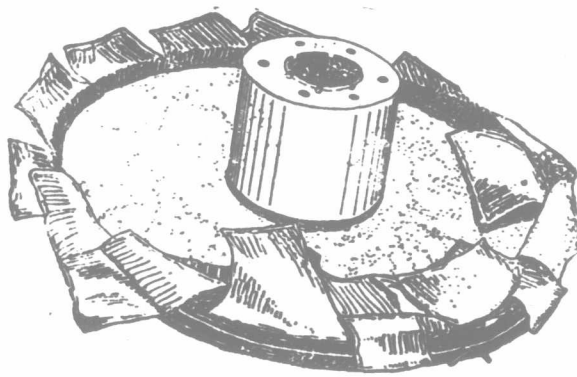

HEATER - VIEW FROM BELOW

size. No separate hover is required, and the chicks are continually supplied with warmed fresh air. In cleaning the brooder, if the heater and lamp are removed, and a pan is placed beneath the hole in the floor of brooder, the litter can be caught and removed in the pan.

"The heater is made of galvanized iron, with the exception of the heat-reflector. This should

be cut from bright tin. The dimensions of the different parts of the heater are as follows: Lower smoke pipe, diameter 3 inches, length 5 1/2 inches; fresh-air chamber, diameter 6 inches, length 5 inches. The fresh-air chamber is attached to the smoke pipe at the bottom. In the floor of the fresh-air chamber 1/2-inch holes should be punched for the ingress of fresh air. The fresh-air chamber is open at the top. Heating chamber, diameter 20 inches, depth 2 inches. A heat re-

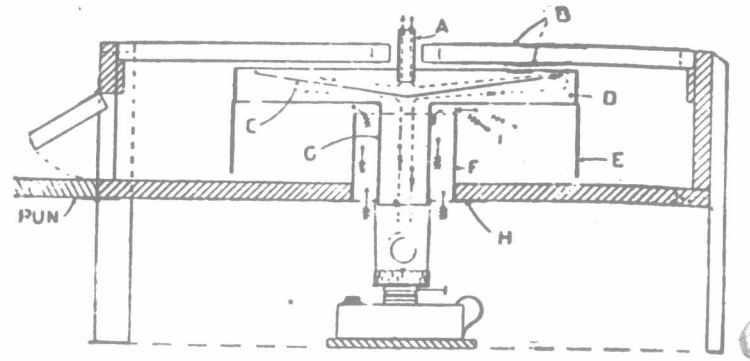

CROSS SECTION

A. Upper smoke pipe to carry off the fumes of the lamp. B. Cotton-covered frame, or roof of brooder. C. Heat-reflector. D. Heating chamber. E. Two-ply flannel to form the warm hover for the chicks. F. Fresh-air chamber. G. Lower smoke-pipe. H. Galvanized-iron rim on which the heater rests. I. Warm fresh air entering the hover.

lector (inverted cone) is placed in the heating chamber. The diameter of the cone is 18 inches, depth 1 1/2 inches. The upper edge of the cone is 1/2 inch below the top of the heating chamber. The apex of the cone is 1/2 inch above the bottom of the heating chamber. The cone is riveted to the heating chamber by three clips at the top. The upper and lower surfaces of the heating chamber should be rigid; they can be stayed to the cone, or held by two wire nails driven through the chamber and soldered.

"Upper smoke pipe: Diameter 1 inch, length 4 inches. The upper smoke pipe should be soldered 1/2 inch inside the heating chamber.

"To complete the heater, two strips of flannel may be placed around the outside of the heating chamber, and tied with a cord to it. The flannel strips should extend four inches below the heater. They reach to within one inch of the floor of the brooder, and form a warm hover for the chicks. The strips should be cut every four inches, and alternately, so as to prevent the escape of heat.

"The foregoing illustrations show how the colony houses are constructed. The floor is 6 feet by 8 feet, and the sides are 8 feet high. The material used depends on what the builder may have convenient. The ordinary pine siding, dressed, gives good results. If four pairs of small rafters, 2 in. by 2 in. by 8 ft., are erected, half-inch lapping may be put on horizontally.

"In each house one brooder is placed. The house is bright and cheerful during the day, and when the chicks cannot be allowed outside they scratch for grain among the litter on the floor. The house will last for years. One house and brooder will rear 75 chicks to marketable age. The brooder can be removed from the house when the chicks are six or eight weeks old, and used for a later hatch."

Stamping Eggs.

J. R. H.'s article in a recent issue of "The Farmer's Advocate" certainly indicates the direction in which egg-handling should be moving. There is no doubt the egg business has suffered for want of this very thing. That some egg-sellers are notoriously—not to say dishonestly—careless, is a fact patent to everybody. Anything with an unbroken shell goes into some egg-baskets. It makes no difference how old or when found, or how long a vagrant biddy has been sitting on her nest, some eggs find their way to the market and are sold under some such misleading name as "fresh-gathered" or "fresh country eggs," to the annoyance and loss of the purchaser. Further, egg-vendors are often annoyingly careless in the way in which they put all eggs, good and bad alike, indiscriminately, into one box. Again, all who have taken pains to observe, know that the eggs of a flock that have been carefully fed on nothing but the purest food and water have a finer flavor than

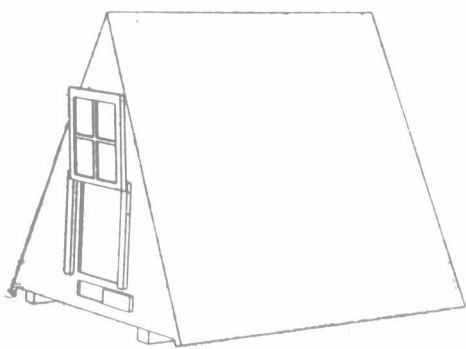

GENERAL VIEW

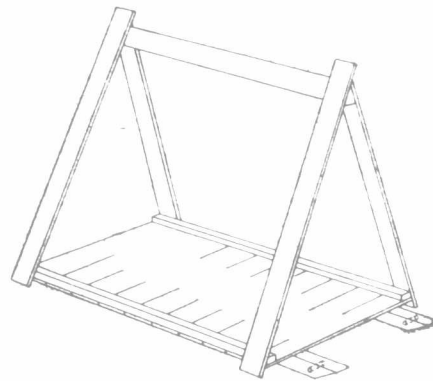

FRAME AND FLOOR.

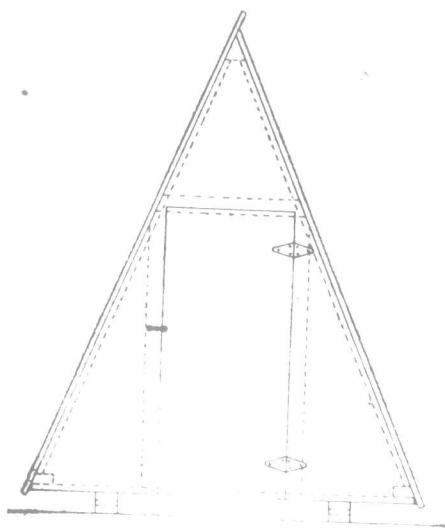

FRONT VIEW

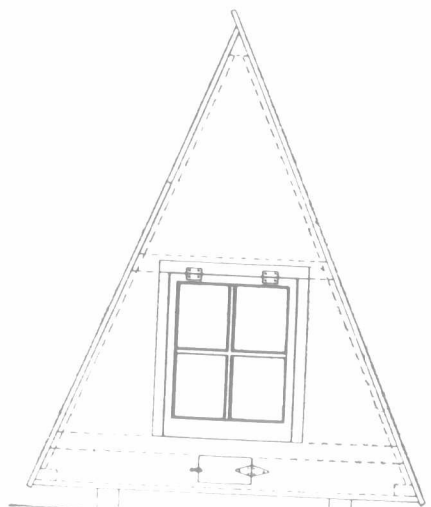

FRONT VIEW

belongs to the flock getting its food anywhere and from anything. Besides, a stamped eggshell may be returned to the grocer, and the loss laid upon the shoulders of the careless or the dishonest producer. In fact, J. R. H. has indicated the way out of a difficulty that we have all felt. This method is in accord with the methods of the day that are aiming more and more at fair play for all, and at giving the man who is careful to produce an excellent article the highest possible returns for his investment of labor and of thought.

M. A.

Feeding for Egg Production.

Continued from page 347.

pick here and a pick there, until, when the day is completed, the crop supply is completed also. My feeding is light in fore part of day, to encourage activity and the use of considerable vegetables, and the soft food at night is easier on the digestive system. This style of feeding was taught me partly by Prof. Gilbert, Ottawa, and it has given me good results; and yet, wishing to make less labor, I am trying the dry mash. At present it appears that with the dry mash more is consumed and no greater productiveness, maybe not as great. But the season may be the cause of results to some extent. However, it is more quickly done, and there is less danger of bound crops, with less eggs without shells.

Now, Mr. Editor, I do not know it all. I am only learning. It is a wonderfully wide field for investigation, but I have tried to make my methods clear to your correspondent. If I have been able to throw out any hints which will help him or any of the many readers of your valuable paper to more satisfactory results, I am sure it is only a pleasure to me.

J. R. HENRY.

Wentworth Co., Ont.

THE FARM BULLETIN.

An Expensive Industry.

A newspaper story last week indicated that there was some reason for believing the Provincial Government would accede to the request of the directorate of the beet-sugar factories at Wallaceburg and Berlin, Ont., by extending for three years the bounty on sugar manufactured in the Province from beets grown in Ontario. In 1901 an annual sum of \$75,000 was set aside for three years for this purpose. It was later extended for two years. The factory owners, whose investment in plants totals over \$1,000,000, claim a further extension of the bonus is necessary if they are to remain in business. Last year the two factories made over 20,000,000 pounds of sugar, and the bounty was divided between them on the basis of their product. Farmers who grow and supply the beets are protected as to prices by clauses of the Bounty Act, providing that these matters are to be the subject of agreements between them and the factory owners, and that all such agreements must be submitted to and obtain the approval of the Minister of Agriculture.

We are not prepared to dispute the position of the companies that a bounty is necessary to keep them in business, nor are we antagonistic to the beet-sugar industry. Beet-growing was welcomed as a good thing for districts near the factories, and as it is one of the few protected interests from which the farmer might stand to profit, we should like to see it a success. But if, with the large measure of fiscal protection enjoyed under the fostering care of the Dominion customs, the beet-sugar industry requires heavy Provincial bonuses for eight years to keep it alive, it looks as though it were a case of taxing the general community pretty heavily to benefit a few localities. It has been stated that it would require forty factories like the two we have to satisfy Miss Canada's sweet tooth. By the present look of things it will pay Jack Canuck to let his sister buy her chocolates abroad, or at least buy the raw material and make her own "fudge" (if we may use such a figure of speech to designate the business of refining).

We are glad there are two beet-sugar factories in Ontario. They have been worth while as an experiment, and may possibly prove the pioneers of an ultimately advantageous industry. If they actually require a continuation of the bounty for three years more we would not say them nay, but may be excused for expressing the hope that no more beet-sugar factories will start up for a few years to come. As a justification for its continuance, it is urged that the bounty serves as a wholesale check in the interests of the whole people, on the big monopolistic refining corporations. Meanwhile Ontario's case may serve as an example to Prince Edward Island, where some newspaper men and others have been crying out for an industry which they think they want, but which would very considerably disappoint them if they got it.

Horse Commission Report.

In reply to the Leader of the Opposition, Hon. Mr. Monteith, Minister of Agriculture, has announced to the Ontario Legislature that the findings of the Royal Commission on the horse-breeding industry are not sufficiently advanced to be laid on the table this session.

Rural Public Schools.

Editor "The Farmer's Advocate":

During the year 1906, and especially during the last few months, there has been considerable thought expended on the problem of "How best to secure the education of our young people," and keep our teachers and schools best equipped for so important a work. Our Government has been trying to advance, urged, perhaps, more or less by the teaching profession, and has sought to so improve our school laws as to bring about better results. In addition to all this, we frequently hear from public speakers, and sometimes through the press, a great deal about our "splendid school system" and great "educational advantages" generally spoken of as being equal to, if not in advance, of other countries and other systems.

Now, sir, it is not my intention to find fault with what has already been accomplished, or belittle any honest efforts that have been put forth to better our condition, for while the higher salaries to be paid and extra facilities required, as well as the improvements asked for in and around our school premises may, in some cases, appear to be rather burdensome, they may in the end prove to be very beneficial indeed. It might be well, however, for us to consider a few facts as they appear to us from a farmer's standpoint. We are often told, and perhaps justly so, that the farmers are the backbone of our country, and we are inclined to believe that no class of people is better able to pay their way and secure the best to be had than the farmer—you can easily perceive that I am a farmer from choice. Now, what are we doing for the education of our children in the rural schools, and what are the results obtained? Our children attend school in our home schools until about twelve or thirteen years of age, at which time the average pupil passes the entrance examination for the high school. Five per cent. of these continue to pursue their studies by attending a high school, while ninety-five per cent. are deprived of the opportunity of getting a higher education. Well, I think I hear someone say, "They can attend high school if they wish, as well as the other five per cent." Let us see what becomes of the five per cent. who do attend the high school, and in the first place we will count the cost to a farmer to send his child to a high school. Living at a distance of five to six miles from school, and in some cases more, it is necessary for his child to board in town, which will cost on an average of one hundred dollars per annum, making in all about four hundred dollars for four years he needs to attend. Some keep a horse and rig and drive back and forth, but this does not lessen the expense any, besides the exposure in all kinds of weather. During all these four years the child is living in an atmosphere of surroundings that does not tend to endear him or her to country homes or country life, being away from home at that very period in life when boys and girls most need a father's guiding hand and a mother's watchful care, and too often instead of becoming sturdy, intelligent citizens, they are filled with light jesting and nonsense, that unfits them for life's realities, and if they return to the country life they have nearly if not entirely shaken off the restraint of father and mother, and regard them as too slow. A few of the others who do not attend high school, feeling the need of better education, may spend a few months at a business college, or at the Agricultural College at Guelph. This class will, perhaps, be equal to another five per cent., leaving ninety per cent. of our young people unschooled, except for such education as they have in our rural public schools, secured before reaching the age of thirteen years, after which time there is no class in which to pursue their studies. Then what is the result? Ninety per cent. of our people in the country are uneducated, and all because our country schools are not in a position, or I may say, by the educational system which we are continually boasting of, deprived of the right to give to our boys and girls that education which will best equip them for life's duties, and thus make them more desirable citizens; or, in other words, are we educating the few and neglecting the masses, by compelling those who desire an education to go to town to get it? I would beg leave here to suggest, as a remedy to this fault, that the standard of our rural public schools should be raised, and this brings us to the question, "How can we best raise the standard of our rural public schools?" and we would suggest that our boys and girls should be able, by attending rural public schools, to qualify themselves to teach in rural public schools, and in order to do this our school law should be so amended as to furnish advanced classes for that purpose. By advanced classes I do not mean what is now termed "continuation classes," but rather classes in which advanced scholars could pursue their studies in the more practical subjects, such as elocutionary reading, penmanship, bookkeeping, grammar, literature, commercial law, mathematics, and such like, instead of being compelled to go to high school and spend their time studying Latin, French, and a host of other things which they have not time to learn, and if they had, would be of very little use to them in after life in the country. Then our boys and girls in the country could spend their winters at least in school, and still be at home to attend to the chores around house and barn, and in two or three years would be able to secure a certificate, enabling them to teach in our rural public schools for a period, and then by attending a Normal school could secure a certificate of higher standing, that might, of course, only allow him to teach in a public school, as his education would only be along the lines of public-school work, and on subjects re-

quired to be taught therein. I may say, in conclusion, that my object in writing is to benefit farmers' sons and daughters, many of whom are wasting valuable time these winter days instead of securing an education.

W. H. KIPP.

Oxford Co., Ont.

[Note.—In the East Middlesex public school inspectorate about 80 per cent. of the rural schools have "Public School Leaving" classes, averaging from one to five pupils each, but they are not increasing, and the pupils usually attend them about one year after passing the H. S. Entrance. Corresponding classes in the graded village schools of two and three rooms are on the increase, the facilities for teaching advanced scholars being better. The discontinuance of the departmental examination for these classes a few years ago removed that motive from before the pupils.—Ed.]

Compulsory Eight-hour Day.

The Canadian Manufacturers' Association has issued the following letter to Farmers' Institutes and Agricultural Societies on the eight-hour day bill now before Parliament:

The labor unions, through their representatives in Parliament and elsewhere, are endeavoring to bring about the adoption of a compulsory eight-hour day. A bill is now before the House, introduced by Mr. Verville, which provides that no workingman engaged on a Government contract shall be allowed to work more than eight hours in any one day. It need scarcely be pointed out that should this measure become law workingmen engaged in all other classes of contracts would soon be clamoring for the same treatment. In a very short time, therefore, the application of an eight-hour day would of necessity become general.

We think that you will agree with us, that it would be most unfortunate if an eight-hour day were forced upon the country just now, when all classes of industry are suffering from the scarcity of help. Any shortening of the hours of labor would simply mean that progress would be retarded and production curtailed. The cost of labor on all public works would be increased approximately 20 per cent., and the burden would fall upon the taxpayers. In the case of the Grand Trunk Pacific, where 50,000 hands will soon be required, the adoption of this principle would mean either that a great national undertaking must be seriously delayed, or that an extra outlay of about \$30,000 a day must be made for labor alone. Higher prices would also have to be paid to sub-contractors for materials, so that in the aggregate, considering the wide range of the Government's activities, the cost to the people of Canada might easily run into many millions.

So far as the farmer is personally concerned, he has nothing to gain, but much to lose. By reason of the fact that the manufacturer's cost of production would be increased, he would be called upon to pay higher prices for most kinds of manufactured goods. He would be absolutely debarred from sharing in Government business if he or his hired help worked more than eight hours a day. Masons, carpenters and plasterers, already difficult to procure for odd jobs about the farm, would be scarcer, and work requiring the services of these men would be subject to even longer delays than at present.

More serious than any of these, however, would be the increased difficulty in securing and retaining an adequate supply of hired help. Despite the efforts of Government Immigration Agents, agricultural labor is still remarkably scarce throughout Canada, so much so that, in the older portions of the country at least, many farms are being turned into pasture simply because it is found impossible to get men to work them. The shorter working day in cities has been largely responsible for the depopulation of the farm. Under an eight-hour day the tendency would be for a still larger number of hired men to gravitate to the big industrial establishments, while those that remained on the farm might be expected to develop traits of carelessness and independence from the mere knowledge that other occupations were open to them at which they would not be required to work such long hours.

This question of an eight-hour day is being forced upon the people of Canada by an organization of workmen representing, it is estimated, only 8 per cent. of the workmen of the country, exclusive of agricultural labor. Furthermore, it is being pressed to an issue at a time when the cry for more help from all classes of industry is loud and insistent. Is this reasonable? Is it just? Are you, as farmers, going to allow your interests to be sacrificed to appease the absurd demands of agitators who represent a comparatively small section of workmen? Manufacturers, employers and contractors are opposing this measure from their respective points of view. Is it not a matter of even greater importance to farmers? If the objections outlined above appeal to you as reasonable, will you not kindly lay your views at once before your representative in Ottawa, or take such other steps as you think would be helpful in opposing this legislation?

A. S. ROGERS, Chairman Parliamentary Committee.
G. M. MURRAY, Secretary.

On January 31st, 1907, there were reported in stock at the Port of Liverpool, England, 77,774 boxes of cheese, compared with 90,611 on December 31st, 1906, and 84,938 on January 31st, 1906.

Dominion Grange.

At the annual convention of the Dominion Grange, in Toronto last week, the Ontario Education Act relating to teachers' salaries, etc., was condemned as arbitrary and coercive. The Dominion Government was commended for refusing an all-round tariff increase, but the tariff was not satisfactory, for such reasons as the following:

A tax of 35 or 50 per cent. on vehicles used on the farm can only be classed as an outrage, while a tariff of 30 per cent. on woollen goods sent us from the mother land is at once an unjust burden on the Canadian who wears woollens, and a slap on the face to the country which provides the chief market for the surplus products of our farms. The new duty imposed on fence wire, while a small thing as compared with other items in the tariff, is decidedly objectionable, in that it adds to the burdens, already too heavy, by increasing the cost of fencing wire to the extent of eight cents per rod. We denounce the whole system of alleged protection on agricultural products. In the main, so-called protection against foreign farm products in the Canadian market does not, and cannot, add one cent to the price of similar products sold in Canada, and the sole object in imposing it is to hoodwink the farmers into accepting a system under which they are hit on that most sensitive nerve, the pocketbook, by a tariff on their clothing, implements and vehicles. In a few cases—such as early fruits and vegetables—where agricultural production can be protected, the system is wrong, in that it adds to the cost of articles of vital necessity to good living.

A strong protest was entered against the bounty system, and it is said that in five years the bounties on steel and iron amounted to eighty cents on every dollar paid in wages in the industry. The report says: "We denounce this whole bounty system, and hope the Dominion Government, which has, when the pressure applied is remembered, done so well in the matter of the tariff, will do still better by wholly withdrawing its present bounty resolutions, and allowing the iron tubs, as well as all other tubs, to stand on their own bottoms."

A protest was made against the proposal to fix all labor on public works at eight hours per day.

The following officers were elected: J. G. Lethbridge, Strathburn, Master; R. A. Sutherland, Stroud, Overseer; W. F. W. Fisher, Burlington, Secretary; Jas. Fallis, Belmore, Treasurer; W. L. Smith, Lecturer; W. Goodfellow, Craigvale, Chaplain; Crawford Allan, Strathburn, Gatekeeper; Albert Carruthers, Whitby, and Alex. Martin, Stewards. The lady officers are: Miss Cowan, Vine, Ceres; Miss Rowe, Whitby, Pomona; Miss Phelps, Whitby, Flora, and Mrs. L. Morecombe, Whitby, Assistant Steward.

Next year's meeting will be held in Toronto.

The Shire Breeders' Annual Meeting.

The annual meeting of the Canadian Shire Horse-breeders' Association was held in the King Edward Hotel, Toronto, February 22nd, President J. M. Gardhouse occupying the chair. The report of the Secretary-Treasurer commented on the fact that while there has been no boom in the breed, importations of stallions and mares have gone steadily on; importations of mares having been repeated by several men. The best price realized for stallions in the Old Country during the past twelve months was 340 guineas; the highest figure for mares was 400 guineas, and for two-year-old fillies, 450 guineas. In Toronto a lot of horses sent out by Messrs. Chambers & Son, and sold at the Repository, averaged \$327.62.

The audited financial statement showed receipts of \$74 in membership fees, the members numbering 37, against \$84 last year. Registration fees amounted to \$86, and the total receipts, plus balance from last year, equalled \$272.80. The expenditures left a balance of \$183.15, as against a balance of \$109.68 at the beginning of the year.

Applications for grants toward prize-lists were received from Winnipeg and Brandon, but it was decided the funds did not warrant any grants to the Western fairs this year. A letter was also read from Dr. A. G. Hopkins, of Winnipeg, urging the holding of the annual meeting at or about the time of the Winter Fair at Guelph.

Reference was made to the death of the former Secretary, the late Mr. Henry Wade, and a committee appointed to draft a letter of condolence to his widow.

The meeting ratified the by-laws which had been drawn up by the directors, to provide for affiliation with the Ontario Horse-breeders' Association, on the same terms as the Clydesdale and Hackney Societies.

The election of officers resulted as follows: President, J. M. Gardhouse, Weston; First Vice-President, Wm. Laking, Haliburton; Second Vice-President, Dr. A. G. Hopkins, Winnipeg. Vice-Presidents for the Provinces: Ontario, W. E. Wellington, Fonthill; Quebec, Wm. Hodgins, Portage du Fort; New Brunswick, T. A. Peters, Fredericton; Nova Scotia, Prof. M. Cumming, Truro; Prince Edward Island, Hon. F. L. Hazzard, Charlottetown; Manitoba, Geo. Greig, Winnipeg; Alberta, C. W. Peterson, Calgary; Saskatchewan, R. C. Sanderson, Indian Head; British Columbia, S. R. O'Neil, Mount Vernon. Directors—Jas. Dalgety, London; Jas. Henderson, Belton; John Gardhouse, Highfield; William Wilkie, Toronto; A. H. Eckford, High River, Alberta; John Breckon, Appley, Ont., and Major Hendrie, Hamilton, Ont. Delegates to Fair Boards—Canadian National, J. M. Gardhouse; Western Fair, Jas. Dalgety and Jas. Henderson; Cen-

tral Canada, Frank Wade and Wm. Laking. Delegates to the Horsemen's Association, W. E. Wellington and J. M. Gardhouse; Record Board, John Gardhouse and Jas. Henderson. The appointment of a Secretary-Treasurer was left to the directors.

Hackney Men Meet at Toronto.

The annual meeting of the Canadian Hackney Horse Society was held in the King Edward Hotel, Toronto, February 20th. President E. C. H. Tisdale commented upon the encouraging number in attendance, contrasting it with the old days, when scarcely enough could be assembled to form a quorum. The report of the Secretary, Mr. Geo. de W. Green, noted the increasing demand for Hackneys, and urged that there is a great field for the breed in Eastern Ontario, where the light road horse now has it almost to himself. Some Old Country Hackney sales of 1906 were cited. Mr. Morton's horses averaged well, with prices as high as 140 guineas. Fifty-four head of Sir Gilbert Greenall's averaged 58 guineas. The best prices realized during the season were 175 guineas for stallions, 650 for mares, and 200 for two-year-old fillies, while geldings sold as high as 395 guineas.

A gratifying financial statement was presented, in which a balance carried forward of \$109.57; fees of 40 members, \$40; registrations, \$237.50, and inspection fees, \$45, went to foot up a total of \$516.17. The disbursements included \$200 to fairs, and left a balance of \$213.27 on hand. Since the statement was made up an additional \$120 in registration fees has been received at Ottawa, \$90 being from one firm—Rawlinson Bros., of Calgary, Alta.

Some correspondence was read, making application for grants to several fairs not hitherto favored, among them East Elgin, Ont. By motion the matter of exhibition grants was referred to the board of incoming directors. The Secretary also read a letter from Dr. A. G. Hopkins, of Winnipeg, suggesting that the meeting of the society be held next year in Winnipeg, or else at the time of the Winter Fair at Guelph, as a larger attendance of Western men would thus be rendered probable.

A communication from the Ontario Department of Agriculture was read, reminding the Association of the incorporation of the Ontario Horse-breeders' Association, and suggesting affiliation. A by-law to this effect was accordingly authorized, and the Secretary instructed to transmit to the Secretary of the Horse-breeders' Association a list of the Hackney Society's members' names, together with the fees, at the rate of \$15 for each 50 members or fraction thereof. To be eligible for membership in the above organization a man must be a member of a breed association or society, and have recorded at least one registration in the previous year.

The election of officers resulted in the return by acclamation of the President and all the Vice-Presidents, except that the name of W. W. Black, of Amherst, was substituted for that of his father, the late Hon. T. R. Black, and a Vice-President was elected for Saskatchewan, a Province hitherto unrepresented. Officers for 1907 accordingly stand: President, E. C. H. Tisdale, Beaverton; First Vice-President, O. Sorby, Guelph; Second Vice-President, W. C. Renfrew, Bedford Park. Vice-Presidents by Provinces—Ontario, R. W. Davies, Toronto; Quebec, Robt. Ness, Howick; Nova Scotia, W. W. Black, Amherst; New Brunswick, H. C. Jewett, Fredericton; Prince Edward Island, C. C. Gardner, Charlottetown; Manitoba, J. A. S. MacMillan, Brandon; Alberta, A. M. Rawlinson, Calgary; British Columbia, Dr. Tolmie, Victoria; Saskatchewan, Jas. Mutch, Lumsden. Directors—Thos. Graham, Claremont, Ont.; Dr. A. B. Campbell, V.S., Berlin, Ont.; Geo. Raikes, Barrie, Ont.; H. M. Robinson, Toronto; Geo. Pepper, Toronto; Senator R. Beith, of Bowmanville, Ont. Representatives to Fair Boards—E. C. H. Tisdale, to the Canadian National; O. Sorby and Capt. Robson, to the Western Fair, London; R. Beith and W. C. Renfrew, to the Central Canada, Ottawa; Robt. Ness and T. H. Hassard, to the Dominion Exhibition at Sherbrooke; F. E. Came and Robt. Ness, to the Montreal Horse Show; J. A. Turner, of Calgary, and Wm. Graham, of Claremont, to Winnipeg; President Tisdale and A. T. Campbell, to St. Thomas; and John Boag and Wm. Stark to Markham and Uxbridge fairs. Geo. Pepper and Robt. Beith were re-elected as representatives of the society on the National Record Board, and Messrs. T. A. Graham and E. C. H. Tisdale representatives to the Canadian Horsemen's Association.

To Establish a Canadian Pony Record.

At the sixth annual meeting of the Canadian Pony Society, held at the King Edward Hotel, Toronto, February 19th, there was a large and enthusiastic attendance. Two important matters were discussed. One was the holding of a pony show at some time during the year. Already some \$600 value in prizes had been guaranteed. The committee instructed to proceed with the arrangements consists of Dr. J. O. Greig, W. W. Davies, H. M. Robinson, Jesse Applegath, W. H. Knowlton, E. T. Campbell, T. B. Foster, G. H. Goodfellow and Thos. Graham.

The other important matter was the formation of a Canadian Pony Record. At present there is no Canadian book for pony registration. It was decided to apply to the Dominion Government for incorpora-

tion as a record society, also to apply to the Ontario Government for incorporation that would make the society eligible for affiliation with the Ontario Horse-breeders' Association. In the National Record scheme the Pony Society will occupy a position analogous to the Dominion Sheep-breeders' and the Dominion Swine-breeders' Associations. These associations have a flockbook and a herdbook in which there is a section for each of the various breeds. The Pony Studbook will likewise have sections for all the recognized breeds of ponies. It was further decided that, whereas the cross of the Hackney pony stallion on the Welsh mares produces the ideal children's pony, in point of temperament, conformation, action and style, there should be some provision for recording such ponies which are the product of several Hackney crosses. It was decided that two straight Hackney crosses should entitle a filly to full registration, while three crosses are insisted on for a stallion. The progeny of a first cross may be entered in the book, but not as a full-registered filly or stallion. To distinguish between these short-cross entrants and animals entitled to rank as full-registered distinctive certificates will be used. It was decided that the standard of registration for ponies should be 14.1 hands.

Officers for 1907 are: Hon. President, G. V. Foster; President, W. J. Stark; First Vice-President, W. R. Mead; Second Vice-President, R. W. Davies; Secretary, H. J. P. Good, Toronto; Treasurer, Arthur Taylor. Directors—George H. Gooderham; Thomas A. Graham, Claremont; H. M. Robinson; E. C. H. Tisdale, Beaverton; William Smith; Jesse Applegath; George Pepper; O. B. Sheppard; C. E. Stone; E. F. Smith. Honorary Directors—W. H. Knowlton, Robert Miller, Hon. Robert Beith, Major A. B. Lee, and Rev. Mr. Baker, Woodstock.

The Clydesdale Association Prosperous.

Packed to the doors was the room in the King Edward Hotel where the Canadian Clydesdale Association held its annual meeting February 21st. President T. A. Graham congratulated the members on having had a prosperous year. They have not been put out of business by steam cars, electric trolleys or motor vehicles, and the Clydesdale trade was never so brisk before.

The Directors' report submitted the following comparative statement of registrations, transfers and membership fees:

	Pedigrees registered.	Transfers.	Membership fees.
1904.....	1,101	792	\$ 854
1905.....	1,066	657	1,142
1906.....	1,556	520	1,446

The financial report showed that the balance carried forward from last year was \$1,716.26, which, with receipts in 1907, made a total of \$6,208.55 on that side the ledger. The disbursements included \$725 grants to exhibitions, and \$429.11 salaries at Ottawa, and footed up a total which left a balance of \$4,495.35 to the good. From this, however, was still to be deducted \$423.53, owing to the Record Committee, and over \$1,100 for cost of printing a volume of the Studbook, which, according to the Secretary's estimate, would leave a net betterment of about \$1,500 in the finances over last year. Some further particulars regarding registrations will be found in the report of the Record Committee to the Record Associations, a synopsis of which was published in our issue of February 14th.

Referring briefly to the death of the Association's former Secretary, the late Mr. Henry Wade, a resolution of regret was passed, and a committee, consisting of Messrs. Wm. Smith, Arthur Johnston and Robt. Miller, appointed to draft a memorial to be engrossed and illumined, and presented to Mrs. Wade.

A letter was read from the Ontario Department of Agriculture, calling attention to the change in the Agriculture and Arts Act, reminding the Association of the organization of an Ontario Horse-breeders' Association, and suggesting affiliation according to the terms in the constitution of that body. These, in brief, are that any pure-bred record society may affiliate and make all its members who have registered one pedigree in the previous year members of the Horse-breeders' Association, by paying to the latter \$15 for every 50 such members, or fraction thereof. That is to say, that if a man joins the Canadian Clydesdale Association and registers one pedigree a year, the Clydesdale Association makes him a member of the Ontario Horse-breeders' Association, ex-officio. The membership fee of the Clydesdale Association is \$2.00. At a directors' meeting a by-law providing for affiliation had been drafted. It was submitted to the general meeting and passed.

In discussing the matter of grants to Western shows, it was resolved that the Western horsemen be asked to organize Provincial Horse-breeders' Associations, and there decide what they desired to do with money available for distributing among Western shows.

Robert Miller read the resolution re importation of stock passed at the recent meeting of the Dominion Cattle-breeders' Association (printed in our issue of February 14th), and asked that it be passed unanimously.—Carried.

A resolution which had been previously debated by the directors was brought forward by John Bright. It provided in substance that the Canadian Clydesdale Association go back to its old plan, in force until 20

years ago, of accepting in the Canadian book pedigrees of imported horses without making it necessary to record any of their ancestors in the Canadian book. This would save the importer a lot of expense, but would proportionately reduce the revenue of the Association. It would also materially reduce the amount of information in the Canadian Studbook, as all that our book would contain about an imported horse would be the pedigree copied from the Scottish book. If one wished to look up the breeding of his sire or grand-sire, it would be necessary to refer to the Scotch Studbook.

Several members objected to any lowering of the value of the Canadian book, and held that frequent

changes in rules were inadvisable. Wm. Smith, of Columbus, thought there might be some call for the change, but urged that action be deferred until next year. As the hour was late, Mr. Bright withdrew his motion.

The election of officers resulted as follows: President, T. A. Graham, Claremont, Ont.; Vice-President, John Bright, Myrtle, Ont. Vice-Presidents by Provinces—Ontario, Peter Christie, M.P., Manchester; Manitoba, John Graham, Carberry; Alberta, John A. Turner, Calgary; Saskatchewan, Alex. Mutch, Lumsden; Quebec, Robt. Ness, Howick; British Columbia, H. M. Vasey, Ladner; Maritime Provinces, W. W. Black, Amherst, N.S. From a long list of nominees for direct-

ors the following were selected by ballot: Robt. Graham, Bedford Park; E. C. H. Tisdale, Beaverton; Jas. Torrance, Markham; A. G. Gornley, Unionville; Wm. Smith, Columbus; Jas. Henderson, Belton; John Boag, Ravenshoe. The appointment of representatives to fair boards was left in the hands of the incoming directors. The meeting confirmed the recent action of the directors in the appointment of a Secretary. The new officer is J. W. Sangster, a Huron County boy, of considerable newspaper experience, who for the past four years has been associated with agricultural journalism in Toronto, which is his present address.

The Ontario Horse - breeders' Exhibition.

The first Ontario Horse-breeders' Exhibition, held in the St. Lawrence Market Building, corner Jarvis and King Sts., Toronto, February 20th to 23rd, was a gratifying success in every way. There were splendid classes of both light and heavy breeds, classes that would compare favorably with those at the Canadian National in the fall. The gate receipts amounted to over \$700, which means that over 2,800 farmers and horsemen paid the 25-cent admission fee to a show which offered no entertainment features, except the judging of stallions and fillies on the line, and the presence of a band throughout. As most of our readers are aware, this exhibition takes the place of the Clydesdale and Shire Spring Stallion Show, that used to be held at the Repository. The addition of Hackneys, Standard-breds and Thoroughbreds makes a complete breeders' exhibition, and to that extent lessens the need for the Society Horse Show, regularly held later on in the spring. It is probable the latter will be held also, however, but it will be more strictly a society event than before, as it will doubtless consist now of harness and saddle classes. A pleasing event was a banquet in the King Edward Hotel on the evening of the opening day. It was tendered as a token of goodwill by the Canadian Horsemen's Association (consisting of professional and amateur harness and saddle horse exhibitors) to the Ontario Horse-breeders' Association, organized according to the provisions of the amended Agriculture and Arts Act. Noteworthy among the many excellent speeches was that of Hon. Nelson Monteith, Minister of Agriculture, who said that the value of the output of the horse business in the Province had doubled in the last ten years. He also intimated that when the findings of the horse investigation committee are published and digested there will be a general recognition of the need for some legislation, though just what form it will take he could not yet say. Among the many who endorsed the Minister for his practical efforts to assist the horse-breeding business were Mr. Geo. P. Graham, Leader of the Opposition in the Provincial Legislature, who declared his sympathy with any judicious legislation.

St. Lawrence Market proved an excellent accommodation for the show, being wider than the Armouries and only 10 feet shorter. If the Canadian Horse Show is held again, the Market Building will doubtless be secured, as there has been difficulty about arranging for the Armouries. We regret that space forbids a very full review of the classes, and that we must content ourselves with giving the awards and a few passing comments of a general character.

CLYDESDALES.

"Canada's Pride" was out in full strength of numbers and excellence, most of the leading Ontario breeders and importers being represented. Smith & Richardson, of Columbus; Hamilton & Hawthorne, Simcoe; T. H. Hassard, Millbrook; Thos. Mercer, Markdale; O. Sorby, Guelph; Hodgkinson & Tisdale, Beaverton; Andrew Aitchison, Guelph; G. A. Brodie, Bethesda; John Boag & Son, Ravenshoe; H. G. Boag, Barrie; T. D. Elliott, of Bolton; J. W. Lowes, of Bethany, and Ambrose Lewis, Ringwood, made up a rattling good competition. Judging was done by Jas. Torrance, of Markham, and Jas. Henderson, of Belton. In the aged stallion class the contest for first place lay between Sorby's Acme and Smith & Richardson's Prince of Mayfield, a horse bred by P. McFarlane, of Stirling, Scotland, got by Royal Stamp, and rising six years old. Choice was divided, and the placing would have been fair either way. Both are medium-sized but powerful, strongly-built horses, with great bone, of the clean flat quality. There were those who preferred the set of the latter horse's hocks, and liked his muscling inside the gaskin, but Acme has, perhaps, an advantage in his breadth over the rump, and got the decision. Third went to Hamilton & Hawthorne's imported black Castle King. With scale enough for a Shire, he combines ample quality and approved draft points throughout. Mr. Hamilton informs us he has been sold to Geo. Clayton, of Grand Valley. He should leave a good account of himself wherever travelled. Awards: 1, Sorby, on Acme (imp.), by Baron's Pride; 2, Smith & Richardson, on Prince of Mayfield (imp.), by Royal Stamp; 3, Hamilton & Hawthorne, on Castle King (imp.), by Sir Everest; 4, H. G. Boag, on Lyon Stewart (Canadian bred), by Lassodie Rover; 5, T. H. Hassard, on Culdrain Prince (imp.), by Prince Thomas; 6, Ambrose Lewis, on Adam Bede (imp.), by Baron's Pride; 7, O. Sorby, on Prince Victor (imp.), by Royal Favorite; 8, T. D. Elliott, on Gallant Barrie (imp.), by Prince Thomas; 9, J. W. Lowes, on King Alfred (imp.), by Prince Alexander.

Section 2, viz., Clydesdale stallions foaled in 1903, brought out the champion, in Baron Richardson, the massive bay horse imported and exhibited by Smith & Richardson. There are plenty of bigger Clydes, but few that are put up on better lines. In body and limbs he fills the eye beautifully, and is a great mover. The second place went to Hassard's Vigorous, an impressive big stallion, with a magnificent forehead, but underpinning that would look better with a bit more breadth of bone. Third position was granted to the Columbus horse, Whinbloom, by Baron o' Buchlyvie. There were many who would have reserved it for Hassard's Dunure Baron, by the same sire, while many more would have fain kept a higher rank for the fifth-prize, Baron Hugo, imported and exhibited by G. A. Brodie, of Bethesda. He is not overly large, but excels in other respects, particularly his way of going. Awards: 1, Smith & Richardson, on Baron Richardson (imp.), by Baron o' Buchlyvie; 2, T. H. Hassard, on Vigorous (imp.), by Up-to-Time; 3, Smith & Richardson, on Whinbloom (imp.), by Prince Thomas; 4, T. H. Hassard, on Dunure Baron (imp.), by Baron o' Buchlyvie; 5, G. A. Brodie, on Baron Hugo (imp.), by Sir Hugo; 6, H. G. Boag, on The Nobleman (imp.), by Hiawatha.

Royal Ardlethen headed a magnificent string of young stallions, foaled in 1904. He is the dark-brown horse, bred by Thos. Winter, Crosbie, Eng., and imported and exhibited by Thos. Mercer. He is big,

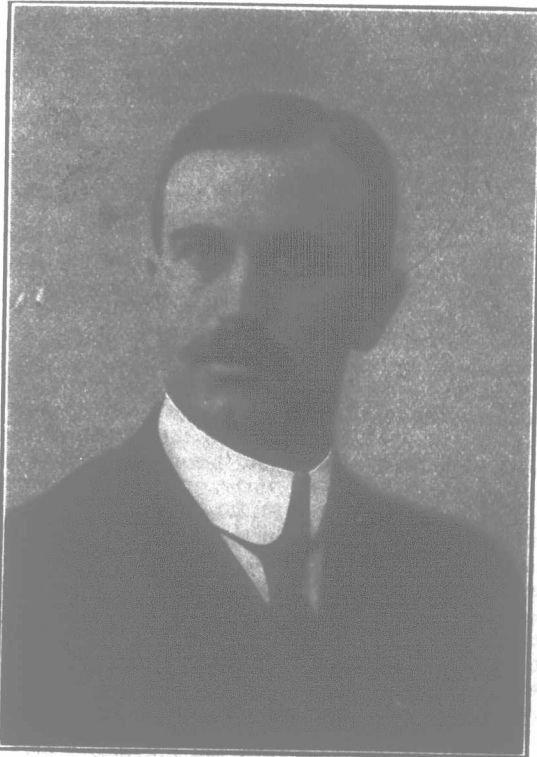

A. P. Westervelt.

Director Live-stock Branch Ontario Dept. of Agriculture

weighty, well muscled and possessed of plenty of good bone, with large feet and the best of pasterns. He was later brought out for championship, but was faulted by the judges on the score of action. There is nothing bad about it, however, and size was a strong point in his favor. The second prize, Baron Buchanan, is a clean-limbed quality sort; while third was a stout son of Old Acme. Fourth went to John Boag & Son, on Lord Newlands, by Good as Gold. He is a well-knit, tippy kind, with his back taut and strong. The prize-list must tell the rest, though there were several good animals left out of it: 1, Thos. Mercer, on Royal Ardlethen (imp.), by Ardletien; 2, Smith & Richardson, on Baron Buchanan (imp.), by Baron Robgill; 3, O. Sorby, on Baron Acme (imp.), by Acme; 4, John A. Boag & Son, on Lord Newlands (imp.), by Good as Gold; 5, Smith & Richardson, on Sir Henry (imp.), by Prince Thomas; 6, Andrew Aitchison, on Gallant James (imp.), by Baron o' Buchlyvie; 7, Thos. Mercer, on Ardlamont (imp.), by The Real Mackay; 8, T. H. Hassard, on Prospector (imp.), by Lord Londonderry; 9, O. Sorby, on Blacon Hero (imp.), by Pride of Blacon.

The three stallions foaled in 1905 were placed thus: 1, Smith & Richardson, on Baron Columbus (imp.), by Baron o' Buchlyvie; 2, T. H. Hassard, on First Baron

(imp.), by Hiawatha; 3, Smith & Richardson, on Passport (imp.), by Marmion.

Of mares foaled previous to 1904 there were only a couple, Meg (imp.), a breezy young Elator mare, shown by Hassard, for first, and Ardyne Bell (imp.), by the same sire, imported and exhibited by Andrew Aitchison.

In the next class, mares foaled in 1904, the judges got down again to real work. Thirteen were forward. Hodgkinson & Tisdale took first and second, on Fife-shire Lass, a big roomy filly, and Silver Queen. Fife-shire Lass was later chosen for female championship. Full awards are: 1, Hodgkinson & Tisdale, on Fife-shire Lass (imp.), by Time Enough; 2, Hodgkinson & Tisdale, on Silver Queen (imp.), by Royal Favorite; 3, T. H. Hassard, on Fashion's Gem (imp.), by Baron's Fashion; 4, John A. Boag & Son, on Miss Pattinson (imp.), by Lord Londonderry; 5, John A. Boag & Son, on Lady Dick (imp.), by Marmion; 6, Walter Leonard, Craigville, Ont., on Lady Barclay (imp.), by Sir Simon.

Fillies of 1905 were out to the number of five, and proved an interesting bunch to place. Queen's Maid is a sweet filly, with all sorts of quality, and a capital mover. Heather Bell is a larger filly, and the makings of an excellent mare, though her hocks are not set just exactly to one's liking, and she might stand more firm on her knees. Awards: 1, Hodgkinson & Tisdale, on Queen's Maid (imp.), by Royal Favorite; 2, Andrew Aitchison, on Heather Bell (imp.), by Ascot; 3, Thos. Mercer, on Fanny of Greenfield (imp.), by Royal Citizen; 4, Jno. A. Boag & Son, on Darlie of Culton (imp.), by Garty Brand; 5, Thos. Mercer, on Longburgh Lass (imp.), by Picador.

CANADIAN-BRED CLYDESDALES AND SHIRES.

Out of eleven entries in the class for Canadian-bred Clydesdale and Shire stallions, foaled previous to 1905, all, so far as we observed, belonged to the Scotch breed. First went to Smith & Richardson, on Prince of Gladden, a white-stocking bay, bred by John Lawrie, of Malvern, Ont. He is a well-grown horse, of considerable quality, rather rangy as yet, but giving promise of growing into a right good one. As they stood, however, Bold Archer might well have gone first, followed by Royal Prince, which had to be content with third. These latter two are a smooth, blocky, well-knit pair. Awards are: 1, Smith & Richardson, Columbus, Ont., on Prince of Gladden, by Hopewell; 2, Smith & Richardson, on Bold Archer, by The Archer; 3, Hodgkinson & Tisdale, on Royal Prince, by The Royal Standard; 4, Jos. E. Teeson, of Thornhill, on Golden Conqueror, by Cloth of Gold; 5, A. E. Frisby, O'Sullivan's Corners, on Sir William Walter, by Balmanno; 6, Smith & Richardson, on Lavender's Best, by Lavender; 7, W. J. Howard & Sons, Amber, Ont., on Balmanno Pride Prince, by Balmanno.

In foals of 1905, the red ribbon decked a rather thick, pleasing colt, called Scottish Commander, bred and exhibited by Geo. Clayton, Peepabun, Ont., sire Scottish Celt; 2, O. Sorby, on Baron Charming, by Elator; 3, R. B. Cowie, Derryville, Ont., on Nelson Foremost, by Foremost; 4, David Pilkey, of Balsam, Ont., on Earl Macqueen, by Macqueen.

A couple of nice fillies foaled in 1904 were shown by Smith & Richardson. First was Lady Lavender, by Lavender; second, Miss Lavender, sire Lavender. The same firm exhibited the only two 1905 fillies, receiving first on Blair Gowrie Lass, by Michaboe, and second on Mysie, by Prince of Scotlandwell.

SHIRES.

The show of Shires was not large, but fairly good. We missed, however, the entries of J. M. Gardhouse, of Weston, whose sale left him in no position to exhibit. Half a dozen aged stallions were forward, and first prize went to Berrywood Drayman, a big bay, purchased, we believe, at the Chambers sale in Toronto by his exhibitor, Thos. Skinner, of Mitchell. The line-up found them: 1, Thos. Skinner, on Berrywood Drayman (imp.), by Iceland; 2, Hamilton & Hawthorne, on Ranging Duke (imp.), by Ridware Ranger; 3, J. B. Hogate, Weston, on Grimsargh Admiral (imp.), by Gunthorpe Advance; 4, Joseph Jacobs, Peterborough, on Merrie Andrew (imp.), by Harold; 5, Joseph Jacobs, on General Buller (imp.), by Ruddington Lord Chancellor; 6, Joseph Jacobs, on Scarcliffe Pilot (imp.), by Saxon Pilot.

Stallions foaled in 1904 turned out the champion of last fall's Canadian National, Birdsall King (imp.), also champion of this show. He is a fine, big, massive stallion, with plenty of flat bone, nice pasterns of approved length and obliquity, first-class feet, and a true free way of going. He was bred by Geo. Hill, of Birdsall, Eng., got by Birdsall Caliph, imported and

exhibited by Hamilton & Hawthorne, though sold now to J. Moore and Jos. Belton, of Grey Co., Ont.; second came John Gardhouse & Sons, of Highfield, on Admiral Togo, by Mars; third, Thos. Irving, of Winchester, Ont., on Whitewall Prince (imp.), by King 3rd.

T. D. Elliott, of Bolton, had a solitary entry with his foal, Sir Ralph Wellington, a Morris & Wellington colt, by Mars.

The only Shire female was a rather good imported ally, rising three years old, bred by Jno. Chambers & Sons, Holdenby, Eng., and exhibited by J. Gardhouse & Sons.

HACKNEYS.

Ontario's interest in Hackneys shows no diminution. Year after year, we come to the exhibitions to find something sensational. Enthusiasm runs high when the judging is going on, for there is no finer sight than a nicely-modelled Hackney stallion performing on the line. There were a lot of good ones in the aged class, over 15.2. First of all was Baltimore, later chosen for reserve champion, who made his first address in the Canadian ring. He is a chestnut, by Rosador, and was imported and shown by Graham Bros. Of excellent conformation, he possesses an extra amount of substance, and has a free, true and pretty level action. Next to him came Colorito, and then Scotch Hazel. Down to fourth they set Hogate's Samuel Smiles, because, while walking, he weaved a bit with his hocks. The judges were: Wm. H. Gibson, Beaconsfield, Que., and Capt. T. E. Robson, London, Ont. Awards follow: 1 and 2, Graham Bros., Claremont, on Baltimore (imp.), by Rosador, and Colorito (imp.), by the same sire; 3, O. Sorby, Guelph, on Scotch Hazel (imp.), by Dairyman John; 4, J. B. Hogate, Weston, on Samuel Smiles (imp.), by Blanch Squire; 5, Graham Bros., on Linden Renown (imp.), by Danegelt's Son; 6, T. H. Hassard, Millbrook, on British Yeoman (imp.), by Pilot 2nd; 7, T. H. Hassard, on Gay Falconer (imp.), by Unique. The male champion, Dalton King, came forward in the section for stallions under 15.2. Dalton King is a smooth, well-built horse, with a clean set of limbs, and grand level action. The placing was: 1, Graham Bros., on Dalton King (imp.), by Garton Duke of Connaught; 2, W. H. Nichols, Hamilton, on Moorale Duke (imp.), by Garton Duke of Connaught; 3, Graham Bros., on Terrington Activity (imp.), by Lord Drewton 2nd; 4, Hamilton & Hawthorne, Simcoe, on Forest Fashion (imp.), sire Copy Ganey; 5, T. H. Hassard, Millbrook, on Tregarthon (imp.), by Garton Duke of Connaught; 6, Jno. A. Boag & Son, Ravenshoe, on Blanch Surprise (imp.), by Rosador; 7, J. Gordon McPherson, V. S., Toronto, of Sharplov (imp.), by Sir Horace.

To the call, stallions rising three years old, four responded, headed by Crayke Mikado, champion last fall at the Canadian National. His action is something extraordinary, and it was rather a surprise that when shown later on against his stable mates, Dalton King and Baltimore, he failed to land either championship or reserve. In his class, however, he was an easy first. Up next to him they moved King's Chocolate, a pretty good mover, howbeit inclined to travel just a bit wide behind. A close rival for the blue colors was Terrington Cleophas, but the judges thought the other horse had enough more quality to entitle him to the place. 1, Graham Bros., on Crayke Mikado (imp.), by Garton Duke of Connaught; 2, Hamilton & Hawthorne, on King's Chocolate (imp.), by Chocolate Jr.; 3, Graham Bros., on Terrington Cleophas (imp.), by Clifton 3rd; 4, T. H. Hassard, on Cedar Conquest (imp.), by Conquest 2nd.

STANDARD-BREDS.

Owing to the temporary absence of Manager Wetherill, the splendid stables of Miss K. L. Wilks, of Galt, were unrepresented, consequently the show in this breed was slim. The judging was done by Robt. Graham, Bedford Park, and O. B. Sheppard, Toronto. In the aged class, Standard-bred stallions, trotters or pacers, the red was easily won by Crow & Murray's bay horse, Arley A, by Westbrook, leaving second position for Fritz Bingen, by Bingen, exhibited by Hugh Scott, Toronto.

There was a nice nut to crack in the next class, Standard-bred trotting stallions, of type and build to produce carriage horses. Rex Edward is a big bay, with lots of scale, clean, hard bone, well-balanced parts, any amount of style, and a superior show of action. His weakest point is, perhaps, a shade of slackness over the loin. Arley A is a smaller horse, but a flash goer. Both horses had ring-side champions, but no mistake was made in awarding the money to the former horse. 1, S. J. Patterson, of Warkworth, on Rex Edward, by Red Shawmut; 2, Crow & Murray, Toronto, on Arley A; 3, Patterson Bros., Coleman, on The Roman, by Budd H.

THOROUGHBREDS.

This breed was judged by Major Hendrie, of Hamilton, and S. B. Fuller, of Woodstock, who placed them as follows: Aged stallions, 1, Crow & Murray, on Cricklade, by Ladas; 2, Dr. Andrew Smith, Toronto, on Kapaŋga Horse, by Spendthrift. Stallions to produce saddle and hunting horses: 1, Thos. G. Patterson, Coleman, on Halfing (imp.), by Macheath; 2, Allen Kemp, Oakville, on Ben Carrick, by Ben Strome; 3, Cheyne & Armstrong, Derry West, on Gold Car, by Goldfinch; 4, Wm. McKay, Doncaster, on Procession, by Order. Kelvin, exhibited by T. Ambrose Woods, of Toronto, was the only entry in the 1904 class.

A few classes of ponies and of heavy-draft geldings in harness completed the show. The first-prize single gelding was Bobby Burns, exhibited by the Dominion

Transport Co.; second was Sport, and the two made up the winning team. The second team was a pair of closely-coupled, thick-set geldings, shown by Smith & Richardson; while third were a somewhat rangier pair, Prince Arthur and Charlie, owned by the Dominion Transport Co. The fourth pair belonged to Jos. Russell, of Toronto.

Ontario Fairs Association.

The annual meeting of the Ontario Fairs and Exhibitions Association, held last week in Toronto, chose the following officers: William Laidlaw, Guelph, President; A. McDonald, Dufferin, First Vice-President; H. A. Gould, Ontario, Second Vice-President; Alex. McFarlane, Ottawa, Secretary; Jos. Hudspeth, Caledonia, and William Collins, Peterborough, Auditors, and George Downey (Peel), D. Evans (Middlesex), Ed. Gough (Parry Sound), George E. Lee (Kent), T. J. Murphy (Norfolk), J. W. Sheppard (Haldimand), and S. J. Wilsdn (Essex), members of the Executive Committee. Mr. J. Lockie Wilson was appointed Corresponding Secretary and Editor.

The retiring President, Mr. J. W. Sheppard, called attention to an omission in the new act governing agricultural societies, that no credit was given in Sec. 19 to societies for expenditures on grounds and buildings. He also thought that rural societies should not be penalized by the restriction of horse-speeding privileges, allowed at Toronto, London and Ottawa shows.

The Secretary reported that many small societies would cease to exist under the new Act, and more societies had their grants increased than decreased.

Mr. J. Lockie Wilson, Superintendent of Agricultural Societies, urged that a seed fair should be held in connection with a stallion and bull show in a number of central points. The farmers of Ontario put from \$7,000,000 to \$8,000,000 worth of seed into the soil every year, so that it was of vital importance to know how to secure the very best return for the outlay.

Hon. Nelson Monteith, Minister of Agriculture, thought too many societies were working for gate receipts rather than bettering the agricultural interests of the locality. He commended the educational campaign, and expressed the view that horse-racing had sometimes been introduced at the expense of agriculture.

A resolution was adopted, asking the Government to amend the clause of the Act relating to horse-racing, and replace it with a clause permitting the individual fair boards to use their own discretion as to whether horse-racing shall or shall not be permitted, subject to restrictions tending to eliminate all objectionable features, such as gambling, pool-selling or betting.

A motion, seeking to amend the present basis of the grant apportionment, was defeated.

Details Called For.

Editor "The Farmer's Advocate":

I notice in your issue of February 7th, \$1,251.01 net profit made from 195-acre farm by "Amateur Farmer," in Wentworth Co., Ont. I do not think January 1st the proper time to take stock of the farm. Is it not better July 1st, before beginning another harvest? In looking over "Amateur Farmer's" figures I find that this \$1,251.01 is not net profit, as there is \$1,241.10 of it in hay, ensilage, roots and feed and grain on January 1st, 1907. This might be all fed to stock, and by July 1st net only \$600. By his figures the readers of your paper cannot learn in what line of farming he raked in the shekels. By his own figures I would think he kept inferior stock, and not very large on a 195-acre farm. His figures for Jan. 1st, 1906, of horses, cattle and pigs amount to \$1,600; for 1907, Jan. 1st, \$1,687, with two horses and three cattle in the lot more than the previous year. "Amateur Farmer's" stock must be on the down grade, as his own figures show a decrease in value from previous year per head. I would think his horses and cattle were of inferior grade, when his horses and colts are only worth \$107 per head, and cattle less than \$25 per head. Good colts under one year are changing hands at \$100, and yearling cattle at \$25 per head in Bruce County. Another item in his figures is \$1,845 for wages, taxes, threshing, etc. (this seems large for general farming); also \$2,702 as cash receipts for year. Now, I would like to see a detailed report of this \$2,702, that we might know something of the line of farming "Amateur" carries on; also estimated value of farm, and how far from city, as all our farms are not situated with the same chances to make money.

Bruce Co.

SUBSCRIBER.

Directors Elect Executive Officers.

At a meeting of the directors of the Dominion Sheep-breeders' Association, held in Toronto February 23rd, John Campbell, of Woodville, Ont., was elected President, and Andrew Whitelaw, of Guelph, Vice-President. The representatives to the National Record Board are R. H. Harding and J. M. Gardhouse. On the same day the directors of the Dominion Cattle-breeders' Association met and elected John Gardhouse, of Highfield, President; W. W. Ballantyne, of Stratford, being chosen as Vice. A. P. Westervelt, Parliament Buildings, Toronto, continues Secretary of both associations.

Programme of Lectures.

Following is the programme of lectures to be delivered at the Eastern Ontario Live-stock and Poultry Show, to be held at Ottawa, March 4th to 8th:

Poultry—Tuesday, March 5th, 8 p.m.—"How much poultry can profitably be kept on a hundred-acre farm," "Precautions necessary to secure large hatches and to have minimum losses in young poultry," "Investigations during 1906."

Swine—Wednesday, March 6th, 2.30 p.m.—"The proper housing of hogs in winter," "Results of practical feed tests relative to the cost of producing bacon hogs," "The advantages to Eastern Ontario farmers of producing a larger number of hogs suitable for the export bacon trade."

Seeds—Wednesday, March 6th, 8 p.m.—"The cultivated barleys (illustrated with specimens and samples)," "Gleanings from field work in Ontario during the past summer," "The import and export of agricultural seeds."

Sheep—Thursday, March 7th, 10 a.m.—"The farmer's flock of sheep, with special reference to the advantages of raising sheep and the possible profits," "The present condition of the sheep industry, and prospects for the future," "Judging mutton sheep (illustrated)."

Beef Cattle—Thursday, March 7th, 2 p.m.—"Methods of raising steers," "Is it possible to build up and maintain a herd of dual-purpose cows?" "Judging beef cattle" (illustrated).

Dairy Cattle—Thursday, March 7th, 8 p.m.—"How to profitably increase the production of the average dairy cow," "Results of practical experience in the keeping of cow records," "Some reasons why the dairy farmers of Eastern Ontario should raise more bacon hogs."

New System of Dairy Instruction.

The year 1907 will mark a new departure in the method of creamery and cheese-factory instruction in Ontario. Hitherto this has been accomplished through the Eastern and Western Dairymen's Associations, with financial support from the Provincial Department of Agriculture. It is now to be taken over and handled directly by the Department. The Province will be divided into districts of 42 or 43 factories each. For each district an instructor will be appointed who will visit all the factories therein, and as many farms as possible. Indeed, effort this year will be concentrated in an attempt to improve conditions at the farms. Hitherto the services of the instructors have been available only to those factories willing to pay for them. The result was that the factories which most needed help refused to employ an instructor. The fee is now to be abolished, and all factories will be visited. It is also intended to make each instructor a sanitary inspector, with authority to enforce his recommendations; provided, however, that before he may take any radical action there may be opportunity for arbitration by a committee, consisting of the local instructor, the chief instructor (Mr. Barr in the West and Mr. Purlow in the East), and the local director of the Dairymen's Association. This is designed as a safeguard against any arbitrary or harsh action by the instructors.

Directors Meeting Ontario Winter Fair.

A directors' meeting of the Ontario Provincial Winter Fair was held in the Secretary's office, Toronto, on Friday, February 22nd. The financial statement presented showed receipts of \$15,470.39, including legislative grants of \$7,230.00, and gate receipts, \$1,952.85. The expenditures, including balance of \$151.07 due the Treasurer from last year, totalled \$15,975.05. The balance now owing to the Treasurer is, therefore, \$504.66.

Some discussion took place upon the suggestion of W. W. Ballantyne, the committee in charge of the Dairy Department, that the scale of points used in making the awards in the milking test be altered. At present 20 points are allowed for every pound of butter-fat produced, and 4 points for every pound of solids not fat. This places a relatively high value on the solids not fat. In some cases a cow gets half as many points for her skim milk as for her butter-fat. For cheesemaking purposes this method of estimating the value of the cow's product might not be so very far out, but for buttermaking it places altogether too high a premium upon the skim milk. Mr. Ballantyne suggested that 25 points should be allowed for each pound of butter-fat and 3 points for each pound of solids not fat. It was decided that the matter be placed in Mr. Ballantyne's hands, to consult with the Presidents of the various Cattle-breeders' Associations interested, and to report to the Executive.

The recommendations of the Poultry Association for prizes were accepted. The appointment of live-stock judges, the revision of the prize-list and the matter of rules were all left in the hands of the Executive. Officers were elected and committees appointed as follows: President, Arthur Johnston; Vice-President, Lieut.-Col. R. McEwen. Executive Committee—Arthur Johnston, Lieut.-Col. R. McEwen, J. Bright, W. W. Ballantyne, Wm. McNeil, Wm. Jones and A. P. Westervelt. Committee on Cattle—John Bright, A. W. Smith, J. T. Gibson, J. M. Tyson and Jas. Bowman. Committee on Sheep—John Jackson, Jas. Tolton, A. W. Smith, Jas. Millar, Lieut.-Col. R. McEwen. Committee on Swine—Wm. Jones, Prof. G. E. Day, G. B. Hood, R. H. Harding, John Barber. Dairy Committee—W. W. Ballantyne, Prof. H. H. Dean, John Bright, John McKee. Poultry Committee—Wm. McNeil, A. W. Tyson.

W. R. Graham, R. Oke, L. H. Baldwin, J. H. Saunders. Judging Competition Committee—Prof. G. E. Day, J. T. Gibson, J. E. Brethour, John Jackson, W. W. Ballantyne, Lieut.-Col. R. McEwen, H. S. Arkell. Seed Committee—G. A. Putnam, Prof. C. A. Zavitz, L. H. Newman, John Barber, G. B. Hood.

Dalgety Bros.' Clydesdale Sale.

The auction sale of Dalgety Bros.' late importation of Clydesdale mares and fillies, held at the Fraser House stables, London, Ont., on Tuesday, February 19th, was attended by a large and appreciative gathering of farmers and breeders. The quality of the stock offered was up to the usual high standard of Messrs. Dalgety's selections, combining size, quality and true

action in a high degree. The bidding was brisk and spirited, and the prices fairly satisfactory, the average for all sold being \$398.50, though some very good bargains fell to buyers, whose investments should prove profitable. Following is the sale list:

- Bloom of Ironside, foaled 1904; G. A. Attridge, Clachan \$475
Baron's Beauty, '03; N. Charlton, Brownsville..... 480
Miss Fauntleroy, '04; J. D. O'Neil, London..... 405
Lady Paul, '04; D. K. McRae, Strathburn..... 395
Spink of Roundlaw, '97; O'Neil & Co., London... 400
Rosebud, '04; C. J. Fitzgerald, Ballymote..... 410
Lady Melbourne, '04; Neil McLachlan, Ailsa Craig. 350
Lady Turin, '02; O'Neil & Co. 400
Madge of Easter Mains, '04; Chas. Priestley, Ailsa Craig 375

- Maggie IV. of Boreland, '04; O'Neil & Co. 300
Brisk, '03; O'Neil & Co. 415
Daisy of Boreland, '04; Neil McLachlan 400
Princess of Sands, '01; O'Neil & Co. 400
Love, '03; O'Neil & Co. 380

Please find enclosed \$1.50, for renewal for 1907 from February 15th, wishing you every success with your valuable paper. I have been a constant reader of it nearly ever since it started, and find it improving each year. Your Xmas. number was worth the year's subscription, and the items are up-to-date and interesting. King's Co., N. B. JOHN RAYMOND.

"New Subscriber," Balsam, Ont., who sends an inquiry re ailing mare, omitted to sign his name. Please forward, and question will be answered.

GOSSIP.

Those who failed to secure as many as they wanted of the choice lot of imported Clydesdale mares and fillies which sold so fast at Dalgety Bros.' sale in London, Feb. 19th, will be pleased to learn that they will have another lot to offer in a month or so. A few of those coming are in foal, and Mr. James Dalgety assures us they are a very choice lot all 'round. Watch "The Farmer's Advocate" for announcement of the sale.

The attention of farmers and breeders is directed to the new advertisement in this issue of the dispersion sale of Aberdeen-Angus and Jersey cattle, heavy and light horses and farm chattels, belonging to Mr. John O'Brien, of London West, three miles from the city of London. These herds, though not large in numbers, are select and good representatives of the breeds. The Aberdeen-Angus herd has produced prizewinners at the Western Fair, London, and at district shows, and are a smooth, thrifty, good-doing lot. This breed is holding its own admirably in Great Britain, the United States and the Canadian West, and commends itself for profitable beef production. The Jerseys, in this sale, are bred from prize-winning and heavy-producing stock, as will be seen from the facts set forth in the advertisement. Make a note of the date, and plan to attend the sale.

SALE DATES CLAIMED.

- March 1st.—Provincial sale of pure-bred cattle, Port Perry, Ont.
March 6th.—Arthur Johnston, Greenwood, Ont., Shorthorns.
March 6th.—E. F. Park, Burgessville, Ont., Cotswold sheep.
March 7th.—Thos. Mercer, Markdale, Ont., imported Clydesdale fillies.
March 7th.—J. C. Ross, Jarvis, Ont., Clydesdales, Shorthorns and sheep.
March 7th.—G. J. Jopling & Sons, Bridgenorth, Ont., Shorthorns.
March 8th.—Innes, Schafer & McClary, Woodstock, Ont., imported Clydesdale mares and stallions.
March 8th.—Provincial sale of pure-bred cattle, Ottawa.
March 12th.—Hay Bros., Tara, Ont., Shorthorns.
March 13th.—Jas. A. Crerar, Shakespear, Ont., Shorthorns.
March 12th-14th.—Estate of D. Milloy, Brantford, Ont., Shorthorns, horses, fat cattle, etc.
March 19th.—John O'Brien, London West, Ont., Aberdeen-Angus and Jersey cattle, and farm stock.
March 29th.—H. E. George, Crampton, registered Holsteins, at Napanee, Ont.

LAST CALL FOR ARTHUR JOHNSTON'S SALE.

Wednesday, March 6th, let it be remembered is the date of the dispersion sale of the noted Greenwood herd of Short-horn cattle, at the farm, near Claremont, C. P. R., and Pickering, G. T. R., when the entire herd of 65 head will be sold without reserve. The result of forty years of selection and breeding by a discriminating judge and judicious feeder will, in this offering, be available to young farmers desiring to lay the foundation of a herd, or to owners of established herds to add choice members of the best Scottish families or scions of some of the best milking strains at the buyer's own price. This sale should attract breeders and farmers from far and near, as it is rarely that such a noted herd is brought under the hammer. Every breeder in the country is interested directly or indirectly in the outcome of this dispersion, and owes it to himself and the interests of the breed to patronize the sale by his presence, if possible, and by his practical

support in some measure. Mr. Johnston has been a liberal supporter of his brother breeders in their public offerings for many years, and well deserves the support of a fellow feeling at the present juncture. Let there be a bumper attendance at Greenwood on March 6th. The place is easy of access from east or west, being only about 25 miles east of Toronto, by either G. T. R. or C. P. R., where conveyances will meet the trains.

QUESTIONS AND ANSWERS.

- 1st.—Questions asked by bona-fide subscribers to the "Farmer's Advocate" are answered in this department free.
2nd.—Questions should be clearly stated and plainly written, on one side of the paper only, and must be accompanied by the full name and address of the writer.
3rd.—In veterinary questions, the symptoms especially must be fully and clearly stated, otherwise satisfactory replies cannot be given.
4th.—When a reply by mail is required to urgent veterinary or legal enquiries, \$1 must be enclosed.

Miscellaneous.

TO SUBDU SOW THISTLE.

A field of good strong soil is very dirty with swine thistle. I think I will put roots on it next year. Could you tell me what would be the best feed to sow for cattle on it this year? K. G. T.
Ans.—Several plans might be tried. Corn could be planted in hills, and, if it were cultivated thoroughly, the treatment would help to subdue the weed, which, we presume, is perennial sow thistle, though our correspondent calls it "swine thistle." Another plan would be to fallow thoroughly till late June, then broadcast rape at rate of 3 or 4 pounds per acre for fall pasturage, to be plowed up in November. If anyone has found a better plan, we shall be pleased to print his experience.

CULTIVATING ROOTS.

I intend putting in a large piece of roots this year. I know how to prepare the ground and handle them fairly well; but the question is what is the quickest and easiest way of doing it—for instance, thinning? D. C.
Ans.—The horse hoe should be started between the rows as soon as the plants show up, setting it narrow the first time to avoid covering the plants with earth, and wider the second time to break the crust near the plants and destroy weeds in the incipient stage. The thinning is done with a narrow-back hoe, 8 to 12 inches wide, cutting from the row of plants the full width of the hoe, leaving a few between each cutting, which, in the case of turnips, can be reduced to a single plant with hoe, pushing from or pulling towards you, without touching them with the hands, but in the case of mangels, beets or carrots, the hand will have to be used occasionally to single them. It will pay well to give a second hand hoeing later on, and horse-hoe frequently.

PREPARED BLOOD FOR CALVES.

Prepared blood has been recommended to feed to calves.

- 1. Where can I buy it?
2. About what is the price?
3. About how much would be a feed for a calf two months old?

J. J. W.

Ans.—I do not know of any prepared blood specially adapted to calf-feeding. Blood-meal is a by-product of the slaughter-house, but in nearly all our Canadian factories it is used entirely as fertilizer, and is difficult to obtain pure, being mixed with considerable foreign substance, which renders it unfit for feeding to stock. The only blood-meal which we have used was obtained from Swift & Co., of Chicago, who make a specialty of preparing this substance for feeding to stock. Even this, however, I would not recommend for calf-feeding, as it had a

very offensive smell, and was better adapted to pig-feeding than to feeding calves. Probably some person who handles this product, seeing this inquiry, will be able to furnish the desired information, as it is possible prepared blood may be obtained in a suitable form for calf-feeding from some dealer in this country. However, I am unable to name any dealer at the present time, and do not know of any Canadian manufacturer advertising such a product. G. E. DAY. Ontario Agricultural College.

Contents of this Issue.

ILLUSTRATIONS.

- Buscot Harold 335
Markaton Royal Harold 335
Combermere Abbess 336
King Forest 336
Border-Leicester Yearling Ram 337
Starting a New Brunswick Orchard... 343
A. P. Westervelt 351

EDITORIAL.

- Experience in Cow-testing 333
Pessimistic, but Wholesome 333
Let us Know What we are Feeding... 333
Our Maritime Letter 334
Making One "Vet." a Year 334

HORSES.

- Our Scottish Letter 334
Some Famous English Shires 335
To Stimulate Growth of Horse Hair... 335
No Act Required 336

LIVE STOCK.

- Cures for Ringworm 337
Handling a Vicious Bull 337
The Dog and Sheep Problems in Nova Scotia 337
Waters from Barrels in Stable 337
Importance of Ventilation Not Discounted 337
Petition for Feedingstuffs Legislation... 338
Would Like to Hear from Sandy Fraser on the Dog Question 338
An Inexpensive Watering System 338
The Lambing Season 338
Watering and Water Tanks 339

THE FARM.

- A General-purpose Barn (illustrated)... 339
Harrying the Editors to the Grave... 339
Care and Management of Manure... 340
Twenty-share Beef Ring (illustrated)... 340
Handy Contrivance for the Farm (illustrated)... 340
Farm Fence Law 340
An Elgin Co. Ventilation and Watering System 340
Basement Stables 341
Practical Farm Drainage (illustrated)... 341
Advantages of the Rural Telephone... 341
Wireworm Experience Asked For..... 341
Top-dressing on Clay 342
Windmill for Pumping a Splendid Investment 342
Roads and Beef Rings 342
Seed Fairs 342
A Faker Convicted 342

THE DAIRY.

- Dairying Again Popular in Prince Edward Island 343
How Cattle are Watered 343
An Oxford County Dairymen's Barn and Herd 343
W. E. Thompson's Dairy Barn 343
Milk Records Reduced Dairying to Business Basis 343
The Turnip Flavor 343
Does It Pay To Keep Individual Milk Records?—A Grist of Letters from Those Who Have Tried 344
Nine Cows Averaged \$91.11 344
Has Taken up Milk Records Again... 344
Has Kept Milk Records for 16 Years... 344
Figures Certain to Show Surprises... 344
Good Exercise in Addition for the Children 344
45 Seconds a Day per Cow 344

- Believes in Milk Records for the Dairyman 344
The Farmer's Advocate Interested Him in Milk Records 344
Will Procure a Pure-bred Bull 345
Requires Little Time to Keep Milk Records 345
Milk Records for a Dual-purpose Herd... 345
Pays to Keep the Records of a Single Cow 345
Milk Records Unnecessary 345
Herd Record of Grade Shorthorns 345
Difficult, but Good 345
Milk Records the Coming Thing 345
Six Years' Experience with Milk Scales 345
It's the Whole Year's Production that Counts 345

GARDEN AND ORCHARD.

- "Number One" 346
How a New Brunswick Orchard was Started 346
Another New Brunswick's Orchard Practice 346
High and Low Headed Fruit Trees 346
American Pomological Society Meeting... 347
Improving an Essex County Farm 347
Growing Early Tomatoes 347

POULTRY.

- A Good Homemade Brooder (illustrated) 345
Stamping Eggs 345
Feeding for Egg Production 349

THE FARM BULLETIN.

- An Expensive Industry; Horse Commission Report; Rural Public Schools; Compulsory Eight-hour Day 349
Dominion Grange; The Shire Breeders' Annual Meeting; Hackney Men Meet at Toronto; To Establish a Canadian Pony Record; The Clydesdale Association Prosperous 350
Ontario Horse-breeders' Exhibition 351
Ontario Fairs Association; Details Called For; Directors Elect Executive Officers; Programme of Lectures; New System of Dairy Instruction; Directors' Meeting, Ontario Winter Fair 352
Dalgety Bros.' Clydesdale Sale 353

MARKETS ... 354

HOME MAGAZINE ... 355 to 368

QUESTIONS AND ANSWERS.

Miscellaneous.

- To subdue sow thistle; cultivating roots; prepared blood for calves... 353
Cement blocks 355
Crown peas; lawful fence; crooked line fence; Clydesdale numbers; unpaid-for machine; heavy ration for dairy cows 356
Eversion; cost, proportions and strength of cement concrete; wild morning-glory—how to mark hens; apportioning line fence; cheese-factory banking; sheep losing wool; cranberry culture 357
Irish immigrants; sticky spread; alfalfa for a cattleman; getting a patent; will have to hustle; maple-syrup making 358
To distinguish ganders—to tell whether cow is in calf; remodelling old barns 371
Scaly leg; how much cement?; nitrate of soda; U. S. customs regulations 373
Hollow brick vs. concrete blocks... 375
Clydesdale numbers; river-driving; worms in horse; cow failing to give milk; water system—sugar beets—lucerne 376
Salt on oats and grass seeding; substitute for roots; feeding green cut bone 377
Veterinary.
Eczema—salivation; constipation—crippled pigs; eczema 365
Probably garget; lump jaw 366
Wooden tongue; swollen legs and body 375

MARKETS.

Toronto.

LIVE STOCK.

Receipts of cattle for the past week were large, especially at the Junction market, where the bulk of the best cattle are now being offered. Trade was brisk for the best, but not as good for unfinished classes. Representatives of the Harris Abattoir, Park Blackwell Abattoir, of the city; The Gunn Packing Co., and The Levack Dressed Meat Co., of the Junction, as well as the Fowler Co., of Hamilton, and all the leading butchers of Toronto, were at the Junction purchasing supplies of the best cattle to be had for butchers' purposes. Messrs. Levack and McIntosh were the heaviest buyers of shipping cattle. On Monday, 25th, at the Junction market, there were 68 cars, and 1,406 cattle; trade good, but prices a shade easier.

Exporters.—Prices ranged from \$5 to \$5.50, but few brought the latter figure, the bulk selling at \$5.15 to \$5.25. Export bulls sold at \$3.50 to \$4.50 per cwt.

Butchers.—The prices in some instances were as high as those paid for shipping cattle, as there is a scarcity of well-finished butchers' heaves; in fact, the export class was invaded to get cattle of suitable quality for the ever-increasing demand for prime-quality beef at the various abattoirs, not only for the city of Toronto, but for outside cities and towns. Prime picked lots and loads sold from \$4.85 to \$5.50; loads of good at \$4.50 to \$4.75; medium, \$4 to \$4.40; common, \$3.75 to \$4; cows, \$3 to \$4, and canners, \$1.50 to \$2.25.

Feeders and Stockers.—There were none offered as such, although the bulk of the cattle on the market were little better than feeders, and, as such, should have been shipped back to the farmers to finish.

Milch Cows.—There was a fair trade in milkers and forward springers. The supply was not as large as at some of the late markets. Several Montreal buyers being on hand caused a fairly strong market. Medium and common milkers and backward springers were not in much demand. The top is practically \$55, while it takes a fairly good cow to land at \$50. A fancy pair of high-grade Durhams of good-milking qualities sold at \$125. Common to fair sold at \$25 to \$30; medium to good, \$35 to \$45; good to choice, \$50 to \$55, and fancy, \$60 to \$65.

Veal Calves.—Supplies have been meager, only a few odd lots of really good to choice vealers being on hand, and these sold at steady prices. Top was \$7 per cwt., the bulk selling at \$5.50 to \$6.50. Heavy calves show little change in values, selling at \$4 to \$4.50 per cwt.

Sheep and Lambs.—The run of sheep and lambs for the past week was light, and best-quality sold at firmer prices. Choice lambs sold at \$7 to \$7.25, and a few selected at \$7.40 per cwt.; common lambs, \$5 to \$6 per cwt.; export sheep, \$4.75 to \$5.25 per cwt.

Hogs.—Farmers were not selling freely on account of packers trying to lower the price, and light deliveries are the order of the market. Selects, \$4.90; lights and fats, \$6.45.

Horses.—Dealers report that the horse trade has been brisk, seldom better than during the past week. Many carloads are reported by the dealers as having been shipped both north and westward. Prices are reported as being fairly steady. Burns & Sheppard, of the Repository, give the following quotations: Single roadsters, \$125 to \$140; single cobs and carriage horses, \$130 to \$150; matched pairs, carriage horses, \$275 to \$475; delivery horses, 1,100 to 1,200 lbs., \$125 to \$165; general-purpose and express horses, 1,200 to 1,350 lbs., \$135 to \$165; draft horses, 1,350 to 1,750 lbs., \$190 to \$225; second-hand workers, \$50 to \$75; second-hand drivers, \$55 to \$80.

BREADSTUFFS.

Grain.—Wheat, No. 2 white winter, 73c.; No. 2 mixed, 71c. to 72c.; No. 2 red, 71½c.; No. 2 Goose, 65c. to 66c. Manitoba, No. 1 Hard, nominal, at 86c., at lake ports; No. 1 Northern, 85½c. to 86c.; No. 2 Northern, 83c.

Corn.—No. 3 American yellow, 52c. to 52½c., on track, at Toronto. Canadian corn is quoted at 44c. to 45c., f. o. b. cars at Western points.

The Sovereign Bank of Canada

has 1195 Shareholders and over 50,000 Customers.

The public are confidently referred to any of these for information regarding the Bank's facilities, methods and attention to business. Interest paid 4 times a year on Savings Deposits.

78 Branches Throughout Canada.

Oats.—No. 2 white, 39c. to 40c.; No. 2, mixed, 38½c. to 39c.

Rye.—67c.

Barley.—No. 2, 52c.; No. 3X, 50c.; No. 3, 47c. to 48c.

Peas.—No. 2, 80c. to 81c.

Buckwheat.—55c. to 56c.

Bran.—\$22 to \$23, at city mills.

Shorts.—\$23. Both bran and shorts are scarce.

Flour.—Manitoba patent, \$9.85, track at Toronto; Ontario, 90 per cent. patents, \$2.67 bid for export; Manitoba patent, special brands, \$4.50; strong bakers', \$4.

COUNTRY PRODUCE.

Butter.—The butter market is a little firmer. Creamery rolls, 28c. to 29c.; creamery boxes, 25c. to 26c.; dairy lb. rolls, 24c. to 25c.; tubs, 22c. to 23c.; bakers' tub, 17c. to 18c.

Eggs.—Market firm for strictly new-laid at 30c. to 32c. per doz.; storage, 24c.; limed, 21c. to 22c.

Cheese.—Prices are firm, with market strong. Large, 14c.; twins, 14½c.

Honey.—Market firm. Strained, 12c.; combs, \$2.60 to \$2.75 per doz.

Evaporated Apples.—8c. to 9c. per lb.

Potatoes.—Prices firm at 85c. to 90c. per bag for New Brunswick Delawares, by the car lot, on track, at Toronto.

Poultry.—Supplies light. Turkeys, 15c. to 17c.; geese, 10c. to 11c.; ducks, 12c. to 14c.; chickens, 12c. to 15c.; hens, 9c. to 10c.

Hay.—Baled—Market firm at \$12 to \$13.50 per ton for No. 1 timothy; No. 2, \$10 to \$11.50.

Straw.—Baled—\$7 to \$7.50
Beans.—Market steady at \$1.55 to \$1.60 for hand-picked; primes, \$1.35 to \$1.40.

SEEDS.

Toronto seedsmen are quoting the following prices for re-cleaned seed to farmers for spring seeding: Red clover, \$14.50 to \$16.50 per cwt.; alsike, \$10.50 to \$13 per cwt.; timothy seed, \$5 to \$7 per cwt.

HIDES AND TALLOW.

Prices are quoted as follows by E. T. Carter & Co., 85 East Front St., Toronto: Inspected hides, No. 1 cows and steers, 10½c.; inspected hides, No. 2, cows and steers, 9½c.; country hides, cured, 9c.; country hides, green, 8c.; calf skins, No. 1, city, 12c.; calf skins, No. 1 country, 11c.; sheep skins, each, \$1.30 to \$1.40; horse hides, \$3.50 to \$3.75; horse hair, No. 1, per lb., 30c. to 32c.; tallow, per lb., 5½c. to 6c.

Chicago.

Cattle.—Plain to best steers, \$4.25 to \$7; cows, \$3.25 to \$4.75; heifers, \$2.60 to \$5; bulls, \$3 to \$4.50; stockers and feeders, \$2.50 to \$5.

Hogs.—Choice heavy shipping, \$7.12½ to \$7.17½; mixed and butchers', \$6.90 to \$7.10; choice light, \$6.90 to \$6.95; packing, \$7 to \$7.10.

Sheep and Lambs.—Sheep, \$4.50 to \$5.85; yearlings, \$4.60 to \$6.65; lambs, \$4.75 to \$7.66.

British Cattle Market.

Liverpool and London cables are firmer at 11c. to 12½c. per lb., dressed weight; refrigerator beef is quoted at 9½c. to 9½c. per lb.

Montreal.

Live Stock.—Cattle were firm and hogs easy. Demand for cattle was good, and as high as 5½c. was paid for a few, the range for finest being, however, 5c. to 5½c., fine being 4½c. to 5c.; good, 4c. to 4½c.; medium, 3c. to 4c., and common, 2c. to 3c. Trade in sheep and lambs was slow, and prices held steady, at 4½c. or 4½c. for sheep, and 6c. to 6½c. for lambs. Milch cows ranged from \$30 to \$55 each. The market for hogs was easier. Select hogs sold at about \$7.40 per cwt., off cars, though some holders were demanding 10c. and 20c. more. Calves sold at \$3 to \$10 each.

Horses.—The market continues very firm. Demand is active for heavy animals, and the supply being small, prices still show the tendency to advance noted in these columns from week to week.

Prices were as follows: Heavy-draft horses, weighing from 1,500 to 1,700 lbs. each, \$250 to \$300 each; light-draft, 1,400 to 1,500 lbs., \$200 to \$250 each; express, 1,100 to 1,300 lbs., \$175 to \$225 each; common express, \$125 to \$150; old broken-down animals, \$50 to \$100 each, and choice driving and saddle animals, \$350 to \$500 each.

Dressed Hogs and Provisions.—Prices practically unchanged, at 10c. to 10½c. per lb. for choicest fresh-killed, abattoir-dressed hogs. Country-dressed are always in fair demand, and prices are holding steady at 8½c. to 9½c., according to quality. Hams and bacon show but little change, being 13½c. to 14c. for hams weighing over 25 lbs., per lb., and 14c. to 15c. for 18- to 25-lb. size, 14½c. to 15½c. for 12 to 18 lbs., and 15½c. to 16½c. for smaller. Choicest bacon is in fair demand at 15½c. to 16c., and green and inferior smoked at 13c. to 14c. Barrel pork is \$20.50 to \$23.50 per bbl., according to quality.

Potatoes.—The market is very firm, and prices have advanced. Two cars of fancy white stock were sold to Toronto at 85c. per 90 lbs., here, and 80c. to 85c. is being bid by merchants for more of the same. Local dealers are trying to buy from Eastern shippers, at 75c. to 80c., on track, here, but are not meeting with much success. Offerings are very light. Dealers are selling in a jobbing way, bagged and delivered into store, at 90c. to 95c. For red potatoes, the price is fully 5c. below the figures quoted above.

Eggs.—The local market has advanced to such an extent that stock is being brought in from the United States. This imported stock is smaller than the Canadian fresh, but it is more reliable in quality. The imported stock is costing 33c. per doz., laid down here. Pickled eggs sold at 26c. to 27c.; cold-store, at 24c. to 28c.; fresh-laid—so called—Canadian eggs are quoted at about 32c. Stocks of held eggs are practically exhausted here, and, as the weather continues cold, the production of new stock is light.

Cheese.—The situation is very firm, and holders are asking 13½c. to 14c. for anything they have. It is not thought, however, that the market will exceed 14c.

Butter.—Prices, here, are 25½c. to 26c. for choicest October makes, 24½c. to 25c. for best winter butter, and 24c. to 24½c. for under-grades. Best rolls are 22c. to 23c., and dairies, 22c. to 23c., according to quality. Considerable butter is being taken from here by Ontario shipments having been made to

Hamilton and west, as well as other sections.

Flour and Feed.—Demand for flour is very fair, and prices hold steady and firm, quotations being \$4 for Manitoba strong bakers', per bbl., in bags, patents being \$1.60. The situation in millfeed is most unusual. For the first time, bran has crossed shorts, and is now selling at a higher price. Although official quotations are \$21 per ton for Manitoba bran, in bags, and \$22 for shorts, bran has actually been sold at \$23.50, and shorts at \$23. It is simply impossible to get sufficient to supply the market.

Hay.—Quotations are still \$13 to \$13.50 per ton for No. 1 timothy, \$12 to \$12.50 for No. 2, and \$11 to \$11.50 for clover and clover mixture.

Hayseed.—Prices offered in the country, f. o. b., are \$1.25 to \$2 per bush of 48 lbs., for timothy; \$6.50 to \$7.75 for red clover, and \$5 to \$6.50 for alsike, per bushel of 60 lbs.

Hides, Tallow and Wool.—Prices are steady, dealers offering, here, 9½c. per lb. for No. 3 beef hides, 10½c. for No. 2, and 11½c. for No. 1. Sales to tanners at ½c. advance. Sheep and lamb skins are 95c. to \$1 each, and No. 1 calf skins, 12c., and No. 2, 10c. per lb., paid to shippers. Horse hides, \$2.25 each for No. 1, and \$1.75 for No. 2. Tallow is 1½c. to 3c. per lb. for rough, and 5c. to 5½c. for rendered. There is no change in wool, the market being firm. Pulled lambs, brushed, 30c. to 32c. per lb., and unbrushed, 30c.; Can. fleece, tub-washed, 25c. to 28c., and in the grease, 18c. to 20c.; Can. pulled, brushed, 30c., and unbrushed, 27c. to 29c.; N-W. Merinos, 18c. to 29c., practically none of latter.

Buffalo.

Veals.—Active and steady at \$4.50 to \$10.50.

Hogs.—Heavy and mixed, \$7.40 to \$7.45; Yorkers, \$7.35 to \$7.40; pigs, \$7.60.

Sheep and Lambs.—Active and higher; lambs, \$5 to \$7.90; yearlings, \$6.25 to \$6.65; wethers, \$5.50 to \$5.75; ewes, \$4.75 to \$5.25.

TRADE TOPIC.

FARMERS' TELEPHONES.—Farmers in Canada no longer need seductive arguments to convince them of the value of the telephone on the farm. How it can relieve the loneliness of farm life, prove of real money value in the marketing of farm products, save from suffering and avert death itself, as well as bring help always near for any emergency; these are old stories to the farmer of this country to-day. He may buy and sell and dicker by telephone, and these things he can do to advantage, for he knows exactly the state of the markets on all his commodities.

Can Reach "Long Distance"!

In addition to the thousands of farmers' telephones that have been installed during the past year by the leading company operating in Canada, many mutual farmers' lines have been built in country districts, the promoters of which have arranged for connection with the long-distance lines of the Bell Telephone Company. Such a connection enhances the value of a small private line immensely, for, by being within reach of all the larger centers of population, the dweller in the country at one stroke obtains many of the advantages possessed by his city cousin, and, as he would no doubt aver, avoids many of the discomforts and annoyances of city life.

A Satisfactory Plan.

Thus, throughout the territory covered by this company, a very large number of private telephone systems, owned by farmers' clubs or local rural telephone companies, have entered into mutually satisfactory working and connecting arrangements with the larger company for a direct interchange of business. By such a plan, several thousand rural telephone users now receive the advantage of local exchange and long-distance connection, and the value of the service to all concerned is greatly enhanced.

It is most encouraging to farmers and others contemplating the erection of private telephone lines to know that economical terms for such long-distance telephoning are possible, and, as those say who have already tried them, under conditions that are extremely favorable.—Advt.



HOME MAGAZINE



Life, Literature and Education.

[Contributions on all subjects of popular interest, whether relating to the Literary Society discussions or not, are always welcome in this Department.]

Our Literary Society.

Education of the Farmer's Daughter.

There is much food for thought in the following essays upon this topic. Comment or discussion is cordially invited. The concluding set of essays will be published next week.

ESSAY I.

Herbert Spencer says that all education should be gained in the following order: (1) That which prepares for direct self-preservation; (2) that which prepares for indirect self-preservation, as the securing of the necessities of life; (3) that which prepares for parenthood; (4) that which prepares for citizenship; (5) that which prepares for the miscellaneous requirements of life." While Mr. Spencer probably did not have "the education of a farmer's daughter" in his mind when he wrote this, still, the education which prepares any human being for the duties of this life, will apply quite as well to a farmer's daughter as to any other. Feeling that one cannot improve on this order of education, consider the case in hand under these headings:

1. "The education which prepares for self-preservation." Nature very early begins this work, as, by instinct, a tiny infant will shield its face from blows, or, yet scarcely able to walk, will run for protection from a fancied danger. But instinct will not always protect; for as people grow older they neglect and disregard Nature's warning voice. How many a being is living a miserable existence because of this disregard? A slight cold neglected becomes tuberculosis; an injured joint, used in spite of pain, develops into permanent deformity. Thus, that she may be able to properly care for her own life, the farmer's daughter must learn the greater principles of physiology as they apply to herself, that she may preserve and develop the health and beauty that are given to her.

2. "The education which prepares for indirect self-preservation, as the securing of the necessities of life." At no time in the world's history have there been so many self-supporting women as at present, and, although they have attempted almost everything else before they tried farming, they are at last learning that "the simple ways and sweet content" of country life greatly overbalance the noise and bustle and glitter of the city. Ruskin says: "A woman in any rank of life should know whatever her husband is likely to know. A man should know thoroughly, but a woman should know enough to sympathize and help; and she should know accurately what she does

know." The sciences most closely connected with farm life are Mathematics—ordinary business transactions and bookkeeping; Physics—dealing with heat, light, ventilation; Chemistry—useful in all ordinary baking and cooking; Biology—foods necessary to and suitable for animal and vegetable life. These sciences, if studied thoroughly, will produce wider interests and pleasant occupation for leisure moments; but, while some may never be able to study them in a class-room under the skilled guidance of a college professor, all can and should know the simpler truths of each science. But if a woman would fit herself for the proud position of a wife, she must know more than these can teach her. She must have true ability for housekeeping and business. Perhaps these are best learned by experience, but this experience should be gained before she dares to marry. The three great essentials to this business of housekeeping are Industry, Order and Economy. I think it was Ruskin who said the two greatest sins a girl could be guilty of were idleness and cruelty. So, if we would succeed in life, as well as attain happiness, we must use well the present. We know not what the future holds. One excellent housekeeper said, "Always be one hour ahead of your work."

The rock of disorder wrecks the happiness of many homes. Some are born with a love of order, some acquire it naturally as they see its advantages, while others must be compelled to be orderly. But fathers and mothers, whoever and wherever you are, in some way or other give your daughters a love of order both in time and place, for the disorder of time soon leads to disorder of all. The business ability of the young woman can be developed by allowing her to earn something by her own labor; to sell her produce according to her own judgment, and to buy her own clothing also according to her own taste and judgment. (I heard of a mother who allowed her ten-year-old daughter to choose all her own clothing; of course, the mother helped by suggestions.) Allow her to buy from a stated sum of money the supplies for the household; teach her to make, mend and remake her clothing, so she will learn economy. But all these things are needful for any woman to know. The farmer's daughter must know how to preserve and care for fruit, meat, vegetables, and whatever food and produce come to her hands. She should know well the work of dairy, garden and poultry-yards, be able to harness a horse and drive it with sense and moderation. If, in addition to all these, she knows how to feed all kinds of stock, drive machinery, or build a load of hay, the knowledge will never hurt her; she may sometimes be able to help an overburdened husband and improve her own health by the outdoor life she leads.

3. "The education which prepares for parenthood." It is truly an awful (I use the word in its truest sense) thought to contemplate that we, who pride ourselves on our high standard of education, have done so little toward preparing our young men and women for the duties of

parenthood. "The fate of the new generation is left to the chances of unreasoning custom, impulse, fancy—joined with the suggestions of ignorant nurses and the counsel of prejudiced grandmothers." How many young mothers ever think of the laws of health when they give their babes cordials and soothing syrup, or shake the children who refuse to eat porridge? Do they ever think of the mental processes of the child who steals matches to set paper on fire just to watch it burn, or whose kisses are bought with candy? If the world would devote half the energy to the proper physiological and psychological training of children that is expended in passing local option, there would be less need of reformatories and penitentiaries. It is just as necessary that prospective parents should be trained in the simpler truths of physiology and psychology as it is that a merchant should know arithmetic.

4. "The education that prepares for citizenship." Every woman should know something of the history of her country, its government, and the various social and political changes through which it passed; but that these may be useful, she must know the minds of men, and how they feel and act under varying conditions. Ruskin says: "A woman's duty as a member of the commonwealth is to assist in the ordering, in the comforting, and in the beautiful adornment of the state." Here the moral side of her character will be developed. Has she patience, courage, independence, kindness, tact? A farmer's daughter needs all these in her social life, and, as a farmer's wife, in helping her husband to choose right instead of might, state instead of party. I firmly believe there is no other class that requires the political "shaking-up" that the farmers do. Perhaps the wives and sisters could do a good work if they studied politics more.

Lastly, we come to "the requirements of life." As amusement occupies the leisure time of life, so that which fits us for amusement should occupy the leisure time of education. Goethe says: "We should guard against a talent we cannot hope to practice in perfection." Then, instead of wasting much time and more money on music or painting, for which one has no talent, seek out the particular accomplishment for which one has genuine ability, and leave all the others strictly alone. And to the farmer's daughter who has no special talent for music, painting, sculpture or poetry, there are still the chances of "seeing God in the skies and in the seas, in the stones and in the stars;" there are still "sermons in trees and books, in running brooks." Canvas never was painted to equal the glorious sunrises and sunsets which daily the Master Painter hangs for our view. Poet nor musician ever dreamed of sweeter melodies than the love songs of the birds or the rippling, gurgling brooks. Sculptors come to the farms for animals which they imitate in marble. Farmers are the kings of the earth. Are we preparing our daughters to share the throne and the crown?

BERTOLET.

Middlesex Co., Ont.

ESSAY II.

The education of farmers' daughters' as of all other young people, should consist in obtaining a knowledge of those arts and occupations that will enable them to enjoy life to the fullest possible extent, and will render them of the greatest possible service to the portion of the world that they may influence. Farmers' daughters whose sphere of activity and usefulness is to be the farm, will require an education that will best fit them to assume the many responsibilities of the farm.

Of course, the greater part of the average farmer's daughter's education will and should be gained on the farm. A few necessary rudiments of an education will be gained in the public school. In the mind of the writer, it is very questionable whether, in the majority of cases, it would be advisable to go beyond the public school in acquiring an education. Of course, the crude and somewhat rough exterior may and undoubtedly will be polished and refined by contact with other humanity in college life, but the country places in our country, where the manners may not be refined by the social advantages around home, are very few indeed, and the manners should take on an added charm because of the fact that the natural grace has not been polished away altogether by the often too superficial college life.

Every young person, boy or girl, should include in their education enough of literary culture and mental training to be able to feel at home in cultured and educated society, and be able to appreciate and enjoy and gain benefit from the best of the literature of the ages. A farmer's daughter should also acquire, at least, a fair knowledge of music, if possible, and it would do no harm, if time and other considerations would permit, to acquire a knowledge of some of the other fine arts.

In this practical world, and this intensely practical age, it is, after all, the education in practical affairs that should demand the most attention and be most diligently studied. The girl who can cook and sew and attend to the many duties of the home in such a way as to make home comfortable and happy, is, after all, one of the queenliest women to be found on this planet. Let our farm girls learn to sew, to make their own dresses, and do the general sewing and mending about the home, as well as a little fancywork between times; let them learn to cook and bake in such a way as to tempt the appetites of the "lords of creation," and let them learn, above all things, the sweet and amiable characteristics that will make them in very truth queens of hearts and homes, and the superficial education and culture the college can give will not be required. The very best place where the education we have outlined can be gained is at home. In the vast majority of cases there is lacking not so much the time as the inclination to gain the comprehensive education we have outlined. A little time each day can be given to reading; that will give the literary culture and mental training. A little time each day will give the needed education in music and the fine arts, while the practical education will be

gained in the daily care of the home. Combining these all together, we have a young woman who can take her place equally well in society or the more prosaic duties of the home.

J. D. TAYLOR.

Waterloo Co., Ont.

Our English Letter.

ON SOME CURRENT TOPICS.

By the time this reaches the readers of our Home Magazine, British politicians will be once more in the throes of debate upon old measures under probably new names. Just now, at the moment at which I write, the columns of the daily papers tell of gay doings in country homes, hunting and shooting out of doors, and, within doors, of theatricals, and every imaginable style of amusement, whilst never a day of the holiday season passes without some one who claims to be an authority on thought-reading, telepathy, occultism, or other et ceteras having some explanation to offer of what is known as the Zancig mystery. Some who have watched this clever couple very narrowly can detect nothing to prove collusion, whilst others, chiefly amongst those who have been or are professionals along somewhat similar lines, do everything short of giving their own methods away to show that the performance is no cleverer than their own, but is just a system of codes, a triumph of trained memories. For both sides of the controversy all this correspondence is a great advertisement, and, meanwhile, to an outsider who does not pretend to have formed any opinion of the subject, it is not without its humorous side. Even if the Zancigs are endowed with the sixth sense, which is claimed for them, I venture to think that it chiefly concerns the majority of us who only know with certainty that we have five senses and no more, to make the most of our limited equipment, and to be content to see with our eyes and to hear with our ears in the simple fashion of our ancestors.

THE CHANNEL TUNNEL.

A question of far deeper import to the whole British nation, at home and abroad, is arousing the keenest interest, for the Channel Tunnel bill will shortly be brought before Parliament, and will not be without influential Cabinet support. I feel sure that our Colonies will give the matter their earnest consideration, and I shall read with avidity every word which reaches me from the pens of the thinkers of Canada upon so

grave an issue, for, in the carrying out or rejection of this project, it goes without saying that our Dominion must be deeply concerned.

Under the head of "Tunnel Madness," a writer in the National Review says: "For an unarmed island like England, enjoying naval supremacy, to deliberately connect herself by a railway with a continent bristling with army corps, seems to us to savor of dementia"; whilst "Britisher," in the Daily Mail, asks: "Will any of those who wish for the tunnel deny that it is only because we are separated from the continent we have been able to hold our own all these years? We are a maritime nation, and, please God, we will continue so to be. No Government or Parliament should have the option of saying 'yes' or 'no' to the construction of a channel tunnel; the only opinion to be taken should be that of all the people (excluding aliens) who live in Great Britain, and God help them if they ever agree to it. Our forefathers fought for the safety of our country, and left it intact, and it is for us to see that we leave it safe for future generations."

The veteran Field-Marshal, Sir Evelyn Wood, is recorded as having said, upon being questioned as to his opinion upon the coming bill in Parliament: "If I were a Minister, I would sacrifice rank and power, and

strip myself of all my authority before I acquiesced in the construction of a Channel Tunnel."

A Frenchman, writing in the *Matin*, a French paper, held "that it would be madness for a nation which has a wet ditch twenty-one miles in width protecting its frontier, to throw away its natural defence." In allusion to this, Sir Evelyn continued: "I hold this view strongly myself. From a military point of view, it is unthinkable that the tunnel should be constructed. I have yet to learn that the people of Jericho, when attacked, pulled down the walls of their city to let the Israelites in." Lord Wolseley's opinion is just as adverse to the project, and it is given to the public under the caption, "Solemn Warning by Lord Wolseley."

Those in favor of it are mostly the merchant and the tourist. The latter may be spared a few minutes of seasickness, and the former prophesies a cheapening of London's food. Apropos of seasickness, Punch and the comic papers have said some rather good things, but the following little incident is given as true—a triumph of mind over matter: Crossing from Folkestone to Boulogne on a sea that was more rough than pleasant were two well-known members of the legal profession, a judge and a barrister. The

latter was suffering silently but sorely when the judge happened to drop against him as he leaned disconsolately over the taffrail. "H'm, You don't seem quite at home here," remarked his lordship. "Can I do anything for you?" "Yes," gasped the seasick lawyer, "I wish you would overrule this motion."

So far the general expression of opinion is decidedly adverse to the tunnel project. "The sea," it is argued, "is Britain's bulwark and pride. Wherever the sea is, there is her frontier, and for many centuries she has guarded her vast empire with her ships. Does national sentiment count for nothing? Are we to surrender it for a mere monetary consideration?" "An Englishman" thus answers these questions: "Even if it were proved that the tunnel would be no danger in war-time, even if it were proved that it would increase our trade, the price would still be too heavy to pay. The national sentiment is worth whatever sacrifice may be made to it. We are insular from other points of view than that of geography. The limitations of the English character, which are its strength, are bred of isolation. The spirit of independence, which appears to strangers a lack of sympathy, is the direct result of our position. The enterprise and adventure which drove our forefathers across the seas and founded our colonial empire, were the enterprise and adventure of islanders. The heroes of Devon, who looked out from Plymouth Hoe, could not find inland a solace for their restless ambition, and it will be a dishonor to Britain if any man be ever permitted to escape from her shores except by boat. "The insular glory of England was celebrated by Shakespeare in words which should be in everyone's mind to-day:

"This fortress, built by Nature for herself,
Against infection and the hand of war;
This happy breed of men, this little world;
This precious stone set in the silver sea,
Which serves it in the office of a wall,
Or as a moat defensive to a house
Against the envy of less happier lands."

"Such is the inheritance we are asked to sell for far less a price than a mess of pottage."

What touches the mother country must touch the daughter colonies, and, therefore, their voices can hardly be silent upon a topic of such vital importance to both.

H. A. B.



"Summer will come again, by-and-bye." Old Ontario in June.

The Quiet Hour.

God's Messengers.

Be not forgetful to entertain strangers: for thereby some have entertained angels unawares.—Heb. xiii.: 2.

I planned a plan, and duly made
A plan to fill one little day.
Pleasure and toil were gauged and weighed,

This hour for work and that for play,
And each for each made room and way.

I set my wilful feet to tread
The wilful path self-chosen as right,
Resolved to walk unhindered,
Nor turn to left, nor turn to right.

But interruptions all day long,
And little vexing hindrances,
Each weak, but all together strong,
Came one by one to fret and tease,
And balk my purpose, and displease.

Friendship laid fetters on the noon,
And fate threw sudden burdens down,
And hours were short and strength failed soon,
And darkness came the day to drown,
Hope changed to grief and smile to frown.

Then I said, sadly, "All is vain;
No use there is in planning aught,
Labor is wasted once again,
And wisdom is to folly brought,
For all the day has gone for naught."

Then spoke a voice within my soul:
"The day was yours, and will was free,
And self was guide and self was goal,
Each hour was full as hour could be—
What space was left, my child, for ME?"

"Where was the moment in your plan
For work of Mine which might not wait?
The need, the wish of fellow man,
The little threads of mutual fate,
Which touch and tangle soon or late?"

"These 'hindrances,' which made you fret,
These 'interruptions,' one by one,
They were but sudden tasks I set,
My errands for your feet to run,
Will you disdain them, child, or shun?"

Oh, blind of heart and dull of soul!
I only felt, the long day through,
That I was thwarted of my goal,
And chafed rebelliously, nor knew
The Lord had aught for me to do!

Forgive me, Lord, my selfish day,
Touch my sealed eyes, and bid them awake
To see Thy tasks along the way,
Thy errands, which my hands may take,
And do them gladly for Thy sake.

—Susan Coolidge.

We read in the Book of Genesis how Abraham and Lot, with ever hospitality, entertained strangers, who proved to be angels in disguise. "I have often so in life," someone has said, "No one knocks at my door, but I am not by

God." An "angel" is a messenger sent by God, so everyone who comes into our lives must be one of His messengers. Let us keep our eyes open so that we may not entertain His messengers "unawares."

Shall we glance for a moment at some of these messengers. First, there is the gift of each new day, which comes to us fresh from God's hand. Let us meet it always with a "glorious morning face," and the gladness of a childlike heart. This day is a wonderful gift from our Father's hand—we can live grandly to-day if we will. What a difference there is in the way different people greet the day. Some come to breakfast looking cross and half awake, and at once begin to grumble about the weather, or to groan dolefully over past, present or possible future troubles. Others are like the morning sunshine, fresh and bright and glad; inspiring their fellows to thank God and take courage. We can all be like that, if we will, and those who welcome each day as a messenger from God will be themselves God's messengers of hope and joy to all around. It is worth while, isn't it? Let us open our eyes each morning to the vision of Christ's face, and, at once, answer His call to work in His vineyard, doing the work He sets before us, not the work we think seems grander. Perhaps He is testing our obedience, intending to give us the work we want when the day is a little more advanced, and we have grown stronger and more able to do it well. And let us try to keep our morning freshness all day long coming to our

Master often, that He may pour new life and gladness into our souls, and refresh us with His peace that passeth all understanding, and the rest which He promises to all the weary who come to Him. Then, if we keep the morning brightness of each day until the evening, so we shall keep a young heart until the end of life. God can make all things new every day, if we will only let Him, as He makes the earth new every spring, and our lives new every morning.

Then there are the special providences, which come to each of us straight from God's hand. I don't mean only such unusual things as a narrow escape from death or a recovery from illness, but the everyday providences which enter into all our lives. The multitudes, fed miraculously by the power of Christ, might marvel at the sudden multiplying of the bread. But that was only a lifting of the veil to teach us that He is always working wondrously. Let us consider the multiplication of the seed we scatter so thoughtlessly in the earth. What but the power of God could change one grain into many, or bring fruit, flowers and vegetables out of the dark earth which looks so dead. We marvel over the signs shown to Joshua and Hezekiah, but how much greater is the everyday wonder, and the power which keeps our earth and all the heavenly bodies hanging upon nothing, and sends them swinging through space in perfect order and harmony.

Though we may not now have the variations in God's order of Nature

which we call "miracles"—the visible baring of His wonder-working arm—we have the far grander certainty that He is working invisibly every moment in every corner of His infinite universe. Our Lord has made this very clear, definite and practical, by telling how God clothes each lily and each blade of grass, watches over the safety of each tiny sparrow, and is far more particularly interested in each event in the lives of His children who are "of more value than many sparrows." All things work together for the good of those who love God, not accidentally, but because they are all special providences, intended to perfect character and make life happy. But God does not do everything for us. A growing plant reaches out into its environment, drawing strength and nourishment from earth and air, from sunshine and storm, from rain and snow, from dew and frost,—while these same influences only hasten the decay of a dead plant, or kill a weak one. So a healthy soul continually reaches out into its environment and extracts strength and spiritual nourishment from everything God puts within its reach,—joy or sorrow, pain or pleasure, work or play, friends or enemies, hindrances or privileges. They are all messengers sent by God with gifts for the hungry, growing plants in His Garden. A healthy soul reaches out and takes the gift from the hand of each messenger, and so grows stronger every hour. It is true and just that "whosoever hath, to him shall be given, and he shall have more abundance: but whosoever hath not, from

him shall be taken away even that he hath." Those who already know the gladness of God's love are ever reaching out to gain more of that priceless knowledge; while those who don't reach out for more grace are gradually losing what God has already given. The water of life is freely offered to all who are athirst, but it is only obtained by those who are in real earnest in their desire for it: "Whosoever will, let him take." God never forces His gifts on us.

But, if even the stranger who knocks at our door is a messenger sent by God, how much more certainly are the relatives and friends who are near and dear to us, His messengers. Is it "unawares" that we are entertaining or refusing to entertain these "angels?" Is it a fine thing to become great and famous in the opinion of the world, while we are leaving a dear father or mother to grow old in loneliness and neglect? Then, if we are always pleasant and polite to strangers, how much rather should we be unfailingly courteous and kindly in word and deed to those in our own homes. Rude words are only too common in some homes, even though love is not absent. If Christ is willing to dwell under our roof, not only as a passing Guest, but as one of the family, we must welcome Him loyally. Every impatient word spoken to a child, or want of courtesy shown to a servant, is really aimed at Him; for He is meeting us continually, and we always have the opportunity of entertaining not only a messenger, but our King Himself. We shall not "unawares" show Him any

slightest discourtesy if we keep close to the heart His saying: "Inasmuch as ye have done it unto one of the least of these My brethren, ye have done it unto Me."

Then there are those dear messengers of His—our friends—who may or may not be our relations. Those whose spirits and hearts are linked with ours in the wonderful mystery of the Communion of Saints. They are very near to us in the quiet hours of the night, though they may be far away in body. Reaching up to God continually, for us, they pour new strength and joy into our lives. We rest confidently on their love, and walk always side by side with them in the sweetness of real fellowship. If you know the joy of having friends who are drawing you ever higher into clearer fellowship with the Friend Whose love "passeth knowledge," then keep fast hold of these messengers from God. Such a friendship is not an easy thing to hold, for true love must always be giving of itself. If you are trying to take all and give little, then you are cultivating selfishness instead of friendship. Give strong love and earnest prayers, and anything else that friendship may demand. But if you have a friend who is like Christ, and who is helping you to grow like Christ, never let him slip "unawares" out of your life—though it may cost you all you have, even to life itself, to hold fast to him. For such a friendship is eternal in its nature. Though you may be far apart in body, prayer can keep you always close to a friend; and a bodily parting is a very small thing when

hearts are one. "We have forever," there is no hurry. God's best gifts go on ripening through all eternity. Those whom God hath joined together in holiest friendship can never be parted by distance or death, so long as each is faithful to the other.

Then there are those other "angels" who are so hard to entertain joyously—the angels of pain, sorrow and death. They, too, come to us carrying priceless gifts from God. Shall we let them go without making our own their gifts of patience, courage, fortitude, trust and joy? They will not force these great graces upon us, but whosoever will may take them, for God wants us to possess them, and sends His dark-robed angels to us in splendid confidence that we will welcome them loyally just because they are His messengers. Joy has often shone with dazzling beauty in a soul walking with the Son of God, through the burning, fiery furnace. As Bishop Ingram says: "To believe that there is Someone who is tempering the flame, who is not letting one single throb of agony be too much or too great, that this is not a matter left to mad chance or to the spite of some devil—it is this which takes away the bitterness from pain. Lie still in the furnace, if the kind face of God is looking down on you; lie still in the furnace, because the moment that the silver is so bright as to perfectly reflect the face bent over it, that moment it will be taken from the furnace."

HOPE.

The Ingle Nook.

The Living-room.

There is a fad which is gaining ground in New York and some of the other large cities just at present—that is, to have no drawing-room, but, instead, a living-room, in which the family is supposed to spend the greater part of its time. Needless to say, this is a fad which will speedily pass away, in the cities at least. In the first place, in an environment in which one's front apartments have to be more or less on dress parade all the time, it is necessary to have at least one room which may never appear even a little bit littered. In the second, in those houses which have so readily turned drawing-room into living-room, there is always a second drawing-room or den, in which the family may gather, safe from the intrusion of the chance caller, and in which books and magazines may be scattered about, and cushions rumped up in the delightfully inviting way which can belong only to the "really and truly" living-room. So that, after all, this city living-room is but an apparent one, differing only from the old-style drawing-room in appearing less stately, more homelike.

However, does it not seem that this drawing-room metamorphosis might be one that might very well be adopted and kept permanently in the country house? In the country there are of necessity fewer callers, and such as come are usually neighbors with whom one is likely to be quite friendly, or dearly-loved friends from a distance—just such visitors as may be taken, while they stay, into the bosom of the family.

How very commonly in the farm home is the "parlor" an all but useless institution, standing for the most part in stiff dignity waiting for the coming stranger, and of about as much general use to the family as the picture gallery in the nearest city. Drawn window-shades, unimpeachable order, it is true, yet very little real comfort after all. Such a parlor is not furnished without expense either. Its carpet, its pictures, its furnishings are likely to be the most costly in the house, and, really, does it not seem a pity to put so much money to so much practical waste?

Of course "every man to his mind," but to mine the comfortable living-room to which one may repair, if one chooses, when the work in the kitchen is done—the room which is not too good to use, one with big easy chairs, a comfortable couch, some book-cases filled with books, and a substantial table at which one may write, or read, or sew—appeals much more strongly than does the ordinary parlor.

Such a living-room need not be expen-

sively furnished. It may have only a pretty linoleum on the floor, or a big rag rug in soft green or crimson or old blue; its book-cases may be homemade; its couch a strong cot with a mattress on it; its curtains scrim, and but sash length, as described by Prof. Evans at the Women's Institute convention; its ornaments perhaps conspicuous by their absence—but it will have the homey look which is better than an air of costliness. The furniture in this room should not be upholstered, but should be of wood, strongly made, comfortable, and quite free from dust-harboring patches of carving. The cushions on the couch should not be "fancy"—good washable denim will be found the best covering. A

ment for money as regards the home can scarcely be made. Nothing exerts a more refining influence over a family than the reading of good literature; nothing can inspire a growing boy more than the life-story of noble and useful men; nothing can interest young and old alike more than entertaining tales of travel, and accounts of far-off lands over the sea. Illustrated books cost more, as a rule, than those without illustrations, yet a home without books with pictures in them suffers from a great lack.

And now I have had my word in the matter. Will you not talk a little about all these things, Chatterers?

DAME DURDEN.



Homemade Book-cases.—An inviting corner in a living-room. Note the cot, with a striped rug over it, which takes the place of a more-expensive couch. Picture molding makes a pleasing finish for the top of these shelves.

few plants at the window will be sure to prove the best decoration, while the pictures should be very few indeed, but well chosen, and simply and tastefully framed in dark wood; gilt is seldom in good taste, except when of the best quality, and for oil-paintings.

Of course the books will cost money. Books, including many of the very best of them, are not, it is true, expensive (unless one is determined to have handsome bindings), yet, as the Scotch say, "Mony a mickle makes a muckle." One does not need, however, to begin with a whole library. A single shelf may be added as the want arises. If the books be of the right kind, a better invest-

Something for Bright Women to Do.

Sometimes we smile yet to think of it—of the halting, befogged way in which, away up in one of the northern counties, we began that branch of the Women's Institute. We had heard of the Institute, of course—who in our fair Province has not?—but of its organization, its method of working, we knew nothing at all. What we did know, however, was that we were determined to have a Women's Institute of our very own, and that we were bound to make it a success. So we met, a round dozen of us, elected officers, and drafted out some sort of a programme. Two or three months later we learned, with some sur-

prise, that the organization to which we had thus affixed ourselves somewhat a la barnacle, was one of the most far-reaching and most systematically organized in the Province; that it was under the especial care and encouragement of the Government; that there was a Center or Hub to which application should have been made; that the mere fact of belonging to the Institute (in regulation order, of course) entitled one to a considerable amount of very useful literature, issued at intervals by the Department; that each branch of the Institute had the privilege of bringing to it, once every year, lecturers trained on all subjects pertaining to the home; that, in short, we had put our best foot foremost more effectually than we had thought in organizing our little society. Needless to say our application was then speedily forwarded to headquarters, and we soon felt the dignity of being properly enrolled members of the institution. To-day I am glad to be able to tell you that little society has grown to be one of the largest in Northern Ontario, and is generally recognized as being one of the most active.

Spring will soon be here; the days are growing longer, and it is easier to get about. If you have not a Women's Institute in your locality, why not begin one at once, and have it in running order in good time, so that you may have the privilege of listening to the lady delegates, who will, in May and June, go out to give lectures wherever their assistance is desired? I can't tell you all about it to-day, but will be glad to answer any questions which may be asked regarding the conducting of meetings, etc. In regard to the business part of it, how to organize, etc., write to Mr. Geo. A. Putnam, Parliament Buildings, Toronto, by whom all such information will be gladly forwarded. And, oh, yes—when you have started your little branch societies write us all about them, will you?

D. D.

Mothers' Meetings.

Dear Dame Durden,—I noticed in "The Farmer's Advocate" a question in reference to a mothers' meeting. I agree that such meetings are better than mere visiting; we sometimes see not many good results come from just calling on our neighbors. Now I will tell you what a few of the women in our district have commenced. We, as members of the Brethren's Church, have commenced a missionary meeting, and we have our appointed places at which we meet every other Thursday. We conduct it like any other meeting, only it is all made up of women. Anyone is welcome. The meeting is announced at half-past two o'clock. Ministers or any man interested may be present, but it is usually made up of women. We open

The balance of time is maintained by the unerring accuracy of the **ELGIN WATCH**



Every Elgin Watch is fully guaranteed. All jewelers have Elgin Watches. An interesting, illustrated booklet about watches, sent free on request to **ELGIN NATIONAL WATCH CO., Elgin, Ill.**

WHY BE SORRY

and disappointed over the results of your baking when you can be *sure* of obtaining the sweetest, fastest loaf that can be made by using "FIVE ROSES" FLOUR. This brand is the ideal flour for bread, and gives more satisfaction to its users than any ordinary brand. There is no uncertainty as to results when you use "Five Roses" Flour, for it only gives one kind, the best.

Ask your grocer for a bag to-day.

LAKE OF THE WOODS MILLING CO., LIMITED.

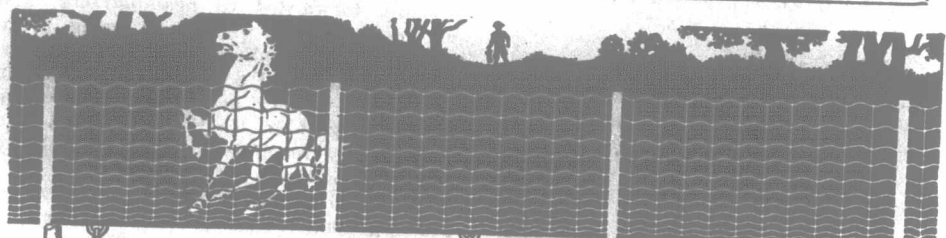

LAMB FENCE

THE TEST THAT TELLS

2497 LBS. TENSILE STRENGTH OF NO. 9 LAMB SPRING STEEL WIRE	Our Fence is made from the VERY BEST high carbon Steel Wire, and has NO SHORT KINKS or BENDS.	1822 LBS. TENSILE STRENGTH OF NO. 9 HARD STEEL WIRE	You're a practical man and know that a short kink or bend in any wire greatly reduces its tensile strength.	1166 LBS. TENSILE STRENGTH OF NO. 9 SOFT WIRE
------------------------------------------------------------	-----------------------------------------------------------------------------------------------	-----------------------------------------------------	-------------------------------------------------------------------------------------------------------------	-----------------------------------------------

THE H. R. LAMB FENCE CO. LTD.
LONDON, ONT. WINNIPEG, MAN.

Make Money

Buy a first-class Drilling Machine and drill wells. You can make it pay. Don't buy cheap machines. Get a good one at the start. A "Crown" will suit you. Catalogue C. Drilling and fishing tools. **Crown Drilling Machine Co., AKRON, O 110. A. R. Williams Machinery Co., Ltd., Toronto, Winnipeg, Vancouver.**

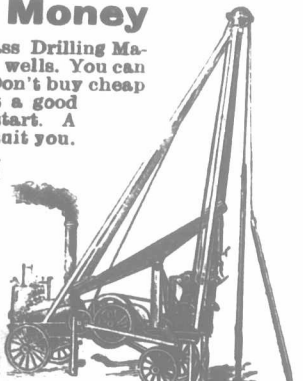

Williams & Wilson, Montreal, Agents for Canada.

A FARM FOR EVERYBODY.

We are prepared to suit the most particular buyer. We have the best assortment of property for sale of any agency in Ontario and will be pleased to show farms, houses or business properties to intending purchasers. Over 2,000 farms for sale. Send for our list.

WESTERN REAL ESTATE EXCHANGE, LTD.,
London, Ont.

\$12 WOMAN'S SUITS, \$5

Suits to \$12. Cloaks, raincoats, skirts and waists at same bottom price. Send for catalogue and fashions. **Southcott Suit Co., Dept. W London, Can.**

Advertise in the Advocate

with song and have prayer, then we read a chapter out of God's Word suitable for mission work, and then questions are asked. Each one gives her views, and we explain the chapter as we get light on it. One is supposed to be the head of the meeting, and be there regularly on time, and if it is not possible for her to attend, another one takes it up and leads the meeting. We find it is a great help to the church to get the women interested in church work. After the chapter is read we have prayer again, and each one prays, and then we sing again and dismiss the meeting, not forgetting to give of what the Lord has prospered us. The leader goes around and takes up a collection. Every three months we send this to some foreign or home mission that is in need—wherever it is needed the most. The money that is taken in each time is kept account of and marked down. I will close for this time, as this is the first time I ever wrote to "The Farmer's Advocate." I like the paper, especially the Quiet Hour. Your plan of mothers meeting is all right, but I would prefer a missionary meeting. We don't stay for supper, as we think it too much confusion. **Russell Co., Ont. MRS. A. E. W.**

Who Knows "Maple Moose"?

Dear Dame Durden,—May I have the pleasure of enjoying a seat at your table among so many kind friends? I have, for some time, been a silent listener to all the advice that can be derived from your Ingle Nook Chats. I find much information has been given to young housewives, and have had success with the many recipes I have tried. I would like very much if some one could give me a good recipe for "Maple Moose." I will enclose a recipe for "Orange Cake," and a prescription for hand lotion, which I received from a nurse in one of our popular hospitals: **Orange Cake.**— $\frac{1}{2}$ cup butter, 2 cups sugar, 4 eggs (separate in beating), juice of $1\frac{1}{2}$ oranges, grated rind of 1 orange, $\frac{1}{2}$ cup water, 2 teaspoons baking powder, 2 cups flour (more if juice requires). **Hand Lotion.**—Glycerine, 1 oz.; bay rum, 1 oz.; wintergreen, 5c. worth; carbolic acid, 1 teaspoonful; gum tragacum, 3c. worth. Soak gum in 1 quart rain water until dissolved, then add other ingredients. **HARRIETT.**
Oxford Co., Ont.

A Letter from Wrinkles.

Dear Dame Durden,—Were I to take the place at your side that Rosebud would give me, I would surely have to put on my thinking cap. I am afraid I could not do her subject justice, as I am too deeply interested, already having our circle broken by one flying from the old nest, out to the West to locate a homestead. In the first eight months he has wandered half round the world, and tells us we are to look for him home from the East, as he has decided to take the round trip. What wonders there will be to tell! A trip round the world cannot fail to be an education to anyone who tries to take in what there is to see, and although at the other side of the world, home is always a place to steer for. Love of home must always have a good influence on either boys or girls. It seems to me, as I said once before, ownership goes a long way to keep the young contented—something of their very own to look after, and take care of. Certainly give them pleasure at home as much as possible. Those who seek homes in the West would be wise to take a helpmate with them, I would say. Think of the pioneers of Ontario—how would they have done without wives good and true to keep their little homes in the backwoods of Canada? There would not have been so many beautiful farms all around us to-day, had it not been for the brave women who did their share, and did it uncomplainingly. The very spot where I sit was a dense forest when the present owner's father came, a very young man, to Canada. I had it from his own lips, that the largest maple tree he ever saw grew only a few rods from his door. What think you of a youth hardly twenty who had never chopped a tree, starting in to clear a farm in such a spot? I often wonder at the courage of those good old pioneers. What patience and perseverance was theirs, and what a country they cleared up for their sons

and daughters, and how ungrateful it would seem for their grandchildren to let these good old homesteads go to decay that they might go to the Northwest and get rich quick! It makes me sad to hear, "So and so has let his farm, because his sons have gone West, and it is impossible to get good reliable men to work. I feel deeply for the employers nowadays, for they have to work hard early and late, and have all the worry and anxiety of where the large wages are to come from to pay for the work that is being, in many cases, but badly done. The wages have to be paid even if the crops are a failure, while the hired man is haggling about the hours he has to work, and the chores he has to do. I am told that the sailors out on the Pacific do whatever is to be done cheerfully, and are ready to crack a joke with their comrades at any time. There is no doubt that the willing workers are the people who succeed in the end. Kindly put me in the waste-paper basket if I have said too much. **York Co., Ont. WRINKLES.**

Answer to June Eve.

Our Dear Dame,—I had a few minutes this evening, so as usual turned to the Nook, and the first thing that I saw was a request from June Eve for something to relieve the suffering from inflamed veins of the leg and foot. I will tell her how I have been cured of that very painful trouble. Get the best extract of witch-hazel—Pond's Extract is the best, I think. Lie down in bed and have the extract bathed on, beginning at the toes, always rubbing up along the vein, to relieve it of as much of the blood as possible. If very bad or swollen, and the veins knotted, lie in bed for a day and keep cloths wet with the extract on the sorest places. If able to sit up during the day, have the bathing done as above, and bandage with a narrow cotton strip, beginning at the toe, keeping it firm and even. Always be sure to rub the veins up toward the body. This is a very stubborn disease, but if the above treatment is persevered in help is sure to follow. I have had no return of the trouble for years. **Wentworth Co., Ont. H. M. H.**

Answer to Maple Leaf.

Dear Dame Durden,—This is my first script to the Nook. We consider "The Farmer's Advocate" an excellent paper, and I enjoy reading it very much. Maple Leaf asks how to hull corn. Boil in weak lye 15 or 20 minutes; drain through a colander, and boil five or ten minutes in fresh water; drain again and boil five or ten minutes; drain again, and it is then ready to cook for use. Any kind of field corn will do. **GIPSY.**
Northumberland Co.

Re Christian Science.

We are in receipt of several letters, some adverse to Christian Science, some upholding it. Were there any object to be gained by prolonging this discussion we would gladly do so, but since no amount of arguing would be likely to produce much effect one way or another, we think it better to call a halt. We must, however, thank Mr. G. W. A., A Brussels Boy, and others, for their kind words regarding "The Farmer's Advocate." We should be glad to hear from them again on some other topic.

Recipes.

Pastry.—One ounce sugar to 1 lb. "Five Roses" flour. Make into stiff paste with 1 gill boiling cream and 3 ozs. butter. Work well, and roll thin. **Short Crust.**—Two ozs. sugar, 1 lb. "Five Roses" flour, $\frac{1}{2}$ lb. butter. Rub together. Put yolks of 2 eggs into some cream. Mix to smooth paste. Roll thin.

One hundred and fifty lives were lost by the wreck of the steamer Larchmont, at Block Island, off the New England Coast. Many of the number were frozen to death on rafts and in lifeboats.



Let me sell you a
CHATHAM
Incubator

On Time

Do you know there is big money in raising poultry? Do you know my incubator will pay you a bigger profit than any other thing you can have on your place?

Well these things are true. Thousands of people all over Canada have proved it every year for the last five years.

I want to quote you a price on my Chatham Incubator,—sold ON TIME and on a 5-year guarantee. I want to send you my Chatham book. This incubator book is free—I'll send it to you for just a postal card.

It tells you how to make money out of chickens.

Chatham Incubators and Brooders will make you money, for a Chatham Incubator will hatch a live, healthy chicken out of every fertile egg put into it, in 21 days.

Will you write for my book to-day? Just say on a postal "Please send me your Incubator Book"—that's all. Address me personally.

Manson Campbell
President

The Manson Campbell Co., Ltd.
Dept. F. 5, Chatham, Ont.

NOTE—I carry large stocks and ship promptly from branch houses at Calgary, Alta.; Montreal, Que.; Brandon, Man.; Halifax, N. S.; Victoria, B. C., and factory at Chatham.

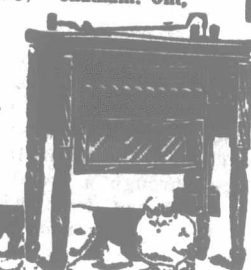

NATURALLY
you look for
Quality
In An Organ

You have simply to see and hear

SHERLOCK-MANNING

to be convinced of its superiority.

Write for catalog.

THE SHERLOCK-MANNING ORGAN CO.,
London, Ontario.



Special Price: Quoted Canadian Trade.

When Writing Please Mention this Paper

Current Events.

The Guild of the Civic Art, of Toronto, has decided to employ Sir Astor Webb, of London, Eng., to draw up plans for the improvement of the city.

Many schoolhouses in North Frontenac, Ont., have been locked, in opposition to the new school act.

Extensive car works will be erected by the National Car Co. at Whitby, Ont.

Sir William Hingston, one of Canada's most eminent physicians, died suddenly in Montreal on Feb. 19th.

Mr. Duncan C. Ross, son of Hon. G. W. Ross, was elected to the Ontario Legislature for West Middlesex by a majority of 124.

The town of Cooktown, North Australia, has been wiped out by a hurricane.

The salary pertaining to the position of British Ambassador to the United States, to which Mr. James Bryce has recently been appointed, has been increased to \$50,000 per year. Mr. Bryce has been granted an additional \$10,000 to provide for his installation expenses.

Seventy-one revolutionists were arrested recently, and 1,500 pounds' weight of revolutionary literature seized at the University of St. Petersburg.

On February 19th Emperor William opened the Reichstag at Berlin. In his speech from the throne, he expressed the hope that peace among the nations will be preserved, and that the results of the coming Hague Conference may be instrumental in "developing further the laws among nations for the good of humanity and peace."

Mr. Joseph Chamberlain is said to be a complete physical wreck, incapable of taking further part in the political life of Great Britain.

A joint expedition to seek the North Pole is being arranged between Lieut. Peary and the Italian Duke D'Abuzzi.

It is stated on good authority that Messrs. Mackenzie and Mann have bought the Quebec and Lake St. John Railway, and that they will build a new line to James Bay, with the object of developing the rich mineral district between.

One hundred and forty persons were drowned by the wreck of the steamer Berlin, from Rotterdam, near the Hook of Holland.

A bill for the reformation of the British House of Lords, providing that hereditary right in itself will not give a seat in the House, was introduced by Lord Newton on Feb. 21st.

Peter Verigin, the Doukhobor leader, asserts that 1,000 more Doukhobors will come to Canada this year.

About the House.

The following recipes, taken from "Tried and True Recipes," a little volume compiled and sold some years ago for church purposes by the Young Women's Guild, of St. Andrew's Church, Kingston, will be welcomed, no doubt, by a great many of our readers into whose hands the original volume has not fallen.

Ham Salad.—Chop the lean and fat together until the bits are the size of peas. Add 1 cup celery or lettuce to every cup of meat and mix thoroughly. Pour over it mayonnaise dressing.

Potato Salad.—Cut finely 5 or 6 potatoes and one small onion. Add pepper and salt to taste. Make a dressing of 1 cup vinegar, 2 tablespoons sugar, 1 tablespoon butter, ½ teaspoon salt, ¼ teaspoon mustard, a speck of Cayenne, 2 eggs well beaten. Put in double boiler and cook, stirring until a smooth paste. Mix with the potatoes while hot.

Fruit Salad Dressing.—Two tablespoons orange juice, ½ tablespoon lemon, ¼ teaspoon vanilla, ½ teaspoon orange-flower water, 6 drops Jamaica ginger, 6 drops almond extract, 6 blocks sugar. Mix thoroughly and add to fruit salad made of sliced raw fruit sprinkled with sugar and cocoanut.

Salad Dressing.—One tablespoon each mustard, butter and sugar; 1 teaspoon salt. Mix to a paste, add 3 eggs, and beat all together until very light. Add a cup of sweet milk and boil in double boiler, stirring all the time. Will keep about three weeks.

Another Salad Dressing.—One tablespoon sugar, 1 level tablespoon salt, 4 tablespoons butter, 1 heaping teaspoon each mustard and flour, 1 cup milk, ½ cup vinegar, 3 eggs. Melt the butter, add flour, stir until smooth, then add milk, and place the mixture in double boiler and boil. Beat eggs, add salt, sugar, mustard and vinegar, stir into the boiling mixture, and cook until thick. This keeps any time, and is greatly improved by adding whipped cream before using.

Cooked Mayonnaise Dressing.—

Yolks of 4 eggs, 2 tablespoons vinegar, 2 tablespoons lemon juice, 2 tablespoons butter, 1 teaspoon mustard, 2 teaspoons salt, ¼ cup cream. Scald the vinegar in a double boiler. Whip the yolks, add vinegar, salt, mustard and lemon juice. Boil until smooth, then add butter and cream. Cool before using. Will keep a long time.

Vanilla Souffle.—Put ½ pint milk in double boiler. Moisten 3 tablespoons flour with a little cold milk, add to hot milk, and cook until it thickens. Separate 4 eggs, add beaten yolks to hot mixture. Take from stove and mix thoroughly, flavor, then lightly fold in the whites beaten stiff. Put in greased cups, stand them in a pan of boiling water, and bake in a moderately hot oven for 15 or 20 minutes. Serve hot with liquid sauce.

Prune Whip.—Wash 1 pound prunes, cover with water, and stew 2 hours. Put through a colander until fine, and whip with an egg-beater until light. Beat whites of four eggs to a stiff froth, add 4 tablespoons white sugar and 1 teaspoon vanilla, then beat all together.

Maple Cream Sauce for Puddings.—One cup brown sugar and 1 cup butter. Boil until browned well, stirring constantly. Take off stove, and add 1 tablespoon flour and 4 cups boiling water.

Carrot Pudding.—One cup each suet, raisins, currants, brown sugar, grated carrot, grated potatoes, 1½ cups flour, 1 teaspoon soda. Steam 3 hours.

Graham Gems.—Two eggs, ½ cup sugar, butter size of an egg, 1 cup sour milk, 1 teaspoon soda, ½ cup flour, 2 cups Graham flour. Bake in gem tins in a quick oven.

Currant Buns.—One and one-half cups sugar, 1 cup shortening, 1 cup sour milk, 2 eggs, 1 teaspoon soda, 1 teaspoon baking powder, nutmeg, 1 cup currants. Mix stiff, drop on buttered pan and bake.

French Tea Biscuits.—Three cups sifted flour, 2½ teaspoons baking powder, piece of butter size of an egg (melted), 1 egg (not beaten), ½ cup sugar, a little nutmeg, 1 cup milk. Mix egg and milk together, then stir into the flour.

PURITY FLOUR



SUCCESS IN BAKING tasty, vitalizing bread depends chiefly on the flour used.

PURITY FLOUR, made solely from the choicest Western Canada Hard Wheat, has no equal as a thoroughly dependable household flour.

Sold Everywhere in the Great Dominion
WESTERN CANADA FLOUR MILLS CO. LIMITED
MILLS AT WINNIPEG, GODERIC, BRANDON



Princess Hair Rejuvenator

Makes old hair young again. Restores gradually gray or faded hair to its former color. Neither greasy nor sticky, clear as water, absolutely harmless. The cleanest and best hair restorer made. Price \$1.00, express paid.

Superfluous Hair

Moles, Warts, Ruptured Veins, etc., always permanently eradicated by our method of Electrolysis. Satisfaction guaranteed. Our scientific treatment for Pimples, Blackheads and Blisters always cures. Send stamp for booklet "F."

Graham Dermatological Institute, Dept. F., 502 Church St., Toronto. Established 15 years.

Grand Trunk Ry. System

One-way Second-class Colonist Rates from London to

San Francisco	\$41.95
Los Angeles	40.95
Mexico City	38.95
Ogden & Salt Lake, Utah	39.45
Helena & Butte, Mont.	41.95
Nelson, B. C.	
Spokane, Wash.	
Victoria, Vancouver & New Westminster, B. C.	

Rates to other points in proportion. Tickets on sale daily from March 1st to April 30th. For full information as to rates and routes, call on

E. DE LA HOOKE, City Passenger and Ticket Agent.
E. RUSE, Depot Ticket Agent.
London, Ont.

J. D. McDONALD,
District Passenger Agent, Toronto.

Please Mention this Paper

The Brantford Cordage Company, of Brantford, manufacturers of binder twine and cordage of all kinds, advertise in this paper the popular four maple-leaf brands, claimed to be better than ever. Their business has been increasing over 25 per cent. each year. They built an addition this year, and are making plans for further extension now. They are running the factory until eight o'clock, and contemplate further additions to plant and machinery for 1908. Good business management, and the use of first-class material has built up the business. Parties interested, should correspond with them for prices and particulars.

Ye Olde Firme of Heintzman & Co., Limited, Established 50 Years.

SURPRISE SALE OF HIGH-CLASS ORGANS

It's worth your while going critically through this list of organs. The best Canadian and foreign makes are represented. Every instrument is in good condition. Prices are sacrificed because selling pianos rather than organs is our business. We want the room. Price does not weigh with us. The opportunity is yours.

ORGANS.

- Geo. Woods Organ—Low back, nice walnut case, 5 octaves, 8 stops, 5 sets of reeds and knee swell. This is a very good make and suitable for a Mission or Sunday School, and is a value at \$33 00
Bell Organ—Low back, Chapel case, 5 stops, 4 sets of reeds and knee swells, 6 octaves, lamp stands, etc. A good toned organ and suitable for almost any kind of music, and a value at 35 00
Bell Organ—Medium high back, with music rack, 5 octaves, 8 stops, including vox humana stop and knee swell special at 38 00
Bell Organ—High back with music rack, 9 stops, 4 sets of reeds, 5 octaves, lamp stands, grand organ and knee swells, special at 39 00
Dominion Organ—Very handsome, high back, cylinder fall, folding mouse-proof pedals lamp stands, etc., 10 stops, couplers, including vox humana stop, grand organ and knee swell. This is a very fine organ, and first-class value at 45 00
Dominion Organ—High back, nice walnut case with extension ends, lamp stands, cylinder fall, grand organ and knee swells, folding mouse-proof pedals, 10 stops, including vox humana stop, 5 octaves, coupler, and elegant organ, and an ornament for any parlor. Special at 48 00
Doherty Organ—High back with mirror, lamp stands, 10 stops, 4 sets of reeds, including vox humana stop, couplers, 5 octaves, grand organ and knee swell. This is a very handsome organ, and a value at 50 00
Kern Organ—Exceptionally handsome high back with music rack, lamp stands, etc., beautiful walnut case, 11 stops, including vox humana stop, couplers, grand organ and knee swells, cylinder fall. This is particularly fine value at 57 00
Uxbridge Organ—High back with mirror and music rack, a very fine case, 11 stops, 4 sets of reeds, treble and bass couplers, grand organ and knee swells, 6 octaves, a very handsome organ and good toned. Special at 63 00
Morpeia Organ—13 stops, 5 octaves, piano case, 4 sets of reeds, couplers, vox humana stop, grand organ and knee swells, mouse-proof pedals, lamp stands. A very nice organ, and excellent value at 64 00
Dominion Organ—High back with extension ends, lamp stands, 11 stops, 5 sets of reeds, couplers, including vox humana stop, 6 octaves, very handsome case, grand organ and knee swells. This is a very handsome organ, and a value at 65 00
Dominion Organ—Very handsome high back with mirror and music rack, lamp stands, etc., 6 octaves, 11 stops, 4 sets of reeds, including vox humana stop, treble and bass couplers, grand organ and knee swells, folding mouse-proof pedals. This is an A1 organ, and first-class value at 66 00
Thomas Organ—5 octaves, piano case. This is a very fine organ, for home or church with beautiful walnut case, 16 stops, 5 octaves, with 8 sets of reeds, folding mouse-proof pedals. A particularly fine organ, and special at 80 00
Goderich Organ—Walnut piano-cased organ, 6 octaves, 11 stops, including vox humana stop, 4 sets of reeds, treble and bass couplers, grand organ and knee swell, practically new. Regular price, \$115. Special at 83 00
Thomas Organ—With rail top and mirror, walnut piano case, beautifully decorated top door, continuous music rack, 6 octaves, 11 stops, including vox humana stop, 4 sets of reeds, treble and bass couplers, grand organ and knee swell. Used less than 3 months. A beautiful parlor organ. Regular price, \$125. Special at 87 00
Doherty Organ—5 octaves, piano case, with rail top and mirror, 13 stops, including vox humana stop, treble and bass couplers, grand organ and knee swells, etc. An exceptionally handsome organ, only slightly shopworn. Regular price, \$115. Special at 89 00
Goderich Organ—Mahogany case, 6 octaves, 11 stops, including vox humana stop, 5 sets of reeds, treble and bass couplers, grand organ and knee swell, slightly shopworn only. Regular price, \$140. Special at 91 00
Thomas Organ—Piano case, with rail top and two mirrors, nice decorated top door, full length music rack, with 6 octaves, 12 stops, including vox humana stop, 5 sets of reeds, treble and bass couplers, grand organ and knee swells, used less than 3 months. A beautiful parlor organ. Regular price, \$140. Special at 92 50
Doherty Organ—Piano case, with rail top and two mirrors, 14 stops, 5 sets of reeds, with treble and bass couplers, grand organ and knee swell, vox humana stop, mouse-proof pedals. This is one of the handsomest organs we have seen, and has been used less than 2 months. Regular price, \$150. Special at 95 00
Mason & Hamlin Church Organ—Low back, two banks of keys, 12 stops, 10 sets of reeds including two in pedal bass, has a handle for pumping as well as foot pedals if desired. This is an A1 organ and is exceptionally fine value at 175 00
Bell Church Organ—This instrument stands 6 feet 6 inches high and 3 feet wide, and is an excellent church organ, single manual, 23 stops and 15 sets of reeds, and can be pumped by hand or foot power. The regular price of this organ is \$600, and is excellent value at 225 00

EASY TERMS OF PAYMENT.

These organs are sold under the following conditions: Organs under \$50, \$5 cash and \$3 per month; organs over \$51, \$8 cash and \$4 per month. The two church organs at \$175 and \$225, call for \$50 cash and \$10 a month. Discount 10 per cent. off for cash. If quarterly or other terms would be more convenient, write what you can do and name your choice, and we will hold it until terms are arranged. Freight paid to any point in Ontario, and satisfactory arrangements made to other provinces.

Ye Olde Firme of HEINTZMAN & CO., Limited 115-117 King St., West, TORONTO, CAN.

Dispersion Sale of Pure-bred Aberdeen-Angus and Jersey Cattle, Grade Cattle and Horses.

Property of Mr. John O'Brien, London West, Ontario, 3 miles from the City of London, on TUESDAY, MARCH 19th. 16 Aberdeen-Angus Cattle—3 bulls and 13 females, 14 Jersey Cows and Heifers, 1 Pair Grade Clydehead Geldings 6 and 7 years old, 1 Heavy Draft Gelding 3 years, 2 Carriage Fillies by Hildenby, 1 Filly and 3 Foals (general purpose) by Kennox. This herd of Jerseys has produced many prizewinners. Spot Cattle exhibited at Western Fair, London, in 1900, and is dam of four in sale. Four cows of one family in the 1-yr. made an official average record of 34 lbs. 8 ozs. milk per cow in the 1-yr. College Bloom, winner of second at Western Fair, and several other prizes in the sale. TERMS—8 months' credit on approved joint notes; 6 per cent. discount for cash. Sale to commence at 1:30 p. m. CAPT. T. E. ROBSON, Auctioneer. JOHN O'BRIEN, Prop., LONDON WEST, ONT.

Pancakes.—Two cups flour, 2 level teaspoons cream tartar, 1 teaspoon soda and pinch of salt, sifted together. Make to batter with 1 egg beaten in 1 cup milk. White Fruit Cake.—Whites of four eggs, 1/2 cup butter, 1 cup white sugar, 1 1/2 cups flour, 2 teaspoons baking powder, 2 ozs. citron peel cut fine, 4 ozs. blanched and chopped almonds, 1/2 cup coconut. Beat butter and sugar to a cream, add the beaten whites of eggs, then the flour careful-

ly sifted with baking powder, then fruit. Bake 40 minutes in a moderate oven. Potato Cake.—One and one-half cups mashed potatoes, 1 egg, 1/2 cup milk, a little salt and pepper, 1 teaspoon baking powder, flour enough to roll. Cut in squares and fry. Chocolate Icing.—Six ounces icing sugar, 1 ounce grated chocolate, 2 tablespoons water; put in a pan and stir over the fire until it is melted, then it is ready for use.

Children's Corner.

[All letters for Children's Corner must be addressed "Cousin Dorothy," 52 Victor Ave., Toronto. Otherwise they will not be published.]

The thanks of both Cousin Dorothy and Apple Blossom are due to those who have kindly sent "Caleb's Courtship." It is too long to print in the Corner.

At an archery party in Margate, A timid young lady, named Harget, Said: "I'll sit over here, Where there's nothing to fear, So she sat down in front of the target."

Little Jennie's Discovery. When electric lights were introduced into the small town on Martha's Vineyard, where little Jennie lives, she went out walking one evening with her mother, says the New York Press. Suddenly coming out from under some trees, she saw the magic light for the first time in her life.

"Oh, mamma!" she cried, fairly dancing with excitement; "mamma, look! See the moon; it's on a stick to-night!"

The Chinese Question. Dear Cousin Dorothy,—I was glad to read in your last issue that there are others who think the Cornerites can do better, if they try. Bravo! Master Fred Black, to make so brave a start, but I cannot agree with you as regards Great Britain ever giving place to China. I wonder if Fred really thinks the little yellow boys and girls of China will ever rise superior to our Canadian boys and girls, for we are part of Great Britain.

Will a people, who so long and so stubbornly resisted Christianity and civilization, an opium-eating people, a people who are naturally treacherous and untrustworthy, ever supplant our noble country? I think not. China has to thank the Anglo-Saxon race for any improvements they have made; but they will never rise to be a free-thinking, liberty-loving people; nor will they ever be able to govern so wisely and well as Great Britain. Hoping to see more on this subject, I remain, EULALIE JEFFS (age 13), Bond Head, Ont.

[An interesting letter has also been received from John Hunter, Vine, Ont., on this subject, but it is not printed for want of space.—C. D.]

The Letter Box.

Dear Cousin Dorothy,—This is my first letter to the Children's Corner. I have two dogs and a pigeon; his name is Peter. We built a new barn this year. It is the best around our place. It has a galvanized roof, which is far ahead of shingles. I go to school, and we have a nice teacher. In our school we have a library, with some very nice books in it. We had a social the other night. We had two contests. GORDON BIGAM (age 11), Crosshill.

Dear Cousin Dorothy,—I have always been very much interested in the Children's Corner, yet this is the first time I have ever written. I am nine years old, and I am a member of the Moira Mission Band; we are educating a little Japanese girl, and we have her photo. She is very intelligent looking and nice. I have one little brother, Roy, and a baby sister, May. If this does not find its way to the waste-paper basket, I will write again. EVELYN SALISBURY, Moira, Ont.

Dear Cousin Dorothy,—This is my first letter to "The Farmer's Advocate." My

father has taken this paper ten years, and I enjoy reading the letters. I often thought of writing before, but never got so far as to do it until I saw Fred Black's letter about China. You must be a very old-fashioned boy, Fred, to be thinking such deep thoughts at your age. I, too, am thirteen. I go to school all the time, and intend to try the Entrance exams soon. I read a good deal, and do some chores every day, but I play a lot too. I can drive the horses, and ride on horseback, and my brother, two years younger than myself, and I have a good time, for mother says she wants me to be a little girl as long as possible. I have an uncle home from the West for the winter. He likes the West fine, and tells such stories of the fine times he has out there. He almost makes me wish I could go too. I have a girl friend out West, who writes to me. She goes to school on a pony, and she has had several bad accidents on it. Once, she broke her arm; another time sprained her ankle. I will close, wishing the cousins all success. ANNIE HALLIDAY, Keward, Ont.

Dear Cousin Dorothy,—I often read the letters of other little girls in the Children's Corner, so I thought I would write a few lines myself. I go to school, and am in the Third Reader. On my way, I go through a wood, and I often pick a bunch of fresh wild flowers for my teacher on summer mornings. A while ago, my papa took me to hear the Bonnie Briar Bush. I thought it was so nice to hear them sing Annie Laurie and Loch Lomond, but I nearly cried when poor Flora Campbell's father turned her away from home. I have a collie dog, and his name is Glen. I am just learning to skate. My sister and I got a new subscriber for "The Farmer's Advocate," and, as a premium, we got a nice microscope and reading glass, both of which we prize very much. Wishing the Children's Corner and its kind editor a pleasant and prosperous year. MILDRED KNEAL (age 11), Holbrook, Ont.

Dear Cousin Dorothy,—I wonder if you have room for another Canadian girl? I suppose that a great many of the girls read books. I am very fond of reading. The last book I read was Charles Dickens' "Old Curiosity Shop." I have read nearly all of his books. I do not like his "Christmas Carol." What is your opinion of it? HOLLY.

Dear Cousin Dorothy,—We have never written to the Children's Corner before, but have enjoyed the letters that other boys and girls have written. Our names are Gretta, Winnie and Stella. We live on farms near each other, and have about the same number of pets. We each have a team of Shetland ponies, and two of us have a team of St. Bernard dogs, and the other has a team of Newfoundland, and we drive these in turns with the ponies to school. We have doves, rabbits, and numerous kittens. Last year, we each had a pet lamb, a calf and a pig, which we raised ourselves, and sold, and kept the money for ourselves. GRETTA F., WINNIE D. AND STELLA S. (ages 9).

Dear Cousin Dorothy,—This is my first letter to the Children's Corner. We live eight miles north of the beautiful St. Lawrence River. We have a pet lamb. I must tell my cousins how we come to have it. Last spring, one of our ewes did not like her little lamb, or the lamb did not like its mother, so we got a nursing bottle (the same as some babies use), and fed the lamb, and you should have seen her grow and play. Papa gave the lamb to my sisters, and they call her Nina. I am in the Fourth Class. RALPH McWALLACE (age 9), Shanly, Ont.

With the Flowers.

Ordering and Planting Seeds.

Already the seed catalogues are fitting about the country with their message of cheer, and garden lovers everywhere are beginning to have visions of future glories. But it is not sufficient to have visions; the prudent must also work.

The best plan, in arranging for next summer's flower garden, is to go over the catalogue (if you haven't one, send to some seedsman who advertises in this paper, as all of these are reliable, for one) and make selections, then send at once for the seeds—February will be none too early to do this. Directions for sowing accompany each packet, so, by ordering early, the difficulty of knowing which are to be sown indoors in March and which left for later sowing in the open ground, will be obviated. It may also be wise to consider just how many flowers one is prepared to work with. Many plants mean much work, and if one has but little time, or is in danger of being overworked, it may be wise to provide only for a few. A few borders well cared for always make a better showing than an extensive garden left to dwindle and become weed-grown.

When preparing the soil for indoor sowing, never make the mistake of putting it in deep boxes. Very few farms are provided with greenhouses, and heavy boxes, which have to be moved about frequently, are utterly out of place in a kitchen or living-room. Besides, the great amount of clay in a deep box is apt to become cold and sodden. First of all, then, obtain or make a number of shallow boxes, leaving cracks about the bottom which will permit of drainage. In the bottom put a good half inch (an inch would be needed in deeper vessels) of pebbles or broken crockery, and cover this over with a layer of coarse material—nothing can be better than fibrous moss—to keep the fine soil above from filtering down. This done, sift in the soil, which should be good loam, with enough sharp sand to make it porous; see that you pack it in well about the edges and corners, as otherwise it will sink and fall away at these places.

Now you are ready to sow the seed. If very fine, it should be simply sprinkled over the surface and gently pressed in; if larger, it will require a covering depending on the size of the seed. A very good rule is to cover with a layer equal in depth to the diameter of the seed. Fine sand or leaf-mould, which do not pack and may be easily pushed aside by the sprouting plantlets, will be found the best covering. Having planted the seed, do not sprinkle roughly with water, but place the box or "flat" in a pan containing the necessary depth of lukewarm water, and allow the soil to absorb the water until moist to the top. Last of all, place a pane of glass over the top of the box, and leave there until the plantlets are well "up," only removing it every day to wipe off the moisture. Do not keep the flat in direct sunshine, but give it all the light possible, and see that it is watered as above often enough to keep the soil moist.

When the first two true leaves develop, prick the plants out into similar flats. This must be done very carefully, by removing little lumps of the earth, and separating the plantlets very gently in order that the tender little roots may not be broken. A third transplanting may be necessary before the plants are finally set in the open, but for this third removal it will only be necessary to transplant into a cold frame out of doors, which may be warmly covered at nights.

By following this plan, exceedingly early flowers may be had. In order to have a succession of bloom, two or three sowings, at intervals of say three weeks apart, should be made.

Clark's Ox Tongue

Prepared from tongues that are a little better in every way, more tasty, more appetizing, and more carefully cooked.

Just what every woman wants in the house to make every meal more enjoyable. Tender, tasty and delicious. Don't have any other.

WM. CLARK, Mfr., Montreal.



"HINGE-STAYS" MAKE DILLON TWICE AS STRONG

Short, stiff, hard, steel wire stays make a "hinge-like" joint at every lateral wire on the Dillon fence. These "Hinge-stays" give our fence a greater degree of elasticity—enable it to withstand greater strain. They act like, and really are, hinges—make our fence swing or spring back into shape after receiving a heavy blow, or the unusual pressure caused by a furious bull or other animal endeavoring to push his way through to freedom. Catalogue tells more about this "twice as strong" fence.

The Owen Sound Wire Fence Co., Limited, Owen Sound, Ont.

IMPORTANT SALE OF 30 Registered Holsteins 30

WILL BE HELD AT

Napanee, Friday, March 29th, 1907

WATCH FOR FULLER PARTICULARS IN NEXT ISSUE.

H. E. George, Crampton, Ontario.

Why Paroid Roofing Costs You Less!

IT'S a simple proposition.

Paroid Roofing costs you less per year because it lasts longer than any other kind of ready roofing.

It lasts longer because it is better made and is made of better materials.

You can see and feel the difference.

We can prove to you the difference.

It will pay you to get the proofs—because it means a saving of dollars to you.

Here are some of the reasons:

The felt that is the foundation of Paroid is made in our own mills, and is stronger, tougher, more durable than any other.

We are in position to know that it is right. You cannot afford to buy a roofing made from a cheap felt or from a manufacturer who does not make his own felt.

Paroid has a thicker, smoother, more pliable and more durable coating than any other.

Just compare samples and see for yourself.

Paroid is the only roofing laid with square, rust-

proof caps, which have the largest and strongest binding surface and cannot leak, work loose and cause leaks.

At every point, and in every way, Paroid is a superior roofing of proved and tested quality. You

don't have to take our word for it. Read our offer.

Paroid has stood the test of time at the hands of the United States Government, of leading manufacturers and railways, of farmers, dairymen and poultrymen everywhere at home and abroad.

Get Building Plans Free

Write to-day for free samples of Paroid. You can tell it's the better kind of roofing. Enclose 4 cents in stamps to pay postage and we will send you free our Book of Plans for Farm, Poultry, Dairy and Live Stock Buildings. It will save you money in building. If your dealer does not handle Paroid, don't take a substitute. Write to us, we pay the freight.

F. W. BIRD & SON,

(Established in U. S. A. in 1877)

Canadian Factory and Office, Hamilton, Ont.

We stand back of every foot of Paroid. Originators of the ready roofing roll containing complete kit for applying.

Some Good Plants for Next Summer's Garden.

1. Aster.—Do not order the quilled or the purple or crimson varieties. The Ostrich Feather, Chrysanthemum and Comet varieties, in white, shell-pink and lavender coloring, are much prettier.

2. Poppies.—The Shirley and Tulip varieties are very beautiful. The California, or Eschscholtzia, a bright yellow poppy, with finely-cut leaves, is very dainty, also. As poppies do not bear transplanting, they are not among the plants that can be started in the house.

3. Coreopsis.—Very graceful plants, with long, fine stems, bearing a profusion of yellow flowers. The mixed brown-and-yellow variety is the prettiest.

4. Annual Phlox.—Drummond's Grandiflora (mixed colors), with a few of the Fimbriata (or fringed) kinds for variety, will be found very satisfactory. The dwarf species will also be found very useful for borders.

5. Cosmos.—A plant with beautiful, finely-cut foliage and attractive flowers that will keep on blooming in the house if removed from the garden in late fall. Early planting is absolutely necessary for the Cosmos.

6. Petunias.—Very easy of cultivation. The fringed and ruffled varieties are the most attractive.

7. Portulaca.—Will grow in sandy soil and in hot, exposed situations where nothing else seems to do well.

8. Gaillardia.—Very showy flowers, resembling in color, somewhat, the Coreopsis, but much larger. Flowers a long time.

9. Zinnia.—The new varieties in rich, deep coloring are very handsome for certain situations. They also bloom a very long time.

10. Verbena.—Should be sown early. Crimson, white and lemon-scented varieties are the best.

The above list is made up chiefly of the more brilliantly-colored flowers, especially satisfactory in that they are easy to cultivate, and bloom a long time. The list will be continued next week, when some of the daintier varieties will be introduced.

TRADE TOPICS.

SIMMERS' SEEDS for field and garden are advertised in this paper by the old-established seed house of J. A. Simmers, Toronto, Ont., whose 1907 catalogue will be mailed free on application.

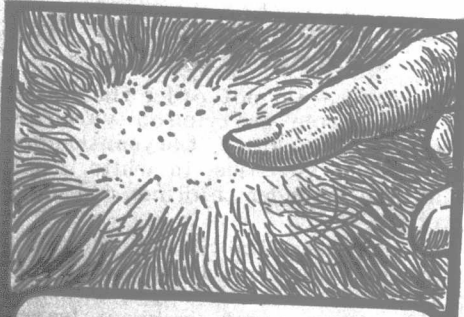

What a Bare Spot Means

Watch closely for the first indication of lice on cattle. Don't wait till they are infested, and rub themselves sore in their misery. The wisest course is to dust Instant Louse Killer into the hair along the back, and at base of tail and horns, whether you see signs of lice or not. If there is a louse on the animal this powder will kill it.

Instant Louse Killer

Does it's work thoroughly—kills lice on poultry, horses, cattle, ticks on sheep, bugs on cucumber, squash and melon vines, cabbage worms, slugs on rose bushes, etc. It is also a standard disinfectant and deodorizer. Guaranteed. Comes in shaker-top cans, and being a powder, may be used in cold weather as readily as in hot weather. Look for the word "INSTANT" on can, as there are many imitations.

1 lb. 35 cents 3 lbs. 85 cents.

If your dealer cannot supply you, send your order to us.

Manufactured by
Dr. HESS & CLARK
Ashland, Ohio, U. S. A.

POULTRY AND EGGS

Condensed advertisements will be inserted under this heading at two cents per word each insertion. Each initial counts for one word, and figures for two words. Names and addresses are counted. Cash must always accompany the order for any advertisement under this heading. Parties having good pure-bred poultry and eggs for sale will find plenty of customers by using our advertising columns. No advertisement inserted for less than 30 cents.

EGGS—White Wyandottes, White Leghorns. Standard stock Fertility guaranteed. Dollar per s. t. g. E. W. Burt, Paris, Ont.

EGGS for hatching from McCormack's prize-winning White Leghorns at \$1 per 15 upwards. Send for mailing list. Jas. L. McCormack, Brantford, Ont.

FOR SALE—Bouen ducks, prizewinning strain. Prices reasonable. Write for particulars. John Inzie, Romney, Ont.

FOR SALE—High-class White Leghorn cockerels. Bred from grand exhibition and laying stock. Prices reasonable for quick buyers. Jas. McCracken, Brantford, Ont.

INCREASE your profits by buying eggs from healthy heavy-laying Barred and White Rocks, White and Silver Wyandottes, Buff and Black Orpington, Brown and White Leghorns, Black Javas, \$1 per fifteen. Black and Silver Spangled Hamburgs, Blue Andalusians and Rhode Island R. ds., \$1.50 per fifteen. F. W. Krouse, Guelph.

MAMMOTH Bronze Turkeys, Silver-Gray Dorkings, Barred Rocks, from prizewinning. Pairs not skinned. Alfred E. Shore, White Oak, Ont.

MAMMOTH Bronze turkeys, bred from imported stock. We have an extra heavy and well-colored lot. T. Hardy Shore & Sons, Glenworth, Ont.

WHITE Wyandottes—Few fine, vigorous cockerels. Eggs in season. W. D. Monkman, Bond Head, Ont.

237-EGG Strain Barred Rocks for particular. Write for circular. J. B. Henry, Warden, Ont.

MAMMOTH BRONZE TURKEYS—I have a few choice M. B. toms, weighing 27 lbs. each, left, and a few heavyweight pullets. They are sired by my prizewinning imported toms. Pairs and trios mated not skinned. W. E. WRIGHT, Glenworth, Ont.

POULTRY PAYS Our Book, "Poultry for Profit and Pleasure" mailed for 10 cents. Delavan Poultry Farm, F. H. E. Goets, Manager, Box 25, Delavan, Wis.

Hatch Chickens by Steam with the EXCELSIOR INCUBATOR OR WOODEN HEN

Simple, perfect, self-regulating. Hatch every fertile egg. Lowest priced first-class hatchery made. GEO. E. STAHL, Guelph, Ill.

Send for free Catalogue.

Bob, Son of Battle.

By ALFRED OLLIVANT.

(Serial rights secured by "The Farmer's Advocate and Home Magazine.")

PART VI.
The Black Killer.

CHAPTER XXVI.
Red-handed.

The sun was hiding behind the Pike. Over the lowlands the feathery breath of night hovered still. And the hillside was shivering in the chillness of dawn.

Down on the silvery sward beside the Stony Bottom there lay the ruffled body of a dead sheep. All about the victim the dewy ground was dark and patchy like dishevelled velvet; bracken trampled down; stones displaced as though by striving feet; and the whole spotted with the all-pervading red.

A score yards up the hill, in a writhing confusion of red and gray, two dogs at death-grips. While yet higher, a pack of wild-eyed hill-sheep watched, fascinated, the bloody drama.

The fight raged. Red and gray, blood-spattered, murderous-eyed; the crimson froth dripping from their jaws; now rearing high with arching crests and wrestling paws; now rolling over in tumbling, tossing, worrying disorder—the two fought out their blood-feud.

Above, the close-packed flock huddled and stamped, ever edging nearer to watch the issue. Just so must the women of Rome have craned round the arenas to see two men striving in death-struggle.

The first cold flicker of dawn stole across the green. The red eye of the morning peered aghast over the shoulder of the Pike. And from the sleeping dale there arose the yodling of a man driving his cattle home.

Day was upon them.

James Moore was waked by a little whimpering cry beneath his window. He leapt out of bed and rushed to look; for well he knew 'twas not for nothing that the old dog was calling.

"Lord o' mercy! whatever's come to yo', Owd Un?" he cried in anguish. And, indeed, his favorite, war-daubed almost past recognition, presented a pitiful spectacle.

In a moment the Master was downstairs and out, examining him.

"Poor old lad, yo' have caught it this time!" he cried. There was a ragged tear on the dog's cheek; a deep gash in his throat from which the blood still welled, staining the white escutcheon on his chest; while head and neck were clotted with the red.

Hastily the Master summoned Maggie. After her, Andrew came hurrying down. And a little later a tiny, night-clad, naked-footed figure appeared in the door, wide-eyed, and then fled, screaming.

They doctored the old warrior on the table in the kitchen. Maggie tenderly washed his wounds, and dressed them with gentle, pitying fingers; and he stood all the while grateful yet fidgeting, looking up into his master's face as if imploring to be gone.

"He mun a had a rare tussle wi' some one—en, dad?" said the girl, as she worked.

"Ay, and wi' whom? 'Twasn't for nowt he got fightin', I war'n't. Nay; he's a tale to tell, has The Owd Un, and— Ah! he! I thowt as much. Look 'ee!" For, bathing the bloody jaws, he had come upon a cluster of tawny red hair, and a pair of eyes of the lips.

"Those few hairs tell me 'tis a passing tale. To but one man in the hill-country could they belong. 'Tis the Black Killer."

"He mun a had a rare tussle wi' some one—en, dad?" said the girl, as she worked.

"Ay, and wi' whom? 'Twasn't for nowt he got fightin', I war'n't. Nay; he's a tale to tell, has The Owd Un, and— Ah! he! I thowt as much. Look 'ee!"

answered. "But Th' Owd Un shall show us."

The old dog's hurts proved less severe than had at first seemed possible. His good gray coat, forest-thick about his throat, had never served him in such a good stead. And at length, the wounds washed and sewn up, he jumped down all in a hurry from the table and made for the door.

"Noc, owd lad, yo' may show us," said the Master, and, with Andrew, hurried after him down the hill, along the stream, and over Langholm How. And as they neared the Stony Bottom, the sheep, herding in groups, raised frightened heads to stare.

Of a sudden a cloud of poisonous flies rose, buzzing, up before them; and there in a dimple of the ground lay a murdered sheep. Deserted by its comrades, the glazed eyes staring helplessly upward, the throat horribly worried, it slept its last sleep.

The matter was plain to see. 'At last the Black Killer had visited Kenmuir.

"I guessed as much," said the Master, standing over the mangled body. "Well, it's the worst night's work ever the Killer done. I reck'n Th' Owd Un come on him while he was at it; and then they fought. And, ma word! it mun ha' bin a fight too." For all around were traces of that terrible struggle: the earth torn up and tossed, bracken uprooted, and throughout little dabs of wool and tufts of tawny hair, mingling with dark-stained iron-gray wisps.

James Moore walked slowly over the battlefield, stooping down as though he were gleaning. And gleaning he was.

A long time he bent so, and at length raised himself.

"The Killer has killed his last," he muttered; "Red Wull has run his course." Then turning to Andrew: "Run yo' home, lad, and fetch the men to carry yo' way away," pointing to the carcass. "And Bob, lad, yo've done your work for to-day, and right well too; go yo' home wi' him. I'm off to see to this!"

He turned and crossed the Stony Bottom. His face was set like a rock. At length the proof was in his hand. Once and for all the hill-country should be rid of its scourge.

As he stalked up the hill, a dark head appeared at his knee. Two big gray eyes, half doubting, half penitent, wholly wistful, looked up at him, and a silvery brush signalled a mute request.

"Eh, Owd Un, but yo' should ha' gone wi' Andrew," the Master said. "Hooever, as yo' are here, come along." And he strode away up the hill, gaunt and menacing, with the gray dog at his heels.

As they approached the house, M'Adam was standing in the door, sucking his eternal twig. James Moore eyed him closely as he came, but the sour face framed in the door betrayed nothing. Sarcasm, surprise, challenge, were all writ there, plain to read; but no guilty consciousness of the other's errand, no storm of passion to hide a failing heart. If it was acting it was splendidly done.

As man and dog passed through the gap in the hedge, the expression on the little man's face changed again. He started forward.

"James Moore, as I live!" he cried, and advanced with both hands extended, as though welcoming a long-lost brother. "Deed and it's a weary while sin' ye've honored ma pur hoose." And, in fact, it was nigh twenty years. "I tak' it ge' kind in ye to look in on a lonely auld man. 'Come ben and let's ha' a crack. James Moore kens weel hoo welcome he ave is in ma bit biggin'."

The Master ignored the greeting.

"One o' ma sheep been killed back o' 't Dyke," he announced shortly, jerking his thumb over his shoulder.

"The Killer?"

"The Killer."

The cordiality beaming in every wrinkle of the little man's face was absorbed in a wondering interest; and that again gave place to sorrowful sympathy. "Dear, dear! it's come to that, has it—at last?" he said gently, and his eyes wandered to the gray dog and dwelt mournfully upon him. "Man, I'm sorry—I canna tell ye I'm surpris'd. Masel, I kent it all along. But gin Adam M'Adam had tellt ye, ye'd no ha' believed him. Weel, weel, he's lived his life, gin ony dog ever did; and noo he mun gang where he's sent a many before him. Puir mon! puir tyke!" He heaved a sigh, profoundly melancholy, tenderly sympathetic. Then, brightening



Dr. WOOD'S NORWAY PINE SYRUP

Cures COUGHS, COLDS, BRONCHITIS, HOARSENESS and all THROAT AND LUNG TROUBLES. Miss Florence R. Mailman, New Germany, N.S., writes:— [I had a cold which left me with a very bad cough. I was afraid I was going into consumption. I was advised to try DR. WOOD'S NORWAY PINE SYRUP. I had little faith in it, but before I had taken one bottle I began to feel better, and after the second I felt as well as ever. My cough has completely disappeared.]

PRICE 25 CENTS.

Advertisements will be inserted under this heading, such as Farm Properties, Help and Situations Wanted, Pet Stock, and miscellaneous advertising.

TERMS—Three cents per word each insertion. Each initial counts for one word and figures for two words. Names and addresses are counted. Cash must always accompany the order. No advertisement inserted for less than 50 cents.

A FINE stock farm of nearly 700 acres; level land; running stream; magnificent pasture; clay loam; large barn with two wings; good house; forty acres of wood; one mile from post office; ten miles east of Hamilton; two miles from railroad. Must be sold to close estate. Will consider exchange for city property. Easy terms. Price less than fifty dollars per acre. Apply Burk & Co., 28 Toronto street, Toronto.

FOR SALE or to rent—The Coatham Gore Cheese Factory. Apply to Wm. George, Tupperville, Ont.

FOR SALE—Two-story brick house. Ten rooms. With six acres of land. One hundred fruit trees. Outshirts of town. Three thousand population. Great Bargain. Drawer F. Clinton, Ont.

IMPORTANT to stockmen—Humane de-horned applied to your calves will effectually dehorn them. The operation causes no pain, and is uniformly successful. Fully guaranteed. Price \$1 per box, prepaid. Write for literature. G. H. Tully, box 86, Brantford, Ont.

MARRIED couple, without family, want situation; wife as housekeeper; man for farm; experienced. Lovett, care Nanckivell, Ingersoll, Ont.

TO RENT, dairy farm at Islington; 100 acres; basement stable; on a milk route. Apply Montgomery, Canada Life Building, Toronto.

WANTED—Ladies in rural districts desirous of engaging in profitable business will do well to write the Robinson Corset & Costume Co., London, Ont.

Special—Several first class farms; ready for crop; close to elevator. Fourteen dollars per acre. Also several choice unimproved three-hundred-and-twenty-acre farms near Moose Jaw. Ten dollars. These exceptional bargains. A. & F. MAYBERY, Moose Jaw, Sask.

SEED CORN on the cob. Canadian-grown and hand-selected of leading varieties is advertised by J. O. Duke, Ruthven, Essex Co., Ont.

Mr. Robert Miller, Stouffville, Ont., writes: "During the past ten days, I have sent to the United States, three small shipments of Shorthorns. There were in the lot one imported bull and nine cows and heifers, mostly bred in Canada. There has not been a more select lot, both in breeding and quality, shipped from Canada for many months. Have sold, this week, the red imported bull calf, Mountain Hero, to Messrs. Hope & Sons, Scugog, Ont. They have been using one of the best imported bulls I know of, and I got him in the exchange. Ever since I have seen his calves, I have had a wish to own him. Have also sold to my old customer, Mr. McClary, of Hillhurst, P. Q., a good young bull, from imported sire and dam; as usual, he took a lot of our best from this district. Good bulls, both imported and home-bred, are wanted, and I have them."

Liver Trouble From Overeating

THE KIDNEYS AND BOWELS ALSO DERANGED AND CURE ONLY OBTAINED BY USE OF

DR. CHASE'S KIDNEY-LIVER PILLS

Hurried eating and lack of proper mastication of the food are among the most common causes of indigestion, and overeating is undoubtedly the beginning of trouble with the liver and kidneys.

Kidney disease and rheumatism are not usually the first indication of a deranged system, but these troubles follow unheeded headaches, constipation and bilious attacks.

Because of that direct and combined action on the liver, kidneys and bowels, Dr. Chase's Kidney-Liver Pills are effective in whatever stage of such derangements they may be used, except when the structure of the kidneys has been wasted away by Bright's disease.

What we would emphasize, however, is the advantage of beginning this treatment at the first indication of trouble with the liver. It is the liver which first feels the result of overeating, because of its difficulty in filtering the blood. Keep the liver right by the timely use of Dr. Chase's Kidney-Liver Pills, and you not only prevent headaches, biliousness and constipation, but entirely escape derangements of the kidneys, which are at once so dreadfully painful and fatal.

Mrs. E. Husband, Moore Street, St. Catharines, Ont., states: "I was seriously afflicted with indigestion and stomach trouble for sixteen years. Finally, I became so bad that I could scarcely eat anything without suffering terrible distress. Gradually I grew weaker and more emaciated, and though treated by three doctors and a specialist, I received no benefit.

"After a time a pain began in my right side, which medical men said was liver trouble. I never got relief until I began the use of Dr. Chase's Kidney-Liver Pills, and they helped me at once. By using about a dozen boxes, I was entirely cured. I owe my cure entirely to this treatment, and make this statement with the hope that some poor sufferer may benefit by my experience."

Dr. Chase's Kidney-Liver Pills, one pill a dose. 25 cents a box, at all dealers, or Edmanson, Bates & Co., Toronto.

SHEET STEEL BRICK
WRITE FOR PRICES
METALLIC ROOFING CO. LIMITED.
TORONTO, CANADA.

TELEGRAPHY
Is the first step towards positions paying from \$5,000 to \$15,000 per annum in railway service. You can become a good operator in six months if you study in the Central Telegraphy School, 3 Gerrard St. east, Toronto. The finest school in Canada. Write for particulars.
W. H. SHAW, Pres. T. R. JOHNSTON, Prin.

CATALOG FREE WRITE TODAY.
Learn by Mail to **Mount Birds**
GAME HEADS, TAN SKINS AND MAKE RUGS. Sportsmen and naturalists may NOW learn at home to mount all kinds of specimens true to life. Save your fine trophies, decorate home and den, make BIG PROFITS in your spare time. A most fascinating art, easily and quickly learned by MEN, WOMEN AND BOYS. WE TEACH BY MAIL all branches of the wonderful art of TAXIDERMISTRY, the art so long kept a secret. Every hunter, trapper and nature-lover needs Taxidermy, and should take our course. 15 complete lessons, best methods, best tools. SATISFACTION GUARANTEED. Thousands of successful students. Highest endorsements. Fine CATALOG, the Taxidermy Magazine, and full particulars FREE for short time. WRITE FOR THEM TODAY.
THE N. W. SCHOOL OF TAXIDERMISTRY
148 S. Omaha, Nebraska.

up a little: "Ye'll ha' come for the gun?"

James Moore listened to this harangue at first puzzled. Then he caught the other's meaning, and his eyes flashed.

"Ye fool, M'Adam! did ye hear iver tell o' a sheep-dog worryin' his master's sheep?"

The little man was smiling and suave again now, rubbing his hands softly together.

"Ye're right, I never did. But your dog is not as ither dogs—There's none like him—none, I've heard ye say yersel, mony a time. An' I'm wi' ye. There's none like him—for devilmint."

His voice began to quiver and his face to blaze. "It's his cursed cunning that's deceived ivery one but me—whelp o' Satan that he is!" He shouldered up to his tall adversary. "If not him, wha else had done it?" he asked, looking up into the other's face as if daring him to speak.

The Master's shaggy eyebrows lowered. He towered above the other like the Muir Pike above its surrounding hills.

"Wha, ye ask?" he replied coldly, "and I answer you. Your Red Wull, M'Adam, your Red Wull. It's your Wull's the Black Killer! It's your Wull's bin the plague o' the land these months past! It's your Wull's killed ma sheep back o' yon!"

At that all the little man's affected good-humor fled.

"Ye lee, mon! ye lee!" he cried in a dreadful scream, dancing up to his antagonist. "I knoo hoo 'twad be. I said so. I see what ye're at. Ye've found at last—blind that ye've been—that it's yer ain hell's tyke that's the Killer; and noo ye think by yer keen impitations to throw the blame on ma Wullie. Ye rob me o' ma Cup, ye rob me o' ma son, ye wrang me in like thing; there's but ae thing left me—Wullie. And noo ye're set on takin' him awa'. But ye shall not—I'll kill ye first!"

He was all a-shake, bobbing up and down like a stopper in a soda-water bottle, and almost sobbing.

"Ha' ye no wranged me enough wi'oot that? Ye lang-leggit liar, wi' yer skulkin' murderin' tyke!" he cried. "Ye say it's Wullie. Where's yer proof?"—and he snapped his fingers in the other's face.

The Master was now as calm as his foe was passionate. "Where?" he replied sternly; "why there!" holding out his right hand. "Yon's proof enough to hang a hummer'd." For lying in his broad palm was a little bundle of that damning red hair.

"Where?"

"There!"

"Let's see it!" The little man bent to look closer.

"There's for yer proof!" he cried, and spat deliberately down into the other's naked palm. Then he stood back, facing his enemy in a manner to have done credit to a nobler deed.

James Moore strode forward. It looked as if he was about to make an end of his miserable adversary, so strongly was he moved. His chest heaved, and the blue eyes blazed. But just as one had thought to see him take his foe in the hollow of his hand and crush him, who should come stalking round the corner of the house but the Tailless Tyke?

A droll spectacle he made, laughable even at that moment. He limped sorely, his head and neck were swathed in bandages, and beneath their ragged fringe the little eyes gleamed out fiery and bloodshot.

Round the corner he came, unaware of strangers; then straightway recognizing his visitors, halted abruptly. His hackles ran up, each individual hair stood on end till his whole body resembled a new-shorn wheat-field; and a snarl, like a rusty brake shoved hard down, escaped from beneath his teeth. Then he trotted heavily forward, his head sinking low and lower as he came.

And Owd Bob, eager to take up the gage of battle, advanced, glad and gallant, to meet him. Daintily he picked his way across the yard, head and tail erect, perfectly self-contained. Only the large gray hair about his neck stood up like the ruff of a lady of the court of Queen Elizabeth.

But the war-worn warriors were not to be allowed their will.

"Wullie, Wullie, wad ye!" cried the little man.

"Bob, lad, coom in!" called the other.

Then he turned and looked down at the man beside him, contempt flaunting in every feature.

"Well?" he said shortly.

M'Adam's hands were opening and shutting; his face quite white beneath the tan; but he spoke calmly.

"I'll tell ye the whole story, and it's the truth," he said slowly. "I was up there the morn'—pointing to the window above—" and I see Wullie crouchin' down alongside the Stony Bottom. (Ye ken he has the run o' ma land o' nests, the same as your dog.) In a minnit I see anither dog squatterin' along on your side the Bottom. He creeps up to the sheep on th' hillside, chases 'em, and doons one. The sun was risen by then, and I see the dog clear as I see you noo. It was that dog there—I swear it!" His voice rose as he spoke, and he pointed an accusing finger at Owd Bob.

"Noo, Wullie! thinks I. And afore ye could clap yer hands, Wullie was over the Bottom and on to him as he gorged—the bloody-minded murderer! They fought and fought—I could hear the roarin' o' where I stood. I watched till I could watch nae langer, and, all in a sweat, I rin' down the stairs and oot. When I got there, there was yer tyke makin' fu' split for Kenmuir, and Wullie comin' up the hill to me. It's God's truth, I'm tellin' ye. Tak' him hame, James Moore, and let his dinner be an ounce o' lead. 'Twill be the best day's work iver ye done."

The little man must be lying—lying palpably. Yet he spoke with an earnestness, a seeming belief in his own story, that might have convinced one who knew him less well. But the Master only looked down on him with a great scorn.

"It's Monday to-day," he said coldly. "I gie yo' till Saturday. If ye've not done your duty by then—and well you know what 'tis—I shall come do it for ye. Ony gate, I shall come and see. I'll remind ye agin o' Thursday—ye'll be at the Manor dinner, I suppose. Noo I've warned ye, and you know best whether I'm in earnest or no. Bob, lad!"

He turned away, but turned again.

"I'm sorry for ye, but I've ma duty to do—so've ye. Till Saturday I shall breathe no word to ony soul o' this business, so that if you see good to put him oot o' the way wi'oot bother, no one need iver know as hoo Adam M'Adam's Red Wull was the Black Killer."

He turned away for the second time. But the little man sprang after him, and clutched him by the arm.

"Look ye here, James Moore!" he cried in thick, shaky, horrible voice. "Ye're big, I'm sma'; ye're strang, I'm weak; ye've ivery one to your back, I've niver a one; you tell your story, and they'll believe ye—for you gae to church; I'll tell mine, and they'll think I lie—for I dinna. But a word in your ear! If iver agin I catch ye on ma land, by—!"—he swore a great oath—"I'll no spare ye. You ken best if I'm in earnest or no." And his face was dreadful to see in its hideous determinedness.
(To be continued.)

Schoolboy "Howlers."

Amongst the gems of a collection of school-boy "howlers" given in the "University Correspondence and College Magazine" are the following:

Socrates died from a dose of wedlock. The name of Caesar's wife was Cæsarea; she was above suspicion.

Simon de Montfort formed what was known as the Mad Parliament—it was something the same as it is at the present day.

The Star Chamber was a room decorated with stars in which tortures were carried out. From this we have the modern expression 'to see stars'—that is, to be in pain.

The Tories objected to the passing of the Reform Bill because they thought that the House of Commons would soon be filled with republicans and sinners.

"Cabal" is a short name for the English Prime Minister; ca stands for Campbell, and ba for Bannerman, and the l at the end means that he is a Liberal.

The Duke of Marlborough was a great general, who always fought with a fixed determination to win or lose.

For Strains
—of Back —of Shoulder
—of Stifle —of Hough
—of Whirlbone —of Knees
—of Fetlock —of Coffin Joint
—of Pastern

Swelling and all Lameness in Horses use

Fellows' Leaming's Essence

Two or three teaspoonfuls in a little Rum or Brandy, cures Sprains, Bruises and Lameness in 24 hours—takes out all the soreness—and puts horses "on their feet again."

50c. a bottle. If your druggist does not have it, send to

National Drug & Chemical Co. Limited, Montreal.

The most savage bull will find his great strength of no avail in an argument with

SAMSON-LOCK FENCING

Samson-Lock-Fencing is the heaviest, strongest, stiffest fence that can be constructed. Laterals and uprights are of hard steel wire, united together at points of intersection in a viselike, immovable grip by our famous Samson-Lock—the strongest fence lock on earth, bar none. Booklet on request.

AGENTS WANTED for the easiest selling, most satisfactory wire fencing. Exclusive territory. Write to-day for our good proposition.

Dennis Wire and Iron Works Co., Limited, LONDON, ONTARIO.

WHY NOT

Be a telegraph operator and earn from \$45 to \$125 monthly. Send to-day for Free Booklet "K" which tells you how.

CANADIAN SCHOOL OF TELEGRAPHY, Cor. Yonge and Queen St., TORONTO. Oldest Telegraph School in Canada.

MONEY IN CANARIES

More profitable than poultry. Expenses unnecessary. We give advice free. Our new book, "Money in Canaries," tells all about it. With book, we send free, if you name this paper, a 10c packet BIRD BREAD. Also, "How to RISE Birds of Lice," and "Bird Magazines." Send for 10-day, stamps or collect. If you buy birds from us, birds shipped anywhere any time. Write to know buying. Address:

COTTAM BIRD SEED
22 Bathurst St., London, Ont.

Rupture Cure

New, natural remedy. Absolutely certain. Scores cured lately. Write for free booklet to L.V. N. MFG. CO., 435 Yonge St., Toronto.

POTASH

may be obtained from all the leading fertilizer dealers in the highly-concentrated forms of

MURIATE of POTASH or SULPHATE of POTASH

For Tobacco, Sugar Beets and Potatoes apply Sulphate of Potash. On all other field crops, as well as in the Orchard, Muriate of Potash will give entirely satisfactory results. Potash is not merely a stimulant, it is a direct plant food, and has a beneficial after-effect. As a rule, to secure best results, Potash ought to be applied along with a Phosphatic Fertilizer early in spring. Any reader of "The Farmer's Advocate" who desires to obtain copies of publications treating of the Results of Fertilizer Experiments in Canada and elsewhere may secure the same **GRATIS** by addressing

THE DOMINION AGRICULTURAL OFFICES OF THE POTASH SYNDICATE,
Rooms 1102-1105 Temple Building, TORONTO, CANADA.



Get Ready for Spring

THIS IS CARNEFAC SEASON

It pays immensely to use CARNEFAC for all **Farm Stock and Poultry**. The cost is but a trifle. It brings the stock out in excellent shape, and prevents untold losses at the critical time, when **colts, calves, pigs and lambs** arrive.

Try it for this season, the results will convince you.
Use Magic Healer for scratches, wire cuts and all sores.

The Carnefac Stock Food Co.,
Toronto.

A Good Investment

and made specially for farm work. They

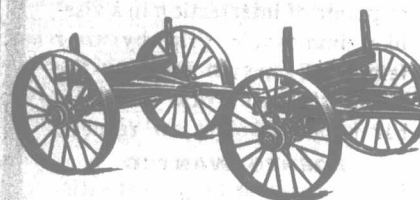

Our Wrought Iron wheels are always ready for use, and there is no re-setting of tires. They have broad flat tires that will not sink into soft ground, which makes loading and unloading easy. The only wheel made that can be taken apart and put together again, and all parts are renewable.

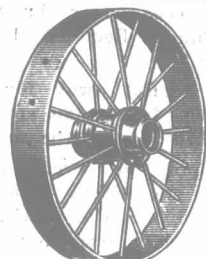

Made any width of tire. Any height desired. To fit any axle. They are absolutely guaranteed. Write to-day for free booklet giving full description of both Wheels and Handy Wagons.
THE DOMINION WROUGHT IRON WHEEL CO., LTD., ORILLIA, ONT.

The Eastern Ontario Live Stock and Poultry Show

WILL BE HELD AT

OTTAWA, ONT., MARCH 4th to 8th, 1907

Exhibits will consist of live and dressed cattle, sheep, swine and poultry; also a dairy show and a seed exhibit. Large cash prizes offered for the various sections. The show will be held in the splendid new building. Practical lectures will be given by experts each day. Live-stock entries close February 23rd; poultry entries close February 18th. Reduced Rates on all Railways. For prize list, entry form or programme apply

J. C. SMITH,
President.

A. P. WESTERVELT,
Secretary, Parliament Buildings, Toronto.

Seeds for the Farm

You Want Good Clean Clover and Timothy.

	Per bushel.
"Sun" Red Clover.....	\$10 50
"Ocean" Alsike.....	10 00
"Gold" Lucerne.....	10 00
"Diamond" Timothy.....	3 50

MY BEST BRANDS.

You can not make a mistake in ordering these. Send for samples and see for yourselves.

SEND FOR 1907 CATALOGUE.

GEORGE KEITH, 124 KING ST. EAST, Toronto, Ont.

Mention the Advocate when writing.

GOSSIP.

For extended reference to the important dispersion sale of the noted Shorthorn herd of Mr. Jas. A. Crerar, Shakespeare, Ont., to take place March 7th, see inside back cover page of this issue.

March 7th is the date of the dispersion sale of the dual-purpose Shorthorn herd of G. J. Jopling & Sons, at Bridgenorth, Ont., six miles from Peterboro, C. P. R. and G. T. R.; 35 head, 18 bulls, 17 females, mostly of deep-milking strains.

John M. Krick, Lincoln Co., Ont., sends the following cure for lice on cattle, which he has used for years without a failure: "Four gallons of rainwater, one-half gallon of coal oil, one bar of Judd soap. Put one-half gallon water on the stove, and slice the soap in. Stir and boil until the soap is dissolved, then put in the rest of the water, and add the oil last of all, and stir until cold. Use it as a wash."

Attention is again called to the advertisement of the dispersion sale, on March 7th, of 7 Clydesdale mares and fillies, a two-year-old stallion, 26 head of Shorthorn cattle, and a number of Cotswold and Hampshire sheep, imported or bred from imported stock, the property of Mr. J. C. Ross, at Jarvis, Ont., on the G. T. R. This stock will be found well worth looking after, as Mr. Ross has been importing and breeding for many years, Clydesdales and sheep, while the Shorthorns are a useful dual-purpose class in good healthy breeding condition, and of good milking strains.

Attention is called to the advertisement of the auction sale to take place on March 12, 13 and 14, of pure-bred stock, fat cattle, horses and chattels belonging to the estate of the late Captain D. Milloy, at Oak Park Farm, near Brantford, Ont. This is one of the very best and most completely-equipped farms in Canada, containing some 600 acres, and everything will be positively sold, as the farm has been disposed of, and the late owner was a bachelor. The herd of 48 head of pure-bred Shorthorns is included in the sale, as well as horses, a great stock of harness in A1 order, fat cattle ready for export, implements and superior household furniture.

MERCER'S CLYDESDALE SALE.

On Thursday, March 7th, as advertised, Mr. Thomas Mercer, of Markdale, Ont., on the Owen Sound branch of the C. P. R., will sell, at auction, 30 imported fillies and mares, from one to six years old, described as a big, quality lot, representing Scotland's richest blood, part of them bred to high-class sires before shipment, and comprising several matched pairs. Mr. Mercer's former importations have been of a superior class, finding ready buyers, and we are assured that this offering is of even a more desirable class. There is room and need for many more mares of this kind in the country, to provide for the great demand for heavy horses. Remember the date, and send for the catalogue, which shows that these mares are sired by some of the most noted horses in Scotland, such as Baron's Pride, Hiawatha and their best sons, and others equally well bred.

Mr. E. F. Park, of Burgessville, Ont., a station on the Stratford to Woodstock and Port Dover branch of the G. T. R., advertises that, on Wednesday, March 6th, he will sell at auction 60 pure-bred Cotswold sheep, comprising 40 ewes in lamb, mostly two- and three-year-olds, and due last of March and in April, 10 ewe lambs, and 12 yearling rams and ram lambs, among them a number of prizewinners. This flock have won a large share of the first prizes at the leading Canadian shows in recent years, including the National at Toronto, the Canada Central at Ottawa, the Dominion Exhibition at Halifax, and the Provincial at Charlottetown, P. E. I. These are large, strong-boned, heavy-fleeced sheep, extra well covered on head and legs. The imported stock ram will also be sold, and several of the other rams are from imported sire and dam. With present prices and prospects, there is no more profitable stock than sheep. And Cotswolds are in great demand in the States and Canada, and steadily gaining in favor.

The attention of readers interested in drilling wells for water, oil, gas or minerals, is called to the advertisement in this issue of the A. R. Williams Machinery Company. Write for their catalogue to any of the agencies named.

Mr. H. Gerald Wade, Ottawa, has tendered his resignation as Registrar of Shorthorn cattle under the National Record Association, to accept the Secretary-Treasurership of the Imperial Dairy and Ice-cream Company, Montreal. He is a son of the late Mr. Henry Wade, and has been connected with the records for fourteen years, where he has done excellent work.

THE WOODSTOCK CLYDESDALE SALE.

Another great sale of imported Clydesdale mares, fillies and stallions, as will be seen from the half-page advertisement in this paper, will be held at Woodstock, Ont., on Friday, March 8th, when Messrs. Innes, Schafer & McClary will sell their new importation, just landed, of 50 mares and fillies, and 10 stallions, from two to six years old, which have been personally selected in Scotland by Mr. Innes and Mr. Schafer. This is the fourth importation Mr. Innes has made, and his well-known good judgment and experience are a sufficient guarantee that the present offering is of the class that will suit the requirements of the farmers of this country, plenty of size, with fine quality, action and breeding combined, being the standard by which they have been selected, and it is confidently believed they will meet the expectations of those looking for the best class of mares and stallions to improve the stock of this country, from which to breed the class of stock that sells for the highest prices. The demand for good heavy horses is getting keener every month, and the supply is so short that buyers cannot fill their orders, and good grade geldings are actually selling for as high as \$500 to \$600 a pair. How much more profitable would it be to buy a pair of imported mares at the same cost, or little more, that will do as much work on the farm, and, at the same time, raise colts that, in two or three years, may sell for more money than the mares cost? The mares in this offering are sired by some of the most noted stallions in Scotland, such as Baron's Pride, Hiawatha, Revelanta, Royal Edward, and sons of these great sires and others, and should all find homes on Ontario farms, or those of other provinces where they are needed, and may do good work in supplying the stock so much needed, and sure to be needed for many years to come, as the country is fast filling up with new settlers, and railroads are being built requiring more work horses. There is no more convenient point to reach, or to ship from, in Western Ontario than Woodstock, where there is also good hotel accommodation. Catalogues will be mailed on application, if they can be got out in time, but no one should fail to attend, if the catalogue does not reach them, as these will be ready by sale day, and certificates of registry in the Scottish Studbook for each will be supplied. See the advertisement, and attend the sale, taking chances for any good bargains that may be open.

TRADE TOPIC.

ENSILAGE SEED CORN of the most popular, tried varieties, is advertised in this paper by E. R. Ulrich & Sons, Springfield, Illinois.

SASKATCHEWAN LANDS.—On another page will be found an advertisement of B. P. Richardson, Grenfell. Mr. Richardson is one of the oldest residents of the Province of Saskatchewan, he having been in the country for upwards of twenty-four years. With a wide knowledge of actual conditions, and with considerable experience in the land business, he will be able to give intending purchasers much useful information. If you are desirous of securing either improved or unimproved lands, we should advise you to write to Mr. Richardson, stating as clearly as possible what you require. From his large list, he will then be able to select that which is best suited to your requirements, and will, no doubt, be in a position to give you the best of satisfaction. Mr. Richardson is very well and favorably known throughout the length and breadth of Western Canada. We bespeak for him a generous share of your patronage.

Important Clydesdale Sale

To be held at the **Caister House Yards,**
WOODSTOCK, ONT., on

FRIDAY, MARCH 8th, 1907

When and where will be sold, by auction, **50 imported mares** and **fillies** and **10 imported stallions**, 2 to 6 years old; personally selected by J. W. Innes and Henry Schafer for size, quality and breeding, comprising the finest procurable in Scotland; all registered. The get of high-class sires, such as Baron's Pride, Hiawatha, Royal Favorite, Prince of Kyle, Revelanta, Royal Edward, Acme, Adlethin, and the best lot ever offered in Woodstock.

SALE TO COMMENCE AT 1 O'CLOCK SHARP.

Send for catalogue. If not out in time to reach you before sale date, do not fail to attend. For catalogue and information, address

CAPT. T. E. ROBSON, London
P. IRVING, Woodstock } Auctioneers.

JAS. W. INNES,
Box 454, Woodstock, Ont.
INNES, SCHAFER & McGLARY CO.

QUESTIONS AND ANSWERS. Veterinary.

ECZEMA—SALIVATION.

Pregnant heifer is covered with a rash, and she salivates so that everything in the manger becomes wet. D. S. M.

Ans.—Give her a thorough washing with strong, hot, soft soap suds. Keep warm, and rub with cloths until dry. Then dress her, every third day, with a four-per-cent. solution of Zenoleum or creolin, as long as necessary. The salivation is due either to disease of the tongue, lips or cheeks, or to irregularity of the teeth. Get your veterinarian to examine her mouth. If the teeth are at fault, he will dress them, and if there is disease of other parts of the mouth, he will prescribe. V.

CONSTIPATION—CRIPPLED FIGS.

1. Horse, fourteen years old, suffers from chronic constipation. We called our veterinarian in, and he dressed his teeth, purged him, and left some medicine. The patient improved, but is still troubled with constipation. The veterinarian disapproves of scalded bran or oil, but recommends boiled oats, which we have given without results.

2. Pigs, three months old, fed on shorts and barley, have become gaunt and stiff, and do not thrive. C. B.

Ans.—1. If he is suffering, give a laxative of either 6 drams aloes and 2 drams ginger, or 1½ pints raw linseed oil. There can be no possible objection to the oil, if carefully given. Give dry bran, and a few raw roots. Give boiled oats, with a cupful of linseed meal twice daily, and if constipation continues, give him some raw linseed oil on each feed, not sufficient to purge him, but just to keep the bowels normal. Two-dram doses each of nuxvomica and ginger, twice daily, will also help.

2. This crippling is due to too high feeding and want of exercise. Purge each with 6 ounces raw linseed oil. Feed on bran, milk and raw roots for a few days, and then give small quantities of chop. Make a mixture of equal parts sulphur, charcoal, and Epsom salts, and give a



U.S. CREAM SEPARATOR

WEARS LONGEST
as well as skims cleanest. Time has proved the simple, strong construction of the U. S. is more durable than any other separator.

**Used 14 Years
Repairs 75 Cents**

FOSS DU LAC, Wis., Nov. 8, 1906.
To whom it may concern:
I have used one of your U. S. Separators for the past fourteen years and it has given the very best satisfaction. I have paid 75 cents for extras since getting the machine. I cannot recommend the U. S. too highly. J. BALSON.

My pictures with plain, easy-to-understand explanations in our new catalogue, make the construction and operation of the U. S. as plain as though the machine was before you. Let us send you a free copy. Just write: "Send Construction Catalogue No. 110". Write today. Don't buy a Cream Separator before you see this book.

VERMONT FARM MACHINE COMPANY
Bellows Falls, Vt.

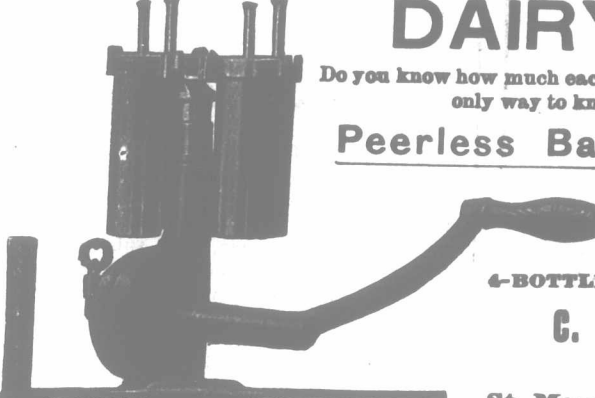

DAIRYMEN

Do you know how much each cow is earning for you? The only way to know this is to buy a

Peerless Babcock Tester

IT WILL TELL YOU
ORDER TO-DAY

4-BOTTLE MACHINE, PRICE, \$5.00

C. Richardson & Co.,
Box 500
St. Mary's, Ontario

dessertspoonful for each once, or, if necessary, to keep the bowels regular, twice daily in food. See that they get regular exercise, and a dry, clean place, with wooden floor, to sleep on. V.

ECZEMA.

Pregnant mare has small pimples all over her body. They are slightly painful, and if rubbed or pick'd off, sometimes a slight scab forms. I have given her oil without results. C. H. W.

Ans.—This is a form of eczema. I would not advise internal treatment as she is in foal, and the less drugs given to pregnant mares, the better. Make a solution of corrosive sublimate, 40 grains to a quart of water. Heat some of this to about blood heat, and dress the affected parts. Rub well with cloths, exclude drafts, and blanket well until thoroughly dry. Dress every third day. A little sulphur, given in soft food, is the safest internal medicine to give under the circumstances. V.

Miscellaneous

CEMENT BLOCKS.

On page 276 of "The Farmer's Advocate" for Feb. 14th, is an article, by John Patterson, re material for cement-block house; also, on page 252 of same issue, more about hollow building material. I would like to ask where the cement blocks can be purchased, and if they are suitable for the foundation of house. Will they make a warm, dry house, and one that is presentable?

INTERESTED SUBSCRIBER.

Ans.—We notice that cement blocks are being very commonly used for house foundation walls above ground, and in some cases the full height of walls, and look well. They should be both warm and dry. Below ground, ordinary cement-concrete would be more economical for foundation. Readers who have had experience with cement-block walls should write us concisely of the results. Our correspondent could secure additional information on this subject by writing the Concrete Machinery Co., 28 Redan St., London, Ont., and Jas. Stewart Mfg. Co., Woodstock, Ont.

Imp. Clydesdale Fillies by Auction

30 Fillies & Mares 30

From 1 to 6 Years of Age

THE PROPERTY OF

MR. T. MERCER, MARKDALE, ONT.,

IN THE VILLAGE OF MARKDALE, ON

Thursday, Mar. 7, '07

Representing Scotland's richest blood, many of them winners last year. A big, flashy, quality lot. Part of them bred in Scotland, and safe in foal. Several matched pairs.

TERMS—Cash, or 12 months on bankable paper, with 5% interest.

Capt. T. E. Robson,
Rudd Mathews, } Auctioneers.

T. Mercer, Prop.,
Markdale, Ont.

CATALOGUES.

Markdale is on the Owen Sound branch of the G. P. R. Morning trains leaving Toronto reach there at 11.30. Sale will be held at the Revere House.

CLEARING SALE

of Pure-bred Registered Stock, at
CLAYFIELD STOCK FARM, JARVIS, ONT., on

THURSDAY, MARCH 7th.

7 Clydesdale Mares and Fillies, also
1 Two-year-old Stallion,
26 Shorthorns.

10 cows, 10 heifers and 6 bulls, also a number of choice **Cotswold and Hampshire Sheep**. **TERMS**: Cash, or 7 months' credit on approved joint notes bearing 5 per cent. interest. Sale to commence at 12 o'clock. Conveyances will meet all trains.

J. C. Ross, Prop., Jarvis, Ont.

Cotswolds at Auction

At the farm, 3 miles north of Burgessville, G.T.R., and
7 miles south-east of Woodstock, G.T.R. & C.P.R., on

WEDNESDAY, MARCH 6th, 1907

When 40 registered Cotswold ewes, 10 ewe lambs and 12 ram lambs and yearlings will be sold to the highest bidder.

Morning train met from south, and noon train from north, at Burgessville, G.T.R. Sale sharp at 3 p.m.

Terms: 8 months' credit on approved paper; 5 per cent. per annum off for cash.

ALMAS & LOGAN,
Auctioneers.

E. F. PARK, Prop.,
Burgessville, Ont.

ADVERTISE IN THE ADVOCATE.

QUESTIONS AND ANSWERS. Miscellaneous.

CROWN PEAS.

Can you or any of your readers inform me where I can get Crown peas for seed?
Dundas Co., Ont.

LAWFUL FENCE.

Is it lawful to put barb wire on the top of a new line fence, which is to be the ideal fencing? If so, what is the lawful height for fencing? M. S. C.

Ans.—See answer to similar question in Feb. 21st issue.

CROOKED LINE FENCE.

A line fence has been left off the line for 30 or 40 years. Can this fence be straightened? This fence was built crooked to save building through the timber. No attempt has been made to straighten it.

Ontario.

Ans.—Yes.

CLYDESDALE NUMBERS.

Can you give me the name and number of the sire of Dunure Blend (11691), also his dam's number; also dam of Linesman (11397)?

Ans.—The sire of Dunure Blend is Mont-trave Mac (958). His dam is Royal Darling (14261), by Royal Champion (8956). The dam of Linesman (11397) is Mary Morrison (13428).

UNPAID-FOR MACHINE.

A hired a manure spreader from B about twenty-one months ago. B bought it about one year before that. A paid for the use of it. B wanted A to store it the rest of the summer, as he had sold out. A did so, and has used it a few days since. B did not pay for the manure spreader. A told the agent, who sold the machine, to come and get it about one year ago. The agent said he had nothing to do with it.

1. Can anyone come on me for harboring it?
2. Can anyone come on me in any shape or form in regard to the spreader?
3. Could I charge anyone for storage, if I saw fit?
4. Would I be entitled to the spreader after it was here a certain length of time?

Ontario.

Ans.—1. No.

2. No.

3. Hardly; at all events, it would be inadvisable to do so.

4. No.

HEAVY RATION FOR DAIRY COWS.

Could you give me any better rations for feeding milch cows than what I am giving? I have twenty-nine cows, and feed 200 lbs. shorts, 200 lbs. maize and gluten-meal, mixed into a slop a meal ahead, with a bushel of ensilage a day to each cow, in two feeds, and two feeds of mixed hay.

E. D. W.
Ans.—If we read our inquirer's letter aright, he is feeding each cow nearly 7 lbs. of shorts and the same of gluten-meal per day. At first glance, our mental comment was "a pretty heavy ration," but on referring to a bulletin on "The Composition of Ontario Feeding Stuffs," by W. P. Gamble, O. A. C., Guelph, we found the brand, "Maize Gluten" meal, given there as containing only 15 per cent. crude protein; whereas the general run of gluten meals have from 20 to 30, and even up to 34 per cent. crude protein. The ration is, therefore, not so excessively rich after all. Had it not been for the information at hand, showing the unusually light nature of this brand of gluten meal, we should have based our answer on an average of the composition of gluten meal. The instance is one of many showing the importance and desirability of a Federal law regulating the sale of these commercial feed-stuffs by requiring them to be sold under a guarantee of their analysis. Our chief criticism of the ration is that it contains hardly enough variety. By reducing the shorts two or three pounds, and the gluten meal the same, and substituting 2 lbs. bran, ½ lb. oil meal, and 2 of mixed chop, consisting, say, of oats, peas and barley or corn, we should expect rather better results. We should also recommend feeding the meal ration dry, scattered over the silage in the manger.

Veterinary.

PROBABLY GARGET.

I have a cow that calved last May, and in August one teat got bad. At last, I could not get any milk out of it, the other three being all right until the last month or so. The milk is all right, but she kicks while I am milking—not at me, but with the other foot—just as if it hurt her to be milked. She is coming in again in July. Will it pay me to keep her for a cow, or will she always be uneasy? What is the cause, and is there any cure? She is a fine milker when all right.

A. B. M.

Ans.—The first was probably a case of garget, caused by inflammation of the quarter, and the present trouble is likely a recurrence. Treatment is bathing long with quite warm water; rub dry after, and oil with melted lard or goose oil. Give a teaspoonful of nitrate of potash, or saltpetre, in feed, or in a pint of water as a drench.

LUMP JAW.

1. I have a cow which I think has lump jaw, and have been trying the prescription which you recommend, viz., iodide of potassium. I have given her it until the necessary symptoms have appeared; that is, tears coming to her eyes, and a scurf rising all over her skin. Now, the questions are: How much more will I have to give her to result in a cure? How long will it take? I might say that this disease has been standing over a year.

D. C.

Ans.—If the lump shows no signs of reducing, repeat the treatment after a week. It is just possible that, owing to its long standing, this treatment may not be effective, though in cases treated early, two weeks is the usual period set for a cure.

3 POWERFUL INSTANCES

OF ZAM-BUK'S WONDERFUL HEALING.

Here are three powerful instances of the varied ways in which Zam-Buk, the great herbal balm, is doing good throughout the Dominion. Have you yet enjoyed its benefit?

Baby Cured of Eczema.

Mrs. L. Taylor, of Pine Ridge, Man., says: "I will never be without Zam-Buk in the house, as I have thoroughly proved it. It cured irritating rash and eczema on my baby's feet during teething. Where there are children, it is invaluable, as it heals their sores and injuries in wonderfully short time."

Trodden on by a Horse—Bad Bruises.

Mr. D. Cumming, of Springmount, Ont., says: "I have proved that Zam-Buk has extraordinary merit. I was trampled on by a horse, and my foot was all black and swollen. I could scarcely move it, the pain was so bad. A few applications of Zam-Buk cured the pain and removed the discoloration. The foot was soon all right again. It is a wonderful balm."

Running Sore Healed.

Mrs. S. J. Holden, of Hannah St., W. Hamilton, says: "My little girl had a running sore on her leg which defied all manner of treatment. Within a few days of trying Zam-Buk, there was a distinct improvement, and the wound is now completely healed. I have since used Zam-Buk for other skin diseases, etc., and find it excellent."

Zam-Buk is an all-round household balm. It is compounded from purely herbal essences, and cures eczema, ulcers, sores, chapped hands, bruises, cuts, burns, etc. It also cures rheumatism, sciatica, neuralgia, and rubbed well in over the chest in cases of cold removes the tightness and aching. All druggists and stores sell at 50c. a box, or post free from the Zam-Buk Co., Toronto, upon receipt of price. 6 boxes sent for \$2.50.

QUESTIONS AND ANSWERS.
Miscellaneous.

EVERSION.

We have a cow that has her withers out every time she lies down, and, when made get up, they go in. She is a good milker, eats well, does not calve until May, and does the same thing every year three months before calving.

SUBSCRIBER.

Ans.—This is a case of eversion of the lining of the vagina, and will probably not get worse, and she will calve all right, then it will disappear. If it is worse than usual, it will be well to put a false floor at the back end of her stall to raise her hind end higher than her front, and wash the protruding part with a weak solution of carbolic acid, say 20 drops to a pint of warm water. In a very bad case, a rope truss is used, tied by straps to a collar around the cow's neck.

COST, PROPORTIONS AND STRENGTH OF CEMENT CONCRETE.

1. How much material will I require for a cement wall under building, 65 feet by 30 feet by 10 feet high?
2. How thick does the wall need to be?
3. What proportion of cement is needed with the gravel?

4. Would a cement wall, one foot thick, be as strong as a two-foot stone wall, built with mortar? W. F. S.

Ans.—1, 2 and 3. About 19 cords of gravel and 63 bbls. of cement would be needed for your wall, if built one foot thick, and mixed one part cement to nine of gravel, which proportion is quite rich enough, if good Portland cement is used. The quantities of both gravel and cement required can be much reduced by imbedding stone in the concrete.

4. A cement wall, one foot thick, is quite heavy enough for barn foundation, though we would not like to say that it was as strong as a two-foot stone wall, properly built. T. B.

WILD MORNING-GLORY—HOW TO MARK HENS.

1. What will kill convolvulus, or wild morning-glory?

2. Will sugar beets keep in common root-house, where there is always a comfortable temperature?

3. What is a good way of marking hens to keep the yearlings from the pullets? C. P. H.

Ans.—1. The best treatment for wild morning-glory is thorough summer-fallowing, with an implement that will cut off every plant an inch or so below the surface. Use this about every four days, from May to October. Follow the next year with a crop of corn, and cultivate thoroughly, keeping every plant below the surface. Do not be discouraged if the cultivation seems to stimulate rather than check the growth of the weed for some weeks. Persevere and succeed.

2. Sugar beets will keep in such a cellar fully as well as mangels, if not better.

3. Aluminum leg-bands, to be had from dealers in poultry supplies advertising in these columns.

APPORTIONING LINE FENCE.

A and B each own one hundred acres of land, side by side. The line fence between the two is divided so that A was to keep in repair the south half, and B the north half. A has just sold twenty acres on the south end to C.

1. Is not C obliged to keep up the whole of the line fence along the land he has just bought?

2. Can C take away one-half of this fence, and force B to build another in its place?

3. Will you kindly give us the law regarding cases of this kind? Ontario.

SUBSCRIBER.

Ans.—A should arrange for a meeting between B, C and himself, and have a readjustment in respect of the fence by agreement of the parties. If, however, it should be found that such an agreement cannot be brought about, then the regular and really the only course is to call in the fenceviewers, and have them decide the matter. Each and every one of the parties is legally required to maintain a just proportion of the boundary fence; but what that just proportion is, it is for the fenceviewers of the locality to determine.

CHEESE-FACTORY BANKING.

At an annual meeting of shareholders of our cheese factory, a motion was put to the meeting, and carried by 13 majority, to change our bank account to another bank. When the vote was taken, several of the shareholders asked to vote on the shares (the by-law reads that all voting be done on the share). We were only allowed one man, one vote. Now, the directors say that the vote was not legal, and that they don't have to change the account, and that the treasurer has the power to bank the money where he likes.

1. Can the directors do this, they being in favor of the old bank?

2. Can the treasurer put the money where he likes, he being paid for our work?

3. How many shareholders would it take to call a special meeting? Ontario.

WOW-WOW.

Ans.—1. As the matter stands at present, yes.

2 and 3. These matters depend upon, and are regulated by, the by-laws of the association; at least, they are usually so dealt with, and such by-laws should accordingly be examined for answer to these two questions.

SHEEP LOSING WOOL.

1. I have a flock of ewes, which I expect to lamb middle of April. They are losing their wool. I have them in a stone basement, which is well ventilated. They are in pretty good order. Would you advise me to clip them at this time of the year, or would there be danger of them losing lambs from the effects of clipping?

2. Would you think it wise to haul manure out at this season of the year, and put it on a meadow, where I intend cutting hay off this year, by spreading it as I take it out, and harrowing it as soon as dry enough in spring? H. M.

Ans.—1. A basement, as a rule, is too warm for sheep, unless the front is open, and they have a dry yard to lie in when they choose. We would examine them closely for ticks or small white fleas, and, if any are found, would treat them with a solution of one of the sheep dips, opening the wool every four or five inches and pouring from a coffee-pot. If they have scab, we would shear them, and treat thoroughly and repeatedly with same preparation, using warm water in either case. If the disease is not present, we would not shear till after lambing, though we do not think there would be much danger of their losing their lambs from that cause if kept warm for a few days after clipping, and done in a mild spell of weather.

2. Yes; we think the practice all right, but would not put horses on ground till it was dry enough to carry them without poaching it.

CRANBERRY CULTURE.

Could you give me information where I could get cranberry plants. I see in the Toronto markets the names of McFarlane's Extra Fancy and Howe's? Is McFarlane a grower? Where could I get papers or books on cranberry culture? R. M. W.

Ans.—There has been little or no attention given to cranberry culture in Ontario, so far as I know, and, consequently, we have but little literature or information on this subject at hand. We have in the library here two books on cranberry culture, but they are rather old and probably somewhat out-of-date. One is by Joseph J. White, published in 1870 by the Orange-Judd Co. The other is by W. Eastwood, and published in 1856.

The most recent publication on the subject is a report of a cranberry investigation made in Wisconsin, and published in Bulletin No. 119 in 1905. This bulletin could, no doubt, be obtained upon application to the Director of the Wisconsin Agricultural Experiment Station, Madison, Wis. It is made up of 77 pages, and contains the most valuable information that can be obtained upon this subject. The names McFarlane and Howe's are names of varieties of the cranberry, which were probably given them by the introducers, both of whom, I believe, were Americans. I know of no one in Ontario who has plants for sale. Probably you could, through correspondence with the Wisconsin Experiment Station, get the names of some Wisconsin growers who could supply you with plants, as the cranberry industry is so important in Wisconsin that they already have there a Cranberry-growers' Association.

O. A. C. H. L. HUTT.

10,000 WELL-BRED CATTLE

For Sale.

Owing to the curtailment of their range by settlement, the **New Walrond Rancho Company, Livingston, Alberta**, intends to offer during the coming summer their entire herd of **Shorthorn, Herdford and Galloway Cattle** for sale.

Owing to the winter feeding and careful handling these cattle are semi-domestic, the young heifers are easily made gentle. For settlers they are the most desirable imaginable, being absolutely free from tuberculosis and other diseases common among fair breeds, and while they are high-class beef cattle, they yield a large quantity of very rich milk.

When necessary to car them, neighbors should combine so as to purchase a train-load, say 300 to 400, smaller numbers cannot be handled profitably.

Bulls will also be disposed of.

For particulars apply to

THE LOCAL MANAGER.

NEW WALROND RANCHE CO'Y, LTD.
Livingston P. O., Alberta.

20 Scotch SHORTHORNS

By Auction

TUESDAY, MARCH 12th, 1907

Belonging to the estate of the late **WM. HAY, Tara, Ontario**. Will be sold at the farm, 1 1/2 miles east of the Village of Tara, where conveyances will meet morning trains from north and south. Nine breeding cows, 5 heifers and 6 bulls, including the stock bull, **Scottish Knight 59248**, representing the **Marr Floras, Cruickshank Lovely, Stamford and Wildame** strains. There will also be sold the **Imp. Clydesdale stallion, Kelviniside**, by **Baron's Pride**, dam by **Macgregor**, and two registered **Clydesdale mares**.

Terms: 10 months' credit on bankable paper. Six per cent. off for cash.

Tara is on the Owen Sound branch of the G. T. R.

HAY BROS., Props., TARA, ONTARIO.

James Cass, Auctioneer.

Catalogues.

ONTARIO DEPARTMENT OF AGRICULTURE PROVINCIAL AUCTION SALES

PURE-BRED CATTLE (Registered)

150 head—males and females—of beef breeds. Will be held at the following points:

Guelph, Feb. 28; Port Perry, March 1; Ottawa, March 8, 1907.

All stock inspected before being accepted. Only good representatives of the various breeds will be offered. Special inducement to purchasers in Ontario.

Freight Paid—The freight on any animal purchased at these sales by residents of Ontario, shipped to purchaser's station in Ontario, will be paid by the Ontario Department of Agriculture. The original receipted freight bill containing the point of shipment and destination, name and registration number of the animal purchased and shipped, the estimated weight for billing, and the rate charged per cwt., should be sent immediately to the Live-stock Branch, Ontario Department of Agriculture, Toronto.

For catalogues and particulars regarding any of the sales, address the Secretary at the point of sale, or make application to

Live-stock Branch Ontario Department of Agriculture, Toronto.

The MAGNET Cream Separator



has a skimmer that takes all the cream out of the milk, besides separating all foreign matter from both. It is made in one piece—therefore easy to clean.

The steel bowl is supported at both ends, making it run steady, and prevents it getting out of balance.

The MAGNET is built with square running gears, the only gear that should be applied to a fast-running machine like a cream separator.

We ask you to compare the strong square gear in the MAGNET with the cheap worm wheels, and in some cases two worm wheels, in other makes, and we know you will select the MAGNET.

Prof. F. M. Logan, of B. C., writes to the MAGNET Cream Separator Co., Hamilton: "There are four points in the construction of a cream separator which should be thoroughly studied by every manufacturer, viz.—ease in cleaning, ease in turning, durability of construction, perfection in skimming. I am pleased to state that, to my mind, your machine, which is made in Canada, combines these to a greater degree than any separator I have examined."

It will pay every farmer who keeps cows to investigate the MAGNET.

Remember the MAGNET turns easier than any other separator.

Write for catalogue.

THE PETRIE MFG. CO., LIMITED,

Hamilton, Ont.,

or Winnipeg, Man.; Calgary, Alta.; St. John, N. B.; Regina, Sask.; Vancouver, B. C.; Edmonton, Alta.

AUCTION SALE

OF VALUABLE

THOROUGHbred STOCK

Chattels and Household Furniture

Belonging to the late DONALD MILLOY, and situated at the premises on the south of the Paris road, known as the "Oak Park Farm," Township of Brantford, on

TUESDAY, WEDNESDAY and THURSDAY
March 12, 13, and 14, 1907

At the hour of 9 o'clock. Lunch at noon.

The implements and horses will be sold the first day. The cattle on the second day. The furniture on the third day.

Forty-eight head of thoroughbred Shorthorn pedigree cattle. Thirty four cows and calves. Twenty-four steers and heifers. A number of thoroughbred horses and colts of excellent quality. Also the implements and carriages, etc., used in carrying on of the business, and all the household furniture now in the dwelling, etc. Intending purchasers can see the above property by applying on the premises. The farm can be reached by electric railway from Paris or Brantford.

Terms: Cash for all purchases of \$25 and under; cash or approved joint notes, payable within 9 months, on amounts over \$25, bearing interest at 6 per cent per annum.

For further particulars apply to

THE TORONTO GENERAL TRUSTS CORPORATION, Administrators
Cor. Yonge and Colborne Sts., Toronto.

Or to Messrs. Hoskin & Ogden, Solicitors, 23 Toronto St., Toronto.

Auctioneer, WELBY ALMAS, Brantford.

It's in the Clamp

The lasting strength of a wire fence rests mainly in the clamp that secures the crossing wires.

The famous Anchor clamp has a grip that never fails. Bending the wires slightly, it keeps them fastened in the one place steadily, in spite of storm and pushing animals. It cannot slip. Nor can the wires spread.

Made from one-inch steel—japanned or galvanized, the latter being proof against rust.

Anyone can put up an Anchor fence. But our agent will do it, if you like. There's no fencing so thoroughly satisfactory. Simple, reliable and wonderfully low-priced.

Write for free catalogue, showing pretty ornamental styles, also farm and garden gates.

Good, live agents wanted.

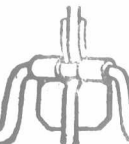

Anchor
Fence Co.
STRATFORD, Ont.

QUESTIONS AND ANSWERS.

Miscellaneous.

IRISH IMMIGRANTS.

Would you kindly tell me, through your paper, where I would find the home for Irish immigrants, as I would like to get one this spring? SUBSCRIBER.

Ans.—We are not aware of such a home, but suggest that you apply to Thos. Southworth, Colonization Dept., Parliament Buildings, Toronto, or Brigadier Howell, Salvation Army Headquarters, Toronto, who can probably supply your need.

STICKY SPREAD.

Mr. H. W. Elgin Co., Ont., writes: What should I do with my rubber-spread? It gets as hard as a board in winter, and in warm weather it is quite sticky. I keep it in my buggy all the time, and in cold weather I can't use it on account of it getting so hard.

Ans.—We should think that there must have been something wrong with the manufacture of the spread, and that you are likely to have very little satisfaction with it. Has anyone had a similar experience?

ALFALFA FOR A CATTLEMAN.

1. Would you advise me to give alfalfa a trial for producing hay for fattening cattle, to be fed along with a silage-and-grain ration? In other words, do you consider its advantages over red clover sufficient to pay for extra labor and care in harvesting. My land is sandy and dry, with a few clay spots. The field I would use had corn last year, and is fairly clean of weeds.

2. Do you consider in taking, say, two crops a year, I would be depleting, or would it build up the land?

3. Is it best to use a nurse crop?

4. Where would be a good place to obtain seed (home-grown preferred)? Perhaps someone who has given it a fair trial would give their opinion also through your valuable paper. H. C. T.

Ans.—1. While we would not counsel farmers generally to displace red clover with alfalfa on land that is easily cultivated, we would advise every Southern Ontario farmer, with suitable land, to try a few acres of alfalfa, and try half a dozen times, if necessary, to secure a successful catch. Alfalfa is better feed than red clover, and more productive, especially in dry seasons. The drawbacks are that it is not suitable for growing in short rotation with other crops, and the first cutting is often difficult to cure. However, if the acreage is not too large, one can usually manage, and it is better to have both alfalfa and clover hay to make, than to have all the meadow of one kind, with the resultant rush of work. Besides, a field of alfalfa is the ideal provision for soiling as an insurance against summer drouth. For these reasons, every one will do wisely to experiment with alfalfa, but it is especially recommended for clay hillsides, which are inclined to wash, expensive to manure and awkward to cultivate. On this land, too, it does best.

2. Cropping with alfalfa depletes the soil of its mineral constituents, viz., potash and phosphoric acid, but should rather increase the nitrogen content. Its effects in both respects are the same as those of clovers, only rather more pronounced. The net effect will be to increase the productiveness of the land. It will grow a better crop of corn, roots or grain after than before being in alfalfa. All crops take something from the land, but alfalfa is less exhausting than almost any other, because it secures its nitrogen from the air. If the alfalfa field is fertilized with wood ashes and with acid phosphate, or bone meal, the yields and fertility of the field may be indefinitely increased. There is no better way to build up a farm than to grow alfalfa; fertilize it as described, and feed the crop to stock. Remember, though, that if you sell a ton of alfalfa or clover, you sell off the farm two or three times as much fertility as in selling a ton of timothy.

3. Though some claim as good success with a nurse crop as without, the chances are generally better by seeding alfalfa alone.

4. There is little alfalfa seed produced in Canada, the yield not being very satisfactory. Order, by sample, from your seedsmen, taking care to examine for purity, and test for germination.

GETTING A PATENT.

As I am thinking of getting a machine patented, would you please give me address of the person or persons to whom I should apply? SUBSCRIBER.

Ans.—Apply to Hon. Sydney Fisher, Dept. of Agriculture, Ottawa, who has charge of the patent office. You will probably find it desirable to employ the services of a solicitor of patents. There may be one in your nearest town or city.

WILL HAVE TO HUSTLE.

Having read your editorial, "Warning to the Unwary," and having been flatteringly favored with a proposal in the form of a postal card, I enclose same, asking if you have ever heard of this firm before. They have been established nearly 60 years. The president's name is given, but not the manager's. I have never heard of them before, and am at a loss to know how they came into the possession of my name. Perhaps they are good, reliable people, and are not schemer's. However, if you know the firm to be all right, make mention of it in your paper, if you consider it worth while. They offer to start me at \$12 per week and expenses. SUBSCRIBER.

Ans.—The parties named on the card are an old firm of subscription-book publishers. We have no information as to their methods of doing business, but our correspondent may rest assured that no firm will continue to pay him \$12 per week and expenses unless he does sufficient business for them to make the outfit profitable.

MAPLE-SYRUP MAKING.

1. When is the proper time to tap trees?

2. How large an auger is required in tapping?

3. What distance from the ground should the hole be made, and how far in?

4. Which is the best, a metal or a wooden spile, and how are they made?

SUBSCRIBER'S SON.

Ans.—1. Trees should be tapped in March or April, when the nights are frosty and days sunny. At times when this alternation does not occur, there is invariably a poor run of sap.

2. The tapping auger is usually from $\frac{3}{8}$ to $\frac{1}{2}$ inch in diameter. Too large a hole is likely to injure the trees.

3. The hole should be from $1\frac{1}{2}$ to 2 inches in depth; somewhat less than this or just deep enough to penetrate the sapwood, if the trees be small second-growth. The holes should never be made close to where marks of recent tapping are visible, and may be made just high enough from the ground to permit of convenience in placing and removing sap-buckets.

4. A tinned or metal spile is best. These may be bought all ready for use, with a hook on the end from which to suspend the sap-buckets. All vessels used in connection with syrup-making should be tin or metal, never wood. When tapping trees, choose those that are exposed to the sun, and tap preferably on the southern side. Strain the sap two or three times before boiling, and keep, while waiting, in a tank placed in the coolest position possible, and with a ventilated cover. While boiling down, keep well skimmed, and when boiled to proper consistency, strain again into settling cans, afterwards pouring the clear syrup from the top into the vessels in which it is to be kept. Many good syrup-makers remove from the evaporator before becoming thick, and allow it to stand for, say, 24 hours to settle. Then complete the boiling in a smaller finishing-pan. Cleanliness is the great secret of making syrup of good quality. If making syrup on a large scale, a well-lighted, well-ventilated syrup-house, with fire-arch, evaporator, patent sap-holder, etc., will be found a great convenience, but, of course, all these things are not necessary if only making a little syrup for home use, though the better the outfit, the better the quality of the syrup made. After a week or ten days, the flow is likely to lessen. Then the spouts should be removed, and the holes deepened slightly, when the run will begin again as before. Grimm & Co., of Montreal, can supply full information regarding syrup-making apparatus.

g a machine
give me ad-
ns to whom
SCRIBER.
Fisher, Dept.
as charge of
probably find
services of a
may be one

STLE.

Warning
been flatter-
in the form
ame, asking
his firm be-
shed nearly
me is given,
have never
a at a loss
into the
perhaps they
nd are not
know the
ention of it
or it worth
at \$12 per
SCRIBER.
n the card
-book pub-
tion as to
s, but our
nd that no
a \$12 per
does suffi-
ke the out-

ING.

me to tap
required in
the ground
ow far in?
metal or a
ey made?
S SON.
tapped in
ights are
imes when
there is

ally from
arge a hole
1 1/2 to 2
than this
trate the
ll second-
be made
t tapping
just high
permit of
oving sap-

is best.
y for use,
which to
ll vessels
up-making
er wood.
nose that
tap pref-
Strain the
illing, and
placed in
nd with a
g down,
boiled to
ain into
ring the
he vessels
ny good
vaporator
ow it to
e. Then
er finish-
at secret
ity. If
a well-
p-holder,
venience,
are not
le syrup
the out-
-syrup
lays, the
e spouts
as deepen-
ill begin
Co., of
ation re-

GOSSIP.

HUGH THOMPSON'S SHORTHORNS.

Few Shorthorn breeders in Canada have a wider circle of friends than Mr. Hugh Thompson, of St. Mary's, Ont., one of the earliest importers. For fifty years of his life he has been intimately associated with importation and breeding of Shorthorn cattle, and to him very much of the credit is due for the high standing of Canadian Shorthorn herds to-day. And although his dealings nowadays are not on a very extensive scale, parties on the lookout for something above the average are pretty sure to find what they are looking for in Mr. Thompson's stables. Just now there is a roan yearling bull, one of the best bred Broadhooks bulls alive, and his individuality is just as high. He is Roan Champion =61617=, by the Flower Girl-bred bull, Flower Champion, bred by Senator Edwards, and a son of the Village-bred bull, Village Champion, dam Pennan Broadhooks (imp.), by the Clipper-bred bull, Cornelius, a full brother to the great champion, Cornerstone, grandam Broadhooks 20th, by the Cruickshank bull, Golden Ray. He is also closely related in his blood lines to the great sire and show bull, Champion of England. Owing to his exceptionally rich breeding, and grand, thick, low-down type, he should make a herd-head of the highest order. Another is a roan yearling, Clementina's Lancaster 68870, by the Toronto grand champion, Old Lancaster (imp.), dam Clementina Blossom, by Imp. Baron Lenton. He is a straight-bred Clementina, a big, growthy chap, and will certainly make a grand sire for somebody. In females, is the roan two-year-old, Village Maid 2nd 68811, by Royal Prince =31241=, a son of the king of sires, Imp. Royal Sailor, and the sire of the two champions, Queen Ideal and Fair Queen, dam Village Maid, by Challenge. She is a straight-bred Cruickshank Village, a nice, smooth, well-put-up heifer, and is safe in calf to Roan Champion. Another is a roan yearling, Belle of the Morning =76205=, by Springhurst =44864=, pronounced by Mr. Duthie as one of the best bulls he saw in Canada, dam Joy Belle, by Imp. Joy of Morning, grandam Vain Belle 2nd (imp.), by Scottish Archer. This heifer won second prize at St. Mary's last fall in strong company, and is a show heifer all over. Her stable mate is another roan yearling that won third prize at the same show, Daisy Cloud, by Imp. Scottish Hero, dam Miss Cloud, a 1,800-lb. cow, and a show cow of a high order, by the Cruickshank Brawith Bud bull, Brawith King. Here are a pair of heifers that would strengthen any herd in the country—a pair hard to equal. All these are for sale. Write Mr. Thompson, to St. Mary's P. O., Ont.

MAPLE BANK SHORTHORNS AND CLYDESDALES.

Thirty-five years ago marks the period of the foundation of the Maple Bank herd, the property of T. Douglas & Sons, Strathroy, Ont.; now 75 strong, founded on some Fashion-bred cows, topped by the following Scotch-bred bulls: Mariner (imp.) =2720=; young Abbotsburn's Heir =15947=, a son of the World's Fair champion, Young Abbotsburn, dam by Imp. Baron Lenton; Valkyrie =21806=, a Victoria-bred bull, by Abbotsford =19446=, dam by Village Herc; Imp. Diamond Jubilee =28861=; Double Gold =37852=, a Bellona-bred bull, by Imp. Golden Drop Victor, dam Imp. Golden Strawberry, and the present stock bull, Diamond =44695=, a Miss Ramsden, by Marvel, dam Lily Ramsden, by Speculator. He is a roan, four years old, won first prize at Toronto as a junior yearling, and all that need be said about his present form is that he has kept and improved his yearling form to maturity, and has proven himself a sire of choice, thick stuff. Fresh female blood has been added to the herd by the purchase of the thick, good cows: Imp. Graceful 8th. A splendid daughter of hers, by Imp. Diamond Jubilee, graces the herd. She, in turn, is nursing a grand heifer calf, by Diamond. The other is Welcome Hillhurst 2nd, by Scottish Hero (imp.), and out of Welcome Honor (imp.). She, too, has an extra nice heifer calf, by Diamond. Barring these, the whole herd is Fashion-bred, got by the above named bulls, and, as is well known of this great strain, they are heavy and persistent milkers, some of them exceptionally so, besides which a

great many of them are strictly up-to-date in the very thick beef type. All told, there are 60 head of cows and heifers, 20 of them being under two years of age, got by Double Gold and Diamond. Many in the herd are prizewinners at London and Strathroy, and among them are some choice things. Any, or all, are for sale, and anyone wanting dairy-bred Shorthorns cannot do better than look after these. In bulls, there are 15, from six months to 2 years of age, all sired by the two last named bulls, and out of grand milking cows. As might be expected from a lot of this kind, there are some extra good ones, first-prize winners at London last fall, particularly a roan yearling, by Diamond, out of a daughter of Valkyrie, and a red yearling, by Diamond, out of a daughter of Diamond Jubilee (imp.), and others nearly or quite as good.

In Clydesdales is the stallion, Royal Viscount (imp.), by Kitchener, by Montrave Mac, by Macgregor, dam by Gallant Poteath, by Top Gallant. He also carries the blood of Darnley and Prince of Wales; is a bay five-year-old, weighs about 1,856 lbs., and is a typical Clydesdale model, with style and quality galore; is right every way, and a high-class sire. In fillies, there is Imp. Miss Calder, a bay, rising four, by Field Marshal, dam by Yong's Prince Charley. Imp. Manilla is a brown, rising three, by Marmion, dam by Prince of Albion. Another, and a mighty good one, is the Canadian-bred, rising three, by the above stallion, and out of a daughter of Red Cross Knight. She is eligible for registration, and is in foal to Imp. Prince Romeo, a son of Prince of Wales. The other two are in foal to Royal Viscount. All these, including the stallion, are for sale. In fact, anything on the farm is for sale, and the Messrs. Douglas are no fancy-price men, but believe in the maxim: live and let live. Strathroy is their post-office address and station, on the G. T. R.

CENTRE AND HILL VIEW HOLSTEINS

Few of the many high-class herds of Holstein cattle in Canada stand higher in the Record of Merit than the Centre and Hill View herd, the property of Mr. P. D. Ede, of Oxford Centre, Ont., about four miles south-east of Woodstock. This great herd now numbers 110 head, at the head of which are the two richly-bred bulls, A. & G. Vaughan Burke De Kol (imp.), whose sire's dam has an official record of 28 lbs. butter in seven days, and whose dam and seven of her sisters have official records that average 22 lbs. each in seven days. Very few bulls are bred on such persistent-producing lines as this. The other is Baron Pietertje Posch, whose sire's dam is the world's champion two-year-old, Alta Posch, with a two-year-old record of 27 lbs. in seven days. This bull is also a full brother to Verbeke Posch, whose yearling record is 52 lbs. of milk in one day, and 15 lbs. of butter in seven days. With two such heavy-producing-bred bulls as these at the head of the herd, and with 40 females in the Record of Merit, with official records of 10 to 18 1/2 lbs. butter in seven days for two-year-olds, 12 to 18 lbs. for three-year-olds, and 16 to 23 lbs. for four-year-olds and over, surely this is a most desirable herd from which to choose a herd-head, and there are now on hand 18, from two months to one year old, and every one out of Record-of-Merit cows, and sired by the above named bulls; certainly an aggregation of young bulls richly bred on producing lines, and some of them at least built on showing lines. Mr. Ede is somewhat in advance of most of his Holstein-breeding brethren on the lines of yearly records and official testing eight months after calving, and is working along those lines as fast as possible. During the last year, he has had five officially tested eight months after freshening, with the highly-satisfactory result of 8.4 and 8.14 lbs. of butter each for two two-year-olds, and 10, 11 and 14 lbs. of butter each for three developed cows. One of them, Maid of Kent, won fifth prize in the American Advanced Registry competition, being the first Canadian-bred cow to gain that distinction. Her fresh record is 478 lbs. of milk, and 22 lbs. 8 ozs. butter in seven days. In the herd are three full sisters of hers, and several of their daughters. This coming summer, over 50 head will be in milk, and all heifers coming in will be officially tested, and should any not qualify, they will not be kept. Write Mr. Ede, to Oxford Centre, Ont.

ESTABLISHED 1867.

BY AUCTION

DISPERSED 1907.

THE OLDEST ESTABLISHED

Shorthorn Herd

IN CANADA, THE PROPERTY OF

ARTHUR JOHNSTON, GREENWOOD, ONT.,

At the Farm, 7th Con. Pickering Tp. on

Wed., March 6th, 1907

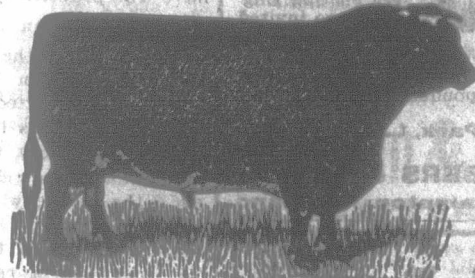

Positively without reserve, the whole herd of 55 HEAD of imported and the get of imported Scotch Shorthorns, representing the Cruickshank Nonpareils, Lavenders, Duchess of Glosters, Village Maids, Marr Princess Royals, Emmas, Claras, Bruce Mayflowers and Fames; Campbell Minas, Kilblean Beauties, Kinellar Beauties, Miss Ramsdens, Bridesmaids, etc. Also the Imp. Bruce Mayflower and the Marr Clara stock bulls. The whole, without doubt, making the choicest lot ever sold by auction in Canada.

Terms: 6 months' credit on bankable paper; 5% per annum off for cash. Conveyances will meet the east and west bound trains at Pickering, G. T. R., and Claremont, O. P. R., the evening before and morning of the sale. The sale will be held under cover in case of bad weather.

Catalogues on application.

Capt. T. E. Robson, Auctioneers, Geo. Jackson.

Arthur Johnston, Prop., Greenwood, Ont.

45 SHOW 45 Shorthorns

BY AUCTION

(Straight Scotch)

The property of JAMES A. CRERAR, Shakespeare, Ont., on

Wednesday, March 13th, 1907

At his farm, one mile north of Shakespeare, Ont., on above date, he will sell his entire herd of 45 head of Imp. and Canadian-bred Short-horns, representing the Daisy, Bellona and Roan Duchess strains, the get of high-class prizewinning bulls. Very many to be sold are Toronto and London winners. All are in splendid condition. There are 35 females and 10 bulls, including the stock bull, Trout Creek Choice 57962.

Shakespeare is on the main line of the G. T. R., a few miles east of Stratford. Conveyances will meet all morning trains.

Terms: Six months' credit, or 5 per cent. per annum off for cash.

Lunch at noon. Catalogues ready by end of February.

JAS. A. CRERAR, Shakespeare, Ont.

CAPT. T. E. ROBSON, Auctioneers, SANDY FRASER

HORSE OWNERS! USE GOMBAULT'S CAUSTIC BALSAM.



A safe, speedy and positive cure. The safest, best ELIXIR ever used. Removes all bunches from horses. Impossible to produce scar or blemish. Send for circulars. Special advice free.

THE LAWRENCE-WILLIAMS CO., Toronto, Canada

Shire Horses



We breed the very best and soundest, which from birth are kept in their natural condition neither forcing nor overfeeding for showing purposes.

No fancy prices, and all delivered free Liverpool landing stage. Correspondence invited.

Station: Athorp Park, L. & N.-W. Ry.

JOHN CHAMBERS & SONS, Holdenby, Northampton, England

Dr. Page's English Spavin Cure.

For the cure of Spavins, Ringbones, Curbs, Splints, Windgalls, Capped Hocks, Strains or Bruises, Thick Neck from Distemper, Ringworm on Cattle, and to remove all unnatural enlargements.



Spavin, or money refunded, and will not kill the horse. Manufactured by Dr. Frederick A. Page & Son, 7 and 9 Yorkshire Road, London, E. C. Mailed to any address upon receipt of price, \$1.00. Canadian agents: J. A. JOHNSTON & CO., Druggists, 171 King St. E., Toronto, Ont.

The Sunnyside Herefords.

To reduce the herd I will sell six breeding cows with heifer calves at foot. Prices reduced 20% from now until March 1st. Some choice heifers and a few bulls under 2 years old. Don't wait and miss this opportunity of procuring closely-bred high-class stock but write for prices or come and see them. H. & C. O'NEIL, SOUTHGATE, ONT.

Shorthorns, Cotswolds and Berkshires.

For sale: 9 yearling bulls, cows, heifers and calves. Over 50 head to select from. Nothing to offer in Cotswolds or Berkshires. CHAS. E. BONNYCASTLE, P. O. and Stn. Campbellford, Ont.

White Hall Shorthorns

Missies, Cecillias, and Lady Victorias. 4 young bulls, 7 heifers, and a few older females. Bred right and will be sold right.

N. A. STEEN, Meadowvale P.O. and Station, Peel Co.

WILLOWBANK SHORTHORN HERD

ESTABLISHED 51 YEARS. FOR SALE: Young bulls and heifers from imp. sires and dams, of most fashionable breeding and type; exceedingly choice. Prices to suit the times. JAMES DOUGLAS, Caledonia P.O. and Sta.

Shorthorns & Berkshires

For sale: Young bulls and calves; also a few young cows and fall pigs. John Racey, Lennoxville, Que.

For Sale: Scotch Shorthorn

Young bulls and heifers. H. K. FAIRBAIRN, THEDFORD, ONT. Rose Cottage Stock Farm

MAPLE LEAF STOCK FARM

4 Choice Young Bulls for Sale. Also some cows and heifers, and prizewinning Berkshire pigs. Terms reasonable. HERBEL GROFF, Alma P.O. & Stn., G.T.R.

GOSSIP.

THE "MANOR" SHORTHORNS AND LINCOLNS.

The "Manor" Stock Farm, the property of Mr. John T. Gibson, of Denfield, Ont., fifteen miles north of London, on the G. T. R., is one of the best known in the Dominion, particularly in connection with its continental reputation as the home of one of the world's choicest flocks of Lincoln sheep. Mr. Gibson is one of Canada's oldest importers of Lincolns. There is no doubt that he has imported a greater number and more prize-winners than any other one man in America. For a great many years, representatives of his importations and flock have won practically everything hung up at Toronto, London and the Chicago International, and the reason is not far to seek: Mr. Gibson is a Lincolnshire man, has been associated with the care of Lincoln sheep all his life, and knows all there is to know about them. On hand, at the present time, are 150 head, all imported, or the progeny of imported sires and dams, practically every one a high-class representative of the breed. For sale are 25 last year's ram lambs and 20 last year's ewe lambs. The Shorthorns represent the Minas, Undines, Miss Ramsdens, Julias, Rosemarys, Bessies and Matildas. Five of the leading breeding cows are imported, and nine-tenths of the balance of the herd are bred from imported stock, sired by such high-class bulls as Nonpareil Archer (imp.); Nonpareil Duke (imp.); the Lovely-bred bull, Imp. Prime Minister, three times a winner at Toronto; the Lustre-bred bull, Imp. Governor-General; the Jilt-bred bull, Jocelyn, a son of Imp. Vice-Consul, and out of Imp. Julia, and the present stock bull, Imp. Proud Gift, sired by Golden Gift, a son of Spicy Robin, the sire of the Toronto grand champion, Spicy Marquis, dam by Monitor of Dalmeny, grandam by Dauntless. Proud Gift is a thick red, thoroughly masculine, and one of the greatest sires of high-class stuff that has crossed the water. All the young stuff in the herd under two year is sired by him, and it is safe to say that a better bunch can scarcely be found in any one herd in the country. Among the young bulls, fit for service, is a red yearling, out of Imp. Miss Ramsden; another red yearling, out of a Matilda-bred cow, a daughter of the Baron (imp.). Another is out of a daughter of Golden Robe, an exceptionally heavy-milking cow, bred on those lines. Another is a red nine-months-old, out of a Bessie-bred daughter of Imp. Prime Minister. Still another is a roan nine-months-old, a show calf, out of a daughter of Imp. Miss Ramsden, and by Imp. Governor-General. All these are sired by Imp. Proud Gift, and certainly are a rare nice bunch, fit to head almost any herd, and will be sold right. In heifers, there are a number from six months to two years, a thick, grand lot, coming winners among them sure. One, a roan ten-months-old, that Mr. Gibson declares is the best he ever bred, and she certainly looks like a winner. All these, both bulls and heifers, the get of Proud Gift, are essentially conspicuous on account of their ideal thick type, grand covering of hair, and extra-doing qualities, and, being out of such grand big, thick cows, cannot fail to be a profitable investment for anyone.

TRADE TOPICS.

The best early potato will appeal to a large constituency of farmers and gardeners. Attention is called to the advertisement in this issue of Snider's best early potato, and to the favorable testimonials selected from a number of similar ones sent us by the advertiser, Mr. Thos. Bousfield Carlisle, Wentworth Co., Ont. His Majesty King Edward VII. recently issued a royal warrant to the manufacturers of the well-known Cooper Sheep Dip, which signifies that this preparation has been selected for future use upon the Royal Buckingham flock of Southdowns. In compliment to Cooper dip is well known for the merits of which are known throughout the sheepmen throughout the Dominion. The Cooper dip is advertised in the Farmer's Advocate.

The common expression, "Robbing Peter to pay Paul," found its origin in London in 1550, when an appropriation was made from Saint Peter's Cathedral (now Westminster Abbey) to make up a deficiency in the accounts of Saint Paul's, the other famous English cathedral. The action roused a good deal of adverse criticism on the part of the people, who coined the phrase for the occasion.

The earliest use of the expression, "To die in the last ditch," was made by William of Orange, the stadholder of the Dutch Republic.

While he was carrying on his apparently hopeless struggle against Louis XIV., Buckingham, who was urging him to yield, asked him whether he did not see the utter ruin of his country that was impending.

"There is one certain means," replied William, "by which I can be sure never to see my country's ruin—I will die in the last ditch!"

THE DEMAND FOR HORSES.

The marked increase in the use of motor trucks of late years has caused a great deal of comment in the press and among horse dealers and users of horses on a large scale as to the probable fate of the horse as a factor in the commercial world, says the American Team Owner. Numerous individuals claiming the right to be heard as authorities on the subject, have predicted that the use of the horse was already decidedly on the wane, and that before the advent of many more years, the horse as a draft animal would be a thing of the past. The idea, which has gained ground among those not inclined to think deeply on such subjects, is the origin of the expression "the horseless age," a phrase employed in reference to the supposition that the time was at hand when machinery on wheels would supplant the horse entirely.

That this idea is radically wrong as far as the immediate future is concerned is conclusively shown by a very important and pertinent fact, and that is, that the demand for horses is at present greatly on the increase in all parts of the world. This may appear an unreasonable assertion to make in the face of the well-known increase in the demand for automobiles, but it is nevertheless true. The explanation is perfectly simple; there is an increase in the demand for both horses and motor trucks, and it is occasioned by the enormous increase in the amount of traffic consequent upon the expansion in the yearly volume of the world's trade.

HAY BROS.' SHORTHORN SALE.

Another excellent Shorthorn herd, to be dispersed by auction, is the old-established and favorably-known herd of the late Wm. Hay, of Tara, Ont., representatives of which are to be found in very many of the leading herds of Canada. The whole herd of 20 head will be sold without reserve, on March 12th, at the farm, one and a half miles east of the village of Tara, where conveyances will meet the morning trains on day of sale. There are nine cows, some with calves at foot, the balance in calf; three heifers rising two; two yearlings, and 6 bulls, five of them from nine to thirteen months of age, the other, the stock bull, Scottish Knight =53248=, bred by J. & W. Russell, Richmond Hill, sired by Imp. Fitzstephen Forrester, dam Centennial Isabella 47th, by Prince of Wales =27131=. He is individually a thick, even, low-down, straight-lined, good kind, and has proven himself a sire of sterling worth. The females belong to the following fashionable strains: Marr Floras, Cruickshank Lovelys, Stamfords and Wildames, the last named noted for dual-purpose qualities, being exceptionally heavy and persistent milkers. There will also be sold the fashionably-bred and high-class Clydesdale stallion, Kelvinside (imp.), a bay six-year-old, sired by Baron's Pride, dam by Macgregor. This horse's colts have invariably won the red wherever shown. Also, there will be sold two registered Clydesdale mares, Nell Gleanor 5332, aged, and her ten-year-old daughter, Kate Sargano 5334, by Imp. Cargano. This mare is heavy in foal to Kelvinside. The terms are ten months' on bankable paper, or 6 per cent. off for cash. Catalogues may be had on application.

Standing Offer



Good always, everywhere. \$100 Reward, for any lameness, curb, splint, founder, distemper, etc., (where cure is possible) that is not cured by

TUTTLE'S ELIXIR

Greatest horse remedy in the world. Tuttle's Family Elixir invaluable for human bruises, pains, rheumatism, etc. Send for free 100 page book, "Veterinary Experience." The perfect horseman's guide. Every disease symptom and its treatment.

TUTTLE'S ELIXIR CO., 66 Beverly Street, Boston, Mass. Canadian Branch, 32 St. Gabriel St., Montreal, Quebec.

Fistula and Poll Evil

Any person, however inexperienced, can readily cure either disease with Fleming's Fistula and Poll Evil Cure—even bad old cases that skilled doctors have abandoned. Easy and simple to apply; just a little attention every fifth day—and your money refunded if it ever fails. Cures most cases within thirty days, leaving the horse sound and smooth. All particulars given in Fleming's Vast-Practical Veterinary Adviser. Write us for a free copy. Ninety-six pages, covering more than a hundred veterinary subjects. Durable bound, illustrated and illustrated. FLEMING BROS., Chemists, 44 Church Street, Toronto, Ontario.

Special Low Rates West



\$41.95 VANCOUVER VICTORIA SEATTLE PORTLAND TACOMA \$39.45 NELSON, B. C. ROSSLAND TRAIL ROBSON SPOKANE, WASH. FROM LONDON.

SECOND CLASS. ONE WAY.

Proportionately low rates from all Ontario stations to above points and many Western and Coast points not named. Tickets good going March 1 to April 30.

Ask for particulars. Tickets good going March 1 to April 30.

See nearest C. P. R. Ticket Agent.

City Office: Corner Richmond and Dundas Sts., London, Ont.



ROCK SALT for horses and cattle, in ton and car lots. TORONTO SALT WORKS, TORONTO

2 GOOD YOUNG SHORTHORN BULLS

and some heifers for sale, very reasonable. They must be sold, as we have disposed of part of the farm.

D. BARTLETT & SON, Smithville, Lincoln Co. Breeders of Shorthorns and Dorsets.

SMITHFIELD STOCK FARM Shorthorns & Yorkshires

Present offering: Young stock of both sexes, sired by the Missie bull, Aberdeen Beau, by (Imp.) Scottish Beau. Also young Yorkshire sows. R. E. WHITE, Balderson, Ont.

ARLINGTON SHORTHORNS AND LEICESTERS

Present offering: 2 bulls 8 and 11 months old, by Christopher's Heir 45459; also a few females of different ages, some from imp. sires. No sheep for sale at present. Stock guaranteed as represented. John Lishman, Hagersville P.O. & Sta.

DEHORNING STOPS LOSS.

Cattle with horns are dangerous and a constant menace to persons and other cattle. Debore them quickly and with slight pain with a KEystone DEHORNER. All over in 2 minutes. Not a harsh method. Leaves a clear, clean cut. Cows give more milk; steers make better beef. Send for free booklet. R. H. McKenna, Fictus, Ontario, Can.



I am offering for sale my entire flock of pure-bred OXFORD DOWN SHEEP.

Consisting of 10 ewes, all in lamb to a pure-bred; also 7 shearlings; all in splendid condition. Prices right. G. GRIEVE, Maple Lodge, Ont.

Offer... everywhere... for any lame... splint, founder... (where cure... is not cured by...)
TITTLE'S
EXIR
Tuttle's human bruises... free 100 page... The perfect... and its treatment...
Boston, Mass.
Montreal, Quebec.

la
Cure...
Toronto, Ontario

ANADIAN
PACIFIC
RAILWAY
0.45
B. C.
AND
SON
E. WASH.

E WAY.
Ontario and
Western and
going March
and
Ont.

ROCK SALT
for horses
and cattle,
ton and
ar lots.

TORONTO
SALT
WORKS,
TORONTO

BULLS
reason-
have
Lincoln Co
sets.

ARM
shires
of both
erdeen
Also

on, Ont.
CESTERS
months old,
w females
sires. No
anted as
P. O. & Sta.
LOSS.

pure-bred
pure-bred;
on. Prices
on, Ont.

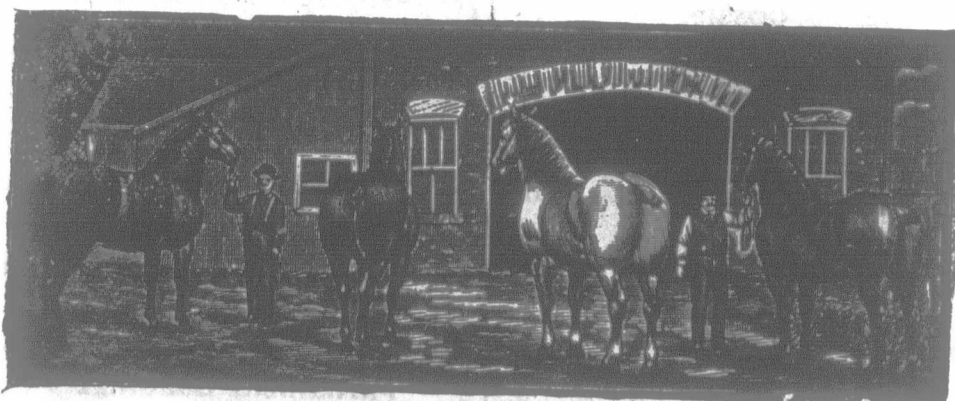

30 PERCHERONS

Also Shires, Hackneys and Clydes and 12 Percheron Mares (2, 3 and 1 year old) have just arrived with our new importation from Scotland, England and France, of high-class stallions and mares. Many of them prizewinners in their native lands. Bred by the best breeders. Percherons, blacks and grays, weighing 1,600 to 2,000 pounds. Shires at two years old weighing 1,700 pounds. Clydes, bays and blacks, 4 and 5 years old, weighing 1,600 to 2,000 pounds, bred by the best in Scotland. Our Hackneys are bays and chestnuts, combining size, quality and breeding that cannot be beaten. These horses can be seen at Toronto and London fairs, and all for sale at reasonable prices.

HAMILTON & HAWTHORNE, Simcoe, Ont.
88 miles south-west of Toronto on the G. T. R.

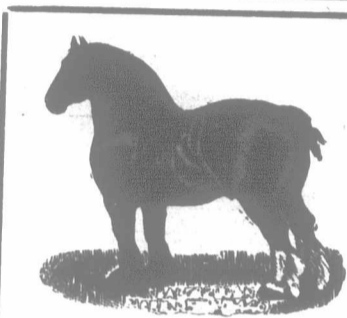

IMP. GLYDESDALES & HACKNEYS

Stallions and fillies of both breeds, representing the best blood of England and Scotland, combining size and quality and faultless action. If in want of something exceptionally choice, come and see me. You will not be disappointed. Prices right.

DUGALD ROSS, Streetsville, Ont.
Write for catalogue.

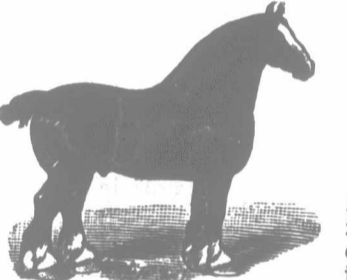

GRAHAM BROS.

"Calmbrogie," CLAREMONT,

IMPORTERS OF

HACKNEYS and GLYDESDALES

Established 80 years, and winners at all large shows in Canada and United States. Best of stock always on hand for sale. New importation of Royal winners just arrived.

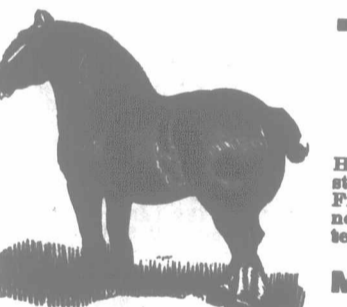

T. H. HASSARD

Millbrook, Ont.

Has on hand 40 head of Clydesdale, Percheron and Hackney stallions, and 25 Clydesdale fillies, representing Scotland, France and England's richest prizewinning blood and most noted sires. An essentially high-class lot. Will be sold on terms to suit purchaser.

MILLBROOK P. O. AND STATION
Long-distance 'Phone.



Graham & Renfrew's

GLYDESDALES and HACKNEYS

Our Clydes now on hand are all prizewinners, their breeding is glit- edged. Our Hackneys, both stallions and mares, are an exceedingly high-class lot. We also have a few high-steppers and carriage horses. Yonge Street cars pass the door every hour. 'Phone North 4428.

GRAHAM & RENFREW, BEDFORD PARK, ONT.

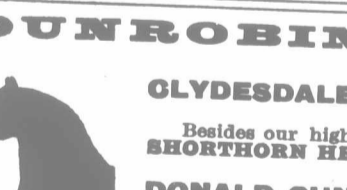

DUNROBIN STOCK FARM

BREEDERS OF

GLYDESDALES, SHORTHORNS and YORKSHIRES

Besides our high-class Clydesdale fillies, we are offering some well-bred SHORTHORN HEIFERS at reasonable money for a quick turnover.

DONALD GUNN & SON, BEAVERTON P. O. & STN.
Farm Three-quarters of a Mile from Station.



SMITH & RICHARDSON,

COLUMBUS, ONT.,

have now on hand a choice selection of Clydesdale Stallions, combining size and quality with straight, true action. Breeding unsurpassed. Individuality unexcelled. Scotland prizewinners. Also a few Canadian-bred stallions, and imp. and Canadian-bred fillies.

Long-distance 'Phone Myrtle Station, C. P. R.
Brocklin or Oshawa, G. T. R.

W. C. KIDD, LISTOWEL, ONT.

Importer of Clydesdales, Shires, Percherons, Belgians, Hackneys, Standard-breds and Thoroughbreds

of highest possible quality and richest breeding. Have sold as many stallions the last year as any man in the business, with complete satisfaction in every case. I have always a large number of high-class horses on hand. My motto: "None but the best, and a straight deal." Will be pleased to hear from any one wanting a rare good one. Terms to suit. Long-distance 'phone. LISTOWEL P. O. AND STATION.

QUESTIONS AND ANSWERS.

Miscellaneous.

TO DISTINGUISH GANDERS—TO TELL WHETHER COW IS IN CALF.

How can one tell geese from ganders, as we bought three, and they are all very much alike? The party told us at the time we bought them that two were geese and one a gander.

2. Is there any reliable way of telling if a cow is in calf, say four or six months since she was bred?

A SUBSCRIBER.

Ans.—1. Until geese are about full grown, the sexes can scarcely be distinguished; after that time, these differences may be noticed: The goose is rounder-bodied and plumper-looking than the gander. The gander's body seems longer, and his head and bill are larger.

The gander's call is shriller (he screams more), and is generally, though not always, on a higher pitch. Probably the most distinctive point is carriage. When going about, the point of the gander's bill is slightly elevated, he appears to be looking rather upward than on the level. The bill of the goose, on the other hand, points slightly downward; she seems more demure, and is less fussy and aggressive. The above points apply, of course, to individuals of the same breed.

2. There is, to our knowledge, no reliable outward indication at six months after breeding, whether the cow is in calf or not. The best sign is the non-appearance of oestrus (heat), but in some cases even that is not a certain indication, as in rare cases comparatively young cows in good condition permanently cease to come in heat, while not in calf, and prove hopelessly barren.

REMODELLING OLD BARN.

A correspondent from Prince Edward Island has written, asking us to outline a plan for rearranging and improving his farm buildings. He has five barns, and intends to re-model rather than go tearing things to pieces. He has his own idea as to what ought to be done, but, as he has just taken up farming after being in commercial life for some years, he wishes advice.

The diagram our correspondent encloses with his letter shows a very complete set of farm buildings. In addition to those mentioned are an ice house, wood house, boiler house, machinery shed and dairy. Three of the barns are so set as to enclose a yard facing south, a sunny, sheltered spot, and it is across the north end of this yard that the proposed cow stable is to be built. Protected on three sides, and open only to the south, it will certainly be warm and sunny. We heartily approve of the idea. It may be wise to refrain from tearing down and building anew, though that is just what a Western Ontario farmer would certainly do, if changes were to be made.

It would be impracticable for us to discuss in detail in "The Farmer's Advocate" all the suggestions offered, and we will but answer a few of the difficulties presented. The horse stable is cold and dark. Needless to say, more windows should be put in. If floor is elevated, with drafts underneath, banking will make a wonderful difference. To improve walls, nothing excels a layer of tar paper inside and boards over it.

For concrete manure gutter behind cows, prepare by leveling the ground into proper shape, and ramming it thoroughly.

Gutters are generally made level from end to end, so as to hinder escape of liquid. The last coat of concrete should be rich and fine, one part cement to two of sand, overlying to the depth of half an inch, three or four inches of gravel concrete, mixed one to nine, and firmly rammed.

Stall space for two cows, seven or seven and a half feet square. Of this, the manger takes two or two and a half feet in front, and the platform five feet. Each horse stall should be eight feet long, exclusive of passage behind, and five feet wide.

T. B.

The Repository

BURNS & SHEPPARD, Props.

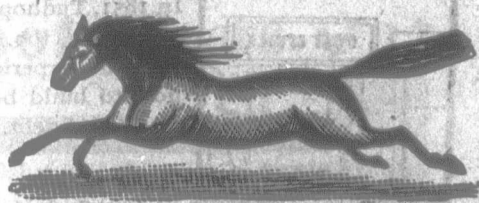

Cor. Simcoe and Nelson Sts., Toronto

Auction Sales of

Horses, Carriages, Buggies, Harness, etc., every Tuesday and Friday, at 11 o'clock.

Special Sales of Thoroughbred Stock conducted

Commissions solicited. Correspondence will receive prompt attention.

This is the best market in Canada for either buyer or seller. Nearly two hundred horses sold each week.

Bawden & McDonnell

EXETER, ONT.,

Have arrived home from Scotland with another importation of

12 Clydes and 2 Hackneys

selected from the best breeders in Scotland, and sired by Baron Frise, Montrose Mac and other noted horses. We have in all about 30 stallions in the barn—Clydes, Shires and Hackneys. Intending purchasers will do well to inspect, as these horses are all high class, and cannot be beat for true breeding quality and size.

SHOE BOILS

Are Hard to Cure, yet

ABSORBINE

will remove them and leave no blemish. Does not blister or remove the hair. Cures any puff or swelling. Horse can be worked \$2.00 per bottle, delivered. Book 6-C Free. A BOROBYNE, J.R., for manking, \$1.00 per bottle. Cures Boils, Bruises, Old Sores, Swellings, Varicose Veins, Varicocele, Hydrocele. Always Pain

W. F. Young, P. O. F., 73 Monmouth St., Springfield, Mass. Canadian Agents, Lyman, Sons & Co., Montreal.

Imp. Clydesdale Fillies!

Have now on hand about a dozen, nearly all imported. A high-class lot and very richly bred. Combine size and quality, and all in foal. Also one-year-old stallion. Write me, or come and see them.

Nelson Wagg, Claremont P. O. & Stn.

SHETLAND PONIES!

P. McCullough & Son Breeders and Importers of Shetland ponies, Markdale, Ont. We showed 8 ponies at Toronto Exhibition in 1905, and got 3 prizes: 3 firsts, 4 seconds and 1 third. All our ponies are imported. Our stallion, Foxglove, took first prize at Toronto. Our mare, Bessie, took first prize, and their foal, Bruce, took first prize also. Good accommodation for mares sent from a distance to breed. Ponies for sale. Our address: Markdale P. O., Ont.

Imported Clydesdales

Two 4-year-old and two 2-year-old stallions; one 2-year-old and two 1-year-old fillies; positively the best bunch I ever imported; richly bred, full of quality, abundance of size, and nice, true action. Will sell them right. Terms to suit.

Telephone con. Geo. G. Stewart, Howick, Que.

No more blind horses—For Specific Ophthalmia, Moon Blindness and other sore eyes BARRY CO. Linn City, Iowa, have sure cure.

We Will Import Welsh Ponies and Shropshire Sheep.

Write for terms and prices. Lloyd-Jones Bros., Burford, Ont.

For Sale—Cheap, or would exchange for Clyde fillies, Imp Hackney Stallion, Stockwell No. 4528 16 hands, 1400 lbs.; kind and sure, and a good getter. Selling to avoid inbreeding. J. C. ANDERSON, Macganagan P. O., Colborne Sta., G. T. R.

Clydesdale Stallions for Sale—Two imported, five and seven years old; first-class animals; also two Canadian-bred, registered, rising three years old. For further particulars apply to

Fleaherty Sts., C. P. R. JAMES PATON, Swinton Park.

Save Your Money

BEFORE ORDERING YOUR YEAR'S SUPPLY of literature, write to The Times Agency, Stair Building, Toronto, for a FREE Specimen copy of THE TIMES WEEKLY EDITION, and full particulars of circulating offers. Anything published supplied. IT WILL SAVE YOU MONEY, TIME, and it reduces the risk of non-delivery to a minimum.

Tudhope Carriages



In 1851, Tudhopes were making Carriages—and mighty good ones, too. Been making them ever since. And 55 years experience taught them a whole lot about how to build better Carriages. Talk it over with the Tudhope agent.

TUDHOPE No. 10

Our Stick Seat Open Buggy. Reinforced side panels, concave risers and steel corners. First quality 38 and 42 inches wheels—rubber tires, bolted between each spoke. Full trimmed shafts, with long painted leather. Silver tips on shafts and whiffletrees. Illustrated catalogue free. Write for it.

THE TUDHOPE CARRIAGE CO., LTD. ORILLIA, Ont.

HODGKINSON & TISDALE, BEAVERTON, ONT.

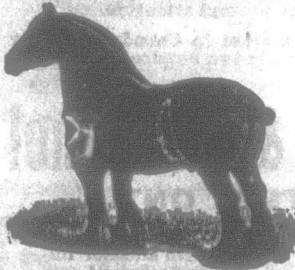

Importers and Breeders of Clydesdale and Hackney Horses. We have on hand at present the choicest specimens of Clydesdale fillies in Canada, also a few extra fashionably-bred young Clyde stallions. People wanting good ones should see these before buying. Our farm, "Simcoe Lodge," is situated near Beaverton, on James Bay and G. T. Railways. Long-distance phone No. 18. Visitors will be met at Beaverton on notification.



THE LA FAYETTE STOCK FARM

J. Crouch & Sons, Props., La Fayette, Ind.

Largest importers in America of German Coach, Percheron and Belgian stallions. Over 200 head on hand at all times. All have the best of bone, style and action, and on which we will put a gilt-edged guarantee they must be satisfactory, sure breeders. Won more prizes in the American show-ring in 1906 than all other importers combined. Our guarantee is the best. Terms to suit buyers. Importations arriving every few weeks insure prospective buyers a large selection from which to make a purchase.

J. CROUCH & SON, La Fayette, Ind. La Fayette is but six hours' ride from Detroit via Wabash Railroad.

40 WAVERLY HACKNEYS 40

Imported Stallions and Fillies.



Every one a high-class actor and a show animal. Splendidly-matched pairs and singles. Positively the highest class lot of Hackneys to be found on any one farm in America. All ages. Also 4 imported Clydesdale fillies. A big flashy lot, full of style and quality.

ROBERT BEITH, Bowmanville P. O. and Station. Long-distance Phone.



THOS. IRVING Winchester, Ont.

Established for over 30 years. Importer and exporter of

HACKNEY, CLYDESDALE and SHIRE STALLIONS and MARES.

New importation of winners just arrived. 90 miles west of Montreal on C. P. R.



LANGTON STOCK FARM CO., LTD. BRANTFORD, ONTARIO.

Breeders and Importers of Hackneys, Clydesdales, Shropshire Sheep, Berkshire Pigs and Scotch Collie Dogs.

2 Choice Hackney Stallions for Sale.

Hackney fillies and mares for sale. Three young Berkshire sows in farrow for sale. We are booking orders for March and April by Danesfield Donovan and from out imp. sows. We have a beautiful litter of puppies—two weeks old for sale, from Hollyrood Rose, sired by Nival Conqueror—also one beautiful puppy half grown.

T. A. COX, Manager.

CLYDESDALES AND FRENCH COACHERS, IMP.



Scottish and Canadian winners, stallions, mares and fillies. Th. Clydes represent the blood of such noted sires as Baron's Pride, Up-to-Time, Royal Favorite, Ethiopia and Acme. They combine size, quality and action. The French Coachers are very flashy, high-stepping lot, and are winners in both France and Canada. Prices are right, and our horses good as the best. Long distance phone.

ROBT. NESS & SON, Howlok, Quebec.

Imported Clydesdale Stallions and Fillies

My new importation comprises 3 stallions, two 3 year old and one 1 year old, by Everlasting, Baron Buchylvie and Ascott, and 5 fillies, by Baron's Pride, Up-to-Time, Royal Favorite, Ethiopia and Acme. They are all winners, and good as ever crossed the water. Come and see them. All are for sale.

A. MITCHELL, Guelph, Ont.

GOSSIP.

THE MAPLES HOLSTEINS.

About seven miles from Woodstock on the one side, and Ingersoll on the other, with Folden's Corners as his P. O., lives Mr. Walburn Rivers, owner of The Maples Stock Farm. Mr. Rivers is one of Oxford's leading breeders of pure-bred stock, with the ambition to own a herd of Holstein cattle second to none in the country. He purchased as a foundation:

Daisy Nightingale of Norval, whose seven-day records are, 371 lbs. of 4-per-cent. milk, and 19.28 lbs. of butter; Abbekirk Tryntje De Kol, with a four-year-old record of 427.9 lbs. milk, and 15.35 lbs. of butter in seven days; Daisy Albino De Kol, whose five-year-old records are 371.906 lbs. milk, and 17.33 lbs. butter in seven days. This cow has now a two-months-old bull calf that is for sale, sired by the stock bull. The other foundation cow is Princess Calamity Clay, whose four-year-old records are 70 lbs. of milk in one day, 473.24 lbs. milk and 19.87 lbs. butter in seven days. He also purchased, as head of these, the richly-bred bull, Lord Wayne Mechthilde Calamity, sired by Daisy Texal 2nd's C. P., whose dam, Daisy Texal 2nd, has an official record, at three years old, of 68 lbs. of milk in one day, and 18 lbs. butter in seven days, and grandam, Calamity Jane, has a record of 572 lbs. of milk and 25 lbs. of butter in seven days, dam Lady Wayne Norine Mechthilde has a twenty-four-months-old record of 11 lbs. 15 ozs. butter in seven days, grandam Lady Wayne Norine, with a five-year-old record of 19 lbs. butter; her milk that year showed 4.68 per cent. of butter-fat. At six years old, she was again tested, her milk showing 4 per cent. butter-fat, and her butter record going up to 22 lbs. in seven days; great-grandam Norine 2nd, who gave 90 lbs. of milk in one day. This bull is now at the head of the herd. Other females, some purchased, some bred in the herd, are: Daisy Wayne, a De Kol, whose two-year-old record is 270 lbs. milk and 12.75 lbs. butter in seven days; Iolena Fairmont Iosco, two-year-old record, 313.59 lbs. milk, 11.18 lbs. butter in seven days; Princess Calamity Wayne, two-year-old record, 268.4 lbs. of milk, 10.24 lbs. of butter in seven days; Iolena Albino Wayne, two-year-old record, 288.3 lbs. milk, 11.01 lbs. butter in seven days; Princess Calamity Posch, two-year-old record, 334.93 lbs. milk, 12.46 lbs. butter in seven days. This cow has a three-months-old bull calf, by the stock bull, that is for sale. Countess Daisy Clay, two-year-old record, 308.625 lbs. milk, 10.85 lbs. butter in seven days. She has an eleven-months-old bull, by the stock bull, that is for sale. Daisy Albino De Kol Duchess, three-year-old record, 349.36 lbs. milk, 15.68 lbs. butter in seven days, has a bull calf, by the stock bull, that is for sale. Iolena Fairmont 3rd's Albino, three-year-old record, 311 lbs. milk, 14.18 lbs. butter. Out of her, by the stock bull, is a yearling bull that is for sale. Although not a large herd, every female in milk is in the Record of Merit, and the several young bulls mentioned are exceptionally richly bred, and should be rapidly picked up as herd-heads. Write Mr. Rivers, to Folden's Corners P. O. He is strictly reliable.

TRADE TOPIC.

Our readers will notice, on another page of this issue, the advertisement of one of our old advertisers, The International Carriage Co., Brighton, Ont. This firm have been selling vehicles, harness, etc., for years, and, having built up a splendid reputation for their work, are well and favorably known from the Atlantic to the Pacific. Their method of doing business is directly with the user, and anyone, by getting their larger illustrated catalogue, which is free for the asking, may tell for themselves what any vehicle or harness will cost, the price of each being plainly given. In our personal dealings with them, we have always found them courteous, honorable and reliable.

FARM LABOR

If you want help for the farm, for the season or the year, write for application form to the

BUREAU OF COLONIZATION
Parliament Buildings
TORONTO.

FREE to RUPTURED

A QUICK NEW CURE



I have made new and important discoveries in the cure of Rupture, and for the next thirty days will give every ruptured person who follows these directions a chance to try this remarkable home cure. FREE. Mark on the picture the location of your Rupture, answer the questions, and mail this to DR. W. S. RICE, 95 CHURCH ST., BLOCK 906, TORONTO, ONT.

Age.....Time Ruptured.....
Does Rupture pain?.....
Do you wear a Truss?.....
Name.....
Address.....

ANNANDALE FINE STOCK FARM

TILLSONBURG, ONT.

Premier sire, Prince Posch Calamity, whose dam and sire's dam average in official test 86 lbs. milk in 1 day and 26 lbs. butter in 7 days.

No stock for sale at present.

GEO. RICE, Tillsonburg, Ont.

Home-seekers! Why go West to a cold climate? Better come to Virginia! We have good land at low prices; raise good crops; have good markets; get good prices for what we sell. We have good schools, churches, social advantages, and everything worth while. Write us about it, and send 5c. for our descriptive literature.
PIEDMONT & TIDE-WATER LAND CO., Inc.
Columbia, Virginia, U. S. A.

Broxwood Herefords

Cows, heifers and calves

For Sale.

R. J. PENHALL, Nover, Ont.

FOREST VIEW FARM HEREFORDS
Four bulls from 8 to 18 months old; praiseworthy and from prize-winning stock. Several heifers bred on the same line; choice individuals for sale.
JOHN A. GOVENLOCK,
Forest Sta. and P.O.

HEREFORDS—We are now offering a few thick, smooth young bulls and a number of females—a low-down, even, beefy lot. If in want of something extra good, correspond with us. We can please you.
T. R. LOVERING, Coldwater P.O. and Sta.

Angus Cattle The kind that get market topers. We have for sale 7 young bulls from 9 to 16 months old; also females all ages. All eligible for the American Herdbook. From good families and good individual merit. J. W. BURT, Aberdeen Farm, Coningsby P. O. 3 1/2 miles from Erin stn., C. P. R.

For Sale—Choice registered Holstein bull Gretequi De Kol, whose dam made over 18 lbs. of butter in seven days at three years old; also one yearling and one two-year old bull at a bargain.

W. A. BRYANT, Cairngorm, Ont.

Aberdeen-Angus—Our herd in 1906 won all principal prizes at Toronto, London, Ont. Exhibition, Halifax, and Provincial at Charlottetown, Prince Edward Island. Also, we got the largest share in our class at Provincial Winter Fair, Guelph. Stock of all ages for sale.
JAMES BOWMAN, Elm Park, Guelph.

Spring Valley Shorthorns

Offer some nice young heifers and cows in calf and with calves at foot; also two nine months' bull calves, both very choice, sired by Imp. Bapton ChanceHor. Prices reasonable. Write, or come and see them.
KYLE BROS.,
Ayr, Ontario.

QUESTIONS AND ANSWERS. Miscellaneous.

SCALY LEG.

Can anyone tell me a cure for scaly legs on chickens, also the cause?

A SUBSCRIBER.

Ans.—The disease is caused by a parasite called the scaly-leg mite, which flourishes in damp and filthy quarters. To get rid of the trouble, keep the poultry houses clean and wholesome, and use liquid lice-killers frequently about the roosts and dropping-boards. The simplest treatment is to rub the legs and toes with pure coal oil.

HOW MUCH CEMENT?

How many barrels of Portland cement will it take to build a cement wall, one foot thick, across two ends and one side of a building 17 by 53, three feet high? Also, should it be mixed pretty wet, or if it is better to put it in about like mortar? YOUNG QUEBEC FARMER.

Ans.—Nine barrels of cement would be sufficient; mixed one part cement to nine of gravel. The gravel and cement should be mixed dry, and water added afterwards. The concrete should not be made so wet that water will run from it, but yet wet enough to show water when rammed. By imbedding as many stones as possible in concrete, the amount of both cement and gravel needed will be much less, but stones should not come within an inch of face of wall on either side. T. B.

NITRATE OF SODA.

1. What precautions should a farmer take not to be cheated in buying fertilizer? I want to use about 600 lbs. of nitrate of soda next spring.

2. What is the lowest price I can expect to pay, and have the real nitrate of soda?

3. Could you give me the address of some dealer in Detroit, Michigan, it would be more handy for me?

4. Is there any duty on fertilizer coming into Canada?

5. Would it be cheaper for me to order it from New York? I think it is cheaper there. Would the freight charges be very high on 600 lbs. of nitrate of soda? L. L.

Ans.—According to the Dominion Fertilizer Act, no mixed fertilizers can be sold or offered for sale in Canada at more than ten dollars per ton, unless accompanied by the guarantee of the Inland Revenue Dept. This guarantee must be stamped on the bags containing the fertilizers, or, if sold in bulk, must be placed on the invoice. Consequently, a farmer need not buy fertilizers without having a clear idea of the amount of the fertilizing substances they contain. In addition to this, it is absolutely necessary that the buyer make himself familiar with the nature of the different materials which may be used in making the fertilizer, and also the availability of the various substances. With regard to chemical fertilizers, such as nitrate of soda, muriate of potash, sulphate of potash, etc., these materials are usually sold on the basis of percentage purity. Thus nitrate of soda may be sold at 95 per cent. pure, which would mean that it would contain 95 per cent. of pure sodium nitrate; and the price can be figured on that basis.

The nitrate of soda may be bought in the original package as shipped by the manufacturer in South America. In such case, there would be no possibility of adulteration here, and it is not probable that the manufacturer would risk the adulteration of a product sold on percentage basis.

2. Nitrate of soda is now sold at about three dollars per hundred, f. o. b., Toronto, in original packages of 224 pounds each, as imported. I think the imported article, got in this way, may safely be taken as up to the guarantee of percentage purity.

3. I do not know the names of any fertilizer dealers in Detroit, Mich. Nitrate of soda may be purchased from almost any of the large seed merchants of London, Hamilton, Toronto, etc., or from Freeman & Co., Hamilton, Ont.

4. I doubt very much if it would be cheaper for you to buy in New York. Our dealers bring fertilizers forward in large quantities, and thus at a lower rate than they could be brought in small quantities. R. HARCOURT.

O. A. C., Guelph.

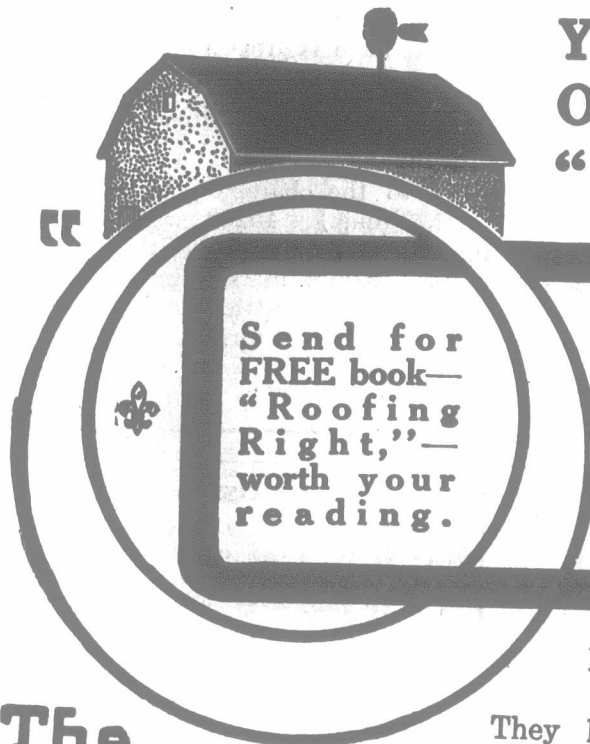

Send for FREE book—"Roofing Right,"—worth your reading.

Your Grandsons Will Be Old Men Before This "Oshawa" Roof Wears Out

Roof your buildings with "Oshawa" Galvanized Steel Shingles this year, and that will be a GOOD roof in 2007. We will give you a written guarantee, backed by \$250,000, that such a roof, properly put on, will need no repairs and no painting for at least twenty-five years.

"OSHAWA" GALVANIZED STEEL SHINGLES

make roofs water-tight, wind-proof, weather-proof, rust-proof, fire-proof for a century,—our plain guarantee keeps it so for 25 years without a cent of cost to the man who buys it.

Made in ONE QUALITY ONLY,—of 28-gauge, semi-hardened STEEL double-galvanized

They lock on all FOUR sides—the ONLY METAL shingle that need NO CLEATS. Easy to put on—a hammer and a snips (tinners' shears) are tools enough. Cost LESS and last longer than any other roof. Tell us the surface area of any roof on your place and we will tell you exactly what it will cost to roof it right.

The Pedlar People of Oshawa

Get the facts before you roof a thing.

Montreal Toronto Ottawa London Winnipeg Vancouver 321-3 Craig St. W. 11 Colborne St. 423 Sussex St. 60 Dundas St. 75 Lombard St. 615 Pender St. 102

Imported and Home-bred

SHORTHORN

Bulls and Helpers.

I now have ready for sale 7 choice young imported bulls of the most select breeding. Two young bulls bred from imported sires and dams, a lot of imported and home-bred females, all of the highest class, best of breeding and at the lowest possible prices.

Ask for catalogue, or, better still, come and see them.

ROBERT MILLER, Stouffville, Ontario.

RAILWAY VIEW STOCK FARM SHORTHORNS Herd headed by Lord Lieutenant, imported, -50050-. Present offering: Four young bulls, from 6 to 8 months old. Cows and heifers, imported and home-bred. Prices reasonable. SCOTT BROS., Highgate P. O., Ont.

Shorthorns for Sale—Herd bull, Prince of Banff (imp.) -45212-, and three young bulls 12 months old; also a few heifers and young cows with calves at foot. Prices reasonable. Correspondence solicited. D. HILL, Staffa P. O., Ont.

Shorthorn Bull—Prince of Stars -49804-. Rich roan Shorthorn herd bull kind, sure, a good handler. The low-down kind. Will sell to avoid inbreeding. Look up this pedigree, and write H. M. VANDERLIP, Gainsville, Ont.

U. S. CUSTOMS REGULATIONS. Can a registered gelding cross into the United States the same as a stallion; that is, duty free? E. A. C.

Ans.—No; only breeding stock is so privileged.

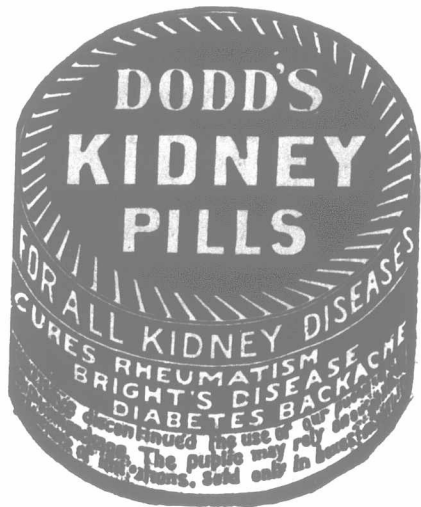

ALEX. YOUNG, Glanford, Ont., LIVE-STOCK AUCTIONEER

Pedigreed Stock a Specialty.

SHORTHORNS AND LEIGESTERS

Present offering: 4 choice young bulls from 6 to 12 months old. All sired by Hosterucian of Dalmeny (imp.) -45920-, and from grand milking dams. Prices away down for quick sale. Also a grand lot of young registered ewes now bred to our stock ram, and a few good rams at reasonable prices. Address: W. A. DOUGLAS, Caledonia Station, Tuscarora P. O.

Glen Gow Shorthorns

Our present offering is 9 bulls, from 6 to 14 months of age, sired by Imp. Ben Loman and Imp. Joy of Morning, and out of Imp. and Canadian-bred cows. Also a number of very choice heifers. No fancy prices asked. Long-distance 'phone. WM. SMITH, Columbus P. O.

GREENGILL HERD of high-class SHORTHORNS

We offer for sale 8 young bulls, a number of them from imp. sire and dam; also females with calf at foot or bred to our noted herd bull, Imp. Lord Roseberry. R. MITCHELL & SONS, Nelson P. O., Ont.; Burlington Jano. Sta.

Shorthorns, Berkshires & Lincolns

A number of heifers and cows with calves at foot. Four bulls from 7 to 12 months, the right sort, at prices to suit the times. Berkshires of both sexes; also the Lincoln ram, Ronald 18901, by Dean & Sons' (imp.) 10608. F. Martindale & Son, Caledonia Sta. York P. O.

Brown Lee Shorthorns—Present offering is 8 young bulls from 8 to 12 months old, a nice straight, good-doing lot, sired by Elmhelm Stamp; also females of all ages, daughters of Imp. Sir Christopher and Imp. Beaumont. Prices very reasonable. DOUGLAS BROWN, Av. P. O. and Staffa.

Maple Hill Stock Farm Scotch Shorthorns—A special offering of a red bull calf of Missie family, sired by Eustic Chief (imp.) -40419-; also some choice females by Wanderer's Star -45585- and Lucerne (imp.) -50063-. WM. R. ELLIOTT & SONS, Guelph, Ont.

Shorthorns for Sale—Five choice bulls, all from imp. sire, and three of them Scotland's Fame (imp.) at head of herd. ALEX. BURNS, Rockwood P. O. and G.T.R. Sta.

Shorthorns Stamford's English Marthas, Nonpareils. 3 choice bulls 14 months old. 3 heifers. 9 cows. Breeding unsurpassed. Canadian and American registration. F. W. EWING, Salem P. O., Elora Station.

John Gardhouse & Sons, Importers and breeders of Scotch Shorthorn cattle, Shire and Clydesdale horses and Lincoln sheep. Just now we are offering a few extra choice heifers—show stuff among them; also three rare good young bulls, bred from imp. sire and dam. Highfield P. O., Western station 3 1/2 miles. Telephone.

SHORTHORNS. Just closed out the season's crop of bulls of breeding age, but have a few very nice youngsters coming up. Anyone wishing a stock bull from the noted Derby (imp.) send orders ahead, as they are all picked up as soon as ready. W. J. SHEAR & SON, Box 288, Owen Sound, Ontario.

A. EDWARD MEYER, Box 275, Guelph, Ont.

Offers for sale, at prices you can stand, young SHORTHORN BULLS. Four of them from imported sire and dams. Several cows with heifer calves at foot by Imp. Scottish Hero, and a few yearling heifers. All are of the choicest Scotch breeding. Write, or better come and look them over. Long-distance 'phone in house.

SHORTHORNS & BERKSHIRES

For Sale: Six extra fine young bulls, some belong to grand milking strains. Also a fine lot of young cows, bred to farrow in March and April, and a grand lot of young sows and boars from three to five months old. S. J. PEARSON, SON & CO., MEADOWVALE, ONT. Stations: Streetsville and Woodville, C.P.R.

KENWOOD STOCK FARM, SHORTHORNS.

Headed by (imp.) Jils Victor -45107-. Offerings are two bull calves, an 11-months Miss Ramsden, from imp. sire and dam; a 12-months Missie, by Elythesome Euler, and other bulls; also heifers of choice breeding. A few choice Berkshire pigs just off the sow. HAINING BROS., Highgate, Ont. Kent Co.

T. DOUGLAS & SONS, STRATHROY, ONT.

Breeders of Shorthorns and Clydesdales. 15 bulls, 60 cows and heifers, 1 imp. stallion, imp. and home-bred fillets. Write us what you want or come and see our stock. Farm 1 mile north of town.

Huntlywood Shorthorns.

Young bulls for sale. The best lot we ever had, by imported Cleoly's Pride (78994), out of imported dams. Broadhooks, Lavenders, Lancasters, etc. Prices reasonable. W. H. GIBSON, Manager, Huntlywood Farm, Becclesfield, Que.

Belmar Parc Shorthorns

WE think we have as great a lot of young show animals as has ever been on one farm in Canada. Our herd is large, the individuals are choice and of the richest Scotch breeding, and our prices are moderate. 15 young bulls, 25 heifers under three years. A splendid group of breeding and show matrons. Mostly in calf to the champion Marigold Sailor =53258= and the prizewinning Nonpareil Archer (imp.) =45202=. Pembroke is on the main line of the C. P. R. and the Canada Atlantic Division of the G. T. R. You can leave Toronto 11 a. m., arrive Pembroke 12.05 p. m., see the herd, and arrive Toronto next morning at 7.20. We prefer you to see the cattle, but if you can't spare the time we take special pride in filling mail orders satisfactorily.

John Douglas, Manager.

PETER WHITE, Pembroke, Ont.

R. A. & J. A. WATT

Offer special inducements to buyers of

SHORTHORN BULLS

For the next few weeks. They also price females of rare quality.

Elora Station, G.T.R. & C.P.R.

SALEM, ONTARIO.

Visitors always welcome.

WESTSIDE SHORTHORN HERD AND BORDER LEICESTER FLOCK.

All Registered in the Herd and Flock Books of Great Britain.

We invite all interested to inspect the cattle and sheep on this farm. The Shorthorns are long-tried families, tracing to the pioneer herds of Scotland through channels of repute. The Border Leicester flock is one of the oldest in Scotland, and embraces blood of the highest breeding. Selections for sale. Visitors from the States and Canada will be cordially welcomed.

A. Cameron & Sons, Westside Farm, Brechin, Scotland.

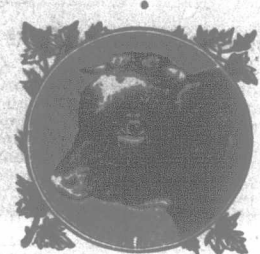

Special Offering of Scotch SHORTHORN BULLS

3 just past two years old; 15 just over one year old;
7 just under one year old.

The best lot we ever had to offer in individuality and breeding,
and prices are right. Catalogue.

John Glancy,
Manager.H. GARGILL & SON,
Cargill, Ont.

AT "MAPLE SHADE"

Our young bulls are the best that our herd has ever produced. We can furnish Cruickshank bulls of high quality to head the best herds, and some that should produce the best prime steers. We have a bull catalogue. Send for one.

JOHN DRYDEN & SON,

Brooklin, Ont.

Stations: Brooklin, G.T.R. Myrtle, O.P.R. Long-distance telephone.

HOLLYMOUNT SHORTHORN:

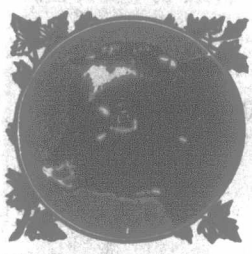

Pure Scotch.
Imported,
and the get of
Imp. stock.

25 HEAD

Anything for sale. 1
young bulls. Breeding
sifted and unsur-
passed. A few heifers.
Prices right.

W. J. Thompson, Mitchell P. O. & Sta
Six Red Shorthorn Bulls

19 to 15 months old, got by Proud Gift
=50077= (imp.); also cows and heifers,
imported and home-bred. Inspection
solicited. We think we have as good
Shorthorn cattle as we have Lincoln
sheep 14 firsts out of a possible 19, our
record at Chicago, 1906.

J. T. GIBSON, Denfield, Ont.

Shorthorns and Clydesdales

I am now offering 6 young bulls from 8 to
20 months old, all Scotch bred, two of
them from extra good milking families,
and a few registered fillies of good quality.

JOHN MILLER, Brougham, Ont.
Claremont Sta., C.P.R.; Pickering, G.T.R.

STRUAN SHORTHORNS

For sale: Choice young bulls from four
to ten months old, sired by Scottish Beau
(imp.) =38059=; also cows and heifers of
different ages. Write for prices, or
come and see my herd.

N. S. ROBERTSON, Ontario

Arnprior, Ontario
12 SHORTHORN BULLS FOR SALE
from 10 months to two years old. Several
of their dams or grandams winners in
Toronto. Prices very moderate. J. & W.
RUSSELL, Richmond Hill Ont.

Queenston Heights

SHORTHORNS

Special offer now: Several choice
Scotch bulls, two of which are
show bulls, a roan yearling and a
red two-year-old by Derby (imp.)
=32059=. Their dam is Bessie's
Maid =47779=, by the great sire
Royal Prince =26062=. There is
no better breeding. Also some
young cows and heifers at low
prices for prompt sale.

HUDSON USHER, Queenston, Ont.

GEORGE D. FLETCHER,

Breeder of Scotch Shorthorn
Cattle and Yorkshire Pigs.

Our herd of the most noted Scotch families is
headed by the \$2,000 Duthie-bred bull, Joy of
Morning (imp.) =32070=, winner of 1st prize at
Dominion Exhibition, Toronto. A few very
choice young bulls from 4 to 9 months old, also
females for sale. In Yorkshires are a choice lot
of either sex, 7 months old, from imp. sire and
dam. Bows bred to imp. hog if desired.

SINKHAM P. O., ONT. ERIN STATION AND TEL.

JOHN LEE & SONS, Highgate, Ont.



SHORTHORNS & LINCOLNS

The champion herd of Elgin,
Kent and Essex counties.
For Sale: 6 choice young bulls
3 reds and 3 roans, of grand
type and quality; also good
selection of young cows and
heifers. Visitors welcome.

T. E. ROBSON,

Live-stock Auctioneer

2 BECHER ST., SON, ONT.

GOSSIP.

Mr. J. F. Elliott, Oxford Centre, Ont.,
expects to arrive home from Scotland
about March 1st, with a choice consignment
of Clydesdale fillies, selected for
their individual excellence, size and
fashionable breeding. They will be sold
by auction, particulars of which will
appear in these columns in due time.

MENIE AYRSHIRES.

Continual improvement is the record of
the noted Menie herd of Ayrshires, the
property of Messrs. Wm. Stewart & Son,
of Menie, Ont., founded 23 years ago by
the purchase of 2 heifers and 1 bull from
James Milne, of the then fashionable
Brodie strain. Among the earlier bulls
in service in the herd was Wellington
Elias Gladstone 330, a bull that left an
indelible stamp of improvement. Following
him was Success; then one bred by
the late Thos. Guy, of Oshawa, from his
prizewinning stock. Then came the great
stock bull, Imp. White Prince, and the
great show cow and six times champion,
Jean Armour, both from the noted herd
of David Morton, of Hamilton. Jean
Armour has been one of the most noted
cows in Canada. Besides being a wonder-
ful producer in her palmy days, she gave
66 lbs. of 4-per-cent. milk a day, and is
still breeding regularly, and her many
daughters and granddaughters now in the
herd contribute greatly to its present
high standard. Another cow that has
contributed greatly to the improvement
of the herd is Red Rose 3rd, a half-sister
to Imp. White Prince. One of the great
show cows is Annie Laurie, a daughter of
Wellington Elias Gladstone, and a Toron-
to champion. She has to her credit
9,250 lbs. of milk a year. A daughter
of hers, Pride of Menie, is also a cham-
pionship cow, and gave 60 lbs. of 4.3 per-
cent. milk a day as a three-year-old.
Lady Ottawa, a daughter of Jean
Armour, also is a sweepstakes cow that
gave 55 lbs. of milk a day. Bessie of
Warkworth won the sweepstakes at Lon-
don last fall, and gave 50 lbs. of 4.6 per-
cent. milk a day. Barbara Allan, at two
years old, gave 38 lbs. of 5.2 per cent.
milk a day, and several others gave from
40 to 60 lbs. a day, some testing as high
as 5 per cent. The present stock bull
is Rob Roy, by Kitchener, a son of Imp.
Minnie of Lessnessock, whose milk record
is 65 lbs. of 4-per-cent. milk, dam Edna,
that has to her credit 55 lbs. of 4-per-
cent. milk a day. Second sire in service
is Queen's Messenger of Spring Hill, by
Imp. King of Beauty, dam Imp. Garlaff
Bloomer, both Toronto champions. This
is the herd that produced that wonderful
heifer, Ethel Mary Stewart, that, as a
two-year-old, gave 10,800 lbs. of milk,
and is now the champion of the herd of
J. P. Roberts, of Pennsylvania. Al-
though sales from this herd for the past
year have been heavier than ever before,
a few heifers can still be spared that cer-
tainly are superior goods.

TRADE TOPIC.

VETERINARY BOOKLET FREE.—We
have just received a sixty-four page book-
let on animal diseases. The symptoms,
cause and remedy are given in plain Eng-
lish, covering nearly every disease
which the horse, cow, hog, sheep and
poultry are heir to. The booklet has
been compiled and printed by the Zenner
Disinfectant Company, 112 Lafayette
Ave., Detroit, Mich., and every reader of
this paper may secure a copy FREE by
sending a postal card, giving your de-
tailed address. The book will be gladly
sent free of all charge, and without obli-
gation. The sooner you write, the sooner
you will receive the booklet.

Bone Spavin

No matter how old the blemish,
how lame the horse, or how many doctors
have tried and failed, use

Fleming's
Spavin and Ringbone Paste
Use it under our guarantee—your money
refunded if it doesn't make the horse go
sound. Most cases cured by a single 45-
minute application—occasionally two re-
quire. Cures Bone Spavin, Ringbone and
Sidebone, new and old cases alike. Write
for detailed information and a free copy of
Fleming's Vest-Pocket
Veterinary Adviser

Ninety-six pages, durably bound, indexed
and illustrated. Covers over one hundred
veterinary subjects. Read this book before
you treat any kind of lameness in horses.
FLEMING BROS., Chemists,
45 Church Street,
Toronto, Ontario

Pure Scotch Shorthorns

WE ARE OFFERING FOR SALE IMP.
SCOTTISH PRIDE =36106=.

3 bulls just two years old. 6 bulls one year old.
7 bull calves from 8 to 12 months. (12 of these
bulls are from Imp. cows.) Choice females of
all ages: 100 to choose from. 2 Imp. Yorkshire
sows due to farrow in March. 10 young sows 5
months old. Write for catalogue and prices.
Our farms are only one-half and one and one-
half miles from Burlington Junction, G. T. R.
Long-distance telephone in residence.

W. G. Pettit & Sons,
Freeman, Ont.

SHORTHORNS

Imp. Keith Baron 36050. Six young bulls from
10 to 18 months old. A lot of 8-year-old heifers
in calf and a few young cows. A bunch of
heifer calves, cheap.

CLYDESDALES

Just now: One pair of matched geldings 5 and
years old; show team.

JAS. McARTHUR, Goble's, Ont.

Glover Lea Stock Farm SCOTCH SHORTHORNS

Superior breeding and individual excellence
for sale: Bulls and heifers—reds and roans,
some from imp. sire and dam. Visitors met at
Ripley station, G. T. R.

R. H. REID, PINE RIVER, ONTARIO.

Pleasant Valley Shorthorns

We are offering 7 high-class young bulls,
by (imp.) Old Lancaster =60068= and
out of imp. and Canadian-bred cows,
of good Scotch breeding; also several
young cows and heifers. Correspondence
solicited.

GEO. AMOS & SON, Moffat, Ontario.

Farm 11 miles east of Guelph, on C.P.R.
one-half mile from station.

MAPLE GROVE SHORTHORNS

My present offering consists of
imported and home-bred cows
and heifers, also four young
bulls bred by Lord Banff's Con-
queror. He is one of the best
stock bulls of his breed. Terms
and prices to suit the times
C. D. WAGAR, Enterprise Stn. & P.O.
Addington Co.

Maple Lodge Stock Farm
1854-1907.

Am now offering a grand lot of
young Shorthorn Bulls, several
from choice milking strains. Also
a few extra good heifers.

A. W. SMITH, MAPLE LODGE, ONT.

QUESTIONS AND ANSWERS. Veterinary.

WOODEN TONGUE.

Steer eats well, but is failing in flesh. He salivates a great deal, and his tongue is enlarged and raw in places.

T. K.

Ans.—This is a form of actinomycosis (lump jaw), called wooden tongue. A recovery is doubtful. Give him iodide of potassium three times daily; commence with dram doses, and increase the dose by 10 grains daily, until appetite and thirst fail, tears run from the eyes, and the skin becomes scruddy. When any of these symptoms appear, cease giving the drug. Repeat treatment, if necessary, in six weeks.

SWOLLEN LEGS AND BODY.

Mare had distemper, and now her legs and body are swollen. Our local veterinarian is treating her, but she is not improving as I would like. What treatment would you suggest?

J. W.

Ans.—Swellings of different nature are liable to occur as a sequel to distemper, and treatment depends upon the nature of the complication. I would advise you to leave the case in the hands of your veterinarian, as he, being present, is in a much better position to treat properly than any person who has not seen the case can possibly be. Do not be discouraged or blame the veterinarian if recovery is not rapid, nor yet if the case proves fatal, as distemper is liable to be followed by different diseases, some of which are often fatal.

Miscellaneous.

HOLLOW BRICK VS. CONCRETE BLOCKS.

1. Having seen, in the columns of your paper, a good deal about basement stables and ventilation, and, also, that a hollow-brick wall is cheaper than lumber or concrete, where could I procure such brick, and at what price? What about a hollow concrete block, which has three dead-air spaces? Are they the same as what you call hollow brick? Would you consider the concrete blocks porous?

2. What system of ventilation could you recommend in a horse stable and a cow stable, built of hollow brick?

3. The two buildings under which I purpose putting basement stables are each 63 x 30, and I would like to raise them 8 or 9 feet, and join the two by a manure shed. Thirty feet by thirty feet is the space between buildings. Could you give me a rough estimate of the cost of such a building made of hollow brick or concrete, and not considering inside fixtures?

4. Would it be better to make manure shed of lumber or brick?

Ans.—1. What are known as hollow brick are made of clay by a powerful tile machine. Each has three dead-air spaces, and, without doubt, they make an excellent non-conducting wall, especially when plastered on the inside. They are manufactured at a few places in East Middlesex, and elsewhere, but could not profitably be shipped to any great distance. Even in the neighborhood where they are manufactured, their use is being limited at the present time by the rage for concrete blocks. Solid concrete walls for barn foundations are on the score of economy and solidity, popular in neighborhoods where stone is scarce.

2. Look up editorial on stable construction, and, also, descriptive article on same subject in our issue of January 17th. Read the numerous letters published since. Live interest in barn ventilation is but of recent date, and the whole subject may be said to be yet in the investigation stage.

3. Contracts for building concrete walls have been let in the vicinity of London for nine cents per cubic foot. The contractor supplies cement, working outfit and labor, the farmer to board the men and supply gravel. At that rate, a cement wall, one foot thick and nine feet high, under your two buildings would cost almost exactly \$300.

4. We would recommend lumber on concrete foundation wall.

T. B.



The FINISHING PERIOD

It requires more feed to produce 100 pounds gain on a fattening steer the second six months than it does the first, and more each month thereafter than the month previous. The advantage of early marketing is evident, but early marketing requires skillful feeding. Every function of the digestive apparatus must be kept in perfect condition. The matter of growth is a matter of digestion. Crowding is always dangerous unless certain precaution is taken to assist nature in eliminating or expelling from the system, waste and poisonous residue that is sure to be deposited under heavy feed.

DR HESS STOCK FOOD

The prescription of Dr. Hess (M. D., D. V. S.) contains bitter tonics which act upon the digestive organs, strengthening and improving them so that the largest possible amount of nutrition is appropriated to building bone, muscle, milk fat, etc., and besides looking after the supply, it also takes care of the overflow—it contains the nitrates which assist nature in expelling through the pores of the skin, and in the urine, those elements that would be harmful if allowed to linger in the system. Furthermore, Dr. Hess Stock Food furnishes iron, the greatest known blood builder, and is mildly laxative, regulating the bowels during the period of dry feeding as though the animal was on pasture, and relieves the minor stock ailments. That bitter tonics, iron, nitrates of soda and potash produce the results above mentioned we refer to Professors Quaitman, Winslow, Finlay Dun, and every medical writer of the age, and sell Dr. Hess Stock Food on a written guarantee.

100 lbs. \$7.00 25 lb. pail \$2.00 Smaller quantities at a slight advance. Duty paid.

Where Dr. Hess Stock Food differs in particular is in the dose—it's small and fed but twice a day, which proves it has the most digestive strength to the pound. Our government recognizes Dr. Hess Stock Food as a medicinal tonic, and this paper is back of the guarantee.

FREE from the 1st to the 10th of Each Month—Dr. Hess (M. D., D. V. S.) will prescribe for your ailing animals. You can have his 96-page Veterinary Book any time for the asking. Mention this paper.

DR. HESS & CLARK, Ashland, Ohio, U. S. A.

Also manufacturers of Dr. Hess Poultry Pan-a-cca and Instant Louse Killer.

Instant Louse Killer Kills Lice.

C. Rankin & Sons, Wybridge, Ont.

Importers and Breeders of

SHORTHORN CATTLE and OXFORD DOWN SHEEP.

FOR SALE—Females and bulls, of all ages from noted Scotch families.

Rowan Hill Herd of High-class SHORTHORNS

Herd headed by the Watt-bred bull, Royal Chief 65495, son of Mildred's Royal. Anything in herd for sale at living prices.

A. Duncan & Sons, Carluke, Ontario.

MAPLE + GROVE + STOCK + FARM Scotch and SHORTHORNS Sootch-Topped SHORTHORNS

Present offering: Cows and heifers in calf to Lord Mysie—50627. Some good young bulls and prize-winning heifers at very reasonable prices. For particulars write to L. B. POWELL, Wallenstein P. O., Wallenstein Station on the Guelph and Goderich Ry., U. P. R. Farm one-half mile from station.

J. BRYDONE,

Breeder of pure Scotch Short horns. Breeding females imported. Headed by the pure Cruikshank (Duthie-bred) bull, Sittytou Victor (Imp.)—80008—(87307). 11 young bulls from Imp. dams for sale. Prices reasonable. Telegraph, Telephone, R. R. Sta. and P. O., Milverton.

GREEN GROVE SHORTHORNS

Fairy Queens, Ury, Flora, Claret, Isabella, Rose of Autumn, Village Girl. Females of all ages 3 choice young bulls. Prices right. Breeding unsurpassed.

W. G. MILSON, Gorrie P. O., Markdale Station

J. Watt & Son

9 extra nice bulls, 10 and 14 months old. 14 well bred young cows and heifers. All in calf or calves at foot. All thick-fleshed and of the right type. Prices moderate. Correspondence invited.

SALEN P. O. Elora Stations, G.T.R. and C.P.R.

FOR SALE 8 SCOTCH SHORTHORN BULLS

Aged 6 to 14 months Marr Beautys, Campbell Claret, Bessies, Clara and Rosebuds, got by the Broadhocks bull, Broadhocks Prince (Imp.) 55002. Also cows and heifers in calf or with calves at foot or being bred to same bull. Prices lowest and terms easy.

DAVID MILNE, Ethel, Ont.

Shorthorns, Clydesdales and Shropshires.

In Shorthorns we have 100 head to select from, of both sexes and all ages. No fancy prices asked. Several choice young Clyde mares and fillies. 75 Shrop. lambs of both sexes. Small profits and quick returns is our motto.

EDWARD E. PUGH, Claremont P. O. and Station. Telephone connection.

Maple Hill Shorthorns: For immediate sale are two yearling bulls—one a Crimson Fuchsia, the other a Duchess of Gloster; both by Imp. Royal Prince, and both head headers. Also a number of heifers that are strictly high-class. Send for catalogue.

DAVID BIRRELL, Greenwood P. O., Pickering, G. T. R. Claremont, C. P. R.

Spring Brook Holsteins and Tamworths

Herd headed by the first-prize bull, Nannet Pieterje Paul, whose dam and sire's dam and g-dam have official butter records averaging over 25 lbs. in 7 days. Females bred and young bulls sired by him for sale. Tamworths of all ages and both sexes. Come and see, or write at once for prices.

A. G. Hallman, Breslau, Ont.

RAISE CALVES WITHOUT MILK

Our BOOKLET plainly tells the story of Bitchford's Cat Meal, with convincing testimony also from some of the 20,000 progressive farmers who have had wonderful results from this perfect milk substitute. Write for booklet—it's FREE.

J. A. Giam vs Toronto Ont.

"GLENARACHY" HOLSTEINS

43 head of big, deep-flanked, heavy-producing Holsteins, many of them milking from 50 to 60 lbs. a day on grass. Young stock of both sexes for sale. A straight, smooth lot.

G. MACINTYRE, Ramfrew P. O. and Str.

Greenwood Holsteins and Yorkshires

For sale: A few richly-bred bulls from one to eighteen months old. Also a few choice females of all ages. Yorkshires of either sex.

D. Jones, Jr., Galedonia P. O. and Sta.

Grove Hill Holsteins

Herd consists of fifty-four head, containing blood of De Kol, Pieterje Kordyke, Keyes, Inka, and other families of good testing qualities. Young stock of both sexes for sale at present in limited quantities. Write for prices.

F. R. Mallory, Frankford P. O. and Sta. Trenton station, G. T. R.

QUEEN CITY HOLSTEINS

If you would like to purchase a young Holstein bull whose sire's dam has an official record of 550 pounds of milk and 25 pounds of butter in seven days, write to R. F. HICKS, Newton Brook P. O., York Co.

HOLSTEINS FOR SALE!

Two three-year olds, two bull calves. Prices right for quick sale. Buff Orpington and White Rock eggs, one dollar per setting. David Rife, Hespeler, Ont.

HOLSTEINS FOR SALE

Four imported and homo-bred bulls, from 8 to 18 months old; also our entire crop of spring-bull calves, from week old to 18 months. Sired by the grandly-bred Imp. bull, Sir Howie's B. Pieterje, whose dam record is over 38 lbs. milk in one day, and from great-producing cows of the most fashionable strains. Can spare a few cows and heifers, from one year up; 16 head to select from. Cheese 1/2. Don't delay if you want one from this herd.

H. E. GEORGE, Crampton, Ont.

RECORD OF MERIT HOLSTEINS

Herd 110 strong. Over 40 head now in the Record of Merit. Two of the richest bred bulls in Canada at head of the herd. For sale: 18 bulls, from 2 months to 1 year of age; all out of Record of Merit cows and sired by the stock bulls.

P. D. HEM, Oxford Centre P. O., Woodstock Station.

Imperial Holsteins—An Advanced Registry

herd for sale. One yearling bull, a Toronto champion, four bulls from 6 to 8 months of age. A. E. on both sides. Imp. in dam from the U. S.

W. H. SIMMONS, New Durham P. O. & Sta.

MAPLE GROVE HOLSTEIN HERD

is made up of Record of Merit cows and heifers with large records, and headed by Lord Wayne Scotch-bred Calamity. Young bulls fit for service at reasonable prices.

Walburn Rivers, Falden's, Ont.

Evergreen Farm Holsteins

is headed by DeKol, which we are offering for sale; sire of 10 daughters in Record of Merit; also a choice lot of young bulls fit for service, from Record of Merit cows with large records.

F. C. FETTER & SON, Burgessville Ont.

LYDALE HERD

Offer a number of young bulls fit for service, out of Record of Merit cows, and sired by Beryl Wayne Paul Concordia, four of whose nearest dams have official records averaging 22 lbs. 11 oss. each. Eight heifers coming two, and due to calve in spring. Younger stock either sex.

J. B. BROWN BROS., Lys, Ont.

A FEW HOLSTEIN BULLS

fit for service, for sale at reasonable prices. Choice females, all ages. If you are willing to pay good prices for good stuff, write me.

A. W. OLEMONS, St. George, Ont.

Holsteins and Yorkshires

R. HONEY, Brickley, Ont., offers a very choice lot of young bulls, also boars and sows fit to mate.

1 1/2 more butter 12 1 lbs.

If you can increase your butter production without any increased cost or any more work won't it pay you to do it? And if you can get more butter from your milk with less work, that will be still better, won't it? That's exactly what you can do if you will do as Mr. LEITING did—buy a Sharples Tubular Separator. Here's what he says about the Tubular:

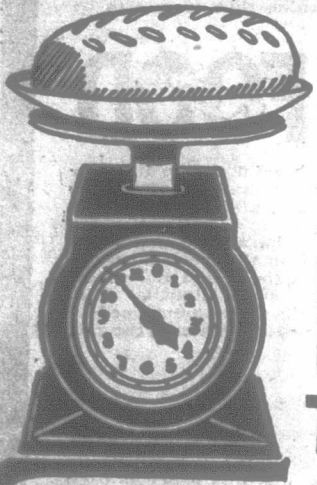

Randolph, Nebraska, Feb. 15th, 1906. Gentlemen:—On the 23rd day of January, 1906, I took a No. 4 Sharples Tubular Separator on trial. On learning that I was in the market for a cream separator, the agent for the disc style "bucket bowl" separator brought one to my farm and requested me to give it a trial before making a purchase. After giving both machines a fair trial, I concluded to keep the Tubular as I consider it far superior to the other machine. It skims closer, runs easier, and is very much easier to wash, there being so many less parts. From three skimmings of milk from 7 cows, we were able to make 1 1/2 lbs. more butter with the Tubular than we could with the "bucket bowl" machine. B. LEITING.

The Sharples Tubular Separator

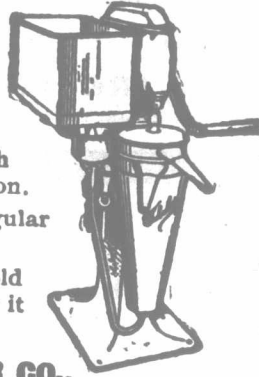

MORE BUTTER
MORE MONEY

gets all the cream there is in the milk, does it so easy that it's not work to run it at all, and is so simple, with only one little part in the bowl to wash and keep clean that comparison is out of the question.

The extra cream it gets makes the Tubular a regular savings bank for its owner.

All the other good money-making points are told in book F-193, which you ought to read. Write for it today—we'll send it free to you.

THE SHARPLES SEPARATOR CO.,
Toronto, Can. WEST CHESTER, PA. Chicago, Ill.

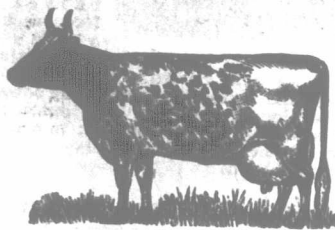

Ayrshires and Yorkshires

We now offer our grand imp. bull, Leansesock Royal Star. Always winner of first prize at Toronto, except once, when he was placed second. Now four years old past. Other young bulls fit for service from heavy-milking stock on both sides, with large teats. Females of almost any age. Young sows in farrow. One aged boar cheap. Pigs from 2 to 4 months old. Prices right. Long-distance 'phone, Campbellford Central.

ALEX. HUME & CO., MENIE, ONT.

Porter's Golden Fawn St. Lambert and Golden Lad JERSEY HERD.

I AM now breeding the two most popular and productive families of the Jersey breed known—the St. Lambert and Golden Lad. And what is more, my foundation stock of both families was purchased from the two most noted and best breeders of Jerseys on the continent: The St. L. from the late Wm. Bolph, of "Glen Rouge"; and the Golden Lad from T. B. Cooper, Linden Grove, U.S.A. My St. L.'s are headed by the little Gandy, Porter's St. L. John Bull; and my Golden Lads by Blue Bell's Fox of Linden Grove—a grandson of Mr. T. B. Cooper's high-priced cow, Blue Bell, which was sold at his 1905 sale for \$3 600. I have a few animals of both sexes for sale.

THOMPSON PORTER, Carleton West.

HIGH GROVE JERSEYS AND YORKSHIRES. For sale cheap, several choice young bulls and a few heifers, some of them prizewinners at Toronto this fall; bred from the best. Twenty young sows just ready to breed. Prices, extended pedigrees, and all information for the asking. ROBT. TUFTS & SON, Tweed P.O. and Station, Brampton, Ont.

Brampton Jersey Herd For sale: 10 bulls from 6 to 18 months old, descended from St. Lambert or imported stock; also females of all ages. For full particulars address: B. H. BULL & SON, 'Phone 68. Brampton, Ont.

SPRINGBROOK AYRSHIRES gave an average of 7,000 lbs. of milk, testing 3.9 per cent. butter-fat in 1905. A few bull calves for sale. Prices quoted for females. W. F. STEPHEN, Box 163, Huntingdon, Que.

SPRINGBURN STOCK FARM, North Williamsburg, Ont., Ayrshires, both sexes and all ages; Berkshires, both sexes and all ages; Oxford Down sheep, a few choice ones left; Buff Orpington fowls, eggs \$1.50 per setting, \$4 per hundred. H. J. WHITTAKER & Sons, Props.

Cattle and Sheep Labels Send your name and address for circular and sample. It costs nothing. Write to-day. Address: F. G. JAMES, Bowmanville, Ont.

AYRSHIRES & POULTRY

Holehouse Pilot (imp.) Heads the Herd. For Sale: One splendid yearling bull, Norfolk Chief, by Sensation of Glenora, grandsire Douglas Dale of Dam of Aber (imp.). A few two-year-old heifers in calf can be spared, bred from producing dams. Prices reasonable, quality considered. Also 10 pair of Toulouse geese, at \$5 per pair. W. Wyandottes, B.F. Rocks, \$1.50 each Pekin and Rouen ducks \$1 each. Write W. THORN, Trout Run Stock Farm, Lynedoch Ont. Norfolk Co.

Hillview Herd of Prizewinning AYRSHIRE CATTLE.

All animals bred and carefully selected for size, constitution, long teats and deep-milking qualities. Select animals of both sexes for sale at reasonable prices. For further information and prices write

A. KENNEDY & SON, Hillview Stock Farm, Vernon, Ont. Winchester Station, C. P. R.

SHANNON BANK STOCK FARM FOR AYRSHIRES AND YORKSHIRES

Young stock of both sexes for sale from imported stock. W. H. TRAN, Cedar Grove, Ont.

AYRSHIRES FROM A PRIZE-WINNING HERD

Have some nice bull and heifer calves for sale at reasonable prices. For particulars, etc., write to WM. STEWART & SON, Campbellford Stn. o Menie P.O., Ont.

STOCKWOOD AYRSHIRES FOR SALE

All ages, from imp. and Canadian bred stock. Prices and terms to suit purchaser. D. M. WATT, St. Louis Sta., Que.

Ayrshires 3 prizewinning bulls fit for service at reasonable prices, also younger ones for pick buyers. N. DYMENT, Bakery Hill Stock Farm, Dundas Stn. and Tel. C appison, Ont.

SHROPSHIRE

Can sell about 20 Ram Lambs. Mostly by an Imp. Better bred ram. GEO. HINDMARSH, Allea Craig, Ont.

QUESTIONS AND ANSWERS. Miscellaneous.

CLYDESDALE NUMBERS.

Who imported Pride of Avon, and what is his number? Who imported Boy in Blue, and what is his number?

W. J. S. Ans.—We do not find a horse named Pride of Avon in the published volumes of the Canadian Clydesdale Studbook. Boy in Blue [295] (112); foaled in 1871; imported by J. Henderson, Duncrief, Ont.

RIVER-DRIVING.

Give the law for river-driving in Quebec. Can a man put a boom across the river for his own lumber, and prevent others from passing?

Quebec. Ans.—It will be necessary for you to consult, personally, a lawyer of the locality in question.

WORMS IN HORSE.

Please give remedy for a horse with worms. He has a ravenous appetite, and no amount of feed seems to satisfy him.

W. H. B. Ans.—Take two drams each of sulphate of copper, sulphate of iron, tartaric acid and calomel, and make into twelve powders. Give a powder every night and morning in feed. After the last has been given, give him a purgative ball of eight drams aloes and two drams ginger. Feed bran only for 24 hours after giving purgative, then increase feed gradually, and work lightly at first.

COW FAILING TO GIVE MILK.

Can you give a remedy for a cow that gives under a pint of milk after calving?

G. P. Ans.—This may be due to illness from some derangement of the cow's system, or to nervousness, owing to treatment or environment, causing her to hold up her milk. If her appetite has failed, we would advise giving a purgative of one pound Epsom salts with two ounces ginger in a quart of warm water as a drench, carefully given, and blanket to keep her comfortable. Follow up with 1 dram each of sulphate of iron and gentian, twice daily for a week, in water as a drench; feed light, at first, of chopped oats and bran, and increase gradually. If from nervousness she holds up her milk, try a sack with sand or other weight in each end, laid across her loins while milking.

WATER SYSTEM—SUGAR BEETS—LUCERNE.

1. My well is 37 1/2 feet deep, with from 2 feet to 4 feet of water. Cow-stable floor is 5 1/2 feet below platform of well. Can I use syphon pump directly below mast of windmill, about 90 feet from well? Give best system of pumping water to house and stable.
2. What is the feeding value of Royal Giant sugar beets, compared with factory beets, mangels and turnips?
3. Had corn last year on clover sod, and would like to sow lucerne with barley in 1908. What grain crop would be best this year?
4. Should rape be sown in spring, or after harvest to be plowed under in fall?

READER. Ans.—1. A syphon pump would not work. The perpendicular height to which the water would have to be raised is too great. There is no one best system of pumping water to buildings. Each windmill company has its own.

2. Large sugar beets, grown for stock, are very valuable roots. Though not nearly so nutritious as the factory beet, they are much superior to mangels, and keep better.

3. Oats, though rather exhaustive, would probably be best. You could afford to give the ground a light coat of manure next winter, if you raised a profitable crop like oats this year. That would make up for the drain on the soil, and increase the chances for a good catch. It seems to us that it would be better to sow the alfalfa this spring with barley, as the land, after hoed crop, should be clean and in excellent condition for a catch of alfalfa.

4. In most seasons, a greater growth could be secured by sowing in spring, though it is something of a nuisance among grain. Better sow in June, and pasture in October with lambs or young cattle. Rape can be more profitably utilized in this way than by plowing it down.

PASTOR AND PEOPLE PRAISE

PSYCHINE

(PRONOUNCED SI-KEEN)

A Marvellous and Triumphant Record of Victory Over Disease.

No medicine has ever effected as large a number of wonderful and almost marvellous cures as Psychine. It has had one continuous record of victories over diseases of the throat, chest, lungs and stomach. Where doctors have pronounced cases incurable from consumption and other wasting diseases Psychine steps in and rescues numberless people even from the very verge of the grave. Coughs, Colds, Catarrh, Bronchitis, Chills, Night Sweats, La Grippe, Pneumonia, and other like troubles, all of which are forerunners of Consumption, yield quickly to the curative powers of Psychine.

Mrs. Campbell, one of the many cured, makes the following statement:

I cannot refrain from telling all who suffer of my remarkable recovery with Psychine. In April, 1902, I caught a heavy cold which settled on my lungs and gradually led to consumption. I could not sleep, was subject to night sweats, my lungs were so diseased, my doctor considered me incurable. Rev. Mr. Mahaffy, First King's Presbyterian Church, recommended Dr. Slocum's Psychine to me, when I was living in Ontario. After using Psychine for a short time I ate and slept well, the night sweats and cough ceased. Months ago I stopped taking Psychine, as I was perfectly restored to health and to-day I never felt better in my life. Psychine has been a god-send to me. MRS. ANDREW CAMPBELL, Cottonwood, N.W.T.

PSYCHINE never disappoints.

PSYCHINE has no substitute.

There is no other medicine "Just as good."

At all dealers, 50c. and \$1.00 per bottle. If not write to

DR. T. A. SLOCUM, Limited, 179 King St. W., TORONTO

Dr. Root's Kidney Pills are a sure and permanent cure for Rheumatism, Bright's Disease, Pain in the Back and all forms of Kidney Trouble. 25c per box, at all dealers.

STOP! LOOK!! LISTEN!!! The Fairview Shropshires have maintained their reputation as winners and producers of winners at both the Chicago International and Guelph Winter Fair. Won at the International: 1 champion, 12 firsts, 1 second, 10 thirds, and 3 fourths—totaling \$397. Won at Guelph: 1 champion, 11 firsts, 19 seconds, 3 thirds, and 1 fourth—total to \$301. Won 1st, 2nd and 3rd twice in very keen competition. At Chicago, Wisconsin Agricultural College's weathers—our strongest opponents—were all sired by rams sold from Fairview. Wishing you all a joyous festive season, I remain, yours cordially, John Campbell Woodville, Ont.

SOUTH DOWNS
AND
Sootch Collies.
Robt. McEwen, Byron, Ont.
Long distance 'Phone.

Ship Your **HIDES SHEEPSKINS FURS** To E. T. CARTER & CO., TORONTO.

Sheep Breeders' Associations.

American Shropshire Registry Association, the largest live-stock organization in the world. Hon. John Dryden, President, Toronto, Can. Address correspondence to MORTIMER LEV-ERING, Secretary, Lafayette, Indiana.

Canadian Agents for the Original McDougall's Sheep Dip & Cattle Dressing Imported direct. Price: Imperial pints, 50c.; imperial half gallon, \$1.25; imperial gallon, \$2.25. Sold by druggists, or charges prepaid on one-gallon tins. THE WORTHINGTON DRUG CO., Toronto, Ontario.

Oxford Down Sheep, Shorthorn Cattle, Yorkshire Hogs. Present offering: Lambs of either sex. For prices, etc., write to John Cousins & Sons, Buena Vista Farm, o Harrieston, Ont.

Woodstock Herd of Large English Berkshires
 I have for sale pigs of all ages, both sexes, from prize-winning stock. I am booking orders for spring delivery from my Imp. and home-bred sows. Come and see or write for prices. My herd was in the front rank of prizewinners at the leading exhibitions this fall.
 C. P. R. and G. T. R. Stations.
 DOUGLAS THOMSON, Box 1, Woodstock, Ont.

Rosebank Berkshires.—Present offering: Boars fit for service. Sows ready to breed. Choice young stock ready to wean, sired by Maple Lodge Doctor and Sallie's Sambo (Imp.), a Toronto winner.
 Lafroy, G. T. R. JOHN BOYES, JR., Churchill, Ont. Long-distance Phone

HILLCREST BERKSHIRES
 Stand unrivalled for individual merit in the herd. Our business for 1906 surpasses former years. The enquiry for choice things increases from year to year. 8 me choice sows for sale, due to farrow in the spring. Also a few boars on hand. Vine Sta. G. T. R. near Barrie. John Lahmer. Vine P. O.

BERKSHIRES 50 IMPORTED AND CANADIAN-BRED 50
 Motto: "Good as Represented."
 Mail orders receive careful attention.
 H. M. VANDERLIP, GAINSVILLE, ONT.

ORCHARD HOME TAMWORTHS
 Herd headed by Newcastle Warrior. This hog won first prize and silver medal at Toronto 1905, and defeated his sire, Colwill's Choice (1943), who has won these honors three years in succession. Our brood sows are large and of the same high quality. If you want choice stock, we can satisfy you at a reasonable price. Young boars fit for service; also young pigs now on hand. All stock shipped in comfortable crates. Express prepaid and satisfaction guaranteed.
 GRANDALL BROS., Cherry Valley, Ont.

Newcastle Herd of Tamworths and Shorthorns.
 We have for quick sale a choice lot of boars and sows from 2 to 6 months old, the produce of sows sired by Colwill's Choice and Newcastle Warrior, both our own breeding, and winners of sweepstakes and silver medal at Toronto, 1901-02-03-05. Several very choice sows due to farrow in March and April. Pedigree furnished with every pig. Several choice heifer calves and heifers in calf to our present stock bull. All of high show quality. Prices right. Daily mail at our door.
 COLWILL BROS., Newcastle, Ont.

MOUNT PLEASANT TAMWORTHS and HOLSTEINS. For sale: An extra choice lot of pigs of either sexes, from one to six months old, and two sows bred to farrow in March. They are nearly all sired by Colwill's Choice No. 1943; won sweepstakes and silver medal at Toronto in 1901-2-3. Also four bulls and one heifer from one to ten months old. Phone in real estate. BERTRAM HOSKIN, The Gully P. O.

Tamworths and Dorset Horn Sheep.
 A choice lot of pigs of different ages and both sexes. Some fine shearing rams and ewe lambs.
 JAMES DICKSON, Orono, Ontario
 "Glenairo Farm."

LARGE ENGLISH YORKSHIRES
 Pigs of the most improved type of both sexes all ages, for sale at all times. We have more imported animals in our herd than all other breeders in Canada combined. We won more first prizes at the large shows this year than all other breeders combined. We won over prizes at Toronto and London, and at St. Louis we furnished all the first-prize hogs in the breeding classes except two; also supplied both champion and grand champions. Prices reasonable.
 D. C. FLATT & SON, Millgrove, Ont.

Large White Yorkshires.
 A number of excellent sows, direct from imported stock, in pig to Worsley Duke, Imp.; also imported sows of different ages. Young boars and sows can be supplied not akin. Orders taken for young pigs. Write for what you want.
 H. J. DAVIS, Woodstock, Ont.
 Importer and Breeder of Yorkshires and Shorthorns.

Meadowbrook Yorkshires
 Young stock of both sexes. A number of sows old enough to breed, all sired by Imp. Dalmeny Topman. Everything guaranteed as represented.
 J. H. SNELL, HAGERSVILLE P. O. & STATION

IMPROVED YORKSHIRES
 Choice young stock from imported prize-winning stock for sale.
 GEO. M. SMITH, HAYSVILLE, ONT.

For Sale—Ohio Improved Chester Whites, the largest strain, oldest established registered herd in Canada; young sows in farrow; choice young pigs, six weeks to six months old; pairs not akin; express charges prepaid; pedigrees and safe delivery guaranteed. Address:
 B. D. GEORGE, Putnam, Ont.

Pat. 1908-04.
 We manufacture Steel Cheese Vats, Cream Vats, Curd Sinks, Water Troughs, Hog Troughs, Steel Tanks, Tanks to Water Stock, Feed Cookers, Evaporators for Making Maple Syrup, Grain Boxes, Thrashers' Steel Tanks, Smoke Stacks, Steel Whey Tanks.
 Ask your implement agent for our free catalogue.
The Steel Trough & Machine Co., Limited,
 Tweed, Ontario.

Morrison Yorks. and Tams.
 on hand, for sale. Are both sexes of both breeds. Bred from prize-winners and extra choice. Prices right.
 Charles Currie, Morrison P. O., Shaw Sta., G. T. R.

OAKDALE BERKSHIRES.
 Of the largest strain imported fresh from England. The produce of these and other noted winners for sale reasonable. Let me book you.
 L. E. MORGAN, Milliken Stn. and P. O.

Fairview Berkshires
 Bred from imported and Canadian-bred sires and dams, and bred on prize-winning lines. My brood sows are large, choice animals. Young stock of both sexes. Some sows bred to Imp. boars.
 HENRY MASON, SCARBORO P. O. Street cars pass the door.

Ohio Improved Chester White:
 100 Pigs to Offer of the long, deep, heavy sort. Breeding stock selected from the most noted families, with a view to size and quality. Booking orders for choice spring pigs; also a few fall pigs for sale. Pairs furnished not akin. Express charges prepaid. Pedigrees and safe arrival guaranteed.
 H. E. GEORGE, Crampton, Ont.

SUNNYMOUNT BERKSHIRES.
 Sunnymount Berkshires are unsurpassed for ideal bacon type and superior breeding. For immediate sale: A few choice boars from 5 mos. up to 15 mos. old.
 JOHN McLEOD, Milton P. O. and Sta., C. P. R. & G. T. R.

PINE GROVE BERKSHIRES!
 Bred on aristocratic lines and from high-class show stuff, sired by the Toronto winner, Willow Lodge Leader. For sale are young animals of both sexes—4 and 6 months of age; of choice bacon type and showing form. W. W. BROWN-RIDGE, Ashgrove P. O., Milton Sta.

Duroc Jerseys—Imported and home-bred sows and boars ready for service. Pigs fit to wean; also Buff Orpingtons and Buff Leghorn cockerels.
 MAC, CAMPBELL, Harwich, Ont.

QUESTIONS AND ANSWERS.
 Miscellaneous

SALT ON OATS AND GRASS SEEDING.

1. Does sowing salt benefit a crop of oats?
 2. Does sowing salt harm or weaken a catch of grass seeds?
 B. McL.
 Ans.—1 and 2. Salt contains none of the constituents usually considered essential to the growth of plants. Sometimes it has a beneficial effect in promoting the decomposition of potash, lime and magnesia compounds already present in the soil. It is believed to increase the solvent action of soil water upon phosphates and silicates, and is also considered to enable the soil to hold moisture better. Salt, at the rate of 200 pounds per acre, often proves profitable on mangels. On grain and other crops, it sometimes proves beneficial, tending to stiffen and brighten the straw, and sometimes ineffective or even injurious. A careful experiment on one's own particular soil is the only means of satisfying oneself as to its effects on either grain or clover. Wash salt from pork-packing establishments has a slight additional value, due to the small amounts of nitrogen and potash usually incorporated with it.

SUBSTITUTE FOR ROOTS.

1. What is the best and cheapest feed to take the place of roots (ground flaxseed at \$2.75 per cwt.; oil cake at \$32 per ton; wheat bran at \$18 per ton) for fat cattle, the other feed used being clover hay and mixed oat and barley chop?
 2. In what quantity should it be fed to cattle weighing about 1,200 lbs.?
 SUBSCRIBER.

Ans.—Properly speaking, none of these feeds will take the place of roots. In composition, they are the very antithesis of roots. Roots are bulky and succulent; the meals are concentrated and dry. Roots are poor in protein, and comparatively strong in carbohydrates; the meals named, especially bran and oil cake, are very narrow in their nutritive ratio; that is, they are relatively much richer in protein than in carbohydrates. To obtain best results, these should be used in conjunction with roots, silage, corn meal and other foods that are abundant in carbohydrates. In one respect only—and this, presumably, is the one our inquirer had in mind—do the foods named resemble roots; they all have a laxative tendency.

2. We would suggest 3 pounds bran and one-half or three-quarters of a pound of ground flaxseed a head per day, together with 6 or 7 pounds of oats and barley chop. Of course, it is understood the cattle would be started on much less of the heavy feeds, and gradually worked up at the discretion of the feeder.

FEEDING GREEN CUT BONE.

How much green bone should be given to one hundred hens daily? Could it be put in a box and left the same as grit or oyster shell?
 J. S.
 Ans.—Ordinarily, 20 hens should have one pound of green cut bone daily. If the hens are laying well, they will eat this amount. If the hens are, very fat, they may not eat so much. My experience is that a hen has to be in good condition before she begins to lay; she may possibly get too fat to lay, but I doubt whether a very lean hen lays. If it were not for the fact that green cut bone heats readily, it could be fed as the correspondent mentions. I know of no food that heats as readily as green cut bone, and the danger in using this food lies in this point. One has to be very careful to have the bone fresh, and if one gets considerable bone ahead, it is to be held at a very low temperature or fed immediately. A painful of bone standing in a room of ordinary temperature, over night, often will heat to such an extent that one can hardly put his hand in the center of the pile; this is not then good feed. For this reason I would consider the proposition impracticable. If the fowls at night have been in the habit of eating green cut bone, begin by feeding one pound to 20 hens every other day for possibly a week, then you might increase the amount per day of the succeeding week, and the third week you might increase the quantity to 1½ pounds. It would only be a day or two when they would refuse to eat 1½ pounds, and from then on you could practically keep the bone constantly in front of them. W. R. GRAHAM.

Suffered Terrible Agony FROM PAIN ACROSS HIS KIDNEYS. DOAN'S KIDNEY PILLS CURED HIM.

Read the words of praise, Mr. M. A. McNamee, Marion Bridge, N.S., has for Doan's Kidney Pills. (He writes us): "For the past three years I have suffered terrible agony from pain across my kidneys. I was so bad I could not stoop or bend. I consulted and had several doctors treat me, but could get no relief. On the advice of a friend, I procured a box of your valuable, life-giving remedy (Doan's Kidney Pills), and to my surprise and delight, I immediately got better. In my opinion Doan's Kidney Pills have no equal for any form of kidney trouble."
 Doan's Kidney Pills are 50 cents per box or three boxes for \$1.25. Can be procured at all dealers or will be mailed direct on receipt of price by The Doan's Kidney Pill Co., Toronto, Ont.
 Do not accept a spurious substitute but be sure and get "Doan's."

MONKLAND YORKSHIRES
 Imported & Canadian-bred
 We keep 35 brood sows, and have constantly on hand between 100 and 200 to choose from. Our supply pairs and trios not akin. Quality and type unsurpassed. Prices right.
 JAS. WILSON & SONS, FERGUS, ONT.
 G. T. R. and C. P. R. Long-distance Phone

GLENBURN HERD OF YORKSHIRES
 Winner of gold medal three years in succession. Offers for sale: 12 young boars, 4 months old; a large number of sows, same age; also 50 smocking pigs, both sexes. Also a grand good Shorthorn bull (roan), 10 months old.
 David Barr, Jr., Box 3, Renfrew, Ont.

Glenhodson Yorkshires.
 Sows bred or ready to breed. Young pigs from three to six months old. Pairs not akin. Satisfaction guaranteed.
 GLENHODSON COMPANY, Myrtle Station, Ont.
 Long-distance phone at farm. Lorne Foster, Mgr.

Maple Grove Yorkshires
 Are among the leading Canadian herds for size, quality and true-ness to type, and are prize-winners all around. For sale are both sexes. All ages. Bred from Imp. and home-bred stock. There are none better.
 H. S. McDIARMID, Fingal P. O., Shedden Station, Breeder and Importer.

Fairview Berkshires
 Are second to none. My herd has won high honors wherever shown. Am now offering sows bred and ready to breed, and younger ones of both sexes, the get of Masterpiece and Just the Thing. An exceptionally choice lot.
 JOHN S. COWAN, Donagel P. O., Milverton Sta.

MAPLE LEAF BERKSHIRES!
 High-class Berkshires of show-ring quality, bred from Imp. stock, for sale: 3 7-months boars by Imp. Folgate Doctor; 2 sows by same Castle, and young boars. Joshua Lawrence, Oxford Centre P. O., Woodstock Station.

Willowdale Berkshires
 Young boars and sows, 3 and 6 months of age, out of Imp. sows, and sired by Imp. Folgate Doctor, Royal Masterpiece, a son of the \$5,500 boar, Masterpiece, and some of them Imp. in dam. Satisfaction guaranteed.
 J. J. WILSON, Milton P. O. and Sta.

ELMFIELD YORKSHIRES
 Have a few young sows from 1 to 7 months, bred and ready to breed; also some young pigs weaned and ready to wean, from Imp. dam and sire. C. S. Hume, Apr. 1st

READ THESE LETTERS

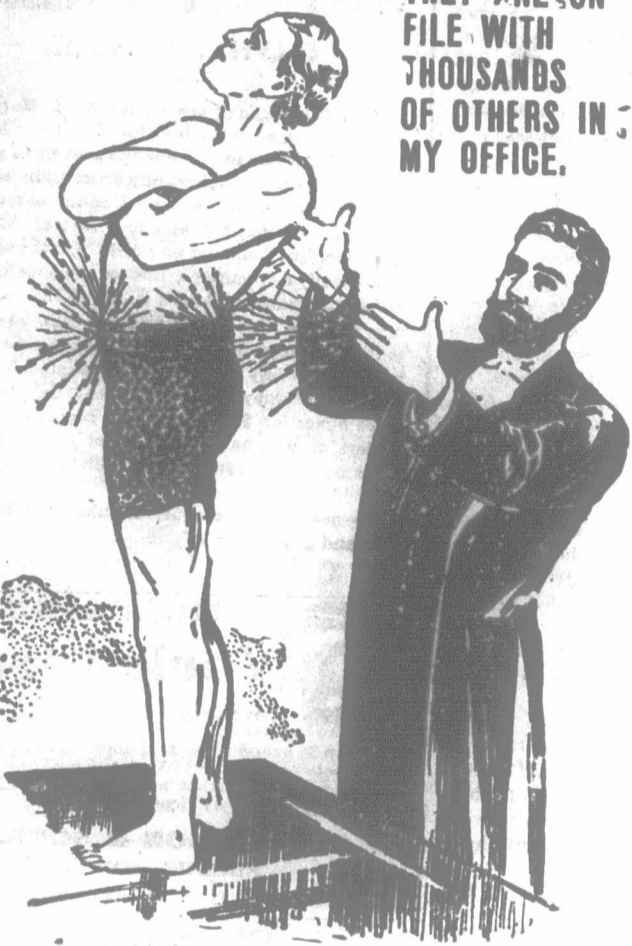

THEY ARE ON FILE WITH THOUSANDS OF OTHERS IN MY OFFICE.

A Man of 70 Made to Feel Young.

Dr. McLaughlin:
Dear Sir,—I am sending you a few lines to let you know the benefit I feel, now I am a new man. For forty years I have had a bad back; now I can run a race or pick up a pin, I feel so smart; no pain. I wore my Belt only four times. I am in my seventieth year; never was so well in health as I am now. When I used to be bad, I would be a month that I could not stoop to lace my boots; now I feel no pain in doing so. I am just as smart as any young fellow at present. Sir, no one would be without one of your Belts if they knew the good to be had from them. I have recommended them highly to all my friends, and you will soon have some orders. Yours sincerely, PHILIP McGAHEY, Riviere aux Pins, Que.

Sciatica Permanently Cured

Dr. McLaughlin,—
Dear Sir,—I am in receipt of your interesting letter regarding Belt. Over two years have elapsed since I got the Belt. When it arrived here, the trouble, which had been very severe from hip to foot, had apparently settled at hip and from knees to toes. The doctor was attending me every day, and, of course, had no good word for the Belt. I, however, adjusted it as directed, and put it on, and in an hour or so I began to feel the sensation all over me, or in every part of the body, and in two or three days was up and around, pain all gone. Of course, I applied the Belt for a while every night, and in a week was feeling well and entirely clear of pain, and, what is better, have never felt a twinge of pain in my limbs since. Work all the time. There are several Belts on the market, cheap, too, but, I suppose, no good; in fact, I heard a man say he would not give five cents for a dozen of them. I am feeling well and smart for my age. With kind regards from—
R. S. OULTON.

Cured After Five Years of Agony.

Dr. McLaughlin:
Dear Sir,—Since calling at your office, on June 22, I must tell you that I am sure it was the Electric Belt that had helped me. I know that I would not have lived if I had not got it when I did, and I cannot be too thankful to you. After five years of agony that I endured, it is like having a new lease of life now. I am gaining two pounds of flesh a week, and am eating solid food. I have been taking liquid food a month nearly, and solid food for three weeks. The people think my cure very rapid and very wonderful. Many of them said I would never eat again. I am certain that you cannot advertise your Electric Belts enough. The only trouble is that there are those sold that are no good. We do not think anything of the money we spent on the Belt. I have to repeat my story over and over again every day to different people, as everyone wants to hear from myself about my cure. I never felt better than I do now. Of course, my nerves began to quiet when I began to use the Belt, and, as you know, I wore it even when I was very weak. I have a host of grateful friends who wish me to thank you also for them, for they were all nearly sick about me, thinking and seeing me starving every day, with plenty of food about me. I cannot speak too highly of your Electric Belt, for it is a perfect fit, and is doing just what you said it would do, and in so short a time. I never expected the cure so quickly. It was a surprise to me, and I can hardly believe it. I now look very well. You would hardly recognize me as the woman who called at your office on June 22. I think my doctor here is as delighted over my recovery as anyone can be. With best wishes for your continued success,
MRS. BERTHA HAMILTON, Erin, Ont.

Nervous Energy Restored Six Years Ago, and Still Strong

Dr. McLaughlin:
Dear Sir,—It is some three years since I wrote you that your Belt had given me perfect satisfaction, and I am still as strong and hearty as any man could expect to be. It is certainly a God-send that such an appliance should be invented for the cure of the ailments of poor, wretched humanity. I can now eat anything that is eatable and digest it well; no trouble worries me and my nerves are very strong. I have been singing the praises of your Electric Belt for six years, and will continue to do so. I cannot say too much for it has made my body a pleasure to own. Believe me, yours very truly,
W. L. FLEMMINGTON, Earl Grey, Sask.

DR. McLAUGHLIN'S ELECTRIC BELT WILL DO THE SAME FOR YOU.

It has been demonstrated that Electricity is the most natural of all remedies for the cure of the ailments which afflict the human body. Every physician of modern ideas is an advocate of electrical treatment, and concedes that it stands far above all medical agents, especially when applied to diseases relating to the nervous system. This is a practical admission of the power of electricity over the nerves and vital organs, hence it must be evident to a thinking person that a means of intelligently applying this wonderful agent should be the greatest boon to suffering humanity.

When we consider that our nervous system, which is the fountain of life to the kidneys, liver, stomach, brain and the various organic functions of the body, depends for its sustenance upon the vitalizing element of electricity, and that without this life it is impossible to keep up a normal condition of health in the body, it is easy to understand that a waste of this life principle will be followed by weakness and disease, and it is also easy to understand why the natural restoration of this electric force in the nervous system will saturate the various vital organs which have become weakened with a new energy which will place every vital part of the body in a state of natural health.

You may say, as many others have said, "Doctor, your arguments sound good, but show me evidence of cures to back up your statements." That is my strongest argument. Every man or woman who comes into my office gets practical illustration of my method of treatment. After seeing original letters from prominent people (letters which I am permitted to exhibit), their doubts are dispelled, they are convinced that the claims I have made are true. You can see these patients and secure from them the verification of my statements. Hundreds of my best testimonials can not be published, as the patients, though recommending my treatment privately, object to publicity.

My Belt will cure Nervous Debility, Stomach Trouble, Rheumatism, Lane Back, Sciatica, any case of Kidney Disease that has not gone as far as Bright's Disease, Indigestion, Constipation, or any weakness caused by ignoring the laws of Nature. My improved Electric Belt is the marvel of electricians, the most wonderful curative device that has ever been introduced.

Read My Offer:

I know how skeptical people are after paying hundreds of dollars to doctors without getting any benefit, and knowing that any man would willingly pay for a cure when he gets it. I now offer any man a complete restoration to manly vigor and health before he pays a cent. There is no deception about this offer either in the making of it or carrying it out. All I ask is fair security that I will be paid when the work is done; this any honest man will be glad to give. I take all the chances, you take none. Isn't that fair? Do you want any better evidence of my confidence in my Belt? Now, if you suffer do not lay this aside and say you will try it later. Act upon it to-day—NOW. Tell me what you are suffering from, and I will arrange a Belt with all necessary attachments suitable for your case, and send it to you, and you can

Pay Only When Cured.

FREE BOOK.—I have a book which gives many hundreds of letters from men whom I have cured. Tells all about the signs of decay in men, how they are caused, how they first appear, the way the vital power is wasted and how all these troubles are cured by electricity. It inspires a man with a desire to be "a man." It is full of things a man likes to read. If you will send for it I will send it to you closely sealed Free. Consultation Free. You are invited. If you cannot call write for this Book at once. Get all the good you can out of life while it lasts.

Dr. McLaughlin's Belt is as good for women as for men. I have a Book especially for women. Free on application.

DR. M. S. McLAUGHLIN,
112 Yonge St., Toronto, Can.

Dear Sir,—Please forward me one of your Books, as advertised.

NAME

ADDRESS

Office Hours: 9 a. m. to 6 p. m.; Wednesday and Sat., until 9 p. m.

GOSSIP.

Mr. J. Brydone, Milverton, Ont., in writing this office, states: "Since last report, we have made the following sales of Shorthorn bulls: Clover Leaf Victor goes to Mr. John Watters, Gorrie; Victor of Maple Hill to W. R. Elliott & Sons, Guelph. Mr. A. Crerar, Moles-

worth, paid us a visit, and took a good one in the thick roan, Spring Hill Victor. Mr. Sol. W. Rist, Elmira, got the red bull, Prince. These were all got by an imported sire, and out of imported cows. Those we have still to offer are rich in the blood of Messrs. Duthie and Marr's herds—suppy fellows, with rich coats. Will sell right for quick sales, to make room for young ones coming."

Mr. A. W. Smith, Maple Lodge, Ont., writes: "The young Shorthorn bulls I offer this year are an exceptionally good lot all around. I do not think we ever had a better lot. They are all the get of No. 1 imported bulls, and several of them are from our choicest milking strains, including a grandson of Irish Egg, first prize Guelph Winter Fair Dairy

Test, who has a record of over 10,000 lbs. milk in one season, and several others almost as good. In breeding, they are mostly of the best Scotch blood, and a number of them would make extra good show bulls. Our prices are very reasonable, and we are always pleased to show them. We can also spare a few handsome heifers. But we have no Leicesters for sale at present."