

**CIHM
Microfiche
Series
(Monographs)**

**ICMH
Collection de
microfiches
(monographies)**



Canadian Institute for Historical Microreproductions / Institut canadien de microreproductions historiques

© 1997

Technical and Bibliographic Notes / Notes techniques et bibliographiques

The Institute has attempted to obtain the best original copy available for filming. Features of this copy which may be bibliographically unique, which may alter any of the images in the reproduction, or which may significantly change the usual method of filming are checked below.

L'Institut a microfilmé le meilleur exemplaire qu'il lui a été possible de se procurer. Les détails de cet exemplaire qui sont peut-être uniques du point de vue bibliographique, qui peuvent modifier une image reproduite, ou qui peuvent exiger une modification dans la méthode normale de filmage sont indiqués ci-dessous.

- | | |
|--|--|
| <ul style="list-style-type: none"> <input type="checkbox"/> Coloured covers / Couverture de couleur <input type="checkbox"/> Covers damaged / Couverture endommagée <input type="checkbox"/> Covers restored and/or laminated / Couverture restaurée et/ou pelliculée <input type="checkbox"/> Cover title missing / Le titre de couverture manque <input checked="" type="checkbox"/> Coloured maps / Cartes géographiques en couleur <input type="checkbox"/> Coloured ink (i.e. other than blue or black) / Encre de couleur (i.e. autre que bleue ou noire) <input type="checkbox"/> Coloured plates and/or illustrations / Planches et/ou illustrations en couleur <input type="checkbox"/> Bound with other material / Relié avec d'autres documents <input type="checkbox"/> Only edition available / Seule édition disponible <input type="checkbox"/> Tight binding may cause shadows or distortion along interior margin / La reliure serrée peut causer de l'ombre ou de la distorsion le long de la marge intérieure. <input type="checkbox"/> Blank leaves added during restorations may appear within the text. Whenever possible, these have been omitted from filming / Il se peut que certaines pages blanches ajoutées lors d'une restauration apparaissent dans le texte, mais, lorsque cela était possible, ces pages n'ont pas été filmées. <input checked="" type="checkbox"/> Additional comments / Commentaires supplémentaires: Various pagings. | <ul style="list-style-type: none"> <input type="checkbox"/> Coloured pages / Pages de couleur <input type="checkbox"/> Pages damaged / Pages endommagées <input type="checkbox"/> Pages restored and/or laminated / Pages restaurées et/ou pelliculées <input checked="" type="checkbox"/> Pages discoloured, stained or foxed / Pages décolorées, tachetées ou piquées <input type="checkbox"/> Pages detached / Pages détachées <input checked="" type="checkbox"/> Showthrough / Transparence <input type="checkbox"/> Quality of print varies / Qualité inégale de l'impression <input type="checkbox"/> Includes supplementary material / Comprend du matériel supplémentaire <input type="checkbox"/> Pages wholly or partially obscured by errata slips, tissues, etc., have been refilmed to ensure the best possible image / Les pages totalement ou partiellement obscurcies par un feuillet d'errata, une pelure, etc., ont été filmées à nouveau de façon à obtenir la meilleure image possible. <input type="checkbox"/> Opposing pages with varying colouration or discolourations are filmed twice to ensure the best possible image / Les pages s'opposant ayant des colorations variables ou des décolorations sont filmées deux fois afin d'obtenir la meilleure image possible. |
|--|--|

This item is filmed at the reduction ratio checked below /
Ce document est filmé au taux de réduction indiqué ci-dessous.

	10x		14x		18x		22x		26x		30x	
									✓			
	12x		16x		20x		24x		28x		32x	

The copy filmed here has been reproduced thanks to the generosity of:

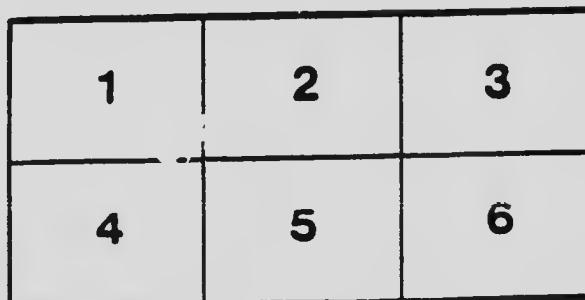
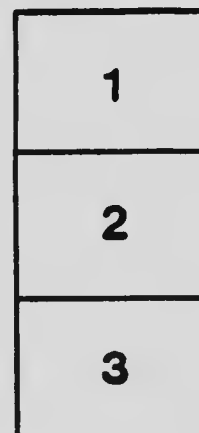
National Library of Canada

The images appearing here are the best quality possible considering the condition and legibility of the original copy and in keeping with the filming contract specifications.

Original copies in printed paper covers are filmed beginning with the front cover and ending on the last page with a printed or illustrated impression, or the back cover when appropriate. All other original copies are filmed beginning on the first page with a printed or illustrated impression, and ending on the last page with a printed or illustrated impression.

The last recorded frame on each microfiche shall contain the symbol \rightarrow (meaning "CONTINUED"), or the symbol ∇ (meaning "END"), whichever applies.

Maps, plates, charts, etc., may be filmed at different reduction ratios. Those too large to be entirely included in one exposure are filmed beginning in the upper left hand corner, left to right and top to bottom, as many frames as required. The following diagrams illustrate the method:



L'exemplaire filmé fut reproduit grâce à la générosité de:

Bibliothèque nationale du Canada

Les images suivantes ont été reproduites avec le plus grand soin, compte tenu de la condition et de la netteté de l'exemplaire filmé, et en conformité avec les conditions du contrat de filmage.

Les exemplaires originaux dont la couverture en papier est imprimée sont filmés en commençant par le premier plat et en terminant soit par la dernière page qui comporte une empreinte d'impression ou d'illustration, soit par le second plat, selon le cas. Tous les autres exemplaires originaux sont filmés en commençant par la première page qui comporte une empreinte d'impression ou d'illustration et en terminant par la dernière page qui comporte une telle empreinte.

Un des symboles suivants apparaît sur la dernière image de chaque microfiche, selon le cas: le symbole \rightarrow signifie "A SUIVRE", le symbole ∇ signifie "FIN".

Les cartes, planches, tableaux, etc., peuvent être filmés à des taux de réduction différents. Lorsque le document est trop grand pour être reproduit en un seul cliché, il est filmé à partir de l'angle supérieur gauche, de gauche à droite, et de haut en bas, en prenant le nombre d'images nécessaire. Les diagrammes suivants illustrent la méthode.

MICROCOPY RESOLUTION TEST CHART

(ANSI and ISO TEST CHART No. 2)



APPLIED IMAGE Inc

1653 East Main Street 14609 USA
Rochester, New York
(716) 482 - 0300 - Phone
(716) 288 - 5989 - Fax







SYDNEY & LOUISBURG RY.

1196

SYDNEY & LOUISBURG RY.

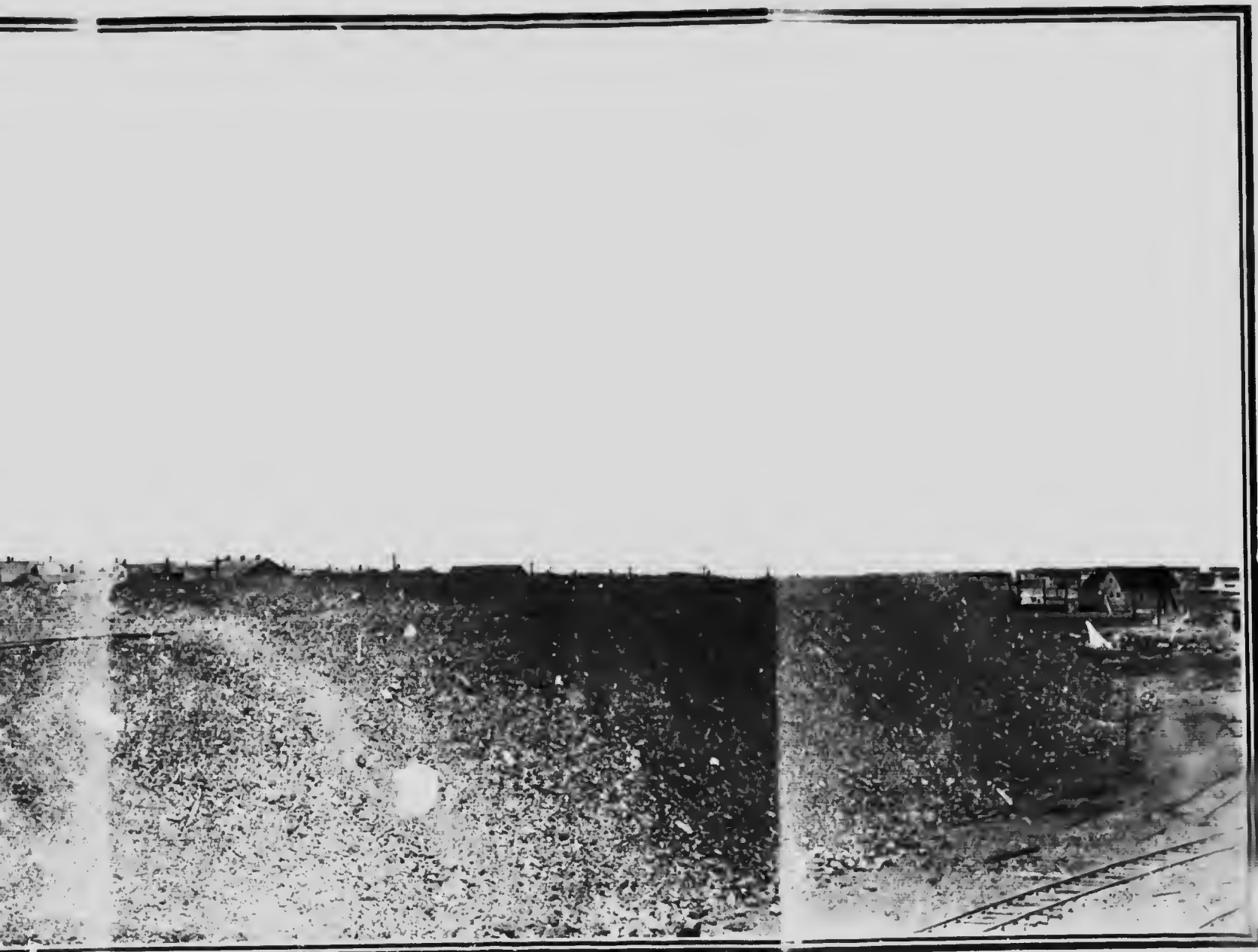
815



Panoramic view of Dominion colliery No. 2, Dominion Coal Co., Glassboro, N. J. — showing bankhead, main shaft, hoisting engine room, power house, etc.



16. S., showing bankhead, main shaft, hoisting engine house, power house, and part of winter's accumulation of banked coal, approximating 300,000 tons.





CANADA
DEPARTMENT OF MINES
MINES BRANCH

HON. W. LAMONTAGNAN, MINISTER, A. P. LOW, LL.D., DEPUTY MINISTER,
EUGENE HANSEL, PH.D., DIRECTOR

AN
INVESTIGATION

OF THE

COALS OF CANADA

WITH REFERENCE TO THEIR ECONOMIC QUALITIES :

AS CONDUCTED AT MCGILL UNIVERSITY, MONTREAL,
UNDER THE AUTHORITY OF THE DOMINION
GOVERNMENT.

IN SIX VOLUMES

BY

J. B. PORTER, E.M., B.Sc.

AND

R. J. DURLEY, M.A.E.

ASSISTED BY

THÉOPHILE C. DENIS, B.Sc., EDGAR STANSFIELD, M.Sc.,
AND A STAFF OF SPECIAL ASSISTANTS.

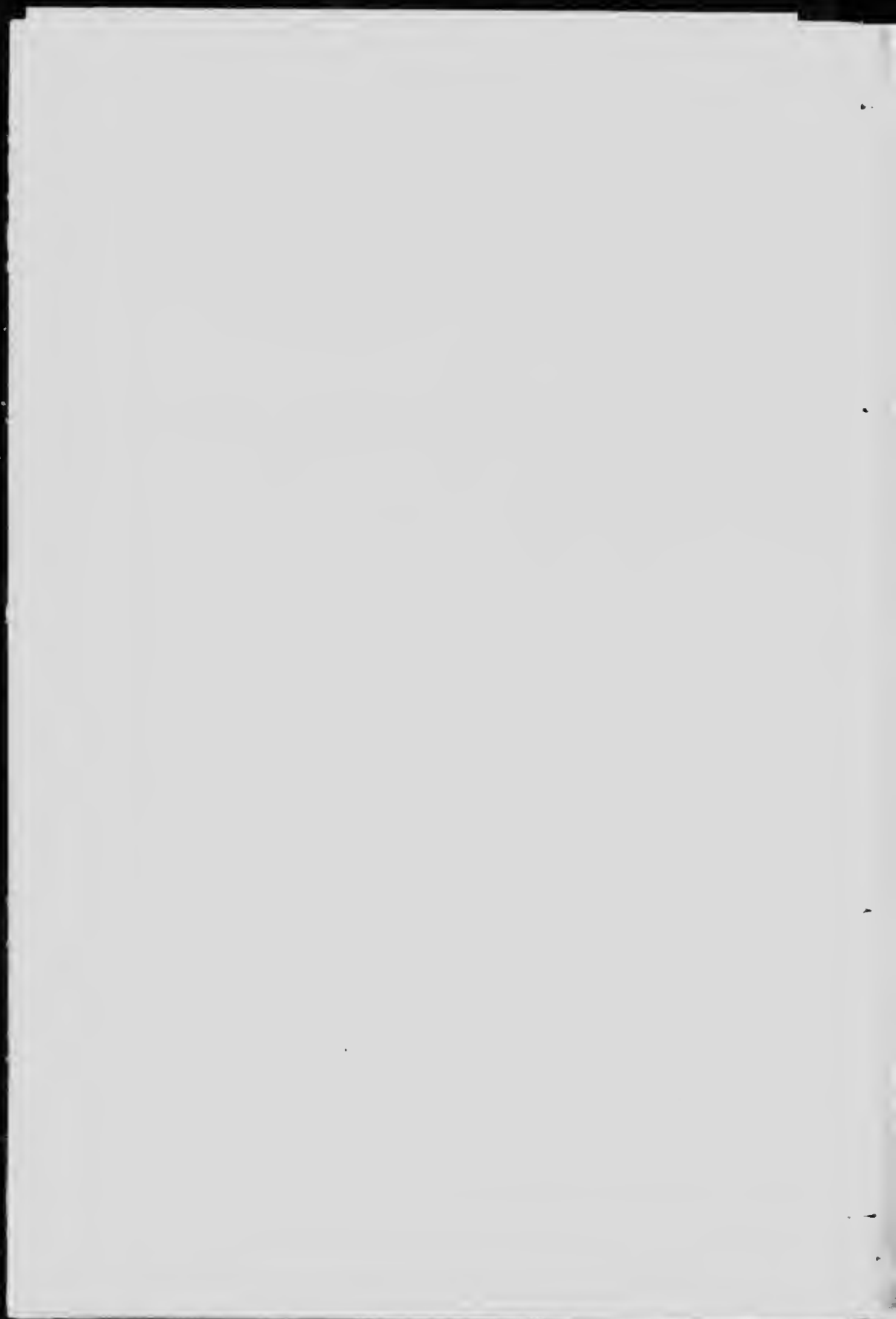
VOL. I



OTTAWA
GOVERNMENT PRINTING BUREAU
1912

PRICE \$1.00

No. 83



LETTER OF TRANSMITTAL

DR. EUGENE HAANEL,
Director of Mines Branch,
Department of Mines,
Ottawa.

SIR,

I beg to submit, herewith, a report on the economic investigation of the coals of Canada, conducted at McGill University, Montreal, for the Mines Branch of the Department of Mines, Ottawa.

I have the honour to be, Sir,

Your obedient servant,
(Signed) **John Bonsall Porter.**

Department of Mining Engineering,
McGill University,
Montreal.

November 7, 1910.



TABLE OF CONTENTS

VOLUME I

PART I.		PAGE
INTRODUCTORY, by J. B. Porter.		3
Technical staff		4
Laboratories.		5
Peat fuel problem.		6
Canada's principal coal fields		6
List of coals tested.		8
Divisions of the investigation.		11
Sampling in the field.		11
Crushing and sampling in the laboratory.		12
Mechanical purification of coal.		12
Coking trials.		13
Boiler trials		14
Producer trials.		15
Chemical laboratory work.		16
The Report.		16
Interpretation of results.		17
PART II.		
THE COAL FIELDS OF CANADA, by T. C. Denis:—		
General.		21
The coals of the Atlantic provinces: Nova Scotia and New Brunswick.		23
The Sydney, N.S., coal basin:—		
History, general description, and statistics.		24
Dominion Coal Co.—Collieries Nos. 1 to 11.		29
Nova Scotia Steel and Coal Co.		34
Mackay Coal Co.		36
Sydney Coal Co.		36
Colonial Coal Co., Ltd		36
North Atlantic Collieries Co		7
Cape Breton Coal Mining Co.		37
The Inverness, N.S., coal field:—		37
Inverness Railway and Coal Co.		42
Mabou Coal Mining Co.		12
Port Hood and Richmond Railway and Coal Co.		13
The Richmond, N.S., coal field.		43

	PAGE
The Pictou, N.S., coal field.	44
Acadia Coal Co.	47
Intercolonial Coal Mining Co.	49
Nova Scotia Steel and Coal Co.	50
The Cumberland, N.S., coal basin.	50
Cumberland Coal and Railway Co., Springhill.	55
Maritime Coal, Railway, and Power Co., Chignecto.	56
" " " Joggins.	57
Eastern Coal Co.	57
Minudie Coal and Transportation Co.	58
Strathcona Coal Co.	58
Other collieries.	58
The New Brunswick Coal basins:—	59
King mine, Grand Lake field, Minto, N.B.	62
The lignites of Northern Ontario	62
The coals and lignites of the Great Plains:—	
Alberta and Saskatchewan	63
The Souris and Turtle Mountain coal fields, Saskatchewan	64
Western Dominion Collieries Co.	67
Eureka Coal and Brick Co.	68
Manitoba and Saskatchewan Coal Co.	68
Other collieries in the district.	68
The Edmonton series and Laramie coal formation, Alberta:—	69
Edmonton Standard Coal Co.	69
Parkdale Coal Co.	70
Strathcona Coal Co.	70
Twin City Coal Co.	70
Alberta Coal Co.	70
Cardiff Coal Co.	71
Diamond Coal Mine, Ltd.	71
The Belly River formation, Southern Alberta:—	71
Cretaceous Series	72
Canada West Coal Co.	73
Reliance Coal Co.	74
Alberta Railway and Mining Co.	74
Royal Collieries, Ltd.	75
Breckenridge and Lund Coal Co.	75
Galbraith Coal Co.	76
Coals of the eastern slopes of the Rocky mountains, Alberta:—	76
The Blairmore-Frank coal field.	77
Maple Leaf Coal Co.	77
Leitch Collieries, Ltd.	78
Hillcrest Coal and Coke Co., Ltd.	78
West Canadian Collieries, Ltd.	78
Canadian American Coal Co.	80

	PAGE
International Coal and Coke Co.	80
The Canmore and Cascade Mountain coal areas	81
H. W. McNeil Co.	83
Bankhead Mines, Ltd.	84
Coals and lignites of British Columbia	85
Rocky Mountain coal fields	86
Crowsnest pass	86
Elk river and Kamamaskis	90
Crowsnest Pass Coal Co., Ltd.	91
Coal Creek colliery	91
Michel colliery	91
Carbonado mines	96
Hosmer Mines, Ltd.	96
Corbin Coal and Coke Co.	99
The Princeton (Similkameen district), Nicola, and Telkwa Valley coal fields	99
Princeton coal fields	99
Granite Creek coal field	101
Nicola Valley coal field	101
Nicola Valley Coal and Coke Co.	103
Middlesboro collieries	103
Diamond Vale Coal and Iron Mines, Ltd.	101
Telkwa coal field	101
Vancouver island and the coast	105
Comox field	106
Nanaimo field	108
Wellington Coal Co.	109
Extension colliery	109
Unicey colliery	110
Western Fuel Company	111
Suquash coal field	113
Pacific Coast Coal Co., Ltd.	113
Queen Charlotte islands	111
Camps —	
Wilson	115
Robertson	115
Anthracite	115
Yukon Territory	116
Whitehorse coal area	116
Tantalus coal area	117
Tantalus mine	117
Tantalus butte	118
Five Fingers mine	119
Rock Creek coal area	119
Coal creek, tributary of Rock creek	120

	PAGE
Coal creek, tributary of Yukon river. . .	120
Cliff creek. . .	121
BIBLIOGRAPHY—	
List of official reports, maps, etc., relating to coal resources of Canada. . .	122

PART III.

COLLECTING THE COAL SAMPLES, by T. C. Denis and E. Stansfield.	
Description of the samples taken:—	129
Maritime Provinces. . .	130
The Great Plains. . .	140
Eastern slopes of the Rocky mountains. . .	142
British Columbia. . .	146
Yukon. . .	153

PART IV.

SAMPLING IN THE TESTING PLANT AND LABORATORY, by J. B. Porter.	
Theory and practice of sampling. . .	157
Brief description of the laboratory equipment, and layout	158
Outline of the method of sampling employed.	158

PART V.

MECHANICAL PURIFICATION OF COAL COMMONLY CALLED COAL WASHING, by J. B. Porter.	
Introduction. . .	163
Impurities of coal and their effects	165
General principles of coal washing. . .	167
Historical sketch of coal washing devices.	169
Present methods of preparing bituminous coal.	171
Crushing machinery. . .	171
Sizing and screening machinery. . .	172
Washing apparatus. . .	172
Trough washers. . .	172
Continuous ascending current washers or classifiers. . .	173
Intermittent current ascending washers or jigs. . .	173
Bumping tables.	176
Washing plants in general.	176
Description of typical washing plants. . .	177
Discussion of the plants above described. . .	188
Preparation of anthracite coal.	190
Special features of anthracite preparation	191
Description of the anthracite breaker at Bankhead, Alta. . . .	192

	PAGE
Tests in the laboratory.	193
Introduction.	193
Specific gravity determinations.	194
Purpose of such tests.	195
Methods employed	195
Screen analyses.	195
Purpose of these tests.	195
Washing tests proper.	196
Apparatus and methods employed.	196
Typical log of one complete test—No. 37.	198
Typical example of the 60 sheets of curve diagrams of coal washing tests, in Appendix I, Vol. III	201
Summary statements in tabular form for all washing trials from each field.	Following 201

PART VI.

MANUFACTURE AND TESTING OF COKE, by E. Stansfield and J. B. Porter.

Introduction.	205
Non-recovery beehive ovens.	206
Non-recovery retort ovens.	208
By-product retort ovens.	209
Comparison of types of ovens.	210

Tests:

Object, scope, and method of testing the coking power of coals.	212
Coking plants at which the tests were made:—	
Dominion Iron and Steel Co., Ltd., Sydney, N.S.	211
Dominion Coal Co., Ltd., Glace Bay, N.S.	211
Nova Scotia Steel and Coal Co., Ltd., Sydney Mines, N.S.	211
West Canadian Collieries, Ltd., Lillooet, Alberta.	214
International Coal and Coke Co., Ltd., Colanum, Alberta	211
Method of conducting coking tests of coals	214
General description of the tests	211
Details of the various methods employed.	216
Preliminary tests.	219
Experiments on the method in general.	219
" " influence of age.	219
" " duration of tests.	221
" " position of test in oven	221
" " blending of coals for coking	221
" " compression of coal	222
" " moisture in coal.	222

	PAGE
Methods devised for comparing the different samples of coke:	
Apparent specific gravity.	222
Real specific gravity, . . .	223
Porosity	223
Strength, . . .	223
Tabulating the records of coking tests:	
Numbering of samples with reference to tests for washing, steaming, etc.	225
List of commercial cokes sampled for comparison tests	231
Results of coking tests.	233
Summary record in tabular form of all coking trials, arranged by coal fields in geographical order. Following	233

VOLUME II

PART VII.

	PAGE
Boiler Tests, by R. J. Durley.	3
Types of boilers, and their efficiency.	3
Coal, and its suitability for steam generating purposes	5
Boiler furnaces and their adaptability for various coals	7
Boiler trials, and their use in testing coals.	9
Equipment: brief description of plant and apparatus used for boiler trials, . . .	15
Method of conducting tests and making measurements; log and calculations for one trial	18
Duties of staff, method of handling fuel and starting and stopping trials, . . .	18
Measurement of water, Dryness of steam, Flue gas analysis.	19
Results of boiler trial No. 58, . . .	21
Log of trial with observation sheets.	24
Summary of observations	23
Summary of results.	26
Details of calculations involved in the determination of the resultant figures given in the summaries of observations and results, . . .	27
Remarks on boiler trials and their results.	32
Value of coal, . . .	32
Composition of coals, . . .	32
Condition of coals when tested, . . .	33
General tabular statement of results of whole series of trials	33
Relative merit of the coals	34
Treatment and behaviour of coal in fire, . . .	39
Remarks on coals as arranged geographically by coal fields	40
Sydney coal field, Cape Breton co., N.S. . . .	40

	PAGE
Inverness coal field, Inverness co., N.S.	41
Pictou coal field, Pictou co., N.S. . .	42
Springhill coal field, Cumberland co., N.S. . .	43
Joggins-Chignecto coal field, Cumberland co., N.S.	44
Grand Lake coal field, N.B. . .	44
Souris, Edmonton, and Belly River coal fields, Saskatchewan and Alberta. . .	45
Frank-Blairmore coal field, Alberta. . .	46
Crowsnest coal field, B.C. . .	47
Cascade coal field, Alberta. . .	48
Nicola Valley coal field, B.C. . .	49
Nanaimo-Comox, and Alert Bay coal fields, B.C.	50

PART VIII.

GAS PRODUCER TESTS, by R. J. Durley.

Gas producers and their method of working. . .	55
Gas producers for non-bituminous fuels. . .	58
Gas producers for bituminous fuels. . .	61
Gas producer tests, and methods of testing coals in gas producers	66
Equipment of experimental plant for gas producer tests of Cana- dian coals. . .	72
General arrangement of plant and accessories . . .	77
Methods of conducting tests, and making measurements: (with log and calculations for one trial). . .	79
Method of handling fuel, and starting and stopping trials	81
Temperatures, pressures, and other details of test	82
Determination of rate of fuel consumption. . .	84
Detailed results of producer trial No. 32. . .	85
Log of trial, with observation sheets. . .	85
Summary of observations . . .	86
Summary of results. . .	89
Details of calculations involved in the determination of the resultant figures given in the summaries of ob- servations and results. . .	95
Remarks on gas producer trials and their results: value of coals for gas producer work . . .	102
Treatment and condition of coals when tested	102
General results. . .	102
Producer efficiency, as illustrated by proportion of combust- ible in coal, in refuse, and in producer contents. . .	103
Relative merit of the coals	107
Remarks on coals, as arranged geographically by coal fields	107
Sydney coal field, Cape Breton, N.S. . .	107
Inverness and Pictou coal fields, N.S.	108

	PAGE
Springhill and Joggins coal fields, N.S., and Grand Lake coal field, N.B.	109
Souris coal field, Sask., Edmonton and Belly River coal fields, Alta.	110
Frank-Blairmore coal field, Alta.	112
Crowsnest coal field, B.C.	113
Cascade coal field, Alta.	115
Nicola Valley, and the Nanaimo coal fields, B.C.	117
Heat expenditure with various coals.	118

PART IX.

WORK OF THE CHEMICAL LABORATORY, by Edgar Stansfield

Introduction.	121
Collection and treatment of samples.	122
Coal samples.	122
Ash samples.	126
Coke samples.	126
Gas samples.	126
Numbering of samples.	127
Records and calculations.	129
Air drying coal.	130
Analytical methods and derived results	131
General remarks.	131
Moisture.	133
Fixed carbon and volatile matter.	131
Ash.	136
Carbon and hydrogen.	136
Sulphur.	140
Nitrogen.	143
Oxygen.	145
Calorific value of solid fuels.	146
Calorific value of ash free coal	155
Calorific value calculated from analysis of coal.	155
Fuel ratio.	156
Carbon-hydrogen ratio.	156
Gas analysis.	157
Gas analysis with Orsat-Muncke apparatus.	158
Gas analysis with Randall and Barnhart apparatus.	158
Gas analysis with Bone and Wheeler gas analysis apparatus.	161
Calorific value of gaseous fuels.	165
Calorific value calculated from analysis of gas	168
Miscellaneous determinations.	173
Experiments on the fusibility of ashes	174

	PAGE
Discussion of work	176
List of coals tested	181
Sydney coal field, N.S.	181
Inverness coal field, N.S.	181
Pieton coal field, N.S.	181
Springhill coal field, N.S.	182
Joggins-Chignecto coal field, N.S.	182
Grand Lake coal field, N.B.	182
Souris coal field, Sask.	182
Edmonton coal field, Alta.	182
Belly River coal field, Alta.	182
Frank-Blairmore coal field, Alta.	183
Crownsnest coal field, B.C.	183
Cascade coal field, Alta.	183
Similkameen coal field, B.C.	183
Nicola Valley coal field, B.C.	181
Nanaimo-Comox coal field, B.C.	181
Alert Bay coal field, B.C.	181
Whitchose coal field, Yukon Territory.	181
Summary record in tabular form of all chemical analyses, arranged by coal fields in geographical order.	Following 181

LIST OF TABLES

VOL. I		PAGE
PART II		
Table	I. Geographical position of coal fields.	22
"	II. Table showing the equivalency of the principal coal seams in the Sydney coal field, with the intervening strata in the several basins.	26
"	III. Showing the suitability of Sydney coals for gas manufacture.	27
"	IV. Analyses of Telkwa coals.	105
"	V. " Graham Island coals.	116
"	VI. " coal from Coal creek; tributary of Rock creek.	120
"	VII. Analysis of coal from Cliff creek.	121
"	VIII. Reports issued by the Dominion Government, on the working coal fields of Eastern Canada, 1863-1911.	122
"	IX. Reports issued by the Dominion Government on the coal fields of Western Canada.	123
"	X. Geological Survey maps covering coal districts.	124
PART V		
Table	XI. Summary record of coal washing tests: Sydney coal field, Cape Breton co., N.S. Following	202
"	XII. Summary record of coal washing tests: Inverness and Pieton fields. Following	202

		PAGE
Table	XIII. Summary record of coal washing tests: Sprunghill, Joggins, and Grand Lake fields	Following 202
"	XIV. Summary record of coal washing tests: Alberta and Saskatchewan lignite fields.	" 202
"	XV. Summary record of coal washing tests: Eastern Crowsnest Pass coal fields.	" 202
"	XVI. Summary record of coal washing tests: Western Crowsnest Pass coal field	" 202
"	XVII. Summary record of coal washing tests: Cascade coal field	" 202
"	XVIII. Summary record of coal washing tests: Coast Range coal fields	" 202
"	XIX. Summary record of coal washing tests: Vancouver Island coal fields.	" 202
 PART VI		
Table	XX. List of cokes made in regular series of tests.	226
"	XXI. List of special cokes made in blending tests.	229
"	XXII. Special tests for comparison of open oven and box cokes.	230
"	XXIII. Special tests for comparison of types of ovens	230
"	XXIV. Special tests for effect of time of coking	231
"	XXV. Special tests for effect of position of box in oven	231
"	XXVI. Special tests for effect of compression of coal	231
"	XXVII. Special test for effect of moisture in coal	231
"	XXVIII. List of special cokes: classified under coke numbers	232
"	XXIX. Special tests for effect of time of coking	Following 233
"	XXX. Sundry special coking tests.	233
"	XXXI. Special cokes—blending tests.	233
"	XXXII. Special tests for comparison of types of ovens.	" 233
"	XXXIII. Special tests for comparison of commercial cokes	" 233
"	XXXIV. Special tests for comparison of open oven and box cokes.	" 233
"	XXXV. Summary record of coking tests: Sydney coal field, Cape Breton co., N.S.	" 233
"	XXXVI. Summary record of coking tests: Inverness coal field, Inverness co., N.S.	" 233
"	XXXVII. Summary record of coking tests: Piéton coal field, Piéton co., N.S.	" 233
"	XXXVIII. Summary record of coking tests: Springhill coal field, Cumberland co., N.S.	" 233

		PAGE
Table XXXIX	Summary record of coking tests: Joggins-Chignecto coal field, Cumberland co., N.S.	Following 233
" XL.	Summary record of coking tests: Frank-Blairmore coal field, Alberta . . .	" 233
" XLI.	Summary record of coking tests: Crowsnest coal field, B.C. . .	" 233
" XLII.	Summary record of coking tests: Similkameen coal field, B.C., Nicola Valley coal field, B.C.	" 233
" XLIII.	Summary record of coking tests: Nanaimo-Coomox coal field, Vancouver island, B.C.	" 233
" XLIV.	Summary record of coking tests: Whitehorse coal field, Yukon Territory . .	" 233

VOL. II

PART VII

Table	I. Detailed record of coal fired	22
"	II. Trials of No. 2 Babcock and Wilcox boiler with No. 36 coal . . .	Following 22
"	III. Detailed record of gas analysis.	23
"	IV. Summary record of boiler tests . . .	Following 32
"	V. Trials of Georges Creek coal on No. 2 Babcock and Wilcox boiler . . .	36
"	VI. Coals in order of evaporation.	38
"	VII. Remarks on combustion of Sydney coals	40
"	VIII. Evaporation with Sydney coals. . .	41
"	IX. " " Inverness coals. . .	41
"	X. Remarks on combustion of Pierson County coals	42
"	XI. Evaporation with Pierson County coals. . .	43
"	XII. " " Springhill coals. . .	43
"	XIII. " " Joggins-Chignecto coals. . .	44
"	XIV. " " Grand Lake coal. . .	44
"	XV. Remarks on combustion of lignites and lignitic coals	45
"	XVI. Evaporation with lignites and lignitic coals	45
"	XVII. Remarks on combustion of Frank-Blairmore coals.	46
"	XVIII. Evaporation with Frank-Blairmore coals. . .	47
"	XIX. Remarks on combustion of Crowsnest coals. . .	47
"	XX. Evaporation with Crowsnest coals.	48
"	XXI. Remarks on combustion of Cascade coals	49
"	XXII. Evaporation with Cascade coals. . .	49
"	XXIII. Evaporation with Nicola Valley coals.	50
"	XXIV. Remarks on combustion of Vancouver Island coals.	50
"	XXV. Evaporation with Vancouver Island coals. . .	51

PART VIII

Table	XXVI.	Composition of gases per cent. by volume. . .	57
"	XXVII.	" anthracite and coke. . .	57
"	XXVIII.	" typical gases from bituminous coal	61
"	XXIX.	Observations of composition of gas by volume. . .	91
"	XXX.	" " gas meter and B.H.P. . .	92
"	XXXI.	" " gas calorimeter and coal weighed	93
"	XXXII.	" " temperatures and pressures.	91
"	XXXIII.	Summary record of gas producer tests. Following	102
"	XXXIV.	Proportion of combustible in coal, in refuse, and in producer contents. . .	105
"	XXXV.	Performance with Cape Breton coals.	108
"	XXXVI.	" " Inverness and Pieton coals. . .	109
"	XXXVII.	" " Springhill, Joggins, and Grand Lake coals.	110
"	XXXVIII.	Performance with lignites and lignitic coals	111
"	XXXIX.	" " Frank-Blairmore coals. . .	113
"	XI.	" " Crowsnest coals. . .	111
"	XII.	" " Cascade coals.	116
"	XIII.	" " Nicola Valley and Nanaimo coal.	117
"	XLIH.	Heat value of coal charged per B.H.P. per hour . . .	118

PART IX

Table	XLIV.	Report of analysis of coal—Coal Testing Laboratory. . .	129
"	XLV.	Recorded temperature of water in calorimeter vessel. . .	118
"	XLVI.	Analysis of producer gas with Randall and Baerhart apparatus. . .	161
"	XLVII.	Analysis of producer gas with Bone and Wheeler apparatus. . .	165
"	XLVIII.	Ethylene: gross or higher calorific value in B.T.U. per cub. ft., moist, at 60°F. and 30"	169
"		Ethylene: net or lower calorific value in B.T.U. per cub. ft., moist, at 60°F. and 30"	169
"	XLIX.	Carbon monoxide: gross and net calorific value in B.T.U. per cub. ft., moist, at 60°F. and 30"	169
"	L.	Methane: gross or higher calorific value in B.T.U. per cub. ft., moist, at 60°F. and 30"	170
"		Methane: net or lower calorific value in B.T.U. per cub. ft., moist, at 60°F. and 30"	171
"	LI.	Hydrogen: gross or higher calorific value in B.T.U. per cub. ft., moist, at 60°F. and 30"	171
"		Hydrogen: net or lower calorific value in B.T.U. per cub. ft., moist, at 60°F. and 30"	172
"	LII.	Comparative ash determinations. . .	179

		PAGE
Table	LIII. Summary of approximate errors in coal analyses	180
"	LIV. Summary record of analyses of coals: Sydney coal-field, Cape Breton co., N.S., Following	181
"	LV. Summary record of analyses of coals: Inverness coal field, Inverness co., N.S.	181
"	LVI. Summary record of analyses of coals: Pictou coal field, Pictou, co., N.S.	184
"	LVII. Summary record of analyses of coals: Springhill coal field, Cumberland co., N.S.	181
"	LVIII. Summary record of analyses of coals: Joggins-Chignecto coal field, Cumberland co., N.S.	181
"	LIX. Summary record of analyses of coals: Grand Lake coal field, N.B.	181
"	LX. Summary record of analyses of coals: Souris coal field, Sask.	181
"	LXI. Summary record of analyses of coals: Edmonton coal field, Alta.	181
"	LXII. Summary record of analyses of coals: Belly River coal field, Alta.	181
"	LXIII. Summary record of analyses of coals: Frank-Blairmore coal field, Alta.	181
"	LXIV. Summary record of analyses of coals: Crowsnest coal field, Alta.	181
"	LXV. Summary record of analyses of coals: Cascade coal field, Alta.	181
"	LXVI. Summary record of analyses of coals: Similkameen coal field, B.C.	181
"	LXVII. Summary record of analyses of coals: Nicola Valley coal field, B.C.	181
"	LXVIII. Summary record of analyses of coals: Nanaimo-Comox coal field, Vancouver island, B.C.	181
"	LXIX. Summary record of analyses of coals: Alert Bay coal field, Vancouver island, B.C.	181
"	LXX. Summary record of analyses of coals: Whitehorse coal field, Yukon Territory.	181
"	LXXI. Summary record of analyses of coals: Standard coal used for comparison.	181

ILLUSTRATIONS

Photographs

VOL. I

Frontispiece—Panoramic view of Dominion Colliery No. 2, Dominion Coal Co., Glace Bay, N.S., showing bankhead, main shaft, hoisting engine house, power house, and part of winter's accumulation of bank coal approximating 300,000 tons.

PART II

Plate	I. Dominion No. 1 colliery, Dominion Coal Co., Glace Bay, N.S. . . .	30
"	II. Dominion No. 2 colliery, Glace Bay, N.S.	31
"	III. Winter view of collieries of Nova Scotia Steel and Coal Co., Sydney Mines, N.S.	31
"	IV. Colliery No. 3, Sydney Mines, N.S.	36
"	V. Tipple and power house, Port Hood Coal Co., Inverness co., N.S.	41
"	VI. Old Cornish pump, Foord colliery, Stellarton, N.S.	46
"	VII. Albion colliery, Stella ton, N.S.	48
"	VIII. Allan shaft, Stellarton, N.S.	48
"	IX. Vale colliery, at Thorburn, Pictou co., N.S. . .	48
"	X. Aensia colliery at Westville, N.S. . .	50
"	XI. Colliery No. 3, Springhill, Cumberland co., N.S. .	56
"	XII. Western Dominion collieries, Taylorton, Saskatchewan.	68
"	XIII. Manitoba and Saskatchewan Coal Co.'s colliery, Bienfait, Sask.	68
"	XIV. Outcrop of lignite at crossing of Pembina river, Alberta. . .	70
"	XV. View on bank of Saskatchewan river, Edmonton, Alta.	70
"	XVI. Parkdale Coal Co.'s colliery, Edmonton, Alta	70
"	XVII. Canada West Coal Co.'s colliery, Taber, Alta	71
"	XVIII. Galt colliery, Lethbridge, Alta. . .	71
"	XIX. Washing plant and Bernard coke ovens at Lille, Alta.	78
"	XX. Denison colliery, Coleman, Alta.	80
"	XXI. Anthracite coal breaker at Bankhead, Alta	81
"	XXII. Coal Creek colliery, Crowsnest Pass Coal Co., Coal Creek, B.C.	92
"	XXIII. Michel colliery, Crowsnest Pass Coal Co., Michel, B.C.	94
"	XXIV. Hosmer mines: main tunnel, Hosmer, B.C.	96
"	XXV. Hosmer mines: steel tipple, Hosmer, B.C.	98
"	XXVI. Pithead, Western Fuel Co., Nanaimo, Vancouver island, B.C.	112

	PAGE
Plate XXVII. Northfield colliery, Nanaimo, Vancouver island, B.C.	113
PART IV	
Plate XXVIII. Sampling a cone of unbroken coal. Department of Mining and Ore Dressing, McGill University.	158
" XXIX. Sampling a flattened cone of coal. Department of Mining and Ore Dressing, McGill University.	158
" XXX. Sampling a quartered pile of coal. Department of Mining and Ore Dressing, McGill University.	158
PART V.	
Plate XXXI. Shaking screens and picking belts, Pendleton collieries, Manchester, England.	168
" XXXII. Shaking screens and picking belt, Manton colliery, England.	168
" XXXIII. Coal tippie of the Springfield Collieries Co., U.S.A.	168
" XXXIV. Triumph four roll coal crusher.	170
" XXXV. Shaking screens and washers, New Cross Hands colliery, Swansea, Wales.	172
" XXXVI. Front end of belts showing arrangements for cleansing and delivery, Clock Face colliery, England.	172
" XXXVII. Jeffrey revolving screens: (a) Heavy screen for run of mine; (b) Screen making 3 sizes; (c) Screen on friction rollers.	172
" XXXVIII. Crusher platform, bar-screen, washer, and dust exhaust, Department of Mining and Ore Dressing, McGill University.	196
" XXXIX. Screens, feeder, and two compartment jig, Department of Mining and Ore Dressing, McGill University.	198
" XL. Revolving screens, jig, Robinson washer, etc., Department of Mining and Ore Dressing, McGill University.	198
" XLI. Drainage bin, screens, and jig, Department of Mining and Ore Dressing, McGill University.	198
" XLII. Drainage bin, for washed coal, Department of Mining and Ore Dressing, McGill University.	198
" XLIII. General view, fines washing section, Department of Mining and Ore Dressing, McGill University.	198
" XLIV. Wilfley table, fines washing section, Department of Mining and Ore Dressing, McGill University.	198
" XLV. Settling boxes and cones, fines washing section, Department of Mining and Ore Dressing, McGill University.	198

VOL. II

PAIR VII

Plate XLVI.	Boiler room, experimental steam plant, Department of Mechanical Engineering, McGill University,	16
-------------	---	----

PAIR VIII

Plate XLVII.	Diagram of Westinghouse double zone producer, vertical section,	64
" XLVIII.	Down-draft producer (No. D), Department of Mechanical Engineering, McGill University	76
" XLIX.	Boys' gas calorimeter as set up for producer tests, Department of Mechanical Engineering, McGill University,	78
" L.	Interior of gas producer laboratory, looking west, Department of Mechanical Engineering, McGill University,	80
" LI.	Interior of gas producer laboratory, looking east, Department of Mechanical Engineering, McGill University,	80

PAIR IX

Plate LII.	Small ball mill for grinding samples, Department of Mining and Ore Dressing, McGill University,	124
" LIII.	Small ball mill, opened for cleansing, Department of Mining and Ore Dressing, McGill University,	124
" LIV.	Drying apparatus—Chemical Laboratory, Department of Mining and Ore Dressing, McGill University,	132
" LV.	Kjeldahl nitrogen distillation apparatus, Chemical Laboratory, Department of Mining and Ore Dressing, McGill University,	141
" LVI.	Koehler bomb calorimeter, general view, Department of Mining and Ore Dressing, McGill University,	148
" LVII.	Randall and Barnhart gas analysing apparatus, general view, Department of Mining and Ore Dressing, McGill University,	158
" LVIII.	Bone and Wheeler gas analysing apparatus, general view, Department of Mining and Ore Dressing, McGill University,	162
" LIX.	Bone and Wheeler gas analysing apparatus, details, Department of Mining and Ore Dressing, McGill University,	162
" LX.	Rack for holding and storing gas samples	164
" LXI.	Ash cylinders after heating, viewed at an inclination	176
" LXII.	Ash cylinders after heating, viewed from above	176

Drawings

VOL. I

PART V

Fig. 1. Ground plan of laboratories, Department of Mining and Ore Dressing, McGill University.	158
" 2. Bradford coal breaker.	170
" 3. (a) Swing-hammer pulverizer without cover (b) Swing-hammer pulverizer with housing completely removed	170
" 4. (a) Sectional elevation of Stedman (Carr) disintegrator (b) Perspective of Stedman disintegrator with housing raised and cages pulled apart.	170
" 5. Elevation and plan of Coxe movable bar screen.	170
" 6. (a) Concentric conical trommel. (b) Concentric cylindrical trommel.	172
" 7. Sectional elevation and perspective of Scaife trough washer	172
" 8. Elevation and plan of Elliott washer	171
" 9. Sectional elevation of Jeffrey-Robinson washer	171
" 10. Sectional elevation of Jeffrey-Robinson washing plant.	171
" 11. Small experimental two compartment jig, Department of Mining and Ore Dressing, McGill University.	171
" 12. (a) Vertical section, Luhrig nut-coal jig (b) Vertical section, Luhrig small coal jig with feldspar bed	171
" 13. Large experimental two compartment jig with three interchangeable piston mechanisms, Department of Mining and Ore Dressing, McGill University	171
" 14. Vertical section, New Century nut-coal jig.	176
" 15. Vertical section, Sheppard nut-coal jig.	176
" 16. Pittsburgh (movable sieve) coal jig.	176
" 17. Campbell table.	176
" 18. Wilfley slime table.	176
" 19. Elevation and plan of a 350 ton capacity Sheppard washery	180
" 20. Elevation and plan of Stein and Boericke washery.	182
" 21. Side and end elevations of a Luhrig washery	181
" 22. Section of coal tippie of Springfield Collieries Co.	186
" 23. Combined coal tippie and Robinson washery	188
" 24. Sectional elevations of Ramsay sludge tank	188
" 25. Diagrammatic scheme for preparation of anthracite coal for market.	190
" 26. Elevation and plan of Langerfeld dry separator. (Slate picker).	192
" 27. Elevations and sections of adjustable comet breaker, Department of Mining and Ore Dressing, McGill University	196
" 28. Elevations and plan of Tulloch feeder, Department of Mining and Ore Dressing, McGill University	198

PART VI

Fig. 29. Beehive coke ovens, International Coal and Coke Co., Coleman, Alta.	207
" 30. Sectional elevations of Bernard retort coke oven	208
" 31. Cross section of Otto-Hoffman retort coke oven, showing also charging barries, coke ram, and quenching floor	209

VOL. II

PART VII

Fig. 32. Standard types of steam boilers	3
" 33. Babcock and Wilcox boilers, Department of Mechanical Engineering, McGill University.	15
" 34. General arrangement of experimental boiler plant, Department of Mechanical Engineering, McGill University	17
" 35. Diagram showing boiler efficiency and rate of combustion	33
" 36. Diagram showing boiler efficiency and percentage of fixed carbon.	34
" 37. Diagram showing boiler efficiency and equivalent evaporation.	35

PART VIII

Fig. 38. Diagram of simple form of gas producer	55
" 39. Suction gas producer (Ruston and Proctor)	58
" 40. Suction gas producer (Pintsch)	59
" 41. Gas producer for lignite briquettes (Koerting)	63
" 42. Twin down-draft gas producers (Power and Mining Machinery Co.)	64
" 43. Double zone gas producer (Westinghouse)	66
" 44. Suction producer No. 1, Department of Mechanical Engineering, McGill University.	75
" 45. Down-draft producer (No. D), Department of Mechanical Engineering, McGill University.	76
" 46. Forty horse-power gas engine, Department of Mechanical Engineering, McGill University.	77
" 47. Section through gas washer, Department of Mechanical Engineering, McGill University.	77
" 48. General arrangement of experimental producer gas plant, Department of Mechanical Engineering, McGill University.	78
" 49. Diagram showing producer efficiency and coal consumption per B.H.P. per hour.	107

PART IX

Fig. 50. Stansfield pressure regulators, Models (a) and (b)	132
" 51. Vertical section, Koehler calorimeter bomb.	146

	PAGE
Fig. 52. Vertical section, Koehler calorimeter	117
" 53. Section of glass parts of Randall and Barnhart gas analysing apparatus.	157
" 54. Diagram of Bone and Wheeler gas analysing apparatus	161
" 55. Vertical section of Boys' gas calorimeter	165
" 56. General view of Boys' gas calorimeter	167

Maps

VOL. I

No. 95. General map of Canada, showing coal fields and locations from whence samples of coals were taken	End
No. 96. General map of coal fields of Nova Scotia and New Brunswick.	"
No. 97. General map showing coal fields in Alberta, Saskatchewan, and Manitoba.	"
No. 98. General map of coal fields in British Columbia	"
No. 99. General map of coal fields in Yukon Territory.	"

Index.

List of Mines Branch Publications

APPENDICES

VOL. III.

APPENDIX I

COAL WASHING TESTS, by J. B. Porter.

VOL. IV.

APPENDIX II

BOILER TESTS AND DIAGRAMS, by R. J. Durley.

VOL. V.

APPENDIX III

PRODUCER TESTS AND DIAGRAMS, by R. J. Durley.

VOL. VI

APPENDIX IV

COKING TESTS, by Edgar Stansfield and J. B. Porter.

APPENDIX V

CHEMICAL TESTS, by Edgar Stansfield.



THE
COALS OF CANADA:
AN ECONOMIC INVESTIGATION
VOL. I

PART I
INTRODUCTORY
BY
J. B. PORTER



THE
COALS OF CANADA:
AN ECONOMIC INVESTIGATION
VOL. I

PART I

INTRODUCTORY

J. B. PORTER

In the autumn of 1906, the Canadian Government, through Dr. A. P. Low, Director of the Geological Survey, decided to undertake a study of the fuels of the Dominion, somewhat on the lines of the fuel tests which had already been commenced by the United States Geological Survey. But inasmuch as the Government had not, at Ottawa, any suitable mechanical laboratories, and as research work had already been done by the Mining Department of McGill University on a number of western coals, Dr. Low invited Dr. Porter, the head of that department, to undertake the larger investigation. This proposal was approved by the University governors, and Dr. Porter was authorized to carry out the tests in the University laboratories, without charge; on the understanding that the Government would pay for such apparatus as might be required to supplement the existing equipment, and to make good all additions to the salaries, wages, and supplies accounts, rendered necessary by the investigation. At the request of Dr. Low, also, the Intercolonial, and Canadian Pacific railways very generously agreed to haul the material—amounting to many hundreds of tons—free of charge.

Shortly after the commencement of the investigation the Dominion Department of Mines was created, under the Hon. William Templeman, as Minister of Mines, and Dr. A. P. Low, as Deputy Minister; and the investigation, together with all matters relating to economic minerals, was transferred from the Geological Survey, to the Mines Branch, under the Directorship of Dr. Eugene Haanel. The original arrangement, was, however, in all other respects, continued without change.

From the beginning it was intended to confine the investigation to the coals and lignites of the Dominion; but owing to limited means, the following points, only, were covered by the scheme:—

- (a). Sampling in the field.
- (b). Crushing the samples and preparing them for treatment.
- (c). Washing, and mechanical purification.
- (d). Coking trials.
- (e). Steam boiler trials.
- (f). Producer, and gas engine trials.
- (g). Chemical laboratory work, and miscellaneous investigations.

TECHNICAL STAFF.

The technical staff engaged in the investigation, comprised:—

- (1). J. B. Porter, E.M., Ph.D., D.Sc., Professor of Mining Engineering, McGill University—Responsible for the organization and general direction of the investigation, and directly in charge of Sections I, IV, and V, and VI (in part).
- (2). R. J. Durley, B.Sc., M.A., Professor of Mechanical Engineering, McGill University—In charge of Sections VII and VIII.
- (3). Théo. C. Denis, B.Sc., Mines Branch, Department of Mines, Ottawa—In charge of Sections II and III (in part).
- (4). Edgar Stansfield, M.Sc., Chief Chemist—In charge of Section IX, and Sections III and VI (in part).
- (5). H. F. Strangways, M.Sc., Dawson Fellow in Mining, McGill University—Assistant in Sections IV and V, 1907.
- (6). H. G. Carmichael, M.Sc., Dawson Fellow in Mining, McGill University—Assistant in Sections IV and V, 1908.
- (7). E. B. Rider, B.Sc., Demonstrator in Mining, McGill University—Assistant in Sections IV and V, 1909-10.
- (8). Chas. Landry, Chief Mechanic of Mining Department, McGill University—Foreman in Sections IV and V.
- (9). J. W. Hayward, M.Sc., Assistant Professor of Mechanical Engineering, McGill University—Assistant in charge of Section VII, 1907, and preliminary work in Section VIII.
- (10). J. Blizard, B.Sc. Lecturer on Mechanical Engineering, McGill University—Assistant in charge of Section VII, 1908, and Assistant in Section VIII.
- (11). D. W. Munn, M.A., B.Sc., Demonstrator in Mechanical Engineering, McGill University—Assistant in Sections VII and VIII.
- (12). G. L. Guillet, M.Sc., Demonstrator in Mechanical Engineering, McGill University—Assistant in Section VII.
- (13). G. Killam, M.A., B.Sc., Demonstrator in Mechanical Engineering, McGill University—Assistant in Section VIII.
- (14). J. S. Cameron, B.Sc., Demonstrator in Mechanical Engineering, McGill University—Assistant in Section VIII.
- (15). A. Balmfirth, Superintendent of McGill University Power House—Foreman in Section VII.
- (16). J. Gardner, Foreman in Section VIII.
- (17). J. Hoult, Fireman in all tests of Section VII.
- (18). J. H. H. Nicolls, B.Sc., Assistant Chemist—Assistant in Section IX, 1908, 1909.
- (19). R. T. Mohan, B.Sc., Assistant Chemist—Assistant in Section IX, 1908.
- (20). P. H. Elliott, M.Sc., Assistant Chemist—Assistant in Section IX, 1908.
- (21). E. J. Conway, B.Sc., Assistant Chemist—Assistant in Section IX, 1908.

- (22). W. B. Campbell, Assistant Chemist—Assistant in Section IX, 1909.
- (23). R. S. Bochner, M.Sc., Demonstrator in Chemistry, McGill University—Assistant in Section IX, 1908, 1909.
- (24). H. Hurtley, B.Sc., Assistant Chemist—Assistant in Section IX, 1909.
- (25). W. P. Meldrum, B.Sc. of the Department of Chemistry, McGill University—Assistant in Section VI, 1909.
- (26). H. H. Gray, B.Sc., Demonstrator in Metallurgy, McGill University—Assistant in Section VI, 1909.
- (27). H. G. Morrison, B.Sc., Assistant Chemist—Assistant in Section IX, 1909, 1910.

There were also a number of machinists, mechanics, and labourers, engaged more or less continuously in the several sections.

In addition to the persons above named, the following members of the University staff very materially aided in the progress of the work by giving occasional assistance and advice:—

Alfred Stansfield, D.Sc., Professor of Metallurgy.

H. T. Barnes, D.Sc., Professor of Physics.

Acknowledgment is also due to the Governors of McGill University, and to W. Peterson, C.M.G., Principal; F. D. Adams, F.R.S., Dean; W. Vaughan, Esq., Secretary; S. R. Burrell, Esq., Chief Accountant, and many others.

LABORATORIES

The laboratories of the Mining and Mechanical Departments of McGill University, in which the tests were made, were built and equipped some few years ago on a scale unequalled at the time in North America, the buildings and apparatus for the Ore Dressing Department alone costing over \$150,000, and the Steam Laboratory an almost equal sum. This equipment needed very little augmentation in respect of sampling, crushing, coal washing, steam boiler tests, and chemical analysis, although a number of minor pieces of apparatus had to be purchased, such as extra calorimeters, pyrometers, thermometers, etc., etc.

In the matter of producer and gas engine tests, larger expenditure was necessary, as the University equipment was on too small a scale for the extensive tests contemplated. An addition 25 × 70 was, therefore, built to the Ore Dressing Laboratory, and equipped with a complete plant of the most modern type, the cost for building and plant being approximately \$12,000. A detailed description of this plant, with cuts of the apparatus, etc., will be found in Part VIII of the report, and similar descriptions of the apparatus used in the other parts of the investigation will be found in the other parts. No attempt, however, will be made to describe the general equipment of the laboratories, although Fig. 1 shows the general arrangement of the main ore dressing room, and several of the views include apparatus not employed in the tests.

PEAT FUEL PROBLEM

During the progress of the above work an additional investigation was conducted by Dr. Eugene Haanel, Director of Mines, who undertook an extensive study of the peat deposits of Quebec and Ontario, and commenced the erection at Ottawa of a peat testing plant. The immediate necessity of this second investigation will be realized when it is stated that, no coal fields of importance occur in Canada between eastern New Brunswick on the east, and Saskatchewan and western Manitoba on the west—a distance of over 2,000 miles—while throughout this great coalless territory there are numerous and very extensive bodies of peat which are all, as yet, wholly undeveloped. As, however, this investigation of the peat problem is an independent inquiry, it is unnecessary to deal with it¹ further in this report.

CANADA'S PRINCIPAL COAL FIELDS

Canada possesses a number of coal fields which may be grouped roughly into four great divisions, three of which are of present importance:—

(1). *The Maritime Provinces:—*

Nova Scotia and New Brunswick —

Bituminous coal only 3,500,000,000 tons estimated²

(2). *The Central Plains and the Eastern Rocky Mountains:—*

Manitoba, Saskatchewan, Alberta, British Columbia —

Anthracite 100,000,000 tons estimated²

Bituminous. 30,000,000,000 " "

Sub-bituminous and lignite 100,000,000,000 " "

(3). *The Pacific Coast and the Western Mountains:—*

British Columbia and the Yukon —

Anthracite 61,000,000 tons estimated²

Bituminous. 10,000,000,000 " "

Lignite. 500,000,000 " "

(4). *The Arctic-Mackenzie Basin:—*

Lignite only 190,000,000 tons estimated²

In addition to the above there are certain small fields—notably one of no present interest, in Ontario, containing some millions of tons of lignitic peat, and others of doubtful extent and value in the far north.

The coals of section (1) Nova Scotia—are similar to the ordinary grades of English and Scotch coal, although in the average they may have a little more ash and considerably more sulphur than the British seams of the same thickness. Most of them make fair coke, and, on the whole, may be taken to be fair to good steam coals, and excellent for domestic use.

¹See, Bulletins Nos. 1 (30), and 4 (71): "Investigation of the Peat Bogs and Peat Fuel Industry of Canada, 1908-1910." Published by the Mines Branch, Department of Mines, Ottawa.

²Compiled from paper by D. B. Dowling—Bulletin Canadian Mining Institute No. 15 June 1911, pp. 87-107. It should be noted that this estimate is of mineable coal already explored with some measure of accuracy. Further discoveries of great importance have just been made in the Skeena district of British Columbia, and others will undoubtedly follow, in the end probably almost doubling the present total.

These coals are largely exploited, and at present provide the largest part of Canada's supply.

The coals of section (2) are enormous in quantity, and many of them excellent in quality, some of the best Crowsnest coals being admirable in every respect. These coals are, however, all of comparatively recent age, geologically (Cretaceous), and, with the exception of the lignites which occur chiefly in the plains, are found in the main uplift of the Rocky mountains; and the beds are much tilted and often very irregular. The coals are, consequently, less uniform in quality than they would otherwise be, and many of them carry large quantities of ash, either inherent or as an unavoidable admixture from mining operations.

These coals are largely exploited: the anthracites by the Canadian Pacific railway near Banff; the bituminous coals by many companies, most of which are operating in the neighbourhood of the Crows Nest Pass branch of the Canadian Pacific railway; the lignites in many places in southern Alberta, near Edmonton, and also at several points in Saskatchewan and Manitoba.

The bituminous coals are, as stated above, very variable, ranging from very high grade steam coals, down. Some of these coals make admirable coke, others will do so if first washed free from their excessive impurities; others do not coke well, or at all, but are useful for steam and domestic purposes. Still others—and this includes the greater part—are still unexploited, and lie to the north of present lines of traffic; but all, or nearly all, are where they can easily be made available as the country becomes settled.

The western coast coals (section (3)) are best developed in Vancouver island, where they have been mined for many years, and in Graham island to the north, where mining has not yet begun; but smaller although important fields are found in many localities, notably at Princeton, on what will probably become the line of the western extension of the Crows Nest Pass branch of the Canadian Pacific railway, at Nicola, near the main line of the Canadian Pacific railway, at Telkwa, near the line of the Grand Trunk Pacific railway, and at Tantalus, near the upper navigable waters of the Yukon.

The Vancouver Island coals are more or less normal bituminous, and some of them coke well. The others are largely, but not wholly lignite, or lignitic-bituminous. Some coke well, but most of them are likely to prove unsuitable for metallurgical purposes (smelter coke); generally, however, they are excellent for domestic use, and for steam raising. Their impurities vary greatly, but on the whole these coals may be likened to those of the second division.

With such vast coal resources, of which but a comparatively small part is developed, it is, of course, impossible for any investigation to be made exhaustive; and in the present case no attempt has been made to deal seriously with any coals except those from mines already developed, and in condition to place their material on the market; but nearly all mines which were in this condition have been sampled, and their product tested on a fairly large scale, usually, 10 tons.

In the following list the coals tested are arranged geographically, beginning with the eastern part of the Atlantic coal field of Cape Breton, Nova Scotia.

LIST OF COALS TESTED

SYDNEY COAL FIELD, CAPE BRETON CO., N.S.

- 50¹ Gowrie Seam, North Atlantic Collieries Ltd., Port Morien, N.S.
- 36 Dominion No. 7. Hub seam, Dominion Coal Co., Ltd., Glace Bay, N.S.
- 35 Dominion No. 9. Harbour seam, Dominion Coal Co., Ltd., Glace Bay, N.S.
- 35SP Dominion No. 5. Phalen seam, Dominion Coal Co., Ltd., Glace Bay, N.S.
- 38 Dominion No. 1. Phalen seam, Dominion Coal Co., Ltd., Glace Bay, N.S.
- 37 Dominion No. 10. Emery seam, Dominion Coal Co., Ltd., Glace Bay, N.S.
- 39 Dominion No. 12. Lingan seam, Dominion Coal Co., Ltd., Glace Bay, N.S.
- 13 No. 1 Colliery, Nova Scotia Steel and Coal Co., Ltd., Sydney Mines, N.S.
- 12 No. 3 Colliery, Nova Scotia Steel and Coal Co., Ltd., Sydney Mines, N.S.

INVERNESS COAL FIELD, INVERNESS CO., N.S.

- 14 Inverness Colliery, Inverness Railway and Coal Co., Inverness, N.S.
- 15 Port Hood Colliery, Richmond Railway Coal Co., Ltd., Port Hood, N.S.

PICTOU COAL FIELD, PICTOU COUNTY, N.S.

- 4 Six Foot seam, Vale Colliery, Acadia Coal Co., Ltd., New Glasgow, N.S.
- 16 Foord seam, Allan Shaft Colliery, Acadia Coal Co., Ltd., Stellarton, N.S.
- 1 Third seam, Albion Colliery, Acadia Coal Co., Ltd., Stellarton, N.S.
- 2 Cage Pit seam, Albion Colliery, Acadia Coal Co., Ltd., Stellarton, N.S.
- 8 Main seam, Acadia Colliery, Acadia Coal Co., Ltd., Westville, N.S.
- 3 Main seam, Drummond Colliery, Intercolonial Coal Mining Co., Ltd., Westville, N.S.

¹ The distinguishing numbers of the coal samples were arbitrarily assigned at the time, and have been retained for convenient reference. They have no other significance. J. B. P.

SPRINGHILL COAL FIELD, CUMBERLAND CO., N.S.

- 19 No. 1 Colliery, Cumberland Railway and Coal Co., Ltd., Springhill,
N.S.
- 5 No. 2 Colliery, Cumberland Railway and Coal Co., Ltd., Springhill,
N.S.
- 6 No. 3 Colliery, Cumberland Railway and Coal Co., Ltd., Springhill,
N.S.

JOGGINS-CHIGNECTO COAL FIELD, CUMBERLAND CO., N.S.

- 7 Chignecto Colliery, Maritime Coal, Railway, and Power Co., Ltd.,
Chignecto, N.S.
- 9 Minudie Colliery, Minudie Coal Co., Ltd., River Hebert, N.S.
- 10 Joggins Colliery, Canada Coals and Railway Co., Ltd., Joggins,
N.S.

GRAND LAKE COAL FIELD, QUEENS CO., N.B.

- 11 King's mine, G. H. King, Minto, N.B.

SOURIS COAL FIELD, SASK.

- 40 Western Dominion Collieries, Ltd., Taylorton, Sask.
- 41 Eureka Coal and Brick Co., Ltd., Estevan, Sask.

EDMONTON COAL FIELD, ALTA.

- 46 Stratheona Coal Co., Ltd., Stratheona, Alta.
- 12 Parkdale Coal Co., Ltd., Edmonton, Alta.
- 45 Standard Coal Co., Edmonton, Alta.

BELLY RIVER COAL FIELD, ALTA.

- 43 Canada-West Coal Co., Ltd., Taber, Alta.
- 44 Galt Colliery, Alberta Railway and Irrigation Co., Ltd., Lethbridge,
Alta.
- 47 Breckenridge and Land Coal Co., Ltd., Lundbreck, Alta.

FRANK-BLAIRMORE COAL FIELD, ALTA.

- 48 Seven Foot seam (No. 1 Byron), Leitch Collieries, Ltd., Passburg,
Alta.
- 32 Hillcrest Colliery, Hillcrest Coal and Coke Co., Ltd., Hillcrest,
Alta.
- 33 Bellevue Colliery, No. 1 seam, West Canadian Collieries Co.,
Ltd., Bellevue, Alta.

- 28 Lille Colliery, No. 1 seam, West Canadian Collieries Co., Ltd.,
Lille, Alta.
- 34 Denison Colliery, No. 2 seam, International Coal and Coke Co.,
Ltd., Coleman, Alta.
- 34 SP Denison Colliery, No. 1 seam, International Coal and Coke Co.,
Ltd., Coleman, Alta.

CROWSNEST COAL FIELD, B.C.

- 31 No. 3 mine, Michel Colliery, Crowsnest Pass Coal Co., Ltd.,
Michel, B.C.
- 30 No. 7 mine, Michel Colliery, Crowsnest Pass Coal Co., Ltd.,
Michel, B.C.
- 29 No. 8 mine, Michel Colliery, Crowsnest Pass Coal Co., Ltd.,
Michel, B.C.
- 51 No. 2 seam south, Hosmer Mines, Ltd., Hosmer, B.C.
- 52 No. 6 seam south, Hosmer Mines, Ltd., Hosmer, B.C.
- 53 No. 8 seam south, Hosmer Mines, Ltd., Hosmer, B.C.
- 27 No. 2 mine, Coal Creek, Crowsnest Pass Coal Co., Ltd., Fernie,
B.C.
- 26 No. 5 mine, Coal Creek, Crowsnest Pass Coal Co., Ltd., Fernie,
B.C.

CASCADE COAL FIELD, ALTA.

- 25 No. 1 or Old mine, H. W. McNeil Co., Ltd., Canmore, Alta
- 23 Pea size, Bankhead Colliery, Bankhead Mines, Ltd., Bankhead,
Alta.
- 23 SP Buckwheat size, Bankhead Colliery, Bankhead Mines, Ltd.,
Bankhead, Alta.
- 23 M Mixed and 23 SP, Bankhead Colliery, Bankhead Mines, Ltd.,
Bankhead, Alta.
- 24 Briquettes from Bankhead Colliery, Bankhead Mines, Ltd.,
Bankhead, Alta.

SIMILKAMEEN COAL FIELD, B.C.

- EX. 1 No. 1 opening, Granite Creek, B.C.
- EX. 2 No. 2 opening, Granite Creek, B.C.
- EX. 3 No. 1 opening, Granite Creek, B.C.

NICOLA VALLEY COAL FIELD, B.C.

- 22 Jewel seam, No. 1 mine, Middlesboro Colliery, Nicola Valley
Coal and Coke Co., Ltd., Coutlee, B.C.
- 22 SP Rat Hole seam, No. 2 mine, Middlesboro Colliery, Nicola Valley
Coal and Coke Co., Ltd., Coutlee, B.C.

- 22 M Mixture of 22 and 22 SP, Middlesboro Colliery, Nicola Valley Coal and Coke Co., Ltd., Coutlee, B.C.

NANAIMO-COMOX COAL FIELD, VANCOUVER ISLAND, B.C.

- 20 Wellington seam, Wellington-Extension Colliery, Wellington Colliery Co., Ltd., Extension, B.C.
 18 Upper seam, No. 1 mine, Western Fuel Co., Ltd., Nanaimo, B.C.
 17 Lower seam, No. 1 mine, Western Fuel Co., Ltd., Nanaimo, B.C.
 21 Lower seam, No. 4 mine, Comox Colliery, Wellington Colliery Co., Ltd., Cumberland, B.C.
 21 SP Lower seam, No. 7 mine, Comox Colliery, Wellington Colliery Co., Ltd., Cumberland, B.C.
 21 M Mixture of Nos. 4 and 7 mines, Comox Colliery, Wellington Colliery Co., Ltd., Cumberland, B.C.

ALERT BAY COAL FIELD, VANCOUVER ISLAND, B.C.

- Ex. 34 Squash mine, Pacific Coast Coal Co., Alert bay, Vancouver island, B.C.

WHITEHORSE COAL FIELD, YUKON TERRITORY

- Ex. 31 Upper seam, Tantalus mine, White Pass and Yukon Railway Co., Ltd., Yukon.
 Ex. 32 Middle seam, Tantalus mine, White Pass and Yukon Railway Co., Ltd., Yukon.
 Ex. 33 Lower seam, Tantalus mine, White Pass and Yukon Railway Co., Ltd., Yukon.

DIVISIONS OF THE INVESTIGATION

A brief statement of the main features of each part of the work will suffice for this introductory statement, full particulars being given in the body of the report.

SAMPLING IN THE FIELD

With a few unimportant exceptions, all of which are noted in the detailed statements, in Part III, the above-named samples were procured by Theo. Denis, B.Sc., of the permanent staff of the Mines Branch, of the Department of Mines—Mr. Denis has since been appointed Superintendent of Mines, by the Provincial Government of Quebec—or by Edgar Stansfield, M.Sc., the chief chemist of the special staff

engaged for the tests; who visited and examined each mine to be sampled, and had the coal selected, sacked, sealed, and shipped under his own supervision. In procuring this main sample, every precaution was taken to secure average coal, as sold; but in addition, a smaller reference sample was personally secured, and sent in sealed tins directly to the chemist.

Other samples were also procured in some cases, in order to determine the differences between the several benches of coal as mined. Seams of minor importance were also sampled in lots ranging from a few pounds to one or more tons.

CRUSHING AND SAMPLING IN THE LABORATORY

The main sample on its arrival at the testing plant at McGill was unsacked, crushed to go through a 2" screen, mixed thoroughly on a large granolithic sampling floor, sampled for the chemist, etc., and finally all resacked and set out for treatment.

MECHANICAL PURIFICATION

Each main sample was experimentally treated in the laboratory with heavy solutions, and the fractions analysed with a view to determining the probable results of washing. In all cases where these preliminary tests gave favourable results, a large lot was treated in the coal washing plant of the University: which includes a specially designed experimental two-compartment slide motion jig; a Robinson washer, and much secondary apparatus. This jig had been specially remodelled for coal washing work, and is provided with automatic feed and side discharge devices for automatically removing the slate and other impurities. The purified coal overflows into a drainage box, in which it is collected and dried. The fine material passing down through the sieves is collected, and is either re-treated or wasted, depending upon its composition. Each of the tests was made on a lot of between three and four tons: which was first crushed, then sized, and then jigged in three separate portions—coarse, intermediate, and small—in order to achieve the most accurate results. The very fine coal was also treated when the coal was suitable for coking, or when, for any reason, there was likely to be a commercial justification for saving the fines. The products both of coal and waste were all recovered, weighed, and sampled; but the coarse and fine products were mixed before sending them to the boilers.

The coal washing work was checked by a further series of tests with heavy solutions. It would, of course, be possible in a laboratory to do extremely thorough washing at an expense disproportionate to the value of the coal; but this was not attempted, the aim being to reproduce commercial conditions. From comparative tests made between laboratory work, and coal washing in standard plants, it is evident that this end has been attained, and the tests as carried on may be taken in a broad way to represent average commercial work.

COKING TRIALS

The question, will a coal make good coke, is one of great practical importance. Heretofore, it has been difficult to answer it without first conducting a series of oven trials on a large and costly scale. Even a full sized experimental oven is unsuitable for such work, as its operation differs much from that of an oven surrounded by others, and as a result, the only safe course has been to send a very considerable quantity of each coal to be tested to a bank of ovens, and to test it under standard conditions; repeating the operation, if necessary, with different coking periods, until a definite conclusion is reached.

It was obviously impossible to carry out costly tests of the above character on all of the fifty odd coals in the series under consideration, hence an extended investigation was undertaken by Dr. Porter and Mr. Edgar Stansfield at the coking plant of the Dominion Iron and Steel Co., Sydney, N.S., with a view to developing some reliable method of working on a small scale. These experiments, supplemented by tests on various types of ovens in different places in Canada, finally led to a satisfactory conclusion, hence it is now possible to test coals in lots of say 50 pounds, the resultant cokes being in every way similar to those produced in commercial ovens, and in most cases virtually indistinguishable from them.

The method in brief is as follows:—

The sample of coal, which should be as fresh as possible, is crushed, washed if necessary, and slightly moistened in some cases, and is thus brought to exactly the conditions in which it would normally go to the ovens. It is then put into rectangular boxes of heavy sheet iron, each holding say 50 pounds. These boxes are freely perforated to permit of the escape of gas; but the perforations are blanked in such a way as to prevent the egress or ingress of coal. The boxes are first weighed, then placed in an oven which is being charged; in fact, they become a part of the regular charge, and are coked under perfectly normal conditions. On the withdrawal of the charge, the boxes are quenched as promptly, yet as lightly as possible, and are then dried and weighed before being opened.

In addition to the straightforward trials to determine whether the several coals would or would not coke, a series of tests was made to determine the effect of moistening, compressing, etc., and of different temperatures and durations of the coking period.

A method had also to be devised, to determine the strength of the cokes produced. Mere crushing tests did not suffice, hence it was finally decided to adopt a standard method of testing in a tumbler to determine the losses in handling, and of crushing to a fixed pressure in bulk to determine strength in coke bins and furnaces.

In addition to the above experiments on the production of metallurgical coke, a limited number of coals have been retorted, and the gases and tar studied both qualitatively and quantitatively. This work is, however,

somewhat beyond the strict limits of the investigation, and it has been impossible to carry it as far as might be desired.

Another series of tests has been made to determine the effect of weathering, and of washing, on coke production. Some coals will only coke when quite fresh; others will coke, but not so well, when stale; while others do not seem to be affected even by comparatively long exposure to the air. The whole matter is somewhat obscure, and chemical analysis does not cast as much light on it as one could wish.

BOILER TRIALS

The boiler trials were conducted in the boiler testing room of the Mechanical Engineering Department of McGill University, and the method used was as far as possible in accordance with standard testing practice. The equipment employed in these tests includes a Babcock and Wilcox boiler, having 639 square feet of heating surface, and 16.79 square feet of grate area; an independent feed pump; weighing tanks, and standard scales for water and coal; together with the necessary apparatus for determining moisture in steam, analysing flue gases, and observing pressures and temperatures. Provision was made for supplying steam under the grate, also for working under forced draft, if required. Except in one or two cases where the character of the coal necessitated a change, the same pattern of fixed grate bars was used throughout the tests. These bars have air spaces, the area of which is 30 per cent of the total grate area. If different grate bars had been used for different grades of fuel, better economy in some instances would probably have been obtained; but it was felt that by using the same grate throughout, the tests would be more completely comparable with one another.

Before commencing the tests, the boiler was thoroughly scaled, cleaned, and tested, and all brick-work around the furnace was rebuilt. Preliminary trials were then made with a standard coal (Georges creek), to make certain that the whole equipment was in good order. The series of regular tests was then begun, the same fireman being employed throughout. It was not found possible to make more than one boiler trial with most of the sample of coal, and it was decided that in every case the same evaporation of 2,000 pounds of water per hour should be aimed at; this being a rate at which the boiler was known to give nearly its best efficiency. The results of the tests show, therefore, the rate at which each sample of coal had to be burnt in order to furnish a certain supply of steam. As a check, the heat losses in every case were determined as far as possible. All the tests were at least of ten hours duration, and the boiler tubes were, of course, cleaned before each run.

Since the practical working of a coal in the fire has a great bearing on its industrial value as a fuel, continuous notes were made of such points as the condition and thickness of the fire; the nature and amount of ash and clinker formed; the frequency of slicing and cleaning the fire, and the method of firing found most suitable for each particular fuel.

PRODUCER TRIALS

In the beginning, it was decided to attempt to carry out the boiler and producer tests on a rather small scale, owing to a wish to make the investigation of immediate value to the numerous small manufacturing and power plants which are springing up all over the country, especially in the west, where for many years they will play a leading part in its industrial development. It was also desired to test all coals with equal thoroughness, and as nearly as possible under identical conditions. The transportation of fifty odd ton samples for distances ranging from 800 to 3,000 miles was a sufficiently serious matter. It was, therefore, decided to work on a scale of approximately 10 H.P., although it was known that bituminous coal producers had not been altogether perfected for so small an output. Assurances were given, however, by several of the leading firms making producers, that they could provide the necessary apparatus.

When, however, specifications were prepared and tenders asked for, the makers both at home and abroad exhibited an unexpected reluctance to guarantee their machinery, and much time was lost in correspondence. In the meanwhile an anthracite producer of approved form was put in; and a series of trial runs on anthracite, coke, etc., were commenced, to drill the staff, and get matters in working order. Ultimately, the makers of two well known types of producers undertook to build plants for bituminous coal, and did actually erect producers with the necessary tar extraction apparatus; but in both cases the producers failed to meet the requirements originally specified, and were, therefore, removed.

The experience gained in the tests above mentioned enabled Professor Durley to design a down draught producer which did meet the requirements; and after a long series of preliminary tests, necessary to arrive at a trustworthy method of operation, it was possible to begin the final tests on the series of coal samples.

As in the boiler trials, the method of flying start was adopted: the actual runs lasting 24 hours, and the total operation almost 36 hours. The time thus occupied was as long as could be managed without a very large increase in the staff, and an even greater increase in the cost; but these 24 hour tests were checked by a sufficient number of longer trials—one lasting 10 days—to show that the apparatus was quite capable of doing continuous, *i.e.*, commercial work.

Criticism may be offered against the use of one producer for all classes of coal, from semi-anthracite to lignite; but in any series of tests it is undesirable to change the apparatus or the conditions of work more than is absolutely necessary. The results have justified the course taken in this case. It is scarcely necessary to say, that the scrubbers, washers, tar extractors, etc., were so fitted that they could be cut out by means of valves and by-passes, and that they were only used when necessary.

CHEMICAL LABORATORY

The necessary work in the Chemical Laboratory has been very considerable. Methods, and in some cases apparatus, had to be devised, tested, and standardized, and all materials, whether raw, temporary, or final products analysed. No count of the total number of analyses has been attempted; but each complete test of a coal has involved over 100 separate determinations. The following enumeration of the different materials analysed, and of the different analyses, determinations, and investigations carried out, will give some idea of the extent of the work done.

MATERIALS ANALYSED: *Coal samples*—main, mine, weathering, boiler trial, gas producer products, coking products, final washed coal, separate products of washery. Specific gravity products, screen analyses, etc. *Coke samples* from coking tests; *gas samples* from boiler trials, gas producer tests and coking tests; *ash samples* from boiler trials, gas producer tests, and laboratory combustion of raw and washed coal.

CHEMICAL DETERMINATIONS MADE: carbon, hydrogen, oxygen, sulphur, nitrogen, moisture, ash, volatile matter, fixed carbon, combustible matter, carbon dioxide, carbon monoxide, ethylene, and methane.

PHYSICAL DETERMINATIONS MADE: fusion temperature of ashes; specific gravity, porosity, and strength of cokes; calorific values of solid and gaseous fuels.

SPECIAL INVESTIGATIONS have been made on the determination of sulphur in coal; determination of volatile matter in coal and coke; solubility of coal in water; determination of physical values of coke; weathering of coal, etc. An investigation is also being carried out on the spontaneous combustion of coal in storage; but as this is in addition to the original research, and is being supported by private contribution, it is not intended to incorporate the results in the main report.

THE REPORT

It will be seen from the above description of the investigation, that an attempt has been made to cover a large field, and yet to do the work in great detail. As a result of this, a very large amount of information has been gathered; but much of it is so highly technical as to be only of interest to specialists, hence it has been thought best to divide the Report—which will comprise six volumes—into two main sections of two and four volumes respectively.

In the first section, of which this introduction forms Part I, there are separate chapters or parts dealing with each of the seven divisions of the investigation outlined in the last few pages. Each of these parts begins with an introduction in which the subject of the division is dealt with in a general way, followed by a more or less extended description and discussion of the experimental work attempted; and concluding with a carefully tabulated summary of all of the tests in that division.

Part II, preceding the technical reports referred to above, is a very full descriptive paper on the history, geology, and present commercial development of the Coal Fields and Coal Mine—Canada, from the pen of Mr. Théo. C. Denis—a member of the permanent staff of the Mines Branch of the Department of Mines. This part of the Report, which is profusely illustrated with maps and photographs, differs from the remainder in that its matter is largely drawn from previous publications of the Geological Survey and other sources, but it possesses great value as an introduction to the somewhat technical reports which follow, and is of importance, on its own account, as the most complete work yet written on the Coal fields of the Dominion.

The first two volumes of the Report, comprising Parts I to IX inclusive, may therefore be considered as complete in themselves, and it is hoped that they will prove of value not only as contributions to the technological literature on Coal, but also as a source of useful and timely information to the general public, on the Coal resources of the Dominion and on the best methods of utilizing these resources.

The remaining four volumes III, IV, V and VI, are already in the press and will be published as promptly as possible. They will be confined exclusively to tabulated records and details of the tests summarized in Volumes I and II, to which they thus become highly technical appendices.

INTERPRETATION OF RESULTS

A matter of the first importance in making public the results of an extended series of tests, such as those reported in the following pages, is to present the information in such a way as to make it as widely useful as possible, and at the same time to guard, as far as practicable, against its misinterpretation.

A study of the analyses of the various coals sampled, or of any of the series of reports of practical trials, will show that certain of the coals are much purer than others, or are better in some other respects. These differences are in fact so marked that it is possible to tabulate the samples in what are apparently orders of merit. Such tables are of decided value if correctly prepared and intelligently used, but if imperfectly understood or improperly used they are almost certain to work hardship, or even injustice, to both producer and consumer.

To illustrate the above point, let us suppose that coal "A" contains less ash than "B," and has a decidedly higher calorific value; but that "B" is much stronger, and, therefore, bears transportation better. Under these conditions "A" will be better for general steam raising service, especially near the mine, while "B" will probably be worth more to the householder who requires lump coal, and to the coal merchant at a distance who has to stand the loss due to breakage in transit.

Again, the ash in "B" although greater in amount than that in "A," may be less fusible, and, therefore, less likely to form clinker. This difference,

if considerable may more than counterbalance the apparent superiority of "A," and may make "B" the better coal for use under boilers.

Again, "A" and "B" may both be weak coals, readily breaking up into slack, but "A" may be dry burning, while "B" has a tendency to coke. In this case "A" would require special grates for steam purposes, and at best, would waste to a considerable extent, while "B" could be used with but little loss in ordinary grates.

In the case of coke manufacture, "A" may be so pure as to require no washing, while "B" must be carefully treated to remove the superabundance of slate and pyrites, yet it is possible that once washed "B" may make the better coke of the two, and may be able to compete successfully with "A" in spite of the expense and loss due to washing.

These illustrations could be extended considerably, but they already suffice to show that each special use for fuel brings into prominence special qualities, and, therefore, that a prospective purchaser of coal should consider not only the relative purity, etc., of all available coals, but also their particular fitness or unfitness for his particular use.

Of greater importance even than any of the points yet named is the cost of transportation. Coal at the mines probably costs the producers from \$1 to \$2.50 per ton, depending on local conditions, but the consumer in the average pays at least double these prices and often very much more. Part of the difference is, of course, the profit of the producer, but by far the greater part is the cost of transportation which, in the average, amounts to at least half, and in many cases more than half of the total cost of coal to the ordinary purchaser. This important factor varies, in individual cases, with the distance between mine and market, the character of the route—whether by rail or water—the amount of competition, etc., but is in general quite independent of the quality of the coal itself. We thus have coals costing the consumers in different parts of the country anything from \$1.50 to \$20 per ton, and while no individual consumer ever has to decide between fuels differing so widely as this, he ordinarily has some choice between coals differing from one another in both price and quality, and although in general a high class fuel is to be preferred, yet there are very many cases where a poor fuel or even a very poor fuel will be found, all things considered, to be commercially more satisfactory.

The above illustrations have dealt with the matter in a very general and superficial way and no attempt has been made here to give sufficiently detailed information to enable a purchaser to decide between different coals, but in each of the subsequent "Parts" of the report dealing specifically with coal washing, coking, steam raising, and gas producing, there will be found an introductory chapter discussing in some detail the general features of the subject, and pointing out, directly or indirectly, the factors which play a part in determining the value of a coal for each specific use.

of
to
In
st,
out
no
ice
the
A"
dy
cial
der
ars-
ust
om
r in
ore.
the
o at
e of-
the
r by
nde-
the
\$20
nel-
iffer-
ral a
poor
com-
and
y de-
onds,
with
nd an
of the
a part

THE
COALS OF CANADA:
AN ECONOMIC INVESTIGATION

VOL. I

PART II

THE COAL FIELDS OF CANADA

BY

T. C. DENIS

PART II
THE COAL FIELDS OF CANADA

BY

THEOPHILE C. DENIS

HISTORICAL

In 1886, the first year in which statistics were collected by the Mines Section of the Geological Survey, the total production of coal in Canada amounted to 2,116,653 tons; whereas in 1908, there was a total production of nearly 11,000,000 tons.

Five provinces, and one territory, contribute to the Canadian coal output; specifically—in the order of quantity produced as follows: Nova Scotia, British Columbia, Alberta, Saskatchewan, New Brunswick, and Yukon Territory. The central part of Canada, namely, the Provinces of Quebec and Ontario, are devoid of coal fields, hence they have to rely on outside sources for their supply.

Two of the most productive of the Canadian coal fields are situated on the sea-boards, one on the Pacific coast, and the other on the Atlantic coast; a fact which is very important, from an Imperial standpoint. Both of these coal fields are near the coast, and have extensive submarine extensions; and both are fortunate in possessing fine natural harbours, capable of accommodating ships of any tonnage. Another coal field is situated in the proximity of the metal mining centres of British Columbia, and within easy reach of the copper and lead smelting centres of both the southern part of the Province, and of the adjoining states to the south. Large tracts of the new western Provinces of Alberta and Saskatchewan are underlaid by fossil fuels. All of these coal fields, as well as others of less importance, will be briefly described in the following notes, in their geographical order, beginning with the eastern provinces, and proceeding westward.

To convey some preliminary idea as to the geographical position of the coal fields in the respective provinces, the approximate central point of each of the principal coal areas will be given by intersections of latitudes and longitudes (west of Greenwich). These, of course, are only to be taken as a rough guide, and a help to locate the fields. Many of these coal areas are at present well developed, and producing steadily, as will be seen in the more detailed descriptions given under the various sections of the report. In others, mainly in the western part of Canada, owing to lack of means of transportation or present lack of market, only prospecting work has been done; but their coals constitute valuable reserves which, in many cases, will be

drawn upon in the near future, considering the rapid rate at which the west is developing, and the establishment of numerous new means of transportation and of communication.

TABLE I.
Geographical Position of Coal Fields.

	Latitude	Longitude
<i>Nova Scotia</i>		
Sydney field.....	46° 10'	60° 10'
Inverness field.....	46° 10'	61° 30'
Pietou field.....	45° 35'	62° 35'
Cumberland field.....	45° 40'	64° 20'
<i>New Brunswick—</i>		
Grand Lake field.....	46° 05'	66° 00'
<i>Manitoba—</i>		
Turtle Mountain field.....	49° 00'	100° 00'
<i>Saskatchewan</i>		
Estevan or Souris field.....	49° 05'	103° 00'
<i>Alberta—</i>		
Belly River field.....	49° 40'	112° 40'
Frank-Bhairmore field.....	49° 35'	114° 25'
Cascade field.....	51° 12'	115° 30'
Edmonton field.....	53° 50'	113° 30'
<i>British Columbia—</i>		
Crowsnest field.....	49° 30'	114° 55'
Nicola Valley field.....	50° 20'	120° 50'
Telkwa Valley field.....	54° 30'	127° 10'
Nanaimo field, V.I.....	49° 10'	123° 55'
Comox field, V.I.....	50° 00'	125° 00'
Squash field.....	50° 37'	127° 15'
Graham island, Q.C.I.....	53° 10'	132° 00'
<i>Yukon Territory—</i>		
Tantalus field.....	62° 10'	136° 10'
Yukon River field.....	61° 30'	140° 00'

Considered as a whole, the resources of fossil fuel in Canada are as follows: In the Province of Nova Scotia there are several large areas of bituminous coal, most of which are being actively worked. In New Brunswick there is one producing field, and two others which are only exploited intermittently. All the above coal measures are of true Carboniferous age.

The Nova Scotia fields, besides supplying the requirements of that Province, send their coal to the Provinces of Quebec and Ontario, the eastern part of the United States, New Brunswick, Newfoundland, Prince Edward Island, and the West Indies: the relative quantity shipped to each being about in the order given.

The coal mined in New Brunswick is used locally.

In Ontario we have extensive areas of very "young" coal, in the form of low grade lignites, in the now inaccessible district of the Moose River basin.

These beds of lignite are found in the glacial deposits above latitude 50 degrees. They are at present very remote from all means of transportation, and, moreover, the quality of this fuel would limit the output to local uses.

In Manitoba, and the northwest provinces, there are very large tracts of prairie land underlain by coal measures; the quality of the product varying from lignite in the east, to bituminous in the west, as the foothills of the Rocky mountains are approached. In the mountain region itself is a small basin where anthracite coal is mined. Across the watershed of the Rockies in British Columbia, the Crowsnest Pass coal field is a very large producer; and on Vancouver island there are two coal areas which were among the first to be worked in Canada.

The coal output of Alberta and Saskatchewan is mainly used in these Provinces and in Manitoba; a certain proportion, however, of the Frank-Blairmore coal field product is converted into coke, and shipped to the principal centres of British Columbia and to the United States. The railways also, use—in their locomotives—a large proportion of the bituminous coal, in western Alberta.

In British Columbia, one-third—very roughly speaking—of the production, is consumed in the Province; one-third is exported to the United States; and one-third used in the manufacture of coke. Of this last product, one-half is used in the Province, while the second half is exported to the United States.

Some of the lignites of the western fields just referred to are of Tertiary age, whereas others, as well as the bituminous coals, are referable to the Cretaceous. Coals referable to this latter period are also present in the Queen Charlotte islands and in other parts of British Columbia.

THE COALS OF THE ATLANTIC PROVINCES

NOVA SCOTIA

The coal-bearing measures of this Province belong to the Carboniferous, and are practically confined to the one of its subdivisions usually designated by the name of the Productive Coal Measures.

All the coal mined in this Province is bituminous in quality.

The following subdivisions into fields of the coal areas of the Province are usually adopted.

- (1.) Sydney coal field.
- (2.) Inverness coal field.
- (3.) Richmond coal field.
- (4.) Pietou coal field.
- (5.) Cumberland coal field.

History, General Description, and Statistics

The Sydney field¹ is situated in the northeast corner of Cape Breton county, with the magnificent deep water harbour of Sydney as its central point; it also takes in a small portion of Victoria county. It is bounded on three sides by the Atlantic ocean and the land areas amount to approximately 200 square miles, being about 32 miles in length from northwest to southeast and about 6 miles in width. The extent of the sea areas is unknown; but a great part of the local field is submarine.

² "The measures enclosing the Cape Breton coals are largely composed of argillaceous shales and sandstones, the solidity and coherence of which favour submarine exploration. As to the general structure, it can be said that the seams appear on the shore, sweep inland, and again enter the ocean, forming segments of ellipses whose centres are out at sea. This structure is observable at Cow Bay, Glace Bay, Lingan, and Sydney, these places presenting a series of basins the seams of which have been correlated, and their equivalence in many cases proved. These basins probably owe their origin to a corrugation of the area by numerous folds which bring the same coal seams repeatedly to the surface along the northeast coast of the island.

"The whole coast is deeply indented by bays and channels, approximately coinciding with the axes of these folds, and affording in the sea-cliffs numerous natural sections of the strata and exposures of coal seams. Some of these bays also constitute excellent harbours, one of which—Sydney harbour—situated towards the centre of the district, ranks among the finest and most commodious on the Atlantic coast of North America. The cliffs are generally from 30 to 80 feet high, standing perpendicularly or frequently overhanging the sea. The country inland is of a gently rolling character, the maximum height being about 250 feet.

"Such natural advantages, combined with its highly favourable geographical position, point to this district as probably the most important in the Dominion for the supply of fuel to steamships navigating the Atlantic. During the few months of winter, when the more northerly harbours are closed or obstructed by ice, an outlet is afforded by the railway connecting many of the collieries with Louisburg, a fine harbour, open and safe for shipping at any season."

The Intercolonial railway offers, of course, another outlet open all the year round.

The strata associated with the coal seams may be enumerated as follows: (1) argillaceous shales; (2) arenaceous shales; (3) red and green marls; (4) sandstone; (5) underlay; (6) limestone; (7) black shale. In the table of equivalency of the different seams at various points of the coal basin, average thicknesses of the intervening strata are given.

¹ See "General map of coal fields of N.S. and N.B.," accompanying this report.

² "Descriptive note on the Sydney Coal fields," H. Fletcher, Geol. Survey of Canada 1909.

The aggregate thickness of coal in workable seams, outcropping on the shore, and for the most part exposed in the bays and cliffs, is from 40 to 50 feet; the seams vary from 3 to 9 feet in thickness. They generally dip at low angles of 5° to 12° and appear to be very little affected by faults and disturbances. As all strata dip seaward, much coal will be available in the submarine, as well as in the land areas. The Sydney mines, which are situated some 3 miles to the northeast of North Sydney, have extensive workings under the sea and the Dominion Coal Company is at present pushing very actively the development of submarine areas in at least one of its mines, viz, the Hub, or Dominion No. 7, near Glace Bay.

"The coal is of the bituminous or 'soft' variety, with comparatively little diversity in the quality of the different seams; all of which yield a fuel exceedingly well adapted for general purposes, while that of some of them is specially well applicable to the manufacture of gas. As compared with the Pietou coal it is characterized, on the whole, by a greater proportion of combustible matter, and a smaller proportion of ash; but on the other hand, it usually contains a greater amount of sulphur;" only a portion of which can be removed by washing. Notwithstanding this fact it is largely used for metallurgical purposes.

The following tabulation, condensed from the work of the Geological Survey, shows the probable equivalency of the different seams of the field at the different places, together with the thickness of the intervening strata.

¹ Fletcher, Hugh.—Descriptive note on the Sydney coal field.

TABLE II
Table Showing the Equivalency of the Principal Coal Seams in the Sydney Coal Field with the Intervening Strata in the Several Basins.

Cow Bay basin, Name of Seam and Thickness,	Glare Bay basin, Name of Seam and Thickness,	Lingan, Name of Seam and Thickness,	Sydney Mines, Name of Seam and Thickness,	Boulderies, Name of Seam and Thickness,	Cape Daphni, Name of Seam and Thickness,
.....	Seam A..... 3'-10" Cranberry head..... 3'-5" Point Acorn..... 3'-2"
.....	Strata..... 306'-00" Strata..... 281'-0" Strata..... 212'-0"
.....	Carr seams..... 9'-10" Lloyd cove..... 7'-2" Bonar..... 6'-10"
.....	Strata..... 183'-0" Strata..... 250'-0" Strata..... 219'-0"
..... 10'-0" Seam B..... 1'-2" Stubbleart..... 7'-6"
..... 9'-8" Barachois..... 350'-0" Strata..... 352'-0" Strata..... 113'-0"
..... 355'-0" Strata..... 7'-1" Sydney Main..... 3 0 6 feet Seam C..... 2'-9"
Blockhouse..... 9'-2" Harbour..... 5'-8" David head..... 7'-1" Strata..... 260'-0" Strata..... 219'-0" 302'-0" Strata..... 269'-0" Strata..... 271'-0" Strata..... 1'-8" Millpond..... 3'-11" Seam D..... 176'-0" Strata..... 237'-0"
Strata..... 1'-4" Bouldier..... 3'-0" Seam D..... 3'-3" W. Fraser..... 1'-8" Millpond..... 3'-11" Seam D..... 176'-0" Strata..... 237'-0" 119'-0" Strata..... 81'-0" Strata..... 97'-0" Strata..... 3'-0" Four feet..... 4'-0"
Strata..... 2'-10" Backpitt..... 1'-5" North head..... 4'-0" Indian cove..... 5'-0" Black Rock..... 126'-0" Strata..... 53'-0" 139'-0" Strata..... 96'-0" Strata..... 91'-0" Strata..... 91'-0" Strata..... 0'-8" Seam F..... 1'-3"
Strata..... 6'-1" Phelan..... 8'-5" Lingan Main..... 7'-2" Seam F..... 1'-3" 202'-0" Strata..... 118'-0" Strata..... 111'-0" Strata..... 112'-0" Strata..... 41'-0" Strata..... 51'-0"
Strata..... 1'-5" Ross..... 3'-7" Seam G..... 2'-4" Stopy..... 4'-0" Seam G..... 6'-0" 335'-0" Strata..... 293'-0" Strata..... 252'-0"
Strata..... 335'-0" Strata..... 293'-0" Strata..... 252'-0"
Long Beach..... 2'-2" Louvey..... 4'-11" Seam H..... 1'-0"

Condensed from Mr. Fletcher's tabulation in "Descriptive notes on Sydney Coal Field. The correctness of the above correlation is guaranteed by some authorities."

The aggregate thickness of coal in the workable beds outcropping on the shores ranges from 30 feet at some places to 60 at others. Most of the Sydney coals are well suited for the manufacture of gas, as the following figures show:

TABLE III
Showing the Suitability of Sydney Coals for Gas Manufacture.

Mines	Gas Cub. ft. per ton	Candle Power	Coke Produced
Little Glee Bay	9,268	15	40 lbs.
" "	9,700	14.75	39 "
International	10,100	16	1,470 lbs.
Sydney mines	8,200	8	1,295 "
Gowrie mines	9,000	15	1,230 "
Caledonia mines	8,900	14.25	36 lbs.
Reserve mines	9,950	13.17	1,500 lbs.

The first printed mention of this coal field was made in a small book published in Paris in 1672 and entitled "Description géographique des Costes de L'Amérique septentrionale." The author was Nicolas Denys, who had obtained valuable mining rights in the island of Cape Breton from Louis XIV. He says "There are mines of coal through the whole extent of my concession, near the sea coast, of a quality equal to the Scotch." This would, therefore, be the first mention of the occurrence of coal in North America, for in the United States the earliest record of the discovery of coal is that of Father Hennepin, who is said to have noticed its existence on the Illinois river in 1679. The coal of Cape Breton island is so plainly visible on many conspicuous points of the coast that it is remarkable that such a long period elapsed between the discovery of the island and the first mention of coal on it.

Mining in a regular way was not begun until about 50 years later, when in 1720 a mine was opened on the north side of Cow bay. The object was to supply with fuel the colony of men at work erecting the fortress of Louisburg. For the next sixty years, the production of coal was very desultory and irregular; but in 1784, the government itself undertook systematic mining in Cape Breton on the 6 ft. seam on the northwest shore of Sydney harbour.

This was worked for three years by the government, then from 1788 to 1826 the mines were alternately leased to private individuals and worked by the government. During this period the output varied between 200 and 1,200 tons per year.

In 1826 and 1827 the General Mining Association acquired all the ungranted mines and minerals of Cape Breton, and also some of the leases of coal mines previously granted, and in 1830, the first shaft sunk in the provinces was put down on the Sydney Main seam, on the west side of Sydney harbour. The intention of the General Mining Association, in opening

the coal mines of Cape Breton, was to establish an extensive trade with the United States; but for a number of reasons, among which was the development of the Pennsylvania anthracite trade through the opening of the Schuylkill canal, as well as high royalties, the coal trade of Cape Breton did not develop as fast as anticipated, and in 1857 the production only amounted to 117,000 tons. In 1857 the government of Nova Scotia and the General Mining Association came to an agreement, whereby the latter surrendered their claim to the mining rights they were holding, retaining only certain definite coal areas in Cape Breton, Pictou, and Cumberland counties. These areas retained by the General Mining Association comprised: 18 square miles on the west side of Sydney harbour comprising Sydney Mines; 11 square miles on the east side of Sydney harbour; between Indian bay and Sydney harbour, 2 square miles comprising the site of Bridgeport mines; 1 square miles at the Albion mines in Pictou county; 1 square miles at the Joggins mines; and 1 square miles at Springhill in Cumberland. In consideration of the surrender, the government agreed to abolish certain fixed rents and to reduce the royalty on coal. In 1858 the Legislature of Nova Scotia obtained possession and control of the mines and minerals of the Province, with the exception of those limits specified, which were retained by the General Mining Association, and an act was prepared giving every facility and encouragement to persons disposed to embark on mining ventures. In 1866 a subsequent act was passed entitling lessees of all mines in full work on the termination of their leases in 1886, to three successive renewals of twenty years each.

As a result of the liberal terms offered, the government, on the adoption of the new regulations, received in the opening of 1856 several applications for leases of mining areas at Cow Bay, Little Glace Bay, and Bridgeport, which had reverted to the Crown, and for several years afterward, prospecting and coal mining were active. In the course of the following five years more than forty licences of exploration were issued for tracts in the Sydney field alone, and some in the Richmond coal field near the Strait of Canso. During the next three or four years, several licences were granted for exploration on the west coast of the island, between Port Hood and Margaree, and also under the sea along the coast from Mira bay to Aconi point. One enthusiastic adventurer even took out a licence for a submarine area accessible only by making a shaft upon the little rock called Flint island, a mile out at sea. Many of these licences were obtained in a spirit of speculation, in hope of selling them to other parties at a profit; therefore, as may be expected, a great many were obliged to surrender their licences. However, several mines were opened and in 1870 there were not less than twenty collieries which were being worked or had been worked to a greater or less extent.

In 1893 a large syndicate was formed under the title of the Dominion Coal Co., to acquire most of the coal lands and mines of the Sydney field. As the ordinary system of leases which were granted for four terms of twenty years each, was not satisfactory to the investors, a new agreement was entered into between the syndicate and the government of Nova Scotia

by which a lease of 99 years was granted on condition that the royalty on the coal sold be increased from 10 cents to 12½ cents per ton.

We give below a short description of the various collieries at present in operation in the Sydney field.

Dominion Coal Company

(Samples Nos. 38, 35, 38, 35 SP, 37, and 39.)

This Company was incorporated in February, 1893, with a capital of \$18,000,000, of which \$15,000,000 is common stock, and \$3,000,000 preferred, and was formed to acquire and work under one management the properties of the following coal companies, which, previous to that date, were operated individually in the Sydney coal field of Cape Breton island: the Caledonia Coal and Railway Company; the Interecolonial Coal Company; the Sydney and Louisburg Coal and Railway Company; the Low Point, Barachois and Lingan Coal Company; Burchell Bros., as well as other coal areas, steamers, lines of railway, etc. At present the Company controls coal lands in Cape Breton to the extent of 125 square miles, of which some 75 miles are held under a special 99 year lease from the Government of Nova Scotia, instead of the regular 20 year lease. In return for this concession the Dominion Coal Co. pays to the Provincial Government a royalty of 12½ cents per ton of 2,240 pounds. The balance of 50 square miles is held under the rules of the Mines Act by 20 year leases, subject to a royalty of 10 cents per ton.

The Dominion Coal Company is by far the largest coal producer in the Dominion of Canada. In 1908 the output was over 1,400,000 short tons, and the possible output capacity of their mines could probably exceed 6,500,000 tons.

Besides its eleven mines which are being worked at present, the Dominion Coal Company operates the Sydney and Louisburg railway, some 40 miles in length, which connects the mines with a shipping pier at Louisburg, and with the International pier and the Interecolonial railway at Sydney. The two piers are also owned by the Company.

The greater part of the coal is shipped by water, in the Dominion Coal Company's own steamers.

The following table gives approximately the disposal of the coal produced:

St. Lawrence ports, Quebec, Montreal, etc.	1,500,000 tons
Boston, Everett Gas Company.	600,000 "
Dominion Iron and Steel Company	600,000 "
Colliery consumption and workmen.	300,000 "
Other ports, Interecolonial railway, etc.	1,100,000 "

The Dominion Coal Company at present operates eleven collieries in the Sydney field. These are all within a radius of a few miles from the town of Glace Bay. All the collieries are connected by rail with the Sydney and Louisburg railway. A short description of each of these collieries is given below:—

¹This was written in 1907. The number is now 17, and in addition the Company has recently acquired the collieries of the Cumberland C. & R. Co., at Springhill.—J. B. P.

²In this description of the Dominion Coal Company's mines, free reference has been made to the articles on the equipment of these collieries, written by F. M. Gray, and published in the Canadian Mining Journal.

*Dominion No. 1 Colliery.*¹ (Samples Nos. 38 and 2038). Seam worked: Phalen. Thickness, 8 feet, dip 1 in 11. Section, coal 2 feet; parting 2 feet; coal 6 feet; floor, fireclay. This colliery was opened in 1830 by the General Mining Association. Worked by shaft 160 feet deep. The mine is divided into two districts, one working the land area, and the second working the submarine coal. The face of the main way of this last district is at present 3,000 feet under the ocean, from the shore-line. Coal is mined by pillar and stall. Percussion pick machines and shearing machines used in rooms and hand picks on pillars. Rates for machine cut coal, 33 cents, for hand cut, 19 cents. Underground haulage is by two endless ropes 17,500 feet and 13,500 feet long, respectively. Ventilation by Dixon fan of Gribal type, 300,000 cubic feet of air per minute, 24 feet in diameter, and two spare Murphy fans, 12 and 8 feet respectively. Lamps used underground are Aekroyd and Best electrically lighted safety lamps, with magnetic locks.

The surface equipment consists of a steam plant of seven Babcock and Wilcox boilers, 1,696 H.P. Compressor plant comprises three Ingersoll compressors of 2,500 cubic feet of free air per minute each, and a small straight line compressor of 900 feet. The hoisting of coal is done by a duplex engine, cylinders 20" x 24", drum 8'-9" diameter. Rope is a 6 strand cast steel rope 1 1/4". The main hoist is a horizontal engine, 16 x 32 cylinders, with a 6 ft. drum.

The bankhead is a steel structure, equipped with slaking screens and picking belts. There are also a wash house, lamp house, fire engine house, etc.

The pumping in the mine is effected by one Northey steam pump 8" x 24", one compound Northey, 12 and 24" x 8 and 12", one 6-stage turbine pump, operated from the Central power station, and one large Cameron pump.

This colliery employs about 700 men and 70 horses. The capacity of output of the mine under present conditions is 2,700 short tons a day.

*Dominion No. 2 Colliery.*² This is the largest colliery of the Dominion Coal Company, and probably the largest in America, as it has a possible hoisting capacity of 6,000 tons per day. Seam worked, Phalen, having the following average section: roof, dark grey shale; coal, 2'-3 1/2"; parting, 0'-1/2"; coal, 1'-11"; floor, fireclay, hard dark blue, worked by a shaft through which is also hoisted the coal from Colliery No. 9 in the Harbour seam. The shaft is 37 x 11 feet to the Harbour seam, 100 feet from the surface, and 24 x 11 feet to the Phalen seam 850 feet from the surface. The air main shaft is 850 feet deep to the Phalen seam. The coal is cut with puncher undercutters and sheared from top to bottom with Little Hardy machines.

Underground haulage is by compressed air locomotives, of which there are seven in operation. Mine cars used are of two ton capacity, running on 36" gauge.

For ventilation, one Walker fan, rated at a capacity of 350,000 cubic feet of air per minute.

¹ See Plate I.

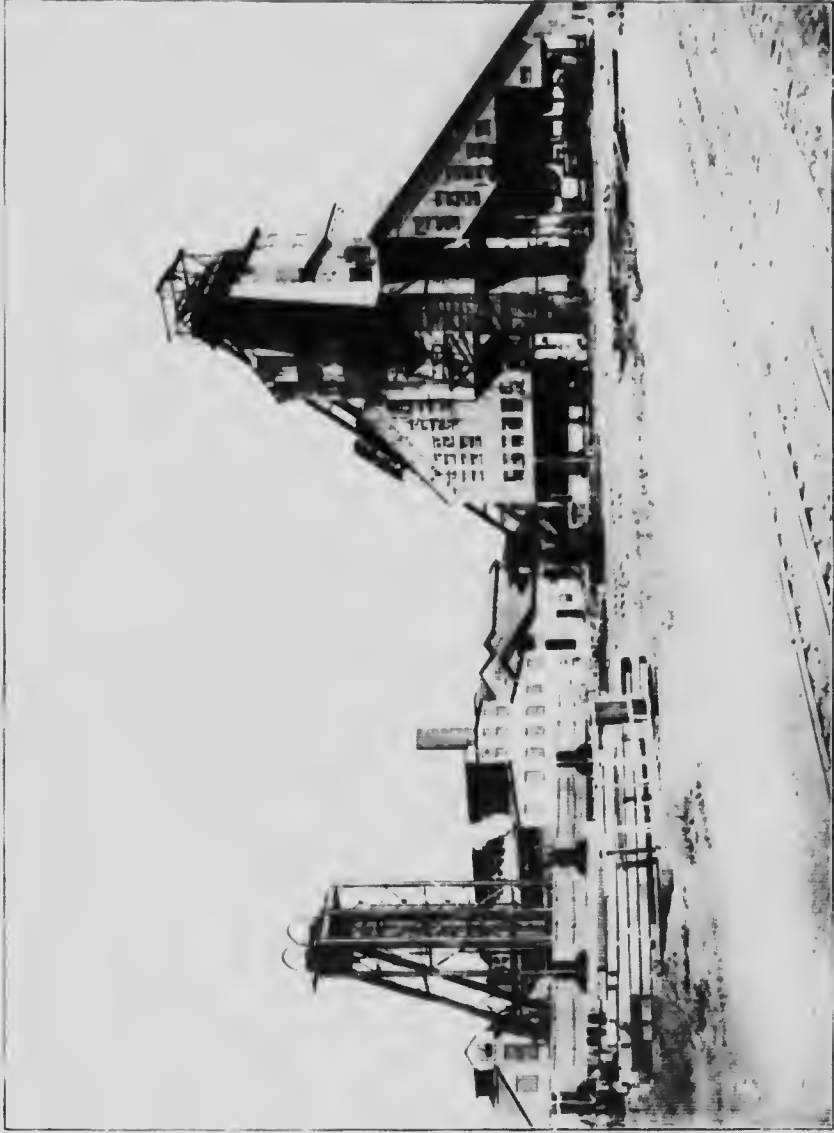
² See Frontispiece and Plate II.

Plate I.



Dominion No. 1 colliery, Dominion Coal Co., Glace Bay, N.S.





Dominion No. 2 colliery, Dominion Coal Co. Glace Bay, N.S.



Safety lamps are used exclusively, the lamp house containing 1,700 Ackroyd and Best lamps.

Hoisting drum is conical, small diameter, 10'-4", large diameter, 14 feet. Hoisting rope 1½" plough steel. The power is supplied to both No. 2 and No. 9 mines by a battery of 20 Babcock and Wilcox boilers rated at 6,360 horse-power.

The hoisting arrangements are unique. The coal is brought to the shaft bottom in two-ton mine cars. These are weighed at the bottom of the shaft and dumped by rotating tipples into storage chutes, which are built below the level of the tipples. The hoisting tanks, mounted on a pivot framework and holding six tons, are loaded automatically by a system of chutes, the catches of which are released by the tank itself. The coal is hoisted and dumped automatically on the screens of the bankhead.

The compressor equipment consists of: one Walker compound, capacity 6,000 cubic feet per minute; three Rand compound, each 3,000 feet; two straight Norwalk.

The mine employs 1,000 men and 100 horses.

The rates paid for mining were, in 1907: machine cut coal 33.3 cents, hand cut coal 49 cents in rooms, and 46 cents in pillars.

Dominion No. 3 Colliery.—On Phalen seam, worked by a slope. Dip of seam 7 per cent. This colliery was opened in 1887; worked by pillar and stall. Rooms 20 feet wide and pillars average 25 feet by 60 feet. Underground haulage is by endless rope, in two hauls of 8,000 feet and 4,500 feet respectively. Mine cars have a capacity of two tons and a 12" gauge. Ventilation by Capell fan, 200,000 cubic feet per minute. Lamp house for 600 Ackroyd and Best safety lamps. Boiler plant, three Babcock and Wilcox boilers totalling 951 H.P.; Walker compressor, compound, 6,000 cubic feet free air per minute.

The bankhead is a modern structure, with rotary tipples and shaking screens. The possible output of No. 3 mine is 1,100 tons, on double shift, with the present equipment. The rates for mining were, in 1907: machine cut coal in rooms, 34.7 cents; hand cut coal, rooms 49 cents, pillars 46 cents.

Dominion No. 4 Colliery.—This is the old Caledonia mine, which was started in 1866, and has been producing steadily since that year. On Phalen seam, which has here the following section: roof, hard clay; coal 6'-6" to 6'-10"; parting 1½"; coal 1'-8"; floor, fireclay. Worked by shaft 185 feet deep, 19 feet × 11 feet, divided into three compartments, for coal and men respectively. Underground haulage is by endless rope, in three sections, 6,200, 5,900, and 3,500 feet. Speed of haulage is under 2 miles an hour.

Ventilation is by a Dixon-Guibal fan, 14 feet in diameter, and a Murphy fan, 12 feet in diameter. Safety lamps used. Boiler plant consists of seven Babcock and Wilcox boilers, rated at 1,380 H.P. Compressor equipment, one American Rand, 3,200 cubic feet free air; one Rand, 2,500 cubic feet, and a small straight line of 900 cubic feet.

The possible output of this colliery is about 1,800 tons per day of one

shift. Rates for mining were: machine cut coal, 33.7 cents, hand cut coal, 19 cents.

Dominion No. 5 Colliery. (Samples Nos. 35 SP and 2035 SP).—This is the Reserve colliery, which started shipping in 1872. Working the Phalen seam which here has the following average section: roof, hard dark grey fireclay; coal 2 feet; parting 1"; coal 6 feet; parting 1½"; coal 1'-6"; floor, fireclay, dark blue. This mine is worked by a slope, the distance between the bankhead and the face of the slope is about 12,000 feet. Underground haulage is by endless rope, with auxiliary electric traction. Ventilation by two fans of 300,000 and 200,000 cubic feet respectively. Safety lamps are used exclusively. The coal is hauled to the bankhead, unloaded by a Phillips dump on shaking screens and picking belts. There are at present 600 men at this colliery, which is worked single shift. When double shifted the output has gone over the 800,000 tons mark in a year. The rates for mining were: machine cut coal rooms, 29.9 to 32 cents; hand cut rooms 49 cents, pillars 46 cents.

Dominion No. 6 Colliery.—This is a comparatively new colliery, as work was begun here in 1901. It is entered by a slope, and its territory is almost entirely submarine. The power plant at present comprises six Babcock and Wilcox boilers rated at 1500 H.P. Ventilation is by a Walker "indestructible" fan of 300,000 cubic feet capacity. The main deeps were, in 1907, over 1,000 feet long, extending under the bed of the sea. The cover at the shore is 375 feet, but increases rapidly. Compressor equipment comprises two Walker engines of a total capacity of 7,000 cubic feet per minute.

The coal is hauled to top of bankhead and unloaded on shaking screens, then passes over picking belts. The possible output of the mine is about 1,500 tons a shift.

Dominion No. 7 Colliery. (Samples Nos. 36 and 2036).—This is the old Hub mine, on the Hub seam, which is the largest seam of the series outcropping on land in the Glace Bay basin. It derived its name from being approximately in the centre of the semicircles formed by the outcrop of the seams of this coal basin. The average thickness of the Hub seam is 9'-6". This was one of the earliest mines in the district. It is worked by a shaft 130 feet deep, divided into three compartments, two being for coal and one for the men. Underground haulage is by electricity. Practically all the workings are submarine. Ventilation is by a Capell fan of a capacity of 200,000 cubic feet per minute. There are two Norwalk compressors of 2,000 cubic feet free air per minute each. Boiler plant consists of two batteries of Babcock and Wilcox boilers of a rated capacity of 500 H.P. The bankhead of hard pine, is equipped with dumping tipples, weigh-tank, screens and picking belts. Coal is undercut with puncher machines, and safety lamps are used exclusively. This mine is the one of all the Dominion Coal Company's collieries in which the workings are most advanced under the bed of the sea. A great deal of development work is being done in it, and when its output reaches the normal, there will be 400 men employed and 30 horses for a production of 1,200 to 1,400 tons per shift.

Dominion No. 8 Colliery.—This is the old International mine, working on the Harbour seam. This was first opened by levels driven in from the shore in 1858. The Harbour seam is 6 feet thick, dipping 1 in 12. The shaft which is near the outcrop is 96 feet deep. Coal is mined by pillar and stall, entirely cut by hand. Boiler equipment consists of two Babcock and Wilcox of 212 and 318 H.P. respectively, and two return tubulars of 75 H.P. each. This is one of the smaller mines of the Dominion Coal Company, and the output is only about 1,000 tons a day.

Dominion No. 9 Colliery. (Samples Nos. 35 and 2035).—This is the Harbour seam, which has the following section: roof, dark grey fireclay; shaly coal 2"; coal 5½"; parting ½"; coal 3'-8"; shaly coal 6"; floor, fireclay. This is worked by the same bankhead as No. 2 mine, the shaft being 100 feet deep to the Harbour seam. Coal cutting is done by punching machines, and the mine employs 550 men, and 60 horses. Haulage underground is by compressed air locomotives. The rated output of No. 9 mine is about 1,600 tons a day.

Dominion No. 10 Colliery. (Samples Nos. 37 and 2037).—This is on the Emery seam, which underlies the Phalen at a depth of 160 feet. The thickness of coal is variable, but an average section gives: roof, grey shale; coal 3'-1"; parting 2"; coal 2 feet; floor, crumbling shale. It is worked by the longwall method from a shaft 169 feet deep, near the bankhead of No. 5 colliery, the power plant and part of the surface equipment being common to both No. 5 and No. 10 collieries.

Underground haulage is by endless rope. Coal is cut by rotary disc coal cutters, worked by compressed air. The present output of the mine is about 1,000 tons a day.

*Dominion No. 12 Colliery.*¹ (Samples Nos. 39 and 2039). This colliery is as yet in the development stage and has not begun shipping.² It is established in the Lingan basin, on the Victoria seam, which is thought to be the equivalent, in this basin, of the Phalen seam. This mine will be worked by a slope, which at the end of the year 1908 had reached a length of 1,600 feet. The seam has here an inclination of 22 per cent. The equipment of the colliery is designed for a daily output of 1,200 tons a day.

Dominion No. 14 Colliery.—This is also a new colliery, which is on the same seam as No. 12, and about one mile to the east of it. The dip is here 17° at the outcrop and flattens out to less than 14°. It is yet in the early stages of development.

*Central Electric Plant.*³—This plant is situated at No. 2 colliery near Glace Bay. There are three generating units, consisting of Westinghouse alternators, 550 K.W. 25 cycle, 3 phase, 125 revolutions per minute, 6,600 volts, directly coupled to a compound horizontal engine of 700 indicated horse-power.

The power generated at this station is used for pumping, for screening machinery, and for colliery lighting, as well as for driving machinery in the

¹This colliery is now completed, and in operation.

²This station is shown on the Frontispiece.

central shops at Glace Bay. It is transmitted at high voltage to all the collieries, where small transformer houses have been installed.

Central Banking Station.—The greater part of the output of the coal mined by the Dominion Coal Company is shipped by water to the Saint Lawrence ports during the season of navigation. As these ports are closed in winter provision has been made to bank about 400,000 tons of coal mined during the winter months.¹ At the opening of navigation in the spring, the banked coal is drawn upon. As a rule some disintegration of the coal has taken place during the three or four months in which it was banked, and on this account it undergoes a screening before shipping. Steam shovels operated on movable tracks load small cars which are hauled up a long incline to the rescreening plant from which standard coal cars are loaded for transportation to the shipping wharves.

It may be added that the standard sizes of coal put on the market by the Dominion Coal Company are as follows:—

Domestic, excludes all below 2½".

Screened, excludes all below 1".

Run of mine.

Nut coal, passes through 1½" and over ¾".

Slack, includes all below ¾".

Nova Scotia Steel and Coal Co.

Samples Nos. 12 and 13.)

This coal area was one of the earliest to be opened in Canada. Work was begun on it in 1781. In 1828 it was purchased by the General Mining Association, who worked it until 1900. It was then acquired from this corporation by the Nova Scotia Steel and Coal Co. This transaction practically severed the connexion of the General Mining Association with the coal mining in Nova Scotia after a career of nearly three-fourths of a century.

The mines are situated 3 miles to the northeast of North Sydney.² There are at present three collieries working, Sydney No. 1, Sydney No. 3, and the Queen Pit or Sydney No. 5.

Sydney No. 1. (Samples Nos. 13 and 2013).—This colliery is on the seam known as Sydney Main which has here a north and south strike and dips to the east. The thickness varies between 5½ and 6 feet. It is worked by a shaft, 14 feet in diameter, 720 feet deep, sunk in 1861, and lined with segments of cast iron. All pumping from the deeps is done by compressed air, to a sump near the shaft bottom, whence it is elevated by a steam pump. This shaft is used to hoist coal. A second shaft about 50 feet distant is used for ventilation and to hoist the men.

The head frame over the coal shaft is built of steel, 90 feet high, and is designed to handle an output much larger than that at present hoisted.

¹A portion of this bank is shown on the Frontispiece.

²See Plates III and IV.





Winter view of collieries of Nova Scotia Steel and Coal Co., Sydney



Winter view of collieries of Nova Scotia Steel and Coal Co., Sydney Mines, N.S.

Plate III.





System of working is all by pillar and room. Pillars are 30 feet wide and rooms 16 feet. Two main systems of underground transportation bringing coal to the pit bottom are used. One is endless haulage, by steel rope 1½", 6 strands of 7 wires each, 22,000 feet long. The other is by an inclined plane haulage handling trains of 30 to 40 cars; the rope in this case being 7". These are only used in main ways. On levels leading to main ways, small compressed air engines are used, and horse haulage is employed from the rooms to the levels.

Ventilation by Guibal fan 30 feet by 10 feet, 64 to 68 revolutions per minute, also Capell fan, 20 feet by 10 feet, running at 101 revolutions. This last alone is used, the first being kept ready in case of emergency.

The lighting on surface and pit bottom is by electricity. Beyond pit bottom safety lamps are used exclusively.

Power plant consists of 5 Babcock and Wilcox boilers 270 H.P. each; and 4 Lancashire of 60 H.P. each. Four of the Babcock and Wilcox boilers are fired with waste gases from a battery of 30 Bauer coke ovens operated near-by. The other boilers are fired with slack coal and coke dust from the ovens, so that practically all the steam power generated here is from waste products.

The coal is screened and picked by hand on a picking belt. This belt delivers the coal into the car by means of a pan or chute operated by two air cylinders. The chute is divided and hinged in the centre and can by means of these two cylinders, be made to fill an empty car and trim it with a very small amount of breakage. The coal goes to deep water shipping pier at North Sydney, or by rail to any destination.

Slack coal, consisting of all fines up to about ¼", is conveyed to the coking plant, which is near No. 1 colliery. It is first screened, and coal which passes over ¼" opening is crushed, and all is stored into a large steel tank for unwashed slack, of a capacity of 500 tons. The coal is washed in jigs. It is afterwards shipped to the Bernard coke ovens near the blast furnaces or the Bauer ovens at No. 1 colliery.

Sydney No. 3. (Samples Nos. 12 and 2012). This colliery is worked by a slope, on the old Sydney Main seam; ventilation is effected by a Capell fan, 15 feet diameter, 7'-11" wide, driven by steam engine. The coal is cut by compressed air punching machines. The slope in 1906 was over 1,500 feet long, entering the submarine areas 3,700 feet from the mouth of the slope, with 300 feet of cover. The coal is taken out of the mine through the slope, by endless haulage. The haulage to the main way is by small compressed air engines, and no horses are used in this mine. The boiler plant of the colliery consists of six Sterling boilers of 250 H.P. each. There are two air compressors, one Walker with a free air capacity of 3,300 cubic feet, and one Norwalk with free air capacity of 4,233 cubic feet. This colliery is capable of an output of 1,500 to 1,800 tons per shift.

Sydney No. 5, or Queen Pit.—This is an old colliery which was formerly worked by the General Mining Association and which has lately been reopened. It is worked by a shaft 300 feet deep. The coal is mined

by hand and underground haulage is altogether by horses. The capacity of the mine is 150,000 tons a year.

Central Electric Power Plant. This consists of two 400 K.W. Canadian General Electrical 250 volt, D. C. generators, connected to two 18 and 36 and 24 vertical cross compound Robb engines, and one 200 K.W. Westinghouse 2,200 volt, three phase 60 cycle motor driven alternator.

Coke Ovens. Coke is manufactured at the blast furnace in 120 ovens of the Bernard retort type. The ovens are 32 feet long, 5' 8" high, 23" wide. The waste gases are now used to generate the steam for the electric power plant.

At No. 1 colliery, there is one battery of thirty ovens of the Bauer retort type, 38 feet long, 7 feet high, and 30" wide.

Coal Washer. This plant is situated at No. 1 colliery. It has a capacity of fifty tons per hour. Slack coal is brought here from the different collieries. It is screened, crushed, and washed in jigs of the Lahrig type.

Mackay Coal Company

Operating near North Sydney on the Indian Cove seam, which dips about 14° and varies between 4'-6" and 5 feet in thickness. Worked by a slope which is 996 feet long. Until lately the coal cutting had been done by hand; but coal-cutting machinery is being introduced, the type being a Sullivan electric chain cutter. Although this is a small mine, it is being developed actively, as may be judged by the fact that in 1907 the output for the year was 7,000 tons, whereas in 1908, it increased to 15,000 tons.

A fan has been put in, of a capacity of 20,000 cubic feet of air per minute. Naked lights are used.

The mine is connected with the Intercolonial railway by a spur 1,800 feet long. The coal is shipped almost altogether by rail and is used locally, mainly for domestic purposes.

The surface equipment of the mine consists of a return tubular boiler of 125 H.P., bankhead hoisting engine 30 H.P., Westinghouse generator, which lights surface plant and furnishes power. This mine employs 35 to 40 men of whom 15 to 20 are miners.

Sydney Coal Company

This Company controls an area of one square mile near Sydney mines, and works the Indian Cove seam, 4'-8" thick, dip 6° to 8°, by a slope 2,600 feet long. Haulage is done by tail rope. The pillar and room system is used, and naked lights employed. Boiler 30 H.P. Most of the output is disposed of locally and delivered by team. Some of the coal is shipped by water, and is loaded on small boats at the end of a pier 500 feet long. The mine employs 20 men, of whom 11 to 16 are underground.

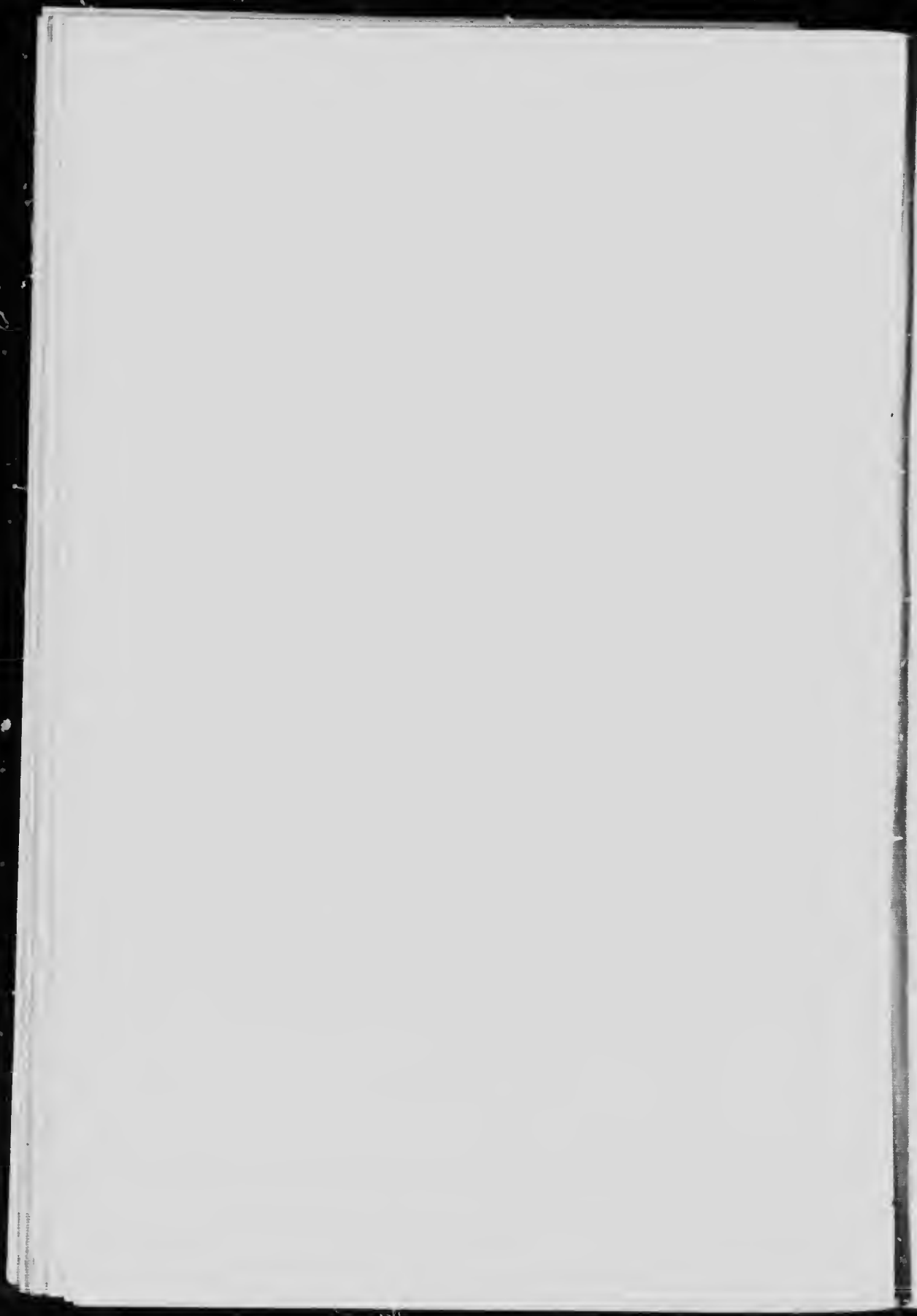
Colonial Coal Company, Limited

This Company is reopening an old property of the Toronto Coal Com-

Plate IV



Colliery No. 3, Sydney Mines, N. S. Nova Scotia Steel and Coal Co.



pany, on Little Bras d'Or, about 4 miles west of Sydney mines. Seam worked is the Collins, which is said to be 6 feet thick. At present, the old mine is being unwatered.

This mine is well situated for shipping by water, and a proposed extension of the Intercolonial railway will pass within three-fourths of a mile of the workings.

Surface equipment now being put up comprises two boilers of 100 and 25 H.P. respectively; haulage engine, workshops, etc. It is expected that shipping, at the rate of 200 tons a day, will begin some time during 1909.

North Atlantic Collieries Company

Sample No. 50

This Company took over the mines of the Gowrie and Blockhouse collieries, at Port Morien, 7 miles southeast of Glace Bay. Seams worked. Blockhouse seam, 9 feet thick, and the McAnlay or Gowrie seam, about 6 feet. These seams are worked by two separate shafts, the one on the Gowrie being 212 feet deep, and the one on the Blockhouse 162 feet. The latter has only recently been completed, and the mine is as yet in the development stage. As to the Gowrie seam, the face of the main way is now more than 7,000 feet from the foot of the shaft, and the greater part of this distance is submarine.

Underground haulage is by endless rope 13,000 feet long. Ventilation by one Walker fan of a capacity of 225,000 cubic feet of air per minute. Boiler plant consists of four return tubulars and two Babcock and Wilcox giving a total of 1,000 H.P. Compressor: Rand-Corliss of a capacity of 3,100 cubic feet of free air per minute. The coal is hoisted to the bankhead, screened and sent to coal pocket of 1,000 tons capacity, on pier, by a Roe aerial tramway, 1,300 feet long. The shipping is all done by boat, and coal is marketed mainly at Quebec, Newfoundland, and Prince Edward Island.

Cape Breton Coal Mining Company

Operating near New Campbellton at the mouth of Big Bras d'Or lake, on an extension of the coal measures of the Sydney mines basin. Work was started at New Campbellton as far back as the early sixties. Seam worked is 4 feet thick, dip 12°. Opened by a slope 1,800 feet long. Bord and pillar method. Ventilation by small fan. Naked lights used. Boiler plant: three boilers aggregating 175 H.P. The coal is shipped by a narrow gauge railway $1\frac{1}{2}$ miles long, to the shipping wharf. The output of the mine is only about 75 tons a day.

INVERNESS COAL FIELD

These coal measures comprise a series of narrow areas on a line extending from Judique to Margaree, along the western shore of Cape Breton

island. They appear as remnants of the rim of a basin, along the coast, the greater part of which has been destroyed and eroded away. Seams of coal of considerable thickness have been worked at Port Hood, Mabou, Inverness, and Chimney Corner, all in Inverness county.

The extreme points of this row of remnants of the formerly extensive coal area are some 40 miles apart in a straight line; this distance is very much greater by following the coast line. The most southern coal measures are found in the vicinity of Little Judique, where a section measured near Cape Susan by Mr. Hugh Fletcher revealed a few thin seams of coal, the thickest of which is under 2 feet. No work has been done at this place.

A short distance north of this, the southern point of another basin comes in and extends a distance of some 7 miles along the coast, whereas the greatest width of the coal measures is some $2\frac{1}{2}$ miles. These beds reappear on Smith island, opposite Port Hood; but it is possible that this island forms a separate basin of coal-bearing rocks.

In this area, which may be called the Port Hood basin, only one seam has been worked; its outcrop has been followed along the shore for a distance of some $1\frac{1}{2}$ miles. The thickness of the seam varies from 6 to 8 feet. Several other seams are known, all of which underlie the one mentioned above, and they outcrop farther inland as the measures dip towards the sea. But of these none are thicker than 20". However, it is reported that some 360 feet above the worked seam another one exists, which is some 6 feet thick, and the outcrop of which is only visible at low water.

Work was begun at Port Hood in 1865, by the Cape Breton Mining Company, who operated for two or three years only.

In 1875 some new workings were opened up about half a mile north of the slope sunk by the above Company, but work was not continued very long. Operations were then abandoned for a great many years.

In 1899 the Port Hood Coal Co. secured extensive leases in this basin, and began operations on a comparatively large scale; but did not meet with all the expected success. The Company was reorganized in 1905 under the name of the Port Hood Richmond Railway Coal Co. and is now operating.¹

Some 10 miles north of Port Hood, another basin of coal measures appears, the southern end of which is at Coal Mine point, and the northern edge at Finley point, a distance of over one mile in a straight line. Between these two heads of land there is a bay from which the coal measures have been eroded; but there is little doubt that the two points above named form part of the same basin. Mr. Richard Brown, in his work on the "Coal Fields of Cape Breton," mentions the presence of four coal seams, varying in thickness from 3 to 15 feet, giving a thickness of 29 feet of coal in a cross section of 550 feet of the measures; but Mr. Hugh Fletcher, who measured sections at Coal Mine point and at Finley point, does not record such thick seams. The strata have been somewhat disturbed, as is shown by the workings of the Mabou and Gulf Coal Co. The beds at the surface start with a dip of

¹This mine was accidentally flooded in 1911 by a break from the sea, and is not now in operation. J. B. P.

75°, then at the end of 450 feet they turn downwards for 90 feet, and finally continue on a regular slope of 17°, seaward.

A section measured by the Mabou Coal Mining Co. is said to have given the following succession, in descending order:—

Coal.....	7 feet
Strata.....	15" to 3 "
Coal.....	8 "
Strata.....	475 "
Coal.....	15 "
Measures.....	25 "
Coal.....	5 "
Measures.....	150 "
Coal.....	3 "
Measures.....	125 "
Coal.....	5 "

The 15 ft. seam has a part of 8" to 10" in the centre.

The measures are mainly beds of shales, some of which contain nodules of ironstone and beds of sandstone.

As early as 1866 attempts were made to open up a mine on one of these valuable coal seams. However, probably owing to the lack of a good harbour within a reasonable distance, little progress was made for some years. Some work was done at different times in a desultory way, to fill local wants. In 1893 a beginning was made towards building a breakwater, and measures were taken to establish some submarine workings; but it was only in 1900 that anything of importance was accomplished. The Mabou Coal Company now controls the greater part of this coal area.

Some 12 miles along the coast north of Port Finley, another narrow fringe of coal-bearing measures comes in, at Port Ban, and this continues with a few interruptions as far north as Cheticamp, a distance of over 50 miles if measured along the coast. In several places there are good seams of coal, on several of which considerable work has been done at various times, and one of which is being worked at present.

Near Broad cove, for instance, the name of which has comparatively recently been changed to Inverness, the coal measures¹ extend a considerable distance inland and dip towards the sea at angles varying between 10 and 20 degrees. On the east they are bounded by rocks of lower Carboniferous age, which consist of yellowish brown sandstones, red, yellow, and white marls, and gypsiferous beds.

From measurements made in 1865 by the surveyor of the Broad Cove Mining Company, the following section of coal-bearing rocks was compiled by Mr. R. Brown, and given in his "Coal Fields of Cape Breton."

Coal (highest bed).....	3'-0"
Strata.....	310'-0"
Coal.....	5'-0"

¹According to Mr. Charles Robb.

Strata,	100'-0"
Coal	7'-0"
Strata,	210'-0"
Coal,	3'-6"

Mr. Charles Robb also made a study of this coal basin, and the results of his investigations were published in the report of the Geological Survey for 1873-74. He states in part:

"The following is an enumeration of the coal seams, in descending order, as far as observed by me, with their approximate thicknesses, and those of the interposed strata.

1. A three foot seam near the shore.
2. A seven foot seam with 376 feet of intervening strata.
3. A four and a half foot seam, with 173 feet of strata intervening.
4. A three foot seam, with 303 feet of intervening strata.
5. A three foot nine inch seam, with 32 feet of strata.

"Between seams No. 4 and No. 5, another, said to be five feet in thickness, is reported to have been found, but was not seen by me, although its existence is regarded as probable. Exclusive of this last referred to, the total quantity of coal contained in these seams may be roughly estimated at 26,000,000 tons on the land areas, and 31,000,000 tons additional if worked under the sea for a distance of one-half mile from the shore. The amount available under the sea may be greatly increased by extending the workings to a greater distance from the shore."

Coal leases in this basin were granted as early as 1865 to Messrs. McCully and Blanchard, who proposed to open up a mine on the 7 ft. seam. As the coast is very exposed and affords no safe place for shipment, the intention was to make an artificial harbour of a sheet of water called McIsaac pond. However, although a few tons of coal were raised in 1867, the main project fell through. Comparatively little was done for several years following this, except for supplying local wants. In 1891 the Broad Cove Coal Mining Company opened several places near the mouth of the Broad Cove river, and a narrow gauge railway was constructed to connect the mine with McIsaac pond, which was to be the shipping harbour. Moreover, the Boston and Nova Scotia Coal Company, with coal holdings at Broad cove and at Chimney Corner, made a survey for a railway to connect Broad cove with the Intercolonial railway at Orangedale. The Broad Cove Coal Co. went on with the work of construction and development until 1899, when it was discontinued and the property was taken over by the Inverness and Richmond Railway and Coal Co. The Company are now operating these mines, as well as the railway which they built, connecting Broad cove, near Inverness, with the Intercolonial railway at Point Tupper.

Immediately north of Marsh point, some 8 miles north of Inverness, another basin of coal measures occurs, the outlines of which are rather indefinite. The rocks are mainly sandstones, which can be followed north as far as the mouth of Margaree river, and at several points seams of coal outcrop.

The point in this basin where the best seams are observed is at Chimney Corner, where several attempts at establishing collieries have been made at different times.

The following is a section, in descending order, measured at this point by Dr. Henry Y. Hind:—

Thin seams,	1'-6"
Strata,	300'-0"
Coal,	3'-0"
Strata,	88'-0"
Coal (main seam)	5'-0"
Strata,	200'-0"
Coal,	3'-6"

The following is taken from a report of the Geological Survey, by Mr. Hugh Fletcher¹, and gives a good idea of the work which has been done at this point:—

Chimney Corner Mines.—Operations on a large scale were carried on at these mines between 1866 and 1873, at a cost of \$11,538. These were principally confined to the lowest seam, but in 1868 a drift was put in on one of the outlying seams, three feet six inches thick, and a few working places turned out of it. In the following year a slope was driven from the surface on the main seam, an engine house erected for pumping and hauling and other arrangements made to place the mine in a condition for shipping coal. This seam was proved by a series of pits for a distance of half a mile, and on the same course pits were sunk at intervals for a distance of three miles from Chimney Corner cove, and seams of coal were exposed which are the supposed continuation of the upper group.

"The workings lie nearly altogether beneath the sea; but the roof being comparatively impermeable to sea water, no inconvenience was felt. If, however, the main slope were situated about half a mile from the harbour, the thickness of the strata between each seam would admit of two or three seams being worked together, and the increased thickness of the roof would guarantee the security of submarine workings.

"In 1872, the main slope was 400 feet down; levels had been driven to the southeast 300 to 800 feet and working places formed. Another slope had also been connected with the workings for ventilation and a tramway constructed along the face of the cliff to a shipping place. One of Cameron's special steam pumps No. 6 kept the mine free from water. The shipments of coal were not large, and the destruction of the engine house and miners' dwellings by fire on March 3rd, 1873, brought this mine to a standstill, and it was not re-opened until Mr. Evans' return in July 1882. . . . Prior to the fire about 10,000 tons of coal are said to have been shipped to Nova Scotia, Prince Edward Island, and various places in the United States and Canada."

Dr. H. Y. Hind estimates the land area underlain by the upper seams at three-fourths of a square mile, and the water area at half a mile, assuming

¹See G. S. Report of Progress 1881-83-84. Page 89 H.

that the latter is thus limited by the synclinal seen on the coast farther south, and which is supposed to be half a mile to the westward of the mine. The quantity of coal in these areas he estimates at 15,000,000 tons, or deducting half for pillars, waste, etc., 7,500,000 tons of available coal; and if the lower seam should prove as valuable as is supposed, this estimate must be greatly increased.

Inverness Railway and Coal Company

(Sample No. 14.)

Operating at Inverness, in Inverness county, on the west coast of Cape Breton island. The seam worked has an average thickness of 7 feet, with two small partings $1\frac{1}{2}$ " each. Dip varies between 15° and 20° , with occasional rolls which are steeper in places, as at the present bottom of the slope, where it reaches 40° . The mine is worked by a slope which is now 3,800 feet long, of which 2,000 feet are under the bed of the ocean. The coal is cut by hand. Pillar and stall method followed. Underground haulage is by rope. Ventilation is by a Walker indestructible fan, rated at 250,000 cubic feet of air per minute. Open lights used throughout the mine.

The boiler plant comprises two Babcock and Wilcox boilers, rated at 212 H.P. each; two Heine boilers aggregating 325 H.P., and one return tubular, giving a total of about 900 H.P.

The tippie is well equipped with conveyers, bucket elevators, shaking screens, etc.

(One electric light unit of 800 lights (16 candle power).)

The mine has at present an output of 900 tons in one shift, which could be increased to 1,200 tons, with small additions.

Men underground, 375, on surface, 75.

The Company also operates the railway, 61 miles long, between Inverness and Point Tupper on the Intercolonial railway. The coal is shipped from this mine, by railway, to Port Hastings, 56 miles distant, where coal-pockets have been erected with a capacity of 2,500 tons, from which vessels are loaded. The annual output of this mine is in the vicinity of 250,000 tons.

Maouu Coal Mining Company

Operating a colliery at Mabou, Inverness county, working two seams, 7 feet and 8 feet, respectively. A slope has been driven on the 7 ft. seam, and a cross-cut tunnel driven from the workings to the 8 ft. seam. At the surface, the general dip is 75° ; at a distance of 150 feet in the slope this changes to almost vertical for 90 feet, then continues on at 17° . The slope on the 7 ft. seam is 1,100 feet long. Pillar and stall system. Undercutters are used in levels.

Boiler plant: 4 return tubular, total of 360 H.P., and 3 Mumford of a total of 300 H.P. Ventilation by Sturtevant fan, 4,000 cubic feet capacity. Bankhead equipment comprises tippie, screen, picking tables. The mine is equipped for a production of 100 tons a day, but has been idle since September 1908.

Port Hood and Richmond Railway and Coal Company

(Sample No. 15.)

Mine at Port Hood, Inverness county. Working on the Seven-foot seam, average thickness 7 feet, parting of clay of 10" at 1 foot from roof. Seam dips 21° at first, and flattens out to 12°. Worked by a slope 2,000 feet long. Face of longest levels are 4,000 feet from slope. The workings are almost entirely submarine. Ventilation by Dickson fan, of a capacity of 200,000 cubic feet per minute. Lighting, by safety lamps, of which there are 300 of Ackroyd and Best type. Boiler plant consists of two Babcock and Wilcox of 250 H.P. each and one return tubular 80 H.P. The lighting plant is a 65 K.W. dynamo (16 candle power). The bankhead is equipped with screens, picking belts, and one straight line 500 cubic feet compressor.

Although the mouth of the slope is only 400 feet from the line of the Inverness railway, almost all the coal is shipped by water. The shipping pier is 2,500 feet from the bankhead, and the wharf pockets have a capacity of 1,800 tons. The coal is conveyed to the wharf by tail rope, in cars containing three tons. Vessels are loaded with 36" Jeffrey belt conveyers. Men employed: 160 underground, and 60 on the surface. The possible output of the mine is about 600 tons a day. The total production in 1908 was about 100,000 tons.

RICHMOND FIELD

In Richmond county, in the southwestern part of Cape Breton island, a small development of coal measures occurs between the strait of Canso and Inhabitants river. The geology of this field, as well as that of all the other coal-fields of Nova Scotia, was studied by Mr. Hugh Fletcher, who states that the strata associated with the coal seams consists mainly of beds of greenish and reddish argillaceous shales, accompanied by sandstones, grey and rusty. Systematic geological work in this field has been limited to a patch of "Millstone Grit and Coal Measures," shown on the map issued in 1881 by the Geological Survey as being an area of about 5 miles east and west, by 4 miles north and south, comprising the extreme southwestern part of Richmond county. Coal seams of workable size are visible on the shore of Cariboo cove, at Sea-coal bay, where, according to Mr. J. Rutherford: "They are in a vertical position, having a dip to the southwest of 75°, the course of the strike being N. 50° W. The principal seam is upwards of 11 feet thick, inclusive of several bands of shale. The others are 4 feet and 5½ feet in thickness, the latter including a band of fire-clay near the middle of the seam, 15 inches thick. The strata are here much disturbed."

Work was begun at Cariboo cove in the early sixties; but although several seams, ranging in width from 3 to 7 feet, had been exposed, on one only was there any actual mining. This seam is 4 feet in thickness and was entered by means of a tunnel driven in from the shore, across 350 feet of measures, until it cut the seam at a depth of 40 feet below the outcrop.

Work was abandoned for a period of about 35 years, but in 1905 it was resumed by the Beeton Coal Company. Two years later the work was discontinued and the mine is at present idle and flooded.

About 1865 the Richmond mine started operations near the northern edge of the development of Coal Measures rocks, at a point on Little river, some 2 miles from its mouth, and about 3 miles north of the workings at Cariboo cove. A shaft was sunk to a depth of 200 feet to a 1 ft. seam, and considerable underground development work was carried on to open up a coal area. Another shaft was put down, some 50 feet deep to a 3 ft. seam, and connected with the deeper one. The coal measures are here very much disturbed, and the dips attain 85° northeast.

This mine was abandoned and reopened several times in after years. Lately the Richmond Coal Company has been working it and in 1908 had about 15 men working in the old shaft, and moreover had started a slope some 800 feet west of the shaft.

PICTOU COAL FIELD

This field situated in the centre of Pictou county, is the easternmost on the mainland of Nova Scotia. Its area is comparatively small; the coal measures which constitute it extending about 12 miles in an east and west direction, by a maximum width of about 3 miles; its total area is approximately 25 square miles. The town of New Glasgow is on its northern boundary about half-way between its eastern and western extremities. The field, therefore, lies about 9 miles from the shore of Northumberland strait.

Although small in extent, its geology is complicated, and the correlation of strata is rendered difficult owing to numerous faults which surround it, and moreover cross it in various directions. These have been mapped out as far as data available allowed, and they are shown on the map of the district accompanying the report by Mr. H. S. Poole, in Volume XIV of the Geological Survey annual reports.

For a short description of the field it may be convenient to divide it up into three districts or sections, the seams of which have not been definitely correlated. The westernmost district has the town of Westville as centre, and may be designated as the Westville section. Then immediately to the east comes the Stellarton or Albion section, with the Albion colliery occupying the centre. The Vale section is the easternmost, and its centre lies approximately 4 miles, in a straight line, southeast of New Glasgow.

Westville Division. This division is separated from the adjacent one to the east, the Albion section, by a fault of great magnitude, the throw of which has been estimated at 2,600 feet. Four seams of coal have been recognized in the district, called respectively the Main seam, the Second, the Third, and the Fourth. A section in descending order is as follows:—

Plate V.



Tipple and Power House, Port Hood Coal Co., Inverness county, N.S.



Various geological horizons above Main seam representing a thickness of	26,000 feet
Coal, Main or Acadia seam.	17 "
Strata.	181 to 260 "
Coal, Second seam.	12 "
Strata.	107 to 126 "
Coal, Third seam.	6 "
Strata.	90 "
Coal, Fourth seam.	8 "

Of these the Main seam is practically the only one worked at present, although some work has also been done on the Second. The average strike is about northwest and southeast and the dip 16° northeast. The quality of the coal varies somewhat along the outcrops, and deterioration from the centre towards the northern and southern extremities of the seams is especially marked in the lower seams.

Stellarton or Albion Section—This occupies the central portion of the Pietou coal fields. On the east it is bounded by the McCulloch fault, which separates it from the Westville district. The coal seams in this district are remarkable on account of their great size, two of them attaining thicknesses of 38 feet and $40\frac{1}{2}$ " respectively; these measurements, however, are not retained over their whole development, and in places they are greatly reduced.

In abstract the section of the coal measures of this division is as follows, in descending order:—

Overlying strata.	1,128 feet.
Coal, Main seam.	38 "
Strata.	118 "
Coal, Deep seam.	22 to $40\frac{1}{2}$ "
Strata.	45 to $106\frac{1}{2}$ "
Coal, Third seam.	11.9 "
Strata.	27 to 113 "
Coal, Purvis seam.	3 "
Strata.	109 to 130 "
Fleming seam.	5.6 "
Parting.	5.6 "
Coal, McGregor seam.	14.10 "
Measures.	241 "
Stellarton oil coal.	5 "

In a very general way, there are some resemblances between the Westville and Stellarton sections; but in detail there is very little similarity, and it is not easy to establish definite correlations in the two sections. The general strike of the outcrops is more east and west than in the preceding division, and the dip varies greatly from 15° to 30° N. In his report on the Pietou coal field Mr. H. S. Poole expresses himself as follows, concerning the seams of the Albion or Central division:—



MICROCOPY RESOLUTION TEST CHART

(ANSI and ISO TEST CHART No. 2)



APPLIED IMAGE Inc

1653 East Main Street
Rochester, New York 14609 USA
(716) 482-0300 - Phone
(716) 288-5989 - Fax

"The differences in the thickness of the several seams, in various parts of the workings, have been referred to, and mention has been made of the Main seam, with 9 feet of coarse coal, near McCulloch brook; 38 feet nearly all good coal at Dalhousie; and 2 feet only at the Pietou pit on the farther side of East river. There the Deep seam, with partings, is 40.5 feet, reducing to 22 feet at the Cage pit; 15'-9" at the Store pits, and represented by black shales only in the neighbourhood of the Pietou pit. The McGregor changes similarly along the crop, thickening also to the Deep, from 15 feet at the outcrop to 17'-3" at one-fourth of a mile down the slope, and to nearly 20 feet in total thickness at the axis of the synclinal, a mile northward of its outcrop."

Four seams are now being worked in this section, viz., the Main, the Deep, the McGregor, and the Third, and it was on the Deep seam that the first discovery of coal was made in the field.

Vale Division. This occupies the eastern part of the Pietou coal field. The measures here take the form of a synclinal, the axis of which skirts the northern base of McLellan mountain in the southern part of the Vale area, in the vicinity of the south fault, and sweeps towards the northeast in a gentle curve between the eastern and western outcrops of the George McKay seam, as delineated on the map issued by the Geological Survey in 1904, and which passes near the eastern extremity of the Mill pond into which flows Marsh brook.

In his report on the Pietou coal field, Mr. H. S. Poole gives the following general section of the measures in this division, made mostly from the work done at the Vale colliery:—

	Feet.
The George McKay 4 ft. seam, good coal.	2.0
Strata.....	100.0
Coal, two bands oil-shale.....	0.8
Shale.....	507.0
Coal, the 6 ft. seam.....	6.0
Strata.....	700.0
Coal, the McBean seam.....	8.0
Strata.....	37.0
Coal.....	2.0
Strata, terminating in black shales.....	304.0

Coal is said to have been discovered in Pietou county in 1798, by the Rev. James McGregor, D.D., in a brook near Stellarton, and in 1802 this gentleman opened a pit on the McGregor seam, and used the coal in his house. In 1807, John McKay obtained a licence to dig for coal to sell to other inhabitants and to export. He discovered the Big seam, which he exploited for several years. After that leases were let to several coal miners, and from 1818 to 1827 the yearly amount mined was about 2,200 chaldrons. In 1825 all the reserved mines of Nova Scotia were leased for a period of sixty years to the Duke of York, and this included the greater part of the Pietou coal field. In 1827 the General Mining Association of London obtained their title through Rundell, Bridge, and Rundell, to whom the Duke of York had



Old Cornish pump, Foord colliery, Stollarton, N.S.



Plate VII.



Albion colliery, Stillarton, N.S.



transferred most of his mining rights in Nova Scotia. In 1827 the General Mining Association sent out Mr. Richard Smith to commence operations, and the Store pits were sunk to a depth of over 200 feet. These were worked until 1839, when the Bye pits were put down, followed in 1850 by the Dalhousie, in 1852 by the Cage pit, in 1866 by the Forster pit, and in 1867 the Foord pit.

The Bye pit were abandoned in 1863 after a series of fires. In 1869 the Forster was found to be on fire and walled in. In 1872 the workings of the Dalhousie pit were crushed in, and in 1880 an explosion in the Foord pit caused the abandonment of both the Foord and the Cage pit. In 1881 slopes were driven on the Third seam, and until 1906 the whole of the production of the Albion or Central area was obtained by means of these slopes at the Albion mines. Now, however, the Allan shafts are being put down a short distance east of the Foord pit, and will soon be in working order.

The monopoly of the General Mining Association ceased in 1856, and, in 1872, mining rights in Pictou county were acquired by the Halifax Company.

In 1865, the Acadia Coal Co. was organized and began work on the McGregor seam, near the place where the original find of coal was made by Dr. McGregor. However, in 1867, they abandoned these workings, and moved the centre of their operations to a new discovery a couple of miles west of the Albion colliery, where the Acadia colliery was established and has since been worked uninterruptedly.

In 1886, the Acadia, the Halifax, and the Vale companies, this last one operating on the easternmost section, amalgamated and took the name of the Acadia Coal Co., who now operate the Acadia, the Allan, the Albion, and the Vale collieries.

In 1868, the Intercolonial Coal Co. was formed in Montreal, and acquired a coal area in the Westville section. Work was begun and a slope sunk which now is the centre of operations of the Drummond colliery, described further on, which has been worked continuously since then.

Acadia Coal Company

(Samples Nos. 1, 2, 8, 16, and 4.)

This Company is operating four collieries in the Pictou coal field, Pictou county, Nova Scotia, and controls an area of 16 square miles, in which are situated the Albion colliery, the Acadia colliery, the Allan shaft, and the Vale colliery.

Albion Colliery. (Samples Nos. 1, 2, and 2002).—Situated at Stellarton, on the Intercolonial railway, 2 miles from New Glasgow. At this colliery three seams are worked, viz., the Deep seam, or Cage Pit seam, the Third seam, and the McGregor seam. Their thickness varies considerably, the Deep seam between 15 and 40 feet, the Third seam averaging about 12 feet, and the McGregor between 15 and 20 feet.

At present the Deep and Third seams are worked by slope No. 2, 4,200 feet long, on Third seam, average dip 22°. The two seams are connected underground by a tunnel through the intervening measures. Tunnels are also being driven from the Deep seam to the Foord seam, to work this latter from these workings. A slope 4,500 feet long, on the McGregor seam, is now mainly used for pumping.

The coal is extracted by bord and pillar method. The bankhead is equipped with tipples, screens, and picking belts. Coal is loaded by means of box car loaders.

Ventilation in Third seam workings is by a Walker fan, capacity 90,000 cubic feet per minute; in McGregor workings by a Walker fan of 150,000 cubic feet. Underground haulage is by horses.

Safety lamps of the Wolf pattern are used exclusively, 300 being required. The output of the Albion colliery is 700 tons a day, but this could be increased to 1,000 tons. Only permitted explosives are used, the chief being Monobel, manufactured in England.

The Company operates a lighting station of 1,200 lights of 16 candle power.

Acadia Colliery. (Samples Nos. 8 and 2008).—Situating at Westville, about 3 miles from Stellarton. Operating on the Main seam, the thickness of which is variable, but averages about 10 feet. Average dip 26°. Worked by slope 5,200 feet long, having an inclination of 22° to 26°. The coal is worked by longwall method, the floor being clayey and very troublesome. The slope and roadways are protected by very wide pillars.

Boiler equipment, five Babcock and Wilcox of 150 H.P. each, and one Sterling 150 H.P. Ventilation is by Capell fan, 150,000 cubic feet capacity. Safety lamps are used exclusively, Wolf pattern, with patent lighting device. Number in use 260. No explosives of any kind are used in this colliery.

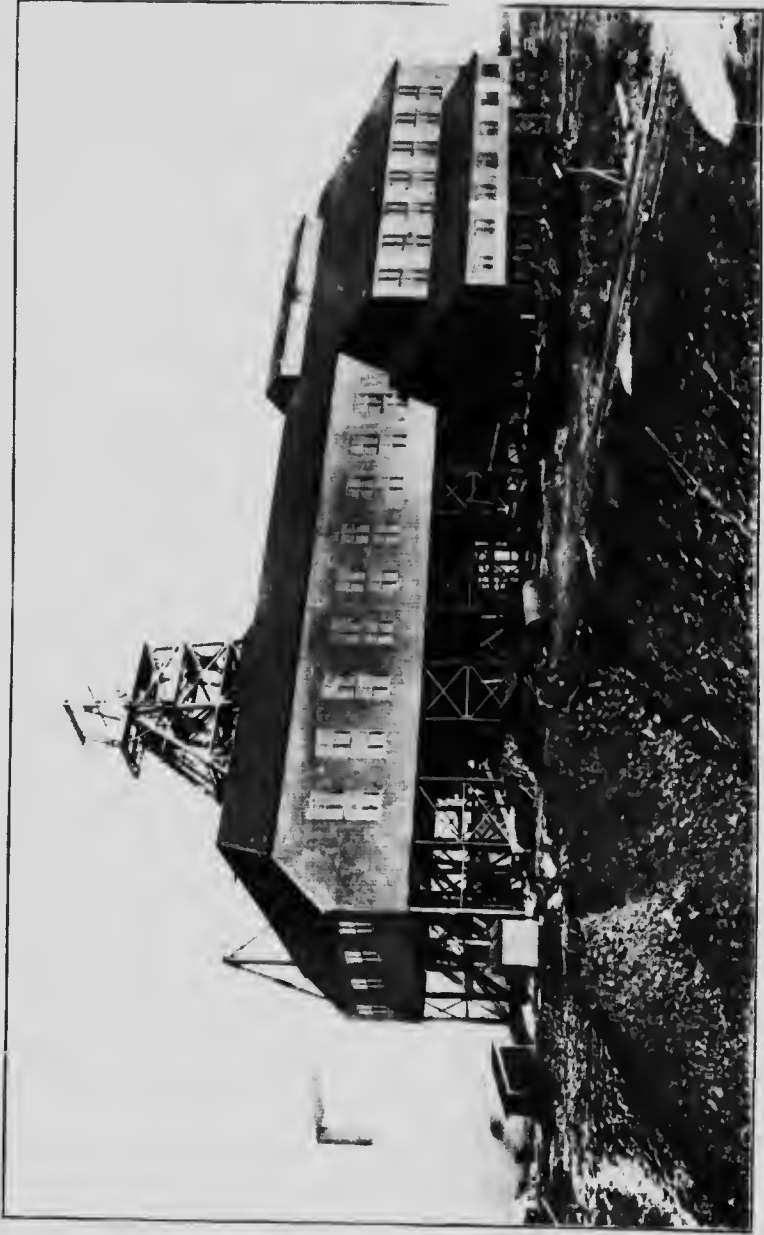
The possible output of the mine is about 600 tons a day, the actual production varying between 300 and 500 tons. There are 230 men underground and 90 on the surface.

The bankhead is equipped with tipples, shaking screens, picking belts, etc. A great proportion of the coal of these collieries is used on the Inter-colonial railway.

Allan Shafts. (Samples Nos. 16 and 2016).—This is a new colliery, located at the north end of the town of Stellarton, at about 1,000 feet from the old Foord pit. The object of the Allan shafts is to cut all the seams of the basin, viz.: The Foord, the Deep or Cage Pit, the Third, and the McGregor seams. The ground for the sinking of the shafts was broken in April, 1904, and in May, 1905, the Foord seam was struck at 884 feet in one shaft and at 1,195 feet in the other. In November 1905, the Cage Pit seam was struck at 1,428 feet. So far the work done at the Allan shafts has been of a development nature.

The two shafts are 330 feet apart. They are of the same size, 24 feet × 12 feet. They have two hoisting compartments and one air way.

Plate VIII



Allan Shaft, Stillarton, N. S.



Plate IX.



Vale colliery, Thordorn, Pictou Co., N.S.



Fair Colliery (Samples Nos. 1 and 2001). This mine is situated at Thorburn, 6 miles southeast of New Glasgow. The seam worked is the Six Foot seam, dip varying from horizontal to 25°, thickness 3 to 8 feet. Worked by slope 2,400 feet long. Both bord and pillar and longwall methods are used. Underground haulage by horse in boxes containing 1,500 pounds.

At the foot of the slope is located a main landing, from which two levels to right and left have been driven. The main one, to the left, is now in 3,000 feet from the landing. The coal is conveyed by horse haulage to the main landing, from here is hoisted up the slope.

Ventilation is by Walker fan, 28 feet diameter, of a capacity of 40,000 cubic feet. Boiler plant consists of three Sterling, of 200 H.P. each, and one return tubular of 50 H.P. Safety lamps of Aekroyd and Best pattern are used exclusively.

The coal is hoisted to the bankhead, dumped on flat shaking screens, and picked on belt 30 feet long. The output of the mine is at present about 150 tons a day. The mine is connected with the Intercolonial railway by a line 7 miles long, owned and operated by the Acadia Coal Company.

The Company owns a modern shipping pier at Pictou Landing, from which coal is shipped by water during the season of navigation. The pier is 10 miles distant from Stellarton, and is reached by the Intercolonial railway.

Intercolonial Coal Mining Company

(Samples Nos. 3 and 2003)

The above Company operates the Diamond colliery at Westville, Pictou county, Nova Scotia, and controls an area of 8½ square miles. The workings are on the Main seam, average dip of 16°. Thickness of seam averages 16 feet, but only 7 feet of this is extracted, a thick roof of coal being left, which is to be ultimately worked. A tunnel connects the Main seam workings with the next seam in the series, the Second seam; but the latter is not worked at present.

The seam is worked by two slopes, No. 4 and No. 5, which are now 7,200 feet long on an average dip of 16°, giving a vertical depth of 1,850 feet from the surface at the face.

Another slope, No. 1, is worked independently on a small scale; the coal from it is hauled to, and cleaned on, the same bankhead.

Mining is done by pillar and bord method, and no explosives are used, the coal being brought down by maul and wedge. The mine is very fiery and Marsaut lamps are used throughout, 700 in number. Ventilation is by a Walker fan, 250,000 cubic feet of air, and a Guibal of 70,000 cubic feet is kept in reserve. Compressor, 3,000 cubic feet free air per minute. Boiler plant consists of 12 Sterlings, one Heine, 12 two-flued horizontal, and 5 egg-end boilers, giving a total of 1850 H.P. of which 1,200 are used for hoisting.

Underground haulage is by horses. The coal is hoisted at a speed of 15 to 20 miles an hour, in rakes of about 10 cars holding 1,500 pounds each. Screening plant consists of two units, each equipped with tipples, shaking screens, and picking belts, making hamp, nut, pea, and slack. The slack is conveyed to a washer of a capacity of 100 tons per day, which supplies 36 beehive ovens.

The output of the colliery is about 1,000 tons a day, but this could easily be increased to 1,400 tons. There are about 900 men employed, of whom 600 are underground.

Part of the product of the mine is transported to a modern shipping wharf, situated at Abererombie, 10 miles north of the mines on the Middle river of Pictou, by a railway owned and operated by the Company. The colliery is also connected by rail with the Intercolonial railway.

Nova Scotia Steel and Coal Company

Marsh Colliery.—Situated 4 miles from Trenton, on the line of railway operated by the Acadia Coal Company. The colliery was opened in 1902 for the purpose of supplying fuel to the Trenton Steel Works, of the Nova Scotia Steel and Coal Company. Seam worked is the McKay seam which gives 4 feet of clean coal. Worked by a slope 3,000 feet long, having an inclination of 8° to 10°. Bord and pillar method is followed, rooms being 15 feet wide. Underground haulage is by tail rope. Ventilation by Sturtevant fan 30,000 cubic feet. Naked lights used, there being no gas in the mine.

Boilers, two tubulars of 80 H.P. each, and one vertical of 25 H.P.

The present output of this colliery is about 200 tons a day, but this could easily be increased. No coal cutting machinery is used, and the coal is shot with black powder.

CUMBERLAND COUNTY

In Cumberland county there are two areas of Productive Coal Measures, separated by a large tract of newer rocks, assigned by Mr. Hugh Fletcher to the Permian and upper Carboniferous; active operations in coal mining are being carried on in both of these districts. One of these areas, the Springhill coal field, is situated approximately in the middle of the county, immediately north of the Cobequid mountains, and of all the coal fields of Nova Scotia it is the farthest remote from the sea-coast, being about 20 miles east of Joggins, on the bay of Chignecto, and approximately the same distance, in a straight line, from Parrsboro, to the south, on the Minas basin.

In the Springhill field, the coal measures are exposed over an area measuring approximately 7 miles north and south, and about 3 miles east and west. This, however, does not represent the whole area available, for to the west the Productive Measures are overlain by newer rocks under which the coal seams dip and can be followed.

Plate X.



Acadia colliery, Westville, N.S.

There are in this field at least five workable seams of coal, ranging in thickness from 4 to 13 feet. The dip is steep, averaging from 25° to 30°, and reaching 75° in places.

In the central part of the district, where active mining operations are being carried on by the Cumberland Coal and Railway Company, the general strike of the seams is north-northeast and the dip towards the west.

The section given below is generalized from the data obtained in the workings of the mine. It is in descending order:—

	Feet
Coal, North seam,	13.0
Measures,	105.0
Coal,	5.0
Measures,	130.0
Coal,	2.4
Measures,	185.0
Coal, Main seam, or East slope seam,	11.0
Measures,	80.0
Coal, Black seam or West slope seam,	11.0
Measures,	100.0
Coal,	4.0
Measures,	176.0
Coal,	2.9

There are at present three seams worked at the collieries of the Cumberland Coal and Railway Company, namely the North slope seam or Thirteen foot seam, the East slope seam, and the West slope or Black seam. These two last are connected by stone drifts and worked together. They have been followed on the slope to 4,100 feet, which brings the face of the slope well under the surface covering of newer rocks.

Although the Springhill field is comparatively remote from the sea-coast, this fact is not detrimental to any extent to the coal mining operations. The Company owns and operates a railway line which connects the colliery with the Intercolonial railway on the north at Springhill Junction, a distance of 5 miles, and on the south it terminates at Parisboro on the Minas Basin arm of the Bay of Fundy, where well-equipped shipping wharves have been erected. The Intercolonial railway takes the greater part of the output of the Springhill collieries.

The other important coal area of Cumberland county is the Joggins coal field, which is the westernmost of Nova Scotia, and the coal measures which constitute it are well exposed on the shores of Chignecto bay, an arm of the bay of Fundy, where they form part of the celebrated Joggins section of Carboniferous rocks, first measured by Sir W. E. Logan in 1843.

The outcrops of the coal-bearing rocks occupy an area some 18 miles in length, from the shore of Chignecto bay eastward, to the vicinity of Economy road, and their general strike is east and west; the average width of the exposed strata is about 2 miles. The coal measures here visible represent

only the northern outcrop of a synclinal which dips to the south and, therefore, the coal seams extend in this direction under the overlying younger rocks which have been referred, by various geologists, to the Permian and the upper Carboniferous.

The axis of this synclinal trough runs approximately east and west, and passes near Shulie, on the shore of Chignecto bay. To the north, according to the Joggins section, there are exposed 15,000 feet of Carboniferous strata, of which 2,540 feet constitute the Productive Coal Measures; while on the south of the axis, somewhat less than 5,000 feet appear, and from these the coal-bearing rocks proper are practically absent. This reversed southern edge of the synclinal, near Apple river, distant 25 miles from South Joggins, rests against a range of pre-Carboniferous rocks, the eastern extension of which forms the Cobequid hills. Some boring operations are at present going on in the region to the south of the axis of this synclinal, to test the underlying strata for the presence of coal seams.

Mining operations in this part of Cumberland county have, heretofore, been confined to the narrow strip above mentioned, some 18 miles long by 2 miles wide. The strata which constitute this coal area are well exposed on the Joggins shore, and the complete section, as measured by Sir Wm. Logan, is given in the Report of Progress of the Geological Survey of Canada for 1843, and in Dawson's *Acadian Geology* (with slight revisions). The division which makes up the Productive Coal Measures is given a thickness of 2,540 feet of strata, containing a great number of coal seams, most of which are very thin. The total thickness of coal aggregates about 38 feet, the thickest seam exposed on the shore being only 4'-6", including some partings. The rocks of the Productive Coal Measures are mainly sandstones and shales, with layers of underclay.

The coal-bearing rocks are overlaid by 2,100 feet of barren strata, and below these comes, according to Sir Wm. Dawson, "The middle of the Millstone Grit series, which constitutes a sort of false coal formation, containing small sedimentary coal beds."

In the vicinity of South Joggins, the Productive Measures show a breadth, on the surface, of about 2 miles, and the average dip is 19°. The thickest coal seam of the series is being worked at the Joggins colliery, and all along the northern margin a number of mines are located. It is difficult to correlate the seams worked at the various mines as their characters change in comparatively short distances. At the Joggins colliery, near the shore, the seam worked, called the Main seam, has the following section:—

Sandstone.	4'-0"
Shale.	0'-6"
Coal.	3'-6"
Shale.	1'-6"
Coal.	1'-6"
Underclay and sandstone.	

At the Strathcona colliery, about 5 miles east of the shore, two seams are being exploited, the lower one being made up as follows:—

Top coal.	7"
Clay parting.	8" to 12"
Lower coal.	20" to 21"

The upper seam, which is separated from the above by about 500 feet of measures, has a thickness of 12", of which 1" to 6" is shaly coal.

At the Chignecto colliery, in the eastern part of the field, about 2 miles east of Maccan station on the Intercolonial railway, there are practically three seams, dipping at an angle of about 38 .

Coal	6'- 2"
Hard shale.	2'- 6"
Coal.	2'- 3"
Shale.	2'- 6"
Coal.	1'-10"

At Maccan station the Eastern Coal Company has lately reopened a coal area, by means of a slope, which at 135 feet cuts a bed presenting the following section:—

Coal.	1'-10"
Shale.	0'- 3"
Coal.	0'- 6"
Shale.	0'- 3"
Coal.	1'- 6"
Shale.	0'- 1"
Coal.	1'- 5"
Shale.	0'- 3"
Coal, with $\frac{1}{2}$ " of shales.	4'- 0"
Shale.	1'- 0"
Coal.	1'- 3"
Total.	12'- 7"

The dip of the measures is about 50°, but the slope does not follow this, as it was driven through the rock at an inclination of 30°.

At the Styles mine, which is situated at the eastern end of the band of coal bearing rocks, or about 17 miles east of the Joggins shore, the dip of the strata is 42° near the surface and it diminishes slightly as depth is attained. The section of the seam worked here is given by Mr. Scott Barlow, in the report of the Geological Survey for 1873-74 as follows:—

Dark brown argillaceous shale with a little coal.	0'- 1 $\frac{1}{2}$ "
Coal (apparently good).	2'- 0"
Brown clay and slate.	0'- 7"
Coal	1'- 1"
Fireclay	

Although the Joggins coal area is bounded on the west by the sea, this does not to any extent favour shipping facilities, for the coast at this point has an exceptional range of tide, and no good harbours. In the early days of the district, coal could only be transported by water, and the collieries near the shore shipped with difficulty, while the mines situated more in the interior shipped by way of the Hebert and the Maccan rivers, which traverse the area at distances of 3 and 9 miles respectively from the Joggins shore. Shipping operations on these streams possessed a character of their own, on account of the extraordinary fall and rise of the tide, which sometimes attains, in the bay of Fundy, a difference of level of 40 feet.

The banks of the rivers present long, deep, sloping sides, with a thick cover of reddish clay silt, which gives them a very peculiar appearance. These streams are navigable at high tide for vessels which can take a cargo of 250 to 300 tons. However, at the present time, the collieries are connected with the Intercolonial railway at Maccan, and the great bulk of the shipping is done by rail.

To the north of the Springhill area, immediately to the south of the line of the Intercolonial railway, there is a small narrow basin of coal measures which does not seem to be connected with either of the other two fields mentioned above. Some work has been done on a seam of coal, in the area near Salt Springs station, but so far this has not been developed into a field of economic importance.

Although the presence of coal in Cumberland county, as revealed in the Joggins section exposed on the coast, was known at an early date, the first stages of coal mining in this vicinity are closely connected with the history of the General Mining Association, who practically had control of the field by their agreement made in 1828 with the Duke of York's representatives. Some mining operations were conducted by them shortly afterwards on the Joggins Main seam. In 1858, by mutual agreement with the Government authorities, this corporation relinquished their rights, the coal lands of Cumberland county were thrown open to outsiders, the General Mining Association retaining 4 square miles in the Springhill field and the same quantity in the Joggins area. As a result, several mines were opened, which worked more or less continually for several years. In the early seventies, active work was begun on the Eleven foot seam by the Springhill Mining Company, in the Springhill section, and surveys were made for the construction of a railway from Springhill to Parrsboro, connecting to the south with a shipping wharf, and to the north with the main line of the Intercolonial railway. In 1879 the General Mining Association disposed of their last holdings in Cumberland county by transferring the 4 square miles which they owned in the Springhill district to the Springhill Company. They had previously, in 1874, divided their concessions in the Joggins area between the Joggins Coal Mining Company and the Joggins Coal Mining Association, the former taking the old workings on the Joggins main seam, and the second opening workings called the Cumberland colliery on the Hardscrabble seam, at a point one-third of a mile from the shore.

Later on, several other small mines were opened up on this strip of coal measures, both east and west of the Intercolonial railway, but none however, were worked very regularly or continuously. In 1837, the completion of the construction of the railway, between Maccan and Joggins, gave a new impetus to the industry, and led to the reopening of several mines which had previously only worked intermittently, owing to difficulties in shipping.

Of the companies now working in Cumberland county, the most important is the Cumberland Coal and Railway Company, operating in the Springhill field. In the Joggins area, there are at present eleven collieries spread over the whole distance of 18 miles of outcrops of coal measures, from the Joggins to the eastern extremity of the field. They do not all work continuously. The most important of the coal companies operating in this area is the Maritime Coal, Railway, and Power Company, who also own the two branches of railway connecting Maccan, Joggins, and Chignecto.

We give below a short description of the collieries established in this district.

Cumberland Coal and Railway Company¹

(Samples Nos. 49, 5, 6).

Operating collieries in the Springhill field, Cumberland county. The total area of coal lands controlled by this Company approximates 190 square miles. The mines now operated are at Springhill. Three seams are worked by means of two hoisting slopes.

No. 2 Slope. (Samples Nos. 5 and 2005).—Driven on seam 10'–6" thick, average dip of 30°, has now a length of some 3,800 feet from the surface. The coal from the workings of No. 1 slope is also hoisted through No. 2, and No. 1 slope is abandoned. The coal from No. 5, or Aberdeen, slope also comes up No. 2 slope. The underground workings are comparatively extensive, some of the coal being hauled in levels from distances of over one mile. Haulage underground is by tail rope. No coal cutting machinery is used, as the seams worked are usually highly inclined, the dip in some cases reaching 85°. No explosives are used, the mines being very fiery. The coal is worked by pillar and bord, the pillars being ultimately extracted.

Ventilation of workings of No. 2 slope is by a double inlet Capell fan, of capacity of 150,000 cubic feet; in No. 5 by a Capell double exhaust fan of same capacity.

Boiler plant comprises 6 double flue; 4 Lancashire and 2 Robb & Mumford, of a total capacity of about 600 horse-power.

Bankhead is equipped with three dumps and revolving tipples, shaking screens, picking belts, etc.

No. 3 Slope. (Samples Nos. 6 and 2006).—Driven on seam 10 feet thick. Slope is now over 4,800 feet long. Average inclination 28°. Levels are

¹The mines of this Company have recently been acquired by the Dominion Coal Company—see p. 29.

driven to great distances on both sides of the slope, some attaining a length of 8,000 feet. Coal is extracted by pillar and bord.

Ventilation is by a Capell fan, double inlet blast, capacity 150,000 cubic feet per minute. Underground haulage is by tail rope. Boilers, 12 double flues, 840 H.P. Masont lamps used underground. Bankhead equipped with five revolving tipples, shaking screens, 4 picking belts 5 feet wide and 45 feet long.

The two collieries have an aggregate capacity of 3,000 tons a day.

The coal is shipped partly by water and partly by rail. The colliery is connected with the shipping piers at Parrsboro, 32 miles south of the mine, and with the Intercolonial railway, 5 miles north of the mine, by a railway operated by the Company. Shipments by water are made by barges, of which the Company owns several. These are towed by the tug *Springhill*, which also belongs to the Company. Besides these, a 1,500 ton steamer is chartered for delivery to American ports.

Maritime Coal, Railway, and Power Company

(Samples Nos. 7 and 10)

Operates two collieries, one at Chignecto and another at Joggins mines. This Company owns and operates a railway line connecting the two mines with the Intercolonial railway at Maccan. A part of the output of the Chignecto mine is converted into electric power at a power station situated at Chignecto, which distributes power at Amherst, Maccan, and other points between these two places. The power plant in the main consists of one 500 kilowatt generator, driven by compound Robb engine; steam generated by Robb boilers fired by Jones underfeed stoker. The power plant has been laid out for making extensive additions and another 500 K.W. generator is to be installed shortly.

Chignecto Colliery. (Sample No. 7).—Maritime coal mine No. 6. Situated at Chignecto, Cumberland county. The seam worked has the following average section:—

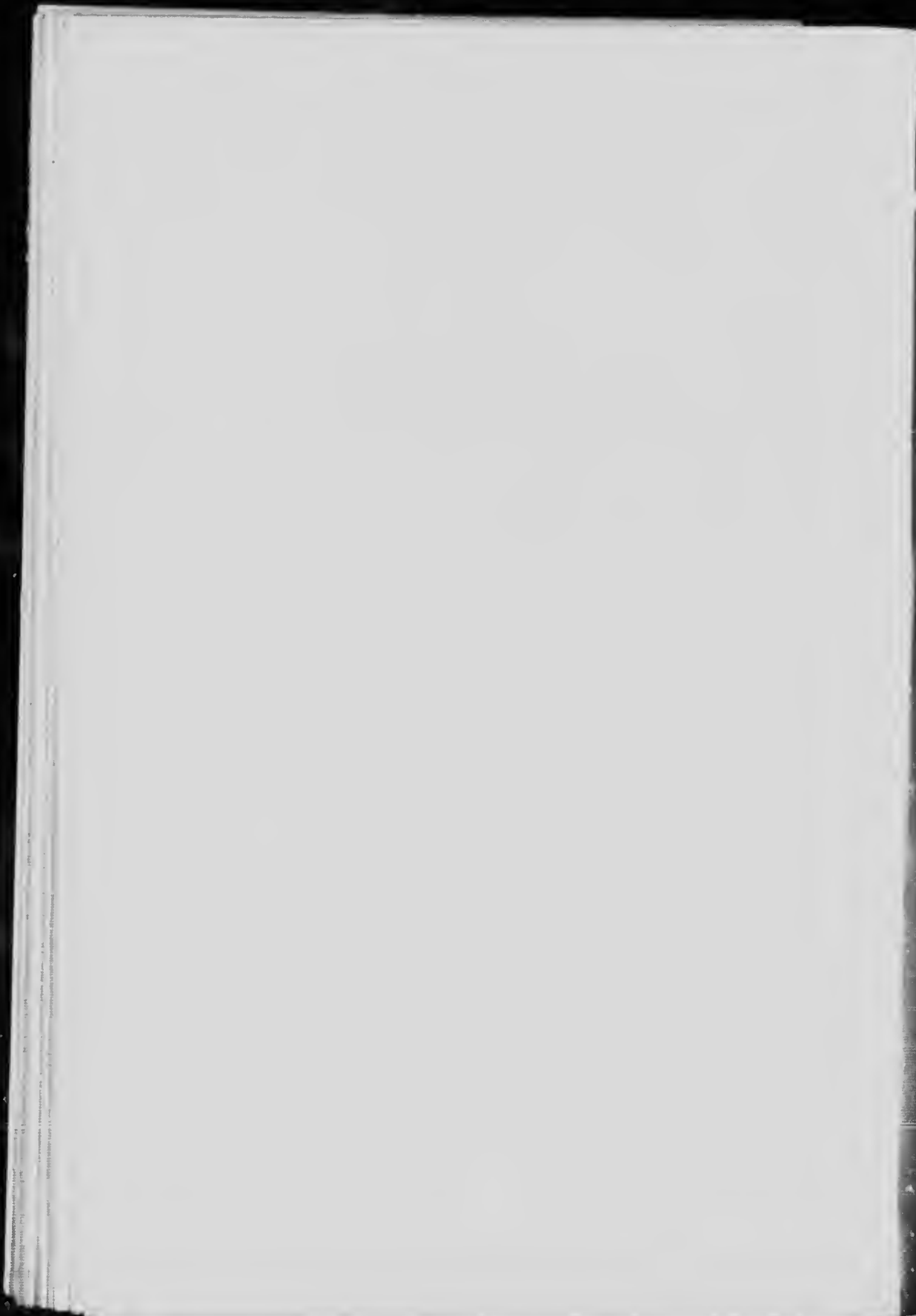
Top coal	3'-0"
Parting	1'-6"
Coal	1'-6"
Parting	0'-5"
Coal bench	0'-6"

The dip of the seam averages 38°. It is worked by a slope 1,900 feet long, with levels at 1,400 and 1,900 feet. The workings in the upper level extend 4,000 feet east and west, and in the lower level 1,000 feet east and west. The system of working is a combination of bord and pillar and long-wall, with both coal cutting machinery and hand cutting. Horse haulage is used underground. Ventilation is by a 12 ft. diameter fan, motor driven, with auxiliary steam, capacity 120,000 cubic feet per minute. Open lights are now used. Hoisting is by one Robb engine with two 12 ft. friction drums. Steam is provided by one 75 H.P. return tubular boiler. The surface

Plate XI



Colliery No. 3, Springhill, N.S., Cumberland Coal Co.



plant comprises rotary tipples and shaking screens, etc. The coal is disposed of to the Intercolonial railway, to the pulp mills in New Brunswick, and locally. The mine is equipped for a production of 600 tons a day.

Joggins Colliery. (Samples Nos. 10, 2010, and 3010) This colliery, formerly worked by the Canada Coal and Railway Co., was acquired in 1907 by the Maritime Coal, Railway, and Power Co., who also operate the Chignecto colliery. The old mine, however, has been abandoned, and a new one under the designation of Maritime No. 7 is now in operation, and is located at Joggins village, near the shore of the bay of Fundy.

The bed worked is the Joggins main seam having the following section--coal 4 feet, shale 3 to 9 feet, coal 1'-9". Only the top bench of 4 feet is worked. The mine is opened by three slopes which are 2,500 feet long. Levels are opened on the east and on the west sides of the slopes respectively, and these are now in from 600 to 1,000 feet. Some coal cutting is done by one compressed air radial machine, but most of it is done by hand. The system of working is by longwall on the east side of the slope and by bord and pillar on the west workings, which are submarine.

Ventilation is by one Sturtevant fan, 8 feet in diameter, of a capacity of 100,000 cubic feet. Lighting is by safety lamps of the Marsaut type, of which 225 are in use. Haulage underground is by horses.

The surface equipment consists of one endless rope haulage engine, four Lancashire boilers of 75 H.P. each, and one Robb "Economic" of 100 H.P., a total of 400 H.P. A McKiernan air compressor of a capacity of 100 cubic feet per minute supplies the coal cutting machine.

The grades of coal turned out are screened, nut, slack, and run of mine. The possible output of the colliery is 1,000 tons a day.

The Intercolonial railway, the Salisbury and Harvey railway, and the Moncton and Buctouche railway, take the greater part of the output of the mine, though some is used in Moncton for domestic purposes.

The mine employs from 110 to 175 men, of whom about 80 to 90 are miners. At present the mine is being developed actively and a great deal of construction is going on.

Eastern Coal Company

This Company operates the Riverside colliery, at Maccan, Cumberland county, Nova Scotia. Work on this mine was begun in 1906 and it is yet in development stage. It is worked by two slopes 1,200 and 500 feet long respectively, on the pillar and bord system. The surface equipment consists of a bankhead some 600 feet long, leading from the mouth of the slope to the screening plant which is situated near the main line of the Intercolonial railway. This plant is equipped with shaking screen and picking belt. Coal cutting is done with a Little Hardy machine worked by a compressor of 1,300 cubic feet free air per minute. Ventilation is natural, and naked lamps are used.

The boiler plant consists of two boilers of 250 H.P. each. The coal is taken mainly by the Intercolonial railway, but a certain proportion is sold in Anlierst. The capacity of the colliery is 500 tons a day.

Minudie Coal and Transportation Company

(Sample No. 9)

This Company operates the Minudie colliery near River Hebert, Cumberland county, N.S., working the Minudie seam, having the following section: top coal 18"; clay parting 6" to 2 feet; bottom coal 10". The coal dip, $18\frac{1}{2}^{\circ}$, and is operated by a slope now 1,900 feet long. The longwall advancing method is used, and all coal is cut by hand.

The surface equipment consists of two horizontal boilers of 120 H.P., one locomotive boiler 35 H.P., and one vertical 25 H.P. The hoisting engine of 75 H.P. is sufficient for an output of 300 tons a day, but the colliery produces from 160 to 200 tons at present. The bankhead is a structure 30 feet \times 90 feet, equipped with revolving tippie, screen, and picking belt.

Ventilation is by exhaust fan, rated capacity of 50,000 cubic feet per minute. Naked lights are used. Explosives used are black powder for coal and dynamite for rock. The mine is connected with the Intercolonial by the Maritime Coal, Power, and Railway Company's line, and with a shipping wharf on the Cumberland basin of the Bay of Fundy by a standard gauge road 6 miles long.

Strathcona Coal Company

Operating the Strathcona colliery, at River Hebert, Cumberland county. The Company controls $2\frac{1}{2}$ square miles of coal lands. Two seams are worked by two slopes, No. 1 and No. 2 respectively. Slope No. 1, 1,000 feet in length, is on the Melvin seam, which has the following section: top coal 7", clay varying from 8" to 12", lower bench 20' to 24'. No. 2 slope, some 500 feet long, is on an overlying seam, 12" thick, with 1" to 3" of shaly coal. The two slopes hoist to the same bankhead. Method of working is by longwall advancing.

The mine has natural ventilation. Boilers, two tubulars of 60 H.P. each, and one of 10 H.P. The equipment is for an output of 125 tons a day, but the production could be easily increased to 200 tons, with a few alterations.

Other Collieries of the Cumberland Field

There are in the Cumberland coal field several other collieries of less importance, which operate more or less regularly, the combined output of which does not at present exceed 10,000 tons a year. Among them may be mentioned:—

The Great Northern Coal Company.—This Company has acquired the Scotia mine, formerly worked by Ripley and Blackburn, near Chignecto, and controls a small area of about one square mile, which is worked by a slope 300 feet long. The coal is hauled by wagon to the Chignecto colliery, and shipped from there over the Maritime Coal, Railway, and Power Company's line.

The Empire Coal and Tramway Company.—Operating the Jubilee mine, situated 3½ miles west of Maccan, on the Joggins line of the Maritime Coal, Railway, and Power Company. Two slopes are driven on a seam, which varies in thickness from 20" to 24". The two slopes are 600 feet apart, and are 275 and 200 feet in length respectively. Worked by longwall method.

The Atlantic Grindstone and Coal Company.—Operates the Fundy mine, near Joggins. This is on the "Old Prospect area" of the General Mining Association. This mine, after having remained idle for some years, has been reopened, and development work is now going on.

Colchester Coal Company.—This Company, which is as yet in the early development stage, is operating the Debert mine, near Debert, in Colchester county. This is on a seam which has a thickness of 3 feet to 3-6". Bore holes have shown in places a thickness of 7 feet. A branch line of railway, 4 miles long, has been constructed to connect the mine with the Intercolonial railway.

NEW BRUNSWICK COAL FIELDS

A large proportion of the Province of New Brunswick is underlain by measures of Carboniferous age, but these are referable to the lower part of the system. The middle Carboniferous, which in Nova Scotia is the main coal-bearing formation, appears to be absent in New Brunswick. In this latter Province the coal seams which are being worked are referable to the Millstone Grit formation, which in Nova Scotia underlies the Productive Measures.

Only two areas have been developed into producing coal fields. The first of these, which is also the largest, is the Grand Lake area, situated in Queens county. In this coal field the measures are very nearly horizontal, and for this reason, while they do not comprise a great thickness of strata, they occupy a considerable area. Two seams of coal occur in this field, separated in places by partings of various thicknesses. The top one is about 20" inches thick, while the lower bench is 10". Sometimes they come together and make a workable seam of 30". The coal occurs quite near the surface, and the deepest shafts in the district do not exceed 40 feet.

From geological observations it has been pointed out that the structure of the Grand Lake coal field proper, embracing an area of about 112 square miles, was evidently that of a shallow basin with a maximum depth of 600 feet, of which fully 200 feet belonged to the lower or barren measures. Nevertheless, hope was long entertained that thicker seams existed at greater depths, and in several places borings were put down to test the underlying strata.

These hopes, however, have not been realized, for at a depth of 217 feet the drill was found to have passed entirely through the coal formation, the cores brought up from that depth being from the underlying older rocks, and no trace of coal beds other than those found near the surface was encountered. However, even if the possibility of the presence of deeper seated coals be eliminated, the known seams of the Grand Lake field contain a large quantity of coal, which has been estimated at about 21,000,000 tons.

Dr. Poole, who made a study of the conditions obtaining in the coal measures of New Brunswick, draws the following conclusions in regard to the occurrence of workable coal seams in that Province:—

“The examination, in short, resulted in a belief that the thin seams of coal worked at Grand lake were of the horizon of strata classed among lower members of the Millstone Grit; that there were no equivalents of the Productive Coal Measures of Nova Scotia deposited north of the Coastal range; and that while there were conditions south of that range more nearly approaching those of the coal basins, the features observable could not be regarded as encouraging for the presence of thick workable coal seams.”

The coal industry in the Grand Lake district can hardly be said to have passed the preliminary stages, although it has been established for many years. Small mines are comparatively numerous, each being worked individually and many of them intermittently. The centre of the industry is Minto, the terminus of the New Brunswick railway, which runs between this point and Norton, on the Intercolonial railway, a distance of 60 miles. A certain proportion of the coal is also hauled to the shore of Grand lake, whence it is shipped by water to St. John.

The mines in this district are worked on a small scale, and of the eighteen or twenty mines in operation, only one has installed a steam hoist, and even this is of a rather primitive character.

The procedure adopted, when the coal seam is too deeply covered to be worked by stripping or removing the whole of the overburden, is to sink a shaft (the deepest of which is under 50 feet) to the seam. When only the upper coal is worked, as in the majority of cases, only 18" to 20" of coal is available, and about 2 feet of the roof has to be mined to allow head room. Levels are driven, radiating from the bottom of the shaft, as the seam is practically horizontal, and worked for a distance of 100 to 500 feet.

When the underground haulage attains this length, it is found more economical to remove the whole plant, and sink a new shaft, some 1,000 feet from the old one. The hoisting is usually done by a horse gin. The average mine employs from 4 to 8 men and works about 175 to 200 days a year, producing from 5 to 12 chaldrons of coal a day. These remarks, however, do not apply to the mine worked by G. H. King at Minto, which is the largest producer in the district. Here the two seams come together, giving an available thickness of coal of about 30".

The following remarks on the coal industry of the Grand Lake district are taken from Dr. Ellis' summary report for 1906:

"In the coal output, there is a marked change for the better, as contrasted with the work of even five years ago. At Minto, the terminus of the New Brunswick railway, from Norton Station on the Intercolonial, a number of mines are worked on the coal seam which was tested there many years ago. At this place there are two seams, one of eighteen to twenty inches, which is that usually worked, and a second and a lower of ten inches. In places these two come together, or have a thin parting only, so that it is possible to mine about thirty inches of coal. This is the thickness measured at the King mine, and the workings are connected with the surface by a shaft thirty feet deep. In drifting, about two feet of shale roof is removed to give head room. The shale parting between the seams at this mine is only three inches."

"The coal after hoisting is carefully screened and inspected by an inspector for the Intercolonial railway, before being shipped to Norton, 55 miles distant by rail, where it is used on the locomotives running between Moncton and St. John, and gives satisfaction as a steam producer. A number of mines in the Minto area are connected by railway, all of them are apparently on the same seam, though only at four are the two seams worked, the others mining the upper or 20" seam only. The output of all the mines in this belt is shipped by rail, but in a number of others situated nearer the shore of Grand lake, the old method of hauling to the wharf and shipping by water, as run of mine coal, is still maintained. But little, if any, attempt is made at cleaning this latter part of the output, and the resulting coal is dirty and unsatisfactory as a first-class fuel, containing considerable slate, and bunches of sulphur. About 1,000 tons of this variety are thus shipped yearly. The seam is sometimes worked by stripping off the surface rock and soil, but this is only possible when the coal lies near the surface. The entire coal output during the past year was about 40,000 tons, which, as compared with the annual production under the old system, of 8,000 to 10,000 tons, shows a marked advance. This output could be largely increased if miners could be readily obtained. The amount of coal taken per acre from the 30" seam is estimated at nearly 4,000 tons, all the coal being removed as the mining progresses. It has thus been proved that the Grand Lake coal, when properly mined and handled, can furnish a fuel for steam or house purposes equal to that produced from most of the mines of Nova Scotia, and that by economic efforts, it will yield a fair profit to the operator. This screened coal brings \$3 per ton delivered to the Intercolonial railway at Norton Station."

The second field in which mining is being carried on on a small scale is in Kent county, in the vicinity of Beersville. A small seam, under 20" in thickness, is worked on the banks of Coal branch, a tributary of the Richibucto river. The mine consists of levels driven into the bank of the stream, and hoisting to the top of the bank is done by a horse whim. A spur 7 miles long connects the mine with the Intercolonial railway. Mining operations are on a small scale.

Another coal-bearing area occurs at Dunsinane, on the Intercolonial, about 30 miles southwest of Moncton, separated from the southern

margin of the main basin by ridges of lower Carboniferous and in places by igneous rocks. On the south, also, a prominent ridge of lower Carboniferous sediments is seen, and the width of the basin of coal rocks is about 4 miles. Near a small brook (Stones brook) the coal outcrops in a seam of 18" to 20", which has been opened by several drifts to a depth of about 75 feet, and small shipments have been made, and have given satisfaction. This coal when carefully mined resembles in character the coal from the Grand Lake basin.

Some years ago a series of borings was made with a diamond drill in this small basin, one of which was carried down to a depth of 1,300 feet. In several of these holes two seams were cut, an upper as seen in the drifts, and a lower of somewhat variable thickness according to the logs. The latter showed a tendency to approach the upper and form one seam, as in the case of the seams at Minto. Borings to settle this point are now in contemplation, and if the dip of the seams is constant, their junction should be a short distance north of Shives siding, in which case a seam with a thickness of 2½ feet may be found. If at a depth not too great, this should be workable, owing to its proximity to the railway.¹

The King Mine

(Sample No. 11)

G. H. King operates the King mine at Minto, New Brunswick. This is the most important of the Grand Lake coal field mines, all of which are, however, small individual undertakings. The property comprises 500 acres. The coal seam worked is 30" thick with almost no parting. The workings are entered by a shaft, 35 feet deep, 25 feet of which is through drift. The seam lies nearly horizontal.

The boiler equipment consists of two boilers of 25 H.P. each. The hoist can raise two boxes per minute containing 300 pounds of coal each. This coal is dumped over a bar screen into a pocket, from which it is loaded into the cars of the New Brunswick Coal and Railway Co., which has spurs connecting several mines with the main line at Minto. The output of the mine is about 40 tons a day, with 20 men working underground.

This coal field is connected with the Intercolonial railway at Norton, by the line of the New Brunswick Coal and Railway Co., 60 miles long. Moreover, a certain quantity of coal is shipped by water to St. John and to Fredericton by way of Grand lake, in schooners which can carry 75 to 100 tons. The total annual production of coal in New Brunswick is at present approximately 60,000 tons.

THE LIGNITES OF NORTHERN ONTARIO

In the central part of Canada, between the western boundary of New Brunswick and the eastern boundary of Manitoba, apart from the very recent

¹ Dr. Ellis' Mineral Resources of New Brunswick, Geological Survey report.

deposits of Quaternary age. all rock formations antedate any known coal-bearing strata. In the early geological periods during which the sedimentary rocks were deposited, conditions, as revealed by fossil remains, were not favourable to the deposition of the thick beds of vegetable matter which in later periods went to make up coal seams, as in the case of Productive Coal Measures. The parts of the Provinces of Quebec and Ontario which are at present accessible contain no rocks newer than the Devonian, with the exception of an area in the Gaspé peninsula. However, in the northern part of Ontario, beds of low grade lignite occur in the clays and sands of glacial age. These lignite deposits, which Dr. James M. Bell called Interglacial coal measures, have been described at length in the Thirteenth Report of the Ontario Bureau of Mines. They are particularly well developed in the Moose River basin, and although they are far too remote to be of any present economic value, they constitute fuel assets which may become important in the future.

COALS AND LIGNITES OF THE GREAT PLAINS ALBERTA AND SASKATCHEWAN

In Manitoba, the easternmost edge of the rocks in which fossil fuels may be present, viz., those of Cretaceous and Tertiary ages, which underlie practically the whole area of the great plains, comes in approximately on the 98th degree of longitude, and the easternmost lignite bearing basin so far recognized is that of Turtle mountain, on the 100th degree of longitude. These rocks extend without any break to the summit of the Rocky mountains, and are usually so little disturbed that in the eastern parts of the plains the various series of beds are, in a general way, found to be nearly horizontal. "Where there are known outcrops of lignite, it would be most probable that the continuation of the beds would, within certain limits, be found along a line representing points of equal elevations." As the mountains are approached, the measures, of course, become more disturbed.

It may, therefore, be stated that in the west the coal seams are referable to the Cretaceous system and to the Laramie formation, which may be regarded as its upward continuation. These rocks are of more recent age than the productive measures of the Atlantic coast, where all the coals are carboniferous.

A very remarkable feature in connexion with the western coals, which has a practical bearing as well as theoretical, is the gradual change in these fuels on approaching the mountains. As we proceed towards the west, from Manitoba to the Rockies, various grades of coals, ranging from lignites to anthracitic coal, are met with and exploited. Dr. Dawson expresses himself as follows on these conditions: "On reviewing the whole of the analyses of the fuels, and referring them to their localities on the map, it will appear that lignites which contain, when thoroughly air-dried, about 12 per cent of water, occupy the eastern part of the area underlain by the Lignite Tertiary, while beyond about the 113th meridian, many, if not most of the fuels

¹ D. B. Dowling, Geol. Surv. Rep. Vol. XV., 1902-3.

met with, contain less than that amount of moisture, and pass, by easy gradations, in some instances, to coals indistinguishable from those of the Carboniferous formation. Those two regions are not, however, mutually exclusive, for west of the line above indicated, lignites of the former class are often found, and also apparently fuels representing all intermediate stages."

In the mountain region, the prevalent formations are of Palaeozoic rocks, but these disturbed areas contain several long fault blocks of Cretaceous and Laramie strata lying parallel to the trend of the mountains, and these contain fuels which are for the most part of the character of bituminous coals. In one case, in the Cascade basin, where the pressure from the west has been such as to virtually overturn the strata, the alteration has proceeded so far as to produce an anthracite of good quality. According to Dr. Dawson, in the disturbed belt of the foot-hills also, the fuels are entitled to rank as true coals: as the analyses show a range from 1.63 to 6.12 in hygroscopic water. The eastern edge of this belt, at a mean distance of 15 miles from the mountains, may be said to coincide with a water content of 5 per cent. This seems to indicate that the improvement in the state of the coals is due to metamorphism by dynamic causes, rather than to age of the coal seams. To the east of this belt of disturbance, the rocks subside almost at once to a condition of practical horizontality, and so continue over the entire area of the great plains.

Although it is impossible, in some cases, to assign boundaries to coal basins, owing to the comparatively small amount of work yet done, as compared with the immense territory in question, we give below a short description of the districts, or coal fields, as they may be separated at present, beginning with the easternmost ones and proceeding towards the west.¹

SOURIS RIVER AND TURTLE MOUNTAIN COAL FIELDS

In this region, which embraces the southeastern part of the Province of Saskatchewan, and the southwestern part of Manitoba, the geological formations have been very little disturbed, and as the surface is covered by a thick and continuous mantle of drift, the study of the structure, and the delineation of the workable areas offer great difficulties.

The two coal districts, viz., the Souris river and the Turtle mountain, are separated by an area in which no coal seams have yet been found and from which the coal measures have probably been eroded away. Therefore, although the coal measures of the two fields were probably at one time continuous, being similar in age and character, it is expedient to consider them as two distinct areas, particularly as their edges are some 50 miles apart.

TURTLE MOUNTAIN FIELD

The Turtle Mountain area is approximately bisected by the longitude meridian 100° 15' west, and its length in Canada is about 40 miles east and west along the 49th parallel of latitude, which practically bisects it.

¹ See also, Map No. 97, showing the coal fields of Alberta, Saskatchewan, and Manitoba.

The southern half lies in the State of North Dakota. The breadth in Canada is about 20 miles north and south.

According to Mr. D. B. Dowling,¹ "the coal horizon does not appear to consist of a series of seams in continuous sheets, but rather of deposits which are limited in extent, though repeated over large areas, and often superposed without the intervention of much clay or sand. The material from which the coal was derived seems in many instances to have been made up of a large percentage of woody matter, but a great part is probably composed of much smaller plant remains, similar in character to much of that in our present swamps and peat bogs, though of different species, such as would be found in a warmer climate."

In quality, this fuel is lignite, rather high in moisture. It disintegrates easily on drying, and will not stand long transportation in its natural state, but could be of great importance for local usage.

Seams have been worked at various points in a small way and intermittently. As early as 1890 a mine was being worked on section 12, township 1, range 24, west of 1st meridian. These workings were called the Vaden mine. The coal was worked by a shaft, some 40 feet deep, and hoisted by means of a farm engine. Dr. Selwyn gives the following notes on this mine in the Summary Report for 1890. "The coal was struck at 40 feet: 4'-6" thick, then 12 feet of sandy shale, and then bands of iron ore; coal 1'-6", then bored 35 feet through sandy shale, total 78'-6"."

Another mine from which a certain quantity of lignite was extracted is the McArthur mine, situated on section 11, township 2, range 33. A shaft was sunk on three seams, which are given as follows by Dr. Selwyn:—

First seam at 17 feet.	2'-6"
Second seam.	2'-6"
Third seam, thickness not ascertained.	

This mine was worked for several years, and the coal sold for local use.

SOURIS RIVER FIELD

This field forms the northern extension of the North Dakota lignite bearing region. The brown coal beds are in this case contained in horizons constituting the base of the Tertiary. The seams are numerous, but owing to the character of the country and to the thick covering of superficial deposits, it is very difficult to study the coal formation in this district. The area covered by the coal-bearing horizons in this part of the Province of Saskatchewan exceeds 4,000 square miles; it extends some 150 miles along the International Boundary, from longitude 102° westward, and has an approximate average width of 25 miles north and south. Of this immense tract, only a very small portion is being worked or has been studied in detail; very little is known of its possibilities beyond the small area in which are situated the mines near Estevan on the St. Paul line of the Canadian Pacific railway.

The Estevan district, as it may appropriately be designated, has been the object of an examination and of a report by Mr. D. B. Dowling of the

¹ Geol. Surv. Can., Annual Summary Report, Vol. xv., 1902-3, p. 202 v.

Geological Survey In this part of the field he has divided up the coal formation into three horizons, the upper, the middle, and the lower.

In the upper horizon the main seam is 4 feet thick and fairly continuous. It locally thickens to as much as 8 feet. In other places the coal seam of the middle division appears to join this upper seam, giving an aggregate average thickness of some 7 feet.

The lignite of the upper horizon has been mined for local use in several places, but generally yields a fuel of rather inferior quality.

The middle horizon is characterized by a very variable seam, ranging from 2 feet to 6 feet in thickness, sometimes split into three seams. In places this is from 10 to 60 feet below the upper seam, from which it is separated by indurated clays and sands, while at other points the upper and the middle seams join together.

The lower horizon contains several seams which in places come together, presenting a thickness attaining sometimes 8 feet. This horizon is the most important one, as the lignite which it contains is of better quality than those in the overlying horizons. Its distance from the middle seam averages probably 50 feet.

The lignite is rather low in fixed carbon, and high in moisture. These conditions make it difficult to transport or to store without great loss, and are also productive of great waste in the course of mining. On a comparatively short exposure to the air, the contained water is lost, and this causes a disintegration, and in time a reduction to powder.

From the commercial standpoint, the lower seam is the most important, and as it attains a thickness of 8 feet, this would yield some 11,000 tons an acre, or nearly 10,000,000 tons to the square mile. According to Mr. D. B. Dowling "from the fossil remains collected at different times from this locality it has been generally recognized that these beds are directly comparable with the Fort Union group, whereas in the Edmonton district of northern Alberta, the beds which were referred to the Laramie are divided into two series: the lower deposited in brackish water, and the upper in fresh water. The upper series, or Paskapoo, contains a fauna that is certainly very similar to that found in the Souris, and may, therefore, be correlated with it. The Souris rocks are thus probably situated at the base of the Tertiary, and above the upper part of the transition series at the top of the Cretaceous."

The following section of the measures, in descending order, was observed at the Sugarloaf hill, on section 33, township 1, range 6, west of 1st meridian.

Surface elevation.	1,855 feet
Clays and sandy clays.	13.6
Lignite.	4.6
Clay, shale, and sandstone.	11.4
Lignite.	1.0
Clay and sandstones	11.9
Lignite.	1.0

Clay,	1.3
Lignite,	0.7
Clay,	6.11
Lignite,	0.3
Shale, sandstone, and clay.	15.0
Lignite,	0.6
Clays and sandstone	12.10
Lignite, lower seam.	8.0

There are several mines operating in this district, the principal ones being described below:—

Towards the western edge of this area, in the Wood Mountain district, sections observed along escarpments show a number of beds of lignite, the character of which resembles closely those of the Estevan district. They are found in beds, ranging in thickness from 3 feet to 17 feet, under similar conditions, in rocks of Laramie age, this formation being continuous along the 19th parallel between longitudes 102 and 107. The lignites have not been exploited in this western part of the area, and the following analyses are of specimens obtained from the outcrop:

	Wood Mountain	
	Lower Seam.	Thick Seam.
Fixed carbon,	16.98%	38.95%
Vol. comb. matter	37.60 "	37.73 "
Water,	12.26 "	18.61 "
Ash,	3.16 "	4.71 "

Western Dominion Collieries Company

(Samples Nos. 40 and 2040)

This Company operates a colliery situated at Taylorton on section 3, township 1, range 6, west of 2nd meridian, in the Souris River lignite field, working a seam of lignite 7'-6" thick, by a slope which goes through the overlying rocks for a distance of 260 feet, and cuts the seam at a vertical depth of 90 feet. From the bottom of the slope a main entry has been driven for a distance of about 3,000 feet, and cross entries on each side extend to distances of about 3,000 feet. The mine works on bord and pillar system. Electric coal cutting machines are being introduced. Ventilation is effected solely by currents induced by large open fires at the foot of up cast shafts. Open lights are used throughout the mine. Underground haulage is by horses. The bankhead has the following dimensions: height, 35 feet, length 140 feet, width 35 feet. Hoisting drum is 52" in diameter, equipped with Mitchell tippie. Boiler plant consists of three boilers, 100 H.P. each, return tubular. Cars are loaded by a Christy box car loader, and weighed on two scales of 100 tons each.

The equipment has been designed for an ultimate output of 1,000 tons inten hours.

The mine is connected with the Estevan section of the Canadian Pacific railway, by a spur line $5\frac{1}{2}$ miles long, from the mine to Bienfait station.

The coal is graded into six sizes, grate, range, lump, run of mine, slack and nut. The main markets are Winnipeg and Brandon.

This Company also controls a colliery near Bienfait, which was installed by the Canadian Pacific railway, and is well equipped with bankhead, sidings, etc., but this mine is only worked intermittently.

Eureka Coal and Brick Company

(Sample No. 41)

This Company is operating on section 13, township 2, range 8, west of the 2nd meridian. The seam worked is $7\frac{1}{2}$ feet thick, and is only 40 feet from the surface; the dip is slight and to the south. The mine is entered by a slope, driven on the seam in the bank of a deep gully. The main entry is at present 2,000 feet long. Horse haulage is employed in the workings and in the slope, and there is natural ventilation. When working to full capacity, the output of the mine is 200 tons a day, with a force of 50 to 60 men. Cars are loaded from a small bankhead at the mouth of the slope. This mine also supplies local wants by wagon. The Company operates an extensive brick-yard.

Manitoba and Saskatchewan Coal Company

This Company is working a seam near Bienfait, Saskatchewan, which has a thickness of 13 feet and lies practically horizontally at an average depth of 80 feet from the surface.

There are two shafts, each 80 feet deep; the hoisting shaft is 17 feet by $10\frac{1}{2}$, and the ventilating shaft 10 feet by 5 feet.

A small compressed air coal-cutting plant has been installed. The system of working is by pillar and stall.

Underground haulage is by horses, as the colliery is new and the workings are not yet extensive.

Ventilation is by a fan, 16 feet in diameter, used as forcing fan in winter and as exhaust fan in summer; its capacity is 100,000 cubic feet of air per minute. Naked lights are used. The boiler plant consists of two 100 H.P. return tubulars. The bankhead has a steel frame, and is equipped with self-dumping cages, shaking screens, and cradle car-loader.

The plant is designed for an ultimate output of 2,000 tons a day. The colliery is connected with the Estevan branch of the Canadian Pacific railway by a spur.

Other Collieries in the District

Beside these collieries, there are a number of less important ones, to the number of fifteen or eighteen, which supply local wants and work only intermittently.

Plate XII.



Western Dominion Collieries, Ltd., Taylorton, Sask.

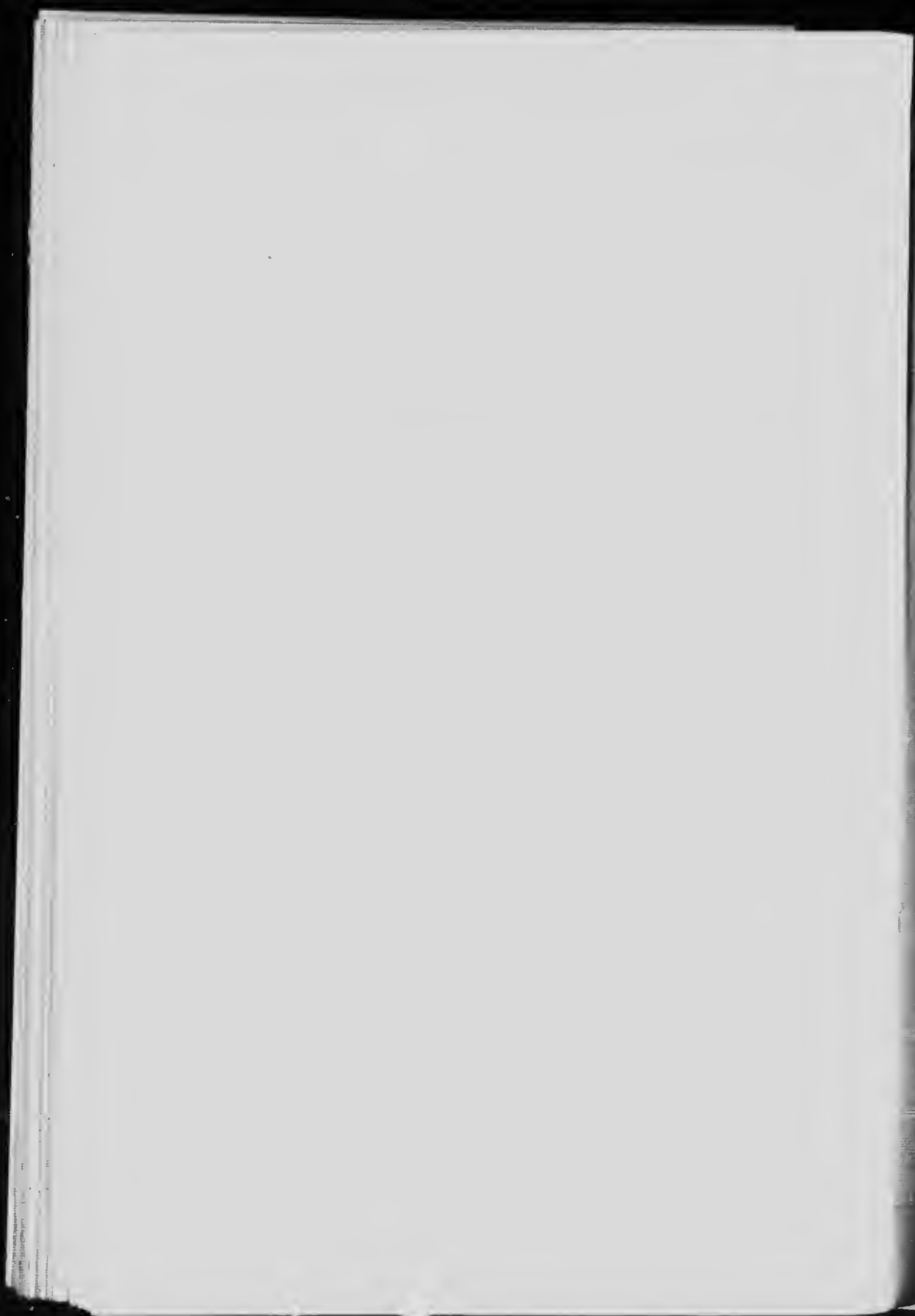
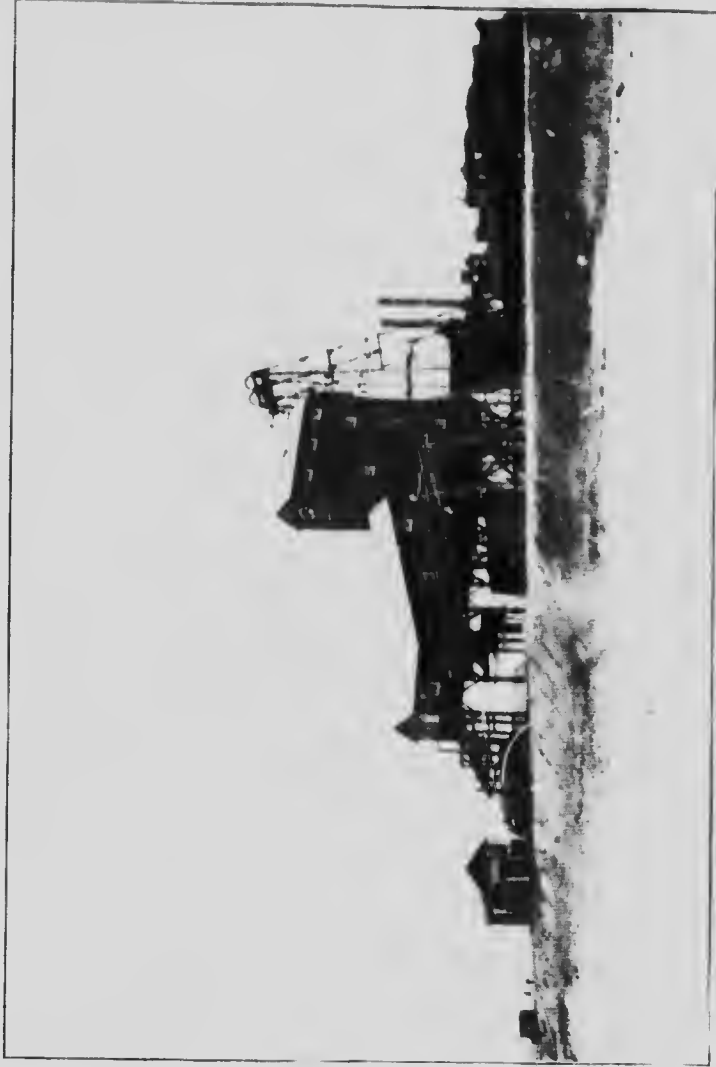


Plate XIII.



Manitoba and Saskatchewan Coal Co.'s colliery, Benfat, Sask.

EDMONTON SERIES AND LARAMIE COAL FORMATION

The Belly River coal horizons next described are overlain by two series which are also coal-bearing. These are the Edmonton series and the lower part of the Laramie, which in western Canada constitute the top of the Cretaceous. There is no sharp line of demarcation between the lower part of the Laramie, which has been placed in the Cretaceous, and the upper part, which is referred to the Miocene. These rocks have a very wide distribution, the central line of which runs approximately from intersection of longitude 113 and the International Boundary to the intersection of longitude 120 with latitude 55° 30'. At its greatest breadth now known, which is along an east and west line passing through the city of Edmonton, the width is about 140 miles, and the total area which these formations cover amounts to over 35,000 square miles.

The Edmonton series is essentially a coal or lignite-bearing formation, the bottom of which rests conformably on the Pierre shales. The top is marked by an extensive coal deposit, well developed in the Edmonton district. To the west, beyond the Pembina river, these rocks disappear under the overlying series, to which the name Paskapoo has been given. At the Pembina crossing, beds of lignite showing thicknesses of 6, 12, and 13 feet outcrop in the rocks of the Edmonton series, and on the Saskatchewan one bed reaches 25 feet of workable coal. In the immediate vicinity of Edmonton there is a very persistent bed of lignite, lying practically horizontally a few feet above the level of the river, and this is extensively worked. This seam gives from 5 to 6 feet of good, clean, lignite which is mainly used for domestic purposes.

The Edmonton series of coal-bearing rocks is overlaid throughout a great part of Alberta by rocks of the Paskapoo series. These would be the equivalents of the beds which in the region below the main line of the Canadian Pacific railway were classed by Dr. G. M. Dawson as the Porcupine hills and the Willow Creek series. They lie in a wide strip between Cardston in the south and Wetaskiwin in the north, 10 to 30 miles on each side of the McLeod-Calgary-Edmonton line of the Canadian Pacific railway, which practically runs through the centre of the region. These upper rocks contain small seams of coal, which are worked for local use, but their importance as coal-bearing beds is insignificant as compared with that of the underlying Edmonton series.

The following collieries are at present working on the lignite seams of the Edmonton series.

Edmonton Standard Coal Company

(Sample No. 45)

This Company operates a mine on river lot 26, Edmonton settlement, on the north bank of the Saskatchewan river, just east of Edmonton. The seam varies from 3'-6" to 6 feet, and is very level, the rise being about 1

foot in 500. The mine is worked by a shaft 60 feet deep sunk in the valley near the mouth of Rat creek. This valley is about 175 feet below the general surface, which means that the coal lies at about 235 feet from the surface.

Work was started in 1905 on pillar and stall system, and the mine has since been producing steadily. The output is 100 tons per shift. The lignite is marketed in Edmonton, mainly for domestic uses.

Parkdale Coal Company

(Sample No. 42)

This Company operates a mine on river lot 22, Edmonton settlement, near Edmonton, by a shaft 196 feet deep, on a seam which is 4'-6" thick, worked by pillar and stall method, using punching machines to undercut the coal. The seam is practically horizontal, and there are headings to the southeast, to the northwest, and to the northeast, which are in approximately 300 feet each. The lignite is dumped on a bar screen 12 feet long and loaded directly, either in wagons for teaming to Edmonton, or in cars for shipping by the Canadian Northern railway, on which line the colliery is situated. The capacity of output of the mine is about 100 tons per shift.

Strathcona Coal Company

(Sample No. 46)

The Company operates on river lot 9, Edmonton settlement, on the south bank of the river, west of the town of Strathcona. The seam is worked by a shaft, the workings extending about 700 feet south and 200 feet north from the foot of the shaft. The lignite is all shipped by teams, mainly to Strathcona. The capacity of the mine is 50 to 75 tons a day.

Twin City Coal Company

This Company began operations in Strathcona city, Block F, in 1908. The seams of lignite are two in number, 5 and 6 feet respectively, and are worked by a shaft 170 feet deep, and parallel entries which are 600 feet in lower seam and 150 feet in upper seam. Method followed is pillar and stall, coal being mined by Hardy coal cutters. Underground haulage is by mules. Open lights used. Boiler plant at present consists of one Robb water tube boiler of 80 H.P. The hoisting is done by a 32 H.P. Allis Chalmers Bullock engine. The tippie is equipped with shaking screen. Coal cutters are worked by a 22 H.P. two-stage Ingersoll air compressor.

The main markets are, at present, the cities of Edmonton and Strathcona. The mine is equipped for a possible output of 500 tons a day.

Alberta Coal Company

This Company operates the Alberta mine, on N.E. $\frac{1}{4}$ section 23, township 55, range 25, west of the 4th meridian; near Moriaville. The seam

Plate XIV.



Outcrop of lignite at crossing of Pembina river, Alberta.

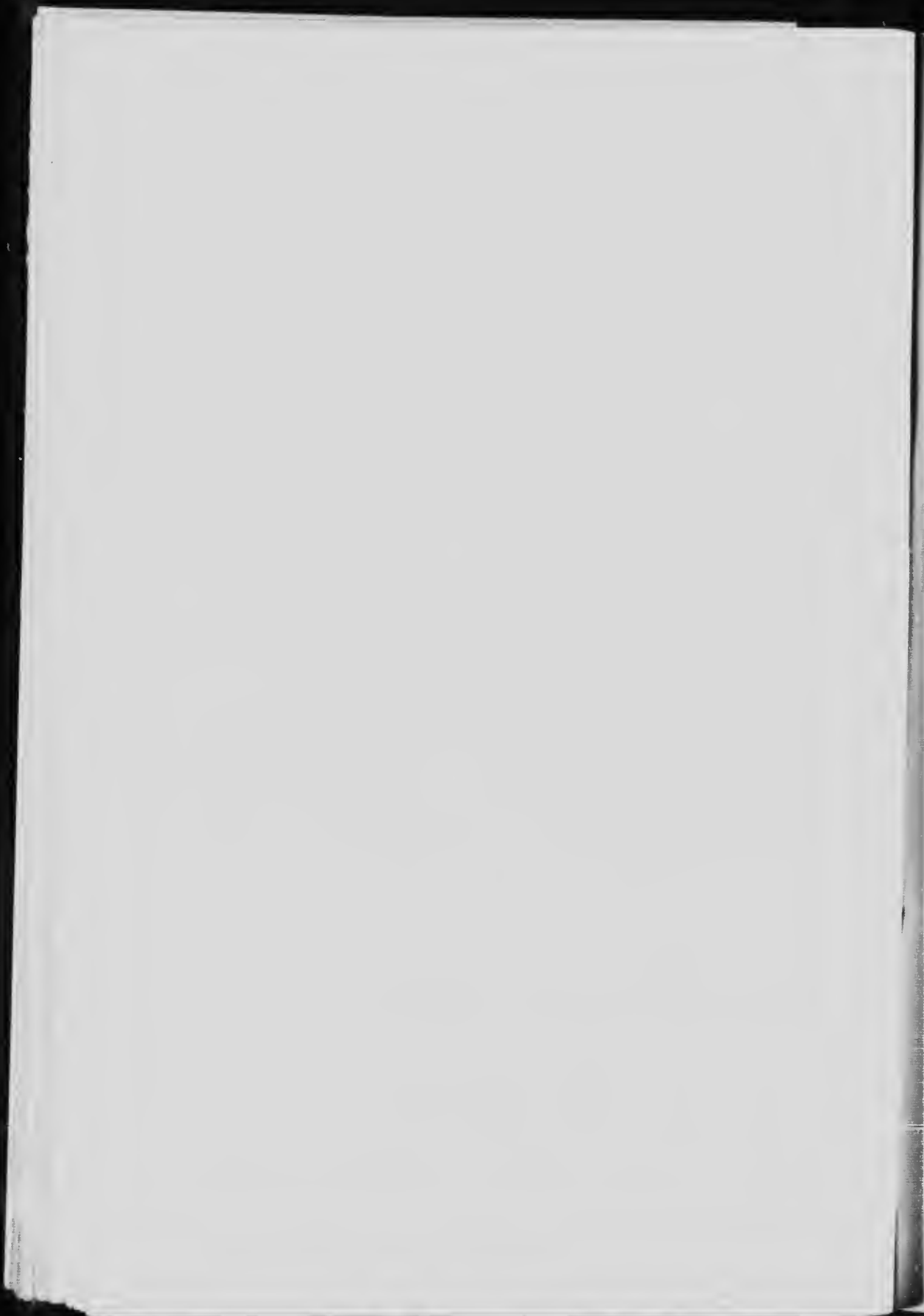


Plate XV.



View on Bank of Saskatchewan river, Edmonton: Edmonton Coal Co.



worked has the following section: coal 6 feet; parting of clay 6" to 2 feet; coal 6 feet. It lies at a depth of 15 to 40 feet from the surface. A slope 130 feet long reaches the coal and from this point a main entry 1,400 feet long runs south, with levels east and west every 200 feet. The rooms are worked north from the levels. Pillars and rooms 20 feet each. Haulage is done by horses. Ventilation is natural, and naked lamps are used. The surface equipment comprises hoisting machinery of 50 H.P., shaker screens, etc. The main market is Edmonton and the towns along the Canadian Northern railway as far east as Saskatchewan; it is expected that in the near future there will be another market along the Grand Trunk Pacific railway. The possible daily output of the colliery is at present 500 tons.

Cardiff Coal Company

Operating the Cardiff mine, on N.W. $\frac{1}{4}$ section 24, township 55, range 25, west of the 4th meridian, adjoining the property of the Alberta Coal Company. The seam of lignite is reached by a shaft 45 feet deep, and the workings of the mine cover an area of some 10 acres. Ventilation is natural, and naked lights are used. The conditions under which the mine is operated are very similar to those of the Alberta mine described above. The equipment is for approximately the same capacity of output.

Diamond Coal Mine, Limited

The mine operated by this Company is situated at Diamond City, in township 10, range 21, west of 4th meridian. The holdings comprise rights for 5,000 acres. The seam is 5 feet thick and lies horizontally. A main entry goes in along the bank of the river, and is about 40 feet above the water level. The lignite is hauled to the tippie along the slope 300 feet in length. Up to the present the total amount of work done is in the vicinity of 10,000 lineal feet, mostly of a development nature. Under-cutting is done by electric cutters; underground haulage is done by electricity; ventilation is natural, but a fan will soon be installed. Open lamps and electric lights are used. The surface equipment comprises 3 boilers of 150 H.P. each, hoisting engine; one 250 K.W. and one 150 K.W. electric generators. The mine is yet in the development stage, but when railway connexion is secured it is the intention to handle 1,200 tons a day.

Besides these mines there are a number of others more or less important which supply the local wants of domestic fuel. Among these may be mentioned the Humberstone Coal Company, the Bush May Coal Company, the Clover Bar Coal Company.

BELLY RIVER FORMATION

The Belly River coal formation occupies the middle of the Cretaceous in the geological scale. As to its distribution in the western provinces, it covers

large tracts in southern Alberta and in Saskatchewan, just east of the 4th principal meridian. The axial line of the territory in Canada covered by the measures of this formation, would have its southern extremity at the intersection of the International Boundary or 49th parallel of latitude and longitude $111^{\circ} 30'$, and its northern one at the junction of latitude 53° with longitude 109° , this giving a development of about 250 miles in length, by an average width of 75 miles, or an area of 18,000 to 20,000 square miles. All of this, of course, is not underlain by coal, but the aggregate quantity of fuel available for economic purposes is enormous. The data available are insufficient for a trustworthy approximate estimate of the quantity of fuel existing in the entire region, but some idea may be hazarded for certain limited areas. For instance, Dr. Dawson has calculated that in the Lethbridge district, taking the proved outcrop of one seam, and supposing this to be workable for a width of one mile, there is present a quantity of 330,000,000 tons of coal. In the Medicine Hat district, taking an area of 30 square miles, there is a quantity of over 150,000,000 tons. Large tracts of the country along the Crows Nest line of the Canadian Pacific railway, between Lethbridge and Taber, have been proved to be underlain by a 4 ft. seam, the area of which has not been sufficiently delimited to advance an estimate of the coal contained. But the potentialities of these resources are very great, and it may be safely said that for centuries to come the output will only be limited by the market.

The coal seams of the Belly River formation are lower in the geological scale than those to the east, in southeastern Saskatchewan and Manitoba. The two coal bearing horizons are separated by a vertical thickness of 1,000 feet of shales.

As to the relative quality, the lignites of the Belly River formation are nearer the true coals than the fuels of the Estevan district; and their fuel ratio much higher.

Dr. Dawson has divided the Cretaceous of this part of Canada into four geological series, to which he assigns the following thicknesses:-

Cretaceous

Fort Hill Sandstone.- In some parts of the district well defined as a massive yellowish sandstone, but unconstant and apparently often represented by a series of brackish water transition beds between the Laramie and Pierre—80 feet.

Pierre Shales.-Neutral grey or brownish to nearly black shales include a zone of pale soft sandstone in the northeastern part of the district, and frequent interpolations of harder sandstones near the mountains: marine—750 feet.

Belly River Series.-Composed of an upper, and a lower pale or yellowish portion, and consisting of alternations of sandstones, sandy clays, shales, and clays—910 feet.

Plate XVI



Parkdale Coal Co.'s colliery, Edmonton, Alta.



"*Lower Dark Shales.*—Grey to nearly black shales, alternating frequently with arenaceous shales—800 feet."

"There is no evidence of disturbance or any unconformity greater than that caused by trifling local erosion, throughout the whole of the great thickness of beds, the passage from one series to the next being frequently of so gradual a character as to leave the observer in some doubt as to the point at which the dividing line should be drawn."¹

The most widely worked seam of this development appears to be at the base of the Pierre shales. It is by far the most persistent, and is operated on quite a large scale in several places along the Crows Nest line of the Canadian Pacific railway, between Lethbridge and Medicine Hat.

The following are sections of coal seams in different parts of the field:—

Lethbridge.		Taber.	
Top coal.	1'-6"	Shaly clay	
Shale.	2'-6"	Roof coal.	7"
Lower bench.	3'-3"	Parting.	3"
		Coal.	41"

The following collieries are now working in this field, which is mainly exploited in its southern part, between Taber and Lethbridge.

Canada West Coal Company

(Sample No. 43)

This Company operates a colliery situated on section 31, township 9, range 16, west of 4th meridian, immediately west of the town of Taber, 30 miles east of Lethbridge, and 75 miles west of Medicine Hat. The Company controls about 12,000 acres of coal lands. The coal worked is almost horizontal, and has the following average section: roof, calcareous and sandy shale, with shells; splinty coal, 3" to 7"; shale parting 3" to 4"; clean coal 41" to 12"; floor, shale and argillaceous rock.

The seam is reached by a slope, driven at an angle of 19° and 300 feet long and is worked by pillar and stall method, the rooms being 35 feet wide. It is undercut by electric coal cutters and by compressed air punchers. Underground haulage is by horses to the main haulage way, where the boxes, containing 3,000 pounds, are picked up by electric locomotives. Haulage from the foot of the slope is by endless chain. On the bankhead, which is of steel, the cars are dumped automatically, the coal weighed and screened on shaking screens, and loaded by an Ottumwa box car loader.

The ventilation is by Capell fan of rated capacity of 300,000 cubic feet of air per minute. Naked lights are used throughout the mine. Boiler plant comprises 6 horizontal tubular boilers of 165 H.P. each. Compressor plant 100 H.P. Rand compressor. Electric plant, two 150 K.W. 250 Goodman electric generators for mine haulage, coal-cutting machinery, motors in shops, and electric lighting.

¹ Geological Survey Report 1882-S4, p. 112 c.

The capacity of the mine with present equipment is over 1,500 tons per eight hour shift, with a force of 350 men

Reliance Coal Company

This Company operates a mine on section 3, township 10, range 16, west of the 1th meridian, on line of Crows Nest Pass branch of the Canadian Pacific railway 2 miles east of Taber, Alberta.

The seam which is reached by a shaft, 100 feet deep, may be the same as at the Canada West Coal Co.'s mine, but it is much more irregular.

The bankhead 60 feet high, is equipped with shaking screens and picking tables. The boiler plant consists of two locomotive boilers of 50 H.P. each. This mine was started in 1905, but has not been in continuous operation. The possible output would be in the vicinity of 300 tons a day.

There are several other mines working in the Taber field, the operations of which are more or less intermittent. The following list is taken from the report of the Inspector of Mines for Alberta for 1908:

Consolidated Mines; Domestic Coal Company; Thos. Irwin; John Howells; John Marsh; Central Coal Company; Fox and Simms; Bucknam and Henderson; Marsh Bros; Imperial Coal Company; Coal City Coal Company; Hannah and Mae; H. Y. Reynolds; Monarch Collieries; Jos. E. Shirts.

Alberta Railway and Mining Company

(Sample No. 44)

This Company operates the Galt colliery, at Lethbridge, Alberta, situated on section 6, township 9, range 21, west of the 1th meridian. The Company owns some 10,000 acres of coal lands in township 9, ranges 21 and 22, and works one seam which has the following section: coal 1'-6"; parting 2" to 6"; bottom coal 2'-6". The general dip is very slight, about 125 feet per mile to the south. The mine is worked by two shafts, 340 feet deep, one for hoisting, and the other for ventilation. The main workings extend to the west under the bed of the Belly river. Coal cutting is done by 27 Ingersoll punching undercutters operated by compressed air.

The method of working which is followed here is by pillar and stall, the pillars being ultimately removed, while the roads are protected by barriers.

The underground haulage is by endless rope, the line now being nearly 1 miles long; supplemented by horse haulage which never exceeds 1,000 feet.

The ventilation is by a Capell fan, of a capacity of 45,000 cubic feet, and the mine is so free from gas that naked lights are used exclusively.

The boiler plant consists of nine Robb-Mumford boilers, aggregating 1,200 horse-power.

Compressor plant comprises one Ingersoll straight line, one Norwalk and one Duplex Rand, and lately there has been added to these a Rand compressor of a capacity of 3,500 cubic feet free air per minute.



Canada West Coal and Coke Co.'s colliery, Taber, Alta

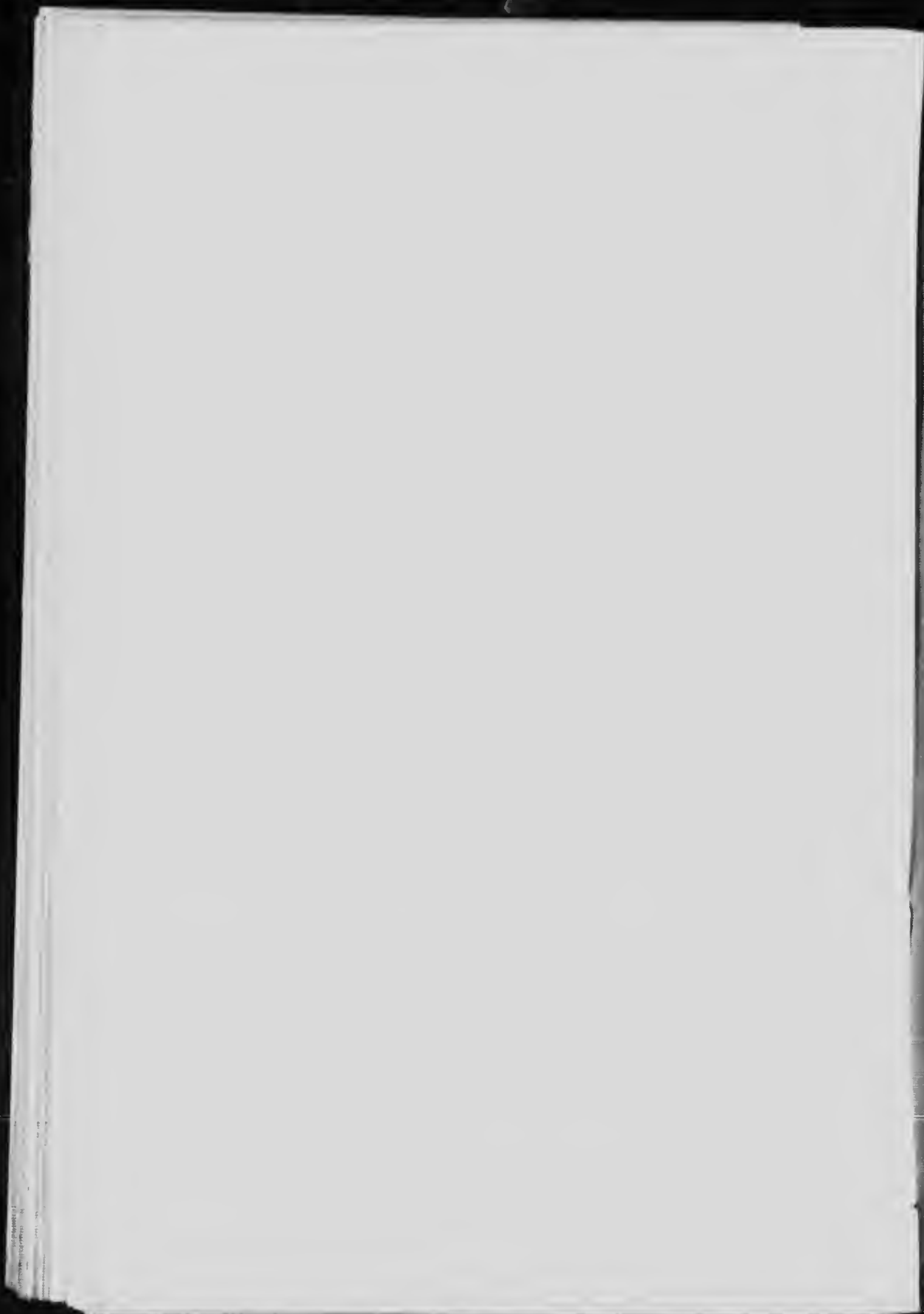
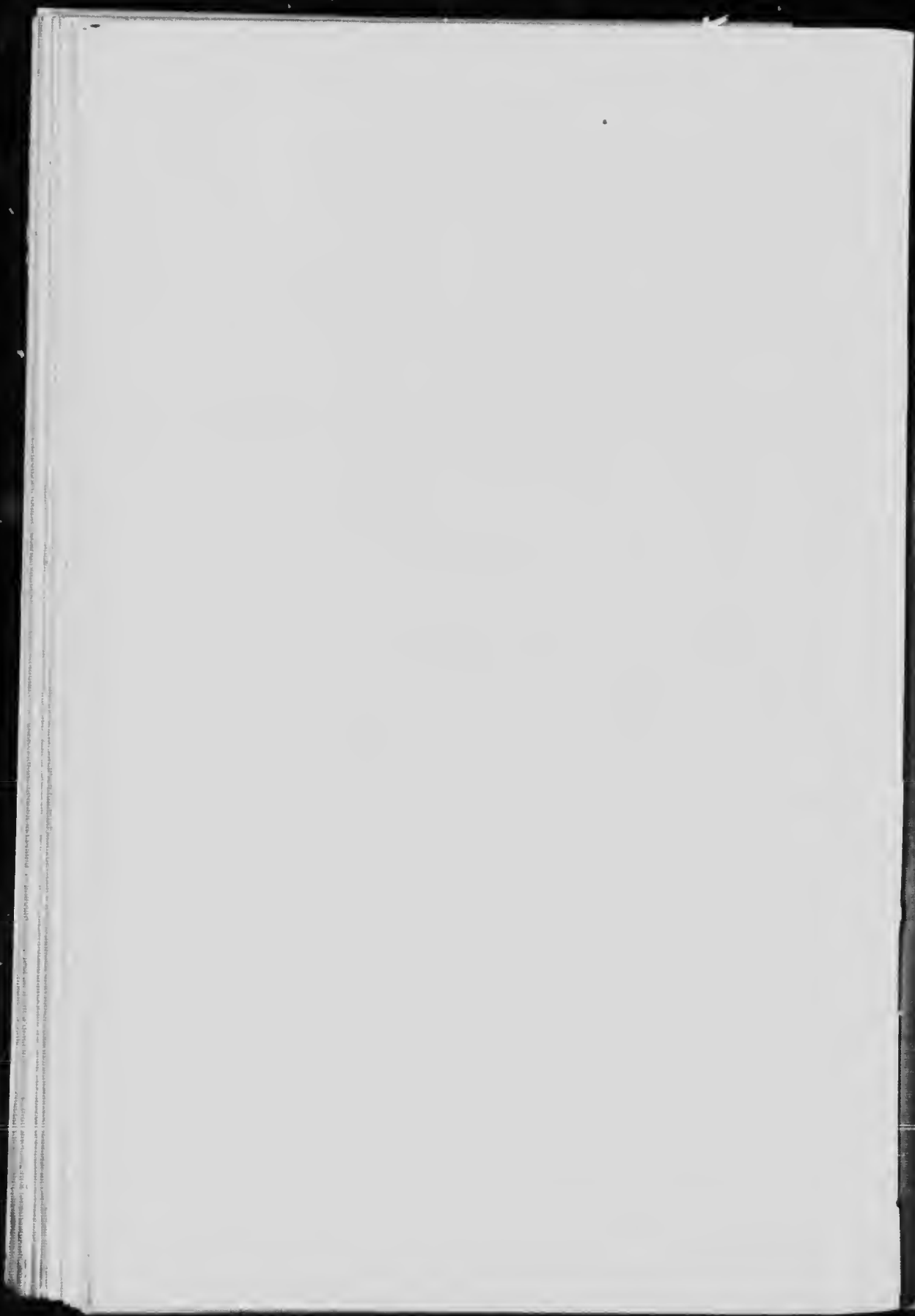


Plate XVIII



Coal colliery, Lethbridge, Alta.



The tippie is equipped with shaking screens, picking belts, box car gravity loader, etc., and like the colliery is laid out for a possible output of 2,000 tons a day, with a force of 600 men.

The Galt colliery has been in operation for over 25 years, and the coal, a high grade lignite, is mainly sold for domestic purposes. It is shipped as far east as Winnipeg, and as far south as Butte and Grand Falls in Montana. The colliery is situated at the junction of the Canadian Pacific railway and the line of the Alberta Railway and Irrigation Company, which connects Lethbridge with Cardston, Alberta, and with Great Falls, Montana.

The Alberta Railway and Irrigation Company are at present developing a new mine $2\frac{1}{2}$ miles directly north of the Galt colliery. The same seam is to be worked by two shafts which cut the coal at a depth of 390 feet. The collieries are to be connected by a standard gauge road $2\frac{1}{2}$ miles long. The new mine is to be equipped with a steel tippie and necessary machinery for an output of 1,800 tons a day.

Royal Collieries, Limited

The mine of the Royal Collieries is situated on section 32, township 9, range 21, west of the 4th meridian, and the Company controls 11 sections of coal lands. The seam being worked, a lignite of good quality, is entered by a slope driven at an inclination of 30° in the side of a coulee. The seam is horizontal, and is worked by pillar and stall, double entry system. The workings extend only a few hundred feet, in three directions, but the mine is being developed rapidly. Mining is done by Ingersoll coal-punching machines.

Underground haulage is by horses; mechanical power will be used later when the mine is developed to a larger extent. Ventilation is by an electrically driven Murphy fan.

There is a hoisting engine, 150 H.P., and the necessary boiler plant to run this, as well as the air compressor and the electric generator.

The tippie is equipped with screens and a steel pocket scale for weighing the coal, which is graded into three sizes, hump, nut, and slack. The tippie can handle 400 tons a day. There are at present 80 men employed, but this number will be increased as the mine develops. Rail connexion with the Canadian Pacific railway at Lethbridge is made by a spur 5 miles long.

Breckenridge and Lund Coal Company

(Sample No. 47.)

This Company operates a colliery at Lundbreck, Alberta, on the Crows Nest Pass line of the Canadian Pacific railway, 75 miles west of Lethbridge. The Company controls about 1,400 acres of coal lands. The mine is located on S.E. $\frac{1}{4}$ section 26, township 7, range 2, west of 5th meridian, on a seam of average thickness of 9 feet, dipping 60° to 80° and rather disturbed. The shaft is 360 feet deep, and there is also a tunnel driven in from the bank of the Belly River, which connects with the shaft. Ventilation is by a Guibal

fan of a rated capacity of 50,000 cubic feet of air per minute. The surface plant is very complete, consisting of steel bankhead, equipped with machinery for self-dumping cages, shaking screens, picking belts, etc. The fine coal going through the screens is raised by bucket elevator to a revolving screen, and classified into nut, pea, and dust.

Boiler plant comprises two Clyde boilers, marine type, of 125 H.P. each. The hoisting engine drum is 10'-6" diameter. The screening plant is designed for an output of 500 tons a day, but could easily be increased. The tippie, power plant, etc., could handle 1,000 tons in 10 hours.

There is a small electric light plant of 350 lights (16 candle power), also a water supply system, etc.

Galbraith Coal Company

This Company operates at Lundbreck, Alberta, in an area contiguous to that controlled by the Breckenridge Lund Coal Company. The mine is situated on section 25, township 7, range 2, west of the 5th meridian. It is working two seams of coal by slopes. The tippie is near the track of the Crows Nest line of the Canadian Pacific railway, and the bankhead is connected with the mine by an incline 1,500 feet long.

COALS OF THE EASTERN SLOPES OF THE ROCKY MOUNTAINS, ALBERTA

Immediately to the west of the wide expanse of upper Cretaceous rocks above described as comprising the coal-bearing formation of the Edmonton series, there occurs between the main range of the Rocky mountains and the formation above referred to, which is very little disturbed, a zone of crumpled rocks which have been subjected to very great dynamic disturbances and faulting.¹ This zone may be said to extend, in Canada, from the International Boundary in the south to a yet undetermined distance in the northern part of the Province of Alberta, the most northern deposits of coal noted so far in this zone of disturbed rocks being in the Yellowhead Pass district.

The coal-bearing areas of this zone along the eastern slopes of the Rocky mountains consist of elongated troughs of lower and middle Cretaceous rocks formed by the folding of the strata, the folds having been induced by the enormous pressure from the west which gave rise to the formation of the Rocky mountains. As a rule the overlying rocks have been eroded away, and there are left, in the synclinals, remnants of coal-bearing rocks, separated from each other by ridges of the older rocks which the anticlinal folds have raised and which have been exposed by subsequent glacial erosion.

The quality of the coals of these measures varies from bituminous coking and non-coking coals to anthracite containing 85 per cent or more of fixed carbon; the amount of volatile matter depending greatly on the degree of dynamic disturbance undergone by the beds. These coals are referable to the lower part and the base of the middle Cretaceous, being, therefore, older than the Belly River coals and the Edmonton series lignite, and they are in rocks known as the Kootanie measures.

¹ See Map No. 97, showing Alberta, Saskatchewan, and Manitoba coalfields.

The whole belt of the foot-hills and adjoining disturbed country to the east of it might be considered as an almost continuous zone strung with disconnected coal-bearing troughs of rocks of the Kootanie series; but from the commercial standpoint it may be divided into separate, and more or less well-defined coal fields.

THE BLAIRMORE-FRANK COAL FIELD.

This is situated in the southeastern part of Alberta and is served by the Crows Nest branch of the Canadian Pacific railway. It lies between longitude $114^{\circ} 15'$ and the summit of the Rocky mountains, comprising, in the main, townships 7, 8, 9, and 10, ranges III, IV, and V, west of the 5th meridian. This is a rather disturbed area, comprising several troughs of coal-bearing rocks, oriented north and south, separated by faults running in the same direction, and by ridges of the older underlying rocks which have been brought to the surface by uplift and subsequent erosion.

The coal-bearing strata have been placed by Mr. W. W. Leach, of the Geological Survey, into the middle and the lower Cretaceous, which are here conformable with the upper Cretaceous and have a general north and south strike.

In this field the total thickness of the middle and lower Cretaceous rocks containing the principal coal seams, approximates 740 feet, in which appear 125 feet of coal. In a section measured in the northern part of the field, on the slope of Cat mountain, one mile northeast of the confluence of Racehorse and Daisy creeks, the coal-bearing rocks have a thickness of 742 feet, and contain seven seams over 8 feet, six seams between 5 and 8 feet, and eight seams under 5 feet. Another section observed in the southern part of the field, on Byron creek, in 480 feet of measures, contains nine seams of 8 feet and over, the thickest measuring 16 feet. The coal as a rule is of good quality, although generally high in ash. When sufficiently pure, or after washing, it yields a good coke.

As has been mentioned before, the coal measures have been greatly disturbed by the folding induced at the time that the mountain building forces were at work. The dips vary from almost horizontal to vertical, and, in at least one case, a coal bed is being worked in slightly overturned strata.

There are at present¹ eight collieries in active operation in this field, besides several other less important openings, either of a prospecting nature or to serve a local demand. They are all on or within easy reach of the Crows Nest line of the Canadian Pacific railway.

Maple Leaf Coal Company

This Company operates a colliery one mile east of Bellevue, near the line of the Crows Nest branch of the Canadian Pacific railway; and controls one square mile of coal lands, on which they are working one seam 7 feet thick by a level adit. The mine is operated on a small scale as yet, em-

¹ Written in 1905 - the number is now greater.

ploying only 15 to 20 men. The equipment comprises a 60 H.P. boiler and a tramway connecting the mouth of the mine with the coal pockets on the railway. These have a capacity of 100 tons.

Leitch Collieries, Limited

(Sample No. 48)

This Company is opening up two coal seams at Passburg, $3\frac{1}{2}$ miles east of Frank. A main entry has been driven on a 7 ft. seam, which is thought to be identical with the Bellevue No. 1 seam. The entry is in 1,200 feet, and at a distance of 950 feet from the mouth a cross-cut tunnel is being driven to another seam. The equipment is temporary and only for development, although a permanent installation is expected to be put in at an early date.

Hillcrest Coal and Coke Company, Limited

(Sample No. 32)

The mine of this Company is situated on section 18, range 3, township 7, west of 5th meridian, 2 miles southeast of the town of Frank, Alberta. Work was started on development in July, 1905. The thickness of the seam exploited varies between 12 and 20 feet. Dip is 30° west. The workings are entered by a tunnel and a slope. The tunnel is 100 feet long, from the end of which a drift 2,600 feet long has been run. The slope, which is separate, is 2,500 feet long. The system followed is pillar and stall. Underground haulage is by horses to the mouth of the tunnel. Here the cars are made up into trains, and hauled to the tippie, a distance of 3,000 feet, by a small locomotive. The coal is here dumped and lowered 240 feet by a retarding conveyer, a chain with disks working in trough, to the coal pockets, from which it is loaded into the cars.

Ventilation is by fan of a rated capacity of 100,000 cubic feet of air. Safety lamps and electric lighting are used.

Boiler plant at the mine consists of two return tubular of 80 H.P. each. There is an air compressor for 10 drills. A small dynamo of 50 lights gives light on the surface and in tunnel.

The mine is equipped for an output of 600 tons a day, which could be increased with slight additions.

The coal pockets are connected with the line of the Crows Nest branch of the Canadian Pacific railway by a spur of standard gauge 2 miles long.

West Canadian Collieries, Limited

(Samples 33 and 28)

This Company controls 16,500 acres of coal lands in the Blairmore-Frank field, and operates two collieries: the Lille colliery, 4 miles north of Frank, and the Bellevue colliery, $1\frac{1}{2}$ miles east of Frank.



Washing plant and Bernard coke ovens, at Lille, Alta.



Lille Colliery. (Samples 28 and 2028).—On two seams, No. 1 and No. 2, which are respectively 4'-6" and 8 feet thick, and dip 35°. These are connected by a rock tunnel 750 feet long. The main entry on No. 1 has been driven for a distance of 5,000 feet, and there is also a slope a short distance south of the tunnel. The seam is worked upwards by chutes 150 feet apart. Every 30 feet breasts are driven across the pitch, then rooms 20 feet wide, leaving 30 ft. pillars. This work is carried upward to the outcrop, then the pillars are drawn in retreat. No coal cutting machinery is used.

Underground haulage is by compressed air locomotives, charged from compressor at pressure of 1,000 pounds per square inch. A hoisting engine is installed at the head of the slope, and has a capacity of 1,000 tons per ten hours.

Ventilation is by Capell-Clifford fan of rated capacity of 180,000 cubic feet per minute.

At the bankhead and power station the boiler equipment consists of four return tubular, giving a total of 600 horse-power.

On coming out of the mine the coal is dumped by a Phillips cross-over tippie to screens and picking belt; the coal over 1½" is shipped, and the undersize is sent to the coal-washer to be cleaned for coking.

The washing plant, erected near the coke ovens, has a capacity of 300 tons per 10 hours. The coal 1½" and under is screened in a washing trommel ¾" apertures; the oversize is marketed and the undersize is water sluiced to spitzkasten classifiers; from these it passes to ten Luthrig jigs which separate the coal from the shale. The refuse from the jigs carries from 50 to 60 per cent ash, but nevertheless is used successfully under the washery boilers. The washed coal carrying 8 to 12 per cent ash is drained and sent to coke oven bins. The washing plant only requires three men to operate it, one for the engine, one for the washing, and a third for the refuse.

From the coke oven bins the washed coal is loaded on lorry cars to charge the ovens. These latter are of the Bernard type, 50 in number, having a total coke output of 150 tons a day, for 18 hour coking, the charge for each oven being eight tons of coal.

The mine and the coking plant are connected with the Crows Nest line of the Canadian Pacific railway at Frank by the line of the Frank and Grassy Mountain railway, 7¼ miles long, standard gauge.

Bellevue Colliery. (Samples 33 and 2033).—This mine, situated on the Crows Nest line of the Canadian Pacific railway, is entered by a rock tunnel 510 feet long cutting four seams which dip at an angle of 40 degrees. On the main seam an entry some 10,000 feet long has been driven, and the coal is worked to the rise. The system of working which is followed here is the same as at the Lille colliery.

Ventilation is by two fans, one on No. 1 seam, capacity 50,000 feet per minute, and a second on No. 4, of a capacity of 15,000 feet. Lighting is by Wolf safety lamps. The tippie equipment consists of a Phillips cross-over feeder and a 6 ft. picking belt 50 feet long. There are two 100 H.P. return tubular boilers, and one small three drill low pressure com-

pressor. It is the intention to shortly install a complete air haulage system and to erect a steel tippie with Green's automatic dump screens, picking belts, box car loader, etc.

The mine employs at present 150 to 180 miners and 80 to 90 labourers underground, and 60 to 80 on the surface.

Canadian American Coal Company

The Company operate a colliery at Frank, Alberta, on the flank of Turtle mountain: controlling some 22,000 acres. The seam is almost vertical and in fact is slightly overthrown in places. It ranges in thickness from 10 to 20 feet, and is worked by a main entry now 9,900 feet long, driven in at the base of the mountain. The coal is worked up the pitch of the seam to the surface, which is reached at 400 to 1,200 feet above the main way, no coal being mined below the level of the main entry. All the cutting is done by hand. Other seams are present, to which cross-cut tunnels have been driven, but are not worked at present.¹

Ventilation is by a Murphy reversible fan of a rated capacity of 130,000 cubic feet per minute. Underground haulage is by main tail rope, to the mouth of the entry. From here the coal is hauled to the tippie, some 1,500 feet, by tail rope. The tippie building is equipped with screens, picking tables, and coal pockets. Boiler plant, 6 boilers, giving a total of 500 horse-power. Lighting is partly by naked lights, and partly by safety lamps; but the mine is not gassy. The mine is equipped for an output of 1,000 tons a day.

International Coal and Coke Company

(Samples 34 and 34 SP)

This Company controls over 3,000 acres of coal lands near Coleman on the Crows Nest Pass line of the Canadian Pacific railway, 5 miles west of Frank. At the mine, which is called the Denison colliery, two seams are being worked, which are designated as No. 2 and No. 1 respectively. They are separated by 150 feet of measures. The main entry is driven on No. 2 seam, and is now over 1½ miles long.² No. 1 seam is reached by a cross-cut tunnel driven from the main entry on No. 2 at 800 feet from the portal. No. 2 seam is 12 to 14 feet in thickness and No. 1 from 6 to 8 feet.

System of mining is by pillar and stall, and the coal is worked up the pitch. Every tenth room is carried through to the outerop, greatly facilitating ventilation. Pillars are subsequently extracted.

The output of No. 2 seam is a good steam coal, whereas that from No. 1 is used for the manufacture of coke.

The underground haulage is by compressed air locomotives, charged under pressure of 1,000 pounds per square inch. Ventilation by Capell fan, diameter 16 feet, capacity 150,000 cubic feet of air per minute. The coal is taken out of the main entry in trains of mine cars which hold 3,000 pounds.

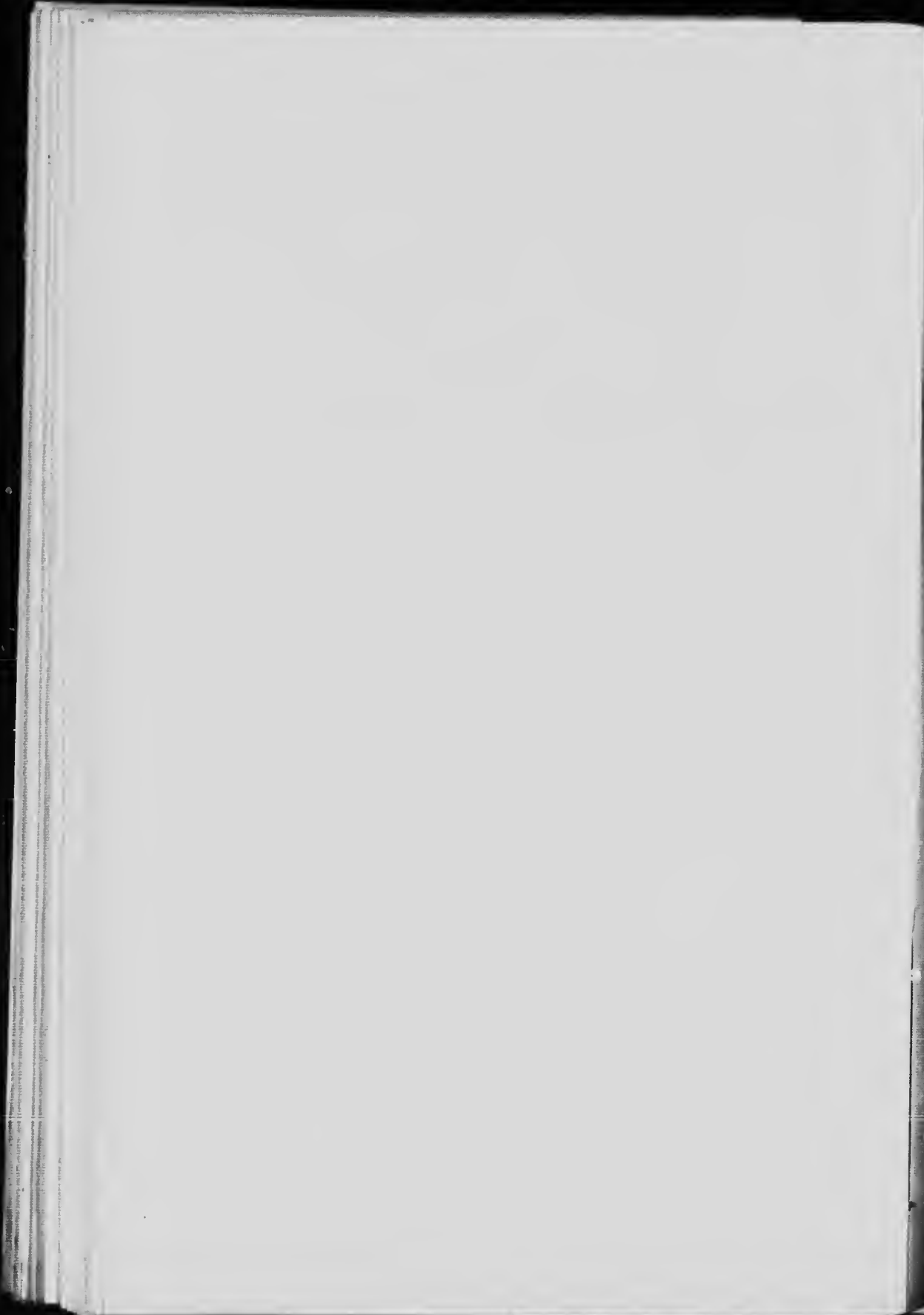
¹ This is the mine whose operations are commonly supposed to have caused the great landslide in 1903.

² This was written in 1908.

Plate XX.



Denison colliery, Coleman, Alta.



hauled by compressed air locomotives to the tipple building, 600 feet distant from the portal of the mine. The cars are hoisted to the top of the tipple, a height of 98 feet, and dumped on bar screens ²/. The coarse coal falls on two picking belts 1 foot wide, 40 feet long. The slack goes to the coke oven bins and the screened coal to the pockets which have a capacity of 2,500 tons.

The steam plant consists of 6 boilers of a total capacity of 700 H.P. Electric power to operate the fan, the lorries, machine shops, and tipple machinery is generated by two 250 K.W. electric generators, directly connected to a 100 H.P. engine. This electric plant also furnishes light for the mine and for the town of Coleman. The compressor for charging the locomotives is a Rand compound, 4 stage, compressing 750 cubic feet per minute to 1,000 pounds.

The capacity of the mine with present equipment is 2,400 tons a day.

The coke oven plant consists of 176 beehive ovens of a diameter of 14 feet, which have a daily total output capacity of 260 tons of coke manufactured from 380 tons of coal. The charge of each oven is 6½ tons of coal which is coked in 72 hours. The resulting coke has a good structure, but is rather high in ash.

The number of men employed in the mine and on the surface, including the coke ovens, is over 550.

CANMORE AND CASCADE MOUNTAIN COAL AREAS.

In this region, on the main line of the Canadian Pacific railway, of which Banff is a well-known point, two coal areas are now being worked, the respective centres of which are Canmore and Bankhead.

In the first of these areas the coal-bearing rocks form a narrow band, in which the dips are to the west, at an angle of 60°. The outcrop of the coal measures, which here also belong to the Kootani formation of the Cretaceous, occupies the valley of the Bow river, to the south of Anthracite. Their width is between three-fourths and one mile, and their length extends several miles north and south of Canmore. Openings have been made in several places on coal seams; and operations are now being conducted at two mines at Canmore about one mile south of the main line of the Canadian Pacific railway, by the H. W. McNeil Company; the general section of the several coal seams in the workings being as follows, in descending order:—

Seam No. 6: Coal, with small shale partings	4'-6"
Rock	245 feet
Seam No. 5: Coal, soft and broken.	3'-3"
Rock	30 to 100 feet
Seam No. 4: Coal, bright and clean	4'-0"
Rock	75 feet
Seam No. 1: Coal, with 8" of slate.	5'-0"

¹ Written in 1908.

Rock	10 ft to 50 feet	
Seam No. 3: Coal		5'-0"
Rock	15 feet	
Seam No. 2: Coal		4'-0"

This strip of coal-bearing rocks extends northwestwards, along the face of the Cascade mountain, and the coal area being worked, the centre of operations being at Bankhead, some 2 miles north of the main line of the Canadian Pacific railway.

There are here seven seams, which are all cut by a main tunnel, the section of the measures follows, in descending order:—

Seam No. 7: Coal	6'-0"	
Parting		60'-0"
Seam No. 6: Coal	6'-0"	
Parting	1'-3"	
Parting	3'-0"	
Parting	2'-6"	
Parting	1'-6"	17'-3"
Sandstone (dip 50°)		150'-0"
Seam No. 3: Coal		
Parting	40'-0"	
Parting	10'-6"	
Coal	1'-0"	
Parting	5'-0"	
Coal	5'-0"	21'-3"
Sandstone (dip 50°)		92'-0"
Seam No. 2: Coal (dip 50°)		
Coal	1'-8"	
Partings	3" to 4'-0"	
Sandstone (dip 50°)		30'-0"
Seam No. 1: Coal (dip 50°)		
Coal beds	1 foot to 4 feet	
Partings	2" to 4 feet	
Sandstone and slates		32'-0"
Seam No. 0: Coal	2" to 2'-6"	

The coal produced at the Bankhead mine is very high in fixed carbon and is practically an anthracite. It is very friable, and as it is prepared for the domestic market it requires a great deal of sizing and screening. This results in the production of a very large proportion of fines, or anthracite dust, which is briquetted and makes a very satisfactory fuel.

Some 3 miles southeast of Bankhead, in the same coal areas, operations were started near the railway some twenty years ago, at a place which is called Anthracite. The coal mined here was low in ash and high in fixed carbon, owing, very probably, to the great pressure to which the measures

were subjected. Operations were continued at this mine until 1904, when the pillars of coal were extracted and the workings abandoned owing to some difficulties which had arisen in following the coal.

Exploration of the foot-hills has been continued northward by D. B. Dowling, and very promising basins of coal-bearing measures were discovered north of the North Saskatchewan river, between this stream and the Brazeau river. High grade bituminous coals occur here, and these fields will doubtlessly become of great importance as soon as transportation facilities are established.

The Cascade basin also extends south of the main line of the Canadian Pacific railway, below the Cammore area, and good seams of coal have been discovered in the district of the Kamauaskis river. In fact, workings were started long ago on a coal seam southeast of the Three Sisters mountain, and the only reason why this enterprise was abandoned was owing to the discovery of seams nearer the railway. In a section measured in this vicinity by Dr. D. D. Cairnes, in a thickness of coal measures of 1,050 feet, ten coal seams of 4 feet and over occur, in which the fixed carbon goes up as high as 85 per cent.

The H. W. McNeil Company

(Sample No. 26.)

The colliery of this Company is at Cammore, some 11 miles southeast of Banff. Five seams are being worked, having the following thicknesses: No. 2 seam, 6 feet; No. 3 seam, 5 feet; No. 4 seam, 4'6"; No. 6 seam, 5 feet; No. 4 seam, 4 feet. The dip is to the southwest, varying between 30° and 50°.

The original mine, which is yet the main producer, is situated in a gully on the right bank of the Bow river, immediately west of the town of Cammore. A new mine is being opened up on the same bank of the river, 1 mile south of the old mine, on what is known as the Sedlock seam. This is probably the extension of one of the seams given above; but the correlation has not been made, the measures being very much disturbed and the beds difficult to follow. The main slope on the seam is over 1,200 feet.

The seams in the old mine are worked by slopes; the main entry is driven on No. 2 seam, which is the lowest of the series, and from this entry connection is made by tunnels to the other seams. The workings to the east extend in some cases to over 5,000 feet. The system of working is by pillar and stall. The main haulage underground is by compressed air locomotives to the foot of the hoisting slope, which is 625 feet long. Secondary haulage is by horses.

Ventilation is effected by one Capell fan, 75,000 cubic feet, and one Wigan-Walker fan of 250,000 cubic feet. Lighting is altogether by safety lamps of the Clanny bonneted type, plug locked. The lamp house contains 400 lamps.

The boiler equipment, in the main, comprises five return tubulars and one Lancashire, giving a total power of 600 horse-power. The compressor

plant consists of a two stage Rand for 30 drills, and one Canadian Rand high pressure compressor for charging the locomotives.

The coal on coming out of the slope is dumped by a Phillips tippie over a bar-screen. The lump goes over a picking table, 25 feet long by 4 feet wide, the two grades, slack and picked coal, then come together again and are conveyed to the storage bins, which have a capacity of about 600 tons. The slack from certain parts of the mine after going through $\frac{1}{2}$ " screens, is washed in a Howe washer of a capacity of 100 tons in ten hours.

The mine employs 300 men, and is equipped for a possible output of 700 tons a day of ten hours. Connexion is made with the main line of the Canadian Pacific railway by a spur some 3 miles in length.

Bankhead Mines, Limited

(Samples Nos. 23, 23 SP, 23 M, and 24.)

This Company controls 3,600 acres of coal lands within the limits of the Rocky Mountain National park, Alberta.

The colliery is at Bankhead, 3 miles north of Banff, and is connected with the main line of the Canadian Pacific railway by a spur $2\frac{1}{2}$ miles long.

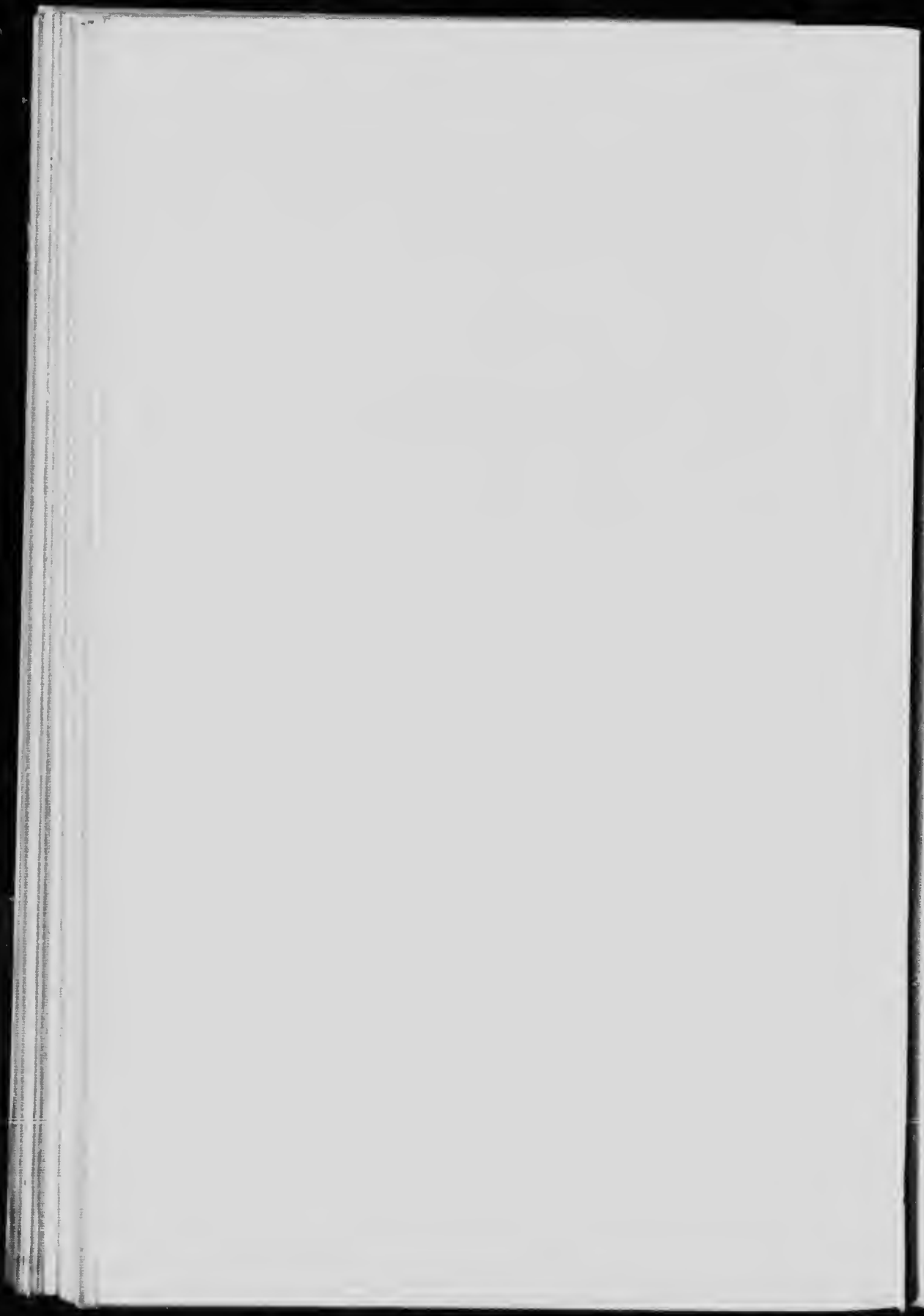
At Bankhead the general dip of the coal-bearing rocks is high, varying between 30 and 50°. The coal seams outcrop on the flank of a range of mountains, forming the west slope of the valley of the Cascade river. The mine is worked by a tunnel 1,200 feet long, which starts in the valley at a level slightly above the river and is driven through gravel and other superficial deposits accumulated in the valley. The tunnel strikes the solid rock on the side of the valley, in a direction parallel to the strike of the beds. At this point a cross-entry is driven at an angle of 15° to the direction of the tunnel, and this cuts the seams at that angle. The cross-entry is 1,800 feet long, cutting 11 seams which, owing to the disturbed state of the measures and other local conditions, vary greatly in thickness, some of them showing as much as 9 feet of good clean coal. The first seams cut, which are the lowest of the series, are of coal very near anthracite in composition and physical character. These have been most actively developed. In the overlying seams, the fixed carbon gradually diminishes and the volatile increases. No. 2 seam has been the most extensively developed, and is being worked to a height of 1,000 feet on the pitch. Only the coal above the main entry is mined as yet, and there will be no need of extracting that below this level for a great many years to come.

The coal is worked by pillar and stall, with subsequent extraction of pillars. The haulage is done by compressed air locomotives, charged under a pressure of 1,000 pounds per square inch. The haulage equipment comprises 7 locomotives, of which 2 are of 12 tons, 2 of $7\frac{1}{2}$ tons, and 3 of 5 tons. Ventilation is by one Capell fan, of a rated capacity of 200,000 cubic feet, and three smaller ones of which one is 11 feet diameter, electrically driven, and two are reversible fans of 12 feet diameter. Lighting is by Wolf safety lamps altogether. The boiler equipment comprises 6 Roth boilers of 150 H.P. each

Plate XXI



Anthracite coal breaker at Bankhead, Ala.



and 2 Jenckes of 150 H.P., giving a total of 1,200 horse-power. The temperature of the water, before entering the boilers, is raised to 150° in a water heater which is heated by the flue gases.

The compressor plant comprises a high pressure four-stage compressor of a capacity of 1,400 cubic feet of free air, compressing to 1,200 pounds, and a low pressure two-stage compressor, capacity of 2,000 cubic feet per minute, which compresses to 100 pounds.

The electric plant consists of two 150 K.W. generators, used for lighting the mine, the surface works, and the towns of Bankhead and Banff. The mine is equipped for a daily output of 1,800 tons, although it could probably handle 2,500. On coming out of the mine, the coal is raised to the top of the "breaker" building, a height of 100 feet, by an incline with an endless chain, to be prepared for the market. The cars are weighed, and dumped over a 3" bar screen; the oversize goes to a picking table and through rolls, to be broken to market size. The pure coal is sized and goes to the pockets; the other coal is sized and cleaned by Emery slate pickers. On account of its anthracitic nature, this coal is largely used for domestic purposes.¹

Large bins for the various grades of coal are provided in the lower part of the structure. These bins discharge the coal on a belt conveyer to be loaded in cars, either by chutes or by a Victor box-car loader. The various grades of anthracite marketed are as follows:—

Broken coal	size between 5" and 3½"
Egg	3½" " 2½"
Stove	2½" " 1½"
Nut	1½" " 7"
Pea	7" " 7"
Buckwheat No. 1	7" " 5"
Buckwheat No. 2	5" " 1"
Buckwheat No. 3	1" " 3"

The dust, constituting a considerable proportion of the coal, which is very friable, is briquetted in a modern very complete Zwoier briquetting plant, using coal tar pitch as binder. The plant consists of two units, each capable of producing 200 tons of briquettes a day. These briquettes are in great demand for domestic use.

COALS AND LIGNITES OF BRITISH COLUMBIA²

In British Columbia there are three main districts in which coal mining operations are actively being pursued. These are the Crow'snest Pass region in the eastern part of the Province; the Nicola Valley district, in the central part; and the east coast of Vancouver island. Besides these, other coal basins are known and more or less prospected, but at present are too remote from means of communication to be of immediate economic value, although they constitute a reserve of fossil fuels of great possibilities.

¹ This breaker is further described in Part IV.

² See Map No. 98, showing British Columbia coalfields.

"The discovery of coal in British Columbia antedated that of gold by more than twenty years, but did not at first produce any effect comparable with that of gold, upon the history of the country. Dr. W. F. Tolmie was the first to make known the existence of coal, on the coast of the Province, in 1835. He was then stationed at the Hudson's Bay Company's post, known as Fort McLoughlin, on Milbank sound, and specimens of coal were brought to him by Indians from the northeast coast of Vancouver island—doubtless from Squash. The steamer *Beaver*, belonging to the Company, arrived on the west coast in 1836, and thereafter small quantities of coal were obtained for her, as well as for blacksmiths' use, from this place; being derived from natural outcrops on the beach. In the year 1849, a coal miner was brought out by the Company, from Scotland, to more fully test the character of the coal on this part of the coast, and in 1851 a further number of miners and some necessary machinery were imported. Exploratory work by sinking and boring was prosecuted along the coast of Vancouver island, between Port McNeill and Beaver harbour, until 1853, but without resulting in any very notable discoveries.

"Meanwhile, in 1850, the existence of coal at Nanaimo had been ascertained by Mr. J. W. McKay, and in the following year it appears that most of the miners above referred to were transferred from the northern end of the island to that place. Work began in earnest at Nanaimo in 1852, and before the close of 1853 some 2,000 tons are reported to have been shipped, chiefly to San Francisco. The price of coal at Nanaimo was at this time \$11 and at San Francisco \$25 a ton. The Hudson's Bay Company, under the name of the Nanaimo Coal Company, continued to work the mines thus opened until 1861, when these were sold to the Vancouver Coal Mining and Land Company. . . . The total shipment from October, 1852, to November, 1859, is returned at 25,398 tons."

The above mines were practically the only ones producing until 1871, with the exception of a small output in 1864 and 1865, from the outcrops near Nanaimo, where the Harewood colliery was subsequently started.

The various coal fields will be briefly described in the following notes, beginning with the easternmost one and proceeding westward.

ROCKY MOUNTAIN COAL FIELDS

CROWSNEST PASS COAL FIELD.

The Crowsnest Pass coal field is situated immediately west of the summit of the Rocky mountains, in Crowsnest pass. It is all included within the Province of British Columbia, excepting a small portion in the immediate vicinity of the pass, which crosses the watershed into the Province of Alberta. The Crows Nest branch of the Canadian Pacific railway crosses the northern part of the coal field, and skirts its western edge for a distance of 25 miles.

The rocks of the coal field are of Cretaceous age and rest on a limestone series referable to the Devono-Carboniferous. These Cretaceous rocks have

¹Dr. Dawson's Mineral Wealth of British Columbia, Geological Survey Report, Vol. III.

the following succession, in descending order, and approximate thickness, as established by Jas. McEvoy, of the Geological Survey:—

Flathead Beds.—Series of brown, friable shales and soft, greenish sandstones. Some of the sandstone beds are harder, and towards the top of the series there is a remarkable bed of conglomerate composed of well rounded dark, cherty quartzite pebbles up to 6" in diameter, loosely held together in a matrix of soft sandstone.

Elk Conglomerates. These are made up of grey shales, and shaly sandstones interbedded with black and brown shales. These hard beds cover the underlying coal-bearing measures, and have to a great extent acted as protection, preventing the erosion of the softer coal measures and saving them from excessive crumpling and folding. At the base of the Elk conglomerate there are thin beds of coal, some of which are of a semi-cannel nature.

Crowsnest Coal Measures.—These are made up of grey shales, and shaly sandstones, containing workable beds of coal. In a section measured near Morrissey, in a thickness of 1850 feet of measures, 198 feet of coal were observed, of which at least 100 feet are workable. The base of these coal measures consists of beds of hard, high-coloured sandstone.

Fernie Shales.—These rocks, immediately underlying the coal-bearing series, consist of some 2,600 feet of black and brown shales, calcareous argillites, and shaly limestones. The thickness of this subdivision of the Cretaceous varies in different parts of the field, and these, with the overlying Crowsnest coal measures, constitute the Kootanic series of Dr. Dawson.

Devono-Carboniferous.—These are heavy light coloured limestones, which entirely surround the basin of Cretaceous rocks given above.

In general, it may be said that the Cretaceous rocks have assumed the form of a flat bottomed basin, the outcrops of the various subdivisions forming the complete rim, while the centre is occupied by the highest rocks of the series. There are, of course numerous local disturbances, but as a whole the strata dip inward towards the centre of the area, at inclinations varying between 20° and 50°.

The following two sections of the coal-bearing rocks, measured on opposite sides of the basin, will give a good idea of the general components of the coal-bearing series. The beds are given in descending order:—

Morrissey Escarpment:

Conglomerate, gritty sandstone, and shale	29' 0"
Coal	2' 6"
Shales and conglomerate and sandstone	150' 0"
Coal	2' 0"
Shale and sandstone	187' 0"
Coal	1' 0"
Shale	3' 0"
Coal	1' 0"
Sandstone	117' 0"
Coal	5' 0"
Shale and sandstone	526' 0"

Coal.....	7'-0"
Shale.....	35'-0"
Coal (impure).....	3'-0"
Shale and sandstone.....	6'-0"
Coal.....	5'-0"
Shale and carbonaceous shale.....	154'-0"
Coal.....	3'-0"
Shale and carbonaceous.....	120'-0"
Coal.....	10'-0"
Shale and carbonaceous shale.....	140'-0"
Coal, upper 10 feet impure.....	36'-0"
Shale and sandstone.....	194'-0"
Coal.....	1'-4"
Shale and coal.....	2'-0"
Coal.....	6'-0"
Shale and shaly sandstone.....	28'-0"
Coal impure.....	2'-0"
Sandstone.....	2'-0"
Coal.....	2'-0"
Shale.....	65'-0"
Coal.....	4'-0"
Shale.....	1'-7"
Coal.....	4'-9"
Shale.....	6'-0"
Coal, bottom 2 feet impure.....	19'-0"
Shale and sandstone.....	170'-0"
Coal.....	2'-6"
Shale.....	364'-0"
Coal.....	1'-4"
Shale.....	1'-3"
Coal.....	46'-0"
Shale.....	16'-0"
Shale and sandstone.....	186'-0"
Coal.....	46'-0"
Shales and sandstones.....	1,216'-0"
<hr/>	
Total thickness of coal beds.....	216 feet

Section measured on south fork of Michel creek:—

Shales and sandstones.....	132'-0"
Coal.....	4'-2"
Shale.....	33'-0"
Coal.....	2'-8"
Shale and sandstone.....	168'-0"
Coal.....	2'-0"
Shale.....	88'-0"

Coal with parting	3' 6"
Shales	86' 0"
Coal with parting	7' 3"
Shale with a little coal	34' 0"
Coal	1' 5"
Shale	12' 0"
Coal	13' 0"
Shale and sandstone	115' 0"
Coal	2' 1"
Shale and covered	113' 0"
Coal with parting	7' 0"
Shales	62' 0"
Coal with parting	25' 2"
Shale with thin coal	10' 0"
Total coal	69' 6"

The points at which the sections were measured are some 10 miles apart, and there is a certain correlation between them, which indicates a fairly persistent continuation of the coal beds.

Mr. Jas. McEvoy has made an approximate estimate of the total available coal in this field. By taking the area covered by the coal measures as being 230 square miles, and assuming a workable thickness of coal seams of 100 feet, which does not appear to be excessive, he arrives at a total quantity of 22,595,200,000 tons.

The opening of the coal mines in this field marked an epoch in the development of British Columbia. Before this time the smelting industries of the Kootenays, and of Washington in the United States, had to depend, in a great measure, on coke from the coast coal mines, the transportation of which, added to a comparatively high initial cost, rendered this fuel very expensive. In fact, the cost of fuel to the smelters has since then been reduced to about one-half.

The first report of the presence of coal in the Crowsnest region was probably that by Dr. Dawson, who pointed out the occurrence of Cretaceous rocks, in which the presence of coal beds was probable. "The existence of a seam was indeed reported, about 20 miles west of the summit of the Crowsnest pass, but the locality has not been examined." (Geological Survey Report for 1880-82). Later on, the district was again visited by this geologist, and in 1883 a preliminary examination was made. This was followed in 1887 by prospecting on the part of the two founders of the coal industry of the Crowsnest Pass district, Wm. Fernie and Lt. Col. Baker. For ten years, between 1887 and 1897, these two men prospected and stripped coal outcrops and finally succeeded in interesting capitalists to the extent of forming a syndicate to acquire these coal lands. A charter was granted for the construction of a railway to serve the new coal fields. This

charter was subsequently bought out by the Canadian Pacific Railway Company, who in 1899 extended their branch line between Medicine Hat and Lethbridge, to cross the summit and afford transportation facilities to the smelters of southern British Columbia by way of Kootenay Landing and Nelson.

Since 1907, another line of railway has entered this coal field, viz., the Great Northern, and now the mines have two outlets to ship the fuel to the great smelting centres of southern British Columbia.

There are at present two very large companies working in this coal field, viz., the Crowsnest Pass Coal Company and the Hosmer Mines, Limited. The first of these has well established collieries at Coal Creek, Michel, and Morrissey or Carbonado, and the second is actively exploiting at Hosmer. Short descriptions of these collieries are given below. A third colliery, worked by the Corbin Coal and Coke Company, is at present developing; it effected some small shipments during 1908.

ELK RIVER AND KANANASKIS

Immediately to the north of the Crowsnest Pass basin of coal measures, but separated from it by a belt of the underlying limestones, there is another trough of coal-bearing Cretaceous rocks, which extends for a distance of some 50 miles, crossing the summit of the main range, into Alberta, at the Kananaskis pass. The difficulties of access, as compared with the coal areas lying close to the railway, have militated against the immediate active development of these areas; but a railway line, connecting with the Canadian Pacific railway at Michel has been located, and it is probable that before long this coal field will be exploited. That large quantities of coal exist in these measures was definitely proved in 1901, by a party of the Geological Survey, when in a section of 3,386 feet, some 12 seams were observed, varying in thickness from 8" to 35 feet.

Owing to the fact that the above-mentioned properties are as yet undeveloped, no samples of them were taken for the present investigation; but the Northern Coal and Coke Co. has recently secured considerable areas on Aldridge creek, a tributary of the Elk river. This Company has explored the property and has taken a number of samples, which have been analysed by their own chemist. An average of eight of these analyses shows 67.3 per cent fixed carbon, 25.6 per cent volatile combustible, and 7.2 per cent ash. Two other samples of very much poorer coal were also analysed, the average analyses for all ten being 63.1 per cent fixed carbon, 24.6 per cent volatile combustible, and 12.3 per cent ash¹. None of these samples was taken by the coal tests staff, and no responsibility can be assumed for their accuracy; but there is very little doubt that they truly represent the seams in question, thus indicating the coal to be of excellent quality.

¹ Private communication from W. H. Aldridge, Trail, B.C., to Dr. Port.

Crowsnest Pass Coal Company, Limited

This Company is the largest coal producer in western Canada the yearly output being exceeded in Canada only by the Dominion Coal Company in Nova Scotia controlling 230,000 acres of coal lands in the Crowsnest Pass district, immediately west of the main range of the Rocky mountains. These coal lands are traversed by the Crowsnest line of the Canadian Pacific railway. The Company operates at present three collieries at Coal Creek, Michel, and Carbonado, respectively. The executive offices are in the town of Fernie, B.C.

Coal Creek Colliery

(Samples Nos. 26 and 27)

This colliery is situated in the valley of Coal creek, a tributary of the Elk river, at the confluence of which streams is the town of Fernie. The mines are 5 miles distant from Fernie, the two points being connected by the line of the Morrissey, Fernie, and Michel railway. The coal outcrops on the side hill on both sides of the valley, and is worked by tunnels and slopes; no shafts being necessary. The valley has a direction of east and west, and mines have been opened on both the north and the south sides of the valley.

The following descriptions of the workings, surface plants, etc., have kindly been furnished by the Company: -

Shafts and Main Entries. One shaft 50 feet deep, used solely for connecting the ventilating fan with the workings of No. 2 mine. In No. 1 mine the slope is 650 feet long, to where it has been stopped by a fault. In No. 2 mine the slope is 1,750 feet down, and will be extended.

In No. 9 mine, which is in the same seam as No. 2, but on the north side of the creek, the slopes have been driven down 650 and 1,000 feet respectively, and are in faulted ground. In No. 5 mine, the slope has been driven down 1,050 feet.

Extent of Main Workings. - In No. 1 mine on the north side of the creek the workings extend northerly for a distance of 3,600 feet, westwardly to the rise 2,200 feet, and 650 feet to the dip. No. 1 mine is now being opened on the south side of the creek in two places: (1), by an entry tunnel from the surface, and (2), by a rock tunnel out of the main entry of No. 2 mine.

In No. 2 mine on the south side of the creek two main entries have been driven southerly for a distance of 1,000 and 1,950 feet respectively (these have both been closed on account of dangerous "mine bumps"). To the dip, or east side, the workings are extending by No. 3 slope of 1,750 feet, and to the rise, above the high line entry (1,950 feet) 850 feet. For the present the area between the main entry (1,000 feet) and the high line entry (1,950 feet long) has been abandoned.

No. 9 mine on the north side of the creek is in the same seam as No. 2 mine. This main entry has been driven 3,150 feet to the northward and ends in very

faulty ground. Westwardly the workings extend 1,100 feet, and at one place the seam directly underlies No. 1 seam, thus showing that the intervening strata, usually about 60 feet thick, have disappeared.

No. 5 mine entry on the north side of the creek has been driven 4,200 feet to the northward, where it has apparently met with the same faulty ground encountered in Nos. 1 and 9 mines, and the workings are now mainly to the west of the main entry 1,250 feet and eastwardly to the dip 850 feet. On the south side of the creek this mine is being prospected by a tunnel.

To the east of this group of mines a seam of coal, 1 foot to 4'-6" thick, is being prospected by a tunnel entry.

Coal Cutting Machinery.—No longwall coal cutting machines are at work, but one Little Hardy is in use in No. 9 and three in No. 1, and three Siskols are also in use in these levels.

System of Working.—Pillar and stall, and a modification of this method, which may be likened to retreating longwall, are both employed.

System of Underground Haulage.—The haulage on the main levels or entries is by air locomotives in Nos. 2, 5, and 9 mines; also by tail rope in all the slopes, with Lidgerwood and Lawson hoists for all supplementary inclines where McGinty jigs are not in use. The haulage engines are all worked by low pressure compressed air, and the locomotives by high pressure air.

Ventilation and Lighting: Fans, Capacity, and Size.—Nos. 1, 2, 5, and 9 mines are ventilated by separate Wilson fans of 200,000 to 285,000 cubic feet per minute capacity. The No. 9 fan also ventilates No. 1 west and main entry workings. These fans are each 16 feet diameter \times 8 feet face, and are driven by engines made by the Erie City Iron Works, having cylinders of 16" diameter \times 18" stroke. No. 1 mine south is ventilated by a Jones fan driven by an electric motor of 35 H.P. No. 5 mine south will be ventilated by a Brazil fan driven by a 30 H.P. motor, with another motor of the same capacity, as a stand-by.

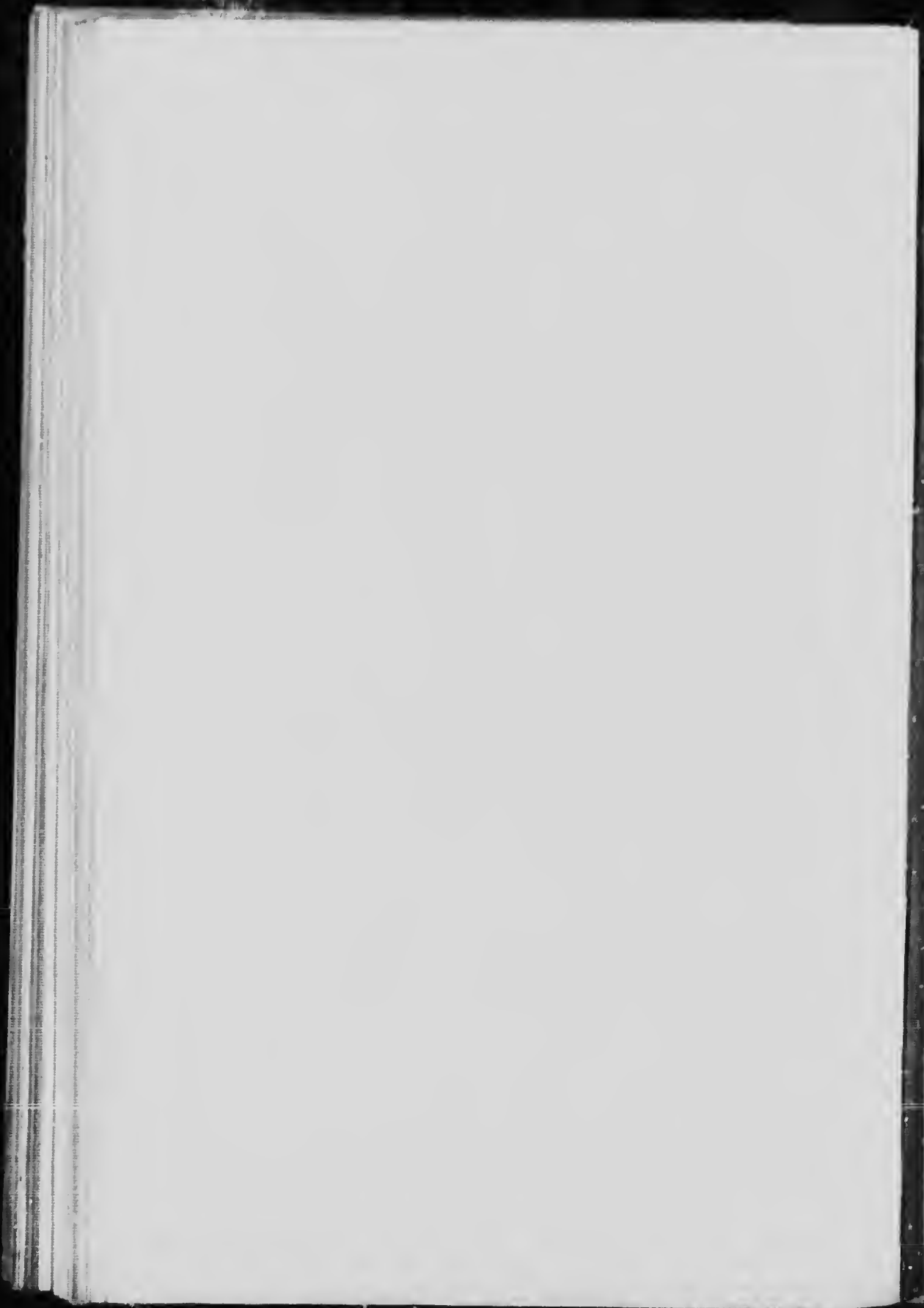
Safety Lamps.—These (750) are all of the Wolf double gauze type, bonneted, magnetically locked, burning naphtha spirit, and furnished with re-lighting apparatus.

Surface Equipment.—One electric hoist having two 35 H.P. motors placed outside No. 1 mine entry to draw up the empty cars to the tunnel mouth. One electric hoist consisting of two 35 H.P. Jeffrey motors, to haul the loaded cars up No. 3 slope out of No. 2 mine. One steam locomotive, 8" cylinders \times 12" stroke, two wheels coupled on each side. Pressure 130 pounds. One steam locomotive, 7" cylinders \times 10" stroke, two wheels coupled on each side. Pressure 130 pounds. Four compressed air motors, 8" cylinders by 11" stroke, two wheels coupled on each side. Pressure in the receiver 800 pounds reduced to 150 pounds. Two compressed air motors, 6" cylinders by 8" stroke, two wheels coupled on each side. Pressure in receiver 800 pounds, reduced to 150 pounds. One 30 H.P. electrical motor, driving the saw-mill. One 5 H.P. electrical motor, driving the barn machinery.

Plate XVII.



Coal Creek colliery, Crownsnest Pass Coal Co., Coal Creek, Pa.



Boiler Plant.—Seven Erie City No. 19 return tubular full flush front, 81" diameter \times 18 feet long, 152 H.P., 125 pounds working pressure. Five Robb-Munford boilers 67" diameter \times 20 feet long, 112 H.P., 125 pounds working pressure. One Abell locomotive type 130 H.P., 125 pounds working pressure. One Home water-tube boiler, 85 H.P., 110 pounds working pressure.

Tipple and Screening Plant.—This steel tipple was made and erected by Heyl and Patterson, of Pittsburgh, U. S. A., and is designed to deal with 1,000 tons per diem. It is fitted with two rotary mechanical operated dumps and will handle two cars at once. From the dumps the coal passes on to the shaking screens, where it is divided into different grades by passing over perforated plates punched with 1", 2" and 3" holes, and which run of mine is being hauled, these are closed by veils. The coal then passes on to picking tables, having a speed of 100 feet per minute, and thence over the linged end of these tables to the cars. The picking tables have refuse conveyors placed alongside, which, moving at a speed of 100 feet a minute, carry the rock to a rock dump, from whence it is removed at the midway track level. Two Fairbanks quick weighing dial beams are used for registering the output, and two Smith box car loaders are in use. The direct current motor actuated machinery used in the loading and screening operations comprises on the north side, two 20 H.P. car hauls; one 10 H.P. rotary dump; one 40 H.P. shaker screen and picking belt; one 10 H.P. trolley conveying loading table at the end of the picking tables. On the south side, one 30 H.P. car haul; one 20 H.P. car haul; one 10 H.P. rotary dump; and one 30 H.P. shaker screen and picking belt.

The full capacity of this tipple plant is probably about 1,000 tons per 10 hours. The structure is 710 feet long from end to end.

Washing Plant.—None.

Compressor Plant.—This comprises: one Walker low pressure cross compound condensing two stage air compressor, with a capacity of 3,500 cubic feet of free air per minute; two Ingersoll-Sargeant Class "A" straight line piston inlet compressors—capacity 1,142 cubic feet free air per minute—only one of these in use; one Ingersoll-Sargeant Class "G" two stage duplex air compressor, capacity 1,710 cubic feet free air per minute and one Rand high pressure cross compound condensing, four stage, air compressor, capacity 1,316 cubic feet of free air per minute, delivering air at a pressure of 1,000 to 1,200 pounds per square inch.

Electrical Plant.—Three Eddy generators—100 K.W. each, belt driven by two Robb steam engines, having 20" cylinders and 20" stroke, the proportion between the driving and the driven pulleys being as 1 to 1.

Pumps Underground.—One Canada Foundry duplex pump, 16" steam cylinder, 8½" water cylinder \times 12" stroke. One duplex Cameron pump, 16" steam cylinder, \times 8" water cylinder, and 36" stroke. All pumps driven by compressed air.

Coal: Grades and Sizes.—Run of mine, fine slack to coke ovens, coal having passed over a 2" screen, coal having passed over a 3" screen, hand picked coal.

Possible Output.—Per day 6,000 tons.

Labour.—Number of miners, 423
Other labour underground and on the surface, 427

Total, 850

Coke Oven Plants at Coal Creek and Michel:—

Type of ovens, Beehive
Number of ovens, 454
Time of coking, 72 hours
Yield, 65 %
Capacity of each oven, 6½ tons coal; 4½ tons coke
Capacity of plant, 663 tons per day

Main Markets.—Coal to Canadian Pacific railway and Great Northern railway, and steam and domestic trade in British Columbia, Alberta, and Washington. Coke to smelters in British Columbia, Montana, and Washington.

Michel Colliery

Samples Nos. 29, 2029, 30, 31, and 2031

This colliery is situated in the valley of Michel creek, some 4 miles from the point where it joins the Elk river. The mines are on the Crows Nest line of the Canadian Pacific railway, at a distance of 24 miles from Fernie, by rail. There are at present five mines in operation at Michel.

Shafts and Main Entries:—

Length of slopes.	No. 3 slope	1,200 feet
	No. 4 "	1,500 "
	No. 5 "	1,200 "
	No. 8 "	800 "

Extent of Main Workings:

No. 3 mine extends westward 2,200 feet, and eastward 1,580 feet.

No. 4 mine extends westward 900 feet, and eastward 1,700 feet.

No. 5 mine extends westward 2,500 feet, and eastward 1,700 feet.

No. 7 mine extends westward 1,200 feet, and eastward 1,200 feet, and northward, say, about 800 feet, and is only opening up and driving levels.

No. 8 mine extends northwest 1,200 feet, northeast 6,980 feet, northerly 1,200 feet, and down the slope to the south 800 feet.

Coal-Cutting Machinery.—No coal cutters are in use here.

Systems of Working.—Pillar and stall and longwall advancing; also longwall retreating.

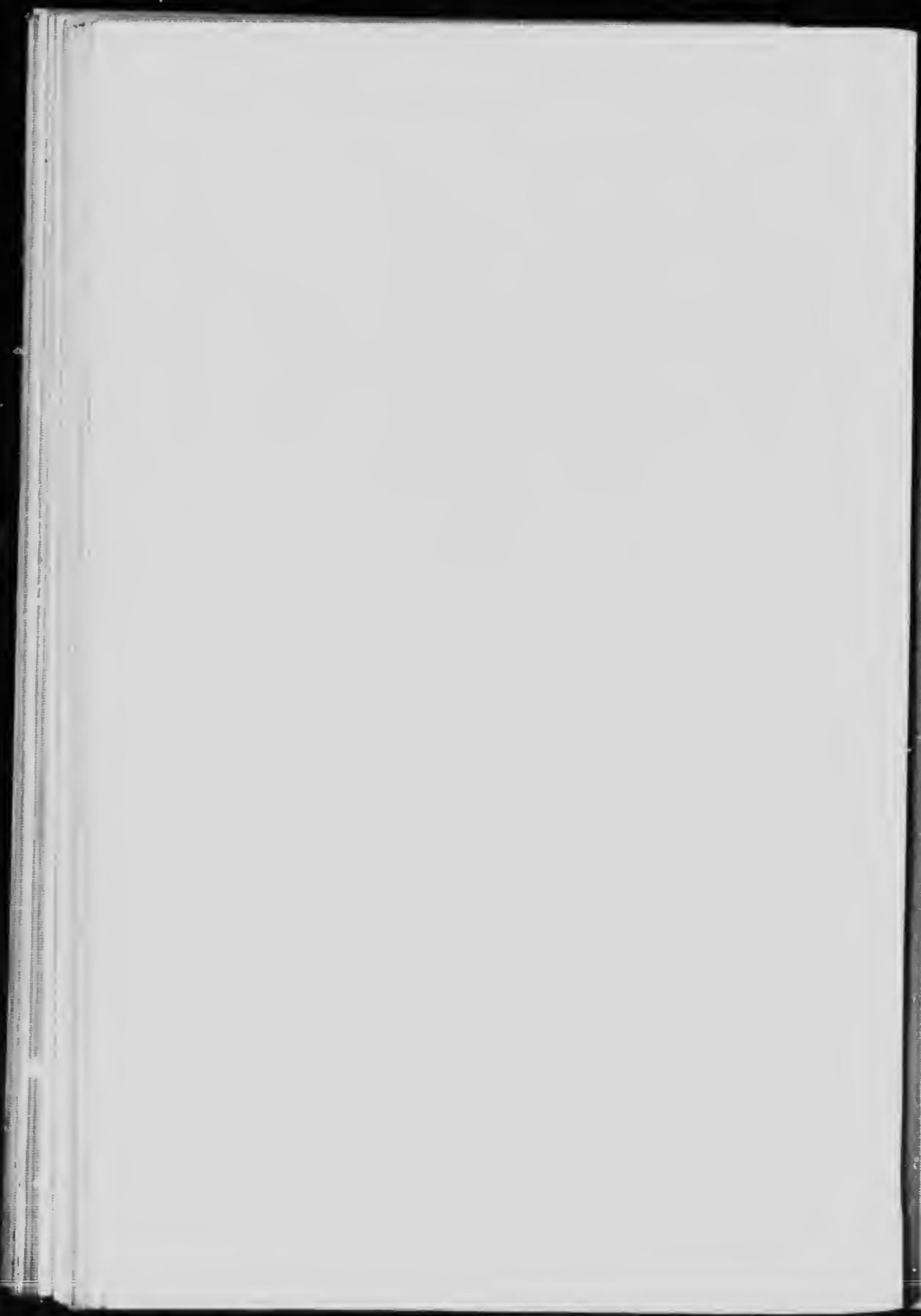
Systems of Underground Haulage.—On the main entries by compressed air, locomotives, and horses. On the inclines and slopes by compressed air hoists and in some stalls by McGinty jigs.

Ventilation: No. 8.—One Walker indestructible ventilating fan, 20 feet diameter × 7'-6" face, capacity of 200,000 cubic feet of air per minute, against

Plate XXIII



Michel colliery, Crowsnest Pass Coal Co., Michel, B.C.



a 3" water gauge, driven by a compound condensing engine. No. 5.—One double inlet Sullivan fan, 12 feet diameter, capacity 190,000 cubic feet of air per minute, against a 2" water gauge, driven by a simple steam engine. Nos. 3 and 1.—One double inlet Wilson fan, 16 feet diameter \times 8 ft. face, capacity 285,000 cubic feet of air per minute, driven by a simple steam engine.

Safety Lamps.—These (SSS) are all of the Wolf double gauze type, bonneted, magnetically locked, burning naphtha spirit, and furnished with Wolf ignition apparatus.

Surface Equipment.—Eleven Erie City No. 17 return tubular, full flush fronts, 72" diameter \times 18 feet long, each 150 H.P., 125 pounds working pressure. Five Abell locomotive type 66 $\frac{1}{2}$ " diameter \times 21'-6" long, 125 H.P., 100 pounds working pressure.

Compressors.—One Walker low pressure cross compound condensing two stage air compressor with a capacity of 3,500 cubic feet of free air per minute; one Rand low pressure cross compound condensing, two stage air compressor, capacity 4,500 cubic feet per minute; and one Rand high pressure cross compound condensing, four stage air compressor, capacity 1,361 cubic feet of free air per minute, delivering air at a pressure of 1,000 to 1,200 pounds per square inch.

Electrical Plant.—One 100 H.P. automatic compound condensing Mettowan engine, directly connected to a 250 K.W. Thompson-Ryan generator. One 100 K.W. Eddy generator.

Tipple and Screening Plant.—This tippie, 600 feet long, was constructed in steel by The C. O. Bartlett and Snow Co., of Cleveland, and has been designed to deal with an output of 1,000 tons per day of 8 hours. The system adopted is that of the Greene self-dumping car haul. The tracks on the south side are superposed, the full cars being on the upper run-way. On the north end the mine cars are dumped by Greene's No. 71 transfer dump which, after dumping, lands the car on the lower deck, from whence it runs to the mine mouth. The loaded cars are hauled from the mine mouth by a series wound motor, which can deal with 150 loaded cars. The coal, when dumped, passes on to a shaking screen, with 90 feet of 1" perforations, 60 feet of 2", and 30 feet of 3" perforations, and also furnished with veil plates for mine run coal. The slack from the screens is conveyed to the slack bin by a belt conveyer. From the screen the coal passes on to a picking table, 70 feet long \times 5 feet wide. The rock, which is picked out, is conveyed on belts to the rock bin. On the other side of the tippie the car door is opened on the dump and then inclined to 65°, spilling the coal to be screened and picked as previously described. The fuel for the boilers is conveyed from the screens by an 18" belt conveyer, delivering to a cable conveyer. The slack for the coke ovens is delivered on to a 36" belt conveyer, and then to a continuous bucket elevator, discharging into a conveyer over the slack bins.

There are 17 motors of the Crocker-Wheeler enclosed dust-proof type providing power for the various movements. Two Ottumwa box car loaders

are also provided, one on each side of the tippie, and served by separate chutes.

Coal: Grades and sizes.—Same as Coal Creek.

Main markets.—Same as Coal Creek.

Possible output of colliery per day.—6,000 tons.

Labour.—

Number of miners	382
Number of employes underground	281
On surface	113
	394
Total	776

Coke Oven Plant:—

Type of oven—Beehive.

Number of ovens—186

Time of coking—72 hours.

Yield per cent—65.

Capacity of each oven—6½ tons of coal 1½ tons coke.

Capacity of plant—688 tons of coke per day.

Carbonado Mines

All the mines and their plants are shut down.

Hosmer Mines, Limited

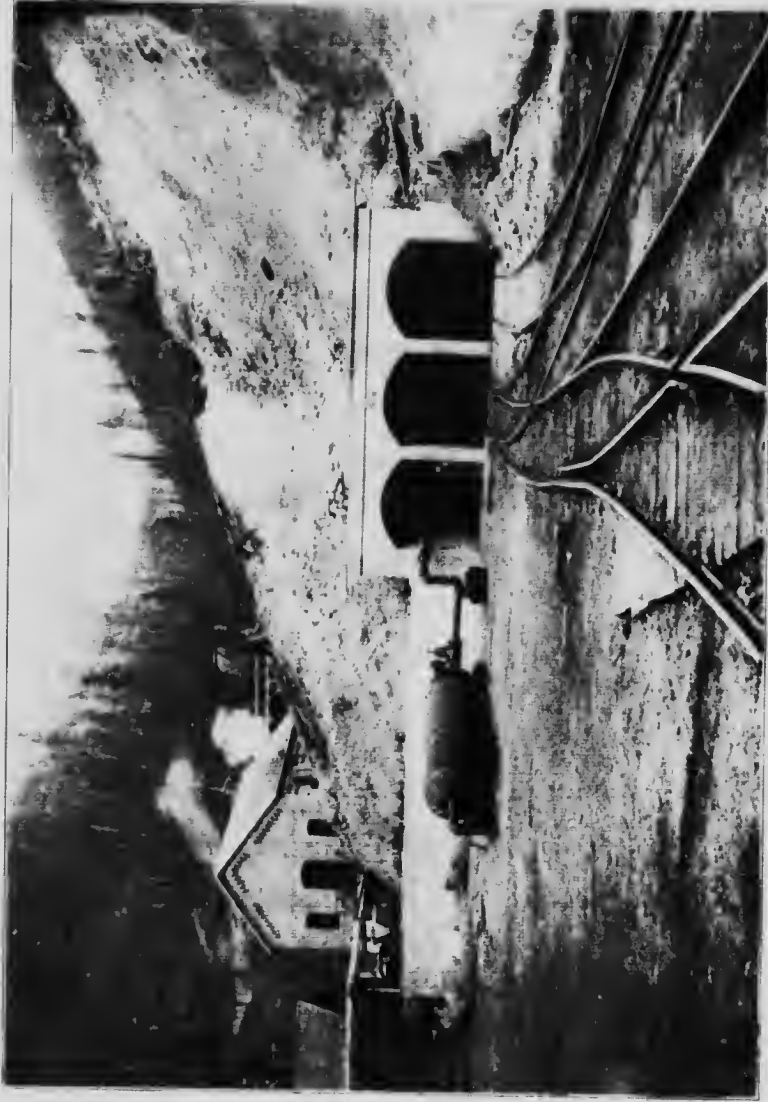
(Samples Nos. 51, 52, and 53)

This Company controls some 4,000 acres of coal lands in the Crowsnest Pass district at Hosmer, 8 miles north of Fernie. The lands are contiguous to the Crows Nest line of the Canadian Pacific railway.

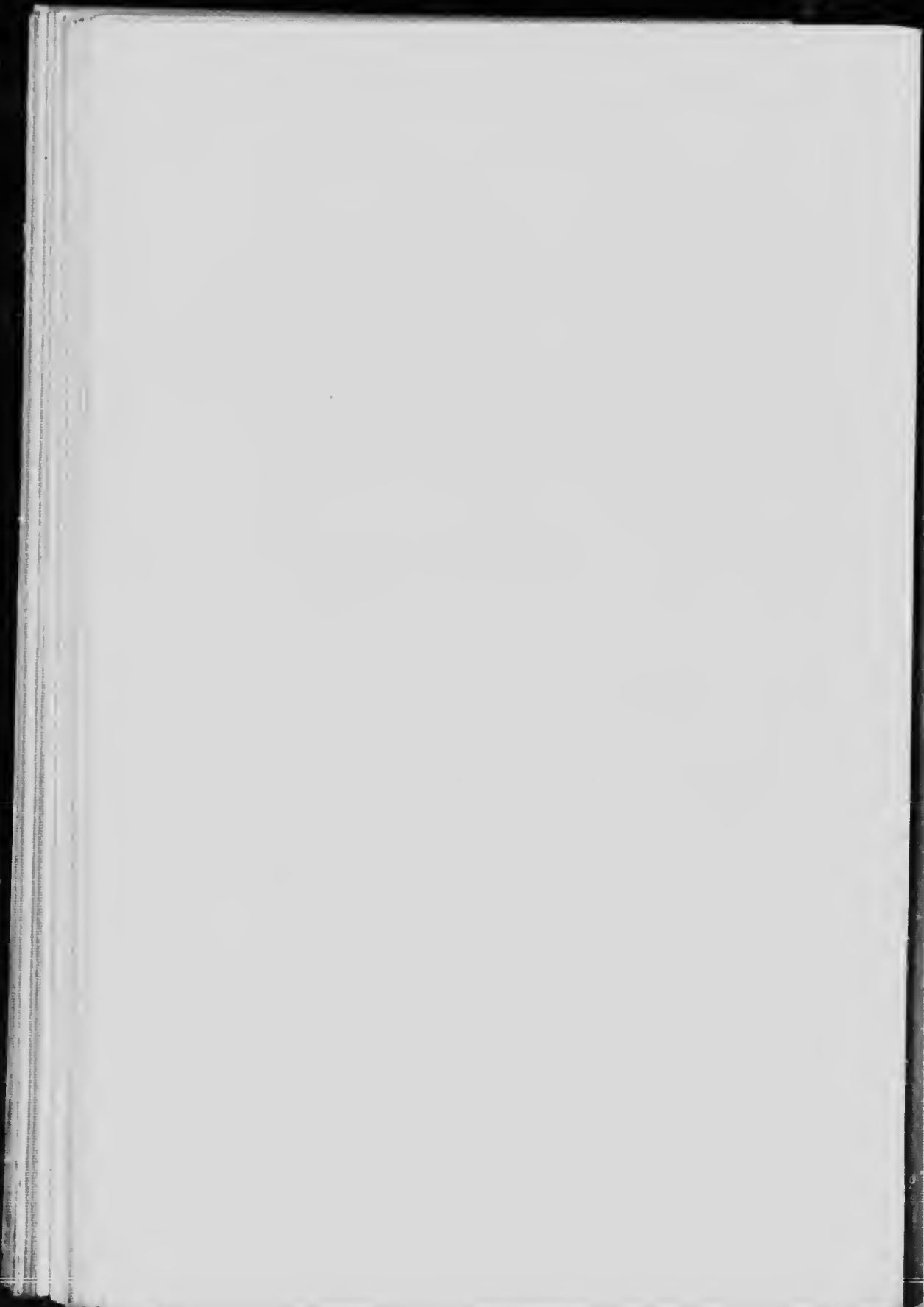
The following description of the mine has been taken in part from the Report of the Minister of Mines for British Columbia, 1908:—

"The property consists of six sections of coal lands, and two sections of surface, on which the town of Hosmer and the improvements connected with the plant are located. The seams, which are thirteen in number, varying from 4 feet to 30 feet, are being opened by tunnels, driven at right angles to the measures, and starting at a point about 600 feet higher than the Canadian Pacific Railway track at Hosmer station. Two tunnels have been driven parallel with one another, the larger tunnel having three compartments, two of which are used for haulage purposes and the third as a travelling and pipe way; the parallel tunnel, of one compartment, is used as a return air-course, in connexion with the ventilation of the mine. The tunnels are 1,900 feet long, and cut ten seams, five of which are being worked or developed with a working thickness of 48 feet, the details being as follows:—

Plate XXIV



Hosmer mines; main tunnel, Hosmer, B.C.



No. 2 seam	10 feet coal
No. 6 " "	7 " "
No. 8 " "	6 " "
No. 9 " "	5 " "
No. 10 " "	20 " "

The seams vary in dip from 65° to 25°. The tunnels were started in the Fernie shales underlying the coal measures, reaching the latter at a distance in of 847 feet and terminating in the hard conglomerate which overlies the measures; and the seams cut, therefore, include the whole series. The quality of the coal is bituminous, rich in hydro-carbon, and, therefore, an excellent coking coal, as well as a steam coal.

At the time the mine was visited for sampling for this investigation, the levels developing seams 6, 8, and 9 were in troubled ground, and the coal produced was very much crushed although otherwise apparently normal. The workings have since been extended beyond the troubled area, and the coal is reported to be much less friable and somewhat better in other respects also.

On account of the condition of the mine at the time of sampling, it was considered best to take the samples at the face of the levels instead of drawing from the screened coal at the tippie, as in the case of the adjoining mines of the Crowsnest Pass Company. This method of sampling puts the Hosmer coal at an apparent disadvantage, which is not justified by the normal condition of the mine. It may be noted here that No. 9 seam probably corresponds with No. 2 seam at Coal Creek, which produces a very excellent steam coal. No. 6 seam produces a good coking coal. No. 10 seam produces probably the best coking coal encountered. It has an exceptionally good roof.

It is estimated by the proprietors that in round numbers there are above the tunnels between 60,000,000 and 100,000,000 tons of coal in Nos. 2, 6, 9, and 10 seams. The present output of 500 tons a day is obtained from development work alone. This output will be gradually increased, the intention of the Company being to mine between 2,000 and 3,000 tons a day.

The room and pillar system is used in mining the coal. The working face is sheared by machine and then picked down. No blasting powder is used. Owing to the pitch of the seams, the coal can be taken directly to the levels by chutes and loaded directly in mine cars, which are hauled to the surface by compressed air locomotives.

The ventilation of the mine is provided for by a 20 ft. × 9 ft. Walker fan, capable of supplying 300,000 cubic feet of air per minute. It is run as an exhaust, but is so arranged that, if necessary, it can be reversed. This fan is driven by a pair of 16" × 30" engines, supplied with steam from three 80 horse-power boilers, and connected up to the fan by a rope drive. The fan is of steel with concrete setting, and the engine house of brick. The lighting is done altogether with safety lamps of the Wolf type, burning 70° naphtha, and furnished with re-lighting apparatus.

¹ At present only 8 feet of the No. 10 seam are being mined.

"The coal is lowered from the tunnel mouth to the level of the tippie by a steam actuated double-track incline, each track being an independent incline. The mine cars, holding two tons of coal each, are lowered in trips of ten, and the empty cars are hoisted in convenient numbers. The haulage engines are a pair of 28" x 48" first motion engines, with 8 ft. drums, fitted with clutches and brakes, which with the reversing gear and throttle, are all handled by steam working through cataract cylinders."

From the foot of the incline the coal is brought to the tippie by air locomotives, in mine cars of two tons capacity, and there dumped on a Phillips cross over tippie. The coal discharges into a steel box from which it is fed by a reciprocating feeder to a shaking screen, size 16 ft. x 6 ft. with $\frac{3}{4}$ " punched holes; it then passes on to two steel picking belts 1'-9" wide and 65 feet long, where boys pick the refuse from it. The lump coal discharges into storage bins of 2,400 tons capacity, and the slack is conveyed to bins with 3,000 tons capacity by a scraper conveyer, the return half of which carries rock and refuse to a bin of 200 tons capacity, from which it is drawn out into self dumping cars and hauled to the refuse dump with air locomotives. The coal in the coal bins is loaded into box cars by a box car loader, and into open cars from chutes. The slack is loaded into seven ton harries, and is hauled by a compressed air locomotive over the coke ovens.

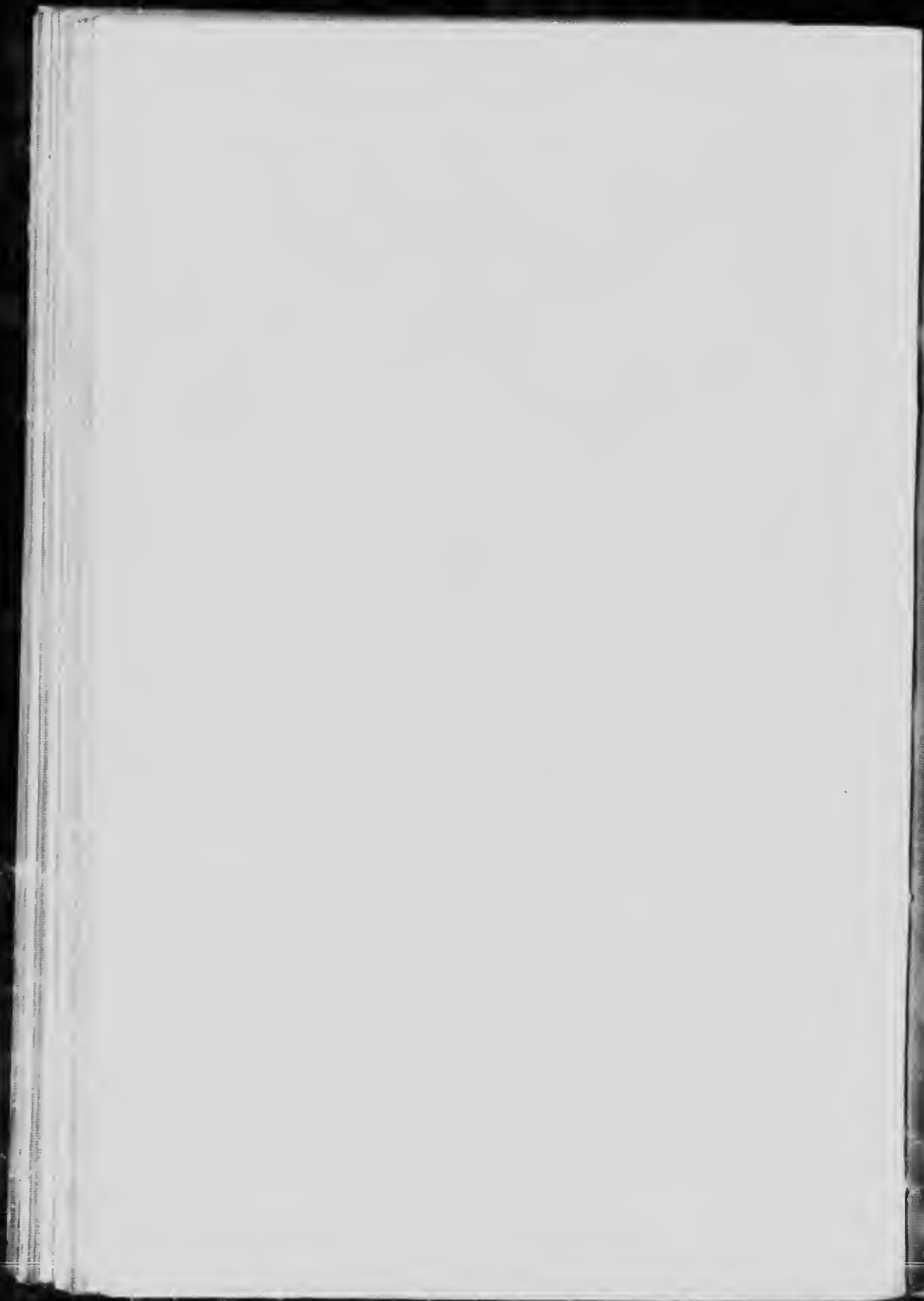
The power for the shaking screens and picking belts in the tippie is derived from a Duplex Atlas engine, 12" x 16". The slack-rock conveyer is driven by a 25 H.P. electric motor. The tippie is built entirely of steel with corrugated roofing. It is designed to operate in two units, each of which may be run independently of the other. At present, only one unit is equipped, the second will be put in commission when the output warrants it.

"There are 240 'Beehive' coke ovens, 12 feet in diameter and 7 feet high, which will give an output of 300 tons of coke a day. 'Belgium ovens,' with by-product recovery and distilling plant, are in contemplation for the next block of ovens required.

"The power-house building, of re-enforced concrete, with steel floor joists and steel roof trusses covered with corrugated iron, contains two, two stage, and two three stage compressors, the former to furnish air at 100 pounds for the rock drills, inside hoisting engines, and various other purposes around the plant, the latter to furnish air at 1,000 pounds for the five compressed air locomotives. Two 75 K.W. alternating current generators, for the purpose of lighting the town and plant, are driven by two 125 H.P. engines. All of these engines are fitted with cut-off valves, the purpose being to carry steam at 120 pounds pressure, cut off early, and use the steam expansively. The exhaust steam from all of these engines is connected into two 20" pipe lines, one known as the 'atmosphere line' and the other as the 'heater line.' By means of valves, the steam from any or all the engines can be turned into either of these lines. When turned into the heater line, the steam passes through a 1,500 H.P. Hoppes exhaust steam heater, heating the boiler feed water to 200° F. A ten-ton travelling crane has been installed for the convenient handling of the machinery.



Hosmer mines; steel trolley, Hosmer, B.C.



"A boiler house, also of re-enforced concrete, with steel trussed roof covered with corrugated iron, and a cement floor, contains six 250 horse-power Babcock and Wilcox boilers, with chain grate stokers with appliances for the convenient handling of coal and ashes." Space is provided for two additional boilers which will be installed when required.

"The town on the Company's property at the present time consists of a general office, mess-house, three officers' residences, several foremen's houses, a large boarding-house, sixty miners' houses, and a hospital, all neatly painted, and supplied with water and electric light. Quite a large and progressive town has been built across the Canadian Pacific Railway tracks, on property not owned by the Company, where are located the stores, hotels, etc., necessary for the maintenance of a miners' camp."

Corbin Coal and Coke Co.

This Company is working the Corbin colliery, in the Crowsnest coal field. The mine, which started operations in 1908, is situated in the centre of the field. The coal lands holdings of the Company comprise some 20 square miles. The colliery is connected with the Crows Nest branch of the Canadian Pacific railway at McGillivray, by the Eastern British Columbian railway, 11 miles long. The seam worked is very thick, attaining 40 feet and more in places. The dip is steep, being 70° to the east. The main entry is a slope 1,800 feet long driven on the coal seam. The work done so far has been of the nature of development. The equipment consists in the main of four boilers, of a total capacity of 120 H.P.; a Crawford and McCrimmon reversible fan of 50,000 cubic feet capacity. A compressed air haulage system is at present being installed. Safety lamps of the Wolf type are used, of which there are 180. The possible output of the colliery is 500 tons at present.

PRINCETON, NICOLA, AND TELKWA VALLEY COAL FIELDS

Besides the above coal fields which are at present worked, and the development of which is rapidly being extended, there are several other districts in which coal-bearing rocks occur. The lack of transportation facilities is the main reason why these other coal fields are at present dormant, but there is no doubt that in the near future they will develop into well-established and producing districts.

PRINCETON CREEK FIELD

This field is likely to become a producer at an early date owing to the prospective construction of the Great Northern railway to and through it. Mr. Chas. Cansell, who in 1906 made an examination of this region for the Geological Survey¹, reports as follows on the Princeton field:

"The remaining rocks are all of Tertiary age, and grouping the sedimentary rocks with the volcanic, we find that they cover the largest proportion of the district. The sedimentary rocks alone in the northern part of the district cover an area of nearly fifty square miles, the basin being fourteen miles long with a variable width of from three to four and a half miles. These sedimen-

¹Summary Report 1906, Geological Survey of Canada. The railway has since been extended, and the mines are now (1911) in operation.



tary rocks consist of thick beds of sandstone, with clay shales, and several seams of coal. The strata do not lie horizontally, but have been tilted at low angles, making an irregular series of folds. Some faults also occur.

"Many drill holes have been bored in this Tertiary basin in search of coal seams, and with some good results. Most of them, however, were put down at or near the edge of the seam and only one near the western edge of the basin. By the kindness of Mr. Ernest Waterman, manager of the Vermilion Forks Mining and Development Company, copies of the records of these drills have been obtained. These have disclosed the thickest coal seams to be in the vicinity of the town of Princeton, where a bed of over eighteen feet in thickness was struck at a depth of forty-nine feet below the surface. The hole in which this seam was found was sunk near the bridge over the Similkameen river to a depth of 280 feet. In this hole coal seams, aggregating thirty-five feet seven inches, were crossed in the first ninety feet, while the rest was in shales and sandstones. Four miles up the Similkameen river a bore-hole sunk to a depth of 257 feet only went through two feet five inches of coal; while a drill hole near the south end of the basin at Ashnola, which penetrated to a depth of 398 feet, gave no workable seam at all, and only a few bands of what is called in the record 'Coaly shale.'

"A bore-hole was also drilled near the western edge of the basin where the sediments dip up for the volcanics, and not far from where there is an outcrop of coal four feet thick. The depth of the hole is 863 feet, and in that distance, seventeen seams of coal were cut through, with an aggregate thickness of fifty and a half feet, of which the thickest seam was nine feet.

"From a study of these records, it would appear that most, though not all, of the workable coal seams are within 300 feet of the surface. It must be noted, however, that no prospecting by drilling has been done north of the Similkameen river, and the basin undoubtedly extends as far north at least as the forks of One-mile creek.

"Coal outcrops in many places both in the Similkameen and Tulameen rivers, also on Summers creek, Bromley creek, and Onemile. At the latter places a cut in the bank made by a stream discloses a bed fifteen feet in thickness of fairly clean coal, with five thin partings of clay, all resting on white clay.

"A sample from the big seam at Princeton, worked by the Vermilion Forks Mining Company, was sent to Mr. Hoffman of the Department. He calls it a lignite, but one of the better class. Analyses by fast coking gave:—

Hygroscopic water	16.17%
Volatile combustible matter	37.58%
Fixed carbon	41.67%
Ash	4.58%
	100.00%
Coke, ¹ per cent.	46.25

¹ This is not coke in a commercial sense.—J.B.P.

Character of coke: pulverulent; colour of ash: brownish yellow.

"Though the age of these beds is put down as the same as the Coldwater group of the Nicola valley, in which coal occurs, there is a difference in the quality of the fuel contained in each. The Nicola coal is considerably higher in fixed carbon and lower in water, but the amount of ash is also higher. Some of the beds of the Princeton coal basin are only in a primary state of formation, and they still show the woody fibre of the slightly altered vegetable remains. Some also have been completely destroyed by combustion, and it is to the combustion of an underlying bed of lignite that Dr. Dawson attributed the metamorphism and colour of the rocks at the Vermilion bluffs."

GRANITE CREEK COAL FIELD

(Samples Ex. 1, Ex. 2, and Ex. 3)

There are a number of promising outcrops of bituminous coal in the high hills on the southern bank of the Tulameen river between Granite creek and Otter Flat, about 12 miles above and west of Princeton. Several of these exposures have been prospected, the most extensive work having been done on a tributary of Granite creek, at an elevation of about 1,200 feet above the Tulameen river, and at Collins gulch, at a slightly lower level.

In the spring of 1908, Dr. Porter examined these developments, which comprised an extended series of trenches and pits and three tunnels, each over 160 feet in depth. Circumstances rendered it impracticable to attempt any careful study of the geology of the field, but at least four separate coal seams were clearly exposed, and three of these being of ample thickness for mining, were sampled as carefully as the amount of development permitted.

The details of the sampling and the results of the subsequent analyses and coking and washing trials, will be found in the body of this report. It is sufficient here to state that all three seams proved to be of workable thickness and to contain coal of fair quality. One of the seams produced excellent coke when tested in Belgian ovens; but subsequent tests on a larger scale, in beehive ovens, are reported to have been less successful, probably because of the choice of the wrong seam or because of unsuitable conditions at the coke ovens.

NICOLA VALLEY COAL FIELD

This field is situated to the south of Nicola lake in the Kamloops district of British Columbia. Although not as extensive as the Crow-nest field, or the Vancouver Island field, it is yet of great economic importance. It stands mid-way between them, hence the coal of the Nicola valley is manifestly destined to find a market in a considerable part of central British Columbia.

The rocks constituting the coal measures of this field lie in areas of very irregular outlines, having a superficies of approximately 40 square miles, the whole of which, however, is not underlain by coal beds. These measures, which have been referred to the Tertiary, rest on Triassic volcanic rocks. It was at first contended that there had been two distinct periods of volcanic

activity in the district, the second one subsequent to the formation of the coal measures. Acting on this supposition, some unsuccessful borings were made in the upper volcanics in the hope of discovering some underlying coal beds. But this contention has now practically been proved to be erroneous, and it is fairly well established that all the volcanics antedate the coal measures in this field.

Mention of existence of coal in this district was made by Dr. Dawson in his report to the Geological Survey in 1877-78. More detailed information concerning these coal measures was published later on, in 1897, by the same geologist in his report on the "Area of the Kandloops map sheet," and in 1901 Dr. Ells made a further examination for the Geological Survey, and the following notes are largely abstracted from his report.

"The most interesting series of outcrops in the Nicola basin is found in what is called the Coal gully, a ragged ravine which cuts the face of the hills west of the Coldwater river, and about one mile south of the forks with the Nicola river. The rise of the hill is steep, the elevation at the top of the main gully, in a distance of 35 chains, being 400 feet above its mouth on the flat area west of the river, while in the next 35 chains, to the contact with the volcanics, there is a further rise of about 350 feet. A small side gully comes in from the west at the mouth of the main gully, and on both of these the rocks are well exposed.

"On Coal Gully proper, four coal seams are exposed with interstratified beds of greyish sandstone and shale, with some conglomerate. On the side gully, there is a contact of the shale with the volcanics ten chains southwest of the junction with the main gully, the rocks in this portion being principally shales, grey, brown, black, or carbonaceous."

Two companies are now actively working in this field, viz., The Nicola Valley Coal and Coke Co., and the Diamond Vale Coal Co. The following is a partial section of the measures from Coal gully, to the Coldwater river, measured by Mr. Alex. Faulds of the Nicola Valley Coal Co. The beds are given in descending order:—

Diamond Vale seam	4'-6"
Sandstones and shales	150'-0"
Rat hole seam (No. 2 mine)	6'-0"
Shales and sandstone	90'-0"
Thin coal	4½"
Shales and sandstone	609'-0"
Gem seam	3'-0"
Sandstone and shale	89'-0"
Major seam	17'-6"
Shales and sandstone	136'-0"
Ells seam	9'-0"
Sandstone and shales	146'-0"
Jewel seam (No. 1 mine), Coal	9'-0"
Parting	2'-6"
Coal	5'-6"

In the Jewel seam, there are several partings in the upper bench of coal, but these appear to pinch out in places and are probably lenticular inclusions.

In the Ells seam there are also two or three partings.

Some prospecting work has recently been done in a smaller coal basin, distant 10 miles to the east of the areas being worked. This detached patch of coal-bearing rocks is called the Quilchena coal area. Diamond drill holes were put down; but so far these measures have not been otherwise exploited.

The following are the mines working in the district:—

Nicola Valley Coal and Coke Company

(Samples Nos. 22, 22 SP, and 22 M.)

This Company operates the *Middlesboro collieries*, situated in Nicola valley, $2\frac{1}{2}$ miles southeast of Coutlee, and controls an area of 2,660 acres. Four mines have been opened on various seams.

Mine No. 1. (Sample No. 22).—Operated by an adit on Coal Gully hill, on the Jewel seam, which has a thickness of 13 feet, including irregular partings, one of which reaches 3 feet in places. Only about 7 feet of this seam is extracted, by pillar and room method. The main gangway is in 1,400 feet, and at a point 550 feet from the entrance a slope has been driven, 850 feet long, to the outcrop of the seam in the side of Coal gully. The workings in this mine, comprising cross-cuts, counter levels, and rooms total up some 4,000 lineal feet. Haulage underground is by horses, to the tippie. Ventilation is natural at present, and open lights are used, as the mine is free from gas. There is a 30 H.P. boiler. The tippie building at the mine is equipped with a Phillips tippie and a coal cleaning plant. It is designed for an output of 250 tons per eight hour shift.

Mine No. 2. (Sample No. 22 SP).—Situated on the side of Coldwater hill, half a mile southeast of No. 1 mine. The seam worked is the Rat hole seam, of a thickness of 6 feet, entered by a tunnel which is now 1,640 feet long. At a point 450 feet from the entrance, the tunnel is connected with the surface by a slope 150 feet long driven to the outcrop. At 1,150 feet a shaft has been sunk from the surface.

Part of the mine was first started on the longwall system; but this is now being changed to pillar and stall. Ventilation is by natural means. Haulage underground is by horses to the tippie building, which is equipped with a Phillips tippie. The mine at present can produce 180 to 200 tons a day.

Mine No. 4.—Very little has been done on this seam yet, which is directly above and several hundred feet higher than No. 1 tunnel. The coal is sent down an outside chute to near the entrance of No. 1 mine. The coal is 14 feet thick, of which the lower 9 feet are extracted by pillar and room. Haulage is done by horses.

Mine No. 5.—On seam about 6 feet thick. Opened by tunnel 300 feet from No. 1 tunnel and on same level so as to use the No. 1 tippie. This is only developing.

The Company started work on this field in 1906, but confined itself to development work until 1908 when the Nicola branch of the Canadian Pacific railway was completed, affording means of shipping. The intention is to install, in the near future, an up-to-date screening plant, boiler house, electric hoists and haulage, large fans, etc.

Diamond Vale Coal and Iron Mines, Limited

The coal mine operated by this Company is situated near Coquitlam, B.C., and the coal lands controlled are adjacent to those of the Nicola Valley Coal and Coke Company. The seam worked is 51" thick with a parting which reduces the available coal to about 42". The seam is entered by a slope driven at an inclination of 40°, and 450 feet long at present. This mine is only in the development stage, as work on the slope was started in 1908. A shaft which had previously been sunk some 2 miles from the present slope was abandoned.

The surface equipment comprises a 280 H.P. Babcock and Wilcox boiler, hoisting engine, air compressor of a capacity of 350 cubic feet per minute, a small ventilating fan, dynamo, pumps, etc.

TELKWA COAL FIELD

There is another prospective field which offers great interest at present, owing to its proximity to the line of the Grand Trunk Pacific railway, which is projected to pass through this district. This is the Telkwa valley in the northern part of British Columbia. Access to this region can only be had at present by way of the Skeena river, or by stage road by Ashcroft and Quesnel; but the construction of the new Transcontinental railway will, of course, furnish the means of transportation necessary to the development of the district.

The region was examined in 1906 and 1907 by W. W. Leach for the Geological Survey, and the following notes are extracted from his report, as published in the Summary Report:—

"The rocks of the Telkwa valley may be roughly divided into four main divisions, consisting, in ascending order, of: (1) the crystalline rocks of the coast range; (2) a great thickness of volcanics; (3) the coal-bearing beds, and (4) a series of eruptives more recent than any of the above mentioned. Immediately overlying the rocks of the second division, and possibly unconformable to them, although both have been subsequently folded and faulted to such an extent that their immediate relationship to one another is somewhat doubtful, occurs a series of rocks composed chiefly of clay shales and containing a number of important coal seams."

"The problem of delimiting the coal areas of this district is one of extreme difficulty. The exceedingly soft nature of the coal-bearing rocks and their consequent failure to resist erosion has resulted in their removal everywhere from the higher ridges, only a few isolated patches remaining in the valleys.

The total thickness of the coal formation being small, probably not in excess of 300 feet, and the folding and faulting being considerable, it is probable that even in the lower valleys the volcanic rocks occupy a large extent of the area, the coal rocks having been removed by denudation."

There are at present four companies holding coal claims in this district, all of which have done prospecting work of a desultory nature. These companies are the Cassiar Coal Co., the Kitimat Development Syndicate, the Transcontinental Development Syndicate, and the Telkwa Mining, Milling, and Development Company.

In places four seams have been uncovered, from 1 foot to 7 feet in thickness, contained in a few hundred feet of measures.

The character of the coal varies from a bituminous to a semi-anthracite, as the following analyses show:—

TABLE IV
Analyses of Telkwa Coals.

	Moisture	Volatile Combust- ible	Fixed Carbon	Asd
Cassiar Coal Co., Goat creek: lower 7 feet of top seam.	1.92	30.45	61.30	6.35
Middle bench, middle seam.	6.60	29.00	56.90	7.50
Telkwa Mining, Milling, and Development Co.				
Coal Creek, 5'-6" seam	1.36	10.87	80.82	6.95
7'-3" "	0.80	11.10	78.90	9.20
1'-0" "	0.58	10.80	82.70	5.90

VANCOUVER ISLAND AND THE COAST

During Carboniferous times, deep sea conditions prevailed over the western part of Canada, and these were not favourable to the formation of coal-bearing horizons. It was only subsequently, in Cretaceous times, after the land had emerged from the water, bringing to the surface the heavy deposits of limestone, that conditions favoured the luxuriant vegetation to which the coal beds owe their origin. These conditions lasted far into the Tertiary period. Therefore, unlike the eastern part of Canada, where the coal seams are found in horizons of Carboniferous age, in western Canada the mineral fuels are associated with rocks of Cretaceous and Tertiary ages. This remark applies to the coal fields of the Plains and the interior of British Columbia as well as to the coal-bearing areas of Vancouver and Graham islands.

The Vancouver Island fields now being exploited are situated on the east coast of the island. "The Cretaceous coal-bearing rocks of Nanaimo and Comox border the southwestern shore of the strait of Georgia, forming a belt of comparatively low rolling or hilly country, between the mountainous regions of the interior of Vancouver island and the coast. Though locally much disturbed and affected by folds and faults parallel to a general north-west and southeast direction, these Cretaceous rocks still preserve, to a

great degree, their original relation to the wide depression now occupied by the strait of Georgia, being largely of the character of littoral formations, such as conglomerates and sandstones, to which category, in a certain sense, the coals may also be added. Series of shaly strata, intercalated with these, and holding truly marine fossils, indicate periods of greater depression; but the fact remains that many of the beds were laid down along the sea-margin nearly at the present level. There is thus every reason to believe that the Cretaceous strata underlie a great part of the actual strait of Georgia, a belief which is strengthened by Richardson's observations of certain small patches of these rocks on the shores of Texada and Lasqueti islands on the north-east side of the strait. It is probable, however, that the rocks maintain their coal-bearing character, with greater regularity, in a direction parallel to the present and former coast line, than they would be found to do if it were possible to follow them far beneath the waters of the strait, where more exclusively marine conditions might be expected to have obtained in Cretaceous times. The somewhat variable character of the Cretaceous from point to point is shown by the fact that Richardson found it necessary to adopt a different series of subdivisions for the measures of the Nanaimo and Comox regions, though these occupy the same general strike and only fail in being continuous by the existence of a few miles of coast near Nanoose harbour, on which the older underlying rocks occur."¹

These coal-bearing rocks outcrop in a long, narrow, almost continuous strip (except for a break of some 12 miles at Nanoose bay) from Cape Mudge, in the north, some 25 miles northwest of Comox, to within 15 or 18 miles from Victoria in the south, a length of some 130 miles, the width varying between 2 miles and 15 miles. On the west they abut against the old crystalline series, whereas to the east they dip under the waters of the strait of Georgia.

The coal measures of the east coast of Vancouver island may, therefore, be naturally divided into two distinct fields, separated by the gap of 12 miles of crystalline rocks in the district of Nanoose. The northern area is the Comox field, and the southern one the Nanaimo field. Another field until recently quite undeveloped exists in the vicinity of Esquimalt, about 125 miles to the north.

COMOX FIELD

The northern trough of Cretaceous rocks, the central part of which forms the Comox lake or Cumberland coal district, extends from Cape Mudge, to Nanoose bay on the south, a distance of some 60 miles. Mr. J. Richardson, of the Geological Survey, estimates its area at about 300 square miles, without taking into consideration the part which may be beyond the shore. He examined more closely the central part of this development, from Browns river to Sable river, a distance of about 18 miles, and the following sections

¹Geological Survey Report, Vol. II, part B.

which he measured in this district will serve to give some idea of the importance of this field.

On Browns river, at the northern end of the field, almost the entire section of the Productive Coal Measures is exposed, with a thickness of 739'-6" of beds of calcareous sandstones and shales, in which occur nine coal seams of varying thickness— from a few inches to 7 feet— the thickest being the lowest. At the Union mine, in a perpendicular cliff, in a section of 122 feet there are eleven coal seams, the thickest of which is 7'-6", underlain immediately by 2'-6" of impure coal running over 20 per cent in ash. This last seam is also the lowest of the series. On the Trent river, in 711 feet of measures, consisting mainly of sandstones and shales, there are 13 seams, of which the thickest is only 3'-8". On Sable river, near Bradley creek, there are exposed 221 feet of measures, including two coal seams of 6 feet and 5'-10", respectively.

The notable differences in the thicknesses of the seams render their correlation in the different sections measured very difficult. But Richardson, considering an area of about 25 square miles, calculates that the quantity of coal underlying the surface is about 25,000 tons per acre.

As to the southern development of the Comox area of Cretaceous rocks from Sable river to Nanoose bay, Richardson expresses himself as follows, "The facts obtained from the various exposures met with from Sable river on the northwest to Northwest bay on the southeast, as already mentioned, a distance of 36 miles, are meagre enough, although there can be no doubt that we have in this distance a continuation of the Productive Coal Measures between Browns and Sable rivers, where workable seams of coal are seen in sections displaying every bed. It, therefore, can hardly be supposed that in their continuation southeast, to Northwest bay, seams of good workable coal are entirely wanting. Indeed it appears to me that they may reasonably be looked for. On account, however, of the few and badly exposed sections, as compared with those to the northwest, the only practicable way of proving the value of this comparatively long stretch of productive measures, is by boring or by sinking a shaft."¹

Since that time a great deal of exploratory work in the shape of boring has been done in this southern extension of the Comox field; but the records are not available. No mining work has been done, and the coal mines at present worked are all in the Cumberland district.

In 1875 work was begun in the Comox field when the Baynes Sound colliery was opened, and a great deal of exploration and prospecting work was done. It was not, however, until 1888, that any active mining operations were initiated, when the Dunsmuir Syndicate opened the Union colliery, and built a railway 11 miles in length, connecting the mines with a suitable shipping place at Union bay.

¹ Geological Survey report, 1876-77.

There are now four mines in the district, all operated by the Wellington Colliery Company.¹ The various mines are designated as follows: No. 4 slope, No. 5 shaft, No. 6 shaft, and No. 7 slope, which are all situated within a radius of 5 miles from the town of Cumberland.

NANAIMO FIELD

The Nanaimo district, as explained above, is constituted by the southern development of the trough of Cretaceous rocks of the eastern coast of Vancouver island, and is separated from the Comox area by an exposure of 10 to 12 miles wide of crystalline rocks. The length of the southern trough, from Nanoose bay to within about 16 miles from Victoria, is approximately 10 miles and includes the large islands of Saltspring, Pender, and Saturna. The coal measures extend to an unknown distance under the sea, and it is impossible to give any estimates of the area which they occupy or of the amount of coal which they contain. The land development, at its greatest breadth, south of the Nanaimo district, measures almost 10 miles across.

Besides the main trough there is a smaller one, situated to the southwest of it and separated from it by a small area of crystalline rocks. This small coal field is the Cowichan area.

The coal measures are seen at Departure bay to rest upon the crystalline rocks. Sections measured in the Nanaimo field show the presence of two main seams. The thicknesses of these, however, as well as of the intervening strata, are very irregular, as shown below.

From measurements made on the north side of Departure bay, as well as other points in the vicinity, the following section was established; given in descending order:—

Fine grained sandstone.	
Argillo-arenaceous shale, and carbonaceous partings showing irregular thin seams of coal.	1 foot
Sandstone, fine grained and in places carbonaceous	63 "
Coal, clean and hard (Douglas seam).	1 "
Sandstone of various textures.	67 "
Coal (Newcastle seam).	1 "
Sandstone and conglomerates.	523 "

In the workings of the No. 4 shaft of the Western Fuel Coal Company, first opened in 1853 by the Hudson's Bay Company,² the relative position of the two seams appears to be as follows, in descending order:—

Slate and conglomerate	21 feet
Coal (Douglas seam)	2 to 6 "
Conglomerate	72 "
Sandstone	84 "
Coal (Newcastle seam)	3 to 8 "

Dr. H. S. Poole spent the summer of 1905 on Vancouver island, engaged

¹This Company also operates in the Nanaimo field, and all of its collieries will be described in one place. See pp. 109-111.

in an examination of the coal fields, for the Geological Survey. In his report he mentions that "The area of the coal-bearing series may, in general terms, be said to extend down the whole east coast of the island, but the area in which it is probable coal in workable thickness exists is very much less, while the area that may be regarded as proved is comparatively small. The difficulties in the way of exploring are numerous; vegetation is rank, the surface is largely disguised under thick layers of wash gravels, and there are no inducements to the public to prospect over the major portion of the more immediately promising ground, as these lands are held by the present coal operators, who have no occasion to explore much ahead of their requirements. Still, if it is desired that a conjecture be hazarded of the quantity of coal exceeding a thickness of 2 feet, and within a vertical depth of 1,000 feet, an estimate of 600,000,000 tons, though based on most incomplete data, would seem conservative, and yet at the same time sufficiently large to allay apprehension of any immediate shortage in the output."

As mentioned in a note given a few pages back, it was in the Nanaimo district that the first coal-mining operations were conducted in British Columbia. In 1852 the Nanaimo Coal Mining Company, a subsidiary of the Hudson's Bay Company, opened up a colliery which was sold in 1861 to the Vancouver Coal Mining and Land Company. In 1902 the holdings were acquired by the Western Fuel Company now operating.

The other large company operating in this field is the Wellington Colliery Company, which began operations in 1871 by opening up the Wellington mine 3 miles west of Departure bay and 5 miles northwest of Nanaimo. The main centre of operations of this Company in the Nanaimo field is at present in the Extension district to the southwest of Nanaimo.

Besides these two large companies there are smaller ones, as the following extract from the report of the Minister of Mines for 1907 shows:

"On Vancouver island three new collieries have begun shipping, as yet on a very small scale, but still a beginning. These new collieries have shipped as follows: The Gibillian colliery, at Wellington, operated by MacIowan & Co., 2,810 tons; the Fiddiek colliery, at South Wellington, operated by the South Wellington Coal Mines, Ltd., 575 tons; and the new East Wellington colliery at Nanaimo, operated by the Vancouver-Nanaimo Coal Mining Co., Ltd., 156 tons."

Wellington Coal Company

Samples Nos. 20, 2020, 21, 21 SP, and 21 M.

The Wellington Coal Company control large areas of land in the Nanaimo district and in the Comox district of Vancouver Island. In the Nanaimo district they operate the Extension colliery to the northwest of the city of Nanaimo; in the Comox district they operate their mines known as the Union colliery.

Extension Colliery. (Samples Nos. 20 and 2020).—The seam worked here is the Wellington, which underlies the basin and dips both ways towards

the seam. The thickness is very variable, between 4 and 44 feet. The main entry is by a tunnel, 5,200 feet long, through rock. East and west of the tunnel, which tops the seam on the main, or No. 4 level, the workings extend nearly $2\frac{1}{2}$ miles each way. The mine is divided into three districts, No. 1, No. 2, and No. 3, in all of which there are separate entries and slopes. The coal from all is hauled out by the main tunnel to the bankhead, but although the three mines are connected underground in several points, they can be isolated in case of accident, as substantial barriers of coal have been left between them.

No coal-cutting machinery is used in the Extension colliery—all the coal being mined by hand. The system of working is by pillar and stall, which in the first instance only takes out 35 per cent of the coal, but the pillars are drawn out. The boiler plant has a capacity of 600 h. p. Power underground haulage is by electric locomotives. Ventilation is by a Murphy fan, 10 feet diameter, in No. 1 mine, and by two Guibal fans, 45 feet diameter, in No. 2 and No. 3 mines. The possible capacity of this colliery is between 1,800 and 2,000 tons per day.

On coming out of the tunnel, the mine cars are hauled to the tippie through a covered way on trestle, 1,800 feet long and 48 feet wide. The coal is dumped on screens. The lump goes over a picking belt, and the slack is shipped to an washery.

The mine is connected with the shipping wharves at Ladysmith by a standard gauge railway 43 miles long. The wharves are three in number and the loading capacity under ordinary circumstances is about 600 tons an hour, but could be increased to 800. The bunkers hold 6,000 tons.

The small coal from the screens is treated in a washer erected at Ladysmith. The coal is sized into nut, pea, and slack. The nut coal is treated in a cone washer, whereas the pea and slack are washed in Lührig jigs. The labour necessary to operate the washing plant requires three Chikanan and one white mechanic. The power and water used in the washer are supplied by means of a dam across a creek, 2 miles distant, which gives a head of 130 feet. The water on issuing from the turbines which furnish the power is used for washing and for conveying away the refuse. The washed coal retains only between 10 and 11 per cent ash.

Union Colliery. (Samples Nos. 21, 24 SP, and 24 M). This colliery of the Wellington Coal Company is situated in the Comox district, and comprises four mines called respectively No. 1, No. 5, No. 6, and No. 7, in the vicinity of the town of Cumberland, some 15 miles from the shipping wharves at Union bay.

No. 1 Mine. (Sample No. 21).—Situated on Comox lake, 2 miles distant from the town of Cumberland. The seam varies from 3 to 8 feet, and is worked by three slopes, converging to one entry near the surface. No. 1 slope, on an inclination of $7^{\circ} 30'$, is 7,500 feet long; No. 2, inclined 41° , is 6,590 feet, and No. 3 is 5,500 feet. Pillar and room system is

followed. Underground haulage is by tail rope. Ventilation is by Guibal fan, of capacity of 110,000 cubic feet a minute. The boiler plant comprises 12 return tubulars of 50 H.P. each, total of 600 H.P., of which 250 is used for generating electric power for coping and hoisting. The coal is hauled to a Phillips tippie and passed over shaking screens and picking belts. The mine is equipped for a daily production of 1,000 tons, and is connected by a standard gauge line with the railway running between Cumberland and the shipping wharf. The screened coal goes to the wharf and the slack to the washer at Union bay.

No. 5 Mine. Situated three-fourths of a mile from the town of Cumberland. This mine is worked by a shaft, which cuts two seams, at depths of 210 feet and 590 feet respectively, the upper seam averaging about 6 feet and the lower one varying between 3'-6" and 4'-6". The main workings are on the lower seam, which is mined by the longwall method. A haulage engine pulls the coal in the slope to the foot of the shaft. Ventilation is by Guibal fan of a capacity of 75,000 cubic feet of air per minute. Boiler plant consists of six return tubulars of 50 H.P. each. The arrangements on the bankhead are similar to those of No. 4 mine; the coal is dumped by Phillips tippie, screened and picked.

No. 6 Mine is in the town of Cumberland, one mile south of No. 5, and is worked by shaft which cuts the same seams as No. 5 at practically the same depths. The workings of the two mines are connected underground. The method of working, and arrangements for hauling, hoisting, etc. are similar to those at No. 5 shaft. The boiler plant consists of a 450 H.P. battery of return tubular boilers. Ventilation is by a 100 x 5 ft. Guibal fan.

No. 7 Mine. (Sample No. 21 SP). This mine is the most recent one opened by the Wellington Coal Co., in the Comox district. It is situated about 4 miles in a northwest direction from No. 5, and 2 miles from No. 4. This is on the same seam as No. 4 mine, and is worked on pillar and stall system from a slope 1,800 feet in length. Ventilation is by a 30 x 11 ft. exhaust fan. The coal is hauled to the bankhead, dumped on bar screens 15 feet long, and picked on a belt 70 feet long.

The coal from all the mines is shipped by the railway to Union bay, 13 miles distant from Cumberland. At Union bay the Company has good steaming wharves, with coal bunkers of a capacity of 1,000 tons. The slack coal is cleaned in a Lathrig washer, which has a capacity of 500 tons in 10 hours. The washed coal goes to a bunker from which the coke ovens are charged. These are in a battery of 100, beehive pattern, of a capacity of 5 tons each.

Western Fuel Company

(Samples Nos. 17, and 18)

The area controlled by this Company consists of some 3,500 acres held in fee simple, the greater part of which was originally acquired from the Hudson's Bay Company.

The collieries are situated at Nanaimo and at present consist of three mines, viz., No. 1 shaft or Esplanade, Protection island, and No. 1 Northfield.

Two seams of coal are worked, called respectively the Douglas or Upper, and the Newcastle or Lower. These are separated by about 60 feet of hard conglomerate.

No. 1 Shaft and Protection Island Shaft.—(Samples 17, 18, and 2018). These two shafts may be regarded as one mine, being connected in many places. They are ventilated by the same fan, and many of the miners of No. 1 mine are lowered to their work by Protection Island shaft. No. 1 shaft, which is sunk on the water edge in the city of Nanaimo, cuts the two seams, the Douglas at 640 feet and the Newcastle at 700. The upper seam varies in thickness between 7 and 10 feet, while the Newcastle is from 30" to 6 or 8 feet. The general dip is about 10°.

The workings of this mine are very extensive. From face to face on opposite sides of the shaft, the distance is nearly $5\frac{1}{2}$ miles. The system of working is by both longwall, and pillar and stall with extraction of pillars, according to thickness and also the depth of overlying strata. As a rule all the coal is removed where the cover exceeds 500 feet. The two seams are connected by two slopes through the intervening measures. Siskol coal cutting machines are extensively used. The underground haulage is partly by electric locomotives and partly by endless rope, to the bottom of No. 1 shaft, from which all the coal is hoisted to the tiple.

Until last year this mine was ventilated by a large Guibal exhaust fan 36 feet \times 12 feet and a smaller Guibal force fan of 20 feet. These, however, have just been replaced by a large Sirocco fan, which delivers 200,000 cubic feet of air. This could be increased to 400,000 by increasing the speed and the motive power. The coal is hoisted to a modern bankhead, dumped by revolving tipples, screened, and picked. The colliery is equipped for a daily output of 2,000 tons. The boiler plant consists of six boilers giving 1,200 H.P.; under which is burned coal sludge from the coal washer. There are two electric generators and two Rand compressors.

The Company owns 10 miles of railway track, with rolling stock, shipping wharves, and storage bunkers having a capacity of 10,000 tons. The slack is washed in a Howe-Robinson coal washer, having a capacity of some 400 tons a day. The refuse from the washer is used under the boilers. Safety lamps of the Wolf type are used exclusively.

The grades of coal prepared at the mine are as follows:—

Lump.	over	3"	round holes
Egg.	through	3"	and over 1 $\frac{1}{4}$ "
Nut	"	1 $\frac{1}{4}$ "	" " 3"
No. 1 Pea.	"	3"	" " 1"
No. 2 Pea	"	1 $\frac{1}{2}$ "	" " 1"
Slack	"	3"	" " 3 $\frac{3}{16}$ " square holes

The coal is marketed in British Columbia, in the United States, and in Alaska.



Pithead, Western Fuel Co., Nanaimo, Vancouver island, B.C.

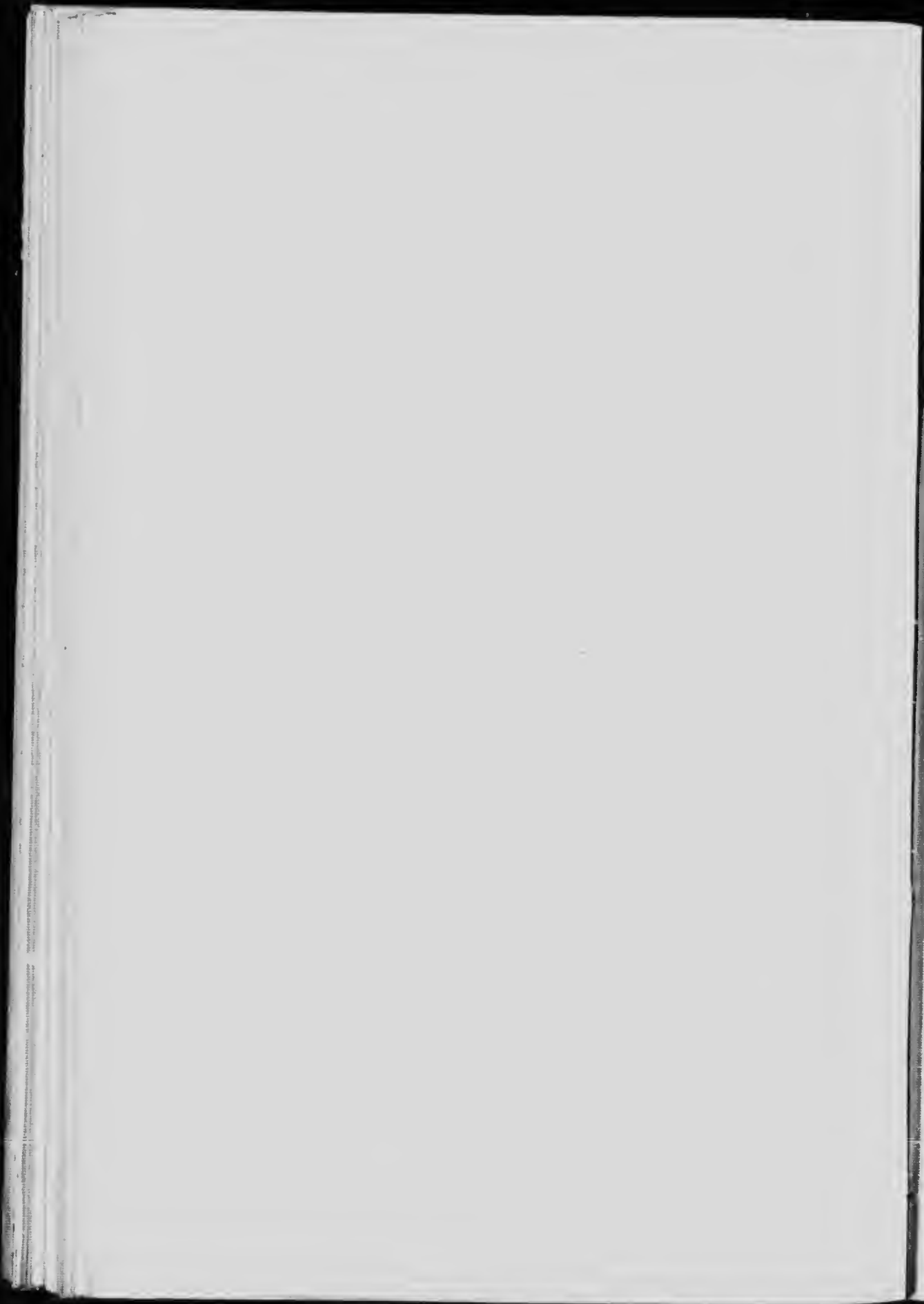
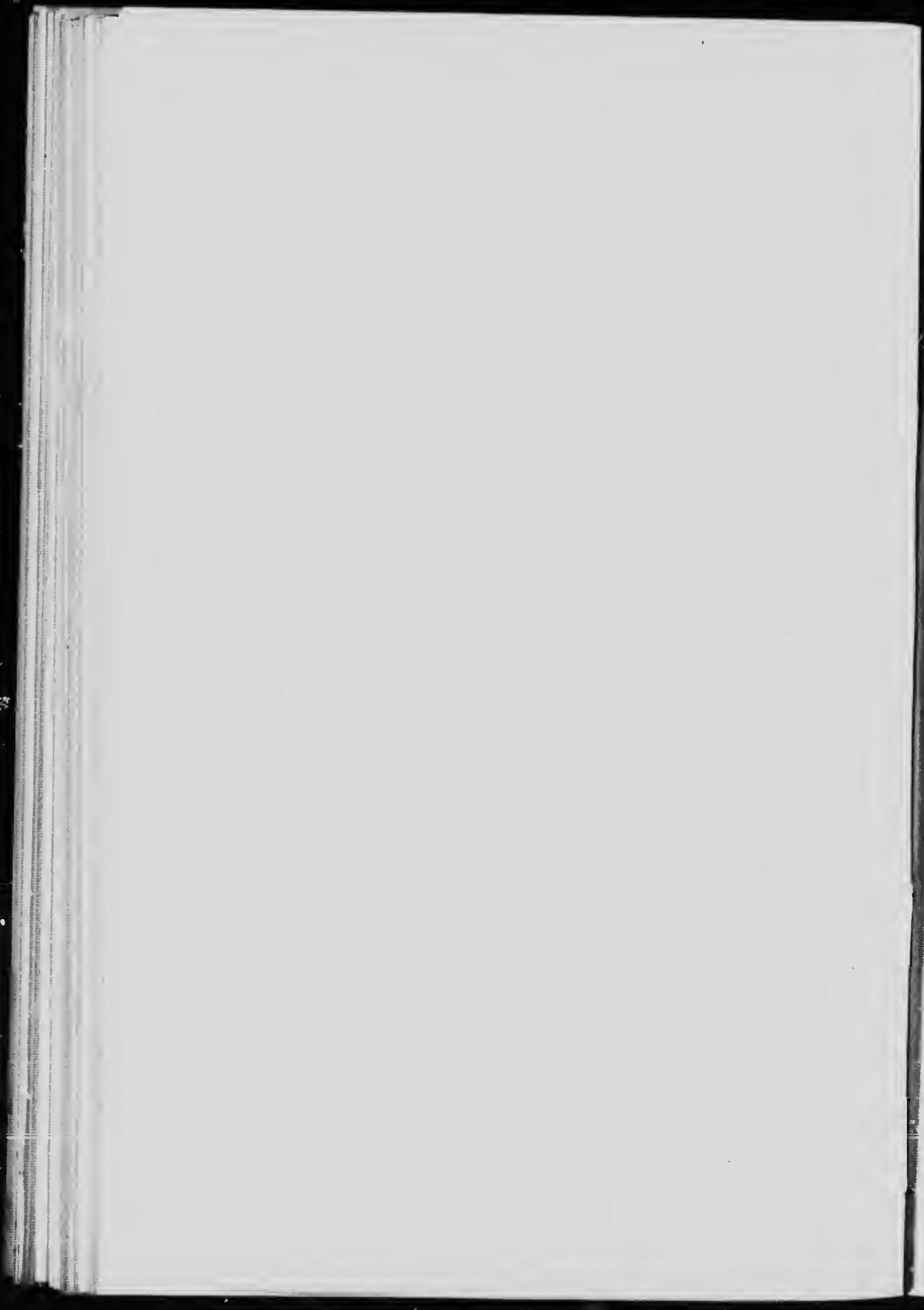


Plate XXVII.



Northfield colliery, Nanaimo, Vancouver Island, B.C.



Northfield Mine, or No. 4.—This mine is situated about 2 miles north-east of Nanaimo at a point where the seams, Douglas and Newcastle, outcrop at the surface. The main workings are on the lower or Newcastle seam, which here varies between 30" and 60" in thickness. There are two entries to the mine. One is by a slope which starts on the outcrop itself, and is used mainly for a travelling way; the second entry is by a shallow shaft 84 feet deep, from the bottom of which a slope has been driven parallel to the first. The main slope is now 4,300 feet long from the shaft bottom, and levels have been driven on each side, at 2,000 feet, 2,500 feet, and 3,000 feet respectively. The coal is mined by longwall system and is cut with Siskol machines. Haulage is by endless rope to the bottom of the shaft. Ventilation is by Clifford-Capell fan of a capacity of 150,000 cubic feet per minute and a Murphy fan which is kept in reserve.

On the surface there is a well-equipped modern plant of modern Link-Belt design, for dumping, screening, and picking the coal. From the picking tables the coal is carried to the bunkers by a system of conveyers. The ship-loading plant is also very complete. There are two conveyers running to the loading wharf, which permit of loading the coal with the least possible breakage.

The boiler plant comprises four return tubular and two flue boilers of a total capacity of 550 horse-power. The compressor plant consists of one Rand compound 2,500 cubic feet free air per minute and three Ingersoll compound of 2,000 cubic feet free air. There is also a hoisting plant and an electric lighting plant.

THE SUQUASH COAL FIELD

The east end of the Suquash coal field commences at Port McNeill—where the upper shales and sandstones are exposed at low tide—and continues northwest to the mouth of Beaver harbour, where the ruins of old Fort Rupert now remain.

The formation is Cretaceous, the strike being northwest and southeast along the east shore of Vancouver island, dipping to northeast at from 5° to 8°.

Pacific Coast Coal Company, Limited

In 1907, a large tract of coal lands was acquired by the Pacific Coast Coal Co., Ltd., of Victoria, B.C., at Suquash,¹ where—about 1852—some coal had been mined on the surface by the Hudson's Bay Company; in that year, under the direction of the Company, a diamond drill was carried to Suquash, under the supervision of Mr. E. Hodgson, engineer in charge of the work.

About the latter part of May operations were begun; and at 172 feet from the surface, at the mouth of the Suquash stream, a 4'-10" seam of excellent coal was encountered. Operations were continued to a depth of 1,204 feet, and were still in coal measures at that depth. Two other seams were encountered at about 900 feet. The line was moved east, down the coast line about half a mile, and another hole was sunk with similar results to No. 1. Another hole was drilled about three-fourths of a mile east from No. 2 hole, with like

¹ Data furnished by W. F. Robertson, Esq., Provincial Mineralogist, Victoria, B.C.

results. The drill was then removed a mile west of No. 1 hole with similar results to Nos. 1, 2, and 3. These holes showed remarkable uniformity in the measures, hence it was decided that development work proper should be done, and a shaft was sunk in the winter of 1908 near No. 1 hole at Suquash stream, striking coal at about 172 feet.

From the bottom of this shaft a slope, now about 2,000 feet in length, extends out under the sea, following the dip of the coal, with levels to the right and left.

The coal is remarkably uniform: for its formation kept about the same thickness of 5'-0" to 5'-6" with some hard bone parting.

This exploration work has shown that the Suquash field is very extensive. It is the intention of the Company, in the near future, to build a railway to some safe shipping point.

On the Testing of Six Tons of Coal from the Suquash Mine¹

(Sample Ex. 34)

It was not intended to include any samples of coal from the northern part of Vancouver island in the present series, as the development of the coals of that district had not proceeded far enough; but, as the report goes to press, the owners of the property at Suquash, near Alert bay, have authorized Dr. Porter to include the results of a private test recently made for them at McGill University.

The sample of about 6 tons was taken by the owners of the property, and sent at their own expense to Montreal, where it was crushed, sampled, washed, and tested under the boilers, under practically the same conditions as the regular samples taken for the purpose of this report.

The results have been included in the series as an extra coal; and while the members of the testing staff have not had anything to do with taking the sample or preparing it for shipment, yet they have no doubt as to the substantial accuracy of the sampling; and thanks are due to the Pacific Coast Coal Company, Limited, of Victoria, B.C.—the owners of the property—for their very great liberality in permitting the publication of the results of the test.

The sample was taken from development work, and bears evidence of surface weathering, thus proving that the workings had not at the time of sampling reached a sufficient depth. It is almost certain that the coal will improve greatly with depth; but like many of the coals from the coast, it will, in all probability, always carry a considerable proportion of ash.

QUEEN CHARLOTTE ISLANDS²

The most important coal-bearing area known on this group of islands, which are situated to the northwest of Vancouver island, is found in a development of Cretaceous rocks on Graham island, the most northerly of the Queen Charlotte islands. In this field, coal outcrops have been located in several places between the Skidegate channel and Yakoun lake in the interior of the

¹ Supplementary note by Dr. J. B. Porter.

² A report by Dr. R. W. Ellis, on the Graham Island coal field, has been published by the Geological Survey—Vol. XVI, part B. 1904.

island. Of these coal occurrences, the most northerly is that known as Camp Wilson on lot 36, township IX; a second deposit is found on lot 20, township V, at Camp Robertson; while a third, at Camp Anthracite, on lot 17, township V, is on the general strike of the Camp Robertson seam, although no correlation between the two has been established, owing to the nature of the intervening country.

Camps Robertson and Wilson are reached by means of a trail up the Honna river.

At Camp Wilson the seam upon which a small prospecting tunnel was driven was found to measure a thickness of 17'-6" with a parting of 6" to one foot of sandstone, the upper level showing 12'-4" of clear coal. The dip of the coal in the lower part of the outcrop is N. 40° E. < 75°.

It is impossible from surface indications to determine the value of the coal seam, but the quality seems good and the seam itself is of large dimensions. Analyses of this coal are given below.

At Camp Robertson, which is some 9 miles south of Camp Wilson, the coal presents different features. A seam has been traced for a distance of 295 feet, by means of four small shafts and two drifts. In shaft No. 1, which is that nearest the camp, there is a large body of coal and shale, the width of which at the surface varies from 20 to 22 feet. Of this thickness the portion opened up by the shaft shows about as follows:—

Coal at bottom.	4 feet.
Sandstone.	1 "
Coal.	2 "
Coal and shale.	2 "

This probably represents the lower of the two seams which appear to exist in this area, the exact relations of which are not easy to determine at one point.

The tunnel at the east end of the outcrop uncovered a seam of coal and shale about 17'-6", of which the coal would total about 8 feet, the character of which corresponds closely to the lower portion of the seam disclosed in shaft No. 1.

The second or upper seam, as seen in the tunnel, is separated from the lower by about 8 feet of shale. The dip of 37° on the upper part of the lower seam decreases to 16° at the bottom of the upper seam, the measures flattening out rapidly. The inner end of the tunnel could not be reached, owing to water, but the seam as measured gave:—

Coal.	1'-3"
Shale parting.	0'-1"
Coal.	5'-0"

The third outcrop, at Camp Anthracite, appears to be in the same strike as the Camp Robertson seam, and about one mile to the southeast of this

latter point. Work was done on this outcrop some years ago, principally on a tunnel driven into the east bank to a distance of 40 feet. The shale and coal are much broken, and the latter is of poor quality.

TABLE V
Analyses of Graham Island Coals:

	Moist.	Vol. Comb.	Fixed Carbon.	Ash.	
Camp Robertson, lower seam . . .	1.33	35.35	48.89	20.05	} Analyst J. T. Donald Samples furnished by W. A. Robertson. Geological Survey.
" "	0.80	23.27	51.39	24.54	
Camp Wilson	1.06	43.48	46.01	9.45	
Camp Anthracite	1.52	8.69	80.07	9.72	
Camp Robertson	1.20	29.13	47.52	22.15	
Camp Wilson	1.91	35.24	59.39	3.45	

YUKON TERRITORY¹

In Yukon territory, coal and lignite occur quite extensively. Three of the most important localities containing these fossil fuels are:—

(1) The Whitehorse coal area, (2) the Tantalus coal area, and (3) the Rock Creek coal area. In the two most southerly localities first mentioned, the coal measures occur mainly in the Tantalus conglomerates, but are also found, to some extent, in the upper portions of the underlying Laberge series. These rocks are all Jura-Cretaceous in age, but from the fossils that have so far been found in them, it is not possible to assign these beds a more definite position in the geological column. The coals in the Rock Creek area, so far as is known, are all lignites, and occur in beds of Tertiary age.

Probably the most important of these coal-bearing districts is the Tantalus area, which crosses Lewes river midway between Whitehorse and Dawson, and in which are situated the Tantalus mine, the Tantalus Butte property, and the Five Fingers mine. This, as well as the Whitehorse area has been examined by Dr. D. D. Cairnes² of the staff of the Geological Survey, and the following notes are, for the most part, taken from his reports.

WHITEHORSE COAL AREA

The Whitehorse coal area is situated about 12 miles to the southeast of Dugdale, a siding on the White Pass and Yukon railway. The coal is anthracitic in character and occurs in Jura-Cretaceous beds of which certain massive cherty conglomerates are the most prominent members; dark, finely-textured shales, and sandstones, however, also occur. The measures strike

¹ See Map No. 99. General map of coal-fields in Yukon Territory.

² Cairnes, D.D.—"A portion of Conrad and Whitehorse mining districts, Yukon": Geol. Surv., Dept. of Mines, Canada, 1908, pp. 20-24.

"Preliminary memoir on the Lewes and Nordenskiöld Rivers coal district, Yukon": Geol. Surv., Dept. of Mines, Can., 1910, pp. 48-55.

in a general way north 74° west, and can be followed for at least 12 miles. Three main seams have been uncovered that measure 9'-8", 10'-1", and 2'-6" respectively, in thickness. A tunnel some 60 feet long has been run on one of these seams, and a few open-cuts have been made; otherwise this area is entirely undeveloped. The seam at the tunnel strikes north 63° west, and dips at an angle of 42° to the northeast. The coal is quite accessible, as a spur with a favourable grade could be built to it from the railway. Therefore, considering the proximity of this area to the Whitehorse copper deposits and to the town of Whitehorse, the coal constitutes a fuel reserve which should prove of considerable value in the comparatively near future.

TANTALUS COAL AREA

The Tantalus coal area includes the Tantalus mine, the Tantalus Butte property, and the Five Fingers mine. The fossil-fuels in this area range in character from high-grade lignites to coking bituminous coals, and are all believed to be of Jura-Cretaceous age; they belong, however, to two different periods of formation, of which the upper horizon occurs near the top of the Tantalus conglomerate, and includes the seams at the Tantalus mine and at Tantalus butte. The lower horizon, which is in the upper portion of the Laberge series, is represented by the seams at the Five Fingers mine. Plant remains, that have been identified as Kootanie types, occur in the coal measures at the Tantalus mine.

All the more important coal seams have been found in the Tantalus conglomerates; those at the Five Fingers mines being the only seams of economic importance so far discovered in the Tantalus area in the lower horizon.

The Tantalus conglomerate extends across Lewes river to the north of Tantalus for at least $2\frac{1}{2}$ miles, and continues to the south up the valley of Nordenskiöld river¹ for about 17 miles, and wherever any considerable thickness of these beds are exposed, coal measures, generally comparatively regular in structure, are to be seen; thus it may be inferred that this area contains a great amount of coal.

(Samples Ex. 31, Ex. 32, and Ex. 33.)

This mine is situated on the left bank of the Lewes river about 190 miles below Whitehorse. The coal outcrops on the river bank and is well situated naturally for economic working. The cars are hauled out of the tunnels by

¹ The Braeburn-Kynoeks coal area is a newly discovered and important field, and is intersected by Klusha creek and Schwatka river, two branches of the Nordenskiöld river. This area lies almost due west of the northern end of Lake Laberge, and crosses the Whitehorse-Dawson waggon-road, midway between Whitehorse and Tantalus. The measures there belong to the lower coal horizon, and have been mapped for over 10 miles along their general northwesterly line of strike. A number of seams of high-grade lignite have been found, two of which are, where uncovered, measure about 8 feet and 4 feet thick, respectively.

mules, and by means of a cable operated by a small stationary steam engine are pulled up an incline, at the top of which the coal is dumped into bunkers ready for loading.

Three seams have been opened up, only the lower two of which are being worked at present; others may be found, as the formation is in most places heavily drift covered. The seams are somewhat variable in width, but have averaged perhaps 7'-6", 6'-6", and 3 feet of coal in the bottom, middle, and top seams respectively. The lower two seams have, in places, not more than 4 feet of rock between them, and the middle and top seams are generally about 7 feet apart. The general strike of the measures is about 10° east of north and the dips of the seams in the workings range from 21° to 40° to the east. The coal is worked by the pillar-and-stall system, from two tunnels which, when visited in October, 1908, were in 692 and 708 feet respectively on the bottom and middle seams. From the bottom seam, nine rooms had been worked up from 50 to 115 feet, No. 1 having been run 160 feet to the surface, for air. From the middle seam there were ten rooms, up, from 70 to 150 feet. Although the seams are dirty, the coal could easily be sorted; but as the wages are \$5 and board, for underground, and \$4 and board for surface work, no sorting has yet been attempted.

Three average samples, E, F, and G, were taken respectively from the breasts of the bottom and lower seams and from the top seam where cross-cut from the middle seam, probably about 300 feet in. These samples, analysed by Dr. Hoffmann, gave:—

	E	F	G
Water.....	0.75	0.76	0.82
Vol. comb. matter.....	23.61	21.74	25.12
Fixed carbon.....	55.21	58.60	66.03
Ash.....	20.43	15.90	8.03
	100.00	100.00	100.00
Proportion of coke.....	75.64	74.50	74.06

These results show that the coals in the laboratory make good coke, and it is hoped that they can be used for smelting when the copper deposits of Whitehorse and the minerals in the other parts of the Yukon become further developed.

Tantalus Butte

At Tantalus Butte, across the river from the Tantalus mine, the same measures again outcrop, but dip to the west, showing the presence of an intervening synclinal fold. The coal outcrops are near the top of the butte, about 400 feet above the river, wash and terrace material covering the formation lower down. The best seam seen contained 5 feet of good firm clean looking coal with 1 foot of coal and shale at the bottom. Altogether the general conditions of the measures, including dip, thickness, etc.,

are similar to those at Tantalus mine, and the property will probably be worked in the near future. The surface samples did not give a firm coke; but possibly fresh coal would give different results. The following is the result of an analysis, by Dr. Hoffmann, of an average sample from the outcrop of the best seam:—

Water.	9.48
Vol. comb. matter	32.28
Fixed carbon.	53.51
Ash.	4.73

Five Fingers Mine

This property is situated on the east side of the river, about 10 miles north of the Tantalus mine. A considerable amount of coal has been shipped from here, but the old workings are now closed on account of the entry being dangerously situated on the steep clay and sand bank of the river and subject to land slides. The old slope was down about 350 feet with rooms run off it, the coal in the lower rooms being 3'-6", to 4 feet thick. The new slope now being sunk is to the north and is in safe ground, and at the time visited was down 525 feet, dipping to the east at 16°. The seam thus opened which is not the same as that mined in the old workings, was at this depth about 2 feet thick, and was apparently increasing. It had previously narrowed to about 6 inches. An average sample of the 2 feet, analysed by Dr. Hoffmann, gave:—

Water.	4.26
Vol. comb. matter	40.26
Ash.	10.81
Fixed carbon	44.67
Coke, per cent.	55.52

The coke is firm and coherent.

ROCK CREEK COAL AREA

Lignite and lignitic coals occur quite extensively in the Tertiary rocks in portions¹ of Yukon Territory; and according to Mr. R. G. McConnell of the Geological Survey, the largest known area of such rocks is the Rock Creek coal area which commences at the Klondike valley, above Rock creek, and extends in a W.N.W. direction to Cliff creek, a distance of about 70 miles. The width of the area has not been determined, but it probably averages 10 miles. It lies along the base of the Ogilvie range and is separated from the Yukon by a narrow strip of the older schistose rocks. These Tertiary rocks

¹ Tertiary rocks similar to those in the Rock Creek coal area, cover a considerable area south of Indian river, above and below the mouth of Quartz creek. A small bed of lignite occurs on a branch of Ruby creek, a tributary of Indian river. See McConnell, R. G.—Ann. Rep. Geol. Surv. of Can., Vol. XIV, p. 23 B-24 B.

² McConnell, R. G.—Ann. Rep. Geol. Surv. of Can., Vol. XIII, pp. 44 A-49 A., Vol. XIV, pp. 23 B-24 B., Vol. XV, pp. 41 A-42 A.

contain a lignite bearing horizon with one or more seams. Seams of lignite outcrop on Coal creek, a tributary, or branch, of Rock creek which itself flows into the Klondike some 12 miles from Dawson at the southern end of the area, and on Cliff creek, a small stream which enters the Yukon on its right limit, 55 miles below Dawson on the northern end. Between these two points, outcrops have been noted at Twelvemile creek, Fifteenmile creek, and other places. Mr. McConnell places the total area underlain by lignite at considerably over 200 square miles.

Coal mining operations have been conducted in several places, including; on Coal creek; tributary of Rock creek; on Coal creek¹ which empties into Yukon river, and on Cliff creek. Neither the property on Coal creek tributary to Rock creek, nor that on Cliff creek have been operated for a number of years.

Coal Creek, Tributary of Rock Creek.

At a point a little over 7 miles from the Klondike river, following Rock creek and Coal Creeks valleys, and some 20 miles from Dawson, two seams of lignite 3 feet and 2 feet to 3 feet thick, respectively, occur, which are separated by a clay parting about a foot thick. An incline about 400 feet in length has been driven on one of these seams and quite a quantity of the fuel mined and sent to Dawson.

The following analyses of the two seams have been furnished by Dr. Hoffman of the Geological Survey:—

TABLE VI
Analyses of Coal from Coal Creek: Tributary of Rock Creek.

	Moist.	Vol. Comb.	Fixed Carbon.	Ash.
Upper seam.....	18.31	34.96	40.88	5.85
Lower seam.....	19.37	33.85	37.45	9.33

Coal Creek, Tributary of Yukon River.

At present the most important coal property in the Rock Creek area is that operated by the Sourdough Coal Co., whose workings are on Coal creek, a small tributary of the Yukon river, which joins the stream 50 miles below Dawson. The mine is situated 12 miles from the mouth of the creek.² The property consists of 960 acres of coal lands, and the Company also owns and controls 12 miles of railway over which coal is conveyed from the mine to the mouth of Coal creek, where it is transported to Dawson by barges and the Company's steamer. The coal is lignitic in character and is found in a number of seams measuring from 4 to 20 feet in thickness. The mine employs

¹ It will be noted that there are two streams in this area, known as Coal creek. The tributary of Rock creek lies near the southern, and the tributary of Yukon river near the northern end, of Rock Creek coal area.

² Report of the Mines Branch on "Mining and Metallurgical Industries."

from thirty-five to forty men, in two shifts of ten hours. The coal is sold in Dawson as follows: run of mine, at wharf, \$10 per ton; delivered, \$12 per ton; screened and delivered in bulk, \$15.

The maintenance of the railway being expensive, the Company purposes installing a power plant at the river and transmitting electrical power to Dawson. At present the greater part of the coal is used in Dawson for the generation of power.

Cliff Creek.

At the northwestern end of the Rock Creek area, on Cliff creek, a small stream which enters the Yukon from the right, 55 miles below Dawson, coal workings were also established some eight years ago, and a considerable quantity of lignite was shipped by barge from this place to Dawson. A tunnel was driven in the measures for a distance of over 800 feet. A section measured at 300 feet from the mouth of the tunnel showed 11 feet of coal in seams separated by clay partings as follows:—

Lignite.....	1'-6"
Thin parting.....	
Lignite.....	0' 5"
Shales, carbonaceous.....	0'-3"
Lignite.....	0' 6"
Shale.....	0'-1"
Lignite.....	2' 0"
Clay.....	1'-3"
Lignite.....	1'-3"
Clay.....	3'-0"
Lignite.....	1'-0"

	15' 0"

The following analyses of these lignites have been furnished by Dr. Hoffman of the Geological Survey:—

TABLE VII
Analyses of Coal from Cliff Creek.

	Moist.	Vol. Comb.	Fixed Carbon.	Ash.
Upper workings.....	8.57	42.02	45.77	3.62
Lower workings.....	10.58	40.10	46.74	2.58

BIBLIOGRAPHY

REPORTS AND MAPS ON THE COAL FIELDS OF CANADA

TABLE VIII

Reports Issued by the Dominion Government, on the Working Coal Fields of Eastern Canada, 1863-1911.

No. of Geol. Survey Publications.	AUTHOR	LOCATIONS
Nova Scotia, New Brunswick, and Prince Edward Island.		
799	Bailey, L. W. . . .	Carboniferous system in New Brunswick, 1900.
661	Bailey, L. W. . . .	Mineral resources of New Brunswick, 1897.
94	Barlow, S.	On the exploration and survey of the Springhill coal field, Cumberland county, 1873-74.
638	Dowling, D. B. . .	Index to reports Geol. Survey, 1863-1884.
Sum. 1902	Ells, R. W.	Geology of Prince Edward Island, with references to proposed borings for coal. Summary report for 1902, Geological Survey.
	Ells, R. W.	On Geological formations of eastern Albert and Westmorland counties, N.S., and portions of Cumberland and Colchester counties, 1888.
89,101	Ells, R. W.	On operations in boring for coal with the diamond drill at Newcastle Bridge, Queens county, N.B., 1872-75.
983	Ells, R. W.	Report on the mineral resources of New Brunswick, 1907.
Sum. 685	Fletcher, H.	Descriptive notes on the Sydney Coal field, 1900.
1908	Fletcher, H.	On a portion of Cumberland county. Summary report Geological Survey, 1908.
108	Fletcher, H.	Report on exploration and surveys in Cape Breton island, 1875-76.
Sum. 1900	Fletcher, H.	Springhill and Inverness coal fields, Summary report 1900.
Sum. 1898 and 1899	Fletcher, H.	Springhill coal field. Summary report Geological Survey, 1898-1899.
75	Hartley, E.	Coal and iron ores of Pictou county, 1866-69.
76	Hartley, E.	Notes on coal from Springhill 1866-69.
69	Hartley, E.	Report on a portion of Pictou coal field 1866-69.
	Ingall, E. D.	Annual reports on mineral statistics and mines of Canada, 1887-1906.
69	Logan, W.E.	Report on Pictou coal field, 1866-69.
94	McQuat, W.	On a portion of the coal field of Cumberland county 1873-74.
1,000	Nicola, F. J.	Index to reports Geological Survey, 1885 to 1907.
803	Poole, H. S.	Coal prospects in New Brunswick, 1900.
871	Poole, H. S.	Report on Pictou coal fields, 1901.
Sum. 1901	Poole, H. S.	The coal problem in New Brunswick, Summary report Geological Survey, 1901.
101	Robb, C.	On explorations and surveys in Cape Breton, 1874-75.
89	Robb, C.	On the coal mines of the Sydney coal field of Cape Breton 1872-73.

TABLE VIII (Continued).

Other Reports on the Coal Fields of Eastern Canada.

Brown, Richard. . . .	Coal fields and coal track of the Island of Cape Breton. Reprint by Maritime Mining Record, Stellarton, N.S., 1899.
Canadian Mining Manual, Vol. I to XIV.	
Gilpin, Edward. . . .	Minerals of Nova Scotia, 1901.
Mines Department of Nova Scotia Annual Reports.	
Rutherford, John. . . .	The coal fields of Nova Scotia. Trans. N. of England Inst. of Min. Eng., 1869-70.

TABLE IX

Reports Issued by the Dominion Government, etc. on the Coal Fields of Western Canada.

No. of Geol. Surv. Publication	AUTHOR	Manitoba, Saskatchewan, Alberta, British Columbia, and Yukon Territory.
Sum. 1900	Brock, R. W. . . .	Coal bearing rocks of Kettle valley, B.C. Summary of Geol. Surv. 1900.
968	Cairnes, D. D. . . .	Report on the Moose Mountain area 1907.
Sum. 1907-8	Cairnes, D. D. . . .	Report of the Whitehorse and Tanalus region, Yukon Territory. Summary report Geol. Surv. 1907-8.
Sum. 1908	Causell, Chas. . . .	Report on Similkameen Mining Division. Summary report Geol. Surv. 1908.
155	Dawson, G. M. . . .	Bow and Belly Rivers region. Preliminary report with special reference to coal deposits, 1880.
408	Dawson, G. M. . . .	Reprint of report 155, 1882.
573	Dawson, G. M. . . .	Coal and lignite in Kamloops district.
108	Dawson, G. M. . . .	Geology of lignite formation at Quesnel, 1875-76.
271	Dawson, G. M. . . .	Mineral wealth of British Columbia, 1887.
155	Dawson, G. M. . . .	Notes on the Coal Measures of the Nanaimo.
115	Dawson, G. M. . . .	Notes on coal rocks of Nicola valley, 1876-77.
212	Dawson, G. M. . . .	Preliminary report on physical and geological features of the portion of the Rocky mountains between latitude 49° and 51° 30', 1885.
147B	Dawson, G. M. . . .	Report on Peace River valley, 1879-80.
Boundary report. . . .	Dawson, G. M. . . .	Report on Tertiary lignite formation in the vicinity of 49th. parallel. Report of Boundary Commissioner, 1873.
949	Dowling, D. B. . . .	Caseade coal field, 1907.
Sum. 1903	Dowling, D. B. . . .	Coal basin in the Rocky Mountains. Summary report Geol. Surv. 1903.
Sum. 1901	Dowling, D. B. . . .	Costigan coal basin, Alberta, Summary report Geol. Surv. 1907.
Sum. 1907	Dowling, D. B. . . .	Explorations in the Rocky mountains. Summary report Geol. Surv. 1907.
638	Dowling, D. B. . . .	Index to reports of Geol. Surv. 1863-1881.
Sum. 1905	Dowling, D. B. . . .	Northern extension of Elk River coal basin, Alta. Summary report on Geol. Surv. 1908.
1,035	Dowling, D. B. . . .	Report on the coal fields of Manitoba, Sask., Alta., and eastern British Columbia, 1909.
868	Dowling, D. B. . . .	Report on the Souris coal field, 1902.
Sum. 1906	Dowling, D. B. . . .	Rocky Mountains coal areas between the Bow and Yellowhead pass. Sum. Report Geol. Surv. 1906.

TABLE IX (Continued).
**Reports Issued by the Dominion Government, etc., on the Coal Fields of
 Western Canada.—Continued.**

No. of Geol. Surv. Publication	AUTHOR	Manitoba, Saskatchewan, Alberta, British Columbia, and the Yukon Territory.
Sum. 1908	Dowling, D. B.	Steam coals of the Cascade basin, Alberta. Summary report Geol. Surv. 1908.
Sum. 1904	Ells, R. W.	Nicola coal basin, B.C. Summary report Geol. Surv. 1904.
Sum. 1904	Ells, R. W.	Quilchena coal basin, B.C. Summary report Geol. Surv. 1904.
940	Ells, R. W.	Report on Graham Island coal field, 1904.
89	Harrington, B. J.	On the coals of the west coast, 1872-73.
168	Hoffmann, G. C.	Analyses of coals and lignites of the North West Territories, 1884.
	Ingalls, E. D.	Annual reports on mineral waters and mines of Canada, 1887-1906.
Sum. 1902	Leach, W. W.	Blairmore-Frank coal field. Summary report 1902.
Sum. 1901	Leach, W. W.	Crowsnest coal field, Summary report Geol. Surv. 1910.
988	Leach, W. W.	Report on the Telkwa valley, B.C., 1908.
Sum. 1907	Malloch, G. S.	The Bighorn coal basin, Alta. Summary report Geol. Surv. 1908.
Sum. 1907	Malloch, G. S.	The Cascade, Palliser, and Costigan coal basin, Alta., Summary report 1907.
Sum. 1900	McConnell, R. G.	Yukon district, lignite areas. Summary report Geological Survey, 1900.
Sum. 1900	McEvoy, James.	Crowsnest Pass coal field. Summary report Geological Survey, 1900.
703	McEvoy, James.	Yellowhead Pass route, geology and natural resources, 1898.
Sum. 1,000	Nicola, F. J.	Index to reports Geol. Surv. 1885 to 1907.
Sum. 1905	Poole, H. S.	Nanaimo-Comox coal field, B.C. Summary report Geol. Surv. 1905.
Sum. 1902	Poole, H. S.	Notes on the geology of anthracite in Alberta. Summary report 1902.
84	Richardson, Jas.	On the coal fields of the east coast of Vancouver island, 1871-72.
116	Richardson, Jas.	Report on the coal fields of Nanaimo, Comox, Cowichan, Burrard inlet, Sooke, B.C., 1876-77.
	Carlyle, W. A.	Report of Minister of Mines of British Columbia, 1895-1898.
	Robertson, W.F.	Reports of Minister of Mines of British Columbia, 1898-1908.
	Canadian Mining Manual	Vols. I to XIV.

TABLE X
Geological Survey Maps, Covering Coal Districts.

No. of Geo. Surv. Publication	LOCATIONS
	Nova Scotia and New Brunswick.
82.	Pictou coal fields. Report 1866-69. Scale 1 m.=1 in.
100.	Index map of Springhill coal field. Scale 1 m.=1 in.
106.	Eastern part of Sydney coal field. Scale 1 m.=1 in.
113.	Western part of Sydney coal field.
145.	Grand Lake Sheet, N.B. Scale 4 m.=1 in.
162.	Newcastle Sheet, N.B. Scale 4 m.=1 in.
184.	Sheet 1 (Cape North Sheet), parts of Inverness and Victoria counties. Scale 1 m.=1 in.

Geological Survey Maps, Covering Coal Districts.—Continued.

No. of Geol. Surv. Publication	LOCATIONS
Nova Scotia and New Brunswick—Cont.	
185.	Sheet 2 (Aspy Bay Sheet), part of Victoria county. Scale 1 m.=1 in.
186.	Sheet 3 (Pleasant Bay Sheet), parts of Inverness and Victoria counties. Scale 1 m.=1 in.
187.	Sheet 4 (Ingonish Sheet), part of Victoria county. Scale 1 m.=1 in.
188.	Sheet 5 (Headwaters of Cheticamp River Sheet), parts of Inverness and Victoria counties. Scale 1 m.=1 in.
189.	Sheet 6 (North Cheticamp), part of Inverness county. Scale 1 m.=1 in.
190.	Sheet 7 (North Shore Sheet), part of Victoria county. Scale 1 m.=1 in.
191.	Sheet 8 (Headwaters Margaree River Sheet), parts of Inverness and Victoria counties. Scale 1 m.=1 in.
192.	Sheet 9 (South Cheticamp Sheet), parts of Inverness county. Scale 1 m.=1 in.
193.	Sheet 10 (Englishtown Sheet), parts of Victoria and Inverness counties. Scale 1 m.=1 in.
194.	Sheet 11 (Margaree Sheet), parts of Inverness and Victoria counties. Scale 1 m.=1 in.
195.	Sheet 12 (Baddeck Sheet), part of Victoria county. Scale 1 m.=1 in.
196.	Sheet 13 (Middle River Sheet) parts of Inverness and Victoria counties. Scale 1 m.=1 in.
197.	Sheet 14 (Broad Cove Sheet), part of Inverness. Scale 1 m.=1 in.
197.	Sheet 15 (Whyocomagagh Sheet), parts of Inverness and Victoria counties. Scale 1 m.=1 in.
199.	Sheet 16 (Port Hood Sheet), parts of Inverness county. Scale 1 m.=1 in.
200.	Sheet 17 (Loch Lomond Sheet), parts of Richmond and Cape Breton counties. Scale 1 m.=1 in.
201.	Sheet 18 (River Denys Sheet), parts of Inverness and Richmond counties. Scale 1 m.=1 in.
202.	Sheet 19 (Judique Sheet), part of Inverness county. Scale 1 m.=1 in.
203.	Sheet 20 (L'Ardoise Sheet), parts of Richmond county. Scale 1 m.=1 in.
204.	Sheet 21 (Saint Peter Sheet), parts of Richmond, and Inverness counties. Scale 1 m.=1 in.
205.	Sheet 22 (Strait of Canso Sheet), parts of Inverness, Richmond, Antigonish, and Guysborough counties. Scale 1 m.=1 in.
206.	Sheet 23 (Aricat Sheet), part of Richmond county. Scale 1 m.=1 in.
230.	Cumberland and fields sheet.
652.	Cape Dauphin Sheet, part of Cape Breton and Victoria counties.
653.	Sydney Sheet, part of Cape Breton and Victoria counties.
654.	Little Glace Bay Sheet, part of Cape Breton county.
675.	Map of principal Mineral Occurrences in New Brunswick. Scale 10 m.=1 in
812.	Preliminary map of Springhill coal field. Scale 50 chs.=1 in.
833.	Map of Pictou coal field. Scale 25 chs.=1 in.
British Columbia, Alberta, Saskatchewan, Yukon Territory	
121.	Coal fields of Comox, Nanaimo, and Cowichan on Vancouver island, 1876-77. Scale 4 m.=1 in.
158.	Index maps of coal and lignite outcrops in the Bow and Belly River district. Scale 10 m.=1 in.
171.	Geological map of the Bow and Belly Rivers districts, 1882-81. Scale 8 m.=1 in.
223.	Reconnaissance map of a portion of the Rocky mountains, between latitudes 49° and 51° 30'. Scale 6 m.=1 in
224.	Cascade coal basin. Scale 1½ m.=1 in.
225.	Geological map of Cypress hills and Wood Mountain districts.
249.	Geological map of Northern Alberta. Scale 8 m.=1 in.
676.	Yellowhead Pass route, from Edmonton to Tete Jaune Cache. Scale 8 m.=1 in.
767.	Geological and topographical map of Crowsnest coal field, East Kootenay district, B.C. Scale 2 m.=1 in.

Geological Survey Maps, Covering Coal Districts.—Continued.

No. of Geol. Surv. Publication	LOCATIONS
British Columbia, Alberta, Saskatchewan, Yukon Territory—Cont.	
804.	Orographic map of lower contour of Turtle mountain, Manitoba. Scale $1\frac{1}{2}$ m.=1 in.
808.	Geological sketch map of Blairmore-Frank coal fields, Alberta. Scale 180 chs.=1 in.
845.	Sketch map of the Cretaceous coal bearing rocks in tps. 10, 19, and 20, ranges 7 and 8, west of 5th meridian. Scale 2 m.=1 in.
890.	Geological map of the coal basins of Quilehena creek, Coldwater river, Coal gully and Guichon creek, Nicola valley, Yale district. Scale 1 m.=1 in.
892.	Geological map of Costigan coal field. Scale 40 chs.=1 in.
922.	Geological map of Graham Island coal field. Scale 1 m.=1 in.
929.	Geological and topographical map of Cascade coal basin showing coal areas. Scale 1 m.=1 in., in four sheets:—
	1. Panther river.
	2. Cascade river.
	3. Cammore.
	4. Wind mountain.
966.	Geological and topographical map of Moose Mtn. region of the "Disturbed Belt." Scale 1 m.=1 in.
989.	Sketch geological map of Telkwa river and vicinity. Scale 2 m.=1 in.
991.	Sketch geological map of vicinity of Tantalus and Five Fingers coal mines. Scale 1 m.=1 in.
1,010.	Coal areas of Alberta, Saskatchewan, and Manitoba. Scale 35 m.=1 in.
1,103.	Tantalus coal area, Yukon. Scale 2 m.=1 in.
1,104.	Braeburn-Kynoeks Coal area, Yukon. Scale 2 m.=1 in.
1,117.	Edmonton. (Topography). Scale $\frac{1}{2}$ m.=1 in.
1,118.	Edmonton. (Cibola Bar coal seam). Scale $\frac{1}{2}$ m.=1 in.
1,132.	Bighorn coalfield. Scale 2 m.=1 in.
1,145.	Bird's-eye view of the southern half of the Bighorn basin from the Saskatchewan river to the divide between Wapiabi and George and Smith creeks.

THE
COALS OF CANADA:
AN ECONOMIC INVESTIGATION
VOL. I

PART III
SAMPLING IN THE FIELD
BY
T. C. DENIS and EDGAR STANSFIELD



PART III.**COLLECTING THE COAL SAMPLES.**

BY

THEO. C. DENIS, AND E. STANSFIELD.

The initial step in the collection of the coal samples was the sending of a circular letter by Dr. Low to the main coal operators in the various Canadian coal fields, stating that, the Government had in view the carrying on of as extensive a series as possible of tests on samples of commercial size—from three to ten tons—of Canadian coals. The coal companies were asked if they would be willing to participate to the extent of supplying the coal free of charge, and of facilitating as much as possible the taking of the samples, under the supervision of an officer of the Department of Mines, Canada. The answers to their letter were very gratifying, and practically all the operators gave their support to the intended investigation.

It having been decided¹ to sample the commercial output of the mines rather than these underground workings, the officers of the Department of Mines were instructed to arrive at each colliery without any warning, and to take the samples without any delay. It is confidently believed that all the samples taken represent fairly, the grades of coal which the several collieries were then producing. They were taken in the regular course of the colliery operations, and every care was exercised to procure coal of average shipping grade, and to avoid any selection, or undue cleaning.

After a general inspection of the tippie, and of the method of handling and preparing the coal for the market, the representative of the Mines Department supervised the taking of the sample, by a method as uniform as possible. This had to be varied in details owing to the wide divergences which exist in the means of handling the coal at the various collieries, but the general method followed was to put one clean empty car under the picking belt or the coal chute, and to run into it the approximate quantity of coal required. The car was then shunted to a siding and the coal shovelled into bags containing an average of 160 pounds each. Each bag was carefully tied, tagged, and sealed by wires and lead seal bearing the government mark. All this work was done in the presence and under the direct supervision of the officer of the Department of Mines.

¹ This decision was arrived at by Dr. Low and Dr. Porter after a careful consideration of the practical points involved. Absolutely irreproachable samples would have been very interesting if practicable; but to have had even reasonably representative and trustworthy samples taken underground by members of the Departmental staff would have involved visits of from two to four weeks at each pit, by parties of two or more men: and even then, questions would inevitably have arisen as to whether the samples had been properly selected, sufficiently or more than sufficiently crushed, hand picked, etc. By drawing the samples directly from what was beyond question the actual commercial output of the pit on its ordinary way to market, all questions of this sort were avoided, and at the same time the work of sampling was greatly facilitated and cheapened.

In all cases the samples were shipped in box cars, protecting the coal from the effects of atmospheric agencies, but as most of the samples were shipped from outlying places in the Dominion, they were usually several weeks in transit. As the moisture content of the main sample was liable to change in that time, a small check sample of from 25 to 40 pounds was taken from the picking belt during the loading of the main sample. After roughly crushing to $\frac{1}{2}$ " size with a hammer, this small sample was quartered down, on a rubber sheet, to a couple of pounds, and this was immediately put into a carefully made, air-tight, double tin, which was sent to the laboratory without delay. Although it was completely analysed, the main object of this check sample was the determination of the moisture.

At first thought it might seem better to have secured this check sample underground by cutting across the face of the seam with a pick and collecting the material with a rubber sheet, but to represent anything like the average composition of the coal of the whole mine, such sampling would have to be done in a great many places in the workings, entailing an expenditure of time, work, and money hardly justified by the result likely to be obtained. It was, therefore, decided to dispense with the underground sample whenever possible, and to simplify the work as much as possible by taking the check sample from the belt at the same time as the main sample, as explained above.

In a few cases it was deemed expedient to depart somewhat from the sampling methods above described. Each case of departure will be stated in the detailed reports which follow.

MARITIME PROVINCES.

SYDNEY COAL FIELD, CAPE BRETON COUNTY, N.S.

150.

Operator.—The North Atlantic Collieries, Ltd.

Colliery.—Port Morien, Cape Breton, N.S. Near Sydney and Louisburg railway. Colliery has its own shipping pier.

Sampling.—Sample of two bags from the Gowrie seam. The coal passes over a $\frac{3}{4}$ " wire shaking screen and a 30 ft. picking belt, with 10 to 12 pickers. The coal from the picking belt was run down a chute into a tub from which it was shovelled into the bags.

Date of sampling.—January 15, 1909.

No. 36.

Operator.—Dominion Coal Company.

Colliery.—Dominion No. 7, or Hub colliery, Glace bay, Cape Breton, Nova Scotia.

¹sampled by E. Stansfield.

Sampling.—Sample of 125 bags, from Hub seam. Coal is domestic grade and passes over 2½" shaking screen, over picking belt 40 feet long, with five men at belt. Ten tons run into box car and bagged. Coal comes altogether from submarine areas.

Date of sampling.—June 21, 1908.

2036.

A supplementary sample of No. 36 coal.

This sample of about 150 pounds, for coking tests, was shipped to Sydney, N.S., by the mine authorities, January, 1909.

No. 35.

Operator.—Dominion Coal Company.

Colliery.—Dominion No. 9, Glace bay, Cape Breton, N.S.

On Harbour seam. Mine is on line of Sydney and Louisburg railway, which line connects the collieries of the Dominion Coal Company with shipping piers at Sydney on the west, and at Louisburg on the east.

Sampling.—Sample of 65 bags of domestic coal. Passes over a 2½" bar screen about 20 feet long, then over a picking belt table 19 feet from available length, with two men on belt. The coal was run into a box car from the picking belt and bagged. Moisture sample taken at same time, 35 pounds quartered down.

Date of sampling.—June 23, 1908.

2035.

A supplementary sample of No. 35 coal.

This sample of about 150 pounds, for coking tests, was shipped to Sydney, N.S., by the mine authorities, January, 1909.

No. 35 SP.

Operator.—Dominion Coal Company.

Colliery.—Dominion No. 5, or Reserve. Situated 3½ miles west of Glace bay, Cape Breton, Nova Scotia.

Sampling.—Sample of 25 bags, from the Phalen seam. Coal goes over 1½" shaking screen, and over belt 10 feet long, with six men picking. Got sample from a car which had just been loaded and was standing in a string of cars in the colliery yard.

Obtained moisture sample from same car, as mine was temporarily stopped for repairs.

Date of sampling.—June 25, 1908

2035 SP.

A supplementary sample of No. 35 SP coal.

This sample of about 150 pounds, for coking tests, was shipped to Sydney, N.S., by the mine authorities, January, 1909.

No. 38.

Operator.—Dominion Coal Company.

Colliery.—Dominion No. 1, situated 3 miles west of Glace bay, Cape Breton, Nova Scotia.

Sampling.—Sample of 125 bags from Phalen seam. Coal passed over 1" screen, and over table 25 feet long, with three men picking. Ten tons were run into car and bagged.

Moisture sample taken on belt.

Date of sampling.—June 26, 1908.

2038.

A supplementary sample of No. 38 coal.

This sample of about 150 pounds, for coking tests, was shipped to Sydney, N.S., by the mine authorities, January, 1909.

No. 37.

Operator.—Dominion Coal Company.

Colliery.—Colliery No. 10, 3 miles west of Glace bay. Using same bankhead as Dominion No. 5 or Reserve.

Sampling.—Sample of 125 bags from Emery seam. Coal is run of mine grade passed over picking table 55 feet long, six men picking. Ten tons were run into car and bagged.

Moisture sample was taken from the belt while car was being loaded.

Date of sampling.—June 25, 1908.

2037.

A supplementary sample of No. 37 coal.

This sample of about 150 pounds, for coking tests, was shipped to Sydney, N.S., by the mine authorities, January, 1909.

No. 39.

Operator.—Dominion Coal Company.

Colliery.—Dominion No. 12, at Lingan, 10 miles northwest of Glace bay, Cape Breton, Nova Scotia.

Sampling.—Sample of 35 bags from the Lingan seam slope in the early stage of development. Coal taken from bank, when it had been dumped a few hours previously. Run of mine coal. No bankhead or surface plant erected yet.

Took moisture sample on bankhead also. This mine was not yet connected by railway. Coal had to be teamed to Dominion No. 1 for shipment.

Date of sampling.—June 27, 1908.

2039.

A supplementary sample of No. 39 coal.

This sample of about 150 pounds, for coking tests, was shipped to Sydney, N.S., by the mine authorities, January, 1909.

No. 13.

Operator.—Nova Scotia Steel and Coal Co.

Colliery.—Sydney No. 1, at Sydney Mines, Cape Breton, Nova Scotia. Connected with the Intercolonial at North Sydney, $3\frac{1}{4}$ miles distant.

Sampling.—Sample of 147 bags of coal, passed over $\frac{3}{4}$ " bar screen, and over picking belt with five men picking. Coal comes from north side, south-east section, $1\frac{1}{2}$ miles from bottom of shaft, three-fourths of a mile from main deep, and from south side, sections 1, 4, 5. Distance from shaft, $1\frac{1}{2}$ miles; length of section, one-fourth mile.

Moisture sample taken while car was being loaded.

Date of sampling.—July 5, 1907.

2013.

A supplementary sample of No. 13 coal.

A sample of about 100 pounds of slack coal, for coking tests, supplied by the mine authorities, January, 1909.

No. 12.

Operator.—Nova Scotia Steel and Coal Co.

Colliery.—Colliery No. 3, Sydney Mines, Cape Breton, Nova Scotia. Connected with Intercolonial railway at North Sydney.

Sampling.—Sample of 150 bags, taken from Sydney main seam. Coal passed over $\frac{3}{4}$ " screen, on a picking belt, with five men picking. Coal comes from sections 7, 8, 9, and 10. No. 7 is 3,200 feet from mouth of slope, and other sections are successively 600 feet farther in. All drivages extend south of main slope 1,200 to 1,600 feet.

Moisture sample was taken from the picking belt at the same time.

Date of sampling.—July 4, 1907.

A supplementary sample of No. 12 coal.
A sample of about 100 pounds of slack coal, for coking tests, supplied by the mine authorities, January, 1909.

INVERNESS COAL FIELD, INVERNESS CO., N.S.

No. 11.

Operator.—Inverness Coal and Railway Company.

Colliery.—Inverness colliery, Inverness, Nova Scotia. This colliery is on the railway line, operated by the Company, connecting Point Tupper, on the Intercolonial railway and Inverness.

Sampling.—Sample of 150 bags. Screened over 3" shaking screen, and picked on belt. Eight men on belt. Of the 150 bags, 122 were taken by the representative of the Mines Department from levels No. 5 and No. 6 east and west. These levels are 2,600 and 3,100 feet down the slope respectively. No. 5 is driven 1,100 feet to east and 2,300 feet to west; No. 6 is 2,900 feet east and west.

The other 28 bags were filled a few days afterwards by the Company, from level 7, at 3,600 feet down the slope, without a representative of the Mines Department being present, the intention being that this would give a fairer average, as the quality of coal improves towards the deep. These last bags were marked with distinguishing tag. Sample for moisture was taken on picking belt with the main sample.

Dates of sampling.—July 12 and 15, 1907.

No. 15.

Operator.—Port Hood, Richmond Railway and Coal Co.

Colliery.—Port Hood colliery, Port Hood, Inverness county, Nova Scotia, on line of Inverness railway.

Sampling.—Sample of 150 bags. Coal passed over 3" shaking screen and picking belt, with eight men cleaning. Coal comes from 1,400 ft. level, 2,000 feet north; and from 1,900 ft. level, 1,500 and 2,000 feet north respectively. Moisture sample taken on picking belt at same time.

Date of sampling.—July 15, 1907.

PICTOU COAL FIELD, PICTOU COUNTY, N.S.

No. 4.

Operator.—Acadia Coal Company.

Colliery.—Vale colliery, at Thorburn, situated 6 miles to the south-east of New Glasgow. Colliery connected with Intercolonial at New Glasgow by the Vale Colliery railway, of the Acadia Coal Company.

Sampling.—The sample is from the 6 ft. seam. The coal is screened or lump grade, passed over $\frac{1}{2}$ " screens, and over picking belt. Sample consists of 75 bags, taken at lower end of the belt, shovelled direct from the belt into the bags. Moisture sample taken on belt at the same time.

Date of sampling.—March 25, 1907.

No. 2001.

Operator.—Acadia Coal Company.

Colliery.—Vale colliery, Thorburn, Pictou county, Nova Scotia.

Sampling.—Sample of 25 bags, supplementary to No. 4. Coal passed over $\frac{1}{2}$ " screen, over picking belt 35 feet long, five men picking. Coal comes from levels and inclines between 1,000 feet and 1,000 feet from bottom of slope.

Coal was shovelled directly from the picking belt into the bags.

Date of sampling.—July 18, 1907.

No. 16.

Operator.—Acadia Coal Company.

Colliery.—Allan shaft colliery, Stellarton, Pictou county, Nova Scotia. On main line of Intercolonial railway, 2 miles southwest of New Glasgow.

Sampling.—Sample of 150 bags. Coal dumped on picking belt from mine boxes as they came up the shaft. Temporary plant for development work. Coal was shovelled from picking belt into bags. Coal comes from the top bench of the Foord seam, east sinking, which is in 500 feet from the bottom of the shaft. Moisture sample was taken at same time on picking belt.

Date of sampling.—July 20, 1907.

2016.

A supplementary sample of coal No. 16.

This sample of about 150 pounds, for coking tests, was shipped to Sydney, N.S., by the mine authorities, January, 1909.

No. 1.

Operator.—Acadia Coal Company.

Colliery.—Albion colliery, Stellarton, Pictou county, Nova Scotia.

The colliery, which is worked by a slope, is situated 2 miles northeast of New Glasgow. It is connected with the Intercolonial railway by a spur $1\frac{1}{4}$ miles long.

Sampling.—The sample is from the third seam, and consists of 134 bags taken directly from the mine boxes, and is, therefore, run of mine coal. One

mine box, holding 1,200 pounds, was taken from each rake, dumped on the floor of the tippie building, and shovelled into the bags.

The sample comes from 4,000 feet down the slope, or about 1,100 feet vertically, from level which is in about 1,400 feet northwest.

Owing to delay in the arrival of the cans to be used for moisture samples, the taking of the check sample was put off, and later on work on this seam was temporarily stopped and no check sample could be obtained.

Date of sampling.—March 26, 1907.

No. 2.

Operator.—Acadia Coal Company.

Colliery.—Albion colliery, Stellarton, Pictou county, Nova Scotia.

Sampling.—Sample of 94 bags, from the Cage Pit seam, taken directly from the mine boxes in same manner as No. 1. The sample comes from 2,600 feet down the slope, from level on north side, which is 2,000 feet long, vertical depth 700 feet.

The sample for moisture was taken three days after the main sample, from about 35 mine boxes, as they came up the slope. About 20 pounds were quartered down to 1 pound 13 ounces.

Date of sampling.—March 26, 1907.

2002.

A supplementary sample of coal No. 2.

This sample of about 150 pounds, for coking tests, was shipped to Sydney, N.S., by the mine authorities, January, 1909.

No. 8.

Operator.—Acadia Coal Company.

Colliery.—Acadia colliery, Westville, Pictou county, situated 4 miles southeast of New Glasgow, on the Pictou town branch of the Interoceanic railway.

Sampling.—Sample of 75 bags from main seam. The coal was shovelled from the picking belt into bags, after passing over 1" screen, and being well picked on belt. Sample comes from No. II level, 5,000 feet south.

Moisture sample taken on picking belt while coal was being bagged.

Date of sampling.—March 28, 1907.

2008.

A supplementary sample of coal No. 8.

This sample of about 150 pounds, for coking tests, was shipped to Sydney, N.S., by the mine authorities, January, 1909.

No. 3.

Operator.—Intercolonial Coal Company.

Colliery.—Drummond colliery, Westville, Pictou county, Nova Scotia. The colliery is situated about $4\frac{1}{2}$ miles southwest of New Glasgow. It is on the branch of the Intercolonial railway which connects Stellarton and Pictou town.

Sampling.—Sample of 125 bags of screened coal passing over 1" screen, and a picking belt 40 feet long, 5 feet wide. Sample obtained by running coal into a hopper car. Coal comes from main seam, from levels 6,400 feet and 6,860 feet, each 3,000 feet long on left of slope.

Moisture sample taken two days later from picking belt.

Date of sampling.—March 27, 1907.

2003.

A supplementary sample of coal No. 3.

This sample of about 150 pounds, for coking tests, was shipped to Sydney, N.S., by the mine authorities, January, 1909.

SPRINGHILL COAL FIELD, CUMBERLAND COUNTY, N.S.

No. 19.

Operator.—Cumberland Coal and Railway Co.

Colliery.—Springhill colliery No. 1, situated at Springhill, Cumberland county, N.S. Connected with Intercolonial railway at Springhill junction, 5 miles distant from colliery, and with shipping piers at Parrsboro, 27 miles by railway.

Sampling.—Sample of about 150 pounds, supplied by mine authorities and shipped to Sydney, Cape Breton, for coking tests, January, 1909.

No. 5.

Operator.—Cumberland Coal and Railway Company.

Colliery.—Springhill colliery No. 2, situated at Springhill, Cumberland county, Nova Scotia.

Sampling.—Sample of 143 bags. Run into box car under picking belt and coal bagged in car. Screened coal passing over $\frac{3}{4}$ " screen, and a long picking belt.

The coal comes from the new sinking in slope, at a distance of 3,800 feet from mouth of slope.

Date of sampling.—April 1, 1907.

2005.

A supplementary sample of No. 5 coal.

This sample of about 150 pounds, for coking tests, was shipped to Sydney, N.S., by the mine authorities, January, 1909.

No. 6.

Operator.—Cumberland Coal and Railway Company.

Colliery.—Springhill No. 3, situated at Springhill, Cumberland county, Nova Scotia

Sampling.—Sample of 150 bags, taken in the same manner as No. 5.

The coal comes from the following workings in the mine: 2,600 ft. level, driven 1,000 feet west; 3,800 ft. level driven east 1,000 feet and west 5,800 feet; 3,200 ft. level driven 1,000 feet west.

Date of sampling.—April 1, 1907.

2006.

A supplementary sample of No. 6 coal.

This sample of about 150 pounds, for coking tests, was shipped to Sydney, N.S., by the mine authorities, January, 1909.

JOGGINS-CHIGNECTO COAL FIELD, CUMBERLAND CO., N.S.

No. 7.

Operator.—Maritime Coal, Railway, and Power Co.

Colliery.—Chignecto colliery, at Chignecto, Cumberland county. Three miles north of Maccan station. Colliery is connected with Intercolonial railway by branch 3 miles long.

Sampling.—Sample of 85 bags. Through misunderstanding the bags were filled by the Company previous to the arrival of the representative of the Mines Department. The sample consists of selected lump coal taken from picking belt. To obtain a new sample would have meant a delay of several days, and the coal was, therefore, shipped as put up by the Company.

Moisture check sample was taken by the representative of the Mines Department on the picking belt. Coal comes from the various workings of the mine, which is operated by slope 1,300 feet long, with levels driven 3,000 feet long, east and west.

Date of sampling.—About April 1, 1907.

No. 9.

Operator.—Minudie Coal Co.

Colliery.—Minudie colliery, River Hebert, Cumberland county, Nova Scotia. Connected with Intercolonial railway by line of Maritime Coal,

Power, and Railway Company, and with shipping pier on Cumberland basin of the Bay of Fundy by standard gauge road, 6 miles long.

Sampling.—Sample of 80 bags (6½ tons). Coal run into a hopper car from picking belt and bags filled by hand. Coal passed over ¾" screen, and over picking belt 30 feet long. Sample comes from all workings. Slope is in 1,100 feet, with levels at 500, 800, 1,000, and 1,200 feet, driven west 1,000 feet, and east 1,200 to 1,400 feet.

Moisture sample taken from mines boxes as they come up the slope on bankhead.

Date of sampling.—April 2, 1907.

No. 10.

Operator.—Maritime Coal, Power, and Railway Company.

Colliery.—Joggins colliery, situated at Joggins mines, Cumberland county, Nova Scotia. Connected with Intercolonial by Company's railway, and with shipping pier at Joggins mines.

Sampling.—Sample of 75 bags (6 tons). Coal passed over ¾" screen, over picking belt, with five pickers at work, and run into box car. Sacked in box car. Coal hoisted from 3,100 ft. level, driven 2,000 feet east and west off the main slope.

Moisture sample taken from picking belt while loading main sample into box car.

Date of sampling.—April 3, 1907.

No. 2010.

A supplementary sample of 20 bags of No. 10 coal, taken later on, to complete tests, under the same conditions and supervision.

No. 3010.

A second supplementary sample of No. 10 coal.

This sample of about 150 pounds, for coking tests, was shipped to Sydney, N.S., by the mine authorities, January, 1909.

GRAND LAKE COAL FIELD, N.B.

No. 11.

Operator.—G. H. King.

Colliery.—King's mine, Minto, New Brunswick colliery, situated in Grand Lake district, New Brunswick, on line of New Brunswick Coal and Railway Co., 65 miles from Norton on Intercolonial railway.

Sampling.—Sample of 114 bags of screened coal. The mine boxes

holding 300 pounds were dumped on a $\frac{3}{4}$ " bar screen. There was no belt, but the coal was roughly picked as it was being loaded into cars.

Moisture sample taken from boxes as they came up the shaft.

Date of sampling. - April 8, 1907.

GREAT PLAINS.

SOURIS COAL FIELD, SASK.

No. 40.

Operator. - Western Dominion Collieries Company.

Colliery. Taylorton mine, situated at Taylorton, section 3, township 1, range 6, west of 2nd meridian, Saskatchewan. Mine connected with Estevan branch of Canadian Pacific railway by a spur $5\frac{1}{2}$ miles long.

Sampling. - Sample of 50 bags, coming from three districts in the mine, viz., East district No. 1, 600 feet from mouth of slope; East district No. 3, 1,000 feet; East district No. 6, 1,600 feet. Entries were in about 800 feet from main slope. From development work, as main slope was not shipping at the time. Grade of coal is equal to fair lump domestic coal.

Moisture sample was obtained from the mine boxes.

Date of sampling. - July 11, 1908.

No. 2010.

Addition sample of 75 sacks shipped two weeks later by the mine authorities.

No. 41.

Operator. - Eureka Coal and Brick Company.

Colliery. Eureka mine, Estevan, Saskatchewan, section 13, township 2, range 8, west of 2nd meridian. Connected with the "Soo" line of the Canadian Pacific railway by a spur 1 mile long.

Sampling. - Sample of 25 sacks taken from the mine boxes as they came out of the tunnel; no plant for screening or preparing. Coal is run of mine, from entry 2,000 feet from mouth of tunnel and 200 feet in entry from S.W. $\frac{1}{4}$ section 13-2-S.

Moisture sample taken from mine boxes.

Date of sampling. - July 11, 1908.

EDMONTON COAL FIELD, ALTA.

No. 46.

Operator. - Stratheona Coal Company.

Colliery.—Stratheona mine, river lot 9, Edmonton settlement, 1 mile west of Stratheona, Alberta.

Sampling.—Sample of 25 sacks, which were taken from bin chutes, of coal freshly mined, comprised of fifteen sacks of lump coal, going over 2½" bar screen; and ten sacks of nut coal going over 1½" bar screen, which would represent the proportion of coal going over 1½" screen, or screened coal as sold. The coal all comes from the north side of the shaft, about 100 feet from the outcrop. Coal on south side of shaft, to the deep, is said to be of better quality. Moisture sample taken at same time and place.

Date of sampling.—July 16, 1908.

No. 42.

Operator.—Parkdale Coal Company.

Colliery.—Parkdale colliery, river lot 22, Edmonton settlement, near Edmonton, Alberta.

Sampling.—Sample of 25 bags, from nine boxes hoisted in the regular course of operation of the mine, from three entries, 300 feet southeast, 300 feet southwest, and 300 feet northwest from bottom of shaft, which is 196 feet deep. Coal is cleaned on a bar screen 1½", 12 feet long.

Moisture sample was taken at the same time. An additional sample of 75 sacks was shipped subsequently, put up under the same condition, by the Company. The two lots were mixed at the testing plant.

Dates of sampling.—July 15 and Aug. 1, 1908.

No. 45.

Operator.—Standard Coal Company.

Colliery.—Standard mine, situated on river lot 26, Edmonton settlement, Edmonton.

Sampling.—Sample of 25 sacks, taken from bank bunkers. Coal had been mined a few hours previous. As boxes come up the shaft coal is cleaned on bar screen 5 feet long with 1½" openings. Coal comes from workings 100 to 300 feet northwest of shaft.

Moisture sample taken at same time.

Date of sampling.—July 16, 1908.

BELLY RIVER COAL FIELD, ALBERTA.

No. 43.

Operator.—Canada West Coal Co.

Colliery.—Taber mine, Taber, Alberta, on Crows Nest line of the Canadian Pacific railway.

Sampling.—Sample of 75 sacks, about 6 tons. The sample was taken from one car of lump coal, and one car of nut coal, which had just been

loaded. Fifty-three bags of lump and 22 of nut were taken, representing the right proportion of screened coal from $\frac{3}{4}$ " shaking screens. The coal is not handpicked, and comes from No. 2 level, 1,200 feet east and west respectively. This level is 800 feet in on main way.

Moisture sample was taken from the cars during sacking of main sample.
Date of sampling.—July 23, 1908.

No. 41.

Operator.—Alberta Railway and Irrigation Company.

Colliery.—Galt colliery, Lethbridge, Alberta, near junction of Canadian Pacific railway (Crows Nest branch) and line of Alberta Railway and Irrigation Company's railway.

Sampling.—Sample of 50 sacks of screened coal, from various workings representing fair average of mine. Coal had been cleaned on screen 12 feet long, 6 feet wide, and a picking table 35 feet long, with six boys picking. Main sample was taken from six cars which were standing in the yard, and had just been loaded.

Moisture sample also taken from the cars.

Date of sampling.—July 22, 1908.

No. 47.

Operator.—Lund Breckenridge Coal Company.

Colliery.—Lundbreck mine, S.E. $\frac{1}{4}$ section 26, township 7, range 2, west of 5th meridian, Lundbreck, Alberta. On the Crows Nest branch of the Canadian Pacific railway.

Sampling.—Sample of 22 sacks. The mine had not been working regularly for five months. Sample was taken from a coal chute in the mine, which had been left partly filled, at time of stopping operations. Coal is, therefore, run of mine.

Moisture sample was taken at same time.

Date of sampling.—July 21, 1908.

EASTERN SLOPES OF THE ROCKY MOUNTAINS.

FRANK-BLAIRMORE COAL FIELD, ALTA.

No. 48.

Operator.—Leitch Collieries, Limited.

Colliery.—Leitch colliery, at Passburg, Alberta, some 5 miles east of Frank, near Crows Nest branch of Canadian Pacific railway.

Sampling.—Sample of 62 sacks from the 7 ft. seam or No. 1 Byron, which is thought to be the same as the No. 1 Bellevue. Coal taken in course of development work from chutes in mines about 1,400 feet from entrance, and sacked at mouth of tunnel. Coal is run of mine.

Moisture sample taken from mine boxes.

Date of sampling.—July 18, 1908.

¹2018.

A supplementary sample of No. 18 coal, for coking tests.

Sample of about 100 pounds run of mine coal, taken by shovelling from big pile of freshly mined coal at mouth of mine, July 29, 1909, lumps of obvious slate being rejected.

No. 32.

Operator.—Hillcrest Coal and Coke Company.

Colliery.—Hillcrest colliery, Hillcrest, Alberta. This mine is near the Crows Nest Branch of the Canadian Pacific railway, 2 miles west of Frank. Mine is connected with the railway by a spur 2 miles long.

Sampling.—Sample of 115 bags of run of mine coal taken from bunker, which was being filled in the course of regular operation of the mine.

Moisture sample was taken at the same time from the bunker.

Date of sampling.—May 4, 1908.

²2032.

A supplementary sample of No. 32 coal, for coking tests.

Sample of about 100 pounds run of mine coal, taken during the loading of box cars, July 29, 1909.

No. 33.

Operator.—West Canadian Collieries.

Colliery.—Bellevue colliery, Bellevue, Alberta, 2 miles east of Frank. The colliery is on the line of the Crows Nest branch of Canadian Pacific railway.

Sampling.—Sample of 137 bags from No. 1 seam. Coal is run of mine coal as it comes direct from the workings, no screening or picking, except for occasional throwing out of conspicuous pieces of rock while spreading coal in cars. Coal comes from 5,000 feet in main tunnel, at average height of 200 feet above tunnel.

Moisture sample taken at same time. Forty pounds quartered down.

Date of sampling.—May 5, 1908.

³2033.

A supplementary sample of No. 33 coal, for coking tests.

^{1, 2, 3} Sample taken by E. Stansfield.

Sample of about 100 pounds run of mine coal, taken by shovelling from the top of a trip of cars as they came from the mine, July 29, 1909.

No. 28.

Operator.—West Canadian Collieries.

Colliery.—Lille colliery, Lille, Alberta, 6 miles north of Frank. The colliery is connected with the Crows Nest branch of the Canadian Pacific railway by line 6 miles long.

Sampling.—Sample of 10 sacks from No. 1 seam, run of mine coal, from 5,000 feet in on main tunnel, the workings being from 100 to 2,000 feet up to the rise. Coal was taken from bank, as colliery was not producing at the time.

Date of sampling.—May 6, 1908.

¹2028.

A supplementary sample of No. 28 coal, for coking tests.

Samples of about 100 pounds run of mine coal taken by shovelling from the top of a trip of cars as they came from the mine, July 30, 1909.

No. 31.

Operator.—International Coal and Coke Company.

Colliery.—Denison colliery, Coleman, Alberta, situated on line of Crows-nest branch of Canadian Pacific railway.

Sampling.—Sample of 178 sacks from No. 2 seam. Coal is run of mine. Small cars cut out of rakes as the trains came out of main tunnel, switched on siding, and shovelled into bags. Coal comes from chutes distant as follows from mouth of main entry: 4,260 feet, 4,900 feet, 5,100 feet, 5,400 feet, 6,000 feet, 6,600 feet, as spotted by miners tags on boxes.

Moisture sample taken from same cars.

Date of sampling.—May 10, 1908.

²2034.

A supplementary sample of No. 31 coal, for coking tests.

Sample of about 100 pounds run of mine coal, obtained by taking one or two shovelfuls of coal off the top of each of a series of cars as they came out of the mine, July, 1909.

No. 34 SP.

Operator.—International Coal and Coke Company.

¹, ² Sample taken by E. Stansfield.

Colliery.—Denison colliery, Coleman, Alberta.

Sampling.—Sample of 12 bags, from No. 4 seam, run of mine coal, from chutes at following distances from mouth of entry: 790 feet, 810 feet, 1,110 feet, 3,000 feet, and 5,740 feet.

Date of sampling.—May 10, 1908.

2034 SP.

A supplementary sample of No. 34 SP coal, for coking tests.

Sample of about 100 pounds run of mine coal obtained by taking one or two shovelfuls of coal off the top of each of a series of cars as they came out of the mine, July 27, 1909.

CASCADE COAL FIELD.

No. 25.

Operator.—The H. W. McNeil Company.

Colliery.—Cannore mine, Cannore, Alberta. The mine is connected with the main line of the Canadian Pacific railway by spur 2 miles long.

Sampling.—Sample of 150 bags, from No. 1, or Old mine. The coal comes from the east workings of the mine. Coal is dumped on grizzly. The lump goes over a picking table, three Chinese labourers picking, and the slack and lump come again together and are conveyed to bunkers. The sample was taken from a bunker, which had just been filled. The coal is, therefore, almost run of mine, except for the picking of the lump, which apparently constitutes 25 per cent of the coal.

Moisture sample taken from bunker conveyer.

Date of sampling.—April 22, 1908.

No. 23.

Operator.—Bankhead Mines (Limited).

Colliery.—Bankhead colliery, Bankhead, near Banff, Alberta. Colliery is connected with main line of Canadian Pacific railway, by spur 2½ miles long.

Sampling.—Sample of 60 bags of pea coal, taken from the bunkers. This size of coal goes through 7" screen and over $\frac{7}{16}$ ". Cleaned by passing over mechanical slater and over Emery picker.

Date of sampling.—April 21, 1908.

No. 23 SP.

Sampling.—Sample of 60 bags the same as No. 23, except that coal is Buckwheat No. 1, which goes through $\frac{7}{16}$ " screen and over $\frac{5}{16}$ ".

¹ Sample taken by E. Stansfield.

This size is cleaned by passing over the slater, but not over the Emery picker.

Date of sampling.—April 21, 1908.

No. 23 M.

A sample obtained by mixing together coals No. 23 and No. 23 SP. These two coals were sampled separately upon arrival at the testing laboratories; they were then thoroughly mixed together and resampled.

No. 24.

Operator.—Bankhead Mines (Limited).

Colliery.—Bankhead colliery, Bankhead, near Banff, Alberta.

Sampling.—Sample of 75 bags of coal dust briquettes, taken from the bunkers.

Sample for moisture was taken from the dryer and briquettes were only a few hours old. Coal tar is now used for binding material in the proportion of about 40 per cent.

Date of sampling.—Briquettes were made April 20, 1908.

BRITISH COLUMBIA.

CROWSNEST COAL FIELD.

No. 31.

Operator.—The Crowsnest Pass Coal Company.

Colliery.—Mine No. 3, Michel colliery, Michel, British Columbia.

The colliery is on the line of the Crowsnest branch of the Canadian Pacific railway.

Sampling.—Sample of 150 bags taken from east level, about 1,200 feet from mouth of entry. Coal was cleaned on 2" grizzly and belt 35 feet long, with four boys picking. The coal is friable; 13 cars holding about 2,500 pounds each, only yielded about 5 tons commercial lump coal.¹

Moisture sample taken on belt.

Date of sampling.—April 30, 1908.

*2031.

A supplementary sample of No. 31 coal, for coking tests.

Sample of about 100 pounds lump coal obtained by picking lumps of over 2" in size off the top of a trip of cars as they came out of the mine, obvious waste being rejected. July 27, 1909.

¹ The screenings are sent to the coke ovens.

² Samples taken by E. Stansfield.

No. 30.

Operator.—The Crowsnest Pass Coal Company.

Colliery.—Mine No. 7, Michel colliery, at Michel, British Columbia.

Sampling.—Sample of 150 bags.

The coal was cleaned on a 2" grizzly and belt 35 feet long, with four boys picking. Sixteen cars, of 2,500 pounds each, gave about 12 tons of commercial coal.¹

Moisture sample taken on belt.

Date of sampling.—April 29, 1908.

No. 29.

Operator.—The Crowsnest Pass Coal Company.

Colliery.—No. 8 mine, Michel colliery, at Michel, British Columbia.

Sampling.—Sample of 175 bags (about 10 tons) of coal from No. 2 district, the faces of which are about 1,500 feet from mouth of tunnel. Coal is dumped on 2" grizzly, passed over belt 35 feet long, four boys picking. Coal run into flat car and bagged. The coal is very friable, and 50 per cent goes through the 2" grizzly and is used for coke.

Moisture sample taken from belt.

Date of sampling.—April 28, 1908.

2029.

A supplementary sample of No. 29 coal, for coking tests.

Sample of about 100 pounds lump coal obtained by picking lumps of over 2" in size off the top of a trip of cars as they came out of the mine, obvious slate being rejected. July 27, 1909.

251.

Operator.—Hosmer Mines, Ltd.

Colliery.—Hosmer mine, at Hosmer, on the Crowsnest line of the Canadian Pacific railway.

Sampling.—A sample of 15 bags, run of mine coal, from No. 2 seam south.

The sample was taken by picking across the face of the seam and shoveling the coal thus brought down into sacks. The coal was hand picked at McGill, only lumps of slate too big to go through a 1½" hole being picked out.

No. 2 seam south is 1,610 feet in main tunnel from mouth; the face from which sample was taken was 740 feet in main gangway off main tunnel.

A moisture sample was taken at the same time by taking a single small cut right across the seam, roughly crushing the coal, and sampling into a tin.

Date of sampling.—July 24, 1909.

¹ The screenings are sent to the coke ovens.

² Sample taken by E. Stansfield.

Operator.—Hosmer Mines, Ltd.

Colliery.—Hosmer mine, Hosmer, B.C.

Sampling.—Sample of 15 bags run of mine coal from No. 6 seam south.

The sample was taken by picking across the face of the seam and shoveling the coal, thus brought down, into sacks. The coal was hand picked upon arrival at McGill University, only lumps of slate too large to pass through a 1½" diameter hole being removed.

No. 6 seam south is 3,355 feet in main tunnel from mouth; the face from which sample was taken was 150 feet in main gangway off main tunnel. The gangway had just passed through a faulted area; the seam was supposed to be all right where the sample was taken, but this was not certain.²

A moisture sample was taken at the same time by taking a single small cut right across the seam, roughly crushing the coal, and sampling into a tin.

Date of sampling.—July 21, 1909.

Operator.—Hosmer Mines, Ltd.

Colliery.—Hosmer mine, Hosmer, B.C.

Sampling.—Sample of 10 bags run of mine coal from No. 8 seam south.

The sample was taken by picking across the face of the seam and shoveling the coal, thus brought down, into sacks. The coal was hand picked upon arrival at McGill University, only lumps of slate too large to pass through a 1½" diameter hole being removed.

No. 8 seam south is 3,790 feet in along main tunnel from mouth; the face from which sample was taken was 85 feet in along main gangway off the main tunnel. The coal was very faulty where sampled, so that the sample probably does not fairly represent the seam.

A moisture sample was taken at the same time by taking a single small cut right across the seam, roughly crushing the coal, and sampling into a tin.

Date of sampling.—July 24, 1909.

Operator.—The Crowsnest Pass Coal Company.

Colliery.—Mine No. 2, Coal Creek colliery, west of Fernie, British Columbia. The colliery is connected with the Crows Nest line of the Canadian Pacific railway, by line 5 miles long.

Sampling.—Sample of 114 bags of commercial screened coal, obtained by cleaning on a 2" shaking screen, and picking belt 70 feet long, running 80 feet a minute. Nine men attend two belts, but usually only one of these is running.

¹ Sample taken by E. Stansfield.

² The quality of the coal is reported to have improved materially as the gangway has advanced.

³ Sample taken by E. Stansfield.

Moisture sample taken from belt
Date of sampling. —April 25, 1908

2027

A supplementary sample of No. 27 coal, for coking tests.
Sample of about 100 pounds taken from apron of picking table, July 26,
1909

No. 26

Operator. —The Crowsnest Pass Coal Company.
Colliery. —Mine No. 5, Coal Creek colliery.
Sampling. —Sample of 151 sacks. Coal is commercial screened coal,
cleaned on 2" shaking screens, and passed over picking tables. Nine
men attend two tables, 70 feet long, but usually only one table running.
Speed of table 55 feet a minute. Sample was run into a box car and bagged.
Moisture sample taken from belt.
Date of sampling. —April 25, 1908.

2026.

A supplementary sample of No. 26 coal, for coking tests.
Sample of about 100 pounds taken from apron of picking table. July
26, 1909.

SIMILKAMEEN COAL FIELD GRANITE CREEK.

Ex. No. 1¹

Operator. —A syndicate to explore certain Tulumeeen coals.
Colliery. —No. 1 opening, Granite Creek, B.C.
Sampling. —The face of the best workable bench of coal was carefully
sampled at the end of a prospecting tunnel a little over 100 feet in from the
outcrop.

Ex. No. 2²

Operator. —A syndicate to explore certain Tulumeeen coals.
Colliery. —No. 2 opening, Granite Creek, B.C.
Sampling. —The face of the best workable bench of coal was carefully
sampled at the end of a prospecting tunnel a little over 100 feet in from
the outcrop.

¹ Sample taken by E. Stansfield.

² Sampled by Dr. J. B. Porter, June, 1908.

Ex. No. 3.¹

Operator.—A syndicate to explore certain Tulameen coals.

Colliery.—No. 4 opening, Granite Creek, B.C.

Sampling.—The face of the best workable bench of coal was carefully sampled at the end of a prospecting tunnel a little over 100 feet in from the outcrop.

NICOLA VALLEY COAL FIELD.

No. 22.

Operator.—Nicola Valley Coal and Coke Company.

Colliery.—Mine No. 1, Middlesboro colliery, near Coutlee, Nicola valley, British Columbia. Colliery is connected by a spur with the Nicola Valley branch of the Canadian Pacific railway.

Sampling.—Sample of 140 bags, taken from Jewel seam, near Coal Gully. Coal represents fair average of workings, which were only in development stage. Sample taken from bank on which were 600 to 800 tons of coal freshly mined.

Moisture sample was also taken from the bank.

Date of sampling.—April 18, 1908.

No. 22 SP.

Operator.—Nicola Valley Coal and Coke Company.

Colliery.—No. 2 mine, Middlesboro colliery, near Coutlee, Nicola valley, B.C.

Sampling.—Sample of 10 bags, from bank of No. 2 mine. This sample was taken with the view of testing it for coking qualities. No. 2 mine is on Coldwater hill, on Rat Hole seam.

Date of sampling.—April 18, 1908.

No. 22 M.

A sample obtained by mixing together coals No. 22 and No. 22 SP. These two coals were sampled separately upon arrival at the testing laboratories; they were then thoroughly mixed together and resampled.

VANCOUVER ISLAND, NANAIMO-COMOX COAL FIELD.

No. 20.

Operator.—Wellington Colliery Company.

¹ Sampled by Dr. J. B. Porter, June, 1908.

Colliery.—Extension mine, Vancouver island. The mine is situated inland, and is connected with the shipping wharves at Ladysmith by standard gauge road, 13 miles long.

Sampling.—Sample of 128 bags (10 tons) from the Wellington seam. Coal had passed over a 14" screen, and over picking tables, with two Chinese labourers picking. Main sample was taken from a car which had just been loaded, cut out by the representative of the Department of Mines from a string of twelve cars, which were being loaded.

Moisture sample taken from the picking belt, thirty-five pounds quartered to small sample.

Date of sampling.—April 8, 1908.

No. 2020.

Supplementary sample of No. 20 coal, for coking tests.

This sample of about 100 pounds was shipped to Frank, Alta., by the mine authorities, April, 1909.

No. 18.

Operator.—Western Fuel Company.

Colliery.—No. 1 mine, Esplanade shaft, Nanaimo, Vancouver island. Sample of 143 bags from the Upper seam, or Southside coal, obtained from the diagonal slope, off No. 1 main slope. Coal is soft, and used for steam raising purposes.

Coal cleaned over 2" screen and picking table 35 feet long, on which six Chinese labourers were picking. One-half of the sample was obtained from a string of five ton cars, and one-half by dumping one five ton car into a bunker.

Date of sampling.—April 4, 1908.

No. 2018.

Supplementary sample of No. 18 coal for coking tests.

This sample of about 100 pounds was shipped to Frank, Alta., by the mine authorities, April, 1909.

No. 17.

Operator.—Western Fuel Company.

Colliery.—No. 1 mine, Esplanade shaft, Nanaimo, Vancouver island. In town of Nanaimo. Coal shipped by water.

Sampling.—Sample of 134 bags, from workings in lower seam situated 1½ miles from the bottom of No. 1 shaft, and 2,000 feet west from the Protection Island shaft. Coal passed over 2" screen, and picking table 35 feet long, on which six Chinese labourers were picking. This lump coal is used for

domestic purposes. Three-fourths of the sample was obtained from a string of five ton cars which had just been loaded, and one-fourth by dumping a car in an empty bunker.

Moisture sample was taken from picking belt.

Date of sampling.—April 6, 1908.

No. 21.

Operator.—Wellington Colliery Company.

Colliery.—No. 4 mine, Cumberland, Comox district, Vancouver island. Colliery is situated inland near Comox lake, and is connected with shipping wharves at Union bay by railway, 11 miles long.

Sampling.—Sample of 75 bags, from lower seam at No. 4 mine. This mine is entered by slope $1\frac{1}{4}$ miles long, and coal comes from practically all over the mine. Coal passes over $\frac{3}{4}$ " bar screen 15 feet long, and over picking belt 40 feet long. This sample was taken on tipple by stopping the belt and shovelling coal into the bags.

Moisture sample was obtained on picking belt during filling of the bags. Thirty pounds broken and quartered.

Date of sampling.—April 11, 1908.

No. 21 SP.

Operator.—Wellington Colliery Company.

Colliery.—No. 7 mine, Cumberland, Comox district, Vancouver island.

Sampling.—Sample of 75 bags from lower seam. Mine is entered by slope 800 yards long, and coal sample comes mainly from working in 600 yard level. Coal is dumped on bar screen $\frac{3}{4}$ " to 1", and passes over belt 70 feet long, three Chinese labourers picking. Belt was stopped and coal shovelled from it into bags.

This coal is from same seam as No. 21, No. 4 mine.

Date of sampling.—April 13, 1908.

No. 21 M.

A sample obtained by mixing together coals No. 21 and No. 21 SP. These two coals were sampled separately upon arrival at the testing laboratories. They were then thoroughly mixed together and resampled.

VANCOUVER ISLAND, ALERT BAY COAL FIELD, B.C.

Ex. 34.

Operator.—Pacific Coast Coal Co.

Colliery.—Suquash mine, Alert bay, Vancouver island, B.C.

Sampling.—Sample of 91 bags, supplied by the mine authorities, during development.

Date of sampling.—October, 1909.

YUKON.

WHITEHORSE COAL FIELD.

¹Ex. 31.

Operator.—White Pass and Yukon Railway Co., Ltd.

Colliery.—Tantalus mine, Whitehorse district, Yukon territory.

Sampling.—Four bags of coal from the upper seam. The cut was taken across the face of the seam, all bone, slate, and rock of $\frac{1}{2}$ " thick and over being discarded.

²Ex. 32.

Operator.—White Pass and Yukon Railway Co., Ltd.

Colliery.—Tantalus mine, Whitehorse district, Yukon territory.

Sampling.—Sample of four bags of coal from the middle seam taken across the face of the seam, all bone, slate, and rock of $\frac{1}{2}$ " thick and over being discarded.

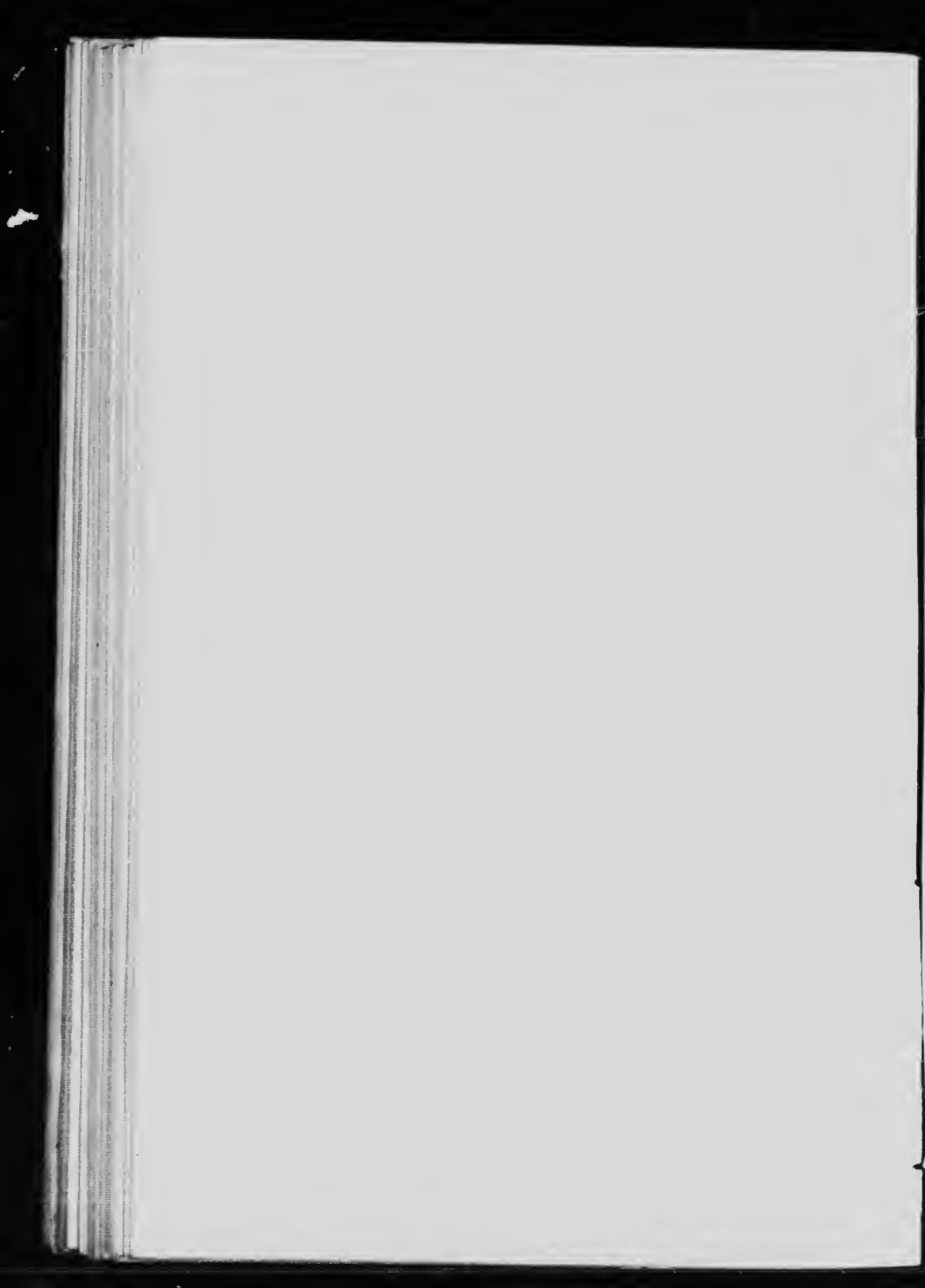
³Ex. 33.

Operator.—White Pass and Yukon Railway Co., Ltd.

Colliery.—Tantalus mine, Whitehorse district, Yukon territory.

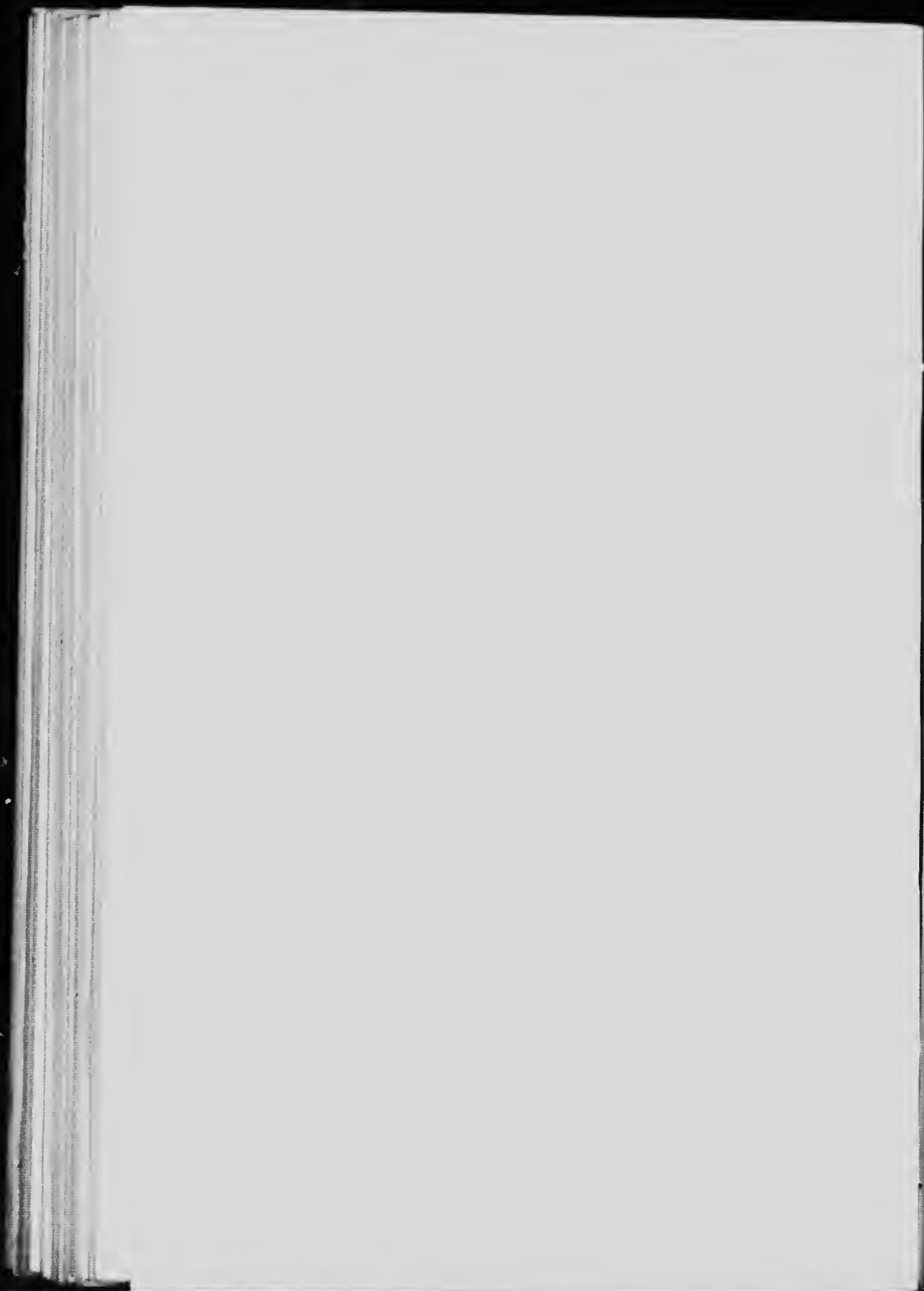
Sampling.—Sample of four bags of coal from the lower seam taken across the face of the seam, all bone, slate, and rock of $\frac{1}{2}$ " thick and over being discarded.

^{1, 2, 3} Samples taken by D. D. Cairnes, of the Department of Mines.



THE
COALS OF CANADA:
AN ECONOMIC INVESTIGATION
VOL. I

PART IV
SAMPLING IN THE TESTING PLANT AND LABORATORY
BY
J. B. PORTER



PART IV**SAMPLING IN THE TESTING PLANT AND LABORATORY.**

By

J. B. PORTER.

One of the great difficulties met with in any investigation of ore or fuel is that of obtaining accurate samples for analysis. The chemist uses for his work only a gram, at most, for each determination, or, in other words, less than a teaspoonful for a whole analysis, yet this minute quantity must represent, and represent truly, a very large quantity of material. In the case of coal, for example, the material itself is very irregular in composition, consisting in the main part of what we may call coal proper with certain more or less constant impurities, and, mixed with this, considerable quantities of rock, clay, and extremely impure coal. A lump taken at random from a lot of commercial coal may be anything from almost pure coal to quite pure rock, and, as a matter of fact, it is often difficult, if not impossible, even for an expert, to find in a pile of coal or ore any single lump which is really representative of the whole.

The only absolutely perfect way, therefore, to obtain a true sample from a large quantity, whether it be one ton or a thousand, is to crush the whole to a comparatively fine powder, to mix that thoroughly and then take out a number of smaller portions, which in turn have to be re-crushed, mixed, and again sampled, and to repeat these operations until a small enough portion for the use of the chemist is obtained. In practice such procedure is, of course, inadmissible, as it ruins the whole mass for any useful purpose, and, therefore, a method must be employed in sampling which will at once leave the main part of the material in approximately its original condition, and yet secure a truly representative portion for the chemist.

The subject of sampling has been thoroughly investigated and certain definite rules have been laid down as governing the procedure. In brief, they recognize the fact that absolute accuracy is impossible, and all that need be attempted is to secure as great accuracy in taking the sample as the chemist himself will attain in his analytical work.

The common custom in the laboratory is for the chemist to start with a sample of a few ounces in weight, which he grinds to an almost impalpable powder, and from this, after carefully mixing it, he takes small portions for each determination. There is for each determination an unavoidable error, usually a very small fraction of 1 per cent. Starting, then, with this error as applied to a portion of say 1 gram, drawn in turn from a lot of a few ounces of a certain degree of fineness, it is possible to calculate the corresponding

degree of fineness to which a lot of say 100 tons must necessarily be crushed, so that say ten tons may be withdrawn from it, with a mathematical certainty of introducing no greater error. Again, this lot of 10 tons, after being crushed to a certain calculable size, may have one ton safely taken from it, and so on until the final small sample for the chemist is secured. It is unnecessary to discuss the subject in detail, or to attempt to calculate the actual sizes to which each succeeding lot should be crushed before sampling, but enough has been said to show that sampling can be done with a high degree of accuracy and yet without undue damage to the main part of the material.

As stated in the introduction, all samples from the mines were sent as promptly as possible to the laboratories of the Mining Department, McGill University, Montreal, and were there prepared for the tests. The equipment of the crushing and sampling section of these laboratories comprises:—

- One adjustable Comet rock breaker.
- One Dodge rock breaker.
- One Sturtevant roller jaw crusher.
- One small Blake crusher.
- One set high speed belt driven rolls.
- Two ball mills.
- One Gates sample grinder.
- One Sturtevant sample grinder.
- One revolving drum screen with three fields.

Two shaking screens with full series of sieves from 3" to 200 mesh, and a number of other crushing and grinding machines and screens not used in the present investigation.

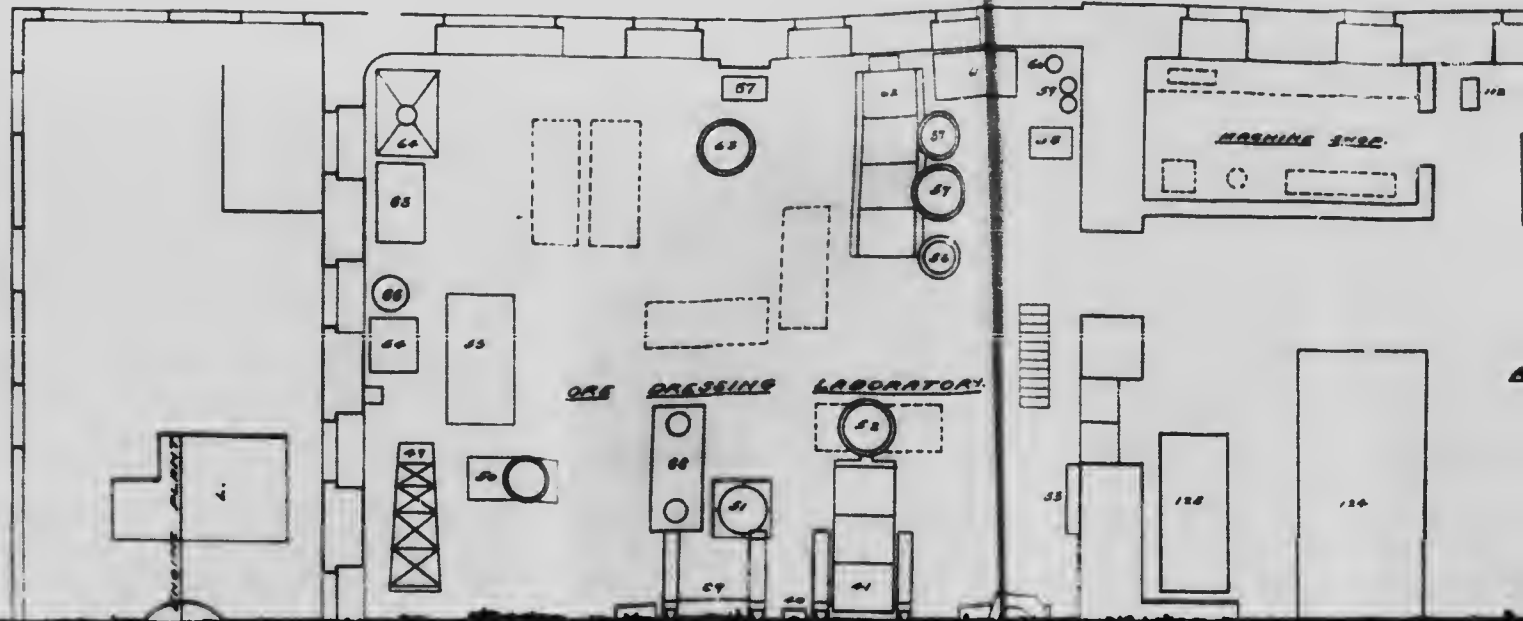
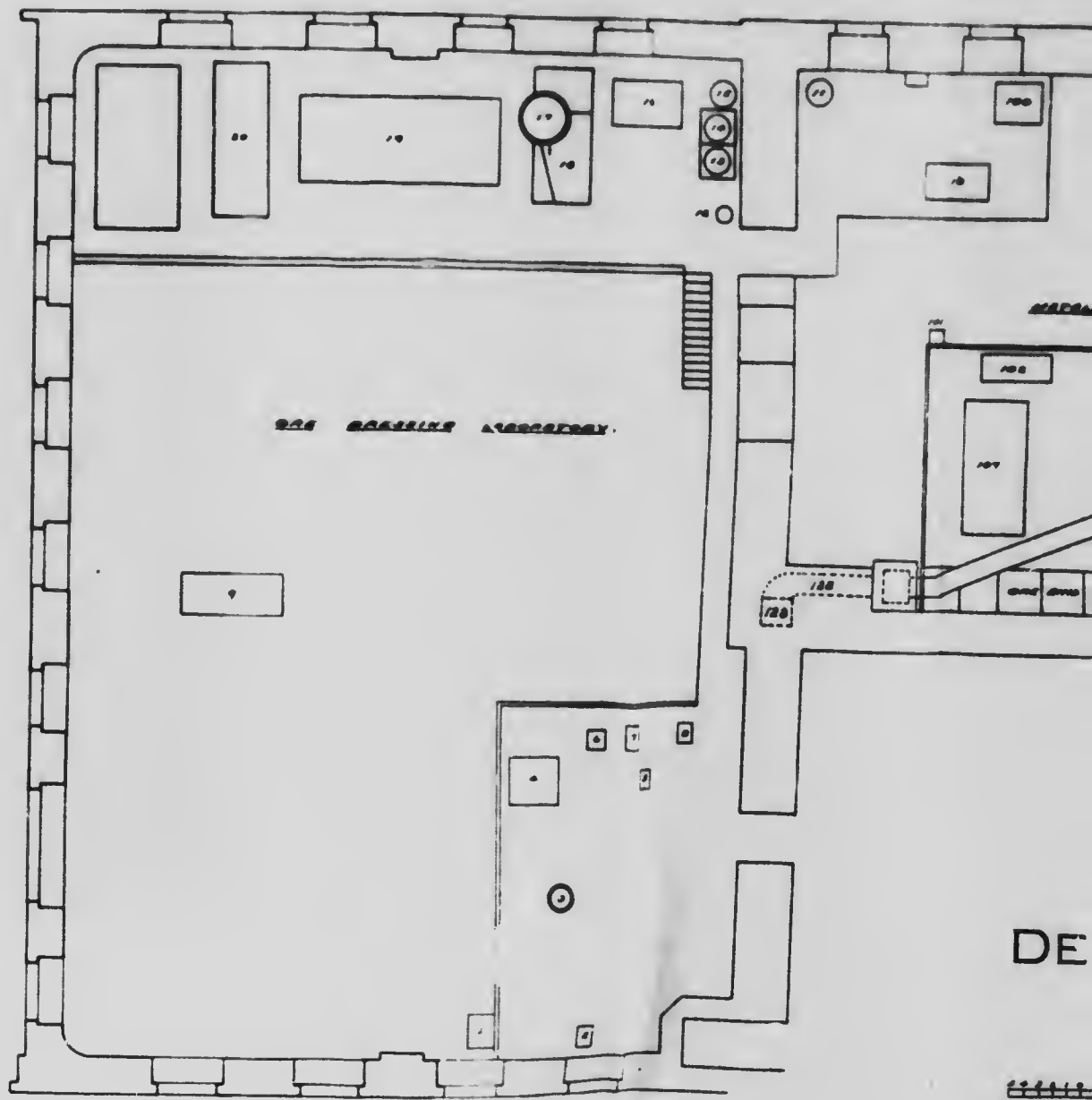
The arrangement of the apparatus is shown in Fig. 1. The large crushers are mounted on an elevated platform with a steel sampling and breaking floor capable of storing and handling 50 tons. They discharge through chutes to screens and thence to elevators or to the granolithic sampling floor at the level of the main ore dressing laboratory. The plant is driven by electric motors of 50 H.P., total capacity, and is provided with a hydraulic lift and with two belt and bucket elevators connecting the crushers with rolls and screens.¹

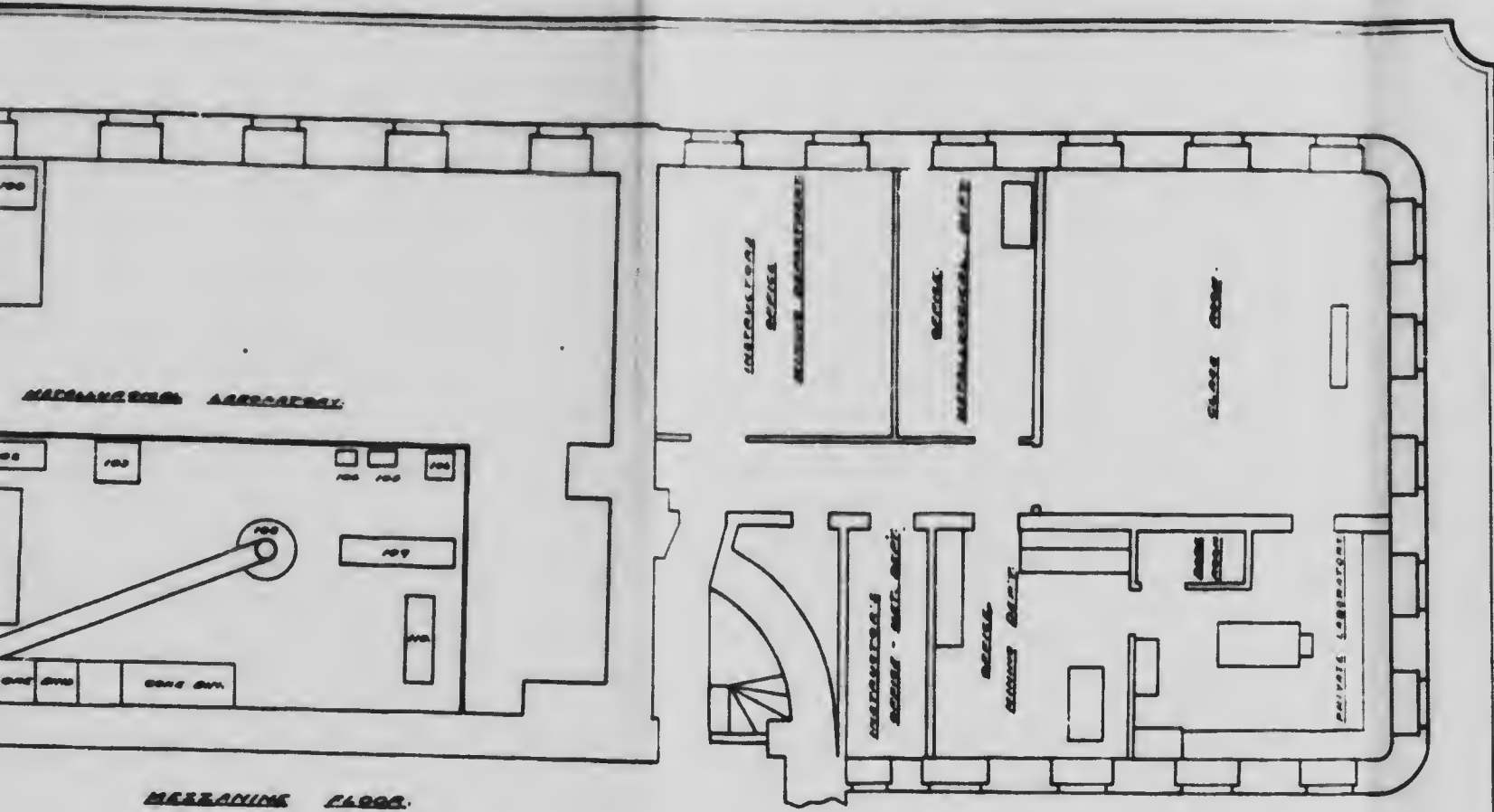
In the investigation under discussion, the original lots of coal received from the field usually ranged between 12 and 5 tons, although in certain instances smaller quantities were sent in. The method of sampling was to unload the whole of each lot on a cement floor, and to sieve it all through a screen of parallel iron bars with 3" open spacing.² Any lumps which were too large to pass the bars were broken with spalling hammers and put through. The whole lot was then thoroughly mixed, by shovelling into a cone and then flattening out this cone into a flat disc and repeating the operation. It was then shovelled to one side, every third shovelful being reserved

¹ The apparatus will be described and illustrated later.

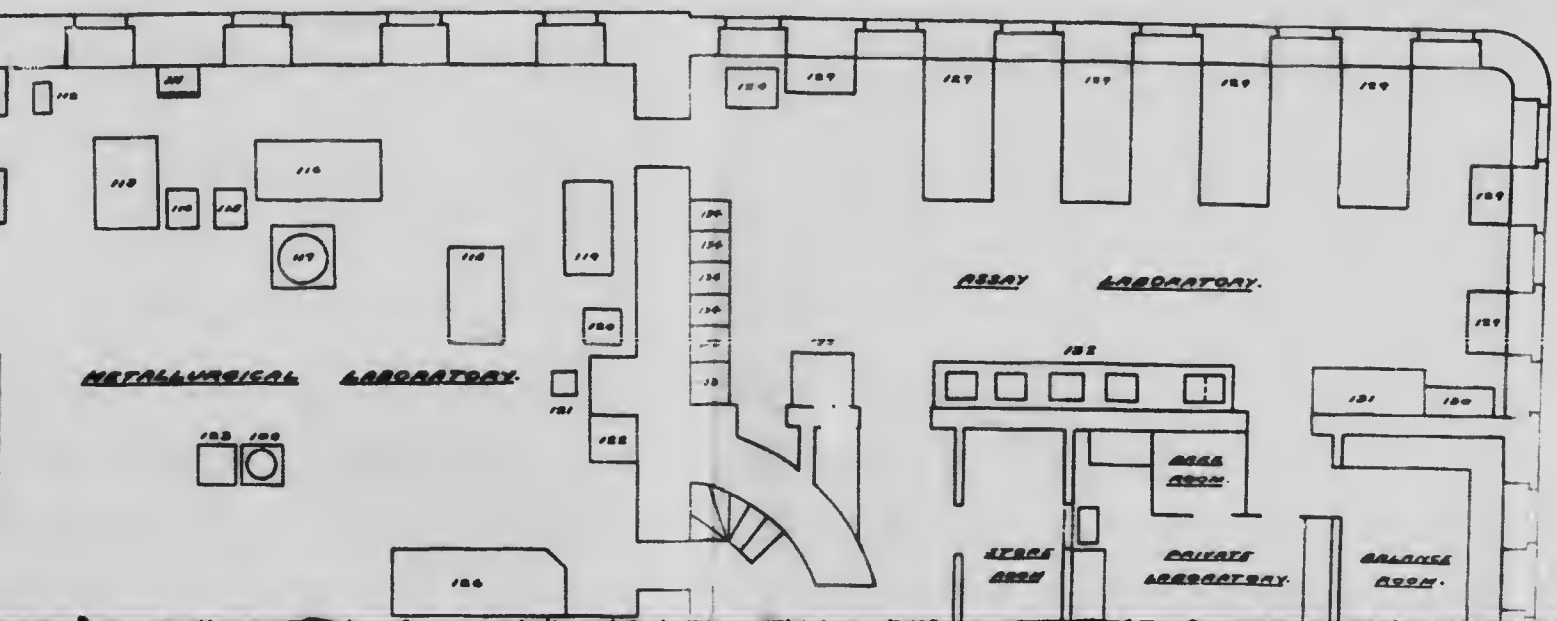
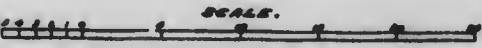
² Plates XXVIII to XXX show the method of sampling, with the difference that the photographs were taken during a special test when the coal was not broken to 3" at first.

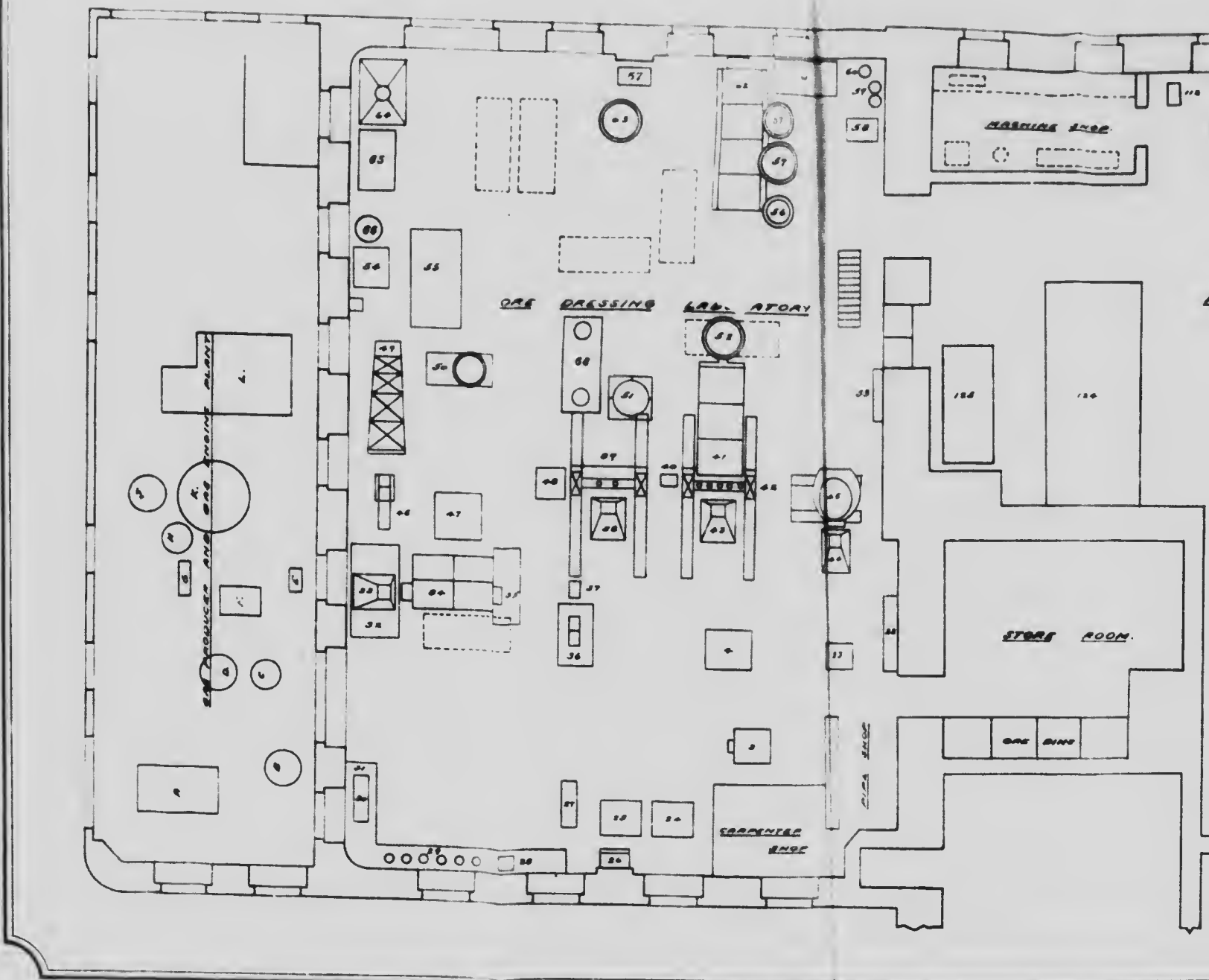
Sampling. A cone of unbroken coal. Department of Mining and Ore Dressing, McGill University.



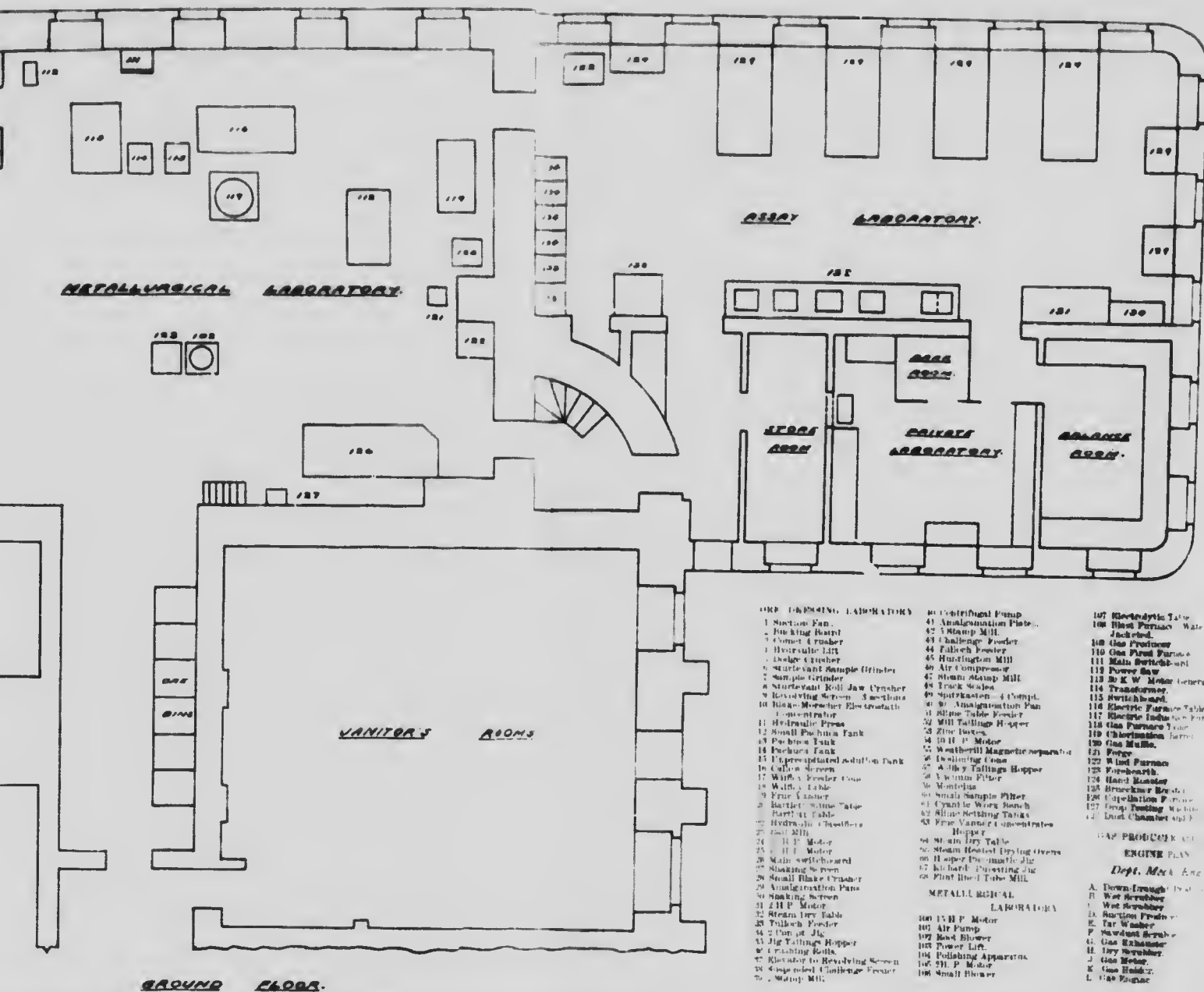


McGILL UNIVERSITY
DEPARTMENT OF MINING AND METALLURGY.





SCALE



METALLURGICAL LABORATORY

- 1 Suction Fan
- 2 Bunking Barrel
- 3 Comet Crusher
- 4 Hydraulic Lift
- 5 Scale Crusher
- 6 Servo-valve Sample Printer
- 7 Sample Printer
- 8 Servo-valve Roll Jaw Crusher
- 9 Revolving Screen Sections
- 10 High-Speed Electromechanical Compressor
- 11 Hydraulic Press
- 12 Small Pachina Tank
- 13 Pachina Tank
- 14 Pachina Tank
- 15 Unpermeated solution Tank
- 16 Cotton Screen
- 17 Wire Cloth Feeder Tray
- 18 Wire Cloth
- 19 Fine Crusher
- 20 Bartlett's Table
- 21 Bartlett's Table
- 22 Hydraulic Press
- 23 Stamp Mill
- 24 10 H.P. Motor
- 25 10 H.P. Motor
- 26 Main switchboard
- 27 Shaking Screen
- 28 Small Blake Crusher
- 29 Amalgamation Pan
- 30 Bunking Barrel
- 31 2 H.P. Motor
- 32 Steam Dry Table
- 33 Pulverizer Feeder
- 34 2 Ton of Jig
- 35 Jig Tailings Hopper
- 36 Troughing Rods
- 37 Receiver to Revolving Screen
- 38 Composite Challenge Feeder
- 39 Stamp Mill

- 40 Centrifugal Pump
- 41 Amalgamation Plate
- 42 Stamp Mill
- 43 Challenge Feeder
- 44 Fallch Feeder
- 45 Huntington Mill
- 46 Air Compressor
- 47 Steam Stamp Mill
- 48 Truck Scale
- 49 Sparkston - 4 Comp.
- 50 Amalgamation Pan
- 51 Alloy Table Feeder
- 52 Mill Tailings Hopper
- 53 Zinc Boxes
- 54 10 H.P. Motor
- 55 Weatherill Magnetic Separator
- 56 Bunking Tray
- 57 Alloy Tailings Hopper
- 58 Vacuum Filter
- 59 Molding
- 60 Small Sample Printer
- 61 Cyanide Wire Bench
- 62 Alloy Settling Tanks
- 63 Fine Hammer Concentrate Hopper
- 64 Steam Dry Table
- 65 Steam Heated Drying Oven
- 66 Hopper for magnetic jig
- 67 Magnetic Drying Jug
- 68 Plant Hot Tube Mill

- METAL LABORATORY
- 100 15 H.P. Motor
 - 101 Air Pump
 - 102 Blast Blower
 - 103 Power Lift
 - 104 Polishing Apparatus
 - 105 2 H.P. Motor
 - 106 Small Blower

- 107 Electrolytic Table
 - 108 Steam Pressure Water Jacketed
 - 109 Gas Producer
 - 110 Gas Prod. Furnace
 - 111 Main Vertical Shaft
 - 112 Power Saw
 - 113 20 K.W. Motor Generator Set
 - 114 Transformer
 - 115 Switchboard
 - 116 Electric Furnace Table
 - 117 Electric Induction Furnace
 - 118 Gas Pressure Table
 - 119 Chromic Acid Furnace
 - 120 Gas Muffle
 - 121 Forge
 - 122 Wind Furnace
 - 123 Forehearth
 - 124 Hand Hammer
 - 125 Brocker's Machine
 - 126 Copulation Furnace
 - 127 Gray Casting Machine
 - 128 Lost Chamber and
- ENGINE PLAN
- Dept. Mech. Eng.
- A. Down-Through
 - B. Wet Scrubber
 - C. Wet Scrubber
 - D. Reaction Furnace
 - E. Tar Washer
 - F. Sawdust Separator
 - G. Gas Washer
 - H. Dry Scrubber
 - I. Gas Washer
 - J. Gas Washer
 - K. Gas Washer
 - L. Gas Washer

TO ACCOMPANY REPORT ON
"THE COALS OF CANADA" No. 21, 1911

d
s
t
o
u
n
c
h
u
d
e
n.

pr
U
of

a n
the

crus
brea
thru
plin
driv
hyd
with

from
insta
nlo
a set
were
throu
cone
tion.

1

2

photo;

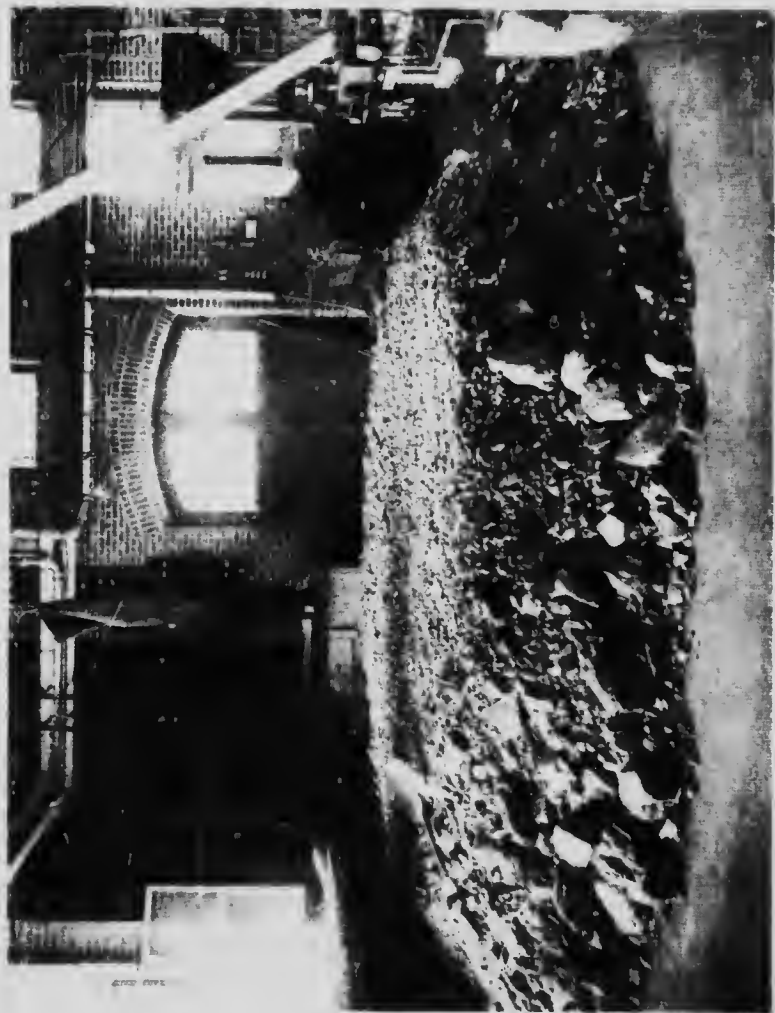
Plate XVIII.



Sampling. A case of unbroken coal. Department of Mining and Ore Dressing, McGill University.



Plate XVII



Sampling. A flattened cone of coal. Department of Mining and Ore Dressing, McGill University.

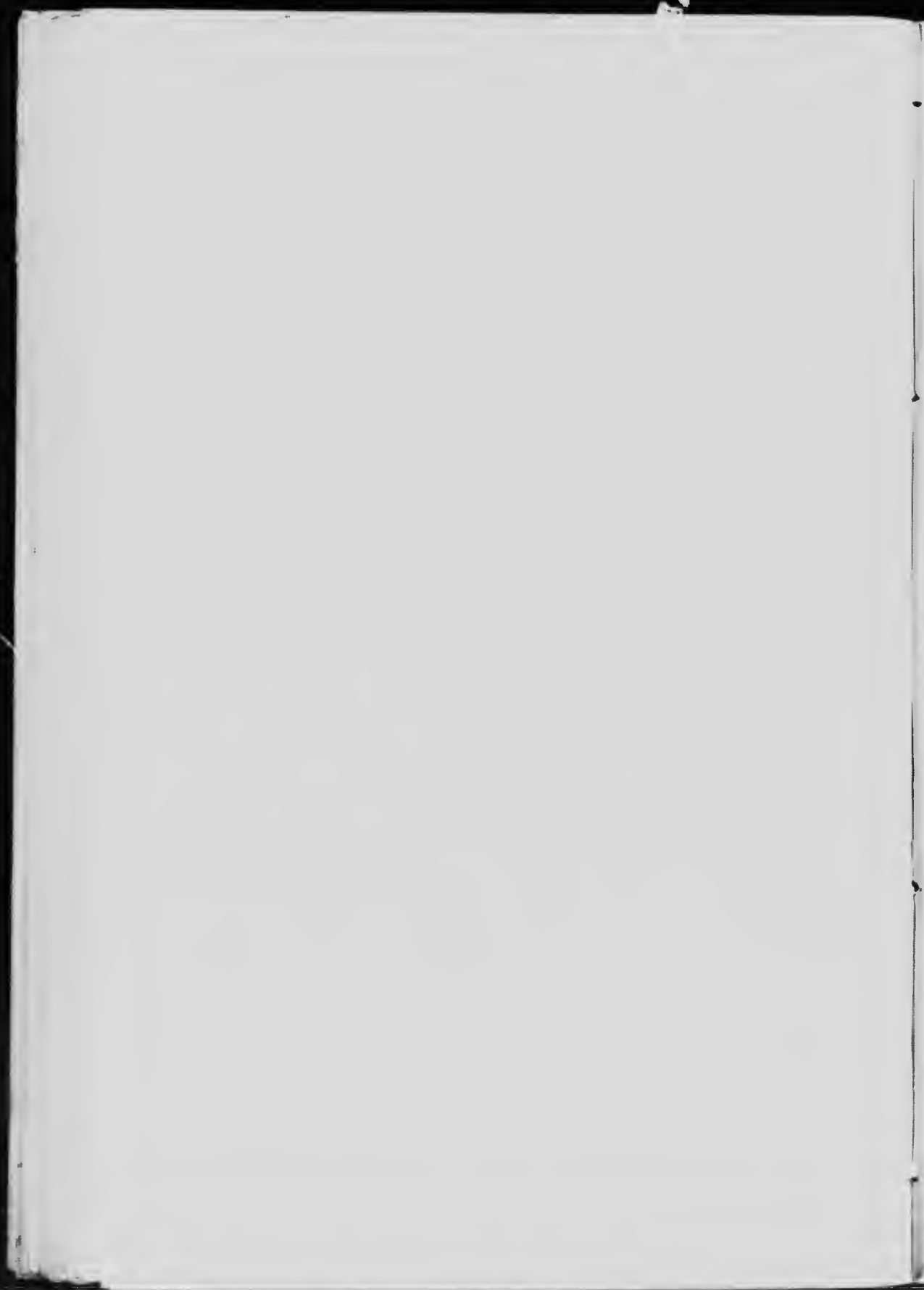
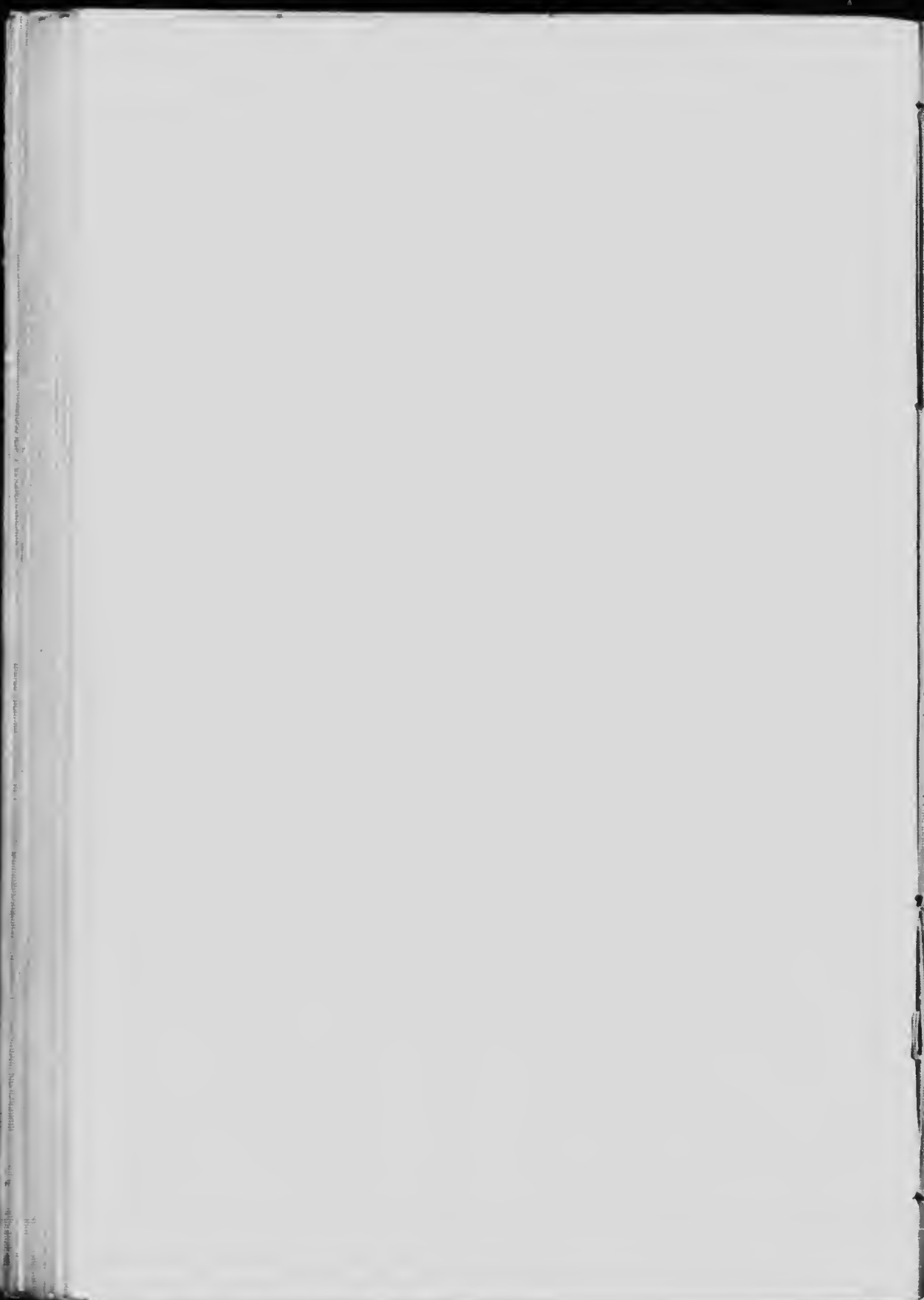


Plate XXX.

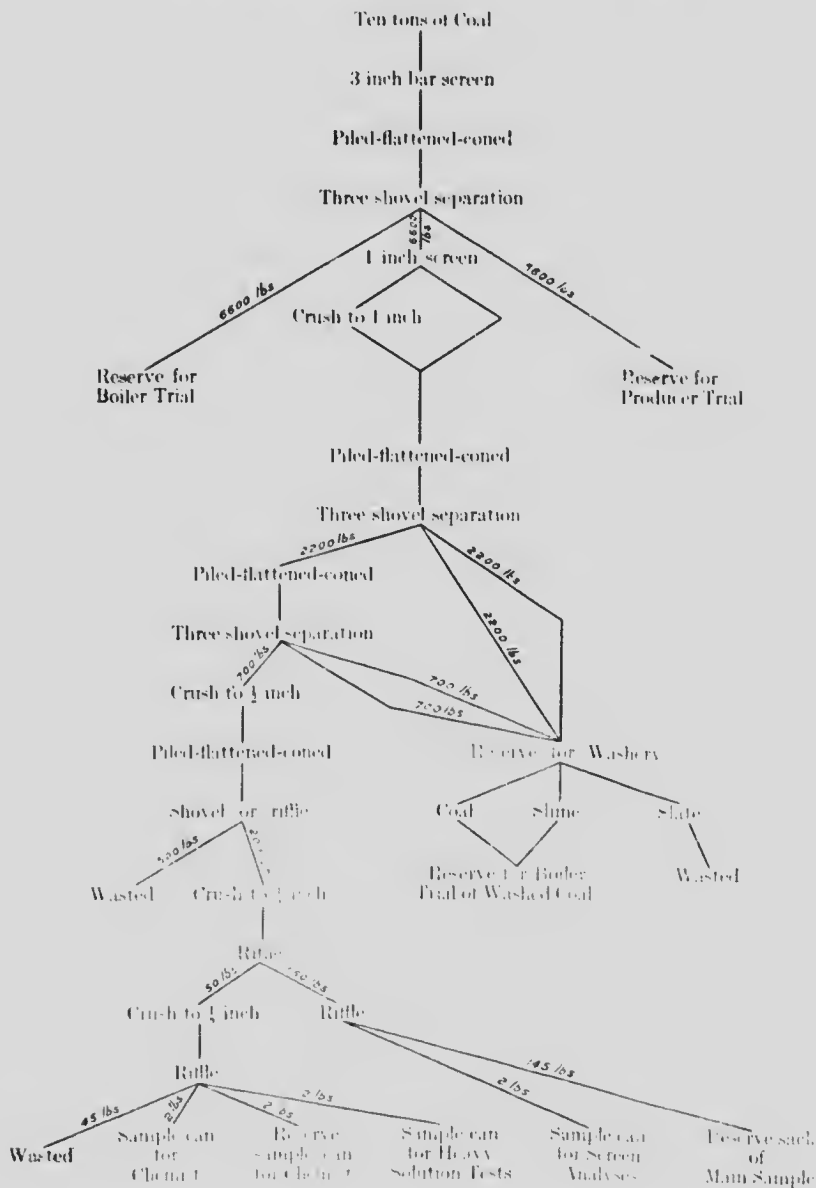


Sampling. A scattered pile of coal. Department of Mining and Ore Dressing, McGill University.



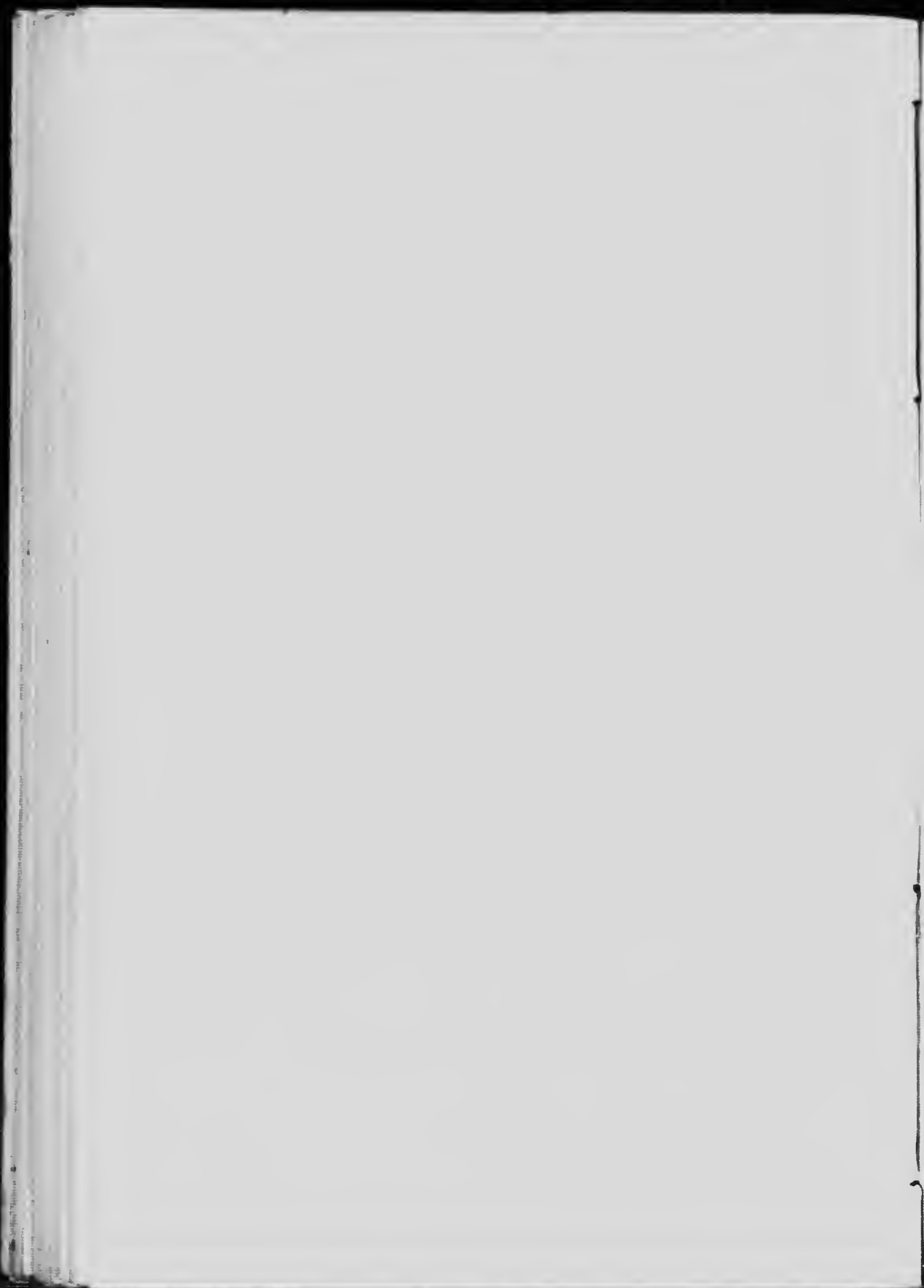
and screened through 1"; the oversize being re-crushed and the whole lot then made into a new and smaller cone, which in turn was flattened and re-coned, and then again shovelled aside, each third shovelful again being reserved. This portion, amounting to about one ton, was then crushed to $\frac{1}{2}$ " size, and was again re-coned and mixed as before, and again reduced, in some cases by the old-fashioned method of coning and quartering, but ordinarily by withdrawing every third shovel. The successive operations of crushing and sampling were continued until a lot of about 125 pounds was secured. This was reduced in a Jones rille with occasional re-crushing to about 5 pounds which was put in sealed tins and sent to the chemical laboratory. The remainder of the rilled sample, amounting to about 120 pounds, was sacked and set aside as a reserve. The operation above outlined is shown in the accompanying diagram.

FLOW SHEET SHOWING ORDINARY TREATMENT OF MAIN SAMPLE



THE
COALS OF CANADA:
AN ECONOMIC INVESTIGATION
VOL. I

PART V
MECHANICAL PURIFICATION OF COAL
BY
J. B. PORTER



PART V**MECHANICAL PURIFICATION OF COAL COMMONLY CALLED
COAL WASHING.**

BY

J. B. PORTER**INTRODUCTION¹**

In tracing the development of the coal mining industry of a new country we find that the first seams successfully mined are almost without exception those which combine large size, good quality, and accessibility to markets; and that the mining methods employed, while producing coal at a comparatively low cost per ton, are in general very wasteful both of pillar coal left underground and of fine material brought to the surface but not utilized.

As the industry develops less wasteful methods are introduced and it also becomes necessary to mine seams of poorer quality and small seams which, even if good in themselves, produce a poorer coal owing to the unavoidably greater proportion of fine coal and roof and floor refuse. At the same time the consumers of coal become more particular as to the quality of their fuel and demand a degree of uniformity in size and a freedom from ash which would have been unthought of at an earlier stage.

To meet the conditions above outlined it ultimately became necessary to provide all collieries with screening and sizing apparatus, and later to erect washing or purification plants wherever the coal contains undue proportions of ash or other objectionable matter.

All of the great coal producing countries have gone through the process of development named,² Germany leading the way in the '70's. The coal as it comes from the mines in the Dortmund and Westphalian coal fields contains only from 20 to 30 per cent of lumps that will stay on a screen with holes 3" in diameter. The amount of shale and slate mixed with the coal in mining these thin seams is also large, and the coal must of necessity be cleaned before it is fit for the market.

Both Canada and the United States are extremely fortunate in being the possessors of enormous areas of coal lands, and until recently mining has been confined, generally speaking, to thick and easily operated seams. The proportion of fine and dirty coal made is, therefore, small when compared with that produced in mining the thin seams of European countries, but

¹ The author wishes to acknowledge the indebtedness to Messrs. H. G. Carmichael, and H. L. Strangways—his assistants in the coal washing investigation—for aid in the preparation of this section of the report.

² Eng. and Mining Journal, Vol. 89, p. 630.

in spite of the comparatively recent development of the coal industries on this continent, their growth has been so great that the exceptionally good seams are being rapidly depleted and poorer coals requiring cleaning are now being mined on a very large scale. Nowhere will better evidence of this be found than in Pennsylvania where the enormous iron trade of Pittsburgh could never have attained its present size if it had not been for the abundance of cheap and excellent coke produced from the coals of the vicinity; yet although Pittsburgh can not be said to have long enjoyed the honour of being the foremost iron and steel centre of the world, the number of washeries either in operation or in the process of erection in its vicinity affords ample proof that the problem of coal washing as a preparation for coke making is rapidly becoming imperative.

Turning for a moment from bituminous coal to the anthracite industry we have perhaps better evidence of the importance of coal sizing and washing. On account of the limited extent of the anthracite fields of the United States the necessity for their conservation became evident at a comparatively early day and the reckless prodigality of thirty years ago has now entirely disappeared. All the anthracite mines are now equipped with breakers and washeries employed in preparing for the market the smaller sizes of coal which were originally discarded as worthless. The enormous piles of culm (as the waste of earlier years was called) are all being worked over, and the coal saved from this source alone amounted in 1906 to 3,846,500 tons, or 6.9 per cent. of the total production.

The supply of good bituminous coal still suffices for nearly all demands except those of the iron and steel industry, which requires coke—speci- ally low in sulphur and ash; there are, however, at the present time in North America, a few plants already engaged in washing bituminous coal for fuel purposes, and the number is bound to increase in time as it becomes necessary, with the increasing demand and the diminishing supply of good coal, to use coals which are unfit for the market as mixed, as is already the case with the anthracites. Looking at the question from the point of view of a consumer who uses considerable quantities of coal for fuel purposes, it can easily be seen that the presence of material which has no calorific value must of necessity be harmful, both because it takes the place of material which has value and because of the extra labor and transportation, and of the harmful effects which will ensue from the clinker and ash that such material will produce. This is proved to be true by the fact that the increase in evaporation following the elimination of such useless material is not in direct proportion to its amount, but in many cases greatly exceeds it, as the improvement both in the nature and quantity of the clinker formed, enables the fireman to use the washed coal to better advantage, and at the same time renders the firing of the boiler a much easier operation and decreases the loss of heat due to cleaning the grate.

See supplement to the Engineering and Mining Journal for March, 1908.

Attention is also being directed more and more to the great advantage to be gained by sizing non-coking bituminous coals as is already done in the case of anthracite. Such sizing, by removing the dust, makes it possible to burn even quite fine dry coal on grates of suitable design. Briquetting of the extremely fine material is also beginning to be done on a comparatively large scale, and this practice is certain to extend greatly, especially in districts where the coals do not coke well or when there is little demand for this material¹.

In treating the question from the ironmaker's point of view, the advantages gained from washing the coal are even greater. The demand for pig iron of a quality suitable for steel manufacture makes it necessary for the producers to avoid having injurious elements in their fuel as well as their ores and fluxes. The necessity is all the more marked because of the rapid depletion of the really high grade pure iron ore reserves. To produce iron of the best quality it is imperative to keep to the lowest possible limit of sulphur content. Certain coals are thus absolutely unfit for metallurgical purposes without washing. As regards the ash in coal or coke for smelting purposes, the practical gain due to washing amounts to more even than in the case of steam fuels above cited. Any foreign matter introduced into a blast furnace requires an extra amount of flux, and consequently an extra amount of fuel in addition to that required simply to reduce the ore, and slag off the impurities due to the ore alone. Further, the physical quality of the coke made from washed coal is superior to that made from the same coal unwashed owing to the smaller size of the coal used and its comparative freedom from foreign matter.

The impurities which exist in coals may be divided into three classes as follows: -

- (1) Innate,
- (2) Sedimentary,
- (3) Infiltrated.

The first of these classes represents chiefly such impurities as the silica and alumina originally present in the parent plant. Such impurities cannot be removed by any process as they are part and parcel of the coal itself. The range of such impurities is surprisingly large. In some cases they amount to only about 2 per cent, in others to as much as 7 per cent. The range in specific gravity of what may be termed pure bituminous coal is from 1.28 to 1.37, and both anthracites and lignites are even more dense.

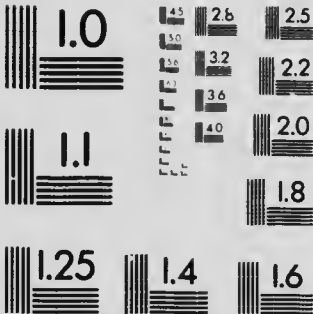
The second of these classes represents chiefly the slates, shales, and fire-clays formed from layers of sediment deposited during short periods of flood

¹ The time has arrived in the development of bituminous coal mining, . . . when it has become necessary to enlarge the markets for the smaller grades. Our methods of mining produce such a large proportion of fine coal that operators have a surplus of these grades of coal on their hands. This is especially true . . . for coals which will not coke. This condition . . . is not a temporary one but has become entirely permanent and will grow rather than diminish. It is, therefore, essential for the best interests of the industry that processes should be developed . . . whereby these smaller grades of coal may be converted into a product for which there are markets. Such a process is found in the briquetting of the smaller coals. (Eng. & Min. Journal, 1909)



MICROCOPY RESOLUTION TEST CHART

(ANSI and ISO TEST CHART No. 2)



APPLIED IMAGE Inc

1653 East Main Street
Rochester, New York 14609 USA
1716-1482 300 Phone
776-1288 5989 Fax

or subsidence in the coal-forming eras. Such slates and shales form partings in the coal seams, and when thin or friable are unavoidably mixed with the coal in mining. To this class, also, belong fragments of roof and floor. The proportion of debris of the latter sort will, of course, be greater in the case of thin seams and often, also, in the coal from those mines in which coal cutting machines are employed. The impurities of this type possess a specific gravity in the neighbourhood of 2.5. Finally, in this second class must also be placed the intermediate material known as "bone" or "splint" coal. This material, which is probably the result of the deposition of sedimentary and organic material together, contains innate impurities which can no more be removed than those of the coal proper. The percentage of such impurities in bone coal varies from 4 per cent to 90 per cent, and its specific gravity ranges between say 1.37, (the limit for good coal, and 2.5, the limit for slate. The better grades of bone coal are, of course, suitable for use and are, in fact, scarcely distinguishable from pure coal. The very poor grades, on the other hand, with specific gravity over say 1.55, are really carbonaceous slate or shale and ordinarily almost worthless as fuel. The intermediate grades, while possessing some fuel value, are objectionable for reasons already given, but their removal presents great difficulty, as coal washing operations depend for their success on the differences in specific gravity of the materials to be separated; and these are very small in this case.

The third class of impurities, namely those due to infiltration, are those which have been deposited from solutions of percolating waters after the formation of the coal bed. To this class belong the carbonates and sulphates of lime, barytes, etc, and numerous minerals containing iron, phosphorus, arsenic, and sulphur. The most important impurity is, by far, the sulphur, which occurs in three forms:—

(1) As a sulphide, chiefly as pyrite or sulphide of iron. (2) As organic compounds. (3) As sulphates.

The first of these forms, pyrite, frequently occurs as large balls and lenses, and always to a greater or lesser extent as thin plates, scales, and small crystals. Its specific gravity, 4.6, is very high, and consequently the larger masses offer absolutely no difficulty in removal by a method depending upon differences in specific gravities. A great deal of trouble is, however, experienced with fine pyrite on account of its tendency to scale and float and to stick to the coal. The removal of pyrite is almost as desirable in fuel as in metallurgical coals, as it adds very considerably to the production of clinker.

Organic sulphur cannot be removed by any washing process as it is definitely combined with the coal itself. While it is injurious in metallurgical coals its existence in fuel coals does not detract greatly from their qualities.

The sulphates are not commonly met with in serious amounts, but when they do occur their removal is difficult. In spite of the fact that there is a marked difference in the specific gravities of coal (1.3 to 1.38) and calcium sulphate (2.3) the flaky form in which it usually occurs and the manner in which it sticks to the coal makes this substance very troublesome to remove.

The elimination as far as practicable of the sedimentary and infiltrated impurities described above constitutes the problem of coal washing. In some cases the process is comparatively simple and easy. Such cases would be those in which the bulk of the impurity is represented by a clean shale or slate with little or no bone coal, and with the sulphur present as comparatively large lumps or crystals of pyrite. On the other hand certain coals contain large quantities of bone and but little clean slate or shale; such coals are exceedingly difficult to wash and often the practical gain ensuing is not sufficient to warrant the expenditure. Then again there is the case of a dirty coal in which the impurities run through the whole mass in very thin bands or lines, and although it is quite frequently worth while for coking purposes to reduce such a coal to a size at which the impurities are unlocked and can eventually be removed by washing; yet to treat it thus would not improve it for use as fuel and might even ruin it, as the resultant fine coal, even if quite pure, would be unsuitable for ordinary use.

Finally, it is usually impossible to use a coal which contains a high percentage of organic sulphur for iron blast furnace coke, because even if all other impurities are eliminated it will generally retain too large a percentage of sulphur.

GENERAL PRINCIPLES OF COAL WASHING.

The mechanical purification of coal depends upon the same fundamental principles, and in a general way involves the use of the same methods and machines as ordinary ore concentration. In both cases the impurities ordinarily differ from the valuable material in strength, character, and specific gravity, and the purification is effected by a three stage treatment of crushing, sizing, and separating.

Crushing is necessary in order to detach the worthless particles from the good and ordinarily is only carried out to a limited extent, as a complete separation would necessitate excessive comminution which would be very costly and would greatly impair the value of the purified material. In practice, therefore, the degree of crushing is determined by economic considerations, and the material is as little broken as possible to secure commercially satisfactory results.

The second operation—sizing—is also one of preparation for the third or final operation of separation. In sizing, the actual dimensions of the particles are of little importance, and the essential thing is to divide the crushed material into graded portions.

It is a simple matter by washing to separate grains of slate say $\frac{1}{4}$ " in diameter from pieces of coal of the same size, or even of three times the size, say up to $\frac{3}{4}$ ", and it is equally easy to separate other grains, either larger or smaller, from coal particles having similar relative dimensions. On the other hand, it is very difficult to effect a separation if the ratio of sizes is very great—say 1 to 6—and impossible to do so if it is still greater.

A mass of crushed ore or coal contains lumps of every size from the largest which can escape through the crusher down to the most impalpable powder, and such a material is quite impossible of separation by washing alone; but by sizing it to a ratio of say 1:3 on sieves having openings of 1", $\frac{1}{2}$ ", $\frac{1}{3}$ ", etc., the several portions can easily be separately washed, as no one of them will contain grains differing by more than one-third in diameter.

The above ratio of 1 to 3 is taken by way of illustration only. If the minerals to be separated differ very greatly in specific gravity, an even larger ratio will suffice. If they differ but little, the separation ratio will be less. The shape of the particles also has a marked influence; for example, if the heavy material tends to be flaky the ratio is lowered. If it is in rounder grains than the light stuff, the ratio is increased. A knowledge of the mineralogy of a mixture to be washed will make possible an approximate determination of the suitable sizing ratio, but the best results can only be obtained by experimental work on the material itself.

Finally, the separation process—which is usually but not always effected by washing—is carried out on the graded lots above referred to and results in two main products, a concentrate, or heavy material, and a tail, or light material. Very frequently an intermediate or middle product is also obtained, comprising particles which have not been sufficiently crushed and which, therefore, contain adhering pieces of both materials. The middles also contain any pieces of minerals of intermediate specific gravity which happen to be present, and a certain number of erratic fragments of both of the main constituents of the mixture.

Generally, the middle product is of small amount if the separation is simple, the sizing has been carefully done, and the ratio is not excessive; but it increases in amount as the sizing becomes imperfect or the mixture becomes more complex. As a rule, a middle product is unsuitable for retreatment on the original machines, but can be separated after further crushing and sizing.

The above remarks apply equally to ore dressing and coal washing, but these two operations differ in one marked respect. The valuable material in ores is almost without exception heavier than the rock which contaminates it, and usually the bulk of the waste material greatly exceeds that of the enriched concentrate. Ore dressing apparatus is, therefore, designed to save a relatively small quantity of heavy and valuable material and to discard a large bulk of worthless stuff. With coal, on the other hand, the heavy material is worthless, and the light and bulky overflow from the machines is the portion saved. In other words, coal washing may be likened to ore concentration, in which the concentrates after being collected are thrown away, while the tailings are saved. Coal is also notable as being the lightest of all important commercial minerals and as having a relatively low tonnage value and a still lower value per unit of bulk. It is, therefore, essential that coal dressing operations be carried out very cheaply, and this in turn involves working on a large scale and with a minimum of labour.

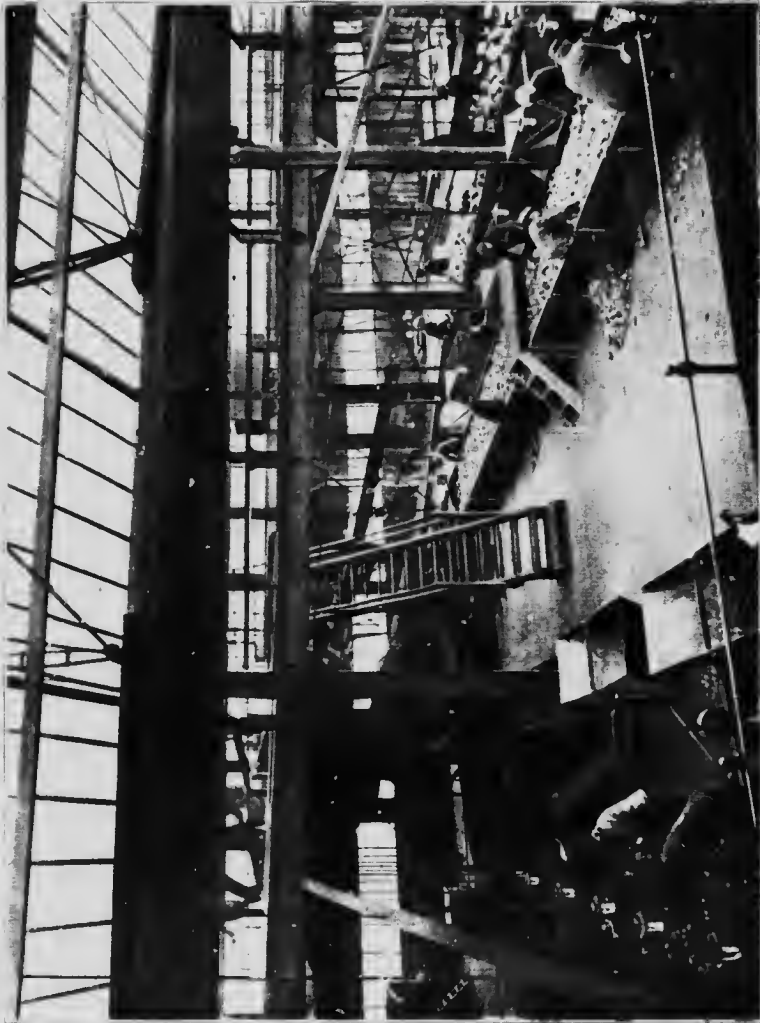
Plate XXXI.



Shaking screens and picking belts, Fendleton colliery, Manchester, England



Photo XXXIII.



Shaking screens and picking belt, Manton colliery, England.



Plate XXXIII



Coal trolley of the Springfield Collieries Co., U. S. A.



No attempt will be made in the following pages to give an exhaustive statement of the methods of coal dressing, still less of the apparatus employed. The history of the development of the process will be briefly sketched and then an attempt will be made to describe in a general way a number of typical machines which have proved especially useful in coal dressing, and a few characteristic washing plants will be outlined. Following this general treatment of the subject, there will be a detailed statement of the methods employed and of the results obtained in the present investigation of Canadian coals.

HISTORICAL SKETCH OF COAL WASHING DEVICES.

The various devices used for the preparation of coal for the market are comparatively modern and largely of European origin. In spite of the fact that crude appliances for concentration were employed for several centuries in the metalliferous branches of mining, the first recorded attempt to adopt the principles of ore dressing to the cleansing of coal was made in Germany in the year 1819. Prior to this no other preparation than hand picking and rough sizing were employed, and even these methods were in use in only a few places.

In 1819 the first washing machine was introduced at the Victoria Mathias colliery in Westphalia.¹ This was a rough type of jig² and consisted of a box with a screen bottom which was moved up and down by hand in water. The coal was fed to the machine until the jig box filled with slate and refuse. The box was then withdrawn and emptied and the operation repeated. As might be expected, the experiment was a commercial failure, owing to the high cost of operation.

In 1851 Berard exhibited a coal washing jig at the exhibition in London, and in 1855 he had an improved apparatus shown in Paris, but apparently no commercial attempts were made to wash coal for ten or fifteen years. Bar screens were introduced commercially about 1860, and the output of some mines was roughly sized into "lump," "small" and "slack." Hand labour was gradually replaced by steam power, and other improvements, such as log washers and power jigs, slowly made their appearance. Nevertheless, up to the year 1870, cleaning and sizing machinery was systematically employed only in a few cases in which blast furnace coke was required from dirty coals. Shaking bar screens, sizing trommels, and travelling belts made their appearance about this time. A radical improvement of the jig washer was the next advance. The machine was made continuous in its action by the introduction of devices for the automatic removal of refuse, and the mechanism for imparting motion to the water was improved. Hitherto this motion was derived from a shaft with cams which lifted the plunger and allowed it to fall. In 1871 this device was replaced by the eccentric now so largely employed, with the result that the apparatus worked much more rapidly and economically.

¹ See paper by Jungblodt in 1902, *Coal and Iron Trade Review*—"Screening and Washing at Dortmund."

² The apparatus used in coal washing is described and illustrated later on.

In 1873 the first coal washing plant of modern type was built at the President colliery, in Westphalia. In this plant the coal was discharged upon an inclined screen and the lumps that remained were hand picked. (This screen had holes of 3" in diameter.) The discharge from the screen was sent to a trommel which made three sizes, smalls, nuts, and cobbles. The smalls were used for coke making, and the cobbles were cleaned by hand picking. The nuts were sent to another trommel and separated into three sizes, each of which was washed in a separate machine.

In 1873 a plant of the Berard type was erected in the United States at Broad Top, Pa., and the next year a larger plant was built at Johnstown, Pa. Simple plants had been employed even earlier near Pittsburgh, but although the United States was thus early in the field very little was done for a time and the real development of the process was left to Germany.

The next improvement was Luhrig's feldspar jig for washing fine coals, which made its appearance in 1875. This introduction of a cheap method of treating the fine coal brought with it the problems of how the washed coal could be effectually dried and the residue in the wash water recovered. The solution of these problems was difficult and involved the use of perforated conveyers, hopper shaped settling tanks, and drainage boxes, etc., and the methods arrived at, although still employed with only minor improvement, cannot be said to be altogether successful.

One interesting method of removing the dust from coal, first tried in 1879 at some collieries in Germany, was the use of an air blast or "duster." It was found, however, that the device possessed no special advantage over screens, although it has continued in use until now to a very limited extent.

By the year 1880 all of the essential features of the present methods had been introduced, although since then both the washing appliances and the buildings, screening and driving machinery, etc., have been greatly improved; but in spite of the introduction of the various bumping tables and improved trough washers, the jig in one or another of its many modified types is still the most widely used washing machine of the present day.

The first washing plants in America were probably those already referred to in the Pittsburgh District and were of the old trough washer type used at the same time in England. The first plant of modern type was that already referred to at the furnaces of the Kemble Coal and Iron Company, in the Broad Top coal region of Pennsylvania. This plant followed the lines of the apparatus invented by Berard, exhibited in London in 1851 and in Paris in 1855. All the coal was reduced to a size below half an inch and washed in three jigs without sizing. The capacity of the plant was only 12 tons per hour and the washed coal was used for the production of coke. Although great improvements have since been made in the construction of the jig and in other mechanical devices, the essential features of this plant were very similar to those most commonly employed at present in America, for washing for coke.

According to Sir I. Lowthian Bell,¹ the only apparatus in use in England

¹ See paper by John Fulton in T.A.I.M.E., Vol. III, 1874.

Plate XXXIV.

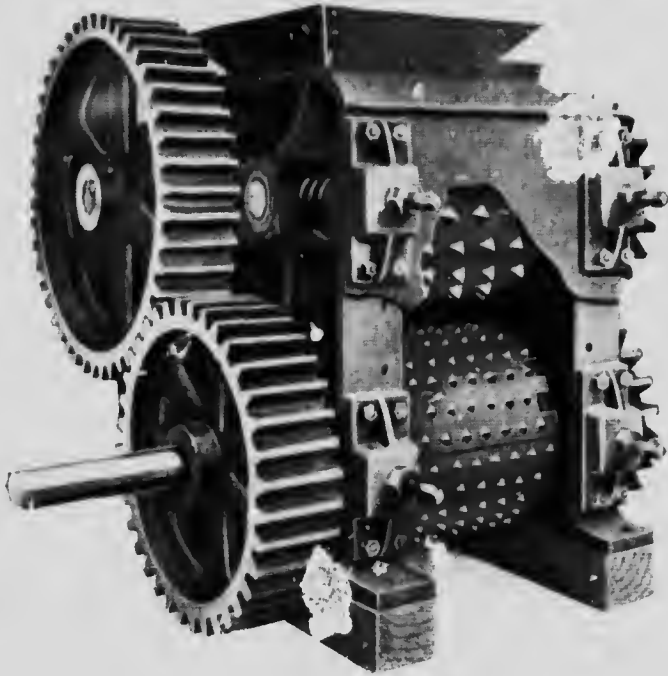
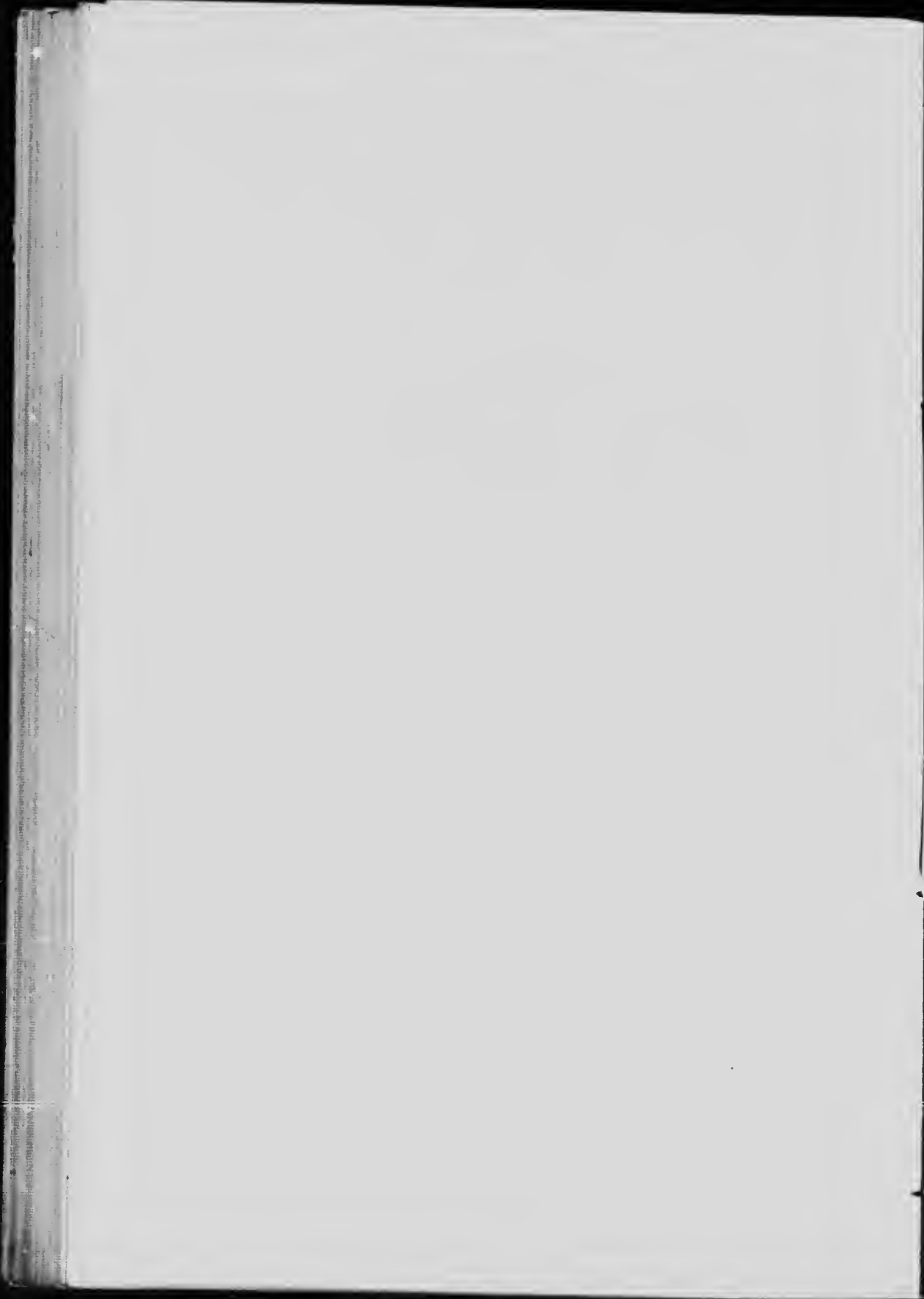


Figure 1. Four roll coal crusher.



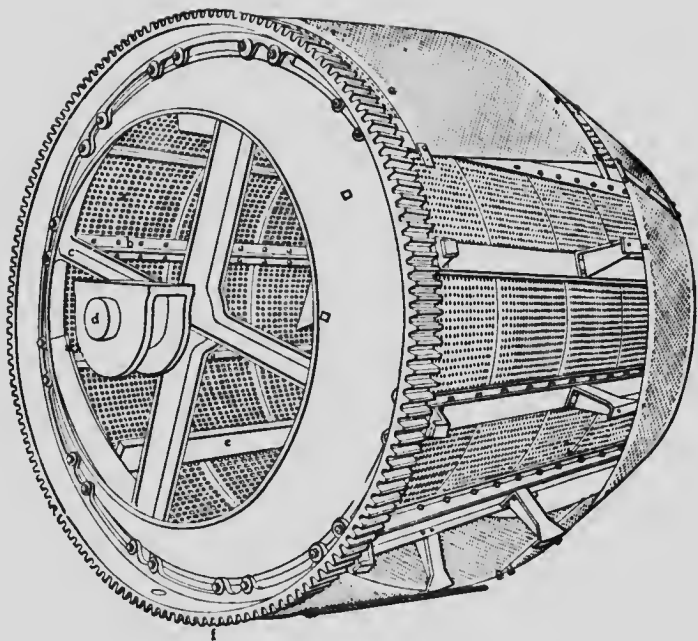
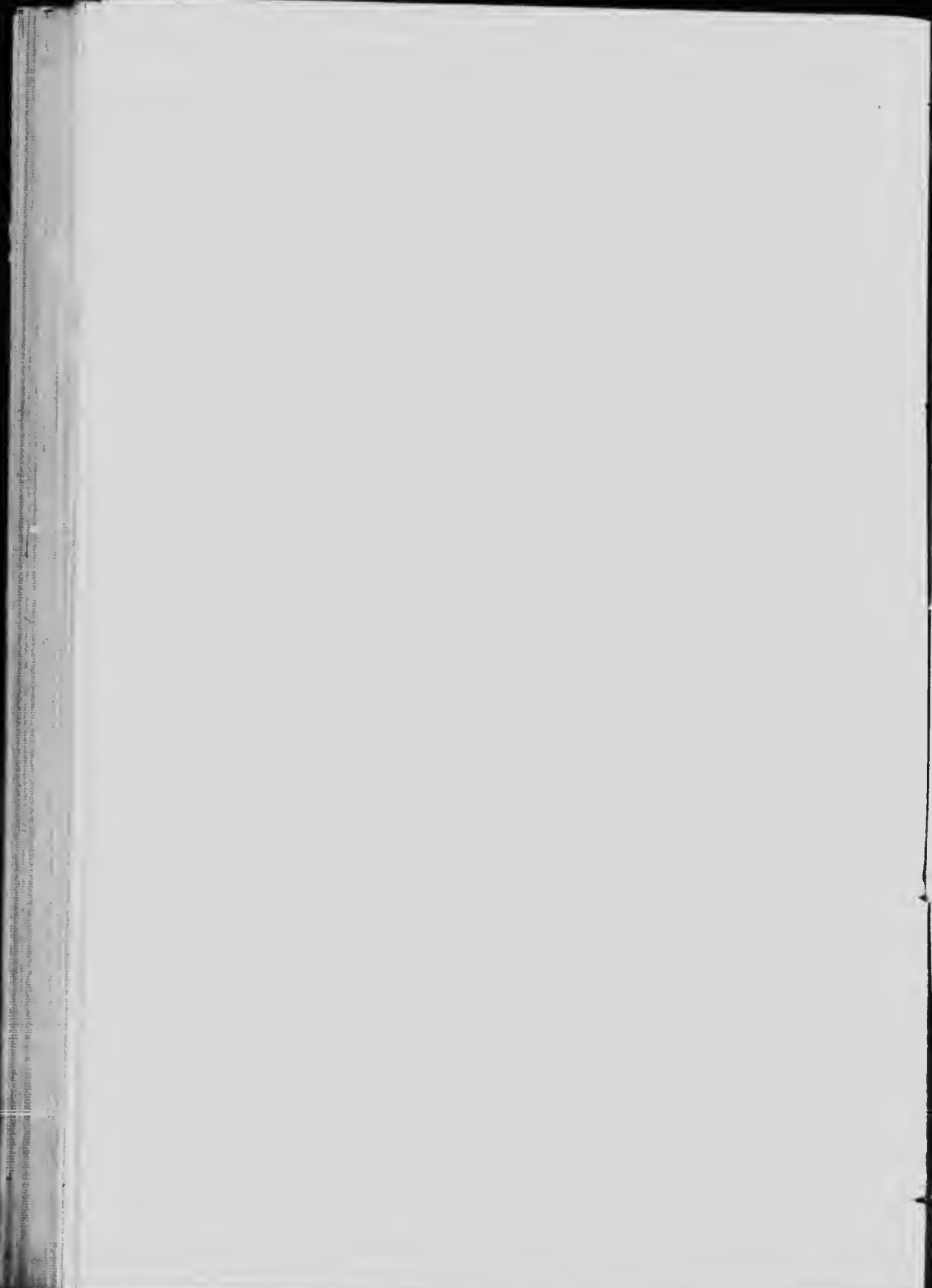


Fig. 2 Bradford coal breaker.



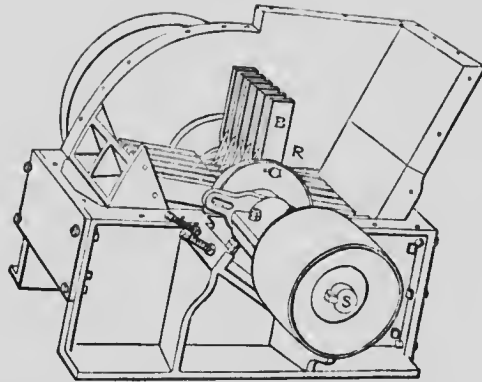


Fig. 3 (a). Swing-hammer pulverizer without cover

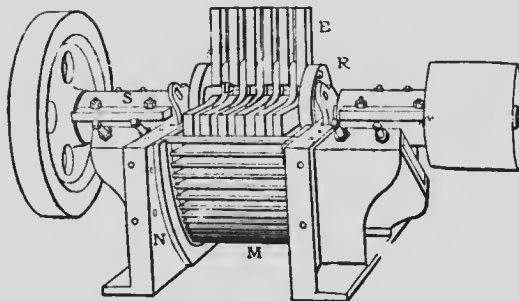


Fig. 3 (b). Swing-hammer pulverizer with housing completely removed.

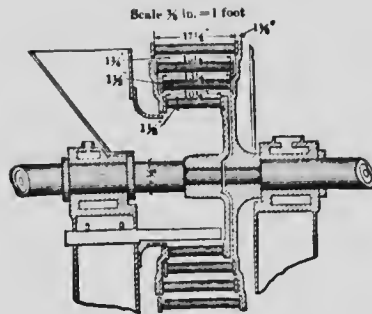


Fig. 4 (a). Sectional elevation of Stedman (Carr) disintegrator.

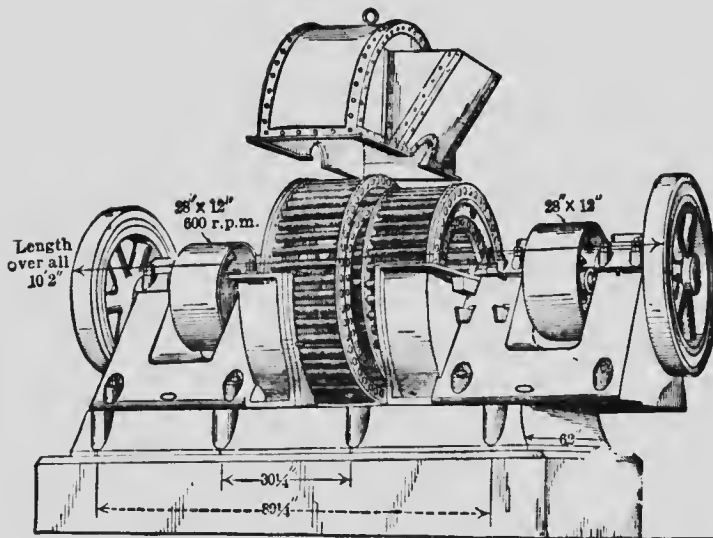


Fig. 4 (b). Perspective of Stedman disintegrator with housing raised and cages pulled apart.



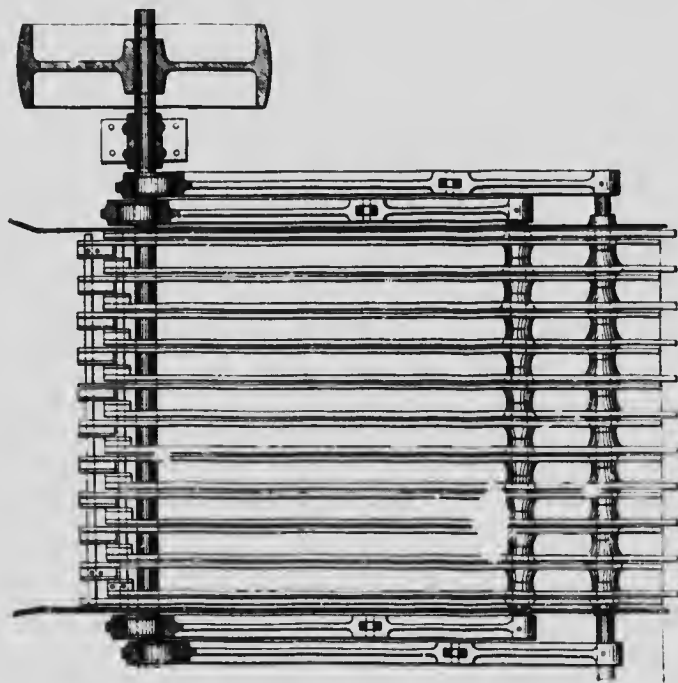
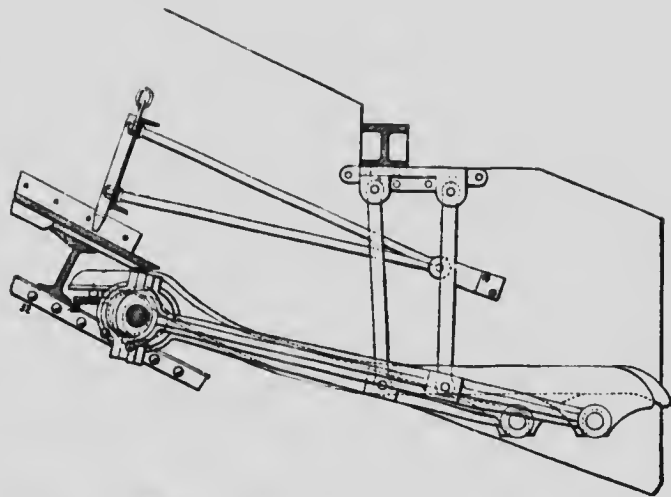


Fig. 5. Elevation and plan of Coxé movable bar screen.



at that time was the simple trough washer. One of the modifications of this washer, namely, the Elliot, is widely used in England and on the Continent at the present time.

PRESENT METHODS OF PREPARING BITUMINOUS COAL

In the following pages an attempt will be made to give a general idea of the various appliances used in modern coal washing operations, without attempting to describe them in detail. The machines may best be grouped under the following heads: crushing machinery; sizing and screening machinery; washing apparatus.

CRUSHING MACHINERY

Where the cleaned coal is to be used for fuel purposes there are generally no crushing arrangements needed, as the lump coal can be sufficiently purified by hand picking¹ and only the screenings require washing. On the other hand, where the coal is to be used for the manufacture of coke, the whole output of the mine is frequently crushed and washed. The larger lumps are usually broken in some type of coarse rolls, either toothed, or corrugated.² One of the more recent machines used for this purpose is, however, the Bradford breaker, which consists of a large revolving horizontal cylinder, the shell of which is made of parallel bars.³ At intervals on the inside of the cylinder are bolted projections or shelves, running lengthwise of the breaker. The coal is fed at the upper end of the cylinder, and is lifted on these projections until it falls off as they approach a vertical position. The good coal being brittle is easily broken and passes out between the bars, while the harder materials such as slate, balls of pyrite, etc., remain unbroken and are rejected at the other end of the machine. Thus there is a marked selective action in this first crushing stage, which in some cases is in itself sufficient to clean the coal. More commonly a further reduction in size is necessary and the broken coal is fed either to fine rolls, disintegrators, or hammer crushers. In some cases the raw coal is fed direct to hammer crushers or to disintegrators, the former being a species of rotating mechanical flail of recent invention,⁴ the latter the well-known cage mill of Brück and Hubner, Carr or Steadman, and consisting of two or more cylindrical steel cages one within the other, revolving with great velocity, each one in the opposite direction to those next it.⁵

In coal washing it is unusual to adjust the apparatus in such a way as to produce any considerable quantity of middle products, but when such are produced and can be successfully treated after a further reduction in size, fine rolls are generally used for this re-crushing.

¹ See Plates xxxi, xxxii, and xxxiii, and Fig. 22.

² See Plate xxxiv.

³ See Fig. 2.

⁴ See Fig. 3.

⁵ See Fig. 4.

SIZING AND SCREENING MACHINERY

Bar screens, revolving screens or trommels, shaking screens and hydraulic classifiers are all extensively used in preparing coal for washing. The general practice is to do coarse screening dry, but in cases in which fine screening is necessary, a spray of water is frequently used to facilitate the operation and to keep the meshes clear. Classifiers or so-called hydraulic sizers were formerly used to a considerable extent for the finer sizes, but in many recent plants they have given place to screens.

It is unnecessary to enter into a critical comparison of the different kinds of screening apparatus used, and it will suffice to say that the best practice inclines to the use of moving bar screens for coarse sizing.¹ In the majority of recent plants the medium sizes are screened on riddles or shaking screens in preference to trommels or revolving screens, although the latter,² often of prismatic section, are still very much used, especially for the finer sizes. Below, say $\frac{1}{4}$ ", coal ceases to be of much value except for coking and for large steam plants with automatic stokers, and, therefore, screening is too costly to be much used; and when such fine material is treated it is usually by hydraulic classifiers such as the Lührig grading boxes, which serve passably well as sizing machines to prepare for subsequent treatment. Usually, however, classification and washing are combined in one operation, as in the Robinson washer, which is very largely used for medium and fine coal.

WASHING APPARATUS

Washing machines may be grouped under four heads:—

- (1) Trough washers.
- (2) Continuous ascending current washers or classifiers.
- (3) Intermittent ascending current washing or jigs.
- (4) Bumping and jerking tables.

Trough Washers

(1). The trough washer is one of the oldest of ore dressing appliances, but the necessity of suspending operations to clean out the riffles is so great an objection that the original form is now seldom used. It consisted of a long, narrow, inclined trough, with riffles at various intervals, and arrangements for stirring the material, either by hand or by mechanical devices. The ore or coal was fed with a stream of water at the upper end and the lighter portion discharged at the lower end, while the heavier particles were caught in the riffles.

The Scaife washer, one of the improved types, possesses, in addition to riffles, a set of scrapers which agitate the refuse.³ It also possesses a second trough, which by means of levers can be brought into operation while the refuse is being dumped from the first. It is thus a continuous machine.

¹ See Plates xxxv and xxxvi, and Fig. 5.

² See Fig. 6, and Plate xxxvii.

³ See Fig. 7.

Plate XXXV.



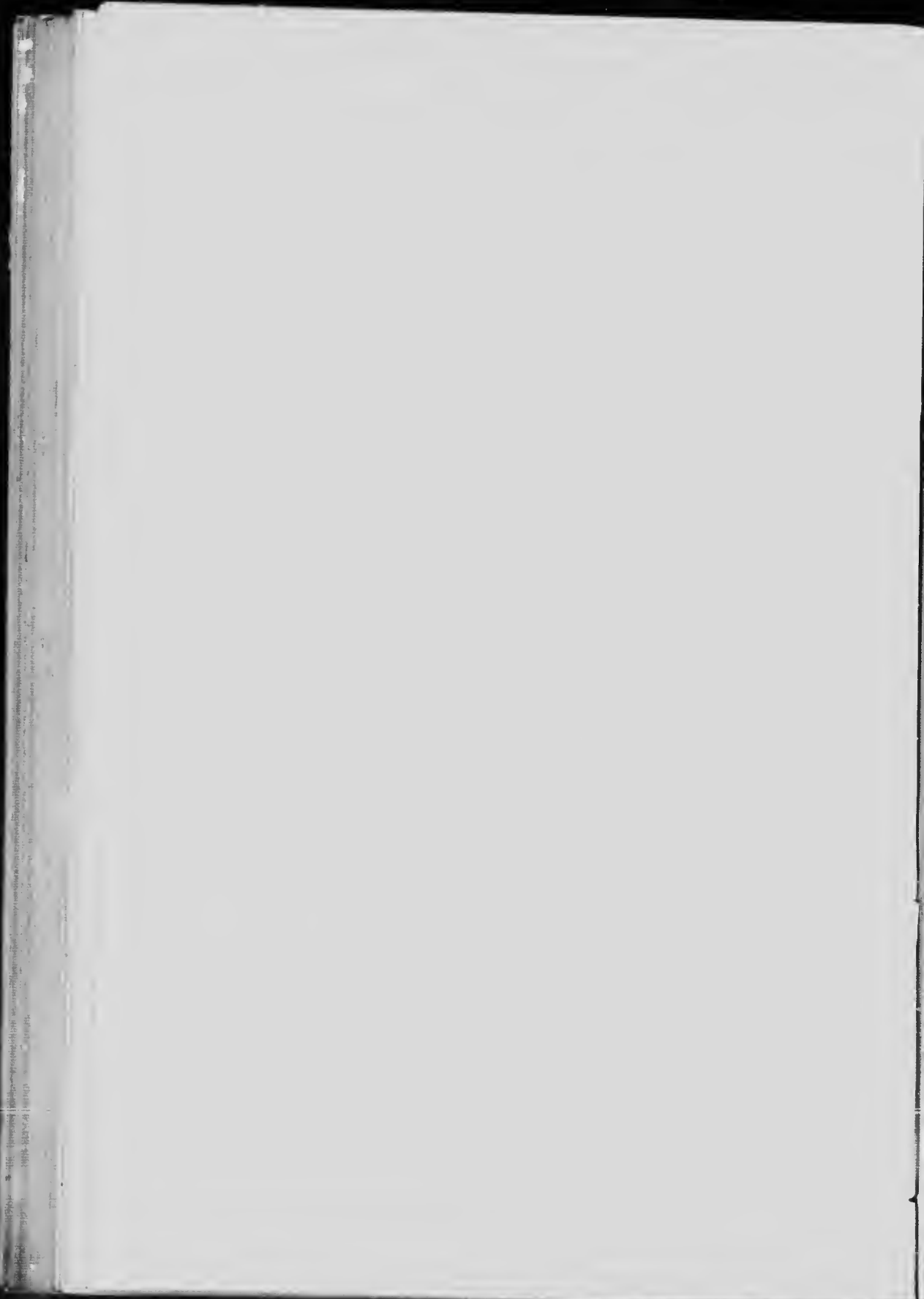
Shaking screens and washers, New Cross Hands colliery, Swansea, Wales.

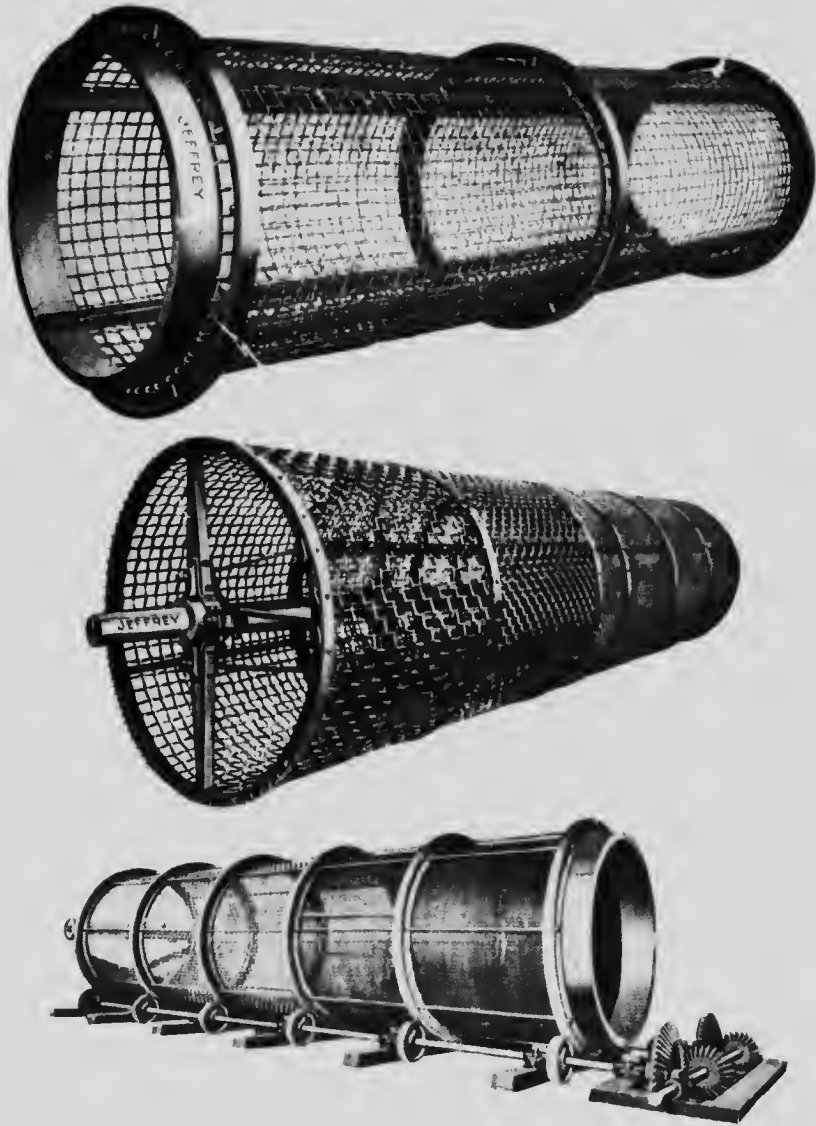


Plate XXXVI.



Front end of belts showing arrangements for elevating and delivery, Clock Face colliery, England





Jeffrey revolving screens.

- (a) Heavy screen for run of mine.
- (b) Screen making three sizes.
- (c) Screen on friction rollers.



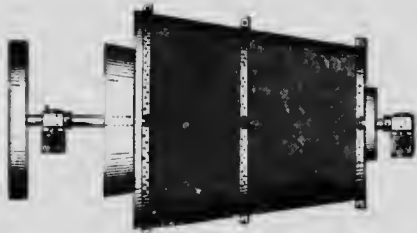


Fig. 6 (a). Concentric conical trommel.



Fig. 6 (b). Concentric cylindrical trommel.

1870
1871
1872
1873
1874
1875
1876
1877
1878
1879
1880
1881
1882
1883
1884
1885
1886
1887
1888
1889
1890
1891
1892
1893
1894
1895
1896
1897
1898
1899
1900
1901
1902
1903
1904
1905
1906
1907
1908
1909
1910
1911
1912
1913
1914
1915
1916
1917
1918
1919
1920
1921
1922
1923
1924
1925
1926
1927
1928
1929
1930
1931
1932
1933
1934
1935
1936
1937
1938
1939
1940
1941
1942
1943
1944
1945
1946
1947
1948
1949
1950
1951
1952
1953
1954
1955
1956
1957
1958
1959
1960
1961
1962
1963
1964
1965
1966
1967
1968
1969
1970
1971
1972
1973
1974
1975
1976
1977
1978
1979
1980
1981
1982
1983
1984
1985
1986
1987
1988
1989
1990
1991
1992
1993
1994
1995
1996
1997
1998
1999
2000
2001
2002
2003
2004
2005
2006
2007
2008
2009
2010
2011
2012
2013
2014
2015
2016
2017
2018
2019
2020
2021
2022
2023
2024
2025

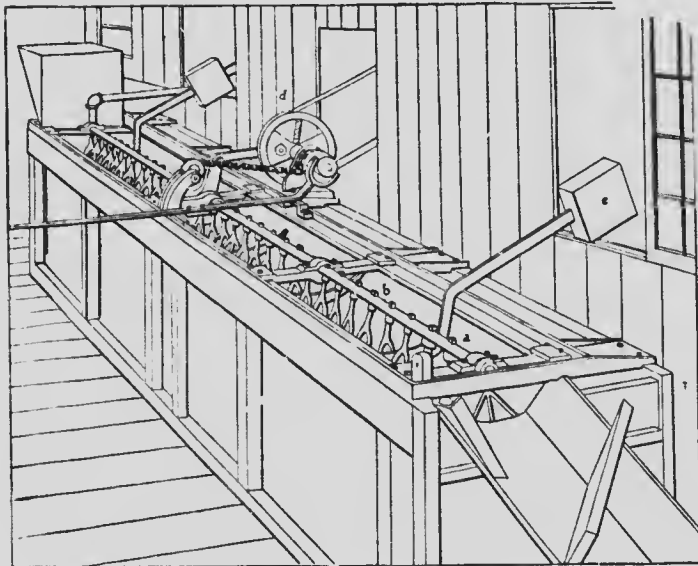
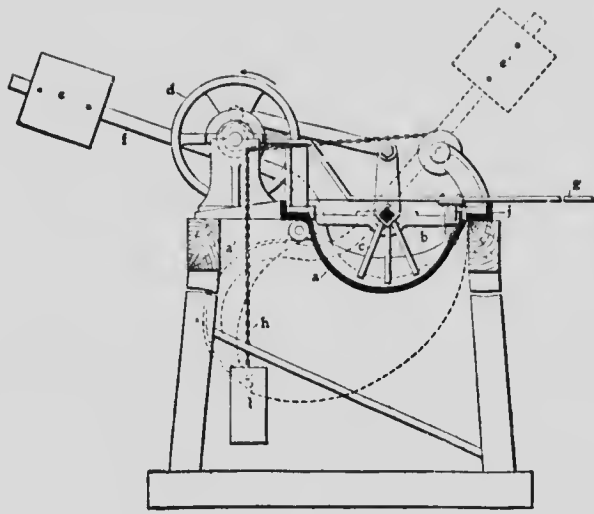


Fig 7. Sectional elevation and perspective of Scaife trough washer.

The Maclellan washer consists of two troughs side by side and between them a smaller trough, slightly lower than the others. The riffles are fixed and a set of scrapers at each riffle delivers the refuse to the central trough, in which a screw conveyer carries it to the upper end of the machine, where it is discharged.

The Elliott washer, which is possibly the best, is extensively used, both in England and on the continent.¹ The riffles in this machine instead of being stationary move up the trough against the descending current and carry the slate and refuse over the top. The whole trough is, in addition, given a slight longitudinal vaning motion.

Continuous Ascending Current Washers, or Classifiers.

(2). The Robinson washer is the most important machine of the continuous ascending current washer type, and is still largely used, although it is a comparatively early form.² It consists of an inverted cone, at the bottom of which a current of water is introduced. Suspended in this cone is a revolving stirrer with winged arms, which causes the water to rotate. The heavy slate and shale sink against the rising current and centrifugal force and are drawn from below at intervals; the washed coal is carried over the top and recovered on finely perforated draining screens. The machine does good and cheap work on medium sizes of coal, but is unsatisfactory with the very fine sizes. It is seldom so clean as a jig in its separation but is usually much less costly to operate.

Intermittent Current Ascending Washers or Jigs.

(3). While there are many different types of jigs employed in coal washing, they differ from ore dressing jigs only in the details of construction. In all of them the coal is fed to a sieve immersed in water. In the earlier forms the sieve is rapidly lowered and raised; in the more recent designs the sieve is fixed and the water is given a rapid pulsating movement. In both the effect is to lift both coal and refuse during the first half of each period and to let them settle, or even suck them back to the sieve in the second half. The coal being much lighter than the refuse rises more rapidly and descends less readily, and as the pulsations are very frequent the whole mass of material is quickly stratified, the heaviest and largest lumps of refuse resting on the screen, the intermediate and smaller material above it and the coal on top. Fresh material is continuously fed at one end with an ample supply of water and as soon as the jig is filled clean coal begins to overflow with the surplus water at the other end and can be recovered, drained, and stored. The slate and bone coal accumulate on the sieve to whatever depth is found most effective, say 2" to 4", and then further accumulations are drawn off as fast as they collect by siphon discharges or other automatic devices.

¹ See Fig. 8.

² See Figs. 9 and 10.

There are two main types of jigs, viz.:—

- (a) Piston jigs.
- (b) Plunger, or movable screen jigs.

The piston jig consists essentially of a hopper bottomed box filled with water and divided at the top by a longitudinal partition.¹ About 10" below the top on one side is a fixed screen, while in the other is a plunger which is moved up and down by suitable mechanism, thus forcing the water up through the screen on the down stroke and sucking it back on the up stroke. The coal is fed at one end of the screen compartment and the pulsations cause the material to stratify more or less completely, as already explained, as it moves from one end to the other. The coal being lighter rises to the top and overflows at the end of the jig, and the heavier impurities are drawn off by some suitable arrangement at the screen level. A certain proportion of fine coal and impurity, termed "hutch," finds its way through the screen and collects in the V shaped bottom of the box. A continuous flow of water is introduced with the coal at the feeding end, and, in some cases, provision is also made for the introduction of water below the screen. The first named water supply is often termed "over water," and tends to neutralize somewhat the force due to the down stroke of the plunger, while the second, or "under water", increases the force due to the down stroke and decreases that due to the suction or up stroke.

The manner in which the refuse is removed from the bottom of the screen varies with the type of jig employed, sometimes the discharge is made continuous, sometimes it is regulated by a hand-controlled gate. The hutch is removed in the same way, or by means of a screw conveyor.

The apparatus above described comprises a one compartment jig and suffices for washing coarse material in all ordinary cases. When the impurities are difficult to separate, or when fine coal has to be jigged, it is usually found necessary to place two more jigs in series, or in ordinary practice to build them together as two or three compartment machines. The action is precisely the same as in a one compartment jig except that the coal, as it overflows from the first compartment, goes to the second and is further cleansed, and so on.

The essential point of difference, however, in the various types of jigs, is that of the plunger mechanism. With many coals, especially when the sizing is not close, the effect of the suction stroke is advantageous, as it aids in the removal of the smaller pieces of refuse by sucking them down the interstices between the larger pieces. Strong suction, is, however, usually a disadvantage where the material as sent to the jig has been sized between close limits. The effect of the suction stroke can be lessened by the use of "slow return" mechanisms instead of simple eccentrics. Of these probably the best known are the slide and cam mechanisms shown in Fig 13 of the experimental jig at McGill. Both give a rapid down stroke followed by a slow return stroke. The same effect is produced by means of double eccentric

¹See Figs. 11, 12, and 13.

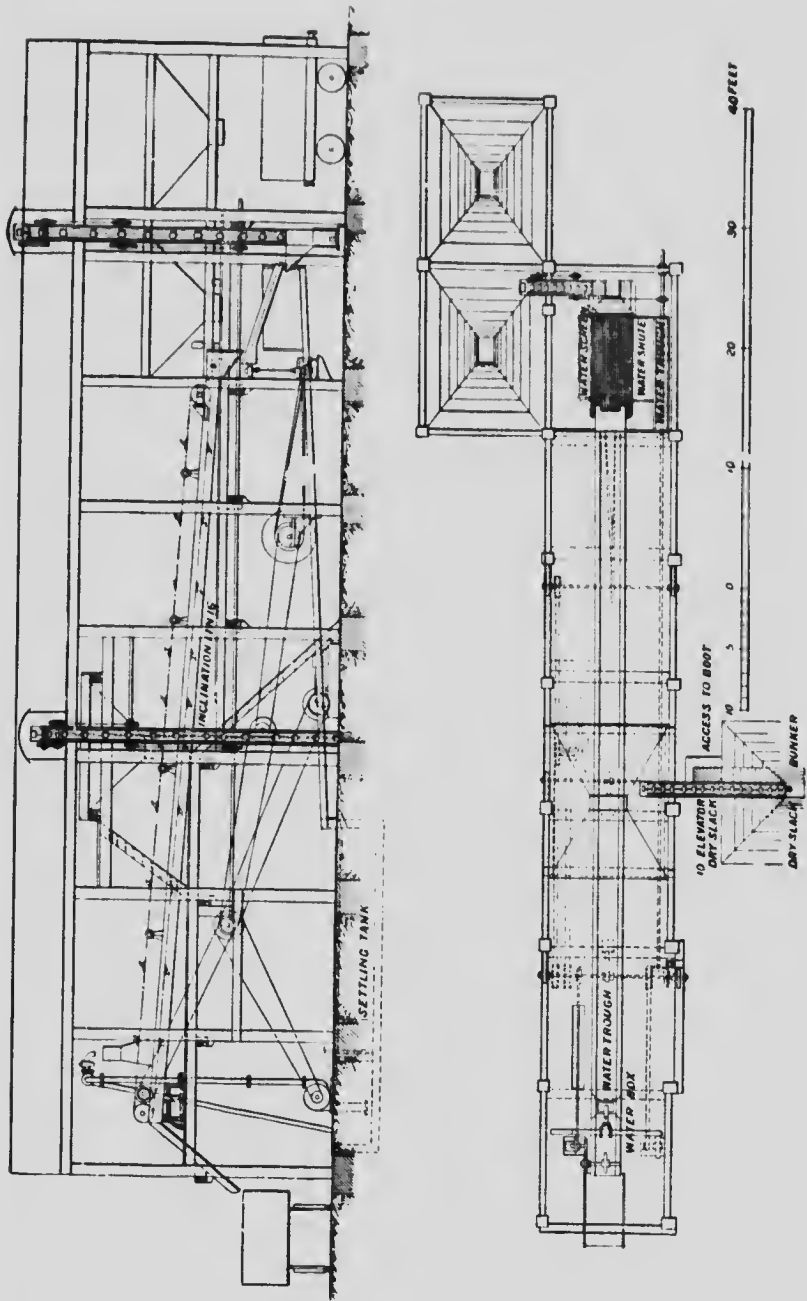
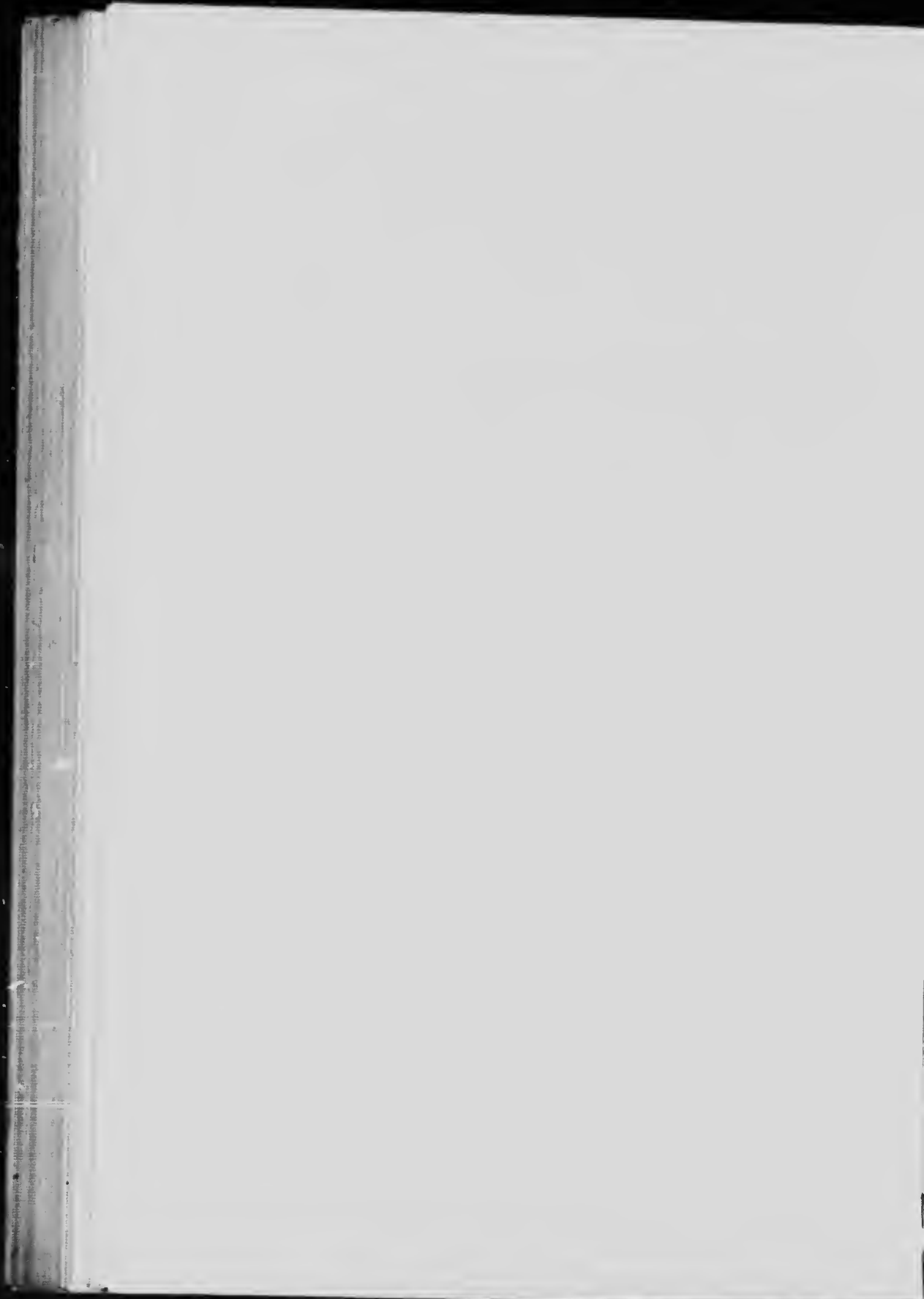


Fig. 8. Elevation and plan of Elliott washer.



1870
1871
1872
1873
1874
1875
1876
1877
1878
1879
1880
1881
1882
1883
1884
1885
1886
1887
1888
1889
1890
1891
1892
1893
1894
1895
1896
1897
1898
1899
1900
1901
1902
1903
1904
1905
1906
1907
1908
1909
1910
1911
1912
1913
1914
1915
1916
1917
1918
1919
1920
1921
1922
1923
1924
1925
1926
1927
1928
1929
1930
1931
1932
1933
1934
1935
1936
1937
1938
1939
1940
1941
1942
1943
1944
1945
1946
1947
1948
1949
1950
1951
1952
1953
1954
1955
1956
1957
1958
1959
1960
1961
1962
1963
1964
1965
1966
1967
1968
1969
1970
1971
1972
1973
1974
1975
1976
1977
1978
1979
1980
1981
1982
1983
1984
1985
1986
1987
1988
1989
1990
1991
1992
1993
1994
1995
1996
1997
1998
1999
2000
2001
2002
2003
2004
2005
2006
2007
2008
2009
2010
2011
2012
2013
2014
2015
2016
2017
2018
2019
2020
2021
2022
2023
2024
2025

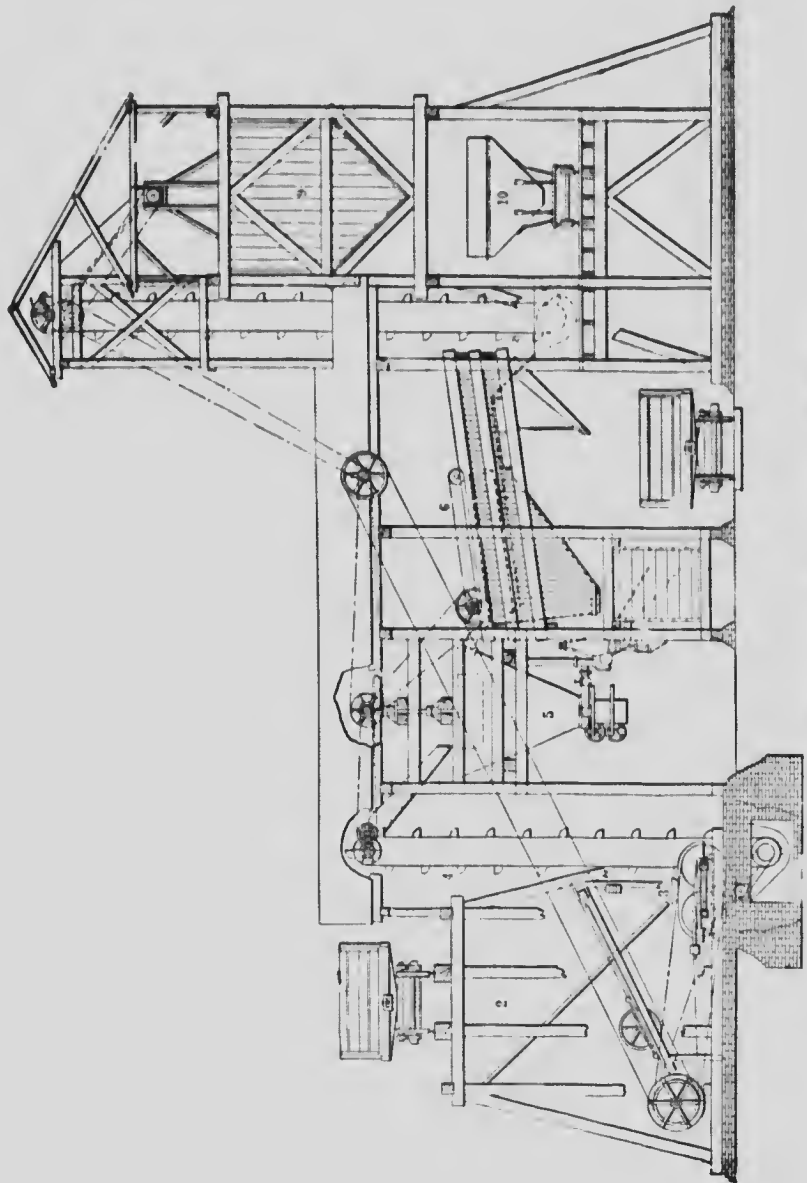
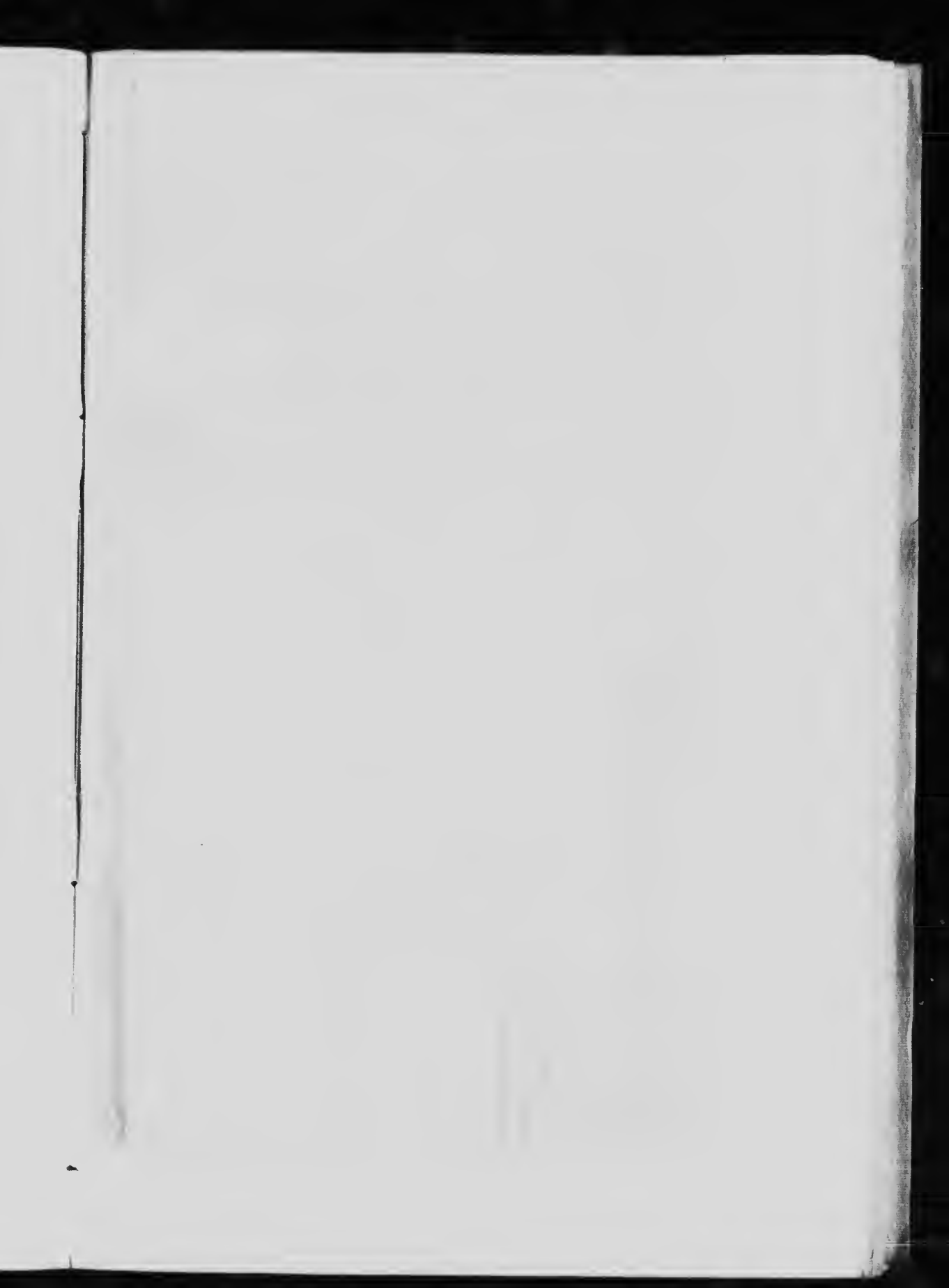
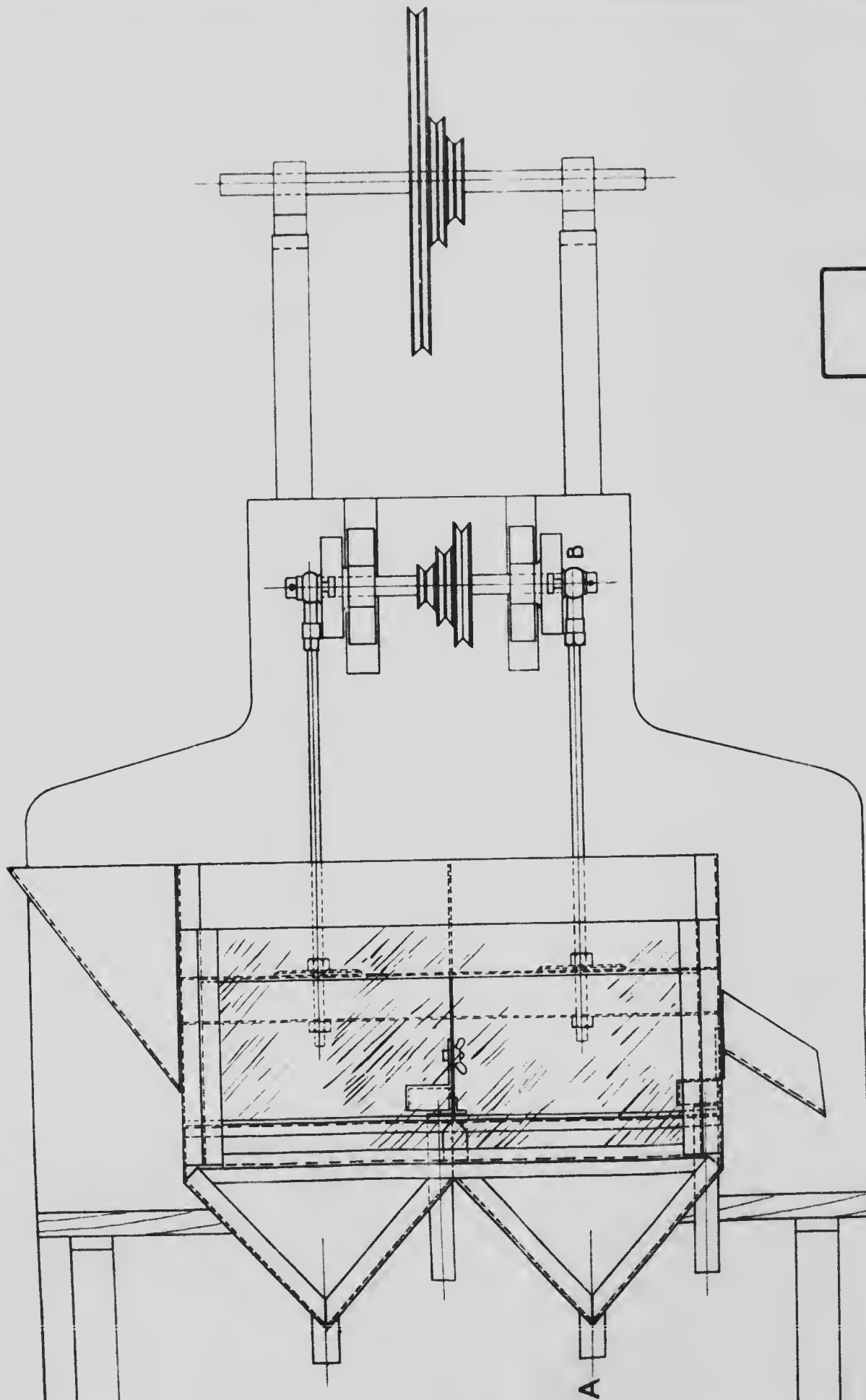


Fig. 10. Sectional elevation of Jeffrey-Robinson washing machine.

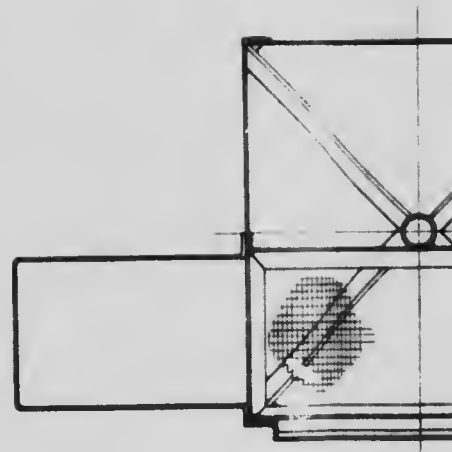


Faint, illegible text visible along the left edge of the page, possibly bleed-through from the reverse side.

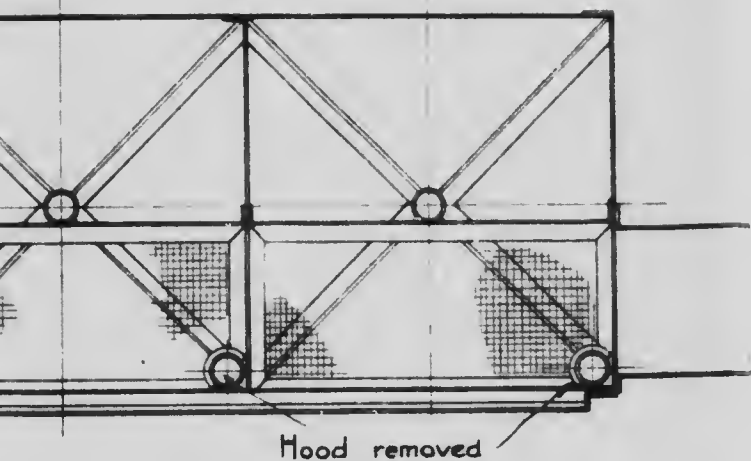




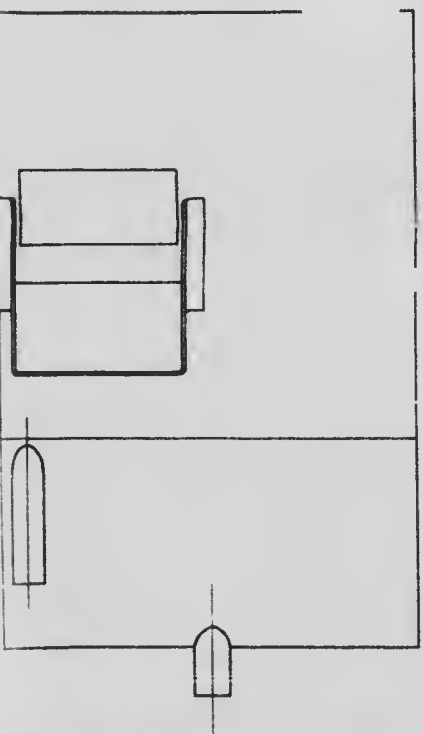
— Front Elevation —



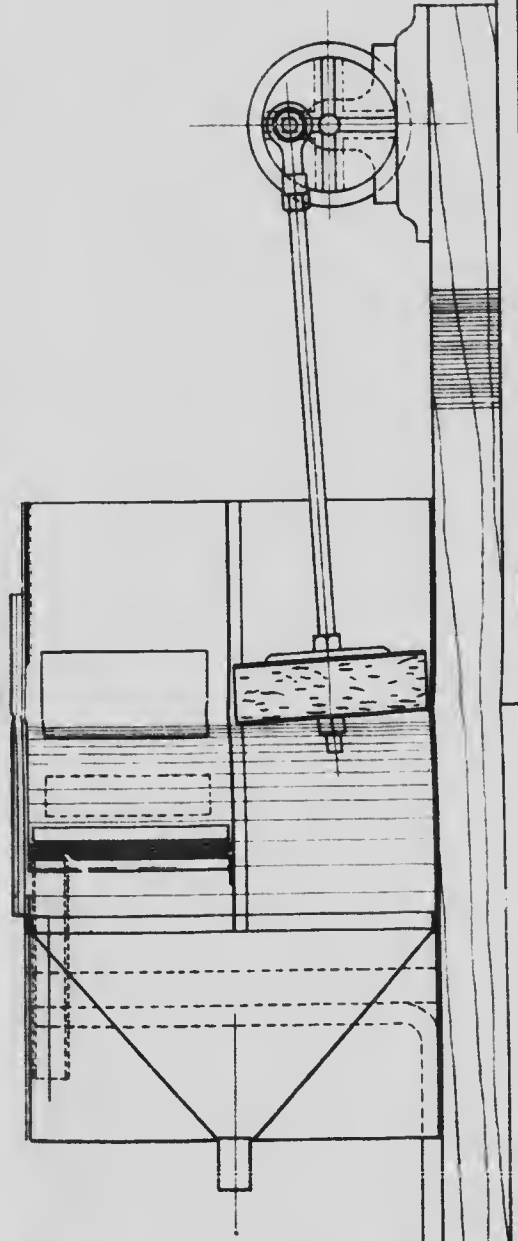
— Side Elevation —



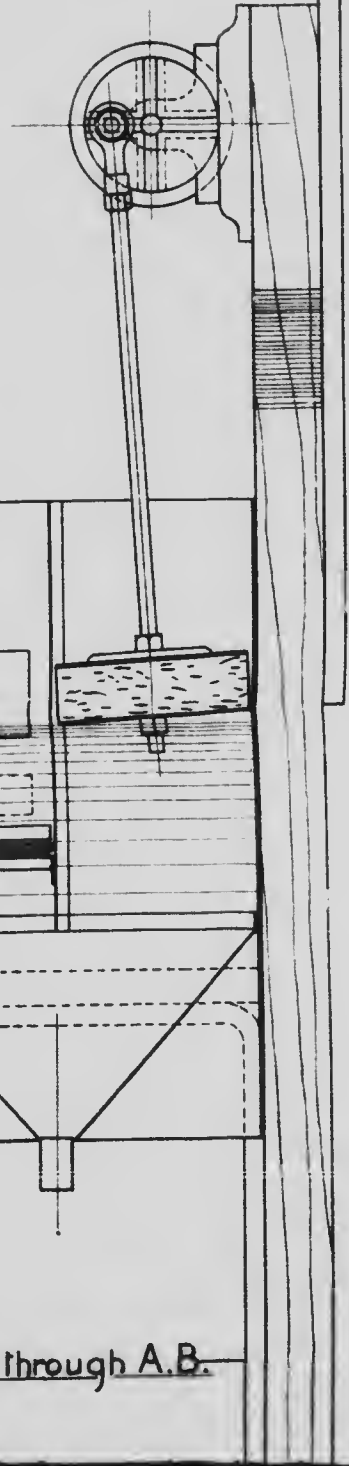
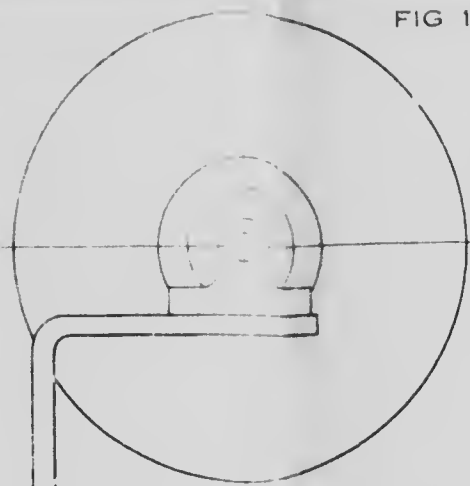
— Plan of Jig Box. —

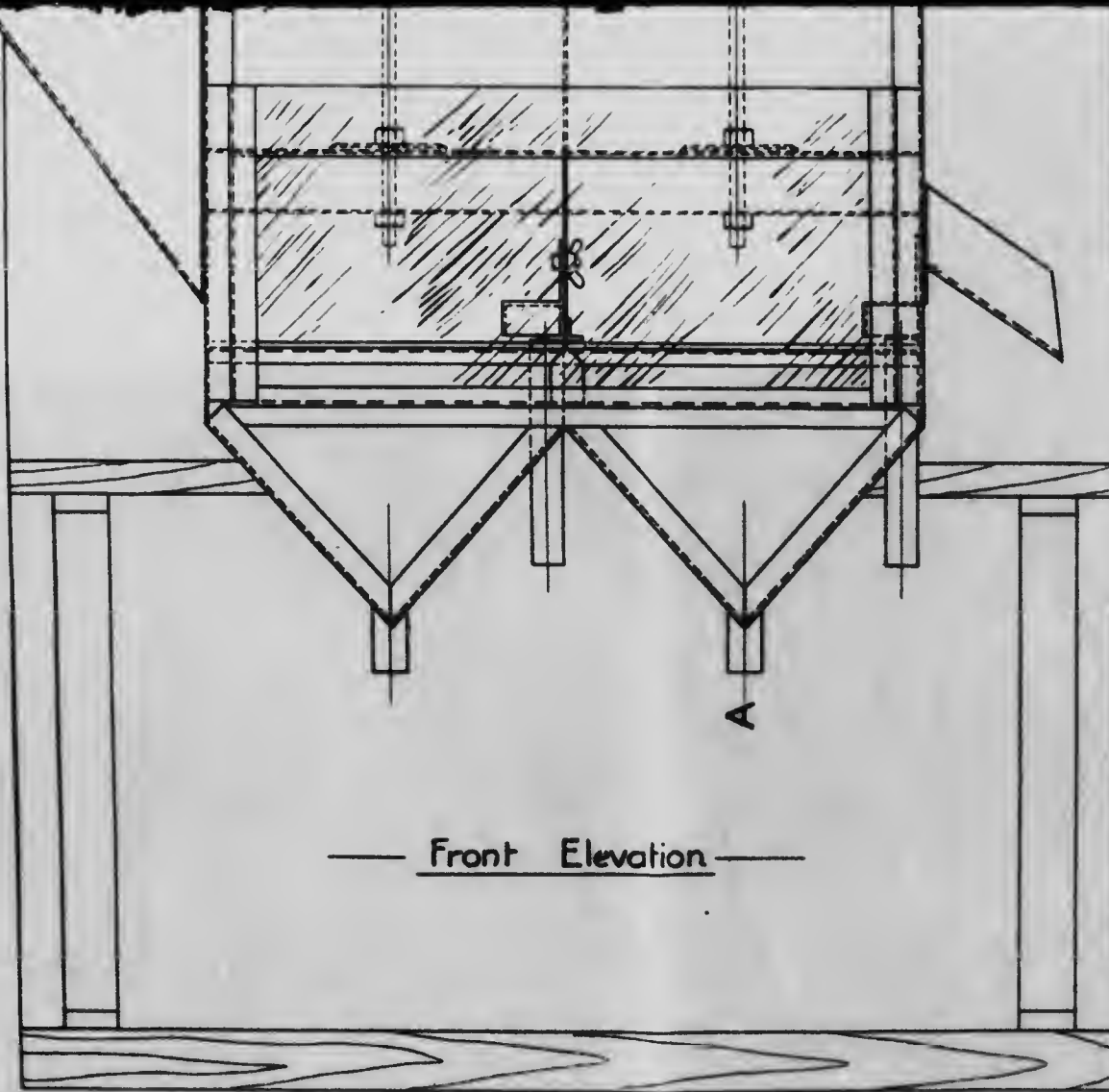


— Side Elevation of Jig Box. —
— Discharge End —



— Section through A.B. —





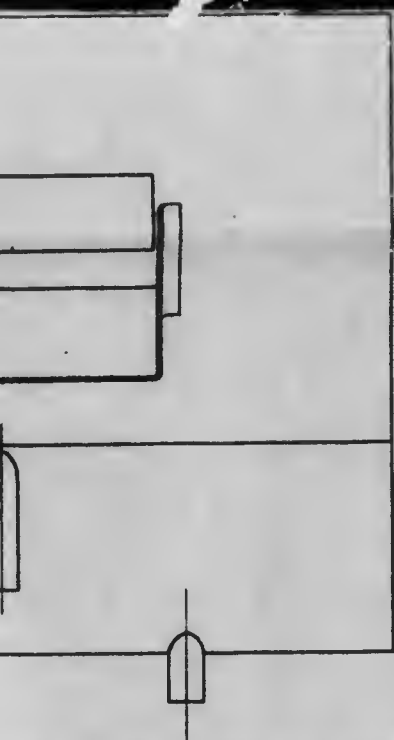
— Side Elevation —
 — D —

2 1 Scale

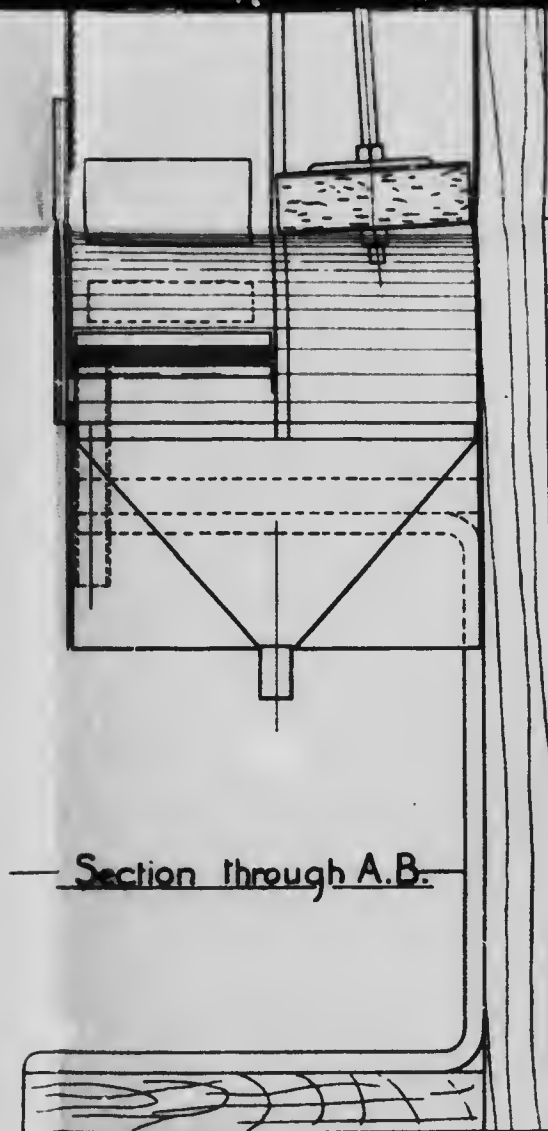
— EXPERIMENTAL TWO —

— MINING I —

— M^cGILL UNIVER —



Side Elevation of Jig Box.—
— Discharge End —



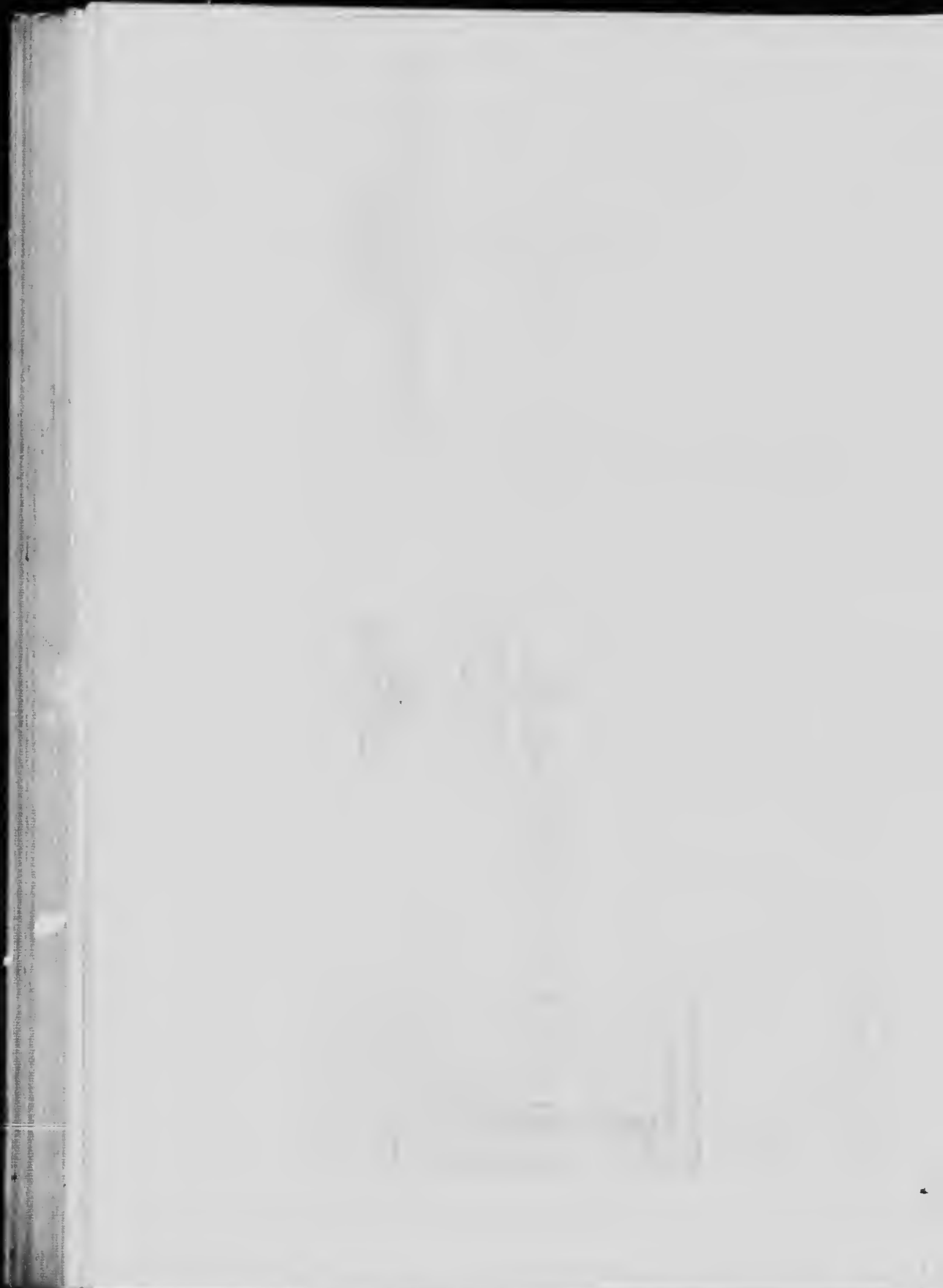
— Section through A.B. —

Scale, in Feet.

0

1

TWO COMPARTMENT JIG. —
ING DEPARTMENT, —
IVERSITY — MONTREAL. —



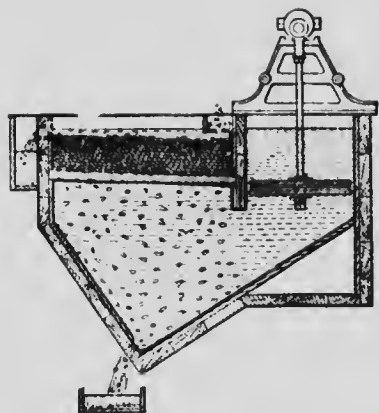


Fig. 12 (a). Vertical section Luhrig nut-coal jig.

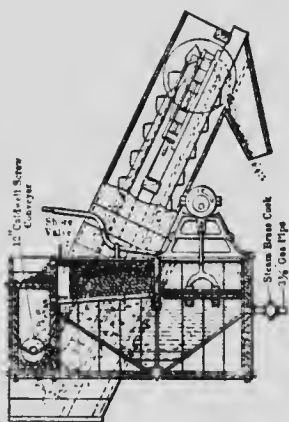
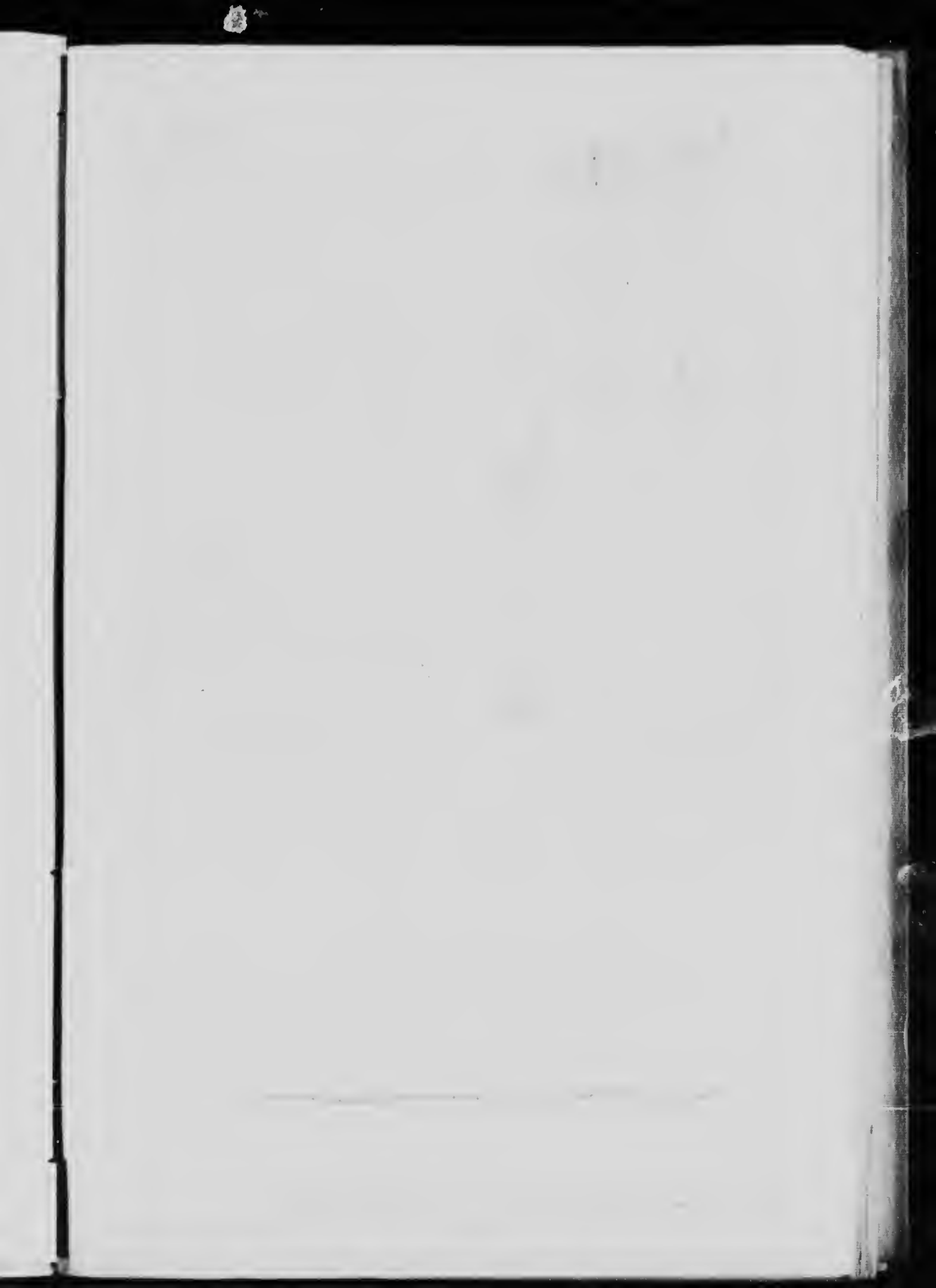
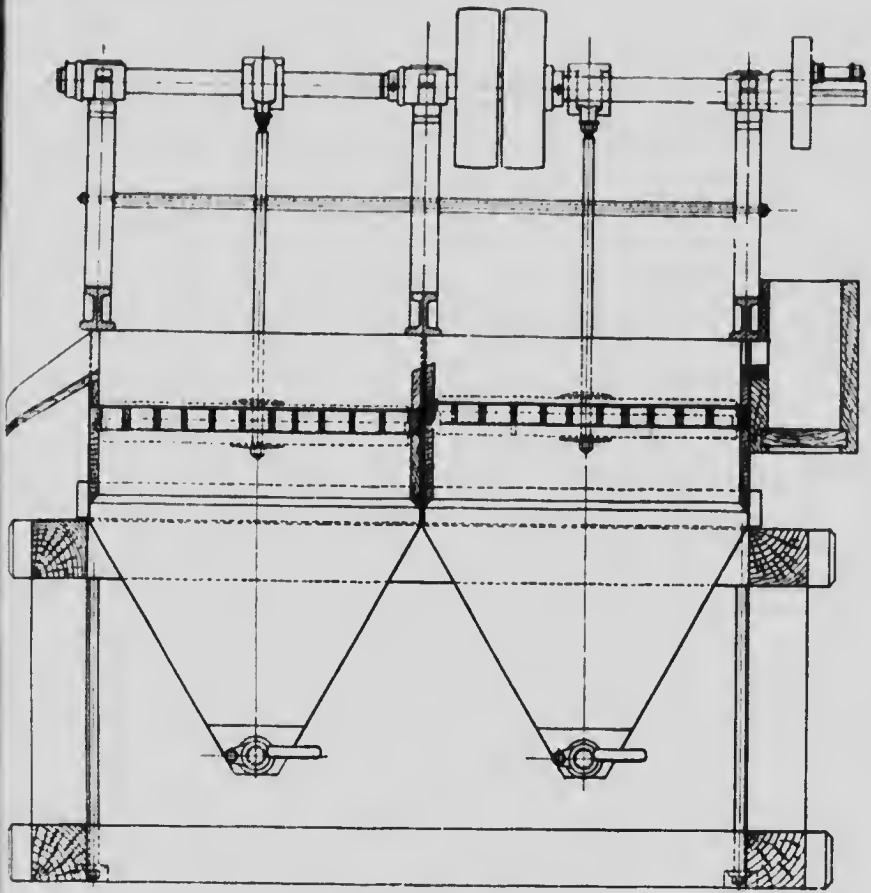


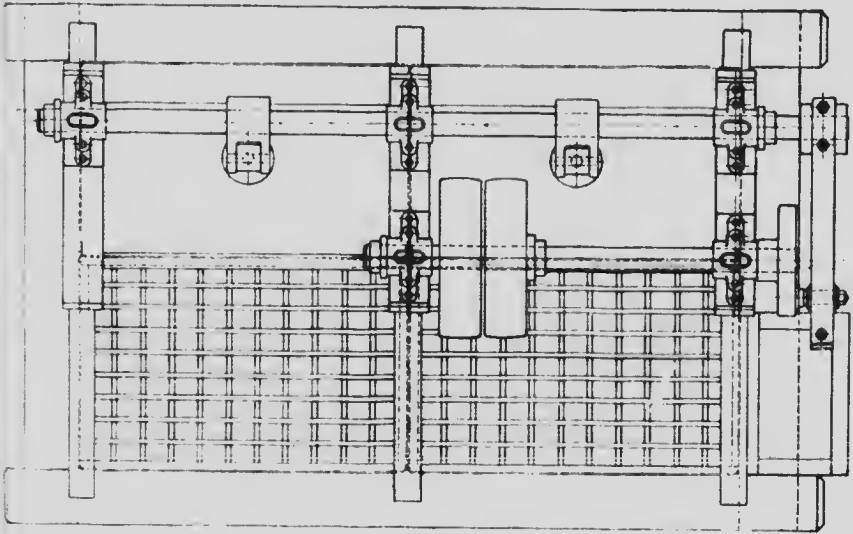
Fig. 12 (b). Vertical section Luhrig small coal jig with feldspar bed.

1870
1871
1872
1873
1874
1875
1876
1877
1878
1879
1880
1881
1882
1883
1884
1885
1886
1887
1888
1889
1890
1891
1892
1893
1894
1895
1896
1897
1898
1899
1900
1901
1902
1903
1904
1905
1906
1907
1908
1909
1910
1911
1912
1913
1914
1915
1916
1917
1918
1919
1920
1921
1922
1923
1924
1925
1926
1927
1928
1929
1930
1931
1932
1933
1934
1935
1936
1937
1938
1939
1940
1941
1942
1943
1944
1945
1946
1947
1948
1949
1950
1951
1952
1953
1954
1955
1956
1957
1958
1959
1960
1961
1962
1963
1964
1965
1966
1967
1968
1969
1970
1971
1972
1973
1974
1975
1976
1977
1978
1979
1980
1981
1982
1983
1984
1985
1986
1987
1988
1989
1990
1991
1992
1993
1994
1995
1996
1997
1998
1999
2000
2001
2002
2003
2004
2005
2006
2007
2008
2009
2010
2011
2012
2013
2014
2015
2016
2017
2018
2019
2020
2021
2022
2023
2024
2025



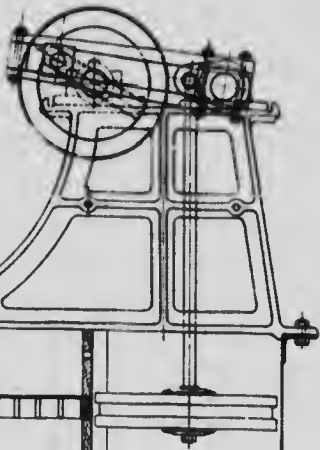


— Slide Driven Jig —
— Longitudinal Sectional Elevation —

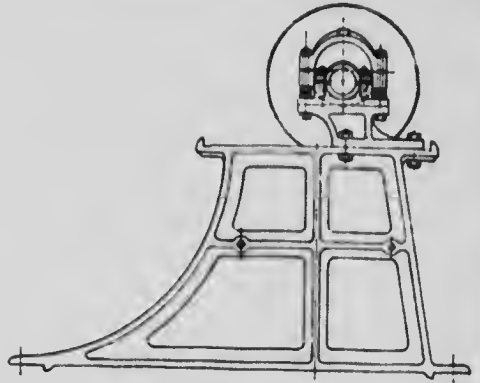


— Slide Driven Jig —
— Plan —

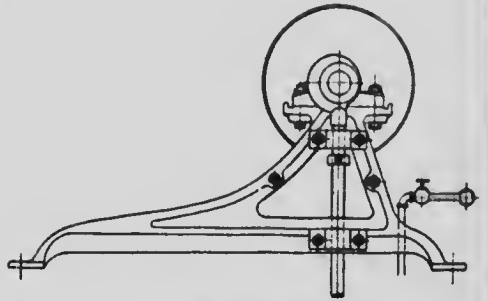
Fig. 13. Large experimental two compartment jig, with three interchangeable piston r



— Slide Driven Jig.
— Cross Section.



— Eccentric Driven Jig.
— End Elevation.



— Cam Driven Jig.
— End Elevation.



1870
1871
1872
1873
1874
1875
1876
1877
1878
1879
1880
1881
1882
1883
1884
1885
1886
1887
1888
1889
1890
1891
1892
1893
1894
1895
1896
1897
1898
1899
1900
1901
1902
1903
1904
1905
1906
1907
1908
1909
1910
1911
1912
1913
1914
1915
1916
1917
1918
1919
1920
1921
1922
1923
1924
1925
1926
1927
1928
1929
1930
1931
1932
1933
1934
1935
1936
1937
1938
1939
1940
1941
1942
1943
1944
1945
1946
1947
1948
1949
1950
1951
1952
1953
1954
1955
1956
1957
1958
1959
1960
1961
1962
1963
1964
1965
1966
1967
1968
1969
1970
1971
1972
1973
1974
1975
1976
1977
1978
1979
1980
1981
1982
1983
1984
1985
1986
1987
1988
1989
1990
1991
1992
1993
1994
1995
1996
1997
1998
1999
2000
2001
2002
2003
2004
2005
2006
2007
2008
2009
2010
2011
2012
2013
2014
2015
2016
2017
2018
2019
2020
2021
2022
2023
2024
2025

gears and by many other means. In some cases the plunger is fitted with valves which open on the return stroke, thus reducing the suction to any desired extent. The plunger motion of the New Century differential motion jig (Fig. 14) is produced by a cam acting against a roller which lifts the plunger and at the same time compresses a spring against a fixed beam. When the high point of the cam passes the roller, the spring immediately forces the plunger downwards with a quick stroke which is easily adjusted. The plunger itself is surrounded by a rubber flap which opens on the ascending stroke and closes on the descending, thus doing away almost entirely with suction effects.¹ Another well known type is the Diescher jig, which differs from the others mainly in that the plunger is directly below the screen. One of the most successful of modern coal jigs is the Baum.² It differs from the ordinary jig in that the pulsation of the water is produced by means of compressed air. An air-tight compartment takes the place of the ordinary plunger and compressed air is introduced by means of slide valves regulated by eccentrics. A very elastic, easily regulated stroke can thus be obtained.

The constant motion of the particles in the screen compartment results in the formation of a large amount of fine coal by attrition. This stuff would work down through the screen but for the layer of refuse on the screen bottom, which, being in constant motion, acts almost as a fluid and floats the fine coal, thus preventing it from reaching the sieve, which it is fine enough to pass through. In order to get this effect the bed of refuse must be fairly thick, and coarse enough not to go through itself, except as it grinds away and is replenished. This layer of refuse is termed the bed, and is absolutely essential to the successful working of the machine. In the treatment of fine coal it is almost impossible to form a really satisfactory bed from refuse alone, as it cakes and compacts. To overcome this difficulty it is customary to use a false bed of feldspar uniformly sized. The screen mesh is in this case sufficiently large to allow the largest particle of impurity in the fine coal to pass through, but not large enough to permit the passage of the feldspar. The refuse works its way through the interstices of the feldspar and through the screen into the hutch box, but the fine coal being lighter is floated off as already explained. This artificial bed may be used with advantage on many kinds of jigs, but perhaps is more freely used by Lührig at present than by other makers.³

The characteristic feature of the movable screen type of jigs, of which the Stewart is a good modern example, consists of a basket or box with a screen bottom hung in a tank of water from eccentric-driven suspension rods which impart to it an upward and downward movement and at the same time give it a slight end swing. The water is thus forced back and forth through the screen bottom, lifting the lighter coal and allowing it to be

¹Another jig, the Sheppard, which combines this effect with a sloping bed, is illustrated in Fig. 15.

²For descriptions of a number of different types of jigs see Fulton's "Treatise on Coke", and Richards' Text Book of Ore Dressing.

³See Fig. 12b.

carried away by a stream of water over the end of the box, while the heavier refuse settles on the screen plate from which it works forward and out into the refuse tank through a valve. A quick down stroke with slow return may be obtained as in the ordinary jig, by the use of the slide or cam. While this jig is used in The Stewart system of coal washing for the treatment of unsized material, coarse and fine, mixed, it seems especially effective for the washing of coarse sized coal. It possesses an enormous capacity in the sizes to which it is generally built. The Pittsburgh jig (Fig. 16) is of this type.

Bumping Tables

The most well known washer in this class is the Campbell. This machine consists of a long shallow box so suspended by two sets of iron rods that it can oscillate longitudinally in the direction of its long axis. The whole machine is slightly inclined towards the discharge end to cause the water and coal to flow in that direction. The surface of the table is covered with a series of transverse toothed riffles, set about 3" apart. At the upper end of a few of the washed coal end of the table, there are a number of slots leading through to a double bottom. The table receives its motion from a special cam and lever arrangement which gives it a quick return motion and causes it to strike sharply against a bumping post, the centre of which is near the middle of the table, and wash water is run on at the head. The effect of the bump is to cause the heavy impurities to travel against the current of water to and over the upper end. The washed coal is carried by the water over the lower end, while the fine impurities are caught by the riffles and settled through the slots at the bottom into the refuse box. This table is much used in North America.²

Another table washer of some importance is the Craig, which has received some recognition in England. It essentially consists of a Y-shaped table, carried on a four-wheeled bogie. The whole machine is driven against a bumping post in much the same way as the Campbell table. It is not by any means, however, as widely used as the latter.³

WASHING PLANTS IN GENERAL.

The chief points to be considered in washing are:—

- (1). To obtain the largest practicable proportion of clean and fairly dry coal without undue waste of fuel in the refuse.
- (2). To crush the coal as little as practicable and, whenever practicable, to save even such fine coal as is necessarily made.
- (3). To wash the coal in such a way that it can be easily and cheaply recovered, drained, and stored for use or shipment.

¹ See Fig. 17.

² For fuller descriptions of the Campbell table see *Can. Min. Jour.*, May 13, 1907, a paper by A. P. Scott. Also *Eng. and Min. Journal*, 1903, Vol. 1, p. 708.

³ The Wilby table shown in Fig. 18 is not used in coal washing but it is included in the series of cuts for reasons which will be explained later.

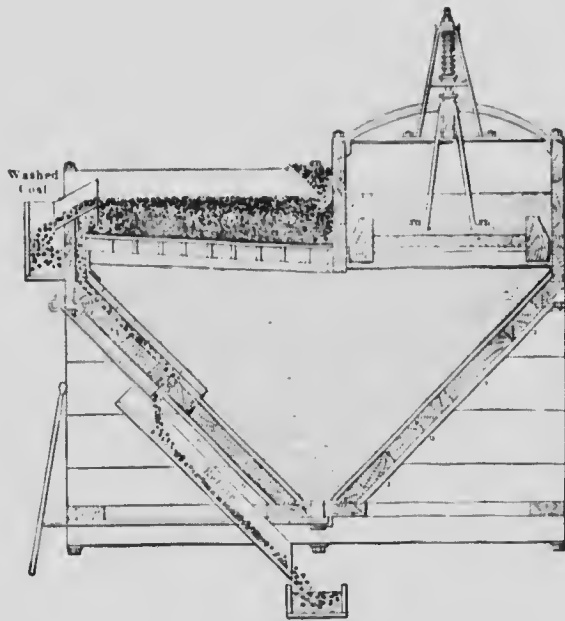


Fig. 14. Vertical section New Century nut-coal jig



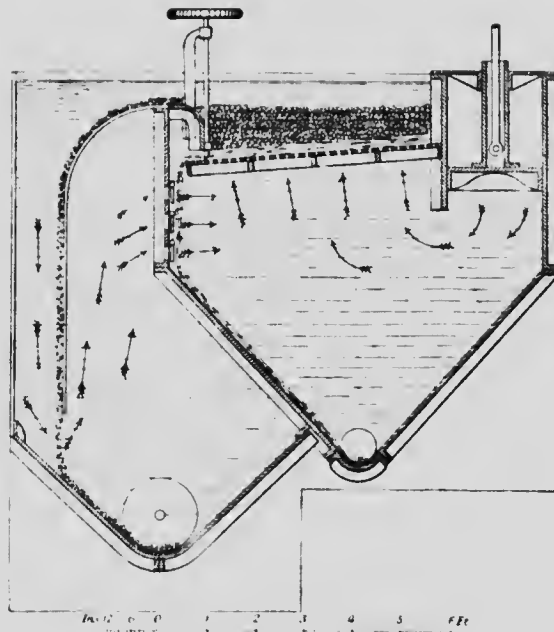


Fig. 15 Vertical section Sheppard nut-coal jig.

1871
1872
1873
1874
1875
1876
1877
1878
1879
1880
1881
1882
1883
1884
1885
1886
1887
1888
1889
1890
1891
1892
1893
1894
1895
1896
1897
1898
1899
1900
1901
1902
1903
1904
1905
1906
1907
1908
1909
1910
1911
1912
1913
1914
1915
1916
1917
1918
1919
1920
1921
1922
1923
1924
1925
1926
1927
1928
1929
1930
1931
1932
1933
1934
1935
1936
1937
1938
1939
1940
1941
1942
1943
1944
1945
1946
1947
1948
1949
1950
1951
1952
1953
1954
1955
1956
1957
1958
1959
1960
1961
1962
1963
1964
1965
1966
1967
1968
1969
1970
1971
1972
1973
1974
1975
1976
1977
1978
1979
1980
1981
1982
1983
1984
1985
1986
1987
1988
1989
1990
1991
1992
1993
1994
1995
1996
1997
1998
1999
2000
2001
2002
2003
2004
2005
2006
2007
2008
2009
2010
2011
2012
2013
2014
2015
2016
2017
2018
2019
2020
2021
2022
2023
2024
2025

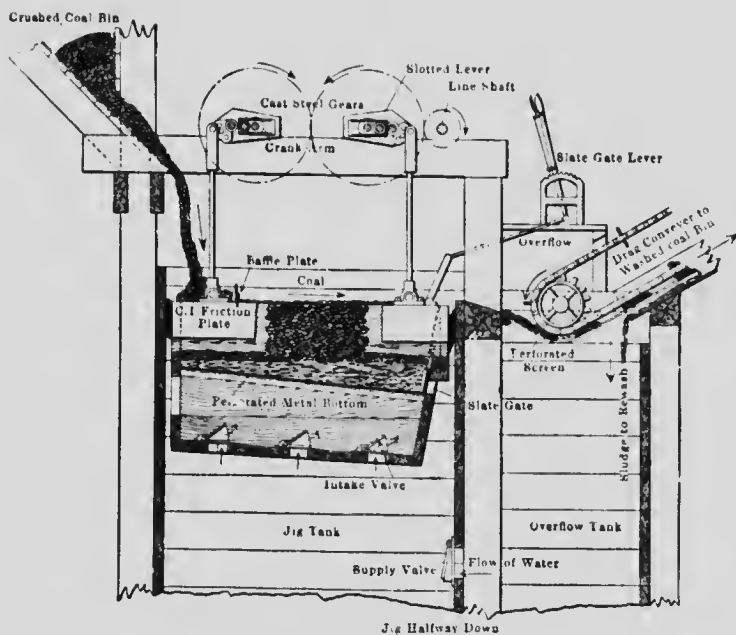


Fig. 16. Pittsburgh movable sieve coal jig.



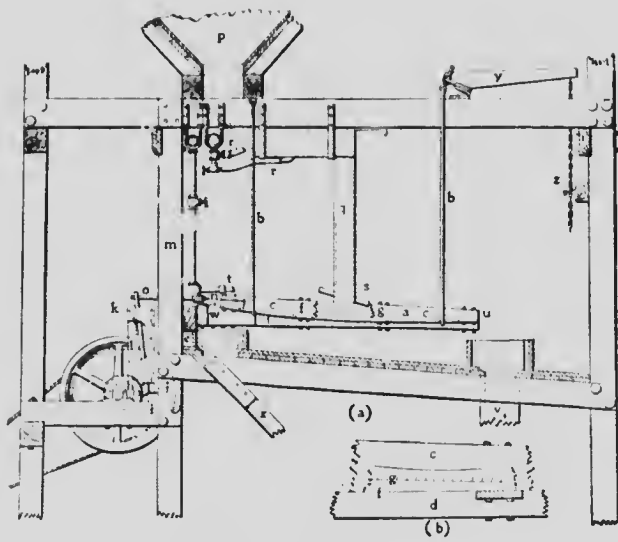
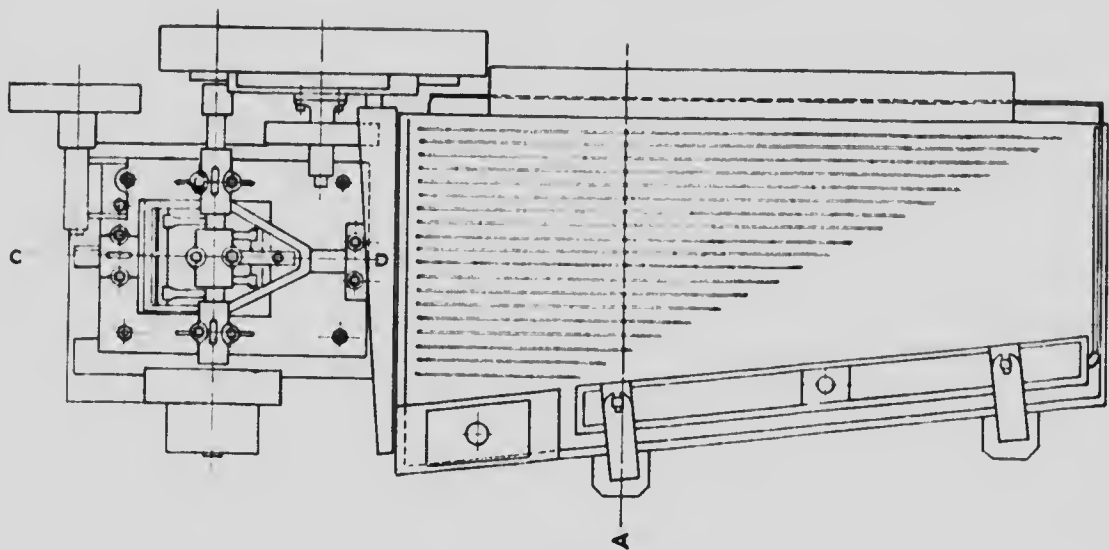
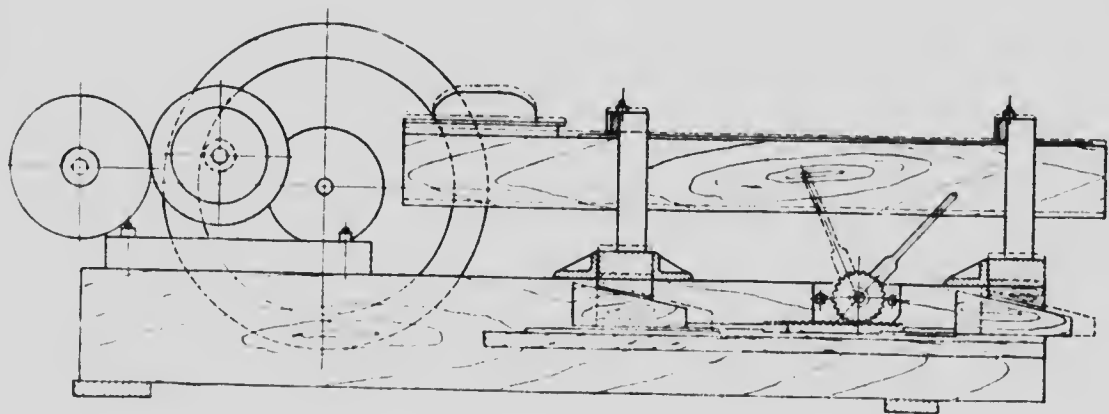


Fig.17. The Campbell table.





— Plan —



— Back Elevation —

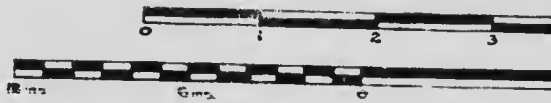
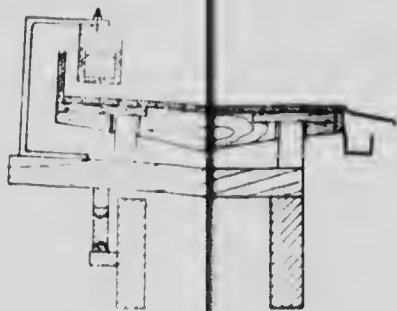
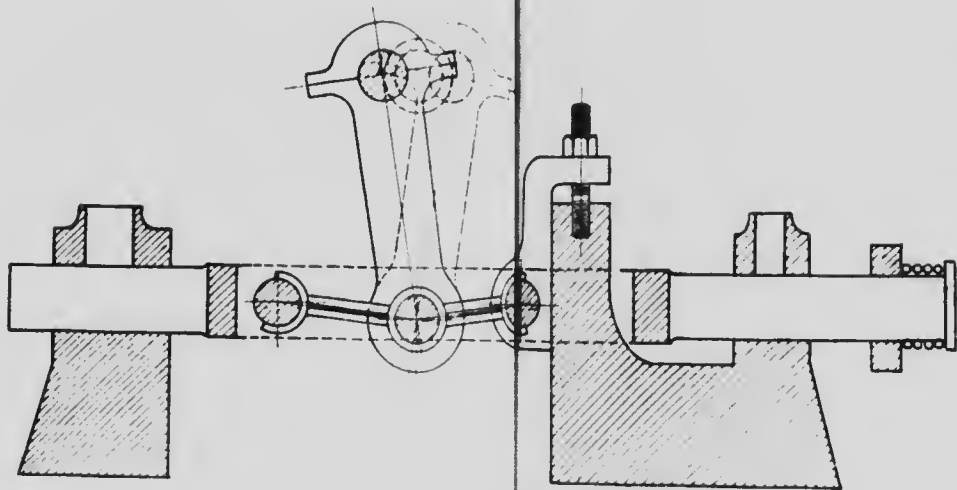


Fig. 18. Wilfley sizer
 (Short scale refers to two upper figures; long scale refers to two lower figures)



— Cross Section on A.B. —



— Longitudinal Section on C.D. —



Wilfey slime table
figures; long scale to two lower figures).

(4). To extract the main part of the refuse from the wash water, so that the latter may be used again, and when finally discharged may be run off without polluting streams or otherwise doing damage.

(5). To accomplish the above results at the lowest possible cost per ton it is necessary to work on a comparatively large scale and to employ automatic, or nearly automatic machinery as far as possible.

(6). It is also very desirable, especially in this country, to keep the first cost of the plant low and to use apparatus which can be easily and cheaply operated and maintained with a minimum of skilled labour.

Coals differ very greatly in composition and character, and there is the greatest diversity in the actual and comparative values of the different sizes and kinds of washed coal produced. The scale of operations and the rates of wages also differ greatly in different places. Therefore a number of different types of washing plants have been developed, each especially suitable for the conditions at some particular place. It is unnecessary to describe any of these plants in detail, but the most interesting types will be outlined in the following pages.

It has already been stated that European plants are generally designed for the treatment of screenings, and, as the output of the individual pits is seldom very large, large central plants with capacities of from 100 to 200 tons per hour treating the screenings from a number of collieries are the rule in European countries.

For reasons that have already been given, washeries are less numerous in North America than in Europe, and in the great majority of cases they are used exclusively for the preparation of coal for coking, although in some places the coal is washed for fuel purposes, in which cases the crushing may not be below 2½" size. In America, more frequently than abroad, washeries are planned to treat the output of a single colliery. Central plants, however, are by no means rare, the washery belonging to the Dominion Iron and Steel Coal Company, near Sydney, N. S., being a case in point, as it is designed to handle the screenings from any or all of half a score of mines all belonging to an independent company.¹ This plant, however, does not confine itself to screenings but also crushes and washes large quantities of run of mine coal, the maximum size going to the washers proper being under 4". Two plants in particular which wash screenings alone from one or more collieries, are those of the Nova Scotia Steel and Coal Company at North Sydney, and the Lille plant in southwestern Alberta. Both these plants wash, chiefly for coke, and there is in the former case a preliminary crushing to ½" before washing.

DESCRIPTION OF TYPICAL WASHING PLANTS.

Modern washing systems differ considerably in the degree of sizing or classification the coal receives, and the thoroughness of the washing depends mainly upon the closeness of this sizing. The more nearly uniform the size of

¹ These companies are now amalgamated.

the coal sent to a washer, the better is the elimination of the impurities. In fact, as already pointed out, where there is a considerable quantity of bone coal present, satisfactory washing cannot possibly be accomplished without close sizing. On the other hand, the larger the number of the sizes made, the more complicated and expensive is the plant. This sizing ordinarily precedes washing, but may under certain conditions follow it, and as this introduces radical differences in treatment, washing systems may conveniently be classified under two heads:—

- (1). Those which size before washing.
- (2). Those which wash first, then size, and finally re-wash the smaller material.

The makers of plants in the first class claim a more efficient washing without undue cost (provided the installation be large enough); while those in the second claim lower costs, both of plant and of operation, and a marked decrease in the loss due to breakage as the material is handled less on its passage through the washer.

A short description of some standard types of washeries in Europe and America will probably serve best to show these and other important differences in design.

Among the best known designers and builders of the first type of washery are:—

- Schuchtermann and Kremer (Germany).
- Humboldt (Germany).
- Luhrig (Germany).
- Coppée (France, Belgium, and England).
- The Hardy Pick Company, using the Elliott washer (England).
- Stein and Boericke (America).
- The Link Belt Manufacturing, who use modified type of Luhrig washer (America).

Amongst those building the second type are:—

- Barré (Germany).
- The Pittsburg Coal Washer Company, using the Stewart system in America.

There are other types of plant which do not belong strictly to either of these two classes. Of these the best known are the old but standard Robinson Ramsay washeries made in America by the Jeffrey Manufacturing Company, and the more recent Campbell table which, on this continent, is installed by Heyland and Patterson of Pittsburgh.

Washerries of the First Class

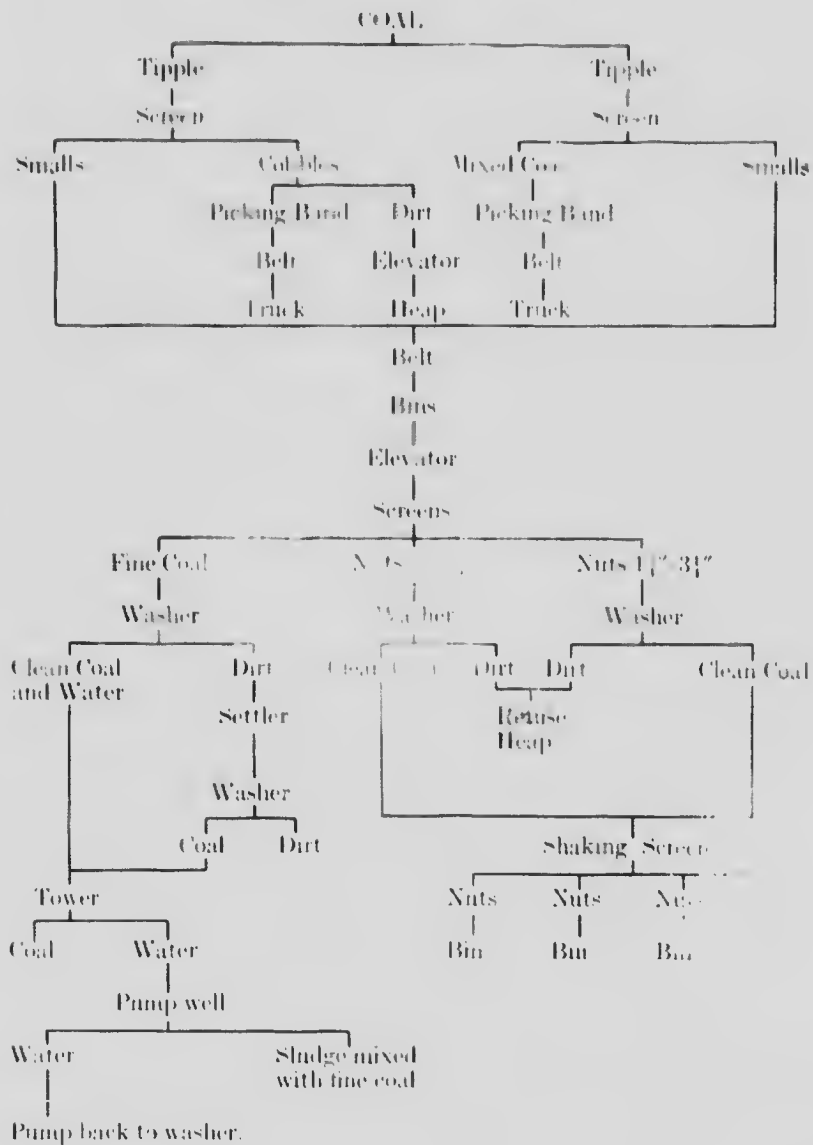
(Size first, then wash.)

(A) Dortmund¹

A plant built by Schuchtermann and Kremer at the Monopol colliery, Dortmund. This plant, which is diagrammatically outlined on page 179, has a

¹ See paper by Jungblodt, 1902, *Iron and Coal Trades Review*, Vol. 65, p. 1173, Screening and Washing at Dortmund.

WASHER (A) SCHUCTE-MANN, DORTMUND



capacity of 100 tons of screenings per hour. The coal is sent from two tipples to a fixed screen, making in one case lump (over 3") and smalls, and in the other mixed coal for special work, and smalls. Both lumps and mixed coal are hand picked and loaded direct into railway cars.

The smalls in both cases go to a stock bunker and are there mixed with the smalls from other shafts. They are then discharged on a screen which makes fine coal (under $\frac{3}{8}$ ") and nuts. The fine coal passes to the washer and thence to the drying tower, where water is drained off, and the coal sent to coke ovens. The nuts are separated into two sizes, and sent to two different washers, passing thence to shaking screen, where they receive an additional sizing. They are then shot into storage bins through special chutes without being dropped and further broken. The slates from the nut washers go straight to the refuse bin, while those from the fine coal washers are re-washed in a separate machine. The wash water from the draining tower (fine coal) and the draining screens (nut coal) is collected and partly cleared in a settling tank and is then sent by a centrifugal pump back to the washers. The nuts preparatory to shipment receive a final sousing with water to clean them of any adhering fine coal, and this water is sent to the fine coal draining tower.

This plant reduces the ash from about 18 per cent in the raw coal to 4 per cent in the washed product, the inherent ash being low and the slate high in quantity.

(B) Dortmund¹

A Humboldt plant built for the Scharnhorst colliery, Dortmund. The amount of coal landed is 1,500 tons per day of 10 hours, of which 500 tons of cobbles are sold unwashed, while the remaining 1,000 tons under 3" are washed. The coal is sent from three tipples, in one case over a smooth chute to be sold unscreened, in the second case by another chute to a 3" screen, and in the third case, to a screen which can be altered in size to suit the demand. The lumps, the unscreened, and the partly screened coal fall on picking belts where the lump dirt is removed by hand. The smalls (all below 3" in size) fall into a storage bin from which they are lifted by an elevator to the sizing screens, which make five sizes of nuts, from 3" to $\frac{5}{16}$ ", and one of fines, including all under $\frac{5}{16}$ ". The nut coals are washed in single compartment jigs and pass thence to draining screens; each size is then discharged into a separate bin, through a special chute designed to minimize breaking. The fine coal is washed in 1 two compartment jigs and passes with the wash water to draining pits which are 12 in number, with a total capacity of 1,200 tons. Seven pits are filled in one shift with about 675 tons of coal, which leaves five pits free at the beginning of the next shift, so that those charged have time to drain. The water from the pits passes to settling tanks located outside the building and when clear enough is used over again. The nuts receive a final sousing to clean them of the fine coal, and the water passes from this operation to

¹ See paper by Jungblodt, Iron and Coal Trades Review, 1902, Vol. 65, p. 1173.

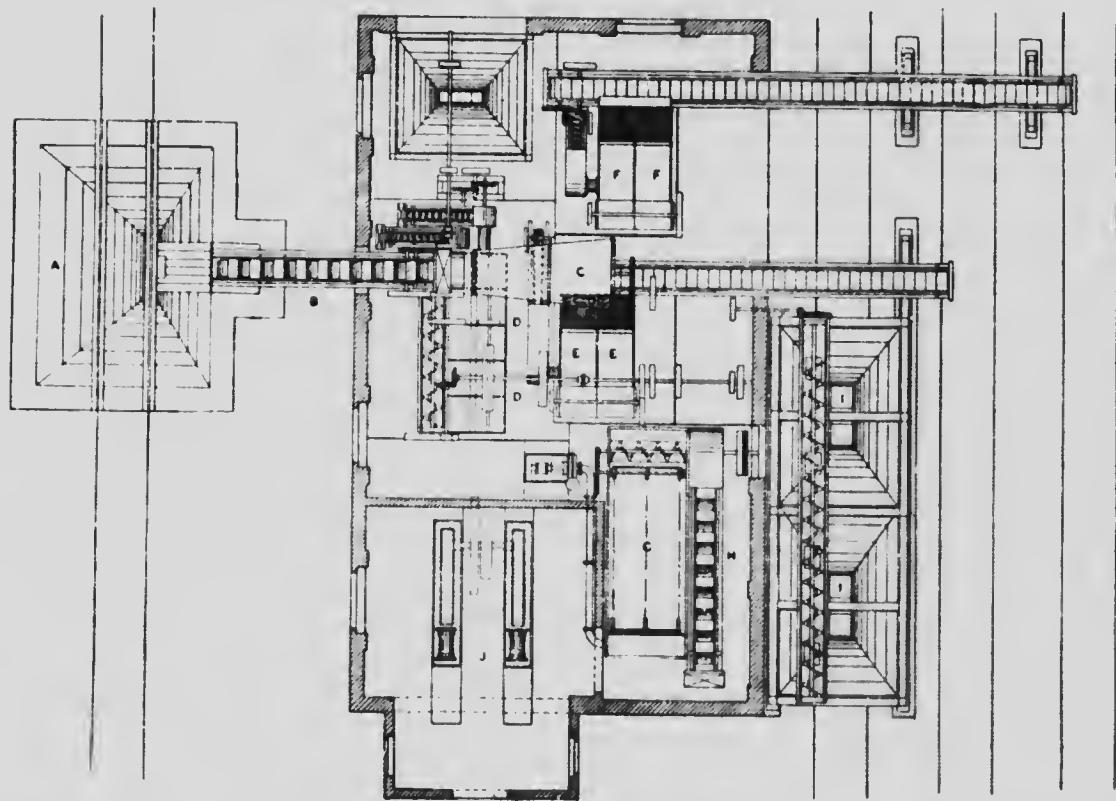
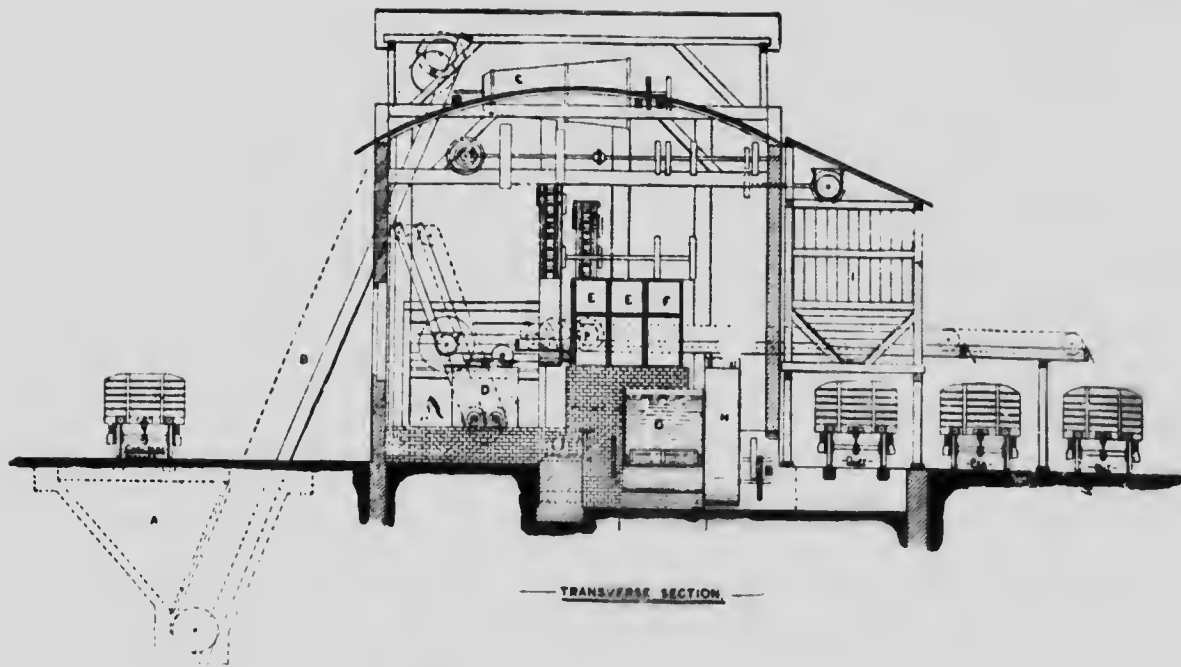
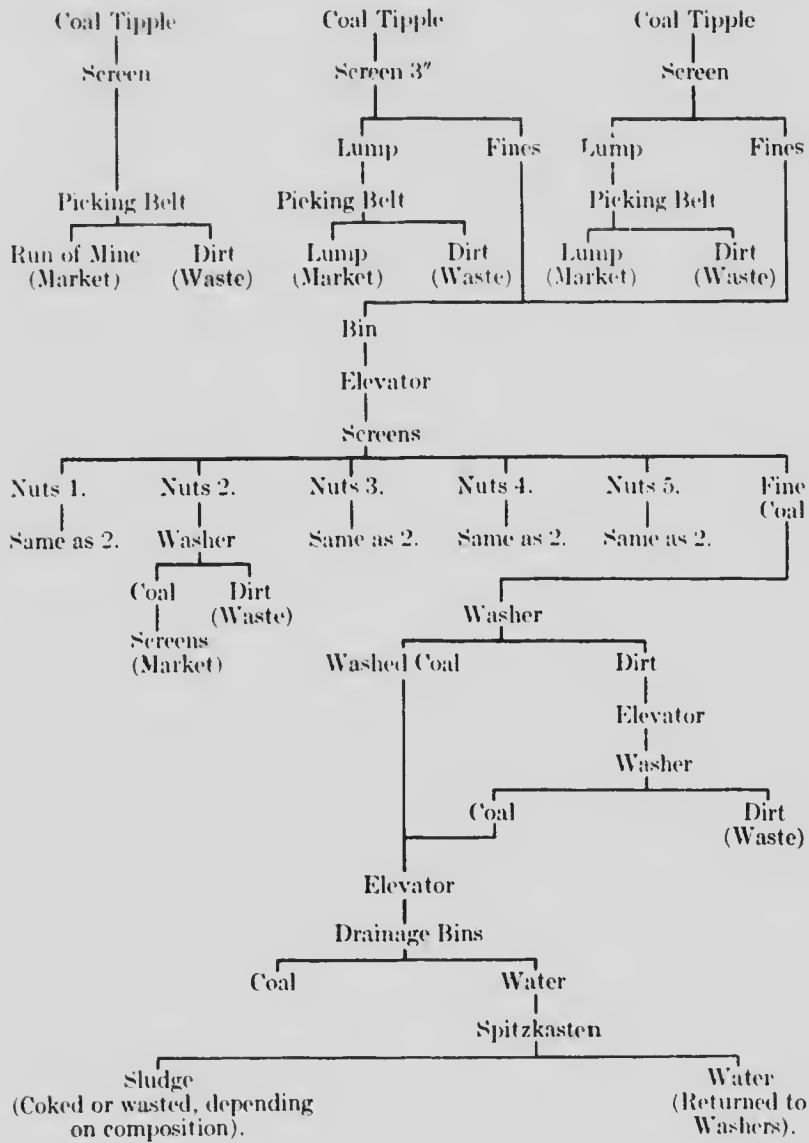


Fig. 19 Elevation and plan of a 350-ton capacity Sheppard washery.

WASHER (B) HUMBOLDT, DORTMUND



the draining pits. The fine coal is sent to the coke ovens, and the nuts, if intended for coke making, are sent to a disintegrator and the crushed coal mixed with the fines in the drying pit. The hutch product of the jigs, and the fines from the draining screens, are re-washed in two special two-compartment jigs and the product added to the fine coal. The sludge from the settling tanks is added to the fine coal in the draining pits.

This plant reduces the ash from about 18 per cent in the raw coal to about 1 per cent in the washed product.

(C) *Bothwell Castle*¹

A plant, of German design, at the Bothwell Castle collieries, Lanarkshire, Scotland, output about 60 tons per hour of washed coal. The coal is separated into lumps and smalls on a 2" screen; the proportion passing this screen is about 55 per cent of the total coal sent to the washer. The lumps are hand picked, the smalls are sent to a trommel which makes six sizes, viz., $\frac{1}{16}$ " to $\frac{7}{16}$ ", $\frac{7}{16}$ " to 1", 1" to $\frac{7}{8}$ ", $\frac{7}{8}$ " to 1 $\frac{1}{4}$ ", 1 $\frac{1}{4}$ " to 1 $\frac{3}{4}$ ", and 1 $\frac{3}{4}$ " to 2". The first two sizes are sent to jigs with feldspar beds, and the other four sizes are washed in ordinary jigs. The large coals are drained on screens and given a final sousing preparatory to shipment. The fines under 1" are sent to a settler, from which they are removed by a scraper conveyer and then allowed to drain. They are used in the colliery boilers to raise steam. The waste water is stored in a tank where it settles for 5 to 8 hours when the washing is stopped at night. This tank gradually accumulates fireclay and other impurities which do not settle well and it is, therefore, discharged from time to time and refilled with fresh water. All water before final discharge is sent to outside settling ponds to avoid polluting the neighbouring streams. The washery was installed at a cost of \$70,000, and resulted in an increase of 11 per cent in the average sales price of the coal, and an assured instead of a precarious market; the ash being reduced from 18 per cent to 5 per cent.

(D) *Polnisch Ostrau*²

A plant installed at Count Wilczek's colliery, Polnisch Ostrau, Austria, by the Hardy Patent Pick Company of Sheffield, using trough washers. All the screenings below 1 $\frac{1}{2}$ " are made into four sizes and sent to Elliott trough washers. The coal then passes to shaking drainage screens. It is then sent to disintegrators and thence to draining towers. No mention is made of sludge recovery.

(E) *Sydney Mines*³

A plant designed by Stein and Boericke of Philadelphia for the Nova Scotia Steel and Coal Company at Sydney Mines, Cape Breton; capacity 50 tons per hour. A plant of similar character is illustrated in Fig. 29.

¹ See digest of the Royal Commission on Coal Supplies of England. The plant illustrated in Fig. 19 is of this type, except that the hand-picking feature is omitted.

² See *Colliery Guardian* for 1903, p. 186, "Coal Washing Plant."

³ A paper read by C. L. Cantley before the Can. Soc. of C. E., March, 1908.

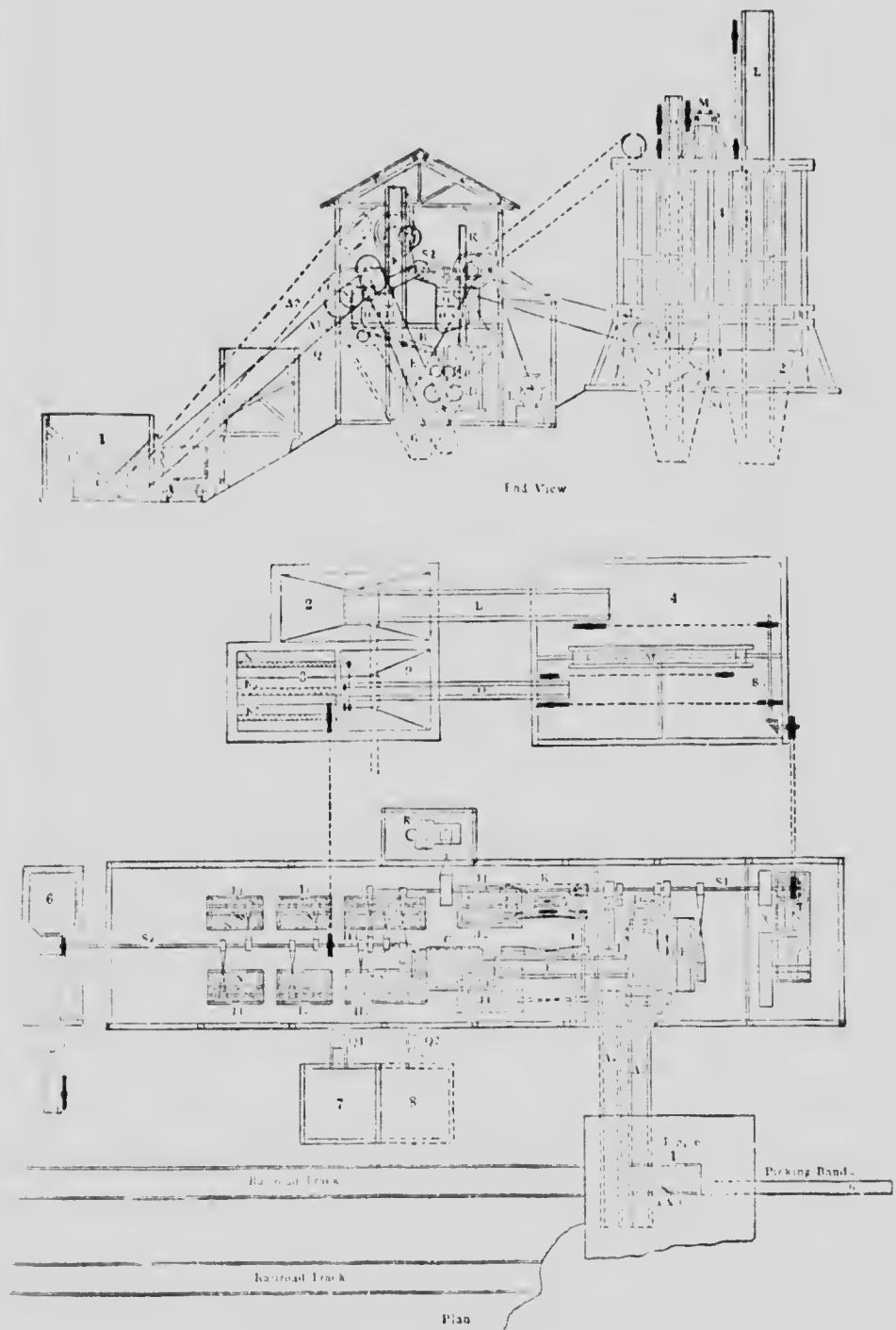
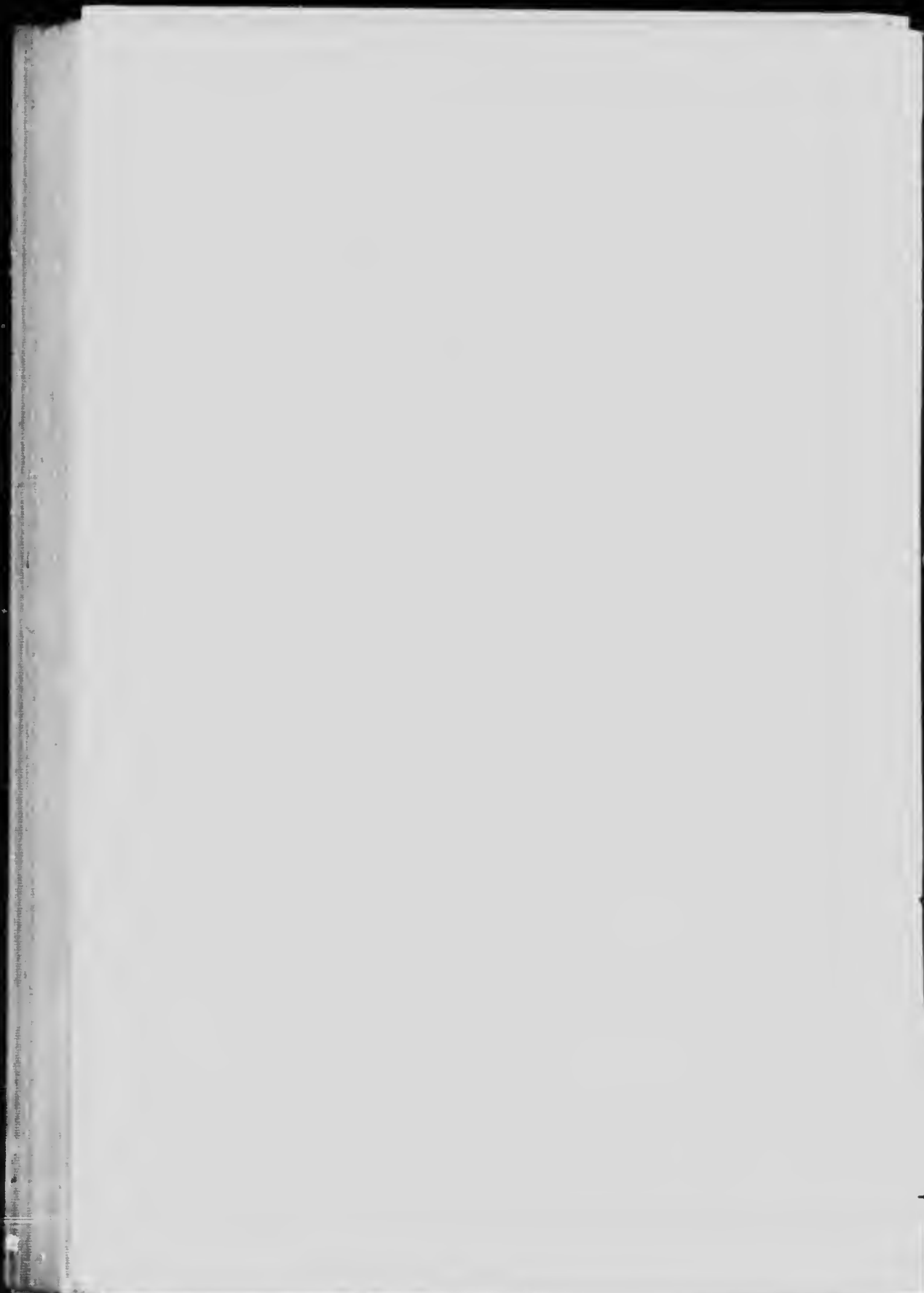


Fig. 20. Elevation and plan of Stein and Boercke washery



The material treated consists of screenings which include so much fireclay and other rubbish that the proportion of ash is from two to three times as great as in the seam proper. The washed coal is all made into coke for blast furnace. The screenings are first sent to coarse rolls, then to a slaking screen with $\frac{1}{2}$ " perforations. The overs from this screen are sent to plain rolls and crushed to $\frac{1}{2}$ " size. All the coal is then reduced to under $\frac{1}{2}$ ", and passes to bins and thence to a slaking screen with $\frac{3}{8}$ " perforations. This screening is done wet. The over-size goes to 4 coarse jigs and the fines to 4 fine jigs. All the jigs were designed for the work in question and use feldspar beds. The washed coal is sluiced to the storage bin, while the slate is re-washed in a special jig. The drainage water from the washed coal-bin passes to a sludge tank where the fine material is settled. This plant does excellent work and is said to reduce the ash from about 16 per cent to approximately 4.5 per cent and the sulphur from 2.2 per cent to about 1.50 per cent. The total yield is 78 per cent, all going to coke ovens. Frequent analyses show the ash content of the refuse to be in the neighbourhood of 55 per cent.¹

(F) *Big Muddy*²

A Lathrig plant erected by the Link Belt Manufacturing company of Chicago, for the Big Muddy Coal and Iron Company, Herrin, Ill., washing for fuel and coke, capacity 100 tons an hour. The coal, unlike that at the coke plants already described, receives a preliminary crushing to a size of about $2\frac{1}{2}$ ". It is then sent to storage bins and passes thence to revolving screens making five sizes. The two large sizes are sent direct to nut coal jigs, while the three smaller sizes are sent to fine coal jigs. Each size is then sent to draining screens, passing thence into storage bins. The refuse from the nut coal jigs is re-crushed and re-jigged together with the refuse from the fine coal jigs. The refuse of this last-mentioned jig then passes to the refuse recovery tank, from which it is elevated and sent to the dump. The screenings and water from the drainage screen flow to the sludge recovery, which consists of large settling tanks in the bottom of which are slowly moving conveyers. The fine coal gradually settles and is taken by the conveyer to the boot of an elevator, whence it is raised and deposited in the shipping bins. The refuse is taken to a similar settler and the clear water from all settlers is used over again. This plant is a typical "Link Belt" works for preparing coal for use as fuel. Out of a total of 42 plants built and equipped either in whole or part by this Company, 15 are engaged in washing coal for fuel purposes.

(G) *Greensburg*³

A Lathrig plant built by the Chicago Link Belt Manufacturing Company for the Alexandria Coal Company, Greensburg, Pa., capacity 600 tons per

¹ This coal was washed in the trials. See Summary Record Tables, and Vol. 14, Appendix I.

² See Fig 21 which illustrates a plant of this type. See also Link Belt Catalogue-Link Belt Mfg. Co.

³ See Link Belt Mfg. Co.'s catalogues.

day for roke. The coal is broken first in a Bradford breaker and then further reduced to $\frac{3}{4}$ " in rolls. It is then sluiced to a Lohrig grading box which is a form of trough classifier, and the several classified lots are delivered each to a different jig, the finer sizes using feldspar beds. All the washed coal is sluiced to a tank, from which it is removed by an elevator with perforated buckets, thus giving the coal a chance to drain. The overflow from this tank goes to a settler and the sludge is recovered. The refuse goes to another settler, from which it is removed by a bucket elevator. This plant is apparently working more for the elimination of sulphur than ash.

(H) Aldridge¹

A plant built by the Link Belt Manufacturing Company for the Montana Coal and Coke Company, Aldridge, Montana, capacity 400 tons per day for coke. The coal is exceedingly dirty and friable, and contains large quantities of fire clay, slate, and bone coal. It is sent first to a breaker reducing it to $\frac{3}{4}$ ". Thence it passes to two grading boxes and from the grading boxes is discharged to two batteries of feldspar jigs. The clean coal goes to a draining screen of $\frac{1}{2}$ " mesh, and is there sprayed to clean it thoroughly. The coal passing the meshes of the draining screen drops into a settling tank and is recovered by means of the sludge elevator. The refuse from all the jigs is re-washed, and the coal recovered is treated as an intermediate product suitable only for fuel purposes. The fireclay gives great trouble on account of its tendency to form an emulsion with the water; consequently the wash water is renewed every two or three days, instead of once a week, as is the custom in many washeries. The three products of this washery are:—

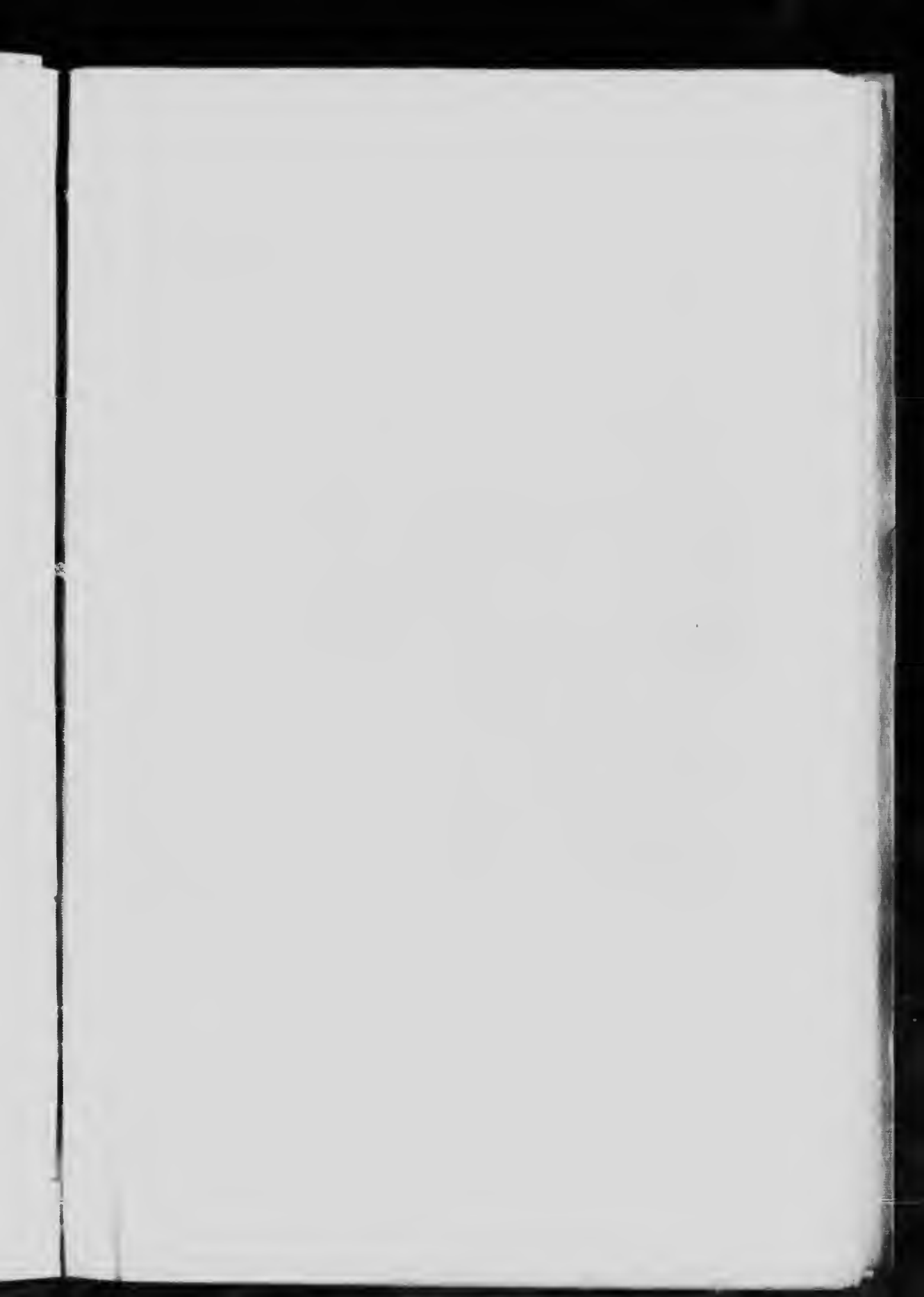
Washed coal for coke	61 per cent	10 to 11 per cent ash.
Intermediate coal for fuel	3 per cent	18 to 20 per cent ash.
Refuse	36 per cent	60 to 68 per cent ash.

(I) Couhula

A plant treating one of the upper Cretaceous coals of the southwestern States, capacity 30 tons an hour, at Couhula, Col. The coal is dirty and shows 8.35 per cent of inherent ash. The rest of the impurity is present as thin flakes of spar, slate, etc. The coal is first run over two screens of $1\frac{1}{2}$ " and $\frac{1}{2}$ " respectively, and the material over $1\frac{1}{2}$ " is hand-picked but not otherwise treated. The coal between $1\frac{1}{2}$ " and $\frac{1}{2}$ " is crushed in rolls to $\frac{1}{4}$ " and added to the other fines, which are then sized on $\frac{1}{4}$ ", $\frac{1}{8}$ ", $\frac{1}{16}$ ", and $\frac{1}{32}$ " screens, thus making four sized products and one lot of fines below $\frac{1}{32}$ ". Each of the four sizes is washed in separate jigs, and the washed coal sluiced to draining screens discharging into storage bins.

¹ See Mines and Minerals for 1903, p. 228.

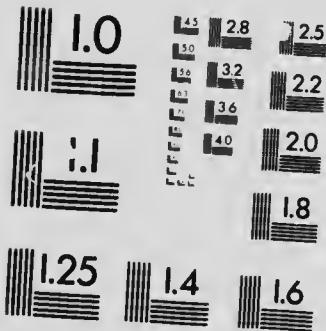
² See E. Tuttle's paper, Vol. 17, School of Mines Quarterly, and Fulton's Treatise on Coke. This is evidently a difficult coal to purify as the screening plant is unusually elaborate and the jigs work on finer stuff than usual, yet the over-all results are not as good as in many other plants.





MICROCOPY RESOLUTION TEST CHART

(ANSI and ISO TEST CHART No 2)



APPLIED IMAGE Inc

1653 East Main Street
Rochester, New York 14609 USA
(716) 482-0300 - Phone
(716) 288-5989 - Fax

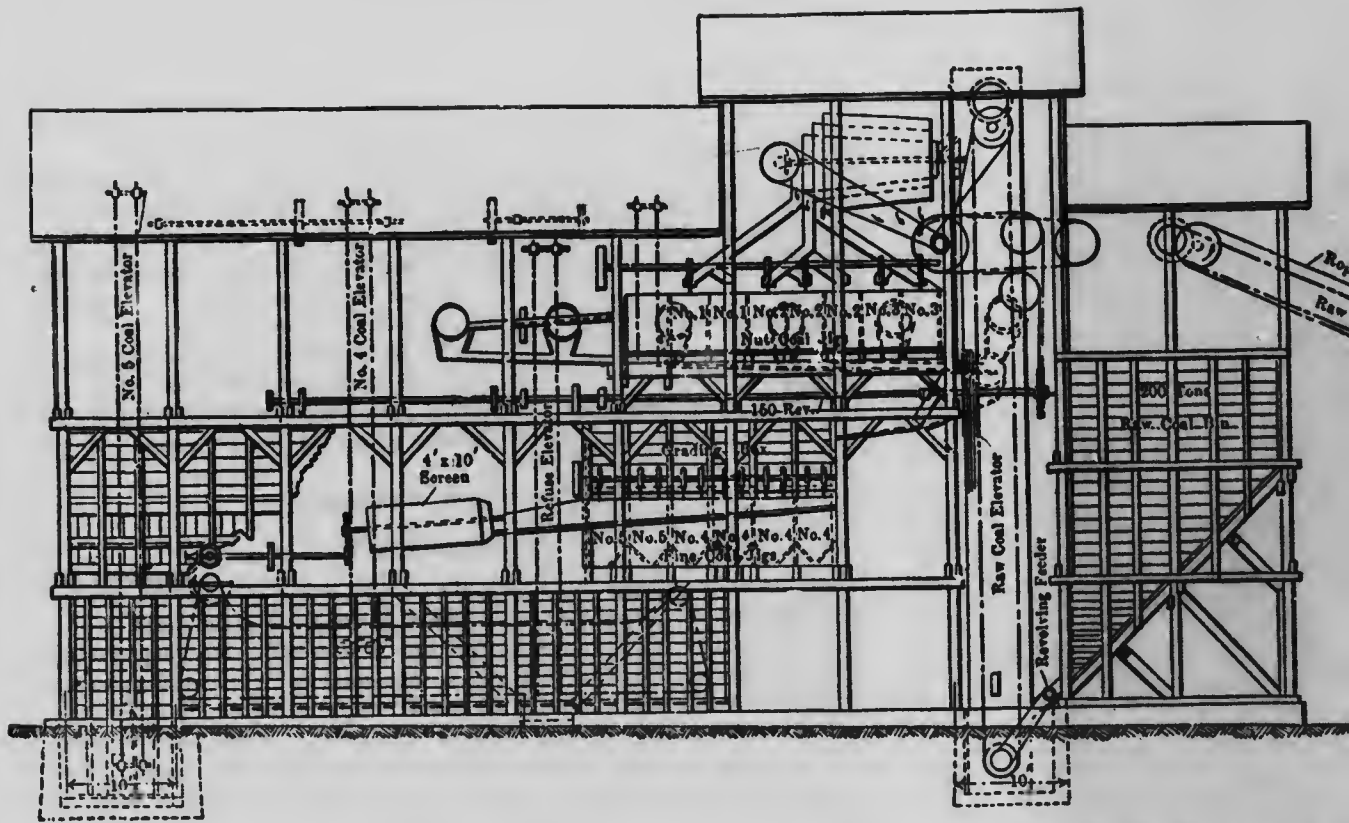
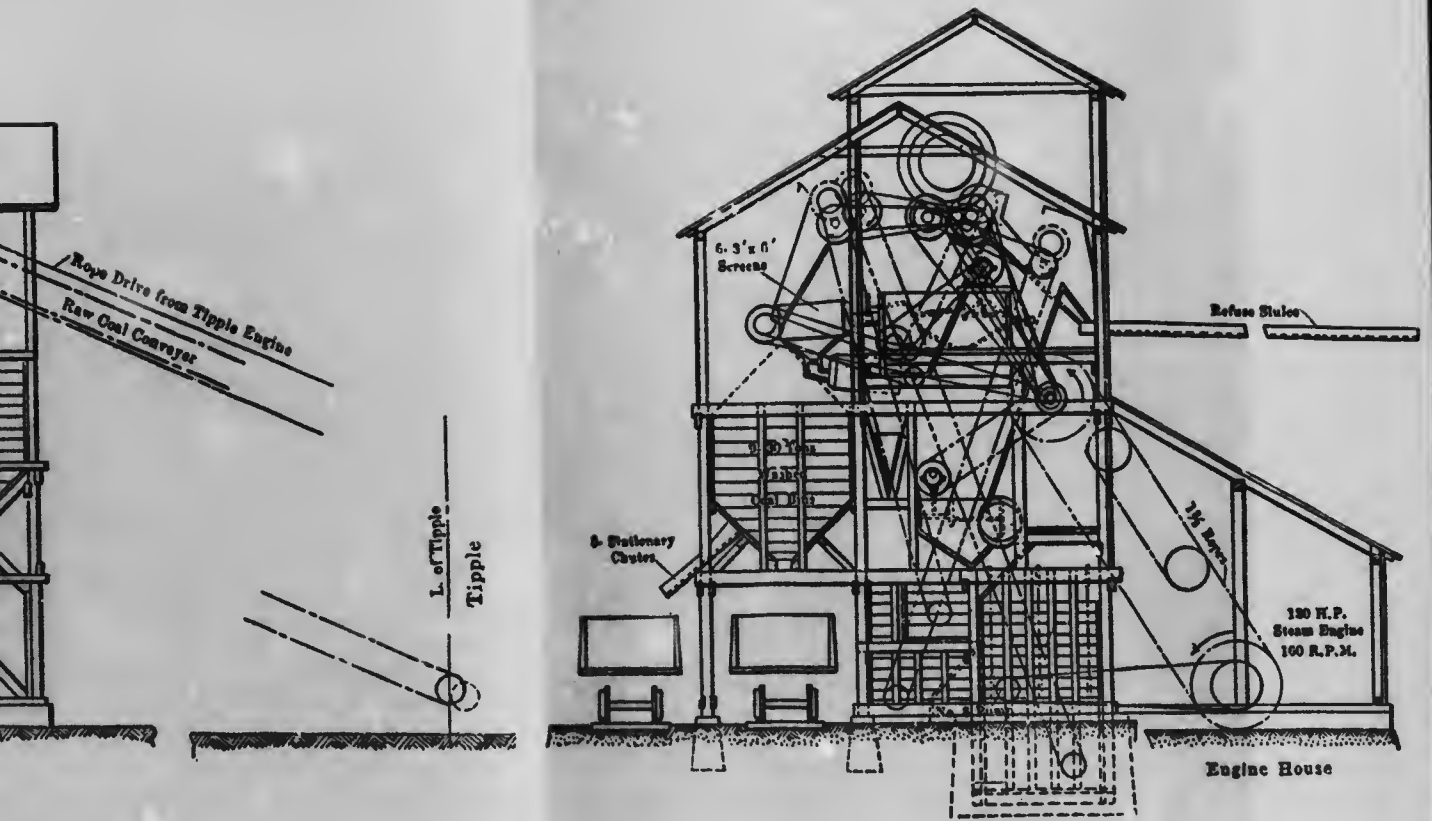


Fig. 21. Side and end elevations.



Side and end elevations of a Luhrig washery.

day 1
ther
whiel
each
coal i
ated
this
anoth
is ap

(II) 2

Coal
for e
quan
ing i
gradi
coal
clean
drops
The 1
as an
gives
water
instea
prod

(I) Co

2
States
shows
thin f
and
but 1
in rol
1" 1'
fines
and tl

1 8
2 8
Coke.
elabora
good a

The coarse jigs treating $\frac{1}{2}$ " to $\frac{3}{4}$ " are arranged so that it is possible to draw off a middle product at a point midway between the lower refuse and the upper coal. This middle product is sent to another set of rolls and still further reduced in size and finally re-washed. The water and coal passing through the drainage screens fall into a settling tank, from which the sludge is recovered by means of a drag conveyer. This sludge is delivered to the discharge end of the draining screen, whence it passes to the storage bins. The finest size of coal from 0" to $\frac{1}{16}$ " is sent to a two-compartment classifier and passes thence to two jigs. All the jigs treating material below $\frac{1}{4}$ " have feldspar beds. The ash in the screenings is reduced from 17.3 per cent to 10.21 per cent.

(J) *Hosmer*¹

A plant built for the Hosmer Mine Ltd., at Hosmer, B.C., in the Crowsnest pass, by The Roberts and Schaefer Co. of Chicago.

The tippie is of steel with corrugated metal sides and roof. The coal is brought from the mine in 2 ton mine cars hauled by electric locomotives, and is tipped by a Phillips cross-over dump to a steel box which feeds a shaking screen 6 feet \times 16 feet with $\frac{3}{4}$ " holes.

The lump coal goes from the screen to steel picking belts and thence to storage bins of 2,100 tons capacity.

The slack from the $\frac{3}{4}$ " screen will no doubt ultimately be washed, but at present it is of sufficiently good quality to go direct to the slack bins by drag conveyer, and thence by tramway to the coke ovens².

Washeries of the Second Class

(Wash first, then size.)

(K) *Gladbeck*³

A Baum plant at Gladbeck colliery in Westphalia, for an output of 100 tons per hour. The coal is sent first to screens with 3" holes, making lumps and smalls. The lumps are picked by hand and the smalls are all sent to a Baum air pulsator jig. Thence they pass to a trommel which makes as many sizes above $\frac{1}{2}$ " as required for the market. (The nut coals are fed to the storage bin by spiral chutes specially designed to prevent breakage.)

The washed coal below $\frac{1}{2}$ " is sent to a second jig and the re-washed coal delivered to a draining conveyer discharging into storage bins. All water from washing and draining is clarified in settling tanks and the sludge drawn off and either added to the fine coal or else wasted, according to its analysis. The fine coal goes to coke ovens, and the coarser sizes to the market, or the coke ovens, as the demand requires. The flow sheet on

¹ See H. H. Yuill's paper, Vol. 13, p. 230, Journ. Can. Min. Inst.

² Plate xxxiii and Fig. 22 illustrate an excellent but somewhat different arrangement of tippie.

³ See Iron and Coal Trades Review for 1903, Vol. 67, p. 247, "Coal Washing", and Colliery Guardian, Nov. 6, 1906.

page 187 shows the ordinary procedure in a Baum system, together with possible combinations suitable for refractory coals.

(L) *Masontown*¹

A plant built by the Pittsburg Coal Washer Company for the Bessemer Coal and Coke Company, Masontown, Pa., washing for coke, capacity 60 tons an hour, using the Stewart system.

The coal is sent to a Pennsylvania hammer crusher which reduces it to a maximum size of $\frac{3}{4}$ ". Thence it passes to two Stewart jigs without any preliminary sizing. The overflow from the jigs discharges on to a perforated plate with $\frac{1}{4}$ " holes, and is taken thence to the storage bins by means of a scraper conveyer. The coal and water passing through the $\frac{1}{4}$ " holes are delivered by a screw conveyer, together with the refuse and hutch from the two jigs, to an elevator, which delivers to a third, or re-wash jig. The fine coal overflowing from this jig falls to the boot of an elevator which carries it to the storage bins. The slate and refuse are removed from the last jig and fall to the boot of an elevator with perforated buckets, which delivers to the refuse bin. The plant is exceedingly simple and requires the attention of only two men, one engaged in firing the boilers and the other in operating the slate gates of the jigs, etc. The raw coal is stated to contain 12.48 per cent ash, the washed coal 7.8 per cent; the sulphur in the raw is 2.58 per cent, which is reduced to 1.41 per cent in the washed coal.

(M) *Howe*²

A plant built by Heyl and Patterson at Howe, Indian Territory, U.S.A., using four Campbell tables, each table washing about 20 tons of screenings per hour for coke.

The screenings, which comprise all coal below $1\frac{1}{2}$ ", are sent to a Williams' disintegrator and there reduced to about $\frac{1}{4}$ " as maximum size. They are then sent to the Campbell tables and the washed product is conducted to the boot end of a sludge tank, whence it is removed by a bucket elevator. The fine coal held in suspension gradually settles at the other end of the sludge tank. A slowly moving scraper travelling close to the bottom of the tank gradually works the fine settled material to the boot of another elevator (sludge), from which it is removed. Heavier particles of this material settling in the bottom of the boot are drawn off by a pipe. The clarified water is pumped back and used over again in the washery.

At another plant built by the same Company, the total output of coal from two mines (about 2,000 tons per day) is crushed first in a Bradford breaker to about 1" size and then in rolls to about $\frac{1}{4}$ ". The coal then passes to a set of Campbell tables and thence for a re-wash to another set and is finally delivered to large settling tanks, where it is allowed to drain for

¹ For a similar plant see paper by Floyd W. Parsons in 1908. Eng. and Mining Journal.

² Mines and Minerals for 1903.

with

ner
60

it
out
a
ins
he
ise
or
an
re-
ed
le
ers
al
he
he

A.,
gs

a
m
ed
ed
at
se
ot
es
e.

al
d
al
t
or
l.

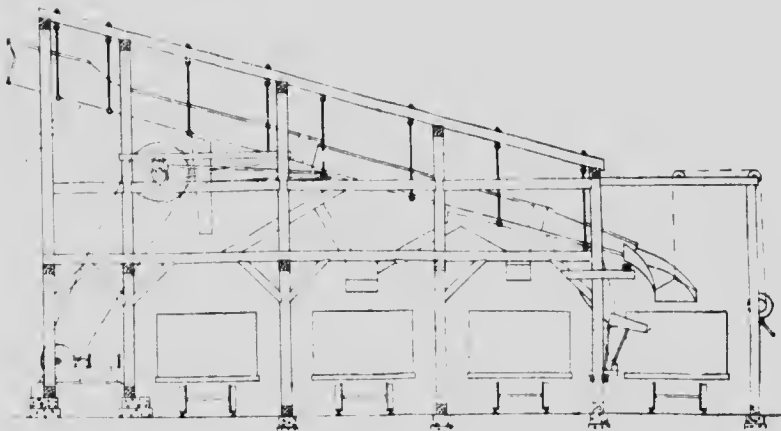
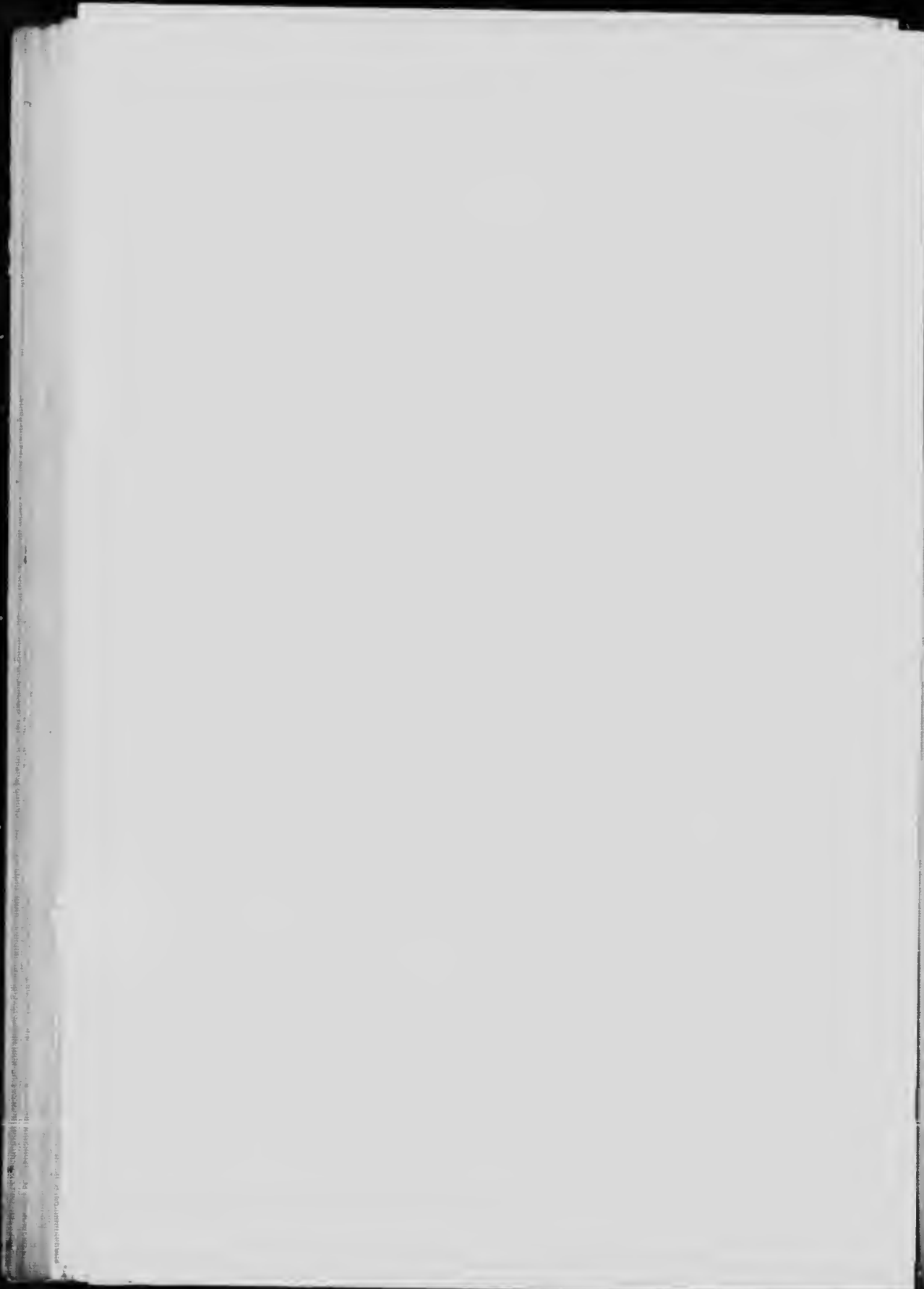
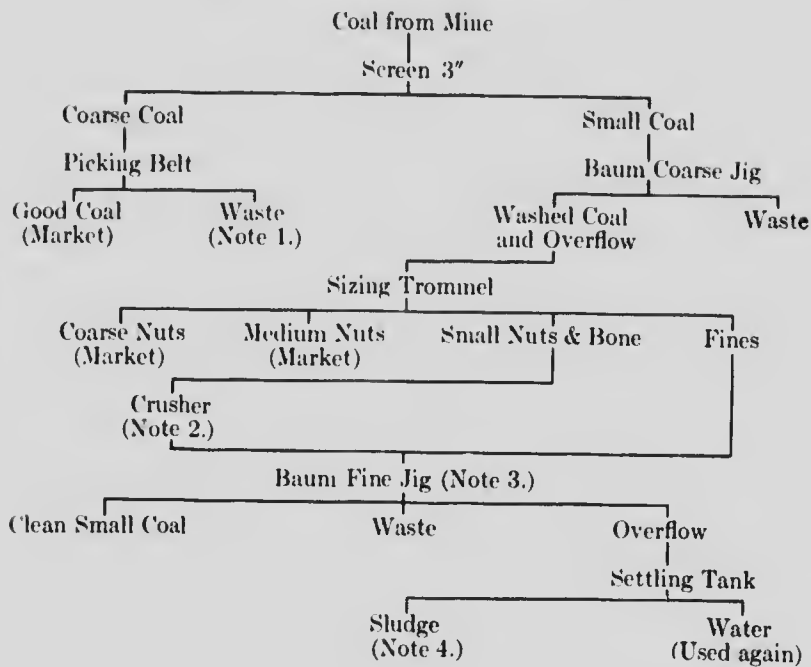


Fig. 22. Section of coal tippie of Springfield Collieries Co.



BAUM SYSTEM

(With modifications occasionally used.)

*Note 1.*

Ordinarily wasted. If contains enough coal it goes to crusher for re-treatment.

Note 2.

This treatment of bone coal is usually omitted—is only followed if quantity is large.

Note 3.

This jig may have a feldspar bed.

Note 4.

The sludge may be saved or wasted, depending on its quality.

3 or 4 days. The excess water from these tanks is pumped and used over again. The settling tanks, which are six in number, are emptied by a travelling bucket elevator which can be moved from tank to tank.¹

(X) *Pratt Mines*²

A Jeffrey Robinson plant, capacity 400 tons per day, at No. 2 Slope, Pratt mines, Alabama, washing screenings for coke.³

The screenings (all below 2") are delivered by a conveyer to two Robinson washers. The washed coal as discharged passes over draining screens and is delivered to bins, and the water passes to a Ramsay ledge tank, where the fine impurities are settled.⁴ The clear water is pumped back to the washer to be used over again.

The raw coal assays on an average 9.98 ash and 1.48 sulphur, and the washed coal 5.78 ash and 1.25 sulphur. An average analysis of the washed coal over 4" is 5.16 ash with 1.27 sulphur, and that under 2" contains 8.52 ash and 1.40 sulphur, showing that the Robinson washer is more suitable for coarse than fine coal, unless the fine coal is much more impure, which is not improbable. The pure coal contains about 3 per cent of inherent ash and about 0.8 organic sulphur. The extreme simplicity and low cost of operation make this type of plant eminently suitable for certain coals. It is doubtful whether it could compete with the more elaborate jig and table plants in the treatment of bony coals and those which require fine crushing to fully unlock the impurities.

There are a large number of plants of this type operating in the central and southern portions of the United States and some few in other parts of the country,⁵ nearly all of them working on screenings, the washed coal being used for coke.

DISCUSSION ON THE PLANTS ABOVE DESCRIBED.

The above abbreviated descriptions of plants are intended to give only a general idea of the various systems employed in various places. Lack of space forbids detailed descriptions which, however, can be found in great numbers in the technical journals.⁶ One point is fully borne out by even these short descriptions, namely that no particular type of plant is suitable for any and every coal. Take for instance the European examples given, all of which are engaged in washing screenings without crushing. The proportion of ash is always large, say from 14 per cent to 18 per cent. No

¹ See also a paper by A. P. Scott in *Can. Mining Journal* for 1907, May.

² See a paper by J. J. Ormsbee in *Tr. Am. Inst. Min. Eng.*, Vol. xxv, pp. 413 and 990.

³ Figs. 9, 10 and 23, illustrate plants of this type.

⁴ See Fig. 24.

⁵ The plant used by the Dominion Coal Company at Port Morien was a Robinson Ramsay containing 4 washers. This plant has recently been destroyed by fire.

⁶ For a bibliography of coal washing, see *Tr. Am. Inst. Min. Eng.*, Vol. xxxvii, p. 256.

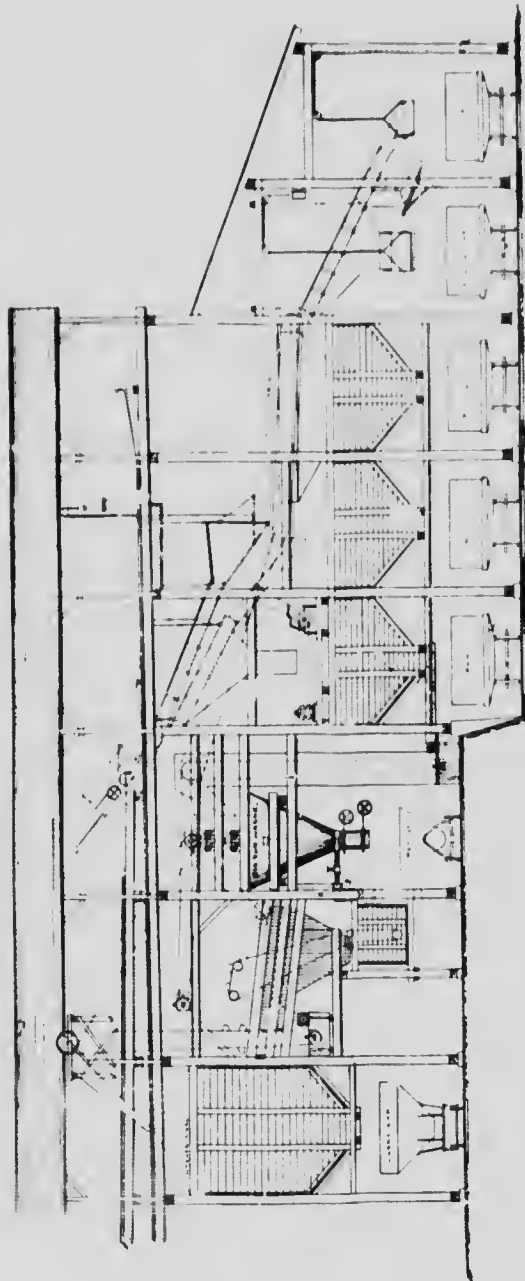


Fig. 23. Combined road tipple and Robinson washery

1870
1871
1872
1873
1874
1875
1876
1877
1878
1879
1880
1881
1882
1883
1884
1885
1886
1887
1888
1889
1890
1891
1892
1893
1894
1895
1896
1897
1898
1899
1900

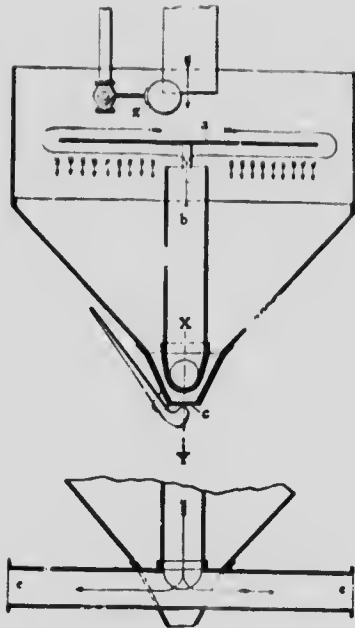


Fig. 24. Sectional elevations of Ramsey sludge tank.

1871
1872
1873
1874
1875
1876
1877
1878
1879
1880
1881
1882
1883
1884
1885
1886
1887
1888
1889
1890
1891
1892
1893
1894
1895
1896
1897
1898
1899
1900
1901
1902
1903
1904
1905
1906
1907
1908
1909
1910
1911
1912
1913
1914
1915
1916
1917
1918
1919
1920
1921
1922
1923
1924
1925
1926
1927
1928
1929
1930
1931
1932
1933
1934
1935
1936
1937
1938
1939
1940
1941
1942
1943
1944
1945
1946
1947
1948
1949
1950
1951
1952
1953
1954
1955
1956
1957
1958
1959
1960
1961
1962
1963
1964
1965
1966
1967
1968
1969
1970
1971
1972
1973
1974
1975
1976
1977
1978
1979
1980
1981
1982
1983
1984
1985
1986
1987
1988
1989
1990
1991
1992
1993
1994
1995
1996
1997
1998
1999
2000
2001
2002
2003
2004
2005
2006
2007
2008
2009
2010
2011
2012
2013
2014
2015
2016
2017
2018
2019
2020
2021
2022
2023
2024
2025

large coal is crushed, as, with one exception, it is to be used for fuel purposes. In the exceptional case of the Polish Ostran plant, the coal is washed as large as possible and afterwards disintegrated for coke. Compare these plants with the Big Muddy plant at Herrin, Ill., where all the coal from the mine is crushed to nut size preparatory to washing for fuel purposes. Take again the Stein and Boericke plant at New Glasgow, the Link Belt plant at Alexandria, the Stewart plant at Masontown, and the Campbell plants in the same region and in Nova Scotia, all engaged in washing for coking purposes. In all of these cases the coal is reduced to a size below $\frac{3}{4}$ " and in the last-mentioned case even smaller.

Why should there be this difference? It is cheaper, simpler, and in some cases little less effective to wash large than small coal, and the storage capacity needed is much less for the former, as the large coal drains so much more quickly. The answer is that the character of the coal is different. Fine crushing is absolutely essential in the plants last mentioned, as all are engaged primarily in the elimination of sulphur rather than ash, and the removable sulphur is present as small crystals of pyrite. The matter of the degree of crushing is, therefore, one which deserves special consideration. First of all, it is out of the question to crush very small with coals intended for the fuel market. Then there is the necessity already mentioned of large storage capacity to permit of sufficient drainage of fines before sending the coal to the coke ovens. Lastly, there is the so-far commercially unsolved problem of economically treating and afterwards utilizing the fine material, generally called sludge, with its attendant difficulty of cleaning the wash water before re-using.

Generally speaking, material below 30 mesh is not improved at all in its passage through a washery. The jig is certainly not capable of economically treating such fine material, and while it may stand more chance of improvement on a bumping table, the present practice of sending unsized material, say from $1\frac{1}{4}$ " to nothing, to any single machine, cannot give satisfactory results. This point is well brought out by W. McD. Mackay, in a paper on slack washing,¹ in which it is shown that in the majority of cases the sludge saved is as high, or higher, in ash than the original coal, although it is occasionally much purer. In some tests of a number of Nova Scotian coals the writer found the same to be the case. As the amount of such sludge is frequently large, attempts are often made to save it, either by filtering the water through a layer of larger coal, or else by recovering it by settling in the sludge tank. In nearly all such cases material is added to the washed lump coal, which is as high or higher in ash than the original coal. In addition it is this fine material which dirties the wash water and necessitates the use of large settling tanks, and, in this connexion, an important point has not received sufficient attention in many plants, namely, that it is very desirable to use clean water as far as possible.

Another point of decided importance is the degree of crushing by which coal will benefit. For each coal there is some point below which the

¹ Trans. Inst. of Mining Eng., 1903.

advantages gained by unloading the fine impurities by fine crushing are more than offset by the disadvantages due to the impossibility of efficiently utilizing the large quantity of fine material thus produced. It has been suggested that the fines be removed before washing and added dry to the washed coal, or else used under boilers in and near the plant. The cleaning of fines by means of an air blast has also been attempted, but the process cannot be said to be altogether successful. It is out of the question to recommend any standard method of treatment of such material. It might be advisable, however, in many cases where the smallest market size now made is $\frac{1}{4}$ " to make another, say $\frac{1}{16}$ " or $\frac{1}{20}$ ", and to treat this on bumping tables, or, if the installation be one using tables, to treat it on separate tables; the finest material after rough treatment on tables might then be sent to a settler of sufficient capacity to settle fine coal down to, say, 40 mesh, and the overflow from this tank to large tanks whose sole purpose would be to clarify the water rather than to save any suspended material. The above presupposes, however, a market for fine coal now often absent, but surely to be looked for in the future.

A comparison of the cost of operation of the various plants used in North America would probably place the old trough washer lowest per ton, the Robinson second, the Stewart third, the Link Belt fourth, and the Campbell fifth. This order would naturally be questioned by the various makers, and the writer cannot put forward any conclusive data in proof of his opinion. The superiority of one plant over another cannot, however, be judged by the cost of operation without an examination also of the results obtained. One plant may be superior to another in one particular case and inferior in another.

In conclusion it need only be pointed out that the adoption of any particular system depends wholly on the nature of the coal and on commercial considerations. In all cases, however, coal washing plants must of necessity be simple in construction and operation, and being so, any wide variety in design is impossible, although there must be certain modifications in design to render them suitable for the treatment of particular coals.

THE PREPARATION OF ANTHRACITE COAL

In the preceding section nothing has been said of the technology of anthracite washing, and in Canada this material is as yet of little importance as, so far as known, the anthracites of the Dominion are unimportant in comparison with the bituminous coals and lignites. In fact there is but one considerable anthracite colliery in operation and it employs methods of purification which are radically different from those used on bituminous coal. It will, therefore, suffice in this article to deal with anthracite preparation in a very general way and to omit all detailed description of dressing plants and methods.

Although it has been conclusively proved that the best results in the use of fuel can be attained by the use of sized coal in furnaces fitted with grates

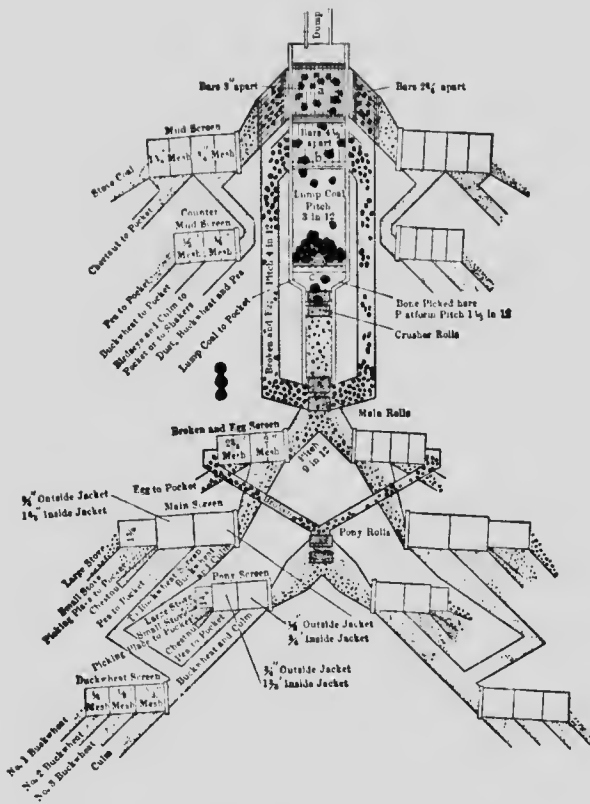


Fig. 25. Diagrammatic scheme for the preparation of anthracite coal for market.



especially designed for the particular size in question, yet this practice is only beginning to be adopted as regards bituminous coal, and the general commercial demand calls for but three grades, run of mine, lump coal, and slack or screenings. With anthracite the case is very different, as this fuel is so slow to ignite and so free from any tendency to agglomerate in burning that it is essential to have it quite carefully sized, and to use it in grates with openings small enough to prevent the loss even of the fines.

All anthracite is, therefore, broken and carefully sized, even if washing is unnecessary, and in the average, a colliery sends nearly a dozen sizes to the markets, viz.: lump, over $4\frac{1}{2}$ " bar screens; boat, over $3\frac{1}{4}$ " bars; furnace, over $3\frac{1}{4}$ " roundpunched screens; egg, over $2\frac{1}{4}$ " round; stove, over $1\frac{1}{2}$ " round; nut, over 1" round; pea, over $\frac{9}{16}$ " round; buckwheat No. 1, over $\frac{5}{16}$ " round; buckwheat No. 2, over $\frac{1}{4}$ " round; buckwheat, over $\frac{1}{8}$ " round, and dust.

Anthracite is also just as liable to require cleaning as bituminous coal, and as it is necessary in any case to size it as above, and often to coarse crush it, the additional cost of washing is usually very low.¹

SPECIAL FEATURES OF ANTHRACITE PREPARATION

The apparatus ordinarily used in anthracite washing differs only in detail from that employed on bituminous coal. Toothed rolls, corrugated rolls, bar and shaking screens and jigs are all employed almost exactly as already described and nothing further need be said of them. Recently there has been a great development of what is often called dry washing, and although as yet this process has only been applicable to fairly coarse coal, and has failed to give as perfect purification as washing, it is much cheaper and is apparently sufficiently good to meet commercial requirements in most cases.

Dry washing depends primarily on the fact that anthracite habitually breaks into roundish lumps, while the slates and stones which form its grosser impurities usually occur in flat or at least flattish pieces. If, then, the broken material is put on inclined chutes which have a slope just sufficient to cause the lumps to slide downward by gravity, the anthracite will, in general, roll more or less freely, while the flatter slate will slide. The friction of rolling is far less than that of sliding, and in addition to this, coal even when sliding on iron develops less friction than slate. Therefore, on the whole, the coal travels down the chutes much more rapidly than the slate.

At certain places in the chutes there are gaps, often arranged with a slightly curved lip on the upper side and a drop in the chute on the lower. The coal moving with high velocity jumps these gaps easily, while the slower slate drops through them and is removed on other chutes with other gaps, the whole apparatus being so arranged that lumps of coal or slate which have gone astray will be recovered and returned to their respective destinations.

¹Fig. 25 shows in a diagrammatic way a very complete scheme for crushing, picking, and screening anthracite as operated in some of the Pennsylvania breakers.

The earliest successful machine of the above type was the Emery slate picker, invented and first used in Pennsylvania some years ago.¹ A more recent type of machine making use of the same principle is the spiral picker of Pardee. In this there are no gaps to jump, but the chute is curved in a spiral with an adjustable outer edge or wing. The material runs down the spiral and the coal soon attains such a velocity that it is carried to the outer edge by centrifugal force, and ultimately jumps out of the trough into another surrounding it, which conveys it to the bins. The slate, moving with less velocity, stays in the trough or, in some cases, even works to the inner edge, which is low, and falls inward to a hopper leading to the waste conveyer.

It is obvious that the apparatus just described is unsuitable for very small coal, and it is rarely used for stuff smaller than $\frac{1}{2}$ ", the finer sizes being cleaned either by washing or by being passed over screens with long, narrow slots which pass the thin flakes of slate but keep the rounder pieces of coal.

As anthracite is not only useless for coking, but does not even agglomerate in burning, there is almost no present use for the very fine sizes except where the conditions justify the manufacture of briquettes.² In the majority of cases in North America this dust is discharged with the slate and other rubbish, the material often being used for filling the mine workings.

(O) Bankhead³

The Canadian Pacific Railway Company owns at Bankhead, near Banff, Alberta, the only anthracite cleaning plant in Canada, and the following outline will describe it sufficiently for present purposes.

The coal is raised in mine cars by incline to the top of the "breaker," where it is screened through 3" bars and the over-size hand sorted into pure coal and bony coal, the waste rock being discarded.

The pure coal is crushed through rolls and screened to the several sizes from 3" down, which have already been named. These sizes are hand picked to remove any rubbish that may have been overlooked and then each is delivered to its proper bin by chutes arranged to minimize breakage.

The bony coal is similarly crushed, and it and the original screenings through 3" are similarly but separately sized, first on fine screens to remove the dust and then on a series of shaking screens making the sizes above named.

The sizes above 2 $\frac{1}{4}$ " are hand picked only, those between 2 $\frac{1}{4}$ " and 1" are put over Emery machines and then hand picked, those between 1" and $\frac{1}{2}$ " are put over slater bars and then over Emery machines, and those under $\frac{1}{2}$ " go to slater bars alone. All are then sent to their proper bins by chutes similar to those used for the pure coal.

¹The Langerfeld separator illustrated in Fig. 26 is of this same type.

²Coal dust is now being successfully used in boiler furnaces etc., and this practice will probably increase very greatly; but it is only possible in specially constructed furnaces.

³See Stockett and Warden, Jour. Canadian Mining Institute, IX, p. 261. This coal is included in the trials.

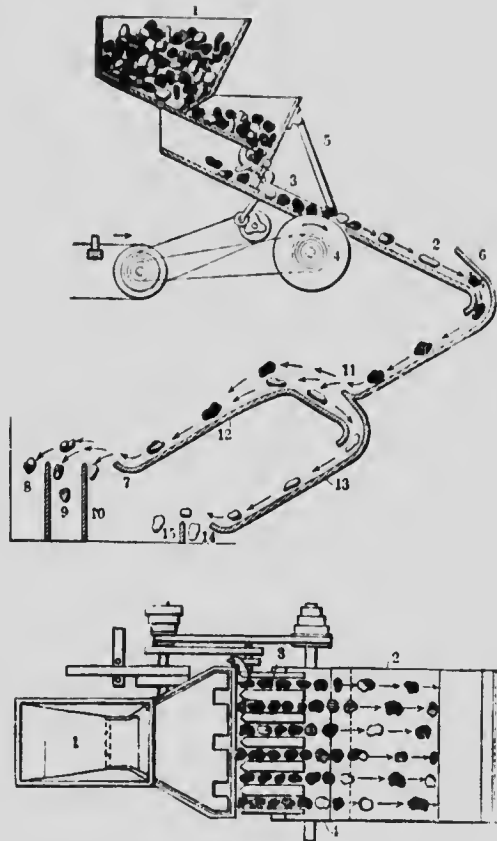


Fig. 26. Elevation and plan of Langerfield dry separator (slate picker).

11
12
13
14
15
16
17
18
19
20
21
22
23
24
25
26
27
28
29
30
31
32
33
34
35
36
37
38
39
40
41
42
43
44
45
46
47
48
49
50
51
52
53
54
55
56
57
58
59
60
61
62
63
64
65
66
67
68
69
70
71
72
73
74
75
76
77
78
79
80
81
82
83
84
85
86
87
88
89
90
91
92
93
94
95
96
97
98
99
100
101
102
103
104
105
106
107
108
109
110
111
112
113
114
115
116
117
118
119
120
121
122
123
124
125
126
127
128
129
130
131
132
133
134
135
136
137
138
139
140
141
142
143
144
145
146
147
148
149
150
151
152
153
154
155
156
157
158
159
160
161
162
163
164
165
166
167
168
169
170
171
172
173
174
175
176
177
178
179
180
181
182
183
184
185
186
187
188
189
190
191
192
193
194
195
196
197
198
199
200
201
202
203
204
205
206
207
208
209
210
211
212
213
214
215
216
217
218
219
220
221
222
223
224
225
226
227
228
229
230
231
232
233
234
235
236
237
238
239
240
241
242
243
244
245
246
247
248
249
250
251
252
253
254
255
256
257
258
259
260
261
262
263
264
265
266
267
268
269
270
271
272
273
274
275
276
277
278
279
280
281
282
283
284
285
286
287
288
289
290
291
292
293
294
295
296
297
298
299
300
301
302
303
304
305
306
307
308
309
310
311
312
313
314
315
316
317
318
319
320
321
322
323
324
325
326
327
328
329
330
331
332
333
334
335
336
337
338
339
340
341
342
343
344
345
346
347
348
349
350
351
352
353
354
355
356
357
358
359
360
361
362
363
364
365
366
367
368
369
370
371
372
373
374
375
376
377
378
379
380
381
382
383
384
385
386
387
388
389
390
391
392
393
394
395
396
397
398
399
400
401
402
403
404
405
406
407
408
409
410
411
412
413
414
415
416
417
418
419
420
421
422
423
424
425
426
427
428
429
430
431
432
433
434
435
436
437
438
439
440
441
442
443
444
445
446
447
448
449
450
451
452
453
454
455
456
457
458
459
460
461
462
463
464
465
466
467
468
469
470
471
472
473
474
475
476
477
478
479
480
481
482
483
484
485
486
487
488
489
490
491
492
493
494
495
496
497
498
499
500
501
502
503
504
505
506
507
508
509
510
511
512
513
514
515
516
517
518
519
520
521
522
523
524
525
526
527
528
529
530
531
532
533
534
535
536
537
538
539
540
541
542
543
544
545
546
547
548
549
550
551
552
553
554
555
556
557
558
559
560
561
562
563
564
565
566
567
568
569
570
571
572
573
574
575
576
577
578
579
580
581
582
583
584
585
586
587
588
589
590
591
592
593
594
595
596
597
598
599
600
601
602
603
604
605
606
607
608
609
610
611
612
613
614
615
616
617
618
619
620
621
622
623
624
625
626
627
628
629
630
631
632
633
634
635
636
637
638
639
640
641
642
643
644
645
646
647
648
649
650
651
652
653
654
655
656
657
658
659
660
661
662
663
664
665
666
667
668
669
670
671
672
673
674
675
676
677
678
679
680
681
682
683
684
685
686
687
688
689
690
691
692
693
694
695
696
697
698
699
700
701
702
703
704
705
706
707
708
709
710
711
712
713
714
715
716
717
718
719
720
721
722
723
724
725
726
727
728
729
730
731
732
733
734
735
736
737
738
739
740
741
742
743
744
745
746
747
748
749
750
751
752
753
754
755
756
757
758
759
760
761
762
763
764
765
766
767
768
769
770
771
772
773
774
775
776
777
778
779
780
781
782
783
784
785
786
787
788
789
790
791
792
793
794
795
796
797
798
799
800
801
802
803
804
805
806
807
808
809
810
811
812
813
814
815
816
817
818
819
820
821
822
823
824
825
826
827
828
829
830
831
832
833
834
835
836
837
838
839
840
841
842
843
844
845
846
847
848
849
850
851
852
853
854
855
856
857
858
859
860
861
862
863
864
865
866
867
868
869
870
871
872
873
874
875
876
877
878
879
880
881
882
883
884
885
886
887
888
889
890
891
892
893
894
895
896
897
898
899
900
901
902
903
904
905
906
907
908
909
910
911
912
913
914
915
916
917
918
919
920
921
922
923
924
925
926
927
928
929
930
931
932
933
934
935
936
937
938
939
940
941
942
943
944
945
946
947
948
949
950
951
952
953
954
955
956
957
958
959
960
961
962
963
964
965
966
967
968
969
970
971
972
973
974
975
976
977
978
979
980
981
982
983
984
985
986
987
988
989
990
991
992
993
994
995
996
997
998
999
1000

An interesting feature of this plant is the use now made of the dust below 1". This material was at first all wasted as it is too fine to be burned even on special grates, but a considerable tonnage is now made into briquettes by admixture with tar, followed by compression. These briquettes make an excellent fuel, both for locomotive and household use,¹ and it is evident that the whole of the dust can be advantageously treated in this way as soon as a sufficient supply of tar can be obtained from the neighbouring coke ovens in the Crowsnest district.

TESTS IN THE LABORATORY.

INTRODUCTION.

The coals tested range from anthracite and semi-anthracite through the whole series of bituminous coals to lignites containing nearly 30 per cent of water, and include fuels of every grade, some of the samples equalling the best coals of the United States and almost equalling the highest grades of Welsh coals, while others contain so much ash or sulphur, or are so friable and dirty, that they are of little or no value except for use in the immediate neighbourhood of the collieries.

The best of the coals will never need washing, and under the present conditions of supply and demand it is probable that the majority of Canadian coals now being mined can be sufficiently purified by screening and hand picking, as already practised at most collieries; but quite a number of them can be decidedly improved by more thorough treatment, and some are virtually worthless until so treated.

A number of collieries are even now washing either their whole product or their slack, and as the industries of the country develop and the demand for coal becomes greater and more discriminating, the number of coals which can be washed with profit will increase. The change will probably first be made in the coke-producing districts of the west; but it is probable that even fuel coals will soon be sized and washed more extensively than at present, especially as consumers are already beginning to appreciate the advantage of using fuel of uniform grade and size, and mine managers are beginning to be forced by the increasing depth of their mines and the greater consequent cost of mining, to utilize the small and dirty seams which are now to a considerable extent neglected.

In laying out the present series of tests it was, therefore, considered necessary, not merely to wash all samples which were likely to be commercially improved by such treatment, but also to examine all of the samples as to what may be called their theoretical or ideal suitability for washing, irrespective of present commercial conditions.

The theoretical tests were made first in all but a few cases, and on the original main sample. It was thus possible to determine in advance whether the practical test would be likely to yield satisfactory results. The

¹These briquettes are included in the trials.

practical tests were then made on all coals which could be considerably improved by washing, and also on certain coals with which commercial failure was anticipated but where the washing was hoped to yield results of scientific interest.

In the following pages both of the methods above referred to will be described in some detail and one test will be given in full, followed by a summary statement of the results of all tests and the general conclusions to be drawn from them. The detailed results of the whole series of tests will be given in Vol. III, appendix I.

The theoretical washing tests were of two kinds, the first dealing with the specific gravity of the coal, and the second with its strength to resist handling, transportation, and crushing. Both were accompanied by numerous determinations of ash and, where necessary, of sulphur.

The specific gravity of coal has already been somewhat discussed. No two coals are exactly alike, but the variations due to other constituents than ash are comparatively small, and all pure bituminous coals, from Canadian localities at least, may be said to have a specific gravity between 1.265 and 1.325. The impure coals range from the higher of these figures to, say, 2.0, which is the minimum specific gravity of bituminous shale or slate; but it is probable that few, if any, coals which have specific gravity over 1.6 are worth burning, and, excepting the anthracites and possibly one or two other special coals, a specific gravity of 1.55 may be taken as the approximate density of the most impure coals that can be profitably burned for commercial purposes.

The above figures are approximate only, and the only way to get exact information regarding any one coal would be to carry on a number of washing tests so arranged that the products of the successive trials would make a series from a very clean coal, from which all bone had been eliminated, to a coal but little better than the original material. Each of these washed coals would then have to be tested under a boiler with suitable grates, etc., and the results of these trials would have to be calculated back to the corresponding quantities of raw coal. Account would also have to be taken of the difference in cost of each class of washing, the cost of dealing with the ash and clinker in each case, and of various other more or less important items affecting the use of the fuel. It would thus be possible by an exhaustive series of large scale tests on any one coal to determine the exact degree of washing which would yield a unit quantity of steam at the lowest cost, but the expense of the investigation would be very great and the results would only be true for one particular place, namely, the immediate vicinity of the washing. The cost of transportation plays so great a part in determining the price of coal to the consumer, that fuel which is to be transported a considerable distance can stand purification expenses which would be altogether unjustifiable if it were to be used on the spot.

SPECIFIC GRAVITY DETERMINATIONS

The actual method of conducting the specific gravity tests is to crush

the coal to whatever size has been determined upon as suitable, and to mix weighed portions of it with solutions of calcium chloride and calcium nitrate which have been prepared to give the desired densities. The light coal floats, the heavy portion sinks, and a few particles of the same specific gravity as the solution remains in suspension. After giving the coal time to free itself from air bubbles¹ and to settle, the float is decanted, the settlings are filtered, and both are washed separately and their percentages of ash and sulphur determined by the chemist.

In the majority of cases the separations were made in special funnels, and solutions of approximately 1.325, 1.375, 1.425, and 1.550 were used, fractionating the coal into five products which for convenience were called pure coal, low, medium, and high ash bone, and refuse.

It proved so difficult to keep the solutions at exactly the desired specific gravity that approximate strengths had to be used and their specific gravity accurately determined for each case. The results were then plotted and curves drawn, and the corresponding percentages for the standard gravities were read from these curves. Appendix I gives both the experimental and calculated data and the curves are also included in all cases.

In some cases, especially at great difficulty was experienced in getting the coal to settle or in some of the results are for this reason less accurate than might be expected. In the later tests made the difficulty was obviated by the use of a large funnel especially designed and built by Mr. G. L. Burland, a Fourth Year student in Mining Engineering in 1899-10. Ordinarily, however, the funnels used proved amply accurate.

Obviously, the size to which the coal is crushed plays a considerable part in determining the properties of the several grades, especially in the intermediate sizes. It was, of course, necessary to adopt a standard size and after some experimenting it was decided to crush the sample until it could all be put through a standard 1.06 mm. sieve. This size is, of course, arbitrarily chosen; but it is at once fine enough to ensure the separation of all coal fit for use and yet not so fine as to reduce the coal to impalpable powder. All of the tests were made on coal of this size and there seems no reason to regret its adoption as a standard.

In summarizing the results, the pure coal and the bone grades are grouped as one, "bone," and this combined with the useful coal is again classed as useful coal. The tables and curves in the appendix can be referred to for more detailed information.

SCREENS

Screen analyses to determine the fineness and the character of the ash-bearing materials were conducted as follows:

The so-called main samples (see p. 160) had already all been crushed

¹ In some cases it is necessary to moisten the coal thoroughly with absolute alcohol before putting it in the heavy solution, as otherwise it is impossible to get the coal free from bubbles and thoroughly wet.

under as nearly as possible identical conditions to pass a standard $\frac{1}{2}$ " screen. A representative portion of this sample was removed by riffing and 100 grams were put through a set of standard sieves as follows:—

Size $\frac{1}{2}$ "	6.34 mm.	Size 24 mesh	0.64 mm.
" $\frac{1}{4}$ "	3.16 mm.	" 50 "	0.30 mm.
" 14 mesh	1.20 mm.	" 100 "	0.153 mm.

The portion remaining on each sieve was weighed and analysed for ash and the results plotted to give two curves:—

- (a). Showing the percentage of each size.
- (b). Showing the percentage of ash in each size.

In plotting, the size of each lot was taken to be equal to the average of the last mesh passed through and that which it just failed to pass, thus the material which had passed the $\frac{1}{2}$ " = 6.34 mm. sieve and failed to pass the $\frac{1}{4}$ " = 3.16 mm. is assumed to have an average diameter of 4.75 mm., and so on, as per the tables. This assumption is not exactly true, but the results are relatively correct and absolutely satisfactory for the purposes for which the figures were used.

The results of the above tests give an excellent indication of the friability of the coal in the matter of fine sizes and dust, the several coals ranging in the order of their percentages of fine material. The test does not, however, indicate very clearly the strength of the coarse lumps, as some coals stand fairly well in lump, yet once broken are easily reduced to powder; while other coals break rather easily to moderately small sizes but pulverize with comparative difficulty. On the whole, however, the results of the tests agree fairly well with observations made on coarser material, and at least shed some light on the important practical question of how the coals will stand handling and shipment without undue production of slack.

The ash determinations in the several sizes show whether the pure or the impure material is the stronger, and in some cases aid materially in interpreting the results of the washing trials.

Unfortunately it was not decided to make screen analyses until a number of samples had been tested in other respects, and the reserve sample crushed too fine to permit of results in parallel with the standard trials. Fortunately, however, the coals omitted were all from one section of the country.

WASHING TESTS PROPER.

The tests just described, and the washing experiments proper, were all performed in the ore-dressing laboratories of the Mining Department of McGill University. These laboratories are on the ground floor of the Macdonald Chemistry and Mining Building, and their general layout and equipment are shown in Fig. 1. The apparatus used for crushing consisted of a Comet rock breaker (See Plate xxxviii and Fig. 27) and a set of belt driven 12" \times 16" high speed, steel rolls. The Comet breaker, which is driven by a 15 H.P. e.e. motor, has a capacity of 8 to 10 tons per hour. The coal, which had already been crushed to pass a 3" screen in connexion with

s

h

of
e
e
e
e
es

y
n
r,
d
le
h
ts
st
ill

or
in

er
ed
y,

all
ill
ld
re
ek
gh
P.
eh
th



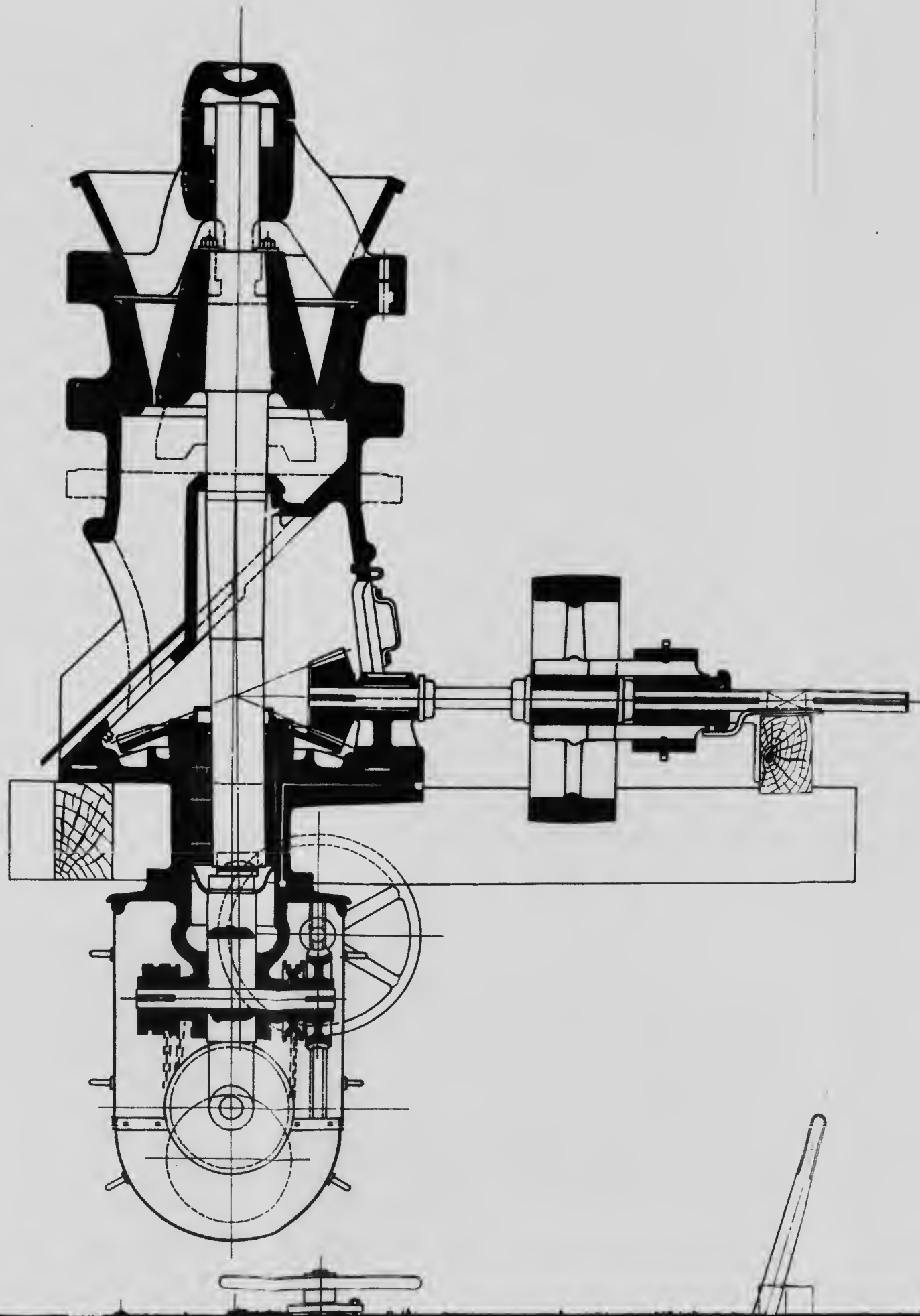
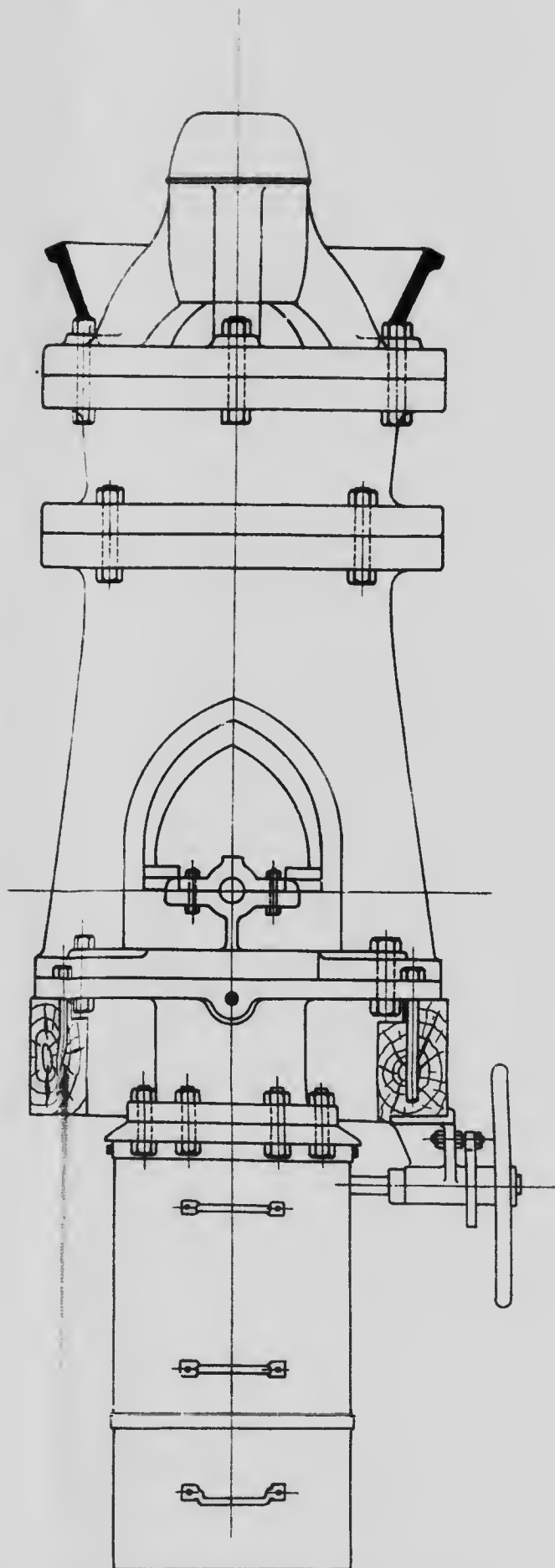
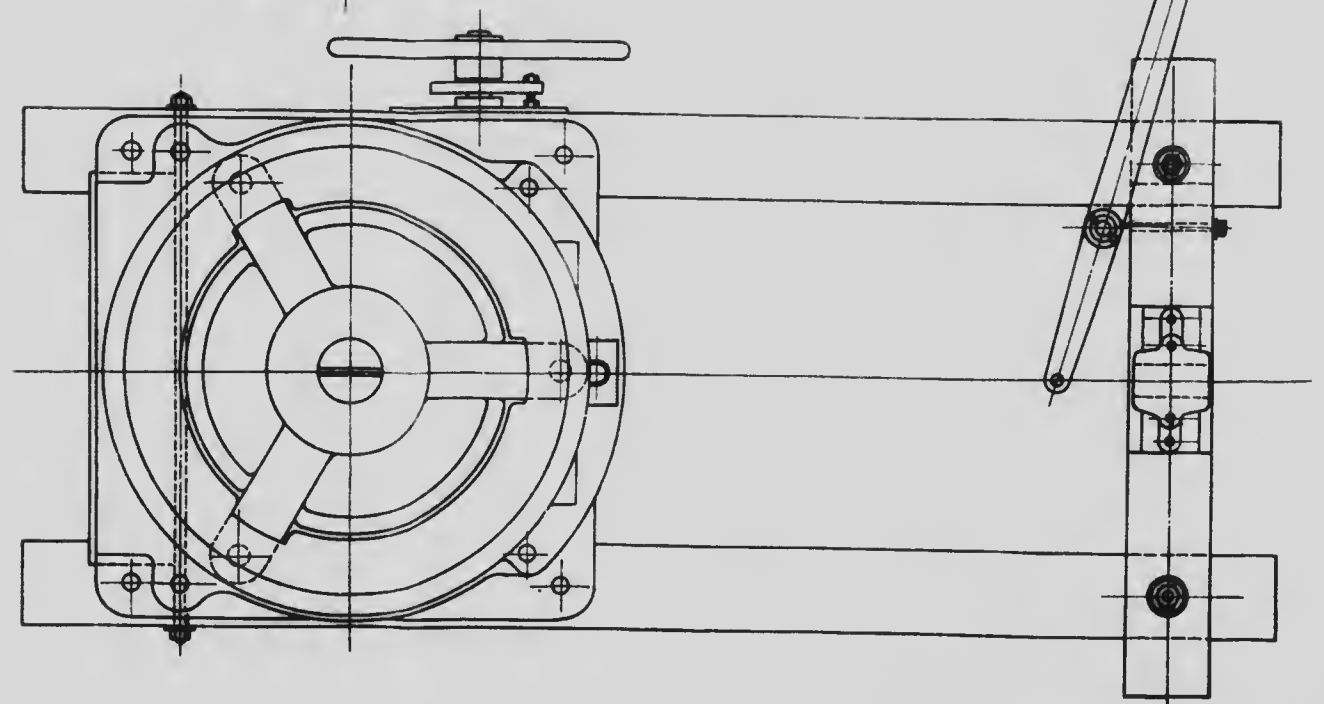
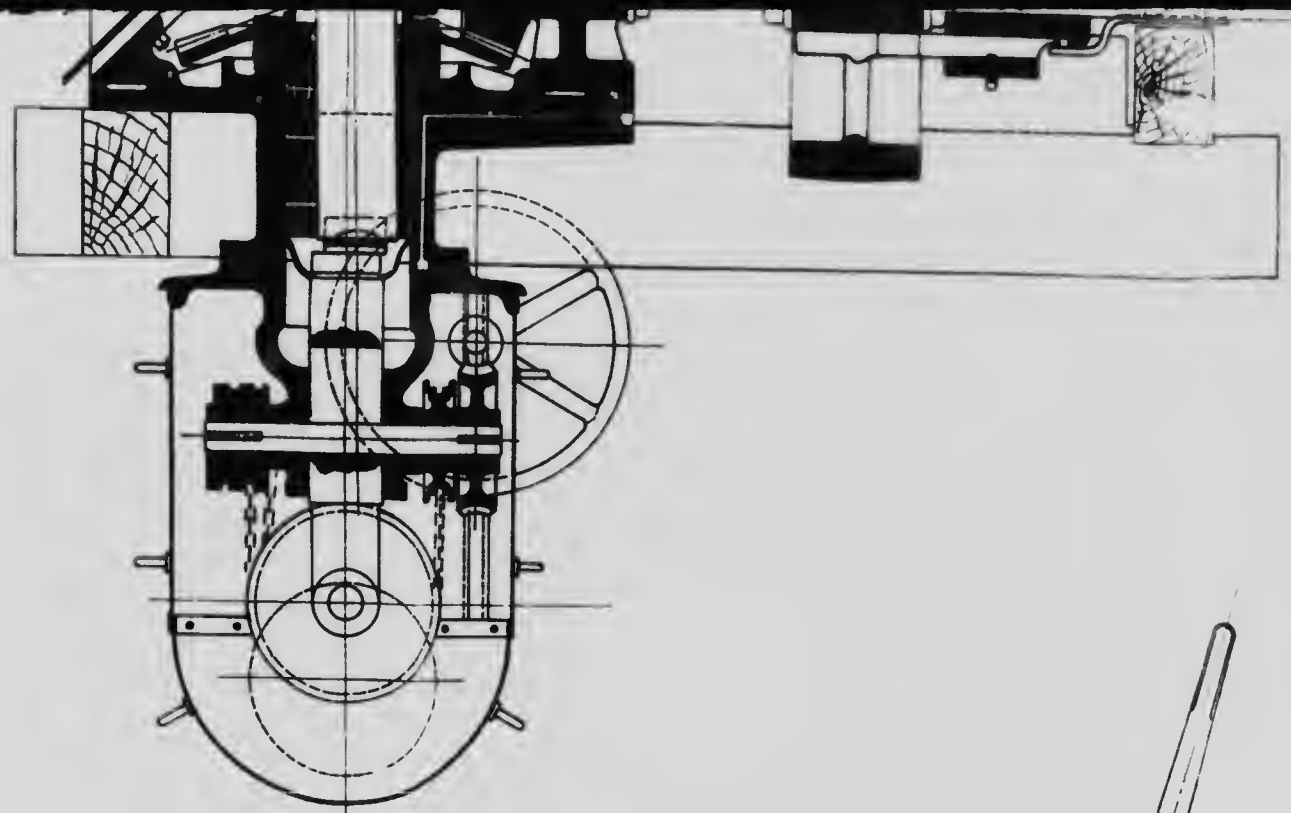
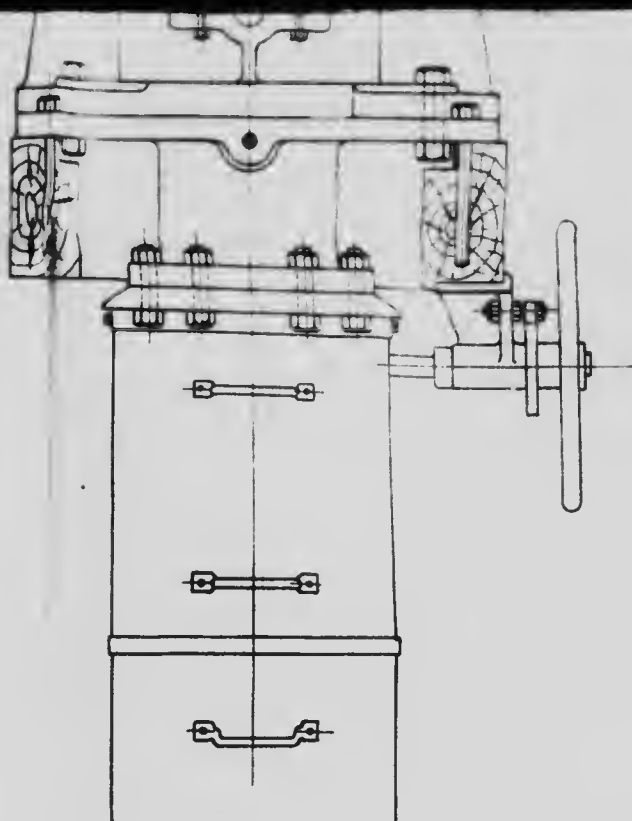


FIG 27







— ADJUSTABLE COMET BREAKER. —

— MINING DEPARTMENT, —

— MCGILL UNIVERSITY MONTREAL, —

under as
A repres
were put

The
and the

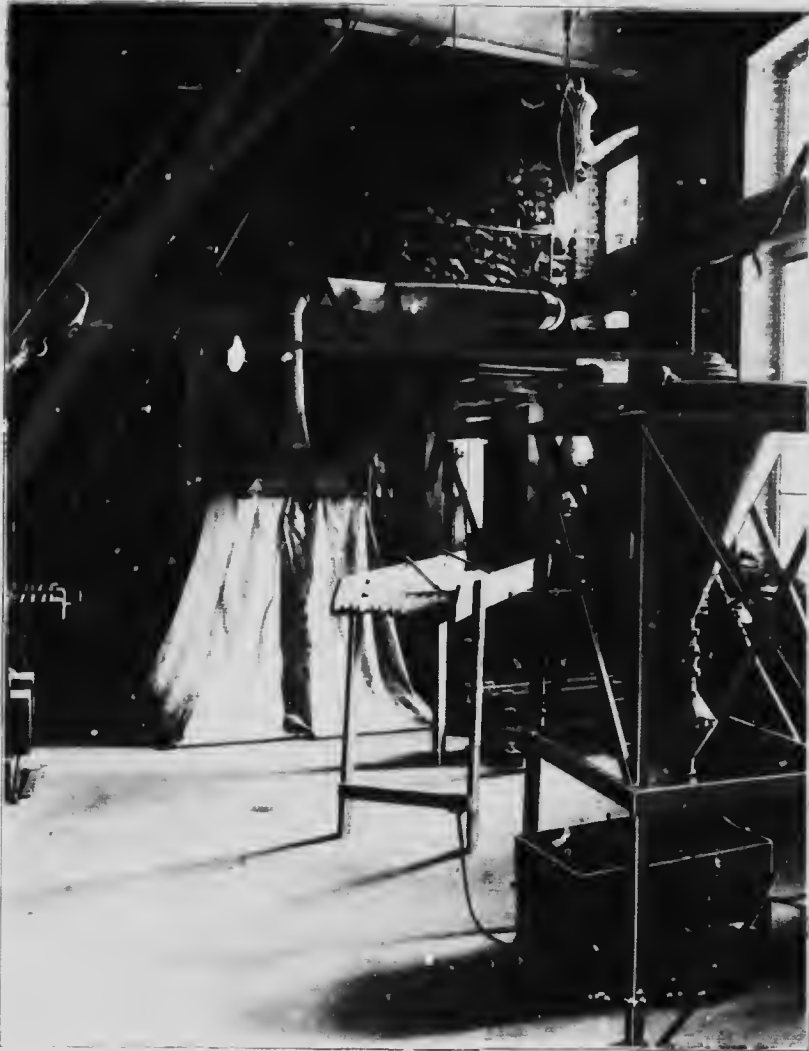
In
the last
material
 $\frac{1}{8}$ " 3.1
and so
results
for whic

The
of the e
the ord
indicate
fairly w
other co
compar
agree fi
shed so
stand h

Th
the imj
"

too fine
howeve

Th
perform
Univer
Chen
shown
breaks
speed,
e.e. m
had a



Crusher platform, bar screen, Robinson washer, and dust exhaust. Department of Mining and Ore Dressing, McGill University.



sampling operations, was, in each case, further crushed to 1" in the Comet breaker, and, after the necessary mixing and third shovelling already described under sampling, was automatically raised by a belt and bucket elevator to a revolving screen with three fields, perforated respectively with $\frac{1}{4}$ ", $\frac{1}{2}$ ", and $\frac{3}{4}$ " round holes (See Plates xxxix and xl). This screen discharged the material in four sizes, viz., $\frac{1}{4}$ " to 0, $\frac{1}{2}$ " to $\frac{1}{4}$ ", $\frac{3}{4}$ " to $\frac{1}{2}$ ", and larger than $\frac{3}{4}$ ", each passing down from the revolving screen through canvas chutes to boxes. Each size, after screening, was weighed and sacked.

The washing proper was conducted in an experimental two-compartment jig, of full commercial size, built by Fraser and Chalmers to special designs by Dr. J. B. Porter (See Plates xxxix, xl, and xli, and Fig. 13.) This jig, which is of standard size, with sieve compartments 32×22 , is provided with several interchangeable mechanisms for giving motion to the water, but in all of the experiments in question the slide mechanism figured in the plates was employed and adjusted to give the pulsion stroke in half the time of the suction. The jig is driven by belts from a pair of coned pulleys arranged to give any desired speed from 90 to 175 R.P.M., the cones being driven by a 15 H.P. c.c. motor. The water supply for the jig is drawn from a storage tank in the roof of the laboratory, and connexions are so arranged as to make the supply independent of any possible variations in the pressure of water in the city mains primarily furnishing the supply. The hydraulic water was led into the jig under the plungers, each compartment having its own supply. By the use of double valves the water could first be adjusted and then shut off completely and turned on again to exactly the same flow. These double valves were also used in measuring the water. The feed water was supplied by a pipe leading into the feed box of the jig. The coal was fed to the jig by a Tulloch feeder (See Fig. 28). A baffle board, 4" deep, was placed across the jig 6" from the feed box, so as to force all the feed to pass under water and so prevent any coal from remaining dry and floating.

Two sizes of coal were separately washed, namely 1" to $\frac{1}{2}$ " and $\frac{1}{2}$ " to $\frac{1}{4}$ ", and screens of $\frac{1}{4}$ " and $\frac{1}{2}$ " mesh respectively were used under the beds. The refuse in the bed was permitted to accumulate on the bed to the proper thickness to ensure good work, and the surplus was then discharged through automatic discharge gates in the side. At the end of the test, the material remaining on the sieves was carefully skimmed by hand, the upper portion, consisting of coal which was suitable for use, being added to the washed coal, while the lower portion was added to the refuse. In some cases, the intermediate layer of mixed coal and refuse was found to be suitable for further washing; if so, it was separately removed, crushed, and added to the finer sizes. The overflow of coal from the jig was discharged with the water into a large box, provided at the end with a fine screen and waste pipes, which in turn led the surplus water and any fine coal to large settling tanks of cement beneath the floor. From this box the coal was transferred to a hopper shaped bin in which it was permitted to drain (See Plates xli and xlii). At the close of each test the settling tanks were pumped out and the settlings removed and dried.

The fine size of coal, from $\frac{1}{8}$ " to 0", being too small for commercial jigging, was either used without further treatment, washed in a Robinson washer, washed on a Willey table, or wasted, as seemed best, after it had been analysed and examined. The Robinson washer (See Fig. 9 and Plates xxxviii and xi) which was used in a few cases only, consisted of a large galvanized iron cone provided with a revolving stirrer, and supply and discharge valves, as in an ordinary Robinson machine, the whole, however, being on a very much smaller scale. Work with this was substantially equivalent to commercial practice, but involved large losses of slime and much trouble in adjusting.

The table employed for a considerable part of the tests was a small Willey concentrator, (See Fig. 18 and Plates xliii, xliiv, and xlv), an instrument eminently fitted for doing good work on material such as coal, but rarely, if ever, used in commercial practice, on account of its comparatively high cost, both primary and in operation. It was, however, found by experiment that the Willey table made possible a separation of the fine coal and refuse which very closely paralleled the work of Campbell tables and other coal washing devices commonly used in practice for similar material, and it was, therefore, deemed proper to use it in a number of tests as being more likely to give results of practical value than any other device which was available in the laboratory. An attempt to use a small Campbell table or any other standard washer would, unquestionably, have given less reliable results.

In the following tables there will be found a complete summary of the results of the whole series of washing trials, together with certain conclusions which have been drawn from them; but the detailed records of the trials, being exceedingly bulky, have been reserved for an appendix (Vol. III) where they are given in full. The complete log of one typical trial is, however, presented as an introduction to the summary statement. It may further be explained that those portions of the summary which give data regarding boiler efficiencies, calorific power, chemical analyses, etc., will be found set forth in great detail in Vol. II, Parts VII and IX, and in their Appendices Vols. IV and VI.

Typical Example of Detailed Log of One Complete Test.

Coal.—No. 37.

Locality.—Reserve, C.B., N.S.

Colliery.—Dominion Coal Co., No. 10 mine, Emery seam.

Sample.—Sample of 125 sacks of unscreened run of mine which, however, had been hand-picked. June 25, 1908.

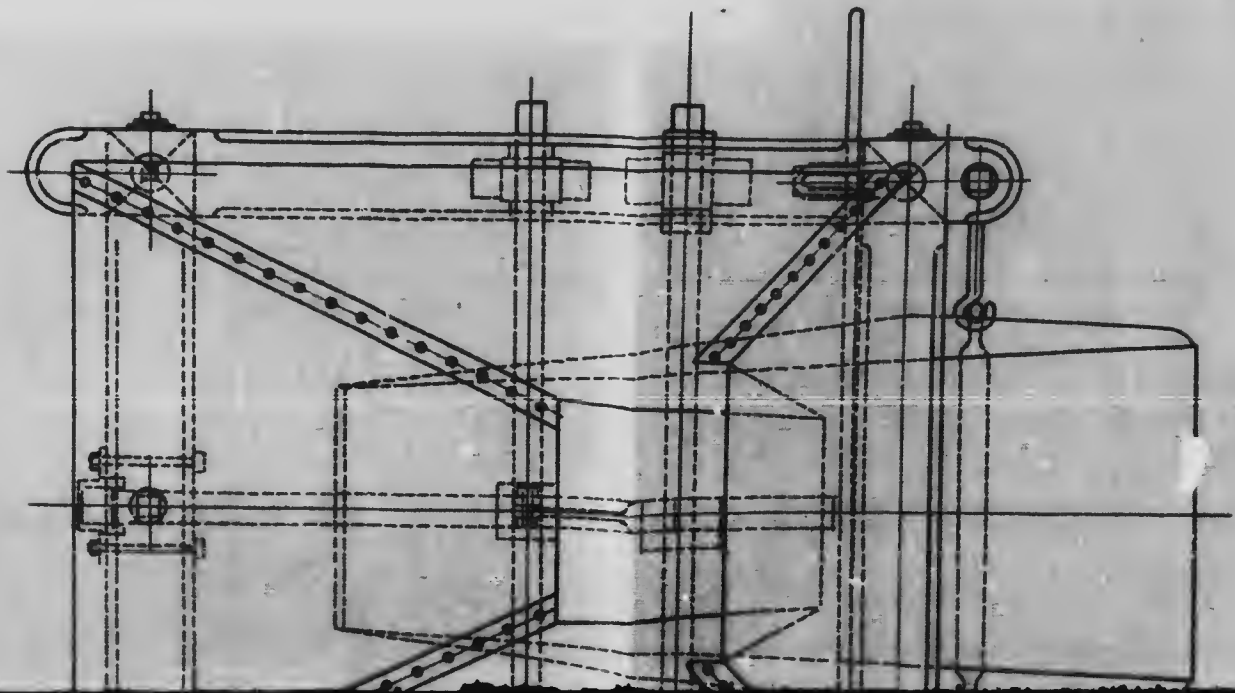
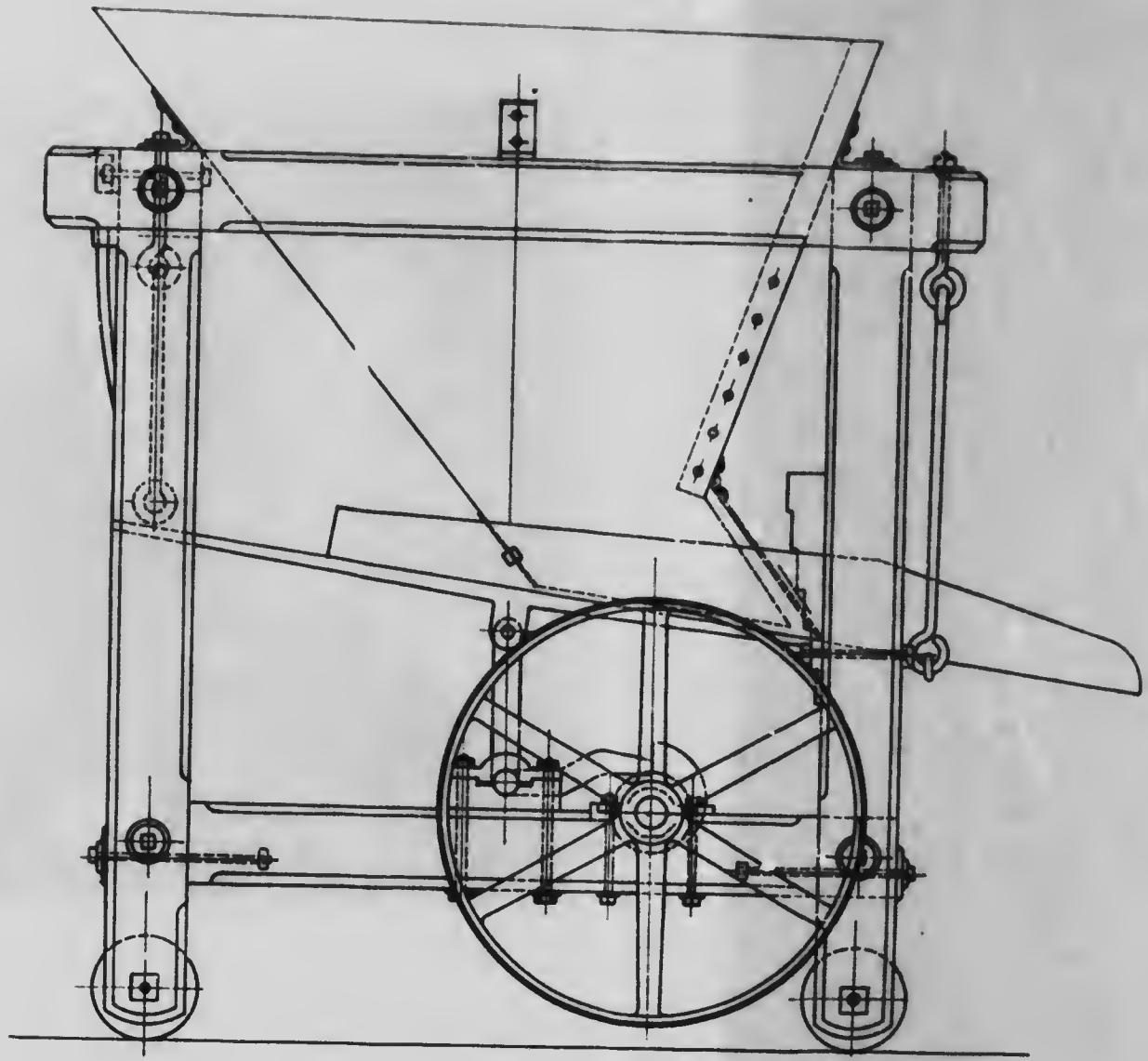
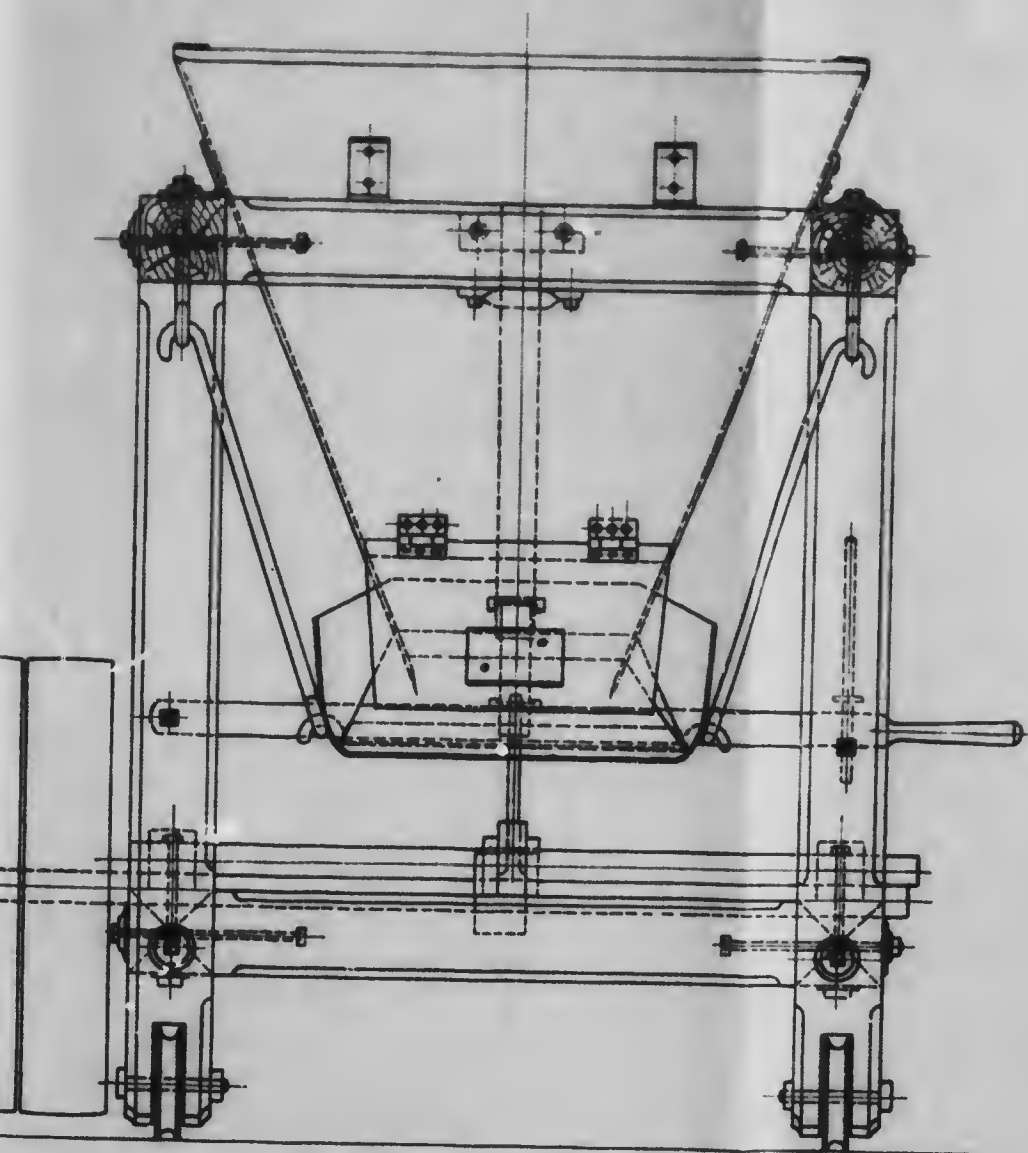
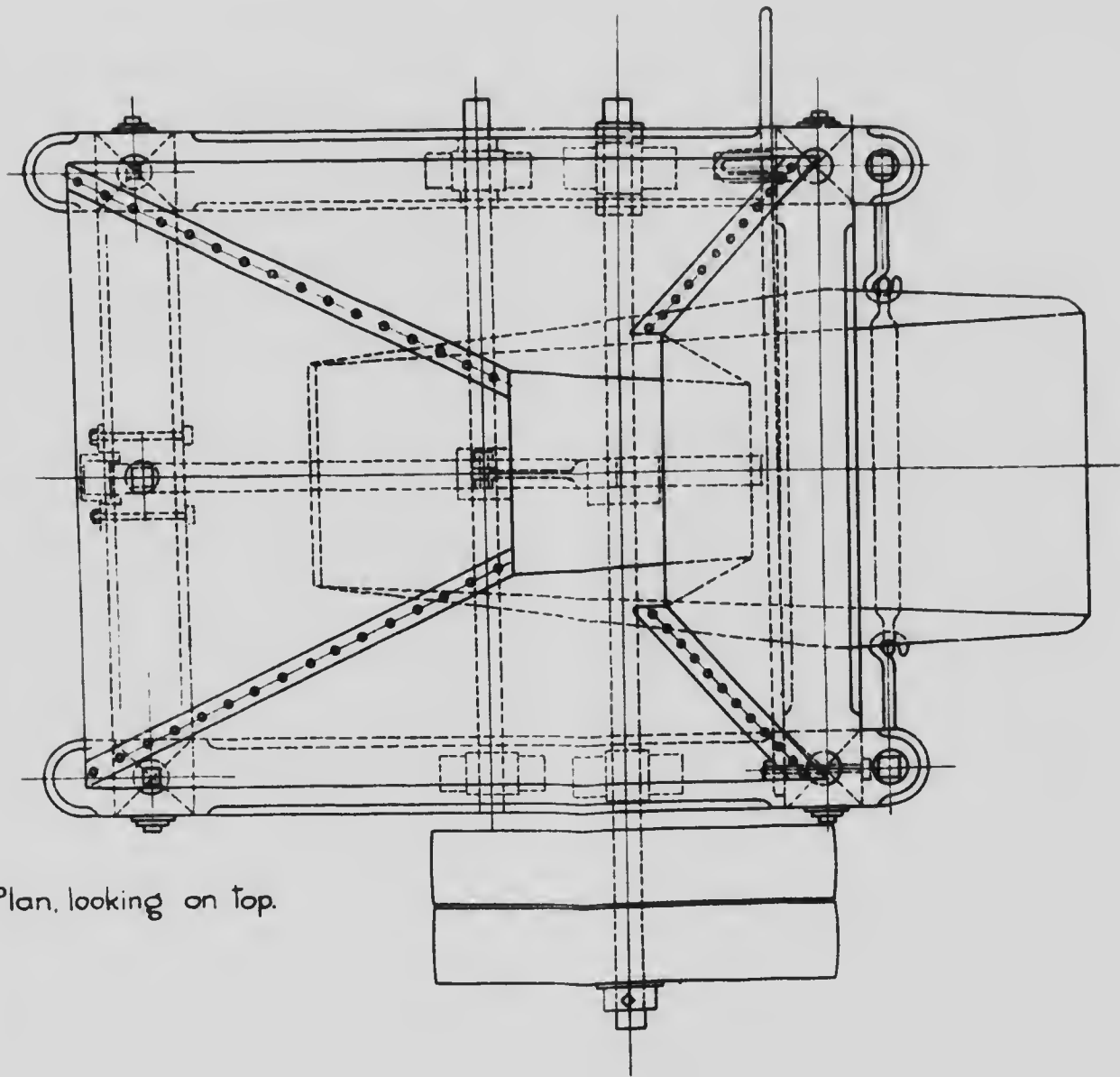


FIG. 28



— TULLOCH ORE FEEDER. —

— MINING DEPARTMENT. —

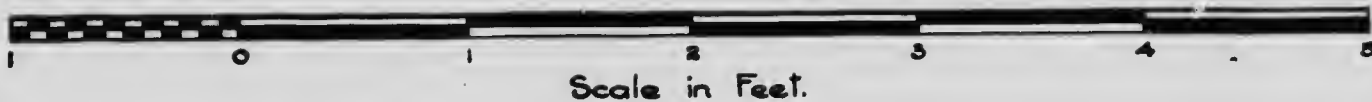


Plan, looking on top.

—TULLOCH ORE FEEDER.—

— MINING DEPARTMENT.—

— M^c GILL UNIVERSITY, - MONTREAL.—



The
was either
washed &
analysed
and (b) w
iron cone
as in an
much su
cial pract

The
Willley &
instrume
coal, bu
comparat
found by
of the f
Campbel
for simila
of tests &
device w
Campbel
given les

In r
results o
which he
being ex
where th
ever, pu
further I
regardin
found se
Appendi

Con

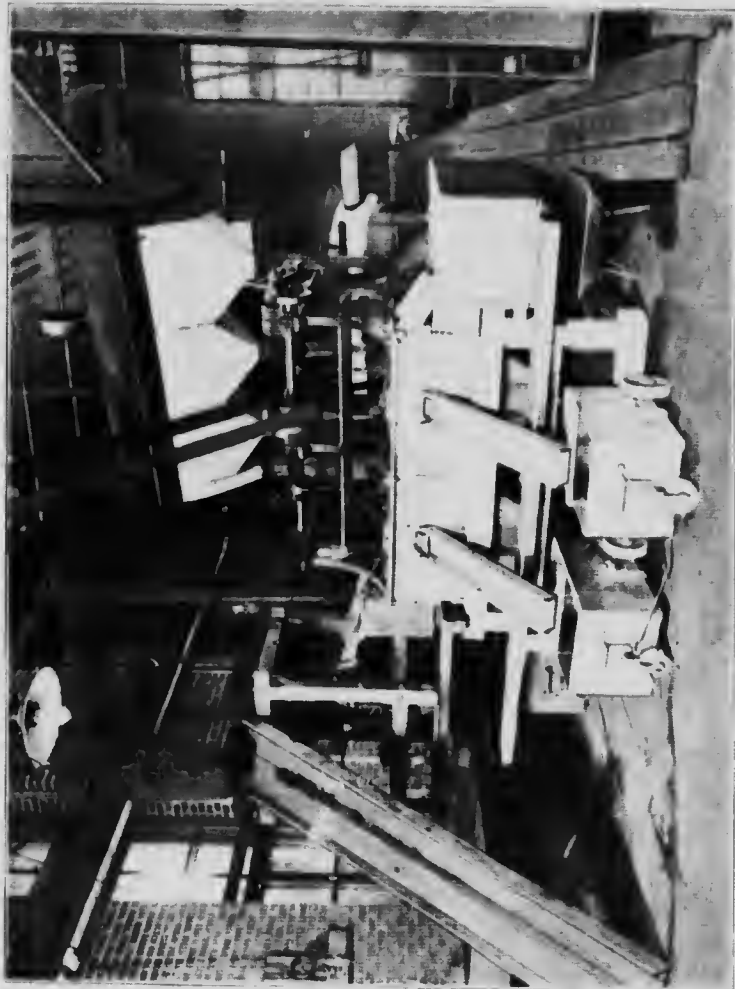
Loc

Coli

Sax

had how

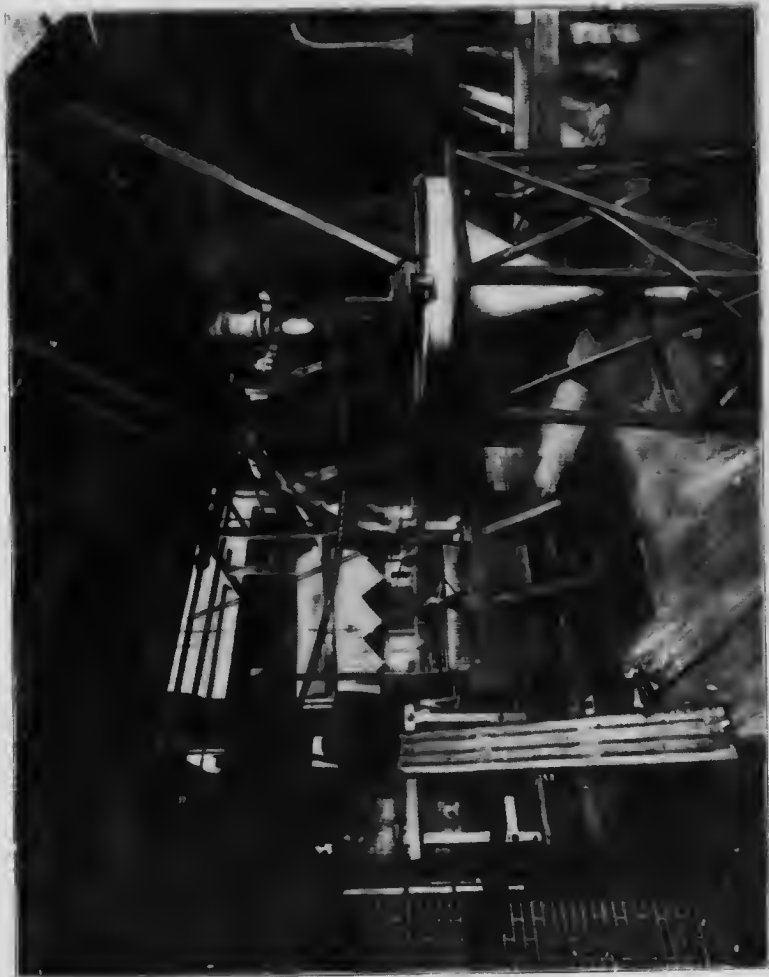
PLATE XXXIX



SERIES, LOCK, AND TWO-COMPARTMENT JIG. DEPARTMENT OF MINING AND ORE-DRESSING, MCGILL UNIVERSITY.



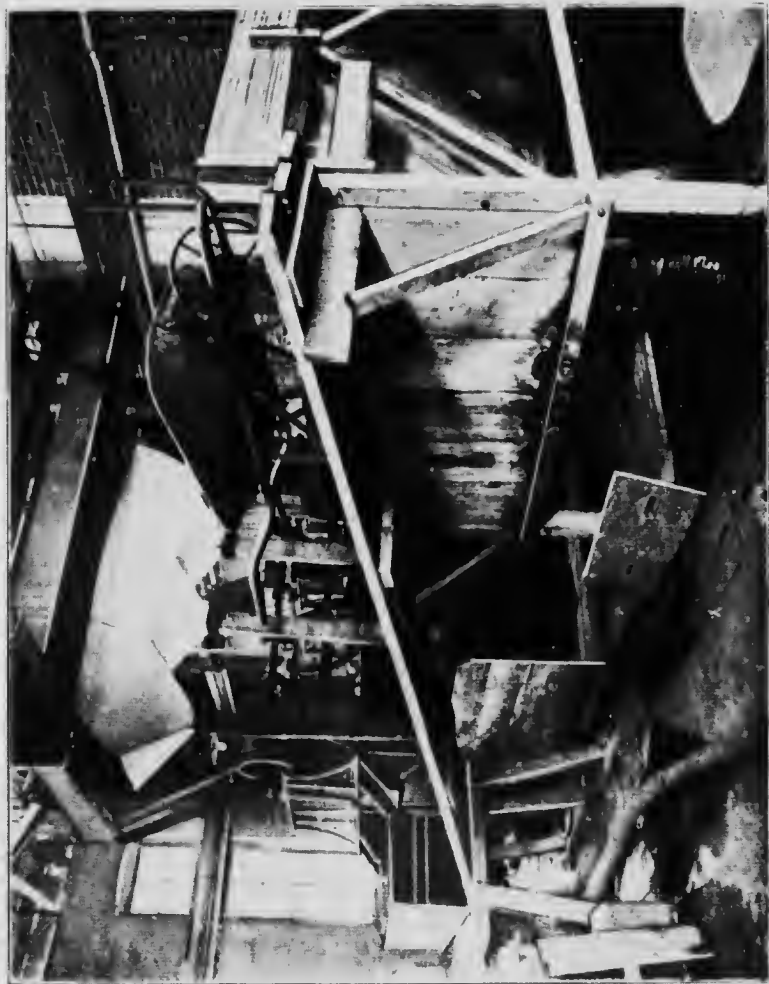
Plate XI.



Revolving screens, fig. Robinson works, Department of Mining and Ore Dressing, McGill University.



Plate XLI.



Drainage bin, screens, and jig. Department of Mining and Ore Dressing, McGill University.

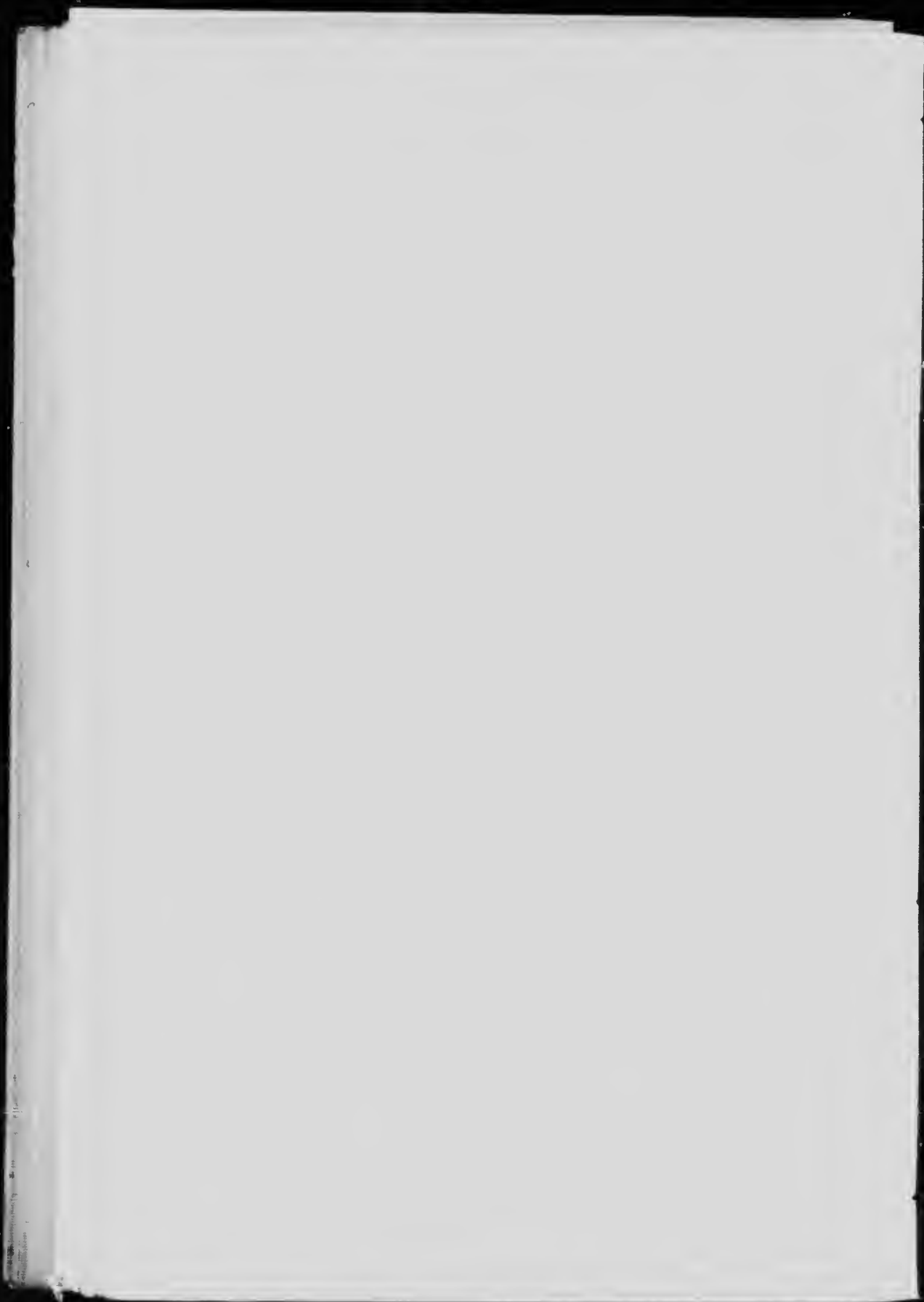
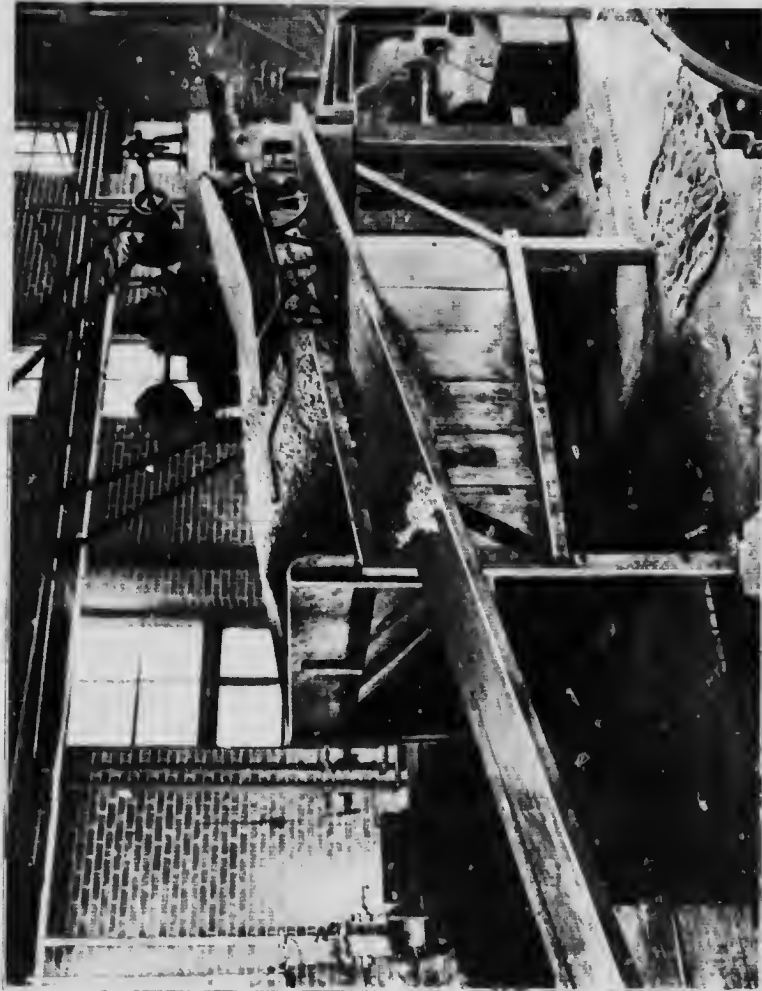


Plate XLII.



Drainage bin for washed coal. Department of Mining and Oil, the McGill University.



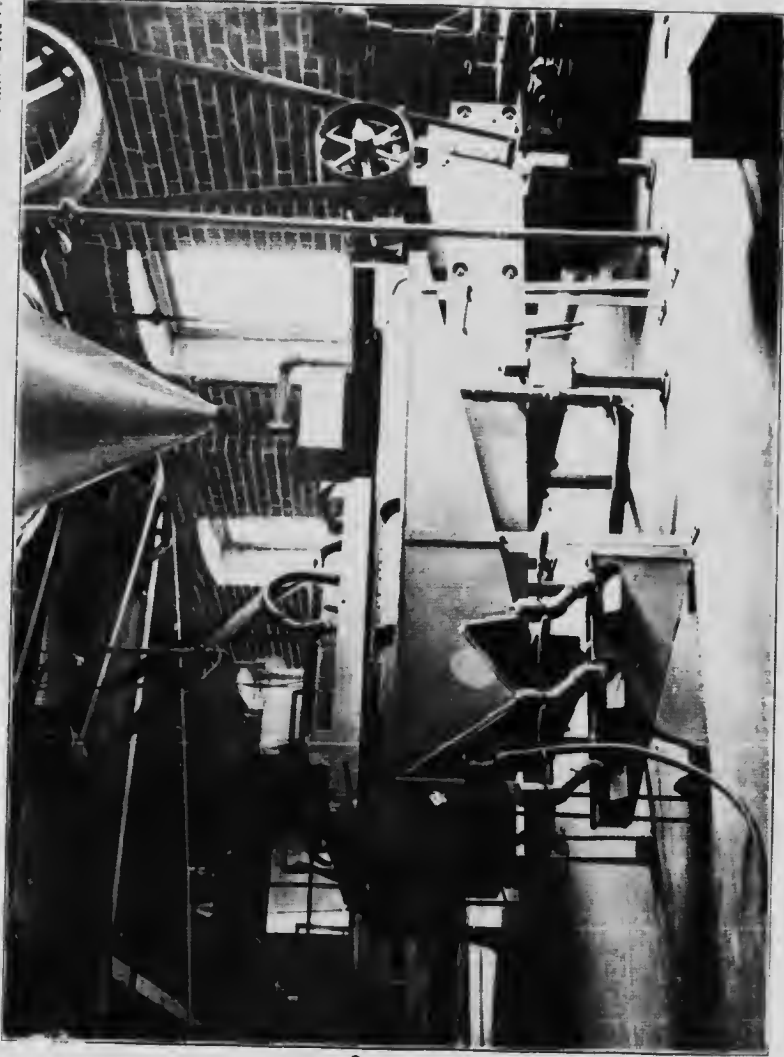
Plate XLII.



General view, fines washing section. Department of Mining and Ore Dressing, McGill University.



Plate XLIV.



Willey table, fines washing section. Department of Mining and Ore Dressing, McGill University.

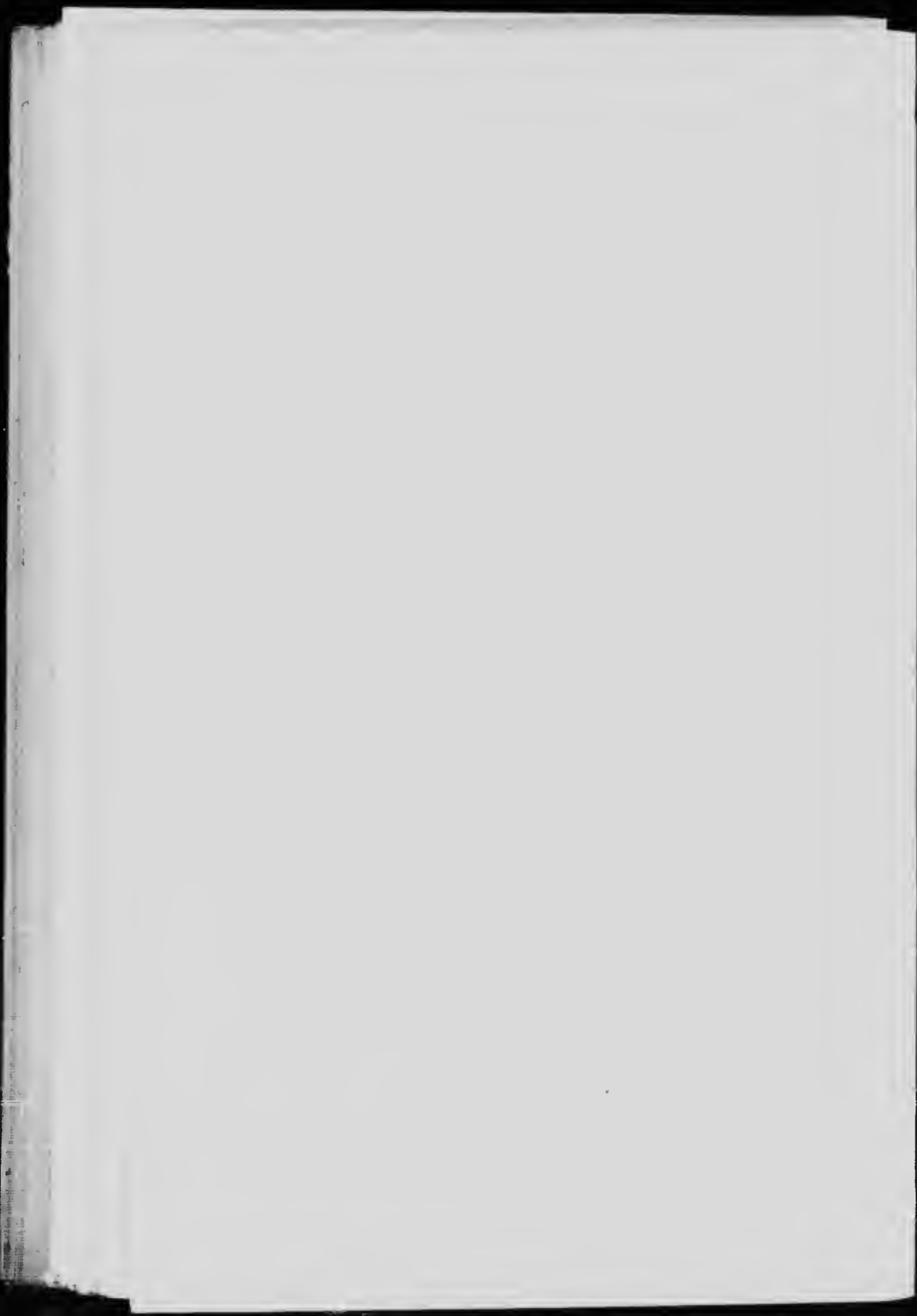
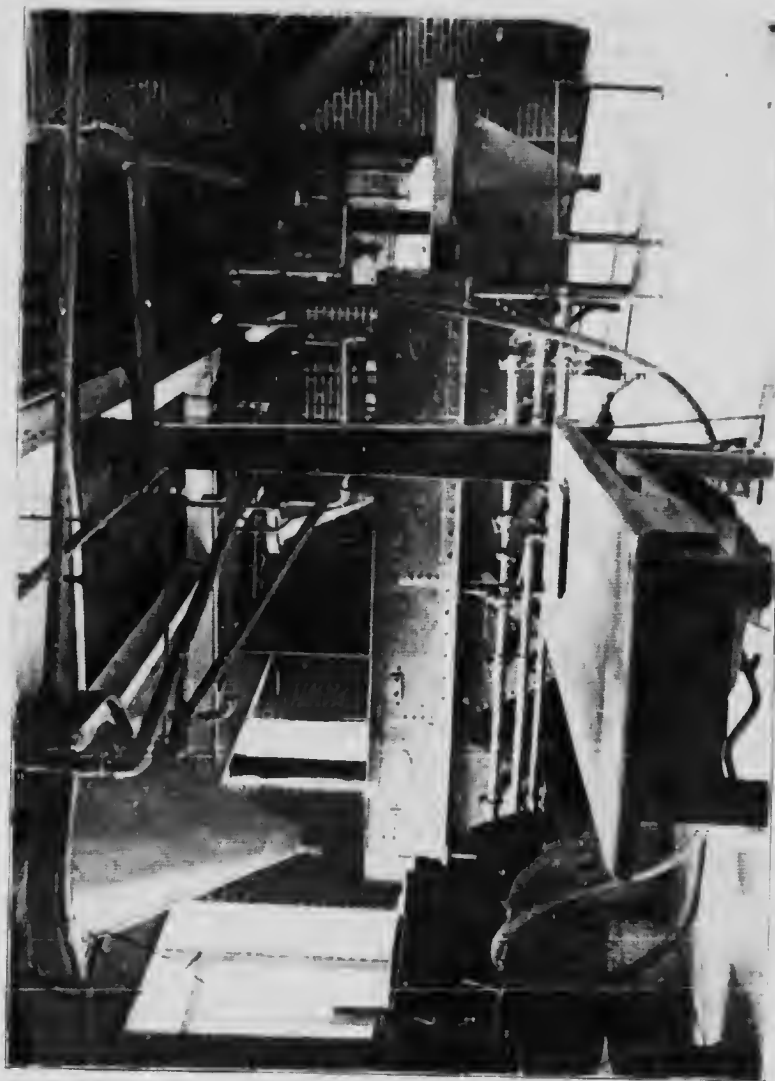


Plate XLV



Settling boxes and cones, fines washing section. Department of Mining and Ore Dressing, McGill University.

1870
1871
1872
1873
1874
1875
1876
1877
1878
1879
1880
1881
1882
1883
1884
1885
1886
1887
1888
1889
1890
1891
1892
1893
1894
1895
1896
1897
1898
1899
1900

(A)

Specific Gravity Tests.

(Coal No. 37)

	Specific Gravity of Solution	Float %	Ash in Float	Sink %	Ash in Sink
(1).....	1.526	86.7	5.1	13.7	58.1
(2).....	1.400	81.1	4.0	18.9	45.2
(3).....	1.360	73.9	3.2	26.1	35.2
(4).....	1.325	57.4	2.4	42.6	23.5

The following results are obtained from the above data and from the chemist's reports:—

- (5) Good coal, sp. gr. under 1.375 %, yield 77.0%, ash 3.5.
- (6) Bone coal, sp. gr. 1.375 to 1.55%, yield 11.0%, ash 18.1.
- (7) Useful coal—sum of (5) and (6), yield 88.0%, ash 5.3.
- (8) Refuse, sp. gr. over 1.55, yield 12.0%, ash 60.0.
- (9) Assay of original sample raw coal as sent to chemist, ash 11.1%.
- (10) Assay of original sample raw coal as sent to chemist, sulphur 2.5%.
- (11) Assay of original sample raw coal as sent to chemist, fuel ratio 1.53.
- (12) Assay of mixed good and bone coal above, fuel ratio 1.43.

Remarks:—The innate ash is higher than in any other of the coals of the neighbourhood. There are, also, large proportions of bone and refuse, the latter, particularly, being high in ash. The coal could be largely improved by washing.

(B)

Screen Analysis.

(Coal No. 37)

	Maximum Screen MM	Minimum Screen MM	Mean Size MM	Per cent of whole Sample	Per cent Ash in Size
(13).....	6.34	3.16	4.75	50.1	11.8
(14).....	3.16	1.20	2.18	17.9	11.6
(15).....	1.20	0.64	0.92	11.5	11.3
(16).....	0.64	0.30	0.47	7.3	10.3
(17).....	0.30	0.173	0.24	6.3	9.7
(18).....	0.173	0.000	0.086	6.9	9.9

Remarks:—The coal is not friable and the proportion of fines in the sample is quite moderate in view of the fact that the sample, itself, was run of mine. The refuse is less friable than the coal.

(C)

(C)

Results of Washing. (Details of Sizes).

Coal No. 37

Original coal and its products	Sizes between 1" and 1 1/2"		Sizes between 1 1/2" and 1 3/4"		Sizes under 1 3/4"	
	Total wt., lbs.	Ash %	Total wt., lbs.	Ash %	Total wt., lbs.	Ash %
(19) Original coal	3,170	10.2	1,757	9.4	1,414	10.2
(20) Washed coal	2,790	5.6	1,569	5.4	1,221	9.73
(21) Refuse coal	480	16.6	174	16.0	306	11.3
(22) Hatch product	0	16.9	8	93.4	0	
(23) Jig slime	0		17	19.4	0	
(24) Table slime	0		0		165	

(D)

Results of Washing. (Totals).

Coal No. 37

	Wt. in lbs.	Ash %	Sulphur %
(25) Original coal	3,170	11.1	2.5
(26) Washed coal	2,790	5.8	2.1
(27) Refuse	480	17.5	
(28) Other products	165		
(29) Loss	0		
(30) Loss in %	0.0		

(E)

Summary Statement of Effect of Washing on Fuel Values.

Coal No. 37

(31) Recovery of washed coal, including good bone	88.5	Ratio 1.00
(32) Reduction in ash	47.8	" "
(33) " " sulphur	16.0	" "
(34) Increase in calorific value — calorimeter	5.7	" "
(35) Increase in evaporation power under boiler	5.8	" "
(36) Decrease in clinker under boiler	52.3	" "
(37) Fuel ratio of original coal	1.53	
(38) " " " washed coal	1.55	
(39) Calorific value of original coal	7,290	
(40) " " " washed coal	7,710	

Remarks on Tables (C), (D), and (E).

The trial was thoroughly successful as far as reduction in ash is concerned. The recovery is also good. The reduction in sulphur should have been better, and no doubt would be in a commercial washery, the product of which should also be even better than the trial in respect to the ash and recovery.



SUMMARY RECORD

Official number of the
report

- Proximate analysis, e
1. Moisture in the check
 2. Volatile matter in m
 3. Fixed carbon "
 4. Ash "
 5. Sulphur "
 6. Calorific value of
 7. Calorific value calcul
- Proximate analysis, e
scale washing te
8. Volatile matter in w
 9. Fixed carbon "
 10. Ash "
 11. Sulphur "
 12. Calorific value of
 13. Calorific value calcul
 14. Ash in refuse from c
- Experimental washin
fine crushed coa
15. Clean coal of under 1
 16. " " " "
 17. Bony " " betwee
 18. " " " "
 19. Refuse of over 1,550
 20. " " " "
 21. Useful coal, being co
 22. " " " "
- Summary statement :
23. Yield of washed coal
 24. Perfection of yield s
tests
 25. Reduction in ash du
 26. Perfection ash redu
tion tests
 27. Reduction in sulphu
 28. Increase in calorific
 29. " " boiler e'
 30. Yield of refuse from
 31. Decrease in clinker i

30=*Gowrie Seam, N.A.* (coal was obtained and tested poorer in quality than any

36=*Hut Seam, Dom. C.* was, however, washed in ore the washed coal is an exception

35=*Harbour Seam, Dom* of what ash there is, and the

35 *SP* = *Phalen Seam,* improvement.

38=*Phalen Seam, Dom*

37=*Emery Seam, Dom.* should wash well. A trial w the market demands it an ex

39=*Langan Seam, Dom* quality. Washing is comm

18=*Main Seam, N.S.S.* ings contain considerable a washing trial shows satisfact

12=*Main Seam, N.S.S.* effect somewhat less improv

*S = Screened coal. P =

TABLE XI
SUMMARY RECORD OF COAL WASHING TESTS, SYDNEY COAL FIELD, CAPE BRETON COUNTY, NOVA SCOTIA.

Official number of the colliery as per list on page 8 of report	No. 50	No. 36	No. 35	No. 35SP	No. 38	No. 37	No. 39	No. 13	No. 12
Proximate analysis, etc., of official samples									
1. Moisture in the cheek sample sealed at mine	%	3.5	2.4	3.4	3.5	4.0	4.9	3.5	5.4
2. Volatile matter in main sample after drying	%	34.7	36.5	38.6	35.0	34.3	35.1	37.4	39.0
3. Fixed carbon	%	53.0	57.6	55.5	59.5	59.8	53.8	55.4	51.3
4. Ash	%	12.3	5.9	5.9	5.5	5.9	11.1	4.8	7.2
5. Sulphur	%	6.4	2.4	3.7	1.8	1.9	2.5	1.8	2.9
6. Calorific value of	Cal.	7010	7700	7780	7800	7780	7200	7660	7600
7. Calorific value calculated to ash free dry coal	Cal.	7990	8180	8270	8250	8270	8200	8050	8150
Proximate analysis, etc., of combined product of large scale washing tests									
8. Volatile matter in washed coal after drying	%	38.2					36.9	40.2	
9. Fixed carbon	%	59.1					57.3	56.2	
10. Ash	%	2.7					5.8	3.5	
11. Sulphur	%	2.0					2.1	1.9	
12. Calorific value of	Cal.	7950					7710	8050	
13. Calorific value calculated to ash free dry washed coal	Cal.	8170					8190	8340	
14. Ash in refuse from coal washing—after drying	%	54.0					47.0	43.5	
Experimental washing tests with heavy solutions on fine crushed coal of official samples									
15. Clean coal of under 1,375	yield %	62.8	90.5	86.5	90.5	88.3	77.5	91.0	87.0
16. " " " " " "	ash %	3.4	1.9	2.8	2.7	2.6	3.5	2.2	1.9
17. Bony " " between 1,375 and 1,550	yield %	20.0	3.5	6.5	7.5	5.2	9.5	3.0	3.5
18. " " " " " "	ash %	12.1	13.8	6.1	12.5	18.2	18.1	5.0	12.2
19. Refuse of over 1,550	yield %	17.2	3.0	7.0	6.0	48.3	60.0	50.0	61.6
20. " " " " " "	ash %	48.6	60.9	50.0	66.0	93.5	87.0	94.0	90.5
21. Useful coal, being combined clean and bony	yield %	82.8	94.9	93.0	98.0	3.5	5.2	2.3	2.3
22. " " " " " "	ash %	5.5	2.4	3.0	3.0				
Summary statement of results of washing									
23. Yield of washed coal—combined product all sizes	%		92.5				88.5	89.4	
24. Perfection of yield as compared with heavy solution tests	%		98.4				101.8	98.7	
25. Reduction in ash due to washing	%		54.3				47.8	51.4	
26. Perfection ash reduction compared with heavy solution tests	%		88.9				89.6	65.7	
27. Reduction in sulphur due to washing	%		16.7				16.0	34.5	
28. Increase in calorific value due to washing	%		3.2				5.7	5.2	
29. " " boiler evaporation due to washing	%		5.6				5.8	4.8	
30. Yield of refuse from washing tests	%		6.9				11.7	8.1	
31. Decrease in clinker in boiler furnace due to washing	%		69.9				52.2	66.1	

Notes and Comments.

(For further data and extended comments, see Volume III)

50=Gowrie Seam, N.A. Collieries Ltd. (S & P)* This coal was not included in the original list as the colliery was closed, but later a small sample of freshly mined coal was obtained and tested. This sample, which, however, may not have truly represented the best that the seam could produce under more favourable conditions, is poorer in quality than any of the other coals sampled in this field. It would, however, apparently wash easily and yield about 10 per cent. of good washed fuel.

36=Hub Seam, Dom. C. Co. No. 7 Mine. (S & P) This coal is quite low in ash and is an excellent fuel, and in a commercial sense it is in no need of washing. It was, however, washed in order to compare the results of a full scale trial with the specific gravity test in the laboratory. The comparison is quite satisfactory and the washed coal is an exceptionally high class fuel.

35=Harbour Seam, Dom. C. Co. No. 9. (S & P). This coal is an excellent fuel as it stands, and was not washed. Its screenings probably carry a considerable part of what ash there is, and the specific gravity tests show that they can be materially improved by washing if desired.

35 SP=Phalen Seam, Dom. C. Co. No. 5. (S & P). The remarks on sample 35 apply also to this coal, except that washing the slack would probably effect less improvement.

38=Phalen Seam, Dom. C. Co. No. 1. (S & P). The remarks on sample 35 apply to this coal.

37=Emery Seam, Dom. C. Co. No. 10. (R. M. & P). This has the highest ash of any of the Dom. C. Co. samples and the specific gravity tests showed that it should wash well. A trial was, therefore, run with satisfactory results. Under present conditions washing is not commercially necessary except for coking, but when the market demands it an excellent washed coal can easily be produced.

39=Lingan Seam, Dom. C. Co. No. 12. (R. M.) Reference to the detailed tests in Volume III will show that this sample indicates a seam of exceptionally good quality. Washing is commercially quite unnecessary, although the screenings might be washed successfully if a very clean slack were desired.

13=Main Seam, N.S.S. & C. Co. No. 1. (S & P). This coal does not require washing for ordinary commercial use, but should be washed for coking. Its screenings contain considerable amounts of ash and sulphur and are regularly washed by the Company, producing an excellent material quite suitable for coking. The washing trial shows satisfactory results which agree well with the Company's returns.

12=Main Seam, N.S.S. & C. Co. No. 3. (S & P). The remarks on No. 13 apply to this coal, although washing is even less necessary and would probably effect somewhat less improvement. The screenings could be washed with advantage but the coal is so like No. 13 that no trial was run.

*S=Screened coal. P=Hand picked to remove rubbish. R. M.=Run of mine

SUMM

Official number of the colli

- Proximate analysis, etc
1. Moisture in the check
 2. Volatile matter in mai
 3. Fixed carbon " "
 4. Ash " "
 5. Sulphur " "
 6. Calorific value of "
 7. Calorific value calcula
- Proximate analysis, etc.
ing tests
8. Volatile matter in was
 9. Fixed carbon " "
 10. Ash " "
 11. Sulphur " "
 12. Calorific value of "
 13. Calorific value calcula
 14. Ash in refuse from coa
- Experimental washing
coal of official sa
15. Clean coal of under 1,
 16. " " " " "
 17. Bony " " between
 18. " " " " "
 19. Refuse of over 1,550.
 20. " " " " "
 21. Useful coal being com
 22. " " " " "
- Summary statement of
23. Yield of washed coal-
 24. Perfection of yield as
 25. Reduction in ash due
 26. Perfection ash reduct
 27. Reduction in sulphur
 28. Increase in calorific v
 29. " " boiler evi
 30. Yield of refuse from
 31. Decrease in clinker in

14=*Inverness Coal, I.C.*
is difficult or impossible to
sulphur materially, and in view
in boilers.

15=*Port Hood Coal, R.R.*
gravity tests indicate greater

4=*Six Foot Seam, A. C.*
would not yield a very high cle
clean coal.

16=*Good Seam, A. C. Co.*
washing will be only moderate;
washing, although the data a

1=*Third Seam, A. C. Co.*
except in the matter of sub
mine coal.

2=*Cage 1st Seam, A. C. C.*
indicate that it can not be la

8=*Main Seam, A. C. Co.*
screened and hand picked coal
case, but the screenings which

3=*Main Seam, I. C. Co.*
gravity tests show it to be mo
confirmed the preliminary test

*8=Screened coal. P=1

O

3

4

5

6

7

8

9

10

11

12

13

14

15

16

17

18

19

20

21

22

23

24

25

26

27

28

29

30

31

for

doc

was

the

of t

lar

tree

and

no s

to r

was

11.27

11.27

11.27

11.27

11.27

11.27

SUMMARY R

Official number of the c

- Proximate analysis,
 1. Moisture in the che
 2. Volatile matter in r
 3. Fixed carbon "
 4. Ash "
 5. Sulphur "
 6. Calorific value of
 7. Calorific value calc
 Proximate analysis,
 8. Volatile matter in v
 9. Fixed carbon "
 10. Ash "
 11. Sulphur "
 12. Calorific value of
 13. Calorific value calc
 14. Ash in refuse from
 Experimental wash
 official sample.
 15. Clean coal of under
 16. " " " "
 17. Bony " " betwe
 18. " " " "
 19. Refuse of over 1.5'
 20. " " " "
 21. Useful coal being c
 22. " " " "
 Summary statement
 23. Yield of washed co
 24. Perfection of yield
 25. Reduction in ash d
 26. Perfection ash rec
 27. Reduction in sulph
 28. Increase in calorif
 29. " " boiler
 30. Yield of refuse fro
 31. Decrease in clinker

5=Springhill, C. Ry. c
 for coke making, does not
 doubt, have shown still gre
 6=Springhill, C. Ry. d
 was washed with good r
 improved by washing.

7=Chignecto Coal, M
 of the testing staff. It is
 far too high for coke makin
 treated with advantage.

9=River Hebert Coal,
 and the other coals from it
 no other considerable dems
 10=Juppine Coal, C. C.
 to wash than either of the

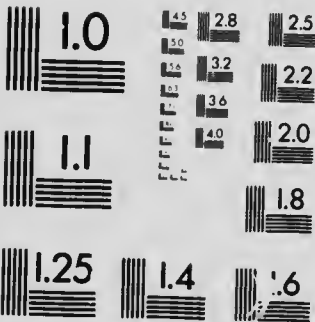
11=Narg's Mine, M
 washed much cleaner than
 any would not be comy

12=exposed coal 1



MICROCOPY RESOLUTION TEST CHART

(ANSI and ISO TEST CHART No. 2)



APPLIED IMAGE Inc

1653 East Main Street
Rochester, New York 14609 USA
(716) 482 - 0300 - Phone
(716) 288 - 5989 - Fax

Off

- 1.
- 2.
- 3.
- 4.
- 5.
- 6.
- 7.
- 8.
- 9.
- 10.
- 11.
- 12.
- 13.
- 14.

- 15.
- 16.
- 17.
- 18.
- 19.
- 20.
- 21.
- 22.

- S
- 23.
 - 24.
 - 25.
 - 26.
 - 27.
 - 28.
 - 29.
 - 30.
 - 31.

- 46
- 47
- 48
- 49
- 50

TI
TI
but no

*S

SUMMARY RE

Official number of the coll

- Proximate analysis, etc
1. Moisture in the check
 2. Volatile matter in ma
 3. Fixed carbon " "
 4. Ash " "
 5. Sulphur " "
 6. Calorific value of "
 7. Calorific value calcul
- Proximate analysis, et
8. Volatile matter in wa
 9. Fixed carbon "
 10. Ash "
 11. Sulphur "
 12. Calorific value of
 13. Calorific value calcul
 14. Ash in refuse from co
- Experimental washing
official samples
15. Clean coal of under 1
 16. " " " "
 17. Bony " " between
 18. " " " "
 19. Refuse of over 1,550.
 20. " " " "
 21. Useful coal being con
 22. " " " "
- Summary statement c
23. Yield of washed coal
 24. Perfection of yield a
 25. Reduction in ash due
 26. Perfection ash reduc
 27. Reduction in sulphu
 28. Increase in calorific
 29. " " boiler cv
 30. Yield of refuse from
 31. Decrease in clinker i

40=*Western Dom. Collier*

41=*Eureka Coal & B. Co*

46=*Strathcona Coal Co.,*

42=*Parkdale Coal Co., I*

45=*Standard Coal Co., I*

These coals are all true li

43=*Canada West Coal C*

44=*Galt Coal, A. R. & I*

These coals are lignitic
but not enough to justify wa

*S=Screened coal. P=

SUMMARY

Official number of the coll

- Proximate analysis, etc
1. Moisture in the check
 2. Volatile matter in ma
 3. Fixed carbon " "
 4. Ash " "
 5. Sulphur " "
 6. Calorific value of "
 7. Calorific value calcul
- Proximate analysis, et
8. Volatile matter in wa
 9. Fixed carbon "
 10. Ash "
 11. Sulphur "
 12. Calorific value of
 13. Calorific value calcul
 14. Ash in refuse from co.
- Experimental washing
of official sample
15. Clean coal of under 1,
 16. " " " "
 17. Bony " " between
 18. " " " "
 19. Refuse " over 1,550.
 20. " " " "
 21. Useful coal, being cor
 22. " " " "
- Summary statement o
23. Yield of washed coal-
 24. Perfection of yield as
 25. Reduction in ash due
 26. Per cent ash reduc
 27. Reduction in sulphu
 28. Increase in calorific
 29. " " boiler ev
 30. Yield of refuse from
 31. Decrease in clinker in

17=*Lun-Breckenridge Co*
uminous coal and contains an
very high in ash. It was not v

48=*Leitch Colliery, L.C.*

32=*Hallerst, C. & C. Co*

33=*No. 1 Seam, Bellevue*

28=*No. 1 Seam, Lille, W*

34=*No. 2 Seam, Denison*

34 *SP*=*No. 4 Seam, Deni*

The above coals are very
pared with so called "high gr
already operate washers or dry
this field, using screenings in

*P=*Hand picked to rem*

TABLE XV
SUMMARY RECORD OF COAL WASHING TESTS, EASTERN CROWSNEST PASS COAL-FIELDS.

Official number of the colliery as per list on page 10 of report		Lundbreck, Alta.		Frank, Alta.			Coleman, Alta.	
		No. 47	No. 48	No. 32	No. 33	No. 28	No. 34	No. 34-81
Proximate analysis, etc., of official samples								
1.	Moisture in the check sample sealed at mine	5.0	1.9	3.0	0.9	1.7	2.0	2.0
2.	Volatile matter in main sample after drying	30.1	27.0	29.3	27.6	25.0	25.1	23.9
3.	Fixed carbon	40.2	55.1	55.4	56.9	58.6	55.1	70.9
4.	Ash	29.7	17.9	15.3	15.5	16.4	19.8	16.2
5.	Sulphur	1.2	0.6	0.6	0.8	0.5	0.4	0.6
6.	Calorific value of " " " " " " " " " " " "	Cal. 5450	6800	6920	6880	6930	6540	6960
7.	Calorific value calculated to ash free dry coal	Cal. 7750	8280	8170	8140	8290	8120	8410
Proximate analysis, etc., of combined product of large scale wash tests								
8.	Volatile matter in washed coal after drying			29.8	28.4			26.1
9.	Fixed carbon			60.4	58.9			62.0
10.	Ash			9.8	12.7			11.6
11.	Sulphur			0.5	0.5			0.4
12.	Calorific value of " " " " " " " " " " " "			Cal. 7450	7210			7320
13.	Calorific value calculated to ash free dry washed coal			Cal. 8260	8260			8280
14.	Ash in refuse from coal washing—after drying			55.2	42.0			17.6
Experimental washing tests with heavy solutions on fine crushed coal of official samples								
15.	Clean coal of under 1,375	45.5	54.6	60.5	51.7	62.5	48.5	48.0
16.	" " " " " " " " " " " " " " " " " "	7.8	5.5	4.1	5.4	4.1	1.4	5.3
17.	Bony " " between 1,375 and 1,550	31.0	24.4	24.0	35.8	23.0	27.5	41.5
18.	" " " " " " " " " " " " " " " " " "	20.5	15.5	15.6	15.0	15.1	7.7	16.3
19.	Refuse " over 1,550	23.5	21.0	15.5	12.5	11.5	21.0	10.5
20.	" " " " " " " " " " " " " " " " " "	71.0	47.0	56.3	45.6	66.0	55.5	51.9
21.	Useful coal, being combined clean and bony	76.5	79.0	81.5	87.5	85.5	76.0	89.5
22.	" " " " " " " " " " " " " " " " " "	13.0	8.4	7.3	9.5	7.3	8.5	10.1
Summary statement of results of washing								
23.	Yield of washed coal—combined product all sizes			81.7	85.5			74.2
24.	Perfection of yield as compared with heavy solution tests			96.7	97.7			96.3
25.	Reduction in ash due to washing			35.9	38.1			41.1
26.	Perfection ash reduction compared with heavy solution tests			71.5	74.7			74.3
27.	Reduction in sulphur due to washing			16.7	37.5			0.0
28.	Increase in calorific value due to washing			7.7	4.8			12.4
29.	" " boiler evaporation due to washing			4.8	2.1			9.3
30.	Yield of refuse from washing tests			15.8	12.8			25.7
31.	Decrease in clinker in boiler furnace due to washing			44.2	33.4			57.1

Notes and Comments.

(For further data and extended comments see Volume III).

Lundbreck Basin.

47=Lun-Breckenridge Colliery. (R.M.)* This sample was taken when the mine was shut down and may not represent its normal state. It is a high ash, low volatile coal and contains an exceptionally large amount of ash and also a good deal of slaty matter. It could be very greatly improved by washing. Ash content very high in ash. It was not washed.

Frank-Blairmore-Coleman Field.

48=Leitch Colliery, L.C. Ltd. (R.M.)

32=Hallcrest, C. & C. Co. (R.M.)

33=No. 1 Seam, Bellevue, W. C. Collieries. (R.M.)

28=No. 1 Seam, Lille, W. C. Collieries. (R.M.)

34=No. 2 Seam, Denison, L.C. & C. Co. (R.M.)

34 SP=No. 4 Seam, Denison, L.C. & C. Co. (R.M. & P.)

The above coals are very much alike and can scarcely be intelligibly compared without reference to the full data in volume III. All are high in ash if compared with so called "high grade coals," but all are low in sulphur and are suitable for coke making if freed from their somewhat excessive ash. Some of the collieries already operate washers or dry cleaning plants for this purpose, and it is probable that it would be commercially advantageous to wash all the coal used for coke making in this field, using screenings in so far as a market could be found for the lump. The time is not yet ripe for washeries for fuel coal in this district.

*P=Hand picked to remove rubbish. R.M.=Run of mine.

1
1
1
1
1
1
1
1
2
2
2
2
2
2
2
2
2
2
2
2
2
2
2
2
2
2
2
2
3
3
3

a
u
t
a
w
n

SUMMARY

Official number of the co

- Proximate analysis, c
1. Moisture in the chee
 2. Volatile matter in ou
 3. Fixed carbon "
 4. Ash "
 5. Sulphur "
 6. Calorific value of
 7. Calorific value calcu
- Proximate analysis,
washing tests
8. Volatile matter in w
 9. Fixed carbon "
 10. Ash "
 11. Sulphur "
 12. Calorific value of
 13. Calorific value calcu
 14. Ash in refuse from c
- Experimental washin
15. Clean coal of under
 16. " " " "
 17. Bony " " betwe
 18. " " " "
 19. Refuse of over 1.55
 20. " " " "
 21. Useful coal, being c
 22. " " " "
- Summary statement
23. Yield of washed coe
 24. Perfection of yield
 25. Reduction in ash d
 26. Perfection ash red
 27. Reduction in sulph
 28. Increase in calorifi
 29. " " boiler t
 30. Yield of refuse froi
 31. Decrease in clinker

31=Michel No. 3, C.N

30=Michel No. 7, C.N.

29=Michel No. 8, C.N.

Isomer No. 2, H.A

Isomer No. 6, H.A

Isomer No. 8, H.A

Coal Creek No. 2, C

=Coal Creek No. 5, C

The above 8 coals, all
and the samples represent c
used. The pure coal is mor
than their own screenings.

With the exception of .
as to wash readily with co
wash their product before
any other producing mine.

*S=Screened coal. P

TABLE XVI
SUMMARY RECORD OF COAL WASHING TESTS, WESTERN CROWSNEST MASS COALFIELD

Official number of the colliery as per list on page 10 of report	Michel, H.C.			Hoamer, B.C.			Lorne, B.C.	
	No. 31	No. 30	No. 29	No. 51	No. 52	No. 5	No. 27	No. 26
Proximate analysis, etc., of official samples								
1. Moisture in the cheek sample sealed at mine	1.4	1.9	3.0	1.7	2.6	4.0	2.2	1.0
2. Volatile matter in main sample after drying	24.8	22.6	24.1	21.3	6	28.0	20.3	24.6
3. Fixed carbon " " " " " " " "	62.7	65.5	65.7	63.4	2.6	7	6.7	65.2
4. Ash " " " " " " " "	12.5	11.9	10.2	15.3	12.4	7	0.0	10.8
5. Sulphur " " " " " " " "	0.5	0.4	0.6	0.3	0.6	0.6	0.5	0.5
6. Calorific value of " " " " " " " " Cal	7370	7420	7490	7060	7270	7770	7680	7490
7. Calorific value calculated to ash free dry coal, " " " " " " " " Cal	8420	8420	8310	8340	8300	8106	8410	8400
Proximate analysis, etc., of combined product of large scale washing tests								
8. Volatile matter in washed coal after drying	25.2							
9. Fixed carbon " " " " " " " "	68.6							
10. Ash " " " " " " " "	6.2							
11. Sulphur " " " " " " " "	0.5							
12. Calorific value of " " " " " " " " Cal	7950							
13. Calorific value calculated to ash free dry washed coal " " " " " " " " Cal	8480							
14. Ash in refuse from coal washing—after drying	50.7							
Experimental washing tests with heavy solutions on fine crushed coal of official samples								
15. Clean coal of under 1,375 " " " " " " " " yield %	77.4	80.8	80.0	55.0	69.0	87.9	83.5	84.7
16. " " " " " " " " ash %	3.3	4.3	3.2	4.5	4.2	2.0	2.4	4.6
17. Bony " " " " " " " " yield %	10.6	9.2	10.0	30.3	17.2	5.7	5.5	8.3
18. " " " " " " " " ash %	32.9	23.2	17.7	15.1	18.2	19.3	21.4	23.2
19. Refuse of over 1,550 " " " " " " " " yield %	12.0	10.0	10.0	14.7	13.8	6.4	14.0	7.0
20. " " " " " " " " ash %	57.3	60.0	60.0	58.6	52.6	35.5	56.0	69.0
21. Useful coal, being combined clean and bony, " " " " " " " " yield %	88.0	90.0	90.0	85.3	86.2	93.6	89.0	93.0
22. " " " " " " " " ash %	6.8	6.2	1.6	8.3	7.0	3.9	3.6	6.2
Summary statement of results of washing								
23. Yield of washed coal—combined product all sizes	82.0							
24. Perfection of yield as compared with heavy solution tests	93.2							
25. Reduction in ash due to washing	50.4							
26. Perfection ash reduction compared with heavy solution tests	109.7							
27. Reduction in sulphur due to washing	0.0							
28. Increase in calorific value due to washing	7.9							
29. " " boiler evaporation due to washing	5.3							
30. Yield of refuse from washing tests	16.5							
31. Decrease in clinker in boiler furnace due to washing	59.8							

Notes and Comments.

(For further notes and extended comments, see Volume II)

- 31=Michel No. 3, C.N.P.C. Co. (S.)
 30=Michel No. 7, C.N.P.C. Co. (S. & P.)
 29=Michel No. 8, C.N.P.C. Co. (S. & P.)
 51=Hoamer No. 2, H.M. Ltd. (R.M. from development work)
 52=Hoamer No. 8, H.M. Ltd. (R.M. from development work)
 53=Hoamer No. 8, H.M. Ltd. (P.M. from development work)
 27=Coal Creek No. 2, C.N.P.C. Co. (R.M.)
 26=Coal Creek No. 5, C.N.P.C. Co. (R.M.)

The above 8 coals, although differing somewhat in ash and other constituents, are all substantially alike in their general characteristics. All are extremely friable and the samples represent only about one-third of the total output of the mines as two-thirds in the average product passes through the 2" bar screens ordinarily used. The pure coal is more friable than the bone and slate and, therefore, these lump samples have the somewhat unusual characteristic of being poorer in quality than their own screenings. All of the coals coke well and the screenings being the purer part are one more suitable as well as the more profitable portion to coke. With the exception of No. 51, which is a development sample, none of the coals require washing under present market conditions. They are, however, so constituted as to wash readily with considerable improvement, and as the purchasers of coke become more discriminating several of the mines will find it to their advantage to wash their product before sending it to the ovens. It was only considered necessary to run a washing test on one sample, and No. 31 was chosen as higher in ash than any other producing mine. The results of this test were quite satisfactory and confirmed expectations based on the specific gravity experiments.

*S=Screened coal. P=Hand picked to remove rubbish. R.M. Run of mine.

Off

- 1.
- 2.
- 3.
- 4.
- 5.
- 6.
- 7.
- 8.
- 9.
- 10.
- 11.
- 12.
- 13.
- 14.
- 15.
- 16.
- 17.
- 18.
- 19.
- 20.
- 21.
- 22.
- 23.
- 24.
- 25.
- 26.
- 27.
- 28.
- 29.
- 30.
- 31.

2.
The s
decide
2.
2.
2.
T
was r
give a
2.
mase c

 Official number of the colliery

- Proximate analysis, etc.
1. Moisture in the cheeks
 2. Volatile matter in main
 3. Fixed carbon " "
 4. Ash " "
 5. Sulphur " "
 6. Calorific value of "
 7. Calorific value calculated
- Proximate analysis, etc.
8. Volatile matter in waste
 9. Fixed carbon " "
 10. Ash " "
 11. Sulphur " "
 12. Calorific value of "
 13. Calorific value calculated
 14. Ash in refuse from coal
- Experimental washing test
15. Clean coal of under 1,3
 16. " " " " "
 17. Bony " " between
 18. " " " " "
 19. Refuse of over 1,550.
 20. " " " " "
 21. Useful coal, being compared
 22. " " " " "
- Summary statement of
23. Yield of washed coal -
 24. Perfection of yield as
 25. Reduction in ash due to
 26. Perfection ash reduction
 27. Reduction in sulphur
 28. Increase in calorific value
 29. " " boiler evaluation
 30. Yield of refuse from washing
 31. Decrease in clinker in

25=No. 1 Mine, Canmore
 The sample, however, contains
 decidedly improved, but as it is
 23=Pea Size Bankhead A
 23 SF= Buckwheat size B
 23 M=Mixture of equal parts
 This coal is an anthracite
 was run to see whether the dry
 give a better product than dry
 24=Briquettes from Bank
 mass compressed in moulds.

TABLE XVII
SUMMARY RECORD OF COAL WASHING TESTS, CASCADE COALFIELD.

Official number of the colliery as per list on page 10 of report	Canmore-Bankhead Field				
	No. 25	No. 23	No. 23SP	No. 23 M	No. 24
Proximate analysis, etc., of official samples					
1. Moisture in the check sample sealed at mine	% 1.2	1.0	1.1		2.7
2. Volatile matter in main sample after drying	% 17.2	11.8	12.6	12.6	17.1
3. Fixed carbon " " " " " "	% 70.5	76.0	71.5	73.3	68.6
4. Ash " " " " " "	% 12.3	12.2	15.9	14.1	14.3
5. Sulphur " " " " " "	% 0.8	0.6	0.6	0.6	0.6
6. Calorific value of " " " " " "	Cal. 7340	7400	7040	7270	7280
7. Calorific value calculated to ash free dry coal	Cal. 8370	8430	8370	8460	8490
Proximate analysis, etc., of combined product of large scale washing tests					
8. Volatile matter in washed coal after drying	% 16.2			12.5	
9. Fixed carbon " " " " " "	% 77.9			78.6	
10. Ash " " " " " "	% 5.9			8.9	
11. Sulphur " " " " " "	% 0.7			0.6	
12. Calorific value of " " " " " "	Cal. 8000			7760	
13. Calorific value calculated to ash free dry washed coal	Cal. 8500			8520	
14. Ash in refuse from coal washing—after drying	% 54.1			55.4	
Experimental washing tests with heavy solutions on fine crushed coal of official samples					
15. Clean coal of under 1,375	yield % 74.5			58.0	
16. " " " " " "	ash % 2.1			2.7	
17. Bony " " between 1,375 and 1,550	yield % 9.5			21.0	
18. " " " " " "	ash % 13.2			17.2	
19. Refuse of over 1,550	yield % 16.0			21.0	
20. " " " " " "	ash % 50.6			46.0	
21. Useful coal, being combined clean and bony	yield % 84.0			79.0	
22. " " " " " "	ash % 3.7			6.0	
Summary statement of results of washing					
23. Yield of washed coal—combined product all sizes	% 81.5			84.0	
24. Perfection of yield as compared with heavy solution tests	% 97.0			106.2	
25. Reduction in ash due to washing	% 52.0			36.9	
26. Perfection ash reduction compared with heavy solution tests	% 62.7			67.4	
27. Reduction in sulphur due to washing	% 12.5			00.0	
28. Increase in calorific value due to washing	% 9.0			6.7	
29. " " boiler evaporation due to washing	% 13.1			14.1	
30. Yield of refuse from washing tests	% 17.2			13.7	
31. Decrease in clinker in boiler furnace due to washing	% 43.2			36.7	

Notes and Comments.

(For further data and extended comments, see Volume III).

25=No. 1 Mine, Canmore, H. McNeil Co. This sample was taken during the last days of a mine which originally produced an exceptionally high class fuel. The sample, however, contained a good deal of removable slate and bone, which thus raised the ash to a fairly high amount. The coal was washed and its quality very decidedly improved, but as it is non-coking it may not pay to wash it under present market conditions.

23=Pea Size Bankhead Anthracite, Banff. (Dry cleaned).

23 SP=Buckwheat size Bankhead Anthracite, Banff. (Dry cleaned).

23 M=Mixture of equal parts of Pea and Buckwheat size. (Dry cleaned).

This coal is an anthracite and the samples were taken from stocks of coal dry cleaned in a "breaker" with screens and automatic slate pickers. A washing test was run to see whether the dry cleaned coal could be materially improved by wet treatment and the results are interesting. Undoubtedly wet treatment even alone will give a better product than dry, but it will probably cost more and it may involve heavier losses of fines.

24=Briquettes from Bankhead Coal. These briquettes are produced from the dust which would be otherwise wasted. Tar is added in proper proportions and the mass compressed in moulds. The sample was not washed.

Official
r

- Pr
1. I
2. V
3. I
4. A
5. S
6. C
7. C
Pro
8. V
9. F
10. A
11. S
12. C
13. C
14. A
Exp
15. CI
16.
17. B
18.
19. R
20.
21. U
22.
Sum
23. Y
24. P
to
25. R
26. P
ti
27. R
28. I
29.
30. Y
31. D

Ex. 1=
Ex. 2=
Ex. 3=

These
but the sam
be taken.

22=No
22 SP=
22 M.=

These s
conditions p

Ex. 31=
Ex. 32=
Ex. 33=

These
They show h
purity than t

*R.M.=

SUMM

Official number of the collier report

- Proximate analysis, etc.,
1. Moisture in the check sample
 2. Volatile matter in main
 3. Fixed carbon " "
 4. Ash " "
 5. Sulphur " "
 6. Calorific value of "
 7. Calorific value calculated from proximate analysis, etc
- large scale washing
8. Volatile matter in washed
 9. Fixed carbon " "
 10. Ash " "
 11. Sulphur " "
 12. Calorific value of "
 13. Calorific value calculated from proximate analysis, etc
 14. Ash in refuse from coal
- Experimental washing of fine crushed coal of
15. Clean coal of under 1,37
 16. " " " " " "
 17. Bony " " between 1
 18. " " " " " "
 19. Refuse of over 1,550. . .
 20. " " " " " "
 21. Useful coal, being comb
 22. " " " " " "
- Summary statement of
23. Yield of washed coal—
 24. Perfection of yield as compared with tests
 25. Reduction in ash due to tests
 26. Perfection of reduction tests
 27. Reduction in sulphur
 28. Increase in calorific value
 29. " " boiler evaporation
 30. Yield of refuse from washing
 31. Decrease in clinker in

Ex. 1=No. 1 Granite Creek.
 Ex. 2=No. 3 Granite Creek.
 Ex. 3=No. 4 Granite Creek.

These three samples of about 100 lbs. each were taken from near the top of the seam but the samples were from near the bottom.

22=No. 1 Colliery, Nicola 1
 22 SP=No. 2 Colliery, Nicola
 22 M.=Mixture of 140 sack

These samples are very impure and the conditions probably do not at present

Ex. 31=Upper Seam, Tant
 Ex. 32=Middle Seam, Tant
 Ex. 33=Lower Seam, Tant

These samples only weighed 100 lbs. They show high ash but rather low sulphur than this can only be seen

*R.M.=Run of mine.

Office

P

- 1.
- 2.
- 3.
- 4.
- 5.
- 6.
- 7.
- 8. Pr
- 9. Y
- 10. A
- 11. S
- 12. C
- 13. C
- 14. A

Ex

- 15. C
- 16.
- 17. B
- 18.
- 19. R
- 20.
- 21. U
- 22.
- 23. Sum
- 24. Y
- 25. Pe
- 26. Pe
- 27. Re
- 28. Inc
- 29.
- 30. Yic
- 31. De

20 = E
 be improv
 for washin
 18 = U
 that it wo
 17 = N
 the specific
 enough to
 21 = C
 21 SP
 21 M =
 tests show
 treatment.

Ex. 34
 lished. TH
 sulphur ver
 practice, es

*S = Sc

SUMMARY

Official number of the colliery

- Proximate analysis, etc.,
1. Moisture in the check sample
 2. Volatile matter in main
 3. Fixed carbon " "
 4. Ash " "
 5. Sulphur " "
 6. Calorific value of " "
 7. Calorific value calculated
- Proximate analysis, etc.,
8. Volatile matter in wash
 9. Fixed carbon " "
 10. Ash " "
 11. Sulphur " "
 12. Calorific value of " "
 13. Calorific value calculated
14. Ash in refuse from coal
- Experimental washing to official samples
15. Clean coal of under 1.37
 16. " " " " " "
 17. Bony " " between 1
 18. " " " " " "
 19. Refuse of over 1,550. .
 20. " " " " " "
 21. Useful coal being comb
 22. " " " " " "
- Summary statement of
23. Yield of washed coal—
 24. Perfection of yield as c
 25. Reduction in ash due to
 26. Perfection ash reducti
 27. Reduction in sulphur
 28. Increase in calorific va
 29. " " boiler evap
 30. Yield of refuse from w
 31. Decrease in clinker in t

20 = *Extension Mine, Welli*
 be improved by treatment and
 for washing even now.

18 = *Upper South Nanaimo*
 that it would be difficult to imp

17 = *North Level Nanaimo*
 the specific gravity tests show t
 enough to justify treatment.

21 = *Comor No. 4, W.C. Co*
 21 SP = *Comor No. 7, W.C.*
 21 M = *Mixture of equal po*
 tests showed it to be more like
 treatment.

Ex. 34 = *Squash Mines, I*
 lished. The mine was in an e
 sulphur very materially, but e
 practice, especially as the mine

*S = Screened coal. P = H

TABLE XIX
SUMMARY RECORD OF COAL WASHING TESTS, VANCOUVER ISLAND COALFIELDS.

Official number of the colliery as per list on page 10 of report	Nanaimo-Comox Field.						Alert Bay
	No. 20	No. 18	No. 17	No. 21	No. 21 SP	No. 21 M	Ex. No. 34
Proximate analysis, etc., of official samples							
1. Moisture in the check sample sealed at mine	oz	1.8	2.2	2.4			
2. Volatile matter in main sample after drying	%	40.1	41.2	41.5	31.6	28.0	30.2
3. Fixed carbon " " " "	%	49.8	48.5	46.6	56.5	60.1	57.8
4. Ash " " " "	%	10.1	10.3	11.9	11.4	11.0	12.0
5. Sulphur " " " "	%	0.4	0.9	1.3	1.0	0.9	0.9
6. Calorific value of " " " "	Btu	7310	7130	6930	7150	7210	7230
7. Calorific value calculated to ash free dry coal	Cal.	8130	7950	7870	8120	8180	8220
Proximate analysis, etc., of combined product of large scale washing tests							
8. Volatile matter in washed coal after drying	%						30.8
9. Fixed carbon " " " "	%						60.3
10. Ash " " " "	%						8.9
11. Sulphur " " " "	%						0.8
12. Calorific value of " " " "	Cal.						7550
13. Calorific value calculated to ash free dry washed coal	Cal.						8290
14. Ash in refuse from coal washing—after drying	%						7569
Experimental washing tests with heavy solutions on fine crushed coal of official samples							
15. Clean coal of under 1,375	yield %	86.0	86.5	84.7		80.0	62.6
16. " " " " between 1,375 and 1,550	ash %	5.5	6.8	8.1		5.3	4.5
17. Bony " " " " " " " " " "	yield %	6.0	10.0	11.7		13.0	13.0
18. Refuse of over 1,550	ash %	22.7	20.0	18		21.7	23.7
19. " " " " " " " " " "	yield %	8.0	3.5	4.2		7.0	23.5
20. Useful coal being combined clean and bony	ash %	45.0	52.5	59.4		71.5	54.0
21. " " " " " " " " " "	yield %	92.0	96.5	95.8		93.0	70.5
22. " " " " " " " " " "	ash %	6.5	8.2	9.3		7.6	8.0
Summary statement of results of washing							
23. Yield of washed coal—combined product all sizes	%					87.5	80.6
24. Perfection of yield as compared with heavy solution tests	%					94.2	106.0
25. Reduction in ash due to washing	%					25.8	34.3
26. Perfect ion ash reduction compared with heavy solution tests	%					85.4	52.9
27. Reduction in sulphur due to washing	%					11.1	10.0
28. Increase in calorific value due to washing	%					4.4	4.1
29. " " boiler evaporation due to washing	%					5.5	
30. Yield of refuse from washing tests	%					12.0	
31. Decrease in clinker in boiler furnace due to washing	%					33.3	

Notes and Comments.

(For further data and extended comments, see Volume III.)

Nanaimo-Comox Field.

20—*Extension Mine, Wellington Colliery Co. (S & P)** This coal does not require washing under present commercial conditions, but if necessary it could easily be improved by treatment and would yield a fairly large percentage of coal carrying about 7 per cent ash and very low sulphur. The screenings might be the better for washing even now.

18—*Upper South Nanaimo Seam, W. P. Co., No. 1. (S & P.)* This coal does not require washing under present conditions and the specific gravity tests show that it would be difficult to improve it very materially by washing.

17—*North Level Nanaimo Seam, W. P. Co., No. 1. (S & P.)* This coal, like the others from the same district, does not require washing under present conditions, and the specific gravity tests show that no great improvement could be effected owing to the high innate ash and sulphur content, however, probably be reduced, but not enough to justify treatment.

21—*Comox No. 4, W. C. Co. (S & P.)*

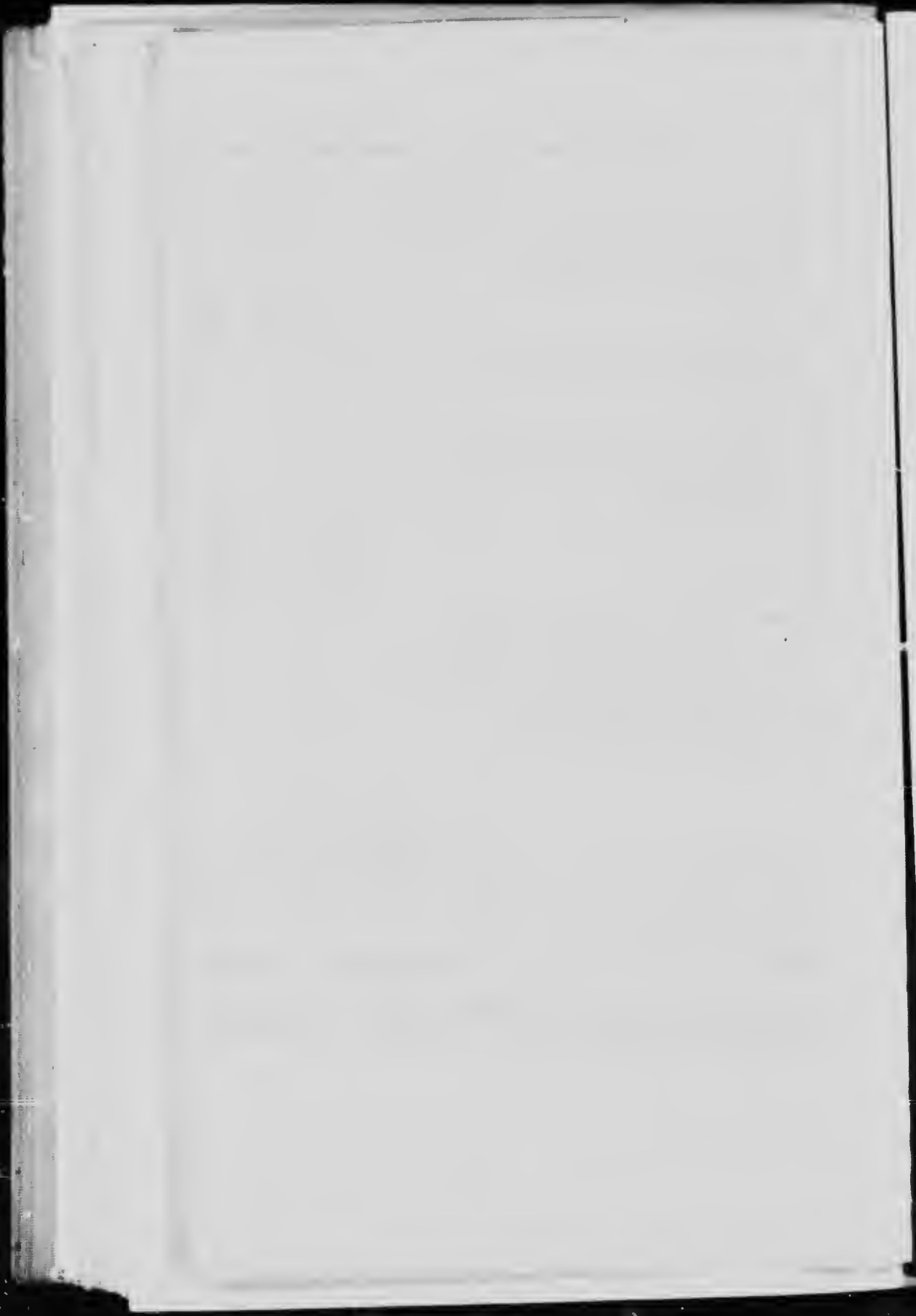
21 SP—*Comox No. 7, W. C. Co. (S & P.)*

21 M—*Mixture of equal parts of the above. (S & P.)* This sample does not need washing any more than the other coals of the district, but the specific gravity tests showed it to be more likely to be benefitted. It was, therefore, washed successfully. The screenings would probably be even more improved by similar treatment.

Alert Bay Field

Ex. 34—*Squash Mines, P. C. Coal Co.* This sample was provided by the owners for a private test, the results of which they very generously permit being published. The mine was in an early stage of development and the sample was probably much dirtier than commercial coal will be. Washing reduced the ash and sulphur very materially, but even better results could have been attained had the coal been crushed finer. It is probable that much better results could be obtained in practice, especially as the mine goes deeper.

*S=Screened coal. P=Hand picked to remove rubbish.



THE
COALS OF CANADA:
AN ECONOMIC INVESTIGATION
VOL. I

PART VI
MANUFACTURE AND TESTING OF COKE
BY
EDGAR STANSFIELD and J. B. PORTER

PART VI

MANUFACTURE AND TESTING OF COKE

BY

EDGAR STANSFIELD AND J. B. PORTER

INTRODUCTION

When bituminous coal is strongly heated, in absence of air, it is decomposed, losing water, gases, and volatile compounds. Many coals so heated first fuse or soften and then harden, as decomposition progresses, ultimately leaving a strong coke which mainly consists of carbon together with the original ash of the coal. This coke, although quite hard, is light and cellular, owing to the bubbles produced in its mass while soft by the escaping gases. Neither anthracite nor lignite coalesces when heated and thus they are incapable of making coke; many bituminous coals also fail to coke, or else make so weak or impure a material as to be worthless.

Coke bears the same relation to coal that charcoal does to wood, and for many purposes, such as blast furnace smelting, it is so far superior to coal as a fuel that it is necessary to go to the trouble and expense of coking the coal before use. Its chief advantages as a fuel are:—

(1). It is strong and hard and does not crumble or soften when burning, so that it can carry a heavy charge of ore, etc., in a blast furnace, for example, without crushing or melting down and so obstructing the blast.

(2). It burns without producing tar or smoke.

(3). It has a high calorific intensity. That is to say, a higher temperature can be obtained by burning coke than by burning coal, although a given weight of coal will naturally evolve a larger quantity of heat than will the coke produced from it.

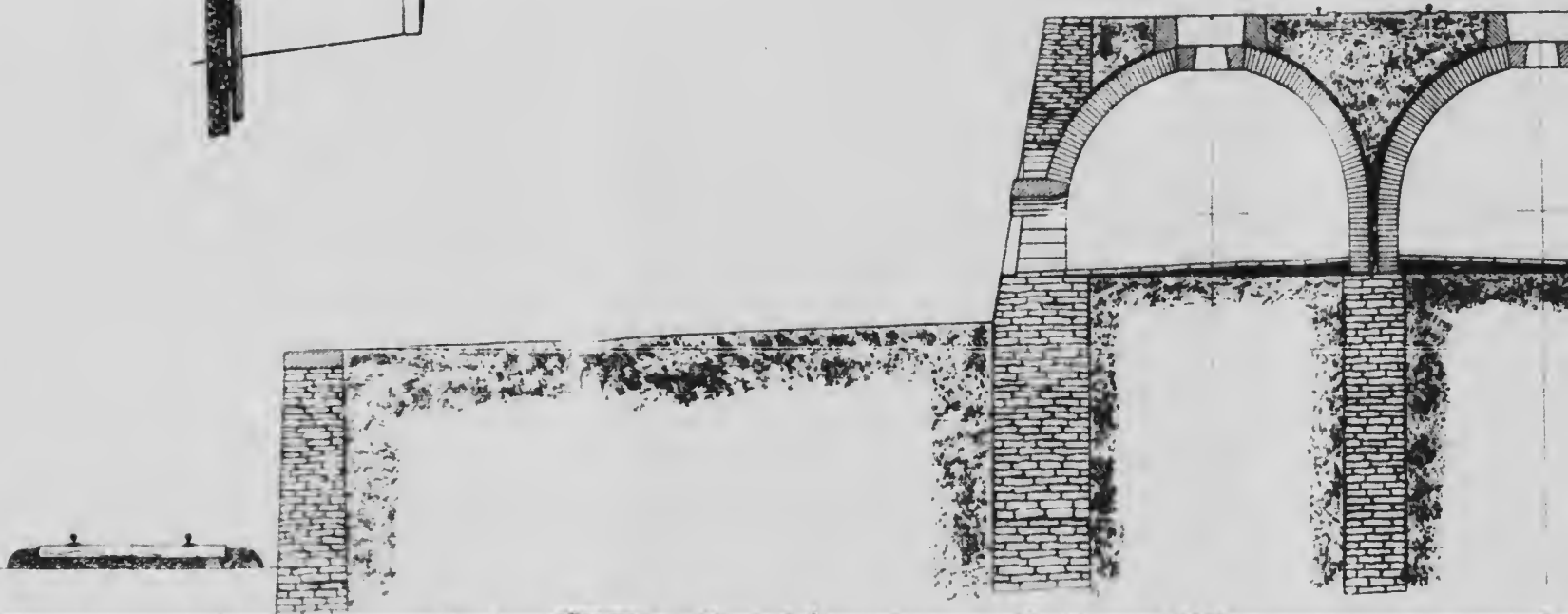
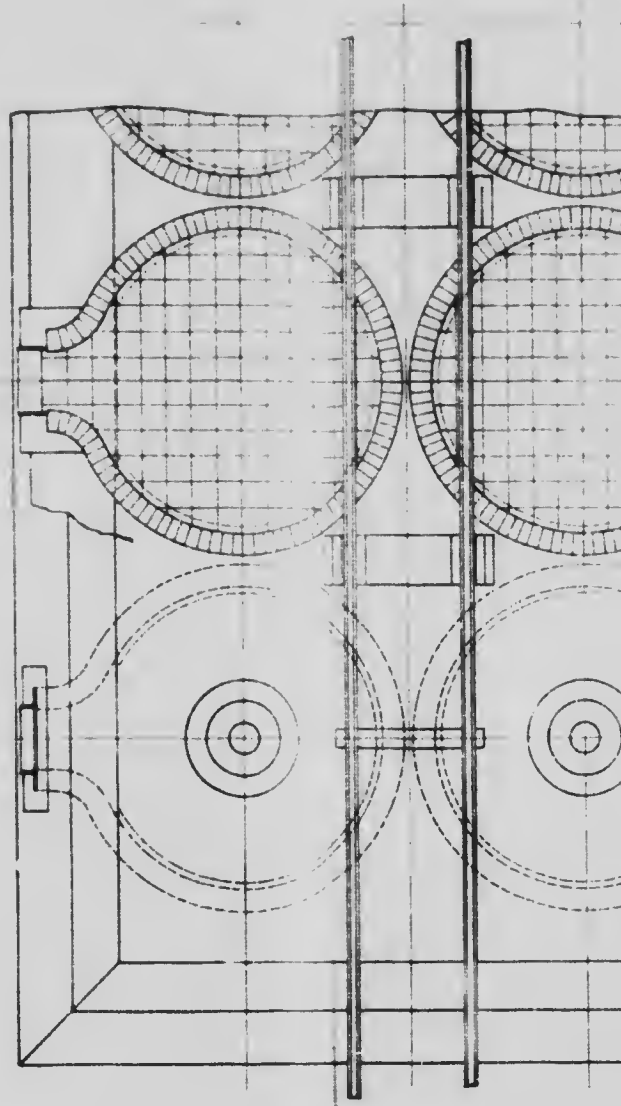
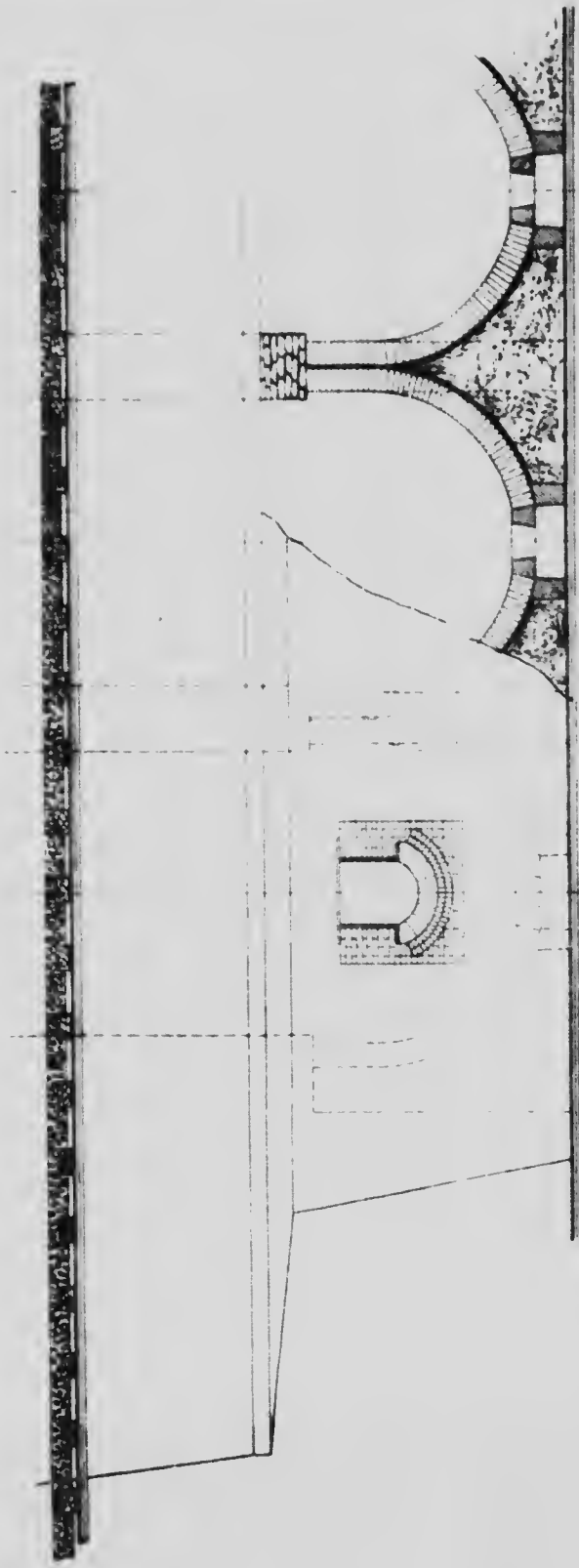
The coking of coal is carried out in what are known as coke ovens. There are two types of these in common use, known respectively as beehive and retort ovens. As stated above, coal during coking loses gas and volatile matter; in some ovens these are immediately burned in or adjacent to the ovens, and produce the heat they require; in other cases the volatile matter is collected and its more valuable constituents saved and only the residual gases burned. Coke ovens, therefore, can also be divided into non-recovery ovens and by-product recovery ovens.

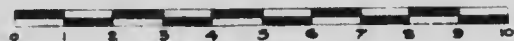
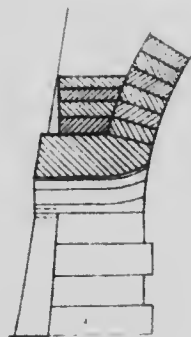
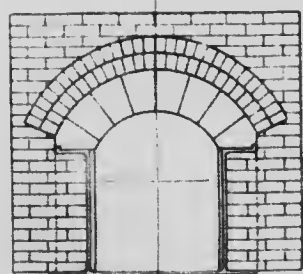
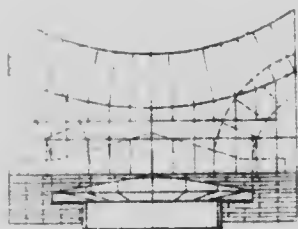
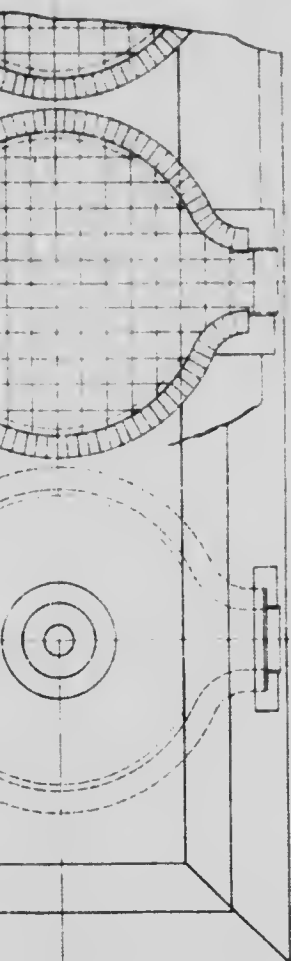
Three types of ovens will be considered as illustrating three of the above classes. A fourth class, the by-product beehive oven, is not very important, and is not employed in Canada.

NON-RECOVERY BEEHIVE OVEN

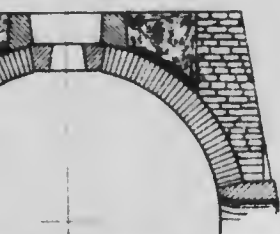
This is the simplest type of oven in common use. It is a circular oven with a domed roof. The diameter and height vary in different ovens, but about 12 feet and 7 feet respectively are common sizes. The ovens are set close together, back to back in long rows, with the object of economizing room and heat, and are usually built of stone or brick and lined with firebrick or silica brick. The general layout of a battery of beehive ovens can be seen in Fig. 29 which, while showing what is practically the arrangement employed by the International Coal and Coke Company, at Coleman, Alta., may also be taken as typical of all ovens of this class.

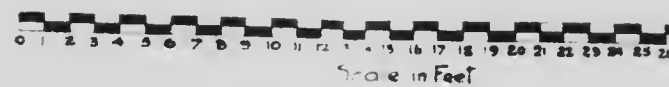
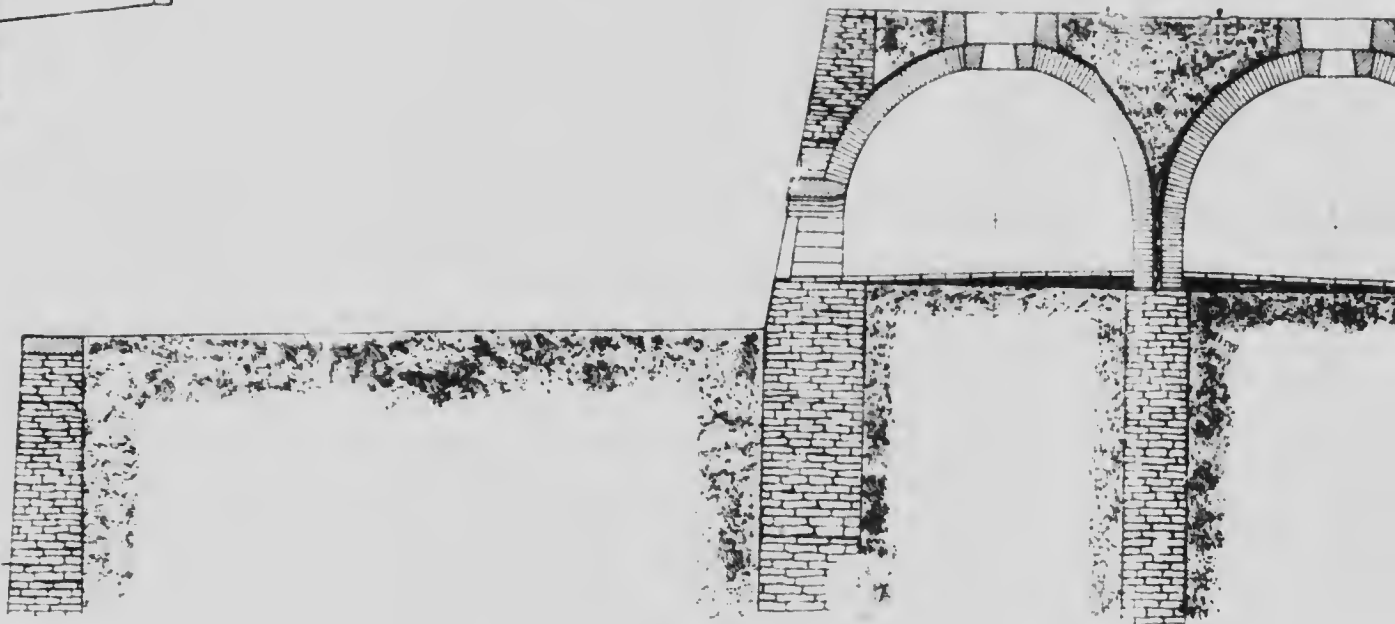
The method of coking a charge in an oven situated in a battery in regular operation is as follows: assuming the oven to be empty but still red hot from a previous charge; a tarry or hopper bottomed car, running on a track over the tops of the ovens, brings a suitable weight of coal for the charge and this coal is then run down a chute into the oven. The coal is levelled out as promptly as possible with a rake, and the door closed with firebricks, the lower courses of which are made air-tight with fireclay. The coal in the oven is heated by the floor and walls, and the gases evolved ignite, sometimes within one hour sometimes not until many hours after charging, the time depending on the initial temperature of the oven and the moisture in the coal. The idea of the operation is to burn the volatile matter given off from the coal over the top of the charge. The heat thus generated is reflected from the roof of the oven, passes down through the coal from above, and gradually completes the coking that was begun by the heat from the floor and the walls. The air necessary for the combustion is supplied through small holes in the top of the door, these openings being regulated so as to carry the coking on at a suitable rate. Care is needed to avoid unnecessary burning of the coke. Sufficient heat is generated by the combustion of the volatile matter to completely coke the coal and also to heat the coke and the walls of the oven to a high temperature; but it is impossible to avoid some waste of coke. The coking, as was stated above, proceeds in the main downwards from above; as the operation draws near its close the coke hardens, and shrinks cracks are formed in the charge, and these cracks passing from the top towards the bottom give the coke a columnar structure. As the volatile matter from the lower layers passes up through the hot upper layers, some of the hydrocarbons are decomposed and thereby deposit carbon on the hot surface of the coke. This deposited carbon not only increases the yield of the coke, and thus decreases the percentage of ash content, but also increases its strength, makes it more resistant to hot carbon dioxide gas and gives it a bright silvery appearance, which is highly regarded by coke users. The progress of the coking can be followed by watching the flame of the burning volatile matter; when this dies down the air openings at the top of the door are completely closed, to avoid burning the coke, and the oven is left sealed up for several





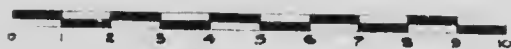
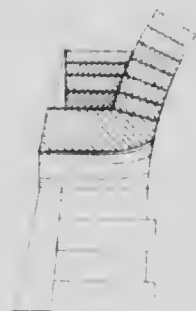
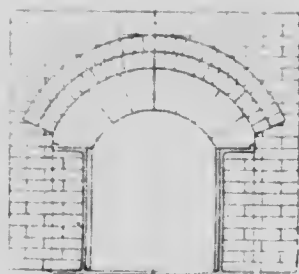
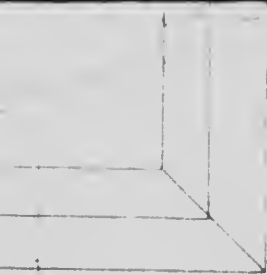
Scale in Feet.



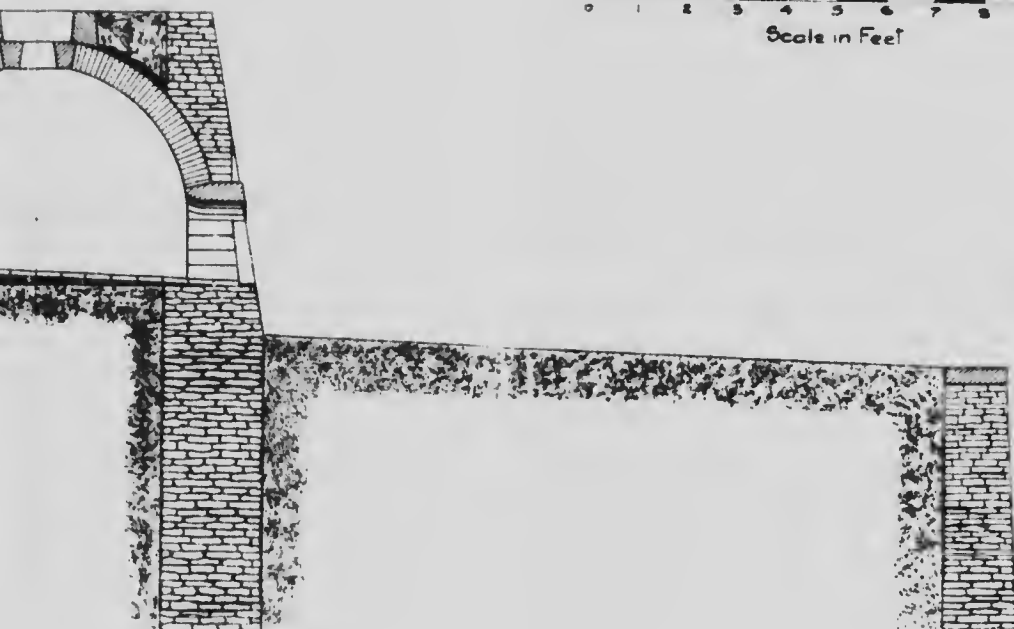


Scale in Feet

— BEEHIVE OVENS.
INTERNATIONAL COAL AND COKE COMPANY
COLEMAN, ALBERTA



Scale in Feet



NS. —
COMPANY'S COLLIERIES.
RTA.

This
with a
about 15
close top
and heat
silica in
in Fig. 2
played b
also be t

The
operation
from a p
over the
and this
out as p
the lowe
oven is 1
within o
dependin
The idea
over the
roof of th
complete
The air r
top of th
at a suit
Sufficient
pletely c
high tem
coking, a
the oper
are form
bottom g
lower lay
are decot
This dep
decreases
it more
appearan
coking ce
when thi
closed, to

hours to allow any volatile matter left to be distilled out. The usual time of coking of a charge in a beehive oven is 72 hours.

When the coking is complete the bricks in the doorway are removed and water is played on the coke from a hose until it is quenched. It is then raked out as rapidly as possible, and the oven is ready for a fresh charge. As little water as possible is used in quenching, both in order to avoid leaving the coke wet and heavy, and also to avoid unduly cooling the walls and floor of the oven. If the coke is properly quenched it is only the surface layer inside the oven which is cooled, and if the fresh charge is soon introduced, the heat from inside the walls and floor reheats the surface of the new charge sufficiently to ignite it.

In a battery making 72 hour coke, ovens 1, 4, 7, etc., would be charged on the same day, ovens 2, 5, 8, etc., on the next, and 3, 6, 9, etc., on the third day; on the fourth day ovens 4, 7, 10, etc., would be once more ready to empty and recharge. In this way there are never two cold ovens side by side, and any cold oven will always have a hot oven on both sides and behind it. The value of this heat equalization is shown by the fact that the coke made in an end oven of a battery is rarely as good as that made in the ovens in the middle, and the product of isolated ovens is even less valuable.

The flames and hot gases, from the ovens in such a battery as that described, escape from the charging hole at the top; a large quantity of heat is thus wasted and the ovens may become a nuisance to the neighbourhood because of their smoke. In some designs of beehive ovens the charging holes are closed, the burning gases passing into a flue which is situated in the walls at the back, that is, between the ovens placed back to back. The hot gases from the flue are led under boilers, and in some cases sufficient steam is thus raised to run the whole colliery supplying the coke ovens with coal.

Other modifications of the simple beehive oven consist in providing flues in the sole or floor, through which hot gases can be led to heat the floor and prevent the formation of black ends, i.e., imperfectly formed coke which otherwise is left in contact with the floor. In some ovens the air for the combustion, instead of entering through the loose brickwork in the doorway, is admitted through special passages in the brickwork in the front of the oven. In this way the air is taken where it is wanted, is more under control, and is preheated by its passage through the hot brickwork. Many methods have also been devised for the rapid drawing of the coke from the oven by mechanical means, thus obviating the laborious and unhealthy work of drawing the coke by hand and lessening the cooling of the oven.

Such modified beehive ovens are the Welsh oven, Thomas oven, Ramsay oven, etc.

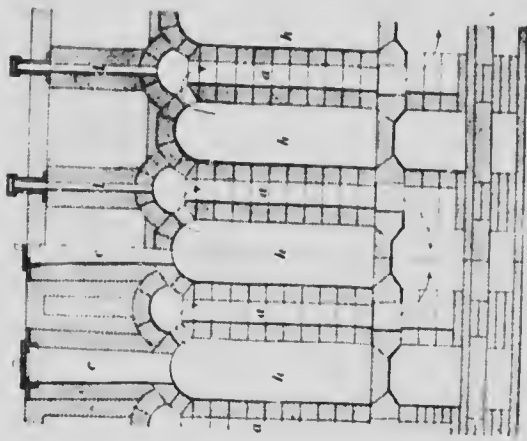
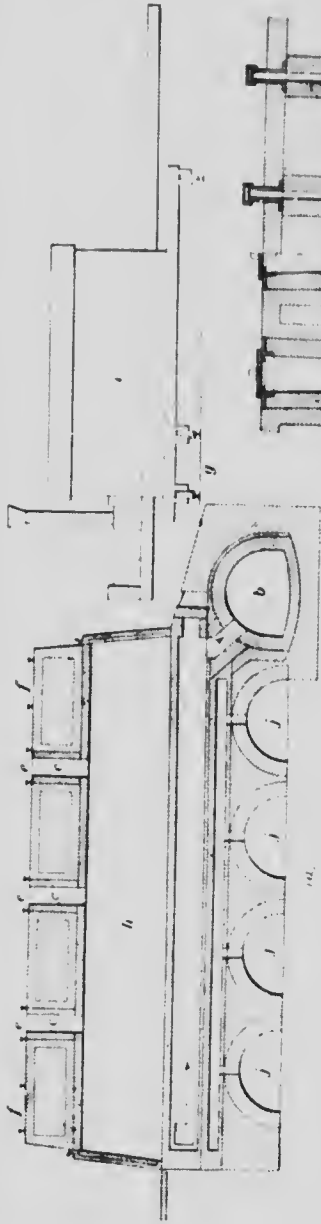
Some beehive ovens have been adapted for the recovery of by-products, but in these the simplicity of the ordinary beehive oven is lost without gaining the advantages to be found in the retort oven.

NON-RECOVERY RETORT OVENS

The Bernard oven as used by the Nova Scotia Steel & Coal Co. at Sydney Mines, N.S., and by the West Canadian Collieries Co., Ltd., at Lille, Alta, may be regarded as typical of this form of oven. A description of the installation at Sydney Mines will be found in a paper by C. L. Cantley on "Some Modern Retort Ovens," *Trans. Can. Soc. C.E.*, Vol. XXII, 1908, pp. 398-424. Fig. 30 shows the Bernard oven.

The ovens are about 33 feet long, 6' 6" high, and have an average width of 24", but taper very slightly from one end to the other to facilitate the removal of the coke. They are built open at each end and are closed during coking by doors which can be lifted by means of hoisting tackle when the coke is to be pushed out. Coal is introduced through three charging holes, **C**, on the top from three ladders running on tracks, **E**. A charge consists of from about 5½ to 6 tons of coal, which at both the above plants has been previously washed. The coal in the oven is levelled immediately after being charged by means of a long rake introduced through a small opening in the door at the pusher end of the oven. The cracks round the doors and all openings into the oven are then carefully luted with fireclay to avoid all leaks of air. The oven being already hot from the previous charge, gases begin to come off from the coal as soon as it is charged. These rise to the top of the oven and pass out through openings in the flue between this oven and the one next to it. Here in a horizontal channel they meet a current of air sufficient to nearly or completely burn them in their passage down a vertical flue leading to a larger horizontal flue immediately beneath the adjacent oven. They are here met by similar burning gases from this oven; the mixture passes under the length of this oven and comes back under the first oven, passing out at the pusher end to a large flue leading to the chimney or fan which provides the draught. In the figure the gases from oven **H 1** are burned in flue **A 1**, between oven **H 1** and oven **H 2**; the gases from **H 2** burn in flue **A 2**, between this oven and the one beyond it; the burning gases unite along the length of the horizontal flue **M 2** underneath oven **H 2**; passing out at one end of this they return along the flue **M 1** underneath oven **H 1**, and pass out into the flue **B**. It will be seen that two ovens thus form one unit with a combined heating system, although the unit is not quite complete in itself, as on one side it shares a flue of the next unit, and on the other side one flue is shared by the following unit, and so on.

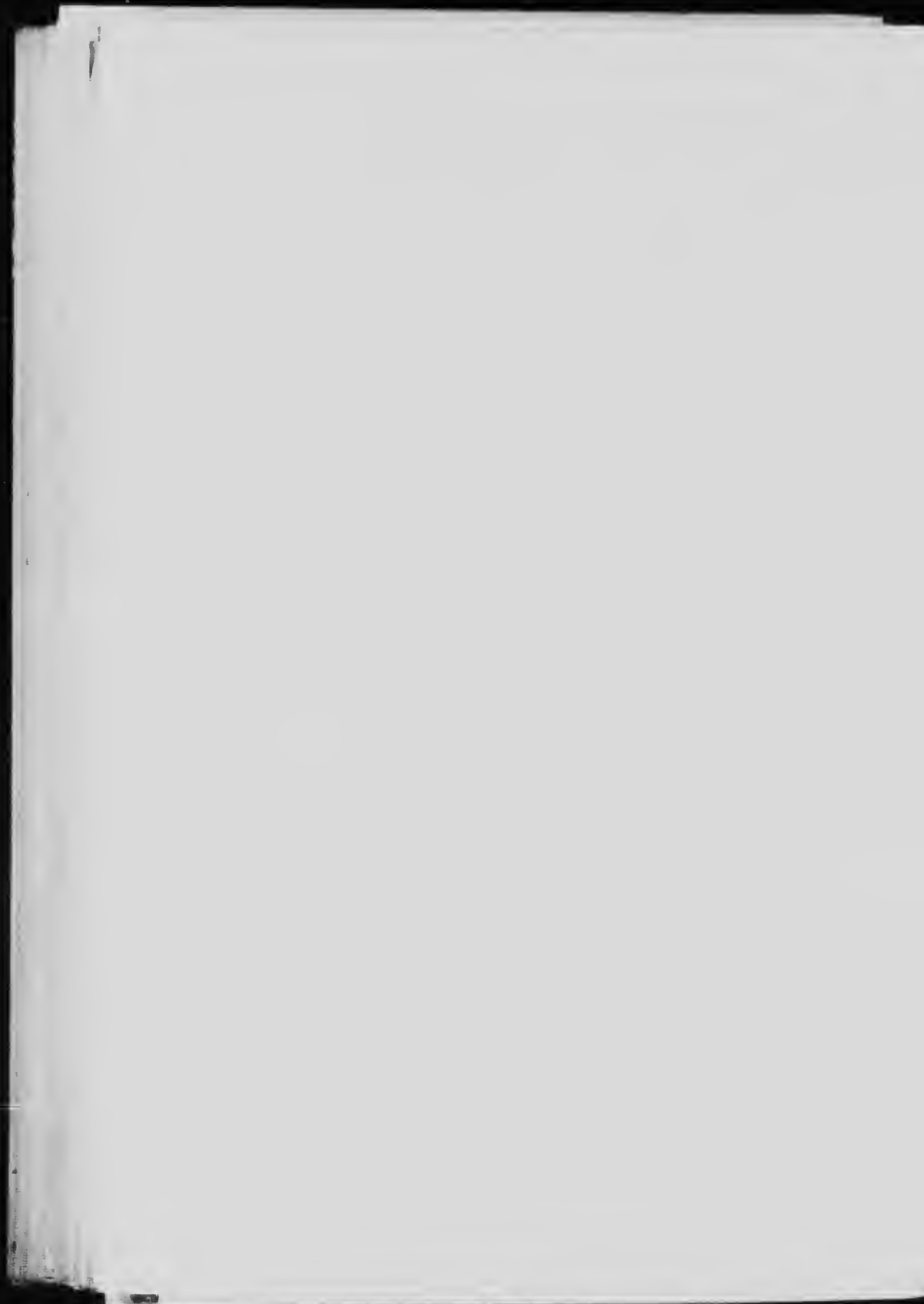
It is customary to make 48 hour coke in the Bernard oven, alternate ovens being charged on alternate days. In this way, a cool, freshly charged oven works in conjunction with the other oven of the unit, which having been charged 24 hours previously is usually burning most vigorously, thus ensuring a uniformity of temperature not otherwise obtainable. The coking in this oven mainly proceeds from the sides inwards, but also from the bottom upwards. A certain amount of decomposition of hydrocarbons and deposition of carbon on the coke will take place in a retort oven, but it is not commonly supposed to be as much as in a beehive oven.



This is a plan view of the boiler, showing the
 tubes, the flues, and the various fittings,
 which are arranged in a regular order,
 and are connected to the boiler by
 the various fittings, and are
 connected to the boiler by the

(b)

Fig. 30. Sectional elevations of Bernard's portable engine.



Section Through Retorts. | Section Through Side Wall

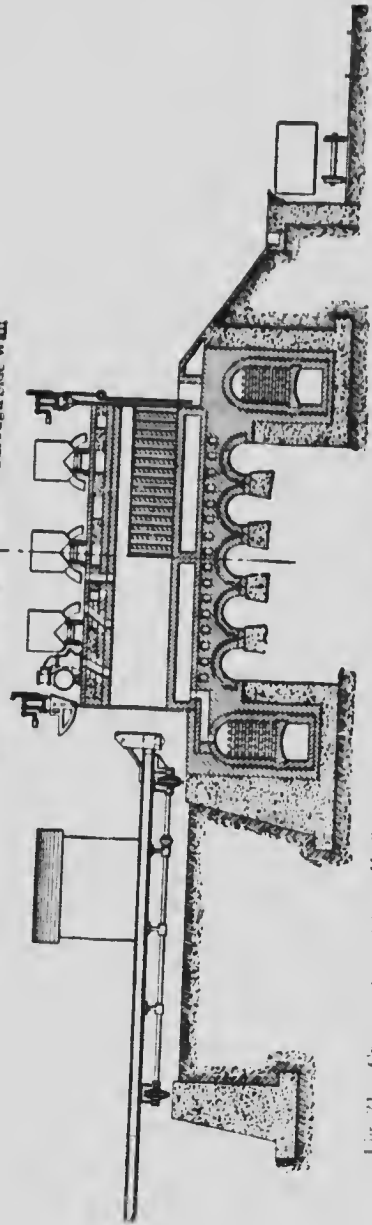
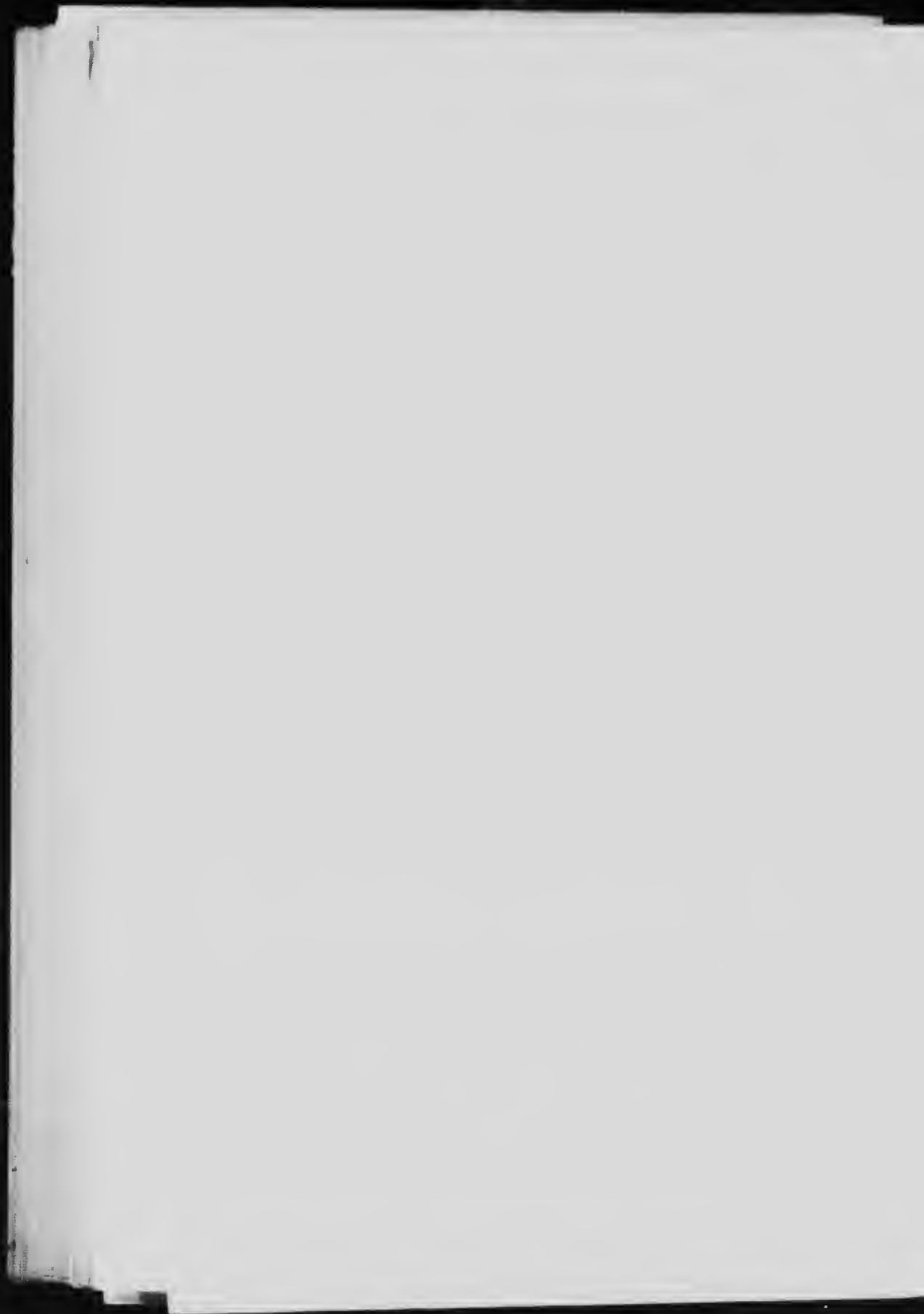


Fig. 31. Cross-section of Otto-Holman retort coke oven, showing also charging larras, coke ram, and quenching floor.



When the coking is completed the doors at the ends of the oven are raised out of the way and the coke pushed out at the wider end of the oven on to the quenching floor by means of an electrically or steam-operated pusher, the ram of which traverses the whole length of the oven. The doors are then replaced and the oven is ready for a fresh charge. The red-hot coke is quenched by means of a stream of water from a hose.

The gases finally leaving the ovens at Lalla pass directly to a chimney; they are still so hot when they leave the top of the chimney that at night a column of flame many feet high is plainly visible. At Sydney Mines the hot gases are first led under a battery of bedlers, from which they are discharged into the stack by means of a fan. It is found that the use of the fan ensures a regular and easily controlled working of the ovens, irrespective of the outside temperature. The bedlers, when 18-hour coke is being made, are said to generate about 2½ pounds of steam from and at 242 °C. per pound of coal charged into the ovens.

Many types of retort ovens are built either for non-recovery, or for by-product recovery. On this account only one list of retort ovens will be given, this will be found at the end of the next section.

BY-PRODUCT RETORT OVEN

The Otto-Hoffman ovens as used by the Dominion Iron & Steel Co., Ltd. at Sydney, N.S., may be taken to illustrate the type. A description of the plant at Sydney will be found in a paper by C. G. Atwater, *Trans. AIME*, Vol. XXXIII (1902), p. 760.

Fig. 31 shows the Otto-Hoffman oven virtually as it is at Sydney, except that the quenching platform there is almost flat and slightly wider than the length of the oven. The general construction is very similar to the Bernard and *c.* is charged and drawn in exactly the same way. The only radical difference is in the method of taking off the gases and heating the oven. In the Otto-Hoffman the only flue opening from each oven is one into a pipe on the roof at the pusher end. The gases from each oven pass through these pipes into a large hydraulic main running the whole length of the battery and leading to the by-product plant, at this main and subsequently in the scrubbers and coolers of the by-product plant, they are cooled and washed, tar and ammoniacs being thus extracted. The gas, after its more valuable constituents have been removed, is returned to the ovens and burned under them, and thanks to the economy of heat due to regeneration, the supply of gas is ordinarily more than sufficient for heating the battery, and unless the coal is exceptionally low in volatile combustible matter surplus heat is available for use in other ways.

The arrangement of the flues, etc., in the opposite ends of an Otto-Hoffman oven, is identical. In the foundation brickwork arch at each end there is a chamber filled with firebrick chequer work, which is known as a regenerator and which is used to preheat the air required for the combustion of the gas. These regenerators are long, latticed brick flues, running the whole length of

the battery. They are connected at one end, by means of a reversing valve, either with the air distributing pipe, or with the chimney. Underneath the whole length of each oven there is a horizontal flue with a gas burner at each end and a brick partition in the middle. Only one of these burners is used at a time. When the burner at the quenching platform end of the oven is being used, gas returned from the by-product extraction plant is forced in here and mixes with hot air which is supplied through the regenerator at that end of the oven. The gas burns in the horizontal flue and passes up through a series of vertical flues between the ovens, as shown in the figure. At the top of the vertical flues the burning gas enters another horizontal flue, which, extending the whole length of the oven, enables the gas to pass to the pusher end, where it descends through the corresponding set of vertical flues into the horizontal flue under this end of the oven and from here passes out into the second regenerator which it heats to a high temperature before escaping to the chimney. At intervals of about half an hour the valves are reversed, gas passes in through the other burner, air comes in through the regenerator which was before being heated, the burning gases pass up the vertical flues at the pusher end and down at the quenching end and out into the regenerator, which has been somewhat cooled by the air current through it during the previous half hour. It will be seen from this description that as long as the coke ovens as a whole are supplying sufficient gas, the temperature in the flues around any oven is independent of the quality or quantity of the gas being given off from that oven.

The following is a list of some of the commoner forms of retort ovens, most of which may be built either for or without by-product recovery: Bauer, Bernard, Brunk, Coppée, Hussner, Koppers, Otto-Helgenstock, Otto-Hoffman, Schmiewind (or United Otto), Seibel, Senet-Solvay, Simon-Carvès.

COMPARISON OF TYPES OF OVENS¹

Until very recently there has been a decided prejudice against retort oven coke and the product of beehive ovens has been greatly preferred, especially for blast furnace work; but this preference for beehive coke is now fortunately dying away. As a matter of fact retort ovens can make as good coke as beehive, and more of it from ordinary coking coals, and can produce a commercial coke from certain classes of coal which cannot be coked in a beehive oven; the retort has thus the wider range of adaptability, and for these reasons has almost altogether replaced the beehive oven abroad.

Beehive ovens not only burn or waste all the gases and volatile matter from the coal with no return except for the coking of the coal, but they also burn a certain amount of the coke itself. Sir Lowthian Bell estimates that the yield from a beehive oven is 10 per cent. less than from a retort oven. That is to say, for every hundred tons of coke produced in a beehive oven approximately twenty tons of coal are needlessly wasted. From the ethical point of view, therefore, there can be no hesitation in condemning the beehive oven, and from the practical point of view it should be remembered that in

¹See also Table XXIX.

addition to its smaller yield the greater waste of carbon in the beehive results in a higher percentage of ash in the resulting coke. The beehive oven is, however, very cheap in first cost, and being simple in construction is also easy to keep in repair, and these facts, together with the widespread prejudice in its favour, and the great number of managers and men familiar with its use and ignorant of foreign practice, explain the unwillingness of coke manufacturers in this country to change over to retort ovens. The coking period in the beehive is, however, usually at least $1\frac{1}{2}$ times as long as in a retort oven, so that if the charge is the same it takes 3 beehive ovens to do the work of 2 retort ovens. The cost of working a beehive oven is also high, as the method of drawing the coke by manual labour is slow and expensive.

In this connexion it may be interesting to quote some evidence given before the recent Royal Commission on Coal Supplies in England. It must, however, be borne in mind that all costs of production and prices of products refer to Great Britain and cannot readily be amended to suit Canadian conditions.

Mr. J. H. Darby said: "To produce 1,000 tons of coke per week in beehive ovens, the capital outlay, without boilers, would be about \$28,800 (£5,760); boilers to save waste heat would cost \$15,000 (£3,000), and hearths, sidings, etc., \$23,600 (£4,720) extra, making a total of \$67,400 (£13,480). He estimates from a coal with 30 per cent volatile matter a 54 per cent yield, 1,850 tons of coal being thus required.

In non-recovery retort ovens for the same output the cost, including, besides the ovens, rams, sidings, hearths, boilers, chimneys, etc., complete, would be about \$76,000 (£15,200). The yield with the same coal would be 64 per cent, 1,560 tons being required.

For a by-product retort oven the cost, including the ovens, compressing and charging plant, rams, sidings, coke hearth, boilers, chimneys, and by-product plant complete, would not be much less than \$200,000 (£40,000). The yield from the above coal would be 68 per cent, 1,470 tons of coal being required per week to produce 1,000 tons of coke.

Mr. Darby's evidence does not cover the working expenses of the plants, or the value of the products produced.

Sir S. A. Sadler, M.P., said many experiments had been made in blast furnaces on Teeside, and that with a sufficient blast retort coke invariably gave a larger yield in a given time than beehive, and the coke had always been found equally efficient in other respects, starting with both fuels perfectly dry.

He estimated the net value of the by-products per ton of coal coked, after deducting all costs, to be, for

20 lbs. sulphate of ammonia,	0.40
6 gallons tar,	0.18
1 gallon crude benzole,	0.08
35 per cent surplus gas, say 2,000 cubic feet,	0.12

Total,	80.78
------------------	-------

He also claims a production of from 10 to 15 per cent more coke than in a beehive oven.

Mr. John Higson, speaking of by-product ovens, stated that firms like the Simon-Carvée Company went to colliery proprietors and said, "Now if you will adopt our installation for making coke, and will sell us small coal for 10 years at x price, we will give you the coke and after ten years we will hand you over the works for nothing."

If it is assumed that the small price probably paid for the coal is counter-balanced by the gift of the coke, it would appear from this evidence that in England the value of the by-products will not only pay for the working of the plants and provide a profit, but will also pay for the capital outlay within ten years.

It is probable that in nearly all cases the non-recovery retort oven is in the long run cheaper than the beehive oven, and that it would prove more profitable in all large plants. The interest on the capital outlay is greater for the first oven, but the working expenses are less and the output of coke is at least 10 per cent more for the same amount of coal.

The profits to be gained by the recovery of by-products are at present, in Canada, somewhat doubtful. On account of the high capital cost of a by-product plant it is essential that it should be reasonably certain of working full time; it is, therefore, usual to erect only large central plants drawing supplies from several collieries. A good market for the products must also be accessible. Tar would fetch good prices in districts where there is anthracite or lignite dust that could be made into briquettes, and when the commercial development of the country is further advanced, large plants for the preparation of coal tar products will probably be built, which will provide a market for the tar; road making and other uses will also require large quantities of tar, which at present, if many of the existing plants recovered by-products, would be a drug on the market. Again, while the Canadian farmer lives on his capital by exhausting the virgin fertility of the soil there is very little demand for ammonium sulphate although it is a valuable fertilizer; but there is little doubt that as years go by it will realize better prices. It is interesting to note that the production of wheat per acre in the United States and Canada, in spite of their virgin soils, is about 45 and 20 bushels respectively, whereas in Scotland it is about 10 bushels; these figures give some indication of the advantage to be gained by the judicious use of fertilizers.

The Dominion Iron and Steel Co. possesses the only by-product plant in Canada. Probably few if any other firms could at present profitably operate such a plant; but we may confidently expect that the tendency of the future will be towards the recovery of tar and nitrogen, coal distillation products which are at present wasted.

TESTS

OBJECT, SCOPE, AND METHOD OF TESTING THE COKING POWER OF COALS

When considering the development of any coal area, or when choosing the location for a metallurgical industry, it is always important to know the

coking properties of the coals of the district. Also, when the time comes to erect ovens, it is well to know the type of oven best suited to give a suitable coke with the coal in question.

It was, therefore, decided to test the coking power of all the coals which were being investigated, whenever there was any possibility of a commercial coke being produced, and also to test typical coals from the different districts in the three kinds of ovens already described. From this main investigation a number of minor investigations have developed.

Three possible methods of making these tests were considered: (1) building a small experimental oven, or battery of ovens, at McGill University or some other central point; (2) coking full-sized charges in existing ovens; (3) coking small samples in boxes—the boxes to be coked as part of the charge of an oven in regular operation.

It is obvious from what has already been said, that no oven is properly complete if it only works as a part of a battery. The end ovens of a battery rarely give good coke as those in the middle, so that for the first method of making tests at least six beehive, or three retort ovens would have been required, of which only one-third would have been available for final results. Even if the very large sum of money necessary for such a plant had been available, it would have been very difficult to satisfactorily run such a miniature battery, and even if the ovens were built to only take $\frac{1}{2}$ or $\frac{1}{4}$ ton charges, it would have involved a large outlay of coal and time. The results obtained by this method would only be for the one abnormal type of oven; they would certainly be regarded with grave suspicion and their value would not be commensurate with the necessary expense.

The second method would have been the best, but it was impossible to carry out with the funds available, even if firms could have been found willing to set aside one or more ovens, for such a series of tests. A single oven charge would require 5 tons at least, and working with varied coals it would be impossible to ensure proper conditions of coking for each coal at the first attempt, so that it would be necessary to have at least 15 tons of each coal to be tested in any one type of oven. The freightage necessary to test all eastern coals in this way at, say, Sydney, N.S., and all western ones in the Crowsnest district, would have been very large and in addition there would have been the cost of the machinery for crushing the coal, and the labour for handling the coal and coke without interfering with the working of the plant at which the tests were being made.

The third method was the one which it was finally decided to adopt. Preliminary tests were very satisfactory, showing that it gave reliable results, and the method is so much simpler and less expensive than the other two that it was practicable to make a far more complete series of tests than would have been otherwise possible.

Thanks are due to the executives of the five firms mentioned below for the ungrudging way in which they placed their coking plants at the service of the tests and assisted in all ways in their power. It is impossible to personally

mention all those who rendered assistance, but thanks are especially due to Mr. F. E. Lucas at Sydney, where the bulk of the tests were carried out, and also to Mr. J. E. Preston at Sydney Mines, Mr. W. P. Williams at Lille, and Mr. W. P. Davidson at Coleman.

COKING PLANTS AT WHICH TESTS WERE MADE

Dominion Iron and Steel Co., Ltd.—Sydney, Nova Scotia.

In this plant there are 10 batteries of Otto-Hoffman by-product recovery ovens, 10 ovens in each battery. The coal used is Phalen seam coal from the Dominion Coal Co; it is used wet after washing in the Steel Company's washery, 10 hour coke being made. Eighty test boxes were coked here in Battery IX, during December, 1908, and January, 1909.

Dominion Coal Co., Ltd.—Glace Bay, Nova Scotia.

This Company has two beehive ovens placed side by side at their Bridgeport colliery. Unwashed slack coal from their Lingau colliery was being used at the time of the tests, 72 hour coke being made. One batch of 8 test boxes of coal was coked here, January, 1909.

Nova Scotia Steel and Coal Co., Ltd.—Sydney Mines, Nova Scotia.

There are two types of ovens in use here, there being 3 batteries each of 10 Bernard ovens, and one battery of 30 Bauer ovens. The Bernard ovens have already been described; the Bauer ovens can be used for by-product recovery, but here they have so far always been used as non-recovery ovens. Washed slack coal from Collieries 1 and 3 is used in the ovens, 18 hour coke being made. Twenty-six boxes were coked in the Bernard ovens and two in the Bauer, the tests being made during January, 1909.

West Canadian Collieries, Ltd.—Lille, Alberta.

The ovens used at this plant are Bernard non-recovery, similar to those used at Sydney Mines, but no attempt is made to save the waste heat, the gases being led straight into the chimney. There are two batteries of 10 ovens, using washed slack coal from the Lille colliery. Sixteen boxes were coked here, June, 1909.

International Coal and Coke Co., Ltd.—Coleman, Alberta.

Beehive ovens are used at this plant, as previously described. The coal is slack or broken coal from seams 2 and 1, mixed in the proportion of one part of No. 2 to two parts of No. 1. Six boxes and one sack of coal were coked here, June, 1909.

METHOD OF CONDUCTING COKING TESTS OF COALS

The method employed was in brief as follows, details and exceptions being given later.

The coking was carried out in metal boxes, holding about 50 pounds of coal and provided with perforated lids. The coal after crushing to pass

through a $\frac{1}{2}$ " screen, was weighed dry and then moistened and charged into a box which had already been weighed empty. The moist coal after being levelled off was covered with a layer of paper to prevent the escape of fines and the box was then closed with a lid resting on the coal and so arranged that it could not come out but was free to sink further in if the pressure on the top was sufficient to compress the coal inside. The box was then weighed full, the weight of water added to the coal being thus determined.

A batch of test boxes having been prepared, they were taken to an oven that was empty, but hot and ready to charge, and the boxes put into it. The method of charging varied with the oven; the boxes, however, were placed on the floor and near the centre. In the case of retort ovens they were charged with their length across the oven in order to get a full section from wall to wall. The boxes being in position, the oven was at once charged with coal by the regular staff and in the usual way and the coking then proceeded exactly as usual. Usually the gases from the boxes caught fire before the oven could be charged, but this initial rapid heating could have had no appreciable effect, as it was stopped almost at once when the regular damp coal was dumped on top.

At the expiration of the coking period determined upon, the coke in the oven was pushed, or drawn, and quenched exactly as usual, and the test boxes at once pulled out from the mass of hot coke. The test coke could not be quenched as quickly as the regular coke as the metal of the boxes prevented the water used from getting to it; the delay, however, was not serious as the glowing coke was likewise protected from the air. The final quenching was accomplished by pouring water on the top of each box; the water which ran through the lid turned to steam and the pressure this generated largely prevented more water from entering until the coke was comparatively cool; the box was then turned over and allowed to drain. The coke was thus mainly cooled by steam, and it was possible, with reasonable care, to completely quench without soaking with water.

After quenching, the boxes were dried in a hot place, as will be explained later, for at least a day; they were then weighed and the percentage yield of dry coke calculated.

The boxes were opened and the coke taken out with as little breakage as possible. Notes on the character of the coke were made at this stage, and it was sampled for chemical analysis. A single wedgeshaped piece, extending from the bottom end to the middle, was considered likely to be more truly representative than one obtained by selecting small pieces from different parts of the mass, but when this was impossible great care was taken to get a fair sample. This sample was crushed and quartered until it would go into a pint preserving jar, in which it was sealed and shipped to the chemist at Montreal.

A large main sample was also shipped to Montreal; upon arrival it was divided into three or four lots, the larger pieces being broken up. One portion was placed in an open tray to be kept for inspection and comparison; some stout double paper bags were also filled, one of these being required for physical tests, another for the Museum at Ottawa, and the remainder being kept in reserve. These samples would weigh from three to four pounds each.

of which was known. No attempt was made to take the same weight of coal each time, but rather to take an amount of coal which would fill the box to the proper extent after moistening.

In the earlier experiments the coal was damped by turning it on to a water-proof sheet and there sprinkling it with water from a watering can and mixing it up well with a small shovel; the moist coal being then carefully transferred to a weighed test box.

Most of the coals, however, were moistened in the test box. The weighed coal was transferred little by little to the weighed test box and there sprinkled from the watering can and mixed well with the shovel; each addition of coal being properly moistened before a further addition was made.

The second method of damping effected a great saving of time over the first, but it had the disadvantage of unavoidably compressing the coal into the test box slightly more than would be done by just shovelling the damp coal into the box. This compression was, however, certainly no greater than that suffered by coal as ordinarily dropped into the ovens from a charging car on the track overhead.

The boxes for the beehive ovens at Coleman were filled with dry coal, as dry coal is used in charging these ovens.

Closing the Boxes

Before charging the boxes, several lugs were made, about 2" long and 1" wide, by making vertical cuts from the top of the ends and sides of the boxes. The lids were made to fit into the boxes and rest on the coal inside; after a lid had been put in the lugs were hammered over, so that although there was nothing to prevent it sinking further into the box, the lid could not come out, or let the contents escape.

It was considered that this method of closing the boxes would result in the contents, during coking, being subjected to the same pressure as the surrounding coal.

Marking the Boxes

The boxes were in all cases marked in duplicate by means of large numbers centre punched on the metal, and as a check the number and arrangement of the lugs holding the lids were varied and recorded.

Charging the Boxes

The boxes were charged into the Otto-Hoffman and Bauer ovens from the coke discharge end of the oven. The boxes were placed one by one just inside the oven on the floor, and with the largest side of the box across the oven; they were then pushed with an iron rod well into the oven, it being arranged that the box nearest the end was at least 6 feet away from it. As many as eight boxes were sometimes coked together in one oven.

A few of the last boxes coked in the Bernard ovens at Sydney Mines were

charged in the above way, but most of them were charged from the pusher end. The boxes were placed one by one in the mouth of the oven and pushed in a few feet with a rod; they were then all pushed through together towards the other end by means of the pusher. This method was not altogether satisfactory, as some of the boxes got squeezed and damaged.

The boxes for the Bernard ovens at Lille were arranged, outside the oven, on a long plank about 10" wide and 2" thick and having cross pieces nailed to it at intervals in order to keep the boxes in position. The plank, with the boxes, was pushed nearly into the oven by hand and was then shoved into the middle by means of the pusher. Eight boxes were charged on one plank. This method gave the best results, all the boxes coming out in perfect condition; it also reduced the risk of damage to the floor or walls of the oven.

Test boxes were charged into the beehive ovens through the doors and pushed in towards the centre by means of a rod. At Bridgeport the boxes were charged right side up as usual. At Coleman the boxes were charged on end, as it was thought that in this way the boxes reaching from the bottom nearly to the top of the charge - cokes more representative of the oven would be produced.

Coking -

The Bernard and Bauer ovens containing test boxes were coked as in the regular practice for 48 hours, and the beehive oven at Bridgeport for 72 hours.

The test boxes in Otto-Hoffman ovens were coked for 48 hours, with a few exceptions duly recorded, instead of for about 40 hours as in the regular working of the plant. The boxes in the beehive ovens at Coleman were coked for 74 hours; the regular time of coking these ovens was either about 96 or 72 hours, according to whether a Sunday did or did not come into the coking period.

Drying the Test Boxes after Quenching

The boxes from the Otto-Hoffman ovens and from the beehive ovens at Bridgeport were dried on the top of a very hot metal flue between the boilers of the Dominion Iron and Steel Company's coke oven plant and the smoke stack. The boxes were left here from one to three days.

The boxes from the Bernard and Bauer ovens at Sydney Mines were dried round the casing of the fan, through which the flue gases passed when leaving the gas-fired boilers of the Nova Scotia Steel and Coal Company.

Three test boxes from Sydney Mines and all the boxes from Lille and Coleman were shipped to Montreal, where they were opened and the coke dried on a steam-heated table before weighing and sampling as usual.

Yield of Coke -

The quantities of coke produced were usually determined with satisfactory accuracy by weighing the boxes and making the necessary corrections

for tare. In a few cases the boxes were damaged in the oven and some coke possibly lost, and in a few cases also defective quenching caused small losses from burning, but note has been made in the detailed sheets of all doubtful cases.

In order to compare the different tests fairly, it was necessary to reduce all results to a common basis of yield of dry coke from dry coal. The moisture in the coal when not known was determined, and probably no appreciable errors have arisen on this account, but moisture in the coke gave more trouble. In the earlier preliminary tests the cokes were weighed undried, but in subsequent tests they were weighed after drying which, it was thought, would give the correct weight. Analyses of samples sent in air-tight jars to the chemist showed that traces of moisture were usually left even after prolonged drying, and the yields were, therefore, corrected for the moisture found. Owing to inability to obtain a sufficient supply of air-tight jars for all the samples, corrected yields for some cokes cannot be stated; but where given they may be taken as trustworthy within the limits of variation unavoidable in coke oven practice.

Fracture of Coke

The normal fracture of the coke made in a test box varied with the oven in which it was coked. The fracture of test coke from an Otto-Hoffman oven, in which the boxes reached almost from wall to wall across the oven, shows the way in which the heat penetrated through the coal from the floor and walls of the oven, by the fracture lines converging from the bottom and ends of the box towards the centre and top of the box. As the Bernard ovens are wider than the Otto-Hoffman the influence of the walls is not so marked, the fracture lines being more nearly vertical. The fracture of box coke from a beehive oven is vertical; if the box were coked on end the fracture would be along the length of the box.

Tests Applied to Coke

When the box was opened the coke was critically inspected and notes were made on its shrinkage in the box, fracture, strength, hardness, brightness, etc. It was analysed later in the laboratory for moisture, ash, volatile matter, and sometimes for sulphur. The real and apparent specific gravities of the coke were determined and its porosity calculated therefrom. The strength of the coke was determined by crushing.

The methods employed in the chemical analyses are described in the report of the work of the chemical laboratory Vol. II, Part IX. The determination of specific gravities is described on pages 221-2 and the crushing tests on coke on pages 222-3.

Preliminary Tests

A number of preliminary tests were carried out in Otto-Hoffman ovens at Sydney, before deciding on the methods to be employed in the regular

roking tests, a summary of these tests and their influence on the procedure adopted is given below; a full account will be found in Vol. VI, Appendix IV, to this report.

In June, 1908, Mr. Denis supervised the experimental coking of 9 drums of coal in the Otto-Hoffman ovens at Sydney, under specifications drawn up by Dr. Porter. Four of these drums were coked in one oven and five in another. In each oven one of the drums was filled with the ordinary washed coal which made up the main part of the charge. At the conclusion of each test a sample was taken of the regular coke made in each oven to compare with that made in the drum.

Samples of drum coke and of open oven coke were sent to several experts; whose opinions are given below.

E. E. Lucas, Superintendent of the coke oven plant of the Dominion Iron and Steel Company, stated that the drum cokes compared very favourably with the open oven coke, in spite of the extra difficulty of quenching to exact degree.

O. E. White-side, General Superintendent, International Coal and Coke Co., Ltd., Colenun, Alta., said, "I, of course, have no analyses or means at my disposal of judging the qualities of the different samples of coke, beyond the physical structure and appearance; but after comparing I am satisfied that these two samples are similar enough to justify you in having full confidence in the results of experimental process."

F. Keffler, Consulting Engineer, The British Columbia Copper Co., Greenwood, B.C., said, "Regarding the cokes I would say we regard the experimental process as sufficiently close to the ordinary process to justify one in feeling confident as to the results. This is illustrated by samples which are substantially identical both as to composition and structure."

J. E. Robertson, Smelter Manager, The Mond Nickel Co., Ltd., Victoria Mines, Ont., said, "Samples are very similar, and so far as the quality of coke can be judged from its appearance, justify confidence in the experimental results."

The above tests and the reports thereon were considered to be satisfactory enough to warrant proceeding with the box method test; but it is worthy of note that additional comparisons made during the progress of the investigation confirmed this conclusion.

Age of Coal

Owing to unavoidable causes the coal samples to be tested varied from five months to twenty-one months old, at the time the regular coking tests were begun in Sydney, and as grave doubts were felt as to the possibility of securing any trustworthy results from samples which had been mined for so long a time, a series of preliminary tests were run on samples ranging from twenty-one months to one week. These indicated that

age had less effect than had been feared, but it was deemed advisable to avoid all chance of error on this account and the various mine managers were asked to furnish fresh samples. In the case of the eastern tests sixteen such samples were asked for and all but one were received. These were tested within a fortnight of their arrival in Sydney, in all cases the corresponding old coals being coked at the same time and in the same oven. Comparison of the cokes produced showed that although in the majority of cases the difference was very slight, in some cases there was a marked deterioration of the coking quality of the coal which had been stored.

The western coal samples had been mined a year later than those from the east, but in consequence of the above results it was felt to be essential to also repeat the coking tests upon these coals, using freshly mined samples. These tests were carried out at Lille and Coleman, Alta. The samples from the Crowsnest Pass district were all taken by Mr. Stansfield within a fortnight of the actual test, but the fresh coals from Vancouver island were supplied by the collieries, and owing to a strike which delayed the trials these were about ten weeks old when tested.

The age of all coals when tested will be found in the list given on page 225 and a statement of all results having a bearing on the effect of the age of the coal on the quality of the coke produced, will be found in Vol. VI, Appendix IV.

Time of Coking¹

Numerous tests were made to find the effect of the time of coking upon the quality of coke produced. Boxes of coal were coked in ovens, the coking time of which varied from 30 to 72 hours. These tests showed that the appearance of the coke improved with increase of time up to 72 hours, but that after from 40 to 48 hours this improvement was very slight, and as this was the regular period of the ovens it was adopted for the regular tests.

Position in Oven²

Four boxes were filled with the same coal and charged into the same oven. One of these was placed on the floor, the other three were supported on a frame in such a way that the bottom of one was 1'-4" above the floor, the second was 2' 8" up, and the third was 4' 0" up. An inspection of the cokes produced showed that while the cokes from the lower half of the oven were superior to those from the upper half, there was very little difference between the two lower boxes, and both were substantially identical with the regular output of the oven. It was, therefore, decided, for simplicity, to coke all boxes on the floor of the oven.

Blending of Coals for Coking³

A few special tests were made in the usual boxes to determine the result of mixing a coal which would not coke, or would not make a

¹ These tests are detailed in table XXIX.

² " " " " " " XXX.

³ " " " " " " XXXI.

merchandise coke with a rich and strong coking coal. Circumstances did not permit much work on this side issue, but the results of the few tests made are interesting and tend to confirm the results of experiments made on certain European coals, namely that with suitable blending it is possible to get coke of fair quality by this process, especially in retort ovens, and thus to utilize a certain amount of slack coal from seams which in themselves are uncoking. The detailed results are given in table XXXI.

Compression of Coal

Tests were made with two boxes of coal; in one of these the coal was compressed as possible during tiling, in the other as little as possible. The lid was fastened tight to prevent change in the oven. The cokes produced were better than that from the compressed coal was denser than usual. The desired effect was to therefore compress the coal as little as possible in the box, but to leave the lid loose so that the coal in the box might be subjected to the pressure of the superincumbent coal, under ordinary conditions.

Moisture in Coal

Three boxes were filled, one with dry coal, one with ordinary damp coal as charged in retort ovens, and one with very wet coal. There was very little difference in the sound of the three cokes; they were all good. The coke from the dry box appeared, however, slightly less sound at the top of the box. It was, therefore, decided to dampen all the coals used and to endeavor to make the added moisture approximate to the moisture in the coal ordinarily charged, as the more nearly the coal inside the box resembled that surrounding it, the more reliable the results would be.

METHODS DEvised FOR COMPARING THE DIFFERENT SAMPLES OF COKE

Determination of Apparent Specific Gravity of Coke

The apparent specific gravity was determined in a simple form of volumeter by observing the water displaced by from 60 to 70 grams of the coke in lumps.

The apparatus employed consisted of a glass cylinder of about 2" diameter, and 250 c.c. capacity, having at the top a ground in tubulated stopper, and at the bottom being drawn out and connected by some stout rubber tubing to the bottom of a 100 c.c. graduated burette. A Mackulane's extraction tube and a Winkler-Hempel gas analysis burette, with stop-cocks, were found to be suitable for the purpose.

Sufficient distilled water was poured into the apparatus to rather more than fill the glass cylinder and rubber tubing. The burette was then raised until the water just reached a file mark on the tubulure of the cylinder stopper, and the reading of the water level in the burette taken. The burette was

1. These tests are detailed in table XXX.

then lowered, the stopper removed from the cylinder, a few lumps of dry, weighed coke introduced, the stopper replaced and the burette raised until the water again reached the tile mark, when the new level of the water in the burette was read. The difference between the first and second readings in the burette gives the volume of water displaced by the coke. The glass cylinder was gently shaken before making the final adjustment, in order to remove any large air bubbles adhering to the coke.

The weight of the coke, in grams, divided by the volume of water displaced, in cubic centimetres, gives the apparent specific gravity. For each coke, determinations were made on three separate samples and the mean of the results taken.

Determination of Real Specific Gravity of Coke

The real specific gravity was determined in specific gravity bottles of 100 c.c. capacity, whose weight, when filled with distilled water at 18° C., was known. Usually from 10 to 20 grams of coke were used for each determination.

The coke tested was that which had been used in the determination of the apparent specific gravity. It was dried for at least 2 hours at 105° C., crushed to pass a 20 mesh screen, and a suitable quantity was introduced into a weighed specific gravity bottle which was then re-weighed, the exact weight of coke introduced being thus determined. The bottle was then about half filled with distilled water which was kept gently boiling under a partial vacuum for about 2½ hours, in order to completely expel the air from the cells of the coke. Four bottles were heated together on an electric heater in a bell jar desiccator which was kept exhausted to about half atmospheric pressure by means of a water jet air pump. The boiling was interrupted two or three times to enable the bottles to be gently shaken, as this was found to cause the coke adhering to the sides and the scum floating on the surface to settle. After the air had been completely removed from the coke, the bottle was cooled, completely filled with distilled water at 18° C., and then weighed.

The weight of the bottle filled with water, plus the weight of coke taken, minus the final weight of the bottle filled with coke and water, gives the weight of the water displaced by the coke, this weight divided into the weight of coke taken gives the real specific gravity of the coke.

Determination of the Porosity of Coke

The percentage of cell space or air space or porosity of coke was determined by the following formula

$$\text{Real specific gravity} - \text{Apparent specific gravity} = 1 - \text{Porosity } \%$$

Real specific gravity

Determination of Strength of Coke

Difficulty was experienced in devising a satisfactory method for de-

termining the strength of coke. The common method is that of finding the crushing strength of inch cubes. The strength of various pieces of the same coke is so different that a large number of cubes require to be tested, and these cubes are often difficult and sometimes impossible to cut true. The results of these tests do not appear to be much trusted by coke users. This method was not employed.

Three methods were tried in an endeavour to obtain a reliable practical test applicable to small quantities of coke, and capable of being repeated by others: a method that would classify the cokes according to their working strength in handling, and in the blast furnace, and the results of which could be expressed numerically. In each case the coke was first crushed and screened to a definite size. The first method consisted in giving the coke a series of drops (20 feet) on to a rigid iron plate; the second consisted in rotating the coke in a square iron box or tumbler with shelves which picked the coke up and dropped it from the top, thus causing the pieces of coke to be broken up both by falling and by rubbing against each other; in the third method the coke was placed in an iron cylinder with a loose fitting piston and then subjected to a definite pressure. The third method was the quickest, gave the most consistent results, showed the greatest difference between a weak and strong coke, and appeared to classify the cokes best; it was, therefore, adopted.

The details of the test were as follows: the coke was crushed in a Comet crusher to pass through a screen of 1" mesh; 500 grams of the pieces which passed through the 1" mesh and stayed on a $\frac{1}{2}$ " were placed in a cylinder of about 5" diameter—21 square inches cross area—and covered by a loose fitting plunger. The coke was then subjected to a pressure of 4,200 pounds—200 pounds per square inch—by means of a testing machine, the pressure being maintained for 2 minutes. The crushed coke was then removed and subjected to a screen analysis. The screens used were $\frac{1}{2}$ ", $\frac{3}{16}$ ", and $\frac{1}{16}$ " mesh and the coke remaining on each screen was weighed.

It now remained to reduce the results to a single number which should approximately represent the strength of the coke. This was done by multiplying the weight of coke remaining on each screen by the reciprocal of the size of the screen above it. A concrete example will explain this best. Of 500 grams of coke treated as above, all of which had passed through a 1" screen and had failed to pass $\frac{1}{2}$ " before the crushing, 347 grams passed through a 1" screen but stayed on a $\frac{1}{2}$ ", 67 grams passed through the $\frac{1}{2}$ " but stayed on a $\frac{3}{16}$ ", and 55 grams passed through the $\frac{1}{16}$ " mesh; adding together (347×1) , $(67 \times \frac{1}{2})$, $(31 \times \frac{1}{16})$ and $(55 \times \frac{1}{16})$, gives 873. This number is called the "factor of strength." It is obvious that the larger this factor the weaker the coke. It is thus possible to take any coke as standard, and by dividing the factors of the other cokes into that of the standard, to get the "relative strengths" of the cokes, with the standard coke as unity. The

coke chosen as standard had a factor of 674, so that the coke given above had a relative strength of $674 \div 873 = 0.772$.¹

Of two cokes of equal strength as found by the above test, the more porous one would be the better. To get a commercial classification of the cokes it, therefore, seems desirable to include both the strength and the porosity; this is done either by multiplying together the relative strength of the coke and its porosity, *i.e.*, the percentage of cell space, or by multiplying the square of the relative strength by the porosity. In these ways numbers are obtained which may be called the "physical value" of the coke. If the porosity is denoted by P and the relative strength by S, the two physical values are distinguished by calling them $P \times S$ and $P \times S^2$, respectively.

These physical values are purely empirical numbers and may appear to be complicated and meaningless; nevertheless, they do appear to give a good commercial classification of the cokes. When coke is required for such work as copper smelting, where porosity is important, classification on the $P \times S$ basis is probably best; but for iron smelting, where strength is essential, classification on the $P \times S^2$ basis is recommended.

TABULATING THE RECORDS OF COKING TESTS

NUMBERING OF COKE SAMPLES

A system of numbering the coke samples was adopted which should not only serve to identify but also to describe the coke. All coke samples bear the letter C to distinguish them from other samples.

Regular cokes made in the Otto-Hoffman ovens at Sydney	C1 X
Regular cokes made in the beehive ovens at Bridgeport	= C2 X
Regular cokes made in the Bernard ovens at Sydney Mines	= C3 X
Regular cokes made in the Bernard ovens at Lille	C4 X
Regular cokes made in the beehive ovens at Coleman	C5 X

In each case X = the number of the coal from which the coke is made.

Special cokes were numbered C, followed by a serial number, e.g., C 121.

The coal samples were numbered serially as taken 1 to 53, some extra samples not in the regular series being numbered Ex. 1, etc. Washed coal was numbered by adding 200 to the number of the unwashed coal, e.g. Ex. 232 is coal Ex. 32 after washing. In cases where a fresh sample of coal was obtained from any mine, it was given a number 2,000 greater than the number given to the original sample from that mine, a second supplementary sample being given a number 3,000 greater.

Thus, No. 29 is a coal from Michel, B.C.

C1 29 is a coke made from this coal in the Otto-Hoffman ovens at Sydney.

No. 2029 is a supplementary sample of the above coal, taken later.

C1 2029 is a coke made from the fresh coal in the Bernard ovens at Lille.

¹"Factors of strength" determined as above, are by no means exact, mathematically; and at first sight it would seem proper to deduct 500 from each factor so determined, in order to eliminate the effect of the crushing to which the coke had already been subjected during its preparation for the crushing test proper. This would give 0 as the factor of a hypothetical coke so strong as to remain absolutely uncrushed under the pressure of 200 lbs. per sq. in. and would give factors of 174 and 373, respectively, for the two actual cokes cited. As a matter of fact, however, this method would put an exaggerated value upon extreme strength, and would give less useful figures than the method recommended by Mr. Stansfield. This matter will be discussed mathematically in Vol. VI, Appendix IV, where an attempt will be made to apply the "KICKS" law. J. B. P.

TABLE XX

List of Cokes made in Regular Series of Tests.¹

Source of Coal	Coal Number	Age of Coal in Mths. ²	Coke Number and Oven in which it was Coked				
			Otto-Hoffman at Sydney	Beehive at Bridgeport	Bernard at Sydney Mines	Bernard at Lille	Beehive at Coleman
North Atlantic Collieries Ltd., Port Morien, N.S., Gowrie seam.	50	$\frac{1}{2}$	C1 50				
Dominion Coal Co., Ltd., Glace Bay, N.S., Hub seam, Dominion No. 7	36	5 $\frac{1}{2}$	C1 36				
Hub seam, Dominion No. 7.	2036	$\frac{1}{2}$	C1 2036				
Harbour seam, Dominion No. 9 . . .	35	5 $\frac{1}{2}$	C1 35				
Harbour seam, Dominion No. 9 . . .	2035	$\frac{1}{2}$	C1 2035				
Phalen seam, Dominion No. 5 . . .	35 SP	5 $\frac{1}{2}$	C1 35 SP				
Phalen seam, Dominion No. 5 . . .	203 SP	$\frac{1}{2}$	C1 203 SP	C2 2035 SP			
Phalen seam, Dominion No. 1 . . .	38	5 $\frac{1}{2}$	C1 38(2)		C3 38		
Phalen seam, Dominion No. 1 . . .	2038	$\frac{1}{2}$			C3 2038		
Emery seam, Dominion No. 10 . . .	37	5 $\frac{1}{2}$	C1 37				
Emery seam, Dominion No. 10 . . .	2037	$\frac{1}{2}$	C1 2037				
Lingan seam, Dominion No. 12 . . .	39	5 $\frac{1}{2}$	C1 39		C3 39		
Lingan seam, Dominion No. 12 . . .	2039	$\frac{1}{2}$			C3 2039		
Nova Scotia Steel & Coal Co., Ltd., Sydney Mines, N.S., No. 1 colliery.	13	17 $\frac{1}{2}$			C3 13(2)		
No. 1 colliery	2013	$\frac{1}{2}$			C3 2013		
No. 3 colliery	12	17 $\frac{1}{2}$	C1 12		C3 12		
No. 3 colliery	2012	$\frac{1}{2}$			C3 2012		
Inverness Ry. & Coal Co., Inverness, N.S., Inverness colliery . . .	14	16 $\frac{1}{2}$	C1 14				
Richmond Ry. Coal Co., Ltd., Port Hood, N.S., Port Hood colliery . . .	15	16 $\frac{1}{2}$	C1 15				
Acadia Coal Co., Ltd., Stellarton, N.S., Six Foot seam, Vale colliery	2004	16 $\frac{1}{2}$	C1 2004				
Foord seam, Allan Shaft colliery . . .	16	16 $\frac{1}{2}$	C1 16				
Foord seam, Allan Shaft colliery . . .	2016	$\frac{1}{2}$	C1 2016				
Foord seam, Albion colliery . . .	1	21	C1 1				

¹—Table XXX, NIA, inclusive for Summary Report of Results of Tests.
²The age of the samples at the time of coking was always slightly less than the time given.

TABLE XX.—(Continued).

List of Cokes made in Regular Series of Tests.

Source of Coal	Coal Number	Age of Coal in Mths.	Coke Number and Oven in which it was Coked			
			Otto-Hoffman at Sydney	Beehive at Bridgeport	Bernard at Sydney Mines	Bernard at Lille
Acadia Coal Co., Ltd., Stellarton, N.S. <i>Coal'd</i> Cage Pit seam, Albion colliery	2	21	C1 2			
Cage Pit seam, Albion colliery.	2002	$\frac{1}{2}$	C1 2002			
Main seam, Acadia colliery.	8	21	C1 8			
Main seam, Acadia colliery.	2008	$\frac{1}{2}$	C1 2008	C2 2008		
International Coal Co., Ltd., Westville, N.S., Main seam, Drummond colliery	3	21	C1 3			
"	2003	$\frac{1}{2}$	C1 2003			
Cumberland Ry. & Coal Co., Ltd., Springhill, N.S.						
No. 1 colliery	49	$\frac{1}{2}$	C1 49			
No. 2 colliery	5	21 $\frac{1}{2}$	C1 5			
"	2005	$\frac{1}{2}$	C1 2005			
No. 3 colliery	6	21 $\frac{1}{2}$	C1 6	C2 6		
"	2006	$\frac{1}{2}$	C1 2006			
Maritime Coal, Ry. & Power Co., Ltd., Chig- necto, N.S., Chignecto colliery	7	21	C1 7			
Minudie Coal Co., Ltd., River Hebert, N.S., Minudie colliery	9	21	C1 9			
Canada Coals & Ry. Co., Joggins, N.S., Joggins colliery	10	21 $\frac{1}{2}$			C3 10	
"	3010	$\frac{1}{2}$			C3 3010	
G. H. King, Minto, N.B., Kings mine	11	21 $\frac{1}{2}$			C3 11	
Canada West Coal Co. Taber, Alta., Canada West colliery	13	5 $\frac{1}{2}$	C1 13			
Leitch Collieries, Ltd., Passburg, Alta., Seven Foot seam, No. 1 By- ron Leitch colliery	48	5 $\frac{1}{2}$	C1 48		C3 48	
"	2018	$\frac{1}{2}$				C1 2018
Hillcrest Coal & Coke Co., Ltd., Hillcrest, Mtg., Hillcrest colliery	32	8	C1 32		C3 32	
"	2032	$\frac{1}{2}$				C1 2032 C5/2032
West Canadian Collieries Co., Ltd., Blairmore, Alta., No. 1 seam, Belle vue colliery	33	8	C1 33		C3 33	

TABLE XX.—(Continued).

List of Cokes made in Regular Series of Tests.

Source of Coal	Coal Number	Age of Coal in Mths.	Coke Number and Oven in which it was Coked				
			Otto-Hoffman at Sydney	Beehive at Bridgeport	Bernard at Sydney Mines	Bernard at Lille	Beehive at Coleman
West Canadian Collieries Co., Ltd., Blairmore, Alta. No. 1 seam, Bellevue colliery	2033	$\frac{1}{2}$				C1 2033	
No. 1 seam, Lille colliery	28	$\frac{1}{2}$	C1 28	C2 28	C3/28		
" " " " " " " " " " " "	2028	$\frac{1}{2}$					C4 2028
International Coal & Coke Co., Ltd., Coleman, Alta. No. 2 seam, Denison colliery	34	$\frac{1}{2}$	C1 34	C2 34			
" " " " " " " " " " " "	2034	$\frac{1}{2}$					C4 2034
No. 1, seam, " " " " " " " " " " " "	34 SP	$\frac{1}{2}$	C1 34 SP				
" " " " " " " " " " " "	2034 SP	$\frac{1}{2}$					C4/2034 SP C5/2034 SP
Crowsnest Pass Coal Co. Ltd., Fernie, B.C., No. 3 mine, Michel colliery	31	$\frac{1}{2}$	C1 31	C2 31			
No. 3 mine " " " " " " " " " " " "	2031	$\frac{1}{2}$					C4 2031
No. 7 " " " " " " " " " " " "	30	$\frac{1}{2}$	C1 30		C3 30		
No. 8 " " " " " " " " " " " "	29	$\frac{1}{2}$	C1 29		C3/29		
No. 8 " " " " " " " " " " " "	2029	$\frac{1}{2}$					C4 2029
Hosmer Mines Ltd., Hosmer, B.C., No. 2 seam south, Hosmer	51	$\frac{1}{2}$					C4 51
No. 6 seam, " " " " " " " " " " " "	52	$\frac{1}{2}$					C4/52 C5/52
No. 8 seam, " " " " " " " " " " " "	53	$\frac{1}{2}$					C4 53
Crowsnest Pass Coal Co. Ltd., Fernie, B.C., No. 2 mine, Coal Creek " " " " " " " " " " " "	27	$\frac{1}{2}$	C1 27				C1 2027
" " " " " " " " " " " "	2027	$\frac{1}{2}$					
No. 5 mine, " " " " " " " " " " " "	26	$\frac{1}{2}$	C1 26	C2 26	C3 26		
" " " " " " " " " " " "	2026	$\frac{1}{2}$					C1 2026 C5 2026
H. W. McNeill Co. Ltd., Cannore, Alta. No. 1 or Old mine, Cannore Bankhead Mines, Ltd., Bankhead, Alta. Bankhead colliery	25	$\frac{1}{2}$	C1/25				
" " " " " " " " " " " "	23 M	$\frac{1}{2}$	C1 23 M				
Prospect samples, Dr. J. B. Porter, No. 1 opening, Granite Creek B.C.	Ex. 1	$\frac{1}{2}$	C1 E. 1				
Do. (washed)	Ex. 201	$\frac{1}{2}$	C1 E. 201				
No. 2 opening	Ex. 2	$\frac{1}{2}$	C1 E. 2				
" " (washed)	Ex. 202	$\frac{1}{2}$	C1 E. 202				
No. 4 opening	Ex. 3	$\frac{1}{2}$	C1 E. 3				
" " (washed)	Ex. 203	$\frac{1}{2}$	C1 E. 203				
Nicola Valley Coal and Coke Co. Ltd., Contlee, B.C., Rat Hole seam, No. 2 mine, Middleboro colliery	22 SP	$\frac{1}{2}$	C1 22 SP				
Mixture from Mines 1 and 2.	22 M	$\frac{1}{2}$	C1 22 M				

TABLE XX. (Continued).

List of Cokes made in Regular Series of Tests.

Source of Coal	Coal Number	Age of Coal in Mths.	Coke Number and Oven in which it was Coked				
			Otto-Hoffman at Sydney	Beehive at Bridgeport	Bernard at Sydney Mines	Bernard at Lille	Beehive at Coleman
Wellington Colliery Co. Ltd., Extension, B.C., Wellington seam, Extension colliery	20 2020	9 24	C1 20				
Western Fuel Co. Ltd., Nanaimo, B.C., Upper seam, No. 1 mine	18	9	C1/18		C3/18		
Upper seam, No. 1 mine	2018	24				C4/2020	C5/2020
Lower seam, No. 1 mine	17	9	C1 17				C1/2018
Wellington Colliery Co., Ltd., Cumberland, B.C., Lower seam, No. 4 mine, Comox colliery	21	8½	C1/21				
Lower seam, Nos. 4 and 7 mines, mixed	21M	8½	C1/21 M		C3/21 M		
White Pass & Yukon Ry. Co. Ltd., Whitehorse, Yukon, Upper seam, Tantalus mine	Ex. 31		C1/Ex. 31				
Upper seam, Tantalus mine (washed)	" 231		C1/Ex. 231				
Middle seam, Tantalus mine	" 32		C1 Ex. 32				
Middle seam, Tantalus mine (washed)	" 232		C1 Ex. 232		C3 Ex. 232		
Lower seam, Tantalus mine	" 33		C1/Ex. 33				
Lower seam, Tantalus mine (washed)	" 233		C1/Ex. 233				

TABLE XXI

List of Special Cokes made in Blending Tests¹

All coals coked for 48 hours in metal boxes in Otto-Hoffman ovens.

	Coke Sample No.
Bankhead Colliery coal, Bankhead Mines, Ltd. (No. 23 M)	
1 part 23 M blended with 2 parts D. I. & S. Co.	C1 23 M + D. I. & S. Co.
1 part 23 M blended with 2 parts No. 31 (No. 3 mine, Michel)	C1 23 M + 31
2 parts 23 M blended with 3 parts No. 26 (No. 5 mine, Fernie)	C1 23 M + 26
No. 1 or Old mine coal, H. W. McNeil Co., Canmore (No. 25)	
1 part 25 blended with 2 parts No. 20 (Wellington seam, Extension)	C1 25 + 20
Western Dominion Collieries Ltd., Taylorton (No. 2010)	
1 part 2010 blended with 2 parts No. 31 (No. 3 mine, Michel)	C1 2010 + 31

¹ See Table XXXI for results of blending tests.

TABLE XXII

Special Tests for Comparison of Open Oven and Box Cokes¹

	Coked Hours	Coke Sample No.
Dominion Coal Co.'s coal - Washed by the D. E. & S. Co. (No. D. E. & S. Co.)		
Coke from oven - Otto Hoffman	*41	C 35 D
" " " "	*41	C 45 D
" from metal drum	*41	C 8 D
" " " "	*41	C 9 D
" from oven	10	C 83
" from box	11	C 1
" " " "	48	C 5
" " " "	48	C 7
Dominion Coal Co.'s Lagan slack coal		
Coke from oven - beehive oven at Bridgeport, N.S.	72	C 82
Coke from box - beehive oven at Bridgeport, N.S.	72	C 81
Nova Scotia Steel & Coal Co. - Washed coal		
Coke from top of oven - Bernard oven at Sydney Mines	48	C 97
Coke from bottom of oven - Bernard oven at Sydney Mines	48	C 98
Coke from box - Bernard oven at Sydney Mines	48	C 86
West Canadian Collieries Ltd. - Washed coal from Lille colliery		
Coke from open oven, Bernard ovens at Lille	48	C 121
Coke from box, Bernard ovens at Lille	48	C 120
International Coal & Coke Co., Coleman. - Mixed coal from seams 2 and 4		
Coke from beehive oven at Coleman	71	C 123
Coke from box, beehive oven at Coleman	71	C 122

*Preliminary tests, June 1908.

TABLE XXIII

Special Tests for Comparison of Types of Ovens¹

	Coked Hours	Coke Sample No.
Dominion Coal Co.'s coal - Washed by the D. E. & S. Co. (No. D. E. & S. Co.)		
Coked in box in Otto-Hoffman oven at Sydney	48	C 5
" " " " " " " "	48	C 7
" " " " Bernard oven at Sydney Mines	48	C 87
" " " " Brier oven at Sydney Mines	48	C 89
Nova Scotia Steel & Coal Co. - Washed coal		
Coked in box in Bernard oven at Sydney Mines	48	C 86
" " " " Brier oven at Sydney Mines	48	C 85

See Table XXXIV

Apparatus used

See Table XXXII for results of tests

TABLE XXIV
Special Tests for Effect of Time of Coking¹

	Coked Hours	Coke Sample No.
Dominion Coal Co.'s coal—Washed by the D. I. & S. Co. (No. D. I. & S. Co.)		
Coked in box in Otto-Hoffman oven at Sydney	30	C 11
Coked in box in Otto-Hoffman oven at "	36	C 12
Coked in box in Otto-Hoffman oven at "	44	C 1
Coked in box in Otto-Hoffman oven at "	48	C 5
Coked in box in Otto-Hoffman oven at "	48	C 7
Coked in box in Otto-Hoffman oven at "	60	C 13
Coked in box in Otto-Hoffman oven at "	72	C 14

TABLE XXV
Special Tests for Effect of Position of Box in Oven²

	Coked Hours	Coke Sample No.
Dominion Coal Co.'s coal—Washed by the D. I. & S. Co. (No. D. I. & S. Co.)		
Coked in box on floor of Otto-Hoffman oven at Sydney	48	C 7
Coked in box 1'-4" above floor of Otto-Hoffman oven at Sydney	48	C 8
Coked in box 2'-8" above floor of Otto-Hoffman oven at Sydney	48	C 9
Coked in box 4'-0" above floor of Otto-Hoffman oven at Sydney	48	C 10

TABLE XXVI
Special Tests for Effect of Compression of Coal³

	Coked Hours	Coke Sample No.
Dominion Coal Co.'s coal—Washed by the D. I. & S. Co. (No. D. I. & S. Co.)		
Light compression—Coked in large box in Otto-Hoffman ovens at Sydney	48	C 15
Heavy compression—Coked in large box in Otto-Hoffman ovens at Sydney	48	C 16

TABLE XXVII
Special Test for Effect of Moisture in Coal⁴

	Coked Hours	Coke Sample No.
Dominion Coal Co.'s coal—Washed by the D. I. & S. Co. (No. D. I. & S. Co.)		
Dry coal, coked in box in Otto-Hoffman oven at Sydney	48	C 4
Ordinary damp coal, coked in box in Otto-Hoffman oven at Sydney	48	C 5
Very wet coal, coked in box in Otto-Hoffman oven at Sydney	48	C 6

List of Commercial Cokes Sampled for Comparison Tests⁵

Sample taken by E. Stansfield at the Mount Royal Foundry Co., Montreal, June 22, 1909. Said to be from Walston, Pennsylvania C 113.

Sample received from Farquhar Robertson, coal merchant, Montreal, June 24, 1909. Said to be from Walston, Pennsylvania C 114.

¹See Table XXIX for results of tests.

²See Table XXX for results of tests.

³See Table XXXIII for results of tests.

Sample received from Farquhar Robertson, coal merchant, Montreal, June 21, 1910. Said to be Empire coke (by-product coke from Solway Process Co., Geneva, N.Y.) made from Pennsylvania coal = C 115

Sample taken from Department of Mechanical Engineering, McGill University, Foundry supply, June 29, 1909. This is probably Walston coke = C 116

Sample taken from the Metallurgical Department, McGill University, June 30, 1909. Said to be gas coke from the Montreal Light, Heat, & Power Co. = C 117

Sample obtained from the Canadian Pacific railway, Angus shops, Montreal. Said to be Vinton coke. A beehive coke from the Vinton Colliery Co. = C 118

Sample obtained from the Canadian Pacific railway from the Angus shops, Montreal. Said to be Empire coke from the Empire Coke Co. = C 119

TABLE XXVIII

List of Special Cokes—Classified under Coke Number

Coke Number	Coal	Oven used	How Coked	Time of Coking	Tests for — and Remarks
C 1	D. I. & S. Co.	Otto-Hoffman	In box	44 Hrs.	Comparison of box and oven coke.
"	"	"	"	44 "	Time of coking.
C 4	"	"	"	18 "	Moisture in coal—dry coal.
C 5	"	"	"	18 "	Comparison of box and oven coke.
"	"	"	"	18 "	Comparison of ovens.
"	"	"	"	18 "	Time of coking.
"	"	"	"	18 "	Moisture in coal—normal damp coal.
C 6	"	"	"	18 "	Moisture in coal—very wet coal
C 7	"	"	"	48 "	Comparison of box and oven coke.
"	"	"	"	18 "	Comparison of ovens.
"	"	"	"	18 "	Time of coking.
"	"	"	"	18 "	Position in oven—floor of oven
C 8	"	"	"	48 "	Position in oven—4' 4" above floor.
C 9	"	"	"	48 "	Position in oven—2' 8" above floor.
C 10	"	"	"	18 "	Position in oven—1' 0" above floor.
C 11	"	"	"	30 "	Time of coking.
C 12	"	"	"	36 "	Time of coking.
C 13	"	"	"	60 "	Time of coking.
C 14	"	"	"	72 "	Time of coking.
C 15	"	"	"	48 "	Compression of coal—light compression.
C 16	"	"	"	48 "	Compression of coal—heavy compression.
C 81	Langon slack	Beehive at Bridgeport	"	72 "	Comparison of box and oven coke.
C 82	"	"	Open oven	72 "	Comparison of box and oven coke.
C 83	D. I. & S. Co.	Otto-Hoffman	"	102 "	Comparison of box and oven coke.

TABLE XXVIII—(Continued).

List of Special Cokes Classified under Coke Number (Continued)

Coke No.	Coal Number	Oven used	How coked	Time of coking	Tests for	and Remarks
C 86	N. S. S. & Coal Co.	Bernard at Sydney Mines	In box	18 Hrs.	Comparison of box and oven coke.	
"	"	"	"	18 "	Comparison of ovens.	
C 87	D. I. & S. Co.	"	"	18 "	Comparison of ovens.	
C 88	N. S. S. & Coal Co.	Bauer	"	18 "	Comparison of ovens.	
C 89	D. I. & S. Co.	"	"	18 "	Comparison of ovens.	
C 97	N. S. S. & Coal Co.	Bernard at Sydney Mines	Open oven	18 "	Comparison of box and oven coke—from top of oven	
C 98	"	"	"	18 "	Comparison of box and oven coke—from bottom of oven	
C 113	Pennsylvania				Coke from Walston, Pa.	
C 111	"				Coke from Walston, Pa.	
C 115	"	By-product Solvay			Empire coke from Empire Coke Co.	
C 116	"				Coke sample from McGill Engineering Bldg. supply.	
C 117	Nova Scotia	Gas retort			Coke from Montreal Light, Heat, & Power Co.	
C 118	Pennsylvania	Beehive			Vinton coke from Vinton Colliery Co.	
C 119	"	Solvay			Empire coke from Empire Coke Co.	
C 120	Lille	Bernard at	In box	18	Comparison of box and oven coke.	
C 121	"	"	Open oven	18	Comparison of box and oven coke.	
C 122	Coleman	Beehive at Coleman	In box	71 "	Comparison of box and oven coke.	
C 123	"	"	Open oven	71 "	Comparison of box and oven coke.	
C 9 D	D. I. & S. Co.	Otto-Hoffman	Metal drum	11 "	Comparison of box and oven cokes. Denis's tests.	
C 9 D	"	"	"	11 "	Comparison of box and oven cokes. Denis's tests.	
C 35 D	"	"	"	11 "	Comparison of box and oven cokes. Denis's tests.	
C 15 D	"	"	"	11 "	Comparison of box and oven cokes. Denis's tests.	

RESULTS OF COKING TESTS.

The tables that follow present a summary record of the whole series of both special and regular coking tests. The methods of conducting the tests and of numbering the samples, etc., have been sufficiently explained above.

LINE 17.

Theoretical yield—this is the yield to be expected from the chemical analysis of the dry coal, and is obtained by adding together the percentages of fixed carbon and ash.

LINE 18.

This is the actual yield (line 16) expressed as a percentage of the theoretical yield (line 17).

LINE 19, 20, and 22.

All measurements and calculations for these values have been carried out to give results to one place of decimals further than reported. In lines 21, 23, and 24, the results were calculated from the numbers in lines 19, 20, and 22, before the last figure was rounded off.

TABLE XXIX
SPECIAL TESTS FOR EFFECT OF TIME OF COKING

1. Source of coal, mine and seam	Dominant Coal Co. Coal				Washed by the Dominion Iron and Steel Co.			
	C 11	C 12	C 1	C 5	C 7	C 13	C 14	
2. Coal or coke number								
3. Moisture in coal or coke	6	6.1			0.4	0.0	1.1	
Proximate analysis of dry coal or coke								
4. Fixed carbon (FC)	91.5	78.2			91.0	90.3	89.8	
5. Volatile matter (VM)	7.2	6.3			4.3	4.0	4.7	
6. Ash	1.3	15.5			4.7	5.7	5.5	
Ultimate analysis of dry coal or coke								
7. Carbon (C)								
8. Hydrogen (H)								
9. Sulfur (S)		1.5						1.2
10. Nitrogen (N)								
11. Oxygen (O)								
12. Ratio FC/VM								
13. Ratio C/H								
14. Age of coal when coked	30	36	41	48	48	60	72	
15. Duration of coking	60.6	68.3			70.6			
16. Yield of dry coke from dry coal								
17. Theoretical yield (FC ÷ ash)								
18. Actual yield as percentage of theory								
19. Apparent specific gravity	0.93	0.97	0.97	0.86	0.80	0.92	0.92	
20. Real specific gravity	1.73	1.62	1.77	1.83	1.79	1.66	1.76	
21. Percentage cell space of pores (P)	46.2	40.3	45.2	53.2	50.1	44.5	47.8	
22. Relative crushing strength (S)	0.90	0.97	0.93	0.93	0.92	0.90	0.96	
23. Physical value (P ₁ S ₁)	41.7	39.2	42.2	49.5	46.1	42.8	46.0	
24. P ₂ S ₂	37.7	38.1	39.4	46.0	42.4	41.1	44.2	
25. Classification								
26. Method of coking								All coked in boxes in Otto-Hoffman oven.

SUNDRY SPECIAL COKING TESTS.

1.	Source of coal - mine and seam	Tests for Effect of Position of Box in Oven		Dominion Coal Co. Coal Washed by the Dominion Iron and Steel Co.		Tests for Effect of Compression of Coal		Tests for Effect of Moisture in Coal	
		CS	CS	C-10	C-15	C-16	C-1	C-3	C-6
2.	Coal or coke number	0.7	0.8	0.9	0.10	0.15	0.1	0.5	0.6
3.	Moisture in coal or coke	0	0.1	1.5	0.7	1.1			
4.	Proximate analysis of dry coal or coke								
5.	Fixed carbon (FC)	91.0	86.5	87.9	89.7				
6.	Volatile matter (VM)	1.3	2.1	1.6	1.5				
7.	Ash	1.7	11.1	10.2	8.8				
7.	Ultimate analysis of dry coal or coke								
8.	Carbon (C)								
9.	Hydrogen (H)								
10.	Sulphur (S)								
11.	Nitrogen (N)								
11.	Oxygen (O)								
12.	Ratio C:VM								
13.	Ratio C:H								
14.	Age of coal when coked								
15.	Duration of coking								
16.	Yield of dry coke from dry coal	70.6	70.4	70.8	76.2				
17.	Theoretical yield (C + 3.4H)								
18.	Actual yield as percentage of theory								
19.	Apparent specific gravity	0.90	0.92	0.93	0.89	0.92	0.97	0.86	0.93
20.	Real specific gravity	1.79	1.64	1.64	1.75	1.76	1.57	1.83	1.84
21.	Percentage cell space or porosity (P ₁)	50.1	41.2	43.1	49.0	47.8	58.1	46.6	49.6
22.	Relative crushing strength (S)	0.92	0.95	0.89	0.86	0.89	0.97	0.93	0.99
23.	Physical value (P ₁ × S)	16.1	41.9	38.8	42.2	42.6	37.4	46.1	49.4
24.	" " (P ₂ × S)	42.1	39.8	34.6	36.4	37.9	36.2	46.0	48.7
25.	Method of coking	On floor of oven	14 feet above floor of oven	24 feet above floor of oven	4 feet above floor of oven	Coal lightly compressed	Coal heavily compressed	Coal ordinary wet	Coal very wet

TABLE XXXI
SPECIAL COKES BLENDING TESTS.

1.	Source of coal name and seam	1 pct. coal 23 M blended with		1 pct. No. 25 with 2 pct. N	
		2 pct. 1 A S C	2 pct. 31	20	11
2.	Coal or coke number	01	01	01	01
3.	Moisture in coal or coke	23 M + 1 A S C	23 M + 31	23 M + 26	25 + 20
	Proximate analysis of dry coal or coke				
4.	Fixed carbon, %				
5.	Volatile matter, %				
6.	Ash				
	Ultimate analysis of dry coal or coke				
7.	Carbon, C				
8.	Hydrogen, H				
9.	Sulphur, S				
10.	Nitrogen, N				
11.	Oxygen, O				
12.	Ratio C:VM				
13.	Ratio C:H				
14.	Age of coal when coked				
15.	Duration of coking				
16.	Yield of dry coke from dry coal				
17.	Theoretical yield, % ash				
18.	Actual yield as percentage of theory				
19.	Apparent specific gravity	1.16	1.19	1.27	1.19
20.	Real specific gravity	1.18	1.88	1.86	1.92
21.	Percentage cell space of porosity, P	31.3	36.8	34.4	32.6
22.	Relative crushing strength, S	0.56	0.58	0.66	0.66
23.	Physical value, P ₁ S ₁	19.3	21.4	22.2	28.1
24.	P ₂ S ₂	10.8	12.5	14.3	18.5
25.	Classification	B	-B	-B	-B

SPE

1. Source of coal - mine and seam

2. Coal or coke number

3. Moisture in coal or coke

4. Fixed carbon (FC)
5. Volatile matter (VM)
6. Ash

7. Carbon (C)
8. Hydrogen (H)
9. Sulphur (S)
10. Nitrogen (N)
11. Oxygen (O)

12. Ratio FC/VM
13. Ratio C/H

14. Age of coal when coked
15. Duration of coking
16. Yield of dry coke from dry coal
17. Theoretical yield (FC + ash)
18. Actual yield as percentage of theor

19. Apparent specific gravity
20. Real specific gravity
21. Percentage cell space or porosity
22. Relative crushing strength (S)
23. Physical value ($P \times S$)
24. " " ($P \times S^2$)

25. Classification

26. Method of coking

25 Classification

Copyright 1955 by American Society of Civil Engineers

TABLE XXXII
SPECIAL TESTS FOR COMPARISON OF TYPES OF OVENS.

1. Source of coal—mine and seam	Dominion Coal Co. Coal. Washed by the Dominion Iron and Steel Co.				Sydney Mines Washed Coal	
	C 5	C 7	C 87	C 89	C 86	C 88
2. Coal or coke number						
3. Moisture in coal or coke	%	0.4				
Proximate analysis of dry coal or coke						
4. Fixed carbon (FC)	%	91.0	90.7	90.7	89.4	88.3
5. Volatile matter (VM)	%	1.3	2.8	2.6	2.8	3.1
6. Ash	%	7.7	6.5	6.7	7.8	8.6
Ultimate analysis of dry coal or coke						
7. Carbon (C)	%					
8. Hydrogen (H)	%					
9. Sulphur (S)	%					
10. Nitrogen (N)	%					
11. Oxygen (O)	%					
12. Ratio FC/VM						
13. Ratio C/H						
14. Age of coal when coked	Months					
15. Duration of coking	Hours	48	48	48	48	48
16. Yield of dry coke from dry coal	%		70.6			
17. Theoretical yield (FC + ash)	%					
18. Actual yield as percentage of theory	%					
19. Apparent specific gravity		0.86	0.90	0.90	0.85	0.87
20. Real specific gravity		1.83	1.79	1.80	1.77	1.78
21. Percentage cell space or porosity (P)		53.2	50.1	50.3	51.8	50.9
22. Relative crushing strength (S)		0.93	0.92	0.78	0.85	0.95
23. Physical value (P×S)		49.5	46.1	39.2	44.0	51.2
24. " " (P×S ²)		46.0	42.4	30.6	37.4	43.8
25. Classification						
26. Method of coking		Iron box Otto-Hoff- man oven	Iron box Otto-Hoff- man oven	Iron box Bernard oven	Iron box Bauer oven	Iron box Bernard oven

1. Source of coal mine
2. Coal or coke number
3. Moisture in coal or coke
 4. Proximate analysis of
 1. Fixed carbon, %
 2. Volatile matter, %
 3. Ash, %
 5. Ultimate analysis of
 1. Carbon, %
 2. Hydrogen, %
 3. Sulphur, %
 4. Nitrogen, %
 5. Oxygen, %
 6. Ratio C/A/M
 7. Ratio C/H
8. Age of coal when coked
9. Duration of coking
10. Yield of dry coke, %
11. Theoretical yield, %
12. Actual yield as per cent
13. Apparent specific gravity
14. Real specific gravity
15. Percentage cell size
16. Relative crushing strength
17. Physical value, P
18. Classification

SPEC

1. Source of coal (mine and seam).

2. Coal or coke number.

3. Moisture in coal or coke.

4. Proximate analysis of dry coal or
Fixed carbon (FC).
5. Volatile matter (VM).
6. Ash.

7. Ultimate analysis of dry coal or c
Carbon (C).
8. Hydrogen (H).
9. Sulphur.
10. Nitrogen.
11. Oxygen.

12. Ratio FC/VM.
13. Ratio C/H.

14. Age of coal when coked.
15. Duration of coking.
16. Yield of dry coke from dry coal.
17. Theoretical yield (FC + ash).
18. Actual yield as percentage of theoretical.

19. Apparent specific gravity.
20. Real specific gravity.
21. Percentage cell space or porosity.
22. Relative crushing strength (S).
23. Physical value ($P \times S^2$).
24. " " ($P \times S^2$).

25. Classification.

26. Method of coking.

TABLE XXXIII

SPECIAL TESTS FOR COMPARISON OF COMMERCIAL COKES

1. Source of coal—mine and state	Walston, Pa.	Wal-ton, Pa.	Empire Geneva, N.Y.	Walston ?	Gas Coke	Vinton	Empire
2. Coal or coke number . . .	C 111	C 111	C 115	C 116	C 117	C 118	C 119
3. Moisture in coal or coke.							
Proximate analysis of dry coal or coke							
4. Fixed carbon (FC).							
5. Volatile matter (VM).							
6. Ash							
Ultimate analysis of dry coal or coke							
7. Carbon (C).							
8. Hydrogen (H).							
9. Sulphur							
10. Nitrogen							
11. Oxygen							
12. Ratio FC/VM							
13. Ratio C/H							
14. Age of coal when coked							
15. Duration of coking							
16. Yield of dry coke from dry coal.							
17. Theoretical yield (FC ÷ ash)							
18. Actual yield as percentage of theory							
19. Apparent specific gravity	1.25	1.23	0.92	1.26	0.86	0.72	0.97
20. Real specific gravity	1.91	1.89	1.92	1.93	1.82	1.61	1.85
21. Percentage cell space or porosity (P)	54.5	54.6	51.8	54.5	52.9	56.0	47.4
22. Relative crushing strength (S)	1.00	1.03	0.95	1.00	0.69	0.71	0.98
23. Physical value (P × S)	35.8	35.6	49.4	34.5	36.5	41.4	46.4
24. " " (P × S ²)	37.2	36.7	47.2	34.5	25.2	30.7	45.5
25. Classification							
26. Method of coking					By-product Solvay process	Beehive oven	

1. Source of coal

2. Coal or coke no

3. Moisture in coal
4. Proximate analysis
5. Fixed carbon
6. Volatile matter
7. Ash

8. Ultimate analysis
9. Carbon (C)
10. Hydrogen (H)
11. Sulphur (S)
12. Nitrogen (N)
13. Oxygen (O)

14. Ratio FC/VM
15. Ratio C/H

16. Age of coal when mined
17. Duration of coal seam
18. Yield of dry coal
19. Theoretical yield
20. Actual yield as received

21. Apparent specific gravity
22. Real specific gravity
23. Percentage cellulosic material
24. Relative crush value
25. Physical value

26. Classification

27. Method of coking

TABLE XXX

TESTS FOR COMPARISON OF OPEN

		Dominion Coal Co. Coal. Washed by the Dominion (No. D L & S. CO.)						
		C 35 D	C 45 D	C 8 D	C 9 D	C 83	C 1	
1.	Source of coal—mine and seam . . .							
2.	Coal or coke number . . .							
3.	Moisture in coal or coke . . .							
Proximate analysis of dry coal or coke								
4.	Fixed carbon (FC) . . .							
5.	Volatile matter (VM) . . .							
6.	Ash					0.8		
Ultimate analysis of dry coal or coke								
7.	Carbon (C)							
8.	Hydrogen (H)							
9.	Sulphur (S)							
10.	Nitrogen (N)							
11.	Oxygen (O)							
12.	Ratio FC/VM							
13.	Ratio C/H							
14.	Age of coal when coked.							
15.	Duration of coking	Months						
16.	Yield of dry coke from dry coal	Hours	11	41	41	41	40?	41
17.	Theoretical yield (FC + ash)							
18.	Actual yield as percentage of theory							
19.	Apparent specific gravity . . .							
20.	Real specific gravity							
21.	Percentage cell space or porosity (P) . . .							
22.	Relative crushing strength (S) . . .							
23.	Physical value (P×S)							
24.	" " (P×S ²)	0.93					0.70	0.75
25.	Classification							
26.	Method of coking	Open Otto-Hoffman oven	Open Otto-Hoffman oven	Iron box Otto-Hoffman	Iron box Otto-Hoffman	Open oven Otto-Hoffman	Iron box Otto-Hoffman	

OF OPEN OVEN AND BOX COKES

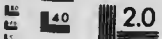
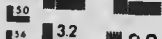
Dominion Iron and Steel Co. (O.)			Dominion Coal Co. Lingan Slack		Nova Scotia Steel & Coal Co. Washed Coal			Lille Colliery. Washed Coal		Denison Colliery, Seams 2 and 4 mixed	
C 1	C 5	C 7	C 82	C 81	C 97	C 98	C 86	C 121	C 120	C 123	C 122
		0.4						0.5	1.1	0.3	1.4
		91.0			89.6	89.7	89.4	84.4	83.4	78.3	77.5
		1.3			1.8	1.5	2.8	0.6	0.8	0.6	1.3
		7.7			8.6	8.8	7.8	15.0	15.8	21.1	21.2
					1.3	1.4	1.3				
41	48	18 70.6	72	72	48	48	48	48	48	74	74
0.97	0.86	0.90	0.75	0.79	0.83	0.81	0.86	1.04	1.17	1.15	1.17
1.77	1.83	1.79	1.74	1.60	1.77	1.82	1.85	1.90	1.87	1.93	1.91
45.2	53.2	50.1	56.8	53.3	53.2	51.2	53.8	45.0	37.6	40.2	38.8
0.93	0.93	0.92	0.68	0.65	0.86	0.81	0.95	0.70	0.78	0.83	0.73
42.2	49.5	46.1	38.6	34.6	45.8	43.7	51.2	35.6	29.3	33.4	28.3
39.4	46.0	42.4	26.2	22.5	39.3	35.3	48.8	28.2	22.9	27.7	20.6
								A	A		+ B
Iron box Otto- Hoff- man	Iron box Otto- Hoff- man	Iron box Otto- Hoff- man	Iron box beehive oven	Open beehive oven	From top of open Bernard oven	From bot. of open Bernard oven	Iron box Bernard oven	Open Bernard oven	Iron box Bernard oven	Open beehive oven	Iron box beehive oven





MICROCOPY RESOLUTION TEST CHART

(ANSI and ISO TEST CHART No. 2)



APPLIED IMAGE Inc

1653 East Main Street
Rochester, New York 14609 USA
(716) 482 - 0300 - Phone
(716) 288 - 5989 - Fax

SUMMARY

SYDNEY COALFIELD

1. Source of coal—mine and seam	Port Morien		Hub Seam, Dominion No. 7				Harbour Seam, Dominion No. 9				Phalen Seam, Dominion No. 5					
2. Coal or coke number.	50	C1 50	36	C1 36	2036	C1 2036	35	C1 35	2035	C1 2035	35 SP	C1 35 SP	2035 SP	C1 2035 SP	C2 2035 SP	38
3. Moisture in coal or coke %	2.8	0.2	2.6	0.0	3.4	0.0	1.6	2.2	2.1	0.1	1.9	0.0	1.9	0.0	2.1
Proximate analysis of dry coal or coke																
4. Fixed carbon (FC) %	53.0	80.7	57.6	91.0	58.3	89.4	55.5	84.7	54.9	90.5	59.5	89.6	58.2	87.7	59.8
5. Volatile matter (VM) %	34.7	1.4	36.5	0.9	37.2	2.2	38.6	1.4	38.2	1.0	35.0	1.1	35.2	1.5	34.3
6. Ash %	12.3	17.9	5.9	8.1	4.5	8.4	5.9	13.9	6.9	8.5	5.5	9.3	6.6	10.8	5.9
Ultimate analysis of dry coal or coke																
7. Carbon (C) %	70.5	76.7	78.2	77.0	76.0	78.6	78.3	78.6
8. Hydrogen (H) %	4.8	5.0	5.2	5.2	5.2	5.3	4.7	5.1
9. Sulphur (S) %	6.4	5.6	2.4	1.8	3.0	2.4	3.7	3.4	3.8	2.8	1.8	1.6	2.3	2.0	1.9
10. Nitrogen (N) %	1.0	1.6	1.5	1.5	1.4	1.4	1.3	1.5
11. Oxygen (O) %	5.0	8.4	7.6	6.7	6.7	7.4	6.8	7.0
12. Ratio FC/VM	1.53	1.58	1.57	1.44	1.44	1.70	1.65	1.74
13. Ratio C/H	14.7	15.3	15.0	14.8	14.6	14.8	16.6	15.4
14. Age of coal when coked Months	5½	5½	5½
15. Duration of coking Hours	40	48	48	48	48	48	48	72
16. Yield of dry coke from dry coal %
17. Theoretical yield (FC+ash) %	65.3	63.5	62.8	61.4	61.8	65.0	64.8	65.7
18. Actual yield as percentage of theory
19. Apparent specific gravity	0.96	0.96	0.84	1.01	0.93	0.94	0.91	0.78
20. Real specific gravity	1.85	1.85	1.86	1.92	1.89	1.88	1.91	1.60
21. Percentage cell space or porosity (P)	47.9	48.2	55.1	47.5	50.7	49.9	52.3	51.5
22. Relative crushing strength (S)	0.73	0.89	0.87	0.82	0.78	0.95	0.90	0.62
23. Physical value (P>S)	34.9	43.1	48.0	38.9	39.5	47.5	46.8	31.9
24. " " (P>S²)	25.5	38.5	41.8	31.8	30.8	45.1	41.9	19.7
25. Classification	A	+A	-A	A	A	A	A

17

TABLE XXXVI
SUMMARY RECORD OF COKING TESTS.

INVERNESS COALFIELD, INVERNESS COUNTY, N. S.

1 Source of coal—mine and seam.	Inverness Colliery		Port Hood Colliery	
2 Coal or coke number	14	C1 14	15	C1 15
3 Moisture in coal or coke	C	7.5	0.3	3.2 0.3
Proximate analysis of dry coal or coke				
4 Fixed carbon (FC)	C	49.6	82.1	48.4 77.9
5 Volatile matter (VM)	C	40.0	1.6	37.1 1.9
6 Ash	C	10.4	16.3	14.6 20.2
Ultimate analysis of dry coal or coke				
7 Carbon (C)	C	67.2		63.7
8 Hydrogen (H)	C	4.8		4.2
9 Sulphur (S)	C	6.0	5.0	7.9 5.6
10 Nitrogen (N)	C	0.9		0.8
11 Oxygen (O)	C	10.7		8.8
12 Ratio FC/VM		1.24		1.30
13 Ratio C/H.		14.0		15.1
14 Age of coal when coked	Months		16½	16½
15 Duration of coking	Hours		48	48
16 Yield of dry coke from dry coal				72.1
17 Theoretical yield (FC + Ash)	C	60.0		62.9
18 Actual yield as percentage of theory				115
19 Apparent specific gravity				1.04
20 Real specific gravity				1.74
21 Percentage cell space or porosity (P)				40.2
22 Relative crushing strength (S)				0.62
23 Physical value (P×S)				24.9
24 Physical value (P×S²)				15.4
25 Classification		C		+ C

1. So

2. Co

3. Mc

Pr

4.

5.

6.

Ul

7.

8.

9.

10.

11.

12. Rf

13. Rf

14. Af

15. Di

16. Yi

17. Tr

18. Ac

19. Al

20. Rf

21. Pf

22. Rf

23. Pl

24.

25. Cl

TABLE XXXV
 SUMMARY RECORD OF
 PICTOU COALFIELD, PICTOU

1. Source of coal—mine and seam	6 ft. Seam Vale Colliery		Foord Seam Allan Shaft Colliery				Third Seam Albion Colliery	
	2004	C1 2004	16	C1 16	2016	C1 2016	1	C1 1
2. Coal or coke number %								
3. Moisture in coal or coke			1.7	0.0	2.8	0.0	2.0	
Proximate analysis of dry coal or coke								
4. Fixed carbon (FC) %			55.4	82.4	57.1	87.3	55.5	
5. Volatile matter (VM) %			33.3	1.3	33.7	0.6	29.8	
6. Ash %	19.1		11.3	16.3	9.2	12.1	14.7	
Ultimate analysis of dry coal or coke								
7. Carbon (C) %			74.1		77.8		71.4	
8. Hydrogen (H) %			4.6		5.0		4.5	
9. Sulphur (S) %			0.6		0.6		1.4	
10. Nitrogen (N) %			1.9		2.2		1.7	
11. Oxygen (O) %			7.5		5.2		6.3	
12. Ratio FC/VM			1.66		1.70		1.86	
13. Ratio C/H			16.1		15.6		15.8	
14. Age of coal when coked Months		16½		16½				21
15. Duration of coking Hours		48		48		48		48
16. Yield of dry coke from dry coal %				73.9		71.9		
17. Theoretical yield (FC + ash) %			66.7		66.3		70.2	
18. Actual yield as percentage of theory				111		108		
19. Apparent specific gravity		1.15		0.99		0.92		1.18
20. Real specific gravity		1.73		1.84		1.86		1.73
21. Percentage cell space or porosity (P)		33.5		46.3		50.7		31.9
22. Relative crushing strength (S)		0.58		1.00		0.97		0.66
23. Physical value (P×S)		19.3		46.1		49.2		21.1
24. " " (P×S ²)		11.1		45.8		47.7		13.9
25. Classification		C		A		+ A		C

LE XXXVII

RD OF COKING TESTS.

D, PICTOU COUNTY, N.S.

Main Seam Colliery		Cape Pit Seam Allison Colliery				Main Seam Asada Colliery				Main Seam Drummond Colliery			
C1 1	2	C1 2	2008	C1 2002	8	C1 8	2008	C1 2008	C2 2008	3	C1 3	2008	C1 2008
	1.9	5.0	1.7	0.0	1.6	0.0	1.4	0.0	1.7	1.1	0.2	1.7	0.0
	58.1	84.6	60.7	86.2	64.8	86.2	64.4	80.3	85.9	60.8	79.9	68.9	82.7
	31.4	0.7	29.5	0.5	26.0	0.7	27.4	0.7	3.6	24.7	1.2	22.6	0.6
	10.5	14.7	9.8	13.3	9.2	13.1	8.2	10.0	10.5	14.5	18.9	13.5	16.7
	74.2		76.9		77.6		80.0			72.6		75.3	
	4.5		4.9		4.7		4.8			4.3		4.4	
	0.9	0.9	2.1	1.6	0.9		0.3			2.5	1.5	1.3	
	2.1		1.7		1.6		2.2			2.1		1.9	1.1
	7.8		4.6		6.0		4.0			4.0			
	1.85		2.05		2.49		2.35			2.46		2.32	
	16.5		15.7		16.5		10.7			16.9		17.1	
21 48		21 48		48 73.2		21 48		48 77.6	72 77.0		21 48		48 78.5
	68.6		79.5		74.0		72.6			75.3		77.4	
				104		103		107	106		102		101
1.13 1.73 31.9 0.66 21.1 13.9				1.05 1.90 44.6 1.00 44.6 44.6		1.06 1.92 44.6 1.05 47.1 49.6		1.02 1.98 48.5 1.01 48.9 49.3	0.89 1.81 50.7 0.85 42.8 36.2		1.09 1.97 44.5 0.91 40.3 36.5		1.04 2.01 48.4 0.96 46.5 44.7
C		C		-A		-A		A			-A		-A

1. Source of coal
2. Coal or coke num
3. Moisture in coa.
- Proximate anal:
4. Fixed carbon
5. Volatile matt.
6. Ash
- Ultimate analy:
7. Carbon (C) . .
8. Hydrogen (H)
9. Sulphur (S) .
10. Nitrogen (N)
11. Oxygen (O) .
12. Ratio FC/VM .
13. Ratio C/H . . .
14. Age of coal whc
15. Duration of cok
16. Yield of dry col
17. Theoretical yiel
18. Actual yield as
19. Apparent speci
20. Real specific gr
21. Percentage cell
22. Relative crushi
23. Physical value
24. " "
25. Classification .

TABLE No. 1
SUMMARY RECORD OF

SPENTHILL COALFIELD, N. S. W.

1. Name of coal, mine and seam		No. of days coking	
		per ton of dry coal	
2. Coal or coke number		11	11
Moisture in coal or coke		2.2	0.2
Proximate analysis of dry coal or coke			
4. Fixed carbon (FC)		64.4	94.5
5. Volatile matter (VM)		33.3	1.3
6. Ash		3.4	5.2
Ultimate analysis of dry coal or coke			
7. Carbon (C)		79.4	75.0
8. Hydrogen (H)		5.1	1.0
9. Sulphur (S)		1.0	1.0
10. Nitrogen (N)		1.9	1.0
11. Oxygen (O)		7.1	8.0
12. Ratio FC/VM		1.91	1.0
13. Ratio C/H		16.0	15.0
14. Age of coal when coked	Months		3
15. Duration of coking	Hours		10
16. Yield of dry coke from dry coal			72.4
17. Theoretical yield (FC + ash)		66.7	67.7
18. Actual yield as percentage of the dry coal			108
19. Apparent specific gravity			0.88
20. Real specific gravity			1.82
21. Percentage cell space porosity (P ₁)			51.9
22. Relative crushing strength (S)			1.01
23. Physical value (P × S)			52.2
24. " " (P × S ₁)			52.4
25. Classification			A

TABLE XXXIII

RECORD OF COKING TESTS.

FIELD: W. IRELAND COUNTY, N. C.

Coke	No. 2 Culberty, Springhill				No. 3 Culberty, Springhill				
	5	C1 5	2005	C1 2005	6	C1 6	C2 6	2006	C1 2006
2	2.0	0.1	2.5	0.2	2.3	0.5		2.4	0.3
5	58.5	81.1	62.0	90.6	55.0	80.8		61.6	92.2
3	32.3	1.7	32.1	1.6	23.5	9.2		33.7	1.5
2	9.2	13.0	5.9	7.8	11.5	17.0		4.7	6.3
	75.1		79.5		73.1			81.2	
	1.9		5.2		1.6			5.2	
	1.6	1.3	0.9	0.7	1.8	1.6		0.9	0.6
	1.2		2.0		1.8			1.8	
	8.0		6.5		7.2			6.2	
	1.81		1.93		1.64			1.83	
	15.3		15.3		15.9			15.6	
3		213		1		213	213		1
0		40		40		40	72		40
2.1		72.4		70.8		74.2			71.7
	67.7		67.9		66.5			66.3	
8		107		101		112			108
88		1.00		0.87		1.03			0.89
82		1.79		1.86		1.85			1.76
9		43.8		53.1		41.6			49.7
01		0.90		0.93		0.86			0.97
2		39.2		19.2		38.2			48.2
1		35.1		15.6		32.8			16.8
		B		A		B			A

1. Sc

2. Co

3. Me

Pr

4.

5.

6.

UL

7.

8.

9.

10.

11. C

12. Ra

13. Ra

14. Ag

15. Du

16. Yie

17. Th

18. Act

19. Apl

20. Res

21. Per

22. Rel

23. Phy

24.

25. Clas

1. Source of coal—mine and s

2. Coal or coke number

3. Moisture in coal or coke .

- Proximate analysis of dry
4. Fixed carbon (FC)
5. Volatile matter (VM) . . .
6. Ash

- Ultimate analysis of dry c
7. Carbon (C)
8. Hydrogen (H)
9. Sulphur (S)
10. Nitrogen (N)
11. Oxygen (O)

12. Ratio FC/VM
13. Ratio C/H

14. Age of coal when coked . .
15. Duration of coking
16. Yield of dry coke from dry
17. Theoretical yield (FC + s
18. Actual yield as percentag

19. Apparent specific gravity
20. Real specific gravity
21. Percentage cell space or p
22. Relative crushing strengtl
23. Physical value ($P \times S$) .
24. " " ($P \times S^2$) .

25. Classification

TABLE XXXIX
SUMMARY RECORD OF COKING TESTS.

JOGGINS-CHIGNECTO COALFIELD, CUMBERLAND COUNTY, N.S.		Chignecto Colliery				Minudie Colliery			Joggins Colliery			GRAND LAKE COAL FIELD, N.B. Kings Mine	
1. Source of coal—mine and seam		7	C1 7	9	C1 9	10	C3 10	3010	C3 3010	11	C3 11		
2. Coal or coke number		7	C1 7	9	C1 9	10	C3 10	3010	C3 3010	11	C3 11		
3. Moisture in coal or coke		3.2	0.2	2.8		0.6		4.8		0.9			
Proximate analysis of dry coal or coke													
4. Fixed carbon (FC)	%	45.7	81.8	48.8		44.8	75.7	50.1	78.0	53.4	80.1		
5. Volatile matter (VM)	%	41.0	1.9	35.7		36.6	3.8	38.4	2.4	32.2	2.1		
6. Ash	%	13.3	16.3	15.5		18.6	20.5	11.5	19.6	14.4	17.8		
Ultimate analysis of dry coal or coke													
7. Carbon (C)	%	66.2		64.8		63.5		68.8		70.3			
8. Hydrogen (H)	%	4.8		4.4		4.1		4.9		4.6			
9. Sulphur (S)	%	6.4	5.6	6.7		5.4	3.9	6.8	5.5	5.8	4.1		
10. Nitrogen (N)	%	1.3		1.1		1.3		1.6		0.6			
11. Oxygen (O)	%	8.0		7.5		7.1		6.4		4.3			
12. Ratio FC/VM		1.11		1.37		1.22		1.30		1.66			
13. Ratio C/H		13.8		14.7		15.5		14.0		15.3			
14. Age of coal when coked	Months		21		21		21½		1		21½		
15. Duration of coking	Hours		48		48		48		48		48		
16. Yield of dry coke from dry coal	%												
17. Theoretical yield (FC + ash)	%	59.0		64.3		63.4		61.6		67.8			
18. Actual yield as percentage of theory	%												
19. Apparent specific gravity		0.96		1.08		0.98		0.86					
20. Real specific gravity		1.65		1.76		1.81		1.80					
21. Percentage cell space or porosity (P)		41.7		38.7		45.8		52.0					
22. Relative crushing strength (S)		0.75		0.63		0.69		0.89					
23. Physical value (P × S)		31.4		24.3		31.7		46.2					
24. " " (P × S²)		23.7		15.3		21.9		41.1					
25. Classification		+ B		- B		B		+ B		- A			



SUMMARY RE

FRANK-BLAIR

1. Source of coal—mine and seam		Leitch Colliery, Passburg				Hillcrest Colliery							
2. Coal or coke number	48	C1 48	C3 48	2048	C4 2048	32	C1 32	C3 32	2032	6C4 2032	C5 2032	33	
3. Moisture in coal or coke %	1.0	0.3	1.1	0.6	1.3	0.0	1.0	1.1	1.5	0.2			
Proximate analysis of dry coal or coke													
4. Fixed carbon (FC) %	55.1	73.5	71.2	53.2	74.9	55.4	77.8	76.6	56.5	80.8	81.1	56.9	
5. Volatile matter (VM) %	27.0	1.0	1.2	28.7	0.8	29.3	0.7	1.5	30.0	0.8	1.8	27.6	
6. Ash %	17.9	25.5	27.6	18.1	24.3	15.3	21.5	21.9	13.5	18.4	17.1	15.5	
Ultimate analysis of dry coal or coke													
7. Carbon (C) %	70.0					70.4						71.5	
8. Hydrogen (H) %	4.4					4.2						4.3	
9. Sulphur (S) %	0.6			1.1		0.6	0.7		0.5	0.7		0.8	
10. Nitrogen (N) %	1.0					1.0						1.0	
11. Oxygen (O) %	6.1					8.5						6.9	
12. Ratio FC/VM	2.04					1.80			1.88			2.06	
13. Ratio C/H	15.9					16.7						16.6	
14. Age of coal when coked Months		5½	5½		½		8	8		½	½		
15. Duration of coking Hours		48	48		48		48	48		48	74		
16. Yield of dry coke from dry coal %		78.3			74.1		76.9			74.1	75.0		
17. Theoretical yield (FC + ash) %	73.0			71.3		70.7			70.0			72.4	
18. Actual yield as percentage of theory		107			104		109			106	107		
19. Apparent specific gravity		1.28	1.25		1.25		1.28	1.15		1.14	1.14		
20. Real specific gravity		1.92	1.95		1.98		1.78	1.88		1.87	1.88		
21. Percentage cell space or porosity (P)		33.6	35.7		37.0		28.2	38.6		38.8	39.2		
22. Relative crushing strength (S)		0.67	0.67		0.66		0.71	0.68		0.71	0.72		
23. Physical value (P×S)		22.5	23.9		22.7		19.9	26.3		27.6	28.2		
24. " " (P×S²)		15.0	16.0		13.9		14.0	17.9		19.6	20.3		
25. Classification		B			B		+ B			- A	+ B		

TABLE A

PRIMARY RECORD OF COKING TESTS.

K-BLAIRMORE COALFIELD, ALTA.

No. 1 Seam, Bellevue Colliery						No. 1 Seam, Lille Colliery						No. 2 Seam, Denison Colliery, Coleman				No. 4 Seam, Denison Colliery, Coleman				
33	C1 33	C3 33	2033	C4 2033	28	C1 28	C2 28	C3 28	2028	C4 2028	31	C1 31	C2 31	2034	C4 2034	34 SP	C1 34 SP	2034 SP	C4 2034 SP	C5 2034 SP
0.2	0.0	1.2	1.0	0.8	0.0	1.1	1.5	0.6	0.7	0.1	1.4	0.6	0.6	0.0	2.4	1.2	1.8
56.9	77.8	76.7	59.2	79.8	58.6	76.6	75.5	70.7	58.9	78.2	55.1	78.2	55.1	72.0	59.9	79.4	58.4	76.0	76.1
27.6	0.6	1.7	26.7	1.1	25.0	0.5	3.7	1.0	25.3	0.5	25.1	1.3	23.7	0.9	23.9	0.9	22.9	1.1	2.1
15.5	21.6	21.6	14.1	19.1	16.4	22.0	20.8	28.3	15.8	21.3	19.8	20.5	21.2	27.1	16.2	19.7	18.7	22.9	21.8
71.5	71.2	68.5	72.6
4.3	4.2	4.0	4.3
0.8	0.9	0.5	0.5	0.6	0.4	0.5	0.6	0.6
1.0	0.9	1.0	1.0
6.9	6.8	6.3	5.3
2.06	2.22	2.34	2.32	2.10	2.32	2.51	2.55
16.6	16.9	17.1	16.9
.....	S 48	S 48	48 76.8	S 48	S 72	S 48	48 79.7	S 48	S 72	48 77.5	S 48	48 78.5	48 79.0
72.4	77.2	73.3	75.0	82.1	79.7	74.9	76.3	76.3	76.1	77.1	79.0	82.0
.....	107	105	109	107	102	101	103	102	106
.....	1.31	1.22	1.16	1.29	1.11	1.25	1.30	1.25	1.06	1.30	1.30	1.29	1.25
.....	1.91	1.86	1.86	1.80	1.78	1.92	1.91	1.78	1.58	1.89	1.93	1.90	1.91
.....	31.5	1.3	37.9	28.2	37.6	34.7	32.3	29.9	33.3	31.3	32.3	32.4	34.4
.....	0.86	1.74	0.80	0.65	0.55	0.68	0.71	0.76	0.42	0.62	0.83	0.60	0.75
.....	27.0	25.3	30.4	18.4	20.8	23.6	22.9	21.8	11.1	19.4	26.9	19.6	25.8
.....	23.1	18.7	24.4	12.0	11.5	16.0	16.2	11.0	6.0	12.0	22.4	11.8	19.3
.....	+ B	+ P	B	+ B	- B	+ B	B	+ B



SUMMARY RECORD

1. Source of coal—mine and seam	No. 3 Mine, Mich.			No. 7 Mine, Mich.			No. 8 Mine, Mich.			
	C1	C2	C3	C1	C2	C3	C1	C2	C3	
2. Coal or coke number	31	31	31	30	30	30	29	29	29	
3. Moisture in coal or coke	0.4	0.0	1.2	0.7			1.1	0.0		
Proximate analysis of dry coal or coke										
4. Fixed carbon (FC)	62.7	81.1	71.9	65.5			65.7	82.6	82.8	
5. Volatile matter (VM)	21.8	1.8	7.1	22.6			24.1	1.2	0.9	
6. Ash	12.5	17.1	18.0	11.9			10.2	16.2	16.3	
Ultimate analysis of dry coal or coke										
7. Carbon (C)	75.5			76.5			76.1			
8. Hydrogen (H)	4.3			4.5			4.5			
9. Sulphur (S)	0.5			0.4			0.6			
10. Nitrogen (N)	1.2			1.2			1.3			
11. Oxygen (O)	6.0			5.5			7.3			
12. Ratio FC/VM	2.83			2.90			2.72			
13. Ratio C/H	17.5			17.0			16.9			
14. Age of coal when coked	Months	84	84				84	84	84	
15. Duration of coking	Hours	48	72				48	48	48	
16. Yield of dry coke from dry coal	%	76.1	81.5				78.7			
17. Theoretical yield (FC + ash)	%	75.2		77.1			75.9			
18. Actual yield as percentage of theory		102	108				104			
19. Apparent specific gravity		1.17	0.97				1.21	1.16	1.10	
20. Real specific gravity		1.88	1.57				1.85	1.86	1.91	
21. Percentage cell space or porosity (P)		37.6	36.8				34.7	37.4	43.5	
22. Relative crushing strength (S)		1.02	0.71				0.77	0.90	0.88	
23. Physical value (P×S)		38.5	26.1				26.7	33.8	38.3	
24. " " (P×S ²)		39.4	18.5				20.5	30.6	33.8	
25. Classification		- B		A			- B	+ B		

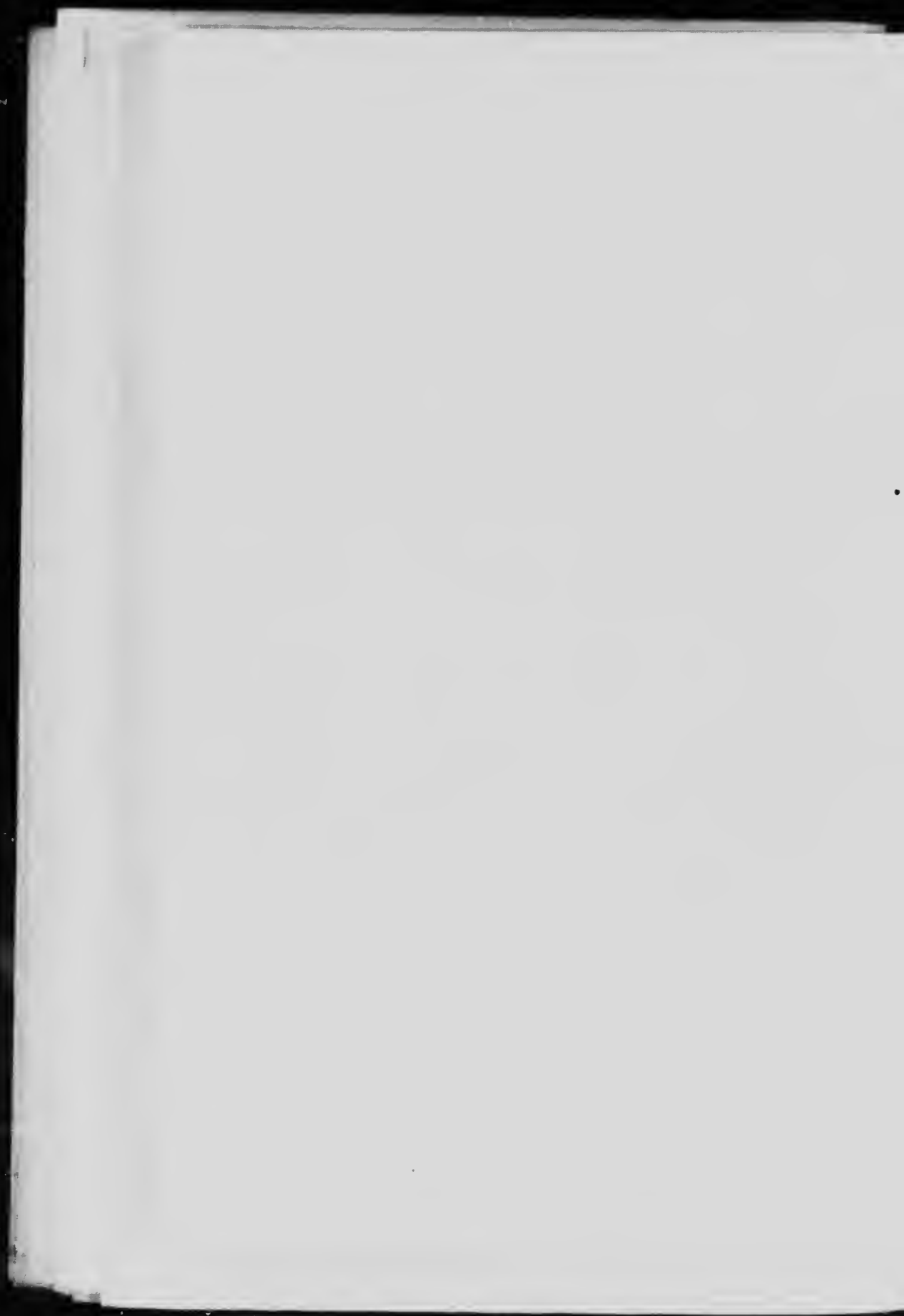
RECORD OF COKING TESTS.

WEST VA. FELD, ILC

No.	No. 2 Seam, South Hosmer		No. 6 Seam, South Hosmer		No. 8 Seam, South Hosmer		No. 2 Mine, Colliery, Perm	
	C1	C4	C2	C1	C5	C4	C1	C5
90.0	51	51	52	52	52	53	53	27
0.1	1.5	1.2	2.8	1.9	1.2	3.0	0.4	1.3
63.4	75.2	62.0	84.7	85	64.5	85.5	64.7	83.1
21.3	1.1	25.6	1.0	1.0	28.0	0.6	26.5	2.4
15.3	23.7	12.4	11.3	13.1	7.5	13.9	9.0	14.5
0.7	74.4	75.9	79.8	79.3	4.2	4.7	4.4	0.5
0.3	0.3	0.6	0.6	0.5	1.4	1.2	1.2	5.6
1.0	1.0	1.2	1.4	1.2	2.98	2.42	2.80	2.40
4.8	4.8	5.4	5.6	5.6	17.7	16.9	15.6	18.0
74.4	78.7	74.4	76.7	77.9	72.0	74.6	73.7	79.7
103	100	103	103	105	104	104	108	108
1.11	1.33	1.12	1.16	1.01	1.18	1.85	1.87	1.87
1.93	1.89	1.89	1.85	1.85	46.4	36.9	36.9	36.9
12.6	29.6	41.1	37.6	0.85	0.85	1.01	1.01	1.01
0.92	0.51	0.86	0.91	0.85	37.2	37.2	37.2	37.2
39.2	15.2	35.3	34.9	39.4	37.5	37.5	37.5	37.5
36.2	7.8	30.4	32.3	33.4	33.4	33.4	33.4	33.4
A	+ C	A	A	A	A	A	+ B	A

No. 5 Mine, Coal Creek Colliery, Perm

No.	C1		C1		C5	
	2026	2026	2026	2026	2026	2026
0.1	0.7	1.3	1.0	0.9	64.8	85.0
0.2	0.7	1.3	1.0	0.9	21.4	0.0
0.3	0.7	1.3	1.0	0.9	10.8	11.1
0.4	0.7	1.3	1.0	0.9	0.5	0.5
0.5	0.7	1.3	1.0	0.9	2.66	2.66
0.6	0.7	1.3	1.0	0.9	8.4	4.8
0.7	0.7	1.3	1.0	0.9	78.2	74.4
0.8	0.7	1.3	1.0	0.9	75.6	103
0.9	0.7	1.3	1.0	0.9	1.10	1.07
1.0	0.7	1.3	1.0	0.9	1.91	1.73
1.1	0.7	1.3	1.0	0.9	48.2	44.9
1.2	0.7	1.3	1.0	0.9	0.89	0.94
1.3	0.7	1.3	1.0	0.9	34.4	42.0
1.4	0.7	1.3	1.0	0.9	30.4	30.3
A	A	A	A	A	A	A



1. Source of coal - mine and seam
2. Coal or coke number
3. Moisture in coal or coke.
- Proximate analysis of dry coal or coke
 4. Fixed carbon (FC)
 5. Volatile matter (VM)
 6. Ash
- Ultimate analysis of dry coal or coke
 7. Carbon (C)
 8. Hydrogen (H)
 9. Sulphur (S)
 10. Nitrogen (N)
 11. Oxygen (O)
12. Ratio FC/VM
13. Ratio C/H
14. Age of coal when coked
15. Duration of coking
16. Yield of dry coke from dry coal
17. Theoretical yield (FC - ash)
18. Actual yield as percentage of theoretical
19. Apparent specific gravity
20. Real specific gravity
21. Percentage cell space or porosity
22. Relative crushing strength (R)
23. Physical value ($P \times R$)
24. " " ($P \times R^2$)
25. Classification

TABLE M
SUMMARY RECORD OF

MILK

1. Source of coal—mine and seam	No. 1 Opening Granite			No. 2
2. Coal or coke number	Ex. 1	Cl Ex. 1	Ex. 201	Ex. 2
3. Moisture in coal or coke	%			
Proximate analysis of dry coal or coke				
4. Fixed carbon (FC)	%	54.0		53.6
5. Volatile matter (VM)	%	33.7		32.1
6. Ash	%	12.3	16.2	7.9
Ultimate analysis of dry coal or coke				
7. Carbon (C)	%	71.6		70.1
8. Hydrogen (H)	%	4.8		4.4
9. Sulphur (S)	%			1.9
10. Nitrogen (N)	%			
11. Oxygen (O)	%			
12. Ratio FC/VM		1.60		1.65
13. Ratio C/H		14.9		15.9
14. Age of coal when coked	Months		½	
15. Duration of coking	Hours		41	
16. Yield of dry coke from dry coal	%			
17. Theoretical yield (FC + ash)	%	66.3		67.6
18. Actual yield as percentage of theory				
19. Apparent specific gravity			0.97	
20. Real specific gravity			1.72	
21. Percentage cell space or porosity (P)			43.8	
22. Relative crushing strength (S)				
23. Physical value (P×S)				
24. " " (P×S ²)				
25. Classification				

TABLE XIII
 RECORD OF COKING TESTS.

MILKAMEEN COALFIELD, B.C.

No. 2 Opening, Granite Creek

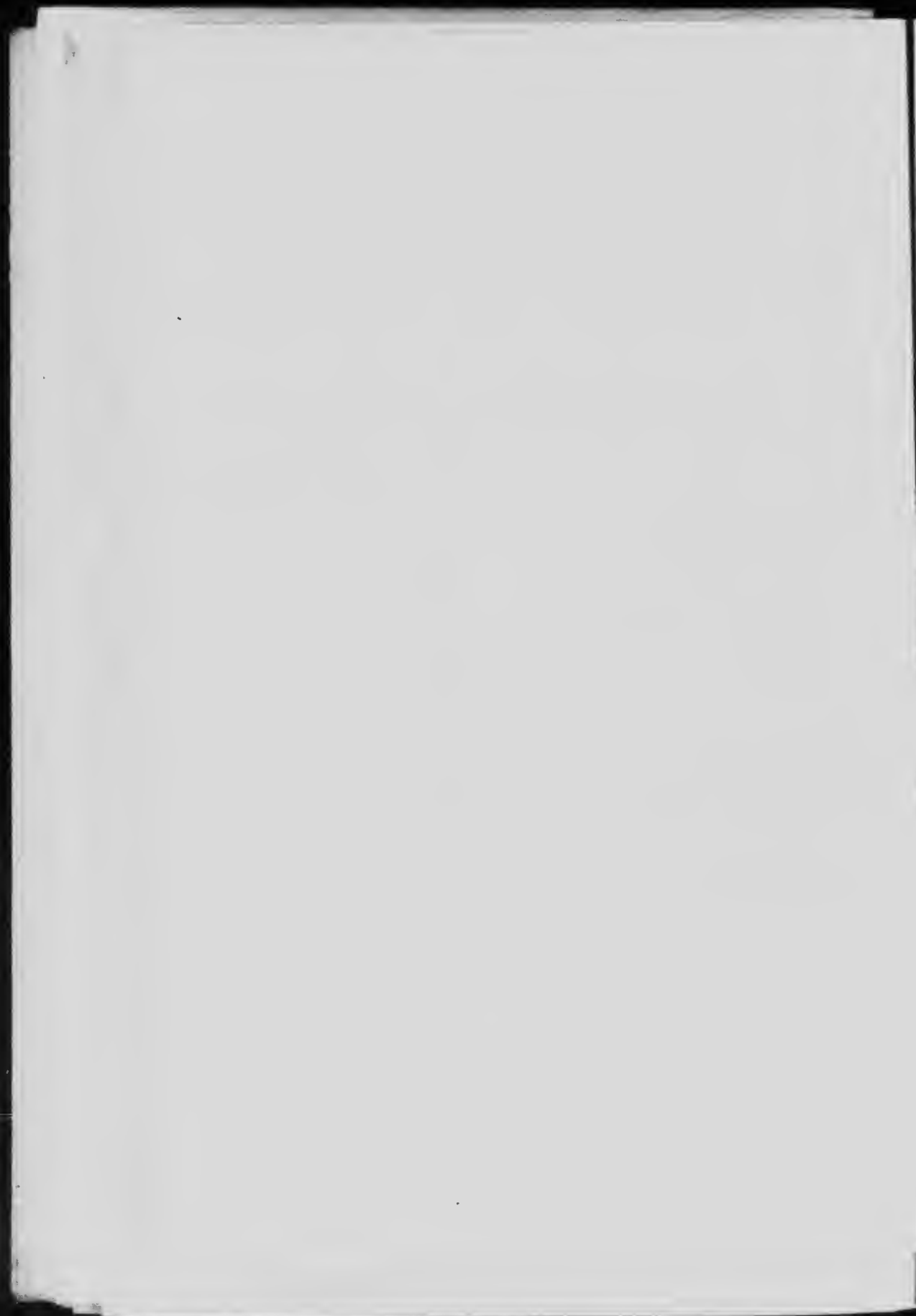
Ex. 2	C1 Ex. 2	Ex. 202	C1 Ex. 202	Ex. 203	C1 Ex. 203
53.6			51.9		
32.1			32.1		
14.0	17.6	10.4	15.3	16.0	13.1
79.1			69.4		
4.4			1		
1.9		1.8			
1.65			1.4		
15.9			16.1		
	41		41		
67.8			67.9		
0.95		0.99			
1.78		1.76			
46.5		43.7			
0.92		0.97			
42.7		42.4			
39.2		41.1			

NICOLA VALLEY COALFIELD,
 B.C.

Middlesboro Col.
 No. 2 Mine

Middlesboro Col.
 Mines 1 and 2

C1 Ex. 203	22 SP	C1 22 SP	22 M	C1 22 M
	2.3		4.0	
	18.1		46.8	
	39.0		39.1	
9.0	12.9		14.1	
	69.4		66.1	
	5.1		4.9	
	0.7		0.9	
	2.0		1.4	
	9.9		12.6	
	1.22		1.20	
	13.6		13.5	
	8		8	
	48		48	
	61.0		60.9	
1.03		1.05		1.03
1.70		1.65		1.59
39.2		36.6		35.0
		0.64		
		23.4		
		14.9		
		+ C		C



1. Source of coal - mine a

2. Coal or coke number . . .

3. Moisture in coal or coke

- Proximate analysis of
4. Fixed carbon (FC) . . .
5. Volatile matter (VM)
6. Ash

- Ultimate analysis of dry
7. Carbon (C)
8. Hydrogen (H)
9. Sulphur (S)
10. Nitrogen (N)
11. Oxygen (O)

12. Ratio FC/VM
13. Ratio C/H

14. Age of coal when coked.
15. Duration of coking
16. Yield of dry coke from t
17. Theoretical yield (FC +
18. Actual yield as percenta

19. Apparent specific gravit
20. Real specific gravity.
21. Percentage cell space of
22. Relative crushing stren
23. Physical value ($P \times S$)
24. " " ($P \times S'$)

25. Classification

SUMMARY RECORD

1. Source of coal—mine and seam		Wellington seam Wellington—Extensio			
		C1 20	202	C1 202	C5 2020
2. Coal or coke number	20				
3. Moisture in coal or coke.	% 1.1	0.7	1.2		1.6
Proximate analysis of dry coal or coke					
4. Fixed carbon (FC)	% 49.8	83.2	51.0	82.9	83.5
5. Volatile matter (VM)	% 10.1	2.9	40.4	3.4	2.9
6. Ash	% 10.1	13.9	8.6	13.7	13.6
Ultimate analysis of dry coal or coke					
7. Carbon (C)	% 72.9				
8. Hydrogen (H)	% 4.7				
9. Sulphur (S)	% 0.1		0.5		
10. Nitrogen (N)	% 1.2				
11. Oxygen (O)	% 10.7				
12. Ratio FC/VM	1.24				
13. Ratio C/H	15.5				
14. Age of coal when coked.	Months	9		4	4
15. Duration of coking	Hours	48		48	74
16. Yield of dry coke from dry coal.	%	68.2			66.5
17. Theoretical yield (FC + ash)	% 59.9		59.6		
18. Actual yield as percentage of theory		114			112
19. Apparent specific gravity		1.00		0.96	0.95
20. Real specific gravity		1.74		1.87	1.82
21. Percentage cell space or porosity (P)		42.6		48.5	48.1
22. Relative crushing strength (S)		0.82		0.86	0.87
23. Physical value (P×S)		35.0		41.8	41.9
24. " " (P×S ²)		28.8		36.4	36.5
25. Classification		- A		A	A

TABLE XLIII

RECORD OF COKING TESTS.

NANAIMO-COMOX COALFIELD, VANCOUVER ISLAND

Upper Seam No. 1 Mine, Nanaimo					Lower Seam No. 3 Mine, Nanaimo		Lower Seam No. 4 Mine, Comox		Lower Seam, Mines 4 and 7 Comox			
C5 2020	18	C1 18	C3 18	2018	C1 2018	C3 18	21	C1 21	21M	C1 21M	C3 21M	
1.6	1.6	1.8	1.3	1.9	1.0	0.7	1.0	0.6	
83.5	48.5	48.1	80.1	46.6	56.5	84.2	57.8	84.5	
2.9	41.2	41.5	2.0	41.5	31.6	3.0	30.2	2.6	2.6	
13.6	10.3	10.4	17.9	11.9	11.9	12.8	12.0	12.9	
.....	72.1	69.0	72.9	73.4	
.....	4.8	4.6	4.4	4.4	
.....	0.9	0.9	0.9	1.3	1.0	0.9	
.....	1.2	1.2	1.0	1.0	
.....	10.7	12.0	8.8	8.3	
.....	1.18	1.12	1.70	1.31	
.....	15.0	15.0	16.5	16.7	
4	9	9	4	9	8½	8½	8½	
74	48	48	74	48	48	48	48	
66.5	62.7	74.4	73.6	
.....	58.8	58.5	58.5	68.4	69.8	
.....	107	109	105	
0.95	1.08	1.05	1.02	1.02	1.04	
1.82	1.72	1.83	1.73	1.72	1.85	
48.1	37.1	42.8	41.2	40.8	44.0	
0.87	0.54	0.65	0.83	0.85	0.92	
41.9	20.1	28.0	34.3	34.7	40.4	
36.5	10.9	18.3	28.6	29.4	37.2	
A	C	B	- A	- A	

1

2

3

4

5

6

7

8

9

10

11

12

13

14

15

16

17

18

19

20

21

22

23

24

25

1

2.

3.

4.
5.
6.

7.
8.
9.
10.
11.

12.
13.

14.
15.
16.
17.
18.

19.
20.
21.
22.
23.
24.
25

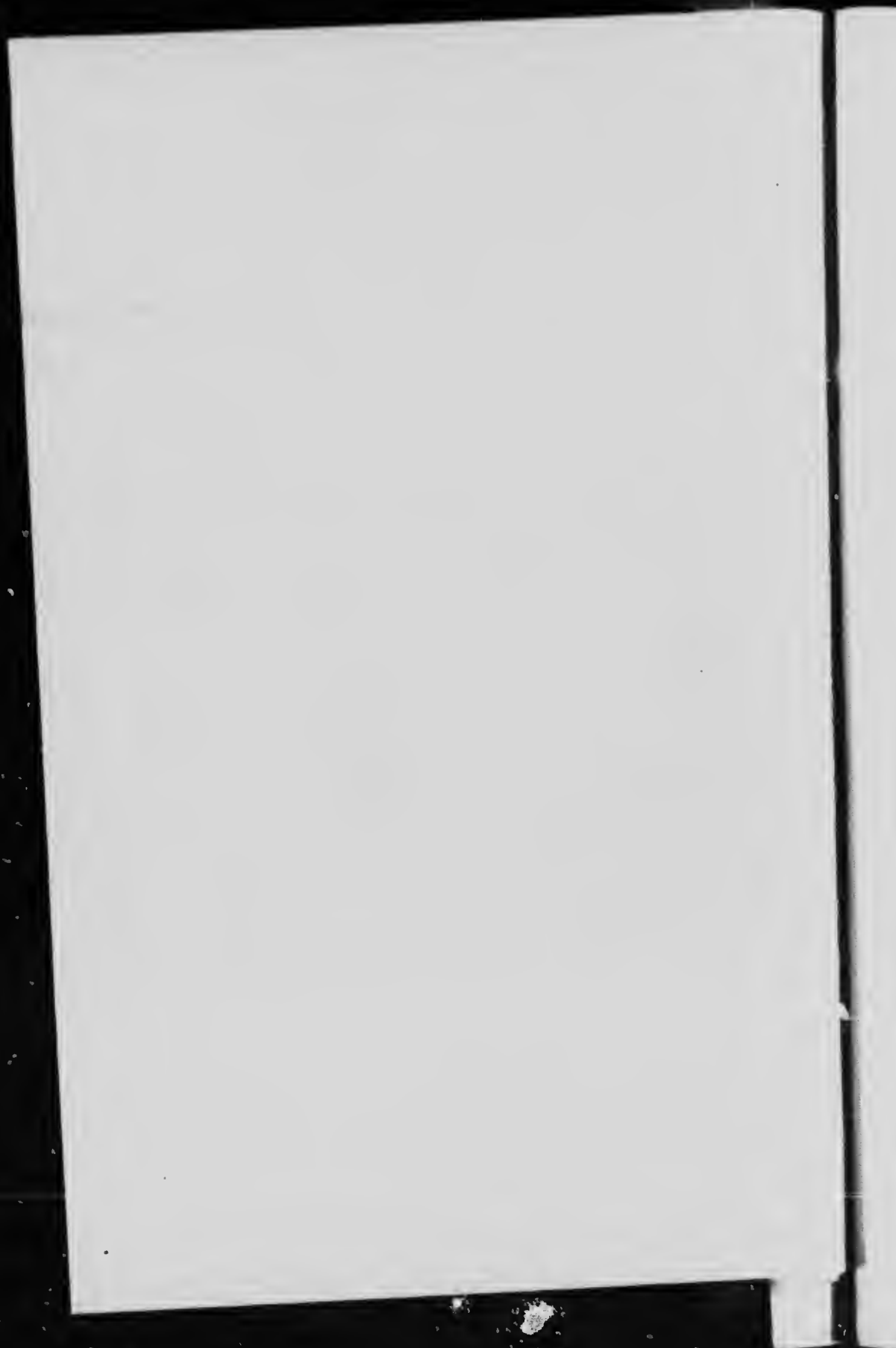
SUMMARY RECORD

Source of coal (mine and seam)		Upper Seam		
2.	Coal or coke number	1x 31	U1 18 31	18
3.	Moisture in coal or coke	%	0.9	0.0
Proximate analysis of dry coal or coke				
4.	Fixed carbon (FC)	%	58.0	50
5.	Volatile matter (VM)	%	25.0	26
6.	Ash	%	17.0	22.8
Ultimate analysis of dry coal or coke				
7.	Carbon (C)	%	69.8	
8.	Hydrogen (H)	%	4.0	
9.	Sulphur (S)	%	0.5	0
10.	Nitrogen (N)	%	0.8	0
11.	Oxygen (O)	%	7.9	
12.	Ratio FC/VM		2.32	2.2
13.	Ratio C/H		17.5	
14.	Age of coal when coked	Months		
15.	Duration of coking	Hours	48	
16.	Yield of dry coke from dry coal	%	76.6	
17.	Theoretical yield (FC + ash)	%	75.0	77
18.	Actual yield as percentage of theory			
19.	Apparent specific gravity		1.56	
20.	Real specific gravity		1.90	
21.	Percentage cell space or porosity (P)		28.7	
22.	Relative crushing strength (S)		0.75	
23.	Physical value (P×S)		21.6	
24.	" " (P×S ²)		16.2	
25.	Classification		4 C	

IG TESTS.

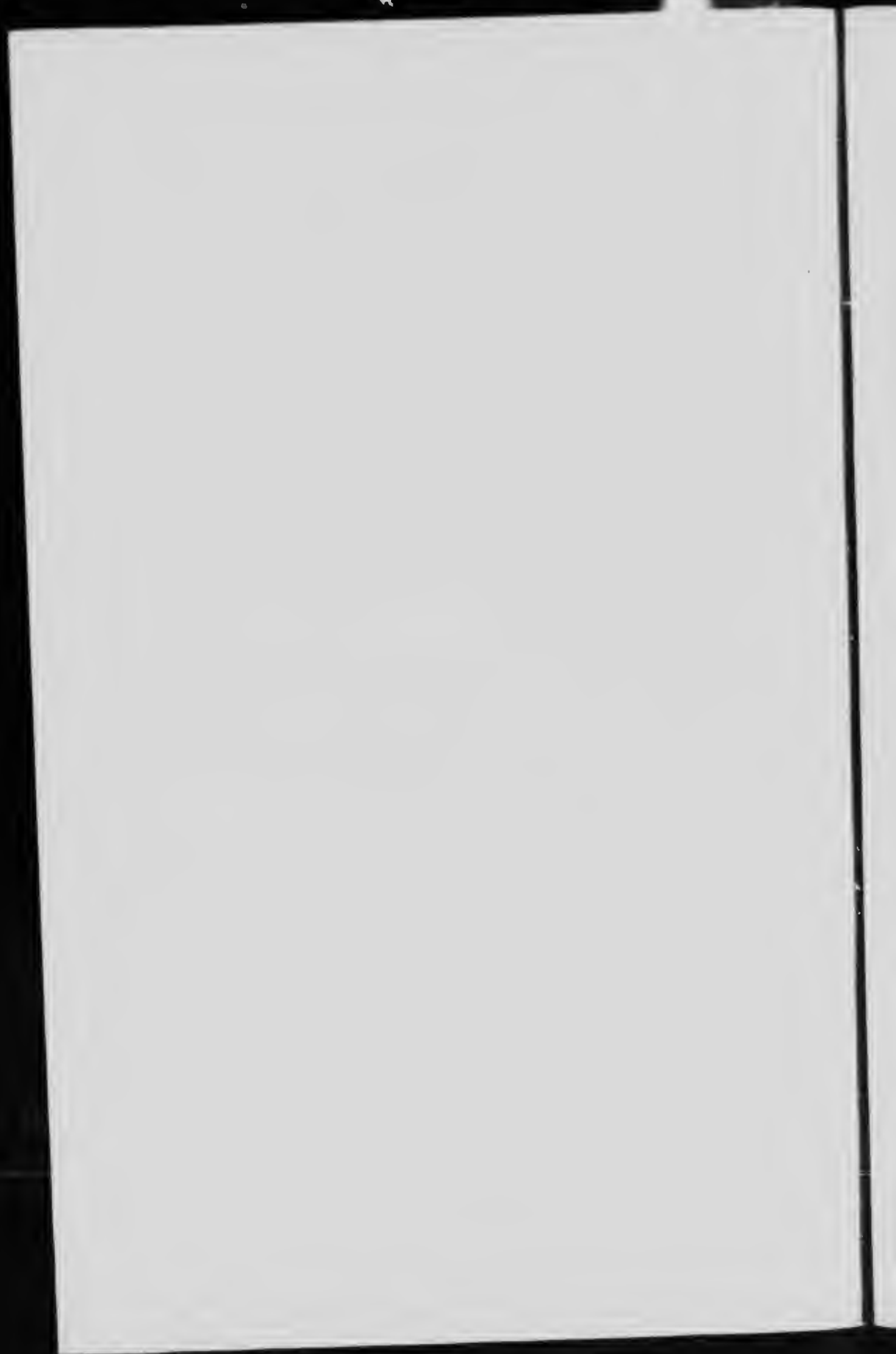
IGRS. LOCALITY OF YUKON TERRITORY

Middle Seam Tantalum Mine				Lower Seam Tantalum Mine				
	Cl Ex. 32	Ex. 232	Cl Ex. 232	Cl Ex. 232	Ex. 33	Cl Ex. 33	Ex. 233	Cl Ex. 233
7	0.0	0.6	0.0		0.7	0.0	0.5	0.0
1	71.3	60.3	80.3		56.0	76.6	59.2	81.4
7	2.5	25.7	2.0		27.8	1.6	28.1	1.4
2	26.2	14.0	17.7		16.2	21.8	12.7	17.2
					71.1			
					4.3			
5		0.4			0.5		0.5	
9		0.8			0.7		0.8	
					7.2			
8		2.34			2.02		2.10	
					16.5			
	48		48	48		28		48
3	76.3		77.0			75.1		74.5
		74.3			72.2		71.9	
	1.37		1.31			1.16		1.14
	1.92		1.86			1.96		1.92
	28.9		29.3			41.1		40.8
	0.67		0.75			0.87		0.98
	19.4		22.0			35.8		40.0
	13.1		16.6			31.3		39.2
	C		- B			- A		- A



INDEX

VOLS I & II



	PAGE		
Cascade Mountain area, See Canada		Coal fields of Canada, bibliography	
Cassiar Coal Co.	107	reports and maps. See Bibliography	120
Central Coal Co.	74	Coalless territory in Canada	6, 21
Chemical analysis. See analysis		Coals and lignites of British Columbia	85
laboratory work of	16	and lignites of great plains	63
Chignecto colliery	53, 56, 138	classes of impurities in	165
Chimney Corner mine	44	of Canada, character of	9
Cluff Creek lignite	121	tested, list of	8
Cluver Bar Coal Co.	74	Coke	6, 7, 18, 30
Coal, anthracite, disposal of dust	192	advantages of as a fuel	205
estimated amount		cost of producing in different	
in Canada	9	types of oven	214
machinery for preparation of	191	manufacture in British Columbia	205
necessity for sizing and cleaning	191	opinions of experts	21
only cleaning plant in Canada	192	ovens at Coal Creek and Madoc	61, 70
only one considerable colliery in Canada	190	comparison of types of	21
preparation of	190	physical values of	21
produced by over-turn of strata	64	porosity of	222
sizes for market	191	specific gravity of	223
small basin of, near Rocky mountains	23	strength of	223
tests applied to	219	Cokes, list of made in tests	226
bituminous, estimated amount of in Canada	6	Coking, effect of age of coal on	220
preparation of	171	effect of blending of coal	221
eastern slope of Rocky mountains	76	effect of compression	222
effect of age on coking	220	effect of moisture	222
estimate of quantity		Coking tests	13, 212
Belly River formation	72	method of conducting	214
estimate of quantity, Bosmer mines	97	summary tables of results, Tables xxix, xli, following part, vi	233
extensive deposits in Yukon Territory	116	tabulating of	225
fields of Canada	6, 21	Colchester Coal Co.	59
geographical position	22	Collecting the coal samples	129
in North America, first mention of	27	Colonial Coal Co.	36
ignite, estimated amount of		Connet rock breaker	196
in Canada	9	Conroy coal field	106
low grade in Ontario	22	Consolidated Mines	71
Turtle Mountain	65	Conway, E. J.	4
field, character of, Manitoba and North West		Copper coke oven	210
Manitoba and North West	23	Corbin Coal and Coke Co.	90, 99
ignite and bituminous	27	Coumbia, Col., washery at	184
mining in Canada, beginning of	23	Craig table	176
Nova Scotia all bituminous	24	Crowsnest Pass Coal Co.	90, 91, 116, 117, 118, 119
production of in Canada	64	largest producer in Western Canada	91
New Brunswick fields	129	Crowsnest Pass coal field	86, 116
samples, collecting of	45	Cumberland Co. areas	50, 58
sizes of great size	45	Coal and Railway Co.	51, 55, 137, 138
standard sizes of Dominion		Curve diagram, coal test No. 37	201
Coal Co.	34	Dawson, Dr., classification of rocks	
washery at Ladysmith	110	in Edmonton series	69
washing	163	coal in Nicola valley reported	102
City Coal Co.	74	estimate of Belly River formation	72
Creek colliery	94, 118, 120	first report of coal in Crowsnest region	89
lignite on	120	local conditions of great plains area	63
		Delbert mine	59
		Dennis, T. C.	4
		coal fields of Canada	17, 21

	PAGE	K	PAGE
Etheridge, C. G., producer tests	60	Kings, J. H., Minto, N. B., coals tested	44
Lilcott, P. H.	122	Kipshald, method of nitrogen determination	143
Leslika process for sulphur determination	130	Kwoerting gas producer	63
Explosion in gas producer plant, risk of slight	50	L	
I		Leitch Collieries, Ltd., coals tested	112
Fireman, importance of method of firing	41	Lignite, moisture in	118
Flow sheet, treatment of main sample	123	Lignites, excellent performance of, fixed carbon and volatile matter in	131
Flue gas, relative merits of samples for tests	177	Log of boiler trial No. 38	21
Frank-Blairston coal field, coals tested	112	Log of boiler trial No. 32	85
Furnaces, and their adaptability	7	Locomts-Petroleum gas producer system	64
G		Lord, Prof. N. W., method of testing for carbon and hydrogen	136
Gas analysis	157	M	
producer efficiency	103	Mahler calorimeter	146
" tests, computation of fuel consumption	67	Maritime Coal, Railway and Power Co., coals tested	41
producer tests, details of equipment of plant	72	Melburn, W. B.	122
producer tests, estimating results	60	Minudie Coal Co., Ltd., coals tested	41
producer tests, methods of conducting and making measurements	70	Moham, R. T.	6
producer tests, methods of testing	66	Moisture in coal, effect of	134
producer tests, remarks on results	102	" samples, how calculated	13, 16
" producer tests, report on typical example of curve diagrams	88	" steam	65
producer trial No. 32, detailed results	85	Mond process gas producer	122
Gas producers used in tests	75	Morrison, H. G.	
Gas samples, how obtained	126	N	
Georges Creek coal, trials of	36	Nanaimo coal field, coal tested	147
Grand Lake coal fields, coals tested	109	Nanaimo-Comox and Alert Bay coal fields, coal tested	50
H		Nesda Valley Coal and Coke Co., coal tested	19, 117
H. W. McNeil Co., coals tested	18, 115	" coal field, coal tested	19, 117
Hartley, H.	122	Nevills, J. H., H.	122
Heat expenditure with various coals	118	Nitrogen, determination of	143
Hillenst Coal and Coke Co., Ltd., coals tested	46	Nova Scotia Steel and Coal Co., coal from tested	107
Husmer Mines, Ltd., coals tested	47	Nova Scotia Steel and Coal Co., remarks on samples from	40
I		O	
International Coal Mining Co., coals tested	42, 108	Oesat Minck apparatus	158
International Coal and Coke Co., Ltd., coals tested	46, 112	Oxygen, determination in coal	145
Inverness coal field, tests of coal from	41, 108	P	
" Railway and Coal Co., coals tested	41	Pacific Coast Coal Co., Ltd., coals tested	50
" and Pierson coal fields, coals tested from	108	Parkside Coal Co., coal tested	15, 110
J		Peabody throttling calorimeter	16
Joggins-Elginette coal field, coals tested	44	Pierson coal field, tests of coal from	42, 108
		Poisoning from producer gas, remedy for	60
		Pollard, Dr. W., methods of ash determination	179, 180
		Port Hood colliery, coal from tested	108
		Power and Machinery Co.'s twin producers	64

Producer gas			
hydrogen and nitrogen		84	
and sulphur content			
in			
relative to			
samples			
		85	
Radiation losses in tests			
Randall and Barahatt specific	88		
Records and calculations			
made and kept	100		
Richmond Railway and Coal Co.			
coal tested			8
Ruston, Proctor and Co. Ltd.			
producer description			
			1
Samples, collection and description			
of	22		
numbering of	27		
Sample tubes, use of	178		
Sammanee, Mady, recorder	17		
Soluble matter in coal	173		
" " water	173		
Sours, Edmonton and Bow River			
coal fields, coal tested	15		110
Specific gravity of coal	174		
Split volatile ratio	156		
Springhill coal field, tests of coal			
from	43		
" and Joggins coal field			
coal from tested	109		
Staff, gas producer tests, duties of	80		
Standard Coal Co., coals from tested	110		
			11
			12
			50
			55
			46
			110
			117
			65
			66



CANADA
DEPARTMENT OF MINES
MINES BRANCH

HON. W. T. MCGILL, Minister of Mines, Ottawa, Ontario
1907

REPORTS AND MAPS OF ECONOMIC INTEREST

MINES BRANCH

REPORTS

1. Mining Conditions of the Keweenaw, Yorkon, and Gribble Hoards of Fe. D. 1902.
2. Great Landslide at Frank, Mich. Report on the R. C. C. and Gribble Hoards. W. Book, M.A. 1903.
3. Investigation of the distillation of iron ore, the process of smelting of iron ores, and the making of steel in open hearth. European Journal of Scientific and Industrial, Eugene Haanel, Ph.D., 1901. (Out of print.)
4. Rapport de la Commission royale pour l'étude des moyens de développer l'industrie métallurgique de la production des métaux de fer et d'acier, sur le traitement des minerais de fer. (French Edition), 1905. (Out of print.)
5. On the location and character of iron-ore deposits of magmatic origin in Minnesota. Eugene Haanel, Ph.D., 1904.
7. Limestones, and the Lime Industry of Manitoba. Preliminary Report on. by J. W. Wells, 1905.
8. Clays and Shales of Manitoba. Their District Value. Preliminary Report on. by J. W. Wells, 1905. (Out of print.)
9. Hydraulic Cements. Raw Materials in Manitoba, Manufacture and Uses of. Preliminary Report on. by J. W. Wells, 1905.
10. Mica: its Occurrence, Exploitation, and Uses. by Fritz Cirkel, M.E., 1905. (Out of print.)
11. Asbestos. Its Occurrence, Exploitation, and Uses. by Fritz Cirkel, M.E., 1905. (Out of print; see No. 99.)
12. Zinc Resources of British Columbia and the Conditions affecting their Exploitation. Report of the Commission appointed to investigate. by W. P. Inglis, 1905.
16. Experiments made at Sudb. Ste. Marie, under Government auspices, in the smelting of Canadian iron ores by the electric furnace process. Final Report on. by Eugene Haanel, Ph.D., 1907.
17. Mines of the Silver-Cobalt Ores of the Cobalt District. Their Present and Prospective Output. Report on. by Eugene Haanel, Ph.D., 1907.
18. Graphite: Its Properties, Occurrence, Refining, and Uses. by Fritz Cirkel, M.E., 1907.
19. Peat and Lignite: Their Manufacture and Uses in Europe. by Erik Nyström, M.E., 1908.
20. Iron Ore Deposits of Nova Scotia. Report on Part I. by Dr. J. E. Woodman.
21. Summary Report of Mines Branch, 1907-8.

22. Iron Ore Deposits of Thunder Bay and Rainy River Districts. Report on. by F. Hille, M.F.
23. Iron Ore Deposits along the Ottawa, Quebec side, and Gatineau rivers. Report on, by Fritz Cirkel, M.F.
24. General Report on the Mining and Metallurgical Industries of Canada, 1907-8.
25. The Tungsten Ores of Canada. Report on. by Dr. T. L. Walker.
26. The Mineral Production of Canada, 1906. Annual Report on. by John McLeish, B.A.
27. The Mineral Production of Canada, 1908. Preliminary Report on. by John McLeish, B.A.
28. Summary Report of Mines Branch, 1908.
29. Chrome Iron Ore Deposits of the Eastern Townships. Monograph on. by Fritz Cirkel, M.F. Supplementary Section, Experiments with Chromite, at McGill University, by Dr. J. B. Porter.
30. Investigation of the Peat Bogs and Peat Fuel Industry of Canada, 1908. Bulletin No. 1, by Erik Nyström, M.F., and A. Anrep, Peat Expert.
31. Production of Cement in Canada, 1908. Bulletin on. by John McLeish, B.A.
32. Investigation of Electric Shaft Furnace, Sweden. Report on. by Eugène Haanel, Ph.D.
42. Production of Iron and Steel in Canada during the calendar years 1907 and 1908. Bulletin on. by John McLeish, B.A.
43. Production of Chromite in Canada during the calendar years 1907 and 1908. Bulletin on. by John McLeish, B.A.
44. Production of Asbestos in Canada during the calendar years 1907 and 1908. Bulletin on. by John McLeish, B.A.
45. Production of Coal, Coke, and Peat in Canada during the calendar years 1907 and 1908. Bulletin on. by John McLeish, B.A.
46. Production of Natural Gas and Petroleum in Canada during the calendar years 1907 and 1908. Bulletin on. by John McLeish, B.A.
47. Iron Ore Deposits of Vancouver and Texada Islands. Report on. by Einar Lindeman, M.F.
55. Report on the Bituminous, or Oil-shales of New Brunswick and Nova Scotia; also on the Oil-shale Industry of Scotland. by Dr. R. W. Ellis.
58. The Mineral Production of Canada, 1907 and 1908. Annual Report on. by John McLeish, B.A.
59. Chemical Analyses of Special Economic Importance made in the Laboratories of the Department of Mines, 1906-7-8. Report on. by F. G. Watt, M.A., F.C.S. With Appendix on the Conventional Methods and Apparatus for the Analysis of Oil-shales. by H. A. Lexterin, Ch.E.
62. Mineral Production of Canada, 1909. Preliminary Report on. by John McLeish, B.A.
63. Summary Report of Mines Branch, 1909.
67. Iron Ore Deposits of the Bristol Mine, Pontiac county, Quebec. Bulletin No. 2, by Einar Lindeman, M.F., and Geo. C. Mackenzie, B.Sc. Schedule of Charges for Chemical Analysis and Assays.
68. Recent Advances in the Construction of Electric Furnaces for the Production of Pig Iron, Steel, and Zinc. Bulletin No. 3, by Dr. Eugène Haanel.
69. Chrysotile-Asbestos: Its Occurrence, Exploitation, Milling, and Uses. Report on—by Fritz Cirkel, M.F. (Second Edition, enlarged).
71. Investigation of the Peat Bogs, and Peat Industry of Canada, 1909-10, to which is appended Mr. Alf Larson's Paper on Dr. M. Ekenberg's Wet Carbonizing Process. from Teknisk Tidkrift, No. 12, December 26, 1908. (translation by Mr. A. Anrep, Jr., also a translation of Lieut. Ekelund's Pamphlet entitled "A Solution of the Peat Problem," 1909 describing the Ekelund Process for the Manufacture of Peat Powder, by Harold, A. Lexterin, Ch.E.). Bulletin No. 4, by A. Anrep, Peat Expert. (Second Edition, enlarged).
79. Production of Iron and Steel in Canada during the calendar year 1909. Bulletin on. by John McLeish, B.A.
80. Production of Coal and Coke in Canada during the calendar year, 1909. Bulletin on. by John McLeish, B.A.

82. Magnetic Correlation of the ...
83. An investigation ...
 conducted at McGill University under the authority of the Dominion Government
 Report on—by J. B. Porter, F.M.S., and others.
 Vol. I—Coal
 Vol. II—Boiler Tests and Diagrams
84. Gypsum Deposits ...
 Report on—by A. ...
85. Production of Coal ...
 calendar year 1909—1.
88. The Mineral Production of Canada ...
89. Reprint of the ...
 25, 1910—London: H.M.S.O.
90. Proceedings of the Commission ...
92. Investigation of the ...
 Capt. Arthur DeGore ...
93. Molybdenum Occurrence in Canada ...
102. Mineral Production of Canada 1910—Annual Report on—by John McLeish, B.A.
103. Mines Branch Summary Report 1910.
104. Catalogue of Publications of the Mines Branch from 1902 to 1910, including Lists of Contents and List of Maps, etc.
110. Western Portion of Formed from ...
 by Howells-Production, M.S.
114. Production of Cement, Limestone Products, and other Strategic Minerals of Canada 1910—Bulletin on—by John McLeish, B.A.
115. Production of Iron and Steel in Canada during the calendar year 1910—Bulletin on—by John McLeish, B.A.
116. Production of Coal and Coke in Canada during the calendar year 1910—Bulletin on—by John McLeish, B.A.
117. General Summary of the Mineral Production of Canada during the calendar year 1910—Bulletin on—by John McLeish, B.A.
143. The Mineral Production of Canada 1910—Annual Report on—by John McLeish, B.A.

18. 1911-1918

83. An Investigation of the Geology of Canada with reference to their Economic Quantities; as conducted at McGill University under the authority of the Dominion Government
 Report on—by J. B. Porter, F.M.S., and others.
 Vol. III
 Appendix I
 Coal Washing Tests and Diagrams, by J. B. Porter.
 Vol. IV
 Appendix II
 Boiler Tests and Diagrams, by R. J. Darby.
 Vol. V
 Appendix III
 Producer Tests and Diagrams, by R. J. Darby.
100. The Building and Character of the ...
 Report on—by Professor W. A. Parks.
111. Diamond Drilling at Point Marmuse, Ont.—Bulletin No. 6—by A. C. Lane, Ph.D., with
 Introductory by A. W. G. Wilson, Ph.D.
118. Mica: Its Occurrence, Exploration, and Uses—Report on—by Hugh S. de Schmal, M.I.E.

IN PREPARATION

83. An investigation of the Coals of Canada with reference to their Economic Qualities. Published at McGill University under the authority of the Dominion Government. Part one, by J. B. Porter, F. M., D.Sc. and others.

Vol. VI

Appendix IV

Cooking Tests, by Edgar Stansfield and J. B. Porter

Appendix V

Chemical Tests, by Edgar Stansfield.

91. Coal and Coal Mining in Nova Scotia. Report on, by J. G. S. Hudson

MAPS

6. Magnetometric Survey, Vertical Intensity, Calabogie mine, Bagot township, Renfrew county, Ontario, by E. Nyström, M.E., 1904
13. Magnetometric Survey of the Belmont Iron Mines, Belmont township, Peterborough county, Ontario, by B. F. Hannel, B.Sc., 1905
14. Magnetometric Survey of the Willow mine, Lavant township, Lanark county, Ontario, by B. F. Hannel, B.Sc., 1905
15. Magnetometric Survey, Vertical Intensity, Iron Ore Deposits at Austin Brook, Bathurst township, Gloucester county, N.B., by E. Landeman, M.E., 1906
33. Magnetometric Survey, Vertical Intensity, Lot 1, Concession VI, Mayo township, Hastings county, Ontario, by Howes-Frèchette, M.Sc., 1909
34. Magnetometric Survey, Vertical Intensity, Lots 2 and 3, Concession VI, Mayo township, Hastings county, Ontario, by Howes-Frèchette, M.Sc., 1909
35. Magnetometric Survey, Vertical Intensity, Lots 10, 11, and 12, Concession IX, and Lots 11 and 12, Concession VIII, Mayo township, Hastings county, Ontario, by Howes-Frèchette, M.Sc., 1909
36. Survey of Mer Bleue Peat Bog, Gloucester township, Carleton county, and Cumberland township, Russell county, Ontario, by Erik Nyström, M.E., and A. Anrep, Peat Expert
37. Survey of Alfred Peat Bog, Alfred and Caledonia townships, Prescott county, Ontario, by Erik Nyström, and A. Anrep, Peat Expert
38. Survey of Wellard Peat Bog, Woodlot and Humberstone townships, Weland county, Ontario, by Erik Nyström, M.E., and A. Anrep, Peat Expert
39. Survey of Newington Peat Bog, Osmdbrook, Roxborough, and Cornwall townships, Stormont county, Ontario, by Erik Nyström, M.E., and A. Anrep, Peat Expert
40. Survey of Perth Peat Bog, Brimstonal township, Lanark county, Ontario, by Erik Nyström, M.E., and A. Anrep, Peat Expert
41. Survey of Victoria Road Peat Bog, Bexley and Carleton townships, Victoria county, Ontario, by Erik Nyström, M.E., and A. Anrep, Peat Expert
48. Magnetometric Map of Iron Crown claim at Klanch river, Vancouver island, B.C., by Lmar Landeman, M.E.
49. Magnetometric Map of Western Steel Iron claim at Sechart, Vancouver island, B.C., by Lmar Landeman, M.E.
50. Vancouver island, B.C., by Lmar Landeman, M.E.
51. Iron Mines, Texada island, B.C., by J. H. Shepherd, C.E.
52. Sketch Map of Bog Iron Ore Deposits, West Arm, Quatsino sound, Vancouver island, B.C., by E. Frank
53. Iron Ore Occurrences, Ottawa and Pontiac counties, Quebec, 1908, by Fritz Cirkel, M.E.
54. Iron Ore Occurrences, Argenteuil county, Quebec, 1908, by Fritz Cirkel, M.E.
57. The Productive Chromite Iron Ore District of Quebec, by Fritz Cirkel, M.E.
60. Magnetometric Survey of the Bristol mine, Pontiac county, Quebec, by Lmar Landeman, M.E.
61. Topographical Map of Bristol mine, Pontiac county, Quebec, by Lmar Landeman, M.E.
64. Index Map of Nova Scotia: Gypsum, by W. F. Jenkinson, M.E.
65. Index Map of New Brunswick: Gypsum, by W. F. Jenkinson, M.E.

- 66. Map of Magdalen County.
- 70. Magnetometric Survey of St. Lawrence County, Ontario, by J. B. Porter.
- 72. Brunter Peat Bog, Ontario.
- 73. Komok's Peat Bog, Ontario.
- 74. Brock's Peat Bog, Ontario.
- 75. Rouben's Peat Bog, Ontario.
- 76. Alfred Peat Bog, Ontario, by A. A. Arnsperg, C.E.
- 77. Alfred Peat Bog, Ontario, Map showing location of bog.
- 78. Map of Asbestos Region, Province of Quebec, by A. A. Arnsperg, C.E.
- 86. Map showing general distribution of sphalerite in Ontario, M.I.
- 91. Map showing Cobalt, Ontario, and vicinity, M.I.
- 95. General Map of Canadian flow of Gold veins, by A. A. Arnsperg, C.E. and J. B. Porter.
- 96. General Map of Coal Fields of New Brunswick, New Brunswick, by A. A. Arnsperg, C.E. Report No. 83, by Dr. J. B. Porter.
- 97. General Map showing Coal Fields of Alberta, Saskatchewan, and Manitoba, by A. A. Arnsperg, C.E. Report No. 83, by Dr. J. B. Porter.
- 98. General Map of Coal Fields of British Columbia, by A. A. Arnsperg, C.E. Report No. 83, by Dr. J. B. Porter.
- 99. General Map of Coal Fields of Yukon Territory, by A. A. Arnsperg, C.E. Report No. 83, by Dr. J. B. Porter.
- 106. Ashcroft Brook Iron Bearing District, Yukon Territory, by A. A. Arnsperg, C.E. Report No. 83, by Dr. J. B. Porter.
- 107. Magnetometric Survey of Yukon Territory, by A. A. Arnsperg, C.E. Report No. 83, by Dr. J. B. Porter.
- 108. Index Map showing Iron Bearing Areas of Yukon, British Columbia, and Alberta, M.I.
- 109. Sections of Diamond Drill Core from O. Dejeu's Ashcroft Brook, by F. Landeman, M.I.
- 141. Tonbrock Iron Bearing District, Alberta, Province of N.S.W., by H. B. Greenacre, M.S.

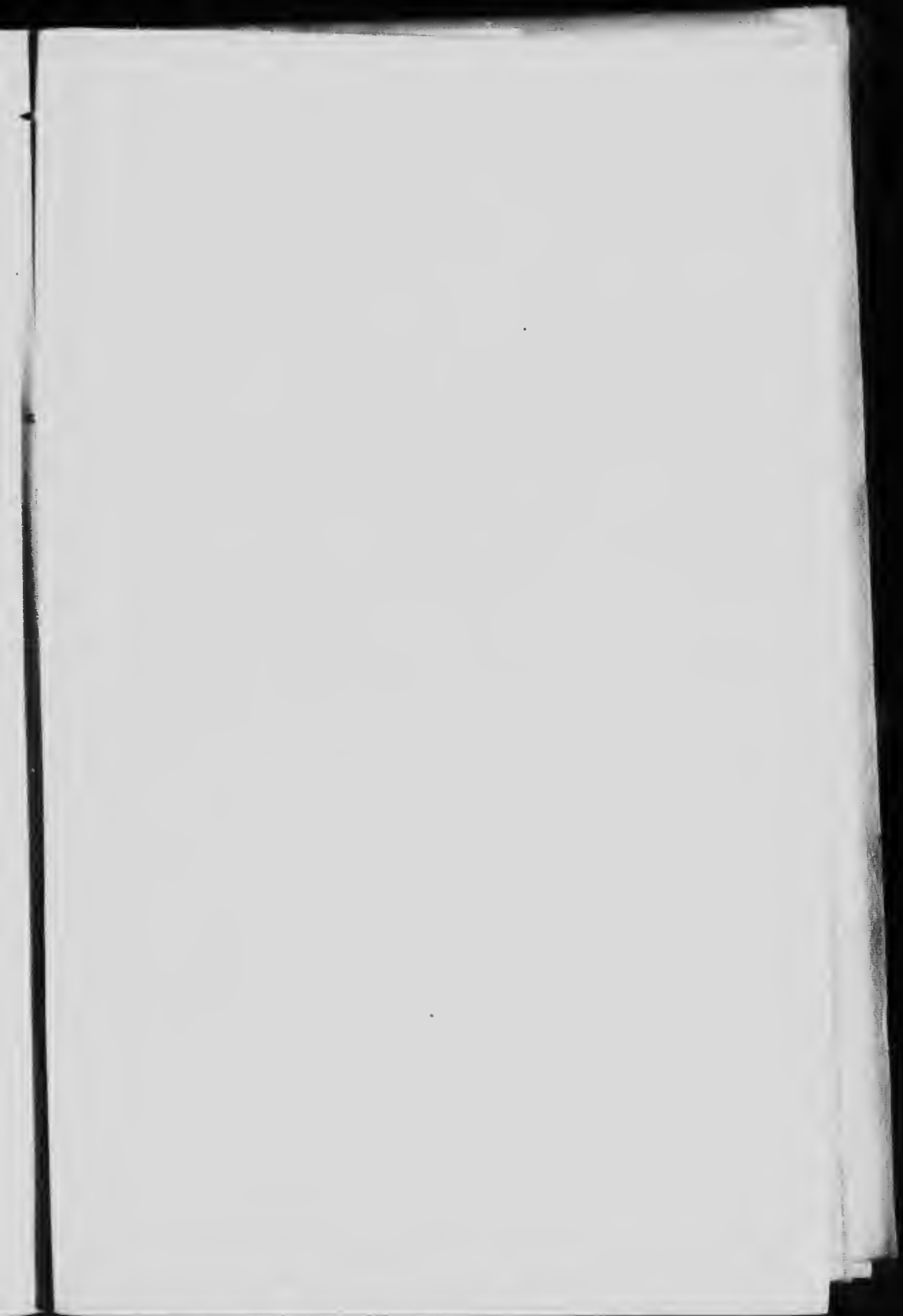
IN THE PRESS

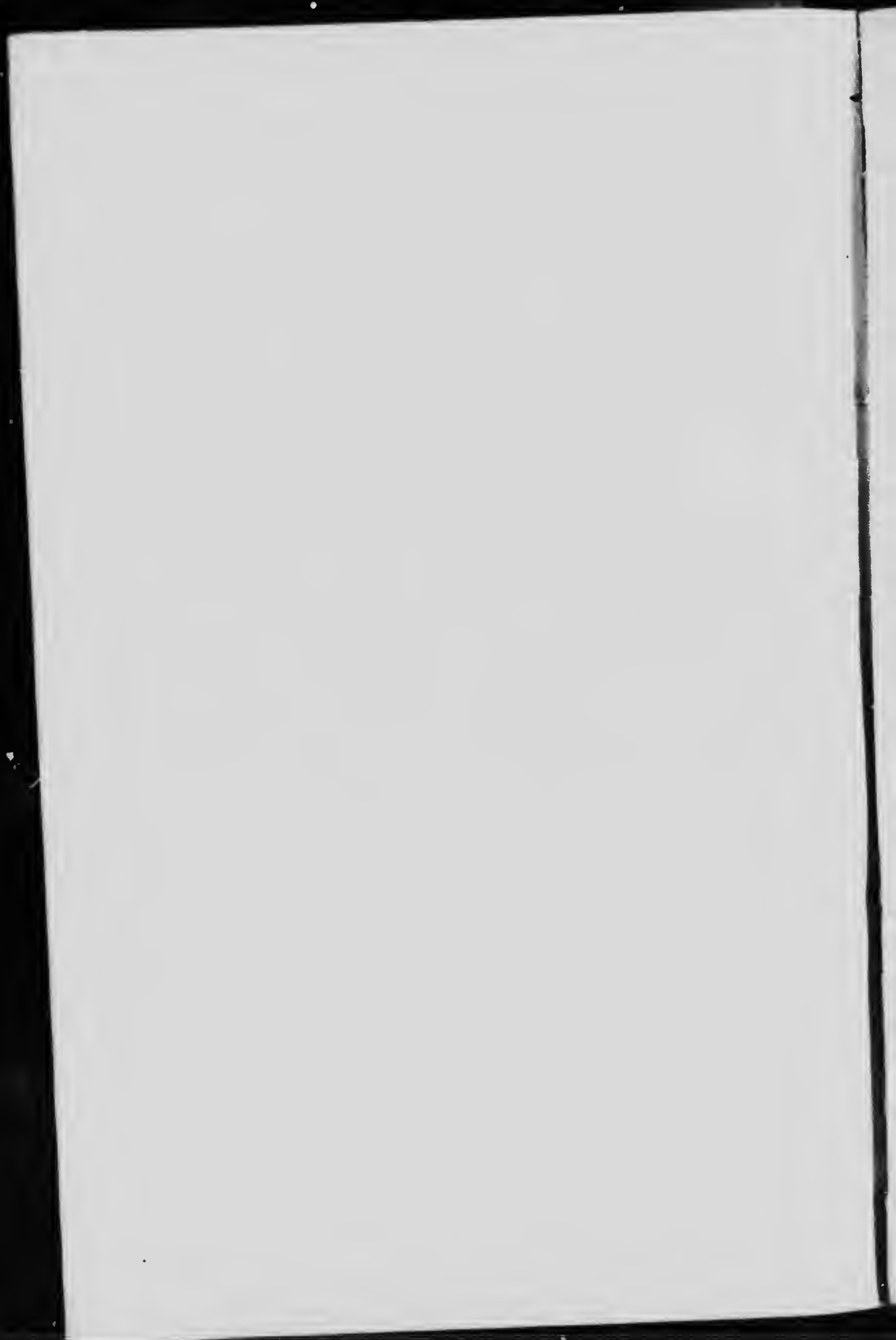
- 112. Sketch plan showing Geology of Port Armanville, Ontario, by Professor A. C. Lane.
- 119-137. Mines, Townships, and Quarries of Quebec, by Hugh S. de Schmal, M.L.
- 138. Mine, Showing Location of Principal Mines and Quarries in the Quebec Mine Area, by Hugh S. de Schmal.
- 139. Mine, Showing Location of Principal Mines and Quarries in the Ontario Mine Area, by Hugh S. de Schmal.
- 140. Mine, Showing Distribution of Principal Mines and Quarries in the Dominion of Canada, by Hugh S. de Schmal.

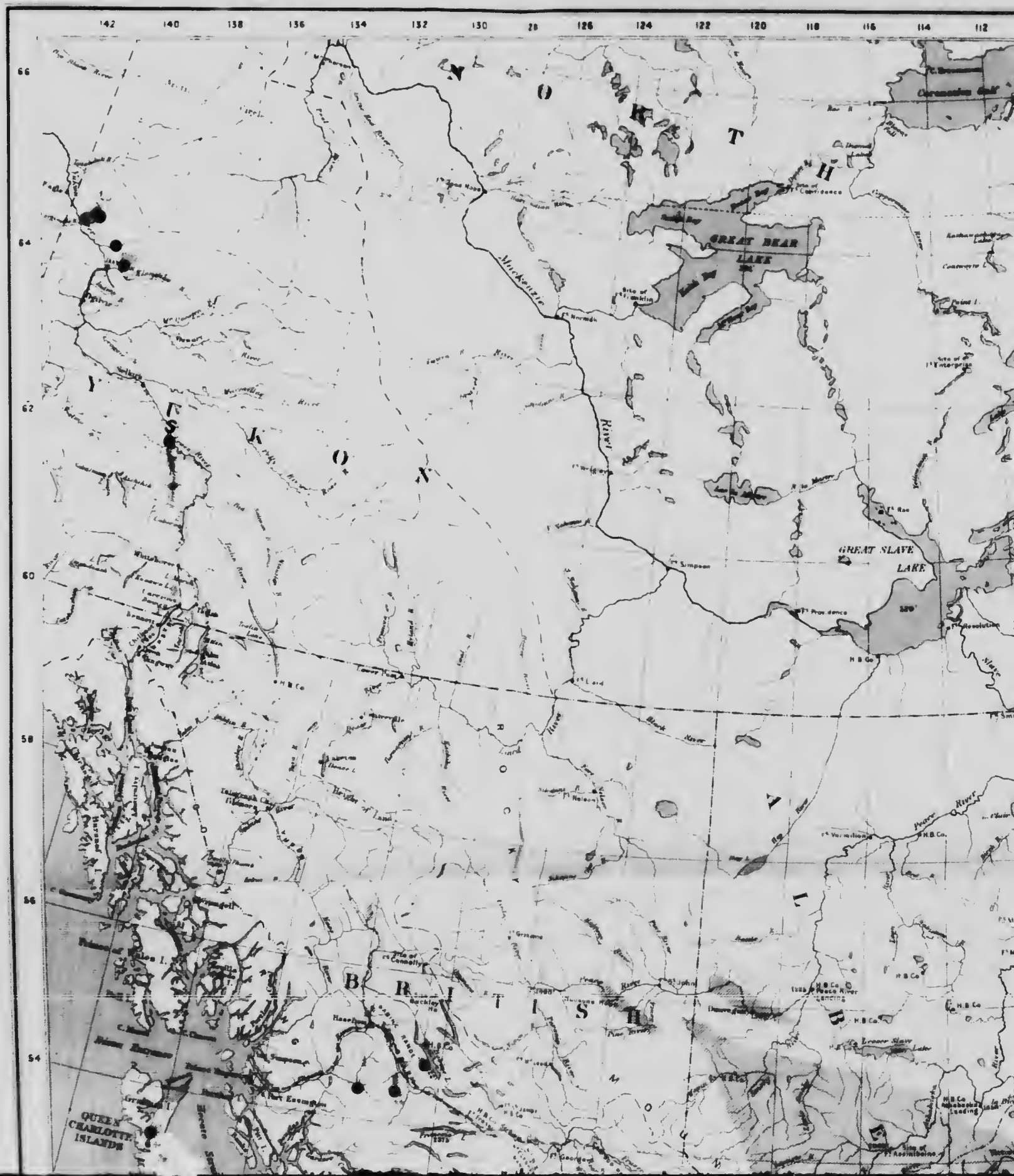
IN PREPARATION

- 143. Holland Peat Bog, Ontario, by A. A. Arnsperg, C.E.
- 146. Distribution of Iron Ore Samples in the District of the North Shore of the River and Gulf of St. Lawrence, by Geo. C. Mackenzie, B.S.
- 152. Map showing the location of peat bog investigated for Ontario, by A. A. Arnsperg, C.E.
- 153. Map showing the location of peat bog investigated for Manitoba, by A. A. Arnsperg, C.E.









CANADA
DEPARTMENT OF MINES
MINES BRANCH

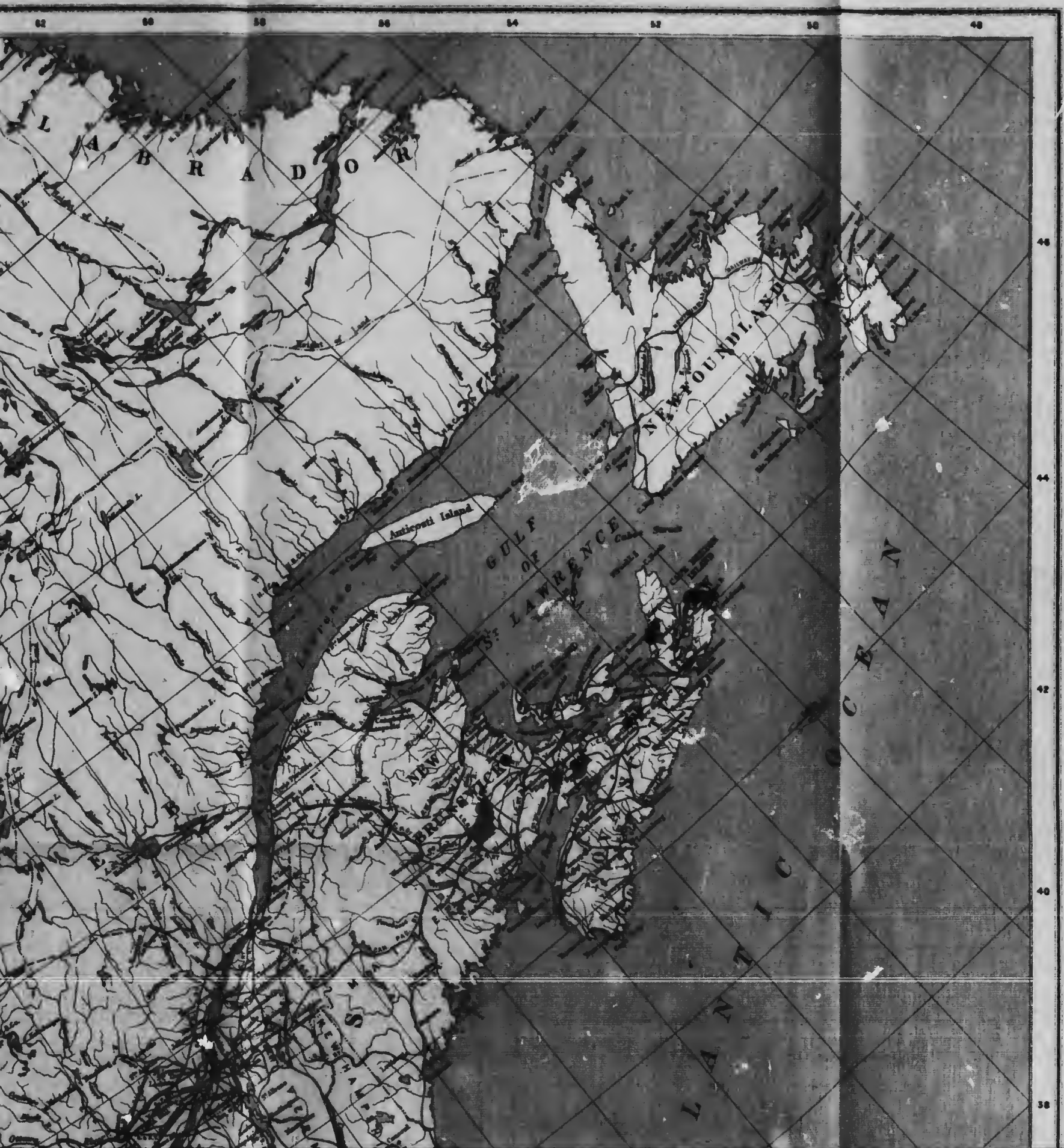
HON W
MINISTER OF MINES
GENE MARILL
191



CANADA
DEPARTMENT OF MINES
MINES BRANCH

HON W TEMPLEMAN MINISTER; A P LOW LL D, DEPUTY MINISTER,
EUGENE HAANEL PH D DIRECTOR
1911







58

56

54

52

50

48

130

128

126

124

122

120

118

116

114

QUEEN
CHARLOTTE
ISLANDS

BRITISH

COLUMBIA

WASHINGTON

MARCOY I.
GRAND I.
JANNEY I.
Cape Mudge

South
C. Fork
C. Fork

Albermarle
W. Fork
C. Fork

Can.
Kootenai
S.

Upper
Arrow
Lower
Arrow
S.

Upper
Arrow
Lower
Arrow
S.

Upper
Arrow
Lower
Arrow
S.

H.B. Co.
H.B. Co.
H.B. Co.

H.B. Co.
H.B. Co.

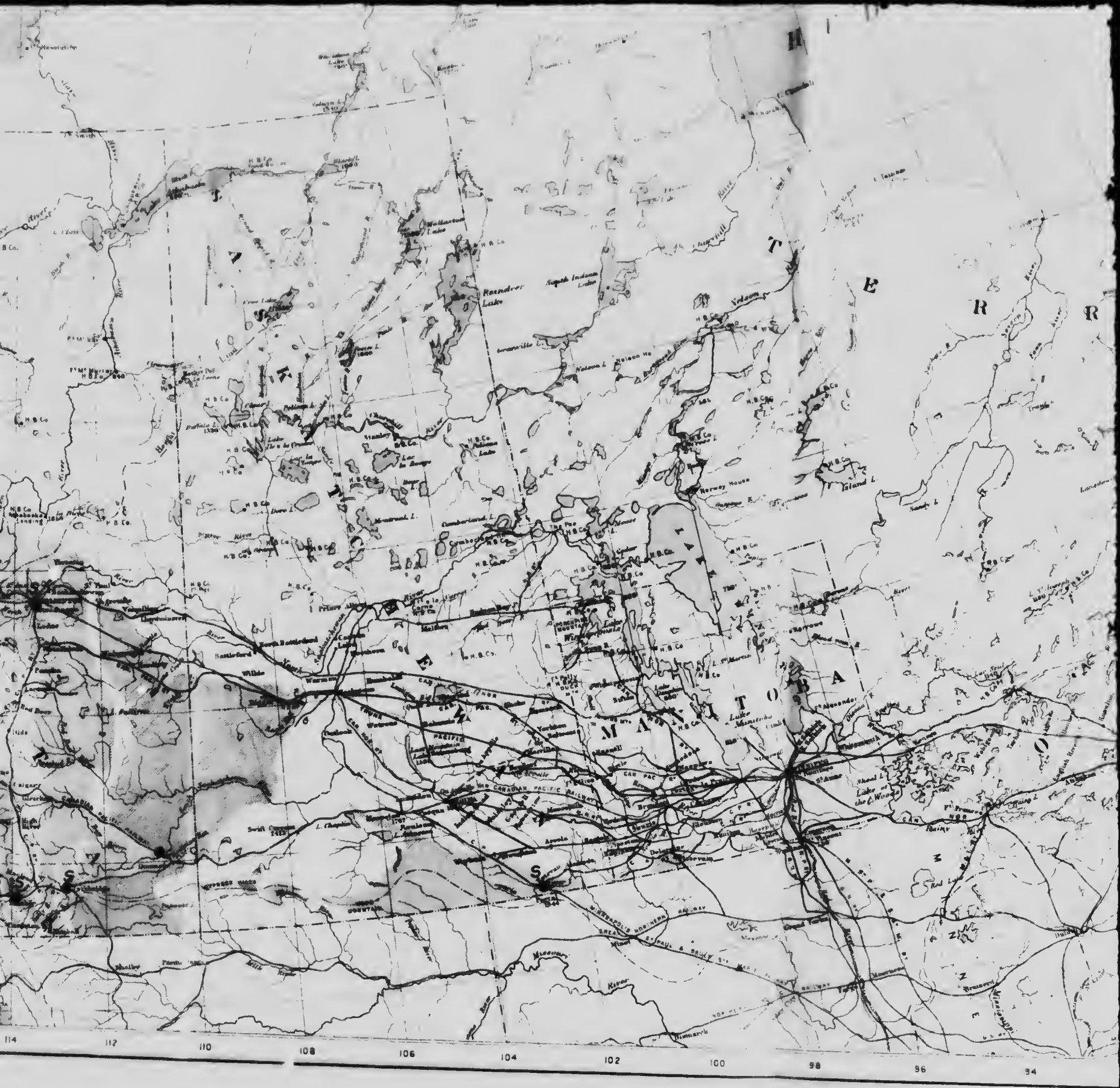
H.B. Co.
H.B. Co.

H.B. Co.
H.B. Co.




H.B. Co.
H.B. Co.

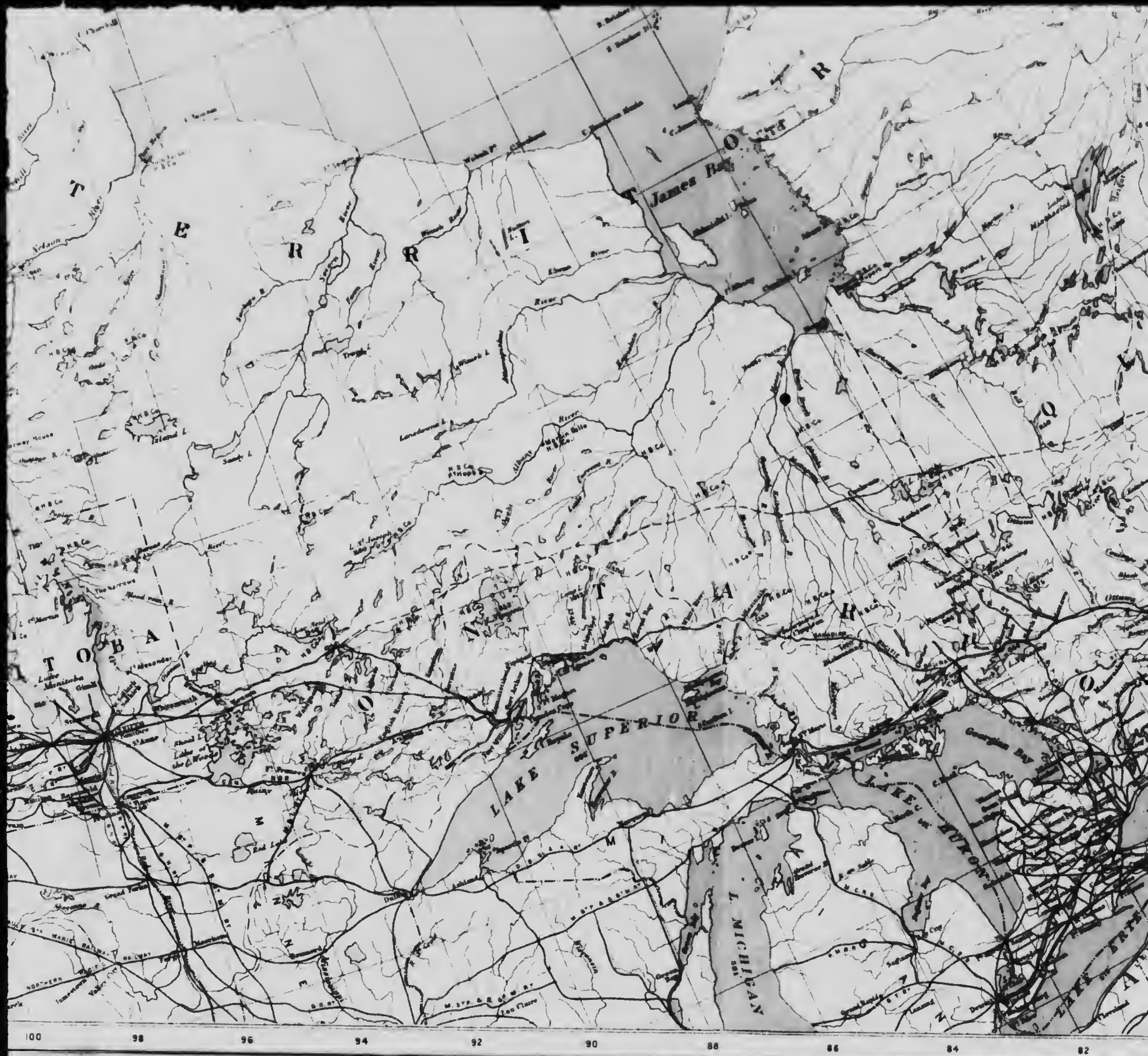
H.B. Co.
H.B. Co.

H.B. Co.
H.B. Co.






Legend

-  Coal bearing formations
-  Coal Fields commercially developed or simple
-  Coal Fields not yet developed



Legend

-  Coal bearing formations
-  Coal Fields commercially developed and sampled
-  Coal Fields not as yet developed







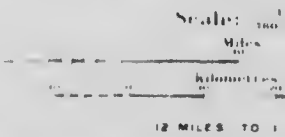


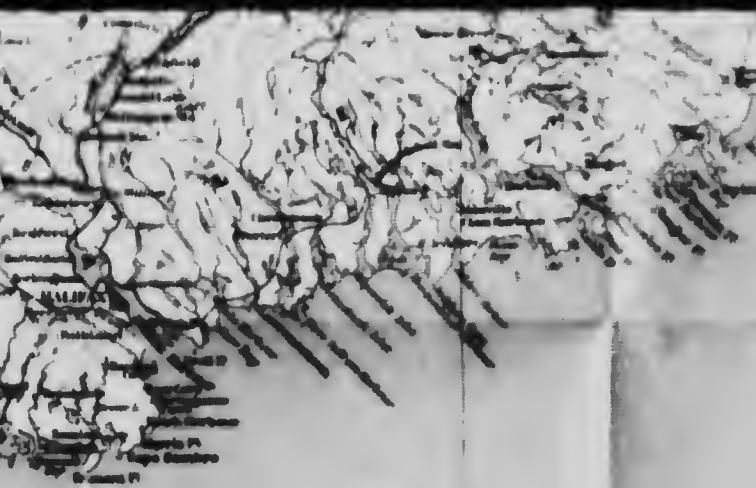




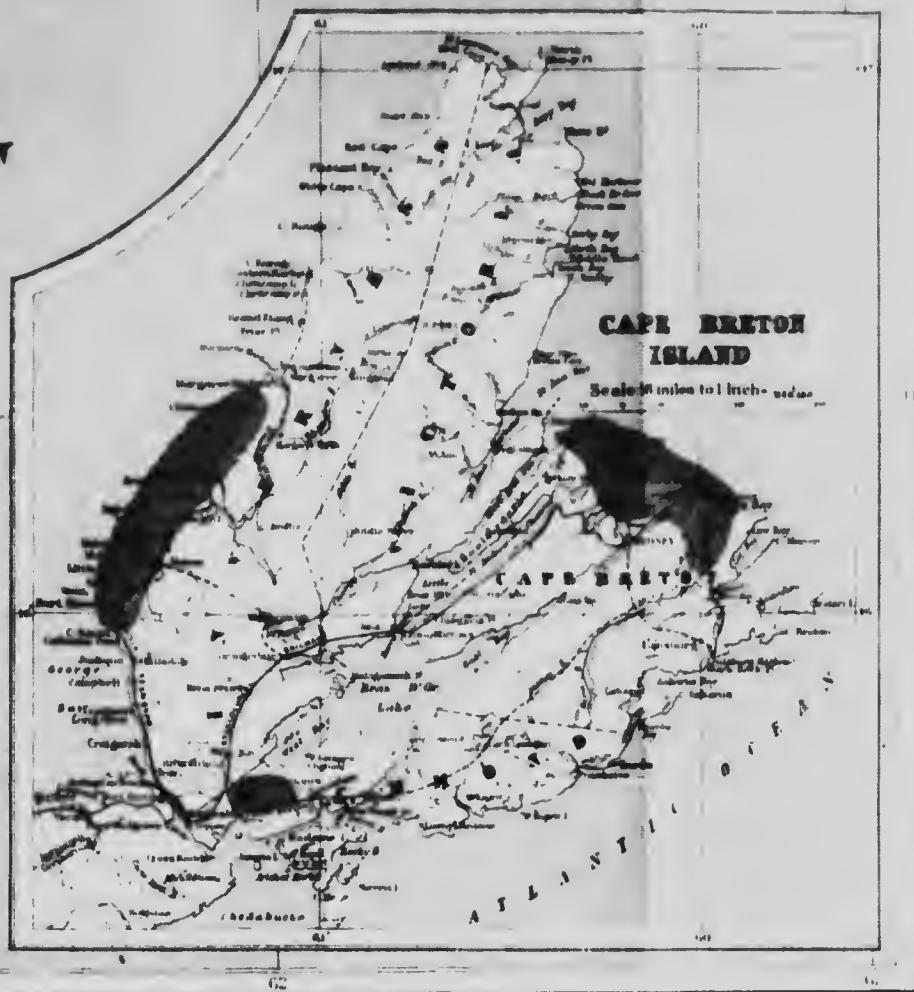
Geol. Map of Nova Scotia and New Brunswick, 1900.

**COAL FIELDS
OF
NOVA SCOTIA AND NEW BRUNSWICK**





O C E A N



Longitude West of Greenwich

63

62

61

MAP OF THE FIELDS OF NEW BRUNSWICK

Scale: 1/2 inch = 1 mile
Miles
Kilometres
1/2 INCH = 1 MILE

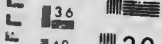
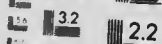
Published by the McGraw-Hill Co., Toronto, Canada, 1908

1/2 inch = 1 mile



MICROCOPY RESOLUTION TEST CHART

(ANSI and ISO TEST CHART No. 2)



APPLIED IMAGE Inc

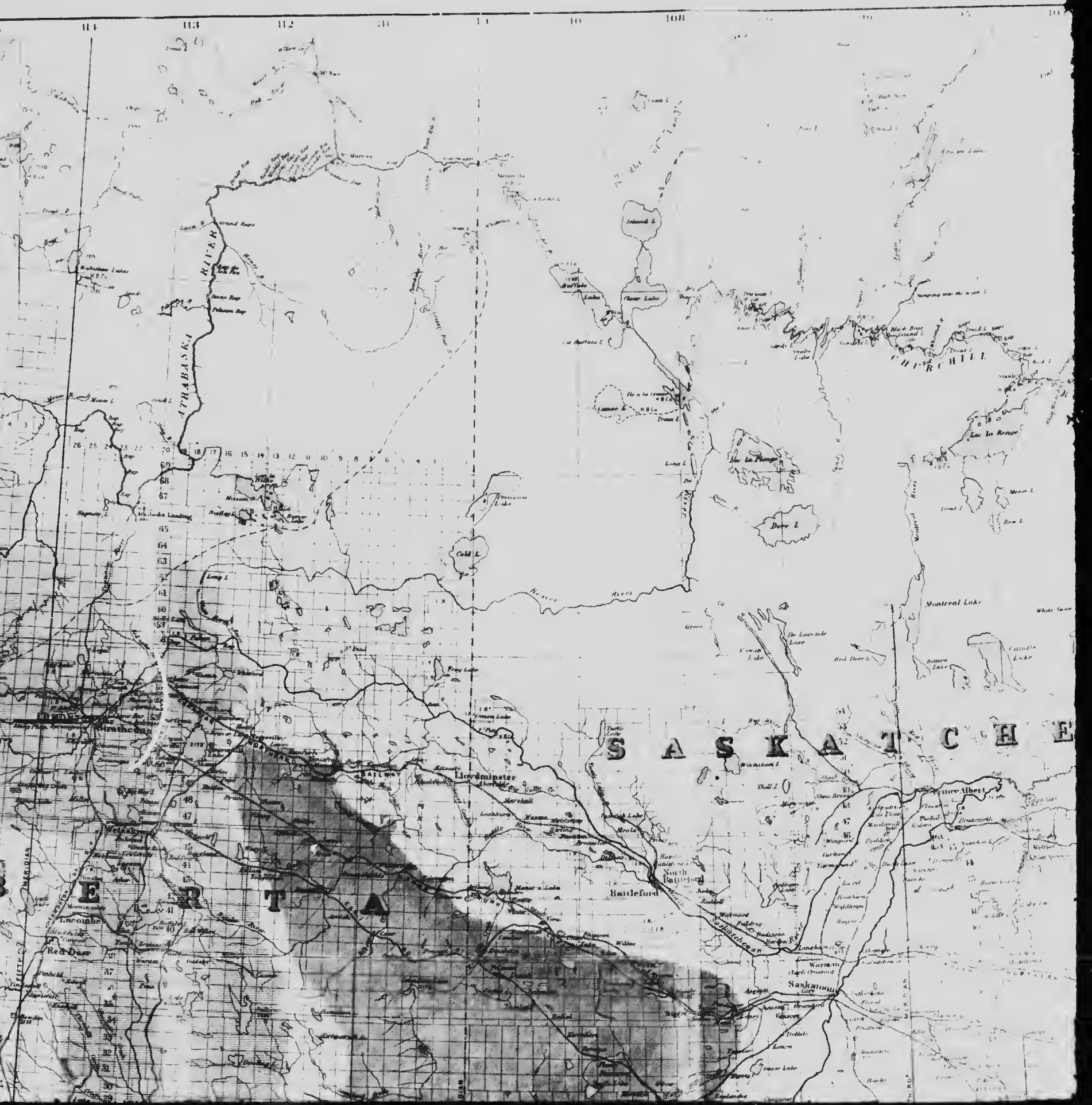
1653 East Main Street
Rochester, New York 14609 USA
(716) 482-0300 - Phone
(716) 288-5989 - Fax





DEPARTMENT
MINES

MINERAL RESOURCES
OF CANADA

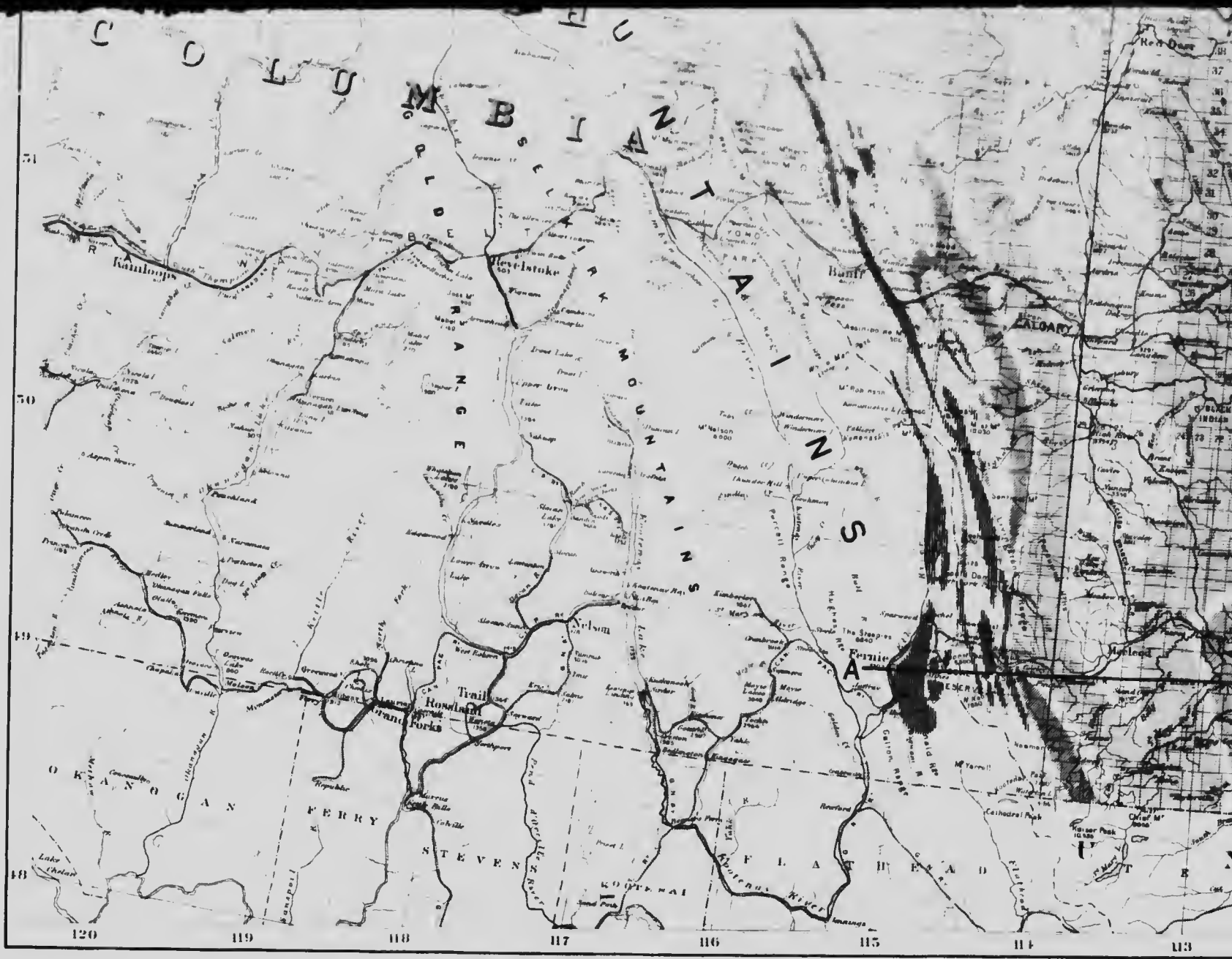


CANADA
DEPARTMENT OF MINES
MINES BRANCH

HON W TEMPLEMAN, MINISTER; A P LOW, LL D, DEPUTY MINISTER
EUGENE MACDONALD, PH D, DIRECTOR




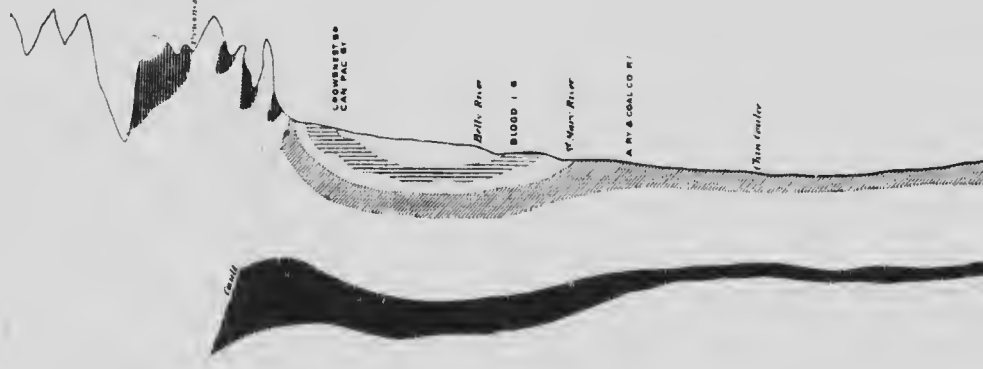


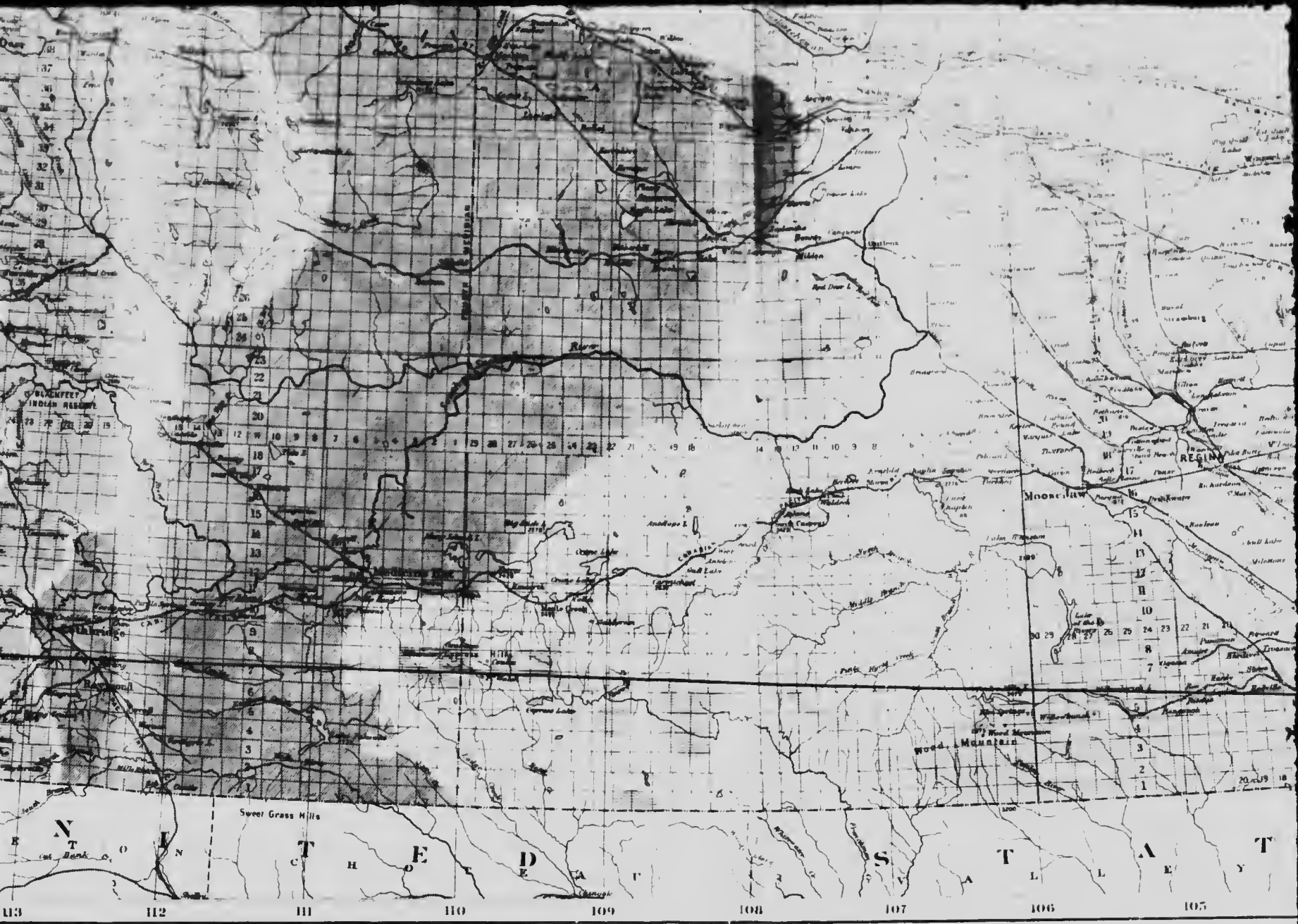


Base map from plates of the map of the Dominion of Canada published under authority of the Department of the Interior

ROCKY MOUNTAINS

- Legend
-  Lacustrine
 -  Belly River Coal Formation
 -  Kootenai Coal Formation



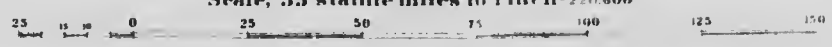


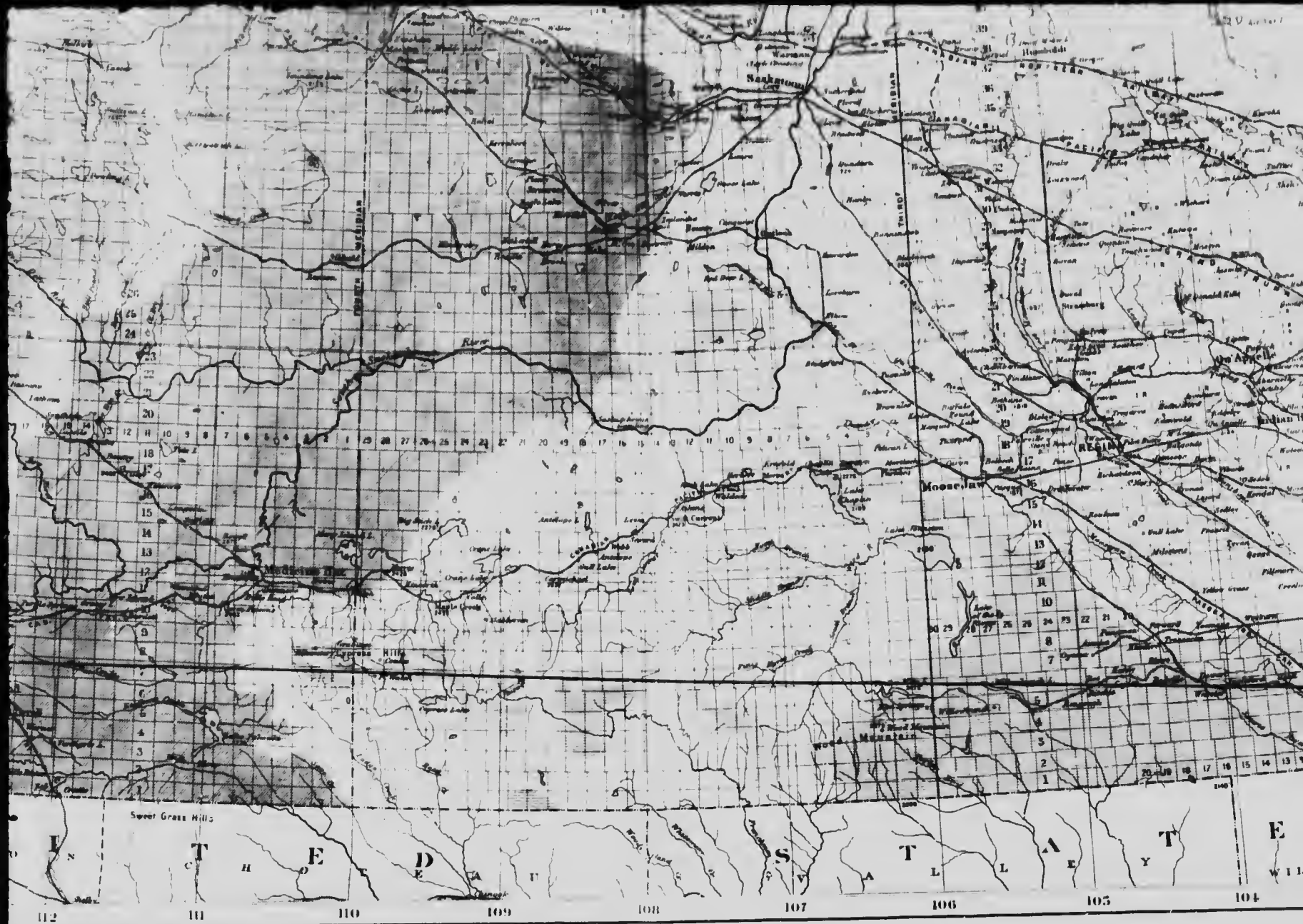
Diagrammatic section along line A B

COAL FIELDS in ALBERTA, SASKATCHEWAN & MANITOBA

by
D. B. DOWLING, B.A. Sc.
1911

Scale, 35 statute miles to 1 inch - 2 207 600





Cypress Hills

Diagrammatic section along line A B

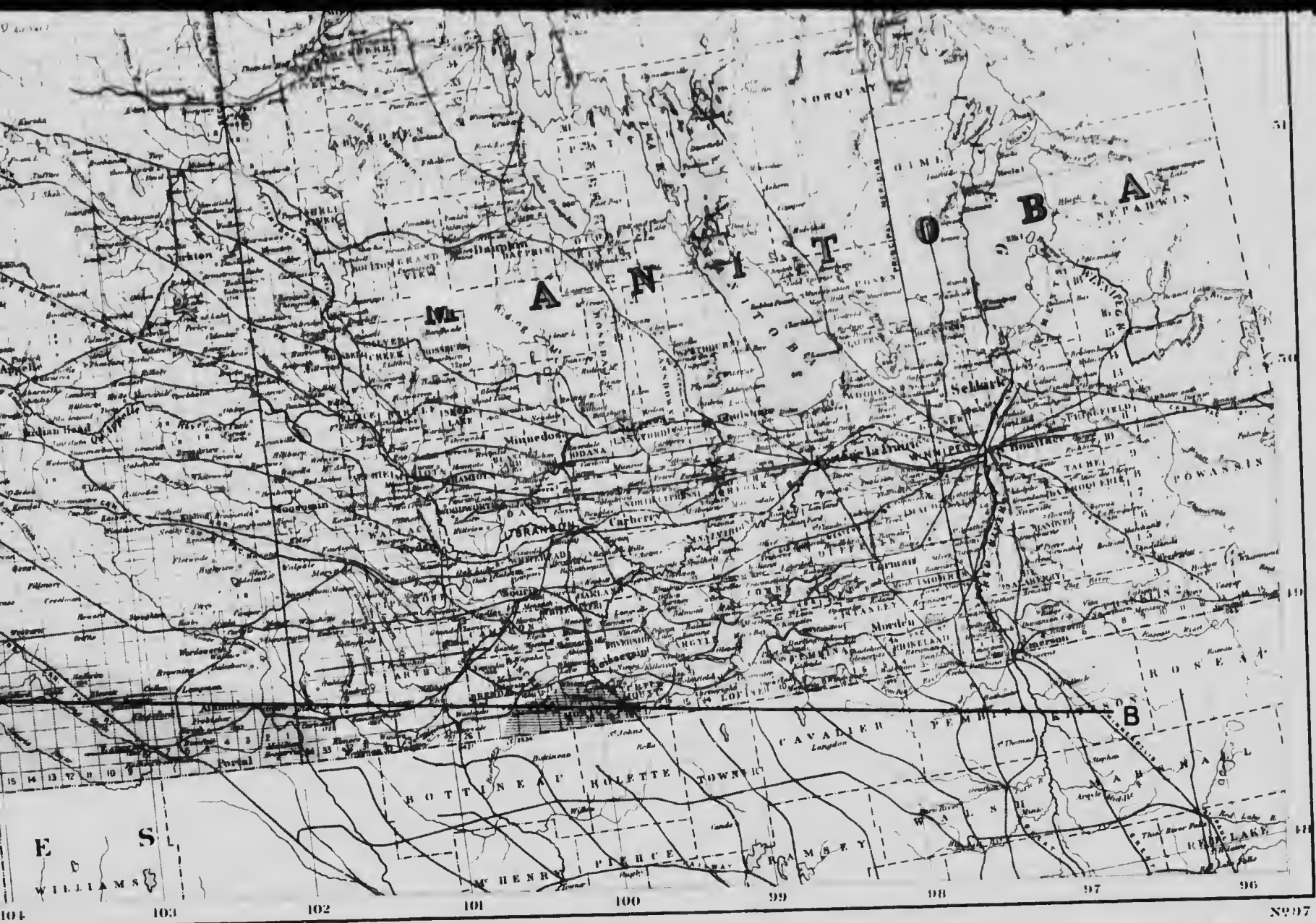
COAL FIELDS in ALBERTA, SASKATCHEWAN AND MANITOBA

by
D. B. DOWLING, B. A. Sc.

1911

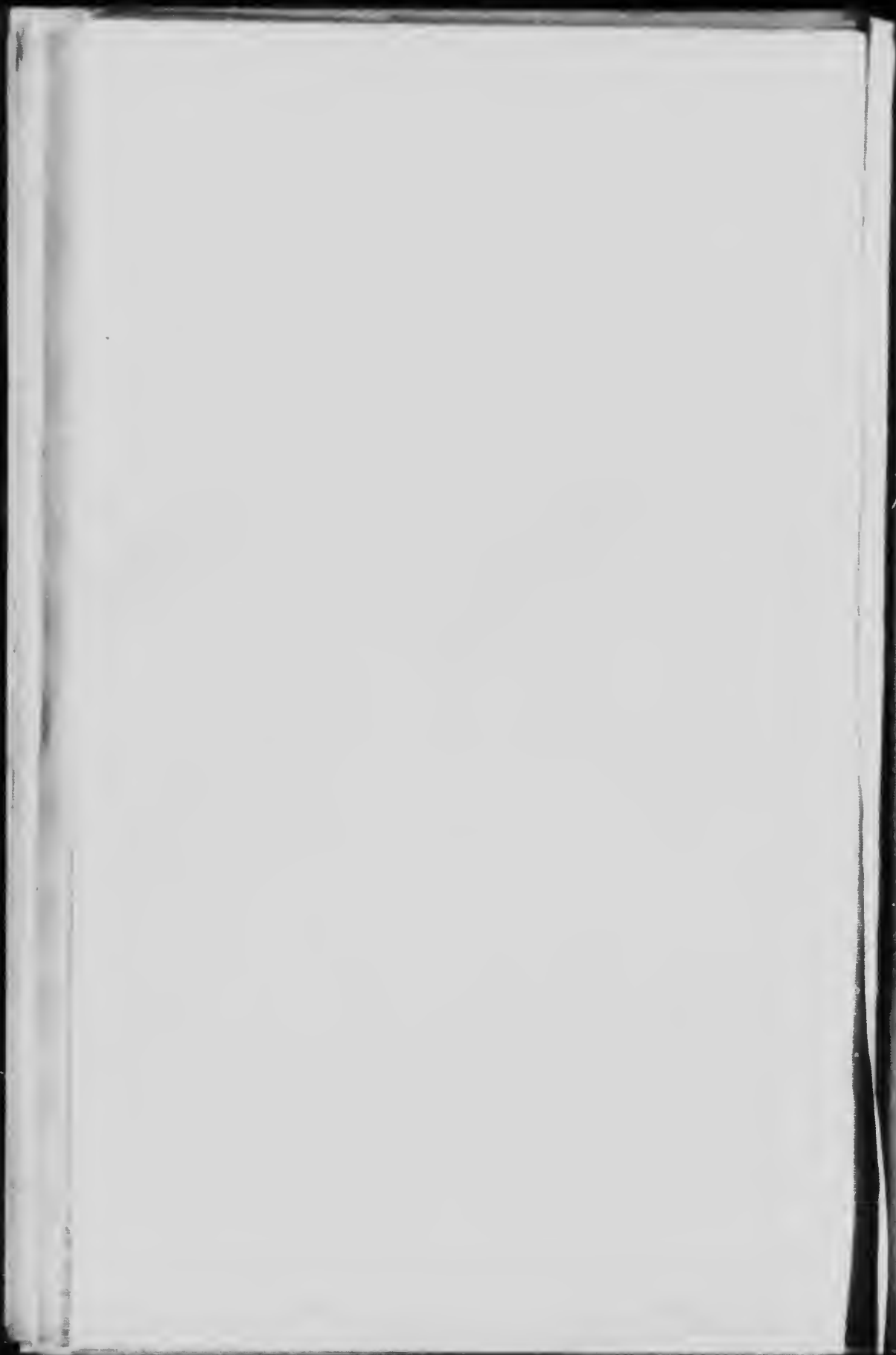
Scale, 35 statute miles to 1 inch - 227,500





To accompany the McGill University Report on "The Coals of Canada," No. 83, 1911









ANADA
DEPARTMENT OF MINES
MINES BRANCH

HENRY T. ...
EUGENE ...



CANADA
DEPARTMENT OF MINES
MINES BRANCH

HENRY W. TEMPLEMAN, MEMBER A.P.L.O.W. LL.D. DEPT. OF MINES
EUGENE MARTEL, PH.D. DIRECTOR







Base Van Bemmelen in Canada Dept of Interior

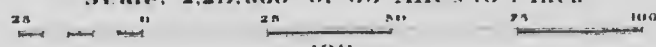


Coal Fields



**GENERAL MAP OF COAL FIELDS
IN
BRITISH COLUMBIA**

Scale, 2,212,000 or 35 Miles to 1 Inch



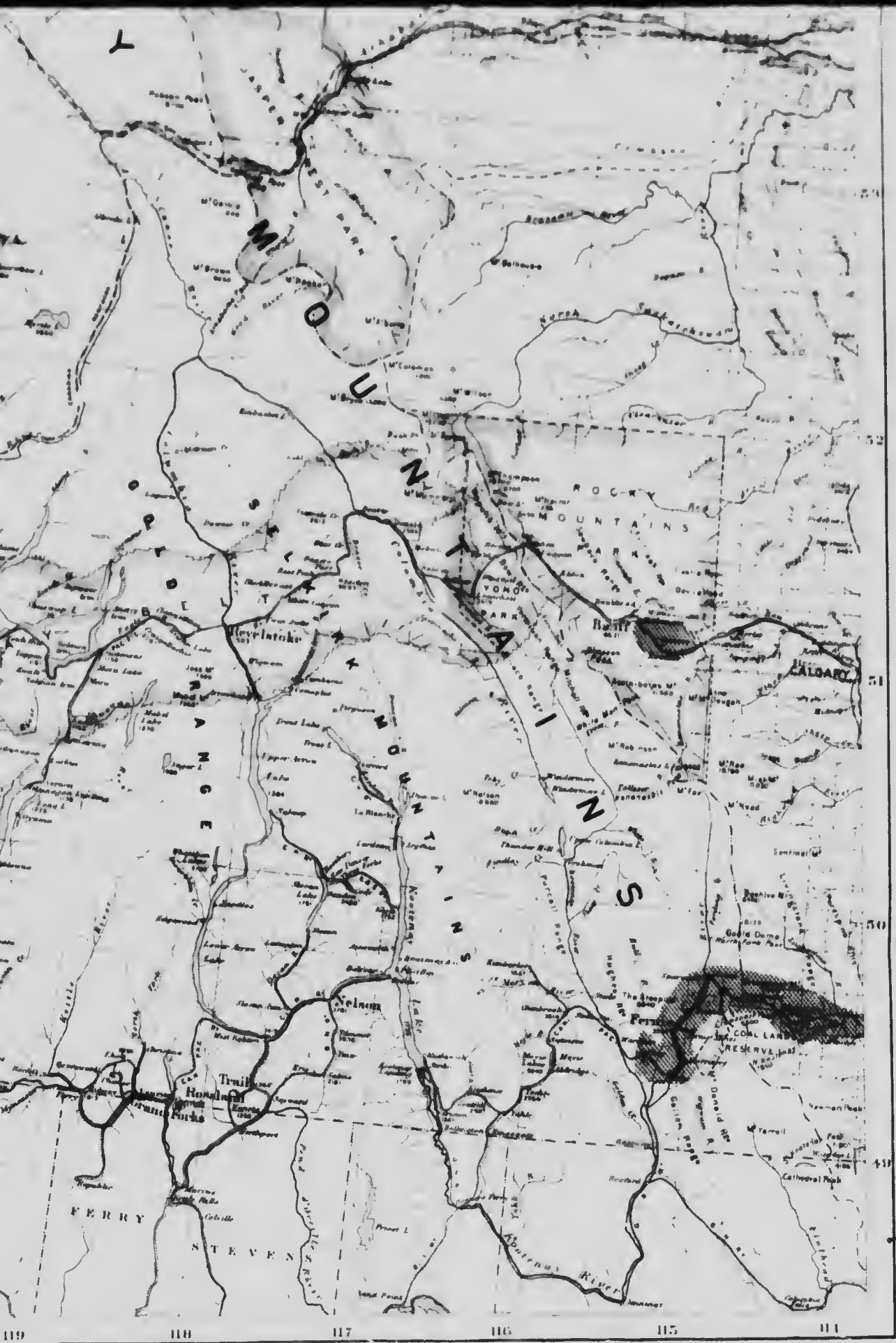
1911



**GENERAL MAP OF COAL FIELDS
IN
BRITISH COLUMBIA**

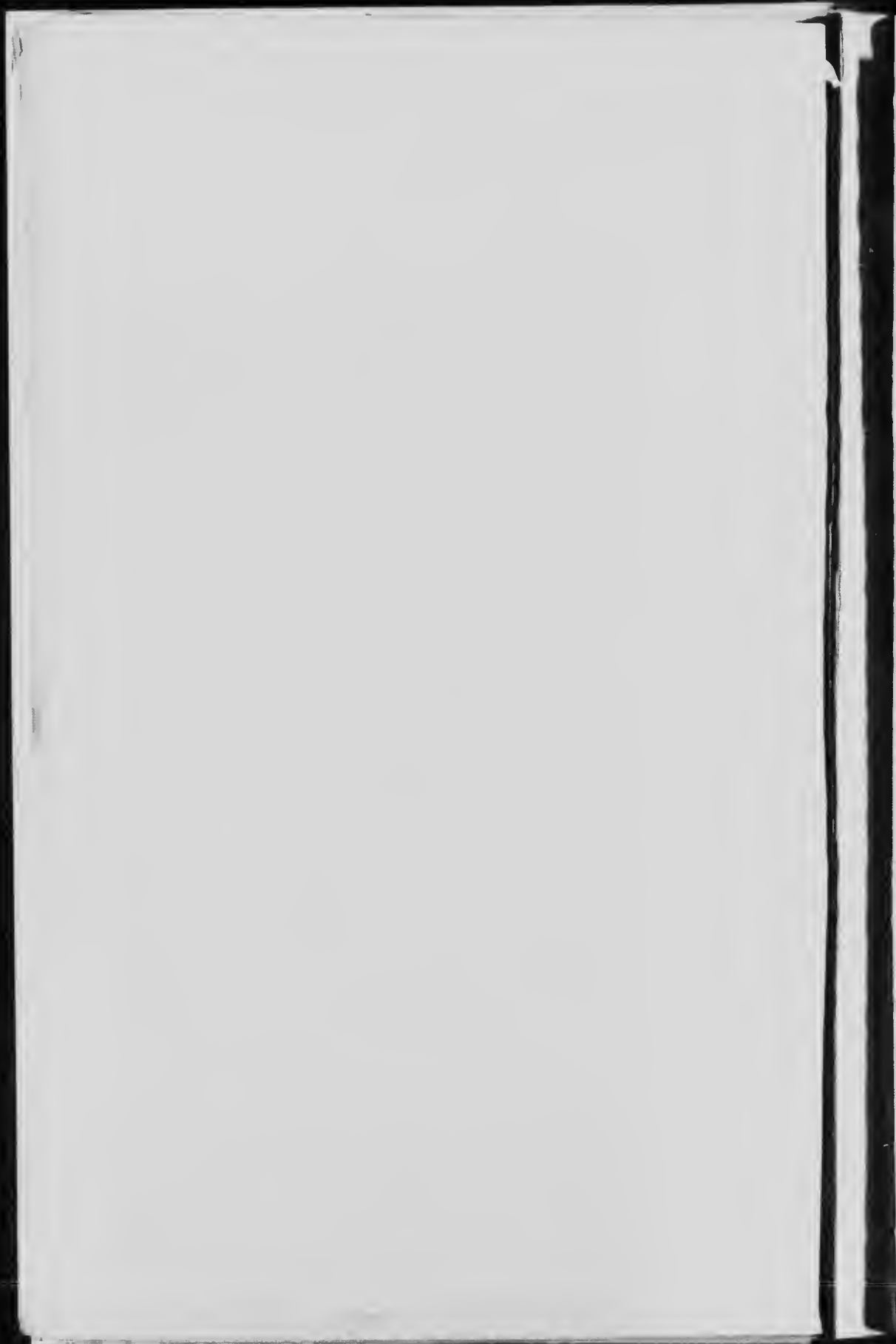
Scale, 2,212,000 or 35 Miles to 1 Inch





No 93

To accompany the McGill University Report
on "The Coals of Canada," No 83 1911





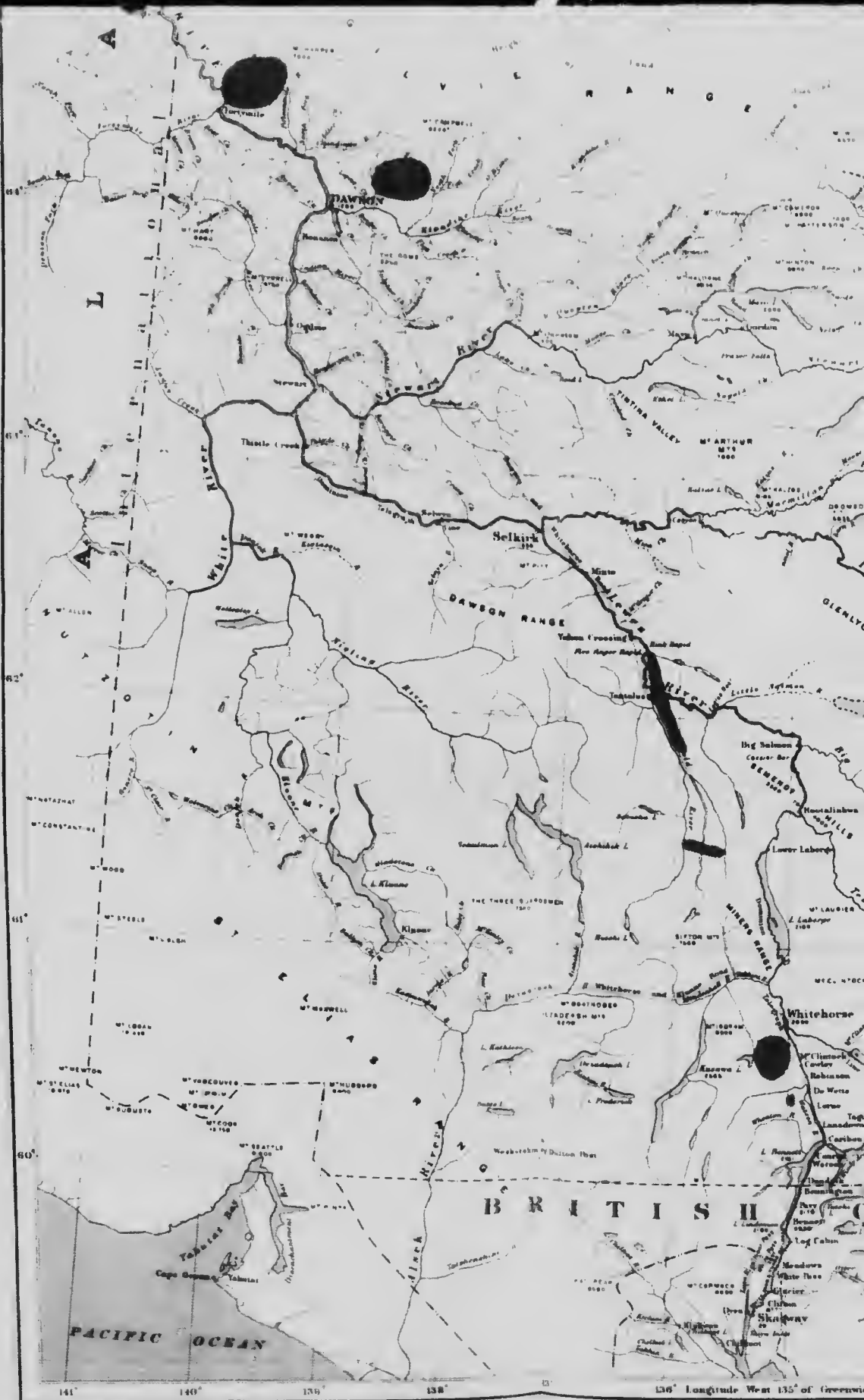


CANADA
 DEPARTMENT OF MINES
 MINES BRANCH
 MINISTER, A. P. LOW LL.D. DEPUTY MINISTER
 W. E. HAANEL Ph.D. DIRECTOR
 1911



Approximate position of Great Bear Coal field

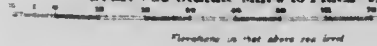




Base Map: General Survey

COAL FIELD in YUKON TERRITORY

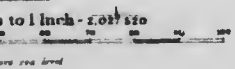
Scale: 32 Statute Miles to 1 Inch - 8



Elevations in feet above sea level

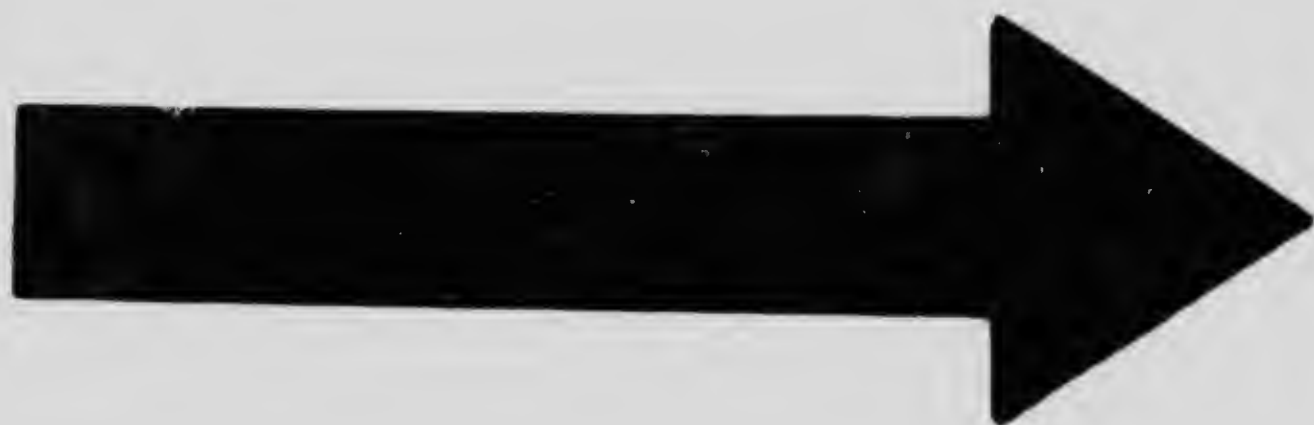


YUKON TERRITORY



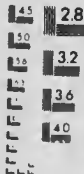
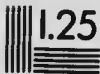
to accompany the McGill University Report
on the Geology of Canada, No. 85
N. 20

Coal Field



MICROCOPY RESOLUTION TEST CHART

(ANSI and ISO TEST CHART No. 2)



APPLIED IMAGE Inc

1653 East Main Street
Rochester, New York 14609 USA
(716) 482 - 0300 - Phone
(716) 288 - 5989 - Fax

FICHE 9 NOT REQUIRED

