

Technical and Bibliographic Notes / Notes techniques et bibliographiques

The Institute has attempted to obtain the best original copy available for filming. Features of this copy which may be bibliographically unique, which may alter any of the images in the reproduction, or which may significantly change the usual method of filming, are checked below.

L'Institut a microfilmé le meilleur exemplaire qu'il lui a été possible de se procurer. Les détails de cet exemplaire qui sont peut-être uniques du point de vue bibliographique, qui peuvent modifier une image reproduite, ou qui peuvent exiger une modification dans la méthode normale de filmage sont indiqués ci-dessous.

Coloured covers/
Couverture de couleur

Coloured pages/
Pages de couleur

Covers damaged/
Couverture endommagée

Pages damaged/
Pages endommagées

Covers restored and/or laminated/
Couverture restaurée et/ou pelliculée

Pages restored and/or laminated/
Pages restaurées et/ou pelliculées

Cover title missing/
Le titre de couverture manque

Pages discoloured, stained or foxed/
Pages décolorées, tachetées ou piquées

Coloured maps/
Cartes géographiques en couleur

Pages detached/
Pages détachées

Coloured ink (i.e. other than blue or black)/
Encre de couleur (i.e. autre que bleue ou noire)

Showthrough/
Transparence

Coloured plates and/or illustrations/
Planches et/ou illustrations en couleur

Quality of print varies/
Qualité inégale de l'impression

Bound with other material/
Relié avec d'autres documents

Continuous pagination/
Pagination continue

Tight binding may cause shadows or distortion along interior margin/
La reliure serrée peut causer de l'ombre ou de la distorsion le long de la marge intérieure

Includes index(es)/
Comprend un (des) index

Title on header taken from:/
Le titre de l'en-tête provient:

Blank leaves added during restoration may appear within the text. Whenever possible, these have been omitted from filming/
Il se peut que certaines pages blanches ajoutées lors d'une restauration apparaissent dans le texte, mais, lorsque cela était possible, ces pages n'ont pas été filmées.

Title page of issue/
Page de titre de la livraison

Caption of issue/
Titre de départ de la livraison

Masthead/
Générique (périodiques) de la livraison

Additional comments:/
Commentaires supplémentaires:

This item is filmed at the reduction ratio checked below/
Ce document est filmé au taux de réduction indiqué ci-dessous.

10X	12X	14X	16X	18X	20X	22X	24X	26X	28X	30X	32X
								/			

The Canadian Patent Office

RECORD



Vol. IV.—No. 7.

JULY, 1876.

Price in Canada \$2.00 per An
United States - \$2.50

CONTENTS.

INVENTIONS PATENTED.....	97
INDEX OF INVENTIONS.....	CVII
INDEX OF PATENTEES.....	CVIII
ILLUSTRATIONS.....	107

INVENTIONS PATENTED.

No. 6088. Improvements in the Legs of Stools, Tables, &c.

(Perfectionnements dans les pieds de bancs, tables, etc.)

Cornelius E. Haynes, Boston, Mass., U. S., 17th May, 1876, for 5 years.

Claim.—The semi-detachable leg C, consisting of the piece D, firmly secured to the seat in any suitable manner, and folding piece Cr, the said pieces D, and Cr, being connected together by the fixed or sliding ferrule E, with slot E, and staple F, or their equivalent.

No. 6089. Process for Separating Woollen from Cotton Fibre.

(Procédé pour séparer la laine du coton.)

Louis R. Broadbent and Charles F. Broadbent, Baltimore, Md., U. S., 17th May, 1876, for 5 years.

Claim.—1st. Steeping the fabric in cold water, then boiling it in hydrochloric acid solution of a specific gravity of from 1.015 to 1.19 for from three to twenty-five minutes and withdrawing it; 2nd. The treatment of the woollen fibre, after being withdrawn from the acid bath, in a bath containing cold water, Marseilles soap and ammonia, and subsequently washing in pure water.

No. 6090. Improvements on Plaiting Machines. (Perfectionnements aux machines à plisser.)

Samuel J. Anderson, Cazenovia, N. Y., U. S., 17th May, 1876, for 5 years.

Claim.—1st. The rack or frame d, in combination with the board h, and a blade for forcing the cloth through between the strips g; 2nd. The method of forming plaits by forcing the cloth through spaces and then ironing the plaits down; 3rd. In combination with a rack d, the knife i.

No. 6091. Hair Restorer. (Restaurateur de chevelure.)

James McCormack, Waverley, Iowa, U. S., 23rd May, 1876, for 5 years.

Claim.—The combination of aqua ammonia, sage and burdock mixed.

No. 6092. Binding Rods for Bridge Beams. (Barres d'assemblage des poutres de ponts.)

Peter Bélyen, Sr., Prariton, Ill., U. S., 23rd May, 1876, for 5 years.

Claim.—The binding-rod C, with its securing bolts c, the cap A, and the joist B, with their notches b.

No. 6093. Clothes Ironing Board, (Planche à repasser le linge.)

Adolphe Gibeau, Montreal, Que., 23rd May, 1876, for 5 years.

Résumé.—1o. La combinaison de la rainure B, et la languette D, avec la planche A, et l'élastique C, pour retenir et repasser le devant de la chemise; 2o. La combinaison des montants E, avec entailles F, pour ajuster sur le dos G, de la chaise; 3o. La combinaison de la patte H, attachée avec boutons I, le support L, lié avec couplets M, et la planchette O, avec dents à degrés N, pour supporter le bout de la planche A, se pliant par eux-mêmes ensemble; 4o. La combinaison des goussets P, recevant le bout de la table et des goussets J, s'appuyant sur le siège K, de la chaise, ainsi que la boîte Q, à l'extrémité de la planche A, qui repose sur le bout de la table.

Claim.—1st. The combination of the groove B, and the tongue D, with the board A, and the elastic C, to hold and iron the front of the shirt; 2o. The combination of the uprights E, with the notches F, to adjust upon the back G, of the chair; 3rd. The combination of the crump H, fastened with bolts I,

the support L, connected with the hinges M, and the board O, with graduated teeth N, to support the end of the board A, folding automatically; 4th. The combination of the stays P, receiving the end of the table and of the stays J, supported upon the seat K, of the chair, as well as the box Q, at the extremity of the board A, which rests upon the end of the table.

No. 6094. Improvements on Slide Valves and Pistons. (Perfectionnements aux tiroirs et pistons à vapeur.)

William G. Beattie, London, Eng., 23rd May, 1876, for 5 years.

Claim.—1st. Forming pistons and piston valves and D-valves of two or more sections, or parts with pistons packing rings d, between the said rings d, being held tight in place by means of an internal valve or piston rod e, outer sleeve f, with collars or shoulders g, and nut or nuts; 2nd. Forming pistons in two parts or sections with piston rings d, between the said rings d, being held tight by means of a nut c.

No. 6095. Improvements on Axle Boxes. (Perfectionnements aux boîtes d'essieux.)

William G. Beattie, London, Eng., 23rd May, 1876, for 5 years.

Claim.—1st. The cylinder a, piston b, rod c, with knob d, and aperture e, e, and f, f; 2nd. The valve for supplying axle box with oil consisting of plug g, casing h, and spring the passage through the plug at l, and handle m; 3rd. The combination of diaphragm n, carriers o, o, wicks p, p, spiral springs and perforations r, r, in an axle box; 4th. The employment of shields for preventing the entry of dust to, or the escape of oil, from axle boxes.

No. 6096. Improvements on Ejector Condensers. (Perfectionnements aux condensateurs éjecteurs.)

James F. Guthrie, Sumerville, Mass., U. S., 23rd May, 1876, for 5 years.

Claim.—1st. The adjustable nozzle D, in combination with the combining nozzle F, and the induction tube G; 2nd. The stuffing box E, attached to the central adjustable nozzle D; 3rd. A hand hole H, through which the adjustable nozzle D, is regulated.

No. 6097. Improvements on Steam Boilers. (Perfectionnements aux chaudières à vapeur.)

Henry F. King, Corry, Pa., U. S., 23rd May, 1876, for 5 years.

Claim.—1st. The upright water back A, having a series of vertical stay plates g, forming the water passage d, in combination with the blind tubes B; 2nd. A wrought iron boiler, an upright water back A, having a series of stay-bolts passing through it, in combination with the plates g, and blind-tubes B.

No. 6098. Puddling Furnace. (Fourneau à réverbère.)

Ananias Smith, Clifton, Ont., 23rd May, 1876, for 5 years.

Claim.—1st. The combination of a puddling or reverberatory furnace A, with one or more combustion chambers B, having passages B₁, leading thereto and adapted for the combustion of liquid fuel; 2nd. The combination of a puddling furnace A, one or more combustion chambers B, adjacent thereto, one or more pipes for supplying the liquid fuel, steam or vapour and a suitable tank N, and steam boiler K, for holding and forcing the same; 3rd. A puddling furnace A, in combination with combustion chambers B, arranged on one or more sides, and chimneys or take ups H, arranged on two or more corners of the same, with flue entrances at or near the base.

No. 6099. Plate-Lifter. (Porte-assiette.)

Daniel M. Skinner and Ezra Gould, Sandwich, N. H., U. S., 23rd May, 1876, for 5 years.

Claim.—The combination of the jaws A, A, and their shanks and hand-
parts a, a, with the intermediate shank-clasp and plate supporter B, all being composed of wire bent.

No. 6100. Safety Lock for Houses of Detention. (Serrure de sûreté pour les maisons de détention.)

Joseph A. Quesnel, Arthabaskaville, Que., 23rd May, 1876, for 5 years.

Résumé.—1o. La combinaison de la détente M, avec le pêne supérieur J, pour le retenir à l'intérieur de la serrure; 2o. La combinaison de la détente M, et du pêne supérieur J, ayant l'entaille a, de la gorge b, avec la clef du pêne supérieur J, pour la retenir engagée et dormante dans la serrure lorsqu'on ouvre la porte d'une cellule; 3o. La combinaison du pêne inférieur

D. avec le pêne supérieur J, pour fermer la porte à clef à l'intérieur; 4o. La combinaison du ressort I, rivé au dos du pêne inférieur D, s'engageant dans l'encoche d, de la tête du pêne supérieur J, avec le pêne supérieur J, pour le rendre dormant; 5o. La combinaison particulière de la détente M, du pêne supérieur J, et de la gâchette F, du levier K, et du ressort I, s'engageant dans l'encoche d, de la tête du pêne supérieur J, avec le pêne supérieur J, et celle du pêne inférieur D.

Claim.—1st. The combination of the detent M, with the upper bolt J, for retaining it inside of the lock; 2nd. The combination of the detent M, and of the upper bolt J, having the notch a, of the groove b, with the key of the upper bolt J, to keep it engaged and fixed in the lock when the door of a cell is opened; 3rd. The combination of the lower bolt D, with the upper bolt J, to lock the door inside; 4th. The combination of the spring I, rivetted on the back of the lower bolt D, engaging in the slot d, of the head of the upper bolt J, with the upper bolt J, to make it dormant; 5th. The peculiar combination of the detent M, of the upper bolt J, and of the follower F, of the lever K, and its spring L, of the lower bolt D, and of its follower F, of the spring I, engaging in the slot d, of the head of the upper bolt J, with the key of the upper bolt J, and that of the lower bolt D.

No. 6001. Electro-Harmonic Telegraph.

(*Telegraphic electro-harmonique.*)

Elisha Gray, Chicago, Ill., U. S., 23rd May, 1876, for 15 Years.

Claim.—1st. The art of telegraphically transmitting composite tones which consists in working a closed circuit with a continuous current from a main battery, portions of the whole of which current are thrown into vibration at will by the transmitters; 2nd. The art of telegraphically transmitting and analyzing composite tones, which consists in working a closed circuit with a continuous current from a main battery, portions of the whole of which current are thrown into vibration at will by the transmitters, each set of vibrations being audibly reproduced by a corresponding receiver; 3rd. The combination of a series of transmitters each operated by a local battery, a main battery, an electric circuit through which a continuous current flows from said battery, and shunt or short circuits between the main battery and transmitters; 4th. The combination of a series of transmitters, a main battery connected therewith by short or shunt circuits, a closed electric circuit through which a current continuously passes from the main battery, and a series of analyzing receivers included in the circuit.

No. 6102. Safety Lock. (*Serrure de sûreté.*)

Joseph A. Quesnel, Arthabaskaville, Que., 23rd May, 1876, for 5 years.

Résumé.—La combinaison du pêne surnuméraire et vertical H, et sa gâchette J, avec le petit pêne E, d'une serrure A, pour en faire une serrure dite de sûreté.

Claim.—The combination of the super-numerary and vertical bolt H, and its follower J, with the small bolt E, of a lock A, to make what is called a safety lock.

No. 6103. Blast Furnace for Reducing Ores.

(*Fourneau volant pour réduire les minerais.*)

Ananias Smith, Clifton, Ont., 23rd May, 1876, for 5 years.

Claim.—1st. The combination of the shaft A, combustion chambers C, pipes U, and W, connecting through intermediate pipes with a steam boiler L, and fuel tank K, connected by a pipe M, 2nd. The combination of a superheater O, steam boiler L, pipe M, liquid fuel tank K, pipes U, and W, with the combustion chambers C, and interior or shaft A, of the furnace; 3rd. The combination with the inside or shaft of the furnace, of one or more water slabs arranged within the same.

No. 6104. Composition of matter to be used Medicinally and as Food.

(*Composé médicamenteux et alimentaire.*)

John L. Johnston, Sherbrooke, Que., 23rd May, 1876, for 5 years.

Claim.—A mixed compound of Beef and other meats with Albumen.

No. 6105. Improvements on Root-Cutters.

(*Perfectionnements aux coupe-racines.*)

Nazaire Aubut, Trois-Pistoles, and Théophile Aubut, Ste. Flavie, Que., 23rd May, 1876, for 5 years.

Résumé.—La combinaison des couteaux à dents H, et des lames à dents G, avec la roue verticale F.

Claim.—The combination of toothed knives H and toothed holes G, with the vertical wheel F.

No. 6106. Improvements on Tobacco Pipes.

(*Perfectionnements aux pipes.*)

Mark Thomson, Cowansville, Que., 23rd May, 1876, for 5 years.

Claim.—1st. The cylindrical tube B closed at one end by cork plug E, and at the other end by enlarged screw D, on end of mouth piece, 2nd. The combination with the cylindrical tube B, of the porous material F.

No. 6107. Improvements on Oscillating Valves.

(*Perfectionnements aux soupapes oscillantes.*)

John Fairburn, Upton Station, Que., 23rd May, 1876, for 5 years.

Claim.—The oscillating valve A, receiving steam internally through pipe I, having a single port a, in combination with a cylinder having the steam inlet ports F, F, coinciding with the port a, and the ports G, G, exhausting above the valve and terminating in a passage E, leading toward each end of the cylinder.

No. 6108. Improvements on Sewing Machines.

(*Perfectionnements aux machines à coudre.*)

John C. Burton, St. Thomas, Ont., 23rd May, 1876, for 5 years.

Claim.—1st. The plate A, having pillars B, B, leaving the spindle C, provided with a grinding wheel D, and pulley E, 2nd. The provision of a rest G, branching from the pillar B, and bending over the grinder D; 3rd. The rest G, having hole H, for receiving the needle while being pointed.

No. 6109. Improvements on Cultivators.

(*Perfectionnements aux cultivateurs.*)

William Green, Brantford, Ont., 23rd May, 1876, for 5 years.

Claim.—1st. The radial links or chains 1, 2 and 3, and lateral links 4 and 5, in combination with a crank pin; 2nd. The cast iron plate D, with flanges E, and F, and the crank plate G, with helical teeth N, formed on the side or edge, and also strap M, between crank pin and pin I; 3rd. The gauge O or crank plate G, in connection with index S, on stay Q, the blocks X and bent lever Y.

No. 6110. Railroad Car Coupling.

(*Attelage de wagons de railroute.*)

George W. Green and Abraham D. Green, Greensville, Ont., 23rd May, 1876, for 5 years.

Claim.—1st. The combination of the stud B, with pin D; 2nd. The combination of the link after E, E, with the coupling box A.

No. 6111. Improvements on Potato-diggers.

(*Perfectionnements aux arrache-patates.*)

James Kenly and Patrick Kenly, Gloucester, Ont., 3rd May, 1876, for 5 years.

The scoop C, and screen D, the combination of the crank shaft J, and rake bars I, provided with rake heads K.

No. 6112. Improvements on Steam Engine Exhausts.

(*Perfectionnement des soupapes d'aspiration de vapeur.*)

Henry D. Dwyer, North Hartland and James M. Foss, St. Albans, Vt., 23rd May, 1876, for 5 years.

Claim.—1st. The combination of the pipes A and A', with the exhaust passages of a steam engine; 2nd. The combination of the conical shaped head B, a series of movable plates F, and the cap B, having a partially rotary movement upon said head to move the plates; 3rd. The combination of the conical shaped head B, the movable plates F, the cap B, and the exhaust nozzle I.

No. 6113. Improvements on Seeding Machines.

(*Perfectionnements aux machines à semer.*)

Peter Milne, Langton, Ont., 23rd May, 1876, for 5 years.

Claim.—1st. The seed box C, having a supplementary sliding bottom J, slotted, subdivided transversely, and both subdivisions operated by levers K; 2nd. The combination with a wheel A, having cam cylinders G, G, the levers E, E, and agitator D; 3rd. The provision to the seed box C, of the slide N.

No. 6114. Improvements in Railway Signals.

(*Perfectionnements dans les signaux de railroutes.*)

Thomas Sills, Fort Erie, Ont., 23rd May, 1876, for 5 years.

Claim.—1st. The combination of the lamp I, and the shade J, 2nd. The combination of the lamp I, and the shade J, with the semaphore arm K; 3rd. The combination of the lamp I, and the shade J, with the semaphore arm K, also the switch fastener N.

No. 6115. Improvements on Metallic Roofs.

(*Perfectionnements aux toitures métalliques.*)

John Power, Kingston, Ont., 23rd May, 1876, for 5 years.

Claim.—1st. A sheet metal roof that will allow of contraction and expansion in all directions; 2nd. The mode of applying sheet metal covering to roofs by strips C, secured at intervals to the sheeting A, and formed to lock slidingly with engaging rails D, interposed at suitable distances between and rivetted to the sheet B, up-turned at their edges, to form ridges with the pitch of the roof and the joints of the up-turned edges rivetted and soldered or otherwise made watertight; 3rd. The combination with the sheets B, of the rails D, and strips C, fixed to the roof sheeting A; 4th. The sheets B, B, rivetted and soldered to the rails D, and secured to the roof sheeting A, by strips C.

No. 6116. Apparatus for Walling Wells.

(*Appareil à murer les puits.*)

Azariah Moore, Shellsburg, Iowa, U. S., 23rd May, 1876, for 5 years.

Claim.—1st. A series of radius arms, upon the outer ends of which the wall may be supported, said arms being pivoted to a centre column and provided with a releasable detent contrivance capable of being operated from the top of the well to allow of the tilting of the arms when the implement is withdrawn from the well; 2nd. The combination with the pivoted radius arms A, of the column D, ring or collar E, and lever F; 3rd. The combination of the radius arms A, the adjustable bearings B, and collar E, provided with a detent contrivance whereby the apparatus may be adjusted to different diameters; 4th. A device for walling wells from the surface, a series of radial arms formed to support the wall while being lowered, and to be released, and withdrawn from beneath the same when the wall is in place; 5th. The combination with the radius arms A, of the ends or chains z, z, attached to the inner ends of the arms and congregated together at z; 6th. The combination with the column D, and collar E, the spring catch N, inserted in the side of the column.

No. 6117. Manufacture of Grain Cradle

Fingers. (*Fabrication des branches des javalius.*)

Christopher P. Keley and James L. Multer, Richwoodville, N. Y., U. S., 23rd May, 1876, for 5 years.

Claim.—1st. The application of a denticulated (or serrated) edged curved or straight knife, fastened in a rotary cutter head cylinder, to a tapering piece of timber, cutting or grooving it out so as to form a set more or less in number of grain cradle fingers, at the same time giving them an elliptical or other sectional form; 2nd. The bending of the fingers, before being entirely separated from each other at the sides or ends.

No. 6118. Saw Sharpening and Setting Machine. (*Machine à affûter et donner la voie aux scies.*)

Rudolph Hensch and Louis Beyer, Washington, D. C., U. S., 23rd May, 1876, for 5 years.

Claim.—1st. The combination with the stand A, of the arm B, and socket A, the arm carrying the driving mechanism, and the socket supporting the table for holding the blade whether for sharpening or setting the saw; 2nd. The head H, part of which is the sharpening file H, and part the helical adjustable spring plate H₂, for first filing the inclined face of a tooth and then carrying the saw blade forward the width of a tooth; 3rd. In combination of the bed K, table L, gauge L₁, jaw L₂, for supporting the saw blade and clamping one edge, and the adjustable rod O, for confining the other edge; 4th. The combination of the stem P, hinged attachment R, gauge S, and jaw S₁, for clamping the saw blade and holding it at any required inclination, for giving the proper set to the teeth; 5th. In combination with the adjustable attachment K, and gauge S, for fixing the back of the blade, the gauge Q, also adjustable for fixing the serrated edge of the blade; 6th. In combination with the adjustable bed for supporting the saw blade at the required inclination, the hammer T, elastic helve T₁, arm V, set screws V₁, and cam G, for giving a regulated blow of the hammer; 7th. The elastic helical reversible blades X, and Y, in combination with the head W, and slide Z, and set screws Z₁, for regulating the pitch of the feed to correspond with the width of the teeth of the saw, and feed the width of two teeth at a time alternately each way.

No. 6119. Wax Thread Sewing Machine.

(*Machine à coudre avec du fil ciré.*)

John E. Wheeler, Lynn, Mass., U. S., (co-inventor with, and assignee of, Lyman L. Barber), 23rd May, 1876, for 5 years.

Claim.—1st. The wedge-shaped adjusting block D, rocking lever E, and presser bar A, in combination with the lever H, and projecting collar B; 2nd. The combination of the shoulder B, and lever H, with the variable adjusting-block D, and operating mechanism, whereby the said block is adjusted by the thickness of the work and the presser bar thereby caused to have a uniform lift from the surface of the work; 3rd. The combination of the presser bar A, and adjustable collar F, with the rocking lever E, and spring G; 4th. The wedge-shaped adjusting blocks D, E, and E₁, or their equivalents when operated by the presser bar, so as to diminish or increase the friction or restraint upon the tension spool thereby regulating the delivery of the thread.

No. 6120. Improvement on Horse Rakes.

(*Perfectionnement des râteliers à cheval.*)

Dennis P. Sharp, Ithaca, N. Y., U. S., 23rd May, 1876, for 5 years.

Claim.—The combination with the flange a, of the rocker B, provided with the two pins or lugs d, d, embracing the flange and adapted to produce friction upon the two opposite sides of the same.

No. 6121. Article of Manufacture for Textile and Fibrous Fabrics.

(*Article de manufacture pour les matières textiles et fibreuses.*)

Samuel Van Benschoten, Evanston, Ill., U. S., 23rd May, 1876, for 5 years.

Claim.—Prepared algae or grass.

No. 6122. Process for Preparing Tan Bark.

(*Procédé de préparation de l'écorce de tan.*)

Jonathan Sherman, Chicago, Ill., U. S., 23rd May, 1876, for 5 years.

Claim.—Drying and grinding, and then compressing the bark sufficiently to crush the cells containing tannin, and at the same time to form small cakes of the ground material convenient for transportation.

No. 6123. Veneer Cutting Machine.

(*Machine à tailler le placage.*)

Henry T. Bartlett, Brooklyn, N. Y., U. S., 23rd May, 1876, for 5 years.

Claim.—1st. The combination of the knife *u*, with the reciprocating frame and horizontal adjustable pressure bar; 2nd. The reciprocating knife carrying frame R, in combination with the gibs z, and vertical guide upon the uprights B, B; 3rd. The gibs z, provided with a recess and lugs *o*₁, for the purpose of guiding the knife frame in its reciprocations; 4th. The radial rods S, in combination with their adjusting devices; 5th. The reciprocating frame R₁, in combination with the mechanism by which it is operated; 6th. The cutting table J, in combination with the screws, gears and shafts by which it is rendered vertically adjustable; 7th. The vertically adjustable table in combination with the reciprocating knife frame R, and their operating mechanism; 8th. The vertically adjustable table in combination with the stay log Y, and the devices by which it is fed forward toward and retracted from the cutting knife; 9th. The stay log Y, in combination with the toggle and the mechanism by which it is operated; 10th. The shaft N₁, the cam *ax*, lever *z*, and adjustable connections *z*₁, in combination with the pawl carrier *t*, ratchet wheel R₂, and screw *or*, for the purpose of feeding forward the stay log; 11th. The shaft N₂, cam *mx*, arm *lx*, vertical rock shaft *rx*, sliding arm *px*, and connection *qx*, in combination with the toggle and stay log for the purpose of retracting the latter during the ascent of the cutting knife; 12th. The shaft N₃, eccentric *a*, eccentric rod *b*, rock shaft *c*, arm *d*, and connection *e*, in combination with the reciprocating frame R₁, radial rods S, and cutting frame R, for the purpose of giving to the latter a horizontal movement or drawing out; 13th. The shaft M, spur gears L, and O, the latter provided with the crank pins P, the connecting rods Q, and cutting frame R, in combination with the radial rods S, adjusting blocks U, and reciprocating frame R₁; 14th. The combination and arrangement of all the devices.

No. 6124. Improvements on Liquid Strainers.

(*Perfectionnements aux couloirs.*)

Henry Hassempfung, Huntingdon, Pa., U. S., 23rd May, 1876, for 5 years.

Claim.—The combination with a bucket A, of a tap B, provided with a guard E, and with a concave surface having eccentric perforations *d*, and a rim *e*, for the reception of one or more strainers.

No. 6125. Combination Lock.

(*Serrure à combinaison.*)

Robert P. Goucher, Lowellville, Ohio, U. S. (Assignee of John McCaskey), 23rd May, 1876, for 5 years.

Claim.—1st. The combination of the two sets of dials G₁, G₂, and D₁, D₂, tumblers G₄, D₄, having notches *z*, *y*, inclines *z*, slide H, with pins *h*, *h*, and *h*₁, latch I, and arm *m*; 2nd. The combination of the tumblers G₄, D₄, slide H, with pins *h*, *h*, and *h*₁, latch I, with arm *m*, and incline *n*, and the headed bolt C, with notch *a*.

No. 6126. Improvements on Refrigerators.

(*Perfectionnements aux réfrigérants.*)

Edward L. Goold (Assignee of James W. Cuthbertson), Brantford, Ont., 23rd May, 1876, for 5 years.

Claim.—1st. Making the refrigerator detachable by means of slot hooks K, K, and pins in hinges I, I, and trough in bottom G; 2nd. The detached ice box L, with the raised platform M.

No. 6127. Improvement on Logging Dogs.

(*Perfectionnement des clameaux de scieries.*)

Otis H. Smith, Waterville, Me., U. S., 23rd May, 1876, for 5 years.

Claim.—Logging dogs made with each spurred arm curved in two directions.

No. 6128. Improvement on Paint Dryers.

(*Perfectionnement des siccatifs.*)

Oscar Russell, Sycamore, Ill., U. S., 23rd May, 1876, for 10 years.

Claim.—Boiling refuse paint; then adding turpentine in about the proportion stated; then reducing the compound to ashes, and then grinding said ashes to powder.

No. 6129. Improvements in Spring Equalizers.

(*Perfectionnements aux équilibrateurs des ressorts.*)

William Smith and John W. Rouse, Independence, Ky., U. S., 23rd May, 1876, for 5 years.

Claim.—A brace for spring vehicles consisting of the two links A, and B, of unequal length, and united together at E, said links being attached respectively to the body G, and reach F, by bearings D, E₁, and C, E₁, which bearings are located with reference to each other.

No. 6130. Self-discharging Ballasting Car.

(*Wagon à distribution automatique de ballast.*)

James W. McDonald, Campbelltown, N. B., 23rd May, 1876, for 5 years.

Claim.—1st. The supplementary frame B₁, the rollers I, in the floor of the main car to carry the apron G, the peculiar way of connecting and placing the hand wheel of the brake on side of car and platform in combination with the main frame of an ordinary car to make a self-discharging ballasting car; 2nd. The sinking of the spiral springs in the bunks in combination with the supplementary frame B, in order to lower the apron G, to the level of the ordinary cars; 3rd. The combination of the grab pulleys D, D₁, and chains F, or their equivalent, the hexagonal rollers H, and their six cogged wheels, and the slotted endless apron G, and its chains with a car truck A; 4th. The combination of the locking device J, the locking crutches *f*, with the locking pulleys E, set on the axle of the car wheel to gear and out gear the apron G; 5th. The combination of the chute L, having slanting wings *h*, with the slotted apron G, to spread the gravel evenly; 6th. The combination of the self-revolving apron K, with the slotted apron G, to widen the dump.

No. 6131. Air Carburetted Apparatus.

(*Appareil à carburer l'air.*)

John F. Barker, Springfield, Mass., U. S., 23rd May, 1876, for 5 years.

Claim.—1st. The combination of a pump driven by a descending weight or other equivalent mechanical power, with a generator buried in the earth and with a part of its periphery built into and exposed within a vault located at a distance from the building lighted, and both the pump and generator connected by pipes; 2nd. The combination of a generator buried in the earth with a portion of its periphery built into and exposed within a vault, and the tube I, provided with drawing off cocks; 3rd. In combination with a generator buried in the earth with a portion of its periphery built into and exposed within a vault, a pump connected therewith, and having the inlet air pipe C₁, and arranged in one end of said pump through which air is admitted to said pump and generator; 4th. In combination with said generator, vault and pump the inlet air pipe C, connected with said pump and extending to a point outside the building in which the pump is located, whereby all danger of explosion in the apartment containing the pump, is entirely obviated; 5th. In combination with said generator the filling pipe and vent pipe provided with a valve *b*, common to both pipes; 6th. In combination with said generator, and pump, both connected by an air pipe the check valve disk *f*, located with its seat *f*₁, in said air pipe; 7th. In combination with the suction pipe C, and pump having the casting C₁, secured therein, the spring B₁, coiled around the shaft of said pump and secured thereto at one end and to the collar placed upon said shaft at the other end; 8th. In combination with the suction pipe C, the pump having the casting C₁, secured therein, the spring B₁, and the winding drum H.

No. 6132. Improvements on Saw-gummers.

(*Perfectionnements aux machines à affûter les scies.*)

Marvin O. Smith, New-Buffalo, Mich., U. S., 23rd May, 1876, for 5 years.

Claim.—1st. The combination of the ring A₁, provided with the flange *ax*, jaws A, having grooves *a*, and slotted *a*₁, carriage W, B, provided with slides *c*, and cross head B₁, arbor C, worm wheel E, cutter C₁, boxes *cu*, lug H, feed screw D, cam lever G, and cog wheel F; 2nd. The combination of the rim A₁, provided with the flanges *ax*₁, with the jaws A, having the grooves *a*, and slots *a*₁, said rim A₁, being adapted for adjustment within the jaws A, to suit the different angles necessary in gumming saws; 3rd. The combination of the arbor C, having cutter C₁, and worm wheel E, with the cog wheel F, secured at the end of feed screw D; 4th. The combination

of the arm J, moving longitudinally with the arbor C, worm wheel E, and pitman K, with the cog wheel F, and feed screw D, whereby a rotary and longitudinal movement is given to the cutter; 5th. The rotary cutter C, having a combined rotary and longitudinal movement in gumming.

No. 6133. Car-coupler. (*Accoupleur de wagons.*)

Joseph King, Port Perry, Ont., 23rd May, 1876, for 5 years.

Claim.—1st. The draw-bar A, having a link B, permanently retained loosely therein ready for coupling; 2nd. The coupling pin D, operating to draw vertically out of the draw head A, in uncoupling and having a swinging motion in the draw head rearward to allow the passage of the opposite link in coupling; 3rd. The coupling pin D, hung on journal G, and attached to the end of a lever E, pivoted to the car for withdrawing the pin for uncoupling engagement without going between the cars.

No. 6134. Safety Valve. (*Souape de sûreté.*)

Erastus B. Kunkle, Fort Wayne, Ind., U.S., 23rd May, 1876, for 5 years.

Claim.—1st. The cup or chambered valve H, the spiral spring J, and disks K, L, respectively provided with a point and recess and arranged within the valve, the pointed pressure adjusting screw M, and the steam pipe or casing A, having cap C; 2nd. The combination of the steam pipe cap C, having a socket S, and screw cap T, with the sealed pressure screw M, to permit the latter to be turned by a wrench.

No. 6135. Improvements on Coffee Pots.

(*Perfectionnements aux cafètières.*)

George W. Hubbard, Windsor, Vt., U. S., 23rd May, 1876, for 5 years.

Claim.—1st. The combination of curb K, with the funnel C, and percolating cup G; 2nd. A coffee pot having the funnel C, and pipe H, for the upward flow of the water, and the annular space *n*, for the downward passage, the bottom having the margin under said passage *n*, elevated above the portion *a*, under the funnel.

No. 6136. Improvements on Clothes Dryers.

(*Perfectionnements aux sècheirs à linge.*)

Napoléon P. Dion, Coaticook, Que., 23rd May, 1876, for 5 years.

Claim.—1st. The combination of the lower slide D, having two eye-bolts *c*, *ct*, and the upper slide G, having one eye-bolt *d*, with the staff B; 2nd. The combination of the cap or cover C, fastened by a chain to the block A, with a block A; 3rd. The combination of the capped pulley F, revolving on a washer at top of the staff B, and protected by the ferrule *e*.

No. 6137. Oven for Baking Bread, Biscuit, &c.

(*Four à cuire le pain, le biscuit, &c.*)

Henry L. Parkin, Chatham, Ont., 23rd May, 1876, for 5 years.

Claim.—1st. The combination of furnace *f*, casing *x*, flues D, D, and E, in connection with passage Y, in such a manner that the heat from the furnace shall first pass over the top of the oven and return under the floor before passing out of the chimney; 2nd. The casing *x*, of any suitable material and flues D, D, and E, and arrangement of furnace *f*, and passage Y, as applicable to ovens.

No. 6138. Improvements on Horse-shoes.

(*Perfectionnements aux fers à chevaux.*)

Jeremiah O'Sullivan, Quebec, Que., 23rd May, 1876, for 5 years.

Claim.—The combination of the sole-plate G, fitting in the rabbit D, of a horse-shoe with the horse-shoe A.

No. 6139. Gas Regulator. (*Régulateur à gaz.*)

Charles H. Edwards, Montreal, Que., and Lycurgus Laffin, Chicago, Ill., U. S., 23rd May, 1876, for 5 years.

Claim.—The cup or valve F, having vertical sides and an open top and a closed flanged bottom extending outward from the sides and provided with the perforations H, H, arranged in its sides, the said valve being freely suspended in the part or opening E, arranged between the receiving chamber N, and the discharging chamber K, and connected to the yielding diaphragm D, arranged across the latter chamber.

No. 6140. Process and Compound Preparation of Groats.

(*Procédé et préparation composée à gruaux.*)

Mathew Tindale, Saint Sophia, Que., 23rd May, 1876, for 5 years.

Claim.—1st. The process of preparing the barley for the flour, by drying the grain over perforated metal plates, tiles or stone slabs covered with sheet iron, paper or other material; 2nd. The mixing of the barley flour, in the proportions stated, with pure oatmeal groats.

No. 6141. Improvements in Barrel Machinery.

(*Perfectionnements dans les machines de tonnellerics.*)

Samuel Wallace, Seaforth, Ont., (Assignee of John D. McEachern), 23rd May, 1876, for 5 years.

Claim.—1st. The hollow cylinder B, supported upon the shaft C, by the divided spiders B₁, B₂, made from one piece of sheet metal in combination with the eccentric shaft B₃, boxes *b*, *b*, and arms *br*, *br*, set screws *d*, *d*, the lugs *d*₃, *d*₃, on the rings *d*, *d*, acting against the knees *d*₂, *d*₂; 2nd. The stopping bar *g*, with a roller *5*, which acts upon the stop *f*, in combination with the collar *g*; 3rd. The pulley V₂, provided with the dogs V₃, in combination with the pinion T₁, attached to the sleeve V, and having the recess T₂; 4th. The sliding block P, having angular grooves *p*, *p*, cut in its face in combination with the rods *o*, *o*, and sleeves N, N; 5th. The hinged arms E, E, with the pressure bar F, operated from the treadle J, by the rods K, and provided with the rollers G, H, and I, in combination with the rods K, K, and treadle J; 6th. The semi-circular support L₂, held by the upright L₃, in combination with the lever L₄.

No. 6142. Improvements on Saw-Clamps.

(*Perfectionnements aux chevauxets porte-scies.*)

Edson B. Cady, Sweetsburgh, Que., 23rd May, 1876, for 5 years.

Claim.—1st. The form of the limbs or portions of the clamp B, D, and their

connections by the uprights F, F, and the pivot G; 2nd. The form of the faces C, E, of the elongated jaws J, J, of the clamp; 3rd. The combination of the cam and lever I, and the fulcrums H, H, upon which it works.

No. 6143. Improvements on Fountain Lamps.

(*Perfectionnements aux lampes-fontaines.*)

Robert H. Webb, Brooklyn, N. Y., U. S., 23rd May, 1876, for 5 years.

Claim.—1st. The vent-tube *v*, in combination with the chamber C, the passage P, and reservoir R; 2nd. The valve K, in combination with the passage P, reservoir R, chamber C, and vent tube *v*; 3rd. The combination of the india rubber friction ring *a*, with the screw-threaded boss *b*, and the screw-threaded standard P.

No. 6144. Improvements on Skates.

(*Perfectionnements aux patins.*)

Percy D. Hedderwick, Glasgow, Scot., 23rd May, 1876, for 5 years.

Claim.—1st. The arrangement and construction of the skate or any mere modification thereof; 2nd. The disc or plate A, with eccentrically curved slots B, B, and a rack *e*, formed around a portion of its periphery; 3rd. The spring lever F, and the employment thereof; 4th. The combination and arrangement of the bars or blocks E, and side grippers D, and the employment of such bars or blocks in conjunction with skates of analogous construction; 5th. The combination or arrangement of the centre pin *a*, and washer *c*; 6th. The arrangement of heel gripper consisting of the saddle or rider *o*, rack *l*, spring *p*, pall *m*, and gripper *m*.

No. 6145. Manufacture of Dry Wood Pulp.

(*Fabrication de la pulpe de bois sec.*)

Isaac W. Bowers and David A. Curtis, Petersburg, Mich., 23rd May, 1876, for 5 years.

Claim.—A revolving grinding cylinder to which the wood is fed, a pulp conducting hopper and endless rotating belt below the cylinder, exposing the wood to a rapidly revolving cylinder with grinding surface of glue, ground flint, quartz and emery; the combination of the hopper and endless pulp conveying belt with an inclined reciprocating screen to separate the coarser and finer pulp particles.

No. 6146. Chains Pump Bucket.

(*Godet de chaquet.*)

William B. Wilcox, Ypsilanti, Mich., U. S., 23rd May, 1876, for 5 years.

Claim.—1st. The combination of the solid body A, with hooks or open links B, at its ends and flange *a*, the springs *b* and bolts *d*; 2nd. The solid body A, with hooked or open ends B, and a flange *a*; 3rd. A nut D, of brass or other suitable material slipped over one end and screwed upon the body holding a rubber of any suitable shape; 4th. The bolt *d*, and spring *b*, working against the end of each hook.

No. 6147. Improvement on Saw-Mill Dogs.

(*Perfectionnements des clameaux de scieries.*)

John A. Fordon and James E. Thomas, Barrie, Ont., 23rd May, 1876, for 5 years.

Claim.—1st. The bar or strap L, in combination with the eccentric bolt G, and lever F; 2nd. The plates A, and B, in combination with slots E, and bolts D; 3rd. The combination of the plate B, with the eccentric bolt G, lever F, and roller I, head bar J, teeth K, and tooth guides C; 4th. The combination of the bar A, with the bar or plate B, guides C, bolts D, slots E, lever F, eccentric bolt G, rollers I, head bar J, and teeth K.

No. 6148. Improvements on Refrigerator Cars. (*Perfectionnements aux wagons réfrigérants.*)

James H. Wickes, New-York, U. S., 23rd May, 1876, for 5 years.

Claim.—1st. The combination of an air distributor situated in the ice chamber below the bottom of the rail road car with an ice feeder extending up through the interior of a car and with an air forcing and suction blower situated below the bottom of the car and driven from one of the car axles; 2nd. The combination with a pulley *d*, mounted on the car axle H, of a shaft vibrating frame H₁, attached to the boom of the car and carrying a graft with a friction pulley *f*, and a pulley *g*, from which motion is transmitted to the blower shaft.

No. 6149. Machine for Lifting Heavy Weights.

(*Machine à soulever les fardeaux.*)

Charles O. Brown, Lawrenceville, Que., 23rd May, 1876, for 5 years.

Claim.—The combination of the lever B, and ratchet C, with wheel A, and axle F, also ratchet D, and bar E, with frame H.

No. 6150. Steam Engine Governor.

(*Gouverneur de machine à vapeur.*)

John E. Wilson, Galt, Ont., 23rd May, 1876, for 5 years.

Claim.—1st. metallic weight A, hollow spindle B, and suspension rod C; 2nd. The combination of the slip collar E, cross head F, connecting rods G, and bell crank H, for operating the cut off valves I.

No. 6151. Ditch Shovel. (*Pelle à fossoyer.*)

Louis Guyon, Verchère, Que., 23rd May, 1876, for 5 years.

Résumé.—1o. La combinaison de la douille B, recourbée en S, et fendue soit en avant, soit en arrière, avec le manche mobile D, vissé à la frette *b*, de la douille B; 2o. La combinaison, avec la pelle A, de la douille B, ayant la platine C, faisant corps avec elle, et posée à la pelle A, avec des rivets *c*, affleurés des deux côtés.

Claim.—The combination of socket B, bent into an S, and split either in front or behind, with the movable handle D, screwed to the hoop *b*, of the socket B; 2nd. The combination with the shovel A, of the socket B, having the plate C, solidly joined with it, and secured on the shovel A, with rivets *c*, flush on both sides.

No. 6152. Process for Treating Copper Pyrites and other Ores of Copper.*(Procédé de traitement des pyrites et autres minerais de cuivre.)*

Thomas H. Cobley, Dunstable, Eng., and Joseph A. Dixon, Glasgow, Scot., 23rd May, 1876, for 15 years.

Claim.—1st. The process in its various alternative modifications for the extraction of copper from copper ores; 2nd. The use of auxiliary agents in the sulphatization of copper in connection with the process; 3rd. Forming bisulphide of magnesium and sulphuretted hydrogen, and for employment in obtaining sulphide of copper from copper ores; 4th. The use of lime or its compounds in the sulphatization of copper ores; 5th. The method or alternative methods or processes of treating copper ores disseminated through limestone and other rocks.

No. 6153. Improvements on Stoves or Furnaces. *(Perfectionnements aux calorifères.)*

Ezra Hawkes, Boston, Mass., U. S., 23rd May, 1876, for 5 years.

Claim.—1st. The separate double flaring fire pot portion *c*, of the fire-pot, and combined with the upper or throat carrying part *d*, and with the grate and ash-pit and the conical mouth *F*, extending down into the ash pit from its top; 2nd. The combination of a supporting chain and a notched or jawed bracket and its guide-wheel applied to either the ash pit or fire place door and arranged therewith and with the part *p*, of the furnace; 3rd. The fire place door having the side wings and a supporting chain and notched bracket provided with a roller or wheel, the said chain being applied to the door and the said bracket being disposed in the front of the furnace.

No. 6154. Improvements on Ploughs and Planters.*(Perfectionnements aux charrues et aux planteurs.)*

John Fay, Wayne, and William Chalmers, Detroit, Mich., U. S., 23rd May, 1876, for 5 years.

Claim.—1st. The pulley *R*, lever *S*₁, ratchet *S*₂, pawl *T*, and chains *U*, *U*, in combination with the tongue and ploughs beam of a sulky plough; 2nd. The combination of the bent swivel bolt *G*, swivel bar *J*, guide bars *L*, *L*, set screws *K*, eye bolt *M*, nuts *N*, and braces *O*, *P*, in combination with the axle and pole to receive and guide a plough beam; 3rd. The arms *B*, *B*, and set screws *C*, in combination with the axle and pole to carry the wheels of a sulky plough and regulate their height; 4th. In combination with the swivel bolt *G*, and swivel bar *J*, the spring *H*, and curved rack *I*; 5th. In combination with the sulky plough the bar *W*, hopper *a*, box *X*, revolving disc *Y*, spring *i*, *j*, recesses *b*, *d*, and chain *e*; 6th. In combination with the hopper and box, the legs *b*, *c*, blades *Z*, and roller *Z*₂.

No. 6155. Stand for Displaying Maps, Charts, &c.*(Appareil pour étaler les mappes, cartes, &c.)*

James Browne, Toronto, Ont., 23rd May, 1876, for 5 years.

Claim.—1st. The horizontal bar *F*, supported by the two vertical bars or tubes *D*, passing through the cross bar *E*, and provided with a cross head guide *G*, having pivoted thereon a pawl *K*, or eccentric roller *S*, with a lever *L*, in combination with a stationary column *B*, with or without a ratchet-rack *M*; 2nd. The cross guide *G*, supporting the vertical bars *D*, and horizontal bar *F*, in combination with the cords or chain *H*, passing over the friction pulleys *J*, and attached to the weight *L*; 3rd. A rack *N*, provided with hooks *I*, and *P*, in combination with one or more hinged legs or supports; 4th. In combination with a horizontal bar *F*, two or more suspension hooks *V*, or such other form as shall permit two or more maps to be hung at the same time from the said horizontal bar *F*.

No. 6156. Improvements in Electric Telegraphs.*(Perfectionnements dans les télégraphes électriques.)*

George Allan, and James W. Brown, London, Eng., 23rd May, 1876, for 5 years.

Claim.—A constructing a relay or pecker to act with a compound motion; *B*, constructing a relay or pecker with the parts *a*, *a*₁, and *f*; *C*, in constructing a relay or pecker with the parts *o*, *q*, and *r*, *r*₁; *D*, constructing a relay or pecker with the parts *u*, *u*₁, and *w*, *w*₁; *E*, the use of equilibrium or compensating springs in combination with relays or peckers.

No. 6157. Improvements in Nut Locks.*(Perfectionnements aux noix à brides)*

Sterne Brunson, Benton Harbour, Mich., U. S., 23rd May, 1876, for 5 years.

Claim.—The catch *g*, having both its ends bevelled on the same plane, and placed in a recess which is large enough to allow it to assume an inclined position when the nut is being screwed on, and a vertical position when the nut is being unscrewed.

No. 6158. Sole Channelling Machine.*(Machine à graver les semelles.)*

John E. Wheeler, Lynn, Mass., U. S. (Co-inventor with and Assignee of James Dargan), 23rd May, 1876, for 5 years.

Claim.—1st. The revolving disk *A*, forming an adjustable guide, provided with the projecting guiding wall of unequal diameters; 2nd. In combination with the revolving disk guide *A*, the bearing blocks *a*, *a*₁, adjusted thereon by the set screws; 3rd. The combination of the disk guide with suitable restraining mechanism *c*, and *C* arranged to stop the disk at determined points in its revolution; 4th. The combination of the revolving guide *B*, with the lever *D*, arranged to operate the same to and from the cutting and grooving mechanism; 5th. The adjustable stops *F*, when arranged upon the rod *E*, to determine the limits of the movement of the guide to and from the cutting and grooving mechanism thereby regulating the location of the channel relative to the sole edge; 6th. The revolving guide *B*, arranged to have a movement to and from the cutting and grooving mechanism.

No. 6159. Composition of Matter for a Filtering Medium.*(Composé pour servir comme agent de Filtration)*

George B. Stock and Andrew F. McPherson, Toronto, Ont., 23rd May, 1876, for 5 years.

Claim.—A compound of shells or shell marl pulverized and made airy.

No. 6160. Improvements on Service and Force Pumps.*(Perfectionnements aux pompes aspirantes et foulantes.)*

William McGuire, Uxbridge, Ont., 23rd May, 1876, for 5 years.

Claim.—1st. The hollow piston head and shaft; 2nd. The service or delivery pipe screwed to side of air chamber and descending about two thirds of piston shaft; 3rd. The position of pump box and bottom valve in connection with piston head and valve; 4th. The attachment of leather flange or washer; 5th. The rubber or other flexible tubes *Z*, *Z*, in duplex pump.

No. 6161. Improvements on Wood-Screws, &c. *(Perfectionnements aux vis à bois, &c.)*

Edwin A. Leland, New-York, U. S., 26th May, 1876, for 5 years.

Claim.—1st. The wood screw in which the bottom of the groove or nick is made serrated or with a succession of alternating projections *a*, and recesses *c*; 2nd. The serrated traversing disk or die *K*, combined in relation with the nicking saw *B*; 3rd. The driver *C*, having the driving end *c*, serrated or constructed with a system of alternating teeth *c*, and recesses *f*.

No. 6162. Improvements on Hand Carts.*(Perfectionnements aux charrettes à bras.)*

Joseph M. Jones, Paris, Ky., U. S., 26th May, 1876, for 5 years.

Claim.—The combination of the sliding box *D*, and suitable supporting clips *J*, with frame *B*, axle *C*, wheels *A*, with or without rods *H*, the combination of a body *D*, springs *L*, sliding frame *K*, and cranked axle *C*, with or without rods *H*.

No. 6163. Improvements on Cracker Machines.*(Perfectionnements aux machines à biscuits.)*

Daniel M. Holmes, New York, U. S., 26th May, 1876, for 15 years.

Claim.—1st. A dough-box *B*, made with an extension and off-set *E*, to receive the cutters and enable them to operate at right angles with the plungers *D*; 2nd. A dough-box made with its discharge openings at right angles with the line of motion of the plungers *D*, that force out the dough; 3rd. A dough-box divided by partitions *b*₁, into two or more compartments, each provided with a discharge opening and with a plunger *D*; 4th. The combination of the detachable and exchangeable cutter head *z*, with the dough-box *B*, and its extension and off-set *E*; 5th. In combination of the cross bar *A*, and its guide pins *Br*, and springs *C*₁, the push bars *D*₁, levers *E*₁, and cams *F*₁, with the detachable head blocks *z*, the cutters *G*, *Y*, and the driving shaft *T*; 6th. A cake machine having the cutters adapted to work within the dough-box, said cutters being surrounded with and embedded in the dough when at work; 7th. The combination with a plunger and dough-box of cutters made with bevelled edges and cutter plates having openings with bevelled edges; 8th. Two endless carriers working in line with each other, and with a space or opening between them beneath the discharge opening of the dough-box.

No. 6164. Boot and Shoe Sewing Machine.*(Machine à coudre les chaussures.)*

Charles Goodyear, Jr., (Assignee of Christian Daucel), New York, U. S., 26th May, 1876, for 5 years.

Claim.—1st. A sewing machine having an awl and a circular needle combined so arranged relatively to the channel guide and to the support for the work as to place the loop or chain formed by the stitch upon the welt instead of in the channel in the out sole; 2nd. A sewing machine in which a straight awl and a circular needle are combined with a suitable rest or support for the edge of the welt and sold to slide upon; 3rd. Mounting the awl and channel gauge or presser foot upon an oscillating plate or lever in such a manner that the feed is effected by the vibratory motion of said plate or lever; 4th. The combination of this oscillating vibratory awl with the channel gauge and an intermittent locking device so arranged that the channel gauge shall be intermittently rigidly locked and released at the proper intervals; 5th. In a sewing machine for stitching soles of boots and shoes to welts, the combination of a piercing instrument or awl for feeding the work with a table or support for the work which is solid beneath the piercing point of the awl, but open at the point where the awl and needle meet; 6th. The combination of the table or rest for the work, with a hooked needle arranged to operate without a cast off.

No. 6165. Improvements on Fire Places.*(Perfectionnements aux foyers.)*

Andrew A. Putz, Simmering, near Vienna, Austria, 26th May, 1876, for 15 years.

Claim.—1st. The construction of a firing apparatus with free continuous admission of air through horizontal and vertical passages; 2nd. The combination of a grate box *A*, with a supply chamber *B*, plate *F*, and ring *E*; 3rd. The construction of the supply chamber *B*, and the appliances for raising or lowering it; 4th. The construction of the stoves when in combination with the firing apparatus.

No. 6166. Improvements on Horse Shoe Machines. *(Perfectionnements aux machines à fers à cheval.)*

Henry H. Gilmore, Cambridge, Mass., U. S., 26th May, 1876, for 5 years.

Claim.—1st. The combination of the shoe lifter and discharger *M*, with the stationary recessed former receiver *I*, and the movable rebated former *H*, creaser *D*, and the pair of benders *K*, *K*; 2nd. The former carrier *G*, provided with the inclined slot *p*, and the segmental recesses *q*, *r*, arranged to receive and operate with the crank of the driving shaft; 3rd. The combin-

ation for operating the creaser such consisting of the toggles C, C', fireated pitman E, stops g, g', projections J, J', and the cams h, h', k, the latter being fixed on the driving shaft.

No. 6167. Improvements on Butter Workers.
(*Perfectionnements aux appareils à apprêter le beurre.*)

James Muenne, Webster City, Iowa, U.S., 26th May, 1876, for 5 years.

Claim.—1st. The combination with a suitable knending board or table, of the removable hand lever C, the same being connected to the table in a manner so that either side of such lever may be used; 2nd. The combination with the table A, and revolving knending board B, provided upon its outer periphery with teeth or projecting flange, of the swivelled hand lever C, having near its outer end pins J, J'.

No. 6168. Boot and Shoe Sewing Machine.

(*Machine à coudre les chaussures.*)

Charles Goodyear, Jr. (Assignee of Christian Daurel), New York, U.S., 26th May, 1876, for 5 years.

Claim.—1st. In a machine designed and adapted to sew seams or welts and turns, the use of an awl, or piercing instrument to penetrate the sole transversely to the path of the awl or needle, so as to pin the sole in its place and hold the between substance of the sole firmly while the needle is piercing the work and tightening the stitch; 2nd. The combination with an awl and needle of a third piercing device operating transversely to the others, and near the path of the same to prevent the stitch from pulling through or breaking out and to keep the seam in place; 3rd. In combination with a circular needle operating from the outer edge of the work, an awl working concentrically or nearly so, with said needle piercing the work in the inside channel and operating as an awl feed in connection with the channel gauge; 4th. The combination of a curved awl, and a channel guide operating together in a channel to feed, guide and hold the work; 5th. Giving to the welt guide a positive motion away from the shoe intermittently between each stitch; 6th. So regulating said motion of the welt guide that it shall move away from the shoe a uniform distance irrespective of variations in the thickness of the upper; 7th. The arrangement of the locking devices for locking and releasing the back, or edge and welt gauges; 8th. The arrangement for regulating the length of the loop according to the thickness of the work to be sewn; 9th. In combination with a circular awl and needle mounting the edge or welt guide upon a slide moving to and from the work at a suitable angle with reference to the last instead of concentrically with the needle; 10th. In mounting the awl in such a manner that it will have an independent oscillating or tipping motion.

No. 6169. Process of Manufacturing Artificial Stone.
(*Procédé de fabrication de la pierre artificielle.*)

William H. Smith, Philadelphia, Pa., U.S., 1st June, 1876, for 5 years.

Claim.—The mode or process of manufacturing artificial stone, that is to say: subjecting granulated or pulverized mineral substances, while in the damp condition and while in a mould, first to comparatively slight pressure or light blows, and then to heavy blows.

No. 6170. Improvements on Talties.

(*Perfectionnements aux compteurs.*)

John French, St. Columban of Sillery, Que., 1st June, 1876, for 5 years.

Claim.—1st. The combination of the wire C, walking beam D, and its spring E, hook F, and its spring I, tally wheel G, and its cog a, and spring H, with sliding pull B, tally circle Q, and its hand c, of the tally box A, to count one tally; 2nd. The combination of the large wheel J, its series of pins K, and its cog h, spring I, striking apparatus L, with the gong M, the tally circle S, and its hand g, of the tally box A, to count fifty tallies; 3rd. The combination of the wheel N, and its pins m, with circle R, and its hand p, of the tally box A, to count up to six thousand pieces.

No. 6171. Hoop Cutting Machine.

(*Machine à tailler les cercles.*)

George V. Griffith Huntington Ind. U.S., 1st June 1876 for 5 years

Claim.—1st. The combination of a reciprocating knife E, with an oscillating table G, whose inner edge forms the axis of oscillation, for the purpose of supporting the hoop blanks close to the cutting edge of the knife; 2nd. The oscillating table G, adapted for adjustment to and from the knife; 3rd. The oscillating table operated from the main shaft, through the medium of the gearing, the cams M, the pivoted arms J, and the connecting rods and links L, K; 4th. The oscillating table having the extent of its oscillations adjustable by means of the screw rods L, and pivoted links K; 5th. The yielding stop or gage Q, combined with the reciprocating knife and oscillating table G; 6th. The yielding stop or gage Q, adapted for adjustment to regulate the thickness of the hoops.

No. 6172. Improvements in Eye Glasses.

(*Perfectionnements aux lunettes.*)

Isaac Alexander, Washington, D. C., U.S., 1st June, 1876, for 5 years.

Claim.—1st. The spring clamp for eye glasses made adjustable by a set screw; 2nd. The spring A, for eye glass cases, made adjustable.

No. 6173. Improvements on Charcoal Furnaces.

(*Perfectionnements aux fourneaux à charbon de bois.*)

Edwin G. Adams, Cohoes, N. Y., U.S., 1st June, 1876, for 5 years.

Claim.—The combination in a case having grate C, and a closed top of the fire F, with or without the hood E, and the inclined sides D, of the fire box.

No. 6174. Combined Milk Cooler and Pan.

(*Boîte-refrigerateur à lait.*)

Nelson D. Ferguson, Carthage, N. Y., U.S., 1st June, 1876, for 5 years.

Claim.—1st. The combination with a milk pan B, of an ice cooler consisting of the cylinder C, removable in receptacle K, perforated bottom tubes G, cover H, with tube I, and valve or cap B; 2nd. The perforated bottom J, connecting with the cylinder C, and with heating pipes L, under the pan B; 3rd. The frame A, having a canvas bottom, in combination with the pan B.

No. 6175. Fare Registering Apparatus.

(*Appareil à enregistrer les billets de passage.*)

Henry T. Davis, London, Eng., 1st June, 1876, for 5 years.

Claim.—1st. A glazed opening B, in the front lid and display plate for displaying a figure or figures denoting the value of fare or monies received whether in combination with a lamp or otherwise; 2nd. The handles 1, 2, 3, 4 and parts in connection therewith for actuating the registering wheels G, H, I, and bell plate K, to strike the bell, and register, and display the figure; 3rd. The bell plate K with studs f, of serratures, and stud b, for actuating the hammer of the bell simultaneously with the displaying of the figure, and the actuating of the registering parts.

No. 6176. Improvement on Lap Robes.

(*Perfectionnement les tabliers de voitures.*)

James Millwin, Albany, N. Y., U.S., 1st June, 1876, for 5 years.

Claim.—The combination of the lap robe A, with the foot pocket B.

No. 6177. Improvement on Carriage Rugs.

(*Perfectionnement des tapis de voitures.*)

James Mirwan, Albany, N. Y., U.S., 1st June, 1876, for 5 years.

Claim.—The combination of the carriage rug A, with the foot pocket B.

No. 6178. Bosom Pad. (*Trompe-Pain.*)

John C. Tallman, New York and Flavel W. Sullivan Newark, N. J., U.S., 1st June, 1876, for 5 years.

Claim.—A bosom pad made of thin sheets of cork covered with muslin moulded or pressed into proper shape as also in the gusset, connection or centre piece and cover A, B, C, D.

No. 6179. Improvements on Anchors.

(*Perfectionnements aux ancres.*)

Thomas J. Whitecar and John M. Powell, Philadelphia, Pa., U.S., 1st June 1876, for 5 years.

Claim.—1st. The double ended tripper, engaging with the arch B, and limiting the movement of the arms B, B, by impinging against the block F, or band G; 2nd. The combination of the wedge block F, with the bifurcated shank A, and tripper E; 3rd. The combination with the notched fluke arms B, of the separately formed notched palms D, inserted in the notches L, and receiving the arms B, in the notches d; 4th. The combination of the bifurcated shank A, inserted tripper E, encircling fluke arms and arch; 5th. The combination of the shank A, fluke arms B, B, arch B, double ended tripper E, and wedge block or band.

No. 6180. Improvements on Volta-electric Appliances.

(*Perfectionnements aux procédés électro-voltaïques.*)

John E. Hetherington, Cincinnati, Ohio, U.S., (Assignee of Isaac L. Pulvermacher), 1st June, 1876, for 5 years.

Claim.—1st. A voltaic electric chain or belt constructed of alternately arranged zinc or copper strips or plates A, B, notched or looped, and strung upon twine or cord; 2nd. Arranging the strips or plates A, B, in alternate order, in two series upon a suitable backing so as to be folded together upon an interposed wet conductor.

No. 6181. Improvements on Volta-electric Appliances.

(*Perfectionnements aux procédés électro-voltaïques.*)

John E. Hetherington Cincinnati Ohio U.S. (Assignee of Isaac L. Pulvermacher), 1st June, 1876 for 5 years.

Claim.—1st. The arrangement of a series of copper and zinc disks, dished or coned in alternate order with a fibrous absorbent material interposed between members of the same element upon a hollow central stem supplied with the exciting fluid and shirred or perforated to cause the passage of the exciting fluid from the tube to the absorbent material between the disks, the whole to form a battery; 3rd. The combination of a hexate tube C, and a rigid fluted or corrugated central cone D, with concave or dished copper and zinc disks A, B, to form a battery; 3rd. One radially slotted disks, provided with tongues e, e, at intervals for the opposite metal disk of the adjoining element to rest upon; 4th. The disk having a slot F, from the periphery to the centre and thread sewed into it in concentric circles; 5th. Batteries formed of disks on a hollow central stem, the disk constructed of thread wrapped wire wound spirally until a suitable diameter is attained, and an aperture left at the centre to engage the central stem.

No. 6182. Improvements in Tube Wells.

(*Perfectionnements dans les puits forés.*)

David H. Zavitz and Edward Milner (Assignees of William Milner), Strathroy, Ont., 1st June, 1876 (Extension of Patent No. 1014), for 5 years.

Claim.—The tube-well having wire screen pockets a, b, c, d, e, f, g, h these pockets extending into the centre or hollow of the tube and having clear and unobstructed but narrow and oblong orifices or opening into these pockets at the circumference of the tube, these orifices or openings being *mn, no, op*, into which sand or other suitable material may be inserted to allow the water to filter through, also in the application or insertion of coarse and or any other suitable material into these pockets to filter the water passing through the pockets being adapted to retain the sand.

No. 6183. Improvements in Wood Planing Machines.

(*Perfectionnements aux machines à raboter le bois.*)

Charles H. Warren, Toronto, Ont., 12th June, 1876, for 5 years.

Claim.—1st. The horizontal knives C, C, finished with a regularly serrated cutting edge forming angular or curved cutting teeth; 2nd. The saws F or their equivalent mounted upon the shaft E, either in front or in rear of the knives C, C, or attached to the horizontal head B, in combination with the heads D, D, provided with knives having a concave cutting edge; 3rd. The combination of the horizontal head B, having knives C, provided with a

straight or a regularly serrated cutting edge, the side heads D, D, provided with knives having a concave cutting edge and the saws F, F, or their equivalent.

No. 6184. Improvements in Chronometric Locks.

(*Perfectionnements aux serrures à mécanisme d'horlogerie.*)

John Burge, Circleville, Ohio, U. S., 12th June, 1876, for 5 years.

Claim.—1st. A seven day dial provided with notches; 2nd. The combination of two notched dials and a connecting yoke or detent plate; 3rd. The combination of two notched dials, a connecting yoke, and adjusting disks, by means of which perfect adjustment of the dials with respect to the yoke can be effected so as to secure the unlocking action at any desired time; 4th. The combination of the dial time mechanism and the direct acting locking and unlocking mechanism; 5th. The combination of an automatic unlocking lever operated by clock work, and a connecting device for attachment to the bolt work of a safe or vault door; 6th. The combination of a connecting device, for attachment to the bolt work of a safe or vault door and a fixed shoulder or block, disconnected from the time mechanism against which the connecting device automatically abuts, and secures the bolt work in the locked position, the instant it is thrown into that position by the usual means; 7th. A connecting device adapted to be attached to the bolt work of a safe or vault door, and to be automatically adjusted in position for receiving (and for releasing) the bolt work; 8th. The combination of the yoke or detent plate and the clapper lever and ratchet secured to the same shaft; 9th. A chronometric lock working in combination with a non time lock, both attached to the same string bar, bolt or bolt work of a safe or vault door.

No. 6185. Machine for Applying the Insole Lining to Boots.

(*Machine à poser la basane dans les chaussures.*)

Charles Monahan and Joseph H. Valpey, St. John, N. B., 12th June, 1876, for 5 years.

Claim.—1st. The combination of the last B, to the upright post A; 2nd. The combination with the last B, and the post A, of the spiral spring E, the support D, and the spring acted guard piece C.

No. 6186. Improvements on Car-couplers.

(*Perfectionnements aux accoupleurs de wagons.*)

James C. Mitchell and Charles W. Roby, Lancaster, N. H., U. S., 12th June, 1876, for 5 years.

Claim.—1st. The combination of the draw bar A, recessed so as to form shoulders a, with the coupling plate C, and pivoted to the draw bar; 2nd. In combination with the draw bar A, and coupling plate C, the coupling link B, provided with shoulder b; 3rd. In combination with the draw bar A, the coupling plate C, operated by means of lever E; 4th. The combination with any car of the draw bar A, furnished with shoulder A₁, and spindle D.

No. 6187. Horse-rake. (*Râteau à cheval.*)

Charles Lundy, Newmarket, and George Blake, Whitby, Ont., 12th June 1876, for 5 years.

Claim.—1st. The ratchet wheel A, cast or otherwise fastened the sheaf wheel B, or its equivalent, fitting upon the axle C, in combination with the pawl E, pivoted to the hub D; 2nd. The shaft G, supported upon and extending across the frame of the machine and provided with sheaf wheels H, or their equivalent, in combination with the sheaf wheels B; 3rd. The lever M, pivoted to the frame of the machine and provided with a disc T, in combination with the friction strap S, operated by the foot lever R; 4th. The tooth bar W, divided in the centre in combination with the teeth V; 5th. The crank lever H, pivoted upon the shaft G, and having forked-shaped end within which the friction wheel I, fits and being provided with a crank buckle J₂, and crank arm K₁, with roller J₂, in combination with the lever L₁, rod P, and treadle O, arranged and operated for the purpose of raising the staple bar.

No. 6188. Machine for Making Tackle Blocks.

(*Machine à faire les mouffes de poulies.*)

Frederick S. Burr, Brooklyn, N. Y., U. S., 12th June, 1876, for 5 years.

Claim.—1st. The combination of plates Q, with removable plates having differential bearings; 2nd. A tackle block machine having five borers, four of which are adjustable with respect to the fifth or central one, the former making the end holes while the latter makes the pin hole; 3rd. The combination with formers fastened to a movable table beside the work of the guide-rolls carried with the work, and admitting the formers to pass them; 4th. The combination in a tackle block machine of two sets of knives and formers working simultaneously on the same piece of wood, the one on top and the other on bottom.

No. 6189. Machine for Attaching Shafts to Buggies and Cutters.

(*Machine à ajuster les limonnières de voitures.*)

William M. Wilcox, Port Perry, Ont., 12th June, 1876, for 5 years.

Claim.—1st. The use of the burr A, rivetted to bolt C; 2nd. The use of the shoulders D, and E, on the axle clip yoke B; 3rd. The openings in draw jack F, and bolt C, in which the shaft coupler T, is inserted, being adapted for the admission of a crooked shaft coupler.

No. 6190. Ironing Board. (*Planche à repasser.*)

Jacob K. Butler, Yarmouth, N. S., 12th June, 1876, for 5 years.

Claim.—1st. In combination with the board A, the screw D; 2nd. The hinged adjustable support C, in combination with the board A; 3rd. The notches H, H, in combination with the frame B; 4th. The pins (t, G), and I, I, in combination with the adjustable support C; 5th. The iron stand E, clamp L, in combination with the screw D.

No. 6191. Bolt Cutter. (*Cisailles à boulons.*)

James Dawson, Greenwood, Ill., U. S., 12th June, 1876, for 5 years.

Claim.—The reversible jaw D, in combination with handle B, stirrup F, set screw e, and cam lever A.

No. 6192. Improvements on Overall Trousers.

(*Perfectionnements aux pantalons de voyage.*)

John L. Griffin, Eastport, Me., U. S., 12th June, 1876, for 5 years.

Claim.—1st. The provision of the elastic strap D, secured to the waist band; 2nd. The reinforcing elastic pieces C, secured at the bottom of the pocket slits; 3rd. The bib E, attached removably to the waist band of the overall, and having a steep F, for its support in wearing.

No. 6193. Draft Equalizing Harness,

(*Harnais régulateur de la traction.*)

Cornelius Cole, Castleton, Ont., 12th June, 1876, for 5 years.

Claim.—The draft equalizing bar A, having the U-shaped bars C, C, attached at each end to connect with the short tugs of the teams harness.

No. 6194. Apparatus for Burning Kerosine and other Oils in Lamps without Chimneys.

(*Appareil pour brûler la Kérosène et autres huiles dans les lampes sans cheminées.*)

Cornelius Godfrey, Huntington, N. Y., U. S., 12th June, 1876, for 5 years.

Claim.—1st. In combination with a lamp having an opening at or near the lower part thereof which connects with an air passage leading to the flame, a nozzle or nipple, of any suitable construction through which air is forced under pressure; the said nozzle being located at some distance below the said opening for the purpose of drawing into the lamp a column or columns of air from the atmosphere surrounding the lamp together with the jet of air emitted from the nozzle; 2nd. In combination with a lamp having an air passage which leads to the flame, and connects with an opening at the lower part of the lamp, the air pipe C, and a conical nozzle D, the said nozzle being secured to the said pipe C, and placed at some distance below the said opening; 3rd. An aerometer or air reservoir, the main portion of which is made from paper or paste board, and the top and bottom of which are secured respectively to covers o, and p, of wood or other unyielding material; 4th. In combination with the hinged sides q, q, and hinged tapering end pieces P, P, the flexible gussets m, m; 5th. The aerometer consisting of the top o, bottom p, hinged sides q, q, and tapering end pieces P, P, the said end pieces being connected with the main body o, by flexible gussets m, m; 6th. In an aerometer, the combination with the top o, bottom p, and hinged sides q, q, of the ribs s, s, and bars t, t; 7th. The method of increasing the brilliancy of the light of kerosene and other oil lamps by forcing oxygen gas through pipes to the lamps.

No. 6195. Improvements on Extension

Ladders. (*Perfectionnements aux échelles a rallonge.*)

Joseph Gagné and Jean B. Peloquin, Montreal, Que., 12th June, 1876, for 5 years.

Claim.—1st. The combination of the extendible legs a, i, and b, d; 2nd. The combination of the extendible legs a, i, and b, d, and pin c, arranged so that the said pin may be removed, and the legs either all used together, or the legs b, and d, used alone.

No. 6196. Improvements on a Car-Coupling.

(*Perfectionnements à un attelage de wagons.*)

Ninian H. Dolson, Chatham, Ont., 12th June, 1876, for 5 years.

Claim.—1st. The concave mouth piece B, either pressed from a sheet, welded, rivetted or otherwise fastened together so as to form a flaring mouth piece or buffer of wrought iron for the purpose of guiding the link into its place when it strikes it at an angle; 2nd. The pin C, and bent bar D, fastened on pin C, carrying rollers E, E; 3rd. In hinged bent lever F, in connection with bent bar D, and rollers E, E, also flat guide piece G, and mortises H, H, the flat guide piece being to keep the pin from turning as well as to aid by its weight in connection with pin C, bent bar D, and hinged bent lever F, to balance the link and hold it in a horizontal position always ready for coupling; 4th. The hook I, pieces J, and K, springs L, and M, and gate N, in connection with bent lever F, for the purpose of keeping the pin in position when raised up to uncouple, and for letting the pin drop when the link is inserted into the opening in mouth piece B; 5th. The side pieces o, o, bent in such a manner that when bolted together, they will fit tightly between top and bottom pieces P, P, for the purpose of strengthening them from unequal height of cars, the strain from bumping does not come in direct line with axis of coupling; the whole forming a complete automatic car-coupler which may be uncoupled from either side or from top of car.

No. 6197. Combined Cane and Umbrella

(*Canne-Parapluie.*)

Monroe M. Copp, Rochester, N. Y., U. S., 12th June, 1876, for 5 years.

Claim.—1st. The combination of the hollow handle or cane H, in two parts connected by the screw slip joint J, of any style of finish and covered with any material, having the threaded tube final F, provided with the sloped shoulder S, lug t, and screw plug P; 2nd. The screw rod D, to which is solidly joined the notch ring N, and the guide rod r, and having the horizontal groove v, in combination with the ribs B, stretchers t, and runner R; 3rd. The combination of the runner R, provided with the groove g, bent stretchers t, ribs B, guide rod r, and screw rod D, with the handle case H, having the slip screw joint J.

No. 6198. Improvements on Steam Engines for Economising Fuel.

(*Perfectionnements aux machines à vapeur pour économiser le combustible.*)

James Metcalfe, Edward Hamer and Richard Metcalfe, Aberystwith, Wales, 12th June, 1876, for 5 years.

Claim.—1st. The use and applications of Apparatus in connection with the blast pipe and injector for the purpose of utilizing the exhaust steam by returning it to the boiler with the feed water either in the form of steam or condensed and forming part of the feed water; 2nd. The use and application of apparatus in connection with the exhaust pipe or steam ports and the injector for the purpose of utilizing exhaust steam; 3rd. The use and application of apparatus in connection with the blast pipe or exhaust pipe and a steam feed pump for utilizing exhaust steam; 4th. The use and application of catch valve and back pressure valves; 5th. The use and applica-

tion of apparatus in connection with the injector or feed pump for supplying hot water to the boiler; 6th. The use and application of an extra combining cone in connection with the injector inserted above the ordinary lowest cone of the injector.

No. 6199. Improvements on Volta-Electric Appliances.

(*Perfectionnements aux appareils electro-voltaiques.*)

Johanna E. Hetherington, Cincinnati, Ohio, U. S. (Assignee of Isaac L. Pulvermacher), 12th June, 1876, for 5 years.

Claim.—1st. In voltaic bands formed of wire spun upon edge cords, the combination of a series of insulating buttons placed at intervals upon one face and a groove or indentation A, in the other face; 2nd. The construction of voltaic bands formed of wire spun upon edge cords, the gutta percha strips or cords B, B; 3rd. The construction of voltaic band formed of wire spun upon edge cords, the arrangement of two gutta percha cords or strips B, B, near the said edge cords and a third at the centre, or near the center of the width of the belt bearing pieces of porous absorbent material C, C; 4th. The pole plate consisting of two cheeks D, D, a tie c, and suitable hinge loops d, d, adapted to be folded and secured to the end of the band.

No. 6200. Improvements on Grates for Stoves and Furnaces.

(*Perfectionnements aux grilles de poeles et de fourneaux.*)

George W. Sweet, Julius F. Quimby and Samuel W. Perry (Assignees of William Morand), Troy, N. Y., U. S., 16th June, 1876, for 5 years.

Claim.—1st. The combination with the supporting bar B, of the stirrup B₁ and pivot block C, supported by trunnions from said stirrup, and having a central hole for supporting a grate; 2nd. The supporting bar B, screw thread bush D, supported from said bar directly or indirectly, and having a central opening n, for the pivot of the grate and recesses m, m, permitting a play of feathers n, of the pivot of the grate; 3rd. The grate A, having a central pivot for its rotation, and radial feathers z, z, and with holes or recesses b, or their equivalents made with its outer rim, screw-threaded bush D, provided with its recesses m, pivot block C, supported by trunnions from the supporting bar B, 4th. The combination with the pivot block C, pivoted with the stirrup B₁, of the stops o, o; 5th. The combination with the pivot block C, pivoted from the stirrup B₁, of the stop r.

No. 6201. Improvements in the Art of and in the Apparatus for Transmitting Musical Sounds Telegraphically.

(*Perfectionnement dans l'art et les appareils de transmission des sons musicaux telegraphiquement.*)

Elisha Gray, Chicago, Ill., U. S., 16th June, 1876, for 15 years.

Claim.—1st. The art of transmitting musical sounds telegraphically by reproducing such sounds at the receiving end of the line by means of a vibrating reed and a sounding box of corresponding pitch; 2nd. The combination of an electro-magnet, a vibrating reed and a sounding box of corresponding pitch united at the receiving end of an electric circuit; 3rd. The combination with an electric circuit of a series of electro-magnets, a series of vibrating reeds producing musical tones of different pitch and a series of correspondently tuned, sounding boxes, whereby each box is caused to sound its own note while rejecting all others; 4th. The vibrating reed constructed with parallel sides and recesses near its fixed end whereby its tendency to vibrate in unison with tones other than its own is prevented; 5th. The combination of an electro-magnet, a vibrating reed a sounding box of corresponding pitch and a local circuit breaking apparatus actuated by the vibrations of a column of air in said sounding box; 6th. The combination of a sounding box, the column of air contained in which is thrown into vibration by tones transmitted through an electric circuit, an adjustable box or chamber across which a diaphragm is stretched and a local circuit breaking mechanism mounted on said adjustable section; 7th. The combination of a sounding box, a diaphragm, a local circuit and a circuit breaking lever vibrating more slowly than the diaphragm, by which said local circuit is controlled.

No. 6202. Improvements on Driving Reins.

(*Perfectionnements aux guides de harnais.*)

Peter Nerney, Attleborough, and Benjamin S. Wright, Boston, Mass., U. S., 16th June, 1876, for 15 years.

Claim.—1st. The slide A, consisting of the frame a, the two small end bars b, b, and the thick or large central bar c; 2nd. In combination with the slide A, provided with cross-bars b, b, c, the rein B, looped or doubled on itself and passed through said slide.

No. 6203. Machine for Making Wires for Soda Water and other Bottles.

(*Machine à faire les fils metalliques pour les bouteilles à eaux gazeuses et autres.*)

Leonard Perrin, London, Ont., 16th June, 1876, for 5 years.

Claim.—The combination of points B, jaws E, E, arm F, threadle G, metallic spring H, jaws I, sliding jaws K, bits L, and levers C, D, J.

No. 6204. Improvement in Sash-holders.

(*Perfectionnement des arrêto-croisées.*)

Henry Lear and James F. Wilson, Simcoe, Ont., 16th June, 1876, for 5 years.

Claim.—The combination of the spring D, and the lever C.

No. 6205. Improvements on Advertising Devices.

(*Perfectionnements aux appareils de publicité.*)

Cullen W. Reed, Chagrin Falls, Ohio, U. S., 16th June, 1876, for 5 years.

Claim.—1st. The combination in a cylindrical frame supported upon a fixed axis, of a series of side panels tangentially connected with the frame for receiving and displaying characters, advertisements, &c.; 2nd. The com-

bination of a series of buckets for receiving currents of air with the cylindrical frame work constructed for displaying characters, advertisements, &c. and a central axis or standard for supporting the frame; 3rd. The combination with a cylindrical or polygonal shaped frame-work for displaying characters, advertisements, &c., of a rotary guard for conducting currents of air upon surfaces or buckets projecting laterally from the frame-work; 4th. The guard constructed with a concave receiving and conducting face and with a guide vane in combination with a cylindrical or polygonal shaped frame constructed for displaying characters, advertisements, &c.

No. 6206. Improvements in Steam Boilers.

(*Perfectionnements dans les chaudières à vapeur.*)

Joseph H. Killey and Walter Muirhead, Hamilton, Ont., 16th June, 1876, for 5 years.

Claim.—The combination of the receiver A, the circulating pipes B, and the collecting funnels C.

No. 6207. Improvements in Lamps.

(*Perfectionnements dans les lampes.*)

Grenville M. Stevens, Deering, Me., U. S., 16th June, 1876, for 5 years.

Claim.—A lamp made up and composed of the base d, stock e, the wooden cup or bowl f, the wooden top h, and metal receptacle a, the said receptacle a, being attached to the cover or top b, by the metallic neck c, held suspended in the cup f, from said wooden cover b, and removable from the cup f, with said top h.

No. 6208. Sap Spout. (*Tuyau de sucrerie.*)

Hiram A. Lawrence, East-Farmham, Que., 16th June, 1876, for 5 years.

Claim.—1st. A sap spout having its holding or fastening point above, in rear of, and independent of the channel whereby weight of bucket suspended to it will not only retain the spout in position but restore it to place when dislodged; 2nd. In combination with any sap spout a purchase hook to secure it to the tree; 3rd. In combination with any sap spout the purchase hook D, having longitudinal edge or heel d₁, and transverse upper edge or horn d₂; 4th. A sap spout having its rear end provided for three-fourths of its circumference with a sharp edge arranged to slightly enter into the bark of the tree for the purpose of preventing leakage; 5th. The combination of the trough A, the turned up end B, and purchase hook D.

No. 6209. Mechanism for Propelling Wheeled Vehicles and Boats.

(*Appareil de propulsion des voitures à roues et des bateaux.*)

Marmaduke Mathews, Toronto, Ont., 16th June, 1876, for 5 years.

Claim.—1st. The toothed quadrant plates E₁ and D₁, pivoted on the standard B₁, or at any other convenient point and provided with the levers E₂ and D₂, in combination with the toothed wheels F, loosely mounted on the axle or shaft A; 2nd. The toothed wheels F, pivoted with the spring pawl H, in combination with the ratchet wheel G, on the axle or shaft B; 3rd. The axle or shaft A, constructed in two pieces and provided with the clutch coupling A₁.

No. 6210. Portable Bath. (*Baignoire portative.*)

Arnold Seligsberg, New-York, U. S., 16th June, 1876, for 5 years.

Claim.—1st. A bath tub composed of a flexible body A, and a skeleton supporting frame B, C, D, E; 2nd. The combination with the flexible body A, of the head and foot braces B, C, and interposed side braces D; 3rd. The combination with the side props or supports E, of the cross heads or T-pieces G, for the connection of the upper frame of the bath tub with said props; 4th. The combination with the flexible folding tub body A, and its head brace B, of the air cushion or pillow N.

No. 6211. Improvements in Nailing Machines.

(*Perfectionnements aux machines à clouer.*)

Charles T. Brandon, Toronto, Ont., 16th June, 1876 for 5 years.

Claim.—1st. The face plate D, provided with the side flanges D₁ and D₂, and adjustable bevelled stops D₃, in combination with the hammer B; 2nd. The form E, provided with the adjustable gauge pieces F, F, and filling piece E₃; 3rd. In combination with the form E, and hammer B, the sliding blocks G, E₁, and strap E₂; 4th. The pivoted clamping irons K, K, with pressure bar K₂, in combination with the form E, provided with the adjustable set screws L, and springs L₁; 5th. The dies G₂ finished with a bevelled face on the underside to correspond with cap of the wash-board; 6th. The stop brackets I, in combination with the die boxes G₃; 7th. The spring cap holder M, in combination with the bevelled dies G₂, and stop-brackets I; 8th. Punch-blocks J₂, provided with the projecting arm J₃, and fitted with the punches J₄, whose points are finished on a bevel to correspond with the cap in combination with the double die boxes G₂, and bar G₁; 9th. The combination of the spring cap holder M, with spring N, and pressure bar K₂; 10th. The combination of the hammer B, with face plate D, and notched table B₁, form E, sash C, clamping irons K, die boxes G, and G₃, and punch blocks J, and J₂.

No. 6212. Improvements on a Churn.

(*Perfectionnements à une barattelle.*)

William H. Hoyt, St. John, N. B., 16th June, 1876, for 5 years.

Claim.—1st. The combination of the dasher and air tube C; 2nd. The combination with the dasher and air tube C.

No. 6213. Improvements in Gang Ploughs.

(*Perfectionnements aux charrues à socs multiples.*)

Archibald Filshie, Elora, Ont., 16th June, 1876, for 5 years.

Claim.—1st. A plough head provided with a double tenon B, B, having projecting side flanges B, B; 2nd. The filling rib or web piece A₁, projecting forward of the usual position of the head of the plough; 3rd. The combination and arrangement of the bars E, E₁, and E₂, braces F, F₁, F₂, and tenons B, B; 4th. The pivoted lever J, connecting rods I, and I₁, in combination with the crank shafts G₂, G₂, provided with the radial arms H, H.

List of Patents issued up to 22nd July, 1876, but not yet Officially published in the Patent Office Record.

- No. 6340. W. S. Mend, San Francisco, California, U. S. A., "Journals and Boxes," 20th July, 1876.
- No. 6341. W. H. Solomon, Stukely, Que., "Stone Lifter," 21st July, 1876.
- No. 6342. E. Metcalf, Port Huron, Mich., U. S. A., "Window Shade and Blind," 21st July, 1876.
- No. 6343. W. S. Worton Indianapolis, Indiana, U. S. A., "Office Desk," 21st July, 1876.
- No. 6344. L. Graf, Newark, New Jersey U. S. A., "Heel and Sole Polishing Machine," 21st July, 1876.
- No. 6345. G. W. Hunter, J. P. Norris, F. L. Chase, Philadelphia, Penn., U. S. A., and H. M. Baker, Washington, U. S. A., "Lifting Jack," 21st July, 1876.
- No. 6346. A. J. Reynolds, Chicago, Ill., U. S. A., "Fruit and Vegetable Evaporator," 21st July, 1876.
- No. 6347. A. Brittain, Montreal, Que. "Sewer Cradle Rib," 21st July, 1876.
- No. 6348. J. C. Mitchell and C. W. Roby, Lancaster, N. Hamp, U. S. A. "Car-Coupler," 21st July, 1876.
- No. 6349. G. Haworth, Saint Michaels Hamlet, Lancaster Co., England, (Assignee of R. J. Ellis, Liverpool, England), "Water Circulating Fire Bar and Bearer," 21st July, 1876.
- No. 6350. J. Collins & W. O'Connor, Guelph, Ont., "Stop Cock," 21st July, 1876.
- No. 6351. P. A. Peer, Comstock, Mich., U. S. A., "Barn-Door Fastening," 21st July, 1876.
- No. 6352. J. T. Averill, St. Paul Minn., U. S. A., "Paper Pulp Process," 21st July, 1876.
- No. 6353. D. Drill, Spring, Penn., U. S. A., "Nut Lock," 21st July, 1876.
- No. 6354. J. Nearing, Sherburn, N. Y., U. S. A., "Wine and Cider Press," 21st July, 1876.
- No. 6355. A. Schmitt, Williamsburgh, N. Y., U. S. A., "Garbage and Street Refuse Receptacle," 21st July, 1876.
- No. 6356. W. T. J. Timers, New York, U. S. A., M. C. Jeffers, New-York, E. T. Beecher, Brooklyn, N. Y., and A. P. Armstrong, New York, U. S. A., "Disinfecting Ship Ventilator and Fog Alarm," 21st July, 1876.
- No. 6357. H. Aitken, Talkirk, Scotland, and W. Young, Clippens, Scotland, "Illuminating Gas Process," 21st July, 1876.
- No. 6358. H. Parly, Burlington, Iowa, U. S. A., "Heat Extracting Apparatus," 21st July, 1876.
- No. 6359. S. W. Wardwell, Jr., G. W. Shaw, and H. Menown, St. Louis, Min., U. S. A., "Sewing Machine," 21st July, 1876.
- No. 6360. J. Stevens, Port Byron, N. Y., U. S. A., "Paper Vessel," 21st July, 1876.
- No. 6361. O. Jenness, Boston, Mass., U. S. A., "Brush Handle," 21st July, 1876.
- No. 6362. L. J. Hewitt, Toronto, Ont. "Illuminator," 21st July, 1876.
- No. 6363. J. W. Hiatt and W. F. Beck, Iowa Falls, Iowa, U. S. A., "Dumping-Box," 21st July, 1876.
- No. 6364. T. Ramsay, (Assignee of J. B. Orr, Glasgow, Scotland), "White Enamel Paint," (Extension of No. 4032,) 21st July, 1876.
- No. 6365. T. Ramsay, (Assignee of J. B. Orr,) Glasgow, Scotland, "White Enamel Paint," (Extension of No. 4032,) 22nd July, 1876.

INDEX OF INVENTIONS.

Advertising devices, C. W. Reed 6205
 Air carburetting, J. F. Barker..... 6131
 Anchors, T. J. Whitecar and J. M. Powell..... 6179
 Axle boxes, W. G. Beattie..... 6095
 Baking oven, H. L. Parkin..... 6137
 Ballasting car, J. W. McDonald..... 6130
 Bark, tan, J. Sherman..... 6122
 Barrel machinery, S. Wallace..... 6141
 Bath, A. Sellgsberg..... 6210
 Boats, propelling, M. Mathews..... 6208
 Boilers, steam, H. F. King..... 6097
 Bolt cutter, J. Dawson..... 6191
 Boot lacing, C. Monahan and J. Valpey..... 6185
 " sewing, C. Goodyear..... 6161
 " and shoes, J. E. Wheeler..... 6158
 Bottles, wires for, L. Perrin..... 6203
 Bridge beams, P. Bilyen..... 6092
 Bucket, pump, W. B. Wilcox..... 6146
 Buggies, shafts, W. M. Wilcox..... 6189
 Butter workers, J. Mcneec..... 6167
 Cane, M. M. Copp..... 6197
 Car, ballasting, J. W. McDonald..... 6130
 Carburetting air, J. F. Barker..... 6131
 Car-coupler, J. King..... 6133
 " J. C. Mitchell and C. W. Roby..... 6186
 Car-coupling, G. W. and A. D. Green..... 6110
 " N. H. Dolson..... 6196
 Carriage rugs, J. Milwain..... 6177
 " shafts, W. M. Wilcox..... 6189
 Cars, refrigerator, J. H. Wickes..... 6148
 Carls, hand, J. M. Jones..... 6162
 Churn, W. H. Hoyt..... 6212
 Clothes dryers, N. P. Dion..... 6136
 " ironing, A. Gibeau..... 6093
 Coffee pots, G. W. Hubbard..... 6125
 Condensers, ejector, J. F. Guthrie..... 6096
 Copper ores, T. H. Cobley and J. A. Dixon..... 6152
 Cotton, separating wool from, L. R. and C. F. Broadbent... 6089
 Cracker machine, D. M. Holmes..... 6163
 Cradle, grain, C. P. Kelsey and J. L. Muller..... 6117
 Cultivators, W. Green..... 6109
 Cutters, roof, N. and T. Aubut..... 6105
 Dogs, logging, O. H. Smith..... 6127
 Dryers, clothes, N. P. Dion..... 6136
 " paint, O. Russell..... 6128
 Ejector condensers, J. E. Guthrie..... 6096
 Electric appliances, J. E. Hetherington..... 6180 6181
 Fabrics, textile, S. Van Benschoten..... 6129
 Fare registering, H. T. Davls..... 6175
 Filtering medium, G. B. Stock and A. F. McPherson..... 6159
 Fire places, A. A. Puz..... 6165
 Food composition, J. L. Johnston..... 6104
 Furnace, blast, A. Smith..... 6103
 " puddling..... 6098
 " charcoal, F. G. Adams..... 6173
 " &c, grates for, G. W. Swett, J. F. Quimby and S. W. Perry..... 6200
 " or stoves, E. Hawkes..... 6153
 Gas regulator, C. H. Edwards and L. Laflin..... 6129
 Glasses, eye, I. Alexander..... 6172
 Grain cradle, C. P. Kelsey and J. L. Muller..... 6117
 Grates for stoves, &c., G. W. Swett, J. F. Quimby and S. W. Perry..... 6200
 Grouts preparation, M. Tindale..... 6140
 Hair restorer, J. McCormack..... 6091
 Harness, C. Cole..... 6193
 Hoop cutting, G. V. Griffin..... 6171
 Horse shoe, H. H. Gilmore..... 6166
 " J. O'Sullivan..... 6155
 Ironing clothes, A. Gibeau..... 6095
 " board, J. K. Butler..... 6190
 Kerosene, &c., C. Godfrey..... 6194
 Ladders, J. Gagné and J. B. Peloquin..... 6195
 Lamps, C. Godfrey..... 6191
 " G. M. Stevens..... 6207
 " R. H. Webb..... 6143
 Lifting weight, C. O. Brown..... 6149
 Lock, J. A. Quessel..... 6100
 " R. P. Goucher..... 6125
 " J. Burge..... 6184
 Logging dogs, O. H. Smith..... 6127

Maps, charts, &c., J. Brown..... 6155
 Medicinal composition, J. L. Johnston..... 6101
 Milk cooler, N. D. Ferguson..... 6174
 Musical sounds, transmitting, E. Gray..... 6201
 Nailing machine, C. T. Brandon..... 6211
 Nut locks, S. Braunson..... 6157
 Ores, copper, T. H. Cobley and J. A. Dixon..... 6152
 " re-tueing, A. Smith..... 6103
 Oven, baking, H. L. Parkin..... 6137
 Pad, bosom, J. C. Tallman and F. W. Sullivan..... 6178
 Paint dryers, O. Russell..... 6128
 Pipes, tobacco, M. Thomson..... 6106
 Pistons and valves, W. J. Beattie..... 6091
 Plating machine, S. J. Anderson..... 6090
 Planing, wood, C. H. Warren..... 6183
 Planters and ploughs, J. Fay and W. Chalmers..... 6151
 Plate lifter, D. M. Skinner and E. Goud..... 6099
 Ploughs, gang, R. Filshie..... 6213
 Pulp, wood, J. W. Bowers and D. A. Curtis..... 6145
 Pump bucket, W. B. Wilcox..... 6146
 " W. McGuire..... 6160
 Pyrites, copper, T. H. Cobley and J. A. Dixon..... 6152
 Railroad coupling, G. W. and A. D. Green..... 6110
 Railway coupler, J. King..... 6133
 " J. C. Mitchell and C. W. Roby..... 6186
 " coupling, N. H. Dolson..... 6196
 " signals, T. Sills..... 6114
 Rake, horse, C. Lundy and G. Blake..... 6187
 " D. P. Sharp..... 6120
 Refrigerators, E. L. Golds..... 6126
 Reins, driving, P. Nerney and B. S. Wright..... 6202
 Restorer hair, J. McCormack..... 6091
 Robes, lap, J. Milwain..... 6176
 Roofs, metallic, J. Power..... 6115
 Root cutters, N. and T. Aubut..... 6105
 Rugs, carriage, J. Millwain..... 6177
 Sap spout, H. A. Lawrence..... 6208
 Sash-holders, H. Lear and J. F. Wilson..... 6204
 Saw clamps, E. B. Cady..... 6142
 " gummers, M. O. Smith..... 6132
 " mill dogs, J. A. Fordon and J. E. Thomas..... 6147
 " sharpening, R. Hennesch and L. Beyer..... 6118
 Screws, wood, E. A. Leland..... 6161
 Seeding machines, P. Milne..... 6113
 Sewing machine, J. E. Wheeler..... 6119
 " J. C. Burton..... 6108
 " boot, C. Goodyear, jr..... 6161
 Shovel, ditch, L. Guyon..... 6151
 Signals, railway, T. Sills..... 6114
 Skates, P. D. Hedderwick..... 6144
 Soda water bottle, L. Perrin..... 6203
 Sole channelling, J. E. Wheeler..... 6155
 Spring equalizers, W. Smith and J. W. Rouse..... 6129
 Stand for maps, &c., J. Brown..... 6155
 Steam boilers, H. F. King..... 6097
 " J. H. Killey and W. Muirhead..... 6206
 " engine, H. D. Dunbar and J. M. Foss..... 6112
 " J. and E. Metcalf and E. Hamer..... 6185
 " governor, J. E. Wilson..... 6150
 Stone, artificial, W. H. Smith..... 6162
 Stools, &c., legs of, C. E. Haynes..... 6088
 Stoves or furnaces, E. Hawkes..... 6153
 " &c., grates for, G. W. Swett, J. F. Quimby and S. W. Perry..... 6200
 Strainers, liquid, H. Hassenpflug..... 6124
 Tables, &c., legs of, C. E. Haynes..... 6088
 Tackle blocks, F. S. Barr..... 6188
 Tallies, J. French..... 6170
 Tan bark, J. Sherman..... 6121
 Telegraph, harmonic, E. Gray..... 6101
 " G. Allan and J. W. Brown..... 6156
 Textile fabrics, S. Van Benschoten..... 6121
 Trowsers, overall, J. L. Griffin..... 6192
 Tube wells, D. H. Zavitz and E. Milner..... 6182
 Umbrella, M. M. Copp..... 6197
 Valve, safety, E. B. Kunkle..... 6124
 " and pistons, W. G. Beattie..... 6094
 " oscillating, J. Fairburn..... 6107
 Vehicle, propelling, M. Mathews..... 6209
 Veneer cutting, H. T. Bartlett..... 6123
 Volta-electric appliance, J. E. Hetherington..... 6180 6181
 Weights, lifting, C. O. Brown..... 6149
 Well, walling, A. Moore..... 6116
 " tube, D. H. Zavitz and E. Milner..... 6182
 Wood planing, C. H. Warren..... 6184
 " pulp, W. Bowers and D. A. Curtis..... 6145
 Wool from cotton, separating, L. R. and C. F. Broadbent... 6099

INDEX OF PATENTEES.

Adam, Edwin G. charcoal furnaces.....	6173
Alexander, Isaac, eye glasses.....	6172
Allen, G., and J. W. Brown, telegraph.....	6156
Auderson, Samuel J., plaiting machine.....	6090
Aubut, N. and T., root cutters.....	6105
Barber, Lyman L., sewing machine.....	6119
Barker, John F., air carburettng.....	6131
Hartlett, Henry T., veneer cutting.....	6125
Beattie, William G., valves and pistons.....	6094
" " axle boxes.....	6095
Benschoten, Samuel Van, textile fabrics.....	6121
Beyer, L., and R. Hensch, saw sharpening.....	6118
Blyen, Peter, bridge beams.....	6092
Blake, G., and C. Lundy, horse rake.....	6157
Bowers, I. W., and D. A. Curtis, pulp.....	6145
Brandon, Charles T., nailing machines.....	6211
Broadbent, C. F. and L. R., separating wool, &c.....	6059
Brown, Charles O., lifting weights.....	6149
Brown, James, map stand.....	6155
Brown, J. W., and G. Allan, telegraphs.....	6156
Branson, Sterne, nut locks.....	6157
Burge, John, chronometric locks.....	6151
Burr, Frederick S., tackle blocks.....	6158
Barton, John C., sewing machines.....	6108
Butler, Jacob K., ironing board.....	6190
Cady, Edson B., saw clamps.....	6112
Chalmers, W., and J. Fay, ploughs.....	6154
Cobley, T. H., and J. A. Dixon, copper ores.....	6152
Cole, Cornelius, harness.....	6193
Copp, Monroe M., cane-umbrella.....	6197
Curtis, D. A., and I. W. Bowers, pulp.....	6145
Cuthbertson, James W., refrigerators.....	6126
Daucel, Christian, boot sewing machine.....	6168
Dargan, James, sole channelling.....	6155
Davis, Henry T., face registering.....	6175
Dawson, James, bolt cutter.....	6191
Dion, Napoleon P., clothes dryers.....	6136
Dixon, J. A., and T. H. Cobley, copper ores.....	6152
Doison, Ninian H., car-coupling.....	6196
Dunbar, H. D., and J. M. Foss, steam engine.....	6112
Edwards, C. H., and L. Laffin, gas regulator.....	6139
Ealrburn, John, oscillating valves.....	6107
Fay, J., and W. Chalmers, ploughs.....	6154
Ferguson, Nelson D., milk pan.....	6174
Filshie, Archibald, ploughs.....	6213
Fordon, J. A., and J. E. Thomas, saw-mill dogs.....	6147
Foss, J. M., and H. D. Dunbar, steam engine.....	6112
French, John, tallies.....	6170
Gagot, J., and J. B. Peloquin, ladders.....	6195
Gibeau, Adolphe, ironing board.....	6093
Gilmore, Henry H., horse shoe machines.....	6166
Godfrey, Cornelius, lamps.....	6194
Goodyear, Charles, Jr., boot sewing machine.....	6164
Goold, Edward L., refrigerators.....	6126
Goucher, Robert B., combination lock.....	6125
Gould, E., and D. M. Skinner, plate-lifter.....	6099
Gray, Elisha, harmonic telegraph.....	6101
Green, A. D. and G. W., car-coupling.....	6110
Green, William, cultivators.....	6109
Griffith, George V., hoop cutting.....	6171
Griffin, John L., trousers.....	6192
Guthrie, James F., ejector condensers.....	6096
Guyon, Louis, ditch shovel.....	6151
Hamer, E., and J. and E. Metcalf, steam engines.....	6185
Hastepflug, Henry, liquid strainers.....	6124
Haynes, Cornelius E., legs of tables, &c.....	6088
Hawkes, Ezra, stoves or furnaces.....	6153
Hedderwick, Percy D., skates.....	6144
Hensch, R., and L. Beyer, saw sharpening.....	6118
Hetherington, John E., volta electric appliances.....	6150
Hoyt, William H., churn.....	6212
Holmes, Daniel M., cracker machines.....	6163

Hubbard, George W., coffee pots.....	6133
Johnston, John L., composition of matter.....	6104
Jones, Joseph M., hand carts.....	6162
Kelsey, C. P., and J. L. Multer, grain cradle.....	6117
Kitley, J. H., and W. Muirhead, steam boilers.....	6206
King, Henry F., steam boilers.....	6097
" " Joseph, car-coupler.....	6133
Kunkle, Erastus B., safety valve.....	6134
Laffin, L., and C. H. Edwards, gas regulator.....	6139
Lawrence, Hiram A., sap spout.....	6208
Lear, H., and J. F. Wilson, sash-holders.....	6204
Leand, Edwin A., wood screws.....	6161
Lui dy, C., and G. Blake, horse rake.....	6187
McCaskey, John, combination lock.....	6125
McCormack, James, hair restorer.....	6091
McDonald, James W., ballasting car.....	6130
McGuire, William, service and fore pumps.....	6160
McPherson, A. F., and G. B. Stock, filtering me.	6159
Macnee, James, butter workers.....	6167
Mathews, Marmaduke, propelling vehicles.....	6209
Metcalf, E. and J., and E. Hamer, steam engines.....	6198
Milne, Peter, seedling machines.....	6113
Milner, E., and D. H. Zavitz, tube wells.....	6182
Milwain, James, lap robes.....	6176
" " carriage rugs.....	6177
Mitchell, J. C., and C. W. Roby, car-coupler.....	6186
Monahan, C., and J. Valpey, boot lining.....	6185
Moore, Azariah, walling wells.....	6116
Multer, J. L., and C. P. Kelsey, grain cradle.....	6117
Nerney, P., and H. S. Wright, driving reins.....	6202
O'Sullivan, Jeremiah, horse shoes.....	6138
Parkin, Henry L., baking oven.....	6137
Perrin, Leonard, wirs for bottles.....	6203
Perry, S. W., G. W. Swett and J. F. Quimby, grates.....	6200
Peloquin, J. B., and J. Gagot, ladders.....	6195
Powell, J. M., and T. J. Whitecar, anchors.....	6179
Power, John, metallic roofs.....	6115
Pulvermacher, Isaac L., volta electric appliances.....	6180
Putz, Andrew A., fire places.....	6185
Queuel, Joseph A., safety lock.....	6100
Quimby, J. F., S. W. Perry and G. W. Swett, grates.....	6200
Reed, Cullen W., advertising devices.....	6205
Roby, C. W., and J. C. Mitchell, car-couplers.....	6186
Rouse, J. W., and W. Smith, spring equalizers.....	6129
Russell, Oscar, paint dryers.....	6188
Sellgsberg, Arnold, bath.....	6210
Sharp, Dennis P., horse rakes.....	6120
Sherman, Jonathan, tan bark.....	6122
Sills, Thomas, railway signals.....	6114
Skinner, D. M., and E. Gould, plate lifter.....	6099
Smith, manias, puddling furnace.....	6083
" " blast.....	6193
" " Marvin O., saw gummers.....	6132
" " Otis H., logging dogs.....	6127
" " William H., artificial stone.....	6169
" " W., & J. W. Rouse, spring equalizers.....	6129
Stevens, Grenville M., lamps.....	6207
Stock, G. H., and A. F. McPherson, altering medium.....	6159
Sullivan, F. W., and J. C. Tallman, bosom pad.....	6178
Swett, G. W., J. F. Quimby and S. W. Perry, grates.....	6200
Tallman, J. C., and F. W. Sullivan, bosom pad.....	6178
Thomas, J. E., and J. A. Fordon, saw-mill dogs.....	6147
Thompson, Mark, tobacco pipes.....	6106
Tindale, Mathew, preparation of groats.....	6140
Valpey, J., and C. Monahan, boot lining.....	6185
Van Benschoten, Samuel, textile fabrics.....	6121
Wallace, Samuel, barrel machinery.....	6141
Warren, Charles H., wood planting.....	6183
Webb, Robert H., lamps.....	6143
Wheeler, John E., sewing machine.....	6119
" " sole channelling.....	6155
Whitecar, T. J., and J. M. Powell, anchors.....	6179
Wickes, James H., refrigerator cars.....	6145
Wilcox, William B., pump bucket.....	6146
" " M., carriage shafts.....	6189
Wilson, John E., steam governor.....	6150
" " J. F., and H. Lear, sash holders.....	6204
Wright, B. S., and P. Nerney, driving reins.....	6202
Zavitz, D. H., and E. Milner, tube wells.....	6182

THE CANADIAN PATENT OFFICE RECORD.

ILLUSTRATIONS.

Vol. IV.

JULY, 1876.

No. 7.

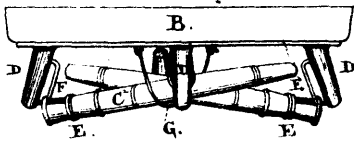

6088 Haynes' Improvements in the Legs of Stools, Tables, &c.

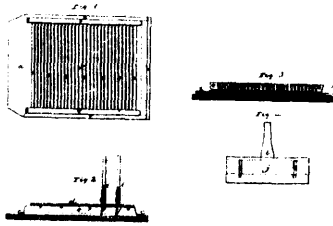

6090 Anderson's Improvements on Plaiting Machines.

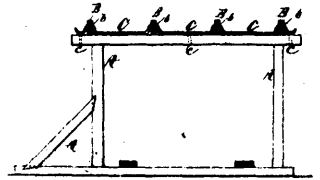

6092 Bilyen's Binding Rods for Bridge Beams.

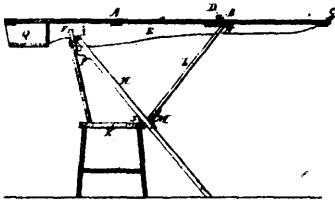

6093 Gibeau's Clothes Ironing Board.

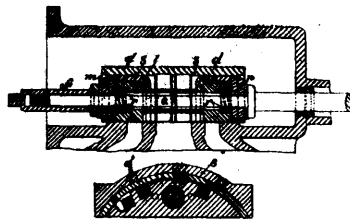

6094 Beattie's Improvements on Slide Valves and Pistons.

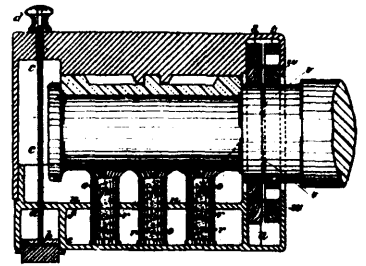

6095 Beattie's Improvements on Axle Boxes.

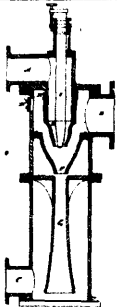

6096 Guthrie's Improvements on Ejector Condensers.

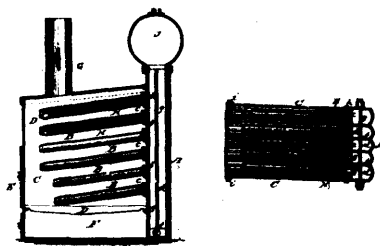

6097 King's Improvements on Steam Boilers.

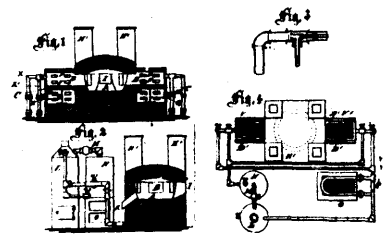

6098 Smith's Puddling Furnace.

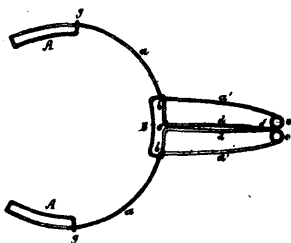

6099 Skinner's Plate Lifter.

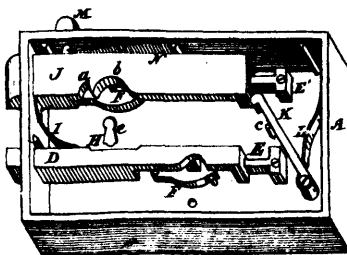

6100 Quesnel's Safety Lock for Houses of Detention.

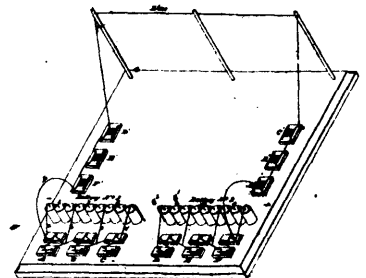

6101 Gray's Electro-harmonic Telegraph.

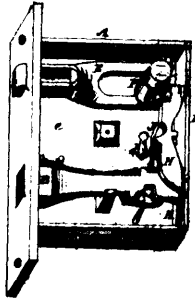

8102 Quesnel's Safety Lock.

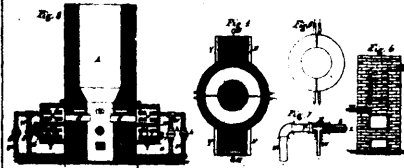

8103 Smith's Blast Furnace for Reducing Ores.

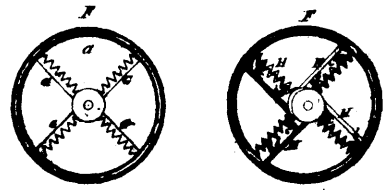

8105 Aubit's Improvements on Root-cutters.

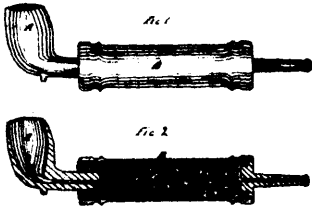

8106 Thomson's Improvements on Tobacco Pipes.

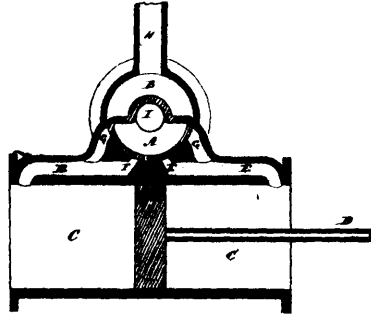

8107 Fairburn's Improvements on Oscillating Valves.

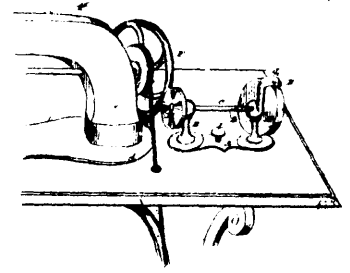

8108 Burton's Improvements on Sewing Machines.

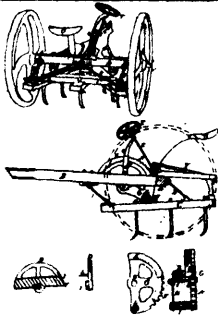

8109 Green's Improvements on Cultivators.

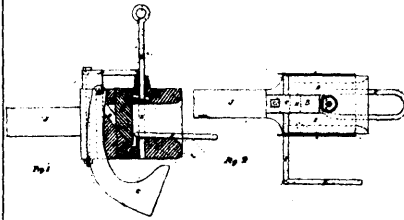

8110 Green's Railroad Car-coupling.

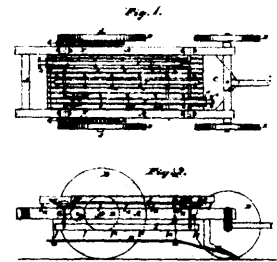

8111 Kealy's Improvements on Potato-diggers.

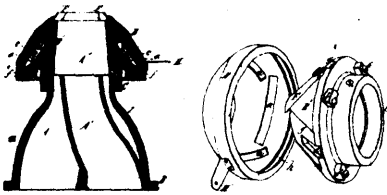

8112 Dunbar & Foss' Improvements on Steam Engine Exhausts.

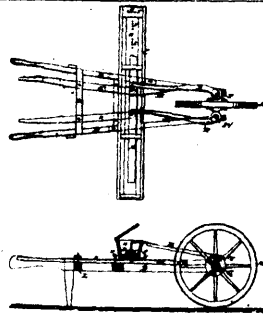

8113 Milne's Improvements on Seeding Machines.

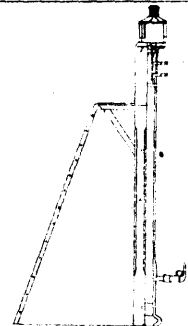

8114 Sills' Improvements in Railway Signals.

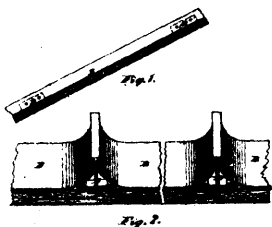

8115 Power's Improvements on Metallic Roofs.

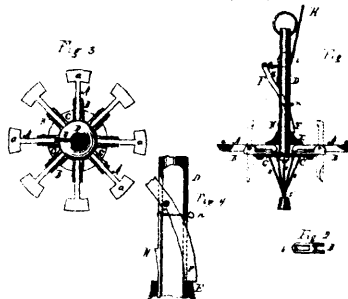

8116 Moore's Apparatus for Walling Wells.

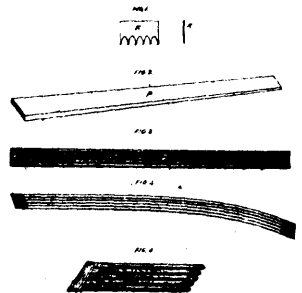

8117 Kelsey's Manufacture of Grain Cradle Fingers.

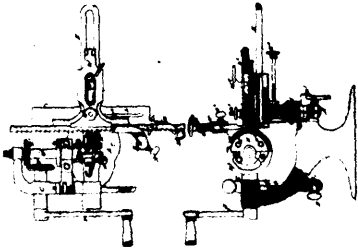

6118 Hensch & Beyer's Saw Sharpening and Setting Machine.

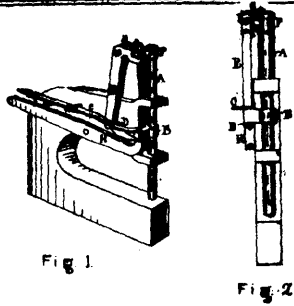

6119 Wheeler's Wax Thread Sewing Machine.

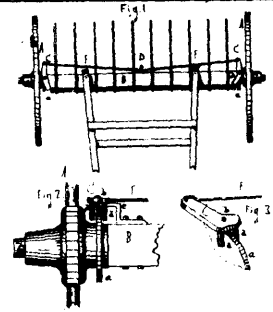

6120 Sharp's Improvement on Horse Rakes.

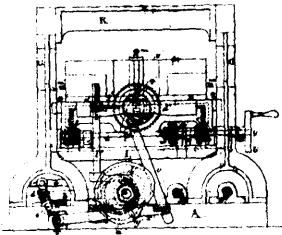

6123 Bartlett & Reed's Veneer Cutting Machine.

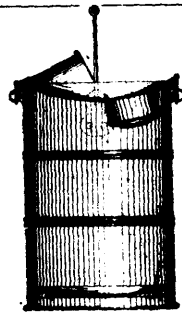

6124 Hassempflug's Improvements on Liquid Strainers.

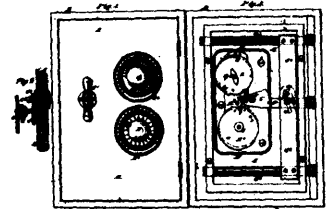

6125 McCaskey's Combination Lock.

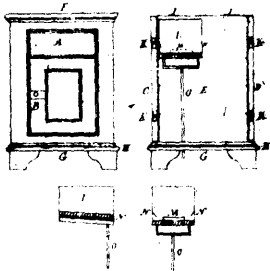

6126 Cuthbertson's Improvements on Refrigerators.

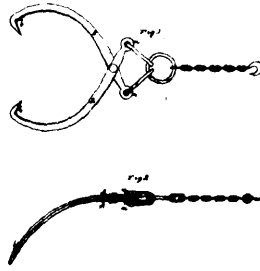

6127 Smith's Improvements on Logging Dogs.

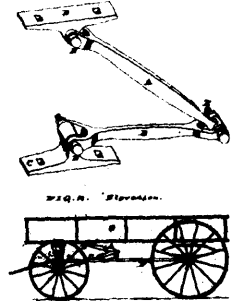

6129 Smith & Rouse's Improvements in Spring Equalizers.

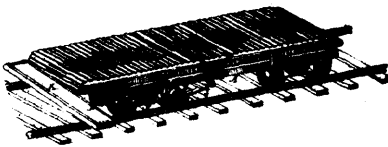

6130 McDonald's Self-discharging Ballasting Car.

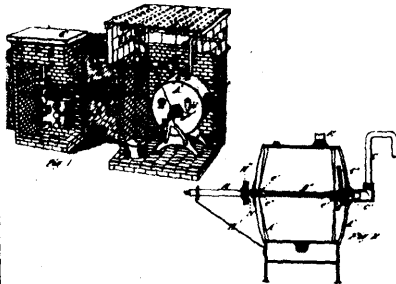

6131 Barker's Air Carburetting Apparatus.

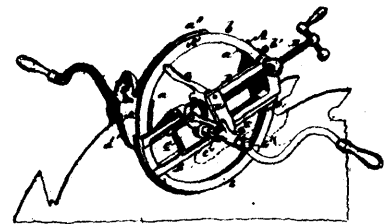

6132 Smith's Improvements on Saw-gummers.

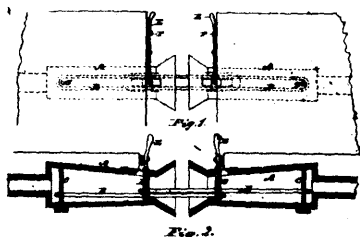

6133 King's Car-coupler.

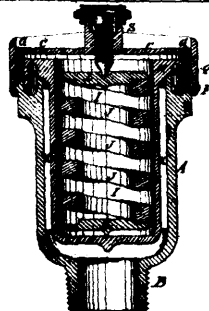

6134 Kunkle's Safety Valve.

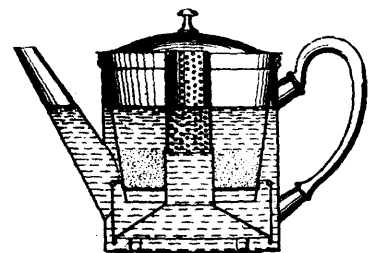

6135 Hubbard's Improvements on Coffee Pots.

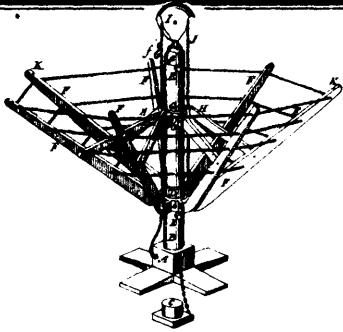

6136 Dion's Improvements on Clothes Dryers.

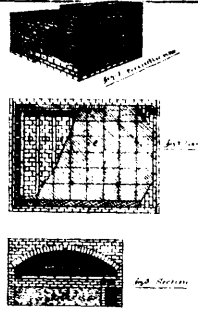

6137 Parkin's Oven for Baking Bread, Biscuit, &c.

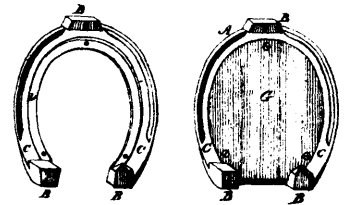

6138 O'Sullivan's Improvements on Horse Shoes.

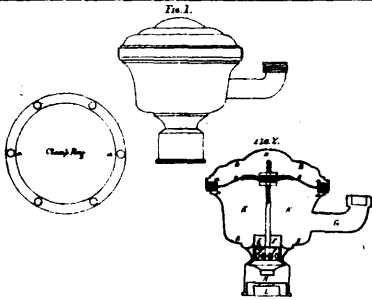

6139 Edwards' Gas Regulator.

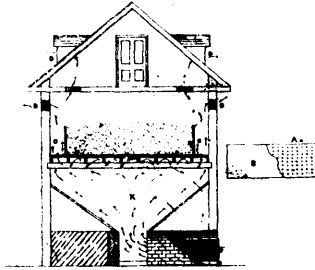

6140 Tindale's Process and Compound Preparation of Groats.

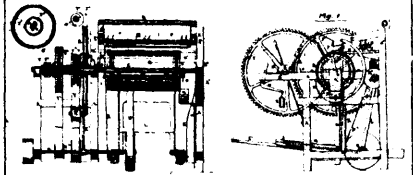

6141 McEachern's Improvements in Barrel Machinery.

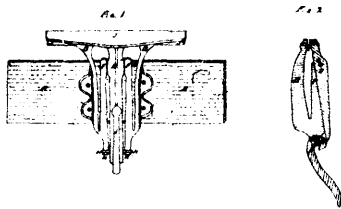

6142 Cady's Improvements on Saw-clamps.

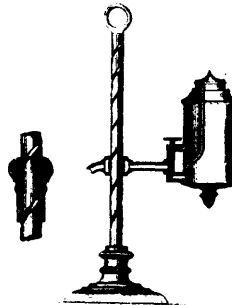

6143 Webb's Improvements on Fountain Lamps.

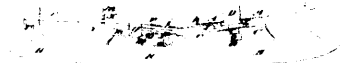

6144 Hedderwick's Improvements on Skates.

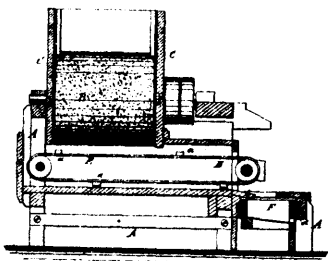

6145 Bowers & Curtis' Manufacture of Dry Wood Pulp.

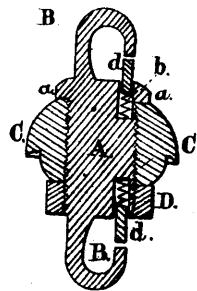

6146 Wilcox's Chain Pump Bucket.

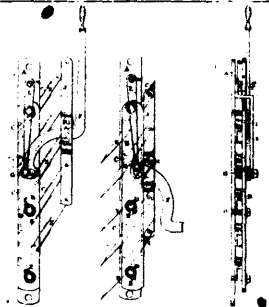

6147 Fardon & Thomas' Improvements on Saw-mill Dogs.

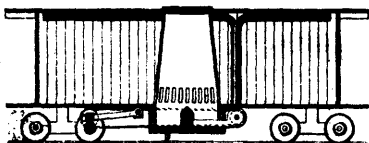

6148 Wickes' Improvements on Refrigerator Cars.

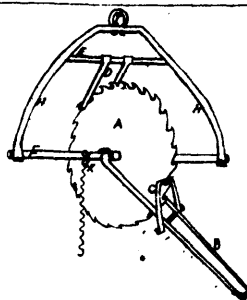

6149 Brown's Machine for Lifting Heavy Weights.

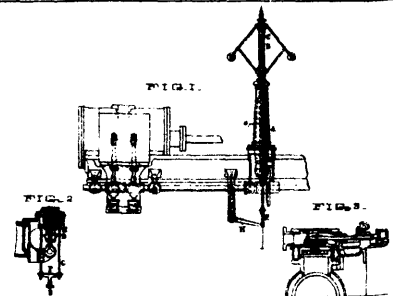

6150 Wilson's Steam Engine Governor.



6151 Guyon's Ditch Shovel.

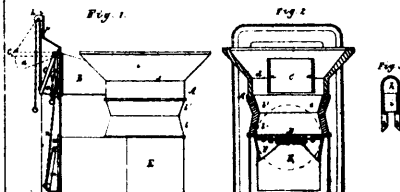

6153 Hawkes' Improvements on Stoves or Furnaces.

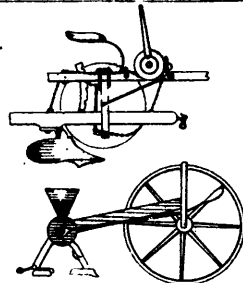

6154 Fay & Chalmers' Improvements on Ploughs and Planters.

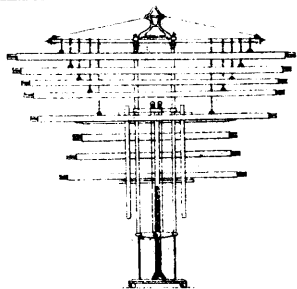

6155 Browne's Stand for Displaying Maps, Charts, &c.

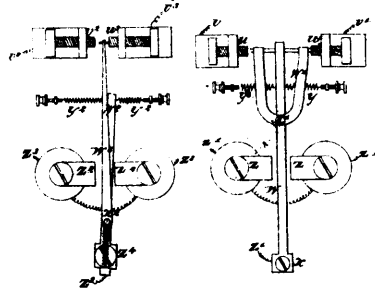

6156 Allan & Brown's Improvements in Electric Telegraphs.

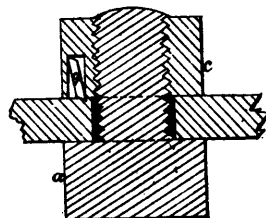

6157 Brunson's Improvements in Nut Locks.

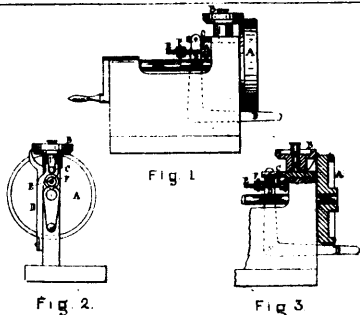

6158 Wheeler's Sole Channelling Machine.

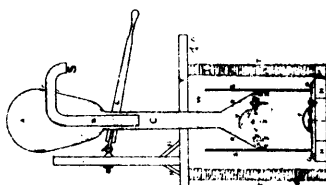

6160 McGuire's Improvements on Service and Force Pumps.

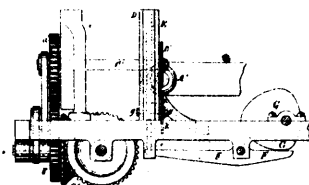

6161 Leland's Improvements on Wood-screws, &c.

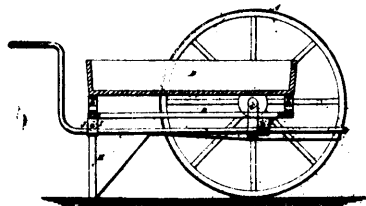

6162 Jones' Improvements on Hand-carts.

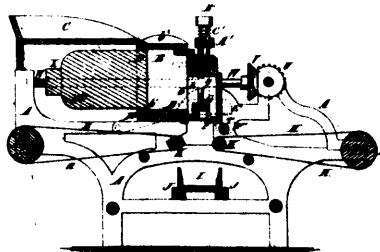

6163 Holmes' Improvements on Cracker Machines.

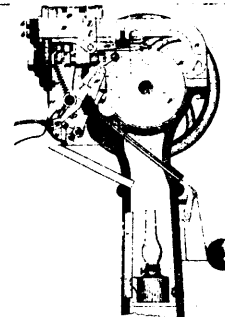

6164 Goodyear's Boot and Shoe Sewing Machine.

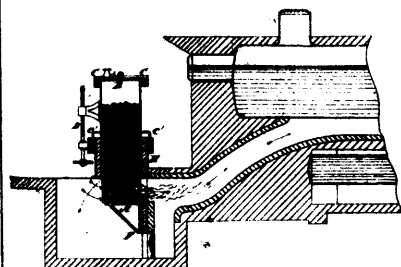

6165 Putz's Improvements on Fire Places.

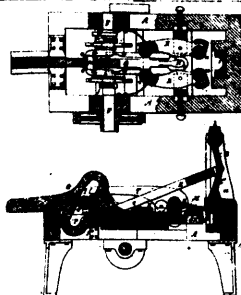

6166 Gilmore's Improvements on Horse Shoe Machines.

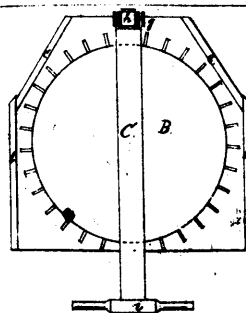

6167 Macnee's Improvements on Butter Workers.

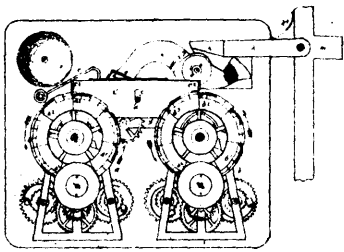

6184 Burge's Improvements in Chronometric Locks.

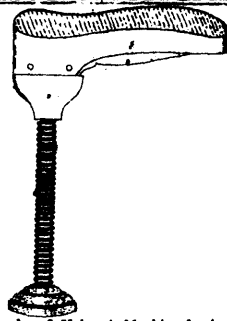

6185 Mosaban & Valpey's Machine for Applying the (sole Lining to Boots.

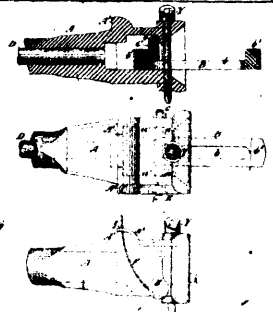

6186 Mitchell's Improvements on Car-couplers.

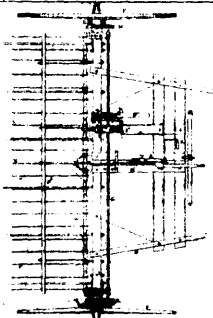

6187 Lundy's Horse-rake.

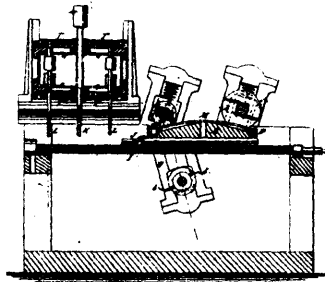

6188 Burr's Machine for Making Tackle Blocks.

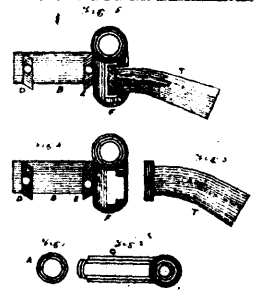

6189 Wilcox's Machine for Attaching Shafts to Buggies and Cutters.

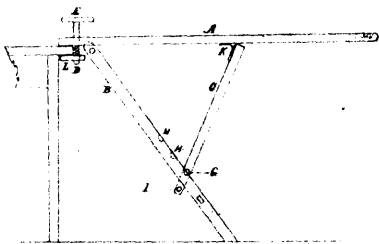

6190 Butler's Ironing Board.

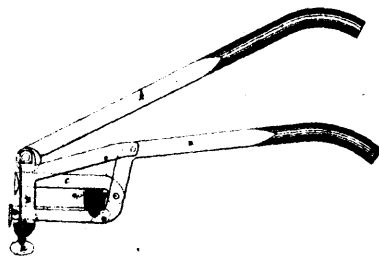

6191 Dawson's Bolt Cutter.

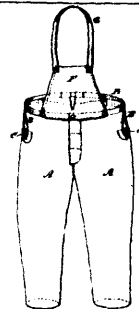

6192 Griffin's Improvements on Overall Trousers.

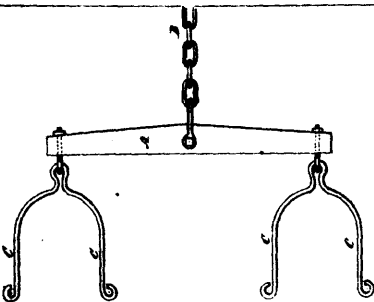

6193 Cole's Draft Equalizing Harness

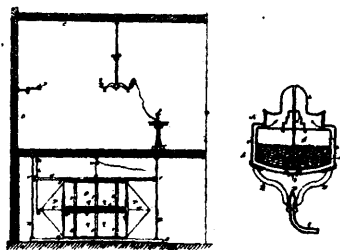

6194 Godfrey's Apparatus for Burning Kerosene and other Oils in Lamps without Chimneys.

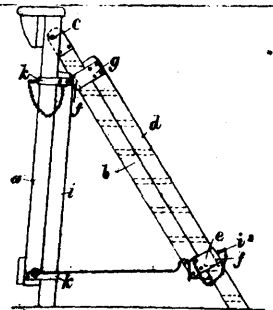

6195 Gagné's Improvements on Extension Ladders.

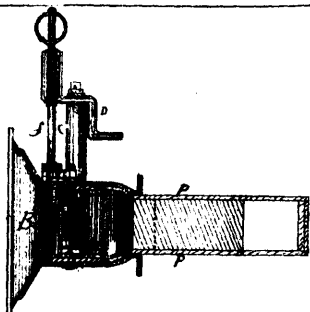

6196 Dolson's Improvements on a Car-coupling.

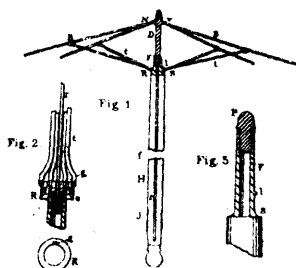

6197 Copp's Combined Cane and Umbrella Frame.

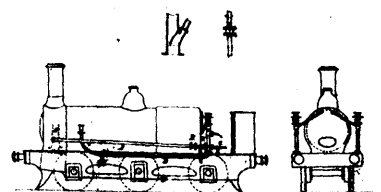

6198 Metcalfe's Improvements on Steam Engines.

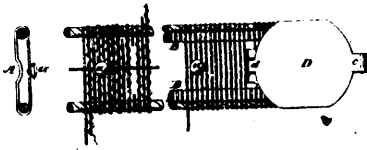

6189 Pulvermacher's Improvements on Volta-electric Appliances.

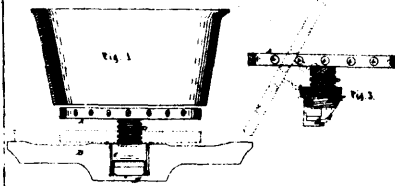

6200 Morand's Improvements on Grates for Stoves and Furnaces.

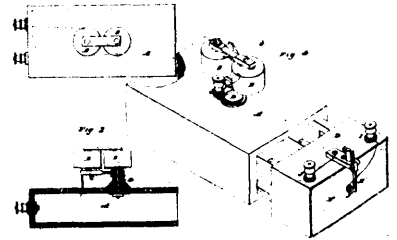

6201 Gray's Improvements in the Art of and in the Apparatus for Transmitting Musical Sounds Telegraphically.

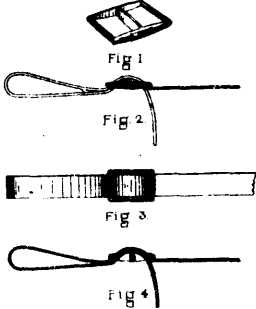

6202 Nerney's Improvements on Driving Reins.

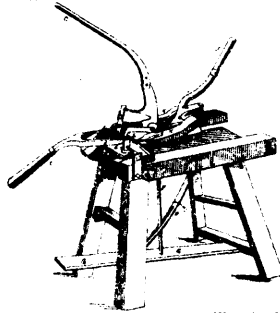

6203 Perrin's Machine for Making Wires for Soda Water and other Bottles.

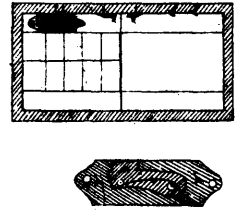

6204 Lear's Improvement in Sash-holders.

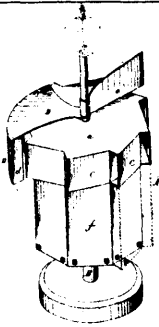

6205 Reed's Improvements on Advertising Devices.

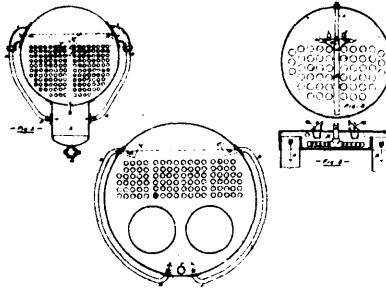

6206 Killey & Muirhead's Improvements in Steam Boilers.

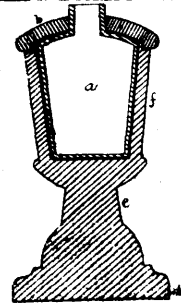

6207 Stevens' Improvements in Lamps.

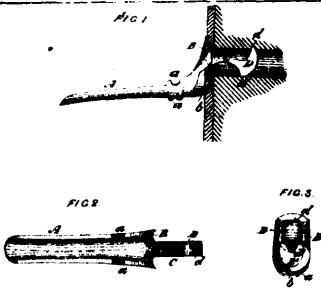

6208 Lawrence's Sap Spout.

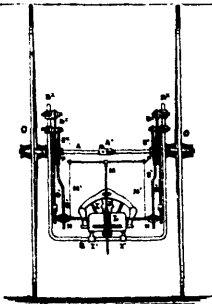

6209 Mathews' Mechanism for Propelling Wheeled Vehicles and Boats.

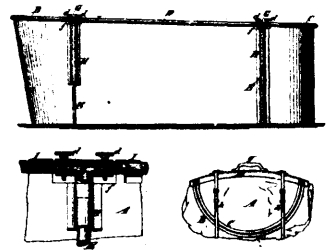

6210 Seligsberg's Portable Bath.

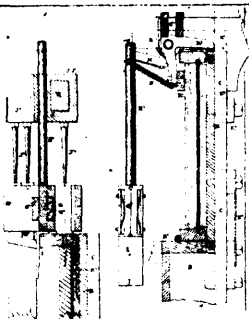

6211 Brandon's Improvements in Nailing Machines.

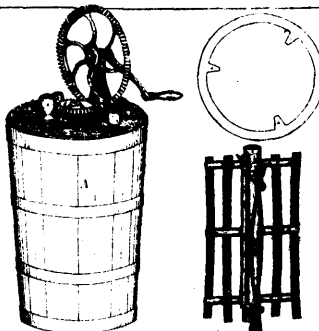

6212 Hoyt's Improvements on a Churn.

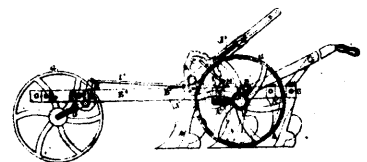

6213 Filabie's Improvements in Gang Ploughs.