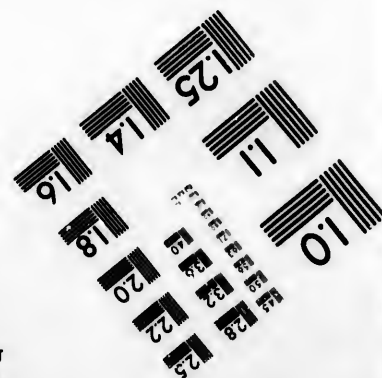
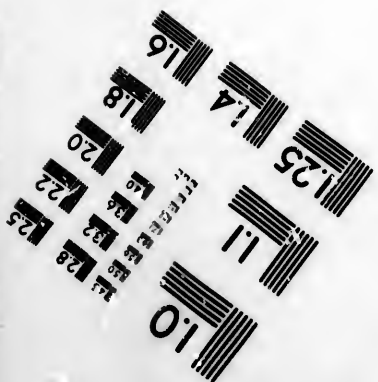
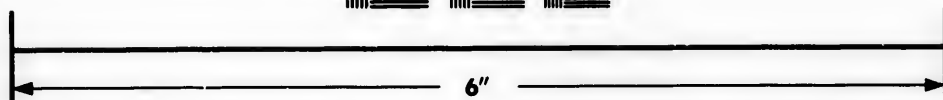
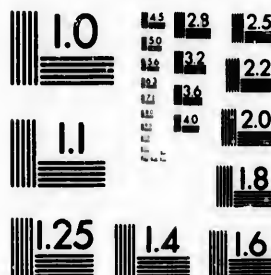

**IMAGE EVALUATION
TEST TARGET (MT-3)**



**Photographic
Sciences
Corporation**

23 WEST MAIN STREET
WEBSTER, N.Y. 14580
(716) 872-4503

**CIHM/ICMH
Microfiche
Series.**

**CIHM/ICMH
Collection de
microfiches.**



Canadian Institute for Historical Microreproductions

Institut canadien de microreproductions historiques

1980

Technical and Bibliographic Notes/Notes techniques et bibliographiques

The Institute has attempted to obtain the best original copy available for filming. Features of this copy which may be bibliographically unique, which may alter any of the images in the reproduction, or which may significantly change the usual method of filming, are checked below.

L'Institut a microfilmé le meilleur exemplaire qu'il lui a été possible de se procurer. Les détails de cet exemplaire qui sont peut-être uniques du point de vue bibliographique, qui peuvent modifier une image reproduite, ou qui peuvent exiger une modification dans la méthode normale de filmage sont indiqués ci-dessous.

- Coloured covers/
Couverture de couleur
- Covers damaged/
Couverture endommagée
- Covers restored and/or laminated/
Couverture restaurée et/ou pelliculée
- Cover title missing/
Le titre de couverture manque
- Coloured maps/
Cartes géographiques en couleur
- Coloured ink (i.e. other than blue or black)/
Encre de couleur (i.e. autre que bleue ou noire)
- Coloured plates and/or illustrations/
Planches et/ou illustrations en couleur
- Bound with other material/
Relié avec d'autres documents
- Tight binding may cause shadows or distortion
along interior margin/
La reliure serrée peut causer de l'ombre ou de la
distortion le long de la marge intérieure
- Blank leaves added during restoration may
appear within the text. Whenever possible, these
have been omitted from filming/
Il se peut que certaines pages blanches ajoutées
lors d'une restauration apparaissent dans le texte,
mais, lorsque cela était possible, ces pages n'ont
pas été filmées.
- Additional comments:/
Commentaires supplémentaires:

- Coloured pages/
Pages de couleur
- Pages damaged/
Pages endommagées
- Pages restored and/or laminated/
Pages restaurées et/ou pelliculées
- Pages discoloured, stained or foxed/
Pages décolorées, tachetées ou piquées
- Pages detached/
Pages détachées
- Showthrough/
Transparence
- Quality of print varies/
Qualité inégale de l'impression
- Includes supplementary material/
Comprend du matériel supplémentaire
- Only edition available/
Seule édition disponible
- Pages wholly or partially obscured by errata
slips, tissues, etc., have been refilmed to
ensure the best possible image/
Les pages totalement ou partiellement
obscurcies par un feuillet d'errata, une pelure,
etc., ont été filmées à nouveau de façon à
obtenir la meilleure image possible.

This item is filmed at the reduction ratio checked below/
Ce document est filmé au taux de réduction indiqué ci-dessous.

10X	12X	14X	16X	18X	20X	22X	24X	26X	28X	30X	32X
<input type="checkbox"/>	<input type="checkbox"/>	<input type="checkbox"/>	<input type="checkbox"/>	<input type="checkbox"/>	<input type="checkbox"/>	<input type="checkbox"/>	<input type="checkbox"/>	<input checked="" type="checkbox"/>	<input type="checkbox"/>	<input type="checkbox"/>	<input type="checkbox"/>

The copy filmed here has been reproduced thanks to the generosity of:

D. B. Weldon Library
University of Western Ontario

The images appearing here are the best quality possible considering the condition and legibility of the original copy and in keeping with the filming contract specifications.

Original copies in printed paper covers are filmed beginning with the front cover and ending on the last page with a printed or illustrated impression, or the back cover when appropriate. All other original copies are filmed beginning on the first page with a printed or illustrated impression, and ending on the last page with a printed or illustrated impression.

The last recorded frame on each microfiche shall contain the symbol → (meaning "CONTINUED"), or the symbol ▼ (meaning "END"), whichever applies.

Maps, plates, charts, etc., may be filmed at different reduction ratios. Those too large to be entirely included in one exposure are filmed beginning in the upper left hand corner, left to right and top to bottom, as many frames as required. The following diagrams illustrate the method:

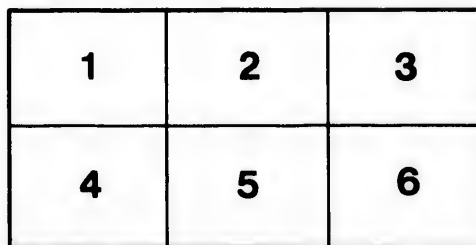
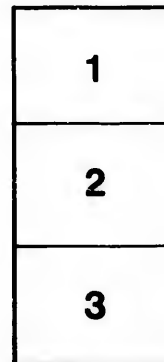

L'exemplaire filmé fut reproduit grâce à la générosité de:

D. B. Weldon Library
University of Western Ontario

Les images suivantes ont été reproduites avec le plus grand soin, compte tenu de la condition et de la netteté de l'exemplaire filmé, et en conformité avec les conditions du contrat de filmage.

Les exemplaires originaux dont la couverture en papier est imprimée sont filmés en commençant par le premier plat et en terminant soit par la dernière page qui comporte une empreinte d'impression ou d'illustration, soit par le second plat, selon le cas. Tous les autres exemplaires originaux sont filmés en commençant par la première page qui comporte une empreinte d'impression ou d'illustration et en terminant par la dernière page qui comporte une telle empreinte.

Un des symboles suivants apparaîtra sur la dernière image de chaque microfiche, selon le cas: le symbole → signifie "A SUIVRE", le symbole ▼ signifie "FIN".

Les cartes, planches, tableaux, etc., peuvent être filmés à des taux de réduction différents. Lorsque le document est trop grand pour être reproduit en un seul cliché, il est filmé à partir de l'angle supérieur gauche, de gauche à droite, et de haut en bas, en prenant le nombre d'images nécessaire. Les diagrammes suivants illustrent la méthode.

rrata
to

pelure,
n à

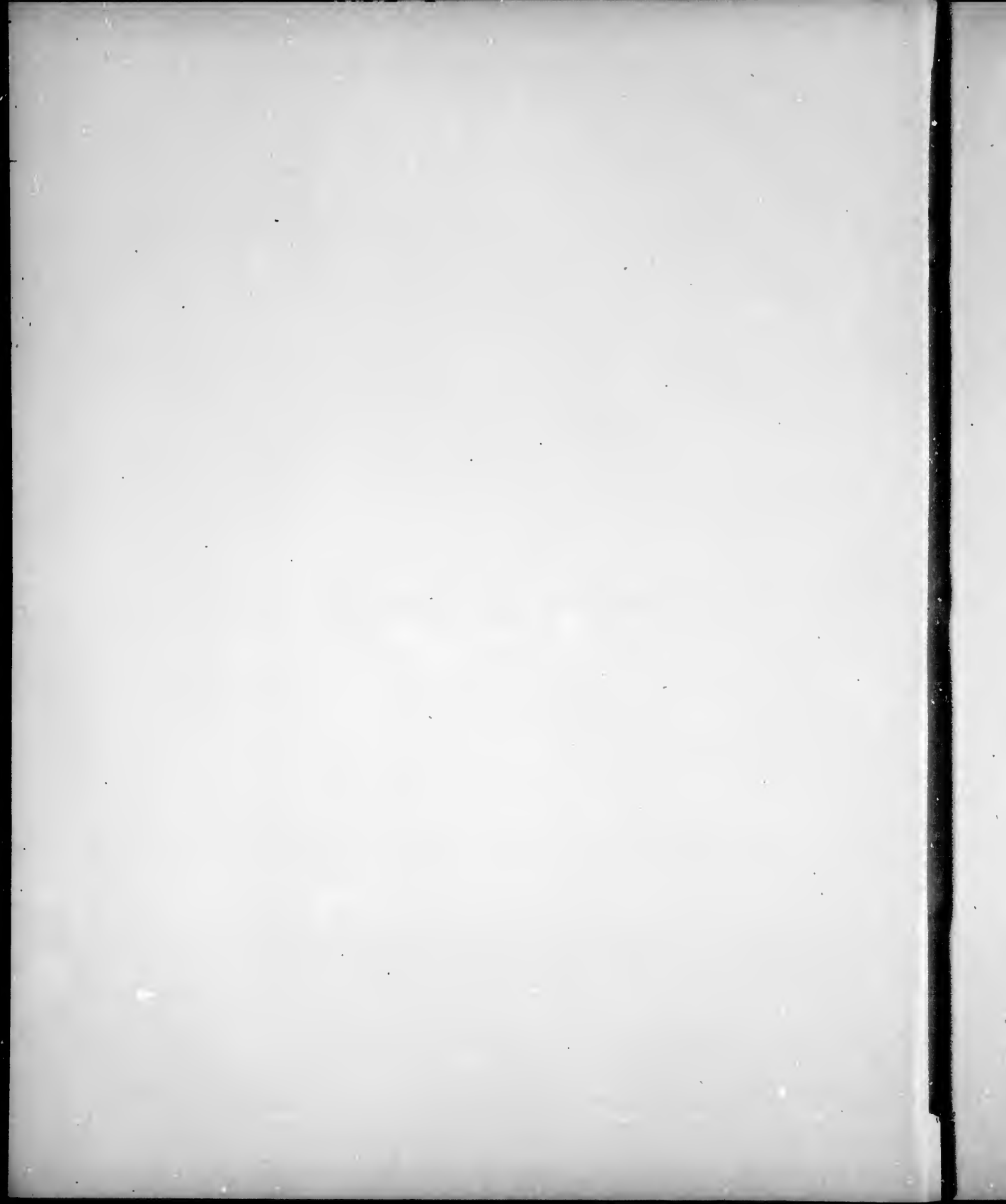



NATIONAL ACADEMY OF SCIENCES.

MEMOIR

UPON THE FORMATION OF A DEAF VARIETY OF THE HUMAN RACE.

BY

ALEXANDER GRAHAM BELL

26428

UPON THE FORMATION OF A DEAF VARIETY OF THE HUMAN RACE.

A PAPER PRESENTED TO THE NATIONAL ACADEMY OF SCIENCES AT NEW HAVEN, NOVEMBER 13, 1883.

INTRODUCTORY REMARKS.

The influence of selection in modifying our breeds of domestic animals is most marked, and it is reasonable to suppose that if we could apply selection to the human race we could also produce modifications or varieties of men.

But how can we ascertain the susceptibility of the human race to variation produced by selection? We cannot dictate to men and women whom they shall marry, and natural selection no longer influences mankind to any great extent.

We can see around us everywhere evidences of the transmission by heredity of characteristics, both desirable and undesirable, but at first sight no general selective influence appears to be at work to bring about the union in marriage of persons possessing the same congenital peculiarities. On the contrary, sexual attraction often appears to operate after the manner of magnetical attraction—"unlike poles attract, like poles repel." Strong, vigorous, and robust men naturally feel a tenderness for weak, delicate, and fragile women, and are generally repelled by physical strength and masculine traits in one of the opposite sex. Even in such characteristics as the color of the hair and eyes, it often appears that unlikes attract.

Certain diseases are known to be liable to transmission by heredity. But we do not find epileptics marrying epileptics, or consumptives knowingly marrying consumptives. Even though persons afflicted with the same hereditary disease were to intermarry for a number of successive generations, it is doubtful whether any permanent variety of the race could be formed in this way, for the increased tendency to disease inherited by the offspring would probably cause a greater tendency to premature death and ultimately occasion the extinction of the variety.

On the other hand, it is reasonable to suppose that the continuous intermarriage of persons possessing congenital defects not associated with diminished vitality or vigor of constitution would result after a number of generations in the production of a vigorous but defective variety of the race. For instance, the absence of coloring matter from the skin and hair is a defect occasionally found among human beings, and we may learn from the success of attempts to propagate Albinism among animals, that we would probably produce a pink-eyed, white-haired variety of the human race by causing Albinos to marry one another; but this is only speculation. We cannot control the marriages of men as we can the breeding of animals, and at first sight there seems to be no way of ascertaining how far human beings are susceptible of variation by selection.

Such a conclusion, however, would be incorrect; and I desire to direct attention to the fact that in this country *deaf-mutes marry deaf-mutes*.

An examination of the records of some of our institutions for the deaf and dumb reveals the fact that such marriages are not the exception, but the rule. For the last fifty years there has been some selective influence at work which has caused, and is still causing, the continuous selection of the deaf by the deaf in marriage.

If the laws of heredity that are known to hold in the case of animals also apply to man, the intermarriage of congenital deaf-mutes through a number of successive generations should result in the formation of a deaf variety of the human race.

On the other hand, if it can be shown that congenitally deaf persons marry one another without any greater liability to the production of deaf offspring than is to be found among the people at large, then it will be evident that we cannot safely apply to man the deductions that have been drawn from experiments upon animals.

There are good grounds for the belief that a thorough investigation of the marriages of the deaf and the influence of these marriages upon the offspring will afford a solution of the problem, "To what extent is the human race susceptible of variation by selection?"

Although the statistics I have been able to collect are very incomplete, I have ventured to bring the subject to the attention of the Academy, in the hope that the publication of the results so far obtained may lead to the completion of the statistics.

CHAPTER I.

UPON THE MATERIALS FOR THE FORMATION OF A DEAF VARIETY OF THE HUMAN RACE AT PRESENT EXISTING IN AMERICA.

The first difficulty encountered in the inquiry is that the published reports of our institutions for the deaf and dumb contain very little information bearing upon the subject, but, judging from the questions that are asked of the parents or guardians of the pupils, there must be among the unpublished records of our institutions an immense collection of valuable facts relating to heredity at present inaccessible to the public. Many of the reports of the institutions contain little more of interest in this connection than a catalogue of the pupils. The mere lists of names, however, become of value by directing attention to the fact that among the pupils who have been admitted to many of our institutions, numerous groups of deaf-mutes are to be found who have the same surname.

No one would be surprised by the moderate recurrence of such common names as "Smith" or "Brown" or "Johnson"—as the recurrences might be accidental, and have no other significance than to indicate the prevalence of these names in the community at large. But can it be accidental that there should have been admitted into one institution eleven deaf-mutes of the name of "Lovejoy," seven of the name of "Derby," and six of the name of "Mayhew." What interpretation shall we place upon the fact that groups of deaf-mutes are to be found having such names as "Blizzard," "Fahy," "Hulett," "Closson," "Brasher," "Copher," "Gortschalg," &c.? Such names are by no means common in the community at large, and the inference is irresistible that in many cases the recurrences indicate blood-relationship among the pupils.

An examination of a number of institution reports shows that these recurrences are altogether too numerous to be entirely accidental, and we are forced to conclude, (1) that deafness runs in certain families, (2) that these families are very numerous, and (3) that they are to be found in all parts of the United States.

The following list of recurring surnames, taken from the 1877 report of the American Asylum for the Education of the Deaf and Dumb (Hartford, Conn.), will show how numerous these recurrences are among the pupils of our older institutions :

TABLE I.—*Recurrence of surnames among 2,106 pupils admitted between the years 1817 and 1877.*

American Asylum for the education of deaf-mutes, Hartford, Conn.

Names occurring 25 times:	Smith.
Names occurring 20 times:	Allen.
Names occurring 17 times:	Brown.
Names occurring 13 times:	Campbell, Davis.
Names occurring 12 times:	White.
Names occurring 11 times:	Clarke, Johnson, Lovejoy.
Names occurring 10 times:	Small.
Names occurring 9 times:	Fuller, Green, West, Williams, Wood.
Names occurring 8 times:	Halley, Bartlett, Perkins, Richardson, Rogers, Wright.
Names occurring 7 times:	Derby, Jack, Marsh, Martin, Merrill, Thomas.
Names occurring 6 times:	Berry, Butler, Hawley, Marshall, Mayhew, Morse, O'Brien, Ruwe, Russell, Stevens, Swett, Taylor, Tripp.
Names occurring 5 times:	Andrews, Ball, Barnard, Blizzard, Chapman, Cook, Curtis, Dennison, Flak, French, Holmes, Howe, Jackson, Kimball, Meacham, Newcombe, Packer, Parker, Pease, Porter, Reed, Slocum, Sullivan, Tilton, Webster, Wilson, Young.
Names occurring 4 times:	Baker, Bennett, Bigelow, Bishop, Burbee, Chandler, Ellis, Emerson, Fahy, Fisher, Foster, Gilbert, Hammond, Hill, Holt, Hulett, Hull, Jellison, Jones, Kendall, Kennedy, Ladd, Luce, Marr, Mayberry, Miller, Morgan, O'Neill, Page, Parsons, Prior, Quinn, Robbins, Ryan, Scovell, Stone, Strong, Stuart, Thompson, Turner, Wakefield, Ward, Welch, Wells, Wiswell.
Names occurring 3 times:	Abbott, Acheson, Allard, Atkins, Badger, Baldwin, Barnes, Barrett, Blakely, Bliss, Boardwin, Briggs, Bruce, Burnham, Canton, Carpenter, Carter, Clossen, Clough, Cobb, Cummins, Daniels, Dennison, Drown, Dudley, Edwards, Fish, Frank, Goodrich, Gray, Haley, Haskell, Holden, Hunter, Ingraham, Jordan, Lafferty, Lambert, Larnbee, Livingston, Lombard, Lyman, Macomber, Mahoney, Mann, McCarty, Mitchell, Moore, Morrison, Mowry, Murphy, Nelson, Newton, Noyes, Osgood, Palmer, Perry, Platt, Pratt, Prescott, Randall, Reynolds, Robertson, Sage, Sawyer, Sherman, Sloane, Stebbins, Stevenson, Taft, Titeombe, Town, Trask, Wardman, Watson, Wentworth, Wheeler, Whitecomb, Wilkins, Winslow, Woodward.
Names occurring 2 times:	These are too numerous to be quoted here. There are two hundred and fourteen of them.

The following tables show that the pupils referred to above constitute more than 63 per cent. of the total number of pupils admitted:

TABLE II.—*Recurrence of surnames among the pupils of the American Asylum for deaf-mutes, Hartford, Conn. (1877 Report.)*

	No. of pupils represented.
764 names occur 1 time.....	764
214 names occur 2 times.....	428
81 names occur 3 times.....	243
45 names occur 4 times.....	180
27 names occur 5 times.....	135
13 names occur 6 times.....	78
6 names occur 7 times.....	42
6 names occur 8 times.....	48
5 names occur 9 times.....	45
1 name occurs 10 times.....	10
3 names occur 11 times.....	33
1 name occurs 12 times.....	12
2 names occur 13 times.....	26
1 name occurs 17 times.....	17
1 name occurs 20 times.....	20
1 name occurs 25 times.....	25
<hr/>	<hr/>
1,171	2,106

TABLE III.—*Showing recurrence of surnames and percentages of the whole.*

(American Asylum, 1877 Report.)

Number of surnames.	Number of pupils represented.	Percentage of the whole.
764 names occur once	764	36.3
214 names occur twice	428	20.3
193 names occur three or more times	914	43.4
1,171	2,106	100.0

The American Asylum, at Hartford, Conn., was established in 1817, under the patronage of Congress, as a school to be open to all the deaf-mutes of the United States. As new centers of instruction sprang up the supply of pupils from the more distant States was practically cut off, and the institution is more representative of the New England States than of the whole country.

This will be obvious from the following table (Table IV), which gives a synopsis of 2,100 cases admitted to the asylum before May, 1877, classified according to residence.

TABLE IV.—*Classification of pupils in respect to residence.*

(American Asylum, 1877 Report.)

Where from.	No.	Where from.	No.
Maine	336	Connecticut	362
New Hampshire	211	California	2
Vermont	233	Pennsylvania	14
Massachusetts	731	Maryland	5
Rhode Island	67	New York	34
New Jersey	7	Illinois	2
District of Columbia	2	Michigan	1
Virginia	11	Wisconsin	1
North Carolina	4	Ohio	6
South Carolina	19	British Provinces	25
Georgia	27	West Indies	1
Alabama	4	West Virginia	1
Louisiana	1		
Texas	1		2,100
Indiana	1		

In order to show that the numerous recurrence of surnames is not confined to the deaf-mutes of the New England States nor to the pupils of our oldest institutions, I give a list of recurring surnames taken from the 1882 report of the Illinois Institution.

This institution, although only opened in 1846, is now the largest of its kind in the world, and it may fairly be taken as representative of a large section of country in the West.*

TABLE V.—*Recurrence of surnames among 1,620 pupils admitted between the years 1846 and 1882.*

(Illinois Institution for the Deaf and Dumb, Jacksonville, Ill.)

Names occurring 18 times: Smith.
 Names occurring 16 times: Brown.
 Names occurring 10 times: Anderson, Miller.
 Names occurring 9 times: Edwards, Wilson.
 Names occurring 8 times: Johnson.

* As the American Asylum and Illinois Institution may be taken as representative institutions, I present in an appendix a critical analysis of all the cases recorded in the reports referred to. (See Tables A to N, in the appendix.)

For this analysis I am indebted to Mr. Frank Z. Maguire, of Washington, D. C., and I have personally verified his results.

Names occurring 7 times: Davis, Jones.
 Names occurring 6 times: Kelly, Mitchell, Moore, Welch, White, Williams, Wright.
 Names occurring 5 times: Adams, Allen, Clark, Hall, Lee, Long, Stephens, Taylor, Thompson, Wolf.
 Names occurring 4 times: Bailey, Barnes, Berry, Cox, Gunn, Harris, Hixon, Huffman, Jacoby, James
 McClelland, Murphy, Sturgeon, Sullivan, Townsend, Walker.
 Names occurring 3 times: Ammons, Baker, Ballard, Boyd, Brasher, Brooks, Buckley, Campbell, Carroll,
 Chamberlain, Conn, Copher, Crawford, Darnell, Doyer, Ford, Fuller, Gibson,
 Goodner, Goodwin, Gortschalg, Gray, Harper, Hill, Keil, Kennedy, Laughlin,
 McFarland, McGary, McLean, McNeal, Merrill, Morgan, Nelson, Nichols,
 Simmonds, Sterling, Stewart, Stout.
 Names occurring 2 times: These are too numerous to be quoted here. There are 150 of them.

The following tables show that the pupils referred to above constitute more than 41 per cent. of the whole number of pupils admitted:

TABLE VI.—*Recurrence of surnames among the pupils of the Illinois Institution for the Deaf and Dumb.*

(1882 Report.)

	No. of pupils represented.
953 names occur 1 time.....	953
150 names occur 2 times.....	300
39 names occur 3 times.....	117
16 names occur 4 times.....	64
10 names occur 5 times.....	50
7 names occur 6 times.....	42
2 names occur 7 times.....	14
1 name occurs 8 times.....	8
2 names occur 9 times.....	18
2 names occur 10 times.....	20
1 name occurs 16 times.....	16
1 name occurs 18 times.....	18
1,184	1,620

TABLE VII.—*Recurrence of surnames and percentages of the whole.*

(Illinois Institution, 1882 Report.)

Number of surnames.	Number of pupils represented.	Percentage of the whole.
953 names occur once.....	953	58.8
150 names occur twice.....	300	18.5
51 names occur three or more times...	367	22.7
1,184	1,620	100.0

The recurrence of numerous surnames among the pupils of very many of our institutions for the deaf and dumb renders it highly probable that a considerable proportion of the deaf-mutes of the country belong to families containing more than one deaf-mute, and hence possess hereditary tendencies to deafness.

The same conclusion is still more forcibly suggested to the mind by a perusal of the few institution reports that record the deaf-mute relatives of the pupils. The following tables (Tables VIII, IX, X, XI, XII) bearing upon this subject have been compiled from the 1877 Report of the

American Asylum.* They show that of 2,106 pupils admitted to that institution, 693, or nearly 33 per cent., were known to have deaf-mute relatives. The significance of this becomes more apparent when we find that in the majority of these cases the pupils have more than one relative deaf and dumb, while in a few cases as many as fifteen deaf-mute relatives are recorded.

TABLE VIII.—*Deaf and dumb relatives of the pupils of the American Asylum for Deaf-Mutes, from the 1877 Report.*

Pupils having deaf and dumb relatives.	Deaf and dumb relatives of pupils	Pupils having deaf and dumb relatives.	Deaf and dumb relatives of pupils.
1	1 great grandfather.	31	2 sisters.
1	1 grandfather.	3	3 sisters.
1	1 grandfather, father, mother and other relatives.	1	4 sisters.
1	1 grandfather, father, 3 children, and other relatives.	7	1 sister and 1 cousin.
1	1 grandfather, father, and brother.	1	1 sister, 1 cousin, and 1 uncle.
1	1 grandfather, father, and sister.	1	1 sister and 3 consins.
0	father and mother	2	1 sister, 3 consins, and 1 uncle.
2	father, mother, and 1 brother.	1	1 sister and 4 consins.
1	father, mother, and 2 brothers.	1	1 sister, 6 consins, and 1 uncle.
1	father, mother, 1 brother, and 1 sister.	1	1 sister and 1 aunt.
4	father, mother, 2 brothers, and 1 sister.	1	1 sister, 2 aunts and other relatives.
1	father, mother, 1 brother, and 2 sisters.	2	1 sister and other relatives.
1	father, mother, 1 brother, and 2 sisters.	1	1 sister and 4 other relatives.
1	father, mother, 1 brother, and 5 uncles and aunts.	2	1 sister and 14 other relatives.
2	father, mother, 1 sister, 1 uncle, and 1 aunt.	1	1 sister and 7 other relatives.
2	father, mother, 2 brothers, and 2 uncles.	7	2 sisters and 1 cousin.
1	father, mother, 2 sisters, and 1 uncle.	1	2 sisters and 2 consins.
2	father, mother, 1 brother, 1 sister, and 1 uncle.	1	2 sisters and 3 consins.
1	father, mother, and 1 cousin.	3	2 sisters and 1 second-cousin.
1	father, son, 1 sister, 2 nephews, and 5 other relatives.	141	1 brother.
1	father, 2 sisters, and other relatives.	47	1 brother and 1 sister.
1	father, 1 brother, and 1 sister.	12	1 brother and 2 sisters.
3	father, 1 brother, 1 sister, and 1 cousin.	8	1 brother and 3 sisters.
2	father, 4 brothers, 1 sister, and 1 cousin.	6	1 brother, 1 sister, and 1 cousin.
1	father, 3 brothers, 2 sisters, and 1 cousin.	2	1 brother, 2 sisters, and 2 consins.
1	mother and 1 brother.	1	1 brother, 1 sister, and 3 consins.
1	mother and 2 sisters.	1	1 brother, 1 sister, and 1 second-cousin.
2	mother, 1 brother, and 1 sister.	2	1 brother, 1 sister, 1 cousin, and 1 uncle.
1	mother, 1 brother, 2 sisters, and 1 cousin.	4	1 brother and 1 cousin.
1	mother, 2 brothers, 1 sister, and 1 cousin.	1	1 brother and 3 consins.
2	mother and 1 uncle.	1	1 brother and 4 consins.
1	mother and 2 uncles.	1	1 brother, 4 consins, and other relatives.
6	1 child.	1	1 brother and 1 aunt.
2	1 child and 1 brother.	1	1 brother and 1 niece.
3	1 child and 1 sister.	2	1 brother and 2 nephews.
1	1 child and 2 sisters.	1	1 brother and other relatives.
1	1 child and 1 cousin.	1	1 brother and 7 other relatives.
1	2 children and 1 brother.	1	1 brother, 1 sister, and 1 second-cousin.
1	2 children, 1 brother, and 2 sisters.	26	2 brothers.
4	3 children.	34	2 brothers and 1 sister.
1	3 children and 1 brother.	11	2 brothers and 2 sisters.
1	3 children, 1 brother, and 1 cousin.	4	2 brothers and 1 cousin.
1	3 children and 1 cousin.	2	2 brothers, 2 consins, and 2 uncles.
1	3 children and other relatives.	2	2 brothers, 1 sister, and 2 consins.
1	4 children.	1	2 brothers, 2 sisters, 1 uncle, and 1 aunt.
1	5 children and 1 brother.	1	2 brothers, 2 sisters, and 11 other relatives.
1	5 children and 2 brothers.	6	3 brothers.
1	5 children, 1 brother, and 2 sisters.	10	3 brothers and 1 sister.
129	1 sister.	2	3 brothers and 3 sisters.
		1	3 brothers, 1 sister, and 2 second-cousins.
		3	4 brothers.

* See "The sixty-first annual report of the directors and officers of the American Asylum, at Hartford, for the education and instruction of the deaf and dumb," presented to the asylum May 15, 1877, pp. 42-98.

TABLE VIII.—*Deaf and dumb relatives of pupils of American Asylum for Deaf-Mutes, &c.*—Continued.

Pupils having deaf and dumb relatives.	Deaf and dumb relatives of pupils.	Pupils having deaf and dumb relatives.	Deaf and dumb relatives of pupils.
7	4 brothers and 2 sisters.	1	1 uncle and 1 aunt.
1	5 brothers.	1	2 uncles.
2	5 brothers and 1 sister.	1	1 niece.
22	1 cousin.	1	1 nephew.
1	1 cousin and 1 uncle.	1	2 nephews, 2 nieces, and 1 other relative.
4	2 consins.	6	1 second-cousin.
1	2 consins and 1 aunt.	4	2 second-cousins.
4	3 consins.	1	1 third-cousin.
1	3 consins and 3 great-uncles.	1	1 relative.
1	3 consins and 2 uncles.	2	2 relatives.
1	3 consins and 2 other relatives.	1	Relatives.
2	4 consins.	1	4 relatives.
2	Consins.	1	4 remote relatives.
1	Several consins.	1	6 relatives.
3	1 aunt.		
6	1 uncle.		
		693	

Pupils having deaf-mute relatives	693
Pupils recorded as sporadic cases	1,413
Total	2,106

TABLE IX.—*Deaf-mute relatives of the pupils.*

(American Asylum for Deaf-Mutes. Report for 1877.)

1 pupil had one or more great-grandparents deaf and dumb.
 5 pupils had one or more grandparents deaf and dumb.
 47 pupils had one or more parents deaf and dumb.
 29 pupils had one or more children deaf and dumb.
 593 pupils had one or more brothers or sisters deaf and dumb.
 160 pupils had one or more consins deaf and dumb.
 38 pupils had one or more uncles or aunts deaf and dumb.
 1 pupil had one or more great-uncles or aunts deaf and dumb.
 48 pupils had one or more distant relatives deaf and dumb.

TABLE X.—*Deaf-mute children of the pupils.*

(American Asylum for Deaf-Mutes. Report for 1877.)

29 pupils had 1 or more children deaf and dumb.
 15 pupils had 2 or more children deaf and dumb.
 13 pupils had 3 or more children deaf and dumb.
 4 pupils had 4 or more children deaf and dumb.
 3 pupils had 5 or more children deaf and dumb.

TABLE XI.—*Deaf-mute brothers and sisters of the pupils.*

(American Asylum for Deaf-Mutes. Report for 1877.)

593 pupils had 1 or more brothers and sisters deaf and dumb.
 271 pupils had 2 or more brothers and sisters deaf and dumb.
 116 pupils had 3 or more brothers and sisters deaf and dumb.
 51 pupils had 4 or more brothers and sisters deaf and dumb.
 15 pupils had 5 or more brothers and sisters deaf and dumb.
 11 pupils had 6 or more brothers and sisters deaf and dumb.

TABLE XII.—*Showing number of pupils having one or more deaf-mute relatives.*

(American Asylum for Deaf-Mutes. Report for 1877.)

693 pupils had	1 or more relatives deaf and dumb.
374 pupils had	2 or more relatives deaf and dumb.
224 pupils had	3 or more relatives deaf and dumb.
120 pupils had	4 or more relatives deaf and dumb.
65 pupils had	5 or more relatives deaf and dumb.
35 pupils had	6 or more relatives deaf and dumb.
15 pupils had	7 or more relatives deaf and dumb.
9 pupils had	8 or more relatives deaf and dumb.
4 pupils had	10 or more relatives deaf and dumb.
3 pupils had	15 or more relatives deaf and dumb.

Without going into detail, the results may be noted of an examination of a few other institution reports* where the deaf-mute relatives are recorded.

TABLE XIII.—*Proportion of the deaf and dumb having deaf-mute relatives.*

Institutions.	Total number of pupils.	Number of pupils having deaf-mute relatives.	Percentage of pupils having deaf-mute relatives.
American Asylum	2,106	693	32.9
New York Institution	1,165	380	32.6
Ohio Institution	560	166	29.6
Indiana Institution	283	103	36.4
Illinois Institution	1,620	356	21.7
Texas Institution	89	21	23.6
Total	5,823	1,719	29.5

The above table shows us that out of 5,823 deaf-mutes taken from different parts of the country no less than 1,719, or 29½ per cent., were known to have relatives deaf and dumb.

If this proportion holds for the whole country, we must have in the United States about 10,000 deaf-mutes who belong to families containing more than one deaf-mute.†

It is to be feared that the intermarriage of such persons would be attended by calamitous results to their offspring.

These are not, however, the only cases in which we would anticipate that the deafness of the parents might be transmitted to the children. The lessons we have learned from the lower animals concerning heredity teach us that a certain physical peculiarity, which may normally make its appearance only sporadically here and there, may be perpetuated and rendered hereditary, by suitable selection, during a number of generations, of those individuals that happen to possess the peculiarity from birth.

* The tables relating to the deaf-mutes of Ohio, Indiana, New York, Texas, and Illinois have been compiled from the following sources:

1. Ohio. "List of pupils admitted to the Ohio Asylum previously to January, 1854." American Annals of the Deaf and Dumb, Vol. VI, pp. 101-116.
2. Indiana. "Catalogue of the pupils of the Indiana Institution from its commencement in 1843 to November 1, 1853." American Annals of the Deaf and Dumb, Vol. VI, pp. 162-169.
3. New York. "List of pupils of the New York Institution, &c., complete from May, 1818, to January, 1854." American Annals of the Deaf and Dumb, Vol. VI, pp. 195-225.
4. Texas. "List of pupils in attendance at the Texas Institution (1881)." See Exhibit A, twenty-fifth annual report of the superintendent of the Texas Institution for the Deaf and Dumb, Austin, Tex., November 1, 1881.
5. Illinois. "List of pupils of the Illinois Institution admitted between 1846 and 1882." Twenty-first biennial report of the trustees, superintendent, and treasurer of the Illinois Institution for the Education of the Deaf and Dumb. Jacksonville, Ill., October 1, 1882.

† The number is probably greater, even exceeding twelve thousand, as will be seen further on. (See Table XVII.)

We have good reason, therefore, to fear that the intermarriage of congenital deaf-mutes, even though the deafness in both cases might be sporadic, would result in many cases in the production of deaf offspring. It is important, then, to arrive at some idea of the numbers of the deaf and dumb who are deaf from birth.

The Compendium of the Tenth Census of the United States shows us that there were living in this country on the 1st of June, 1880, no less than 33,878 deaf-mutes, and that "more than one-half" were congenitally deaf.*

The proportion can be obtained more exactly from an address delivered in Jacksonville, Ill., on the 29th day of August, 1882, before the tenth convention of American instructors of the deaf and dumb, by the Rev. Fred. H. Wines,† who had charge of the department of the census relating to the deaf and dumb. Pending the full publication of the census returns, the statements of Mr. Wines concerning the census of the deaf and dumb must evidently be received as authoritative.

In the address referred to Mr. Wines gave the results of an analysis of 22,472 cases from the census, from which it appears that of these deaf-mutes 12,154, or 54.1 per cent., were reported as congenitally deaf, and 10,318, or 45.9 per cent., were stated to have lost their hearing after birth.

If we apply these figures to the total mentioned in the Compendium of the Census (33,878) we find that there are probably 18,328 congenital and 15,550 non-congenital deaf-mutes in the United States.

Deductions drawn from the breeding of animals would lead us to expect that the congenitally deaf would be more likely than those who became deaf from accidental causes to transmit their defect to their offspring. Another indication pointing in the same direction is to be found in the fact that the proportion of the deaf and dumb who have deaf-mute relatives is very much greater among the congenital than among the non-congenital deaf-mutes.

The following tables (Tables XIV, XV, and XVI) have been compiled from the reports of the American institutions for the deaf and dumb already referred to:

TABLE XIV.

Name of institution.	Date of opening.	Pupils were admitted or were in attendance during the years—	Total number of pupils.	Cause of deafness.			Pupils recorded to have deaf-mute relatives.			
				Congenital.	Disease or accident.	Not stated.	Total number admitted or in attendance.	Cause of deafness.		
								Congenital.	Disease or accident.	Not stated.
American Asylum	1817	1817-1877	2,106	973	1,040	93	693	552	131	10
New York Institution	1818	1818-1853	1,165	488	432	245	380	287	74	19
Ohio Institution	1829	1829-1853	560	208	268	84	166	118	32	16
Indiana Institution	1844	1844-1853	283	149	121	10	103	72	31
Illinois Institution	1846	1846-1882	1,620	418	947	255	356	194	120	42
Texas Institution	1857	1881	89	26	53	10	21	11	8	2
Total			5,823	2,262	2,864	697	1,719	1,234	396	89

* Compendium of the Tenth Census, Part II, page 1664.

† See Proceedings of the Tenth Convention of American Instructors of the Deaf and Dumb, Jacksonville, Ill., August, 1882, pp. 122-123, published by the Illinois Institution for the Deaf and Dumb, Jacksonville, Ill., with the twenty-first biennial report of that Institution.

TABLE XV.—*Proportion of the non-congenitally deaf who have deaf-mute relatives.*

Institutions.	Number of non-congenital deaf-mutes.	Number having deaf-mute relatives.	Percentage having deaf-mute relatives.
American Asylum.....	1,040	131	12.6
New York Institution.....	432	74	17.1
Ohio Institution.....	288	32	11.9
Indiana Institution.....	124	31	25.0
Illinois Institution.....	987	120	12.7
Texas Institution.....	53	8	15.0
Total.....	2,864	396	13.8

TABLE XVI.—*Proportion of the congenitally deaf who have deaf-mute relatives.*

Institutions.	Number of congenitally deaf pupils.	Number having deaf-mute relatives.	Percentage having deaf-mute relatives.
American Asylum.....	973	552	56.7
New York Institution.....	488	287	58.8
Ohio Institution.....	208	118	56.7
Indiana Institution.....	149	72	48.3
Illinois Institution.....	418	194	46.4
Texas Institution.....	26	11	42.3
Total.....	2,262	1,234	54.5

The above tables (Tables XIV, XV, and XVI) show that of 2,262 congenital deaf-mutes, more than one-half—or 54.5 per cent.—had deaf-mute relatives; and that even in the case of those pupils who became deaf from apparently accidental causes, 13.8 per cent. had other members of their families deaf and dumb.

If we apply these results to the total returned by the Tenth Census, we obtain the following figures (Table XVII) as a probable approximation to the number of sporadic and non-sporadic cases of deafness among the deaf-mutes of the country.

TABLE XVII.—*Estimate of the probable number of sporadic and non-sporadic cases of deafness among the deaf-mutes of the United States in the year 1880.*

Cause of deafness.	Number who have relatives deaf and dumb.	Sporadic cases.	Total.
Congenital.....	9,989	8,339	18,328
Disease or accident.....	2,146	13,404	15,550
Total.....	12,135	21,743	33,878

If to the estimated number of deaf-mutes who have relatives deaf and dumb we add the presumed number of sporadic cases among the congenital deaf-mutes we reach a total of 20,474 cases where the deafness would probably tend to become hereditary by intermarriage. But these are

not all the cases in which we would anticipate that intermarriage might be productive of deaf offspring. The late Dr. Harvey L. Peet states, as the result of his researches,* that the hearing brothers and sisters of a deaf-mute are about as liable to have deaf children as the deaf-mute himself. It is only reasonable to assume that a tendency towards deafness exists in a family containing more than one deaf-mute, so that if hearing persons belonging to such families were to intermarry, or were to marry deaf-mutes—or if a consanguineous marriage were to take place in such a family—we would not be surprised if some of the offspring should be deaf. *In addition therefore to the 20,474 deaf-mutes referred to above, we must include the hearing and speaking members of their families before we can form an adequate conception of the number of persons who possess a predisposition towards deafness.*

It will thus be seen that we have abundant materials in the United States for the formation of a deaf variety of the human race by selection in marriage.

*American Annals of the Deaf and Dumb, Vol. VI, p. 235.

CHAPTER II.

MARRIAGES OF THE DEAF.

Having shown that a large proportion of the deaf and dumb possess hereditary tendencies toward deafness, the question naturally arises: "Do many of the deaf and dumb marry?"

It is the custom in some of our institutions to hold periodical reunions of former pupils, and in some cases advantage has been taken of the opportunities thus presented to obtain information concerning the marriages of the pupils, &c. An examination of the reports of the American Asylum, New York, Ohio, Indiana, and Illinois institutions, yields the following results:

TABLE XVIII.

Name of institution.	Date of opening.	Date of report.	Total number of pupils admitted.*	Total number recorded to have married.	Percent-age.
American Asylum.....	1817	1877	2,106	642	30.5
New York Institution.....	1818	1854	1,165	191	16.4
Ohio Institution.....	1829	1854	560	56	10.0
Indiana Institution.....	1844	1854	287	26	9.1
Illinois Institution.....	1846	1882	1,020	174	10.7
Total.....			5,738	1,089	19.0

*The total number of pupils noted includes the children who were in attendance at the dates of the reports.

In the Appendix I have presented in tabular form a critical analysis of all the cases mentioned in the reports of the American Asylum and Illinois Institution, classifying the pupils according to the decades in which they were born. The labor involved has deterred me from making a similar examination of the pupils of the New York, Ohio, and Indiana institutions until more complete materials can be obtained than are to be found in reports published in 1854. The American Asylum and Illinois Institution, however, as I have stated before, may be taken as representative institutions, and an examination of the tables in the Appendix leads to the conclusion that *a very considerable proportion of the deaf children admitted to our institutions marry.* This will be obvious, from the following considerations:

Pupils of the American Asylum, born in the year 1840, were 37 years of age in 1877 (the date of the report), and the pupils of the Illinois Institution, born in 1840, were 42 years of age in 1882 (the date of the Illinois report), hence we may safely assume that, of the pupils of these institutions who were born before 1840, all, or nearly all, who intended to marry had married before the dates of the reports; and in most cases it is probable that the fact of marriage had been recorded. If,

then, we eliminate from the totals given in the above table, all the pupils of these institutions who were born since the year 1839, we obtain the following results:

TABLE XIX.—*Proportion of the pupils of our institutions for the deaf and dumb who marry.*

Name of institution.	Date of opening.	Date of report.	Total number of pupils born before 1840.	Total number of these recorded to have married.	Percentage.
American Asylum	1817	1877	1,100	522	47.4
Illinois Institution	1846	1882	159	49	30.8
Total			1,259	571	45.4

Whatever may be the exact percentage for the whole country, the indications are that a considerable proportion of the adult deaf-mutes of the United States are married.

INTERMARRIAGES OF THE DEAF AND DUMB.

When we attempt to form an idea of the extent to which intermarriage takes place among deaf-mutes, we are met by the difficulty of the imperfection of the institution records. In very few cases is it specifically stated that a deaf-mute has married a hearing person.* The record usually stands that the pupil has "married a deaf-mute," or that he is simply "married," leaving it uncertain whether the marriage was contracted with another deaf-mute or with a hearing person. When we eliminate all the uncertain cases we obtain from the institution reports the following results:

TABLE XX.—*Proportion of the deaf and dumb who marry deaf-mutes.*

Name of institution.	Date of opening.	Date of report.	Total number of pupils recorded to have married.	Total number recorded to have married deaf-mutes.	Percentage.
American Asylum	1817	1877	642	502	78.2
New York Institution	1818	1854	191	142	74.3
Ohio Institution	1829	1854	56	39	69.6
Indiana Institution	1844	1854	26	21	80.8
Illinois Institution	1846	1882	174	152	87.3
Total			1,089	856	78.6

The large percentage of marriages with deaf-mutes reported from Indiana and Illinois suggests the explanation that *intermarriages among the deaf and dumb may perhaps have become more common of late years*. Both institutions are of comparatively recent origin (the one founded in 1844, the other in 1846); and the report of the Illinois Institution, which exhibits the largest proportion of deaf-mute intermarriages, contains the record of much later marriages than those mentioned in the Indiana report, for the Indiana record stops at 1854, whereas the Illinois report gives the statistics of the institution to October, 1882.

Unfortunately we are unable to ascertain from the reports the dates of the marriages. If we assume, however, that as a general rule the older deaf-mutes were married before the younger, we

* Only one case in the American Asylum and ten in the Illinois Institution. It is probable, however, that in most cases where the pupil is simply recorded as "married" the record means marriage with a hearing person.

may be able to approximate to the order of the marriages by classifying the pupils according to their period of birth. Although I have not attempted a minute classification, excepting in the cases shown in the Appendix, it is comparatively easy to arrange all the married pupils referred to above into four classes: (1) those born before 1810; (2) those born in the period 1810-1839; (3) those born in the period 1840-1859; (4) those born since the commencement of 1860. The results are shown in the following table:

TABLE XXI.

Period of birth.	Total recorded to have married.	Total recorded to have married deaf-mutes.	Percentage.
Before 1810.....	129	72	55.8
1810 to 1839.....	715	577	80.7
1840 to 1859.....	231	196	84.1
1860 and after.....	12	11	91.7

The number married who were born since 1859 is too small to be relied upon for a percentage. It is only to be hoped that the percentage given above is excessive. The indications are very clear, however, that *of the deaf and dumb who marry, the proportion who marry deaf-mutes has steadily increased.* This conclusion is strengthened when we find that the above result, which has been deduced from a summation of all the cases recorded in the reports of the American Asylum, New York, Indiana, Ohio, and Illinois institutions, is also true of the cases recorded in each report taken separately. This will be obvious from the following table:

TABLE XXII.

Name of institution, with date of opening and of report.	Period of birth.	Total recorded to have married.	Total recorded to have married deaf-mutes.	Percentage.
American Asylum..... Date of opening, 1817. Date of report, 1877.	Before 1810.....	100	55	55.0
	1810 to 1839.....	422	350	82.9
	1840 to 1859.....	120	97	80.8
New York Institution..... Date of opening, 1818. Date of report, 1854.	Before 1810.....	29	17	58.6
	1810 to 1839.....	162	125	77.2
Ohio Institution..... Date of opening, 1829. Date of report, 1854.	1810 to 1832.....	56	39	69.6
Indiana Institution..... Date of opening, 1844. Date of report, 1854.	1822 to 1836.....	26	21	80.8
Illinois Institution..... Date of opening, 1846. Date of report, 1882.	1810 to 1839.....	49	42	85.7
	1840 to 1859.....	113	99	87.6
	1860 and after..	12	11	91.7

The only institution that gives any indication of a decrease in the proportion of pupils married to deaf-mutes is the American Asylum. The pupils born in 1859 were only 18 years of age

in 1877, the date of the report, so that it is certain that a considerable number of the pupils born between 1840 and 1859 were married after the date of the report, and so escaped enumeration. It is questionable, however, whether this could affect the *proportion* who were married to deaf-mutes.

It is more reasonable to suppose that in this case the apparent decrease is real, for an entirely different method of investigation leads to a similar result. In the years 1843, 1857, 1867, and 1877 the directors of the American Asylum published in their reports the statistics of the institution, giving the names of those pupils who had married. If we assume that the pupils who were not recorded as married in the 1843 report, but who were recorded as married in the 1857 report, were married between the years 1843 and 1857, &c., we can divide the marriages reported from the American Asylum into four classes: (1) Marriages contracted before 1843, (2) marriages contracted between 1843 and 1857, (3) marriages contracted between 1857 and 1867, and (4) marriages contracted between 1867 and 1877. The results are shown in the following table:

TABLE XXIII.—*Marriages of the pupils of the American Asylum.*

Presumed date of marriage.	Total recorded as married.	Total recorded to have married deaf-mutes.	Percentage.
Before 1843.....	143	95	66.4
Between 1843 and 1857.....	217	175	80.6
Between 1857 and 1867.....	131	110	84.0
Between 1867 and 1877.....	151	122	80.8

In this case we find that although the number of pupils presumed to have married between 1867 and 1877 is greater than the number who married in the preceding decade, the proportion who married deaf-mutes is less.

It is evident from a comparison of all the tables that *of the deaf-mutes who marry at the present time not less than 80 per cent. marry deaf-mutes, while of those who married during the early half of the present century the proportion who married deaf-mutes was much smaller.*

It is of course a matter of importance to ascertain to what extent congenital deaf-mutes intermarry, but unfortunately the institution records are too imperfect to allow us to draw conclusions on this point. Six hundred and fifty-four pupils of the American Asylum and Illinois Institution are each recorded simply to have "married a deaf-mute," without one word of explanation as to the name of the deaf-mute or the cause of deafness.*

It will thus be understood that the records of deaf-mute marriages are very imperfect, and it is to be hoped that some of our large institutions may publish fuller information concerning them. In the case of a deaf-mute partner it should be stated whether the deafness was congenital or not.

* Since the reading of this paper it occurred to me that some light might be thrown upon the subject by the theory of Probabilities. I therefore submitted the question to Prof. Simon Newcomb, who not only agreed with me in this idea, but was kind enough to present a solution of the problem deduced from the data given in this paper. He thinks the most probable conclusion to be this:

1. Of the congenitally deaf who married deaf-mutes one-half married congenitally deaf and one-half non-congenitally deaf.
2. Of the non-congenitally deaf who married deaf-mutes three-sevenths married congenitally deaf and four-sevenths non-congenitally deaf.

The full text of Professor Newcomb's letters will be found in Appendix Z.

I would also suggest that, wherever possible, the names of the husbands and wives of the pupils should be given, and the fact recorded as to whether they belong to families containing more than one deaf-mute or not. This is important even in the case of marriage with a hearing person, for in most of the cases of such marriages that have come under my personal observation the hearing partner belonged to a family containing deaf-mutes.

However imperfect may be the records of the marriages of the deaf it is abundantly evident, (1) *that there is a tendency among deaf-mutes to select deaf-mutes as their partners in marriage*; (2) *that this tendency has been continuously exhibited during the past forty or fifty years, and* (3) *that therefore there is every probability that the selection of the deaf by the deaf in marriage will continue in the future.*

It is evident, then, that we have here to consider, not an ephemeral phenomenon, but a case of continuous selection. For instance, should it appear that there are in this country any considerable number of deaf-mutes who are themselves the offspring of deaf-mutes the indications are that a large proportion of these persons will marry, and that of those who marry, the majority will marry deaf-mutes. Thus, there is every indication that in the case of the deaf and dumb the work of selection will go on from generation to generation.

CHAPTER III.

DEAF-MUTE OFFSPRING OF DEAF-MUTE MARRIAGES.

In a paper upon "Hereditary Deafness"* (published in 1863), Rev. W. W. Turner, then principal of the American Asylum, said that "statistics, carefully collated from records kept of deaf-mutes as they have met in conventions at Hartford, show that in 86 families with one parent a congenital deaf-mute, one-tenth of the children were deaf; and in 24 families with both parents congenital deaf-mutes, about one-third were born deaf.

In support of this conclusion he presented the following table :

TABLE XXIV.

Class.	Parents.	Number of families.	Number of children deaf.	Number of children hearing.	Total.
1	One hearing and 1 congenitally deaf	30	15	77	92
2	One incidentally and 1 congenitally deaf	56	6	120	126
3	Both congenitally deaf	24	17	40	57
	Total	110	38	237	275

Dr. Turner cited in connection with his subject the case of one woman who lived to see great grandchildren, and of these no less than sixteen were deaf-mutes.

Regarding intermarriage, he said : " It is a well-known fact that among domestic animals certain unusual variations of form or color which sometimes occur among their offspring, may, by a careful selection of others similar and by a continued breeding of like with like, be rendered permanent, so as to constitute a distinct variety. The same course adopted and pursued in the human race would undoubtedly lead to the same result." He concluded with the remark, " that every consideration of philanthropy as well as the interests of congenitally deaf persons themselves should induce their teachers and friends to urge upon them the impropriety of intermarriage."

It is reasonable to suppose that, whatever influence Dr. Turner's statements may have exerted upon the marriages of the deaf throughout the country, his conclusions and beliefs must have had considerable weight with the pupils of his own institution, and this may perhaps have been the cause of the decrease in the proportion of intermarriages noted among the pupils of his institution since the date of his paper. (See Table XXIII.)

In the report of the New York Institution, published in the American Annals of the Deaf and Dumb, July, 1854 (vol. vi, pp. 193 to 241), Dr. Harvey L. Peet gave the following table, showing the number of pupils of the New York Institution married, as compared with the married pupils of other American institutions, and compared with the marriages of the deaf in Europe, no distinction being made between those who were congenitally deaf and those who became deaf from accidental causes.

* See Proceedings National Conference of Principals of Institutions for the Deaf and Dumb, Washington, D. C., 1868; see, also, American Annals for the Deaf and Dumb, 1868, Vol. XIII, pp. 244-246; also article "Deaf and Dumb" Encyclopædia Britannica.

Dr. Peet stated that of all the families embraced in the table "about one in twenty have deaf-mute children where both parents are deaf-mutes, and about one in one hundred and thirty-five where only one is a deaf-mute; and that the brothers and sisters of a deaf-mute are about as liable to have deaf-mute children as the deaf-mute himself, supposing each to marry into families that have or or each into families that have not shown a predisposition toward deaf-dumbness."

TABLE XXV.

Name of institution.	Married hearing persons.		Married deaf-mutes.	
	Males.	Females.	Males.	Females.
Pupils of the New York Institution*	19	29	66	77
Pupils of the Hartford Asylum*	41	25	104	89
Pupils of the Ohio Asylum	13	4	18	21
Pupils of the Groningen Institution (Holland)	28	8	6	6
City of Paris	14	4	15	15
Belgium (census of 1835)	7	1	1
Ireland (census of 1851)	45	32	5	5
Yorkshire Institution (England)	1	2
Leipsic Institution (Germany)	4	1
Prague Institution (Bohemia)	6	2	2
Luxemburg Institution (Netherlands)	2
Lyons Institution (France)	2
Geneva Institution (Switzerland)	1
Russia Institution (incidental notices)	2	1	1
Bavaria Institution (incidental notices)	1
Total	188	106	218	217
Deduct the three American institutions	75	58	188	187
Remains for Europe	113	48	30	30

* Some marriages have been deducted from the Hartford list that appear also in the New York list. There have also been marriages between educated and uneducated mutes, or between deaf-mutes of our schools and semi-mutes not pupils.

From this table it appears that at the time of the investigation (1854) marriages of deaf-mutes and especially between two deaf mutes, were far more common in America than in Europe; and that, except among the pupils of the New York Institution, there were twice as many deaf-mute men with hearing wives, as deaf-mute women with hearing husbands.

Principals of institutions for the deaf and dumb have personal knowledge of their pupils, and may therefore be able to arrive at correct conclusions regarding the results of intermarriage.

It is extremely difficult, if not impossible, for others to arrive at an independent conclusion from the data published in the institution reports. It is even impossible to ascertain from these reports the mere number of the deaf offspring recorded as born to the pupils. The nature of the difficulty will be understood by an example. From the 1877 report of the American Asylum we find that—

George W. A— (born about 1803) "married a deaf-mute" and had 3 deaf children.

Mary R— (born about 1808) "married a deaf-mute" and had 3 deaf children.

Jonathan M— (born about 1814) "married a deaf-mute" and had 3 deaf children.

Paulina B— (born about 1817) "married a deaf-mute" and had 3 deaf children.

Now the query presents itself, "how many deaf children were born to these pupils?" Perhaps Mary R— was the wife of George W. A—, and Paulina B— the wife of Jonathan M—, in which case there are only 6 deaf children in all. It is possible, however, that in such cases the males and females were not related in marriage, and upon this supposition there were 12 deaf children.

There is generally nothing in the institution reports to guide us to a solution of the problem. If the names of the husbands and wives of the pupils were recorded it would be possible to arrive at some conclusion. As it is, the most we can do is to ascertain the number of deaf children recorded as the offspring of the male pupils and those noted as born to the female pupils. Even though it were possible to arrive at a correct conclusion regarding the total number of deaf offspring recorded in the reports, still we would not be able to ascertain the actual number of deaf children born to the pupils. For it is obvious, from the following considerations, that the number recorded is so much less than the number born as to lead to the inference that in a considerable proportion of cases the deaf offspring are not recorded at all until some of the children make their appearance in the institution as pupils. This means that they may not be recorded until 10, 20, or even 25 years after the date of their birth. I may be wrong in such a supposition, but I do not know how otherwise to account for the imperfection of the records:

(1) In the 1877 report of the American Asylum the married male pupils were recorded to have had 36 deaf children born to them and the married female pupils 28. Whereas 57 children of deaf-mute marriages have already been admitted into the institution as pupils (November, 1883*), all of whom were born before the 1877 report was issued. This does not include a number of deaf-mutes who have been admitted into other institutions in New England whose parents were pupils of the American Asylum, nor does it include children too young to be sent from home.

(2) In the 1882 report of the Illinois Institution the married male pupils were recorded to have had 10 deaf children born to them and the married female pupils 8. Whereas 14 children have already been admitted into the Illinois Institution (November, 1883†) one or both of whose parents were deaf.

(3) A comparison of the four reports of the American Asylum containing the statistics of the institution shows that only a small proportion of the deaf offspring of the *later marriages* are recorded in the 1877 report. This will be obvious from the following table:

TABLE XXVI.—*Congenitally deaf pupils who married deaf-mutes.*

Presumed date of marriage.*	Number of males married.	Recorded number of deaf children born to the males.	Number of females married.	Recorded number of deaf children born to the females.
Before 1843.....	18	4	17	11
Between 1843 and 1857..	42	13	46	5
Between 1857 and 1867..	22	..	30	1
Between 1867 and 1877..	38	..	26	..

* Deduced from a comparison of the four reports of the American Asylum. (See Introduction to Table XXIII.)

From this table it appears that 116 congenital deaf-mutes (males and females) have married deaf-mutes since the 1857 report was issued and that only *one* deaf child resulted from these marriages (!). This is most extraordinary, in view of the results obtained by Dr. Turner, which were based upon the marriages of the pupils of the same institution, and we must conclude that the records of the later marriages are defective so far as the deaf offspring are concerned.

An examination of the tables in the appendix shows that of all the pupils of the American Asylum and Illinois Institution 445 males and 371 females are recorded to have married. In the 445 families formed by the males there were (according to the reports) 46 deaf children, or 10.3 deaf children for every 100 families; and in the 371 families formed by the females there were 36 deaf children, or 9.7 in 100 families.

* Reported to the writer by Mr. Williams, the present principal of the institution.

† Reported to the writer by Dr. Gillett, the present principal of Illinois Institution.

If we add together the total number of males and females reported to have married and the total number of deaf children stated to have been born to them, we obtain the following figures: 816 individuals married, and 82 deaf offspring. We cannot conclude from this that the records indicate that 82 deaf children were born to the 816 pupils referred to, for many of the male pupils mentioned had undoubtedly married female deaf-mutes educated in the same institution with themselves. In such cases the deaf offspring were probably recorded twice—once under the name of the father and once under the name of the mother. If we desire to obtain, not the actual number of deaf children recorded to have been born to the pupils, but the *proportionate number*, we may safely add together the children recorded to have been born to the male and female pupils; for, if 816 families have 82 deaf children, the proportionate number of deaf children (10 for every 100 families) is a mean between the results obtained from the marriages of the males and females considered separately, and is more reliable than either from being based on larger numbers. In the following tables this plan of addition has been adopted, and it must be remembered that the number of families noted and the number of deaf children born, as deduced from the reports of the American Asylum and Illinois Institution, must not be taken to indicate the *actual* number of families formed by the pupils of these institutions, nor the *actual* number of deaf children born to them. They simply indicate a proportion, which is expressed in the third column by a percentage.

If none of the males married females recorded in the same reports, then the figures in the following tables would indicate *actual* as well as proportionate numbers; but this is not the case.

TABLE XXVII.—*Proportion of deaf offspring resulting from the marriages of deaf-mutes.*

[Deduced from the reports of the American Asylum and Illinois Institution.]

Married couples.	Number of families.	Number of deaf children.	Percentage (number of deaf children to every 100 families).
Both parties deaf-mutes.....	654	66	10.1
One party a deaf-mute.....	162	16	9.9
One or both parties deaf-mutes....	816	82	10.0

The following tables enable us to compare the above results with those obtained from each institution, considered separately:

TABLE XXVIII.—*Proportion of deaf offspring as deduced from reports of Illinois Institution and American Asylum.*

ILLINOIS INSTITUTION.

Married couples.	Number of families.	Number of deaf children.	Percentage (number of deaf children to every 100 families).
Both parties deaf-mutes.....	152	17	11.2
One party a deaf-mute.....	22	1	4.5
One or both parties deaf-mutes....	174	18	10.3

AMERICAN ASYLUM.

Both parties deaf-mutes.....	502	49	9.8
One party a deaf-mute.....	140	15	10.1
One or both parties deaf-mutes....	642	64	10.0

The percentages obtained indicate, of course, the number of deaf children for every 100 families as recorded in the reports, and not the actual number of deaf children for every 100 families (which is known to be greater).

The general results obtained from the two institution reports are remarkably concordant.

In the case of the American Asylum, however, it appears that the pupils who married hearing persons had a larger proportion of deaf children than those who married deaf-mutes (!) Such a remarkable result requires explanation. The pupils assumed to have married hearing persons are simply recorded in the report as "married," but from private correspondence with the present principal (Mr. Williams) I find that in most, if not in all, cases so recorded the record is really intended to indicate marriage with a hearing person.

Even in the case of the congenitally deaf pupils of the American Asylum it appears that those who married hearing persons had a larger proportion of deaf offspring than those who married deaf-mutes. The following table shows that this result can be deduced not only from the tables in the appendix, but from the table quoted above from Dr. Turner's paper on Hereditary Deafness:

TABLE XXIX.

Class.	Marrriages of the congenitally deaf.	Dr. Turner's results (1868) for pupils of the American Asylum.			Results from 1877 report of American Asylum.		
		Number of families.	Number of deaf children.	Percentage (number of deaf children for every 100 families).	Number of families.	Number of deaf children.	Percentage (number of deaf children for every 100 families).
1	One parent congenitally deaf and the other a hearing person.....	30	15	50.0	57	14	24.6
2	Both parents deaf-mutes (one congenitally deaf and the other incidentally deaf).....	56	6	10.7	(?)	(?)	(?)
3	Both parents deaf-mutes (both congenitally deaf).....	24	17	70.9	(?)	(?)	(?)
4*	Both parents deaf-mutes (one or both congenitally deaf).....	80	23	28.7	239	31	14.2

* Class 4 gives summation of classes 2 and 3.

I have already stated that in the majority of the cases that have fallen under my personal observation where a deaf-mute was married to a hearing person that *the hearing person belonged to a family containing deaf-mutes*, and this is significant in the light of the results deduced above, especially when we remember that the late Dr. Harvey L. Peet found that "the brothers and sisters of a deaf-mute are about as liable to have deaf-mute children as the deaf-mute himself, supposing each to marry into families that have or each into families that have not shown a predisposition toward deaf-dumbness." If we examine the cases of the pupils who are presumed to have married hearing persons in the light of this idea, separating the sporadic cases from those who have deaf-mute relations, we obtain the following results:

We find from the tables in the appendix that 162 deaf-mutes were "married," presumably, to hearing persons. Of these deaf-mutes 50 are stated to have had deaf-mute relatives, and they are recorded to have had 15 deaf children, or more than 27 deaf children for every 100 families; on the other hand, 107 of these deaf-mutes were noted as sporadic cases, and only one deaf child is recorded as the offspring of the marriages!

We have here a clear indication that a hereditary tendency towards deafness, as indicated by the possession of deaf relatives, is a most important element in determining the production of deaf offspring. The following table shows that it may even be a more important element than the mere fact of congenital deafness in one or both of the parents.

TABLE XXX.—Deaf-mute offspring of deaf-mute marriages.

[Results deduced from the tables in the appendix, combining the figures obtained from the reports of the American Asylum and Illinois Institution. 1

Description of married couples.	Number of families.	Number of deaf children.	Percentage* (number of deaf children to every 100 families).
(1) Father known to be a deaf-mute (summation of all cases where the cause of father's deafness is stated):			
(a) Father recorded to be congenitally deaf	187	25	13.3
(b) Father recorded to be non-congenitally deaf	237	18	7.6
(2) Mother known to be a deaf-mute (summation of all cases where the cause of mother's deafness is stated):			
(a) Mother recorded to be congenitally deaf	173	31	17.9
(b) Mother recorded to be non-congenitally deaf	179	4	2.9
(3) Father known to be a deaf-mute (summation of all such cases):			
(a) Father known to have deaf-mute relatives	132	23	17.4
(b) Father recorded as a sporadic case	313	23	7.3
(4) Mother known to be a deaf-mute (summation of all such cases):			
(a) Mother known to have deaf-mute relatives	153	25	16.3
(b) Mother recorded as a sporadic case	218	11	5.0
(5) One parent known to be a deaf-mute (summation of all cases where the cause of deafness was stated):			
(a) Deaf-mute parent recorded to be congenitally deaf	360	56	15.5
(b) Deaf-mute parent recorded to be non-congenitally deaf	416	22	5.3
(6) One parent known to be a deaf-mute (summation of all cases):			
(a) Deaf-mute parent known to have deaf-mute relatives	285	48	16.8
(b) Deaf-mute parent recorded as a sporadic case	531	34	6.4
(7) One parent recorded to be congenitally deaf (summation of all cases):			
(a) Congenitally deaf parent known to have deaf-mute relatives	230	41	17.8
(b) Congenitally deaf parent recorded as a sporadic case	130	15	11.5
(8) One parent recorded to be non-congenitally deaf (summation of all cases):			
(a) Non-congenitally deaf parent known to have deaf-mute relatives	53	5	9.4
(b) Non-congenitally deaf parent recorded as a sporadic case	363	17	4.7
(9) Both parents known to be deaf-mutes (summation of all cases):			
(a) One parent known to have deaf-mute relatives	230	33	14.7
(b) One parent recorded as a sporadic case	424	33	7.8
(10) Both parents known to be deaf-mutes and one recorded as congenitally deaf:			
(a) Congenitally deaf parent known to have deaf-mute relatives	186	27	14.5
(b) Congenitally deaf parent recorded as a sporadic case	112	15	13.4
(11) Both parents known to be deaf-mutes, and one recorded as non-congenitally deaf:			
(a) Non-congenitally deaf parent known to have deaf-mute relatives	43	4	9.3
(b) Non-congenitally deaf parent recorded as a sporadic case	288	16	5.5
(12) One parent known to be a deaf-mute and the other presumed to be a hearing person (summation of all cases):			
(a) The deaf-mute parent known to have deaf-mute relatives	55	15	27.3
(b) The deaf-mute parent recorded as a sporadic case	107	1	0.9
(13) One parent recorded to be a congenital deaf-mute, the other presumed to be a hearing person:			
(a) Congenitally deaf parent known to have deaf-mute relatives	44	14	31.8
(b) Congenitally deaf parent recorded as a sporadic case	18	None.	(†)
(14) One parent recorded to be a non-congenital deaf-mute, the other presumed to be a hearing person:			
(a) Non-congenital deaf-mute parent known to have deaf-mute relatives	10	1	10.0
(b) Non-congenital deaf-mute parent recorded as a sporadic case	75	1	1.3
(15) General results (summation of all cases of marriage recorded):			
Average	816	82	10.0

* The percentages are given as deduced from the institution reports. The true percentages are probably much greater, but *proportionally greater*.

(a) The large proportion of deaf offspring resulting from marriages where the father was known to have deaf-mute relatives, and from those where the mother was known to have deaf-mute relatives, and the comparatively small proportion where either parent appeared to be free from hereditary taint, seem to point to the conclusion that *in a large proportion of cases in which the marriages were productive of deaf offspring both parents had deaf-mute relatives (even in the case where one parent was a hearing person).*

(b) A similar process of reasoning leads to the conclusion that *in a large proportion of marriages where deaf offspring resulted both parents were probably congenitally deaf where both were deaf-mutes, and one parent congenitally deaf where only one was a deaf-mute.*

(c) It is thus highly probable that *a large proportion of the deaf offspring of deaf-mute marriages had parents who were both congenitally deaf, and who also both had deaf-mute relatives.*

(d) *Non-congenital deafness, if sporadic, seems little likely to be inherited.*

(e) Another deduction we may make is that *more of the deaf offspring whose parents had deaf relatives will marry than of those whose parents were recorded as sporadic cases, for there are more of them; and they will have a greater tendency than the others to transmit their defect to the grandchildren.*

These results are in close accordance with the experience of the venerable principal of the Pennsylvania Institution, as expressed in the following letter:

PENNSYLVANIA INSTITUTION FOR DEAF AND DUMB,
Philadelphia, November 14, 1883.

A. GRAHAM BELL, Esq.:

DEAR SIR: Continued ill health has prevented an earlier compliance with your request of October 15. The list I now send is full and accurate, according to the records of the institution and my recollection. In regard to most of the cases, I know of no place where fuller information can be obtained than our books furnish.

A residence of more than forty years in this institution has afforded me abundant opportunity for observation in regard to the subject of your research. A statement of the conclusions I have arrived at may be of some interest and use to you.

In regard to the marriage of deaf mutes with each other, if both the man and the woman are deaf from birth, there is very great danger—I should say a strong probability—that some of the offspring will be born deaf. I know a family, however, where the mother is one of three congenitally deaf children and the father one of five, and the seven children they have had are all without defect. In the list sent you all the parents, except in two cases, were born deaf. In one of these two cases the father could hear; in the other the mother is a semi-mute.

Where both parents became deaf adventitiously, there seems to be no more probability of the offspring being born deaf than there is where both parents hear.

Where only one of the parents is congenitally deaf, the children almost always hear.

Any further information I can give will be furnished willingly.

Yours, respectfully,

JOSHUA FOSTER.

My attempts to deduce from the records of the marriages of the deaf the influences that cause the production of deaf offspring have met with only partial success. Valuable indications have been obtained, but precise and accurate results are unattainable, on account of imperfect data. It occurred to me some time ago that a different method might lead to an exhaustive examination of the subject. It is known that few of the deaf and dumb married before the establishment of educational institutions in this country, and nearly 78 per cent. of all the marriages recorded in the reports of the American Asylum (the oldest institution in the country), seem to have been contracted since the year 1843. The probabilities are, therefore, that the vast majority of the deaf offspring born *are still living*, and from them may be obtained an accurate account of their ancestry. It also appeared probable that the majority of these deaf-mutes would at some period

of their lives, make their appearance in institutions for the deaf and dumb, and from the institution records might be obtained their names and addresses. Such considerations as the above led me to send to all the institutions in the country a circular letter of inquiry requesting the names and addresses of all the pupils who had been admitted who had deaf-mute parents, and returns have been received from a number of institutions.*

A starting point has thus been gained for a new investigation of the subject. The cases returned are sufficient in number to throw some light upon the proportion of deaf offspring born to deaf-mutes as compared with the proportion born to the community at large. The total number of deaf-mutes in the country, according to the recent census, is 33,878, which gives us a proportion of one deaf-mute for every 1,500 of the population. If, then, the proportion of deaf-mutes, originating among the deaf-mutes themselves, were no greater than in the community at large, they should constitute only 1 in 1,500 of the deaf-mute population. In other words, we should not have more than 23 deaf-mutes in the United States who are themselves the children of deaf-mutes. The returns received from the institutions, however, show that no less than 215 such children *have already been admitted as pupils* into 35 of the 58 institutions of the country (23 institutions not replying to my queries). Pupils are rarely admitted before they are 10 or 12 years of age and many do not reach the institution until they are much older. Hence it is evident that this number does not at all express the total number of such cases in the United States. Even if we suppose that no more than 230 such cases are to be found in the country, the proportion is ten times greater than in the community at large, or 1 in 150. But when we consider that nearly all of these children were born deaf, whereas nearly half of the deaf-mutes of the country (45.9 per cent.) became deaf from accidental causes, we realize that the liability to the production of *congenital deaf-mutes* is more nearly *twenty* times that of the population at large than ten times. It is evident that whatever may be the actual number of deaf-mutes in the country who have one or both parents deaf, the true number is much greater than that assumed above. From which it follows that the liability to the production of deaf offspring is also greater. While, then, we cannot at present arrive at any percentage, it is certain that *the proportion of deaf-mute offspring born to deaf-mutes is many times greater than the proportion born to the people at large.*

* See Tables S, T, U, and W of the Appendix. My best thanks are due to the principals and superintendents for their assistance in this investigation.

CHAPTER IV.

FAMILIES OF DEAF-MUTES.

The reports of the American Asylum, New York, Ohio, Indiana, and Illinois Institutions show that in each institution deaf-mutes have been received who belong to families containing five, six, or even more deaf-mutes; and there is abundance of evidence to indicate that such families are very numerous in the United States. In cases where there are five or six children of one family deaf and dumb some of them marry when they grow up, and in many cases they marry persons who belong, like themselves, to families containing several deaf-mutes. Thus it happens that we have here and there, scattered over the country, *groups of deaf-mute families* connected together by blood and marriage.

The probability is very strong that the deaf-mute children of deaf-mute marriages will at some time or other make their appearance in the educational institutions of the country, and we might reasonably hope to be able to trace the family relations from the published reports of the institutions. Unfortunately, in the majority of cases, the information that can be gleaned in this way is very fragmentary and uncertain, for the names of the husbands and wives of the pupils are rarely quoted, so that it is impossible in the great majority of cases to trace the connections. A female deaf-mute, when she marries, changes her name to that of her husband; the new name is not recorded in the institution reports, and we lose track of her branch of the family. Should she have deaf offspring they make their appearance in the institution under another family name, and the connection is not obvious. So far as my researches have gone they indicate the probability of a connection by blood or marriage between many of the largest of the deaf-mute families of the New England States.

In the following diagram (Fig. 1) I exhibit the results of an attempt to trace the connections of the Brown family, of Henniker, N. H., in which there are known to be at least four generations of deaf-mutes.

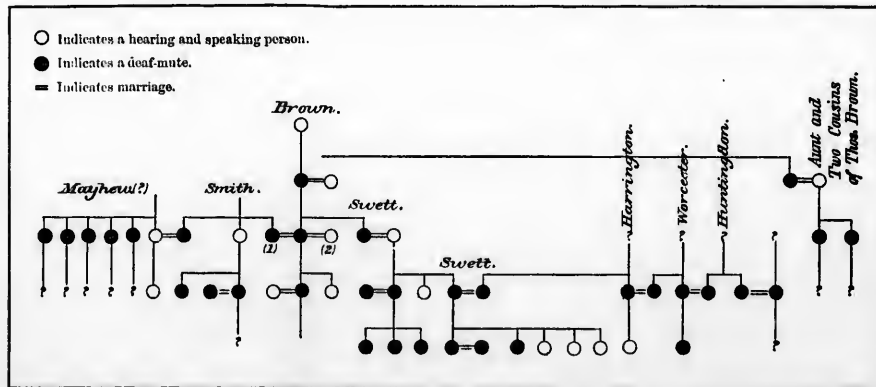

FIG. 1.—The Brown family of Henniker, N. H., and a few of its connections.

The Brown family, of Henniker, N. H.—The ancestor of this family was one of the early pioneers of New Hampshire. He left Stowe, in Massachusetts, somewhere about the year 1787, and settled in Henniker, N. H.

His deaf-mute son Nahum (born in 1772) married a hearing lady, by whom he had a son and daughter, both deaf and dumb. His son Thomas, when he entered the American Asylum as a pupil, was recorded to have had "an aunt and two cousins deaf and dumb." (This branch of the family has not yet been certainly identified.) Thomas married a deaf-mute (Mary Smith, of Chilmark, Mass.), by whom he had two children, Thomas L. (a deaf-mute) and a hearing daughter who died young. The son Thomas L. married a hearing lady (Almira G. Harte, of Burlington, Vt.), and removed to Michigan, where he became one of the teachers of the Michigan Institution for the Deaf and Dumb. I have no information concerning his descendants.

The deaf-mute daughter of Nahum married a hearing gentleman, Mr. Bela M. Swett, of Henniker, N. H., by whom she had three sons (Thomas B., William B., and Nahum). The eldest son, Thomas, was born deaf; the second son, William, was born deaf in one ear, and lost the hearing of the other in childhood from measles; and the third son, Nahum, could hear. The eldest son, Thomas, married a deaf-mute, and his three children (Mitchell, Charlotte E., and Mary S.) are deaf-mutes. The second son, William, married a deaf-mute (Margaret Harrington) by whom he had five children, all of whom could hear at birth, but two of them (Persis H. and Lucy Maria) lost their hearing so early in life as to necessitate their education in institutions for the deaf and dumb. Two others died young and one has retained her hearing into adult life. The eldest daughter (Persis, born 1852) has married a deaf-mute. It will thus be seen that three families of deaf-mutes have sprung from Nahum Brown, and in two of these the deafness has descended to the fourth generation. In the other family it descended to the third generation, beyond which I have been unable to trace the family. The deaf-mute connections of the Brown family have only been partially worked out.

1. The wife of William B. Swett was Margaret Harrington, who had a deaf-mute brother, Patrick, who married a deaf-mute (Sarah Worcester), who had a twin deaf-mute brother (Frank), who married a deaf-mute (Almira Huntington), who had a deaf-mute sister (Sophia M.), who married a deaf-mute (James R. Hines).* Frank Worcester, one of the twin deaf-mutes has a deaf-mute son—the other twin (Susan) has a child who hears.

2. On the other side of the family, the wife of Thomas Brown (Mary Smith, of Chilmark, Martha's Vineyard) had a hearing brother (Capt. Austin Smith), who had two deaf-mute children (a son and a daughter). The son (Freeman N.) married a deaf-mute (Deidama West).† Mrs. Brown also had a deaf-mute sister (Sally), who "married a hearing man of Martha's Vineyard (Hariff Mayhew) who had 5 deaf-mute brothers and sisters."

The Lovejoy family.—This is another New England family in which deafness has been handed down through four generations. Benjamin Lovejoy, a deaf-mute, of Sidney, Me., is recorded in

* The father and mother of James R. Hines (Isaac and Sophia) were both deaf-mutes, and he has a deaf-mute son (Eddie), and a cousin deaf and dumb. His mother (Sophia Rowley) also has a deaf-mute cousin.

† They had a deaf-mute daughter (Lovina). Deidama West had a deaf-mute mother, Deidama (Tilton) West, and two maternal uncles deaf and dumb (Franklin and Zeno Tilton) who married deaf-mutes. She also had three brothers and one sister deaf and dumb (George, Benjamin, Joseph L., and Rebecca). George married a deaf-mute (Sabrina Rogers), and has a deaf-mute child (Eva S. West). Benjamin married a hearing lady (Mary Hathaway). I have no information concerning their offspring. Rebecca married a deaf-mute (Eugene Trask), who had a deaf-mute brother (John Trask) who married a deaf-mute. George Trask, a deaf-mute, born about 1880, is probably the son of Eugene Trask and Rebecca West.

the reports of the American Asylum to have had "a grandfather, father, and 3 children deaf and dumb." There are other families of deaf-mutes of the same name which are obviously connected. (See Fig. 7.)

The Ouat family, of Illinois.—Two members of this family entered the Illinois Institution in 1859 and 1862. It was recorded of them in the 1882 report that there had been deafness in the family for five generations. No particulars, however, are given.

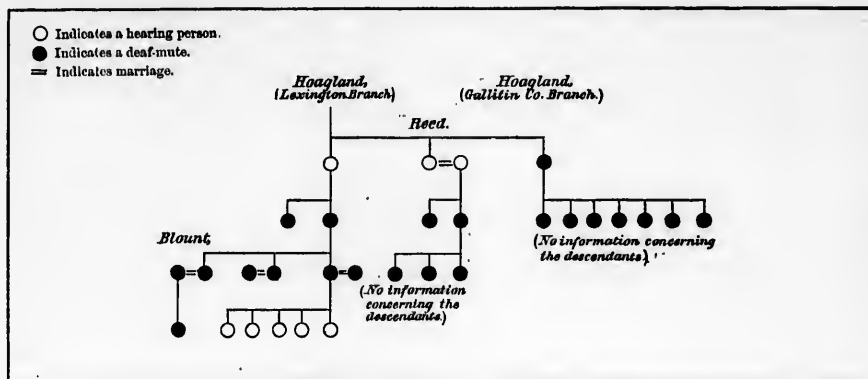

FIG. 2.—The Hoagland family of Kentucky.

The Hoagland family, of Kentucky (Fig. 2.)—This is one of the most remarkable of the deaf-mute families of America. In the above diagram I have attempted to show the family connections so far as they are known to me. In 1853 this family was stated to consist of a father, himself deaf and dumb, with 7 deaf-mute children. He had 2 deaf-mute nephews, one of whom was married and had two deaf-mute children. He also had a hearing sister who had two deaf-mute sons, one of whom had 3 children, all deaf-mutes.*

The principal of the Kentucky Institution has kindly furnished me with the following additional particulars concerning this family. He says:

"In 1822 two brothers, Thomas and William Hoagland, entered our institution. Thomas never married, but William married a deaf-mute. He had a son and two daughters, all of whom were mutes and married mutes. Jesse, the son, has five children, all of whom can hear. Mrs. Blount, the eldest daughter, has one son, a mute; Clara, the other daughter, is childless. This may be called the Lexington branch, as their home was there. Another, the Gallatin County branch, contained seven deaf-mutes. In another branch, the Reeds, the father and his three children are mutes. Only a part of all these mutes have been at school, and it is difficult to trace in the scanty records the exact relationship between the different branches."

The Adkins family, of Kentucky.—This family was stated in 1853 to contain nine deaf-mutes.†

The Grisson family, of Kentucky.—I am indebted to the principal of the Kentucky Institution for the following very instructive particulars concerning this family:

"There were three or four deaf-mute brothers and sisters of this family who were pupils here (Kentucky Institution) about the year 1828; one of them, William, married a deaf-mute lady and

* American Annals of the Deaf and Dumb, vol. vi, p. 255.

† American Annals of the Deaf and Dumb, vol. vi, p. 256.

had a numerous family, all of whom could hear. One of his sons married his cousin, also a hearing person, and all of their five children are deaf-mutes."

In 1870 Mr. Benjamin Talbot, then principal of the Iowa Institution, published in the American Annals of the Deaf and Dumb (vol. xv, p. 118) an account of some families of deaf-mutes residing in his State. One or two of the most remarkable cases may be noted which are of a particularly suggestive character.

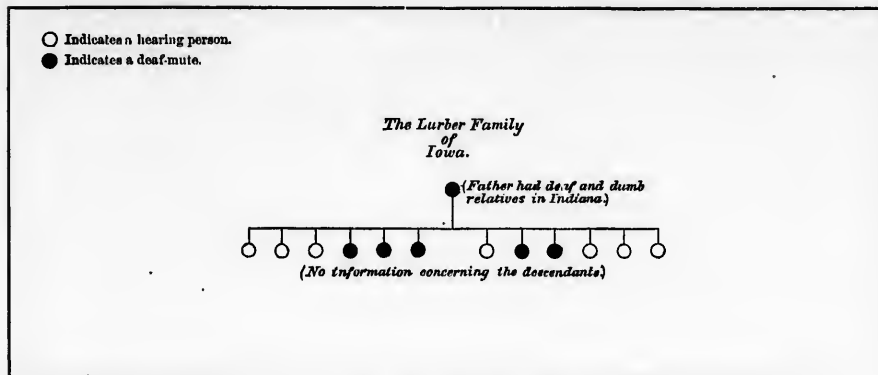

FIG. 3.—The Lurber family of Iowa.

The Lurber family, of Iowa (Fig. 3).—"The father is a deaf-mute, without education, who came to Iowa from Indiana, where there are, or have been, several deaf-mute relatives. Of twelve children in this family only one, and she the eighth, was born deaf. Four others, the fourth, fifth, sixth, and ninth, have lost their hearing in whole or in part, and have been sent to school here (Iowa Institution)."

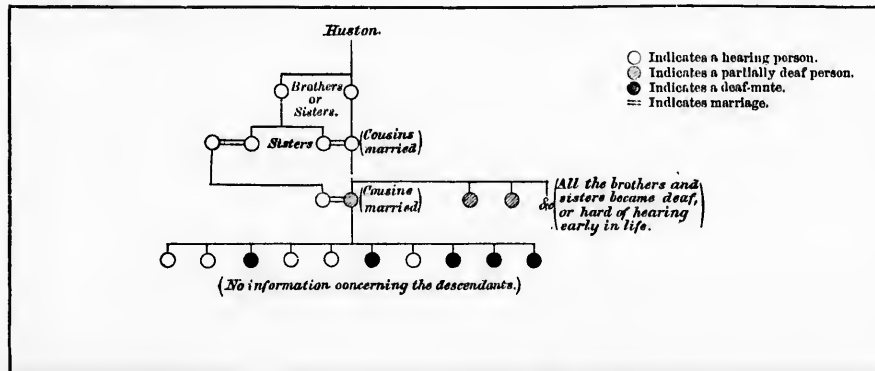

FIG. 4.—The Huston family of Iowa.

The Huston family, of Iowa (Fig. 4).—"There have been ten children in this family, of whom the third and eighth lost their hearing by disease, while the sixth, ninth, and tenth were born deaf.

Mr. Huston's grandmothers were sisters, and the grandfather and grandmother of this family were first cousins. Mr. Huston's brothers, like himself, were healthy and long lived, but, like him, *they all became deaf*, or at least hard of hearing, comparatively early in life."

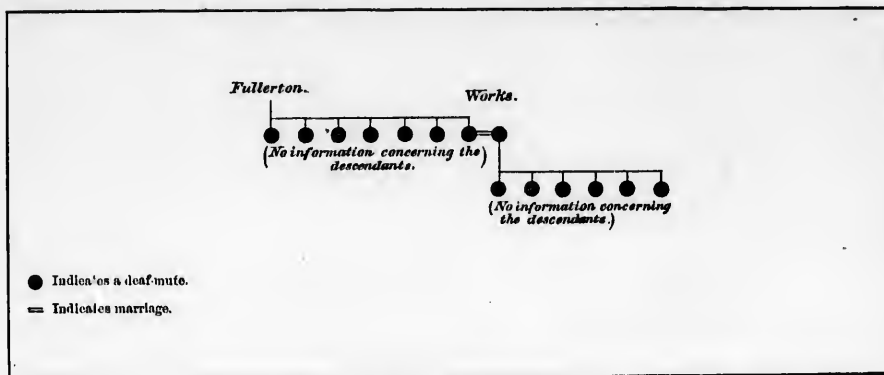

FIG. 5.—The Fullerton family of Hebron, N. Y.

The Fullerton family, of Hebron, N. Y. (Fig. 5).—Sayles Works, born 1806 (a presumed congenital deaf-mute of the New York Institution), married Jane Fullerton, born 1806 (a congenital deaf-mute educated in the same institution), who had six brothers and sisters deaf and dumb. All of their six children were deaf and dumb. There were thus fourteen deaf-mutes in this family. I have no information concerning the descendants.

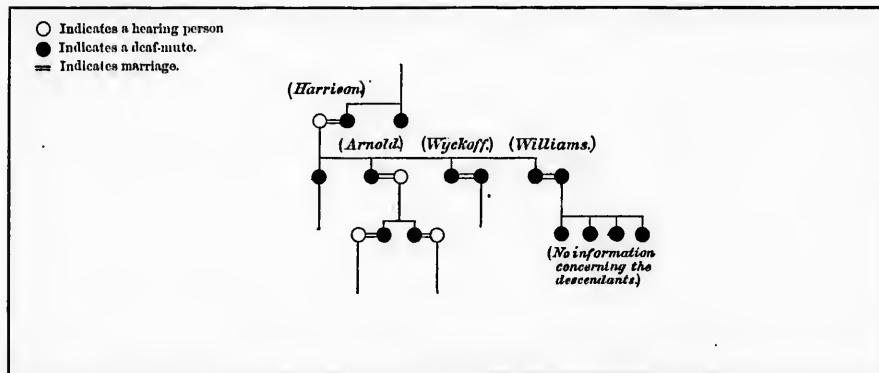

FIG. 6.—A family indicated in the 1854 report of the New York Institution.

A remarkable family reported from the New York Institution for the Deaf and Dumb.—The particulars of this family, as gleaned from the 1854 report of the New York Institution, are shown in the above diagram (Fig. 6): As the descent is in the female line, this genealogical table could not have been made had it not been for the fact that the New York report gives the names of the husbands and wives of some of the pupils.

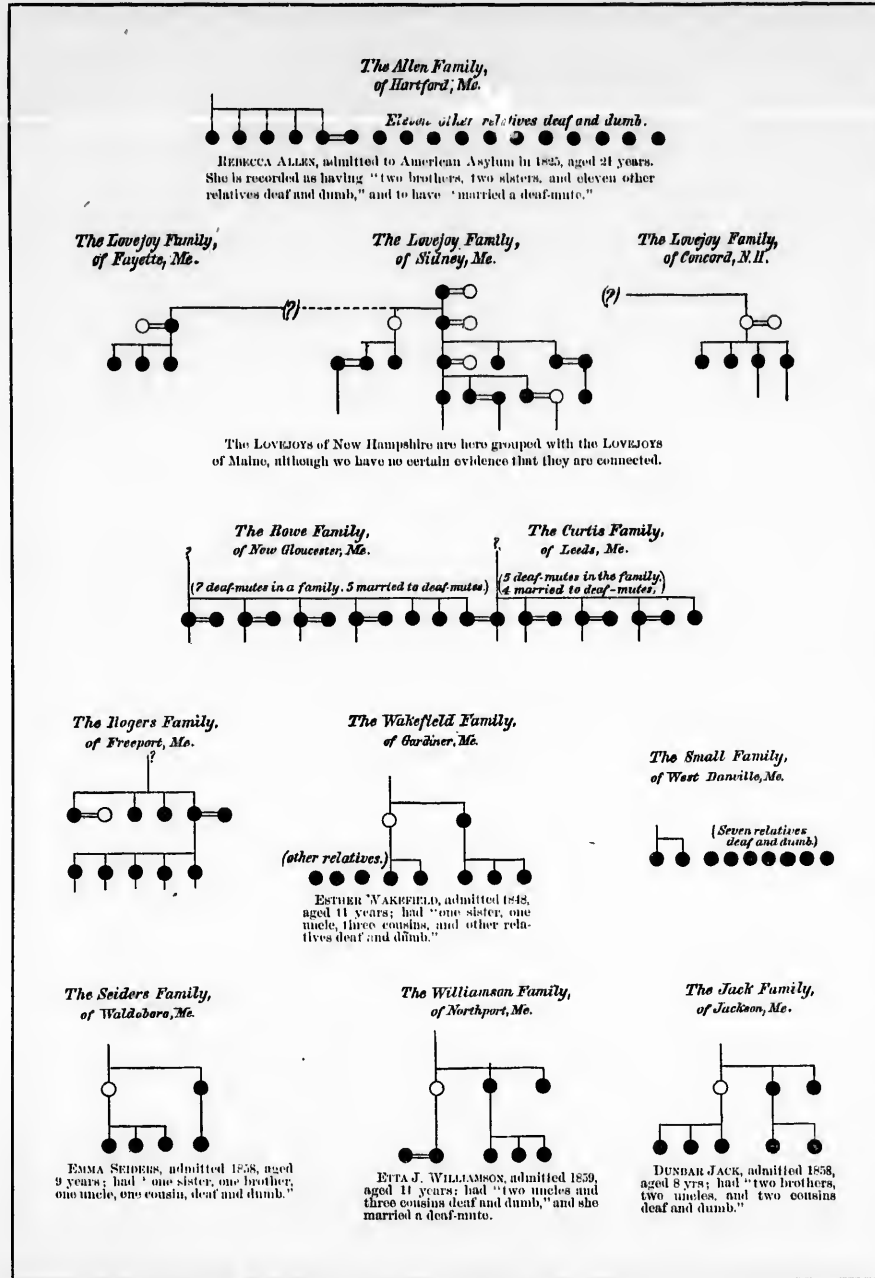

FIG. 7.—A group of deaf-mute families from Maine.

A group of deaf-mute families from Maine.—Members of the deaf-mute families shown in Fig. 7 have been admitted into the American Asylum at Hartford, Conn. There is no record showing any relationship between the families, but their close proximity to one another is extremely suggestive. The fact that there are four generations of deaf-mutes in the Lovejoy family suggests the idea that some of the other families may perhaps be descended from it through the female line. Whatever the explanation, it is at all events remarkable that so many large deaf-mute families should have originated in small places within a few miles of one another.

It must not be supposed that I have attempted to give an exhaustive list of the large deaf-mute families. I have simply given specimen cases to prove that in many different parts of the country deafness has been transmitted by heredity. There are many more large families known to me which are not alluded to above.

CHAPTER V.

UPON THE GROWTH OF THE DEAF-MUTE POPULATION.

The full returns of the 1880 census, so far as regards the deaf and dumb, have not yet been published; but, as stated before, Rev. Frederick H. Wines, who had charge of this department of the census, presented to the tenth convention of American instructors of the deaf and dumb the results of an analysis of 22,472 cases of deaf-mutes reported in the census returns. The tables presented by Mr. Wines have been reproduced in the Appendix. (See Tables N, O, P, Q.)

It will be observed that the cases are classified according to the period when deafness occurred and according to the cause of deafness (whether congenital or not). I have rearranged these cases into decades, so as to correspond with the classification of the pupils of the American Asylum and Illinois Institution, and have represented the results graphically in the following diagram:

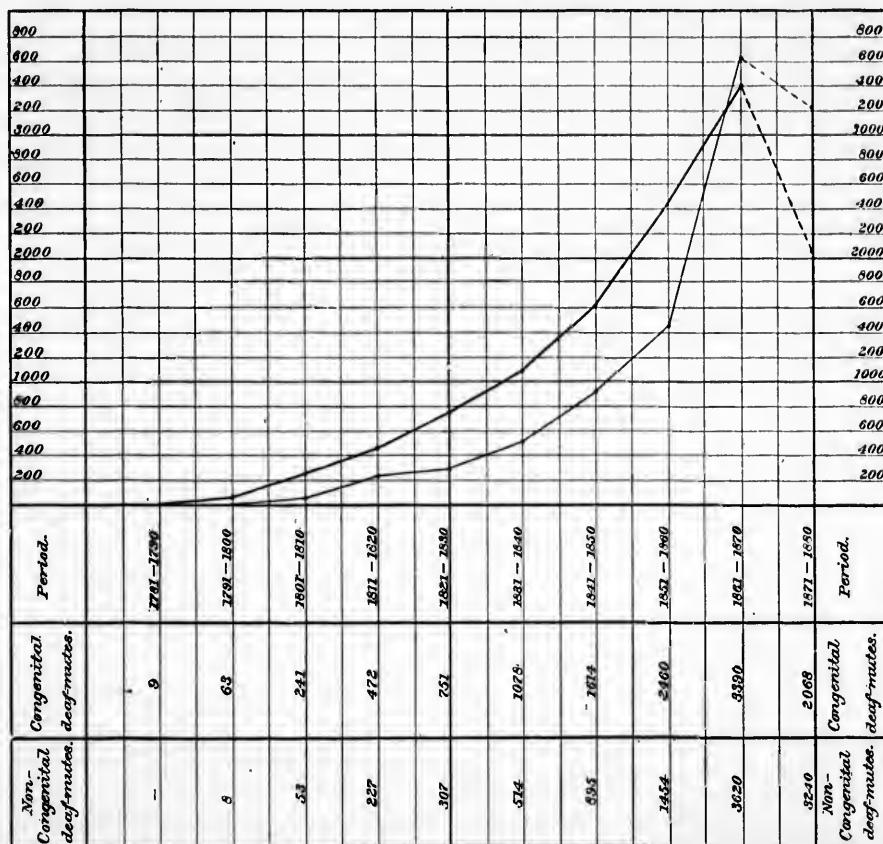

FIG. 8.—Relation between the congenital and non-congenital deaf-mutes of the country, according to the Rev. Fred. H. Wines. The congenital deaf-mutes are indicated by the dark line; the non-congenital, by the light line.

The ordinates of the curves represent, respectively, the number of congenital and non-congenital deaf-mutes who became deaf in the decades indicated by the abscissae. In the case of the congenital deaf-mutes the ordinates also represent the number who were born in the decades given, but this is not true of the non-congenitals. It will be observed that the number of deaf-mutes returned who became deaf in the last decade, 1871-'80, is less than the number who became deaf in the preceding decade. This does not necessarily mean that the number actually was less, but more probably indicates that the returns for the last decade are imperfect. Mr. Wines says that "In proportion to the degree of their youth the younger deaf-mutes are not enumerated. Fewer deaf-mutes who are babes in arms are enumerated than at the age of three years, and fewer at three years than at seven. The apparent maximum at seven is not the actual maximum; the actual maximum is at some younger age not yet ascertained."

In the above diagram those portions of the curves that are believed to be unreliable from this cause are indicated by dotted lines.

It will be observed that among the older deaf-mutes the congenitals are more numerous than the non-congenitals; whereas among the younger the reverse appears to be the case. There is no apparent diminution in the numbers of the congenitally deaf born of late years; and the reversal of the relation between the two classes must be attributed to an abnormal increase in the number of those who became deaf from disease or accident. It looks as if a wave of deafness-producing disease had swept over the continent about the time of the late civil war.

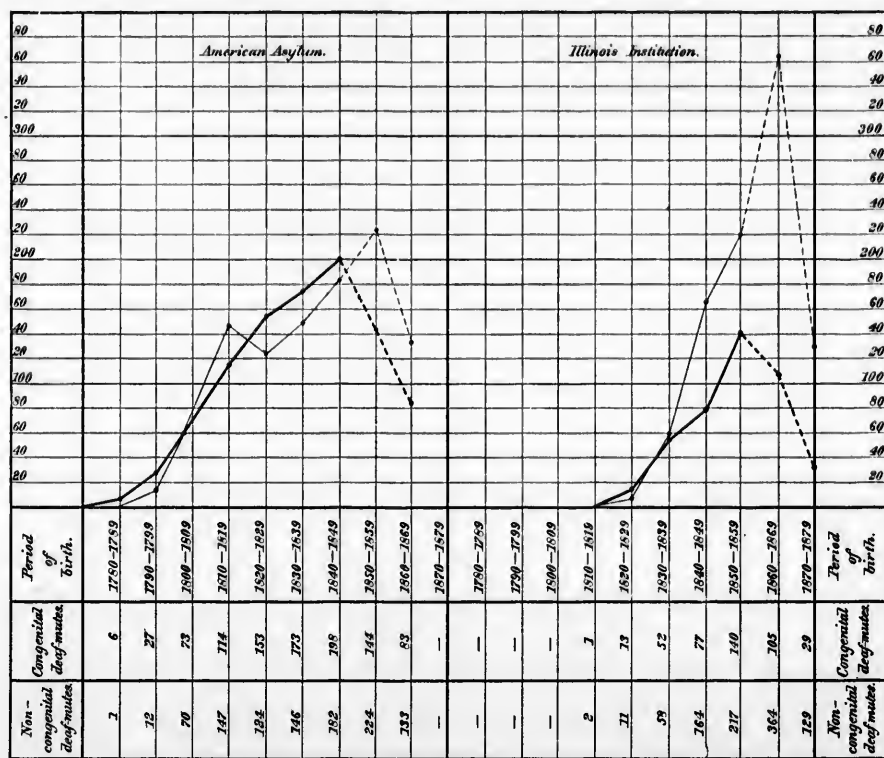

FIG. 9.—The dark lines indicate those pupils who were born deaf, and the light lines those who became deaf from disease or accident.

There are indications also of a similar though less disturbance in the numbers of those who lost their hearing from disease during the decade 1811 to 1820. An examination of the reports of the American Asylum and Illinois institution may throw light upon the nature of these disturbances. By classifying the pupils of these institutions according to their period of birth, we obtain the results that are exhibited graphically in the foregoing diagram (Fig. 9).

The apparent decrease in the number of pupils born in the last two decades is susceptible of simple explanation. Very few pupils are received into institutions for the deaf and dumb before they are ten or twelve years of age, while it is not uncommon for pupils to be admitted at twenty or twenty-five years of age or even older.

A pupil born in the year 1809 would only be 13 years of age in 1882 (the date of the Illinois report). It is evident, therefore, that of those deaf mutes who were born in the decade 1860 to 1869 who will ultimately make their appearance in the Illinois institution all had not been received at the date of the report.

A similar explanation can be given in the case of the American Asylum. The dotted lines indicate those portions of the curves which are known to be inaccurate on this account.

In regard to the American Asylum the abnormal increase in the number of pupils who became deaf from disease or accident who were born during the decade 1810-'19 is very marked. Another abnormal increase is observable in the number of those who became deaf in the decade 1860-'69. Indeed, the relations of the congenital and non-congenital deaf-mutes are reversed in a similar manner to that shown in Fig. 8. In regard to the Illinois pupils (see Fig. 9) it will be observed that the increase in the numbers of the non-congenitally deaf is so enormous, that of the pupils who were born in the decade 1860-'69 there were more than three times as many non-congenitally deaf as there were congenitally deaf, and of those born in 1870-'79 more than four times, whereas the census returns show that more than half of all the deaf-mutes living in this country (1880) were born deaf.

In the reports of the American Asylum and Illinois institutions the year when each pupil was admitted and his age when admitted are noted, with few exceptions. From these elements the period of birth has been calculated. The period when hearing was lost has also been ascertained in all cases where the age of the pupil when deafness occurred is stated in the report.

In tables K and L of the Appendix the non-congenital pupils of both institutions are classified according to the period when hearing was lost and according to the disease that caused deafness. In regard to the Illinois report it is unfortunately the case that the age of the pupil when deafness occurred is not stated in 327 cases out of 947, so that we are only able to classify about two-thirds of the cases in this way. The results are shown graphically in the upper diagrams of Fig. 10.

From the tables in the Appendix we have clear evidences of two epidemics of "spotted fever,"* or epidemic cerebro-spinal meningitis. One epidemic during the decade 1810 to 1819, reaching a maximum in the year 1815, and the other (a great epidemic) in the decade 1860 to 1869, continuing in the last decade, 1870 to 1879.

The pupils who became deaf from cerebro-spinal meningitis and from scarlet fever are classified according to the period when deafness occurred in the lower diagrams of Fig. 10.

The numbers of the non-congenitally deaf are evidently subject to great and sudden fluctuations on account of epidemical diseases which cause deafness, whereas the growth of the congenitally-deaf population seems to be much more regular.

*According to Dr. Russell Reynolds "spotted fever" is a popular name for epidemic cerebro-spinal meningitis. See "A System of Medicine," 1880, Vol. I, pp. 296-7.

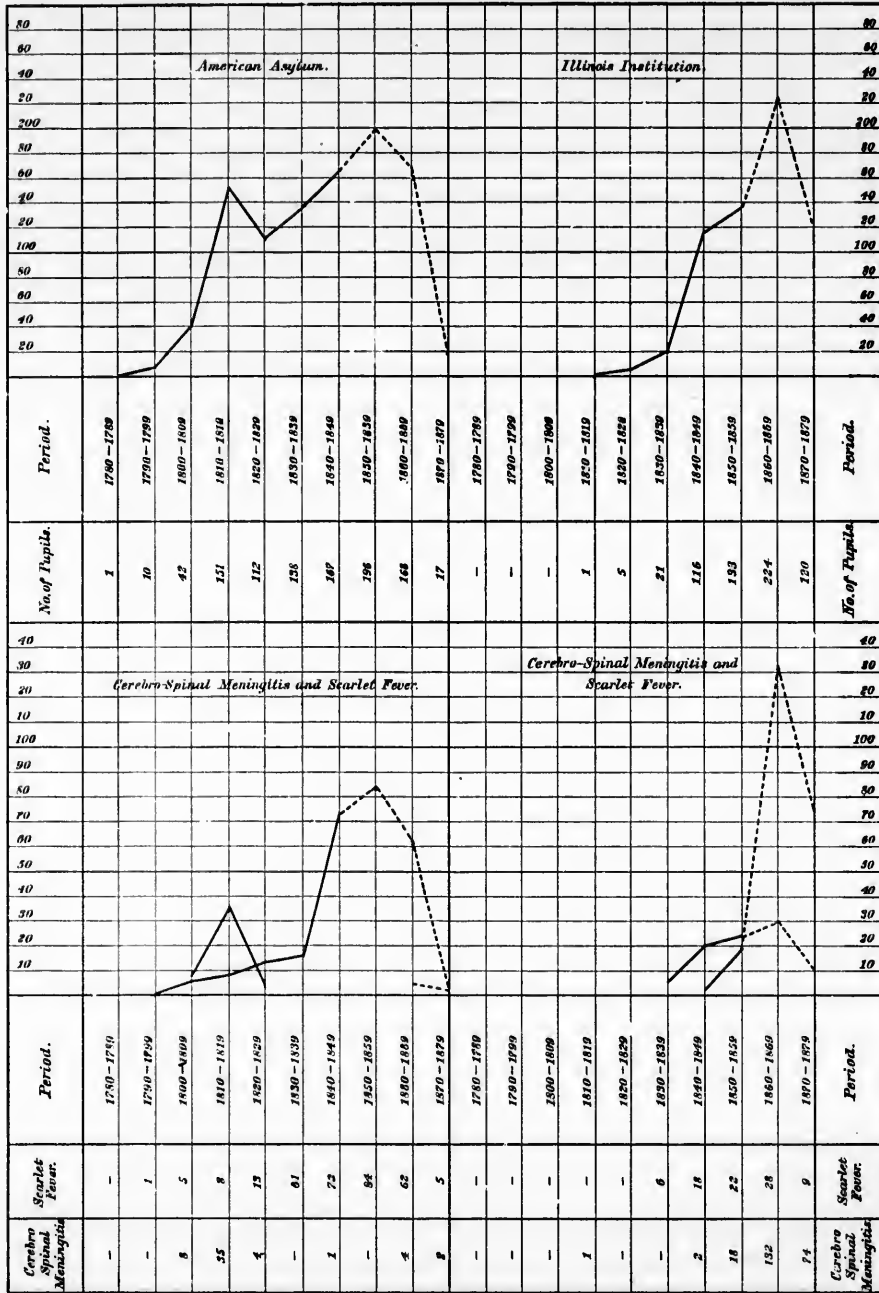

FIG. 10.

In Table T of the Appendix I have classified 215 cases of deaf-mutes who are the offspring of deaf-mutes according to their period of birth, separating those who have one parent deaf from those who have both. The results are shown graphically in Fig. 11.

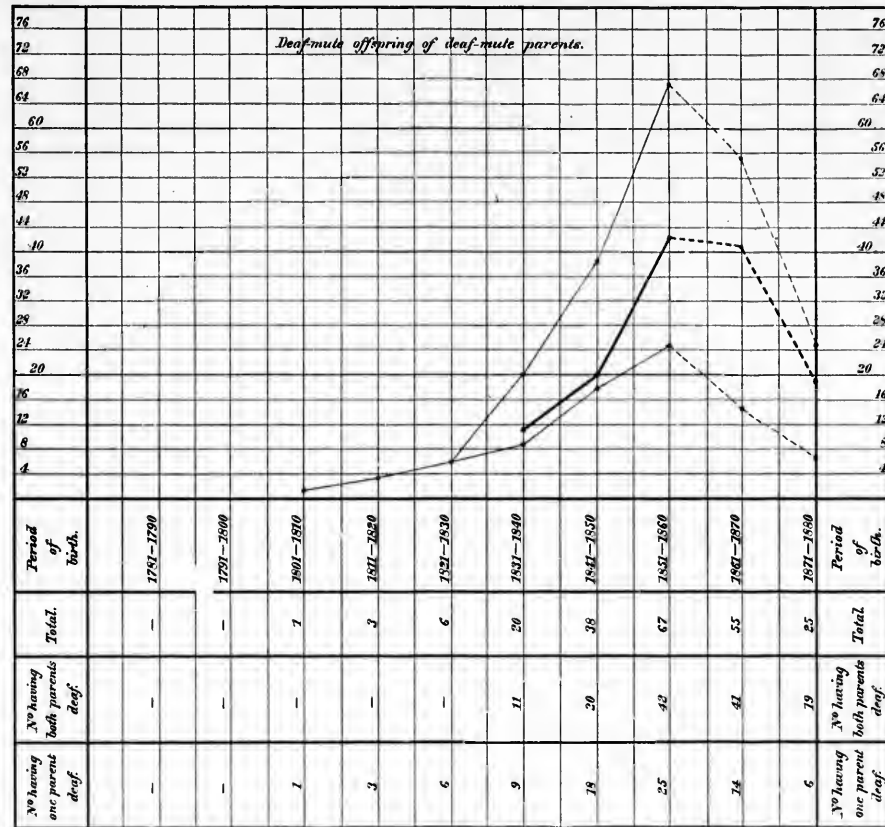

FIG. 11.—The dark line indicates the deaf-mutes who have both parents deaf. The lower light line represents those who have one parent deaf, and the upper line the total number of deaf-mutes returned who have one or both parents deaf.

No deaf-mute having both parents deaf has been returned who was born before the year 1832. It seems probable, therefore, that the oldest deaf-mute in the country whose parents were both deaf-mutes is only now a little past middle age. We have therefore received into our institutions only the first generation of deaf-mutes born from the intermarriage of deaf-mutes. The apparent decrease in the number born since 1861 does not necessarily indicate a real decrease, for many of the deaf-mutes born in the decade 1861 to 1870 have not yet been admitted to institutions for the deaf and dumb. Those portions of the curves that we know to be unreliable from this cause are represented in dotted lines.

In concluding this portion of my subject it may be well to institute a comparison between the deaf-mute population and the total population of the country as returned by the census of 1880.

In Table U of the Appendix I have classified the people of the United States according to the decades in which they were born, and have reduced the number born in each decade to a percentage of the whole. In the same table I have classified the 12,154 congenital deaf-mutes mentioned by Mr. Wines in a similar manner, and also the deaf-mutes who have both parents deaf-mutes. We can thus examine upon the same scale the distribution of the three classes according to age. The results are shown graphically in the diagram, Fig. 12.

The ordinates represent the percentage of the whole who were born in the decades indicated by the abscissæ.

If we assume that the numerical relation now existing between congenital deaf-mutes and hearing persons of *the same age* approximately represents the proportion of the congenitally deaf to the whole population born at the period when they were born, we have a means of comparing the growth of the congenitally deaf population with that of the population at large.

The indications are that the congenital deaf-mutes of the country are increasing at a greater rate than the population at large; and the deaf-mute children of deaf-mutes at a greater rate than the congenital deaf-mute population.

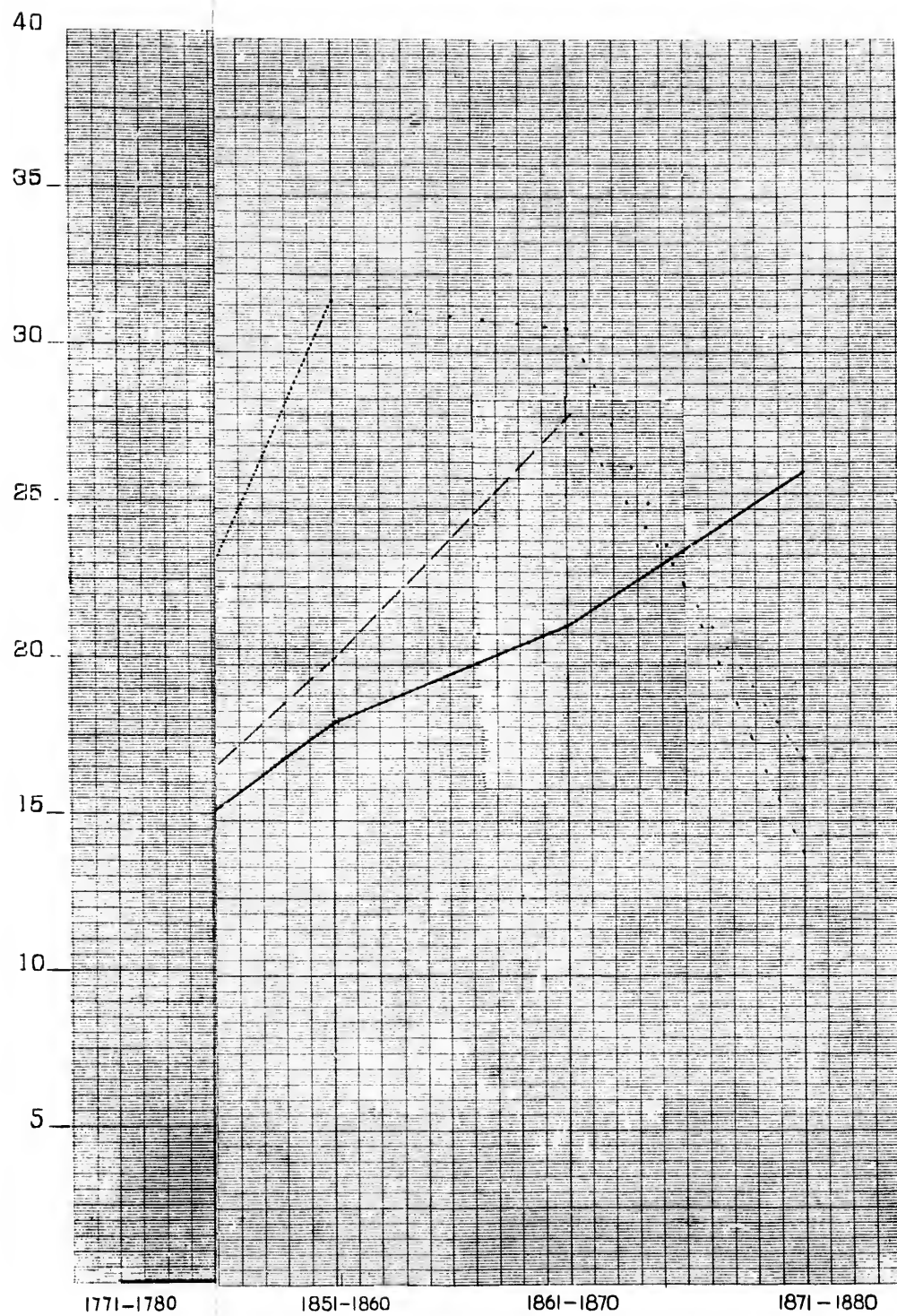

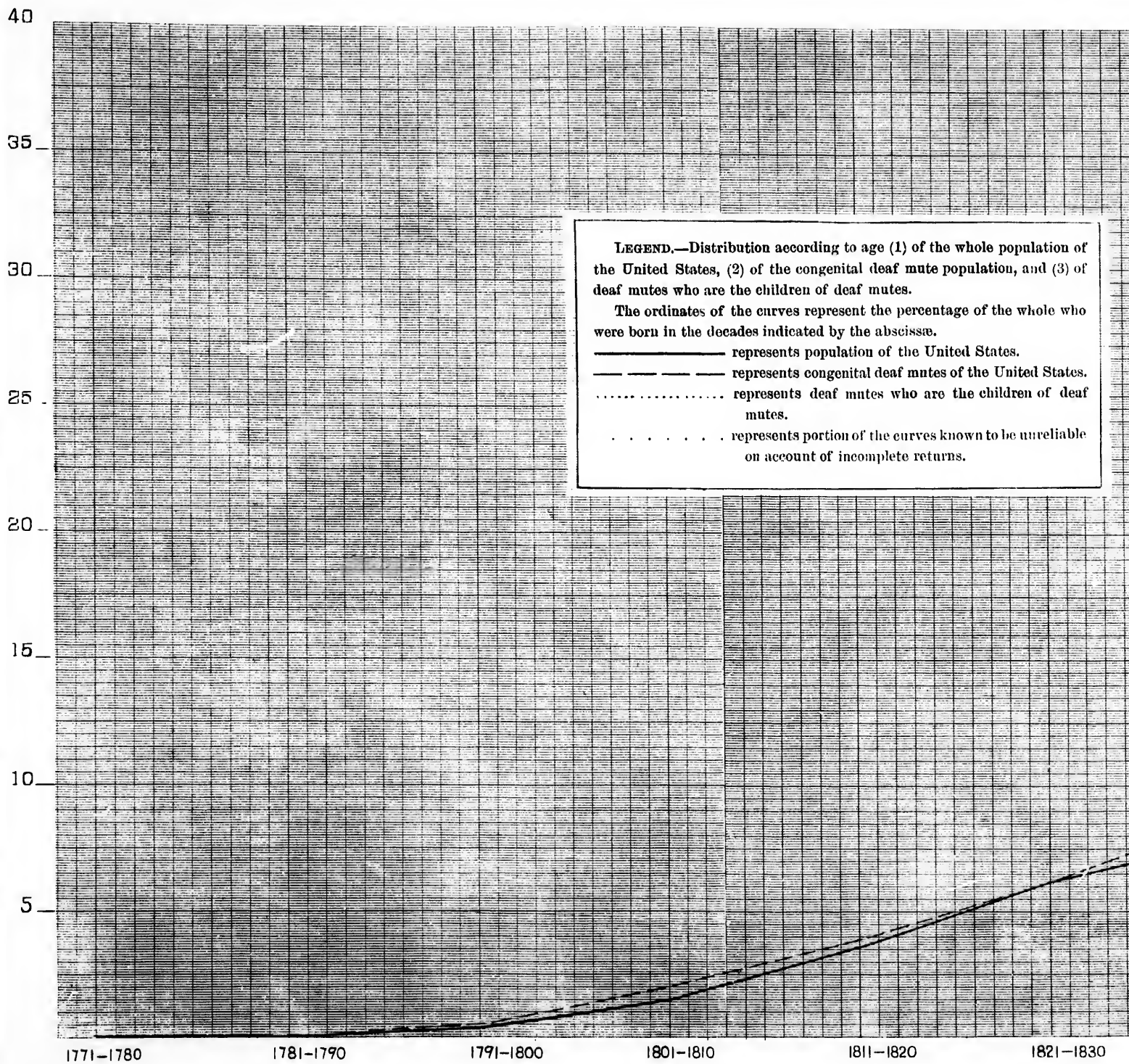

LEGEND.—Distribution according to age (1) of the whole population of the United States, (2) of the congenital deaf mute population, and (3) of deaf mutes who are the children of deaf mutes.

The ordinates of the curves represent the percentage of the whole who were born in the decades indicated by the abscissæ.

— represents population of the United States.
 - - - represents congenital deaf mutes of the United States.
 represents deaf mutes who are the children of deaf mutes.
 represents portion of the curves known to be unreliable on account of incomplete returns.

FIG. 12.

whole population of
population, and (3) of
e of the whole who
d States.
f the United States.
he children of deaf
own to be unreliable
.

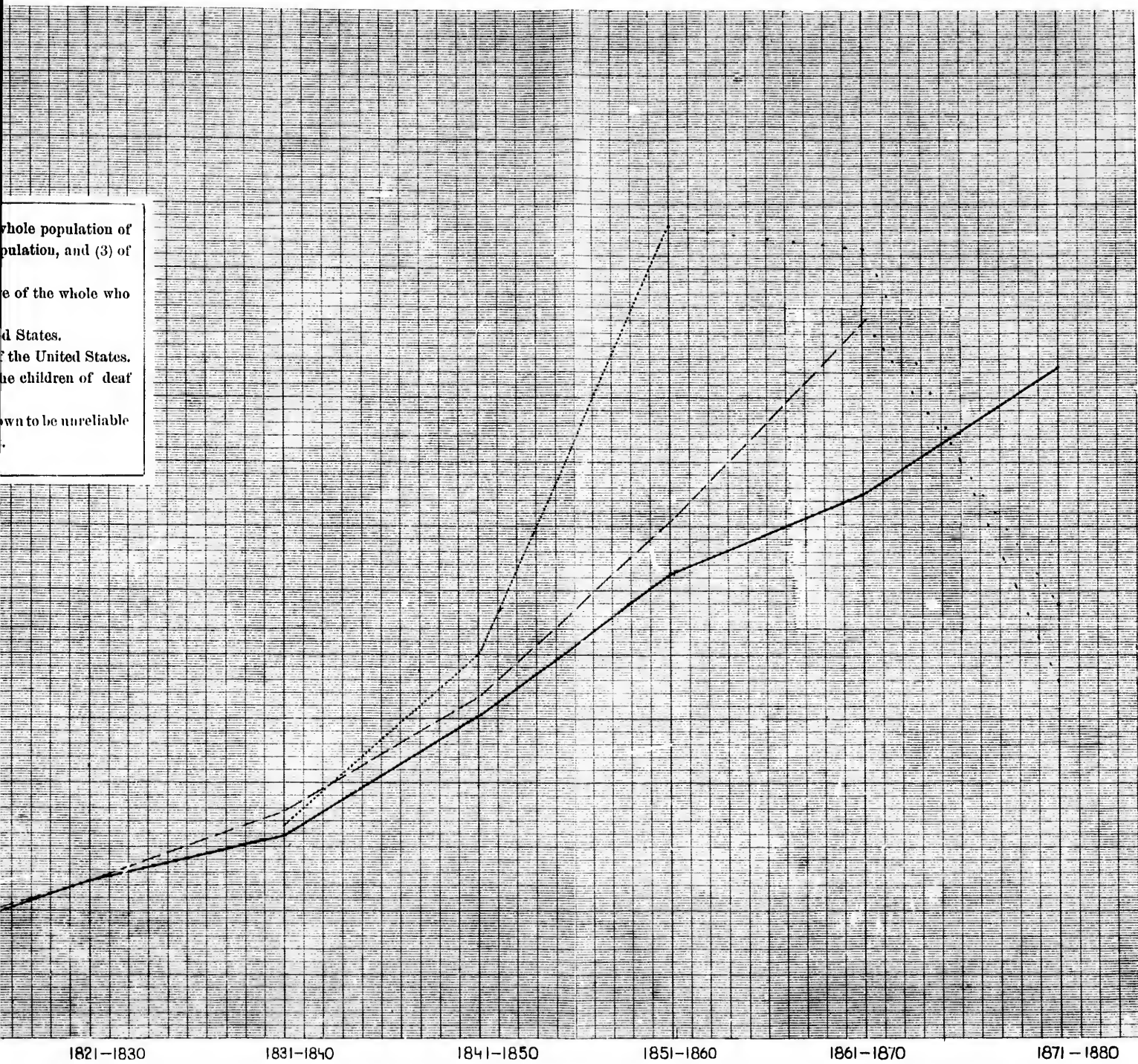

CHAPTER VI.

UPON THE CAUSES THAT DETERMINE THE SELECTION OF THE DEAF BY THE DEAF IN MARRIAGE.

In the preceding chapters I have shown that sexual selection is at work among the deaf and dumb, tending to produce a deaf variety of the human race.

Those who believe as I do, that the production of a defective race of human beings would be a great calamity to the world, will examine carefully the causes that lead to the intermarriages of the deaf with the object of applying a remedy.

It is a significant fact that "before the deaf and dumb were educated comparatively few of them married";* and intermarriage (if it existed at all) was so rare as to be practically unknown. This suggests the thought that the intermarriages of the deaf and dumb have in some way been promoted by our methods of education. When we examine the subject from this point of view a startling condition of affairs becomes apparent.

Indeed, if we desired to create a deaf variety of the race, and were to attempt to devise methods which should compel deaf-mutes to marry deaf-mutes, we could not invent more complete or more efficient methods than those that actually exist and which have arisen from entirely different and far higher motives.

Let us, then, consider how we might proceed to form a race of deaf-mutes, if we desired so to do, and let us compare the steps of the process with those that have been adopted by philanthropists and others, from the purest and most disinterested motives, to ameliorate the condition of the deaf and dumb. How would we commence?

1. With such an object in view, would it not be of importance to separate deaf-mutes from hearing persons as early in life as possible and make them live together in the same place, carefully guarding them from the possibility of making acquaintances among hearing persons of their own age? This is what we do. We take deaf children away from their homes and place them in institutions by the hundred, keeping them there from early childhood to the commencement of adult life.

2. It would also be of importance to promote social intercourse among them in adult life, so that the boys and girls of former years should meet again as men and women. We might, for instance, hold periodical reunions of former pupils at the institutions. This again is what we do.

Indeed, the graduates of our institutions now commonly organize themselves into societies or associations for the promotion of social intercourse in adult life. Societies of deaf-mutes are to be found in all large cities and in many of the smaller ones. Rooms are hired in a central locality, which become the rendezvous of the deaf-mutes of the neighborhood. After the business of the day is done, the deaf-mutes of the city meet together for social intercourse and on Sundays for public worship. Not only do local societies exist, but there are State associations for promoting social intercourse between the deaf-mutes of a State. Periodical conventions are held in different

* See "The Causes of Deafness," by the Rev. W. W. Turner, American Annals of the Deaf and Dumb, vol. i, p. 32.

parts of the State, attended by deaf-mutes of both sexes. At these meetings they amuse themselves in various ways. Sometimes they hold fairs; have theatrical representations in dumb show, spectacular tableaux, dancing, &c.

Not only do these State associations exist, but a National Association has been formed for the purpose of promoting social intercourse between the scattered deaf-mutes of the country. The Second National Convention of Deaf-Mutes met only a short time ago in New York, and was attended by hundreds of deaf-mutes from all parts of the United States.

3. Another method calculated to foster class-feeling among the deaf and dumb would be to provide them with newspapers and periodicals of their own, which should make a specialty of "personals" relating to the deaf and dumb—newspapers that should give full accounts of the deaf-mute conventions and reunions, and keep their readers informed of the movements of deaf-mutes, their marriages, deaths, &c. Quite a number of such newspapers have come into existence;* the majority being supported by the educational institutions of the country, with the benevolent object of teaching the deaf-mutes the art of printing. These papers, I understand, are generally edited and printed in the institutions, under the superintendence of the teachers. It was only natural to include among the items "personals" concerning former pupils, and that former pupils of the institution should take pleasure in reading them. In addition to the periodicals printed in the institutions, others have appeared edited and managed by adult deaf-mutes not connected with any institution. These latter papers became the organs of communication between the adult deaf-mutes, and were affiliated with the conventions and associations above referred to.

4. The methods specified above, while they serve to facilitate social intercourse between adult deaf-mutes, do not necessarily prevent them from also associating with hearing persons. As there are 1,500 hearing persons for every one deaf-mute, it seems difficult to formulate any plan which would restrict their choice of partners in life to deaf-mutes alone or to the hearing members of deaf-mute families. Let us consider how this could be accomplished.

What more powerful or efficient means could be found than to teach the deaf-mutes to think in a different language from that of the people at large? This is what we do. In the majority of our institutions for the deaf and dumb a special language is used as the vehicle of thought, a language as different from English as French or German or Russian. The English language is confined to the school-room, and is simply taught as a school exercise, much as French and German are taught in the public schools.

The deaf-mutes *think* in the gesture language, and English is apt to remain a foreign tongue. They can communicate with hearing persons by writing, but they often write in broken English, as a foreigner would speak. They think in gestures, and often translate into written English with the idioms of the sign language. The constant practice of the sign language interferes with the mastery of the English language, and it is to be feared that comparatively few of the congenitally deaf are able to read books understandingly unless couched in simple language. They are thus in a great measure cut off from our literature. This is another element in forcing them into each other's society. They are able to understand a good deal of what they see in our daily newspapers, especially if it concerns what interests them personally, but the political speeches of the day, the leading editorials, &c., are often beyond their knowledge of the English language.

*These must not be confounded with the American Annals of the Deaf and Dumb, a journal of a very different character, not intended to be read specially by deaf-mutes themselves. This journal is a quarterly magazine, devoted to the discussion of subjects connected with the education of the deaf and dumb, and forms the official organ of communication between teachers. It is one of the most admirably conducted special journals in existence, and contains within its pages almost the complete literature of the world relating to the education of the deaf and dumb.

*Deaf-mutes think
of sign language*

5. Another method of consolidating the deaf and dumb into a distinct class in the community would be to reduce the sign-language to writing, so that the deaf-mutes would have a common literature distinct from the rest of the world. Such a species of writing would constitute a form of ideography like the Egyptian hieroglyphics. This, I understand, has already been accomplished by the late Mr. George Hutton, of Ireland, afterwards principal of the Institution for the Deaf and Dumb in Halifax, Nova Scotia.* The full publication of his method was prevented by his premature death; but a committee was appointed by the Indianapolis Convention of American Instructors of the Deaf and Dumb, to act in conjunction with his successor and son, Mr. J. Scott Hutton, to attempt the recovery of the system from the posthumous papers of Mr. George Hutton. I have not yet seen the report of the committee.

6. Another and very powerful method of obstructing intercourse with hearing persons and compelling deaf-mutes to associate exclusively with one another would be to disseminate throughout the community incorrect ideas concerning the deaf and dumb, so that people should avoid and even fear them. The growth of erroneous ideas is favored by collecting deaf-mutes into institutions away from public observation. People rarely see a deaf-mute, and their information concerning them is chiefly derived from books and periodicals.

Whatever the cause, it is certainly the case that adult deaf-mutes are sometimes hampered by the instinctive prejudices of hearing persons with whom they desire to have business or social relations. Many persons have the idea they are dangerous, morose, ill-tempered, &c. Then again people do not understand the mental condition of a person who cannot speak and who thinks in gestures. He is sometimes looked upon as a sort of monstrosity, to be stared at and avoided. His gesticulations excite surprise and even sometimes alarm in ignorant minds. In connection with this subject I may say that as lately as 1857 a deaf-mute was shot dead in Alabama by a man who was alarmed by his gestures.† In fact fallacies concerning the deaf and dumb are so common as to touch us all and to suggest the advisability of seriously examining the fundamental ideas we hold concerning them.

I have elsewhere discussed the subject of "Fallacies concerning the deaf and the influence of these fallacies in preventing the amelioration of their condition," and shall not therefore enlarge upon the subject here. I shall simply give a few of the conclusions at which I arrived in the paper referred to.‡

"1. Those whom we term 'deaf-mutes' have no other natural defect than that of deafness. They are simply persons who are deaf from childhood, and many of them are only 'hard of hearing.'

"2. Deaf children are dumb not on account of lack of hearing, but of lack of instruction. No one teaches them to speak. ←

"3. A gesture-language is developed by a deaf child at home, not because it is the only form of language that is natural to one in his condition, but because his parents and friends neglect to use the English language in his presence in a clearly visible form. ←

"4. (a) The sign-language of our institutions is an artificial and conventional language derived from pantomime. ←

"(b) So far from being natural either to deaf or hearing persons, it is not understood by deaf children on their entrance to an institution. Nor do hearing persons become sufficiently familiar

* See Mr. Hutton's article "Upon the Practicability and Advantages of Mimography," American Annals of the Deaf and Dumb, vol. xiv, pp. 157-182.

† See American Annals of the Deaf and Dumb, vol. x, p. 116.

‡ See Bulletin Philosophical Society of Washington, D. C., October 27, 1883; also American Annals of the Deaf and Dumb, January, 1884.

The hearing people have the wrong idea about d. p. because they are shut off

with the language to be thoroughly qualified as teachers until after one or more years' residence in an institution for the deaf and dumb.

→ (c) The practice of the sign language hinders the acquisition of the English language.

→ (d) It makes deaf-mutes associate together in adult life, and avoid the society of hearing people.

(e) It thus causes the intermarriage of deaf-mutes and the propagation of their physical defect.

"5. Written words can be associated directly with the ideas they express, without the intervention of signs, and written English can be taught to deaf children by usage so as to become their vernacular.

→ "6. A language can only be made vernacular by constant use as a means of communication, without translation.

"7. Deaf children who are familiar with the English language in either its written or spoken forms can be taught to understand the utterances of their friends by watching the mouth.

"8. The requisites to the art of speech-reading are:

(a) An eye trained to distinguish quickly those movements of the vocal organs that are visible (independently of the meaning of what is uttered);

(b) A knowledge of *homophenes*—that is, a knowledge of those words that present the same appearance to the eye; and,

(c) Sufficient familiarity with the English language to enable the speech-reader to judge by context which word of a homophenous group is the word intended by the speaker."

7. From what has been said above it will be seen that we have in actual operation the elements necessary to compel deaf-mutes to select as their partners in life persons who are familiar with the gesture language. This practically limits their selection to deaf-mutes and to hearing persons related to deaf-mutes. They do select such partners in marriage, and a certain proportion of their children inherit their physical defect. We are on the way therefore towards the formation of a deaf variety of the human race. Time alone is necessary to accomplish the result.

If we desired such a result what more could we do to hasten the end in view? We might attempt to formulate some plan which should lead the deaf children of deaf-mutes to marry one another instead of marrying deaf-mutes who had not inherited their deafness; or to marry hearing persons belonging to families in which deafness is hereditary. If, for instance, a number of the large deaf-mute families of the United States—families in which we know deafness to be hereditary—were to settle in a common place so as to form a community largely composed of deaf-mutes, then the deaf children born in the colony would be thrown into association with one another and would probably intermarry in adult life, or marry hearing persons belonging to the deaf-mute families. Though fewer in number than the original deaf settlers, they would probably be more prolific of deaf offspring; and each succeeding generation of deaf-mutes would increase the probability of the deaf-mute element being rendered permanent by heredity. Such a result would certainly ensue if the numbers of the deaf and dumb in the colony were constantly kept up by the immigration of congenital deaf-mutes from outside; and if a large proportion of the hearing children born in the colony were to leave and mingle with the outside world. Under such circumstances we might anticipate that a very few generations would suffice for the establishment of a permanent race of deaf-mutes with a language and literature of its own.

Plans for the formation of a deaf-mute community have a number of times been discussed by the deaf-mutes themselves. The idea originated in the action of Congress in endowing the American Asylum for Deaf-mutes at Hartford with a tract of land. Mon. Laurent Clerc, in conversation with some of the earlier pupils of the American Asylum, remarked that it would be a good

plan to sell a portion of the land for the benefit of the institution and retain the remainder as *head-quarters* for the deaf and dumb, to which they could emigrate after being educated.* This idea took root in the minds of the pupils of the American Asylum, and afterwards developed into a number of independent and eccentric schemes for the formation of a deaf-mute community. Some of the pupils before their graduation formed an agreement to emigrate to the West and settle in a common place.†

Then a number of years afterwards a deaf-mute publicly urged the formation of a deaf-mute commonwealth. Congress was to be petitioned to form a deaf-mute state or territory, &c. The details, though quite impracticable, brought forward the fact that a number of schemes of somewhat similar character were in the minds of deaf-mutes in different parts of the country. One deaf-mute publicly offered to contribute \$5,000 towards such a scheme if others could be found to join him. It was urged that the natural affection of the parents would lead to the distribution of the land among their children, and that as the majority of their children could hear and speak the land would soon pass out of the control of the deaf-mutes themselves. This was to be remedied in various ways—as, for instance, by legislation—so as to secure descent in the deaf-mute line alone. The American Annals of the Deaf and Dumb became the channel of communication between the various thinkers.‡ The scheme that received most approbation was the purchase of a tract of land by a few of the wealthy deaf-mutes, who were to agree to sell out the land in small blocks to other deaf-mutes. The whole scheme was afterwards discussed at a convention of the deaf-mutes of New England, and was overthrown by the influence of the Rev. W. W. Turner, Mr. Laurent Clerc, and other teachers, in conjunction with the most intelligent of the deaf-mutes themselves. Since then the subject has not been publicly discussed, to my knowledge; but such a scheme is still favored by individual deaf-mutes, and may therefore be revived in organized shape at any time.§

CONCLUSION.

I think all will agree that the evidence shows a tendency to the formation of a deaf variety of the human race in America. What remedial measures can be taken to lessen or check this tendency? We shall consider the subject under two heads: (1) repressive, (2) preventive measures.

(1) *Repressive measures.*—The first thought that occurs in this connection is that the intermarriage of deaf-mutes might be forbidden by legislative enactment. So long, however, as deaf-mutes of both sexes continue to associate together in adult life, legislative interference with marriage might only promote immorality. But, without entirely prohibiting intermarriage, might not the marriages of the deaf be so regulated as to reduce the probabilities of the production of deaf offspring to a minimum? For instance, a law forbidding congenitally deaf persons from intermarrying would go a long way towards checking the evil. Such a law might, however, become inoperative on account of the impossibility of proving that a person had been born deaf.

Legislation forbidding the intermarriage of persons belonging to families containing more than one deaf-mute would be more practicable. This would cover the intermarriage of hearing persons belonging to such families, and also the case of a consanguineous marriage in a deaf-mute family.

In order to justify the passage of such an act, however, the results of intermarriages of this kind should be more fully investigated than is possible at the present time on account of limited

* See speech by Laurent Clerc, "American Annals of the Deaf and Dumb," vol. x, p. 212.

† See "American Annals of the Deaf and Dumb," vol. x, p. 73.

‡ See vol. x, pp. 72-80; 136-160; 212-215.

§ Since this paper was read, a European philanthropist has commenced the colonization of a tract of land in Manitoba by deaf-mutes. I am informed by a friend who resides in Winnipeg that about 24 deaf-mutes, with their families, have already arrived from Europe and have settled upon the land. More are expected next year.

data. Steps should be taken towards the collection of special statistics, and the institutions should be urged to publish the materials in their possession. I wrote to the principals of all the institutions in the country, requesting them to forward to me such of their published reports as contained any of the required statistics. Although my request was honored by a response from a large number of institutions, the information contained in the reports in reference to the subject of inquiry was generally of the most meagre description.

Among repressive measures should perhaps be included the influence of friends to prevent undesirable intermarriages. While such action might affect individual cases it could not greatly influence the general result. For there is no subject on which a man will so little brook interference as one of this kind where his affections are involved.

A due consideration of all the objections renders it doubtful whether legislative interference with the marriage of the deaf would be advisable.

(2.) *Preventive measures.*—The most promising method of lessening the evil appears to lie in the adoption of preventive measures. In our search for such measures we should be guided by the following principle: (1.) *Determine the causes that promote intermarriages among the deaf and dumb; and (2) remove them.*

The immediate cause is undoubtedly the preference that adult deaf-mutes exhibit for the companionship of deaf-mutes rather than that of hearing persons. Among the causes that contribute to bring about this preference we may note: (1) segregation for the purposes of education, and (2) the use, as a means of communication, of a language which is different from that of the people. These, then, are two of the points that should be avoided in the adoption of preventive measures. Nearly all the other causes I have investigated are ultimately referable to these.

Segregation really lies at the root of the whole matter; for from this the other causes have themselves been evolved by the operation of the natural law of adaptation to the environment.

We commence our efforts on behalf of the deaf-mute by changing his social environment. The tendency is then towards accommodation to the new conditions. In process of time the adaptation becomes complete; and when, at last, we restore him to the world as an adult, he finds that the social conditions to which he has become accustomed do not exist outside of his school life. His efforts are then directed to the restoration of these conditions, with the result of intermarriage and a tendency to the formation of a deaf-mute community.

The grand central principle that should guide us, then, in our search for preventive measures should be the retention of the normal environment during the period of education. The natural tendency towards adaptation would then co-operate with instruction to produce accommodation to the permanent conditions of life.

The direction of change should therefore be towards the establishment of small schools, and the extension of the day-school plan. The practicability of any great development of day schools will depend upon the possibility of conducting very small schools of this kind economically to the State; for the scattered condition of the deaf and dumb in the community precludes the idea of large day schools, excepting in the great centers of population. The principle referred to above indicates that such schools should be of the minimum size possible; for the school that would most perfectly fulfil the condition required would contain only one deaf child. It also points to the advisability of coeducation with hearing children—but this is not practicable to any great extent. No instruction can be given through the ear, and complete coeducation would only therefore be possible by a change in the methods of teaching hearing children. It is useless to expect that such a change would be made for the benefit of the deaf and dumb on account of their limited number.

Partial coeducation is, however, possible, for some studies are pursued in the common schools in which information is gained through the eye. For instance, deaf-mutes could profitably enter

can
intermarriage

day
schools

coeducation
with hearing children

partial

the same classes with hearing children for practice in writing, drawing, map-drawing, arithmetic on the black-board, sewing, &c. For other subjects special methods of instruction would be necessary, and these demand the employment of special teachers. They do not, however, necessitate special schools or buildings, and a small room in a public school building would accommodate as many deaf children as one teacher could successfully instruct. Considerations of economy render advisable the appropriation of a room of this kind, as the appliances of a large school might thus be obtained without special outlay.

The average *per capita* cost of the education of a deaf child in an American institution is \$223.28 per annum.* Very small day schools could be maintained at no greater cost. The cost, at an institution, however, includes board and industrial training. On the day-school plan the parents would generally assume the expense of maintenance, and some special provision would have to be made for industrial training. This need give no concern, for so many deaf-mutes are earning their livelihood by trades which they were *not* taught in the institutions as to demonstrate the practicability of apprenticing deaf-mutes in ordinary shops.

The indications are that in all places where three or four deaf children could be brought together near their homes the cost would be no more to form them into a class in the nearest public school building under a special teacher than to send them to an institution. On the basis of the average *per capita* cost at an institution the sum of \$609.84 would be received for three, and \$893.12 for four pupils; and such sums would probably be sufficient to pay the salary of a special teacher, as well as to cover incidental expenses.

If this is so the day-school system could be made to penetrate into the smaller centers of population as well as into the large cities, in which case it would exert a considerable influence as a remedial agent. The plan of forming small classes of deaf children in public school buildings recommends itself as affording the closest approximation possible, on the large scale, to the normal conditions of life.

Segregation during education has not only favored the tendency towards the formation of a race of deaf-mutes, but has led to the evolution of a special language adapted for the use of such a race—"the sign-language of the deaf and dumb." This is especially true in America where the sign-language is employed by a large majority of the teachers in instructing their pupils. In foreign countries the vast majority employ, for this purpose, the ordinary language of the people. This will fully appear by reference to Table V in the Appendix.

The lack of articulate speech should also be noted as an indirect cause of segregation in adult life, operating to separate deaf-mutes from hearing persons. Hence, instruction in articulation and speech-reading should be given to every pupil.

This is done in Germany. Indeed, in 1882, more than 65 per cent. of all the deaf and dumb in foreign schools were being taught to speak and understand the speech of others, whereas in America less than 9 per cent. were to be found in oral schools.†

According to more recent statistics compiled by the Clarke Institution‡ we find that in May, 1883, about 14 per cent. of the deaf and dumb in American institutions were using speech in the

* See Table X in the Appendix.

† See American Annals of the Deaf and Dumb, vol. xxviii, pp. 47-61; also, Table V, in the Appendix—from which it will appear that of 7,155 American deaf-mutes, only 584, or less than 9 per cent., were to be found in oral schools; whereas of 19,318 deaf-mutes in foreign schools, 12,662, or more than 65 per cent., were taught to speak in purely oral schools.

‡ See Appendix to Sixteenth Annual Report of the Clarke Institution. See, also, Table Y in the Appendix. Complete returns were not obtained, but the cases noted number 6,232, thus comprehending the vast majority of the pupils under instruction in May, 1883. Of these 886, or 14 per cent., were under oral instruction; 1,105, or 18 per cent., received occasional instruction in speech in sign institutions; and 4,241 received no instruction in articulation whatever.

could be in hearing school

school-room as the language of communication with their teachers; 18 per cent. were taught to speak as an accomplishment, and 68 per cent. received no instruction whatever in articulation.

Nearly one-third of the teachers of the deaf and dumb in America are themselves deaf,* and this must be considered as another element favorable to the formation of a deaf race—to be therefore avoided.

The segregation of deaf-mutes, the use of the sign-language, and the employment of deaf teachers produce an environment that is unfavorable to the cultivation of articulation and speech-reading, and that sometimes causes the disuse of speech by speaking pupils who are only deaf.

Having shown the tendency to the formation of a deaf variety of the human race in America, and some of the means that should be taken to counteract it, I commend the whole subject to the attention of scientific men.

* See American Annals of the Deaf and Dumb (January, 1883), vol. xxviii, pp. 56-57. Out of 481 teachers 154, or 32 per cent., were deaf.

APPENDIX.

1. Tables A to M give an analysis of 3,726 cases of deaf-mutes from the American Asylum and Illinois Institution. For this analysis I am indebted to Mr. Franck Z. Maguire, of Washington, D. C.; and I have personally verified his results. The relation of the tables to one another will be understood from the following classification:

Classification of Tables A to K.

Total number of pupils of the American Asylum and Illinois Institution (see Table A).	{	Whose deafness was stated to be <i>congenital</i> (see Table B).	{	Recorded to have deaf-mute relatives (see Table E).
				Recorded as sporadic cases (see Table F).
		Whose deafness was stated to be <i>non-congenital</i> (see Table C).	{	Recorded to have deaf-mute relatives (see Table G).
				Recorded as sporadic cases (see Table H).
		The cause of whose deafness was <i>not stated</i> (see Table D).	{	Recorded to have deaf-mute relatives (see Table I).
				Recorded as sporadic cases (see Table J).

Table A gives the summation of Tables B, C, and D.

Table B gives the summation of Tables E and F.

Table C gives the summation of Tables G and H.

Table D gives the summation of Tables I and J.

In Table K the non-congenitally deaf pupils are classified according to period of birth and according to period when deafness occurred.

In Table L the non-congenitally deaf pupils of the American Asylum are classified according to the period when hearing was lost, and according to the diseases that caused deafness.

In Table M the non-congenitally deaf pupils of the Illinois Institution are classified according to the period when hearing was lost, and according to the diseases that caused deafness.

2. Tables N, O, P, Q relate to the Tenth Census of the United States (1880), and give the results of an analysis of 22,472 cases of deaf-mutes from the census returns. (See communication by the Rev. Fred. D. Wines upon the 1880 census of the deaf and dumb; proceedings of the 10th convention of American instructors of the deaf and dumb, Jacksonville, Ill., August, 1882, pp. 122-127, published with the 21st biennial report of the Illinois Institution for the Deaf and Dumb.)

Table N gives an analysis of 22,472 cases of deaf-mutes living June 1, 1880, showing the number who became deaf each year since the year 1770.

Table O shows the number of these deaf-mutes who became deaf each year since 1873, separating the congenital from the non-congenital cases.

Table P classifies the 22,472 cases by periods of five years and reduces the number who became deaf in each quinquennial period to a percentage of the whole on a basis of 10,000 cases in all.

Table Q classifies the 22,472 cases by periods of five years and separates the congenital from the non-congenital cases.

3. Table R shows the number of deaf-mutes in the United States living June 1, 1880, arranged according to race and sex and according to cause of deafness. The materials for this table have

been furnished in advance of the publication of the census returns by the courtesy of General Seaton, General Superintendent of the Census. (See "Science," vol. iii, p. 244; and "American Annals of the Deaf and Dumb," vol. xxix p, 160.)

4. Table S shows (*a*) the number of schools and institutions for the education of the deaf and dumb in the United States, 1883; (*b*) the date of opening of each institution; (*c*) the number of deaf children under instruction, 1883; and (*d*), the total number of pupils that have been received into the institutions. These particulars have been obtained from the "American Annals of the Deaf and Dumb," vol. xxix, pp. 90-94. The table also shows (*e*) the number of deaf children whose parents were deaf mutes who have been received into the institutions. These particulars have been received directly from the principals or superintendents of the institutions and schools in answer to a circular-letter of inquiry. The total number of such pupils cannot be ascertained from the table as some of the institutions have not yet made returns.

5. Table T gives an analysis of 215 cases of deaf-mutes whose parents were deaf.

6. In Table U the total population of the country, the congenitally deaf population, and the deaf-mutes who have both parents deaf, are classified according to their period of birth, and the number of persons born in each period has been reduced to a percentage of the whole.

7. Table V contains a tabular statement of the institutions of the world in 1882, showing the methods of instruction employed. This Table is taken from the "American Annals of the Deaf and Dumb," for January, 1883, vol. xxviii, p. 61.

8. Table W gives a list of those pupils of our institutions for the deaf and dumb who are stated to have deaf parents. The information has been obtained directly from the principals and superintendents of the institutions in answer to a letter of inquiry.

9. Table X shows the *per capita* cost of the education of a deaf child in an American institution. This table was prepared by the principal of the Illinois Institution from materials published in the American Annals of the Deaf and Dumb, and from other materials privately collected and published in the Twenty-first Biennial Report of the Illinois Institution (1882), pp. 16-17.

10. Table Y contains a tabular statement concerning the teaching of articulation in the institutions of the United States in May, 1883. The information was obtained by the principal of the Clarke Institution, Northampton, Mass., directly from the principals of the other institutions in reply to a circular of inquiry. See Appendix B, Sixteenth Annual Report of the Clarke Institution for Deaf-Mutes, September 1, 1883.

11. Appendix Z contains an examination of the marriages of the pupils of the American Asylum and Illinois Institution by the light of the theory of Probabilities, with the object of determining approximately the proportion of the congenitally deaf who marry congenital deaf-mutes. This investigation has been kindly undertaken by Prof. Simon Newcomb, to whom I am indebted for the results obtained.

TABLE A.—Total number of pupils.

AMERICAN ASYLUM.

Period of birth.	Grand total.		Not recorded to have married.		Total.				Married to deaf-mutes.				Not recorded to have married deaf-mutes.																					
					Total.		Males.		Females.		Total.		Males.		Females.		Total.		Males.		Females.													
	Males.	Females.	Total.	Males.	Females.	Total.	Recorded number of deaf children born to the pupils.	Recorded number of deaf children.	Recorded number of deaf children born to the females.	Recorded number of deaf children.	Recorded number of deaf children.	Recorded number of deaf children born to the pupils.	Recorded number of deaf children.	Recorded number of deaf children.	Recorded number of deaf children born to the females.	Recorded number of deaf children.	Recorded number of deaf children.	Recorded number of deaf children born to the pupils.	Recorded number of deaf children.	Recorded number of deaf children.	Recorded number of deaf children born to the females.	Recorded number of deaf children.												
1766-1769	1	1	2	1	1	1																												
1770-1779	2	1	3	1	1	2																												
1780-1789	7	4	11	5	2	3																												
1790-1799	44	24	68	20	27	12																												
1800-1809	158	95	253	63	78	42	30	80	4																									
1810-1819	276	132	408	124	127	72	55	149	11																									
1820-1829	288	170	458	118	144	90	54	144	8																									
1830-1839	323	184	507	140	195	112	83	129	5																									
1840-1849	387	214	601	173	291	169	122	96																										
1850-1859	367	231	598	156	363	222	141	24	1																									
1860-1869	228	140	368	88	228	140	88																											
Unknown	4	3	7	1	4	3	1																											
Total	2,106	1,219	3,325	887	1,464	865	599	642	29	(1)	354	16	36	288	13	28	502	24	(1)	263	14	30	239	10	19	140	5	15	91	2	6	40	3	9

TABLE B.—*Congenitally deaf pupils.*

AMERICAN ASYLUM.

Period of birth.	Grand total.						Not recorded to have married.						MARRIED.						Not recorded to have married deaf mutes.														
	Total.			Total.			Total.			Total.			Total.			Total.			Total.			Total.											
	Males.	Females.	Total.	Males.	Females.	Total.	Males.	Females.	Total.	Males.	Females.	Total.	Males.	Females.	Total.	Males.	Females.	Total.	Males.	Females.	Total.	Males.	Females.	Total.									
	Recorded number of deaf children.	Recorded number of deaf children born to the pupils.	Recorded number of deaf children.	Recorded number of deaf children.	Recorded number of deaf children born to the pupils.	Recorded number of deaf children.	Recorded number of deaf children.	Recorded number of deaf children born to the pupils.	Recorded number of deaf children.	Recorded number of deaf children.	Recorded number of deaf children born to the pupils.	Recorded number of deaf children.	Recorded number of deaf children.	Recorded number of deaf children born to the pupils.	Recorded number of deaf children.	Recorded number of deaf children.	Recorded number of deaf children born to the pupils.	Recorded number of deaf children.	Recorded number of deaf children.	Recorded number of deaf children born to the pupils.	Recorded number of deaf children.	Recorded number of deaf children.	Recorded number of deaf children born to the pupils.	Recorded number of deaf children.	Recorded number of deaf children born to the pupils.								
1760-1769	1	1	2	1	1	2																											
1770-1779	1	1	2	1	1	2																											
1780-1789	6	4	10	4	2	6																											
1790-1799	27	14	41	20	9	29																											
1800-1809	73	42	115	40	21	61																											
1810-1819	114	62	176	52	26	78																											
1820-1829	153	83	236	75	44	119																											
1830-1839	173	95	268	112	62	174																											
1840-1849	198	102	300	146	77	223																											
1850-1859	144	86	230	131	85	216																											
1860-1869	83	51	134	83	51	134																											
Total	973	549	1522	677	386	1063	291	296	587	154	10	23	142	10	25	359	16	(1)	120	8	17	11P	8	17	57	4	14	34	2	6	23	2	8

TABLE B.—*Congenitally deaf pupils*—Continued.
ILLINOIS INSTITUTION.

Period of birth.	Grand total.				Not recorded to have married.				MARRIED.									
	Total.		Total.		Total.		Total.		Total.		Total.		Total.		Total.		Total.	
	Males.	Females.	Males.	Females.	Males.	Females.	Males.	Females.	Males.	Females.	Males.	Females.	Males.	Females.	Males.	Females.	Males.	Females.
1810-1819	1	1	1	1	1	1	1	1	1	1	1	1	1	1	1	1	1	1
1820-1829	13	7	8	1	5	1	1	4	1	4	1	1	4	1	1	1	1	1
1830-1839	52	33	36	25	16	4	11	8	1	16	4	8	1	1	8	3	4	1
1840-1849	77	43	34	55	32	22	11	11	1	20	1	10	1	2	10	1	2	1
1850-1859	140	73	67	122	65	57	8	10	17	8	8	8	0	1	8	1	1	1
1860-1869	105	63	42	104	63	41	1	1	1	1	1	1	1	1	1	1	1	1
1870-1879	29	10	10	29	10	10	1	1	1	1	1	1	1	1	1	1	1	1
Unknown	1	1	1	1	1	1	1	1	1	1	1	1	1	1	1	1	1	1
Total	415	238	180	354	205	149	64	6	6	59	6	30	2	2	29	4	6	5

TABLE C.—*Non-congenitally deaf pupils.*
AMERICAN ASYLUM.

Period of birth.	Grand total.				Not recorded to have married.				MARRIED.				Not recorded to have married deaf mutes.													
	Males.		Females.		Total.		Total.		Total.		Total.		Total.		Total.		Total.									
	Recorded to have deaf children.	Recorded number of deaf children born to the pupils.	Recorded to have deaf children.	Recorded number of deaf children born to the females.	Recorded to have deaf children.	Recorded number of deaf children born to the males.	Recorded to have deaf children.	Recorded number of deaf children born to the females.	Recorded to have deaf children.	Recorded number of deaf children born to the males.	Recorded to have deaf children.	Recorded number of deaf children born to the females.	Recorded to have deaf children.	Recorded number of deaf children born to the males.	Recorded to have deaf children.	Recorded number of deaf children born to the females.	Recorded to have deaf children.	Recorded number of deaf children born to the males.								
1700-1750	1	1	1	1	5	3	3	5	3	3	2	3	2	3	2	3	2	3								
1770-1779	1	1	1	1	5	3	3	5	3	3	2	3	2	3	2	3	2	3								
1780-1789	12	7	5	4	27	13	13	20	10	10	20	10	20	17	17	34	17	3								
1790-1799	70	43	27	30	16	14	40	20	13	10	20	10	20	17	17	34	17	3								
1800-1809	147	81	66	58	82	36	80	76	40	37	34	42	37	34	34	42	37	6								
1810-1819	124	79	45	62	41	21	62	38	1	24	1	24	1	19	1	14	9	5								
1820-1829	146	85	61	79	46	33	67	30	2	28	2	28	2	24	2	26	2	5								
1830-1839	162	109	73	145	89	56	37	30	17	17	26	13	13	13	11	11	7	4								
1840-1849	224	137	87	206	130	76	18	7	11	1	12	4	8	6	1	3	3	1								
1850-1859	133	80	53	133	80	53	1	1	1	1	1	1	1	1	1	1	1	1								
1860-1869	1	1	1	1	1	1	1	1	1	1	1	1	1	1	1	1	1	1								
Unknown	1	1	1	1	1	1	1	1	1	1	1	1	1	1	1	1	1	1								
Total	1,040	622	418	719	437	282	321	8	185	6	13	136	2	249	7	135	6	13	114	1	72	1	56	23	1	1

TABLE C.—*Non-congenitally deaf pupils—Continued.*
ILLINOIS INSTITUTION.

Period of birth.	Grand total.						MARRIED.						Not recorded to have married deaf mutes.														
	Not recorded to have married.			Total.			Total.		Married to deaf-mutes.		Total.		Total.		Total.		Total.										
	Males.	Females.	Total.	Males.	Females.	Total.	Total.	Males.	Females.	Total.	Males.	Females.	Total.	Males.	Females.	Total.	Males.	Females.									
1810-1819	2	1	1	1	1	1	1	1																			
1820-1829	11	4	7	6	2	4	5	2																			
1830-1839	58	29	29	41	29	21	17	1																			
1840-1849	164	102	62	123	79	44	41	2																			
1850-1859	217	122	95	192	109	83	25	2																			
1860-1869	364	206	158	358	202	156	6	4																			
1870-1879	129	69	60	129	69	60																					
Unknown	2	1	1	2	1	1																					
Total	947	534	413	852	482	370	95	6 (7)	52	4	5	43	2	2	82	5 (7)	44	3	4	38	2	13	1	6	1	1	5

TABLE D.—Pupils the cause of whose deafness was not stated.
AMERICAN ASYLUM.

Period of birth.	Grand total.				Not recorded to have married.				MARRIED.														
	Total.		Females.		Total.		Males.		Total.		Males.		Females.		Total.		Males.		Females.				
	Recorded to have deaf children.	Recorded number of deaf children born to the pupils.	Recorded to have deaf children.	Recorded number of deaf children born to the males.	Recorded to have deaf children.	Recorded number of deaf children born to the females.	Recorded to have deaf children.	Recorded number of deaf children born to the pupils.	Recorded to have deaf children.	Recorded number of deaf children born to the males.	Recorded to have deaf children.	Recorded number of deaf children born to the females.	Recorded to have deaf children.	Recorded number of deaf children born to the pupils.	Recorded to have deaf children.	Recorded number of deaf children born to the males.	Recorded to have deaf children.	Recorded number of deaf children born to the females.					
1760-1769	1	1																					
1770-1779																							
1780-1789																							
1790-1799	5	3	2	3	2	2																	
1800-1809	15	10	5	8	5	3	7																
1810-1819	15	9	6	9	6	3	6																
1820-1829	11	8	3	7	5	2	4																
1830-1839	5	4	1	4	4		1																
1840-1849	7	3	4	6	3	3	1																
1850-1859	19	8	11	16	7	9	3																
1860-1869	12	9	3	12	9	3																	
Unknown	3	2	1	3	2	1																	
Total	93	57	36	68	42	26	25	1 (2)	15		10	1	1	14	1	8		6	1	1	11	7	4

TABLE D.—Pupils the cause of whose deafness was not stated.—Continued.

ILLINOIS INSTITUTION.

Period of birth.	Grand total.		Not recorded to have married.		MARRIED.															
					Total.				Married to deaf-mutes.				Not recorded to have married deaf mutes.							
	Total.	Males.	Females.	Total.	Males.	Females.	Total.	Males.	Females.	Total.	Males.	Females.	Total.	Males.	Females.					
1819.....	2		2	1	1		1													
1820-1829.....	3	2	1	1	1	1	1	1	1	1	1	1	1	1	1					
1830-1839	17	11	6	15	10	5	2	1	1	2	1	1	1	1	1					
1840-1849	27	16	11	24	15	9	3	1	2	1	1	2	1	1	1					
1850-1859	57	25	32	54	23	31	3	2	1	1	2	2	1	1	1					
1860-1869	104	61	43	89	60	29	5	1	4	1	4	4	1	3	1					
1870-1879	43	26	17	43	26	17														
Unknown	2	1	1	2	1	1														
Total.....	255	142	113	240	126	104	15	2	6	2	3	9	11	2	6	5	4	4	4	4

TABLE E.—Congenitally deaf pupils recorded to have deaf mute relatives other than children—Continued.

ILLINOIS INSTITUTION.

Period of Birth.	Grand total.		Not recorded to have married.		MARRIED.						Not recorded to have married deaf mutes.				
	Total.	Males.	Total.	Males.	Total.		Total.		Total.		Total.		Total.	Males.	Females.
					Males.		Females.		Males.		Females.				
	Total.	Males.	Total.	Males.	Total.	Males.	Total.	Males.	Total.	Males.	Total.	Males.	Total.	Males.	Females.
1810-1819															
1820-1829	9	4	5	6	3	1	3	1	3	1	1	1			
1830-1839	25	16	9	17	13	4	8	1	3		3	5	1	1	
1840-1849	34	18	16	21	12	9	13		6	7	12	5	7	1	1
1850-1859	69	30	39	57	26	31	12		4	8	11	4	1	1	1
1860-1869	47	29	18	47	29	18									
1870-1879	11	8	3	11	8	3	1								
Unknown	1	1					1								1
Total	196	106	90	159	89	70	37	2	17	1	34	2	15	19	1

TABLE F.—*Congenitally deaf pupils recorded as sporadic cases.*
AMERICAN ASYLUM.

Period of birth.	Grand total.		Not recorded to have married.				MARRIED.				Not recorded to have married deaf mutes.														
	Total.	Males.	Total.	Males.	Females.	Total.		Males.		Females.		Total.	Males.	Females.											
						Total.	Females.	Total.	Females.	Total.	Females.														
1760-1769	1	1	1	1																					
1770-1779	1	1	1	1																					
1780-1789	1	1	1	1																					
1790-1799	12	8	4	9	5	4	3	2	2	2	2	1	1	1											
1800-1809	30	16	14	14	6	8	16	2	10	1	3	5	1	1											
1810-1819	47	31	16	31	18	18	16	1	13	1	3	9	1	1											
1820-1829	42	20	22	21	9	12	21	2	11	1	10	1	1	1											
1830-1839	72	40	32	51	28	23	21	12	12	9	12	12	8	1											
1840-1849	91	47	44	67	36	31	24	11	11	13	11	11	13	1											
1850-1859	84	48	36	88	47	36	1	1	1	1	1	1	1												
1860-1869	45	29	16	45	29	16																			
Unknown																									
Total.....	426	241	185	323	179	144	103	5	62	3	41	2	4	87	5	5	52	3	5	35	2	4	16	10	6

TABLE F.—Congenitally deaf pupils recorded as sporadic cases.—Continued.
ILLINOIS INSTITUTION.

Period of birth.	Grand total.				Not recorded to have married.				Total.				MARRIED.				Total.				Not recorded to have married deaf-mutes.				MARRIED.									
	Males.		Females.		Males.		Females.		Total.		Males.		Females.		Total.		Males.		Females.		Total.		Males.		Females.		Total.		Males.		Females.			
	Total	Females	Total	Females	Total	Males	Total	Females	Total	Males	Total	Females	Total	Males	Total	Females	Total	Males	Total	Females	Total	Males	Total	Females	Total	Males	Total	Females	Total	Males	Total	Females		
1810-1819	1				1																													
1820-1829	4		2		2				2																									
1830-1839	27	17	10	19	12	7	8	3	5	1	1	3	2	3	8	3	5	1	1	3	2	3	3	2	3	5	1	1	3	2	3			
1840-1849	43	25	18	34	20	14	9	1	5			4	1	2	8	1	5			3	1	2	1	2	1	5					1			
1850-1859	71	43	28	65	39	26	6		4			2			6		4						2											
1860-1869	58	34	24	57	34	23	1					1			1								1											
1870-1879	18	11	7	18	11	7																												
Unknown																																		
Total	222	132	90	195	116	79	27	4	(1)	16	1	11	3	5	25	4	(1)	15	1	1	10	3	5	2	1	1	1	10	3	5	2	1	1	

TABLE G.—Non-congressionally deaf pupils recorded to have deaf-mute relatives other than children.
AMERICAN ASYLUM.

Period of birth.	MARRIED.																						
	Grand total.				Not recorded to have married.				Total.				Married to deaf-mutes.				Not recorded to have married deaf-mutes.						
	Males.		Females.		Total.		Males.		Females.		Total.		Males.		Females.		Total.		Males.		Females.		
	Total.	Males.	Total.	Females.	Total.	Males.	Total.	Females.	Total.	Males.	Total.	Females.	Total.	Males.	Total.	Females.	Total.	Males.	Total.	Males.	Total.	Females.	
1766-1769																							
1770-1779																							
1780-1789																							
1790-1799	4	1	3	1	3	1	3	2	2	3	1	3	1	3	2	2	3	1	3	2	2	3	
1800-1809	12	8	4	7	5	2	5	3	3	3	2	5	2	5	3	3	2	5	2	5	3	3	
1810-1819	6	3	3	1	1	5	5	3	3	4	2	4	2	4	3	3	2	4	2	4	3	3	
1820-1829	14	7	7	8	3	5	6	1	2	1	1	5	1	3	2	1	1	1	1	1	1	1	
1830-1839	19	7	12	11	6	5	8	1	7	1	8	1	3	7	1	7	1	8	1	3	7	1	
1840-1849	26	13	13	20	12	8	6	1	4	1	4	1	3	1	3	1	3	1	3	1	3	1	
1850-1859	30	15	15	24	13	11	6	1	2	4	1	1	4	1	4	1	4	1	2	2	1	1	
1860-1869	14	6	8	13	6	8																	
Unknown																							
Total	125	60	65	86	46	40	39	2	(1)	14	25	2	2	30	1	(1)	9	21	1	1	9	1	1

TABLE G.—Non-congenitally deaf pupils recorded to have deaf mute relatives other than children—Continued.

ILLINOIS INSTITUTION.

Period of Birth.	Grand total.			Not recorded to have married.			MARRIED.											
							Total.				Married to deaf-mutes.				Not recorded to have married deaf-mutes.			
	Total.	Males.	Females.	Total.	Males.	Females.	Total.	Males.	Females.	Total.	Males.	Females.	Total.	Males.	Females.	Total.	Males.	Females.
1810-1819	2	2	1	1	1	1	1	1	1	1	1	1	1	1	1	1	1	1
1820-1829	6	2	4	1	1	1	1	1	1	1	1	1	1	1	1	1	1	1
1830-1839	22	12	10	17	16	7	5	1	3	1	1	5	1	2	3	1	1	3
1840-1849	39	19	20	33	15	18	6	2	4	2	2	6	2	4	2	2	2	4
1850-1859	37	24	13	37	24	13												
1860-1869	14	6	8															
1870-1879																		
Unknown																		
Total	120	65	55	106	57	49	14	3	8	2	6	13	3	7	2	2	6	1

TABLE H.—Non congenitally deaf pupils recorded as sporadic cases.
AMERICAN ASYLUM.

Period of birth.	MARRIED.																	
	Grand total.						Not recorded to have married.						MARRIED.					
	Total.		Males.		Females.		Total.		Males.		Females.		Total.		Males.		Females.	
1760-1769	1	1	1	1	1	1	1	1	1	1	1	1	1	1	1	1	1	
1770-1779	1	1	1	1	1	1	1	1	1	1	1	1	1	1	1	1	1	
1780-1789	8	6	2	3	2	1	5	4	2	2	2	2	2	2	2	2	2	
1800-1809	58	35	23	23	11	12	35	24	11	11	18	10	8	17	14	3	3	
1810-1819	141	78	63	57	31	26	84	47	37	37	72	40	32	32	27	5	5	
1820-1829	110	72	38	54	38	16	56	34	1	22	43	26	17	13	8	5	5	
1830-1839	127	78	49	68	40	28	59	38	2	21	54	33	25	21	5	5	5	
1840-1849	156	96	60	125	77	48	31	19	12	12	22	12	10	9	7	2	2	
1850-1859	194	122	72	182	117	65	12	5	7	7	8	3	5	4	2	2	2	
1860-1869	119	74	45	119	74	45												
Unknown	1	1	1	1	1	1												
Total	915	562	353	653	391	262	282	171	6	111	219	6	126	6	13	45	18	

TABLE H.—*Non-congenitally deaf pupils recorded as sporadic cases—Continued.*
ILLINOIS INSTITUTION.

Period of birth.	Grand total.						Not recorded to have married.						MARRIED.						Not recorded to have married deaf-mutes.									
	Total.			Total.			Total.			Total.			Total.			Total.			Total.			Total.			Total.			
	Males.	Females.	Total.	Males.	Females.	Total.	Males.	Females.	Total.	Males.	Females.	Total.	Males.	Females.	Total.	Males.	Females.	Total.	Males.	Females.	Total.	Males.	Females.	Total.	Males.	Females.	Total.	
1810-1819.....	2	1	1	1	1	1	1	1	1	1	1	1	1	1	1	1	1	1	1	1	1	1	1	1	1	1	1	1
1820-1829.....	9	2	7	5	1	4	4	4	4	4	4	4	4	4	4	4	4	4	4	4	4	4	4	4	4	4	4	4
1830-1839.....	52	27	25	37	19	18	15	1	8	8	8	8	8	8	8	8	8	8	8	8	8	8	8	8	8	8	8	8
1840-1849.....	142	90	52	106	69	37	36	1	21	1	2	15	7	1	1	1	1	1	1	1	1	1	1	1	1	1	1	1
1850-1859.....	178	103	75	159	94	65	39	9	9	9	10	7	10	7	7	7	7	7	7	7	7	7	7	7	7	7	7	7
1860-1869.....	327	182	145	321	178	143	6	4	4	4	2	2	2	2	2	2	2	2	2	2	2	2	2	2	2	2	2	2
1870-1879.....	115	63	52	115	63	52	52	52	52	52	52	52	52	52	52	52	52	52	52	52	52	52	52	52	52	52	52	52
Unknown.....	2	1	1	2	1	1	1	1	1	1	1	1	1	1	1	1	1	1	1	1	1	1	1	1	1	1	1	
Total.....	827	469	358	746	425	321	81	3	(1)	44	2	37	1	1	1	37	1	2	32	1	12	1	1	7	1	1	5	

TABLE J.—*Pupils, the cause of whose deafness is not stated, who are recorded as sporadic cases.*
AMERICAN ASYLUM.

Period of birth.	Grand total.			Not recorded to have married.			MARRIED.						Not recorded to have married deaf mutes.					
	Total.			Total.			Total.			Total.			Total.			Total.		
	Males.	Females.	Total.	Males.	Females.	Total.	Males.	Females.	Total.	Males.	Females.	Total.	Males.	Females.	Total.	Males.	Females.	Total.
1700-1750	1		1															
1750-1775																		
1775-1799	5	3	8	1	2	3												
1800-1809	15	10	25	5	3	8												
1810-1819	15	9	24	6	3	9												
1820-1829	10	7	17	4	2	6												
1830-1839	5	4	9	1	4	5												
1840-1849	7	3	10	1	3	4												
1850-1859	17	7	24	6	8	14												
1860-1869	6	6	12		6	6												
Unknown	2	2	4		2	2												
Total	83	52	135	25	1	26	1	1	14	1	1	1	6	1	11	7	4	11

TABLE J.—Pupils the cause of whose deafness is not stated, who are recorded as sporadic cases—Continued.

ILLINOIS INSTITUTION.

Period of birth.	Grand total.				Not recorded to have married.				MARRIED.											
	Total.		Females.		Total.		Females.		Total.				Females.				Total.			
	Males.	Females.	Males.	Females.	Males.	Females.	Males.	Females.	Total.	Males.	Females.	Total.	Males.	Females.	Total.	Males.	Females.	Total.	Males.	Females.
1810-1819...	2	2	1	1	1	1	1	1	1	1	1	1	1	1	1	1	1	1	1	1
1820-1829...	2	1	1	1	1	1	1	1	1	1	1	1	1	1	1	1	1	1	1	1
1830-1839...	14	5	14	9	5	5	5	5	5	5	5	5	5	5	5	5	5	5	5	5
1840-1849...	23	14	20	13	7	3	3	3	3	3	3	3	3	3	3	3	3	3	3	3
1850-1859...	44	20	41	18	23	3	3	3	3	3	3	3	3	3	3	3	3	3	3	3
1860-1869...	91	54	37	86	53	33	5	5	5	5	5	5	5	5	5	5	5	5	5	5
1870-1879...	37	23	14	37	23	14	14	14	14	14	14	14	14	14	14	14	14	14	14	14
Unknown...																				
Total...	213	121	92	200	116	84	13	1	1	5	1	1	8	10	1	1	1	1	1	3

TABLE K.—Non-congenital pupils.

Period.	American Asylum.		Illinois Institution.	
	Classified according to period of birth.	Classified according to period when hearing was lost.	Classified according to period of birth.	Classified according to period when hearing as lost.
1760-1769				
1770-1779				
1780-1789	1	1		
1790-1799	12	10		
1800-1809	70	42		
1810-1819	147	151	2	1
1820-1829	124	112	11	5
1830-1839	146	133	58	21
1840-1849	182	167	164	116
1850-1859	224	196	217	133
1860-1869	133	168	364	224
1870-1879		17	129	120
Unknown	1	38	2	327
Total	1,040	1,040	947	947

TABLE L.—Non-congenital pupils of the American Asylum, classified according to the period when hearing was lost and according to the disease that caused deafness.

Cause of deafness.	1780-1789.	1790-1799.	1800-1809.	1810-1819.	1820-1829.	1830-1839.	1840-1849.	1850-1859.	1860-1869.	1870-1879.	Total.
Scarlet fever ¹		1	5	8	13	61	72	84	62	5	311
Brain fever ²				4	15	7	21	12	14	2	75
Epidemic cerebro-spinal meningitis ³			8	35	4		1		4	2	54
Measles		1		7	4	6	10	8	2		38
Whooping-cough			2	2	6	4	5	6	4		29
Hydrocephalus ⁴				3	3	6	1	3	2	1	19
Typhus fever			3	4	4	1	2	2	4	1	17
Convulsions ⁵				2	2	3	3	4	4	1	17
Disease of ear ⁶			2	12	24	22	23	23	13		124
Diseases of lungs and air passages ⁷				1	1	2	6	6	14		30
Miscellaneous diseases ⁸		1	2	4		6	7	11	13	5	49
Accident ⁹		1	1	5	3	9	5	15	13	1	54
Diseases not specified	1	6	19	64	35	11	11	17	22		186
Total	1	10	42	151	112	138	167	196	168	17	1,002
Period when hearing was lost unknown											38
Total											1,040

¹Includes canker-rash (15 cases). ²Includes inflammation of brain, inflammation of head. ³Includes spotted fever (51 cases), meningitis (3 cases). ⁴Includes dropsy in head, dropsy in brain, water on brain. ⁵Includes fits, paralytic fit (1 case), paralysis and convulsions (1 case). ⁶Includes disease in head, humor in head, abscess in head, eruption in head, gathering in head, serofula in head, sores in head, ulcers in head, ulcers in ears, sores in ears, discharge from ears, gathering in ears. ⁷Includes lung fever (11 cases), cold (18 cases), influenza (1 case). ⁸Includes small-pox, chicken-pox, diphtheria, croup, bilious fever, catarrhal fever, erysipelas, palsy, salt rheum, mumps, spasmodic cough, marasmus, rickets, teething, cholera infantum, inflammation of bowels. ⁹Includes fall (39 cases), discharge of cannon, pistol-shot, seal (2 cases), fright (2 cases), blow on head, run over by cart, sea-bathing.

TABLE M.—*Non-congenital pupils of the Illinois Institution, classified according to the period when hearing was lost and according to the disease that caused deafness.*

Cause of deafness.	1810-1819.	1820-1829.	1830-1839.	1840-1849.	1850-1859.	1860-1869.	1870-1879.	Unknown.	Total.
Spotted fever *					2	27	12	7	48
Meningitis *	1					6	29	143	179
Scarlet fever			6	18	22	28	9	27	110
Brain fever				6	9	31	17	10	73
Inflammation of brain				5	2	4	2	12	25
Congestion of brain				1	2	3		5	11
Disease of ear ¹		1	1	7	8	15	3	28	63
Diseases of lungs and air passages ²		1	1	7	6	6	12	17	50
Accident ³		1	1	6	9	11	5	7	40
Measles				4	6	8	8	11	37
Typhoid fever		1		3	8	14	6	5	37
Whooping-cough			2	4	2	3	1	8	20
Convulsions ⁴				5	2	6	1	3	17
Quinine			1	1	6	3		3	14
Hydrocephalus			2	2	4	2			10
Diphtheria					1	4	1	4	10
Miscellaneous diseases ⁵			1	24	14	17	6	19	81
Diseases not specified		1	6	23	30	36	8	18	122
Total	1	5	21	116	133	224	120	327	947

* Epidemic cerebro-spinal meningitis.

¹ Includes gathering in head (3 cases), scrofula (10 cases), gathering in ears, sore ears, carache, rising in head, risings, swelling in head, gradual loss, inflammation of head, sickness in head.

² Includes cold (31 cases), lung fever, pneumonia, bronchial affection, influenza, catarrh (5 cases).

³ Includes shock of lightning, sunstroke, exposure to heat, fell into water, sea-sickness, burn, scald, sprain in neck, tar cap for scald-head, washing in cold spring, fright (2 cases), fall (22 cases), drinking lye (1 case).

⁴ Includes spasms and fits.

⁵ Includes mumps (7 cases), bilious fever (9 cases), nervous fever (6 cases), congestive chill (7 cases), winter fever (8 cases), remittent fever (3 cases), teething, jaundice, pernicious fever, worms and fever, ague, paralysis, vaccination, small-pox, chicken-pox, cholera, cramp, cramps, ebills, cold plague, worm fever, typhus fever, cholera infantum, inflammation of bowels, disease of kidney, cancer, rickets, erysipelas, spinal disease (6 cases).

TABLE N.—Analysis of 22,472 cases of deaf-mutes from the census returns, showing the number of these deaf-mutes living June 1, 1880, who became deaf each year since the year 1770.

Year.	No.	Year.	No.	Year.	No.	Year.	No.
1870-'80.....		1860-'70.....	751	1850-'60.....	527	1840-'50.....	453
1878-'79.....	161	1868-'69.....	605	1858-'59.....	436	1838-'39.....	219
1877-'78.....	207	1867-'68.....	721	1857-'58.....	484	1847-'48.....	264
1876-'77.....	300	1866-'67.....	710	1856-'57.....	402	1846-'47.....	221
1-75-'76.....	414	1865-'66.....	794	1855-'56.....	422	1845-'46.....	230
1-74-'75.....	472	1864-'65.....	797	1854-'55.....	349	1844-'45.....	308
1873-'74.....	750	1863-'64.....	776	1853-'54.....	382	1843-'44.....	237
1872-'73.....	1,168	1862-'63.....	692	1852-'53.....	303	1842-'43.....	209
1871-'72.....	1,067	1861-'62.....	642	1851-'52.....	349	1841-'42.....	215
1870-'71.....	769	1860-'61.....	470	1850-'51.....	260	1840-'41.....	153
Ten years.....	5,308		7,018		3,914		2,509
1839-'40.....	318	1829-'30.....	200	1819-'20.....	147	1809-'10.....	81
1838-'39.....	139	1828-'29.....	93	1818-'19.....	54	1808-'09.....	36
1837-'38.....	158	1827-'28.....	111	1817-'18.....	73	1807-'08.....	46
1836-'37.....	135	1826-'27.....	95	1816-'17.....	77	1806-'07.....	15
1835-'36.....	125	1825-'26.....	95	1815-'16.....	73	1805-'06.....	27
1834-'35.....	188	1824-'25.....	120	1814-'15.....	83	1804-'05.....	37
1833-'34.....	141	1823-'24.....	88	1813-'14.....	49	1803-'04.....	23
1832-'33.....	126	1822-'23.....	80	1812-'13.....	45	1802-'03.....	11
1831-'32.....	157	1821-'22.....	100	1811-'12.....	55	1801-'02.....	11
1830-'31.....	105	1820-'21.....	67	1810-'11.....	43	1800-'01.....	7
Ten years.....	1,592		1,058		699		294
1799-1800.....	23	1789-'90.....	3	1779-'80.....			
1798-'99.....	10	1788-'89.....		1778-'79.....			
1797-'98.....	11	1787-'88.....	2	1777-'78.....			
1796-'97.....	6	1786-'87.....		1776-'77.....			
1795-'96.....	4	1785-'86.....		1775-'76.....			
1794-'95.....	4	1784-'85.....	4	1774-'75.....			
1793-'94.....	8	1783-'84.....		1773-'74.....			
1792-'93.....	1	1782-'83.....		1772-'73.....			
1791-'92.....	3	1781-'82.....		1771-'72.....			
1790-'91.....	1	1780-'81.....		1770-'71.....	1		
Ten years.....	71		9		1		

TABLE O.—Analysis of 22,472 cases of deaf-mutes from the census returns.

[This table shows that the decline in the number of these deaf-mutes returned who became deaf since 1873 affects the congenital, as well as the non-congenitally deaf.]

Year in which deafness occurred.	1873.	1874.	1875.	1876.	1877.	1878.	1879.
Total number.....	1,168	750	472	414	300	207	161
Congenitally deaf.....	348	271	203	202	130	105	46
Non-congenitally deaf.....	820	479	269	212	170	102	115

TABLE P.—Analysis of 22,472 cases of deaf-mutes taken from census returns, classified by periods of five years.

[The number who became deaf in each quinquennial period is reduced to a percentage of the whole on a basis of 10,000 cases in all.]

Period.	Number.	Per cent.	Period.	Number.	Per cent.
1781-1785.....	4	.0002	1831-1835.....	717	.0319
1786-1790.....	5	.0002	1836-1840.....	875	.0389
1791-1795.....	17	.0008	1841-1845.....	1122	.0499
1796-1800.....	54	.0024	1846-1850.....	1387	.0617
1801-1805.....	89	.0040	1851-1855.....	1643	.0731
1806-1810.....	205	.0091	1856-1860.....	2371	.1011
1811-1815.....	275	.0122	1861-1865.....	3377	.1503
1816-1820.....	424	.0189	1866-1870.....	3641	.1620
1821-1825.....	464	.0206	1871-1875.....	4226	.1881
1826-1830.....	594	.0265	1876-1880.....	1082	.0481

TABLE Q.—Analysis of 22,472 cases from the census returns, classified by periods of five years, and separating the congenital from the non-congenital cases.

Period.	Congenital.	Non-congenital.	Total.
1781-1785.....	4	0	4
1786-1790.....	5	0	5
1791-1795.....	15	2	17
1796-1800.....	48	6	54
1801-1805.....	79	10	89
1806-1810.....	162	43	205
1811-1815.....	193	82	275
1816-1820.....	270	145	424
1821-1825.....	328	136	464
1826-1830.....	423	171	594
1831-1835.....	477	240	717
1836-1840.....	601	274	875
1841-1845.....	719	403	1,122
1846-1850.....	895	492	1,387
1851-1855.....	998	645	1,643
1856-1860.....	1,462	809	2,271
1861-1865.....	1,639	1,738	3,377
1866-1870.....	1,759	1,882	3,641
1871-1875.....	1,585	2,641	4,226
1876-1880.....	483	599	1,082
Total.....	12,354	10,318	22,472

TABLE R.—Total number of deaf-mutes in the United States living June 1, 1880, classified according to race and sex.

Causes of deafness.	Colored.		Foreign white.		Native white.		Total.	
	Males.	Females.	Males.	Females.	Males.	Females.	Males.	Females.
Congenital.....	714	587	545	434	5,229	4,520	6,488	5,551
Injury to ear.....	7	2	8	2	34	17	49	21
Disease of ear.....	7	8	10	7	204	166	221	181
Other diseases.....	178	147	306	252	4,172	3,398	4,656	3,767
Miscellaneous.....	72	28	81	77	610	423	764	52
Not stated.....							6,3-9	5,263
Total.....	979	772	950	782	9,249	8,494	18,567	15,311

TABLE S.—Institutions for the deaf and dumb in the United States, 1883.

A.—PUBLIC INSTITUTIONS.

No.	Name.	Location.	Date of opening.	Number of pupils.				Total number of pupils who have received instruction.	Admitted since the opening of the institution.		
				During the year 1883.	Present December 1, 1883.		Number of pupils having one parent deaf.		Number of pupils having both parents deaf.	Total number having one or both parents deaf.	
					Male.	Female.					
1	American Asylum	Hartford, Conn.	1817	210	126	74	174	2,325	23	35	58
2	New York Institution	Washington Hts., New York, N. Y.	1818	488	310	178	369	2,963	31	22	53
3	Pennsylvania Institution	Philadelphia, Pa.	1820	362	206	156	298	2,079	2	19	21
4	Kentucky Institution	Danville, Ky.	1823	167	98	69	136	830			
5	Ohio Institution	Columbus, Ohio.	1829	505	274	231	107	2,008	2	11	13
6	Virginia Institution	Staunton, Va.	1839	80	44	36	74	546			
7	Indiana Institution	Indianapolis, Ind.	1844	328	175	153	312	1,495			
8	Tennessee School	Knoxville, Tenn.	1845	147	90	57	118				
9	North Carolina Institution	Raleigh, N. C.	1844	111	56	48	104				
10	Illinois Institution	Jacksonville, Ill.	1846	575	325	250	501	1,700	5	9	14
11	Georgia Institution	Cave Spring, Ga.	1846	93	53	40	85	325			
12	South Carolina Institution	Cave Spring, S. C.	1849	58	26	32	48	185	0	6	6
13	Missouri Institution	St. Louis, Mo.	1851	950	152	98	199	835	3	0	3
14	Louisiana Institution	Baton Rouge, La.	1852	43	25	18	58		0	3	3
15	Wisconsin Institution	Delaware, Wis.	1852	337	134	103	208	665	3	1	4
16	Michigan Institution	Flint, Mich.	1854	271	145	126	266	948			
17	Iowa Institution	Council Bluffs, Iowa	1855	290	170	120	260	657			
18	Mississippi Institution	Jackson, Miss.	1856	78	35	43	76				
19	Texas Asylum	Austin, Tex.	1857	97	65	32	86	203			
20	Columbia Institution	Washington, D. C.	1857	100	83	17	88	489	1	8	9
21	Alabama Institution	Talladega, Ala.	1860	51	30	21	51	185	0	0	0
22	California Institution	Berkeley, Cal.	1860	126	80	46	121	262	1	0	1
23	Kansas Institution	Olathe, Kansas.	1861	190	102	88	157	339			
24	Le Centreux S. Mary's Institution	Buffalo, N. Y.	1862	167	94	73	154	350	0	1	1
25	Minnesota School	Fairbault, Minn.	1863	47	82	65	129	330	4	1	5
26	Institution for Improved Instruction	New York, N. Y.	1867	157	108	79	161	311	0	0	0
27	Clarke Institution	Northampton, Mass.	1867	94	49	45	91	220	2	1	3
28	Arkansas Institute	Little Rock, Ark.	1868	80	47	33	52	195			
29	Maryland School	Frederick City, Md.	1868	108	60	48	99	278	0	5	5
30	Nebraska Institute	Omaha, Nebr.	1869	115	74	41	93	181			
31	Hornace Mann School	Boston, Mass.	1869	91	41	50	80	212	0	1	1
32	St. Joseph's Institute	Fordham, N. Y.	1869	279	125	154	237	333			
33	West Virginia Institution	Romney, W. Va.	1870	71	41	30	60	199	0	2	2
34	Oregon School	Salem, Oregon.	1870	33	16	17	20	72	0	0	0
35	Institution for Colored	Baltimore, Md.	1872	15	8	7	13	39			
36	Colorado Institute	Colorado Sp's, Colo.	1874	49	19	30	43	70	1	0	1
37	Erle Day-School	Erle, Pa.	1874	12	9	3	10		0	0	0
38	Chicago Day-School	Chicago, Ill.	1875	58	30	28	48	125	0	0	0
39	Central New York Institution	Rome, N. Y.	1875	180	111	69	153	243			
40	Cincinnati Day-School	Cincinnati, Ohio.	1875	35	21	14	28	82	0	0	0
41	Western Pennsylvania Institution	Turtle Creek, Pa.	1876	120	79	41	102	184			
42	Western New York Institution	Rochester, N. Y.	1876	162	81	81	143	219	3	2	5
43	Portland Day-School	Portland, Me.	1876	35	17	18	35	37	0	0	0
44	Rhode Island School	Providence, R. I.	1877	33	16	17	25	45	0	0	0
45	Saint Louis Day-School	Saint Louis, Mo.	1878	49	32	17	42	73	0	0	0
46	New England Industrial School	Beverly, Mass.	1880	19	11	8	19	30	1	5	6
47	Dakota School	Sionx Falls, D. T.	1880	23	14	9	21	28	0	0	0
48	Oral Branch Pennsylvania Institution	Philadelphia, Pa.	1881	73	45	28	66	73	1	0	1
49	Seranton Oral School	Seranton, Pa.	1883	14	7	7	12	14			
50	New Jersey Institution	Trenton, N. J.	1883	82	47	35	81	82			
50	Public institutions			6,991	3,898	3,093	5,993	23,119	83	132	215

TABLE S.—Institutions for the deaf and dumb in the United States, 1883—Continued.

B.—DENOMINATIONAL AND PRIVATE INSTITUTIONS.

	Name.	Location.	Date of opening.	Number of pupils.				Total number of pupils who have received instruction.	Admitted since the opening of the institution.		
				During the year 1883.	Male.	F. male.	Present December 1, 1883.		Number of pupils having one parent deaf.	Number of pupils having both parents deaf.	Total number having one or both parents deaf.
51	Whipple's Home School	Mystic River, Conn.	1869	16	14	2	10	51			
52	German Evangelical Lutheran Institution.	Norris, Mich.	1875	44	28	16	44	100	0	0	0
53	St. John's Catholic Institute	Saint Francis, Wis.	1876	48	30	18	43	127	0	0	0
54	F. Knapp's Institute	Baltimore, Md.	1877	34	23	11	30	50			
55	Phonological School	Milwaukee, Wis.	1878	2	5	3	7	50			
56	St. Joseph's Institute	Hannibal, Mo.	1882	18	7	11	17	18	0	0	0
57	A. Graham Bell's School	Washington, D. C.	1883	2	1	1	2	2	0	0	0
58	Voice and Hearing School	Chicago, Ill.	1883	2	7	1	8	8			
8	Denominational and private institutions.			178	115	63	162	406	0	0	0
58	Institutions in the U. S.			7,169	4,013	3,156	6,155	23,525	83	132	1215
	National College*	Washington, D. C.	1861	45	45	0	34	252			

* The National Deaf-Mute College is a distinct organization within the Columbia Institution. Its officers and students are included in the statement of the Columbia Institution given above.
 † Eliminating cases where same pupil is returned from more than one institution; 83 have one parent deaf; 124 have both parents deaf; total, 207.

TABLE T.—Deaf-mute offspring of deaf-mute parents.*

[Analysis of 215 cases received into American institutions for the Deaf and Dumb before November, 1883.]

Period of birth.	Deaf-mutes who have one parent deaf.	Deaf-mutes who have both parents deaf.	Total.	Period of birth.	Deaf-mutes who have one parent deaf.	Deaf-mutes who have both parents deaf.	Total.
1771-1780				1841-1850	18	20	38
1781-1790				1851-1860	25	42	67
1791-1800				1861-1870	14	41	55
1801-1810	1		1	1871-1880	6	19	25
1811-1820	3		3	Total	82	133	215
1821-1830	6		6				
1831-1840	9	11	20				

* A slight error has been discovered in the table owing to duplicate returns in 8 cases. The general result, however, is not affected. The correct figures for deaf-mutes having both parents deaf (reading down the column) should be 11, 29, 36, 37, 23; total, 134.

TABLE U.—Deaf-mute population compared with the population at large.

Period of birth.	Population of the United States (1880), classified according to period of birth, and the number of persons born in each period reduced to a percentage of the whole.		12,154 congenital deaf-mutes living June 1, 1880, classified according to period of birth, and the number of deaf-mutes born in each period reduced to a percentage of the whole.		Deaf-mutes both of whose parents were deaf-mutes, classified according to period of birth, and the number of deaf-mutes born in each period reduced to a percentage of the whole.	
	Number of persons.	Percentage.	Congenital deaf-mutes.	Percentage.	Deaf-mutes both of whose parents were deaf and dumb.	Percentage.
1871-1880.....	13,394,176	26.7051	2,068	17.015	19	14.3
1861-1870.....	10,726,601	21.3866	3,398	27.958	41	30.8
1851-1860.....	9,168,393	18.2798	2,460	20.240	42	31.6
1841-1850.....	6,369,362	12.6992	1,611	13.280	20	15.0
1831-1840.....	4,558,256	9.0882	1,078	8.870	11	8.3
1821-1830.....	3,111,317	6.2033	751	6.179		
1811-1820.....	1,830,095	3.6488	472	3.883		
1801-1810.....	776,567	1.5482	241	1.983		
1791-1800.....	196,197	0.3912	63	0.518		
1781-1790.....	20,863	0.0416	9	0.074		
—1780.....	4,016	0.0080				
Total.....	50,155,783	100.0000	12,154	100.000	133	100.0

TABLE V.—Tabular statement of the institutions of the world for the education of the deaf and dumb.

Country.	NUMBER OF PUPILS.						METHODS OF INSTRUCTION.											
	No. of institutions.	Total.	Male.	Female.	Manual.				Oral.			Combined.		Not reported.				
					No. of institutions.	No. of pupils.	No. of teachers.	No. of institutions.	No. of pupils.	No. of teachers.	No. of institutions.	No. of pupils.	No. of teachers.	No. of institutions.	No. of pupils.	No. of teachers.		
Australia.....	3	147	82	65	11	1	14	2							2	133	9	
Austria-Hungary.....	17	1,147	656	454	64				17	1,147	64							
Belgium.....	10	864	482	382				5	339		5	525						
Brazil.....	1	32	32		3										1	32	3	
Canada.....	7	893	397	496	84	1		1	150	27	5	653	57					
Denmark.....	4	326	150	176	41	1	142	15	2	150	23					1	34	3
France.....	67	3,482			4	254		28	1,062		17	871			18	395		
Germany.....	90	5,608	1,042	908	580			90	5,608	580								
Great Britain and Ireland.....	44	2,650	1,413	1,237	244	8	558	54	20	496	56	13	1,356	109	7	243	25	
Italy.....	35	1,491	815	676	247			34	1,405	227	1	86	10					
Japan.....	2	65	37	28	7	2	65	7										
Luxembourg.....	1	29	15	14	3			1	20	3								
Mexico.....	2	30	23	7	7	2	30	7										
Netherlands.....	3	465	256	209	40			3	465	40								
New Zealand.....	1	22	13	9	2			1	22	2								
Norway.....	7	283	195	128	34			6	234	23	1	59	11					
Portugal.....	1	8	7	1	1										1	8	1	
Russia (including Courland and Finland).....	10	584	303	221	59	3	122	10	5	247	26	2	245	23				
Spain.....	7	222	125	97	16						7	222	16					
Sweden.....	17	680	421	259	76	2	111	0	3	68	10	5	324	35	7	177	22	
Switzerland.....	11	389	182	198	39			11	389	39								
United States.....	55	7,155	4,085	3,070	681	8	346	26	12	584	62	35	6,225	393				
Total.....	397	26,473	10,751	8,545	2,029	32	1,042	130	239	13,246	1,182	61	10,566	654	37	1,010	63	

*The reports from France and Prussia do not indicate the sex of the pupils.

TABLE W.—A partial list of deaf children of deaf parents.

Name.	Where educated.	When admitted.	Age.	Remarks.
Acheson, Charles	American Asylum	1864	10	Both parents deaf-mutes.
Acheson, Dutco W.	New England Industrial School	1881	8	Do.
Acheson, Eugene A.	American Asylum	1876	8	Do.
Acheson, George W.	do	1864	11	Do.
Acheson, Pauline M.	Horace Mann School	1872	5	Do.
Do	American Asylum	1878	11	Do.
Acheson, Robert	do	1869	10	Do.
Allard, Hattie M.	do	1871	8	Do.
Allen, Ann W.	do	1845	9	Do.
Allen, Ellen	do	1849	9	Do.
Allen, Mabel H.	do	1881	8	Father a deaf-mute.
Allen, Sarah	do	1843	10	Both parents deaf-mutes.
Arnold, Fanny	New York Institution	1835	10	Mother a deaf-mute.
Arnold, Jane	do	1833	15	Do.
Atherholt, Colonel	Ohio Institution	1851	13	Mother a deaf-mute.
Ballin, Albert	New York Institution	1868	7	Father a deaf-mute.
Barnard, Lucretia R.	American Asylum	1863	10	Both parents deaf-mutes.
Barnes, Rosa I.	Western New York Institution	1883	6	Do.
Bayne, Mary E.	Pennsylvania Institution	1878	10	Do.
Beleke, Charles	Illinois Institution	1879	9	Do.
Berry, Francis	New England Industrial School	1863	12	Do.
Bender, Caroline	New York Institution	1859	14	Father partially deaf.
Bennett, Mary L.	Pennsylvania Institution	1875	9	Both parents deaf-mutes.
Do	New York Institution	1882	16	Do.
Bentz, Anna De H.	Pennsylvania Institution	1869	11	Do.
Bodine, Charles Van W.	New York Institution	1867	7	Both parents "hard of hearing."
Brasher, Fanny C.	Illinois Institution	1882	13	Do.
Brown, Susan F.	American Asylum	1865	14	Father a deaf-mute.
Brown, Thomas	do	1822	18	Do.
Brown, Thomas L.	do	1851	12	Both parents deaf-mutes.
Brown, Helen H.	do	1855	13	Mother a deaf-mute.
Braner, Harry A.	Western New York Institution	1876	10	Mother somewhat deaf.
Bucklen, Simeon D.	New York Institution	1812	12	Father a deaf-mute.
Bueklea, Martha Ann	do	1838	12	Do.
Burgess, W. Taylor	West Virginia Institution	1878	21	Both parents deaf-mutes.
Burgess, Jane E.	do	1880	19	Do.
Burt, Harrison A.	New York Institution	1863	15	Mother partially deaf.
Butler, Phoebe M.	do	1878	18	Father deaf in one ear.
Cairnes, William T.	Maryland School	1881	10	Both parents deaf-mutes.
Campbell, Lizzie	Clarke Institution	1877	16	Mother partially deaf.
Churchill, Anna R.	New York Institution	1858	12	Father "hard of hearing."
Cook, Elizabeth	do	1851	13	Both parents deaf-mutes.
Cooper, William E.	Minnesota School	1865	11	Both parents slightly deaf.
Crawford, Josephine L.	do	1879	21	Mother somewhat deaf.
Culver, Annie J.	American Asylum	1878	9	Both parents deaf-mutes.
Culver, John	do	1882	11	Do.
Culver, Heman M.	do	1861	9	Do.
Daniels, Willie E.	New England Industrial School	1882	7	Do.
Derby, Ira H.	American Asylum	1861	11	Do.
Diamond, Albert	Le Couteux St. Mary's Institution	1867	9	Do.
Dithorn, Mary E.	Pennsylvania Institution	1859	10	Do.
Driskell, Elsie A.	Illinois Institution	1867	8	Do.
Duntz, Caroline	New York Institution	1855	(1)	Father deaf in one ear.
Dupece, Franklin L.	Oral Branch Penn Institution	1882	10	Mother slightly deaf.
Edwards, Walter D.	Illinois Institution	1864	8	Both parents deaf-mutes.
Edwards, Mary E.	do	1867	10	Do.
Felton, John	Wisconsin Institution	1869	14	Mother a deaf-mute.
Genet, William F.	New York Institution	1859	13	Both parents deaf-mutes.
George, Dudley W.	Columbia Institution	1871	16	Do.
Getman, Ida	New York Institution	1874	7	Do.

TABLE W.—A partial list of deaf children of deaf parents—Continued.

Name.	Where educated.	When admitted.	Age.	Remarks.
Gloyno, Mary	New York Institution	1868	7	Mother "hard of hearing."
Goodneas, Alex	Wisconsin Institution	1874	17	Father a deaf-mute.
Hahn, Maximilian	New York Institution	1868	13	Father partially deaf.
Hall, William Franklin	do	1865	12	Both parents deaf-mutes.
Hall, Florida	Western New York Institution	1883	6	Mother a deaf-mute.
Hennricks, Henry	Minnesota School	1870	20	Father very deaf.
Hine, James	American Asylum	1846	8	Both parents deaf-mutes.
Hines, William W	Ohio Institution	1878	9	Do.
Hord, Edwin	Missouri Institution	1864	14	Father a deaf-mute.
Hord, Mary E	do	1866	11	Do.
Howell, Wallace F	New York Institution	1865	10	Do.
Howell, William L	do	1868	9	Do.
Heusel, Helen Estelle	do	1875	7	Both parents deaf-mutes.
Jones, Florence Harriet	do	1864	7	Do.
Kershner, John M	Pennsylvania Institution	1880	11	Do.
Kershner, Emma R	do	1883	10	Do.
Kindred, Marla J	Illinois Institution	1890	15	Father a deaf-mute.
Kindred, Elizabeth	do	1890	13	Do.
Kingsley, Isabella	American Asylum	1833	13	Mother a deaf-mute.
Koffman, Abey	New York Institution	1868	15	Father "hard of hearing."
Koffman, Samuel	do	1868	12	Do.
Koffman, Lewis	do	1868	10	Do.
Laird, James F	Pennsylvania Institution	1862	14	Both parents deaf-mutes.
Laird, Elizabeth I	do	1867	11	Do.
Lalster, Eleanor Jane	New York Institution	1849	12	Father a deaf-mute.
Lancaster, Lucra C	do	1877	14	Mother deaf in one ear.
Lloyd, John, jr	do	1878	17	"Father deaf from old age."
Lovejoy, Benjamin	American Asylum	1844	15	Father a deaf-mute.
Lovejoy, Hartwell	do	1851	17	Do.
Lovejoy, Sarah	do	1851	15	Do.
Lovejoy, Emma	do	1851	10	Do.
Lovejoy, Erastus	do	1860	17	Do.
Lovejoy, Abigail	do	1860	12	Do.
Lovejoy, Lydia A	do	1867	10	Do.
Lovejoy, Hattie M	do	1873	9	Do.
Lovejoy, Poscon P	New England Industrial School	1885	15	Do.
Marsh, Catharine B	American Asylum	1852	10	Both parents deaf-mutes.
Marsh, Paulina N	do	1855	10	Do.
Marsh, Jonathan F	do	1860	11	Do.
Marshall, George W	Illinois Institution	1863	10	Do.
Marshall, Benjamin F	do	1866	9	Do.
Marshall, Edith H	American Asylum	1879	11	Do.
Marshall, Gilbert F	do	1879	9	Do.
Marshall, Leslie G	do	1882	8	Do.
Mayhew, Benjamin	do	1858	12	Do.
Mayhew, Jared	do	1864	11	Do.
Mayo, Hawes	do	1865	10	Mother a deaf-mute.
McClave, Robert	Ohio Institution	1865	12	Both parents deaf-mutes.
McClurg, Drucilla H	Pennsylvania Institution	1877	12	Do.
McGregor, Bessie	Ohio Institution	1883	5	Do.
McLaughlin, Amanda	Western New York Institution	1876	6	Do.
Meacham, Mary O	American Asylum	1860	14	Mother a deaf-mute.
Meacham, Rebecca A	do	1866	9	Do.
Meacham, George	do	1868	8	Do.
Meacham, Allen B	do	1872	11	Both parents deaf-mutes.
Mende, Margaret	Minnesota School	1873	10	Mother very hard of hearing.
Metrash, Robert L G	American Asylum	1872	9	Both parents deaf-mutes.
Munson, Lizzie	New York Institution	1879	9	Mother partially deaf (recent).
Ormsly, Edward E	New York Institution	1870	13	Mother "hard of hearing."
Park, James M	Columbia Institution	1871	10	Both parents deaf-mutes.
Do	Ohio Institution	1864	12	Do.

TABLE W.—A partial list of deaf children of deaf parents—Continued.

Name.	Where educated.	When admitted.	Age.	Remarks.
Pier, John W.	Ohio Institution	1876	8	Both parents deaf-mutes.
Place, Larissa	New York Institution	1863	14	Father a deaf-mute.
Pimm, Joshua R.	do	1858	9	Both parents deaf-mutes.
Pimm, Rachel A.	do	1861	11	Do.
Pimm, Martha	do	1864	13	Do.
Pimm, Charles Augustus	do	1867	(7)	Do.
Purvis, James H.	Columbia Institution	1865	16	Do.
Purvis, Amanda J.	Pennsylvania Institution	1865	12	Do.
Purvis, Kate L.	do	1870	12	Do.
Purvis, Mary	do	1872	13	Do.
Purvis, Mary A.	do	1871	11	Do.
Purvis, Timothy	do	1872	6	Do.
Purvis, James M.	do	1880	11	Do.
Riggs, Charles A.	American Asylum	1878	10	Do.
Ramsey, Ann E.	Pennsylvania Institution	1840	12	Mother a deaf-mute.
Redmond, Henry	New York Institution	1883	7	Both parents deaf-mutes.
Richardson, George E.	Clarke Institution	1880	6	Mother partially deaf.
Risley, Lamm L.	New York Institution	1856	13	Both parents deaf-mutes.
Risley, Charles E.	do	1870	6	Do.
Roberts, John James	do	1877	8	Father deaf in one ear.
Rogers, Jane I.	South Carolina Institution	1855	9	Both parents deaf-mutes.
Rogers, William H.	do	1858	16	Do.
Rogers, David S.	do	1860	11	Do.
Do	Columbia Institution	1868	17	Do.
Rogers, Laura A.	South Carolina Institution	1867	10	Do.
Rogers, Clara A.	do	1869	10	Do.
Rogers, Nettie S., daughter of Wm. H. Rogers.	do	1889	7	Do.
Sawhill, Collins S.	Columbia Institution	1878	21	Do.
Do	Ohio Institution	1871	14	Do.
Do	Pennsylvania Institution	1869	12	Do.
Sawhill, Isaac H.	Ohio Institution	1870	12	Do.
Do	Columbia Institution	1878	26	Do.
Sawhill, Jesse U.	Ohio Institution	1871	9	Do.
Sawhill, William L.	do	1873	10	Do.
Sawhill, Lavina A.	do	1870	8	Do.
Schroeder, Anthony	Minnesota School	1877	16	Father very deaf.
Scovel, Harriet E.	American Asylum	1818	14	Father a deaf-mute.
Scovel, Steven	do	1838	25	Do.
Scovel, Olive	do	1838	15	Do.
Shannon, William	New York Institution	1876	12	Mother "hard of hearing."
Shelley, John	do	1855	15	Mother becoming deaf.
Stevenson, Charles W.	Columbia Institution	1863	12	Both parents deaf-mutes.
Do	Maryland School	1868	14	Do.
Stevenson, Georgiana	Columbia Institution	1863	9	Do.
Stiles, Peninah Anna	New York Institution	1868	11	Father a little deaf.
Stratton, Sarah C.	Pennsylvania Institution	1857	12	Mother a deaf-mute.
Stratton, James Wells	New York Institution	1874	7	Both parents deaf-mutes.
Straw, Mary	Ohio Institution	1869	12	Father a deaf-mute.
Suart, Emma M.	Illinois Institution	1883	12	Mother partially deaf.
Suart, Mabel C.	do	1883	11	Do.
Sutton, Rosa P.	Ohio Institution	1883	10	Both parents deaf-mutes.
Sweet, Persis H.	American Asylum	1863	11	Do.
Sweet, Charlotte E.	do	1872	11	Do.
Sweet, Mitchel	do	1873	11	Do.
Sweet, Lucy Maria	Clarke Institution	1882	18	Do.
Sweet, Margaret S.	American Asylum	1875	9	Do.
Tate, Margaret	Missouri Institution	1870	(7)	Mother a deaf-mute.
Taylor, Anna R.	American Asylum	1851	13	Do.
Townsend, Albert M.	Illinois Institution	1873	12	Both parents deaf-mutes.
Turner, Lucy M.	American Asylum	1864	15	Do.
Van Kirk, Joseph S.	Pennsylvania Institution	1856	11	Do.

TABLE W.—A partial list of deaf children of deaf parents—Continued.

Name.	Where educated.	When ad- mitted.	Age.	Remarks.
Van Kirk, John	Pennsylvania Institution	1850	11	Both parents deaf-mutes.
Van Ktrk, Charles H.	do	1861	11	Do.
Veughn, Emily W.	Illinois Institution	1877	9	Do.
Watson, Frederick W.	California Institution	1883	15	Mother a deaf-mute.
Webster, Joseph	New York Institution	1850	12	Father a deaf-mute.
Wells, Anna E.	Illinois Institution	1863	19	Mother deaf adult life.
Wells, Helen D.	Maryland School	1883	8	Both parents deaf-mutes.
West, Rebecca T.	American Asylum	1856	12	Mother a deaf-mute.
West, George	do	1861	13	Do.
West, Benjamin D.	do	1868	15	Both parents deaf-mutes.
West, Deldana J.	do	1868	12	Do.
Wildfang, Daniel	Wisconsin Institution	1860	12	Mother a deaf-mute.
Wildfang, Addie	do	1883	8	Both parents deaf-mutes.
Williams, Laura	New York Institution	1833	12	Father a deaf-mute.
Williams, Elizabeth	do	1846	12	Both parents deaf and dumb.
Williams, Harriet	do	1850	12	Do.
Weldt, William	Louisiana Institution ..	1883	13	Do.
Weldt, A.	do	1883	11	Do.
Weldt, Annie	do	1883	8	Do.
Wise, George A.	New England Industrial School ..	1881	11	Do.
Wise, Lottie	do	1881	8	Do.
Wolpert, David H.	Colorado Institution	1874	7	Father deaf in one ear.
Woolver, Margaret Ann	New York Institution	1863	12	Mother partially deaf.
Worcester, Ira E.	American Asylum	1879	9	Both parents deaf-mutes.
Works, William S.	New York Institution	1848	15	Do.
Works, Martha Jane	do	1848	13	Do.
Works, Mary Ann	do	1851	13	Do.
Works, Charles H.	do	1855	(?)	Do.
Whittington, Louis	Columbia Institution	1860	(?)	Mother a deaf-mute.
Wyncoop, Cora A.	New York Institution	1856	(?)	Father a deaf-mute.
Wyncoop, Frederick	Western New York Institutior	1877	11	Mother a deaf-mute.
Zimmerman, Alice	Maryland School	1879	8	Both parents deaf-mutes.
Zimmerman, Jennie	do	1883	9	Do.

TABLE X.—Showing per capita cost for the education of a deaf child in an American institution.

Name of institution.	Number of pupils Dec. 1, 1881.	Amount expended for support.	Per capita.
American Asylum, Hartford, Conn.	180	\$47,641	\$264 07
New York Institution, New York City	481	131,307	273 00
Pennsylvania Institution	319	71,301	223 51
Kentucky Institution	139	26,705	192 12
Ohio Institution	432	79,612	184 28
Virginia Institution *	85	19,185	225 70
Indiana Institution	325	54,831	165 48
Tennessee Institution	103	24,369	236 50
North Carolina Institution	90	34,000	344 44
Illinois Institution	508	85,000	167 32
Georgia Institution	47	14,241	230 00
South Carolina Institution	37	8,092	218 70
Iowa Institution	192	37,350	194 57
Wisconsin Institution	478	40,888	229 14
Michigan Institution	249	43,003	175 11
Mississippi Institution	97	19,610	149 25
Columbia Institution (including the National College)	117	51,108	406 64
Alabama Institution	44	12,500	284 09
California Institution †	108	35,352	327 80
Missouri Institution	100	43,410	226 40
Kansas Institution	146	19,500	133 56
La. Couteaux St. Mary's*	128	19,100	148 43
Minnesota Institution	112	24,425	218 03
Improved Instruction Institution, New York	137	35,454	258 78
Clarke Institution, Massachusetts	88	25,437	287 00
Arkansas Institution	59	13,600	230 55
Maryland Institution	84	23,180	276 02
St. Joseph's Institution *	250	27,588	110 35
West Virginia Institution	78	19,472	249 64
Oregon Institution	20	4,000	163 84
Colorado Institution	39	7,579	194 33
Central New York Institution	100	34,287	214 29
Western Pennsylvania Institution	104	19,011	182 79
Western New York Institution	116	27,901	240 52
Total	5,247	1,171,571	223.28

* Conducted by sisters of charity; no salaries paid.

† Has a blind department.

‡ Superintendent's last report states per capita cost \$183.05.

TABLE X.—*Tabular statement concerning the teaching of articulation in the institutions of the United States, May, 1883.*

No.	Name.	Location.	Date of opening.	Chief executive officer.	Articulation teacher first employed.	Employed constantly since?	No. teachers of articulation now employed.	No. pupils in institution.	No. receiving instruction in articulation.	No. making a means of articulation.	No. taught articulation as a means of instruction.
1	American Asylum	Hartford, Conn.	1817	Job Williams, M. A., principal	1855	No. (a)	2	188	35	None.	35
2	New York Institution	Washington Heights, New York, N. Y.	1818	Isaac Lewis Peet, L. L. D., principal; Carlton Carson, M. D., superintendent and resident physician.	1818	No. (b)	8	448	200	33	167
3	Pennsylvania Institution	Philadelphia, Pa.	1820	Joshua Foster, principal	1879	Yes.	2	315	70	None.	70
4	Kentucky Institution	Danville, Ky.	1823	D. C. Dudley, M. A., superintendent	1828	Yes.	None.	146	6	(9) 6	None.
5	Ohio Institution	Columbus, Ohio	1829	Benjamin Talbot, M. A., acting superintendent	1828	Yes.	2	430	80	None.	80
6	Virginia Institution	Staunton, Va.	1839	Charles S. Koller, principal	1876	Yes.	1	57	16	10	6
7	Indiana Institution	Indianapolis, Ind.	1844	William Glenn, superintendent	1876	Yes.	1	327	41	None.	41
8	Tennessee School	Knoxville, Tenn.	1845	Thomas L. Moses, principal	1880	Yes.	1	102	13	13	None.
9	North Carolina Institution	Raleigh, N. C.	1844	W. J. Young, principal	1880	Yes.	1	80	10	10	None.
10	Illinois Institution	Jacksnawille, Ill.	1846	Philip G. Gillett, L. L. D., superintendent	1868	Yes.	3	523	133	None.	133
11	Georgia Institution	Cave Springs, Ga.	1846	W. O. Connor, principal	None.	None.	None.	76	8	None.	8
12	South Carolina Institution	Cedar Spring, S. C.	1849	Newton F. Walker, superintendent	1889	Yes.	1	48	6	6	None.
13	Missouri Institution	Fulton, Mo.	1851	William D. Kerr, M. A., superintendent	1874	Yes.	2	162	53	None.	53
14	Louisiana Institution	Baton Rouge, La.	1852	R. G. Ferguson, M. A., superintendent	None.	None.	None.	32	(d) 4	None.	4
15	Wisconsin Institution	Delavan, Wis.	1852	John W. Swiler, M. A., superintendent	1868	Yes.	1	190	33	33	None.
16	Michigan Institution	Flint, Mich.	1854	F. A. Platt, M. A., principal; Dan. H. Church, superintendent	1876	Yes.	1	245	28	(e) 28	None.
17	Iowa Institution	Council Bluffs, Iowa.	1855	Rev. A. Rogers, superintendent	1878	No. (f)	1	270	28	10	18
18	Mississippi Institution	Jackson, Miss.	1856	J. R. Dobyus, superintendent	1882	Yes.	1	72	24	None.	24
19	Texas Asylum	Austin, Texas	1857	John S. Ford, superintendent	1879	No. (b)	None.	87	None.	None.	None.
20	Columbia Institution	Washington, D. C.	1857	E. M. Gallaudet, Ph. D., L. L. D., president	1870	Yes.	1	51	31	None.	34
21	Alabama Institution	Talladega, Ala.	1860	Joseph E. Johnson, M. D., principal	None.	None.	None.	45	None.	None.	None.
22	California Institution	Beckley, Cal.	1860	Warren Wilkinson, M. A., principal	1831	Yes.	1	116	45	None.	45
23	Kansas Institution	Olathe, Kans.	1862	G. L. Weckhoff, acting superintendent	1882	Yes.	1	137	32	12	20
24	Le-Conte's St. Mary's Institution	Buffalo, N. Y.	1862	Sister Mary Anne Burke, principal	1873	Yes.	1	153	91	17	74
25	Minnesota Institution	Fairbault, Minn.	1863	Jonathan L. Noyes, M. A., superintendent	1880	Yes.	1	127	32	6	28
26	Institution for Improved Instruction	New York, N. Y.	1867	D. Greenberger, principal	1867	Yes.	14	166	166	166	None.
27	Clarke Institution	Northampton, Mass.	1867	Miss Harriet B. Rogers, principal	1867	Yes.	12	85	66	85	None.
28	Arkansas Institute	Little Rock, Ark.	1868	H. C. Hammond, M. A., principal	None.	None.	None.	52	None.	None.	None.
29	Maryland School	Fredrick City, Md.	1868	Charles W. Ely, M. A., principal	1871	Yes.	2	94	66	(106)	None.
30	Nebraska Institute	Omaha, Nebr.	1869	J. A. Gillespie, B. D., principal	1881	Yes.	2	89	56	13	43
31	Horace Mann School	Boston, Mass.	1869	Miss Sarah Fuller, principal	1869	Yes.	8	83	83	83	None.
32	Whipple's Home School	Mystic River, Conn.	1869	J. Whipple, proprietor	1868	Yes.	2	12	12	12	None.

(a) "Interval of 5 years, 1866-1868." (b) "Employed, 1818-1821; 1840 one year, and from 1867 to present time." (c) "Semi-mutes taught almost wholly by lip-reading." (d) "Taught by principal." (e) "To some extent." (f) "Fire interrupted." (g) "Also in 1860 and 1882." (h) "Could not procure teacher." (i) "We now give all our young pupils at least a year's careful instruction in speech before deciding whether the effort shall be discontinued or not."

TABLE V.—*Tabular statement concerning the teaching of articulation in the institutions of the United States, May, 1883.—Continued.*

No.	Name.	Location.	Date of opening.	Chief executive officer.	Articulation teacher first employed.	Employed constantly since?	No. teachers of articulation now employed.	No. pupils in institution.	No. receiving instruction in articulation.	No. studying articulation.	No. taught articulation by means of institution.
33	St. Joseph's Institute.	Fordham, N. Y.	1869	Miss Mary B. Morgan, superintendent.	1870	Yes.	6	241	(a) 19	75	14
34	West Virginia Institution.	Romney, W. Va.	1870	J. C. Covell, M. A., principal.	1871	No. (b)	None.	66	None.	None.	None.
35	Oregon School.	Salem, Oreg.	1870	Rev. P. S. Knight, principal.		None.	None.	23	None.	None.	None.
36	Institution for Colored.	Baltimore, Md.	1872	F. D. Morrison, M. A., superintendent.		None.	None.	13	None.	None.	None.
37	Ev. Lutheran Institution.	Norris, Mich.	1873	H. D. Uhlrig, principal.	1873	Yes.	3	40	40	40	None.
38	Colorado Institute.	Colorado Springs, Colo.	1874	P. W. Downing, principal, J. B. Kennedy, superintendent.		None.	None.	37	517	2	5
39	Eric Day School.	Eric, Pa.	1874	Miss Mary Welsh, teacher.	1874	Y.	1	10	10	10	None.
40	Chicago Day Schools.	Chicago, Ill.	1875	P. A. Emery, M. A., principal.	1882	Y. s.	1	(d)			None.
41	Central New York Institution.	Rome, N. Y.	1875	Edward B. Nelson, B. A., principal.	1877	Yes.	1	163	25	29	5
42	Cincinnati Day School.	Cincinnati, Ohio.	1875	A. F. Wood, principal.		None.	None.	26	None.	None.	None.
43	Western Pennsylvania Institution.	Turtle Creek, Pa.	1876	Thomas MacIndree, Ph. D., principal.	1882	Yes.	1	102	13	6	7
44	Western New York Institution.	Rochester, N. Y.	1876	Z. F. Westervelt, principal.	1876	Yes.	4	136	125	9	(e) 120
45	Portland Day School.	Portland, Me.	1876	Miss Ellen L. Barton, principal.	1877	Yes.	4	33	33	33	None.
46	St. John's Catholic Institute.	Saint Francis, Wis.	1876	Rev. Charles Fessler, principal.	1876	Yes.	2	42	24	None.	34
47	Rhode Island School.	Providence, R. I.	1877	Miss Katharine H. Austin, principal.	1877	Yes.	3	30	30	30	None.
48	Mr. Knapp's School.	Baltimore, Md.	1877	Frederick Knapp, principal.	1877	Yes.	4	40	40	40	None.
49	Phonological Institute.	Milwaukee, Wis.	1878	Adam Stettner, principal.	1878	Yes.	2	21	21	21	None.
50	Saint Louis Day School.	Saint Louis, Mo.	1878	D. A. Simpson, B. A., principal.		None.	None.	41	None.	None.	None.
51	New England Industrial School.	Beverly, Mass.	1878	William B. Sweet, superintendent.	1880	Yes.	1	19	6	1	5
52	School of Articulation.	Marquette, Mich.	1877	Mrs. A. M. Kelsey, principal.	1870	Yes.	(f)				None.
53	Seranton Day School.	Seranton, Pa.	1880	Jacob M. Kechler, principal.		None.	None.	12	None.	None.	None.
54	Dakota School.	Sioux Falls, Dak.	1880	James Simpson, superintendent.		None.	None.	19	None.	None.	(g) 2
55	Oral Branch Pennsylvania Institution.	Philadelphia, Pa.	1881	Miss Emma Garrett, teacher in charge.	1881	Yes.	7	60	60	60	None.
	Institutions in the United States.						112	6,232	1,991	886	1,105
	National College.	Washington, D. C.	1864	E. M. Gallaudet, Ph. D., LL. D., president.	1877	No. (h)	None.	31	None.	None.	None.

(c) These figures seem not to do justice to the articulation work done.

(d) "Only two years."

(e) "Taught by principal and a hearing teacher."

(f) "No further definite information."

(g) "School closed June, 1882."

(h) "Semi-mutes, who converse orally with all who can hear."

(i) "Employed or 3 or 4 years; discontinued because of interference with legitimate work of the college. With a few lip-readers, considerable use is made of speech in recitation."

APPENDIX Z.

The following table, combining all the cases of marriage recorded in Tables A to J, was submitted to Prof. Simon Newcomb for his opinion regarding the number of congenital deaf-mutes who had married congenital deaf-mutes. The Reports of the American Asylum and Illinois Institution give no information bearing on this point; but it seemed possible to determine the probabilities from the data given in the table, especially as the intermarriages, in a large proportion of cases, undoubtedly occurred between deaf-mutes who had been educated in the same Institution, and who were therefore *both* included in the table:

Cause of deafness,	Deaf-mutes who are recorded to have married deaf-mutes.			Deaf-mutes stated to have married, but who are not recorded to have married deaf-mutes.		
	Males.	Females.	Total.	Males.	Females.	Total.
Congenital	150	148	298	37	25	62
Non-congenital	179	152	331	58	27	85
Not stated	14	11	25	7	8	15
Total	343	311	654	102	60	162

The main question proposed was this: Of the congenital deaf-mutes who are recorded to have married deaf-mutes, what proportion have married *congenital* deaf-mutes?

Professor Newcomb has been kind enough to send the following letters in reply to the query:

NAUTICAL ALMANAC OFFICE, NAVY DEPARTMENT,
Washington, D. C., May 20, 1884.

DEAR MR. BELL: Although the question you ask seems to admit of a satisfactory answer, I notice a singular defect in the statistical table. It contains not a single case of a deaf-mute being reported as having married a hearing person. If this is an accidental omission in making the copy for you it ought to be corrected. If there is really no such record the case is very singular.* It would look as if the parties were ashamed to state that they had married hearing persons, or the recorders had rejected all such cases.

The main question you ask can, I think, be answered by the theory of probabilities. Your table, if I understand it correctly, shows that out of 629 persons in the institution (of whom 329 were males and 300 females) a little less than one-half (298) were congenital deaf-mutes. Now, I see no reason for supposing that the persons whom they married would be divided in any essentially different proportion between the two classes.

It is true that could we learn from the census tables how the entire deaf of the country of marriageable ages, say, between the ages of twenty and thirty, are divided between the two classes, our conclusions might be modified. If, for example, it should be found that of the total number of deaf alluded to only one-third were congenital cases, we

* Only eleven deaf-mutes were specifically stated to have married hearing persons, and 151 were recorded simply as "married."

might be allowed to suppose that the marriages reported were divided according to this ratio, rather than according to the approximate ratio of equality found in the asylum. But we should consider that this surplus of non-congenital deaf would indicate a class who associate principally with hearing persons, and who would, therefore, be less likely to marry deaf-mutes than others would. I think, therefore, that under the circumstances, we should regard the ratio given by statistics of the institution as the most probable one. Of course the reason for this is strengthened if, as you intimate, a large proportion of the statistics may be mutual. Allowing for a probable slight tendency of the two classes congenital and non-congenital to choose each other, I think the most probable conclusion would be this:

Of the congenital deaf *one-half* married congenital and *one-half* non-congenital deaf.

Of the non-congenital *three-sevenths* married congenital deaf and *four-sevenths* non-congenital deaf.

And I consider these results sufficiently probable to form the basis of conclusions in cases where slight changes in the numbers would not change the general result.

If you wish your table returned please inform me.

Yours, very truly,

S. NEWCOMB.

WASHINGTON, D. C., May 26, 1884.

DEAR MR. BELL: The remarkable agreement between the ratio of congenital and non-congenital cases in the census reports, and in the numbers married, affords a strong confirmation of the probable soundness of the conclusion I indicated to you. The small discrepancy to which you allude probably arose from the twenty-five "not stated" cases. I return you the tables.

Yours, very truly,

S. NEWCOMB.

○

