

**Technical and Bibliographic Notes / Notes techniques et bibliographiques**

The Institute has attempted to obtain the best original copy available for filming. Features of this copy which may be bibliographically unique, which may alter any of the images in the reproduction, or which may significantly change the usual method of filming, are checked below.

L'Institut a microfilmé le meilleur exemplaire qu'il lui a été possible de se procurer. Les détails de cet exemplaire qui sont peut-être uniques du point de vue bibliographique, qui peuvent modifier une image reproduite, ou qui peuvent exiger une modification dans la méthode normale de filmage sont indiqués ci-dessous.

Coloured covers/  
Couverture de couleur

Covers damaged/  
Couverture endommagée

Covers restored and/or laminated/  
Couverture restaurée et/ou pelliculée

Cover title missing/  
Le titre de couverture manque

Coloured maps/  
Cartes géographiques en couleur

Coloured ink (i.e. other than blue or black)/  
Encre de couleur (i.e. autre que bleue ou noire)

Coloured plates and/or illustrations/  
Planches et/ou illustrations en couleur

Bound with other material/  
Relié avec d'autres documents

Tight binding may cause shadows or distortion along interior margin/  
La reliure serrée peut causer de l'ombre ou de la distorsion le long de la marge intérieure

Blank leaves added during restoration may appear within the text. Whenever possible, these have been omitted from filming/  
Il se peut que certaines pages blanches ajoutées lors d'une restauration apparaissent dans le texte, mais, lorsque cela était possible, ces pages n'ont pas été filmées.

Additional comments:/  
Commentaires supplémentaires:

Coloured pages/  
Pages de couleur

Pages damaged/  
Pages endommagées

Pages restored and/or laminated/  
Pages restaurées et/ou pelliculées

Pages discoloured, stained or foxed/  
Pages décolorées, tachetées ou piquées

Pages detached/  
Pages détachées

Showthrough/  
Transparence

Quality of print varies/  
Qualité inégale de l'impression

Continuous pagination/  
Pagination continue

Includes index(es)/  
Comprend un (des) index

Title on header taken from:/  
Le titre de l'en-tête provient:

Title page of issue/  
Page de titre de la livraison

Caption of issue/  
Titre de départ de la livraison

Masthead/  
Générique (périodiques) de la livraison

This item is filmed at the reduction ratio checked below/  
Ce document est filmé au taux de réduction indiqué ci-dessous.

10X	14X	18X	22X	26X	30X
<input type="checkbox"/>	<input type="checkbox"/>	<input type="checkbox"/>	<input type="checkbox"/>	<input checked="" type="checkbox"/>	<input type="checkbox"/>
12X	16X	20X	24X	28X	32X

From the finest Brass  
Sand to the Coarsest  
Pipe and Core Sand.  
WRITE FOR PRICES

**MOULDING SAND**

and FINE SAND,  
also Extra Fine Quality

foundry  
supplies  
Ceylon Plumbago

Manufacturers of  
HAMILTON, ONT.

The Hamilton Foundry and Machine Co., Limited,  
HAMILTON, ONT.

**MANUFACTURER**  
AND INDUSTRIAL WORLD  
DEVOTED TO THE MANUFACTURING INTEREST OF THE DOMINION

VOL 41.

TORONTO, JULY 6, 1900.

No. 1.

**MAGNOLIA METAL**  
ANTI-FRICTION  
Used by all the  
Leading Governments

THE BEST ANTI-FRICTION METAL  
FOR ALL MACHINERY BEARINGS  
For Sale by all Dealers  
Beware of Imitations.  
**MAGNOLIA METAL CO.**  
Owners and Sole Manufacturers.



296-297 West St., New York.  
MONTREAL—  
524 Board of Trade Bldg.  
Chicago, Ill.—Fisher Building,  
261 Dearborn St.  
London, Eng.—49 Queen Victoria St., E.C.  
Cleveland, O.—15 S. Water St.  
Atlanta, Ga.—411 Ansell Bldg.  
San Francisco, Cal.—  
C. E. Moore & Co.

Magnolia Metal is still selling at the same price it has always sold at—No advance.

**ANILINE DYEWORKS**  
L. ARINES  
DOMINION DYEWOOD & CHEMICAL CO.  
TORONTO

**"CARRON"  
PIG IRON**

THE BRAND that first made  
Scotch Iron famous and the  
best all-round Iron to-day.

SAME NOTES SHIPPED FROM  
STOCK IN MONTREAL.

**C. LESLIE & CO.,**  
CANADIAN AGENTS,  
MONTREAL

"Every Factory in Canada should  
the best Belting." Our "EXTRA" brand

**THE J. C. McLAREN BELTING CO.**

Factory: MONTREAL. TORONTO. VANCOUVER

**Fensom's**  
ELECTRIC  
HYDRAULIC  
STEAM  
HAND-POWER  
All made of the best  
material and  
finest workmanship.

The Fensom  
Elevator  
Works....  
52, 54, 56  
Duke Street,  
Toronto, Ont.  
**Elevators**

**RUBBER GOODS OF ALL  
KINDS.**



61 and 63 FRONT ST. WEST, TORONTO.

**Walkerville  
Malleable Iron**  
Co., (Limited)  
Manufacturers of—  
REFINED AIR FURNACE  
**Malleable Castings**

ALSO LIGHT IRON CASTINGS.  
**WALKERVILLE, ONTARIO.**

**PATENTS** Fetherstonhaugh & Co.  
TORONTO MONTREAL OTTAWA WASHINGTON

FRISBIE, ONT.

SEND FOR CATALOGUE.

# THE ROYAL ELECTRIC CO.

See Pages 4, 5 and 138.

THERE ARE NOW IN USE

Over 3,000,000 Horse Power

## Babcock & Wilcox Water Tube Boilers

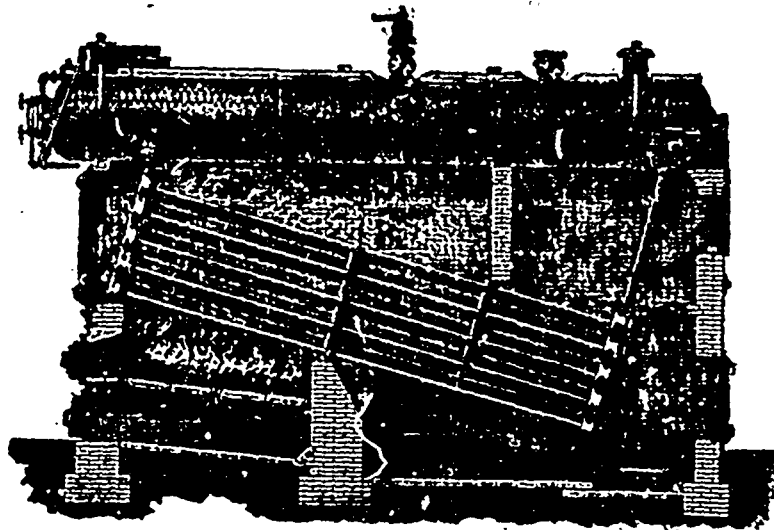

Head Office for Canada—

202 St. James St., - MONTREAL.

LARGE BOOK

"STEAM"

Sent Free on Application.

Toronto Office—

114 King St. West, - TORONTO.



## CROWN Boiler Compound

*Scientifically and Chemically Correct.*

MADE TO SUIT YOUR INDIVIDUAL LOCAL REQUIREMENTS  
BASED ON ACTUAL WATER ANALYSIS and  
BOILER CONSTRUCTION.

### REFERENCES:

Copy of Letter from Christie, Brown & Co., Toronto, to  
C. K. Johnston & Co., Toronto.

TORONTO, August 14th, 1899.

MESSRS. C. K. JOHNSTON & CO., City.

DEAR SIRS.—We have used your Crown Boiler Compound for three months, and are glad to inform you that we find it fully comes up to your claims for it.

We have used various other compounds, but the most they did was to prevent the scale from adhering to the tubes, etc., and it had to be taken out bodily. With yours, we find it dissolves the scale, which comes away through the blow off as mud. Our engineer reports the result as most satisfactory, and we have instructed him to use it in our establishment till further orders.

Kindly send in another barrel at your earliest convenience and oblige.

Yours truly,  
(Signed) CHRISTIE, BROWN & Co., Limited.  
Per R. Hawry, Manager.

Copy of Letter from Christie, Brown & Co., Toronto, to  
C. K. Johnston & Co., Toronto.

TORONTO, June 9th, 1900.

MESSRS. C. K. JOHNSTON & CO., City

GENTLEMEN.—We have now been using your "Crown Boiler Compound" for a year and can truthfully say it is the best we have ever used. Our engineer reports that our boilers are kept in first-class condition without any scraping or other mechanical cleaning, and with no injury whatever, as far as he can discern, to the joints, packing, or any part of the boiler or engine.

We consider the iron package in which it is supplied an excellent idea, as it prevents waste through evaporation or leakage, besides being convenient and ornamental.

Yours truly,  
(Signed) CHRISTIE, BROWN & Co., Limited.  
Per R. Hawry, Manager.

And the following, many of whom have given us strong testimonials, the only one allowed to go from their respective establishments:—Gendron Mfg. Co., John Abell Engine & Machine Works Co., A. R. Williams Machinery Co., Wm. & J. G. Greay, Dominion Radiator Co., Toronto Carpet Mfg. Co., H. McLaughlan & Co., Canada Cycle and Motor Co., Aug. Newell & Co., Octavius McCormack & Co., Standard Silver Co., Hungerford Smith & Co., Menzie-Turner, etc., etc., all of Toronto, Hamilton Steel & Iron Co., Hamilton Water Works Co., of Hamilton, Ont.

SEND FOR PARTICULARS TO

C. K. JOHNSTON & CO., 168 Adelaide St. West, - Toronto.

When writing to Advertisers kindly mention THE CANADIAN MANUFACTURER.

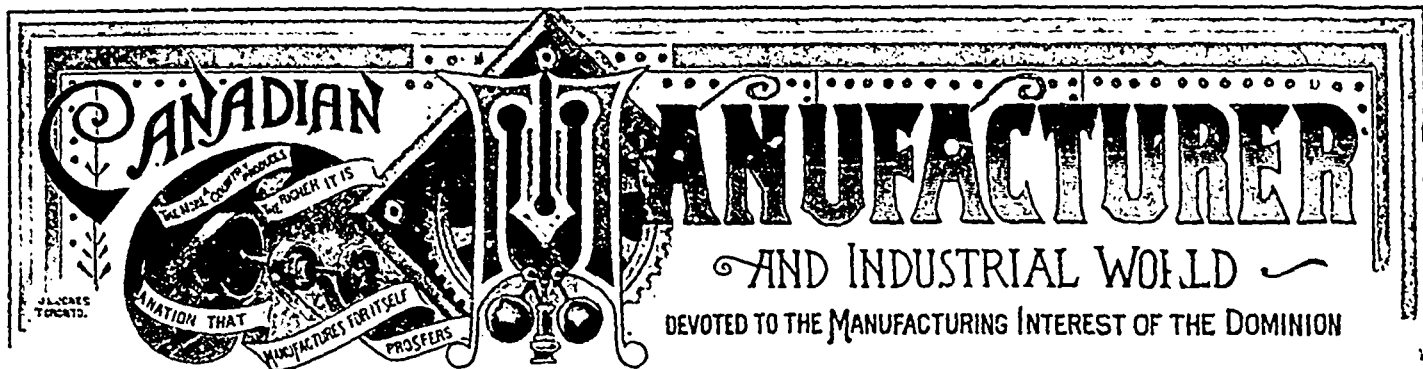

Vol. 41.

TORONTO, CANADA, JULY 6, 1900.

No. 1.

ESTABLISHED IN 1880

PUBLISHED ON THE FIRST AND THIRD FRIDAYS OF EACH MONTH

J. J. CASSIDY, - Editor and Manager.

SUBSCRIPTIONS:

Canada and United States. \$1.00 per Year.

All other Countries in Postal Union, Eight Shillings Sterling per Year, Including Postage.

**THE CANADIAN MANUFACTURER PUBLISHING COMPANY, Limited**

McKinnon Building, Cor. Melinda and Jordan Sts., TORONTO.

Cable Address: "CANAMAN." Western Union Telegraphic Code used.

FRANK B. WHITE COMPANY

The Fisher Building, CHICAGO.

150 Nassau St., NEW YORK.

Represent the Advertising Department of THE CANADIAN MANUFACTURER in the United States.

**TARIFF EDITION**

... CONTAINING ...

	Begins on page.	Index on page.
The Canadian Tariff . . . . .	7	47
The Canadian Export Duties . . . . .	45	
The United States Tariff . . . . .	81	133
The British Tariff . . . . .	163	165
The Newfoundland Tariff . . . . .	167	189
Index of Advertisers . . . . .	199	

# The Royal Electric Co.

MONTREAL. HALIFAX. TORONTO. VANCOUVER.

On October 15, 1895, the first "S.K.C." Generator manufactured in Canada was put in operation. To-day the following "S.K.C." Generators are in Service and on order:

COMPANY.	TOWN.	KILOWATT CAPACITY.
W. J. Fletcher.....	Alliston, Ont.....	60
C. O'Dell Electric Co.....	Annapolis, N.S.....	60
Bale St. Paul Electric Co.....	Bale St. Paul, Que.....	25
Corporation of Barrie.....	Barrie, Ont.....	150
Berlin Gas Co.....	Berlin, Ont.....	50
Bowmanville Electric Light Co.....	Bowmanville, Ont.....	90
Brantford Electric & Operating Co.....	Brantford, Ont.....	540 (2-Mach)
Cockshutt Plow Co.....	Brantford, Ont.....	20
Wood Bros.....	Brantford, Ont.....	50
Bridgewater Power Co.....	Bridgewater, N.S.....	40
G. H. Davidson.....	Brighton, Ont.....	30
Calgary Water & Power Co.....	Calgary, Alberta.....	150
Corporation of Campbelltown.....	Campbellton, N.B.....	60
The Electric Co.....	Chicoutimi, Que.....	80 (2-Mach)
Drayton Electric Light Co.....	Drayton, Ont.....	40
Corporation of Dundalk.....	Dundalk, Ont.....	30
Edmonton Electric Light & Power Co.....	Edmonton, N.W.T.....	75
Corporation of Farnham.....	Farnham, Que.....	30
Hamilton & Prout.....	Forest, Ont.....	30
Corporation of Fort William.....	Fort William, Ont.....	180
Trent River Paper Co.....	Frankford, Ont.....	40
The Electric Light Co.....	Glen Williams, Ont.....	30
John Phillip.....	Grand Valley, Ont.....	60
E. F. G. Fletcher.....	Gravenhurst, Ont.....	40
Greenwood Electric Co.....	Greenwood, B.C.....	150
Hamilton Electric Light & Cataract Power Co.....	Hamilton, Ont.....	6,840 (7-Mach)
Lake & Bailley.....	" ".....	50
Lawry Packing Co.....	" ".....	75
Volta Storage Battery Co.....	" ".....	75
Riordan Paper Mills Co.....	Hawkesbury, Ont.....	30
Corporation of Joliette.....	Joliette, Que.....	120
Kootenay Electric Co.....	Kaslo, B.C.....	75
J. T. Ayers.....	Lachute, Que.....	120
Corporation of Liverpool.....	Liverpool, N.S.....	75
Corporation of Markham.....	Markham, Ont.....	20
Corporation of Moncton.....	Moncton, N.B.....	60
Dominion Cotton Mills Co.....	Montreal, Que.....	180
McGill University.....	" ".....	10
Montreal Street Railway Co.....	" ".....	576 (2-Mach)
Montreal Water & Power Co.....	" ".....	300
The Royal Electric Co.....	" ".....	2,555 (11-Mach)
Labrador Electric & Pulp Co.....	Murray Bay, Que.....	125
Napanee Water & Electric Co.....	Napanee, Ont.....	35
Corporation of Newmarket.....	Newmarket, Ont.....	50
Eastern Townships Electric Light Co.....	North Hatley, Que.....	75
Corporation of Orillia.....	Orillia, Ont.....	600 (2-Mach)
Owen Sound Electric Illuminating & Manufacturing Co.....	Owen Sound, Ont.....	50

## Direct Current **Dynamamos** and **Motors.**

Railway Generators and Apparatus.

Electric Supplies of all Kinds.

Write us your requirements.

When writing to Advertisers kindly mention THE CANADIAN MANUFACTURER.

# The Royal Electric Co.

**MONTREAL. HALIFAX.** **TORONTO. VANCOUVER.**

COMPANY.	TOWN.	KILOWATT CAPACITY.
Penman Manufacturing Co . . . . .	Paris, Ont . . . . .	30
Canadian Electric & Water Power Co. . . . .	Perth, Ont . . . . .	236 (2-Mach)
Electric Light & Power Co . . . . .	Peterborough, Ont . . . . .	180
Penetanguishene & Midland E. St. Ry. Co. . . . .	Penetanguishene, Ont. . . . .	150
Corporation of Picton . . . . .	Picton, Ont. . . . .	120
Central Electric Company . . . . .	Portage la Prairie, Man . . . . .	150
Maple Leaf Rubber Co . . . . .	Port Dalhousie, Ont. . . . .	150
Montmorency Electric Power Co. . . . .	Quebec, Que . . . . .	1,080 (8-Mach)
Chambly Manufacturing Co. . . . .	Richelieu, Que. . . . .	16,000 (8-Mach)
A. Riendeau . . . . .	Richelleu, Que . . . . .	100
Richmond Co. Electric Co. . . . .	Richmond, Que. . . . .	60
W. McMahon . . . . .	Ridgetown, Ont. . . . .	60
Iron Mask Gold Mining Co. . . . .	Rossland, B.C. . . . .	150
St. Catharines Electric Light & Power Co . . . . .	St. Catharines, Ont. . . . .	200
Geo. Wilson & Co . . . . .	" " . . . . .	0
Welland Vale Manufacturing Co . . . . .	" " . . . . .	30
St. Jerome Power & Electric Light Co. . . . .	St. Jerome, Que . . . . .	75
St. Thomas Gas & Electric Co . . . . .	St. Thomas, Ont. . . . .	150
Shawinigan Water & Power Co. . . . .	Shawinigan Falls, Que . . . . .	288
Sherbrooke Gas & Water Co. . . . .	Sherbrooke, Que . . . . .	810 (3-Mach)
S. George . . . . .	Stouffville, Ont . . . . .	20
Corporation of Sudbury . . . . .	Sudbury, Ont. . . . .	75
Sussex Water & Electric Co. . . . .	Sussex, N.B. . . . .	40
Sydney Gas & Electric Co . . . . .	Sydney, C.B. . . . .	210 (2-Mach)
Teeswater Light & Power Co. . . . .	Teeswater, Ont. . . . .	20
North Shore Power Co . . . . .	Three Rivers, Que. . . . .	480 (2-Mach)
Tweed Electric Light Co. . . . .	Tweed, Ont. . . . .	30
Vankleek Hill Electric Co. . . . .	Vankleek Hill, Ont. . . . .	50
Windsor Electric Light Co. . . . .	Windsor, N.S. . . . .	140 (2-Mach)
Corporation of Winnipeg . . . . .	Winnipeg, Man. . . . .	75

**77 Companies.**

**117 Generators.**

**38,410 KILOWATT CAPACITY.**

**CUSTOMERS ARE BEST REFERENCES.**

**APPARATUS SPEAKS FOR ITSELF.**

SOLE MANUFACTURERS IN CANADA OF THE

# "S.K.C." SYSTEM

**GENERATORS—MOTORS—TRANSFORMERS.**

The only perfected system for the supply of Power and Light from the same Generator and Circuit. Sole Agents for the Dominion of the

**RECO. INCANDESCENT LAMPS.**

**STANLEY WATT METERS.**

**ENQUIRIES SOLICITED.**

When writing to Advertisers kindly mention THE CANADIAN MANUFACTURER.

# CANADIAN GENERAL ELECTRIC CO.,

LIMITED

The Largest Manufacturers of Electrical  
Apparatus under the British Flag.

## .. Electrical Apparatus ..

Direct Current Generators and Motors.

ALTERNATING CURRENT GENERATORS

Single Phase — Two Phase — Three Phase.

“**ROTARY CONVERTERS**”

“INDUCTION MOTORS”

“SYNCHRONOUS MOTORS”

Complete Equipment of Electric Railways.

“POWER TRANSMISSION PLANTS”

ELECTROLYTIC APPARATUS

Electrical Apparatus for Operation of Hoists, Pumps,  
Blowers, Compressors.

“**Electrical Supplies of all Kinds.**”

Head Office: TORONTO, ONT.      Factories: PETERBORO', ONT.

BRANCH OFFICES: Halifax, Montreal, Winnipeg, Rossland, Vancouver.

# THE CANADIAN TARIFF.

## An Act to Amend the Customs Tariff, 1897.

ASSENTED TO JUNE 13, 1898.

### A TRUE COPY FROM THE OFFICIAL TEXT.

HER MAJESTY, BY AND WITH THE ADVICE AND CONSENT OF  
THE SENATE AND HOUSE OF COMMONS OF CANADA,  
ENACTS AS FOLLOWS :

1. Section 6 of *The Customs Tariff, 1897*, is hereby repealed and the following is substituted therefor:—

"6. The importation into Canada of any goods enumerated, described or referred to in schedule C to this Act is prohibited; and any such goods imported shall thereby become forfeited to the Crown and shall be destroyed or otherwise dealt with as the Minister of Customs directs; and any person importing any such prohibited goods, or causing or permitting them to be imported, shall for each offence incur a penalty not exceeding two hundred dollars."

2. On and after the first day of August, one thousand eight hundred and ninety-eight, section 17 of the said Act shall be repealed and the following shall be substituted therefor:—

"17. Articles which are the growth, produce or manufacture of any of the following countries may, when imported direct into Canada from any of such countries, be entered for duty or taken out of warehouse for consumption in Canada at the reduced rate of duty provided in the British preferential tariff set forth in schedule D to this Act:—

"(a) The United Kingdom;

"(b) The British colony of Bermuda;

"(c) The British colonies commonly called the British West Indies, including the following:—

The Bahamas;

Jamaica;

Turks and Caicos Islands;

The Leeward Islands (Antigua, St. Christopher-Nevis, Dominica, Montserrat, and the Virgin Islands);

The Windward Islands (Grenada, St. Vincent and St. Lucia);

Barbados;

Trinidad and Tobago;

(d) British Guiana;

(e) Any other British colony or possession the customs tariff of which is, on the whole, as favorable to Canada as the British preferential tariff herein referred to is to such colony or possession.

"Provided, however, that manufactured articles to be admitted under such preferential tariff shall be *bona fide* the manufactures of a country or countries entitled to the benefits

of such tariff, and that such benefits shall not extend to the importation of articles into the production which there has not entered a substantial portion of the labor of such countries. Any question arising as to any article being entitled to such benefits shall be decided by the Minister of Customs, whose decision shall be final.

"2. Raw sugar, including all sugar described in item 436 of schedule A, may, when imported direct from any British colony or possession, be entered for duty or taken out of warehouse for consumption in Canada at the reduced rate of duty provided in the British preferential tariff.

"3. The Minister of Customs, with the approval of the Governor-in-Council, shall determine what British colonies or possessions shall be entitled to the benefits of the preferential tariff under paragraph (c) of subsection 1 of this section.

"4. The Minister of Customs may, with the approval of the Governor-in-Council, make such regulations as are deemed necessary for carrying out the intention of this section."

3. Item 221 in schedule A to the said Act is hereby repealed and the following substituted therefor:—

"221. India-rubber boots and shoes; rubber belting, rubber cement and all manufactures of India rubber and gutta percha, n.o.p., twenty-five per cent. ad valorem, 25 p.c."

4. Items 435 and 436 in schedule A to the said Act are hereby repealed and the following are substituted therefor:—

"435. All sugar above number sixteen Dutch standard in color, and all refined sugars of whatever kind, grades or standards, testing not more than eighty-eight degrees by the polariscope, one dollar and eight cents per one hundred pounds, and for each additional degree one and one-half cent per one hundred pounds. Fractions of five-tenths of a degree or less not to be subject to duty, and fractions of more than five tenths to be dutiable as a degree.

"436. Sugar n.e.s. not above number sixteen Dutch standard in color, sugar drainings or pumpings drained in transit, melado or concentrated melado, tank bottoms and sugar concrete, testing not more than seventy-five degrees by the polariscope, forty cents per one hundred pounds, and for each additional degree one and one-half cent per one hundred pounds. Fractions of five-tenths of a degree or less not to be subject to duty, and fractions of more than five-tenths to be dutiable as a degree. The usual packages in which imported to be free."

5. On and after the first day of July, one thousand eight



# DIRECT CONNECTED

And Belted Motors for **ELEVATORS**

Using Current **ONLY** when Elevator is Moving.

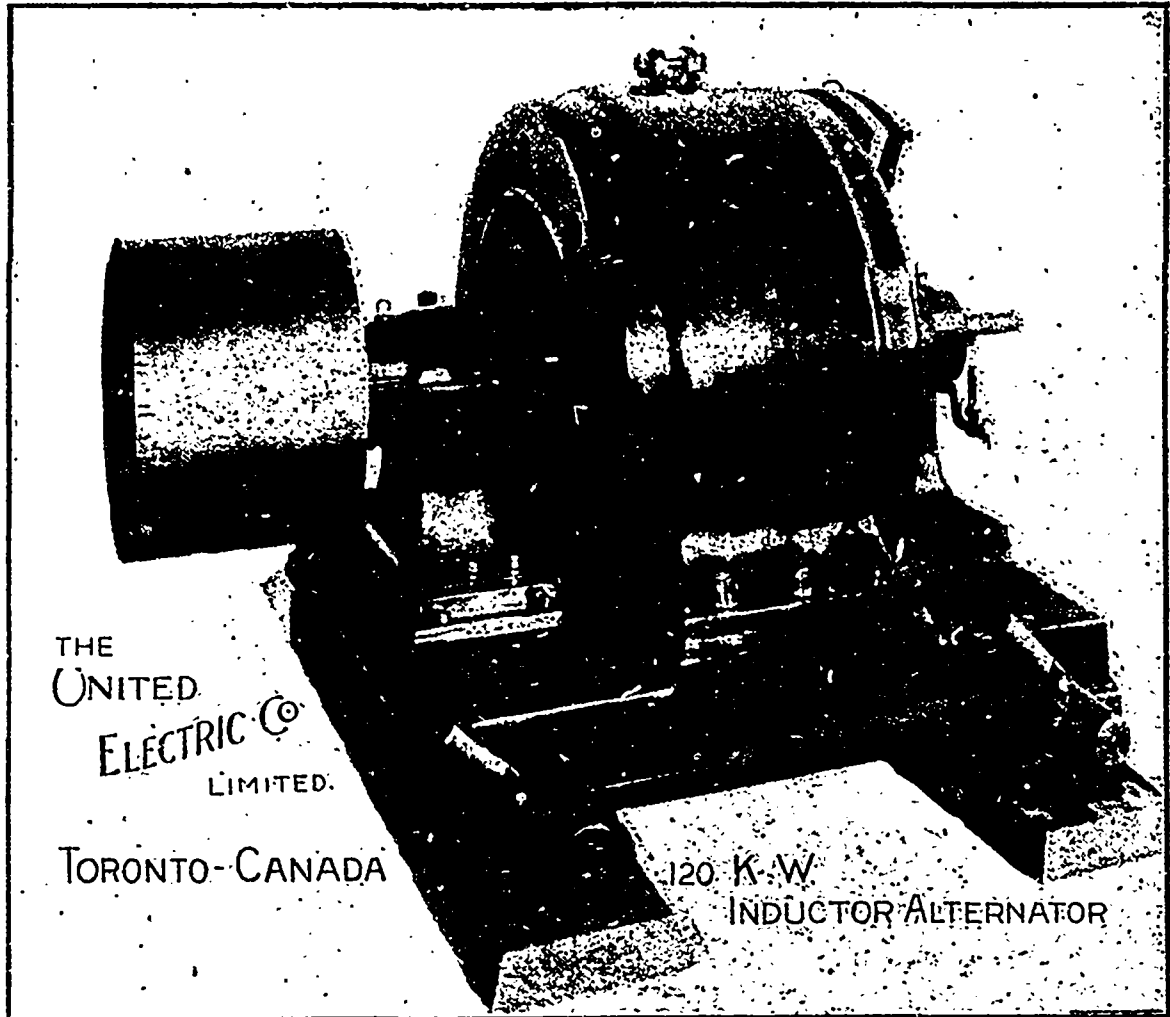

Direct Connected Units for Isolated Plants both Power, Light and Heat.

Complete Line of Motors and Generators either Bi-polar or Multi-polar from One H.P. to 1,000 H.P. Sizes.

Complete Line of Arc Lamps for all Circuits, Switch Boards and Feeder Panels, Electrical Appliances.

## THE UNITED ELECTRIC COMPANY, LIMITED, TORONTO.

When writing to Advertisers kindly mention THE CANADIAN MANUFACTURER.

# DIRECT CONNECTED

And Belted Motors for **ELEVATORS**

Using Current ONLY when Elevator is Moving.

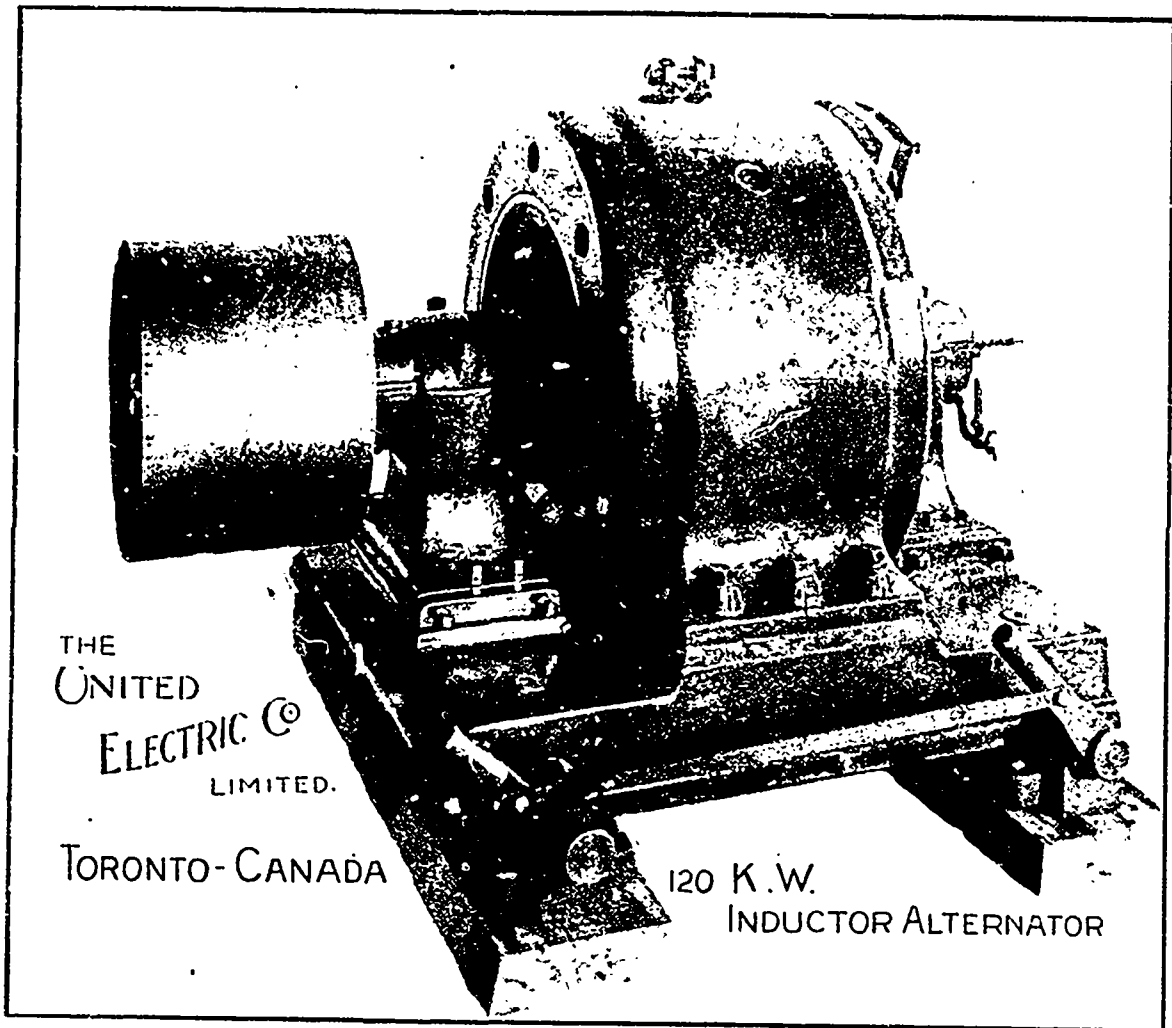

Direct Connected Units for Isolated Plants, both Power,  
Light and Heat.

Complete Line of Motors and Generators, either Bi-polar or Multi-polar,  
from One H.P. to 1000 H.H. Sizes.

Complete Line of Arc Lamps for all Circuits, Switch Boards and Feeder  
Panels, Electrical Appliances.

This is a reproduction of the opposite page showing the advantage of using  
COATED PAPER IN CATALOGUES.

When writing to Advertisers kindly mention THE CANADIAN MANUFACTURER

USE RED

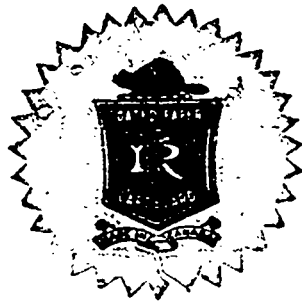

SEAL BRAND

# COATED PAPER

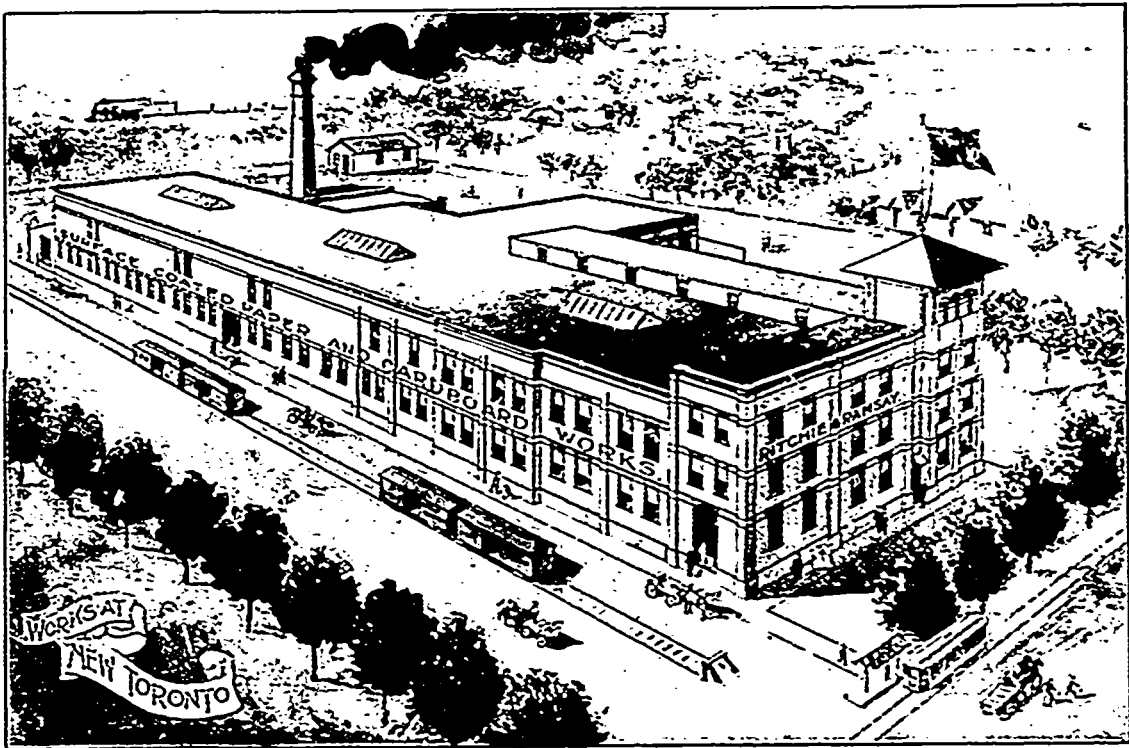

IN CATALOGUES

IT HAS

NO SUBSTITUTE

MANUFACTURED BY

# RITCHIE & RAMSAY

TORONTO.

EASTERN AGENT:

**C. HOWARD SMITH**

704 CRAIG ST., MONTREAL

When writing to Advertisers kindly mention THE CANADIAN MANUFACTURER.

## The Canadian Tariff.

hundred and ninety-eight, items 445 and 446 in schedule A to the said Act shall be repealed.

6. On and after the said first day of July, the following item shall be inserted in schedule B to the said Act instead of item 616:—

“616. Tobacco, unmanufactured, for excise purposes under conditions of the Inland Revenue Act.”

7. On and after the first day of August, one thousand eight hundred and ninety-eight, schedule D to the said Act shall be repealed and the following substituted therefor:—

## “SCHEDULE D.

## “BRITISH PREFERENTIAL TARIFF.

“On articles entitled to the benefits of this preferential tariff under section seventeen, the duties mentioned in schedule A shall be reduced as follows: The reduction shall be one-fourth of the duty mentioned in schedule A, and the duty to be levied, collected and paid shall be three-fourths of the duty mentioned in schedule A.

“Provided, however, that this reduction shall not apply to any of the following articles and that such articles shall in all cases be subject to the duties mentioned in schedule A, viz., wines, malt liquors, spirits, spirituous liquors, liquid medicines and articles containing alcohol; tobacco, cigars and cigarettes.

“Provided further, that the reduction shall only apply to refined sugar, when evidence satisfactory to the Minister of Customs is furnished that such refined sugar has been manufactured wholly from raw sugar produced in the British colonies or possessions.”

NOTE.—An Act to Amend Schedule D is now under consideration by the Dominion Government, which, when passed, will increase the tariff preference in favor of British goods from twenty-five per cent. to thirty-three and one-third per cent. The operation of this Act went into effect July 1, 1900, as will more fully appear in page 43 at the end of the Canadian Tariff.

8. Except as herein otherwise provided, this Act shall be held to have come into force on the sixth day of April, in the year, one thousand eight hundred and ninety-eight.

## An Act to Consolidate and Amend the Acts respecting the Duties of Customs.

ASSENTED TO JUNE 29, 1897.

HER MAJESTY, BY AND WITH THE ADVICE AND CONSENT OF THE SENATE AND HOUSE OF COMMONS OF CANADA, ENACTS AS FOLLOWS:

1. This Act may be cited as The Customs Tariff, 1897.
2. In this Act and in any other Act relating to customs, unless the context otherwise requires,
  - (a) The initials “n.e.s.” represent and have the meaning of the words “not elsewhere specified;”
  - (b) The initials “n.o.p.” represent and have the meaning of the words, “not otherwise provided for;”
  - (c) The expression “gallon” means an imperial gallon;
  - (d) The expression “ton” means two thousand pounds avoirdupois;
  - (e) The expression “proof” or “proof spirits,” when applied to wines or spirits of any kind, means spirits of a strength

## The Canadian Tariff.

equal to that of pure ethyl alcohol compounded with distilled water in such proportions that the resultant mixture shall at a temperature of sixty degrees Fahrenheit, have a specific gravity of 0.9198 as compared with that of distilled water at the same temperature;

(f) The expression “gauge,” when applied to metal sheets or plates, or to wire, means the thickness as determined by Stubbs’ standard gauge;

(g) The expression “in diameter,” when applied to tubing, means the actual inside diameter;

(h) The expression “sheet,” when applied to metals, means a sheet or plate not exceeding three-sixteenths of an inch in thickness;

(i) The expression “plate,” when applied to metals, means a plate or sheet more than three-sixteenths of an inch in thickness.

3. The expressions mentioned in sections two of The Customs Act, as amended by section two of The Customs Amendment Act, 1888, whenever they occur herein or in any Act relating to the customs, unless the context otherwise requires, have the meaning assigned to them respectively by the said section two; and any power conferred upon the Governor-in-Council by The Customs Act to transfer dutiable goods to the list of goods which may be imported free of duty, is not hereby abrogated or impaired.

4. Subject to the provisions of this Act and to the requirements of The Customs Act, chapter thirty-two of the Revised Statutes, as amended, there shall be levied, collected and paid upon all goods enumerated, referred to as not enumerated, in schedule A to this Act, the several rates of duties of customs set forth and described in the said schedule and set opposite to each item respectively, or charged thereon as not enumerated, when such goods are imported into Canada or taken out of warehouse for consumption therein.

5. Subject to the same provisions and to the further conditions contained in schedule B to this Act, all goods enumerated in the said schedule B may be imported into Canada, or may be taken out of warehouse for consumption in Canada without the payment of any duties of customs thereon.

6. The importation into Canada of any goods enumerated, described, or referred to in schedule C to this Act, is prohibited; and any such goods imported shall thereby become forfeited to the Crown, and shall be destroyed, and any person importing any such prohibited goods, or causing or permitting them to be imported, shall for each offence incur a penalty of two hundred dollars.

7. The whole or part of the duties hereby imposed upon fish and other product of the fisheries may be remitted as respects either the United States or Newfoundland, or both, upon proclamation of the Governor-in-Council, which may be issued whenever it appears to his satisfaction that the Governments of the United States and Newfoundland, or either of them, have made changes in their tariffs of duties imposed upon articles imported from Canada, in reduction or repeal of the duties in force in the said countries respectively.

8. The export of deer, wild turkeys, quail, partridge, prairie fowl and woodcock, in the carcase or parts thereof, is hereby declared unlawful and prohibited; and any person exporting or attempting to export any such article shall for each such offence incur a penalty of one hundred dollars, and the article so attempted to be exported shall be forfeited, and may, on reasonable cause of suspicion of intention to export, be seized by any officer of the customs, and if such intention is proved, shall be dealt with as for breach of the customs laws: Provided, that this section shall not apply to the export, under such regulations as are made by the Governor-in-Council, of any carcase or part thereof of any deer raised or bred by any person, company or association of persons upon his or their own lands.

THE  
Volta Electric Storage Co.

LIMITED.

Hamilton, Ont.

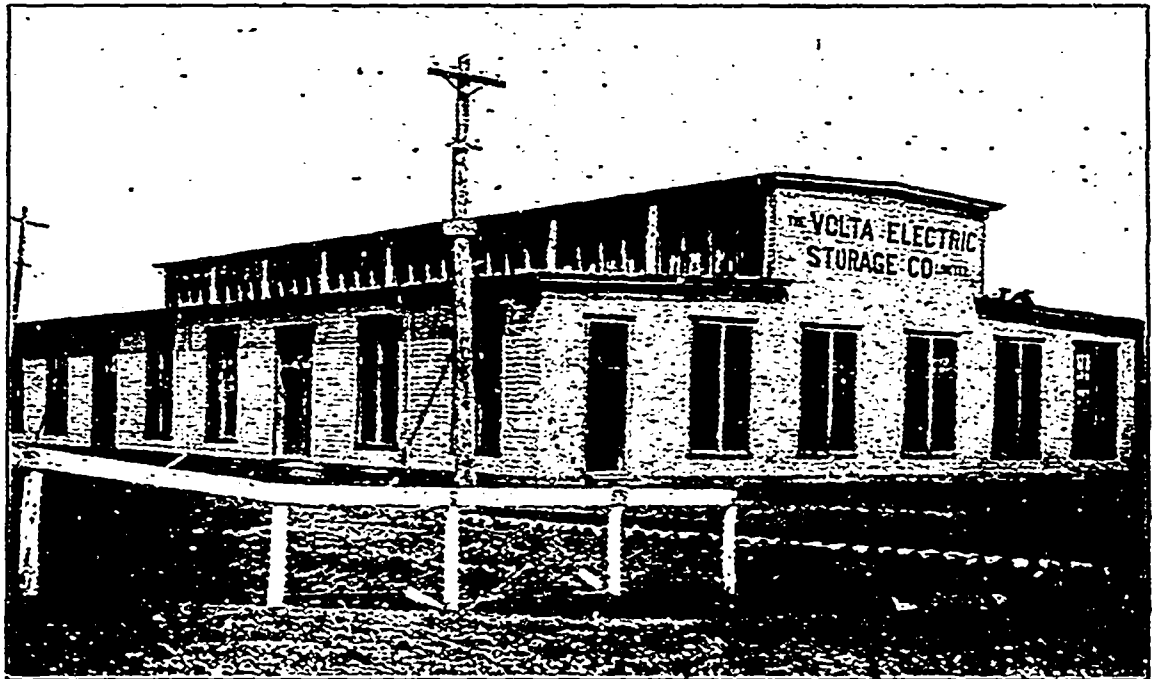

MANUFACTURERS OF

**STORAGE BATTERIES**

For Domestic Use and Foreign  
Export.

## The Canadian Tariff.

9. Regulations respecting the manner in which molasses and syrups shall be sampled and tested for the purpose of determining the classes to which they belong with reference to the duty chargeable thereon shall be made by the controller of customs, and the instruments and appliances necessary for such determination shall be designated by him and supplied to such officers as are by him charged with the duty of sampling and testing such molasses and syrups; and the decision of any officer (to whom is so assigned the testing of such articles) as to the duties to which they are subject under the tariff shall be final and conclusive, unless upon appeal to the commissioner of customs within thirty days from the rendering of such decision, such decision is, with the approval of the controller, changed; and the decision of the commissioner with such approval shall be final.

10. In the case of all wines, spirits or alcoholic liquors subject to duty according to their relative strength of proof, such strength shall be ascertained either by means of Sykes's hydrometer, or of the specific gravity bottle, as the controller of customs directs; and in case such relative strength cannot be correctly ascertained by the direct use of the hydrometer or gravity bottle, it shall be ascertained by the distillation of a sample and the subsequent test in like manner of the distillate.

11. All medicinal or toilet preparations imported for completing the manufacture thereof, or for the manufacture of any other article by the addition of any ingredient or ingredients, or by mixing such preparations, or by putting up and labelling the same, alone or with other articles or compounds, under any proprietary or special name or trade mark, shall be valued for duty under the provision of sub-section two of section sixty-five of The Customs Act, as amended by section fifteen of chapter fourteen of the statutes of 1888.

12. All medicinal preparations, whether chemical or other, usually imported with the name of the manufacturer, shall have the true name of such manufacturer and the place where they are prepared, and the word "alcoholic," or "non-alcoholic," permanently and legibly affixed to each parcel by stamp, label or otherwise, and all medicinal preparations imported without such names and word so affixed may be forfeited.

13. Packages shall be subject to the following provisions:—

(a) All bottles, flasks, jars, demijohns, carboys, casks, hogsheads, pipes, barrels, and all other vessels or packages, manufactured of tin, iron, lead, zinc, glass or any other material capable of holding liquids, and all packages in which goods are commonly placed for home consumption, including cases, not otherwise provided for, in which bottled spirits, wines or malt liquors or other liquids are contained, and every package being the first receptacle or covering inclosing goods for the purpose of sale, shall, in all cases not otherwise provided for, in which they contain goods subject to an ad valorem duty or a specific and ad valorem duty, be charged with the same rate of ad valorem duty as is to be levied and collected on the goods they contain, and the value of the packages may be included in the value of such goods;

(b) All such packages as aforesaid containing goods subject to a specific duty only, and not otherwise provided for, shall be charged with a duty of twenty per cent. ad valorem;

(c) Packages not hereinbefore specified, and not herein specially charged with or declared liable to duty, and being the usual and ordinary packages in which goods are packed for exportation, according to the general usage and custom of trade, shall be free of duty;

(d) All such special packages or coverings as are of any use, or apparently designed for use other than in the importation of the goods they contain, shall be subject to the same rate of duty as would thereon be levied if imported empty or separate from their contents;

## The Canadian Tariff.

(e) Packages (inside or outside) containing free goods shall be exempt from duty when the packages are of such a nature that their destruction is necessary in order to release the goods.

14. Any person who, without lawful excuse, the proof of which shall be on the person accused, send or brings into Canada, or who, being in Canada, has in his possession, any bill-heading or other paper appearing to be a heading or blank capable of being filled up and used as an invoice, and bearing any certificate purporting to show, or which may be used to show, that the invoice which may be made from such bill-heading or blank is correct or authentic, is guilty of an indictable offence and liable to a penalty of five hundred dollars, and to imprisonment of a term not exceeding twelve months, in the discretion of the court, and the goods entered under any invoice made from any such bill-heading or blank shall be forfeited.

15. With respect to goods imported for manufacturing purposes that are admissible under this Act for any specific purposes at a lower rate of duty than would otherwise be chargeable, or exempt from duty, the importer claiming such exemption from duty, or proportionate exemption from duty, shall make and subscribe to the following affidavit or affirmation before the collector of customs at the port of entry, or before a notary public or a commissioner for taking affidavits:—

I, (name of importer) the undersigned, importer of the (names of the goods or articles) mentioned in this entry, do solemnly (swear or affirm) that such (names of the goods or articles) are imported by me for the manufacture of (names of the goods to be manufactured) in my own factory, situated at (name of the place, county and province), and that no portion of the same will be used for any other purpose or disposed of until so manufactured.

16. Nothing contained in the forgoing provisions shall affect the French Treaty Act, 1894, or chapter three of the statutes of 1895, intitled An Act respecting Commercial Treaties affecting Canada.

17. When the customs tariff of any country admits the product of Canada on terms which, on the whole, are as favorable to Canada as the terms of the reciprocal tariff herein referred to are to the countries to which it may apply, articles which are the growth, produce, or manufacture of such country, when imported direct therefrom, may then be entered for duty, or taken out of warehouse for consumption in Canada, at the reduced rates of duty provided in the reciprocal tariff set forth in schedule D to this Act.

2. Any question arising as to the countries entitled to the benefits of the reciprocal tariff shall be decided by the Controller of Customs, subject to the authority of the Governor-in-Council.

3. The Governor-in-Council may extend the benefits of the reciprocal tariff to any country entitled thereto by virtue of a treaty with Her Majesty.

4. The Controller of Customs may make such regulations as are necessary for carrying out the intention of this section.

18. Whenever the Governor-in-Council has reason to believe that with regard to any article of commerce there exists any trust, combination, association or agreement of any kind among manufacturers of such article or dealers therein, to unduly enhance the price of such article or in any other way to unduly promote the advantage of the manufacturers or dealers at the expense of the consumers, the Governor-in-Council may commission or empower any judge of the Supreme Court or Exchequer Court of Canada, or of any superior court in any Province of Canada, to enquire in a summary way into and report to the Governor-in-Council

F. N. PHILLIPS, President.

GEO. H. OLNEY 2nd, Sec'y and Treas.

**Eugene F. Phillips**

**Electrical Works (Limited)**

**MONTREAL, - CANADA**

**BARE and INSULATED ELECTRIC WIRE**

Electric Light Line Wire

Incandescent and Flexible Cords

**RAILWAY FEEDER and TROLLEY WIRE**

Rubber Covered, Magnet, Office and Annunciator Wires  
Cables for Aerial and Underground Use.



**U.S. Factory: AMERICAN ELECTRICAL WORKS, Providence, R. I.**

NEW YORK STORE:

**W. J. WATSON, Agt., 26 Cortlandt St.**

CHICAGO STORE:

**F. E. DONOHOE, Agt., 241 Madison St.**

**Motors, Dynamos, Electrical Supplies**

ALL SIZES

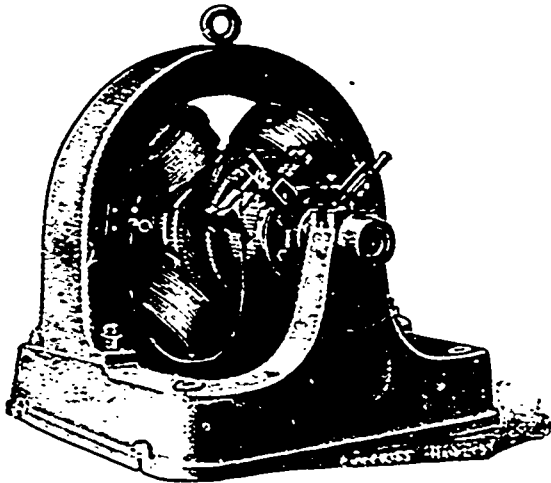

**COMMUTATORS REFILLED.**

Will you write us for prices when in need of anything  
Electrical?

**Toronto & Hamilton Electric Co.**

**HAMILTON, ONTARIO.**

When writing to Advertisers kindly mention THE CANADIAN MANUFACTURER.

OF ALL KINDS

Contractors for Electrical Work.

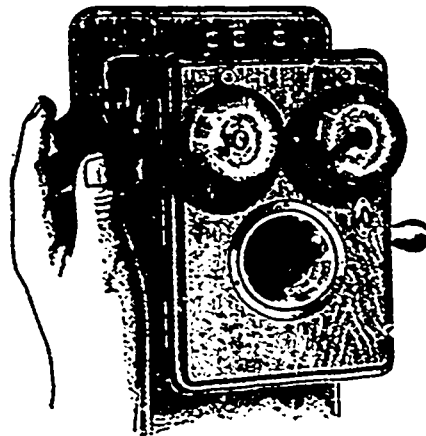

Special Attention  
Given to Repairs.  
**Get Our Prices**

**THE TORONTO ELECTRICAL WORKS CO.**

LIMITED

**42 Adelaide St., West, TORONTO.**

The Canadian Tariff.

whether such trust, combination, association or agreement exists.

2. The judge may compel the attendance of witnesses and examine them under oath and require the production of books and papers, and shall have such other necessary powers as are conferred upon him by the Governor-in-Council for the purposes of such enquiry.

3. If the judge reports that such trust, combination, association or agreement exists, and if it appears to the Governor-in-Council that such disadvantage to the consumer is facilitated by the duties of customs imposed on a like article, when imported, then the Governor-in-Council shall place such article on the free list, or to reduce the duty on it as to give to the public the benefit of reasonable competition in such article.

19. The following Acts are hereby repealed:—The Customs Tariff, 1894, being chapter thirty-three of the statutes of 1894; chapter twenty-three of the statutes of 1895, intituled An Act to amend the Customs Tariff, 1894; and chapter eight of the statutes of 1896, intituled An Act further to amend the Customs Tariff, 1894.

20. All Orders in Council and all departmental regulations inconsistent with any of the provisions of this Act are hereby repealed.

21. The foregoing provisions of this Act shall be held to have come into force on the twenty-third day of April, in the present year one thousand eight hundred and ninety-seven, and to apply and to have applied to all goods imported or taken out of warehouse for consumption on or after the said day: Provided, that in the case of goods which were imported or taken out of warehouse for consumption, and on which duty was paid, on or after the twenty-third day of April, one thousand eight hundred and ninety-seven, in accordance with the rate of duty set forth as payable on such goods in the resolutions respecting the duties of customs introduced in the House of Commons on the twenty-second day of the said month, or in any such resolution subsequently introduced in the said House, the duty so paid shall not be affected, nor shall the person paying it be entitled to any refund or be liable to any further payment of duty, by reason of such rate of duty being altered by any resolution introduced subsequently to that in accordance with which such duty was paid and before the passing of this Act.

SCHEDULE A.

Goods Subject to Duties.

Ales, Beers, Wines and Liquors.

- 1 Ale, beer and porter, when imported in casks or otherwise than in bottle, sixteen cents per gallon ..... 16c p gall
- 2 Ale, beer and porter, when imported in bottles (six quart or twelve pint bottles to be held to contain one gallon), twenty-four cents per gallon ..... 24c p gall
- 3 Cider, not clarified or refined, five cents per gallon ..... 5c p gall
- 4 Cider, clarified or refined, ten cents per gallon.. 10c p gall
- 5 Lime juice and fruit juices, fortified with or containing not more than twenty-five per cent. of proof spirits, sixty cents per gallon; and when containing more than twenty-five per cent. of proof spirits, two dollars per gallon ..... \$2 p gall
- 6 Lime juice and other fruit syrups and fruit juices, n.o.p., twenty per cent. ad valorem .... 20 p c
- 7 Spirituous or alcoholic liquors, distilled from any material, or containing or compounded from or with distilled spirits of any kind, and any mixture thereof with water, for every gallon thereof of the strength of proof, and when of a greater strength than that of proof, at the same rate on the increased quantity that there would be if the liquors were reduced to the strength of proof. When the liquors are of a less strength than that of proof, the duty shall be a rate herein provided, but computed on a reduced

The Canadian Tariff.

quantity of the liquors in proportion to the lesser degree of strength; provided, however, that no reduction in quantity shall be computed or made on any liquors below the strength of fifteen per cent. under proof, but all such liquors shall be computed as of the strength of fifteen per cent. under proof, as follows:—

- (a) Ethyl alcohol, or the substance commonly known as alcohol, hydrated oxide of ethyl or spirits of wine; gin of all kinds, n.e.s.; rum, whiskey and all spirituous or alcoholic liquors, n.o.p.; amyl alcohol or fusel oil, or any substance known as potato spirit or potato oil; methyl alcohol, wood alcohol, wood naphtha, pyroxylic spirit or any substance known as wood spirit or methylated spirits, absinthe, arrack or palm spirit, brandy, including artificial brandy and imitations of brandy; cordials and liqueurs of all kinds, n.e.s.; mescal, pulque, rum shrub, schiedam and other schnapps; tafia, angostura and similar alcoholic bitters or beverages, two dollars and forty cents per gallon ..... \$2.40 p gall
- (b) Spirits and strong waters of any kind, mixed with any ingredient or ingredients, as being or known or designated as anodynes, elixirs, essences, extracts, lotions, tinctures or medicines, or medicinal wines (so called), or ethereal and spirituous fruit essences, n.e.s., two dollars and forty cents per gallon and thirty per cent. ad valorem ..... \$2.40 p gall & 30 p c
- (c) Alcoholic perfumes and perfumed spirits, bay rum, cologne and lavender waters, hair, tooth and skin washes, and other toilet preparations containing spirits of any kind, when in bottles or flasks containing not more than four ounces each, fifty per cent. ad valorem ..... 50 p c
- When in bottles, flasks or other packages, containing more than four ounces each, two dollars and forty cents per gallon and forty per cent. ad valorem ..... \$2.40 p gall & 30 p c
- (d) Nitrous ether, sweet spirits of nitre and aromatic spirits of ammonia, two dollars and forty cents per gallon and thirty per cent. ad valorem ..... \$2.40 p gall & 30 p c
- (e) Vermouth, containing not more than thirty-six per cent., and ginger wine containing not more than twenty-six per cent. of proof spirits, ninety cents per gallon ..... 90c p gall
- If containing more than these percentages respectively of proof spirits, two dollars and forty cents per gallon ..... \$2.40 p gall
- (f) Medicinal or medicated wines, containing not more than forty per cent. of proof spirits, one dollar and fifty cents per gallon.. \$1.50 p gall
- 8 Wines of all kinds, except sparkling wines, including orange, lemon, strawberry, raspberry, elder and currant wines, containing twenty-six per cent. or less of spirits of the strength of proof, whether imported in wood or in bottles (six quart or twelve pint bottles to be held to contain a gallon), twenty-five cents per gallon; and for each degree or fraction of a degree of strength in excess of the twenty-six per cent. of spirits as aforesaid, an additional duty of three cents until the strength reaches forty per cent. of proof spirits; and in addition thereto, thirty per cent ad valorem ..... 30 p c
- 9 Champagne and all other sparkling wines in bottles containing each not more than a quart but more than a pint, three dollars and thirty cents per dozen bottles; containing not more than a pint each, but more than one-half pint, one dollar and sixty-five cents per dozen bottles; containing one-half pint each or less, eighty-two cents per dozen bottles; bottles containing more than one quart each shall pay, in addition to three dollars and thirty cents per dozen bottles, at the rate of one dollar and sixty-five cents per gallon on the quantity in excess of one quart per bottle, the quarts and pints in each case being old wine measure; in addition to the above specific duty there shall be an ad valorem duty of thirty per cent ..... \$3.30 p doz \$1.65 p doz \$2c p doz \$1.65 p gall 30 p c



# What We Have Done

FOR OTHERS

# We Can Do for You.

If you are considering the re-design of your power plant, the extension of your lighting system, or the electrical equipment of a new property, and will give us an opportunity

**WE  
WILL**

1. Consider your problem.
2. Work out a solution.
3. Submit to you a proposition covering the entire equipment.
4. Take the contract and guarantee the **OPERATION** and **ECONOMY** of the complete installation.

We are not connected with any manufacturing company, and, therefore, are free to use any approved make of apparatus desired by the purchaser.

**R. A. L. GRAY, ELECTRICAL CONTRACTOR,** 83 York Street TORONTO.

# RODERICK J. PARKE

**CONSULTING**

**ELECTRICAL ENGINEER**

Special attention given to the furnishing of—

**ESTIMATES OF COST, PLANS, SPECIFICATIONS,  
DESIGN AND SUPERVISION OF**

**Municipal Electrical Lighting Plants.**

**Commercial Electrical Lighting and Power Plants and Systems.**

**Electrical Power Distribution and Application in Manufacturing.**

**Long Distance Electrical Power Transmission Plants and Systems.**

**REPORTS AND TESTS OF EXISTING PLANTS.**

**ARBITRATIONS CONDUCTED. COMPETENT VALUATIONS MADE.**

*A Staff of Competent Experienced Engineers on Hand.*

Long Distance  
Telephone No. 8047

**Offices, 409 & 410 Temple Building, TORONTO, Canada.**

When writing to Advertisers kindly mention THE CANADIAN MANUFACTURER.

The Canadian Tariff.

10	But any liquors imported under the name of wine, and containing more than forty per cent. of spirits of the strength of proof shall be rated for duty as unenumerated spirits.	
Animals and Agricultural, Animal and Dairy Products.		
11	Animals, living, n.e.s., twenty per cent. ad valorem	20 p c
12	Live hogs, one and one-half cent per pound	1½ per lb
13	Meats, n.e.s. (when in barrel, the barrel to be free), two cents per pound	2c per lb
14	Meats, fresh, n.e.s., three cents per pound	3c per lb
15	Canned meats, and canned poultry and game, extracts of meats and fluid beef not medicated, and soups, twenty-five per cent. ad valorem	25 p c
16	Mutton and lamb, fresh, thirty-five per cent. ad valorem	35 p c
17	Poultry and game, n.o.p., 20 per cent. ad valorem	20 p c
18	Lard, lard compound and similar substances, cottolene and animal stearine of all kinds, n.e.s., two cents per pound	2c per lb
19	Tallow and stearic acid, twenty per cent ad valorem	20 p c
20	Beeswax, ten per cent. ad valorem	10 p c
21	Candles, n.e.s., twenty-five per cent. ad valorem	25 p c
22	Paraffine wax candles, thirty per cent. ad valorem	30 p c
23	Soap, common or laundry, one cent per pound	1c per lb
24	Castle soap, mottled or white, two cents per pound	2c per lb
25	Soap, n.e.s., thirty-five per cent. ad valorem	35 p c
26	Pearline, and other soap powders, thirty per cent. ad valorem	30 p c
27	Glue, liquid, powdered or sheet, and muclage, gelatine, and isinglass, twenty-five per cent. ad valorem	25 p c
28	Feathers, undressed, twenty per cent. ad valorem	20 p c
29	Feathers, n.e.s., thirty per cent. ad valorem	30 p c
30	Eggs, three cents per dozen	3c p doz
31	Butter, four cents per pound	4c p lb
32	Cheese, three cents per pound	3c p lb
33	Condensed milk (weight of the package to be included in the weight for duty), three and one-quarter cents per pound	3¼c p lb
34	Condensed coffee with milk, milk foods and all similar preparations, thirty per cent. ad valorem	30 p c
35	Apples, including the duty on the barrel, forty cents per barrel	40c p brl
36	Beans, fifteen cents per bushel	15c p bush
37	Buckwheat, ten cents per bushel	10c p bush
38	Pease, n.e.s., ten cents per bushel	10c p bush
39	Potatoes, n.e.s., fifteen cents per bushel	15c p bush
40	Rye, ten cents per bushel	10c p bush
41	Rye flour, including the duty on the barrel, fifty cents per barrel	50c p brl
42	Hay, two dollars per ton	\$2 p ton
43	Vegetables, n.o.p., twenty-five per cent. ad valorem	25 p c
44	Barley, thirty per cent. ad valorem	30 p c
45	Dutiable breadstuffs, grain, and flour and meal of all kinds, when damaged by water in transit, twenty per cent. ad valorem on the appraised value, such appraised value to be ascertained as provided by sections 58, 70, 71, 72, 73, 74, 75 and 76 of the Customs Act	20 p c
46	Buckwheat, meal or flour, one-fourth of one cent per pound	¼c p lb
47	Cornmeal, including the duty on the barrel, twenty-five cents per barrel	25c p brl
48	Indian corn for purposes of distillation, subject to regulations to be approved by the Governor in Council, seven and one-half cents per bushel	7½c p bush
49	Oats, ten cents per bushel	10c p bush
50	Oatmeal, twenty per cent. ad valorem	20 p c
51	Rice, uncleaned, unhulled or paddy, one-half cent per pound	½c p lb
52	Rice, cleaned, one and one-quarter cent per pound	1¼c p lb
53	Rice and sago flour and sago, and tapioca, twenty-five per cent. ad valorem	25 p c
54	Rice, when imported by makers of rice-starch for use in their factories in making starch, three-fourth of one cent per pound	¾c p lb

The Canadian Tariff.

55	Wheat, twelve cents per bushel	12c p bush
56	Wheat flour, including the duty on the barrel, sixty cents per barrel	60c p brl
57	Biscuits not sweetened, twenty-five per cent. ad valorem	25 p c
58	Biscuits, sweetened, twenty-seven and one-half per cent. ad valorem	27½ p c
59	Macaroni and vermicelli, twenty-five per cent. ad valorem	25 p c
60	Starch, including farina, corn starch or flour and all preparations having the qualities of starch, the weight of the package to be in all cases included in the weight for duty, one and one-half cent per pound	1½c p lb
61	Seeds, viz:—garden, field and other seeds for agricultural or other purposes, n.o.p., sunflower, canary, hemp and millet seed, when in bulk or in large parcels, ten per cent. ad valorem	10 p c
	When put up in small papers or parcels, twenty-five per cent. ad valorem	25 p c
62	Mustard, ground, twenty-five per cent. ad valorem	25 p c
63	Mustard cake, fifteen per cent. ad valorem	15 p c
64	Sweet potatoes and yams, ten cents per bushel	10c p bush
65	Tomatoes, fresh, twenty cents per bushel and ten per cent. ad valorem	20c p bush and 10 p c
66	Tomatoes and other vegetables, including corn and baked beans, in cans or packages, n.e.s., the weight of the cans or other packages to be included in the weight for duty, one and one-half cent per pound	1½c p lb
67	Pickles, sauces and catsups, including soy, thirty-five per cent. ad valorem	35 p c
68	Malt, upon entry for warehouse subject to excise regulations, fifteen cents per bushel	15c p bush
69	Extract of malt (non-alcoholic), for medicinal and baking purposes, twenty-five per cent. ad valorem	25 p c
70	Hops, six cents per pound	6c p lb
71	Compressed yeast, in bulk or mass of not less than fifty pounds, three cents per lb; in packages weighing less than fifty pounds, six cents per pound; the weight of the package in the latter case to be included in the weight for duty	6c p lb
72	Yeast cakes and baking powder, the weight of the packages to be included in the weight for duty, six cents per pound	6c p lb
73	Trees, viz:—apple, cherry, peach, pear, plum and quince, of all kinds, and small peach trees known as June buds, three cents each	3c each
74	Grape vines, gooseberry, raspberry, currant and rose bushes; fruit plants, n.e.s., and shade, lawn and ornamental trees, shrubs and plants, n.e.s., twenty per cent. ad valorem	20 p c
75	Blackberries, gooseberries, raspberries, strawberries, cherries and currants, n.e.s., the weight of the package to be included in the weight for duty, two cents per pound	2c p lb
76	Cranberries, plums and quinces, twenty-five per cent. ad valorem	25 p c
77	Prunes, including raisins, dried currants and California or silver prunes, one cent per lb	1c p lb
78	Apples, dried, desiccated or evaporated; dates, figs and other dried, desiccated or evaporated fruits, n.e.s., twenty-five per cent. ad valorem	25 p c
79	Grapes, two cents per pound	2c p lb
80	Oranges, lemons and limes, in boxes of capacity not exceeding two and one-half cubic feet, twenty-five cents per box	25c p box
	In one-half boxes, capacity not exceeding one and one-fourth cubic feet, thirteen cents per half box	13c p ½ box
	In cases and all other packages, per cubic foot holding capacity, ten cents	10c p cub ft
	In bulk, per one thousand oranges, lemons or limes, one dollar and fifty cents	\$1.50 p M
	In barrels, not exceeding in capacity that of the one hundred and ninety-six pounds flour barrel, fifty-five cents per barrel	55c p brl
81	Peaches, n.o.p., the weight of the package to be included in the weight for duty, one cent per pound	1c p lb
82	Fruits in air-tight cans or other packages, the weight of the cans or other packages to be	

# John Bertram & Sons

CANADA TOOL WORKS

## DUNDAS, ONT., CANADA.

MANUFACTURERS AND BUILDERS OF

### METAL WORKING MACHINE TOOLS

FOR

- Machine Shops
- Ship Yards
- Boiler Shops
- Rolling Mills
- Locomotive and Car Shops
- Brass Shops

CORRESPONDENCE SOLICITED.

Also Specialists in

### Paper Mill Machinery.

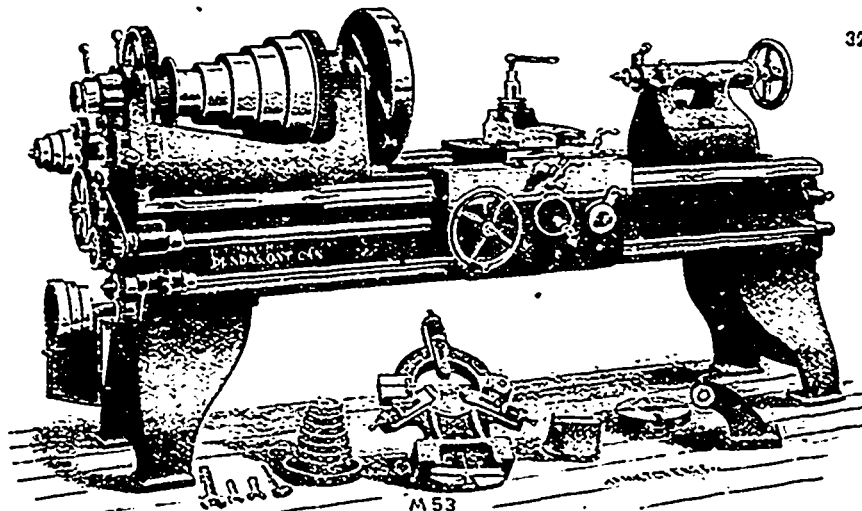
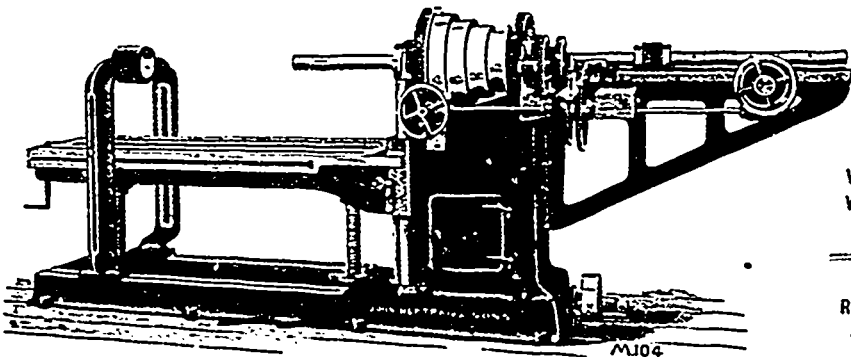
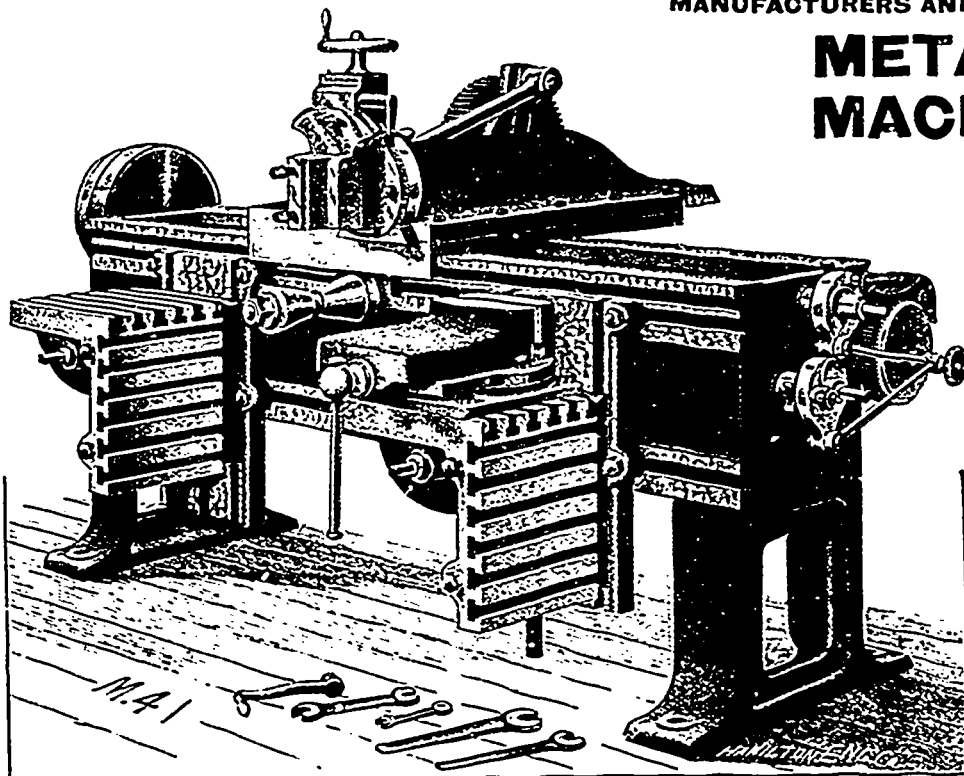

Branch Offices and Agencies

Vancouver, B.C.  
WM. HAMILTON  
MFC. CO.

Winnipeg  
ROBT. DOUGLAS  
463 Main St,

Montreal  
321 St. James  
Street

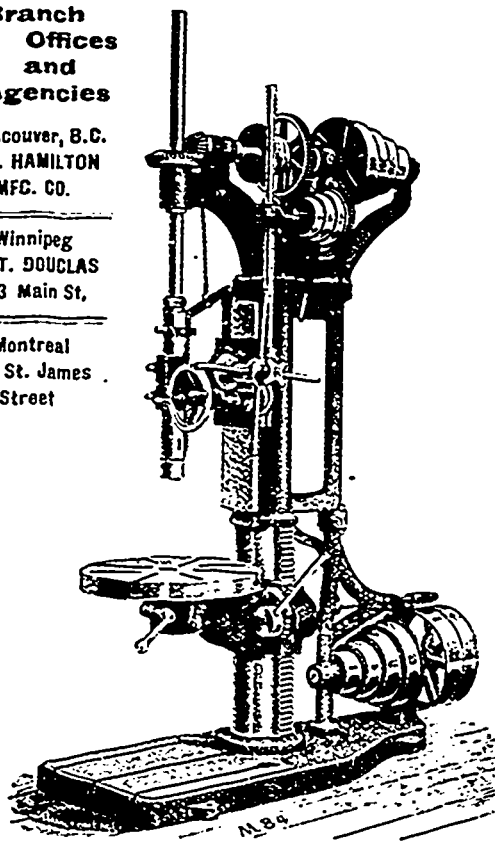

When writing to Advertisers kindly mention THE CANADIAN MANUFACTURER.

The Canadian Tariff.

	Included in the weight for duty, two and one-quarter cents per pound .....	2½c p lb
83	Fruits preserved in brandy, or preserved in other spirits, two dollars per gallon .....	\$2 p gall
84	Preserved ginger, thirty per cent. ad valorem .....	30 p c
85	Jellies, jams and preserves, n.e.s., three and one-quarter cents per pound .....	3¼c p lb
89	Honey, in the comb or otherwise, and imitations thereof, three cents per pound .....	3c p lb
87	Tea and green coffee, n.e.s., ten per cent. ad valorem .....	10 p c
88	Coffee, roasted or ground, when not imported direct from the country of growth and production, two cents per pound and ten per cent. ad valorem .....	2c p lb and 10 p c
89	Coffee, roasted or ground, and all imitations thereof and substitutes therefor, including acorn nuts, n.o.p., two cents per pound .....	2c p lb
90	Extract of coffee, n.e.s., or substitutes thereof of all kinds, three cents per pound .....	3c p lb
91	Chicory, raw or green, three cents per pound ..	3c p lb
92	Chicory, kiln-dried, roasted or ground, four cents per pound .....	4c p lb
93	Cocoa shells and nibs, chocolate and other preparations of cocoa, n.e.s., twenty per cent. ad valorem ..	20 p c
94	Cocoa paste, chocolate paste, cocos and cocoa butter, n.o.p., four cents per pound .....	4c p lb
95	Nuts, shelled, n.e.s., five cents per pound .....	5c p lb
96	Almonds, walnuts, Brazil nuts, pecans and shelled peanuts, n.e.s., three cents per pound..... And nuts of all kinds, n.o.p., two cents per pound .....	3c p lb 2c p lb
97	Cocoanuts, n.e.s., one dollar per hundred.....	\$1 p 100
98	Cocoanuts, when imported from the place of growth, by vessel, direct to a Canadian port, fifty cents per hundred .....	50c p 100
99	Cocoanut, desiccated, sweetened or not, five cents per pound .....	5c p lb
100	Nutmegs and mace, twenty-five per cent. ad valorem .....	25 p c
101	Spices, viz:—ginger and spices of all kinds, unground, n.e.s., twelve and one-half per cent. ad valorem .....	12½ p c
	Ground, twenty-five per cent. ad valorem....	25 p c
102	Fine salt in bulk, and coarse salt, n.e.s., five cents per one hundred pounds .....	5c p 100 lb
103	Salt, n.e.s., in bags, barrels and other packages—the bags, barrels or other packages, being the first coverings or inside packages, to bear the same duty as if such packages or first coverings were imported empty—seven and one-half cents per hundred pounds .....	7½c p 100 lb

Fish and Products of the Fisheries.

104	Mackerel, one cent per pound .....	1c p lb
105	Herrings, pickled or salted, one-half cent per pound .....	½c p lb
106	Salmon, fresh, one-half cent per pound .....	½c p lb
107	Salmon, pickled or salted, one cent per pound ..	1c p lb
108	All other fish, pickled or salted, in barrels, one cent per pound .....	1c p lb
109	Foreign-caught fish, imported otherwise than in barrels or half-barrels, whether fresh, dried, salted or pickled, not specially enumerated or provided for by this Act, fifty cents per hundred pounds .....	50c p 100 lb
110	Fish, smoked and boneless, one cent per pound ..	1c p lb
111	Anchovies and sardines, packed in oil or otherwise, in tin boxes measuring not more than five inches long, four inches wide and three and a half inches deep, per whole box, five cents.....	5c p box
	(b) In half boxes measuring not more than five inches long, four inches wide and one and five-eighths deep, per half box, two and one-half cents.....	2½c p ½ box
	(c) In quarter boxes, measuring not more than four inches and three quarters long, three and a half inches wide and one and a quarter deep, per quarter box, two cents ..	2c p ¼ box
112	Anchovies and sardines when imported in any other form, thirty per cent. ad valorem .....	30 p c
113	Fish preserved in oil, except anchovies and sardines, thirty per cent. ad valorem .....	30 p c

The Canadian Tariff.

114	Fresh or dried fish, n.e.s., imported in barrels, or half barrels, one cent per pound.....	1c p lb
115	Salmon and all other fish prepared or preserved, including oysters, not specially enumerated or provided for in this Act, twenty-five per cent. ad valorem.....	25 p c
116	Oysters, shelled, in bulk, ten cents per gallon..	10c p gall
117	Oysters, shelled, in cans not over one pint, three cents per can, including the cans .....	3c p can
118	Oysters, shelled, in cans over one pint and not over one quart, five cents per can, including the cans .....	5c p can
119	Oysters, shelled, in cans exceeding one quart in capacity, an additional duty of five cents for each quart or fraction of a quart of capacity over a quart, including the cans .....	5c p quart
120	Oysters in the shell, twenty-five per cent. ad valorem.....	25 p c
121	Packages containing oysters or other fish, n.o.p., twenty-five per cent. ad valorem.....	25 p c
122	Oils, spermaceti, whale and other fish oils, and all other articles the produce of the fisheries not specially provided for, twenty per cent. ad valorem.....	20 p c

Books and Paper.

123	Albumenized and other papers and films chemically prepared for photographers' use, thirty per cent. ad valorem .....	30 p c
124	Books, viz:—Novels or works of fiction, or literature of a similar character, unbound or paper-bound or in sheets, including freight rates for railways and telegraph rates, bound in book or pamphlet form, but not to include Christmas annuals or publications commonly known as juvenile and toy books, twenty per cent. ad valorem .....	20 p c
125	Books, printed, periodicals and pamphlets, or parts thereof, n.e.s.—not to include blank account books, copy books, or books to be written or drawn upon, ten per cent. ad valorem .....	10 p c
126	Advertising and printed matter, viz.—Advertising pamphlets, advertising pictorial show cards, illustrated advertising periodicals: illustrated price books, catalogues and price lists, advertising almanacs and calendars; patent medicine or other advertising circulars, fly sheets or pamphlets; advertising chromos, chromotypes, oleographs or like work produced by any process other than hand painting or drawing, and having any advertisement or advertising matter printed, lithographed or stamped thereon, or attached thereto, including advertising bills, folders and posters, or other similar artistic work, lithographed, printed or stamped on paper or cardboard for business or advertising purposes, n.o.p., fifteen cents per pound.....	15c p lb
127	Labels for cigar boxes, fruits, vegetables, meats, fish, confectionery or other goods or wares: shipping price or other tags, tickets or labels, and railroad or other tickets, whether lithographed or printed, or partly printed, n.e.s., thirty-five per cent. ad valorem .....	35 p c
128	Bank notes, bonds, bills of exchange, cheques, promissory notes, drafts, and all similar work, unsigned, and cards or other commercial blank forms printed or lithographed, or printed from steel or copper or other plates, and other printed matter, n.e.s., thirty-five per cent. ad valorem ..	35 p c
129	Printed music, bound or in sheets, ten per cent. ad valorem.....	10 p c
130	Photographs, chromos, chromotypes, artotypes, oleographs, paintings, drawings, pictures, engravings or prints, or proofs therefrom, and similar works of art, n.o.p.: blue prints, building plans, maps and charts, n.e.s., twenty per cent. ad valorem .....	20 p c
131	Newspapers or supplemental editions or parts thereof, partly printed and intended to be completed and published in Canada, twenty-five per cent. ad valorem .....	25 p c
132	Union collar cloth paper in rolls or sheets, not glossed or finished, fifteen per cent. ad valorem ..	15 p c
133	Union collar cloth paper in rolls or sheets, glossed or finished, twenty per cent. ad valorem ..	20 p c

**COWAN & CO.,** GALT, ONTARIO,  
CANADA.

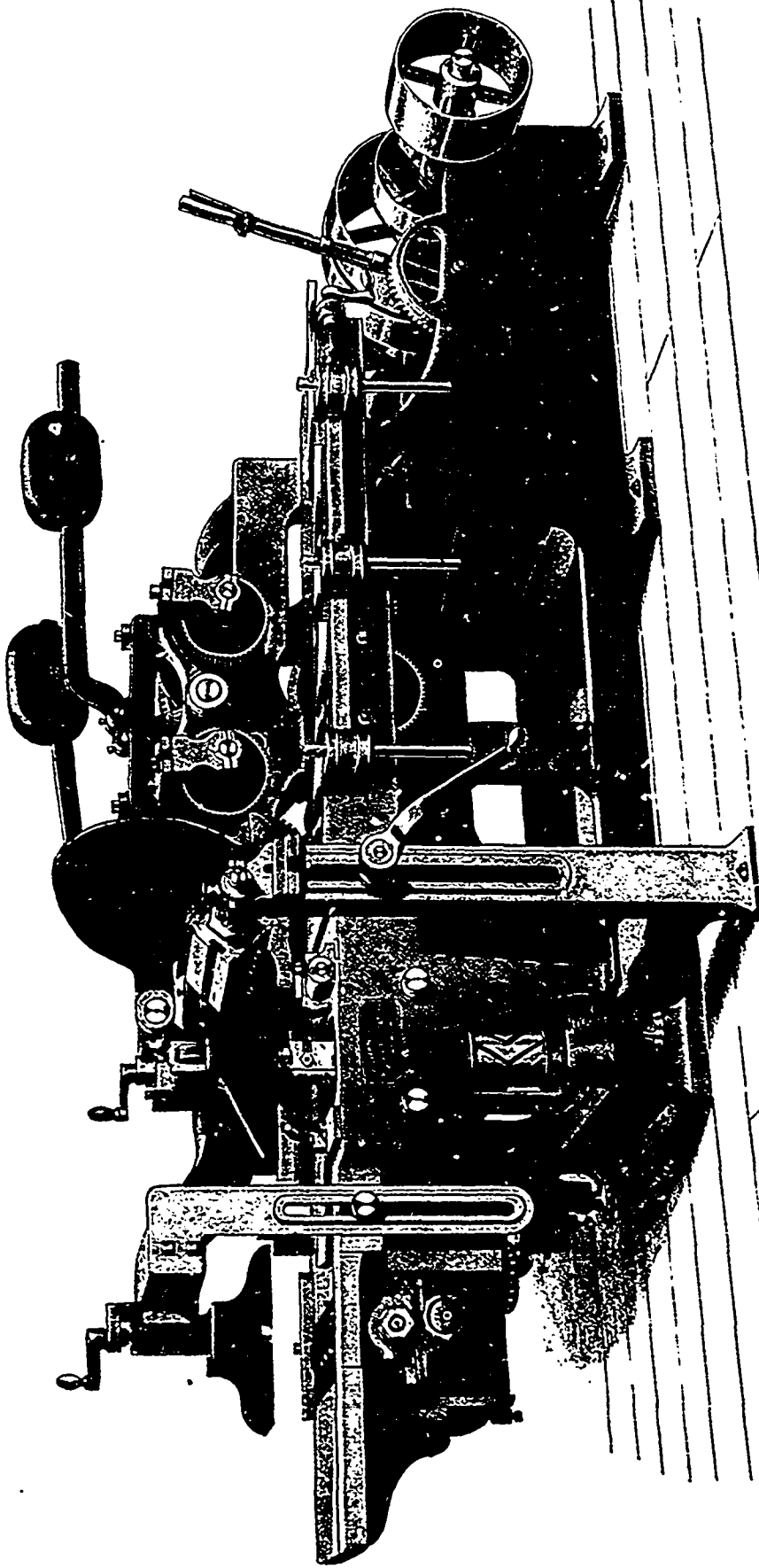

IMPROVED 12" MOULDER.

# **WOOD-WORKING MACHINERY**

*We  
Manufacture*

OF EVERY DESCRIPTION AND FOR ALL PURPOSES.

**Saw Mills, Corliss and Slide Valve Engines, Boilers,**

**DAKIN'S IMPROVED FEED WATER HEATERS, PURIFIERS, Etc.**

*Get Our Prices Before Buying Elsewhere.*

*When writing to Advertisers kindly mention THE CANADIAN MANUFACTURER.*

*Send For Catalogue.*

**We Make the Best.**

The Canadian Tariff.

- 134 Mill-board, not straw-board, ten per cent. ad valorem ..... 10 p c
- 135 Straw board, in sheets or rolls; tarred paper, felt or straw board; sandpaper, glass or flint paper, and emery paper or emery cloth, twenty-five per cent. ad valorem ..... 25 p c
- 136 Paper sacks or bags of all kinds, printed or not, twenty-five per cent. ad valorem ..... 25 p c
- 137 Playing cards, six cents per pack ..... 6c p pack
- 138 Paper hangings or wall papers, borders or bordering, and window blinds of paper of all kinds, thirty-five per cent. ad valorem ..... 35 p c
- 139 Printing paper and paper of all kinds, n.e.s., twenty-five per cent. ad valorem ..... 25 p c
- 140 Ruled and border and coated papers, papeteries, boxed papers, pads not printed, papier-mache ware, n.o.p.; envelopes and all manufactures of paper, n.e.s., thirty-five per cent. ad valorem ..... 35 p c

Chemicals and Drugs.

- 141 Acid, acetic acid and phrologneous, n.e.s., and vinegar, a specific duty of fifteen cents for each gallon of any strength not exceeding the strength of proof, and for each degree of strength in excess of the strength of proof an additional duty of two cents. .... 15c p gall
- The strength of proof shall be held to be equal to six per cent. of absolute acid, and in all cases the strength shall be determined in such manner as is established by the Governor in Council.
- 142 Acid, acetic acid, crude, and pyrologneous crude, of any strength not exceeding thirty per cent. twenty-five per cent. ad valorem ..... 25 p c
- 143 Acid, muriatic and nitric, and all mixed or other acids, n.e.s., twenty per cent. ad valorem ..... 20 p c
- 144 Acid, sulphuric, twenty-five per cent. ad valorem ..... 25 p c
- 145 Acid phosphate, n.o.p., twenty-five per cent. ad valorem ..... 25 p c
- 146 Sulphuric ether, chloroform, and solutions of peroxides of hydrogen, twenty-five per cent. ad valorem ..... 25 p c
- 147 All medical, chemical and pharmaceutical preparations, when compounded of more than one substance, including patent and proprietary preparations, tinctures, pills, powders, troches, lozenges, syrups, cordials, bitters, anodynes, tonics, plasters, liniments, salves, ointments, pastes, drops, waters, essences and oils, n.o.p.; provided that drugs, pill-mass and preparations not including pills or medicinal plasters, recognized by the British or the United States pharmacopoeia or the French Codex as official, shall not be held to be covered by this item; all liquids, containing alcohol, fifty per cent. ad valorem; and all others, liquid or not, twenty-five per cent. ad valorem ..... 50 p c
- 148 Pomades, French or flower odors preserved in fat or oil for the purpose of conserving the odors of flowers which do not bear the heat of distillation, when imported in tins of not less than ten pounds each, fifteen per cent. ad valorem. . . 15 p c
- 149 Perfumery, including toilet preparations (non-alcoholic), viz.:—Hair oils, tooth and other powders and washes, pomatums, pastes and all other perfumed preparations, n.o.p., used for the hair, mouth or skin, thirty per cent. ad valorem ..... 30 p c
- 150 Liquorice paste and liquorice in rolls and sticks twenty per cent. ad valorem ..... 20 p c
- 151 Paraffine wax, thirty per cent. ad valorem. .... 30 p c
- 152 Antiseptic surgical dressing, such as absorbent cotton, cotton wool, lint, lamb's wool, tow, jute, gauzes and oakum, prepared for use as surgical dressings, plain or medicated; surgical belts and trusses, electric belts, pessaries and suspensory bandages of all kinds, twenty per cent. ad valorem ..... 20 p c
- 153 Surgical and dental instruments (not being furniture) and surgical needles, ten per cent. ad valorem until January 1, 1898, thereafter free ..... 10 p c
- 154 Cod liver oil, twenty per cent. ad valorem .... 20 p c

The Canadian Tariff.

Opium.

- 155 Opium, crude, the outward ball or covering to be free of duty, one dollar per pound. .... \$1 p lb
- 156 Opium, powdered, one dollar and thirty-five cents per pound ..... \$1.35 p lb
- 157 Opium, prepared for smoking; five dollars per pound ..... \$5 p lb

Colors, Paints, Oils, Varnishes, etc.

- 158 Dry white and red lead, orange mineral and zinc white, five per cent. valorem ..... 5 p c
- 159 Orches, ochrey earths, raw siennas and colors, dry, n.e.s., twenty per cent. ad valorem ..... 20 p c
- 160 Oxides, umbers, burnt siennas, and fire proofs, n.e.s., laundry bluing of all kinds, rough stuff and dry and liquid fillers, anti-corrosive and anti-fouling paints commonly used for ships' hulls, and ground and liquid paints, n.e.s., twenty-five per cent. ad valorem ..... 25 p c
- 161 Paints and colors, ground in spirits, and all spirit varnishes and lacquers, one dollar and twelve and one-half cents per gallon ..... \$1.12½ p gall
- 162 Paris Green, dry, ten per cent. ad valorem. .... 10 p c
- 163 Ink for writing, twenty per cent. ad valorem. . . 20 p c
- 164 Blacking, shoe, and shoemakers' ink; shoe, harness and leather dressing, harness soap, and knife or other polish or composition, n.o.p., twenty-five per cent. ad valorem ..... 25 p c
- 165 Putty, of all kinds, twenty per cent. ad valorem ..... 20 p c
- 166 Turpentine, spirits of, five per cent. ad valorem ..... 5 p c
- 167 British gum, dextrine, sizing cream and enamel sizing, ten per cent. ad valorem ..... 10 p c
- 168 Varnishes, lacquers, japans, japan driers, liquid driers, and oil finish, n.e.s., twenty cents per gallon and twenty per cent. ad valorem. . . 20 c p gall and 20 p c
- 169 Linseed or flaxseed oil, raw or boiled, lard oil, neatfoot oil, and sesame seed oil, twenty-five per cent. ad valorem ..... 25 p c
- 170 Illuminating oils, composed wholly or in part of the products of petroleum, coal, shale or lignite, costing more than thirty cents per gallon, twenty-five per cent. ad valorem ..... 25 p c
- 171 Lubricating oils, composed wholly or in part of petroleum, costing less than twenty-five cents per gallon, five cents per gallon ..... 5c p gall
- 172 Crude petroleum, fuel and gas oils (other than naphtha, benzine or gasoline), when imported by manufacturers (other than oil refiners) for use in their own factories for fuel purposes or for the manufacture of gas, two and one-half cents per gallon ..... 2½c p gall
- 173 Oils, coal and kerosene distilled, purified or refined, naphtha and petroleum, and products of petroleum, n.e.s., five cents per gallon ..... 5c p gall
- 174 Barrels, containing petroleum or its products, or any mixture of which petroleum forms a part, when such contents are chargeable with a specific duty, twenty cents each ..... 20c each
- 175 Lubricating oils, n.e.s., and axle grease, twenty-five per cent. ad valorem ..... 25 p c
- 176 Olive oil, n.e.s., twenty per cent. ad valorem. . . 20 p c
- 177 Essential oils, ten per cent. ad valorem ..... 10 p c
- 178 Vaseline, and all similar preparations of petroleum for toilet, medicinal or other purposes, thirty-five per cent. ad valorem ..... 35 p c

Coal.

- 179 Bituminous slack coal, such as will pass through a half-inch screen, subject to regulations to be made by the Controller of Customs, twenty per cent. ad valorem, but not to exceed thirteen cents per ton of 2,000 pounds (being the equivalent of fifteen cents per ton of 2,240 pounds): Provided that if the United States Congress fixes the duty on slack coal at a rate not exceeding fifteen cents per ton of 2,240 pounds, then the duty on such coal imported into Canada, as provided in this item, shall be the minimum duty on such coal from all countries, notwithstanding section seventeen of this Act ..... 20 p c
- 180 Coal, bituminous, round and run of mine, and coal, n.e.s., fifty-three cents per ton of 2,000 pounds (being the equivalent of sixty cents per ton of 2,240 pounds): Provided that if the

# J. BALLANTINE & CO.

## PRESTON, - - CANADA.

Planers and Matchers—all kinds, Surface Planers, Endless Bed Planers, Moulders—all sizes, Door Clamps, Mortisers, Tenon Machines, Band Saws and Re-saws, Rip Saws—all kinds, Shapers, Arm Sanders, all kinds of Blind and Sash Machinery, Embossing and Drop Carving Machines, Gang Dove-Tailing Machines, Swell Front Attachments, Cabinet Planers, Closet Seat Machinery.

Automatic Gauge Lathes, Knife Grinders, Boring Machines, Saw Arbors, Wood Turning Lathes, and many other kinds. We are getting out new and improved Machinery all the time. Having had over thirty years' experience in designing and drafting Wood-working Machinery, we are prepared to supply our customers with the very latest and most improved Machinery in the Dominion.

WE USE CUT GEARING ON OUR MACHINERY. WE ARE THE ONLY FIRM IN THE DOMINION DOING THIS.  
Enquire prices and have your orders placed with us. It will pay you.

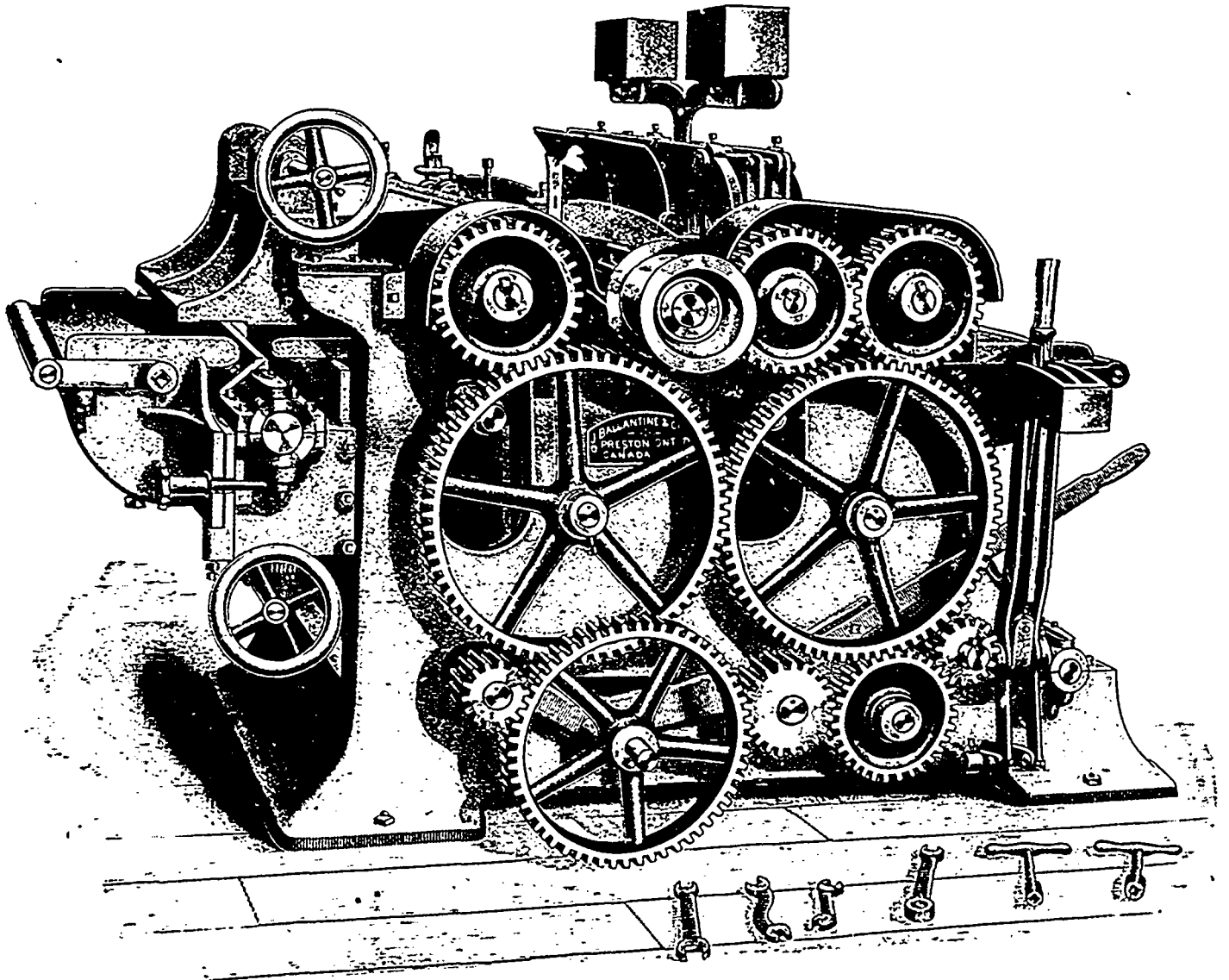

No. 1½ Double Surface Planing Machine

With Broken Roll and Sectional Pressure Shoes, with 4 Changes of Feed Namely 30, 38, 45, 54, Running Feet per Minute. Planes 26 inches wide, 8 1-2 inches thick.

When writing to Advertisers kindly mention THE CANADIAN MANUFACTURER.

The Canadian Tariff.

United States Congress fixes the duty on such coal at a rate not exceeding forty cents per ton of 2,240 pounds, the Governor in Council may by proclamation reduce the duty mentioned in this item to forty cents per ton of 2,240 pounds, or the equivalent thereof per ton of 2,000 pounds, and the duty declared by such proclamation shall then be the minimum duty on such coal from all countries, notwithstanding section seventeen of this Act ..... 53c p ton of 2,000 lbs

Earthenware, Cements, Slate and Stoneware.

- 181 Building brick, paving brick, stove linings and fire brick, n.e.s., and manufactures of clay or cement, n.o.p., twenty per cent. ad valorem. . . . . 20 pc
- 182 Earthenware and stoneware, viz.: demijohns, churns or crocks, thirty per cent. ad valorem. . . . . 30 pc
- 183 Drain tiles, not glazed, twenty per cent. ad valorem . . . . . 20 pc
- 184 Drain pipes, sewer pipes, chimney linings or vents, chimney tops and inverted blocks, glazed or unglazed, and earthenware tiles, thirty-five per cent. ad valorem . . . . . 35 pc
- 185 China and porcelain ware, also earthenware and stoneware, brown or colored and Rockingham ware, white granite or iron stoneware, "c. c." or cream-colored ware, decorated, printed or sponged, and all earthenware, n.e.s., thirty per cent. ad valorem . . . . . 30 pc
- 186 Baths, tubs and wash-stands of earthenware, stone, cement or clay, or of other material, n.o.p., thirty per cent. ad valorem . . . . . 30 pc
- 187 Cement, Portland and hydraulic or water lime, in bags, barrels or casks, the weight of the package to be included in the weight for duty, twelve and one-half cents per one hundred pounds . . . . . 12½c p 100 lbs
- 188 Plaster of Paris, or gypsum, ground, not calcined, fifteen per cent. ad valorem . . . . . 15 pc
- 189 Plaster of Paris, or gypsum, calcined or manufactured, the weight of the package to be included in the weight for duty, twelve and one-half cents per one hundred pounds . . . . . 12½c p 100 lbs
- 190 Lithographic stones, not engraved, twenty per cent. ad valorem . . . . . 20 pc
- 191 Grindstones, not mounted, and not less than thirty-six inches in diameter, fifteen per cent. ad valorem . . . . . 15 pc
- 192 Grindstones, n.e.s., twenty-five per cent. ad valorem . . . . . 25 pc
- 193 Flagstone, sandstone and all building stone, not hammered or chiselled; and marble and granite, rough, not hammered or chiselled, fifteen per cent. ad valorem . . . . . 15 pc
- 194 Marble and granite, sawn only; flagstone and all other building stone, dressed; and paving blocks of stone, twenty per cent. ad valorem. . . . . 20 pc
- 195 Marble and granite, n.e.s., and all manufactures or marble or granite, n.o.p., thirty-five per cent. ad valorem . . . . . 35 pc
- 196 Manufactures of stone, n.o.p., thirty per cent. ad valorem . . . . . 30 pc
- 197 Roofing slate, twenty-five per cent. ad valorem; provided that the duty shall not exceed seventy-five cents per square . . . . . 25 pc
- 198 Slate mantels and other manufactures of slate, n.e.s., thirty per cent. ad valorem . . . . . 30 pc
- 199 Slate pencils and school writing slates, twenty-five per cent. ad valorem . . . . . 25 pc
- 200 Mosaic flooring of any material, thirty per cent. ad valorem . . . . . 30 pc

Glass and Glassware.

- 201 Common and colorless window glass, and plain colored, opaque, stained or tinted, or muffled glass, in sheets, twenty per cent. ad valorem . . . . . 20 pc
- 202 Ornamental, figured, and enamelled colored glass, vitrified or painted, chipped, figured, enamelled, and obscured white glass; stained glass windows, and memorial or ornamental window glass, n.o.p., and rough rolled plate glass, thirty per cent. ad valorem . . . . . 30 pc
- 203 Plate glass, not bevelled, in sheets or panes, not exceeding twenty-five square feet each, n.o.p., twenty-five per cent. ad valorem . . . . . 25 pc

The Canadian Tariff.

- 204 Plate glass, not bevelled, in sheets or panes, n.e.s., thirty-five per cent. ad valorem . . . . . 35 pc
- 205 Plate glass, bevelled, in sheets or panes, n.o.p., thirty-five per cent. ad valorem . . . . . 35 pc
- 206 Silvered glass, bevelled or not and framed or not, thirty-five per cent. ad valorem . . . . . 35 pc
- 207 German looking-glass plate (thin plate), un-silvered or for silvering, twenty per cent. ad valorem . . . . . 20 pc
- 208 Glass demijohns or carboys, empty or filled, bottles, decanters, flasks, phials, glass jars and glass balls, lamp chimneys, glass shades or globes, cut, pressed or moulded crystal or glass tableware, decorated or not, and blown glass tableware, thirty per cent. ad valorem . . . . . 30 pc
- 209 Bent plate or other sheet glass, and all other glass, and manufactures of glass, n.o.p., twenty per cent. ad valorem . . . . . 20 pc
- 210 Spectacles and eyeglasses, thirty per cent. ad valorem . . . . . 30 pc
- 211 Spectacle and glass frames and metal parts thereof, twenty per cent. ad valorem . . . . . 20 pc

Leather, Rubber and Manufactures of.

- 212 Dongola, cordovan, calf, sheep, lamb, kid or goat, kangaroo, alligator, or other upper leather, and all leather, dressed, waxed, glazed or further finished than tanned, n.e.s., harness leather, and chamols skin, seventeen and one-half per cent. ad valorem . . . . . 17½ pc
- 213 Skins for morocco leather, tanned but not further manufactured; sole leather, and belting leather, of all kinds; tanners' scrap leather; and leather and skins, n.o.p., fifteen per cent. ad valorem . . . . . 15 pc
- 214 Glove leathers, tanned or dressed, colored or uncolored, when imported by glove manufacturers for use in their own factories in the manufacture of gloves, ten per cent. ad valorem . . . . . 10 pc
- 215 Jappanned, patent or enamelled leather, and morocco leather, twenty-five per cent. ad valorem . . . . . 25 pc
- 216 Leather-board, leatheroid, manufactures thereof, n.o.p., twenty-five per cent. ad valorem . . . . . 25 pc
- 217 Whips of all kinds, including thongs and lashes, thirty-five per cent. ad valorem . . . . . 35 pc
- 218 Belting, of leather or other material, n.e.s., twenty per cent. ad valorem . . . . . 20 pc
- 219 Boots and shoes, and slippers, of any material, n.e.s., twenty-five per cent. ad valorem . . . . . 25 pc
- 220 Manufactures of raw hide, and all manufactures of leather, n.o.p., twenty-five per cent. ad valorem . . . . . 25 pc
- 221 India-rubber boots and shoes; and all manufactures of India-rubber and gutta percha, n.o.p., twenty-five per cent. ad valorem . . . . . 25 pc
- 222 India-rubber clothing and clothing made waterproof with India-rubber, rubber or gutta percha hose, and cotton or linen hose lined with rubber, rubber mats or matting, and rubber packing, thirty-five per cent. ad valorem . . . . . 35 pc

Metals and Manufactures of.

- 223 Iron or steel scrap, wrought, being waste or refuse, including punchings, cuttings or clippings of iron or steel plates or sheets having been in actual use; crop ends of tin plate bars, or of blooms, or of rails, the same not having been in actual use, one dollar per ton . . . . . \$1 p ton  
Nothing shall be deemed scrap iron or scrap steel, except waste or refuse iron or steel fit only to be re-manufactured in rolling mills.
- 224 Iron in plgs, iron kentleledgc. and cast scrap iron, two dollars and fifty cents per ton . . . . . \$2.50 p ton
- 225 Ferro-silicon, ferro-manganese, and spiegeleisen, five per cent. ad valorem . . . . . 5 pc
- 226 Iron or steel ingots, coggled ingots, blooms, slabs, billets, puddled bars and loops or other forms, n.o.p., less finished than iron or steel bars, but more advanced than pig iron, except castings, two dollars per ton. . . . . \$2 p ton
- 227 Rolled iron or steel angles, tees, beams, channels, girders, and other rolled shapes or sections, weighing less than thirty-five pounds



# THE STURTEVANT

Blowers, Exhausters, Steam and  
Electric Fans

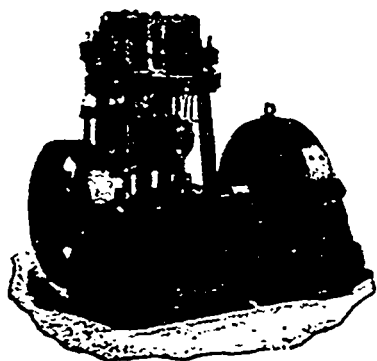

Engines Motors

Generators

Generating Sets

Exhaust  
Heads  
Steam  
Traps  
Forges, Etc.

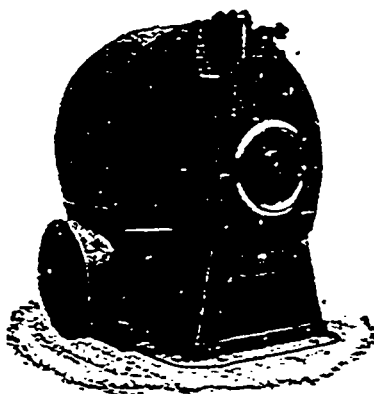

Mechanical  
Draft

FOR  
STEAM  
BOILERS

**BLOWER SYSTEM**

OF

Heating, Ventilating,  
Moistening and Drying

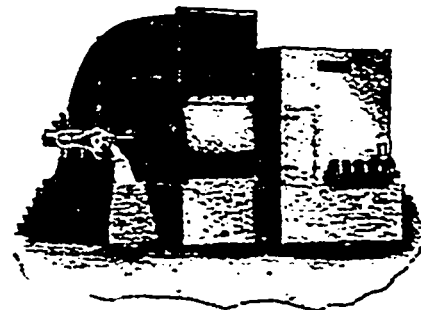

**B. F. STURTEVANT Co.**

BOSTON, MASS., U.S.A.

Warerooms—BOSTON

34 Oliver St.

NEW YORK

131 Liberty St.

PHILADELPHIA

135 W. Third St.

CHICAGO

15 S. Canal St.

LONDON, E.C.

75 Queen Victoria St.

The Canadian Tariff.

per lineal yard, not punched, drilled or further manufactured than rolled, n.o.p., seven dollars per ton .....	\$7 p ton
228 Rolled iron or steel angles, tees, beams, channels, joists, girders, zees, stars or other rolled shapes, or trough, bridge, building or structural rolled sections or shapes, not punched, drilled or further manufactured than rolled, n.e.s., and flat eye-bar blanks not punched or drilled, ten per cent. ad valorem .....	10 pc
229 Bar iron or steel, rolled, whether in coils, rods, bars or bundles, comprising rounds, ovals and squares, and flats; and rolled shapes, n.o.p.; and rolled iron or steel hoop, band, scroll, or strip, eight inches or less in width, number eighteen gauge and thicker, n.e.s., seven dollars per ton .....	\$7 p ton
230 Universal mill or rolled edge bridge plates of steel when imported by manufacturers of bridges, ten per cent. ad valorem .....	10 pc
231 Rolled iron or steel plates, not less than thirty inches in width, and not less than one quarter of an inch in thickness, n.o.p., ten per cent. ad valorem .....	10 pc
232 Rolled iron or steel sheets or plates, sheared or unsheared, and skelp iron or steel, sheared or rolled in grooves, n.e.s., seven dollars per ton .....	\$7 p ton
233 Skelp iron or steel, sheared or rolled in grooves, when imported by manufacturers of wrought iron or steel pipe for use only in the manufacture of wrought iron or steel pipe in their own factories, five per cent. ad valorem .....	5 pc
234 Rolled iron or steel sheets number seventeen gauge, and thinner, n.o.p.; Canada plates: Russia iron: flat galvanized iron or steel sheets, terne plate, and rolled sheets of iron or steel coated with zinc, spelter or other metal, of all widths or thickness, n.o.p., and rolled iron or steel hoop, band, scroll or strip, thinner than number eighteen gauge, n.e.s., five per cent. ad valorem .....	5 pc
235 Chrome steel, fifteen per cent. ad valorem ..	15 pc
236 Steel, in bars, bands, hoops, scroll or strips, sheets or plates, of any size, thickness or width, when of greater value than two and one-half cents per pound, n.o.p., five per cent. ad valorem .....	5 pc
237 Swedish rolled iron and Swedish rolled steel nail rods under half an inch in diameter, for the manufacture of horse-shoe nails, fifteen per cent. ad valorem .....	15 pc
238 Iron and steel railway bars or rails of any form, punched or not, n.e.s., for railways, which term for the purposes of this item shall include all kinds of railways, street railways and tramways, even although they are used for private purposes only, and even although they are not used or intended to be used in connection with the business of common carrying of goods or passengers, thirty per cent. ad valorem ..	30 pc
239 Railway fish plates and tie plates, eight dollars per ton .....	\$8 p ton
240 Switches, frogs, crossings and intersections for railways, thirty per cent. ad valorem .....	30 pc
241 Locomotives for railways, n.e.s., thirty-five per cent. ad valorem .....	35 pc
242 Iron or steel bridges, or parts thereof: iron or steel structural work, columns, shapes or sections, drilled, punched or in any further stage of manufacture than as rolled or cast, n.e.s., thirty-five per cent. ad valorem .....	35 pc
243 Forgings of iron or steel of whatever shape or size or in whatever stage of manufacture, n.e.s., and steel shafting, turned, compressed, or polished; and hammered iron or steel bars or shapes, n.o.p., thirty per cent. ad valorem ..	30 pc
244 Iron or steel castings, in the rough, n.e.s., twenty-five per cent. ad valorem .....	25 pc
245 Stove plates, stoves of all kinds, for oil, gas, coal or wood, or parts thereof, and sad or smoothing, hatters' and tailors' irons, plated wholly or in part, or not, twenty-five per cent. ad valorem .....	25 pc
246 Springs, axles, axle bars, n.e.s., and axle blanks, and parts thereof, of iron or steel for	

The Canadian Tariff.

railway or tramway or other vehicles, thirty-five per cent. ad valorem .....	35 pc
217 Cart or waggon skeletons or boxes, thirty per cent. ad valorem .....	30 pc
218 Cast iron pipe of every description, eight dollars per ton .....	\$8 p ton
219 Wrought iron or steel boiler tubes, n.e.s., including flues and corrugated tubes for marine boilers, five per cent. ad valorem .....	5 pc
250 Tubes of rolled steel, seamless, not joined or welded, not more than one and one-half inch in diameter: and seamless steel tubes for bicycles, ten per cent. ad valorem .....	10 pc
251 Wrought iron or steel tubing, plain or galvanized, threaded and coupled or not, over two inches in diameter, n.e.s., fifteen per cent. ad valorem .....	15 pc
252 Wrought iron or steel tubing, plain or galvanized, threaded and coupled or not, two inches or less in diameter, n.e.s., thirty-five per cent. ad valorem .....	35 pc
253 Other iron or steel pipe or tubing, plain or galvanized, riveted, corrugated or otherwise specially manufactured, n.o.p., thirty per cent. ad valorem .....	30 pc
254 Iron or steel fittings for iron or steel pipe, of every description, and chilled iron or steel rolls, thirty per cent. ad valorem .....	30 pc
255 Iron or steel cut nails and spikes (ordinary builders'): and railroad spikes, one-half of one cent per pound .....	½ c p lb.
256 Wrought and pressed nails and spikes, trunk, clout, coopers', cigar box, Hungarian, horse-shoe, and other nails, n.e.s., horse, mule and ox shoes, thirty per cent. ad valorem ..	30 pc
257 Wire nails, of all kinds, n.o.p., three-fifths of one cent per pound .....	3/5 c p lb
258 Composition nails and spikes and sheathing nails, fifteen per cent. ad valorem .....	15 pc
259 Iron or steel shoe tacks, and ordinary cut tacks, leathered or not, brads, sprigs and shoe nails, double pointed tacks, and other tacks of iron and steel n.o.p., thirty-five per cent. ad valorem .....	35 pc
260 Screws, commonly called "wood screws," of iron or steel, brass or other metal, including lag or coach screws, plated or not, and machine or other screws, n.o.p., thirty-five per cent. ad valorem .....	35 pc
261 Coil chain, coil chain links, and chain shackles, of iron or steel, five-sixteenths of an inch in diameter and over, five per cent. ad valorem ..	5 pc
262 Barbed wire, and galvanized wire for fencing, numbers nine, twelve and thirteen gauge, fifteen per cent. ad valorem, until January 1, 1901: thereafter free .....	15 pc
263 Buckthorn strip fencing, woven wire fencing, and wire fencing of iron or steel, n.e.s., fifteen per cent. ad valorem .....	15 pc
264 Wire, single or several, covered with cotton, linen, silk rubber or other material, including cable so covered, n.e.s., thirty per cent. ad valorem .....	30 pc
265 Brass wire, plain, ten per cent. ad valorem ..	10 pc
266 Copper wire, plain, tinned or plated, fifteen per cent. ad valorem .....	15 pc
267 Wire cloth, or woven wire of brass or copper, twenty-five per cent. ad valorem .....	25 pc
268 Wire, of all metals and kinds, n.o.p., twenty per cent. ad valorem .....	20 pc
269 Wire rope, stranded or twisted wire, clothes line, picture or other twisted wire and wire cable, n.e.s., twenty-five per cent. ad valorem ..	25 pc
270 Wire, cloth or wove wire, and wire netting, of iron or steel, thirty per cent. ad valorem .....	30 pc
271 Needles, of any material or kind, and pins manufactured from wire of any metal, n.o.p., thirty per cent. ad valorem .....	30 pc
272 Lead, old, scrap, pig and block, fifteen per cent. ad valorem .....	15 pc
273 Lead, in bars, and in sheets, twenty-five per cent. ad valorem .....	25 pc
274 Lead pipe, lead shot and lead bullets, thirty-five per cent. ad valorem .....	35 pc

# The Buffalo Fan System of Heating and Ventilation

by a Forced Circulation of Air

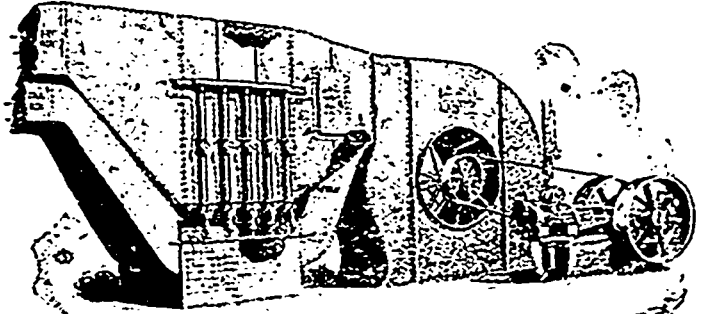

Type of Apparatus for Double Duct Installations.

## The Buffalo Down Draft Forge System

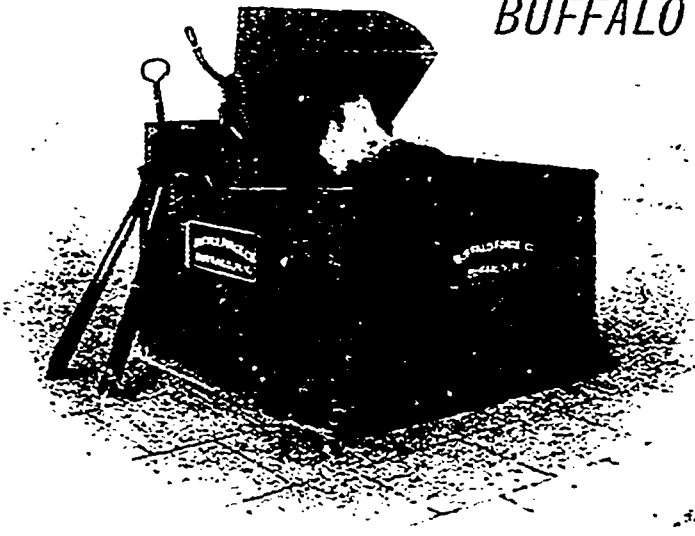

O. D. Forge, for Heavy Work.

## BUFFALO AUTOMATIC ENGINES,

Especially adapted to electric lighting or other exacting service.

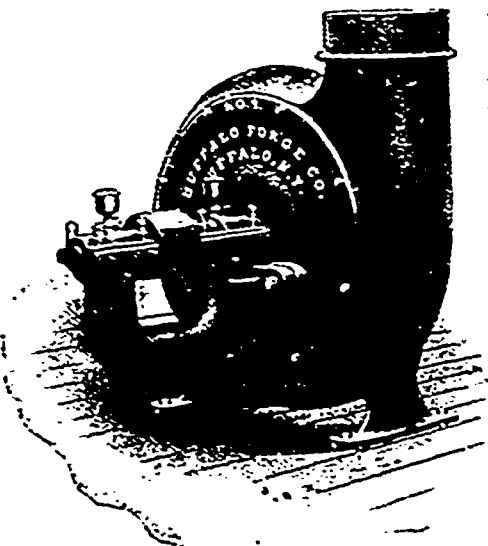
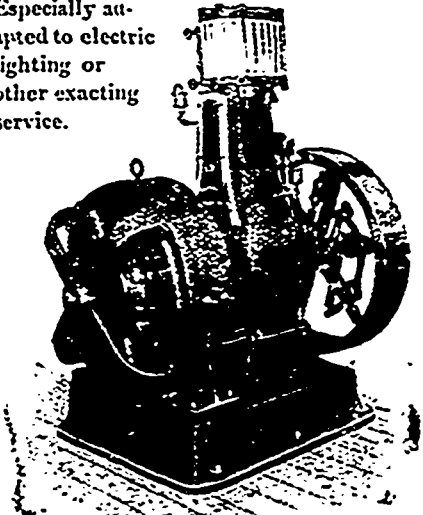

Buffalo "B" Volume Blowers and Exhausters.

# Buffalo Forge Co'y

BUFFALO  
N. Y.

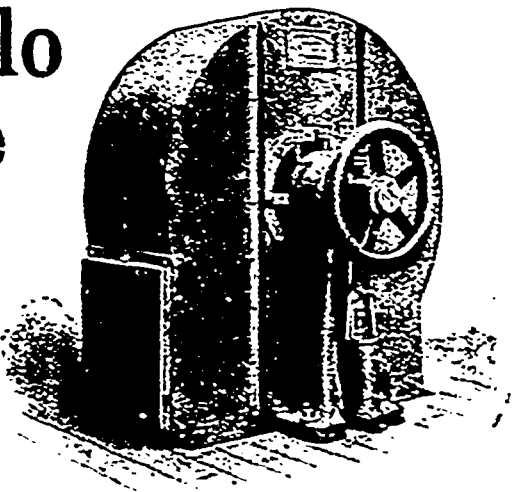

Type of Fan for Forced Draft Applications.

E. A. WALLBERG, Canadian Representative, 41 TEMPLE BUILDING. - - TORONTO, ONT. Western Loan and Trust Bldg., MONTREAL, QUE.

The Canadian Tariff.

275 Lead, manufactures of, n.o.p., thirty per cent. ad valorem .....	30 pc
276 Brass and copper nails, tacks, rivets and burrs or washers, bells and gongs, n.e.s., and all manufactures of brass or copper, n.o.p., thirty per cent. ad valorem .....	30 pc
277 Zinc, manufactures of, n.o.p., twenty-five per cent. ad valorem .....	25 pc
278 Nickel anodes, ten per cent. ad valorem .....	10 pc
279 Iron or steel nuts, washers, rivets and bolts, with or without threads, and nut, bolt and hinge blanks, and T and strap hinges of all kinds, n.e.s., three-quarters of one cent per pound and twenty-five per cent. ad valorem ..	1/4 pc lb and 25 pc
280 Builders', cabinet-makers', upholsterers', harness-makers', saddlers', and carriage hardware, including butt-hinges, locks, curry combs or curry cards, horse-boots, harness and saddlery, n.e.s., thirty per cent. ad valorem .....	30 pc
281 Skates of all kinds, roller or other, and parts thereof, thirty-five per cent. ad valorem .....	35 pc
282 Gas meters, thirty-five per cent. ad valorem ..	35 pc
283 Safes, doors for safes and vaults, scales, balances, weighing beams, and strength testing machines of all kinds, thirty per cent. ad valorem .....	30 pc
284 Carvers, knives and forks of steel, butcher and table steels, oyster, bread, kitchen, cooks', butcher, shoe, farrier, putty, hackling and glaziers' knives, cigar knives, spatulas or palette knives, razors, erasers or office knives, pen, pocket, pruning, sportsmen's or hunters' knives, manicure files, scissors, trimmers, barbers', tailors' and lamp snuffers, horse and toilet clippers, and all like cutlery, plated or not, n.o.p. — When any of the above articles are imported in cases or cabinets, the cases or cabinets shall be dutiable at the same rate as their contents. — thirty per cent. ad valorem .....	30 pc
285 Knife blades or blanks, and table forks of iron or steel in the rough, not handled, filed, ground, or otherwise manufactured, ten per cent. ad valorem .....	10 pc
286 Celluloid, moulded into sizes for handles of knives and forks, not bored nor otherwise manufactured; also, moulded celluloid balls and cylinders, coated with tin-foil or not, but not finished or further manufactured, and celluloid lamp shade blanks, ten per cent. ad valorem .....	10 pc
287 Bird, parrot, squirrel and rat cages, of wire, and metal parts thereof, thirty-five per cent. ad valorem .....	35 pc
288 Files and rasps, n.e.s., thirty per cent. ad valorem .....	30 pc
289 Adzes, cleavers, hatchets, saws, wedges, sledges, hammers, crow-bars, cant-dogs and track tools; picks, mattsacks, and eyes or poles for the same; anvils, vices; and tools, of all kinds, for hand or for machine use, including shoemakers' and tinsmiths' tools or bench machines, n.o.p., thirty per cent. ad valorem ...	30 pc
290 Axes, scythes, sickles or reaping hooks, hay or straw knives, edging knives, hoes, rakes, pronged forks, snaths, farm, road or field rollers, post hole diggers, and other agricultural implements, n.e.s., twenty-five per cent. ad valorem .....	25 pc
291 Shovels and spades, iron or steel, n.e.s., shovel and spade blanks, and iron or steel cut to shape for the same; and lawn mowers, thirty-five per cent. ad valorem .....	35 pc
292 Britannia metal, nickel silver, Nevada and German silver, manufactures of, not plated, and manufactures of aluminium, n.o.p., twenty-five per cent. ad valorem .....	25 pc
293 Sterling and other silver-ware, nickel-plated ware, gilt or electro-plated ware, wholly or in part, of all kinds n.e.s., thirty per cent. ad valorem .....	30 pc

The Canadian Tariff.

294 kinds; and electric apparatus, n.e.s., twenty-five per cent. ad valorem .....	25 pc
295 Electric light carbons and carbon points, of all kinds, n.e.s., thirty-five per cent. ad valorem ..	35 pc
296 Carbons, over six inches in circumference, fifteen per cent. ad valorem .....	15 pc
297 Lamps, side-lights and head-lights, lanterns, chandeliers, gas, coal or other oil fixtures and electric light fixtures, or metal parts thereof, including lava or other tips, burners, collars, galleries, shades and shade holders, thirty per cent. ad valorem .....	30 pc
298 Lamp springs, and glass bulbs for electric lights, ten per cent. ad valorem .....	10 pc
299 Rabbit metal, type metal, phosphor tin and phosphor bronze, in blocks, bars, plates, sheets and wire, ten per cent. ad valorem .....	10 pc
300 Type, for printing, including chases, quoins and slugs, of all kinds, twenty per cent. ad valorem .....	20 pc
301 Plates, engraved on wood, steel, or other metal, and transfers taken from the same, including engravers' plates of steel, polished, engraved or for engraving thereupon, twenty per cent. ad valorem .....	20 pc
302 Stereotypes, electrotypes, and celluloids for almanacs, calendars, illustrated pamphlets, newspaper advertisements or engravings, and all other like work for commercial, trade or other purposes, n.e.s., and matrices or copper shells for the same, one and one-half cent per square inch .....	1 1/2 pc sq in
303 Stereotypes, electrotypes and celluloids of newspaper columns, and bases for the same, composed wholly or partially of metal or celluloid, one-fourth of one cent per square inch. — And matrices or copper shells for the same, one and one-half cent per square inch .....	1/4 pc sq in 1 1/2 pc sq in
304 Clothes wringers, for domestic use, and parts thereof, thirty-five per cent. ad valorem .....	35 pc
305 Buckles of iron, steel, brass or copper, of all kinds, n.o.p. (not being jewellery), thirty per cent. ad valorem .....	30 pc
306 Guns, rifles, including air guns and air rifles not being toys, muskets, cannons, pistols, revolvers or other firearms; cartridge cases, cartridges, primers, percussion caps, wads or other ammunition, n.o.p., bayonets, swords, fencing foils and masks; gun or pistol covers or cases, game bags, loading tools and cartridge belts, of any material, thirty per cent. ad valorem .....	30 pc
307 Agate, granite or enamelled iron or steel hollow-ware, thirty-five per cent. ad valorem .....	35 pc
308 Enamelled iron or steel ware, n.e.s., iron or steel hollow-ware, plain black, tinned or coated; and nickel and aluminium kitchen or household hollow-ware, n.e.s., thirty per cent. ad valorem .....	30 pc
309 Tinware, plain, japanned or lithographed, and all manufactures of tin, n.e.s., and manufactures of galvanized sheet iron or of galvanized sheet steel, n.o.p., twenty-five per cent. ad valorem ..	25 pc
310 Signs, of any material, framed or not; and letters of any material, for signs or similar use, thirty per cent. ad valorem .....	30 pc
311 Fire engines and fire extinguishing machines, including sprinklers for fire protection, thirty-five per cent. ad valorem .....	35 pc
312 Brass pumps of all kinds, and garden or lawn sprinklers, thirty per cent. ad valorem .....	30 pc
313 Printing presses, printing machines, lithographic presses and type-making accessories therefor; folding machines, book binders', book-binding, ruling, embossing and paper cutting machines, and parts thereof, ten per cent. ad valorem .....	10 pc
314 Sewing machines, and parts thereof, thirty per cent. ad valorem .....	30 pc
315 Steam engines, boilers, ore crushers and rock crushers, stamp mills, Cornish and belted rolls, rock drills, air compressors, cranes, derricks, percussion coal cutters, pumps, n.e.s., wind-mills, horse-powers, portable engines, threshers, separators, fodder or feed cutters, potato	

# PRATT & LETCHWORTH CO.

Buffalo, N.Y.

AND

Brantford, Ont.

---

*Manufacturers*

.....of.....

MALLEABLE IRON

---

---

AND

STEEL CASTINGS.

---

---

The Canadian Tariff.

diggers, grain crushers, fanning mills, hay tedders, farm waggons, slot machines, and typewriters, and all machinery composed wholly or in part of iron or steel, n.o.p., twenty-five per cent. ad valorem ..... 25 p c

316 Machine card clothing, twenty-five per cent. ad valorem ..... 25 p c

317 Mould boards or shares, or plough plates, land sides, and other plates for agricultural implements, when cut to shape from rolled plates of steel but not moulded, punched, polished, or otherwise manufactured, five per cent. ad valorem ..... 5 p c

318 Mowing machines, harvesters, self-binding or without binders, binding attachments, reapers, cultivators, ploughs, harrows, horse-rakes, seed drills, manure spreaders, weeders, and malleable sprocket or link belting chain for binders, twenty per cent. ad valorem ..... 20 p c

319 Trawls, trawling spoons, fly hooks, sinkers, swivels, and sportmen's fishing bait, and fish hooks, n.e.s., thirty per cent. ad valorem ..... 30 p c

320 Patterns of brass, iron, steel or other metal (not being models), thirty per cent. ad valorem ..... 30 p c

321 Manufactures, articles or wares, not specially enumerated or provided for, composed wholly or in part of iron or steel, and whether wholly or partly manufactured, thirty per cent. ad valorem ..... 30 p c

Vehicles.

322 Freight wagons, drays, sleighs and similar vehicles, twenty-five per cent. ad valorem ..... 25 p c

323 Buggies, carriages, pleasure carts and similar vehicles, n.e.s., including cutters, children's carriages and sleds, and finished parts thereof n.o.p., thirty-five per cent. ad valorem ..... 35 p c

324 Railway cars (or other cars), wheelbarrows, trucks, road or railway scrapers and hand carts, thirty per cent. ad valorem ..... 30 p c

325 Bicycles and tricycles, thirty per cent. ad valorem ..... 30 p c

Manufactures of Wood, Cane, Cork.

326 Cane, reed or rattan, split or otherwise manufactured, n.o.p., fifteen per cent. ad valorem.... 15 p c

327 Corks, and other manufactures of cork wood or cork bark, n.o.p., twenty per cent. ad valorem ..... 20 p c

328 Sawed boards, planks and deals planed or dressed on one or both sides, when the edges thereof are jointed or tongued and grooved, twenty-five per cent. ad valorem ..... 25 p c

329 Lumber and timber, manufactured, n.e.s., twenty per cent. ad valorem ..... 20 p c

330 Pails and tubs of wood; churns, brooms and whisks, wash-boards, pounders and rolling pins, twenty per cent. ad valorem ..... 20 p c

331 Veneers of wood not over three thirty-seconds of an inch in thickness, seven and one-half per cent. ad valorem ..... 7 1/2 p c

332 Mouldings of wood, plain, gilded or otherwise further manufactured, twenty-five per cent. ad valorem ..... 25 p c

333 Wood pulp, twenty-five per cent. ad valorem... 25 p c

334 Manufactures of wood, n.o.p., twenty-five per cent. ad valorem ..... 25 p c

335 Fishing rods, walking sticks and walking canes, of all kinds, n.e.s., thirty per cent. ad valorem ..... 30 p c

336 Picture frames and photograph frames, of any material, thirty per cent. ad valorem ..... 30 p c

337 Umbrella, parasol and sunshade sticks or handles, n.e.s., twenty per cent. ad valorem... 20 p c

338 Coffins and caskets, and metal parts thereof, twenty-five per cent. ad valorem ..... 25 p c

339 Show-cases, of all kinds, and metal parts thereof, thirty-five per cent. ad valorem..... 35 p c

340 Billiard tables, with or without pockets, and bagatelle tables or boards, cues, balls, cue-racks, and cue-tips, thirty-five per cent. ad valorem ..... 35 p c

341 Vulcanized fibre, kartavert, indurated fibre, and like material, and manufactures of, n.e.s., twenty-five per cent. ad valorem ..... 25 p c

342 Blinds of wood, metal or other material, not textile or paper, thirty per cent. ad valorem . 30 p c

The Canadian Tariff.

343 House, office, cabinet or store furniture of wood, iron, or other material, in parts or finished; wire screens, wire doors and wire windows; cash registers; window cornices and cornice poles of all kinds; hair, spring and other mattresses, bolsters and pillows, including furniture springs and carpet sweepers; thirty per cent. ad valorem ..... 30 p c

344 Window shade or blind rollers, thirty-five per cent. ad valorem ..... 35 p c

Jewellery and Material therefor, etc.

345 Watch cases, thirty per cent. ad valorem .... 30 p c

346 Clocks, watches, watch glasses, clock and watch keys, and clock movements, twenty-five per cent. ad valorem ..... 25 p c

347 Watch actions and movements, ten per cent. ad valorem ..... 10 p c

348 Precious stones, n.e.s., polished, but not set, pierced or otherwise manufactured, and imitations thereof, ten per cent. ad valorem..... 10 p c

349 Composition metal for the manufacture of jewellery and filled gold watch cases, ten per cent. ad valorem ..... 10 p c

350 Jewellery, for the adornment of the person, including hat pins, hair pins, belt or other buckles, and similar personal ornamental articles commercially known as jewellery, n. o.p., and all manufactures of gold and silver, n.e.s., thirty per cent. ad valorem ..... 30 p c

351 Fancy writing desks, fancy cases for jewellery, watches, silverware, plated-ware and cutlery; glove, handkerchief and collar boxes or cases, brush or toilet cases, and all fancy cases for similar fancy articles, of any material; fans; dolls and toys of all kinds; ornaments of alabaster, spar, amber, terra cotta or composition; sauettes and bead ornaments, n.e.s., thirty-five per cent. ad valorem ..... 35 p c

352 Gold, silver and aluminum leaf, Dutch or schlag metal leaf; brocade and bronze powders and gold liquid paint, twenty-five per cent. ad valorem..... 25 p c

Minerals.

353 Asbestos in any form other than crude, and all manufactures thereof, twenty-five per cent. ad valorem ..... 25 p c

354 Plumbago, not ground or otherwise manufactured, ten per cent. ad valorem ..... 10 p c

355 Plumbago, ground, and manufactures of, n. e.s., and foundry facings of all kinds, twenty-five per cent. ad valorem ..... 25 p c

Musical Instruments.

356 Pianofortes, organs and musical instruments of all kinds, thirty per cent. ad valorem..... 30 p c

357 Brass band instruments, parts of pianofortes and parts of organs, twenty-five per cent. ad valorem ..... 25 p c

Provided that musical instrument cases shall be dutiable at the same rate as their contents when imported containing the instruments.

Textiles, Hats, Furs, etc.

358 Cotton batts, batting and sheet wadding, cotton warps and cotton yarns, dyed or not, n.e.s., twenty-five per cent. ad valorem ..... 25 p c

359 Cotton fabrics, white or gray, bleached or unbleached, n.o.p., twenty-five per cent. ad valorem ..... 25 p c

360 Cotton fabrics, printed, dyed or colored, n.o.p., thirty-five per cent. ad valorem ..... 35 p c

361 Damask of linen, stair linen, diaper, napkins, doilies, table and tray cloths, sheets, quilts, towels, and like articles of linen or cotton, or of linen and cotton combined made up or not, n.o.p., thirty per cent. ad valorem ..... 30 p c

362 Embroideries, n.e.s., laces, braids, fringes, cords, elastic, round or flat; garter elastic, tassels and bracelets, n.o.p., braids, chains, cords, or other manufactures of hair, n.e.s., handkerchiefs of all kinds; lace collars and all similar lace goods; lace nets and nettings of cotton, linen, silk or other material; shams, curtains,

# THE IMPERIAL VARNISH AND COLOR CO.

LIMITED



Having the most modern and up to date factory with extensive storage capacity, manufacturers can always rely on getting the very best goods thoroughly matured and uniform.



Highest Grade Durable Coach Varnishes,  
 Agricultural and Wagon Varnishes,  
 Polishing Varnishes, Rubbing Varnishes,  
 Casket Varnishes, Boat and Spar Varnishes,  
 Furniture Varnishes,  
 High Grade Architectural Varnishes.  
 Granitine Floor Finish, Baking Japans,  
 Elastilite Varnish for Interior or Exterior Use.  
 Lithographers' Varnish, Air Drying Japans,  
 Enamels, Electric Insulating Compounds.



## The Imperial Varnish and Color Co.

LIMITED

TORONTO, ONTARIO, CANADA.

The Canadian Tariff.

when made up, trimmed or untrimmed; regatta, badges and belts of all kinds, n.o.p.; linen, silk and cotton clothing, and all other articles made up by the seamstress from linen or cotton fabrics, n.o.p., corsets of all kinds, corset clasps, busks, blanks and steels, and covered corset wires, cut to lengths, tipped or untipped, thirty-five per cent. ad valorem . . . . . 35 pc

363 White cotton embroideries, twenty-five per cent. ad valorem . . . . . 25 pc

364 Jeans, sateens and coutils, when imported by corset and dress stay makers for use in the manufacture of such articles in their own factories, twenty per cent. ad valorem . . . . . 20 pc

365 Collars and cuffs, of cotton, linen, xylonite, xyolite or celluloid, thirty-five per cent. ad valorem . . . . . 35 pc

366 Shirts of any material, and ladies' or misses' blouses and shirt waists, thirty-five per cent. ad valorem . . . . . 35 pc

367 Crapes, black, twenty per cent. ad valorem . . . . . 20 pc

368 Velvets, velvetens, silk velvets, plush and silk fabrics, thirty per cent. ad valorem . . . . . 30 pc

369 Ribbons of all kinds and materials, and manufactures of silk or of which silk is the component part of chief value, n.e.s., thirty-five per cent. ad valorem . . . . . 35 pc

370 Cotton sewing thread in hanks, three and six cord, fifteen per cent. ad valorem . . . . . 15 pc

371 Cotton sewing thread and crochet cotton, on spools or tubes or in balls, and all other cotton thread, n.e.s., twenty-five per cent. ad valorem . . . . . 25 pc

372 Silk in the gum, or spun, not more advanced than singles, tram and thrown organzine, not colored, fifteen per cent. ad valorem . . . . . 15 pc

373 Sewing and embroidery silk, and silk twist, twenty-five per cent. ad valorem . . . . . 25 pc

374 Jute cloth, uncolored, not otherwise finished than bleached or calendered, ten per cent. ad valorem . . . . . 10 pc

375 Horse clothing of jute, shaped or otherwise manufactured, thirty per cent. ad valorem . . . . . 30 pc

376 All manufactures of hemp, flax or jute, n.e.s., or of flax, hemp and jute combined, twenty-five per cent. ad valorem . . . . . 25 pc

377 Bags or sacks of hemp, linen or jute, and cotton seamless bags, twenty per cent. ad valorem . . . . . 20 pc

378 Felt, pressed, of all kinds, not filled or covered by or with any woven fabric, twenty per cent. ad valorem . . . . . 20 pc

379 Hair-cloth of all kinds, thirty per cent. ad valorem . . . . . 30 pc

380 Sails for boats and ships, twenty-five per cent. ad valorem . . . . . 25 pc

381 Cloths, not rubbered or made waterproof, whether of wool, cotton, unions, silk or ramie, sixty inches or over in width and weighing not more than seven ounces to the square yard, when imported exclusively for the manufacture of mackintosh clothing, under regulations to be adopted by the Governor-in-Council, fifteen per cent. ad valorem . . . . . 15 pc

382 Featherbone, plain or covered, in coils, twenty per cent. ad valorem . . . . . 20 pc

383 Stockinettes for the manufacture of rubber boots and shoes, when imported by manufacturers of rubber boots and shoes, for use exclusively in the manufacture thereof in their own factories, fifteen per cent. ad valorem . . . . . 15 pc

384 Cloth duck, grey or white, n.e.s., twenty-two and one-half per cent. ad valorem . . . . . 22½ pc

385 Oiled silk and oiled cloth, and tape or other textile India-rubbered, stocked or coated, n.o.p., thirty per cent. ad valorem . . . . . 30 pc

386 Women's and children's dress goods, coat linings, Italian cloths, alpacas, orleans, cashmeres, henriettas, serges, bunnings, nun's cloth, bengallines, whip-cords, twills, plains or jacquards or similar fabrics, composed wholly or in part of wool, worsted, the hair of the camel, alpaca, goat, or like animal, not exceeding in weight six ounces to the square yard, when imported in the grey or unfinished state for the purpose of being dyed or finished in Canada, under such regulations as are estab-

The Canadian Tariff.

lished by the Governor-in-Council, twenty-five per cent. ad valorem . . . . . 25 pc

387 Socks and stockings of all kinds, thirty-five per cent. ad valorem . . . . . 35 pc

388 Knitted goods, n.e.s., undershirts and drawers, and hosiery of all kinds, n.e.s., thirty-five per cent. ad valorem . . . . . 35 pc

389 Shawies of all kinds, railway or travelling rugs and lap dusters of all kinds, thirty per cent. ad valorem . . . . . 30 pc

390 Wool, viz., Leicester, Cotswold, Lincolnshire, South Down, combing wools, or wools known as lustre wools and other like combing wools, such as are grown in Canada, three cents per pound . . . . . 3c plb

391 Worsted tops made from such wools as are mentioned in the next preceding item, fifteen per cent. ad valorem . . . . . 15 pc

392 Yarns, woolen and worsted, n.e.s., thirty per cent. ad valorem . . . . . 30 pc

393 Yarns, composed wholly or in part of wool, worsted, the hair of the alpaca, goat or like animal, costing thirty cents per pound and over, when imported on the cop or tube or in the hank by manufacturers of woolen goods for use in their products, twenty per cent. ad valorem . . . . . 20 pc

394 Fabrics, manufactures, wearing apparel and ready-made clothing, composed wholly or in part of wool, worsted, the hair of the alpaca, goat or other like animal, n.e.s., blankets, bed-comforters or counterpanes, flannels, cloths, doe-skins, cassimeres, tweeds, coatings, overcoatings and felt cloth, n.e.s., thirty-five per cent. ad valorem . . . . . 35 pc

395 Mats, door or carriage, n.e.s., thirty-five per cent. ad valorem . . . . . 35 pc

396 Carpeting, rugs, mats and matting of coeoa, straw, hemp or jute; carpet linings and stair pads, twenty-five per cent. ad valorem . . . . . 25 pc

397 Turkish or imitation Turkish or other rugs or carpets, and carpets, n.e.s., thirty-five per cent. ad valorem . . . . . 35 pc

398 Enamelled carriage, floor, shelf and table oil-cloth, linoleum and cork matting or carpets, thirty per cent. ad valorem . . . . . 30 pc

399 Window shades in the piece or cut and hemmed or mounted on rollers, n.e.s., thirty-five per cent. ad valorem . . . . . 35 pc

400 Webbing, elastic and non-elastic, twenty per cent. ad valorem . . . . . 20 pc

401 Umbrellas, parasols and sunshades of all kinds and materials, thirty-five per cent. ad valorem . . . . . 35 pc

402 Gloves and mitts, of all kinds, thirty-five per cent. ad valorem . . . . . 35 pc

403 Hats, caps and bonnets, n.e.s., and hat, cap and bonnet shapes, thirty per cent. ad valorem . . . . . 30 pc

404 Braces or suspenders, and metal parts thereof, thirty-five per cent. ad valorem . . . . . 35 pc

405 Boot and shoe and stay laces of any material, thirty per cent. ad valorem . . . . . 30 pc

406 Fur skins, wholly or partially dressed, fifteen per cent. ad valorem . . . . . 15 pc

407 Caps, hats, muffs, tippets, capes, coats, cloaks and other manufactures of fur, n.o.p., thirty per cent. ad valorem . . . . . 30 pc

408 Church vestments of any material, twenty per cent. ad valorem . . . . . 20 pc

Sundries.

409 Ships and other vessels, built in any foreign country, whether steam or sailing vessels, on application for Canadian register, on the fair market value of the hull, rigging, machinery, and all appurtenances; on the hull, rigging, and all appurtenances, except machinery, ten per cent. ad valorem; on the boilers, steam engines and other machinery, twenty-five per cent. ad valorem . . . . . 10 pc  
25 pc

410 Canoes, skiffs, or open pleasure sail-boats, of any material, twenty-five per cent. ad valorem . . . . . 25 pc

411 Canvas, and sail twine of hemp and flax, when to be used for boats' and ships' sails, five per cent. ad valorem . . . . . 5 pc

412 Blasting and mining powder, two cents per pound . . . . . 2c plb



# NORTON EMERY WHEEL CO.

# WORCESTER MASS.

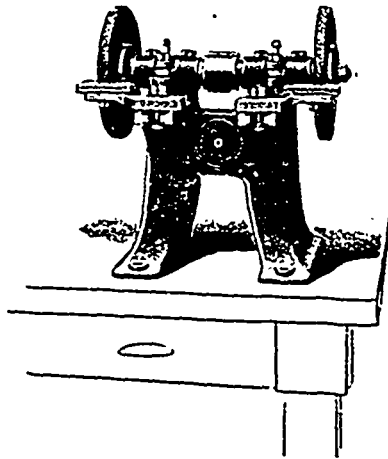

Emery Wheels, Corundum Wheels,  
Emery Wheel Machinery,  
India Oil Stones, Emery Specialties and Novelties.

.....FREE CATALOGUES.....

## NORTON WHEELS.

Quick-Cutting Durable, Waterproof.

## NORTON MACHINES.

Firm—Heavy—Strong.

### THE WALKER UNIVERSAL TOOL AND CUTTER GRINDER,

Will grind Cutters, Reamers, Cylindrical Work—internally or externally, straight or taper. A universal machine in every respect.

### INDIA OIL STONES,

Uniform Quality.

Wonderful Durability.

Every Stone Guaranteed.

MONTREAL—

## THE FAIRBANKS CO.,

749 Craig Street.

QUEBEC—

## F. H. ANDREWS & SON,

64 St. Paul Street.

**CORRESPONDENCE SOLICITED.**

When writing to Advertisers kindly mention THE CANADIAN MANUFACTURER.

The Canadian Tariff.

- 413 Cannon, musket, rifle, gun and sporting powder and canister powder, three cents per pound 3c p lb
- 414 Nitro-glycerine, giant powder, nitro and other explosives, three cents per pound. . . . . 3c p lb
- 415 Glycerine, when imported by manufacturers of explosives, for use in the manufacture thereof in their own factories, ten per cent. ad valorem 10 p c
- 416 Torpedoes, firecrackers and fireworks of all kinds, twenty-five per cent. ad valorem. . . . . 25 p c
- 417 Fertilizers, compounded or manufactured, ten per cent. ad valorem. . . . . 10 p c
- 418 Lamp wicks, twenty-five per cent. ad valorem 25 p c
- 419 Photographic dry plates, thirty per cent. ad valorem. . . . . 30 p c
- 420 Emery wheels, and manufactures of emery, twenty-five per cent. ad valorem . . . . . 25 p c
- 421 Lead-pencils, pens, penholders and rulers of all kinds, twenty-five per cent. ad valorem . . . . . 25 p c
- 422 Magic lanterns and slides therefor, philosophical, photographic, mathematical and optical instruments, n.e.s., cyclometers and pedometers, and tape lines of any material, twenty-five per cent. ad valorem. . . . . 25 p c
- 423 Tobacco pipes of all kinds, pipe mounts, cigar and cigarette cases, cigar and cigarette holders, and cases for the same, smokers' sets and cases therefor, and tobacco pouches, thirty-five per cent. ad valorem. . . . . 35 p c
- 424 Trunks, valises, hat boxes, carpet bags, tool bags or baskets, satchels, reticules, musical instrument cases, purses, portmanteaux, pocket-books, fly-books and parts therefor, n.o.p., and baskets of all kinds, thirty per cent. ad valorem 30 p c
- 425 Frames, clasps and fasteners for purses and chatelaine bags or reticules not more than seven inches in width, when imported by manufacturers of purses and chatelaine bags or reticules, for use in the manufacture thereof, in their own factories, twenty per cent. ad valorem. . . . . 20 p c
- 426 Buttons, viz :—Pantaloen buttons wholly of metal, and shoe buttons, n.e.s., twenty-five per cent. ad valorem. . . . . 25 p c  
Buttons of all kinds covered or not, n.o.p., including recognition buttons and cuff or collar buttons (not being jewellery), thirty-five per cent. ad valorem. . . . . 35 p c
- 427 Combs for dress and toilet, including mane combs of all kinds, thirty-five per cent. ad valorem. . . . . 35 p c
- 428 Brushes, of all kinds, twenty-five per cent. ad valorem. . . . . 25 p c
- 429 Hair, curled or dyed, twenty per cent. ad valorem. . . . . 20 p c
- 430 Artificial flowers, twenty-five per cent. ad valorem. . . . . 25 p c
- 431 Twine and cordage of all kinds, n.e.s., twenty-five per cent. ad valorem. . . . . 25 p c
- 432 Rove, when imported for the manufacture of twine for harvest binders, five per cent. ad valorem. . . . . 5 p c
- 433 Binders' twine or twine for harvest binders of hemp, jute, manilla or sisal, and of manilla and sisal mixed, ten per cent. ad valorem until 1st January, 1898, thereafter to be free. . . . . 10 p c
- 434 Hammocks, lawn tennis nets, sportsmen's fish nets, and other articles manufactured of twine, n.o.p., thirty per cent. ad valorem. . . . . 30 p c

Sugar, Syrups and Molasses.

- 435 All sugar above number sixteen Dutch standard in color, and all refined sugars of whatever kinds, grades or standards, one cent per pound. . . . . 1c p lb
- 436 Sugar, n.e.s., not above number sixteen Dutch standard in color, sugar drainings, or pumpings drained in transit, melado or concentrated melado, tank bottoms and sugar concrete, one-half cent per pound; the usual packages in which imported to be free. . . . . ½c p lb
- 437 Glucose or grape sugar, glucose syrup and corn syrup, or any syrups containing any admixture thereof, three-fourths of one-cent per pound. . . . . ¾c p lb

The Canadian Tariff.

- 438 Sugar-candy, brown or white, and confectionery, including sweetened gums, candied peel and pop-corn, one-half of one cent per pound and thirty-five per cent. ad valorem. . . . . ½c p lb and 35 p c
- 439 Maple sugar, and maple syrup, twenty per cent. ad valorem. . . . . 20 p c
- 440 Syrups and molasses of all kinds, n.o.p., the product of the sugar cane or beet, n.e.s., and all imitations thereof or substitutes therefor, three-fourths of one cent per pound . . . . . ¾c p lb
- 441 Molasses produced in the process of the manufacture of cane sugar from the juice of the cane without any admixture with any other ingredient, when imported in the original package in which it was placed at the point of production and not afterwards subjected to any process of treating or mixing, the package in which imported, when of wood, to be free,—  
(a). Testing by polariscope forty degrees or over, one and three-fourths cent per gallon. . . . . 1¾c p gall  
(b). When testing by polariscope less than forty degrees and not less than thirty-five degrees, one and three-fourths cent per gallon . . . . . 1¾c p gall  
And in addition thereto one cent per gallon for each degree or fraction of a degree less than forty degrees. . . . . 1c additional p degree

Tobacco, and Manufactures of

- 442 Cigars and cigarettes, the weight of the cigarettes to include the weight of the paper covering, three dollars per pound and twenty-five per cent. ad valorem. . . . . \$3 p lb and 25 p c
- 443 Cut tobacco, fifty-five cents per pound. . . . . 55c p lb
- 444 Manufactured tobacco, n.e.s., and snuff, fifty cents per pound. . . . . 50c p lb
- 445 Foreign leaf raw tobacco, unstemmed, unmanufactured, for excise purposes under conditions of the Inland Revenue Act, after June 30, 1897, ten cents per pound, to be computed on the weight when ex-warehoused. . . . . 10c p lb
- 446 Foreign raw leaf tobacco, stemmed, unmanufactured, for excise purposes, under conditions of the Inland Revenue Act, after June 30, 1897, fourteen cents per pound, to be computed on the weight when ex-warehoused. . . . . 14c p lb

Unenumerated Goods.

- 447 All goods not enumerated in this Act as subject to any other rate of duty, nor declared free of duty by this Act, and not being goods the importation whereof is by this Act or any other Act prohibited, shall be subject to a duty of twenty per cent. ad valorem. . . . . 20 p c

SCHEDULE B.

Free Goods.

- 448 Articles for the use of the Governor-General.
- 449 Articles when imported by and for the use of the Army and Navy, viz : Arms, military or naval clothing, musical instruments for bands, military stores and munitions of war; also articles consigned direct to officers and men on board vessels of Her Majesty's navy, for their own personal use or consumption.
- 450 Articles imported by or for use of the Dominion Government, or for any of the departments thereof, or by and for the Senate or House of Commons, including the following articles when imported by the said Government or through any of the departments thereof for the use of the Canadian militia: Military clothing, musical instruments for military bands, military stores and munitions of war.
- 451 Articles for the personal or official use of Consuls General who are natives or citizens of the country they represent and who are not engaged in any other business or profession
- 452 Travellers' baggage, under regulations prescribed by the Controller of Customs.
- 453 Carriages for travellers and carriages laden with merchandise, and not to include circus troupes or hawkers, under regulations prescribed by the Controller of Customs.
- 454 Apparel, wearing and other personal and household effects, not merchandise, of British subjects dying abroad, but domiciled in Canada; books, pictures, family plate or furniture, personal effects and heirlooms left by bequest.

# Canada Switch & Spring Co.

(LIMITED)

**ENGINEERS and MANUFACTURERS.**

SPRINGS,  
STEEL CASTINGS,  
FROGS,  
FORGINGS,  
TRUCKS FOR  
ELECTRIC  
RAILWAYS,  
TRACK MATERIAL  
OF ALL KINDS.

**Specialties for Steam and  
Electric Railways.**

Interlocking Switch and Signal Plants under  
the Patents of MESSRS. SAXBY &  
FARMER (Limited,) of London, Eng.  
TURNBUCKLES.

**Canal Bank, Montreal.**

ESTABLISHED 1866

## A. C. Leslie & Co., Montreal.

**IRON, STEEL AND METAL MERCHANTS**

AGENTS FOR

"Gautier" Bar Steel, Shafting and  
Agricultural Shapes.

"Sanderson's" Tool and Drill Steel.

"Dominion Crown" Bars and Hoops.

Plates and Structural Steel.

"Standard" Coil Chain.

"Carron" and other Pig Iron.

Steel Billets, Wire Rods, Etc.

"Queen's Head" Galvanized Iron.

"Orb" Corrugated Iron.

Sheet Iron and Steel, all Grades.

Tin, Terne and Canada Plates.

Sheet Zinc, Ingot Tin.

"Whitecross" Wire and Rope.

Hy. Wright's Anvils & Vices.

"Alpha" Linseed Oil, Etc.

*Special Prices for Import to Wholesale Buyers.*

When writing to Advertisers kindly mention THE CANADIAN MANUFACTURER.

## The Canadian Tariff.

- 455 Settlers' effects, viz: Wearing apparel, household furniture, books, implements and tools of trade, occupation or employment, guns, musical instruments, domestic sewing machines typewriters, live stock, bicycles, carts and other vehicles and agricultural implements in use by the settler for at least six months before his removal to Canada, not to include machinery, or articles imported for use in any manufacturing establishment, or for sale; provided that any dutiable article entered as settlers' effects may not be so entered unless brought with the settler on his first arrival, and shall not be sold or otherwise disposed of without payment of duty, until after twelve months' actual use in Canada; provided also, that under regulations made by the Controller of Customs, live stock, when imported into Manitoba or the North-west Territories by intending settlers, shall be free until otherwise ordered by the Governor-in-Council.
- 456 Animals brought into Canada temporarily and for a period not exceeding three months for the purpose of exhibition or of competition for prizes offered by any agricultural or other association; (but a bond shall be first given in accordance with regulations prescribed by the Controller of Customs, with the condition that the full duty to which such animals would otherwise be liable shall be paid in case of their sale in Canada, or if not re-exported within the time specified in such bond.)
- 457 Horses, cattle, sheep, swine and dogs, for the improvement of stock, under regulations made by the Treasury Board and approved by the Governor-in-Council.
- 458 Menageries, horses, cattle, carriages and harness of, under regulations prescribed by the Controller of Customs.
- 459 Admiralty charts.
- 460 Typewriters, tablets with movable fixtures and musical instruments, when imported by and for the use of schools for the blind, and being and remaining the sole property of the governing bodies of the said schools and not of private individuals: the above particulars to be verified by special affidavits on each entry when presented.
- 461 Globes, geographical, topographical and astronomical; maps and charts for the use of schools for the blind; pictorial illustrations of insects or similar studies, when imported for the use of colleges, schools and scientific and literary societies; manuscripts and insurance maps, and album insides of paper.
- 462 Philosophical instruments and apparatus—that is to say, such as are not manufactured in Canada, when imported for use in universities, colleges, schools, scientific societies and public hospitals.
- 463 Botanical and entomological specimens; mineralogical specimens; skins of birds and skins of animals not natives of Canada, for taxidermic purposes, not further manufactured than prepared for preservation; fish skins; and anatomical preparation and skeletons or parts thereof; and specimens, models and wall diagrams for illustration of natural history for universities and public museums.
- 464 Books, viz.: Books on the application of science to industries of all kinds, including books on agriculture, horticulture, forestry, fish and fishing, mining, metallurgy, architecture, electric and other engineering, carpentry, ship-building, mechanism, dyeing, bleaching, tanning, weaving and other mechanic arts, and similar industrial books; also books printed in any language other than the English and French languages, or in any two languages not being English or French or in three or more languages; and Bibles, prayer books, psalm and hymn-books, religious tracts, and Sunday school lesson pictures.
- 465 Books, embossed, for the blind, and books for the instruction of the deaf and dumb and blind.
- 466 Books printed by any Government or by any association for the promotion of science or letters, and official annual reports of religious or benevolent associations, and issued in the course of the proceedings of the said associations, to their members, and not for the purpose of sale or trade.
- 467 Books, not printed or reprinted in Canada, which are included and used as text books in the curriculum of any university, incorporated college or normal school in Canada; books specially imported for the bona fide use of incorporated mechanics' institutes, public libraries, libraries of universities, colleges and schools, or for the library of any incorporated medical, law, literary, scientific or art association or society, and being the property of the organized authorities of such library, and not in any case the property of individuals—the whole under regulations to be made by the Controller of Customs—provided that importers of books who have sold the same for the purpose mentioned in this item, shall upon proof of sale and deliv-

## The Canadian Tariff.

- ery for such purpose be entitled to a refund of any duty paid thereon.
- 468 Books, bound or unbound, which have been printed and manufactured more than twelve years.
- 469 Newspapers, and quarterly, monthly and semi-monthly magazines, and weekly literary papers, unbound; and tailors' milliners', and mantle-makers' fashion plates.
- 470 Paintings in oil or water colors, by artists of well-known merit, or copies of the old masters by such artists; and paintings in oil or water colors, the production of Canadian artists, under regulations to be made by the Controller of Customs.
- 471 Clothing and books, donations of, for charitable purposes, and photographs, not exceeding three, sent by friends and not for the purpose of sale.
- 472 Lifeboats and life-saving apparatus specially imported by societies established to encourage the saving of human life.
- 473 Coins, cabinets of, collections of medals and other antiquities, including collections of postage stamps; gold and silver coins, except United States silver coin; medals of gold, silver or copper, and other metallic articles actually bestowed as trophies or prizes and received and accepted as honorary distinctions, and cups or other prizes won in bona fide competitions; and medals commemorating the Diamond Jubilee of Her Majesty Queen Victoria, until the thirty-first day of December, 1897, and dies for manufacturing such medals.
- 474 Locomotive and railway passenger, baggage and freight cars, being the property of railway companies in the United States, running upon any line of road crossing the frontier, so long as Canadian locomotives and cars are admitted free under similar circumstances into the United States, under regulations prescribed by the Controller of Customs.
- 475 Models of inventions and of other improvements in the arts—but no article shall be deemed a model which can be fitted for use.
- 476 Aluminum in ingots, blocks or bars, strips, sheets or plates; alumina and chloride of aluminum, or chloralium, sulphate of alumina and alum cake; and alum in bulk only, ground or unground.
- 477 Ambergis; ammonia, sulphate of, sal-ammoniac, and nitrate of ammonia; arsenic; bromine, Burgundy pitch; cinnabar, cochineal, cyanide of potassium and cyanogen or compound of bromine and potassium for reducing metals in mining operations; iodine, crude; kroyolite or cryolite, mineral; oxalic acid; quinine, salts of; saltpetre; calcareous tufa; alizarine and artificial alizarine; aniline oil, crude; aniline salts and arseniate of aniline; annatto, liquid or solid; aniline dyes and coal tar dyes in bulk or packages of not less than one pound weight.
- 478 Antimony salts; antimony, or regulus of, not ground, pulverized or otherwise manufactured.
- 479 Artificial limbs.
- 480 Asphalt or asphaltum; bone pitch, crude only; and resin or rosin in packages of not less than one hundred pounds, and resin oil.
- 481 Anchors for vessels.
- 482 Bees.
- 483 Bells, when imported for the use of churches only.
- 484 Bismuth, metallic, in its natural state; blood albumen and tannic acid.
- 485 Blast furnace slag.
- 486 Blanketing and lapping, and dies or mills for engraving copper rollers, when imported by cotton manufacturers, calligraphers, and wall paper manufacturers, for use in their own factories only.
- 487 Bolting cloth not made up.
- 488 Bones, crude, not manufactured, burned, calcined, ground or steamed.
- 489 Book-binders' cloth.
- 490 Boracic acid, and borax, ground or unground, in bulk of not less than twenty-five pounds.
- 491 Bristles, broom corn and hair brush pads.
- 492 Brass and copper, old and scrap, or in blocks; and brass or copper in bolts, bars and rods in coil or otherwise, not less than six feet in length, unmanufactured, and brass or copper in strips, sheets or plates, not polished, planished or coated, and brass or copper tubing, in lengths of not less than six feet, and not polished, bent or otherwise manufactured, and copper in ingots or pigs.
- 493 Britannia metal in pigs, blocks or bars.
- 494 Buckram, when imported for the manufacture of hat and bonnet shapes.
- 495 Bullion, gold and silver, in ingots, block, bars, drops, sheets or plates, unmanufactured; gold and silver sweepings, and bullion or gold fringe.

A. A. AYER, President.  
T. B. BROWN, Vice-President.

WALTER H. LAURIE, General Manager.

JOHN LAURIE, Treasurer.  
WAYLAND WILLIAMS, Secretary.

Established 1871.

Incorporated 1894.

# Laurie Engine Co.

Works and Offices,  
1012 & 1014 St. Catherine St.

Machinery and Supply Warehouses,  
321 St. James St. & 766 Craig St.

## MONTREAL

### Builders of Improved Corliss Automatic Engines, Single and Compound

The Laurie Corliss is the most Economical Engine on the market for the reason that it saves its price in fuel, in many cases in less than twelve months. Numerous instances of this fact can be given, some within the last six months. We have installed several engines without charge, taking as remuneration the amount saved on the fuel bill for a given time.

**A Laurie Patent Feed Water Heater** used with a Corliss or any other kind of engine will effect a constant saving of 10 to 15 per cent. in the fuel bill, and that without any cost for maintenance and attention, only the first cost which is trifling compared with the advantages gained. Write for prices.

We will be pleased to give any information or advice in regard to steam installations or improvements.

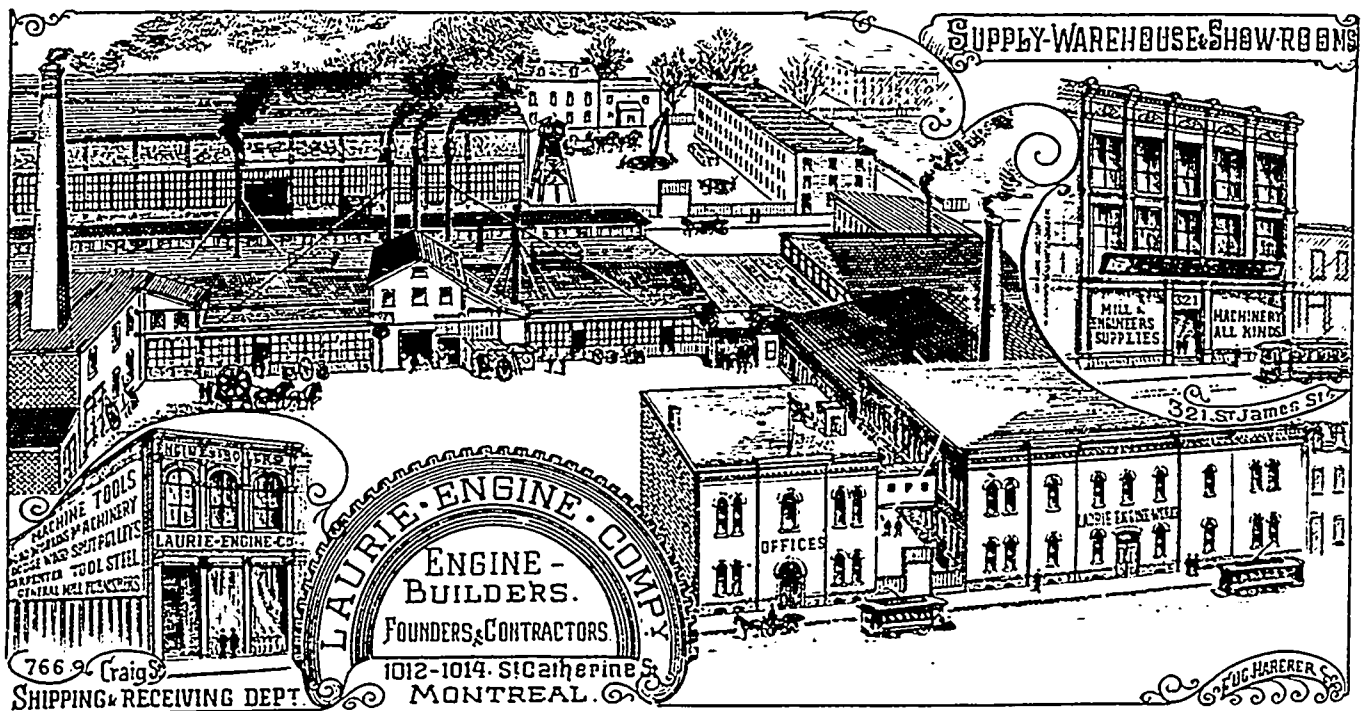

At our Supply Warehouses we have a constant stock of

**ENGINES AND BOILERS OF ALL SIZES, IRON AND WOOD WORKING MACHINERY,  
MACHINE TOOLS, SHAFTING, HANGERS AND PULLEYS.**

Agency for **WELL-KNOWN DODGE WOOD SPLIT PULLEYS,  
CARPENTER TOOL STEEL** (incomparable for Tool making),  
**SPOONER'S COPPERINE, LAMBETH COTTON ROPE.**

**Emery Wheels, Twist Drills, Gauges, Valves, Separators,  
Fans, Blowers, Forges.** Write for our Catalogue.

When writing to Advertisers kindly mention THE CANADIAN MANUFACTURER.

## The Canadian Tariff.

- 496 Barr-stones, in blocks, rough or unmanufactured, not bound up or prepared for binding into mill-stones.
- 497 Caplins, unfinished Leghorn hats and Manila hoods.
- 498 Casts, as models for the use of schools of design.
- 499 Cane and rattans, not manufactured; oslers or willows, and bamboos, unmanufactured, and bamboo reeds, not further manufactured than cut into suitable lengths for walking sticks or canes, or for sticks for umbrellas, parasols or sun-shades.
- 500 Cat-gut or gut cord, for musical instruments; and cat-gut or worm gut, unmanufactured, for whip and other cord.
- 501 Celluloid, xylonite or xyolite in sheets, and in lumps, blocks or balls in the rough.
- 502 Chloride of lime, in packages of not less than twenty-five pounds weight; cobalt, ore of; oxide of cobalt, oxide of tin and oxide of copper; copper, persulfate of, crude; diazon's blood; gypsum, crude (sulphate of lime); lava, unmanufactured; manganese, oxide of; phosphorus; litharge; saffron, saffron cake, safflower, and extract of; sulphate of iron (coppers); sulphate of copper (blue vitriol); sulphur and brimstone, crude, or in roll or flour; tartar emetic and gray tartar; cream of tartar in crystals and argal or argols; verdigris, or sub-acetate of copper, dry; zinc, salts of, and tartaric acid crystals.
- 503 Chronometers and compasses for ships.
- 504 Citron, lemon and orange rinds in brine.
- 505 Clays, including China clay, fire clay and pipe clay; gannister and sand.
- 506 Coal, anthracite and anthracite coal dust; coke.
- 507 Coal and pine pitch, and coal and pine tar in packages of not less than fifteen gallons.
- 508 Colr and colr yarn; raw cotton or cotton wool; and cotton waste, not dyed, cleaned, bleached or otherwise manufactured; cotton yarns, number forty and finer; and mohair yarns.
- 509 Communion plate, when imported for the use of churches.
- 510 Crucibles, clay or plumbago.
- 511 Curling stones.
- 512 Cups, brass, being rough blanks, for the manufacture of paper shells or cartridges, when imported by manufacturers of brass and paper shells and cartridges, for use in the manufacture of such articles in their own factories.
- 513 Davron's unsat, diamond dust or bort and black, for borers, and diamond drills for prospecting for minerals, not to include motive power.
- 514 Domestic fowls, pure-bred, for the improvement of stock, homing or messenger pigeons and pheasants and quails.
- 515 Drugs, crude, such as barks, flowers, roots, beans, berries, balsams, bulbs, fruits, insects, grains, gums and gum resins, herbs, leaves, nuts, fruit and stem seeds—which are not edible and which are in a crude state and not advanced in value by refining or grinding or any other process of manufacture and not otherwise provided for; egg yoke, fuller's earth, in bulk only, not prepared for toilet or other purposes; lead, nitrate and acetate of, not ground; litmus and all lichens, prepared or not prepared; musk, in pods or in grain; roots, medicinal, viz.:—alkanet, crude, crushed or ground, aconite, calumba, folla digitalis, gentian, ginseng, jalap, ipecacuanha, iris, orris root, liquorice, sarsaparilla, squills, taraxacum, rhubarb and valerian, unground; vaccine and ivory vaccine points, gum chicle or sappato gum, crude; platinum and black oxide of copper for use in the manufacture of chlorate; potash, chlorate of, not further prepared than ground, and free from admixture with any other substance; and bacteriological products or serum for subcutaneous injection.
- 516 Duck for belting and hose, when imported by manufacturers of such articles for use in the manufacture thereof in their own factories; and canvas or fabric, not frictionized, for the manufacture of bicycle tires when imported by the manufacturers of bicycle tires for use exclusively in the manufacture of bicycle tires in their own factories.
- 517 Dyeing or tanning articles, in a crude state, used in dyeing or tanning, n.e.s.; berries for dyeing or used for composing dyes; turmeric, nut galls and extracts thereof; lac, crude, seed, button, stick and shell; indigo, indigo paste and extract of, and indigo auxiliary or zinc dust; persis, or extract of archill and cudbear; terra japonica, gambler or cutch, extract of logwood, fustic, oak and oak bark and quebracho; camwood and sumac and extract thereof, tanners' bark, hemlock bark and oak bark; ground logwood, ground fustic, patent prepared dyes, and ground oak bark; iron liquor, solutions of acetate or nitrate of iron for dyeing and calico printing; madder and mun-

## The Canadian Tariff.

- jeet, or Indian madder, ground or prepared, and all extracts of; red liquor, a crude acetate of aluminum prepared from pyroligneous acid, for dyeing and calico printing.
- 518 Emery in bulk, crushed or ground.
- 519 Felt, adhesive for sheathing vessels.
- 520 Fertilizers, uncompounded or unmanufactured, including phosphate rock, kainite or German potash salts, German mineral potash, bone-dust, bone black or charred bone and bore ash, fish offal or refuse, guano and other animal or vegetable manures.
- 521 Fibre, Mexican, natural, and tampeco or istle and vegetable fibres; fibrilla, flax fibre and flax tow; grass, Manila, Esparto or Spanish, and other grasses, and pulp of, including fancy grasses, dried but not colored or otherwise manufactured; moss, Iceland, and other mosses, seaweed and seaweed, crude or in their natural state, or cleaned only; and kelp.
- 522 Fire bricks, for use in processes of manufacture, or for manufacturing purposes.
- 523 Fillets of cotton or rubber not exceeding seven inches wide, when imported by and for the use of manufacturers of card clothing in their own factories.
- 524 Fish hooks, for deep sea or lake fishing, not smaller in size than number 20; hank, cod, pollock and mackerel fish lines; and mackerel, herring, salmon, seal, seine, mullet, net and trawl twine in hanks or coil, barked or not,—in variety of sizes and threads,—including gilling thread in balls, and head ropes, barked marlin, and net morsels of cotton, hemp or flax, and deep sea fishing nets or seines, when used exclusively for the fisheries, and not to include hooks, lines or nets commonly used for sportsmen's purposes.
- 525 Flint, flints and ground flint stones; felspar, cliff, chalk, China or Cornwall stone, ground or unground; gravels; precious stones in the rough.
- 526 Florist stock, viz.:—Palms, bulbs, corms, tubers, rhizomes, arceria spiraea and lilies of the valley; seedling stock for grafting, viz.: plum, pear, peach and other fruit trees; seeds, viz.: annatto, beet, carrot, flax, turnip, mango, mustard, sowing rapeseed and mushroom spawn; aromatic seeds which are not edible and are in a crude state, and not advanced in value or condition by grinding or refining or by any other process of manufacture, viz. anise, anise star, caraway, cardomom, coriander, cumin Britain; beans, viz.: tonquin, vanilla and nux vomica crude only, locust beans and locust bean meal, and cocoa beans, not roasted, crushed or ground; fruits, viz.: bananas, plantains, pineapples, pomegranates, guavas, mangoes and shaddocks; wild blueberries, wild strawberries and wild raspberries, and trees, n.e.s.
- 527 Fossils, shells, tortoise and mother-of-pearl, and other shells unmanufactured.
- 528 Foot-grease, being the refuse of cotton seed after the oil has been pressed out, but not when treated with alkalis; and grease, rough, the refuse of animal fat for the manufacture of soap and oils only.
- 529 Fur skins of all kinds not dressed in any manner.
- 530 Gilders' moulds and goldbeaters' skins.
- 531 Gums, viz.:—Amber, Arabic, Australian, copal, dammar, elemi, kaurie mastic, sandarac Senegal, shellac; and white shellac in gum or flake for manufacturing purposes; and gum tragacanth, gum gedda and gum barbery.
- 532 Hair, cleaned or uncleaned, but not curled, dyed or otherwise manufactured; and horse-hair not further manufactured than simply cleaned and dipped or dyed, imported by manufacturers of hair cloth for use in the manufacture of such article in their own factories.
- 533 Hatters' furs, not on the skin, and hatters' plush of silk or cotton; and hatters' bands (not cords), bindings, tips and sides, hat sweats and linings both tips and sides, when imported by hat and cap manufacturers for use in the manufacture of these articles only in their own factories.
- 534 Hemp, unpressed.
- 535 Hemp paper, made on four cylinder machines and calendered to between .006 and .008 inch thickness for the manufacture of shot shells; primers for shot shells and cartridges, and felt board sized and hydraulic pressed, and covered with paper or uncovered, for the manufacture of gun wads, when such articles are imported by manufacturers of shot shells, cartridges and gun wads, to be used for these purposes only in their own factories, until such time as the said articles are manufactured in Canada; provided always that the said articles, when imported, shall be entered only at such port or ports as

# OUR SPECIALTIES

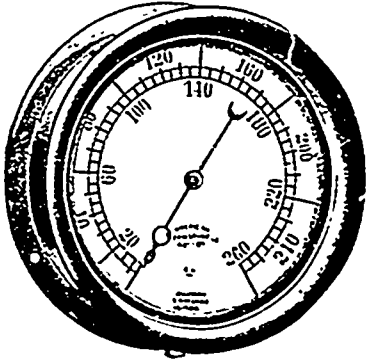

Pressure Gauge.

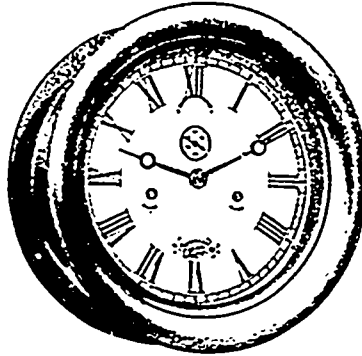

Marine and Loco. Clocks.

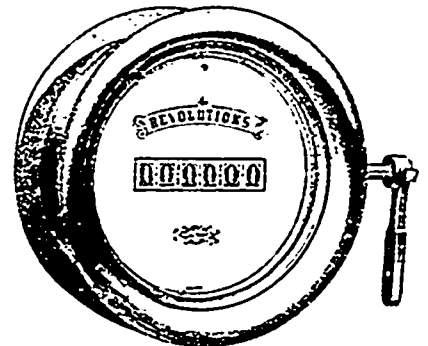

Revolution Counters.

## Pantographs,

AND

## Amslers Polar Planimeters.

**AMERICAN**  
*Thompson Improved Indicator with IDEAL Reducing Wheel attached*

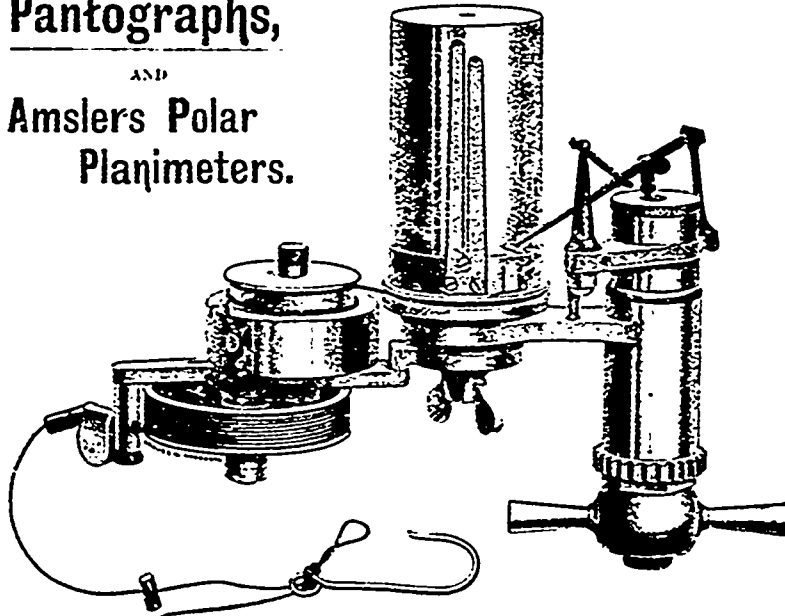

Adopted by the  
Government  
for use on  
Gun-Boats and  
Cruisers  
of the  
U.S. Navy.

“ORIGINAL”  
**THOMPSON**  
**INDICATOR.**



Brass Water Relief Valve.



Side Outlet Pop Valve. (Illustration).



Vacuum Valve (Illustration).



Portable Pop Valve. (Illustration).



Iron Water Relief Valve.



Stationery Pop Valve. (Illustration).

MANUFACTURED ONLY BY

# American Steam Gauge Company,

Manufacturers of Gauges that Gauge, Pops that Pop, Indicators that Indicate,

New York Branch  
35 Decy St.,  
NEW YORK.

34, 36 and 38 CHARDON STREET, BOSTON, MASS.  
Send for Catalogue.

Western Branch--  
16 North Canal St.  
CHICAGO.

When writing to Advertisers kindly mention THE CANADIAN MANUFACTURER.

## The Canadian Tariff.

- are named by the Controller of Customs, and at no other place; samples of such articles to be furnished to the collector of the said port or ports by the Customs Department for the guidance of the officers when accepting free entries of such materials.
- 536 Hides and skins, raw, whether dry, salted or pickled, and raw pelts.
- 537 Hoofs, horn strips, horn and horn tips in the rough, not polished or otherwise manufactured than cleaned.
- 538 Hoop iron not exceeding  $\frac{3}{8}$  inch in width and being 25 gauge and thinner, used for the manufacture of tabular nuts.
- 539 Ice.
- 540 Indian corn, not for purposes of distillation and under Customs regulations.
- 541 Ingot moulds; iron sand or globules or iron shot and dry putty for polishing glass or granite.
- 542 Iron or steel masts, or parts thereof, and iron or steel beams, angles, sheets, plates, knees and cable chain for wooden, iron, steel or composite ships and vessels; and iron, steel or brass manufactures which at the time of their importation are of a class or kind not manufactured in Canada, when imported for use in the construction or equipment of ships or vessels.
- 543 Ivory and ivory nuts, piano key ivories and veneers of ivory unmanufactured.
- 544 Junk, old.
- 545 Jute and jute butts; and jute cloth, as taken from the loom, not colored, cropped, mangled, pressed, calendered nor finished in any way.
- 546 Jute, flax or hemp yarn, plain, dyed or colored, jute canvas, not pressed or calendered, when imported by the manufacturers of carpets, rugs and mats, jute webbing or jute cloth, hammocks, twines and floor oil cloth, for use in the manufacture of any of these articles only, in their own factories.
- 547 Lamp black and ivory black.
- 548 Lasting, mohair cloth, or other manufactures of cloth, when imported by manufacturers of buttons for use in their own factories, and woven or made in patterns of such size, shape or form, or cut in such manner as to be fit for covering buttons, exclusively. These conditions to be ascertained by special examination by the proper officer of Customs, and so certified on the face of each entry.
- 549 Leeches.
- 550 Lime juice, crude only.
- 551 Locomotive and car wheel tires of steel in the rough.
- 552 Meerschaum, crude or raw.
- 553 Metal glove fasteners; paper-mache shoe buttons, shoe eyelets, shoe eyelet hooks, shoe lace wire fasteners, and sewing machine attachments.
- 554 Mineral waters, natural, not in bottle, under regulations prescribed by the Controller of Customs.
- 555 Machinery imported exclusively for mining, smelting and reducing, viz.:—coal cutting machines except percussion coal cutters, coal heading machines, coal augers and rotary coal drills, core drills, miners' safety lamps, coal washing machinery, coke-making machinery, ore drying machinery, ore roasting machinery, electric or magnetic machines for separating or concentrating iron ores, blast furnace water jackets, converters for metallurgical processes in iron or copper, briquette making machines, ball and rock emery grinding machines, copper plates, plated or not, machinery for extraction of precious metals by the chlorination or cyanide processes, monitors, giants and elevators for hydraulic mining, amalgam sates, automatic ore samplers, automatic feeders, flgs, classifiers, separators, set rts, buddles, vanners, mercury, pumps, pyrometers, bullion furnaces, amalgam cleaners, gold milling slime tables, blast furnace blowing engines, wrought iron tubing, butt or lap welded, threaded or coupled or not, not less than  $\frac{3}{4}$  inches diameter, when imported for use exclusively in mining, smelting, reducing or refining.
- 556 Nickel; and ores of metal of all kinds; and siliceous or crystallized quartz.
- 557 Oakum.
- 558 Oils, viz.:—Cocanut and palm in their natural state; and carbolic or heavy oil; oil of roses and ottar or attar of roses, and olive oil for manufacturing soap or tobacco, or for canning fish.
- 559 Oil cake and oil cake meal, cotton seed cake and cotton seed meal, and palm nut cake and meal.
- 560 Oysters, seeds and breeding, imported for the purpose of being planted in Canadian waters.

## The Canadian Tariff.

- 561 Oleo-stearine and degrass.
- 562 Palm leaf, unmanufactured.
- 563 Platts, plain, not to include braid or fancy trimmings, composed of chip, manilla, cotton, mohair, straw, Tuscan and grass.
- 564 Platinum wires and platinum in bars, strips, sheets or plates, platinum retorts, pans, condensers, tubing and pipe, when imported by manufacturers of sulphuric acid for use in their works in the manufacture or concentration of sulphuric acid.
- 565 Potash, muriate and bichromate of, crude, caustic potash, and red and yellow prussiate of potash, also pot and pearl ash, in packages of not less than twenty-five pounds weight.
- 566 Pimento.
- 567 Pumice and pumice stone, ground or unground.
- 568 Quicksilver.
- 569 Quills in their natural state or unplumed.
- 570 Rags of cotton, linen, jute, hemp and woolen, paper waste, clippings, and waste of any kind except mineral.
- 571 Rennet, raw and prepared.
- 572 Ribs of brass, iron or steel, runners, rings, caps, notches, ferrules, mounts and sticks or canes in the rough, or not further manufactured than cut into lengths suitable for umbrellas, parasol or sunshade or walking sticks, when imported by manufacturers of umbrellas, parasols and sunshades for use in their factories in the manufacture of umbrellas, parasols, sunshades or walking sticks.
- 573 Rubber and gutta percha, crude (caoutchouc or India-rubber, unmanufactured; powdered rubber and rubber waste; hard rubber in sheets but not further manufactured, and re-covered rubber and rubber substitute.
- 574 Rolled round wire rods in the coil, of iron or steel, not over three-eighths of an inch in diameter, when imported by wire manufacturers for use in making wire in the coil, in their own factories.
- 575 Rubber thread, elastic.
- 576 Reeds, square or round, and raw-hide centres, textile-leather or rubber heads, thumbs and tips, and steel, iron or nickel caps for whip ends, when imported by whip manufacturers, for use in the manufacture of whips in their own factories.
- 577 Rollers, copper, for use in calico printing, when imported by calico printers for use in their factories in the printing of calicoes and for no other purpose (such rollers not being manufactured in Canada).
- 578 Astrakhan or Russian hair skins and China goat plates or rugs, wholly or partially dressed, but not dyed.
- 579 Salt, imported from the United Kingdom or any British possession, or imported for the use of the sea or gulf fisheries.
- 580 Sausage skins or casings, not cleaned.
- 581 Scrap iron and scrap steel, old and fit only to be re-manufactured, being part of or recovered from any vessel wrecked in waters subject to the jurisdiction of Canada.
- 582 Silk, raw or as reeled from the cocoon, not being doubled, twisted or advanced in manufacture in any way; silk cocoons and silk waste.
- 583 Silk in the gum or spun, when imported by manufacturers of silk underwear to be used for such manufacture in their own factories.
- 584 Silver, nickel and German, in ingots, blocks, bars, strips, sheets or plates, unmanufactured.
- 585 Steel rails weighing not less than 45 pounds per lineal yard for use only in the tracks of a railway which is employed in the common carrying of goods and passengers and is operated by steam motive power only; provided that this item shall not extend to rails for tracks of a railway which is used for private purposes only, nor shall this item extend to rails for use in the tracks of any electric railway, street railway or tramway.
- 586 Soda, sulphate of, crude, known as salt cake, barilla or soda ash, caustic soda; silicate of soda in crystals or in solution; bichromate of soda, nitrate of soda or cubic nitre, sal soda, sulphide of sodium, nitrite of soda, arseniate, binarseniate, chloride chlorate, bisulphite and stannate of soda.
- 587 Spurs and statts, used in the manufacture of earthenware.
- 588 Steel bowls for cream separators, and cream separators.
- 589 Steel saws and straw cutters cut to shape, but not further manufactured.
- 590 Crucible sheet steel, eleven to sixteen gauge, two and one-half to eighteen inches wide for the manufacture of mower and reaper knives, when imported by the manufacturers thereof for use for such purpose in their own factories.



**FINE**

**CRUSHING and GRINDING  
MACHINERY**

**STURTEVANT MILL CO.,**

Send for Circular.

**104 Clayton St., Boston, Mass.**

**TOOLS AND SUPPLIES**

CALIPERS, SQUARES,  
GAUGES,  
MICROMETERS,  
DIVIDERS, Etc.

WE  
CARRY  
A  
FULL  
STOCK

**MACHINE TOOLS**

SHEET  
AND  
ROLL

Sand Paper

BAND  
AND  
RE-SAW

Blades

**RICE LEWIS & SON, Limited,**  
**TORONTO**

*THE* **Crocker Patent Turbine**

Horizontal Setting, with Quarter Turn Elbow.

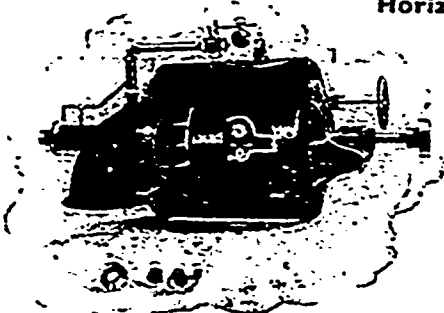

Where the nature of the location will permit its use this type has many advantages. It is very suitable for direct connection to dynamos, and many are in operation in this class of service.

Notice how complete and compact this arrangement is, and how easily it may be installed. Can you use anything of this kind? Your inquiries will receive prompt attention.

**W**ATER POWERS examined and Reports made. Estimates submitted for Complete Equipments.

**The JENCKES MACHINE CO.,**  
**42 Lansdowne St., Sherbrooke, Que.**

## The Canadian Tariff.

- 591 Steel of number twenty gauge and thinner, but not thinner than number thirty gauge, for the manufacture of corset steels, clock springs and shoe shanks, when imported by the manufacturers of such articles for exclusive use in the manufacture thereof in their own factories.
- 592 Flat steel wire, of number sixteen gauge or thinner, when imported by the manufacturers of crinoline or corset wire and dress stays, for use in the manufacture of such articles in their own factories.
- 593 Steel valued at two and one-half cents per pound and upwards, when imported by the manufacturers of skates, for use exclusively in the manufacture thereof in their own factories.
- 594 Steel, under one-half inch in diameter, or under one-half inch square, when imported by the manufacturers of cutlery or of knobs, or of locks, for use exclusively in the manufacture of such articles in their own factories.
- 595 Steel of number twelve gauge and thinner, but not thinner than number thirty gauge, for the manufacture of buckle clasps, bed fasts, furniture casters, and ice creepers, when imported by the manufacturers of such articles, for use exclusively in the manufacture thereof in their own factories.
- 596 Steel of number twenty-four and seventeen gauge, in sheets sixty-three inches long, and from eighteen inches to thirty-two inches wide, when imported by the manufacturers of tubular bow sockets for use in the manufacture of such articles in their own factories.
- 597 Steel for the manufacture of bicycle chain, when imported by the manufacturers of bicycle chain for use in the manufacture thereof in their own factories.
- 598 Steel for the manufacture of files, augers, auger bits, hammers, axes, hatchets, scythes, reaping hooks, hoes, hand-rakes, hay or straw knives, wind mills and agricultural or harvesting forks, when imported by the manufacturers of such or any of such articles for use exclusively in the manufacture thereof in their own factories.
- 599 Steel springs for the manufacture of surgical trusses, when imported by the manufacturers for use exclusively in the manufacture thereof in their own factories.
- 600 Flat spring steel, steel billets and steel axle bars, when imported by manufacturers of carriage springs and carriage axles for use exclusively in the manufacture of springs and axles for carriages or vehicles other than railway or tramway, in their own factories.
- 601 Spiral spring steel for spiral springs for railways, when imported by the manufacturers of railway springs for use exclusively in the manufacture of railway spiral springs in their own factories.
- 602 Steel strip and flat steel wire, when imported into Canada by manufacturers of buckthorn and plain strip fencing, for use in the manufacture of such articles in their own factories; and barbed fencing wire of iron or steel after January 1, 1888.
- 603 Galvanized iron or steel wire number nine, twelve and thirteen gauge, after January 1, 1888.
- 604 Stereotypes, electrotypes and celluloids of newspaper columns in any language other than French and English, and of books, and bases and matrices and copper shells for the same, whether composed wholly or in part of metal or celluloid.
- 605 Surgical and dental instruments (not being furniture) and tagging needles, after January 1, 1888.
- 606 Tagging metal, plain, japanned or coated, in coils, not over one and a half inch in width, when imported by manufacturers of shoe and corset laves for use in their factories.
- 607 Tails, undressed.
- 608 Tea and green coffee imported direct from the country of growth and production, and tea and green coffee purchased in bond in the United Kingdom, provided there is satisfactory proof that the tea or coffee so purchased in bond is such as might be entered for home consumption in the United Kingdom.
- 609 Teasels.
- 610 Tin, in blocks, pigs, bars and sheets, tin plates, tin crystals, tin strip waste, and in tin foil, tea lead.
- 611 Timber or lumber or wood, viz., lumber and timber planks and boards of amaranth, cocoboral, boxwood, cherry, chestnut, walnut, gumwood, mahogany, pitch pine, rosewood, sandal-wood, syamora, Spanish cedar, oak, hickory, white-wood, African teak, black-heart ebony, lignum vitae, red cedar, redwood, satin-wood and white ash, when not otherwise manufactured than rough-sawn or split or creosoted, vulcanized or treated by any other preserving process; sawed or split boards, planks, deals, and other lumber when not further manufactured than dressed on one side only or creos-

## The Canadian Tariff.

- soted, vulcanized or treated by any preserving process; pine and spruce clapboards; timber or lumber hewn or sawed, squared or sided or creosoted; laths, pickets and palings; staves not listed or jointed of wood of all kinds; fire wood, handle, heading, stave and shingle bolts, hop poles, fence posts, railroad ties; hubs for wheels, posts, last blocks, wagon, oar, gun, heading and all like blocks or sticks rough hewn, or sawed only; felloes of hickory wood, rough sawn; to shape only, or rough sawn and bent to shape, not planed, smoothed or otherwise manufactured; hickory billets and hickory lumber, sawn to shape for spokes of wheels, but not further manufactured; hickory spokes, rough turned, not tenoned, mitred, throated, faced, sized, cut to length, round tenoned or polished; shingles of wood; the wood of the persimmon and dogwood trees; and logs and round unmanufactured timber, ship timber or ship planking, not specially enumerated or provided for in this Act.
- 612 D shovel handles, wholly of wood, and Mexican saddle trees and stirrups of wood.
- 613 Corkwood, or cork bark, unmanufactured.
- 614 Saw-dust of the following woods: Amaranth, cocoboral, box-wood, cherry, chestnut, walnut, gumwood, mahogany, pitch pine, rose-wood, sandal-wood, syamora, Spanish cedar, oak, hickory, white-wood, African teak, black-heart ebony, lignum vitae, red cedar, red-wood, satin-wood, white ash, persimmon and dogwood.
- 615 Treennails.
- 616 Tobacco, unmanufactured, for excise purposes, under conditions of the Inland Revenue Act, until July 1, 1897.
- 617 Tubes, rolled iron not welded or joined, under one and one-half inch in diameter, angle iron, nine and ten gauge, not over one and one-half inch wide, iron tubing lacquered or brass covered, not over one and one-half inch in diameter, all of which are to be cut to length for the manufacture of bedsteads, and to be used for no other purpose, and brass trimmings for bedsteads, when imported by or for manufacturers of iron or brass bedsteads to be used for such purposes only in their own factories, until such time as any of the said articles are manufactured in Canada.
- 618 Turpentine, raw or crude.
- 619 Turtles.
- 620 After January 1, 1888, binders' twine, or twine for harvest binders, of hemp, jute, manilla or sisal, and of manilla and sisal mixed, and all articles upon which duties are levied which enter into the cost of the manufacture of such twine, under regulations to be made by the Controller of Customs.
- 621 Ultramarine blue, dry or in pulp.
- 622 Varnish, black and bright, for ships purposes.
- 623 Whalebone, unmanufactured.
- 624 Whiting or whitening, Paris white and gilders' whiting, blanc fixe and satin white.
- 625 Wire, crucible cast steel.
- 626 Wire rigging for ships and vessels.
- 627 Wire, of brass, zinc, iron or steel, screwed or twisted, or flattened or corrugated, for use in connection with nailing machines for the manufacture of boots and shoes, when imported by manufacturers of boots and shoes, to be used for such purposes only in their own factories.
- 628 Steel wire, Bessemer soft drawn spring, of numbers ten, twelve and thirteen gauge, respectively, and homo steel spring wire of numbers eleven and twelve gauge, respectively, when imported by manufacturers of wire mattresses, to be used in their own factories in the manufacture of such articles.
- 629 Wool and the hair of the camel, alpaca, goat and other like animals, not further prepared than washed, n.e.s.; noils, being the short wool which falls from the combs in worsted factories; and worsted tops, n.e.s.
- 630 Wool or worsted yarns, when renapped, dyed or finished and imported by manufacturers of braids, cords, tassels and fringes to be used in the manufacture of such articles only in their own factories.
- 631 Yarn spun from the hair of the alpaca or of the angora goat, when imported by manufacturers of braids for use exclusively in their factories in the manufacture of such braids only, under such regulations as are adopted by the Controller of Customs.
- 632 Yellow metal, in bolts, bars and for sheathing.
- 633 Zinc, spelter and zinc in blocks, pigs, sheets and plates; and seamless drawn tubing.
- 634 Molasses, second process, or molasses derived from the manufacture of "molasses sugar," testing by polariscope less than thirty-five degrees, when imported by manufacturers of blacking, for use in their own factories, in the

# Richelieu and Ontario Navigation Co.

## "NIAGARA TO THE SEA"

Operating both PASSENGER and FREIGHT LINES

BETWEEN

HAMILTON, TORONTO, ROCHESTER (Charlotte), KINGSTON,  
GANANOQUE, BROCKVILLE, PRESCOTT,  
CORNWALL, MONTREAL, QUEBEC and the SAGUENAY.

## DAILY TOURIST LINE

TORONTO TO MONTREAL, QUEBEC and the SAGUENAY, through  
the THOUSAND ISLANDS and Running all the  
RAPIDS of the ST. LAWRENCE.

## Semi-Weekly FREIGHT SERVICE

Steamers Leave HAMILTON and TORONTO Mondays and Thursdays  
via Bay of Quinte, for MONTREAL.

RETURNING—Leave MONTREAL Mondays and Thursdays.

**LOW FREIGHT RATES and QUICK DESPATCH.**

C. F. GILDERSLEEVE,

General Manager.

THOS. HENRY,

Traffic Manager.

GENERAL OFFICES, - - - MONTREAL

When writing to Advertisers kindly mention THE CANADIAN MANUFACTURER.

The Canadian Tariff.

manufacture of blacking,—conditional that the Importers shall in addition to making oath at the time of entry that such molasses is imported for such use and will not be used for any other purpose, cause such molasses to be at once mixed in a proper tank made for the purpose with at least one-fifth of the quantity thereof of cod or other oil, whereby such molasses may be rendered unfit for any other use, such mixing to be done in the presence of a Customs officer at the expense of the Importer, and under such further regulations as may from time to time be considered necessary in the interest and for the protection of the revenue, and that until such mixing is done and duly certified on the face of the entry thereof by such Customs officer the entry shall be held to be incomplete and the molasses subject to the usual rate of duty as when imported for any other purpose.

635 Bags, barrels, boxes, casks and other vessels exported filled with Canadian products, or exported empty and returned filled with foreign products; and articles the growth, produce and manufacture of Canada, when returned after having been exported; provided that proof of the identity of such articles and goods shall be made under regulations to be prescribed by the Controller of Customs, and that such articles and goods are returned within three years from time of exportation, without having been advanced in value or improved in condition by any process of manufacture or other means; provided further that this item shall not apply to any article or goods upon which an allowance of drawback has been made the re-importation of which is

The Canadian Tariff.

hereby prohibited except upon payment of duties equal to the drawback allowed; nor shall this item apply to any article or goods manufactured in customs or excise bonded warehouse and exported under any provision of law.

SCHEDULE C.

Prohibited Goods.

- 636 Books, printed paper, drawings, paintings, prints, photographs or representations of any kind of a treasonable or seditious, or of an immoral or indecent character.
- 637 Reprints of Canadian copyright works, and reprints of British copyright works which have been copyrighted in Canada also.
- 638 Coin, base or counterfeit.
- 639 Oleo margarino, butterine or other similar substitute for butter.
- 640 Tea adulterated with spurious leaf or with exhausted leaves, or containing so great an admixture of chemical or other deleterious substances as to make it unfit for use.
- 641 Goods manufactured or produced wholly or in part by prison labor, or which have been made within or in connection with any prison, jail or penitentiary; also goods similar in character to those produced in such institutions, when sold or offered for sale by any person, firm or corporation having a contract for the manufacture of such articles in such institutions or by any agent of such person, firm or corporation, or when such goods were originally purchased from or transferred by any such contractor.

# AN ACT TO AMEND THE CUSTOMS TARIFF.

IN FORCE JULY 1, 1900.

HER MAJESTY, BY AND WITH THE ADVICE AND CONSENT OF THE SENATE AND HOUSE OF COMMONS OF CANADA, ENACTS AS FOLLOWS:—

1. The Customs Tariff, 1897, is amended by inserting after item 555 in schedule B thereto the following item:—

555a. Machinery of a class not made in Canada, when imported exclusively for use in factories for the manufacture of beet root sugar.

2. This section shall be deemed to have come into force on the twenty-fourth day of March, one thousand nine hundred.

2. On and after the first day of July, one thousand nine hundred, the schedule D substituted by section 7 of chapter 37 of the statutes of 1898 for schedule D of The Customs Tariff, 1897, shall be repealed, and the following shall be substituted therefor:—

SCHEDULE D.

BRITISH PREFERENTIAL TARIFF.

On articles entitled to the benefits of this preferential tariff under section seventeen, the duties mentioned in schedule A shall be reduced as follows: The reduction shall be one-third of the duty mentioned in schedule A, and the duty to be levied, collected and paid shall be two-thirds of the duty mentioned in schedule A.

Provided, however, that this reduction shall not apply to any of the following articles and that such articles shall in all cases be subject to the duties mentioned in schedule A, viz., wines, malt, liquors, spirits, spirituous liquors, liquid medicines and articles containing alcohol; tobacco, cigars and cigarettes.

Provided, further, that the reduction shall only apply to refined sugar when evidence satisfactory to the Minister of Customs is furnished that such refined sugar has been manufactured wholly from raw sugar produced in the British Colonies or possessions.

E. W. B. SNIDER, President.

W. W. SNIDER, Vice-President.

H. W. ANCHES, Manager, Secretary and Treasurer.

# Toronto Foundry Co., Limited

Manufacturers  
of.....

**Soil Pipe and Fittings,  
Sinks and Boiler Stands,**

**146, 148, 150 Niagara St.,**

CATALOGUE ON  
APPLICATION

**TORONTO**

TELEPHONE 5335.

When writing to Advertisers kindly mention THE CANADIAN MANUFACTURER.

WE GUARANTEE OUR PRICES TO BE AS LOW AS OFFERED BY ANY MAKERS—  
FOR EQUAL QUALITY.



ORDERS ADDRESSED TO OUR MONTREAL OR TORONTO FACTORY WILL HAVE PROMPT CARE

# Canadian Export Duties.

AN ACT RESPECTING EXPORT DUTIES.

ASSENTED TO JUNE 29, 1897

A TRUE COPY FROM THE OFFICIAL TEXT.

An Act Respecting Export Duties.

ASSENTED TO JUNE 29, 1897.

HER MAJESTY, BY AND WITH THE ADVICE AND CONSENT OF THE SENATE AND HOUSE OF COMMONS OF CANADA, ENACTS AS FOLLOWS:

1. If any country now or hereafter imposes a duty upon the articles enumerated in item 611 in Schedule B to The Customs Tariff, in 1897, or upon any of such articles when imported into such country from Canada, the Governor-in-Council may, by proclamation published in the Canada Gazette, declare the following export duties, or any of them, chargeable upon logs and pulpwood exported from Canada to such country, that is to say:—On pine, Douglas fir, spruce, fir balsam, cedar and hemlock logs, and pulp wood, an export duty not exceeding three dollars per thousand feet, board measure; and in case of the export of any of the above-mentioned logs or pulpwood in shorter lengths than nine feet, then a rate per cord may be levied in the same way, not greater than the equivalent of the above-mentioned rate per thousand feet, board measure; and such export duty shall be chargeable accordingly after the publication of such proclama-

tion: Provided that the Governor-in-Council may, by proclamation published in like manner, from time to time remove and re-impose such export duty.

2. The Governor-in-Council may, by proclamation published in the Canada Gazette, impose export duties as under upon the following ores and metals, and each such duty shall be chargeable accordingly after the publication of such proclamation; and the Governor-in-Council may, by proclamation published in like manner, from time to time remove and re-impose such export duties:—

(a) On nickel contained in matte, or in the ore, or in any crude or partially manufactured state, and upon copper contained in the matte or ore which also contains nickel—when exported from Canada—upon such nickel, an export duty not exceeding ten cents per pound, and upon such copper, an export duty not exceeding two cents per pound;

(b) On ores which contain copper, or any metal other than nickel or lead, when exported from Canada, an export duty not exceeding fifteen per cent. on the value of the said ores;

(c) On lead ores, and on lead and silver ores, when exported from Canada to a country which imposes an import duty on lead in bars or in the form of pig lead in excess of the import duty on lead contained in lead ores or in lead and silver ores,—an export duty on the lead contained in the ores so exported from Canada, to an amount per pound equivalent to such excess.

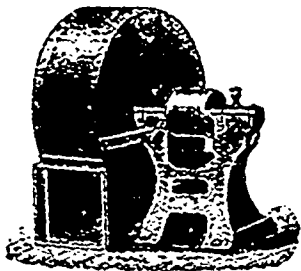

## PLANING MILL STEEL PLATE EXHAUST FANS

For removal of refuse from Wood-Working Machinery.

## CYCLONE DUST SEPARATORS

Made of Galvanized Steel. All Sizes for Fans from 30 inches up.

Estimates cheerfully given for Complete Installations of Fans, Piping, Gates, Hoods and Separators, with or without Shavings Feed Attachment to Boiler Fires.

**McEACHREN HEATING and VENTILATING CO.,** - **Galt, Ont.**

We make Forge, Cupola and Disc Fans, Electric Fans, Heaters and Fans for Lumber and Wool Drying, etc., and for Heating of Factories. Steam Traps, Oil Separators, Etc.

When writing to Advertisers kindly mention THE CANADIAN MANUFACTURER.



Portland Cements

English, German,  
Belgian, Canadian  
and American Brands.

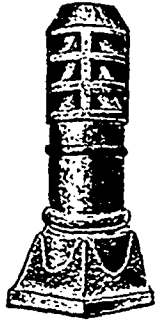

Fire Bricks

Ganister, Silex,  
Kaolin.

Fire Clay



Drain Pipes

Flue Linings, Etc.

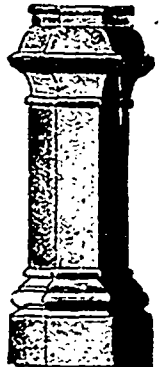

Calcined Plaster,

Land Plaster,  
Plasterers' Hair, Whiting.

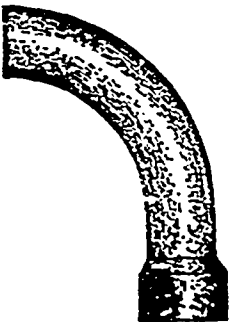

Keene's Victoria Cement  
Plaster.

Wheelbarrows, Contractors' and Founders'  
Supplies.



**F. HYDE & CO.**

31 Wellington St.,

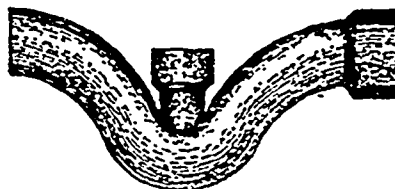

**MONTREAL.**

# Index to Canadian Tariff.

A		No. of Item.				No. of Item.	
Absorbent cotton, surgical dressing	152	Amalgama safes and cleaners	555	Articles, Dominion Government	450	Senate or House of Commons	450
Acetate of aluminum (red liquor)	517	Amaranth, lumber, etc., of rough sawn or split, etc.	611	made from cotton or linen fabrics, N.O.P.	362	produce of the fisheries, N.O.P.	122
iron (iron liquor)	617	sawdust	614	to officers and men of navy	449	unenumerated	447
lead, not ground	515	Amber gum	531	used in dyeing or tanning, crude, N.E.S.	517		
Acid, acetic and pyroligneous, N. E. S., crude, not over 30 p.c.	141	ornaments	351	Artificial alizarine	477	brandy	7 (a)
boracic	142	Ambergris	477	flowers	430	limbs	479
muratic and nitric	400	Ammonia, aromatic spirits of, nitrate of	477 (d)	Artistic work, other than hand-painting or drawing, N.E.S.	126		
other, N.E.S.	143	sulphate of	477	Artotypes	130		
oxalic	477	Ammoniac, sal.	477	Arts, Improvements in	475		
phosphate, N.O.P.	145	Ammunition, N.O.P.	306	mechanic, books on	464		
stearic	19	Amyl alcohol	7 (a)	Araucaria	520		
sulphuric	144	Anatomical preparations	463	Asbestos, other than crude, and manufactures of	353		
taunic	484	Anchors	481	Ash, bone	520		
tartaric crystals	502	Anchovies, in tin cans	111	soda	580		
Acids, mixed	143	Angle iron, 9 and 10 gauge, for manufacture of bedsteads	617	white-lumber, etc.	611		
Aconite root, unground	515	Angles, iron or steel, for vessels	542	of sawdust	614		
Acorn nuts, N.O.P.	59	rolled iron or steel, less than 35 lbs. per 1 yard	227	Ashes, pot and pearl, in packages not less than 25 lbs.	565		
Actions, watch	347	rolled iron or steel, N.E.S.	228	Asphalt or asphaltum	480		
Adhesive felt for sheathing vessels	519	Angora goat hair, yarn spun from, for manufacturing braids	631	Associations, religious or benevolent, annual reports of	466		
Admiralty charts	459	Angostura bitters	7 (a)	Astrachan hair skins, not dyed	578		
Adulterated tea, prohibited	640	Aniline, arseniate of	477	Astronomical globes	461		
Advertising almanacs	126	dyes, not less than 1 lb.	477	Attachments, binding	318		
bill, folders and posters	126	oil, crude	477	sewing machine	553		
calendars	126	salts	477	Attar of roses	558		
circulars and flysheets	126	Animals for exhibition or competition, for improvement of stock	456	Augers, coal	555		
chromos, chromotypes, etc.	126	living	11	steel, for manufacture of	598		
pamphlets	126	Animals, skins of, for taxidermic purposes	463	Auger bits do	598		
periodicals	126	Animal manures	520	Australian gum	531		
Adzes	289	stearine	18	Automatic samplers, etc.	555		
African teak, lumber, etc.	611	Anise seed, crude, not ground, etc.	526	Auxiliary, indigo	517		
sawdust	614	star seed, crude, not ground, etc.	526	Axes	290		
Agate ware, hollow	307	Annatto, liquid or solid	477	steel for manufacture of	598		
Agriculture, books on	464	seed, crude, not ground, etc.	526	Axle bars, iron or steel, for railway or tramway vehicles, etc., for manufacture of axles for vehicles, etc.	600		
Agricultural forks, steel for	598	Annual reports of religious or benevolent associations	466	blanks, iron or steel, for railway or tramway vehicles, etc.	246		
Agricultural implements, plates for, cut to shape, but not moulded, etc.	317	Anodes, nickel	278	for manufacture of axles for vehicles, etc.	246		
N.E.S.	290	Anodynes, alcoholic, N.E.S., N.O.P.	7 (b)	Axles, iron or steel, for railway or tramway vehicles, etc.	246		
settlers	475	Anthracite coal	506	grease	175		
Air guns and rifles	390	dust	506				
compressors	345	Anti-corrosive and anti-fouling paints	160				
Alabaster ornaments	341	Antimony salts, not ground, pulverized or manufactured	478				
Album insides of paper	431	Antiseptic surgical dressing	152				
Albumen blood	484	Antiquities, collections of	473				
Albumenized paper for photographers	123	Anvils	289				
Alcohol amyl	7 (a)	Apparatus, electric, N.E.S., life saving	472				
ethyl	7 (a)	philosophical, not manufactured in Canada, for colleges, etc.	462				
methyl	7 (a)	Apparel, wearing, wool, worsted, hair of alpacas, goat or like animal, N.E.S., wearing, of British subject dying abroad	394				
wood	7 (a)	wearing, settler's	454				
Alcoholic bitters and beverages	7 (a)	Apples, dried, desiccated or evaporated	526				
liquors	7 (a)	plum	526				
liquors, N.O.P.	7 (a)	Apple trees	53				
perfumes	7 (c)	Arabic gum	531				
Ale in bottles	2	Archill, extract of	517				
casks, etc.	1	Architecture, books on	464				
Allizarine artificial	477	Argal or argols	502				
Alkanet root, crude, crushed or ground	515	Arms, for use of army and navy	206				
Alligator leather	212	fire	206				
Almanacs, advertising	126	Army and navy, articles imported by and for use of	440				
Almonds	96	Aromatic seeds, viz.—anise, anise star, caraway, cardamom, coriander, cumlin, fennel and fennel-greek, crude, not ground, etc.	526				
Alpacas, fabrics, to be dyed and finished in Canada, etc.	356	sprits of ammonia	7 (d)				
hair fabrics, N.E.S.	394	Arrack	7 (a)				
manufactures, viz.—blankets and flannels, cloths, doeskins, cassimeres, tweeds, coatings, overcoatings and felt cloth, N.E.S.	394	Arsenate of aniline	477				
hair or wool, not further prepared than washed, N.E.S.	629	of soda	556				
hair, yarn spun from, for manufacturing braid	631	Arsenic	477				
ready-made clothing or wearing apparel, N.O.P.	394	Articles exported and returned, fancy, N.E.S.	351				
yarn costing 30c. and over per lb.	393	for use of Governor-General	448				
Alpacas, to be dyed and finished in Canada, etc.	356	for the personal use of Consuls-General	451				
Alum, in bulk only	476	iron or steel, N.O.P.	321				
cake	476	by and for army and navy	440				
Alumina	476						
sulphate of	476						
Aluminium, in ingots, blocks or bars, strips, sheets or plates, chloride of	476						
crude, acetate of, etc. (red liquor), for dyeing and calico printing	517						
hollow-ware, N.E.S.	308						
leaf	352						
manufactures of, N.O.P.	292						



CABLE ADDRESS  
"GUTTPERCH," TORONTO

# CANADA.

Codes: A. 1 1888 Edition  
A.B.C. 4th Edition.  
Directory. Liebers. Private.

FACTORIES  
115-165 West Lodge Ave. } TORONTO  
124-148 O'Hara Ave., }



H. D. WARREY, Pres. & Treas.  
C. N. CANDEE, Secretary.

We make a *Specialty of Manufacturing for the Canadian Market Rubber Goods for the Holders of Canadian Patents, and Solicit Correspondence with Rubber Manufacturers who desire to have their specialties*  
**MADE IN CANADA.**

## SOLE MANUFACTURERS IN CANADA OF

Kelly-Springfield Solid Carriage Tires.

"Maltese Cross" Carbolized Rubber Fire and Suction Hose.

"Eureka," "Paragon," and other High Grades of Cotton Fire Hose.

"Goodrich" and "Hartford" Single Tube Bicycle Tires.

### MANUFACTURERS OF

**Mechanical Rubber Goods**  
**Rubber Insulating Compounds**  
**Belting, Matting, Clothing**  
**Packing, Valves, Tubing**  
**Hose, Carriage Cloths.**

"MALTESE CROSS" and "LION"

**Rubber Boots and Shoes.**

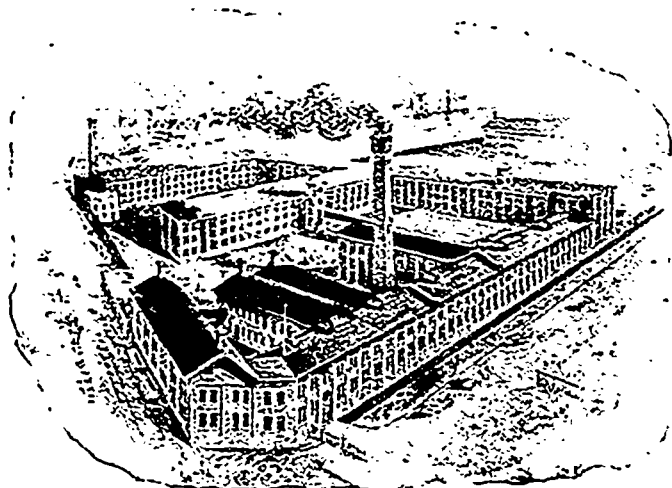

# The Gutta Percha & Rubber Mfg. Co. of Toronto

LIMITED.

49-61-63 WEST FRONT STREET, TORONTO, ONTARIO, CANADA.

When writing to Advertisers kindly mention THE CANADIAN MANUFACTURER.

Index to the Canadian Tariff.

	No. of Item.		No. of Item.		No. of Item.
Barberry gum.....	531	Blechnate of potash, crude.....	565	Blown glass tableware.....	208
Barbed wire.....	282	soda.....	586	Blowing engines, blast furnace.....	555
fencing wire.....	602	Bicycle chain, steel for manufac-		Blueberries, wild.....	526
Barbers' shears.....	284	ture of.....	597	Blue prisms.....	130
Barilla.....	580	Bicycles.....	325	ultramarine, dry or in pulp.....	621
Bark, cork, manufactures of, N.		settlers.....	455	vitriol.....	502
O.P.....	327	canvass for manuf. of tires for.....	516	Bluing, laundry.....	160
unmanufactured.....	613	Billets, hickory.....	611	Boards, felt, sized, etc., for manu-	
hemlock.....	517	iron or steel.....	226	facture of gun wads.....	535
Bark, oak.....	517	steel, for manufacture of		mill.....	134
oak, extract of.....	517	axles.....	600	Boards, straw, in sheets or rolls.....	135
tanners'.....	517	Billiard tables, cues and balls.....	349	tarred.....	135
Barked marine.....	517	Bills, advertising.....	126	Boards, bugatelle.....	340
Barks, crude drugs, N.O.P.....	515	of exchange, unsigned.....	128	sawed, planed, jointed, etc.....	328
Barley.....	44	Bismuthate of soda.....	580	undressed or dressed on one	
Barrels, Canadian manuf., exported		Blinding attachments.....	318	side only, etc.....	611
and returned.....	635	Blindings, hatters'.....	533	wood, of certain kinds, when not	
containing petroleum.....	174	Blinder twine.....	433 &	otherwise manufactured than	
aluminum.....	476	Blinders, chain for.....	318	sawn, etc.....	611
axle, iron or steel, for railway		Bird cages.....	287	Boats, sail, open pleasure.....	410
or tramway vehicles, etc.....	246	Birds, skins of, for taxidermie pur-		life.....	472
for manuf. of axles for vehicles,		poses.....	463	sails for.....	380
etc.....	600	Biscuits, sweetened.....	58	Bolters, composed wholly or in part	
brass.....	492	not sweetened.....	57	of iron or steel, N.O.P.....	315
Britannia metal.....	493	Bismuth, metallic, in its natural		Boiler tubes of wrought-iron or	
copper.....	492	state.....	484	steel.....	249
gold and silver bullion.....	495	Bisulphite of soda.....	586	Bolsters.....	343
iron or steel, hammered, N.O.		Bits, anger-steel for manufacture		Bolt blanks, iron or steel, N.E.S.....	279
P.....	243	of.....	598	Bolts, brass.....	492
railway, N.E.S.....	238	Bitters, N.O.P.....	147	copper.....	492
lead.....	273	angostura, tafia and similar al-		handle.....	611
nickel and German silver in.....	584	colic.....	7 (a)	heading.....	611
phosphor bronze.....	250	Bituminous coal, round, etc.....	180	iron or steel, N.E.S.....	279
platinum.....	564	slack.....	179	stave.....	611
puddled iron or steel.....	220	Blackberries.....	75	shingle.....	611
steel, more than 2½% per lb.,		Black bone.....	520	yellow metal in.....	632
N.O.P.....	230	crape.....	367	Bolting cloth, not made up.....	487
tin.....	610	diamonds for borers.....	513	Bolsters.....	343
bars, tin plate, crop ends of.....	223	heart, ebony, lumber, etc., of.....	611	Bonds, unsigned.....	128
yellow metal in.....	632	sawdust of.....	614	Bone, ash.....	520
Base coin, prohibited.....	638	lorry.....	547	black.....	520
Bases for electrotypes, etc., of		lamp.....	547	charred.....	520
books, etc.....	604	Black oxide of copper, for manu-		dust.....	520
newspaper columns.....	303	facture of chlorate.....	515	pitch, crude.....	480
Baskets of all kinds.....	424	varnish for ship's use.....	622	Bones, crude, not manufactured,	
Baths, N.O.P.....	186	Blackening, shoe.....	164	etc.....	488
Batteries, electric.....	294	molasses used for the manu-		Boneless fish.....	110
galvanic.....	294	facture of.....	634	Bonnet shapes.....	403
Battling, cotton.....	358	Blades, knife, in the rough.....	285	Bonnets, N.E.S.....	403
Batts, cotton.....	358	Blank fixc.....	624	Bonnet shapes, buckram for manu-	
Bayonets.....	306	Blankets, wool, worsted, hair of al-		facture of.....	404
Bay run.....	351	paca, goat, and like animals, N.		Bookbinding machines.....	313
Bead ornaments, N.E.S.....	351	E.S.....	394	Bookbinders' cloth.....	489
Beams, iron or steel, for vessels.....	542	Blanketing and lapping imported		Books, viz.:—Bibles, prayer books,	
rolled iron or steel, less than 35		by cotton manufacturers, call-		psalms and hymn books.....	464
lbs. per 1 yd.....	227	co printers and wall-paper		British subjects dying abroad,	
N.E.S.....	228	manufacturers.....	486	donations of, for charitable pur-	
weighing.....	283	Blank forms, commercial, printed		poses.....	471
Bean, meal, locust.....	526	or lithographed.....	128	electrotypes, etc., of.....	604
Beans.....	36	Blanks, axle, iron or steel, for rail-		embossed, for the blind.....	465
sced, from G.B.....	526	way vehicles, etc.....	246	illustrated price.....	126
baked, in cans or other pack-		bolt, nut and hinge, N.E.S.....	279	for the instruction of the deaf	
ages.....	66	celluloid lamp shade.....	286	and dumb and blind.....	465
cocoa, not roasted, crushed or		corset.....	362	fly.....	424
ground.....	526	Blanks, eye bar, flat, not punched		mechanics' institutes, public	
crude drugs, N.O.P.....	515	or drilled.....	228	free libraries, university, col-	
locust.....	526	knife, in the rough.....	285	lege, law libraries, etc.....	467
viz.:—tonguin, vanilla and nux-		shovel, and iron or steel cut to		not printed in Canada, for uni-	
vomica, crude only.....	526	shape for.....	291	versities and colleges.....	467
Bed, comforters, wool, etc.....	394	spade, and iron or steel cut to		viz.:—novels, etc., paper, bound,	
Bedsteads, certain articles for man-		shape for.....	291	or in sheets.....	124
ufacture of.....	617	Blast furnace slag.....	485	railway, freight and telegraph	
Bed-fast, steel, for manufacture of.....	595	blowing engines.....	535	rates, in book and pamphlet	
Beef, fluid, not medicated.....	15	water jackets.....	555	form.....	124
Beer, in bottles.....	2	Blasting powder.....	412	pocket.....	424
cans, etc.....	2	Bleached cotton fabrics, N.O.P.....	359	printed in any other than French	
Bees.....	482	Bleaching, hocks on.....	464	or English language, etc.....	464
Beeswax.....	20	Blind, embossed books for, etc.....	465	printed by any government or	
Beet seed.....	526	maps and charts for schools of.....	461	association for promotion or	
syrups, N.E.S.....	440	rollers.....	344	learning, etc.....	466
Bells, when imported for use of		typewriters, tablets and musi-		printed and manufactured more	
churches.....	483	cal instruments for schools of.....	460	than 12 years.....	468
other.....	276	Blinds, window, of paper.....	138	printed, N.E.S.....	125
Belts, buckles, jewellery.....	350	not textile or paper.....	342	prohibited.....	636
Belted rolls.....	315	Blocks, lead.....	272	scientific.....	464
Belting chain for blunder.....	318	tin.....	610	settlers'.....	455
duck for, imported by manufac-		aluminum.....	476	Root laces.....	405
turers.....	516	brass and copper in.....	492	Roots, N.E.S.....	219
of leather or other material, N.		Britannia metal.....	493	Roots, horse.....	280
E.S.....	218	burrstones, rough.....	496	India-rubber.....	221
leather.....	213	celluloid, xylonite or xylolite in		rubber, stockettes for.....	383
Belts, cartridge.....	306	the rough.....	501	wire (brass, iron, steel and	
surgical and electric.....	152	gold and silver bullion.....	495	zinc) twisted, for manufacture	
of all kinds, N.O.P.....	362	gun, rough hewn or sawed only		of.....	627
Bench machines, N.O.P.....	289	heading, rough hewn or sawed		Boracic acid.....	490
Bengallies, to be dyed and finished		only.....	611	Borax, in bulk of not less than 25	
in Canada, etc.....	356	inverted, earthenware.....	184	lbs.....	490
Bent plate glass.....	209	last and like blocks, rough		Borders, wall paper.....	138
Berries, black, goose, rasp and		hewn, etc.....	611	Borders, black diamonds for.....	513
straw.....	75	nickel and German silver in.....	584	Bort, or diamond dust.....	513
blue, straw and rasp, wild.....	526	oak, rough hewn or sawed only.....	611	Botanical specimens.....	463
cranberries.....	76	paving, of stone.....	194	Bottles, glass.....	298
crude drugs, N.O.P.....	515	phosphor bronze.....	299	Bottoms, tank, sugar.....	424
for dyeing or for composing		wagon, rough hewn or sawed		Bow sockets, tubular, steel for.....	586
dyes.....	517	only.....	611	Bowls, steel, for cream separators.....	588
Berry bushes, goose and rasp.....	74	zinc in.....	623	Boxes, collar.....	351
Bessemer steel wire for wire mat-		Blood albumen.....	464	exported and returned.....	625
tresses.....	628	dragon's.....	502	glove.....	351
Beverages, angostura, tafia and sim-		Blooms, crop ends of.....	223	handkerchief.....	351
ilar alcoholic.....	7 (a)	iron or steel.....	226	hat.....	424
Bibles.....	464	Blouses, ladies' and misses'.....	366	or skirts, cart.....	247

# ELECTRICAL SUPPLIES

We desire to call your attention to the fact that we carry one of the most complete stocks in Canada of all kinds of Electrical Supplies, and wish to have your orders for rosettes, cut outs, sockets, tubes, cleats, insulated wires, electric fixtures, meters, instruments, motors, dynamos, etc. We will be pleased to send information and catalogues upon request.

## MUNDERLOH & CO. MONTREAL

---

### NON-CONDUCTING COVERINGS

---

—FOR—

**Pipes, Boilers, Heaters,  
Tanks, Etc.**

### MINERAL WOOL

—FOR—

**INSULATION OF HEAT, COLD AND SOUND**

**ASBESTOS MATERIALS, ENGINE PACKINGS, Etc., Etc.**

**Eureka Mineral Wool & Asbestos Company**  
TORONTO

When writing to Advertisers kindly mention THE CANADIAN MANUFACTURER.

Index to the Canadian Tariff.

	No. of Item.
Boxed papers.....	140
Boxwood, lumber, etc., of.....	611
sawdust.....	614
Bracelets, N.O.P.....	362
Braces, or parts thereof.....	404
Brads.....	259
Braids.....	362
alpaca or angora goat yarn for manufacture of.....	641
hair.....	362
wool or worsted yarn for manu- facture of, etc.....	620
Brandy.....	7 (a)
artificial.....	7 (a)
fruits preserved in.....	83
imitations.....	7 (a)
Brass band instruments.....	357
bars.....	492
blocks.....	492
bolts.....	492
buckles, N.O.P.....	305
burrs, rivets or washers.....	276
cups for manufacture of paper shells or cartridges.....	512
in sheets or plates.....	492
in strips, etc.....	492
manufactures of, N.O.P.....	276
not manufactured in Canada, for ships or vessels.....	542
nails and tacks.....	276
old.....	492
pumps.....	312
ribs for manufacture of umbrel- las, parasols, etc.....	572
rods.....	492
screws, N.O.P.....	260
scrap.....	492
trimmings for bedsteads.....	617
tubing.....	492
wire.....	265
wire cloth or woven wire.....	267
twisted, for manufacture of boots and shoes.....	627
Brazil nuts.....	46
Bread knives.....	284
Breadstuffs, damaged by water in transit.....	45
Breeding oysters.....	560
Bricks, fire, for manufacturing purposes, etc.....	522
Bricks, fire, N.E.S.....	181
for building.....	181
paving.....	181
Bridge plate, universal mill.....	230
structural sections, N.E.S.....	228
Bridges, iron or steel.....	242
Bright varnish for ships' use.....	622
Brimstone, crude, or in roll or flour.....	502
Briquette-making machines.....	555
Bristles.....	491
Britannia metal, manufacture of, not plated.....	292
in pigs, blocks and bars.....	493
British copyright works, reprints of, copyrighted in Canada, pro- hibited.....	637
gum.....	107
subjects dying abroad, personal and household effects of.....	454
Brocade powders.....	352
Bromine.....	477
Bronze, phosphor, in blocks, bars, sheets and wire.....	291
powders.....	352
Broom corn.....	491
Brooms.....	330
Brushes.....	428
Brush cases.....	351
pads, hair.....	491
Buckle clasps, steel, 12 to 30 gauge, inclusive, for manufac- ture of.....	595
Buckles, N.O.P.....	305
belt, or other jewellery.....	350
Buckram, for manufacture of hat and bonnet shapes.....	494
Buckthorn-fencing wire, etc., for manufacture of.....	263
Buckwheat.....	37
meal or flour.....	46
Buddles.....	555
Buds, June.....	73
Bugle, N.E.S.....	323
Builders' hardware.....	280
Building brick.....	181
plans, N.E.S.....	130
stone, not hammered or chis- elled.....	193
stone, dressed.....	194
structural sections, N.E.S.....	228
Bullis, crude drugs, N.O.P.....	515
floral stock.....	526
glass, for electric lights.....	294
Bullets, lead.....	274
Bullion fringe.....	495
furnaces.....	555
gold and silver, in blocks, bars, ingots, etc.....	495
Bustings, to be dyed and finished in Canada, etc.....	386
Burgundy pitch.....	477
Burners.....	297

	No. of Item.
Burnt siennas, N.E.S.....	160
Burr-stones, in blocks, rough.....	496
Burrs, brass and copper.....	276
Bushes, gooseberry, raspberry, cur- rant and rose.....	74
Busks, for corsets.....	302
Bulldozers' nails and spikes.....	255
Butchers' steels and knives.....	284
Butter.....	31
cocoa.....	94
substitutes, prohibited.....	639
Butterine, prohibited.....	639
Butt hinges.....	280
Button lic.....	517
Buttons, cloth, for manufacture of collar, cuff and recognition, not jewellery.....	426
pautiloon, metal.....	426
Buttons, paper mache, shoe.....	553
shoe, N.E.S.....	426
all other, N.O.P.....	426
Butts, jute.....	545
<b>C</b>	
Cabinets of coins.....	473
Cabinet-makers' hardware.....	280
furniture.....	343
Cable, chalu.....	542
Cables, covered.....	294
wire, N.E.S.....	269
Cages, bird, parrot, squirrel and rat.....	287
Caie, alum.....	470
cotton seed.....	559
meal oil.....	559
Cake, mustard.....	63
oil.....	559
palm nut.....	559
saffron.....	502
salt.....	596
Cakes, yeast.....	72
Calcereous tufa.....	477
Calendars, advertising.....	120
Calf leather, dressed, waxed or glazed.....	212
Calico printing, copper rollers for use in.....	577
California prunes.....	77
Calumna root, unground.....	515
Camel hair fabrics, etc., to be dyed and finished in Canada, etc., not further prepared than washed, N.E.S.....	386
Camwood and extract thereof.....	620
Canada plates.....	517
Canadian copyright works, reprints prohibited.....	234
millita, certain articles for use of.....	637
of.....	450
Canary seed.....	61
Candied peel.....	438
Candles, N.E.S.....	21
paraffine wax.....	22
Car-dy, sugar.....	438
Cane, syrups, N.E.S.....	440
split or manufactured, reed, etc., N.O.P.....	326
unmanufactured.....	499
Canes, bamboo reeds cut into lengths for.....	499
umbrella, parasols, etc., rough or cut into lengths, etc.....	572
walking, N.E.S.....	335
Canned meats.....	15
oysters.....	117, 118, 119
penitry and game.....	15
Canister powder.....	413
Cannon powder.....	413
Cat-rans.....	306
Canoes.....	410
Can't dogs.....	289
Canvas, jute, not pressed, etc., for manufacture of carpets, etc., to be used for boats and ships' sails.....	411
for manufacture of bicycle tires.....	516
Cacutouch, crude.....	573
Capes, fur.....	407
Caplins.....	497
Caps, fur.....	407
N.E.S. and cap shapes.....	403
for manufacture of umbrellas, parasols and sunshades.....	572
for whip ends, of steel, iron or nickel.....	576
percussion.....	306
Caraway seed, crude, not ground, etc.....	326
Carbolic oil.....	558
Carbon points.....	275
Carbons, electric light, N.E.S.....	29.
over 6 in. in circumference.....	296
Carboys, glass.....	208
Cardamon seed, crude, not ground.....	526
Card clothing, cotton and rubber fil- lets for manufacture of.....	523
Card clothing, machine.....	316
Cards, curry.....	280
pletorial show.....	126
playing.....	137
printed or lithographed (com- mercial).....	128
Carpentry, books on.....	464

	No. of Item.
Carpet bags.....	424
cork.....	398
linings.....	396
ewcepers.....	313
Carpeting of cocoa, straw, hemp or jute.....	363
Carpets, jute, hemp or flax yarn, for the manufacture of.....	546
N.E.S.....	397
Carriage hardware, N.E.S.....	280
inats, N.E.S.....	395
oil cloth, enamelled.....	398
Carriages, childrens'.....	323
for travellers.....	453
laden with merchandise.....	453
menagerie.....	453
N.E.S.....	323
Carrot seed.....	520
Cars, railway, running on lines crossing frontier.....	474
railway or other.....	324
Car-wheel tires of steel, in the rough.....	551
Cartridge belts and cases.....	306
Cartridges.....	306
brass cups for manufacture of primers for the manufacture of.....	512
535	
Cart skeins or boxes.....	247
Carts, hand.....	324
pleasure, N.E.S.....	324
settlers'.....	455
Carvers.....	284
Cases, cartridge.....	306
fancy.....	351
elgar and cigarette and holders for smokers' sets.....	424
musical instruments.....	424
show.....	339
watch.....	345
Cashmeres to be dyed or finished in Canada, etc.....	386
Cash registers.....	343
Casings, sausage, not cleaned.....	580
Caskets.....	339
Casks, etc., exported and returned.....	635
Cashmeres, wool, worsted, hair of alpaca, etc., N.E.S.....	394
Casters, steel for manufacture of.....	595
Castings, malleable iron, N.E.S.....	255
iron or steel in the rough, N.E.S.....	244
Castis, as models, for use of schools of design.....	498
Cast iron, scrap.....	221
pipe of every description.....	248
steel wire, crucible.....	626
Castile soap, mottled or white.....	24
Catalogues.....	128
Cat-gut, for musical instruments.....	500
unmanufactured, for whip cord.....	600
Catsups.....	67
Cattle for improvement of stock .. menagerie.....	457
Caustic potash.....	458
soda.....	565
"C.C." ware, decorated, printed or sponged.....	586
185	
Cedar, red, lumber and timber, planks and boards of.....	611
saw-dust.....	614
Spanish, lumber and timber planks and boards of.....	611
saw-dust.....	614
Celluloid balls and cylinders, moulded, not finished.....	286
collars.....	365
Celluloid cuffs.....	365
in sheets and in lumps, blocks or balls in the rough.....	501
lampshade blanks .. moulded into sizes for knife and fork handles, not bored, etc.....	286
286	
Celluloids, for almanacs, newspaper advertisements, etc., N.E.S.....	302
for almanacs, matrices or copper shells for .. of books, etc., and matrices, bases and copper shells for same.....	302
604	
newspaper columns.....	303
bases, matrices or copper shells for.....	303
Cement, baths, tubs and wash- stands.....	186
manufactures of, N.O.P.....	181
including Portland and hydrau- lic or water line.....	187
Centres, raw-hide, for manufacture of whips.....	576
Chain, bicycle, steel for manufac- ture of.....	597
shackles and links.....	261
for blinders.....	318
cable.....	542
Chains, hair.....	362
(iron or steel) 5-16 of an inch and over.....	261
Chalk stone.....	525
Chamois skins.....	212
Champagne.....	9
Chandellers.....	207

ESTABLISHED 1859

# H. R. IVES & CO.

General Founders

MANUFACTURERS OF

## Brass and Iron Bedsteads

PLAIN and ORNAMENTAL IRON STAIRCASES,  
RAILINGS, CRESTING, ELEVATOR ENCLOSURES.

Artistic and Wrought Iron Work OF EVERY DESCRIPTION  
ETC., ETC.

OFFICE AND WORKS

Queen Street, - MONTREAL.

# The Abbott-Mitchell Iron and Steel Company

OF ONTARIO, LIMITED.

MANUFACTURERS OF

Bar Iron and Steel,  
Nails, Spikes, Horse Shoes,  
Bolts, Washers, Etc.

BELLEVILLE, ONT.

When writing to Advertisers kindly mention THE CANADIAN MANUFACTURER.

Index to the Canadian Tariff.

No. of Item.	No. of Item.	No. of Item.
Channels, rolled iron or steel, less than 35 lbs. per l. yd. ....	Cloth, wire, of brass or copper....	Collars of cotton, linen, xylonite, etc. ....
rolled iron or steel, N.E.S. ....	iron or steel .....	lace .....
Charitable purposes, donations of clothing and books for.....	Clothes-line wire .....	light fixtures .....
Charred bone .....	wringers .....	Collectors of metals, antiquities ..
Charts, N.E.S. ....	Clothing, card, cotton and rubber ..	postage stamps .....
Admiralty .....	allets, for manufacture of .....	Cologne water .....
for use of schools for blind....	cotton, N.O.P. ....	Colored cotton fabrics, N.O.P. ....
Chases for printing .....	donations of, for charitable ..	Colors, dry, N.E.S. ....
Chateleine leags, frames, clasps or fastners for, not more than 7 inches wide .....	horse, jute .....	ground in spirits .....
Chesse .....	India-rubber .....	Columns, newspapers, celluloids, etc., of .....
Chemical preparations, N.O.P. ....	linen, N.O.P. ....	Combing woods, such as are grown in Canada .....
Chesques, unsigned .....	made waterproof with India-rubber .....	Combs, curry .....
Cherries, N.E.S. ....	Clothing, machine card .....	for dress and toilet and mane combs .....
Cherry lumber and timber, planks and boards of .....	mackintosh, certain cloths for manufacture of .....	Comforters, best, wool, etc. ....
saw-dust .....	military or naval, by and for use of army and navy .....	Commercial blank forms .....
trees .....	military, for use of Canadian militia .....	Commons, House of, articles by and for use of .....
Chestnut, lumber and timber, planks and boards of .....	ready-made, wool, worsted, hair, of alpaca, etc., N.O.P. ....	Common soap .....
saw-dust .....	shk, N.O.P. ....	Communism plate imported for use of churches .....
Chicle gum, crude .....	Cloths, horse hair for manufacture of .....	Compasses for ships .....
Chicory, kiln-dried, roasted or ground .....	Italian, to be finished in Canada, etc. ....	Competition, animals for .....
Chicory, raw or green .....	not rubbered, etc., for manufacture of mackintosh clothing ..	Competitions, cups and prizes won in .....
Children's carriages .....	tray, damask of linen .....	Composition metal for manufacture of filled gold watch cases....
Chilled iron or steel rolls .....	table .....	ornaments .....
Chimney linings or vents and tops. ....	of wool, worsted, hair of alpaca, goat, etc., N.E.S. ....	nails and spikes .....
Chimneys, lamp .....	Clout nails .....	or polish, N.O.P. ....
China clay .....	Coach screws, N.O.P. ....	Compound, lard .....
goat plates or rags, not dyed..	Coal anthracite .....	of bromide and potassium....
stone .....	dust .....	Compressed yeast .....
ware .....	anchors and drills .....	Compressors, air .....
Chip platts .....	bituminous, slack .....	Concentrated melado .....
Chloralum .....	cutters .....	Concrete, sugar .....
Chloride of aluminum .....	cutting machines .....	Condensed coffee, with milk....
lime .....	healing machines .....	milk .....
soda .....	dust, N.E.S. ....	Condensers, platinum, by manufacturers of sulphuric acid, etc.
Chlorate of potash, ground only ..	N.E.S. ....	Confectionery .....
soda .....	oil fixtures, or parts thereof ..	labels for .....
platinum and black oxide of copper, for manufacture of .....	oil, illuminating, costing more than 20c. per gallon .....	Consul-General, articles for use of ..
Chloroform .....	oil, N.E.S. ....	Converters, machinery .....
Chocolate .....	pitch .....	Cooks' knives .....
paste .....	tar .....	Coopers' nails .....
Chrome steel .....	dyes, not less than one lb .....	Coyal gum .....
Chromos, advertising .....	washing machinery .....	Coppers .....
N.E.S. ....	Coarse salt, N.E.S. ....	Copper, black oxide of, for manufacture of chlorate .....
Chromotypes, advertising .....	Coat linings, to be dyed and finished in Canada, etc. ....	buckles, N.O.P. ....
N.E.S. ....	Coated papers .....	burs, rivets or washers .....
Chronometers .....	sheet iron, 17 gauge and thinner ..	ingots .....
Church vestments .....	Coats, fur .....	blocks .....
Clurns .....	Coatings, wool, worsted, hair of alpaca goat, etc., N.E.S. ....	in pigs, bars, rods and bolts ..
earthen or stoneware .....	Collalt, ore of .....	manufactures of, N.E.S. ....
Cider, clarified or refined .....	oxide of .....	metals .....
not clarified or refined .....	Coalmeal .....	nails and tacks .....
Cigarettes .....	Cocoa beans, not roasted, crushed or ground .....	old and scrap .....
Cigarette cases and holders therefor ..	Cocoa butter .....	oxide of .....
for .....	carpets, mats and matting .....	plates, not planished or coated, tanning machinery .....
Cigars .....	nuke, N.E.S. ....	Copper, precipitate of, crude .....
Cigar boxes, labels for .....	Imported direct by vessel .....	rivets .....
knives .....	not dedicated .....	rollers for use in calico printing ..
cases and holders therefor .....	paste .....	sheets, not planished or coated ..
Cinabar .....	preparations of, N.E.S. ....	strips .....
Circulars .....	shells and shells .....	sub-acetate of, dry .....
Citron rinds in brine .....	Coccolnut oil, natural .....	sulphate of .....
Clapboards, pine .....	Commercial, lumber and timber, planks and boards of .....	shells, for stereotypes, etc., of almanacs, etc., N.E.S. ....
spruce .....	saw-dust .....	shells, for the stereotypes, etc., of books, etc. ....
Clasps, buckle, steel 12 to 50 gauge for manufacture of .....	Cocoons, silk .....	shells, for the stereotypes, etc., of newspaper columns .....
corset .....	Cocoes .....	tubing .....
for purses, etc., not more than 7 inches wide .....	Colliliver oil .....	wire .....
Classifiers .....	fish lines .....	cloth, or woven wire .....
Clay crucibles .....	Coffee condensed, with milk .....	Copyright works, prohibited .....
manufactures of, N.O.P. ....	extract of, and substitutes .....	Corlage, N.E.S. ....
baths, tubs and washstands .....	green, N.E.S. ....	Corl, gut for musical instruments ..
Clays, including China clay, fire clay and pipe clay .....	Imported direct from country of growth, etc. ....	Corlalls, N.O.P. ....
Cleavers .....	purchased in bond in United Kingdom .....	N.E.S. ....
Cleavers, amalgam .....	roasted or ground, not imported direct .....	Corloran leather, dressed, waxed or glazed .....
Cliff stone .....	roasted or ground, and imitations and substitutes, N.E.S. ....	Cords, N.O.P. ....
Clippers, horse and toilet .....	Collans .....	half .....
Clippings, paper waste .....	Corralled ingots, iron or steel .....	whip, to be drel and finished in Canada, etc. ....
iron or steel .....	Coll chain and links .....	wool or worsted yarn for manufacture of, etc. ....
Cleaks, fur .....	Coln, base or counterfelt, prohibited ..	Core drills .....
Clock keys .....	Colne cabinets of gold and silver, except U. S. silver coln. ....	Corlander seed, crude, not ground, etc. ....
spring, steel, for manufacture of, etc. ....	Colr .....	Cork bark, unmanufactured .....
Clocks and clock movements .....	yarns .....	manufactures of, N.O.P. ....
Cloth, bookbinders .....	Coke .....	carpet .....
bolting, not made up .....	making machinery .....	matting .....
emery .....	Collar boxes .....	Corkwood, unmanufactured .....
felt, N.E.S. ....	buttons, not jewellery .....	manufactures of, N.O.P. ....
hair .....	cloth paper, union, glossed or finished .....	Corks .....
jute, not otherwise finished than bleached, etc. ....	cloth paper, union, not glossed or finished .....	Corns, florist stock .....
jute, as taken from the loom, etc. ....	or finished .....	Cornless and corn-see poles .....
Cloth, mohair, etc., for the manufacture of buttons .....	Collar boxes .....	Corn, broom .....
num's, to be dyed and finished in Canada, etc. ....	buttons, not jewellery .....	flour .....
oiled, India-rubbered, soaked or coated, N.O.P. ....	cloth paper, union, glossed or finished .....	Indian, for distillation .....
paper, union collar, glossed or finished .....	cloth paper, union, not glossed or finished .....	not for distillation .....
not glossed or finished .....		

*The* **PARMENTER & BULLOCH CO., Limited, GANANOQUE, ONT.**

Copper, Brass and Coppered Rivets and Burrs and Carpenters Braces, Counter-Sunk, Round or Cone Head, Clout Hinge and Wagon Box Nails, with Long Chisel Points

Steel Wire Moulding Nails, Standard Steel Penny Wire Nails, Steel Wire Brads, Wire Roofing Nails, Tubular and Bifurcated Rivets.

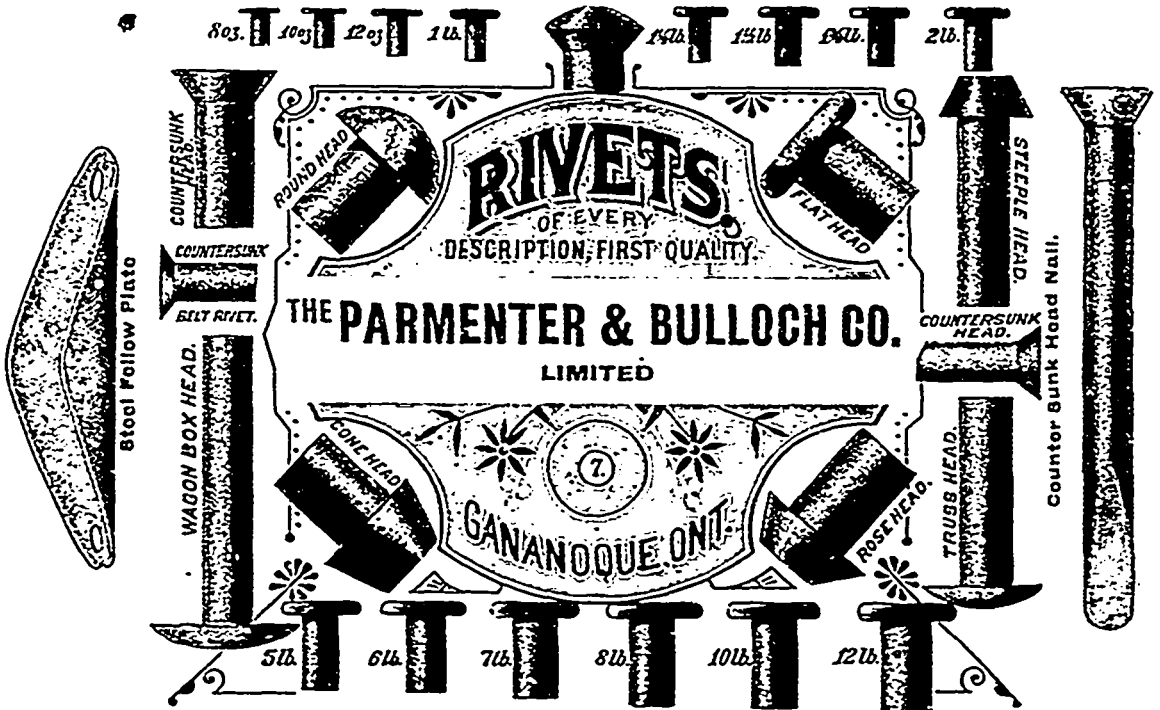

Head Office and Works, GANANOQUE.

BRANCHES—32 and 34 St. Dizier St., MONTREAL.  
29 Melinda St., TORONTO.

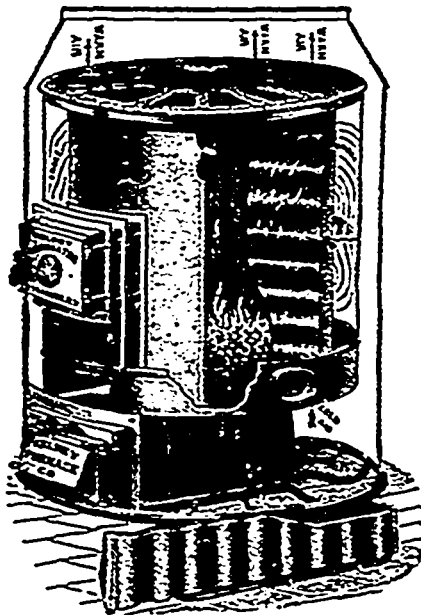

**NOT HARD TO SEE**

The great difference between

**KELSEY WARM AIR GENERATORS** (Patented)

And the Ordinary GLOBE

**STOVE HOT AIR FURNACE.**

USERS SOON DISCOVER that the Kelsey is

**A Heat Maker! A Fuel Saver!**

**NOTE PARTICULARLY—**

Construction of Fire-Pot  
Great Heating Surface  
**LARGE AIR CAPACITY.**  
MADE IN 6 SIZES.

**SPECIAL FEATURES—**

Warming Rooms at a Distance. Better Quality of Warm Air.  
Freedom from Gas and Dust. No Fire-Pot to Burn Out.  
No Heat Lost in Cellar.

Our Kelsey Booklet Tells Why, Send for one.

EXCLUSIVE MAKERS FOR CANADA.

**The JAMES SMART MFG. CO., Limited, Brockville, Ont.**

When writing to Advertisers kindly mention THE CANADIAN MANUFACTURER.

Index to the Canadian Tariff.

	No. of Item.
Cornmeal.....	47
pop.....	438
Corn, starch.....	60
symp.....	437
N.E.S., in cans or other pack- ages.....	66
Cornish rolls.....	315
Coruwall stone.....	525
Corrugated tubes or lines for ma- rine boilers.....	249
Corsets.....	362
Corset blanks and busks.....	362
clasp.....	362
laces, tagging metal for manu- facture of.....	606
steels.....	362
steels, steel 20 to 30 gauge, in- clusive for manufacture of etc. wire, flat wire of steel, 16 gauge and thinner, for manufacture of.....	592
wires.....	262
Cotswold combing wools.....	290
Cottolene.....	18
Cotton absorbent.....	152
batts.....	358
batting.....	358
clothing, N.O.P.....	362
cloth of certain kinds for manufacture of waterproof clothing.....	291
collars.....	295
crochet, on spools, tubes or in balls.....	371
cuffs.....	295
damask.....	261
duck, grey or white.....	294
embroideries, white.....	363
fabrics, articles made from, N. O.P.....	362
white or grey, N.O.P.....	359
printed, dyed or colored, N.O.P. fillets, 7-in. and under, wide, for card clothing.....	523
batters' plash.....	533
hose, lined with rubber.....	122
net merrills.....	524
nettings.....	562
platts.....	563
rags.....	570
raw.....	568
seamless bags.....	377
seed-cake.....	559
seed-meal.....	559
seed refuse, etc. (foot-grease) sewing-thread, in hanks.....	370
on spools, tubes or in balls.....	371
thread, N.E.S.....	371
wadding, sheet.....	358
warps, N.E.S.....	358
waste.....	508
wool.....	508
wool, surgical dressing.....	152
yarns, N.E.S.....	358
No. 40 and finer.....	508
Counterfelt coin, prohibited.....	638
Counterspanes, wool, etc.....	234
Couillis, imported by corset and dress stay makers.....	264
Covered wire.....	264
corset wire.....	362
Covers, gun or pistol.....	206
Cranberries.....	76
Craps.....	315
Crapes, black.....	367
Cream, coloured ware, decorated, printed or sponged.....	186
Cream separators and steel bowls for.....	558
slag.....	167
of tartar in crystals.....	592
Creepers, i.e., steel for manufacture of.....	595
Crossed lumber or timber.....	511
Crisoline wire, flat wire, steel, 10 gauge and thinner, for manu- facture of.....	592
Crochet cotton, on spools, tubes or in balls.....	371
Crocks, earthen or stoneware.....	182
Crop ends of tin plate bars, etc.....	151
Crossings for railways.....	240
Crow-bars.....	282
Cruelries, plumbago or clay.....	510
Cruelible cast steel wire.....	625
sheet steel for mowers and reaper knives.....	290
Crude acetate of aluminium, etc., (fred liquor), for dyeing and calico printing.....	517
acetic acid.....	142
alkanet root.....	515
Crude aniline oil.....	477
aromatic seeds, not edible, anise, caraway, etc.....	526
beans, viz.:—Toaquin, vanilla and nux vomica.....	526
bi-chromate of potash.....	525
bone pitch.....	480
bones, not manufactured, etc.....	488
brimstone.....	502
caoutchouc.....	673

	No. of Item.
Crude drugs, such as berries, beans, etc., not edible, etc., N.O.P.....	515
dyeing or tanning articles, N.E. S.....	517
gum chicle or sappato gum.....	515
gypsum.....	502
iodine.....	477
lac.....	517
lime juice.....	550
meerschbaum.....	552
moss.....	521
muriate of potash.....	565
oils, by manufacturers for fuel and gas purposes.....	172
opium.....	155
petroleum, etc., by manufactur- ers for fuel purposes or for manufacture of gas.....	172
precipitate of copper.....	502
pyroligneous acid.....	142
rubber.....	679
sulphur.....	502
sea-weed.....	521
grass.....	521
sulphate of soda.....	523
turpentine.....	618
Crushed alkanet root.....	515
emery in bulk.....	518
Crushers, ore, rock, grain.....	315
Cryolite, mineral.....	477
Crystal glass tableware.....	205
Crystallized quartz.....	556
Crystals, cream of tartar.....	502
tartaric acid.....	502
tin.....	610
Cubic nitre.....	586
Cudbear, extract of.....	517
Cue racks and tips.....	340
Cues, billiard and bagatelle.....	340
Cuff buttons, not jewellery.....	426
Cuffs of cotton, linen, xylonite, xyloite or celluloid.....	365
Cultivators.....	318
Cumin seed, crude, not ground, etc. Cups and other prizes won in bona fide competitions.....	473
Cups, brass, for shells or cartridges.....	512
Curled hair.....	429
Curling stones.....	511
Current bushes.....	74
wine.....	8
Currants, N.E.S.....	75
dried.....	77
Curry cards.....	280
cumbs.....	280
Curtains.....	362
Cut glass tableware.....	205
nails and spikes of iron or steel.....	255
tacks, brads or sprigs.....	259
tobacco.....	443
Cutch.....	517
Cutlery, cases for.....	351
steel, under 1/2 in., for manu- facture of.....	524
N.O.P.....	524
Cutters.....	351
coal and feed.....	315
straw, steel for, cut to shape only.....	589
Cutting machines, coal.....	555
paper.....	313
Cuttings, iron or steel.....	223
Cyanide of potassium.....	477
Cyanogen.....	477
Cyclometers.....	422
Cylinders, celluloid, moulded, not finished.....	599
D	
Damask of linen or cotton.....	361
stair linen and drape.....	361
Dammur gum.....	521
Dates.....	78
Deaf and dumb and blind, books for instruction of.....	465
Deals, sawed, undressed, or dress- ed on one side only, etc.....	611
Deals, sawed, planed, jointed, etc.....	323
Decanters, glass.....	208
Decoras.....	561
Demijohns, earthen or stoneware, glass.....	182
glass.....	208
Dental instruments.....	153 and 605
Derivicks.....	315
Desecrated apples.....	78
coconut.....	10
fruits, N.E.S.....	78
Desks, writing, fancy.....	351
Dextrine.....	167
Diagrams, wall.....	463
Diamond drills for prospecting for minerals.....	513
dust or borax.....	513
Diamonds, black, for borers.....	513
unset.....	513
Diaper linen.....	361
Dies, for manufacture of jubilee medals.....	473
Diggers, post hole.....	290
potato.....	315
Digitalis, foliæ.....	515
Discs for engraving copper rollers.....	450

	No. of Item.
Discs for cotton and wall paper manufacturers and calico printers.....	450
Doekskins, wool, worsted, hair of al- pacca, goat, etc., N.E.S.....	394
Dogs, for improvement of stock.....	457
Uogwood.....	611
saw-dust.....	614
Dolls.....	351
Domestic fowls, pure bred, for im- provement of stock.....	514
sewing machines, settlers.....	455
Dominion Government, articles im- ported by, and for use of.....	450
Donations of clothings and books for charitable purposes.....	471
Dongola leather, dressed, waxed or glazed.....	212
Door mats, N.E.S.....	395
Doors for safes and vaults.....	253
wire.....	343
Doylets.....	361
Drafts, unsigned.....	128
Dragon's blood.....	502
Drain pipes, glazed or unglazed.....	154
tiles, not glazed.....	183
Drainings, sugar, drained in transit Drawers.....	430
N.E.S.....	388
Drawings, prohibited.....	636
Drawn tubing, zinc seamless.....	130
Drays.....	633
dress combs.....	322
goods, women's and children's to be finished in Canada, etc. stays, flat wire of steel, 16 gauge and thinner for manu- facture of.....	427
592	
Dressing, shoe, harness and leather, surgical, antiseptic.....	164
Dried apples.....	78
currants.....	77
fruits, N.E.S.....	76
fish, N.E.S., in barrels or half- barrels.....	114
not imported in barrels.....	100
Driers, Japan.....	168
liquid.....	168
Drills, diamond, for prospecting for minerals.....	513
rock.....	315
core and rotary, coal.....	556
seed.....	318
Drops, medicinal, N.O.P.....	147
gold and silver bullion.....	495
Drugs, crude, such as berries, beans, etc., not edible, etc., N.O.P.....	513
Dry colors, N.E.S.....	159
fillers, N.E.S.....	160
plates, photographic.....	419
putty for polishing glass or granite.....	541
sub-acetate of copper-verdigris.....	502
ultramarine blue.....	621
white and red lead, orange min- eral and zinc white.....	158
Drying machinery, ore.....	535
"D" shovel handles of wood.....	612
Duck, cotton, grey or white.....	394
for belting and hose, when im- ported by manufacturers of such articles.....	516
Dumb and deaf and blind, books for instruction of.....	465
Dust, coal, anthracite.....	508
diamond.....	513
zinc.....	517
Dusters, lap, of all kinds.....	389
Dutch metal leaf.....	352
Dyed cotton fabrics, N.O.P.....	365
hair.....	429
Dyes, aniline, not less than one lb. berries for composing.....	477
coal-tar, not less than one lb. patent, prepared.....	477
Dyeing articles, crude, N.E.S.....	517
Dyeing berries for.....	517
books on.....	464
Dynamox, electric.....	294
E	
Earth, fallers.....	515
Earth, ochre.....	189
Earthenware, brown or colored.....	183
bath tubs and washstands.....	186
demijohns, churns or crocks, stills and spurs, used in manu- facture of.....	182
tiles.....	557
N.E.S.....	184
183	
Ebony, black heart, lumber and timber, planks and boards of saw-dust.....	611
614	
Edging knives.....	290
Effects, personal and household, of British subjects dying abroad, left by bequest.....	454
settlers.....	454
Eggs.....	50
Elastic, garter.....	362
rubber thread.....	575
round or flat.....	362
webbing.....	400



The Largest Manufacturing Plants have found 15 per cent.  
Economy by using

# GREEN'S FUEL

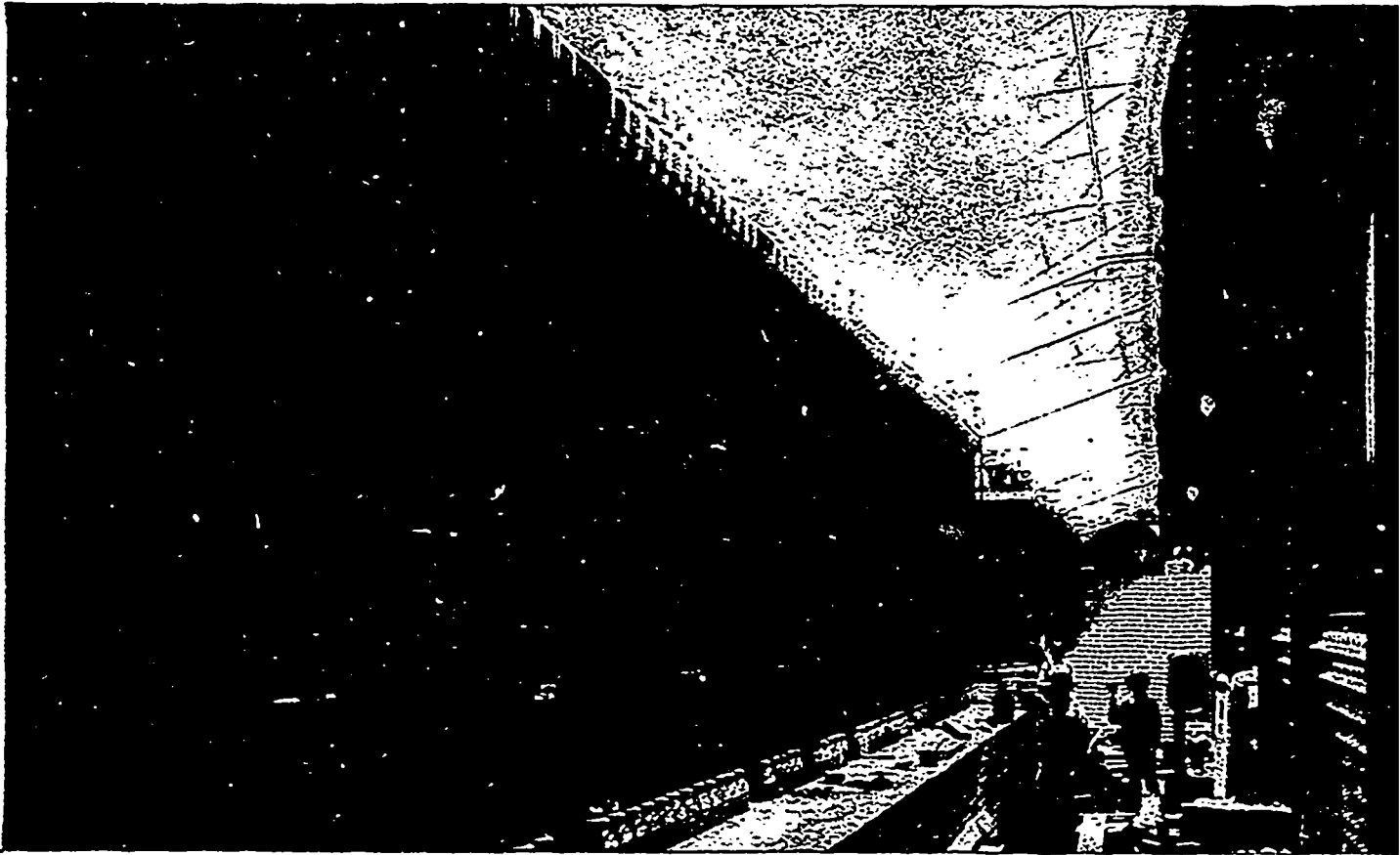

## Economizer

Great Saving in Fuel. Heats Feed Water and Water for  
Manufacturing Purposes. 30,000,000 B.H.P. in use.

WRITE FOR BOOK, GREEN'S ECONOMIZER.

THE

# Green Fuel Economizer Co.

54 Street Railway Chambers, MONTREAL.

When writing to Advertisers kindly mention THE CANADIAN MANUFACTURER.



# METALLIC CEILINGS

Made in a Great Variety of Designs, Suitable  
for every Description of Buildings.

A MODERN SUBSTITUTE FOR WOOD AND PLASTER.

Light in weight, will not crack or drop off, are durable, have air-tight joints, easily applied, practically fire-proof, highly artistic, do not harbor vermin or germs of disease, and possess splendid acoustic properties.

Send us an outline of any room you wish to do, giving exact shape and accurate measurements, and we will be pleased to submit designs, estimates and plans, free of charge.

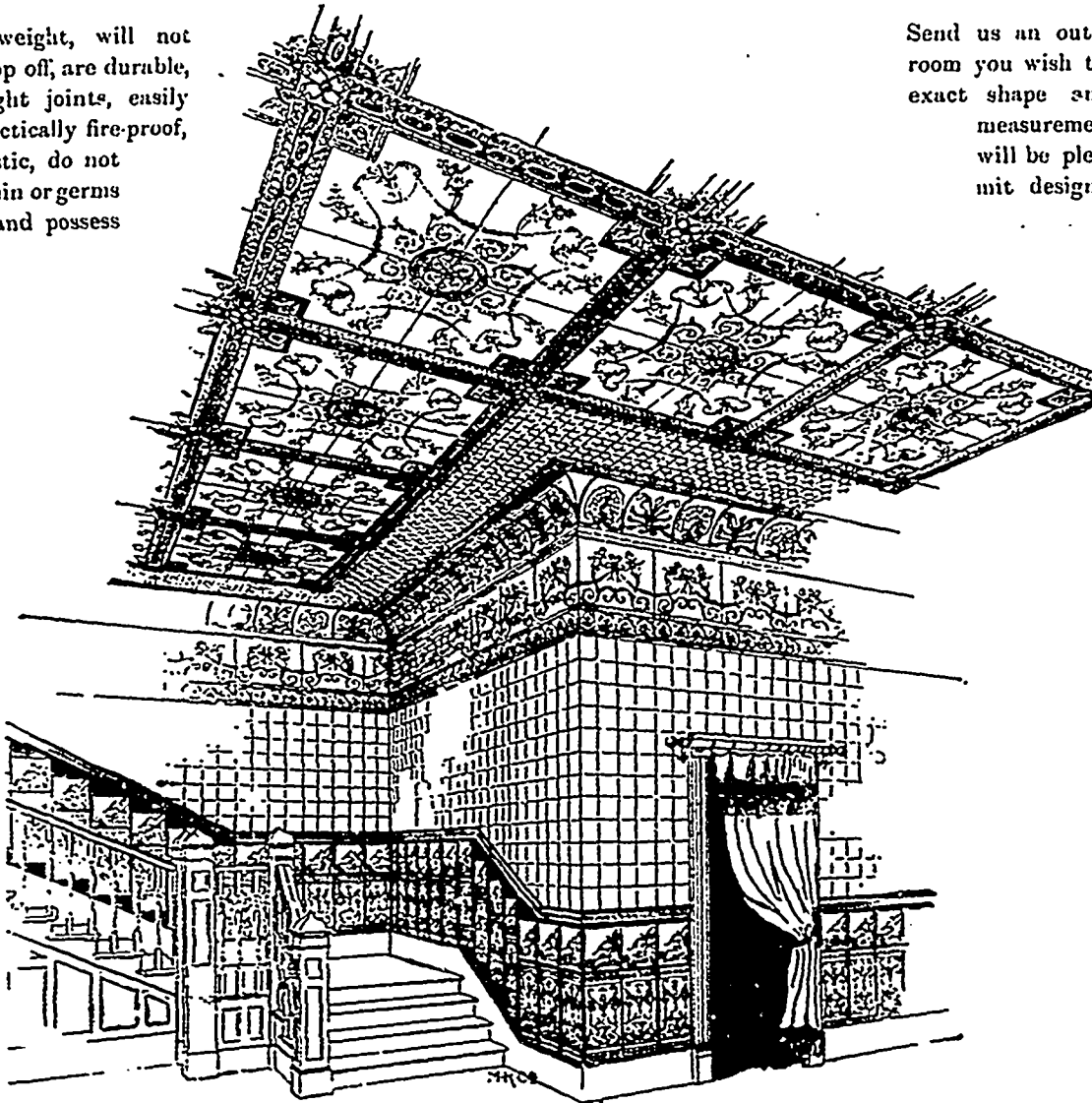

The illustration shows Dado, Wall Plates, Frieze, Cornice, Border, Mouldings and Ceiling Plates Complete.

We Manufacture all kinds of **SHEET METAL BUILDING MATERIAL**

SEND FOR ILLUSTRATED CATALOGUE GIVING COMPREHENSIVE INFORMATION OF OUR IMPORTANT PRODUCTS.

## METALLIC ROOFING CO.

MANUFACTURERS

LIMITED

TORONTO, - - CANADA.

When writing to Advertisers kindly mention THE CANADIAN MANUFACTURER.

Index to the Canadian Tariff.

	No. of Item.		No. of Item.		No. of Item.
Fresh fish, N.E.S., in barrels or half-barrels.....	114	Glass, figured, enamelled and obscured, white.....	202	Grindstones, N.E.S.....	192
otherwise than in barrels or half-barrels.....	109	flasks and phials.....	208	Grinding machines, rock emery.....	535
lamb.....	10	globes, shades and lamp chimneys.....	208	Ground alkaneet.....	515
meats, N.E.S.....	14	iron sand and dry putty, etc., for polishing.....	541	chleory.....	92
mutton.....	10	jars.....	208	coffee, not imported direct and imitations, etc.....	88
salmon.....	100	looking, German, unsilvered.....	207	emery, in bulks.....	518
tomatoes.....	95	muffled.....	201	flint stones.....	525
Erilage, bullion.....	495	ornamental, figured and enamelled, coloured.....	202	Ground fustic.....	517
Fringes.....	362	painted and vitrified.....	202	logwood.....	517
wool or worsted yarn for manufacture of.....	630	paper.....	135	mustard.....	62
Frogs for railways.....	240	plain coloured, stained, tinted or muffled, etc., in sheets.....	201	oak bark.....	517
Fruit essences, spirituous or ethereal, N.E.S.....	7 (b)	plate, not over 25 sq. ft., not bevelled.....	203	spices, N.E.S.....	101
Fruit juices containing spirits.....	5	N.D.S., not bevelled.....	204	Guano.....	520
N.O.P.....	6	rolled, rough.....	202	Guavas.....	526
plants, N.E.S.....	74	bevelled, N.O.P.....	205	Gum, amber, Arable and Australian.....	531
syrups, N.O.P.....	6	silvered.....	206	barberry.....	531
trees, seedling stock for grafting.....	526	tableware, blown.....	218	British.....	107
Fruits in air-tight cans and other packages.....	82	cut, pressed or moulded.....	208	chicle.....	515
viz.: bananas, plantains, pineapples, pomegranates, guavas, mangoes and shaddockes, wild blue, straw and raspberries.....	526	window, common and colorless memorial, etc., N.O.P.....	202	copal.....	531
crude drugs, not edible, etc., N.O.P.....	515	windows, stained.....	202	dammara and elemy.....	531
dried, desiccated or evaporated, N.E.S.....	78	Glaziers' knives.....	254	gedda.....	531
labels for.....	127	Gloves, geographical, topographical etc.....	461	kaurie.....	531
preserved in brandy or in other spirits.....	531	glass.....	208	mastic.....	531
Fruit seeds, crude drugs, not edible, etc., N.O.P.....	515	Globules, iron, for polishing granite and glass.....	541	Gum, resin, crude drugs, not edible, etc., N.O.P.....	515
Fuel oils, by manufacturers for fuel purposes or for manufacture of gas.....	172	Glove boxes or cases.....	351	sandarac, senegal and shellac.....	531
Fullers' earth.....	515	fasteners, metal.....	553	sappato.....	515
Fur caps, hats, muffs, tippets, capes, coats and cloaks.....	407	leathers.....	214	trazacanth.....	531
skins, not dressed in any manner.....	529	Gloves of all kinds.....	402	white shellac, for manufacturing purposes.....	531
wholly or partially dressed.....	402	Glucose.....	427	Gumwood, lumber and timber, planks, boards of.....	611
other manufactures of, N.O.P.....	407	symp.....	437	saw-dust.....	614
Furs, hatters, not on the skin.....	533	Glue.....	27	Gum, crude drugs, not edible, etc., N.O.P.....	515
Furnace slag, blast.....	485	Glycerine for manuf. of explosives.....	415	sweetened.....	438
Furnaces, bullion.....	535	Goat hair fabrics, to be dyed and finished in Canada.....	386	Gun blocks, rough hewn or sawn only.....	611
Furniture of wood, iron or other material.....	343	and manufactures, N.E.S.....	394	covers.....	306
British subjects dying abroad.....	454	or wool, washed only, N.E.S.....	629	powder.....	413
household, settlers' effects, etc.....	455	manufactures, viz.: blankets, etc., N.E.S.....	394	felt board for manufacture of.....	535
springs.....	343	plates or rugs, China, not dyed.....	378	Guns.....	306
casters, steel for manufacture of.....	545	wearing apparel or ready-made clothing, N.E.S.....	394	settlers'.....	455
Fusel oil.....	7 (a)	(Angora) yarn, for manufacture of brads.....	631	Gut cord for musical instruments, worm, unmanufactured, for whip and other cord.....	500
Fusic, extract of.....	517	Goat leather.....	212	Gutta-percha hose, packing, etc.....	522
ground.....	517	Gold beater's moulds.....	530	crude.....	573
G		skins.....	530	manufactures of, N.O.P.....	573
Galleries, light fixtures.....	297	bullion, in bars blocks, ingots, etc.....	495	unmanufactured.....	573
Galvanic batteries.....	294	Gold, coin.....	473	Gypsum, crude.....	562
Galvanized sheet iron or steel, manufactures of, N.O.P.....	309	fringe.....	495	ground, not calcined.....	158
wire, 9, 12 and 13 gauge, for fencing.....	262 and 603	leaf.....	352	calcined or manufactured.....	189
Gambler.....	517	liquid paint.....	352	H	
Game bags.....	306	manufactures of, N.E.S.....	350	Hacking knives.....	284
canned.....	15	medals.....	473	Hair brush pads.....	491
N.O.P.....	17	insulating slime tables.....	555	Hair of camel, goat, etc., washed only, N.E.S.....	629
Gannister.....	505	sweepings.....	465	cleaned or uncleaned, not curled cloth of all kinds.....	532
Garden seeds, N.O.P.....	61	Gongs, N.E.S.....	270	curled or dyed.....	429
sprinklers.....	312	Goods, dress, wool, worsted, etc., to be finished in Canada, etc., manufactured by prison labour, prohibited.....	641	horse, for manufacture or horse hair cloths.....	532
Gas fixtures or parts thereof.....	237	unenumerated.....	447	manufactures of.....	362
Gas meters.....	282	Gooseberry bushes.....	74	mattresses.....	343
oils, by manufacturers for fuel purposes, etc.....	172	Gooseberries, N.E.S.....	75	non-alcoholic.....	149
Gauzes, surgical dressing.....	152	Government, Dominion, articles imported by and for use of.....	450	pins, jewellery.....	350
Gedda, gum.....	531	Governor General, articles for use of.....	448	skins, Russian, etc.....	578
Gelatine.....	27	of.....	448	washes, alcoholic.....	7 (c)
Generators, electric.....	294	Grain crushers.....	315	Hammered iron or steel bars or shapes, N.O.P.....	243
Gentian root, unground.....	515	damaged by water in transit.....	45	shapers.....	250
Geographical globes.....	491	Grains, crude drugs, not edible, etc., N.O.P.....	515	steel for manufacture of.....	595
German looking-glass.....	207	musk in.....	515	Hammocks.....	434
mineral potash.....	520	Grating, seedling stock for.....	526	Hand carts.....	324
potash salts.....	520	Granite and manufactures, N.E.S.....	195	Handkerchief boxes or cases.....	351
silver, manufactures of, not plated.....	292	iron sand, dry putty, etc., for polishing.....	541	Handkerchiefs.....	362
ingots, etc.....	584	not hammered or chiselled.....	100	Handle bolts.....	611
Giant powder.....	414	sawn only.....	194	Handles, umbrella, parasol, etc., N.E.S.....	337
Glants, hydraulic mining.....	555	ware, hollow.....	307	"D." shovel, wood.....	612
Gilder's whiting.....	624	white.....	185	Hand rakes, steel for.....	598
Gilling thread.....	524	Grape sugar.....	437	Hangings, paper.....	138
Giltware, plated.....	203	vines.....	70	Hard rubber in sheets, but not further manufactured.....	573
Gin of all kinds, N.E.S.....	7 (a)	Grapes.....	74	Hardware, builders', cabinet-makers', upholsterers', etc.....	250
Ginger.....	101	Grass Manilla, Esparto or Spanish, etc.....	521	carriage, N.E.S.....	250
preserved.....	84	platts.....	563	Harness dressing.....	164
wine.....	7 (c)	pulp of.....	521	leather.....	212
Ginseng root, unground.....	515	Grasses, fancy, dried only.....	521	makers' hardware.....	280
Girders, rolled iron or steel, less than 25 lbs. p. l. yard.....	227	Gravels.....	525	menagerie.....	458
N.E.S.....	228	Grey tartar.....	502	and saddlery, N.E.S.....	250
Glasses, watch.....	356	Grease, axle.....	175	soap.....	164
Glass, all other, and manufactures of, N.O.P.....	209	foot, refuse of cotton seed, etc. rough, refuse of animal fat, for manufacture of soap and oils.....	528	Harrows.....	318
balls.....	208	Green chleky.....	61	Harvest binder twine.....	433 & 620
lent plate.....	209	coffee, imported direct, etc.....	68	Harvesters without binders.....	318
bottles and decanters.....	208	N.E.S.....	67	self-binding.....	318
bulbs for electric lights.....	208	Paris, dry.....	162	Harvesting forks, steel for.....	598
carbony and demijohns.....	208	Grindstones, not mounted, not less than 30 inches in diameter.....	191	Hatchets.....	259

# The Wilkinson Plough Co.

TORONTO. LIMITED

## RAILROAD CONTRACTORS

Heavy and Light R.R. PLOUGHS.

ROOTER and PICK PLOUGHS.

DRAG and WHEEL SCRAPERS.

NAVY BARROWS, Steel or Wood Wheel.

Most Improved Steel CATTLE GUARDS.

All repairs shipped same day as ordered.

## HARDWARE MERCHANTS

### Wheelbarrows

All kinds for Stable, Garden, Boys, Brick Yards, Merchants and Municipalities.

### WAREHOUSE

### TRUCKS

Two, three and four wheel, with and without springs, stock or to order.

### LAWN ROLLERS

Steel, Iron and Wood Wheels all sizes and kinds.

### ALL STEEL 5 TON CRANE. STEADY AND FAST.

Can be crated in small space for export. Weight. 2½ tons.

### MUNICIPALITIES

Road Planers, Scrapers, Road Ploughs.

### FARMERS

Ploughs, Landrollers, Ensilage and Straw Cutters, Root Pulpers, Scufflers, Turnip Drills, Drag Harrows, Pulverizers, Most Improved Walking Gangs; 2, 3, 4 furrow, 6, 8, 10 inch.

Weights and Measurements promptly furnished for export.

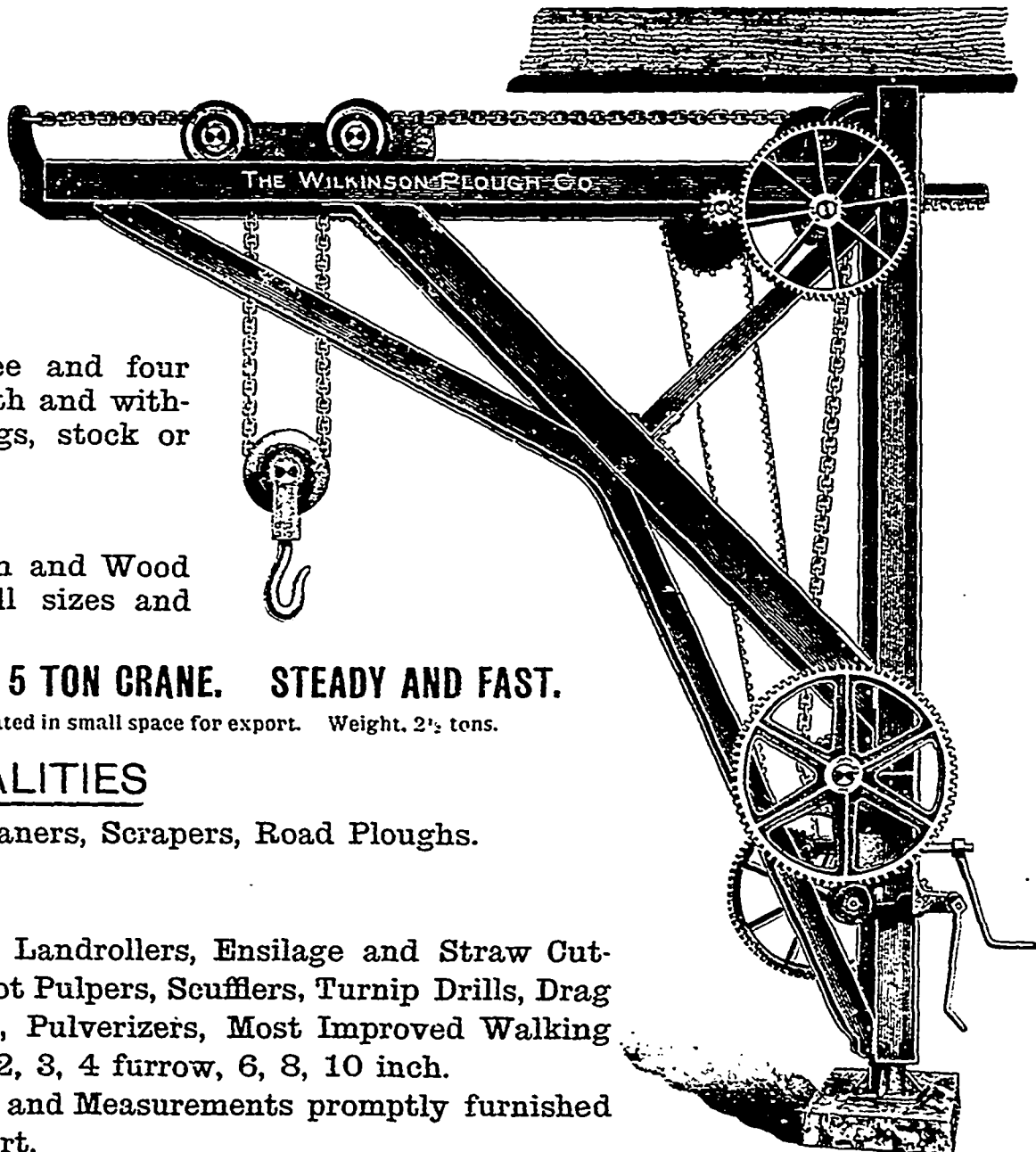

Index to the Canadian Tariff.

	No. of item.
Hatters' bindings, tips and sides...	533
furs, not on the skin .....	533
furs .....	245
plush of silk or cotton .....	533
Hay .....	42
knives .....	290
steel for .....	598
tedders .....	315
Heading blocks, rough hewn or sawed only .....	611
blots .....	611
machines, coal .....	555
Head lights .....	297
ropes .....	524
Heads for whips, rubber or textile leather .....	576
Heavy oil (carbolle) .....	558
Heirlooms, left by bequest .....	454
Hemlock bark .....	517
Hemp bags or sacks .....	377
carpets, mats and matting .....	396
flax and jute combined, manufactures of .....	376
manufactures of, N.E.S. ....	370
net, morsels of .....	524
paper for manufacture of shot shells .....	535
rags .....	570
sail twine, to be used for boats' and sbips' sails .....	411
seeds .....	61
twine for harvest binders. 433 & undressed .....	620
yarn, by manufacturers of carpets, twines, etc. ....	534
Henriettas, to be dyed and finished in Canada .....	386
Herbs, crude drugs, not edible, etc., N.O.P. ....	515
Herring net twine .....	524
Herrings, pickled or salted .....	105
Hewn timber .....	611
Hickory billets .....	611
felloes .....	611
lumber, sawn for spokes .....	611
lumber and timber planks and boards of .....	611
saw-dust .....	614
spokes, rough turned, not tenoned, mltred, etc. ....	611
Hides, raw .....	536
Hinge blanks, N.E.S. ....	279
Hinges, T and strap .....	279
Hinges, butt .....	280
Hoes .....	290
steel for manufacture of .....	598
Hogs, live .....	12
Holders, cigar and cigarette, and cases .....	423
shade .....	297
Hollowware, agate, granite or enamelled iron or steel, .....	307
iron or steel, plain, etc. ....	308
N.E.S. ....	308
Homing pigeons .....	513
Homo steel, spring wire for mattresses .....	625
Honey and imitations .....	56
Hoops, manilla .....	497
Hoofs in the rough, not polished, etc. ....	537
etc. ....	533
fly and fishing, N.E.S. ....	319
for deep sea and lake fishing .....	524
reaping .....	290
steel for .....	598
Hoop iron, for tubular rivets or steel, 18 gauge and thicker, etc. ....	329
thinner than 18 gauge, N.E.S. ....	334
steel, more than 2 1/2 c. per lb. ....	136
Hop poles .....	611
Hops .....	70
Horns in the rough, not polished, etc. ....	537
strips in the rough .....	537
tips .....	537
Horse boots .....	280
clippers .....	284
clothing, jute .....	375
hair, not further manufactured than dyed, etc. ....	532
powers and parts .....	315
rakes .....	318
shoe nails .....	256
shoes .....	256
Horses for improvement of stock menagerie .....	457
Horticulture, books on .....	464
Hose, cotton or linen lined, with rubber .....	222
duck, when imported by manufacturers .....	516
gutta-percha or rubber .....	222
Hosiery, N.E.S. ....	358
House of Commons, articles imported by and for use of .....	450
House furniture .....	343
Household effects of British subjects drying abroad .....	454
furniture, settlers .....	455
hollowware, N.E.S. ....	308

	No. of item.
Hubs, rough hewn or sawn only for wheels .....	611
Hungarian nails .....	256
Hunters' knives .....	284
Hydrated oxide of ethyl .....	7 (a)
Hydraulic cement .....	187
Hydrogen, solution of peroxides of .....	146
Hymn books .....	464
Ice .....	539
creepers, steel for manufacture of .....	595
Iceland moss, crude or cleaned only .....	521
illuminating oils, costing more than 30c. per gallon .....	170
illustrated advertising periodicals .....	126
price lists, etc. ....	126
illustrations of insects, pictorial, for colleges, etc. ....	461
imitations of brandy .....	7 (a)
lucifer .....	86
precious stones, polished, not set, etc. ....	348
roasted or ground coffee .....	89
Turkish, etc., rugs and carpets .....	397
implements, agricultural, plates for, cut to shape, but not moulded, N.E.S. ....	317
implements, settlers' .....	290
improvements in the arts .....	455
of stock, animals, for .....	457
fowls for .....	514
India-rubber boots and shoes .....	221
clothing, etc. ....	221
manufactures of, N.O.P. ....	221
unmanufactured .....	578
Indian corn for distillation .....	48
not for distillation .....	540
madder, ground or prepared, and extract of .....	517
Indigo .....	517
auxiliary .....	517
extract of .....	517
paste .....	517
Indurated fibre .....	341
Industrial books .....	464
Ingot moulds .....	531
Ingots, aluminum .....	476
cogged, iron or steel .....	226
copper .....	492
gold and silver bullion .....	495
iron or steel .....	226
nickle and German silver in .....	584
Ink for writing .....	163
shoemakers' .....	164
Insects, crude drugs, not refined, etc., N.O.P. ....	515
pictorial illustrations of, for colleges, etc. ....	461
Insides, album, paper .....	461
Instruments, brass band .....	357
musical, for army and navy .....	449
Canadian militia .....	450
schools of the blind .....	460
settlers' .....	455
N.O.P. ....	456
philosophical, for colleges, etc., photographic, mathematical and optical, N.E.S. ....	422
surgical and dental .....	153 & 405
telephone and telegraph .....	214
Insulators of all kinds .....	214
Insurance maps .....	161
Intersections for railways .....	240
Inventions, models of .....	475
Inverted blocks, earthenware .....	184
Iodine, crude .....	477
Ipecacuanha root, unground .....	515
Iris root, unground .....	515
Iron, acetate of (iron liquor) .....	517
angle, for manufacture of bedsteads .....	617
angles, rolled, N.E.S. ....	228
less than 35 lbs. per lineal yard, N.O.P. ....	227
for vessels .....	542
articles, manufactures of, etc., N.O.P. ....	321
axles, axle bars, etc., for railway vehicles, etc. ....	246
hand, 8 in. or less wide, 18 gauge, and thicker, N.E.S. ....	229
thinner than 18 gauge, N.E.S. ....	274
S .....	229
bar, rolled .....	229
bars, pieces, punchings and clippings of, etc. ....	229
hammered, N.O.P. ....	242
beams for vessels .....	542
rolled, not less than 35 lbs. per lineal yard .....	227
Iron, beams, rolled, N.E.S. ....	228
billets .....	226
blooms .....	226
rollers and machinery, N.E.S. ....	315
boiler tubes, wrought .....	249
bolt blanks .....	279
bolts .....	279
brads, shoe tacks, sprigs and tacks, N.O.P. ....	259
bridges .....	242
buckles, N.O.P. ....	305

	No. of item.
Iron building or bridge structural sections, N.E.S. ....	228
caps for whip ends .....	576
castings in the rough, N.E.S. ....	244
chains, 5-16 of an inch and over, channels, not less than 35 lbs. per lineal yard .....	227
rolled, N.E.S. ....	228
column sections, etc., N.E.S. ....	242
cut to shape for spade and shovel blanks .....	291
enamelled, agate, etc., hollowware, N.E.S. ....	307
eye bar blanks, N.E.S. ....	308
fencing, barbed wire .....	602
buckthorn strip, etc. ....	263
flats .....	229
flues, wrought, for marine boilers, forgings, N.E.S. ....	249
forks, table, in the rough .....	243
furniture, house, cabinet or office .....	285
galvanized, manufactures of .....	343
girders, rolled, not less than 35 lbs. per lineal yard .....	300
girders, rolled, N.E.S. ....	227
globules for polishing granite or glass .....	228
huge blanks .....	541
hinges, T and strap .....	279
hollowware, N.E.S. ....	279
hoop, for tubular rivets .....	539
8 in. or less wide, 18 gauge and thicker, N.E.S. ....	220
thinner than 18 gauge, N.E.S. ....	224
Ingots, and cogged Ingots .....	220
Joists, rolled, N.E.S. ....	228
kentledge .....	224
knives for vessels .....	542
knife blades or blanks, rough liquor, solution of acetate or nitrate of iron, for dyeing and calico printing .....	285
loops, etc. ....	517
manufactures of, N.O.P. ....	226
manfs., not manufactured in Canada, for ships or vessels .....	321
masts for ships, or parts of .....	542
nails, cut .....	255
N.E.S. ....	256
nitrate of (iron liquor) .....	517
nut blanks .....	279
nuts .....	279
pieces, punchings or clippings of plate, etc. ....	224
in pigs .....	224
pipe, cast .....	248
pipe, fittings for .....	254
plates for vessels .....	542
Canada .....	231
pieces, punchings, etc., of, 30 in. wide and over, and 1/4 in. and over thick .....	223
sheared or unsheared .....	231
Iron, puddled bars .....	232
rails, crop ends of, etc. ....	226
railway bars or rails, N.E.S. ....	227
ribs for manuf. of umbrellas, parasols and sunshades .....	228
rivets .....	279
rods, rolled, round, wire, for manufacture of wire .....	574
Swedish rolled, under 1/2 in. in diameter .....	237
rods, nails, Swedish rolled, under 1/2 in. in diameter, for manuf. of horse-shoe nails .....	227
rolls, chilled .....	224
Russia .....	234
sand for polishing granite or glass .....	224
scrap, cast .....	511
old, etc., part of vessels wrecked in Canadian waters .....	224
wrought, having been in actual use, etc. ....	581
screws, N.O.P. ....	225
scroll, 8 in. or less wide, 18 gauge and thicker, N.E.S. ....	229
thinner than 18 gauge, N.E.S. ....	234
sections, rolled, less than 35 lbs. per lineal yard, N.O.P. ....	227
sections, N.E.S. ....	227
shapes, rolled .....	227
less than 35 lbs. per lineal yard .....	227
N.E.S. and N.O.P. ....	228
sheets, 17 gauge and thinner .....	224
flat, galvanized .....	224
sheared or unsheared .....	512
for vessels .....	512
coated, N.O.P. ....	224
pieces, punchings, etc., of, skelp, sheared or rolled in grooves .....	224
for manuf. of steel pipe .....	224
shot, for glass or granite .....	541
slabs .....	226
spikes, cut .....	255

THE  
CANADA  
PAINT  
COMPANY  
LIMITED

90 Bay St., - TORONTO  
572 William St., - MONTREAL  
Oxide Mines: ST. MALO  
Graphite Mines: CARLETON  
Address Enquiries to—  
HEAD OFFICE  
572 WILLIAM ST., MONTREAL  
Cable Address—  
"ELEPHANT," MONTREAL.

VARNISH  
and JAPANS

For 'BUS, CAB, CART or  
TROLLEY  
For House Decorators,  
Yachts, Furniture,  
Pianofortes, Chairs  
and Bicycles.  
Enamels, Stains  
Wood Fillers.  
Manufacturers to the  
Jobbing and Wholesale  
Trade and for Export.

COLOR MAKERS

Dry Colors  
Pulp Colors  
Coach Colors  
Lead Grinders  
Graphite Paint  
Oxide Paint  
Liquid Paint

**Paint** For all  
Purposes.

Correspondence Invited.

Write for Catalogues  
and Color Cards.

THE  
**CANADA PAINT CO.** MONTREAL  
TORONTO

**POTATO MACHINERY**

OUR POTATO PLANTER

Also  
PLANTS  
CORN.  
BEANS.  
ENSILAGE.  
DISTRIBUTES  
FERTILIZER.  
THE ONLY CONCERN IN THE WORLD MAKING A COMPLETE LINE OF POTATO MACHINERY.  
AN ESTABLISHED REPUTATION. TWENTY YEARS ON THE MARKET.  
WRITE FOR PARTICULARS.

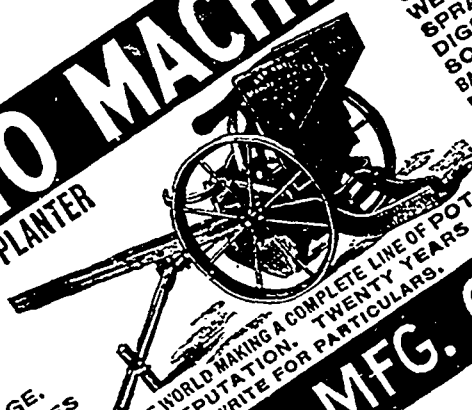

WE MAKE  
CUTTERS,  
WEEDERS,  
SPRAYERS,  
DIGGERS,  
SORTERS,  
BARREL CHURNS,  
POST-HOLE  
AUGERS,  
LAWN SWINGS.

**ASPINWALL MFG. CO.** JACKSON,  
MICH., U.S.A.

Index to the Canadian Tariff.

	No. of Item.
iron springs for railway or tramway vehicles, etc.	246
stars, rolled, N.E.S.	228
steam engines, N.E.S.	315
stoneware	185
strip, 8 in. or less wide, 18 gauge and thicker, N.E.S.	220
thinner than 18 gauge, N.E.S.	284
sulphate of	502
tees, less than 35 lbs. per lineal yard	227
N.E.S.	228
terne plate	234
trough sections, N.E.S.	228
tubes for manufacture of bedsteads	617
tubing, lacquered or brass covered, for manufacture of bedsteads	617
tubing, wrought, for mining over 2 in. in diam., N.E.S.	555
2 in. or less in diam., N.E.S.	251
other, N.O.P.	252
ware, enamelled, N.E.S.	308
washers	270
wire, galvanized, 0, 12 and 13 gauge	603
cloth, wove wire and wire netting, for manufacture of boots and shoes	270
twisted, for boots and shoes	627
work, structural	627
Iron zees, N.E.S.	228
Irons, sad, hatters' and tailors'	245
Isinglass	27
Istic	521
Italian cloth, to be finished in Canada, etc.	286
Ivory black	547
nuts, unmanufactured	543
unmanufactured	543
vaccine points	515
veneers of	543
Ivories, piano key	543
Jackets, water, blast furnace	555
Jacquards, to be dyed and finished in Canada, etc.	286
Jalap root, unground	515
Jams, N.E.S.	85
Japau driers, N.E.S.	168
Japanned leather	215
Japaus, N.E.S.	108
Japonica, terra	517
Jars, glass	208
Jeans, imported by corset and dress-stay makers	364
Jellies, N.E.S.	56
Jew elery	350
Jewels, cases for	351
Jigs, mining machinery	555
Joists, rolled iron or steel, N.E.S.	228
Julec, lime, containing spirits, crude	5
N.O.P.	550
Jules, fruit, containing spirits	5
N.O.P.	6
June buds	73
Junk, old	544
Jute and jute butts	545
bags or sacks	377
canvas, not pressed, etc., by manufacturers of carpets, etc.	546
carpets, mats and matting	396
cloth as taken from the loom, not coloured, etc.	545
cloth not otherwise finished than bleached or calendered	374
flax and hemp combined, manufactures of	376
horse clothing, shaped	375
manufactures of, N.E.S.	376
rags	570
surgical dressing	152
twine for harvest binders	433
yarn, by manufacturers of carpets, rugs, mats, etc.	620
K	
Kainite	520
Kangaroo leather, dressed, waxed or glazed	212
Kartavert	341
Kauric gum	531
Kelp	521
Kentledge, iron	224
Kerosene oils, N.E.S.	173
Keys, watch and clock	346
Kid leather, dressed, waxed or glazed	212
Kiln-dried chicory	92
Kitchen knives	284
hollowware, N.E.S.	308
Knees, iron or steel, for vessels	542
Knife blades and blanks in the rough	285
polish, N.O.P.	164
Kalitted goods, N.E.S.	388
Knives, hay or straw and edging, steel for manufacture	280
reaper and mower, steel for manufacture of	500

	No. of Item.
Knobs, steel for manufacture of	594
Kryolite, mineral	477
L	
Labels for fruit, confectionery, etc.	127
Lac, crude, seed, button, stick and shell	517
Lace collars and similar goods	302
nets	302
wire fasteners, shoe	653
Laces, N.O.P.	302
boot, shoe and stay	405
shoe and corset, tagging metal for manufacture of	606
Lacquers	161
N.E.S.	168
Ladies' blouses and shirt waists	366
Lug or coach screws, N.O.P.	260
Lamb, fresh	16
leather, dressed, waxed or glazed	212
Lambs' wool, surgical dressing	152
Lamp black	547
Lamp chimneys	208
shade blanks, celluloid	256
shears	254
springs	298
wicks	418
Lamps	270
miners' safety	555
Landslides, cut to shape, but not moulded, etc.	317
Lanterns	297
magic, and slides therefor	422
Lap-dusters	359
Lapping and blanketing, for cotton manufactures, etc.	486
Lard	18
compound and like substances, oil	169
Lashes for whips	217
Last blocks, rough hewn or sawn only	611
Lastings for manufacture of buttons	548
Laths	611
Laundry soap	23
blueing	160
Lava, unmanufactured	502
tips	297
Lavender water, alcoholic	7 (c)
Lawn mowers	291
sprinklers	312
tennis nets	434
trees, shrubs and plants	74
Lead, acetate of, not ground	515
bullets	274
dry, red and white	158
In bars and sheets	273
manufactures, N.O.P.	275
nitrate of, not ground	515
old scrap, pig and block	272
penicils	421
pipe	274
shot	274
tea	610
Leaf, Dutch or schlag metal	352
gold and silver and aluminium	352
palm, unmanufactured	562
Leaf, tobacco, unstemmed	445
stemmed	446
Leather, belting	213
belting of	218
board	216
dressing	164
harness	212
heads for manufacture of whips	576
Japanned	215
manufactures of, N.O.P.	220
Morocco	215
skins for	213
patent or enamelled	215
scrap, tanners	213
upper, including dongola, kid, lappa, etc., dressed	212
N.E.S., dressed, etc.	212
N.O.P.	213
Leathers, glove, for glove manufacturers	214
Leatheroid	216
Leaves, crude drugs, not edible, etc., N.O.P.	515
Leeches	549
Lezhorn hats, unfinished	497
Leicester combing wool	390
Lemon rinds, in brine	504
wine	8
Lemons	80
Lesson pictures, Sunday School	464
Letters for signs, etc.	310
Libraries, books for	467
Lichens	515
Life boats	472
saving apparatus	472
Light, electric carbons or carbon points	205
gas or coal oil fixtures or parts thereof	207
glass bulbs for	290
Lights, head and side	297
Lignite oils, illuminating, over 30c. per gall.	170

	No. of Item.
Lignum vitæ, lumber and timber, planks and boards of	611
saw-dust	614
Lilles of the valley	526
Limbs, artificial	479
Lime, chloride of	502
Juice, containing spirits, crude	5
N.O.P.	650
sulphate of (gypsum, crude)	6
602	
Limes	80
Lincolnshire combing wools	390
Linens, bags or sacks	377
clothing, N.O.P.	302
collars	305
cuffs	365
damask of	301
stair and dliaper	301
fabrics, articles made from, N.O.P.	302
hose lined with rubber	222
nettings	302
rags	570
Lines, fishing, not including sporting tackle, etc.	524
tape	422
Liniments, N.O.P.	147
Linings, carpet	306
stove	181
tips and sides, for hats	533
chimmney	184
coat, to be finished in Canada, etc.	386
Link belting chain for binders	318
Links, coil chain	261
Linoleum	398
Linseed oil	169
Lint	152
Liquors of all kinds, N.E.S.	7 (a)
Liquid paints and fillers, N.E.S.	160
paint, gold	352
drier, N.E.S.	168
Liquor, iron solution of acetate or nitrate of iron, for dyeing or calico printing	517
red, crude acetate of aluminium	517
Liquors, alcoholic or spirituous	7
N.O.P.	7 (a)
Liquorice paste	150
In rolls and sticks	150
root, unground	515
Lists, illustrated price	126
Literary papers, weekly, unbound	468
Litharge	502
Lithographed commercial blank forms	128
tickets, posters, etc.	127
Lithographic presses, etc.	313
stones, not engraved	190
Litmus	515
Live hogs	12
stock, settlers'	455
Living animals, N.E.S.	71
Loading tools	306
Locks, N.E.S.	280
steel for manufacture of	594
Locomotive wheel tires, steel, rough	551
Locomotives for railways, N.E.S., running on lines crossing frontier, etc.	241
474	
Locust bean meal	526
beans	526
Logs	611
Logwood, extract of	517
ground	517
Looking-glass, German	207
Loops, iron or steel	226
Lotions, alcoholic, N.E.S.	7 (b)
Lozenges, N.O.P.	147
Lubricating oils, petroleum, costing less than 25c. per gall.	171
N. E. S.	175
Lumber, creosoted, squared or sided	611
hickory, sawn to shape for spokes	611
manufactured, N.E.S.	329
of amaranth, coccolora, etc., rough, sawn or split, etc.	611
sawed, undressed, or dressed on one side only	611
Lumps, celluloid, xvolite or xylonite, in the rough	501
Lustre wools, etc.	390
M	
Macaroni	59
Mace	100
Machinery and hollers, composed wholly or in part of iron or steel, N.E.S.	315
Machine attachments, sewing, nailing, certain wire, for use in connection with	553
card clothing	627
screws, N.O.P.	316
260	
Machinery, mining, smelting and reducing	553
Machines, bench, N.O.P.	289
fire extinguishing	311
Machinery, N.E.S.	315
folding and cutting	313



# SIMPLE POWERFUL DURABLE ECONOMICAL EFFICIENT

## ROTARY PUMPS BUFFALO, N.Y.

### OIL, LARD, SOAP-STOCK, GLUE, TALLOW.



**ROTARY OIL PUMP.**

Made in Four Sizes.

PRICE.

- No. 0001—1½ inch suction and discharge, 1-5 gallon per revolution. \$30.00
- No. 0002—1½ inch suction and discharge, 1-6 gallon per revolution. 25.00
- No. 0003—1 inch suction and discharge, 1-8 gallon per revolution. 22.50
- No. 0004—½ inch suction and discharge, 1-12 gallon per revolution. 20.00

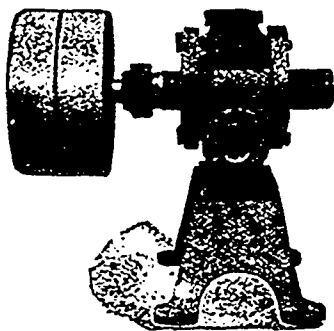

**ROTARY OIL PUMP.**

Made in Two Sizes.

PRICE.

- No. 002—2 inch suction and discharge, ½ gallon per revolution... \$45.00
- No. 001—1½ inch suction and discharge, 1-3 gallon per revolution. 40.00

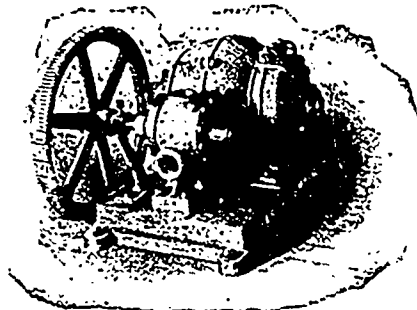

**Special Electric Motor Pump.**

Any size, 2 inches to 4 inches.  
Beer, Oil, Soap.

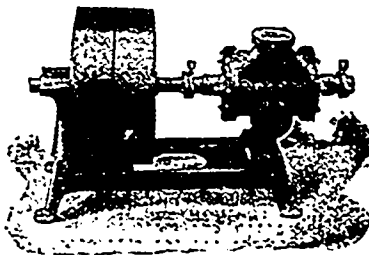

No. 2

**Iron Soap, Oil or Lye Pump.**

4-inch suction and discharge.  
Capacity, 200 gallons per minute  
Pulleys, 5x18 inches. Speed, 120 r. p. m.

PRICE, \$125.00

**No. 1 PUMP.**

Same style as No. 2.  
3-inch suction and discharge.  
Price \$100.



No. 0002

**Special Creamery Pump.**

With Head in Place.



No. 0002

**Special Creamery Pump.**

Showing head removed for cleaning pump.

**Hand Rotary Creamery Pump.**

PRICE.  
Iron, Bronze

- No. 0001—1½ inch suction and discharge, 1-5 gallon per rev. \$30.00 \$50.00
- No. 0002—1½ inch suction and discharge, 1-6 gallon per rev. 25.00 45.00
- No. 0003 1 inch suction and discharge, 1-8 gallon per rev.... 22.50 42.50
- No. 0004—½ inch suction and discharge, 1-12 gallon per rev. 20.00 40.00

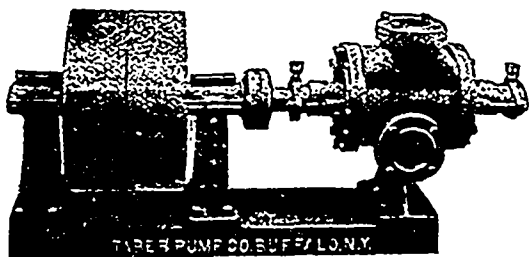

**No. 4—Special Iron Soap Pump.**

Clutch Shaft.

4-inch suction and discharge. Capacity, 1000 pounds of soap per minute.  
Floor space, 25x60 inches. Speed, 120 r.p.m. Pulleys, 6x24 in.  
Weight 800 pounds.  
PRICE, \$150.00

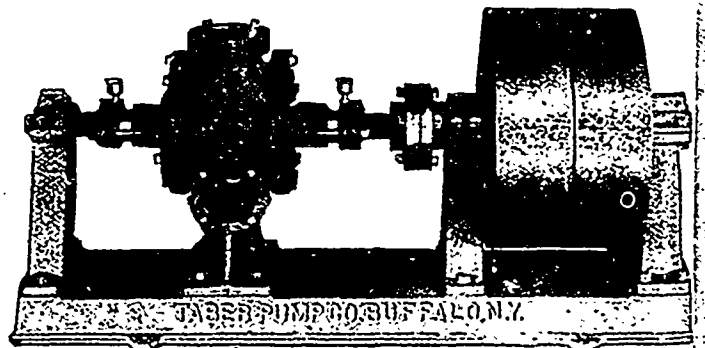

No. 6.

**Special Brewers', Distillers' & Soap Makers' Pump**

When writing to Advertisers kindly mention THE CANADIAN MANUFACTURER.

Index to the Canadian Tariff.

Table with 3 columns: Item description, No. of Item, and Item description. The table lists various goods such as machinery, metal, and foodstuffs, each with a corresponding tariff number. It is organized into three main columns for readability.

# American Impulse Wheel Co.

MANUFACTURERS OF

WATER WHEELS FOR

## Power and Electrical Transmission



ILLUSTRATED CATALOGUE MAILED TO ANY PART OF THE WORLD.  
SEND FOR IT.

---

**AMERICAN IMPULSE WHEEL CO.**

120 Liberty Street, NEW YORK, U.S.A.

When writing to Advertisers kindly mention THE CANADIAN MANUFACTURER.

Index to the Canadian Tariff.

	No. of item.	P	No. of item.		No. of item.
Oar blocks, rough hewn or sawed only	611	Packages, Canadian, exported and returned containing oysters and other fish, N.O.P.	635	Perfumes preparations, N.O.P.	149
Oatmeal	50	Paint, gold liquid	352	spirits	7 (c)
Oats	49	Paints, anti-corrosive and anti-fouling ground in spirits	160	Perfumery, non-alcoholic	149
Ochres	159	N.E.S.	160	Perfumes, alcoholic	7 (c)
Ochrey earths	159	Paintings, copies of the old masters, by artists of well-known merit, oil or water colours, by artists of well-known merit	470	Periodicals, illustrated, advertising, N.E.S.	120
Odours, French or flour, preserved in oils, etc.	148	oil or water colours by Canadian artists	470	Peroxides of hydrogen, solutions	125
Offal, fish	530	prohibited	470	Persimmon wood	140
Office furniture	343	N.E.S.	470	saw-dust	613
Onions	54	Palettes knives	284	Persis	517
Oiled silk and cloth, N.O.P.	355	Pallings	611	Personal effects of British subjects dying abroad	454
Oil, kailine crude	377	Palm leaf, unmanufactured	562	left by bequest	454
cake and oil-cake meal	559	nut cake and meal	559	Pessarles	152
carbolic or heavy	558	oil, natural	558	Petroleum, barrels containing crude, imported by manufacturers for fuel purposes, etc.	174
cloth, floor, etc., enamelled	348	spirit	7 (a)	Illuminating oils, costing over 20c per gallon	170
coal and kerosene, N.E.S.	173	Palmis	526	lubricating oils, less than 25c per gallon	171
coal, fixtures or parts	237	Pampulets, advertising	126	oils, N.E.S.	173
cocoa-nut, natural	558	N.E.S.	125	preparations of, similar to vaseline	178
cod-liver	154	Pans, platinum, for manufacturers of sulphuric acid, etc.	504	Pharmaceutical preparations, N.O.P.	147
essential	177	Pantalon buttons	426	Phasants	514
fish, N.E.S.	168	Paper, aluminum insides	461	Phials	208
fuel and gas, by manufacturers for fuel purposes, etc.	172	borders	138	Philosophical instruments, N.E.S. and apparatus, not manufactured in Canada, etc.	452
fusil	7 (a)	boxed	140	Phosphate, acid, N.O.P.	145
hair, non-alcoholic	149	cutting machines	313	rock	520
illuminating, petroleum, coal, shale or lignite, costing more than 20c per gallon	170	envelopes	140	Phosphor bronze and phosphor tin in blocks, bars, sheets and wire	209
lard	162	hangings or wall	138	Phosphorus	502
linseed or flaxseed	162	hemp for manufacture of shot shells	535	Photograph frames	336
lubricating, less than 25c per gallon	171	manufactures of	140	Photographic dry plates	419
N.E.S.	175	pads	140	instruments, N.E.S.	422
medicinal, etc., N.O.P.	147	printing	139	Photographers' paper, chemically prepared	123
meat's-foot	162	printed, bordered and coated	140	Photographs prohibited	636
Oil, olive, N.E.S.	176	sacks and bags of all kinds	136	sent by friends	471
for manufacturing soap or tobacco, or for canning fish	558	sand, glass, flint and emery	135	N.E.S.	130
paintings by artists of well-known merit	470	shells, brass cups for manufacture of	512	Pianofortes	356
Canadian artists	470	tarted	135	parts of	357
palm, natural	558	union collar cloth, glossed or finished	133	Piano key Ivories	543
petroleum, for fuel purposes, etc.	172	not glossed or finished	132	Pickets	611
potato	7 (a)	waste clippings	570	Pickled fish, other, in barrels, not in barrels or half barrels, N.O.P.	108
of roses	558	of all kinds, N.E.S.	139	herrings	105
resin	480	Papers, aluminized, etc., for photographers	123	salmon	107
sesame seed	169	news, partly printed	131	Pickles	67
spermaceti, whale and other fish oils, N.O.P.	122	weekly, literary, unbound	469	Picks, and eyes and polls for	289
Olintments, N.O.P.	147	window blinds	135	Pictorial illustrations of insects, for colleges, etc.	461
Old brass	432	Papeteries	140	show cards	126
copper	432	Paper-mache shoe buttons	553	Picture frames	336
junk	544	ware, N.O.P.	140	wire	369
lead	372	Paraffine wax	151	Pictures left by bequest	454
scrap iron and steel recovered from vessels wrecked in Canadian waters	581	candles	33	Sunday School, lesson	464
Oleographs, advertising	126	Parasol or sunshade sticks, bamboo reed for	499	N.E.S.	130
N.E.S.	120	sticks or handles, N.E.S.	337	Pigeons, homing or messenger	514
Oleomargarine, prohibited	629	of bamboo, not manufactured	499	Pigs, Britannia metal in	493
Oleo-stearine	561	Parasols	401	copper in	492
Olive oil, N.E.S.	176	articles for the manufacture of	572	iron in	494
for manufacturing soap or tobacco or for canning fish	558	Paris green, dry	162	lead in	494
Opium, crude	123	plaster of, ground, not calcined, calcined or manufactured	189	tin in	610
powdered	156	Paris white	624	stencils	633
prepared for smoking	157	Parrot cages	287	Pillows	343
Optical instruments, N.E.S.	422	Passenger cars, railway, running on lines crossing frontier, etc.	474	Pills, N.O.P.	147
Orange miterial	158	Paste, chocolate	94	Pineapples	636
rinds in brine	501	coas	517	clapboards	611
wine	8	liquores	150	pitch, in pkgs. not less than 15 galls. each	507
Oranges	80	Pastes, non-alcoholic	149	tar, in packages, not less than 15 galls. each	507
Ore crushers	315	N.O.P.	147	Plas, hat and hair, jewellery	250
of ball	302	Patent leather	215	wire, N.O.P.	271
drying machinery	555	prepared dyes	417	Pipe, cast iron	248
roasting machinery	555	preparations, N.O.P.	147	lead	274
samplers, automatic	555	Patterns	520	mounts	423
Ores of metal of all kinds	556	Facing brick	181	platinum, for manufacture of sulphuric acid	524
Organs	350	blocks of stone	194	iron or steel, fittings of	524
parts of	357	Peaches, N.O.P.	81	Pipes, drain	154
Orleans, to be dyed and finished in Canada, etc.	286	Peach trees	525	sawer	154
Ornamental trees, shrubs and plants	74	seedling stock for grafting	525	tobacco	423
Ornaments of alabaster, spar, amber, etc.	351	Peanut shells, N.E.S.	195	iron or steel, other N.O.P.	323
Orris root, unground	315	Pear trees	525	metal cases or covers	306
Osters, unmanufactured	420	Pearl ashes, in pkgs. of not less than 25 lbs	565	Pistols	306
Ottar of roses	358	Pearline	226	Pitch, bone, crude	480
Ovals, rolled iron or steel	120	Pease, N.E.S.	26	Burgundy	477
Oversettings, wool, worsted, hair of alpaca, etc., N.E.S.	304	seed from G. B.	26	coal	507
Ox shoes	236	Pecans	26	pine	507
Oxalle acid	477	Pedometers	422	lumber and timber, planks and boards of	611
Oxide of ethyl, hydrated	7 (a)	Peel, candied	436	saw-dust	614
manganese	502	Pelte, raw	526	Plain strip fencing wire, etc., for manufacture of	602
copper, cobalt and tin	502	Penells, lead	419	Plains, to be dyed and finished in Canada, etc.	524
black, for manufacture of chlorate	515	slate	193	Plate, chip, manilla, cotton, mohair, straw, Tuscan and grass	503
Oxides, N.E.S.	100	Pen knives	284	Planking, ship	611
Oyster knives	284	Pens and pen holders	421	Planks, sawed, undressed or dressed on one side only, etc.	611
Oysters, canned, in cans not over 1 pint	117	Perceusion caps	506	of certain lumber, rough sawn or split, etc.	611
over 1 pint but not over 1 qt.	118	coal cutters	315	sawed, planed, jointed, etc.	328
exceeding 1 qt.	119				
in the shell	120				
packages containing, N.O.P.	121				
preserved or prepared, N.O.P.	115				
seed and breeding	560				
shelled, in bulk	116				



# F. E. MYERS & BRO.

A  
Line  
without an  
equal on  
the Globe.

Write  
for 1900  
Large  
Poster  
and  
Catalogue.

A  
Complete  
Line of  
Force,  
Lift,  
Windmill,  
Tank,  
Power,  
and  
Spray  
PUMPS.

A  
Complete  
Line of  
Carriers,  
Forks,  
Pulleys,  
Hooks,  
Store Ladders,  
Cycle Stands,  
Gate Hangers,  
and  
Lawn Swings

CANADIAN  
AGENTS  
WANTED.

CANADIAN  
AGENTS  
WANTED.

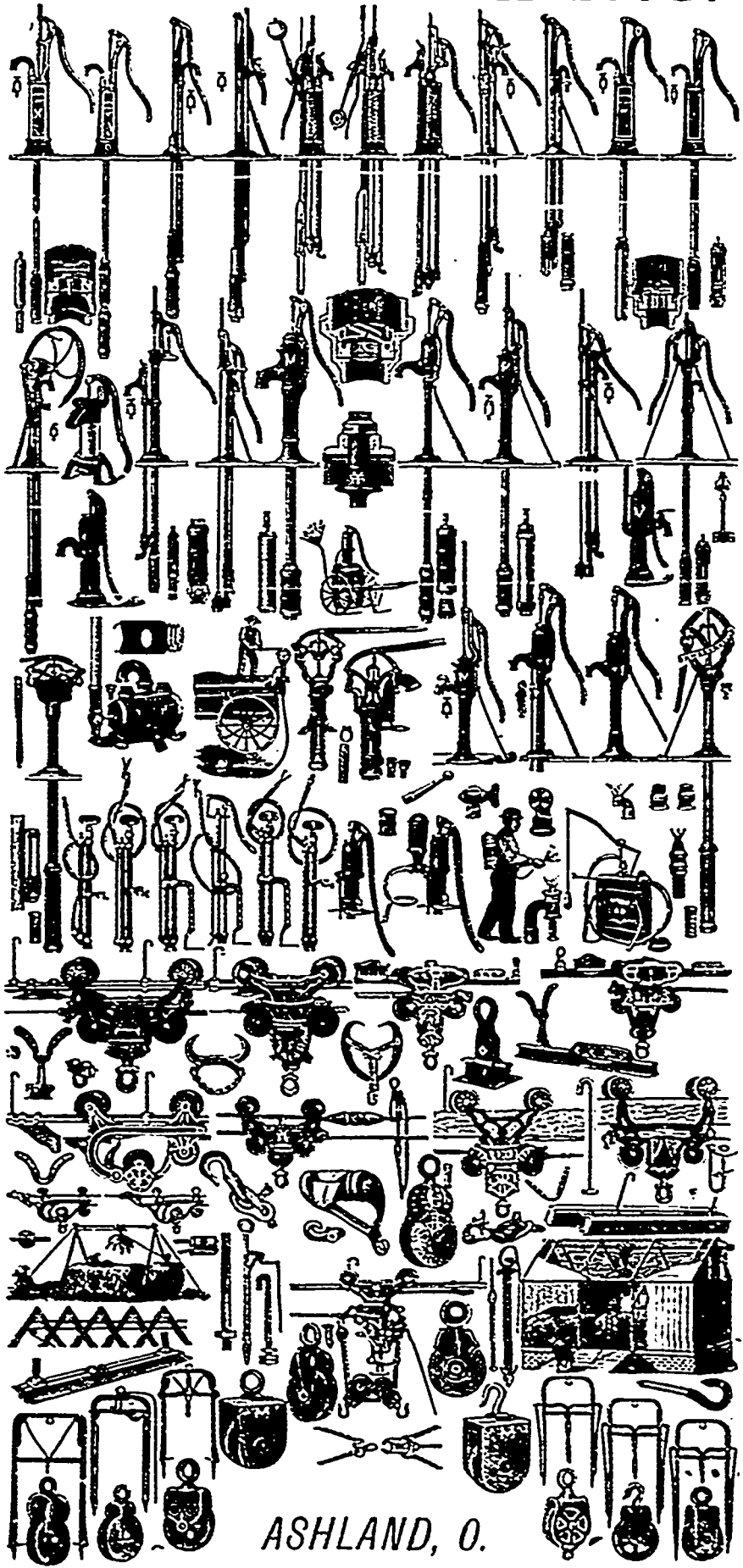

ASHLAND, O.

## PUMPS AND HAY TOOLS

When writing to Advertisers kindly mention THE CANADIAN MANUFACTURER.

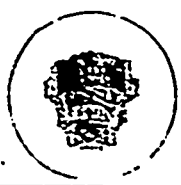

Index to the Canadian Tariff.

	No. of Item.		No. of Item.		No. of Item.
Plans, building, N.E.S.	130	Potato diggers, spirit or oil	315	Racks, cue	340
Plantulus	526	Potatoes, N.E.S.	39	Rags, of cotton, linen, jute, hemp and wool	570
Plants, fruit, N.E.S.	74	sweet	64	Railroad spikes	255
shade, lawn and ornamental	74	Pouches, tobacco	423	tickets	127
Plaster of Paris, calcined or manufactured	189	Poultry, canned	15	ties	611
ground, not calcined	188	N.O.P.	17	Railway bars or rails, iron or steel	238
Plasters, N.O.P.	147	Pounders	330	N.E.S.	324
Plate, pieces, punchings or clippings of, etc.	223	Powder, blasting and mining	412	cars	474
bridge, rolled iron or steel, not less than 20-in. wide, etc.	221	caulster	413	running on lines crossing frontier	238
communication	509	cannon, musket, rifle gun and sporting	413	fish-plates	224
family left by bequest	454	glaut	414	freight rates	389
glass, rough rolled	202	Powdered opium	156	rugs	324
not bevelled, not over 25 sq. feet	203	rubber	573	scrapers	241
not bevelled, N.E.S.	204	Ponders, baking	72	Railways, locomotives for, N.E.S.	240
bevelled, N.O.P.	205	brocade and bronze	352	switches, frogs, crossings and intersections for	240
bent	206	soap	26	Rails, iron or steel, crops from, etc.	223
German looking	207	tooth and other, non-alcoholic	149	railway, N.E.S.	238
universal mill, or rolled edge steel	230	N.O.P.	147	steel, not less than 45 lbs. per lineal yard, etc.	585
rolled iron or steel, sheared or unsheared	232	Prayer books	464	Raisins	77
Plated cutlery	284	Precious stones in the rough, and imitations, polished, not set, etc., N.E.S.	348	Rakes, horse	318
ware, nickel and electro	283	Precipitate of copper, crude	562	N.E.S.	240
cases for, fancy	351	Preparations, anatomical, medicinal, chemical and pharmaceutical, N.O.P.	147	Rauic cloth, for mackintosh clothing	381
Plates, for agricultural implements, not moulded, etc.	317	of petroleum, similar to vase-line	178	Rape seed	526
aluminum	476	patent and proprietary, N.O.P.	147	Raspberry bushes	74
brass and copper	492	perfumed, N.O.P.	149	wine	8
Canada	254	tollie, alcoholic	7 (c)	Raspberries, wild	526
China, goat, etc.	578	non-alcoholic	149	N.E.S.	222
copper	492	Prepared opium (for smoking)	157	Rasps	27
inlaid	355	Preserved ginger	84	Rat cages	27
dry, photographic	419	Preserves, N.E.S.	85	Rattan, split or manufactured, N.O.P.	326
engraved on wood, steel, etc.	301	Pressed felt, not filled, etc., by any woven fabric	378	Rattans, unmanufactured	493
fashion, tailors' and mantle-makers'	469	glass tableware	268	Raw chicory	91
gold and silver bullion	46	nails and spikes	256	cotton	508
nickel and German silver in store	245	Presses, lithographic	313	hide centres for whips	576
Plates, iron or steel, 20 in. and over wide, etc.	221	printing	313	manufactures of, N.O.P.	230
for vessels	542	Price books and lists, illustrated	125	hides, dry, salted or pickled	526
phosphor bronze	291	Primers	306	meerschaum	522
plough, etc., cut to shape, but not moulded, etc.	317	Primers for manufacture of shot shells and cartridges	535	pelts	526
platinum	564	Printed blank forms, commercial	128	reunett	571
railway fish	520	books, N.E.S.	125	sleannas	159
steel, more than 2½ c. p lb.	524	cotton fabrics, N.O.P.	240	skins	526
terne	434	matter, N.E.S.	128	silk	582
tic, railway	610	music	129	tobacco leaf, unstemmed	445
tin	631	paper, prohibited	636	stemmed	446
zinc	631	advertising bills, etc.	128	turpentine	618
Platinum, for manufacture of chloride	515	Printing machines	313	Razors	284
retorts, pans, condensers, etc., by manuf. of sulphuric acid	564	paper	313	Ready-made clothing, wool, etc., N.O.P.	244
bars, strips, sheets or plates	564	presses	313	Reapers	318
wire	564	type for	300	Reaper knives, steel for manufacture of	520
Playing cards	157	Prisms, prohibited	636	Reaping hooks	220
Pleasure carts, N.E.S.	323	Prison labour, goods produced by, prohibited	641	steel for manufacture of	528
Pleasure plates, cut to shape but not moulded, etc.	317	Prizes won in competitions	473	Recognition buttons	426
Ploughs	318	Prohibited books, papers, paintings, colas	636	Recovered rubber	573
Plumbago crucibles	510	copyright works	637	Red cedar, lumber and timber, planks and boards of	611
manufactures of, N.E.S.	535	goods made in prisons	641	saw-dust	614
unmanufactured	354	oleomargarine, butterine, etc.	639	lead, dry	158
Plum trees	73	tea, adulterated	640	liquor, a crude acetate of aluminum, etc.	517
seedling stock for grafting	525	Promissory notes, unsigned	128	prussiate of potash	563
Plums	76	Pronged forks	290	wood, lumber and timber, planks and boards of	611
Plush fabrics, N.E.S.	368	Proprietary preparations, N.O.P.	147	saw-dust	614
hatters', of silk or cotton	373	Prunella	566	Reducing machinery	535
Pocket books	424	Prunes	77	Reeds, bamboo, for umbrellas, etc., for whips, square	576
knives	284	Pruning knives	284	split or otherwise manufactured	325
Pods, musk in	515	Prussiate of potash, red and yellow	563	N.O.P.	325
Points, carbon, N.E.S.	235	Psalm books	464	Refined sugars	475
Ivory vaeclae	515	Padded bars, iron or steel	226	Refuse, fish	520
Poles, cornice	343	Pulp of grass	521	Regalia	362
Poles, hop	611	ultramarine blue	621	Registers, cash	343
Polish, knife and other	164	wood	533	Regulus of antimony	478
Pollock fish lines	324	Pulque	567 (a)	Religious tracts	464
Polls for picks and mattocks	282	Pumice and pumice stone	436	Repet, raw or prepared	571
Pomades preserved in fat, etc.	148	Pumpings, sugar drained in transit	312	Reports, annual, of religious or benevolent associations	466
Pomatums, non-alcoholic	143	mercury	312	Reprints of copyright works copyrighted in Canada, prohibited	637
Pomegranates	526	N.E.S.	315	Resin, in pkgs., not less than 100 lbs.	480
Pop corn	428	Punchings, iron or steel	223	Resins, gum, crude drugs, not edible, etc., N.O.P.	515
Porcelain ware	185	Pure-bred domestic fowls	514	Reticules	424
Portable machines, or parts, engines	315	Purses	424	frames, clasps and fasteners for	422
Porter, in bottles	1	fasteners, frames and clasps for	425	platinum	564
casks, etc.	1	Putty	165	Revolvers	306
Portland cement	187	dry, for polishing glass or granite	541	Rhizomes	526
Portmanteaux	424	knives	284	Rhubarb root, unground	515
Postage stamps, collections of	473	Pyroligneous acid, N.E.S.	141	Ribbons of all kinds	363
Posters	126	crude, not over 50 p.c.	142	of brass, etc., for manufacture of umbrellas, etc.	373
Post-hole diggers	240	Pyrometers	555	flour	53
Posts, fence	611	Pyroxylic spirit	7 (a)	for making starch	54
rough hewn or sawed only	611	Quails	514	uncleaned, unbulled or paddy	51
Pot ashes, in pkgs., not less than 25 lbs.	565	Quarterly magazines, unbound	519	Rifle powder	413
Potash, bichromate of, crude	565	Quartz, crystallized	556	Rifles	306
caustic	565	Quebracho, extract of	317	Rigging, wire, for ships and vessels	626
chlorate of, ground, etc.	515	Quicksilver	528	Rinds, citron, orange and lemon, in brine	504
German mineral	520	Quills, natural or unplumed	520		
muriate of, crude	563	Quills, linen or cotton, N.O.P.	521		
prussiate of, red and yellow	565	Quince trees	73		
salts, German	520	Quinines	76		
Potassium, cyanide of	477	Quinine, salts of	477		
		Quins for printing	320		

## Feed Water Heaters

Save fuel and filter and purify the feed water for steam boilers. Use only the exhaust.

HIGH GRADE

**STEAM AND POWER PUMPING MACHINERY** For Every Purpose

Single, Duplex and Triplex; Electric Motor or Belt Drive.

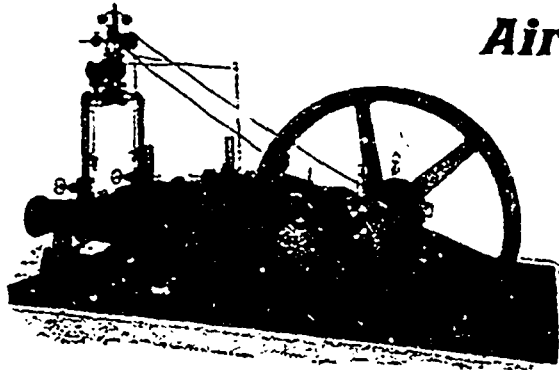
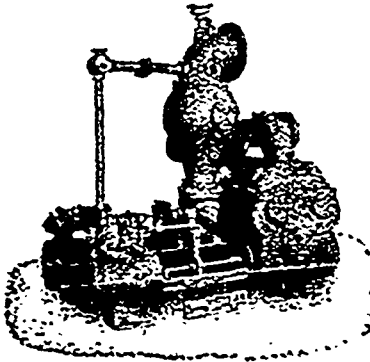

## Air Compressors

For pumping water, running pneumatic tools, operating Rock Drills and Coal Cutters, etc., etc.

**OIL MILL MACHINERY  
FILTER PRESSES.**

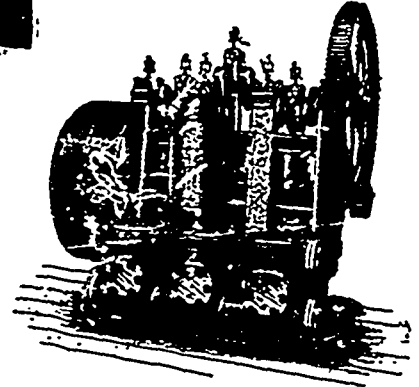

Jet-CONDENSERS—Surface  
AIR PUMPS  
VACUUM PUMPS  
AIR and CIRCULATING PUMPS  
THE VICTOR  
TURBINE Water Wheels  
POWER TRANSMISSION MACHINERY.

If interested in any of these lines  
ADDRESS—

**The STILWELL-BIERGE & SMITH-VAILE CO.,** 284 LEHMAN ST., DAYTON, OHIO, U.S.A.

BRANCH HOUSES—

CHICAGO, 311 Dearborn St.  
NEW YORK, 141 Broadway.

PHILADELPHIA, 612 Arch St.  
BOSTON, 51 Oliver St.

NEW ORLEANS, 504 Hennen Bldg.  
LONDON, E.C., 97 Queen Victoria St.

MAKERS OF

## Children's Vehicles Reed and Rattan Furniture.

TO THE FOREIGN TRADE—

We have a special line in Reed Furniture that can be knocked down.

Our RECLINING GO-CART is the only one that will give you any position required.

Write for our Illustrated Catalogues, they are graded as follows. In writing kindly mention grade required.

GRADE "A"—Children's Carriages, Baby Carriers, Stanley and Go-Carts.

GRADE "B"—Reed Furniture.

GRADE "D"—Velocipedes, Tricycles, Express Wagons, Sulkies, Toy Barrows, Shoo-Fly Rockers, Doll Cabs, Doll Go-Carts, Baby Carriers, Stanley and Go-Carts, Invalid Chairs, Delivery Wagons and Carts.

GRADE "F"—Sleighs.

THE  
**GENDRON MFG. CO., Limited**

**TORONTO, CANADA.**

When writing to Advertisers kindly mention THE CANADIAN MANUFACTURER.

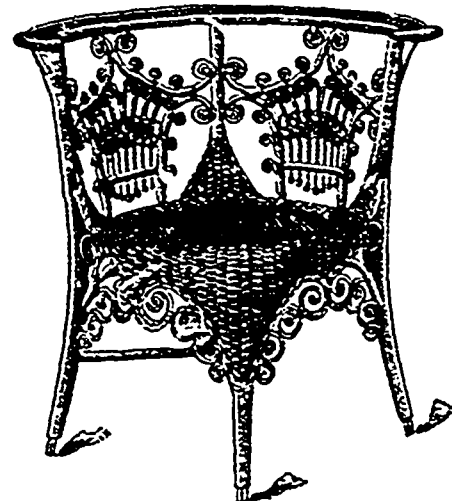

Index to the Canadian Tariff.

	No. of Item.		No. of Item.		No. of Item.
Rings for manufacture of umbrellas, etc.	572	Ruled paper	140	Scroll, iron or steel 8 in. and less wide, 18 gauge and thicker, N.E.S.	229
Rivets, brass	276	Rulers	421	iron or steel thinner than 18 gauge, N.E.S.	234
copper	276	Rolling machines	313	steel, more than 2 1/2 c. per lb., N.O.P.	238
iron or steel	279	Run	7 (a)	Scythes	290
tubular, hoop iron for manufacture of	538	bay	7 (c)	steel for manufacture of	598
Road scrapers	324	shrub	7 (a)	Seal net twine	524
rollers	290	Run of mine coal	180	Seamless bags, cotton	377
Roasted chicory	92	Runners for manufacture of umbrellas, etc.	572	drawn tubing, zinc	633
coffee, not imported direct	88	Russia iron	234	tubes of rolled steel, not over 1 1/2 in. in diameter	250
and imitations of, etc.	89	Russian hair skins	578	steel, for bicycles	250
Roasting machinery, ore	535	Rye	40	Seagrass, crude, natural or cleaned only	521
Rock crushers and drills	315	flour	41	Seaweed, crude, natural or cleaned only	521
phosphate	520			Sections, iron or steel, further manufactured than rolled	242
emery grinding machines	555			rolled iron or steel, less than 35 lbs. per lin. yd.	227
Rockingham ware	185	Sacks of hemp, linen or jute	377	rolled iron or steel, N.E.S.	228
Rods, brass	492	paper	136	structural building and bridge iron or steel, N.E.S.	228
copper	492	Sad Irons	245	trough, iron or steel, N.E.S.	228
fishing	335	Saddle-trees, Mexican	612	Seed cake, cotton	559
iron or steel for manufacture of wire	574	Saddlers' hardware	280	drills	318
Swedish rolled iron, under 1/2 in. in diameter	237	Saddlery, N.E.S.	280	lac.	517
Rods, Swedish rolled steel, under 1/2 in. in diameter, etc., for manufacture of horse-shoe nails	237	Safes, amalgam	283	meal, cotton	550
Roll, blinestone in	502	and doors of	283	pease and beans from G.B.	526
sulphur in	502	Safety lamps, miners'	555	oysters	560
Rolled edge steel plate, not less than 30 inches wide, etc.	231	Safflower and extract of	502	rape, sowing	526
edge bridge plate, universal mill	230	Saffron and extract of	502	Seeding stock for grafting	526
German silver	634	cake	502	Seeds, viz.: annatto, beet, carrot, flax, turnip, mangel and mustard	520
iron tubes for manufacture of bedsteads	617	Sago	53	aromatic, viz.: anise, anise star, carraway, coriander, cardamom, cumin, fennel and fenu-greek, crude, not edible, etc.	526
iron nail rods, Swedish, for manufacture of horse-shoe nails	237	flour	53	stem and fruits, crude drugs, not edible, etc., N.O.P.	515
or steel angles, channel, etc., less than 35 lbs. per yd.	237	Sail boats, open pleasure	410	N.O.P.	61
angles, channels, etc., N.E.S.	237	Sail-twine of hemp or flax and canvas, for boat's or ship's sails	411	sunflower, canary, hemp and millet	61
bars	237	Sails for boats and ships	380	Seines, fish and twine for	524
beams, joists, etc., N.E.S.	237	Sal aminouac	477	Self-linding harresters	318
shapes, N.O.P.	237	soda	586	Semi-monthly magazines, unbound	469
sheet or plates sheared, etc.	237	Salmon, fresh	106	Senate, articles imported by and for use of	450
sheets, 17 gauge and thinner	234	net twine	524	Senegal gum	531
Rolled iron or steel hoop, band, scroll or strip, thinner than 18 gauge, N.E.S.	234	pickled or salted	107	Separators, cream, and steel bowls and parts	558
rods, Swedish, under 1/2 in. in diameter, etc.	237	prepared, etc., N.E.S.	115	Set, and parts	315
round wire rods for manufacture of wire	574	Salt cake	586	mining machinery	555
steel tubes, not more than 1 1/2 in. in diameter	250	course, N.E.S.	102	Serges, to be dyed and finished in Canada, etc.	386
Roller skates	281	fine, in bulk, N.E.S.	102	Serum for subcutaneous injection	515
Rollers, copper, for use in calico printing	577	from United Kingdom, etc.	576	Sesame seed oil	169
road or field	290	for use of fisheries	579	Sets, smokers', and cases for	423
window shade	344	N.E.S., packages containing	103	Settlers' effects	435
Rolls, chilled iron or steel	254	in bags, barrels, etc.	103	Sewer pipes	184
Rolling pins	330	Saltpetre	477	Sewing machine attachments	553
Rolls, corals and belted	315	Salted fish, all other in barrels, not in barrels or half-barrels	109	machines or parts	314
Roofing slate	197	herrings	105	domestic, settlers'	455
Roots, orris	515	salmon	107	Sewing silk	373
medicinal	515	Salts, aniline	477	thread, cotton, in hanks	370
crude drugs, not edible, etc., N.O.P.	515	antimony	478	on spools, etc.	371
Rope wire	269	German potash	520	Shackles, chain	261
Ropes, head	524	of quinac	477	Shaddocks	526
Rose bushes	74	of zinc	502	Shade blanks, lamp, celluloid	286
Roses, attar of, or ottar of	558	Salves, N.O.P.	147	rollers, window	344
oil of	558	Samplers, ore, automatic	555	trees, shrubs and plants	74
Rosewood, lumber and timber planks and boards of	611	Sandarac gum	531	Shades and shade holders	297
saw-dust	614	Sand	505	glass	206
Rosin oil	480	iron for polishing granite or glass	541	window, N.E.S.	329
In packages of not less than 100 lbs	480	paper	135	Shafting, steel, turned, etc.	243
Rotary coal drills	555	Sandstone not hammered or chiselled	103	Shale oils, illuminating, over 30c per gall.	170
Rough burr-stones, in blocks	496	Sandalwood, lumber and timber, planks and boards of	611	Shams	362
grease, refuse of animal fat, for manufacture of soap and oil	528	saw-dust	614	Shanks, shoe-steel for manufacture of	591
marble	103	Sappato gum, crude	515	Shapes, hat, cap and bonnet, and bonnet, buckram for manufacture of	494
stuff, N.E.S.	160	Sardines in tin boxes	111	of iron or steel, rolled, less than 35 lbs. p. l. yard	227
Round unmanufactured timber	611	any other form	112	N.E.S. and N.O.P.	228
Rounds, bar iron or steel, rolled	229	Sarsaparilla root, unground	515	further manuf'd than rolled	242
Roze, for manufacture of binder twine	432	Satchels	424	etc.	242
Rubber hose, packing, mats and mottles	222	Sateens for corset and dress stay makers	364	hammered, N.O.P.	243
boots, stockinettes for	383	Satin, white	624	Shares, plough, cut to shape, etc.	317
cotton or linen hose lined with	383	wood, lumber and timber, planks and boards of	611	Shawls of all kinds	389
crude	573	saw-dust	614	Shears	284
fillets for card clothing	573	Sauces	67	Sheathing nails	258
hard, in sheets	573	Sausage skins or casings, not cleaned	580	yellow metal for	510
heads for whips	573	Saw-dust of certain woods	614	vessels, felt adhesive for	510
India, boots and shoes	221	Sawed boards, planks, etc., undressed or dressed on one side only, etc.	611	Sheep for the improvement of stock leather, dressed, waxed, etc.	212
Rubber clothing, etc.	221	boards, planks and deals, planned timber	611	Sheet aluminum	476
manufactures of, N.O.P.	221	Saws, steel for, cut to shape only, of all kinds	260	brass	492
powdered	573	Scales	283	celluloid, xylonite or xyllite	501
recovered	573	Schledam	352 (a)	copper, not coated or planished	492
shirts	573	Schlag metal leaf	352	glass	209
substitute	573	Schnapps	284 (a)	hard rubber, not further manufactured	573
thread, elastic	573	Sclasons	284	iron or steel for vessels	542
waste	573	School writing slates	199	manufs. of, N.O.P.	309
Rubberized oilcloth	383	Schools of blind, articles for	460	30 in. wide and 1/4 in. and over thick	231
Rugs, railway or travelling	389	Scrap brass	492		
cocoa straw, hemp or jute	396	copper	492		
China goat, etc., not dyed	578	iron, cast	224		
N.E.S.	397	or steel from vessels wrecked in Canadian waters	581		
		lead	223		
		or steel, wrought, waste	272		
		leather, tanners'	324		
		Scrapers, road or railway	343		
		Screens, wire	343		
		Screws, commonly called wood screws	260		
		metal, N.O.P.	260		



# MACHINERY

## Iron and Wood Working Tools

## *ENGINES, BOILERS*

Feed Water Heaters and Steam Pumps

Shafting, Hangers, Pulleys

Leather and Rubber Belting

## *New and Second-Hand Machinery*

### CANADA MACHINERY AGENCY

W. H. NOLAN, Manager

298 ST. JAMES ST., - MONTREAL.

## To Manufacturers!

**Do You** Publish Catalogues and Circulars ?  
 Advertise in Trade Journals

We can Supply You with Artistic and Mechanically Correct

**PHOTO-ENGRAVINGS, WOOD CUTS,  
 ELECTROTYPES, ZINC ETCHINGS, ETC.**

OF ANYTHING YOU MAY DESIRE.

FIRST-CLASS IN EVERY PARTICULAR.

AT PRICES THAT DEFY COMPETITION. ASK FOR ESTIMATES.

*The Canadian Manufacturer Publishing Co., Limited,*  
 TORONTO, CANADA.

Index to the Canadian Tariff.

	No. of item.
Sheet iron, No. 17 gauge and thinner, N.O.P.	234
flat galvanized	234
coated, N.O.P.	234
steel, more than 2½c. p. lb., N. O.P.	236
music, printed	129
steel, crucible, for manufacture of mower and paper knives	590
wadding	353
Sheets of German silver	584
gold and silver bullion	405
iron or steel, No. 17 gauge and thinner, N.O.P.	234
lead	273
linen or cotton, N.O.P.	361
nickel silver	584
phosphor bronze	209
platinum	564
rolled iron or steel, sheared or unsheared	232
rubber in	573
silver, nickel and German	584
tin	610
zinc in	633
Shelf oil cloth, enamelled	398
Shellac, gum	531
Shellac, in	517
Shellac gum	531
white, in gum or flakes, for manufacturing purposes	531
Shelled nuts, N.E.S.	95
oysters, in bulk	116
pea-nuts	96
Shells, cocoa	93
copper, for electrotypes, etc., of books, etc.	604
for stereotypes, etc., of almanacs, etc.	302
for stereotypes, etc., of newspaper columns	303
paper, brass cups for	512
shot primers and hemp paper for	535
unmanufactured	527
Shingle bolts	611
Shingles	611
Ship building, books on	404
planking	611
timber	611
Shipping tags	127
Ships, chronometers and compasses for	503
foreign, applying for Canadian register	409
sails for	380
whip rigging for	626
Shirts and shirt waists	366
Shoemakers' ink	164
Shoe blacking	164
huttons, papier-mache	553
N.E.S.	426
dressing	164
knives	284
eyelets, hooks and fasteners	553
laces	405
tagging metal for manufacture of	606
nails	259
shanks, steel for manufacture of tacks	591
makers' tools	289
Shoes, horse, mule and ox	256
India-rubber	221
iron or steel wire used in manufacture of	627
rubber, stockinettes for	383
wire of brass, iron, steel and zinc, twisted, for the manufacture of	627
N.E.S.	219
Shot, iron, for polishing glass or granite	541
lead	274
shells, hemp paper for manufacture of	525
primers for	525
Shovel blanks, and iron or steel cut to shape for	291
handles, "D." wood	612
Showers	291
Show cards, pictorial	126
cases	329
Shrub, rum	7 (a)
Shrubs, shade, lawn and ornamental	74
Sieves	290
Side lights	297
Sided timber	611
Sides and tips, hatters', and linings for	533
Siennas, burnt, N.E.S.	160
raw	159
Signs	310
Silic	556
Silicate of soda	536
Silicon, ferro	225
Silk cloth, for manufacture of mackintosh clothing	381
clothing, N.O.P.	362
cocoons	582
embroidery	373

	No. of item.
Silk fabrics	368
hatters' plush	533
in the gum or spun, not more advanced than singles, etc.	372
manufactures, N.E.S.	369
nettings	362
oiled, India-rubbered, flocked, etc.	385
raw or as reeled from cocoon	582
sewing	373
twist	373
velvets	368
waste	582
Silver bullion, in blocks, bars, ingots, etc.	495
coin, except U.S. silver coin	473
German, Nevada and nickel, manufactures of, not plated	292
ingots, etc.	584
leaf	352
manufactures, N.E.S.	350
medals won in competition, etc.	473
nickel ingots, etc.	584
primes	77
sweepings	495
ware, sterling or other	293
cases for, fancy	351
Silvered glass	206
Slakers	319
Sisal and manilla twine mixed, for binders	433, 620
twine for binders	433, 620
Sizing cream	167
enamel	167
Skates	281
steel for manufacture of	593
Skins, cart or wagon	247
Skeletons, or parts thereof	463
Skeip iron or steel, sheared, etc., N.E.S.	232
for manufacture of steel pipe	233
Skiffs	410
Skin washes, alcoholic	7 (c)
Skins, Russian hair	578
chamois	212
for taxidermic purposes, viz.: birds and animals	463
fish	463
fur, wholly or partially dressed not dressed in any manner	406
for Morocco leather, tanned only	213
gold beaters	330
raw, whether dry, salted or pickled	536
sausage, not cleaned	580
N.O.P.	213
Slabs, iron or steel	226
Slack coal, bituminous	179
Slag, blast furnace	485
Slate pencils	199
mantels	198
manufactures of, N.E.S.	198
roofing	197
Slates, school, writing	199
Sledges	289
Sleds, children's	322
Sleds	322
Sleighs	422
Slides, magic lantern	219
Slippers, N.E.S.	219
Slime tables, mining	553
Slot machines	315
Slugs for printing	300
Smelting machinery	555
Smoked fish	110
Smokers' sets, etc., cases for	432
Smoothing irons	245
Sraths	290
Snuff	444
Soap, castile, mottled or white	21
common or laundry, not perfumed	23
harness	164
powders	26
rough grease, refuse of animal fat, for manufacture of	528
N.E.S.	25
Sockets, electric	294
tubular bow-steel for manufacture of	536
Socks of all kinds	387
Soda, arsenate of	586
ash	586
bichromate of	586
bisarsenate of	586
bisulphite of	586
caustic	586
chlorate of	586
chloride of	586
nitrate of	586
nitrite of	586
sal	586
sulfate of	586
stannate of	586
sulphate of, crude	586
Sodium, sulphide of	586
Sole leather	213
Solutions of peroxides of hydrogen	146
Soups	15
Southdown combing wools	390
Sowing rape seed	526
Soy	67

	No. of item.
Spade blanks, and iron or steel cut to shape for	291
Spades	291
Spanish grass	521
cedar, lumber and timber planks and boards of	611
saw-dust	614
Spar ornaments	351
Sparkling wines	9
Spatulas	284
Spawn, mushroom	520
Specimens, botanical	463
entomological	463
mineralogical	463
for illustrating natural history	463
Spectacle frames, parts of	211
Spectacles	210
Spelter, zinc	633
Spermaceti oil	122
Spices, N.E.S.	101
Spiegelstein	225
Spikes, composition	238
cut, of iron or steel	235
Spikes, railroad	255
wrought and pressed	256
Spiraea	626
Spiral railway springs, steel for	601
Spirit, palm	7 (a)
potato	7 (b)
pyroxylic	7 (d)
varnishes	161
wood	7 (a)
Spirits of ammonia, aromatic	7 (d)
fruits preserved in	83
lime juice and fruit juices fortified with	6
methylated	7 (a)
of ultra, sweet	7 (d)
Spirits of turpentine	166
of wine	7 (a)
palats and colors ground in	161
perfumed	7 (c)
Spirituos or alcoholic liquors	7
fruit essences, N.E.S.	7 (b)
liquors, N.O.P.	7 (a)
Spokes, hickory, rough-turned only	611
lumber sawn in shape for	611
Sporting powder	413
Sportsmen's knives	284
fish nets	434
Spreaders, manure	318
Sprigs, cut	239
Spring mattresses	343
steel, flat for vehicle springs	600
spiral, for spiral railway springs	601
Springs and parts of, iron or steel, for railway vehicles, etc.	246
for manufacture of surgical trusses	599
clock-steel for manufacture of furniture	343
lamp	298
Sprinklers for fire protection	311
lawn	312
Sprocket or link chain for blades	318
Spruce claphboards	611
Spurs and stiffs, used in manufacture of earthenware	587
Square reeds for manufacture of whips	576
Squared timber	611
Squares, bar iron or steel rolled	229
Squills, root, unground	515
Squirrel cages	297
Stained glass windows	202
Stair line	361
pads	396
Stamp mills	315
Stamps, postage, collections of	473
Stannate of soda	586
Starch and similar preparations	60
corn	60
rice for the manufacture of	54
Stars, iron or steel, N.E.S.	228
Statuettes, N.E.S.	351
Stave bolts	611
Staves of wood	611
Stays, dress-flat wire of steel for manufacture of	592
stay laces	405
Stearic acid	19
Stearine, animal, N.E.S.	18
Steam engines, portable, and parts	315
N.E.S.	315
Steel angles for iron vessels, etc.	542
rolled, less than 35 lbs. per l. yard, N.O.P.	227
rolled, N.E.S.	228
articles, manufactures, etc., N. O.P.	321
axles, axle bars, etc., for railway vehicles, etc.	246
axle bars, for manufacture of axles	600
bands, thinner than 18 gauge, N. E.S.	234
8-in. and less wide, 18 gauge and thicker, N.E.S.	229
more than 2½c. p. lb., N.O.P.	236

# JOHN McDOUGALL

Caledonian Iron Works, - MONTREAL

MANUFACTURER OF

ENGINES BOILERS  
MACHINERY  
HEAVY FORGINGS  
And CASTINGS of Every Description.

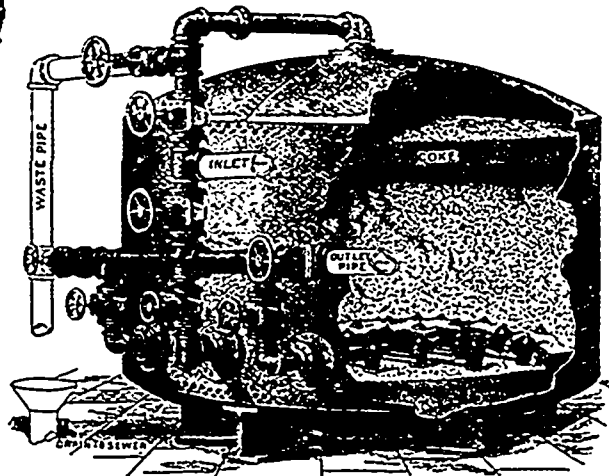
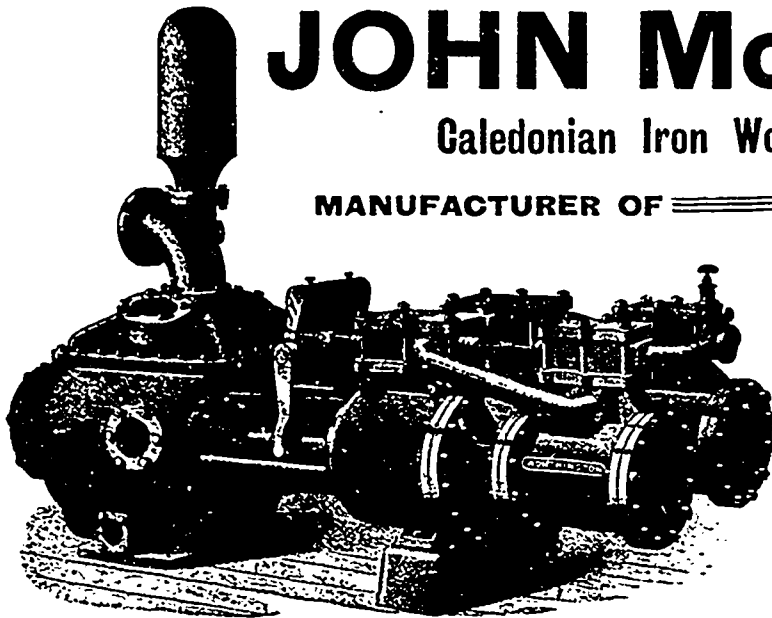

GENERAL AGENT FOR

“Worthington Pumps.”

“New York Filter Co.’s” Filters.

“McCormick” Turbines.

“Rife” Hydraulic Engines, Etc.

## THE BEST IS NONE TOO GOOD

The largest machinery builders in Canada and United States use our Babbitt Metal.  
Is this not sufficient proof of its superiority over other anti-friction metals?  
If the largest users are satisfied with our Babbitt Metals, why should it not suit you?  
We can furnish you with numbers of testimonials.

**SYRACUSE  
BABBITT**

**BEATS  
THEM  
ALL**

Importers and Dealers in

PIG TIN  
ANTIMONY  
INGOT COPPER  
ALUMINUM

NICKEL  
BISMUTH  
IRON AND STEEL  
SCRAP



Manufacturers of

BABBITT METALS  
SOLDER  
TYPE METALS

COLUMBIA  
PHOSPHOR TIN  
AND ALL OTHER  
WHITE METALS

## SYRACUSE SMELTING WORKS,

WILLIAM and ST. THOMAS STREETS,

MONTREAL

**B. GREENING WIRE CO.**  
(LIMITED)  
WIRE MANUFACTURERS  
& METAL PERFORATORS  
**HAMILTON  
& MONTREAL.**

Wire Screens for Every Class of Material.

Perforated Metal of Steel, Copper, Brass, Zinc for all purposes.

Special Attention given to Minors' Requirements.

When writing to Advertisers kindly mention THE CANADIAN MANUFACTURER.

Index to the Canadian Tariff.

	No. of Item.
Steel bars, rolled	229
bars, railway, N.E.S.	238
hammered, N.O.P.	243
more than 2½c. per lb., N.O.P.	236
Steel beams for vessels	542
rolled, less than 35 lbs. per l. yard.	227
N.E.S.	228
billets.	226
for springs and axles.	600
blooms.	226
boiler tubes.	249
boilers and machinery, N.E.S.	315
bolt blanks.	279
bolts.	279
bows for cream separators.	588
brads, springs and tacks, N.O.P.	239
bridge plate, universal mill.	230
bridges.	242
buckles, N.O.P.	305
caps for whip ends.	576
castings in the rough, N.E.S.	244
chains, 5-16 of an inch and over channels, rolled, less than 35 lbs. per l. y., N.O.P.	227
N.E.S.	228
chrome.	245
column sections, further manufactured than rolled, etc.	242
crucible sheet, for manufacture of mower and reaper knives.	300
cutlery, N.O.P.	254
cut to shape for spade and shovel blanks.	291
eye bar blanks, flat.	223
fencing, barbed wire.	602
buckthorn, strip, etc.	263
flats.	229
forgings, N.E.S.	242
for manufacture of files.	700
bicycle chain.	397
hammers, augers and auger bits, etc.	598
tubular bow sockets.	598
for knob and lock manufacturers and cutters.	594
for corset steels, clock springs and shoe shanks.	591
for saws and straw cutters, cut to shape only.	589
for manufacture of skates.	593
buckle clasps, bed fasts, furniture castors and ice creepers.	595
galvanized sheet manufacture of, N.O.P.	309
girders, rolled, less than 35 lbs. per l. yard.	227
girders, rolled, N.E.S.	228
hinge blanks.	279
hinges, T and strap, N.E.S.	279
hollow-ware, enamelled, agate, etc.	307
plain, etc.	308
hoop, 8-in. and less wide, 18 gauge and thicker, N.E.S.	229
hoop, thinner than 18 gauge, N.E.S.	234
more than 2½c. per lb., N.O.P.	236
P.	236
ingots and cogged ingots.	226
joints, rolled, N.E.S.	228
knees for iron vessels, etc.	542
knife blades or blanks and table forks, in the rough.	285
loops, etc.	226
Steel manufactures, not manufactured in Canada, for ships and vessels.	542
masts for ships, or parts of.	242
nails, cut.	245
nail rods, Swedish.	247
nails, N.E.S.	245 & 246
netting.	270
nut blanks.	279
nuts.	279
pieces, punchings or clippings of plate, etc.	223
ple, fittings for.	234
plate, universal mirror rolled edge.	230
agricultural, cut to shape etc.	317
more than 2½c. per lb., N.O.P.	236
engravers.	301
plates, for iron or steel vessels, etc.	542
30 in. wide and over, and ¼ in. and over thick.	241
sheared or unsheared.	232
puddled bars.	226
rails, crops from, etc.	223
not less than 45 lbs. per l. yard, for railway tracks, etc.	585
railway bars or rails, N.E.S.	238
ribs for manufacture of umbrellas, parasols, etc.	572
rivets.	279

	No. of Item.
Steel, rolled round wire rods for manufacture of wire.	574
rolls, chilled.	254
scrap, old, etc., recovered from wrecks.	581
having been in use.	223
screws, N.O.P.	260
scroll, 8-in. and less wide, 18 gauge and thicker, N.E.S.	229
thinner than 18 gauge, N.E.S.	234
P.	236
sections, rolled, less than 35 lbs. per l. yd., N.O.P.	227
rolled, N.E.S.	228
shafting, tunnel, etc.	243
shapes, hammered, N.O.P.	243
rolled, less than 35 lbs per l. yd.	227
rolled, N.E.S.	228
sheets, 17 gauge and thinner, N.O.P.	234
flat, galvanized.	234
coated, N.O.P.	234
for iron vessels, etc.	542
sheared or unsheared.	232
more than 2½c. per lb., N.O.P.	236
skelp, sheared, etc., N.E.S.	232
for manufacture of steel pipe slabs.	233
spikes, cut.	235
spring, flat, for springs and axles.	600
for the manufacture of surgical trusses.	599
spiral, for manufacture of spiral railway springs.	601
springs, for railway vehicles, etc.	246
stars, rolled, N.E.S.	228
steam engines, N.O.P.	315
strip for manufacturing wire fencing, 8-in. and less wide, 18 gauge and thicker.	229
Steel strip, thinner than 18 gauge, N.E.S.	234
more than 2½c. p. lb., N.O.P.	236
structural sections, building and bridge, rolled.	228 & 242
tees, less than 35 lbs. per l. yd.	227
N.E.S.	228
tires, locomotive and car wheel, rough.	551
trough sections, rolled.	228 & 242
tubing, over 2-in. in diameter.	251
2-in. in diameter or less, N.E.S.	252
tubes or pipes, other, N.O.P.	253
rolled, not welded, etc., not over 1½ in. diameter.	250
seamless, for bicycles.	250
ware, N.E.S.	308
washers.	279
wire, crucible cast.	625
flat for dress stays, crinoline and corset wire.	582
flat, for manufacture of wire fencing.	602
for manufacture of mattresses.	628
galvanized, 9, 12 and 13 gauge.	603
for manufacture of boots, shoes, etc.	627
Zees, N.E.S.	228
Steels, corset.	284
table and butchers.	531
steel for manufacture of.	531
stem seeds, crude drugs, not edible, etc., N.O.P.	515
Stereotypes for almanacs, etc., N.E.S.	302
matrices or copper shells for of books, etc., matrices or copper shells for.	604
for newspaper columns.	303
bases, matrices and copper shells for.	303
Sterling silverware.	293
Stick lark.	517
Sticks as last blocks, etc., rough hewn or sawed only.	611
umbrella, etc., rough, or cut to length only.	572
bamboo reeds for.	499
N.E.S.	327
walking, N.E.S.	325
bamboo reeds for.	499
Stills and spurs, for the manufacture of earthenware.	587
Stirrups of wood.	612
Stock, animals for improvement of, florist, viz: palms, orchids, azaleas, catl, flower bulbs, etc.	457
fowls for improvement of.	526
live, settlers.	455
seedling, for grafting.	526
Stockinettes for rubber boots and shoes.	383
Stockings of all kinds.	387

	No. of Item.
Stone, building, dressed.	194
not hammered, etc.	193
baths, tubs and washstands.	186
chalk.	525
china or Cornwall.	525
cliff.	525
flint.	525
manufactures of, N.O.P.	196
paving blocks.	194
quartz.	507
Stones, burr, rough, for blanding into mill stones.	496
curling.	511
ground flint.	525
lithographic, not engraved.	190
precious, N.E.S., polished but not set, and imitations of.	548
precious, in the rough.	525
Stoneware, brown or colored.	185
demijohns, churns or crocks.	182
Store furniture.	343
Stores, military, by and for use of army and navy.	449
for use of Canadian militia.	450
Stove plates.	245
linings.	181
Stoves.	245
Stranded wire.	269
Strap hinges.	279
Strawberries, wild.	526
N.E.S.	75
Strawberry wine.	8
Straw boards.	135
carpeting, rugs, mats, etc.	396
Straw cutters, steel for.	589
knives.	290
steel for manufacture of.	598
Straw platts.	563
Strength testing machine.	283
Strip fencing, buckthorn wire, etc., for manufacture of.	602
Strips, aluminium.	476
German and nickel silver.	584
brass.	492
horn in the rough.	337
iron or steel, 8 in. and less wide, 18 gauge and thicker, N.E.S.	229
platinum.	564
thinner than 18 gauge, N.E.S.	234
steel, more than 2½c. per lb., N.O.P.	236
Structural sections, building and bridge.	228
work, iron or steel.	242
Stuff, rough, N.E.S.	160
Sub-acetate of copper, dry.	502
Substitute, rubber.	573
for extract of coffee, N.E.S.	90
for roasted or ground coffee.	89
Sugar above No. 16 D.S. in color.	435
cane, syrups and molasses.	440
candy.	438
concrete.	436
drainings or pumpings, drained in transit.	436
grape or glucose.	437
maple.	439
N.E.S., not above 16 D.S.	436
Sugars, refined.	435
Sulphate of alumina.	476
ammonia.	477
copper (blue vitriol).	502
iron (copperas).	502
lime.	502
soda, crude.	586
Sulphide of sodium.	586
Sulphur, crude, in roll or flour.	502
Sulphuric acid.	144
articles for the manufacture of.	564
ether.	146
Sumac and extract thereof.	517
Sunday School lesson pictures.	464
Sunflower seed.	61
Sunshade sticks or handles, N.E.S.	337
of bamboo, not manufactured.	499
Sunshades, articles for the manufacture of.	572
Sunshades.	401
Surgical belts and trusses.	152
dressing, antiseptic.	152
instruments.	153 & 605
needles.	153
trusses, steel springs for.	599
Suspenders or parts thereof.	404
Suspensory bandages.	152
Sweats, hat, for the manufacture of hats.	533
Swedish rolled iron or steel nail rods, for manufacture of horse-shoe nails.	237
Sweepers, carpet.	343
Sweepings, gold and silver.	495
Sweet potatoes.	64
spirits of nitre.	7 (d)
Sweetened gums.	438
Swine for improvement of stock.	457
Switches for railways.	240
Swords.	306
Sycamore, lumber and timber planks and boards of.	611
saw-dust.	614

# John Inglis & Sons

Corliss  
Engines  
Marine  
Engines  
High Speed  
Engines  
Flour Mill  
Machinery

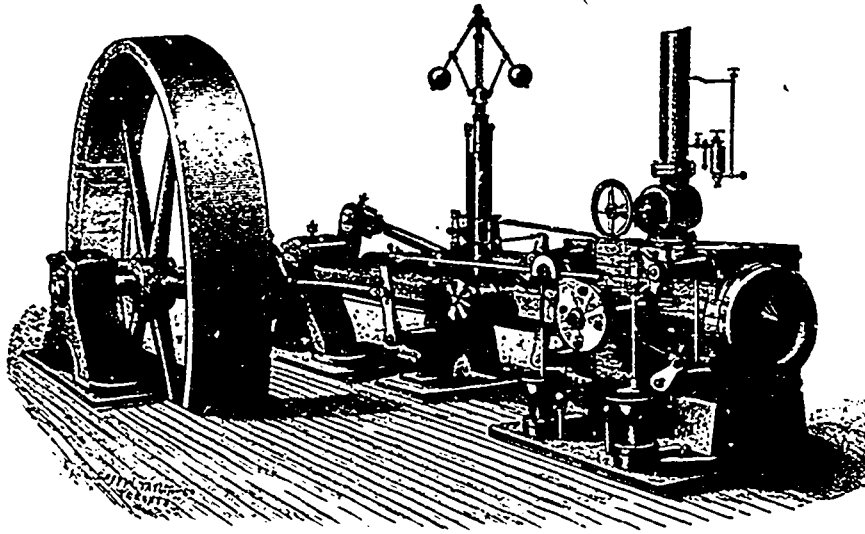

Stationary  
Boilers  
Marine  
Boilers  
Water Tube  
Boilers  
Shafting  
Pulleys, etc.

## Engineers and Boiler Makers

TORONTO, ONT.



**SEPARATORS FOR EVERY SERVICE**

Our new Catalogue shows a very complete line of Separators designed to cover special requirements for large steam storage, extreme high pressure, extra water capacity, etc.

**AUSTIN SEPARATORS**

Are guaranteed, and are without a rival for eliminating condensation from Live Steam and removing oil grease and other impurities from exhaust.

Hundreds of testimonials in our new catalogue. Write for it.

**AUSTIN SEPARATOR CO.**  
38-40 Woodbridge St.  
DETROIT, MICH., U.S.A.

**CANADA IRON FURNACE CO., LIMITED**  
*Montreal, Radnor and Three Rivers*

Manufacturers of the well-known

**"C.I.F." Three Rivers Charcoal Pig Iron**

Suitable for Car Wheels, Cylinders and Fine Castings, where the utmost strength is required.

UNSURPASSED IN STRENGTH BY SWEDISH, RUSSIAN OR AMERICAN CHARCOAL IRON.

Offices: *Canada Life Insurance Bldg., Montreal.*

**MONTREAL PIPE FOUNDRY CO...**  
(Limited)

SUCCESSORS TO

**DRUMMOND-McCALL PIPE FOUNDRY CO.**  
(Limited)

Manufacturers of

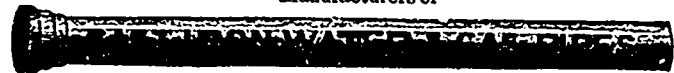

"Specials," Hydrants, Valves, Etc.

Offices: - - - **Canada Life Building,**  
**MONTREAL**

Index to the Canadian Tariff.

	No. of Item.
Syrup, corn	437
glucose	437
maple	439
Syrups containing admixtures of	
glucose or corn	437
fruit, N.O.P.	6
medicinal, N.O.P.	147
N.O.P., product of sugar cane	410
<b>T</b>	
Table cloths, N.O.P.	301
forks, not handled, etc.	285
oil-cloth, enamelled	398
steels	284
ware, glass, cut, moulded or	
pressed	208
blown	208
Tables, bagatelle	340
billiard	340
silmc, gold miling	555
Tablets, with moveable fixtures for	
schools of blind	460
Tacks, brass and copper	276
cut and tacks N.O.P.	259
shoe	259
Tadn bitters	7 (a)
Tagging metal for manufacture of	
shoe and corset laces	606
Tags, shipping, &c	127
Tailors' fashion plates	469
irons	245
Tails, undressed	607
Tallow	19
Tampico	521
Tank bottoms, sugar	436
Tanners' bark	517
scrap leather	213
Tannic acid	454
Tanning articles in crude state, N.	
E.S.	517
hooks on	464
Tape, rubbered, etc.	385
lines	422
Tapioca	53
Tar, coal	507
ores	477
pitch	507
Taraxacum root, unground	515
Tartar paper	135
Tartar, cream of, crystals	502
Tartar, emetic	502
gray	502
Tartaric acid in crystals	502
Tassels	630
Tax for manufacture of, etc.	
Tea adulterated with spurious leaf,	
etc., prohibited	640
imported direct from country of	
growth	608
lead	610
N.E.S.	57
purchased in bond in United	
Kingdom	608
Teak, African, lumber and timber,	
planks and boards of	611
saw-dust	614
Tensels	609
Tedders, hay	315
Tees, rolled iron or steel, less than	
35 lb. per l. yd.	227
N.E.S.	228
Telegraph rates	124
instruments	294
Telephone instruments	294
Tennis nets, lawn	434
Terra cotta ornaments	351
japonica	517
Terne plate	234
Textile leather heads for manufac-	
ture of whips	576
"T" blades	279
Thongs for whips	217
Thread, cotton, sewing, in hanks	370
on spools	371
N.E.S.	371
gilling	324
rubber elastic	575
Threshers	315
Thumbs and tips for manufacture	
of whips	576
Tickets	127
Tie plates, railway	239
Ties, railroad	611
Tiles, drain, not glazed	183
earthenware	184
Timber, hewn or sawed	611
manufactured, N.E.S.	329
of certain kinds, rough sawn,	
etc.	611
round, unmanufactured	611
ship	611
squared or sided or creosoted	611
Tin crystals	610
foil	610
in blocks, pigs, bars and sheets,	
manufactures of, N.E.S.	369
oxide of	502
phosphor	299
plate bars, crop ends of	223
plates	610
strip waste	610
Tiware	309

	No. of Item.
Tinctures, alcoholic, N.E.S.	7 (b)
N.O.P.	147
Tinsmiths' tools	289
Tips, cue	340
horn, in the rough	537
Tips, lava or other	297
and slides, and linings for, hat-	
ters'	533
for manufacture of whips	576
Tippets, fur	407
Tires, bicycle, duck or canvas for	
manufacture of	516
locomotive and car-wheel, of	
steel, in the rough	551
Tobacco, cut	443
manufactured, N.E.S.	444
Tobacco, pipes	423
pouches	423
unmanufactured, unstemmed for	
excise purposes	445 & 616
unmanufactured, stemmed, for	
excise	446 & 616
Toilet cases	271
clippers	284
combs	427
preparations, alcoholic	7 (c)
non-alcoholic	149
of petroleum, similar to vase-	
line	178
Tomatoes, fresa	65
N.E.S., in cans, etc.	66
Tonquin beans, crude only	526
Toules, N.O.P.	147
Tool bags	424
hand or machine	289
loading	306
settlers'	455
track	289
Tooth powders and washes	149
washes, alcoholic	7 (c)
Topographical globes	161
Tops, chimney	184
worsted	391
N.E.S.	629
Torpedoes	416
Tortoise shells, unmanufactured	527
Tow, flax	521
surgical dressing	152
Towels	361
Tows	351
Track tools	289
Tracts, religious	464
Tragacanth, gum	531
Transfers taken from plates, engrav-	
ed on wood or metal	301
Travellers' baggage	452
carriages for	453
travelling rugs	389
Trawl twine, for nets, etc.	524
Trawls and travelling spoons	319
Tray cloths, damask of linen, etc.	361
Treenails	615
Trees, viz.: apple, cherry, peach,	
pear, plum and quince	73
fruit, seedling stock for grafting	526
shade, lawn and ornamental	74
N.E.S.	526
saddle, Mexican	612
Tricycles	325
Trimmers	281
Trimmings, brass, for bedsteads	617
Trinches, N.O.P.	147
Trophies, honorary	473
Trucks	324
Trunk nails	256
Trunks	424
Trusses, surgical	152
steel springs for	599
Tubes, boiler, wrought iron or steel,	
corrugated, for marine boilers	249
rolled iron, not welded, for man-	
ufacture of bedsteads	617
steel, not welded, seamless,	
not more than 1/2 in. in dia-	
meter	250
seamless, for bicycles	250
Tubers	526
Tubing, brass	492
copper	492
lacquered or brass covered, for	
manufacture of bedsteads	617
wrought iron, etc., for mining,	
etc.	555
platinum, by manufacturers of	
sulphuric acid	564
wrought iron or steel, over 2	
in. in diameter, N.E.S.	251
wrought iron or steel, 2 in.	
or less in diameter, N.E.S.	252
iron or steel, other, N.O.P.	253
zinc, seamless drawn	611
Tubs	330
N.O.P.	186
Tubular bow sockets, steel for	598
rivets, hoop iron, for manuf. of	538
Tufa, calcareous	477
Turkish rugs or carpets	397
Turnerie	517
Turnip seed	526
Turpentine, raw or crude	618
spirits of	166
Turtles	619

	No. of Item.
Tuscan platts	503
Tweeds, wool, worsted, half of al-	
paca, goat, etc., N.E.S.	394
Twills, to be dyed and finished in	
Canada, etc.	386
Twine, N.E.S.	431
articles, manufactures of, N.	
O.P.	434
for harvest binders	433 & 620
jute, flax or hemp yarn for the	
manufacture of	546
rove for manufacture of twine	
for harvest binders	432
sail, of hemp or flax	411
Twines, fishing, to be used in mak-	
ing nets, etc.	524
Twist, silk	373
Twisted brass, iron and copper wire	
for manufacture of boots and	
shoes	627
Twisted wire, N.E.S.	269
Type metal	264
for printing	309
Type writers	415
for schools of the blind	400
settlers'	455
<b>U</b>	
Ultramarine blue, dry or in pulp	621
Umbels, N.E.S.	160
Umbrellas handles or sticks, N.E.S.	337
Umbrellas	401
articles for the manufacture of,	
sticks of bamboo, not manufac-	
tured	499
unbleached cotton fabrics, N.O.P.	359
unbound newspapers, magazines,	
uncleaned hair	469
undershirts	532
undershirts	388
Underwear, silk in the gum or spun	
for	582
Undressed leathers	28
hemp	534
tails	607
Unenumerated articles	447
Union cloths of certain kinds for	
manufacture of mackintosh	
clothing	381
collar cloth paper, glossed or fin-	
ished	133
collar cloth paper, not glossed	
or finished	132
universal mill steel plate	230
Unmanufactured bamboos, osiers	
and willows	490
Unmanufactured caoutchouc	573
India-rubber	573
lava	502
palm leaf	562
shells	527
timber, round, N.O.P.	611
tobacco for excise purposes	616
whalebone	623
Unplumed quills	569
Unset diamonds	513
Unsigned notes, drafts, etc.	128
Upholsterers' hardware	280
Upper leather, dressed, waxed or	
glazed	212
<b>V</b>	
Vaccine	515
points, ivory	515
Valerian root, unground	515
Valises	424
Valley, lilies of the	526
Vanilla beans, crude only	526
Vanners, mining	555
Varnish, black and bright, for	
ships' use	622
Varnishes, spirit	161
N.E.S.	163
Vaseline and similar preparations of	
petroleum	178
Vaults, door for	283
Vegetable fibres	521
manures	520
Vegetables, N.O.P.	43
N.E.S., in cans or other pack-	
ages	66
labels for	127
Vehicles, viz.: freight wagons,	
drays, sleighs, etc.	322
buggies, etc., N.E.S.	324
settlers'	455
Velveteens	368
Velvets	368
silk	368
Veneers of ivory	543
wood	231
Vents, chimney	184
Verdigris, dry	502
Vermicelli	59
Vermouth wine	7 (c)
Vessels, foreign, applying for Can-	
adian register	409
felt, adhesive, for sheathing	610
wire rigging for	626
wood, iron, steel or composite	
-beams, sheets, etc., for	
iron, steel or brass manufac-	
tures, not manufactured	542

**ASK Track Bolts and Spikes  
US Bridge and Roof Rods  
ABOUT Wrought and Cast Washers**

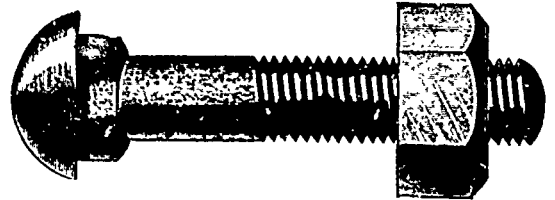

Railroad and Contractors' Supplies, Carriage and Machine Bolts, Plow and Special Bolts, Square and Hexagon Nuts

**Bridge RIVETS Boiler**

Drop Forgings of all kinds.  
COACH SCREWS.

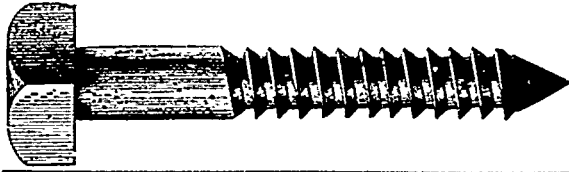

**The SWANSEA FORGING CO.**

LIMITED

SWANSEA, NEAR TORONTO.

**WINDMILLS!**

The sun never sets on the CANADIAN AIRMOTOR. The CANADIAN AIRMOTOR has established its reputation in Canada, and it is rapidly finding its way to FOREIGN LANDS.

Why? Because of POWER DEVELOPED, SIMPLICITY of MECHANISM, DURABILITY AND STRENGTH.

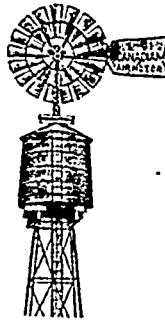

We do not Manufacture the CHEAPEST, but BEST. Do not buy "SHODDY."

WE ALSO MANUFACTURE

HALLADAY WINDMILLS, STEEL TOWERS of all descriptions, TANKS, (Railway and Village Supply), GRINDERS, HAY TOOLS, WATER BASINS, and WATER SUPPLY MATERIAL of all kinds. PUMPS:—BRASS, IRON, PORCELAIN and WOOD, a full line.

**ONTARIO WIND ENGINE and PUMP CO., Limited, Atlantic Ave., TORONTO.**

COMPLETE LINES OF

Tinsmiths'

Canners' and

Sheet Metal Workers'

Tools and Machines

.....

**BROWN, BOGGS & CO.**

HAMILTON, ONT.

When writing to Advertisers kindly mention THE CANADIAN MANUFACTURER.

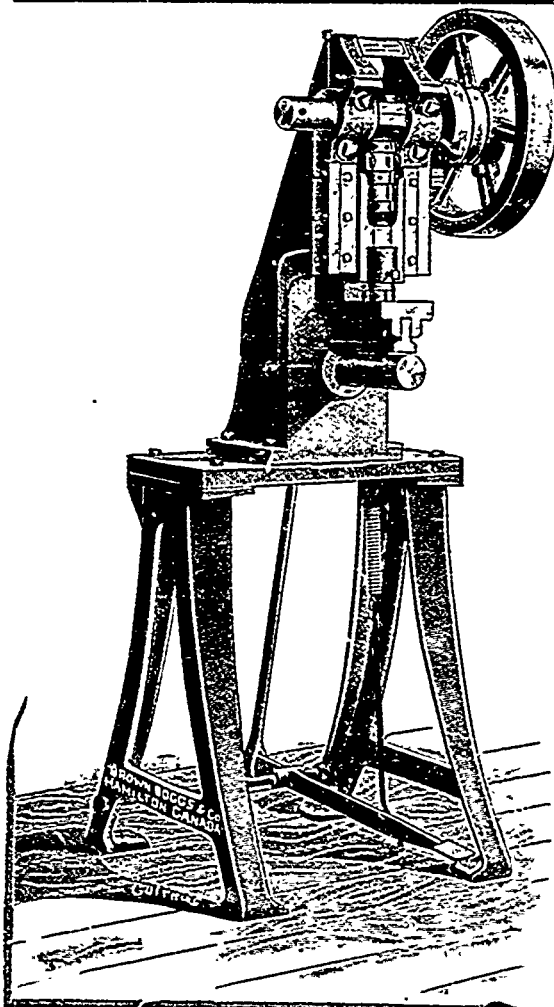

Index to the Canadian Tariff.

	No. of Item.		No. of Item.		No. of Item.
Vessels, wrecked in Canadian waters—scrap-iron and steel from	581	White lead, dry.....	153	Wool and hair of camel, alpaca, goat, etc., washed only, N.E.S. cloth for manufacture of machine-into clothing.....	620
Vestments, church.....	408	Paris.....	621	combustible such as is grown in Canada.....	381
Vinegar.....	141	sattu.....	624	.....	390
Vines, grape.....	74	shellac, in gum or flake, for manufacturing purposes.....	531	cotton.....	608
Vises.....	280	wood, lumber and timber planks and boards of.....	611	surgical dressing.....	152
Vitriol, blue.....	502	sawdust.....	614	Wool fabrics, etc., to be dyed and finished in Canada.....	386
Vulcanized fibre.....	341	zinc.....	158	and manufactures of, N.E.S., manufactures, viz.: blankets, flannel, cloths, doekings, cassimeres, tweeds, etc., N.E.S., ready-made clothing or wearing apparel, N.O.P.....	394
<b>W</b>		Whiting, gliders.....	621	yarns, costing 30c per lb. and over.....	393
Wadding, sheet, cotton.....	358	or whitening.....	624	for manufacture of braids, cords, tassels and fringes.....	630
Wads, gun.....	306	Wicks, lamp.....	418	N.E.S.....	392
felt board for manufacture of.....	545	Wild blueberries.....	526	Woolen rags.....	570
Wagon blocks, rough hewn or sawed only.....	611	raspberries.....	526	Worm gut, unmanufactured, for whip cord, etc.....	500
skelns or boxes.....	247	strawberries.....	526	Worsted fabrics, etc., to be dyed, etc., in Canada, etc.....	386
Wagons, farm.....	315	Willows, unmanufactured.....	499	and manufactures, N.E.S., manufactures, viz.: blankets, flannels, etc., N.E.S.....	394
freight.....	322	Wizemills.....	315	ready-made clothing, N.O.P.....	394
Waists, ladies' and misses.....	306	steel for manufacture of.....	598	tops.....	391
Walking sticks, bamboo reeds cut into lengths only.....	499	Window blinds, paper.....	128	N.E.S.....	629
and canes, N.E.S.....	335	cornices and poles.....	343	yarns for manufacture of braids, cords, tassels and fringes.....	630
Wall diagrams.....	463	glass, common and colourless.....	201	costing 30c per lb. and over.....	393
Walnut, lumber and timber, planks and boards of.....	611	memorial.....	202	N.E.S.....	392
saw-dust.....	614	Window shade rollers.....	344	Woolen rags.....	570
Wall paper.....	138	shades, N.E.S.....	349	Worm gut, unmanufactured, for whip cord, etc.....	500
Walnuts.....	16	Widows, stained glass.....	202	Worsted fabrics, etc., to be dyed, etc., in Canada, etc.....	386
Wares, iron or steel, N.O.P.....	321	wire.....	343	and manufactures, N.E.S., manufactures, viz.: blankets, flannels, etc., N.E.S.....	394
Warp, cotton, N.E.S.....	358	Wine, ginger.....	7 (c)	ready-made clothing, N.O.P.....	394
Washboards.....	339	spirits of.....	7 (a)	tops.....	391
Washstands, N.O.P.....	186	vermouth.....	7 (c)	N.E.S.....	629
Washers, brass or copper.....	276	Wires, containing more than 40 p. c. spirits.....	10	yarns for manufacture of braids, cords, tassels and fringes.....	630
iron or steel, N.E.S.....	279	medicinal, alcoholic.....	7 (b)	costing 30c per lb. and over.....	393
Washes, non-alcoholic.....	149	not over 40 p.c. spirits.....	7 (f)	N.E.S.....	392
spirituous.....	7 (c)	of all kinds, except sparkling.....	8	Woven wire fencing, iron or steel, brass or copper.....	267
Washing machinery, coal.....	555	sparkling.....	9	iron or steel.....	270
Waste, of any kind, except mineral waste.....	570	Wire, barbed.....	262	Wranglers, clothes.....	304
clippings, paper.....	570	brass.....	265	Writing desks, fancy.....	351
cotton.....	508	iron, steel or zinc, for boot and shoe manufacturers.....	627	ink.....	163
rubber.....	573	and shoe manufacturers.....	627	slates, school.....	199
silks.....	582	cable, N.E.S.....	269	Wrought iron or steel boiler tubes, N.E.S.....	249
Waste tin strip.....	610	cloth, of brass or copper or woven wire.....	267	tubing over 2 inches in diameter 2 ins. or less in diameter.....	257
Watch actions or movements.....	347	iron or steel.....	270	tubing for mining, etc.....	255
cases.....	345	copper.....	266	nails and spikes, N.E.S.....	256
glasses and keys.....	346	covered.....	261	scrap iron and scrap steel.....	223
Watches.....	346	corset.....	362	<b>X</b>	
cases for, fancy.....	351	crucible cast steel.....	625	Xylonite collars.....	365
Water, cologne.....	7 (c)	doors, screens and windows.....	343	cuffs.....	365
color paintings by artists of well-known merit.....	470	fencing, iron or steel, N.E.S.....	263	sheets and in lumps, blocks or balls, in the rough.....	501
by Canadian artists.....	470	barbed.....	602	Xylonite collars.....	365
jackets, blast furnace.....	555	for manufacture of fencing.....	602	cuffs.....	365
lavender.....	7 (c)	wire mattresses.....	628	sheets and in lumps, blocks or balls, in the rough.....	501
mineral, natural, not in bottles.....	554	galvanized, of certain gauges, for fencing.....	262	<b>Y</b>	
Waters, N.O.P.....	147	galvanized iron or steel, 9, 12 and 13 gauge.....	603	Yarns.....	64
Water lime cement.....	17	galvanized iron or steel, 9, 12 and 13 gauge.....	603	Yarn, alpaca or angora, for manufacture of braids.....	631
Wax, bees.....	20	iron or steel, for manufacturing boots.....	627	jute, hem or flax, by manufacturers of carpets, jute cloth, twines, etc.....	516
paraffine.....	151	nails, N.O.P.....	257	Yarns, coil.....	508
caudles.....	22	netting.....	270	cotton, No. 40 and finer.....	508
Wearing apparel of British subjects dying abroad.....	454	of all kinds, N.O.P.....	268	N.E.S.....	558
wool, worsted, hair of alpaca, etc., N.O.P.....	384	phosphor bronze.....	280	moirai.....	508
settlers'.....	457	plus.....	271	wool or worsted, for manufacture of braids, cords, tassels and fringes.....	620
Weaving, books on.....	464	platinum.....	564	woolen, worsted etc., costing 30c. per lb. and over.....	393
Webbing, elastic and non-elastic.....	400	rigging for ships and vessels, rods, rolled round, for manufacture of wire.....	626	or worsted, N.E.S.....	392
Wedges.....	289	facture of wire.....	574	Yeast cakes.....	72
Weeders.....	318	rope.....	289	compressed.....	71
Weekly literary paper, unbound.....	469	shoe lace fasteners.....	553	Yellow metal in bolts, bars and for sheathing.....	632
Weighing beams.....	281	steel, flat, for manufacture of crinoline or corset wire and dress stays.....	502	Yellow prussiate of potash.....	565
Whale oil.....	122	stranded or twisted, clothes line, picture or other twisted wire, wove, iron or steel.....	269	Yolk, egg.....	515
bone, unmanufactured.....	621	wave, iron or steel.....	270	<b>Z</b>	
Wheat.....	55	Wire, corset, covered.....	362	Zinc in blocks, plgs, sheets and plates.....	633
flour.....	56	Wood, alcohol.....	7 (a)	dust.....	517
Wheel-barrow.....	321	cork, manufactures of, N.O.P.....	327	manufactures of, N.O.P.....	277
wheels, emery.....	420	unmanufactured.....	613	salts of.....	502
hubs for, rough hewn or sawed only.....	611	dogwood.....	611	seamless drawn tubing.....	633
hickory lumber sawn to shape for spokes of.....	611	fir.....	611	spelter.....	631
Whip cords, to be dyed and finished in Canada, etc.....	396	furniture, house, cabinet, or office.....	343	white.....	158
Whips, articles for manufacture of all kinds.....	217	manufactures of, N.O.P.....	334	wire for manufactures of boots and shoes.....	627
Whiskey.....	7 (a)	mouldings.....	332		
Whisks.....	340	naphtha.....	7 (a)		
White ash, lumber and timber, planks and boards of.....	611	palis, tubs, etc.....	330		
saw-dust.....	614	persimmon.....	611		
cotton embroideries.....	363	pulp.....	333		
fabrics, N.O.P.....	359	screws.....	260		
glass, obscured.....	202	shovel handles, "D".....	612		
granite ware.....	185	spirit.....	7 (a)		
		staves.....	611		
		stirrups.....	612		
		vencers.....	331		

Advertise in Canadian Manufacturer

SEND FOR RATES.



THE LARGEST RADIATOR MANUFACTURERS UNDER THE BRITISH FLAG.

# Safford Patent Radiators

FOR HOT WATER AND STEAM HEATING.

No

Wrought Iron Bolts  
PACKING  
Leaky Joints.



MOST EFFICIENT

BEST CONSTRUCTION

ALL IRON TO IRON SCREWED JOINTS  
LARGEST VARIETY.

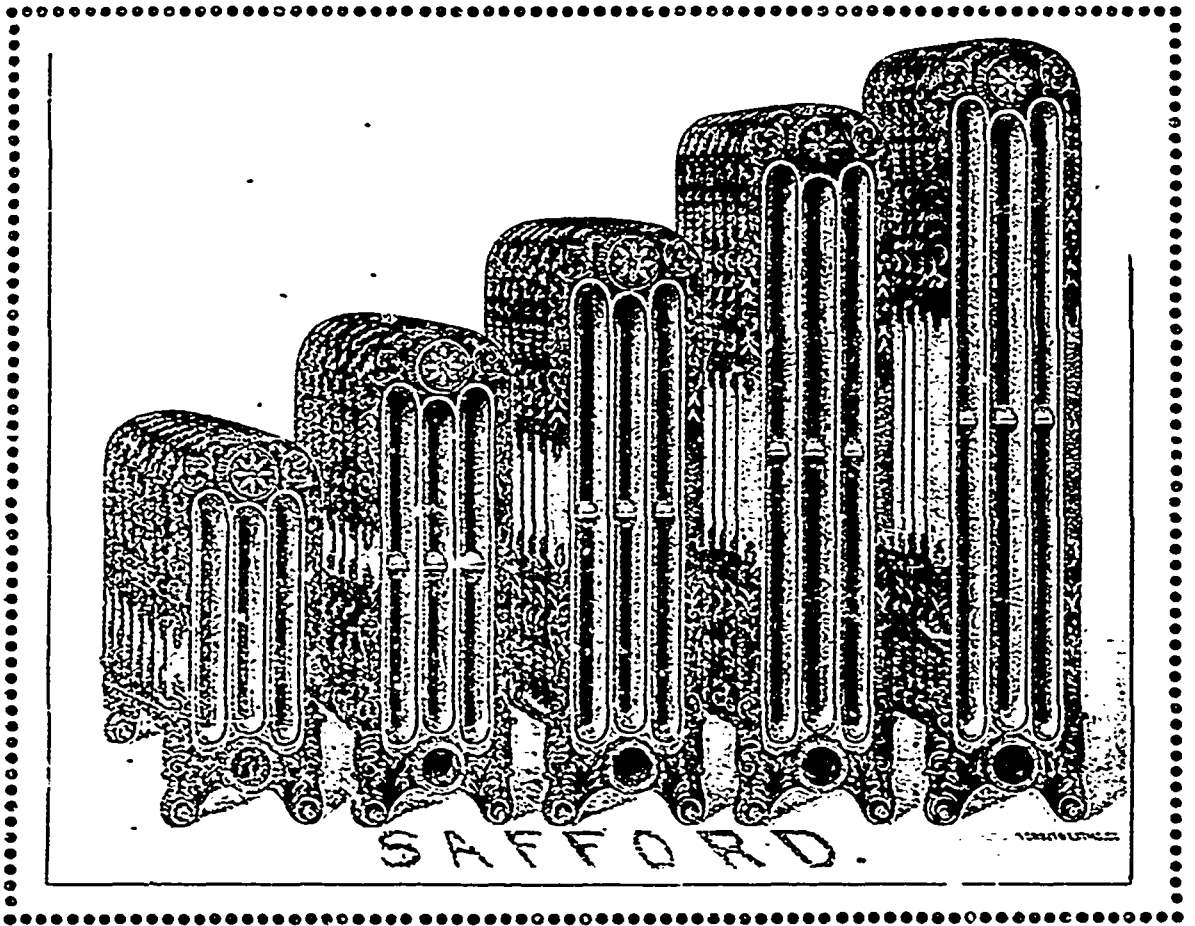

The Largest and Most Prominent Buildings in Canada are Heated with "Safford Radiators."

WE MANUFACTURE NOTHING BUT . . .

## . . RADIATORS . .

The Dominion Radiator Company, Limited,  
Toronto, Ont.

BRANCHES.

MONTREAL - QUEBEC - ST. JOHN - WINNIPEG - VANCOUVER - LONDON, ENG.

When writing to Advertisers kindly mention THE CANADIAN MANUFACTURER.

# THE AMERICAN TARIFF.

Which Became Law and Went into Effect July 24, 1897.

A TRUE COPY FROM THE OFFICIAL TEXT.

An Act to provide Revenue for the Government and to encourage the industries of the United States.

Be it enacted by the Senate and House of Representatives of the United States of America in Congress assembled, that on and after the passage of this Act, unless otherwise specially provided for in this Act, there shall be levied, collected and paid upon all articles imported from foreign countries, and mentioned in the schedule herein contained, the rates of duty which are, by the schedule and paragraphs, respectively prescribed, namely:

## SCHEDULE A.

### Chemicals, Oils and Paints. Acids.

- 1 Acetic or pyroigneous acid, not exceeding the specific gravity of one and forty-seven one-thousandths, three-fourths of one cent per pound; exceeding the specific gravity of one and forty-seven one-thousandths, two cents per pound; boracic acid, five cents per pound; chromic acid and lactic acid, three cents per pound; citric acid, seven cents per pound; salicylic acid, ten cents per pound; sulphuric acid or oil of vitriol not specially provided for in this Act, one-fourth of one cent per pound; tannic acid or tannin, fifty cents per pound; gallic acid, ten cents per pound; tartaric acid, seven cents per pound; all other acids not specially provided for in this Act, twenty-five per centum ad valorem.
- 2 All alcoholic perfumery, including cologne water and other toilet waters and toilet preparations of all kinds, containing alcohol or in the preparation of which alcohol is used, and alcoholic compounds not specially provided for in this Act, sixty cents per pound and forty-five per centum ad valorem.
- 3 Alkalies, alkaloids, distilled oils, essential oils, expressed oils, rendered oils, and all combinations of the foregoing, and all chemical compounds and salts not specially provided for in this Act, twenty-five per centum ad valorem.
- 4 Alumina, hydrate of, or refined bauxite, six tenths of one cent per pound, alum, alum cake, patent alum, sulphate of alumina and aluminous cake, and alum in crystals or ground, one-half of one cent per pound.
- 5 Ammonia, carbonate of, one and one-half cents per pound; muriate of, or sal ammoniac three-fourths of one cent per pound; sulphate of, three-tenths of one cent per pound.
- 6 Argols or crude tartar or wine lees crude, containing not more than forty per centum of bitartrate of potash, one cent per pound; containing more than forty per centum of bitartrate of potash, one and one-half cents per pound; tartars and lees, crystals, or partly refined argols, containing not more than ninety per centum of bitartrate of potash, and tartrate of soda or potassa, o. Rochelle salts, four cents per pound containing more than ninety per centum of bitartrate of potash, five cents per pound; cream of tartar and patent tartar, six cents per pound.
- 7 Blacking of all kinds, twenty-five per centum ad valorem.
- 8 Bleaching powder or chloride of lime, one-fifth of one cent per pound.
- 9 Blue vitriol or sulphate of copper, one-half of one cent per pound.
- 10 Bone char, suitable for use in decolorizing sugars, twenty per centum ad valorem.
- 11 Borax, five cents per pound; borates of lime or soda, or other borate material not otherwise provided for, containing more than thirty-six per centum of anhydrous boracic acid, four cents per pound; borates of lime or soda, or other borate material not otherwise provided for, containing not more than thirty-six per centum of anhydrous boracic acid, three cents per pound.
- 12 Camphor, refined, six cents per pound.
- 13 Chalk (not medicinal nor prepared for toilet purposes) when ground, precipitated naturally or artificially, or otherwise prepared, whether in the form of cubes, blocks, sticks or disks, or otherwise, including tailors' billiard, red or French chalk, one cent per pound. Manufactures of chalk not specially provided for in this Act, twenty-five per centum ad valorem.
- 14 Chloroform, twenty cents per pound.
- 15 Coal-tar dyes or colors, not specially provided for in this Act, thirty per centum ad valorem; all other products or preparations of coal tar, not colors or dyes and not medicinal, not specially provided for in this Act, twenty per centum ad valorem.
- 16 Cobalt, oxide of, twenty-five cents per pound.
- 17 Collodion and all compounds of pyroxylin, whether known as celluloid or by any other name, fifty cents per pound; rolled or in sheets, unpolished, and not made up into articles, sixty cents per pound; if in finished or partly finished articles, and articles of which collodion or any compound of pyroxylin is the component material of chief value, sixty-five cents per pound and twenty-five per centum ad valorem.
- 18 Coloring for brandy, wine, beer, or other liquors, fifty per centum ad valorem.
- 19 Copperas or sulphate of iron, one-fourth of one cent per pound.
- 20 Drugs, such as barks, beans, berries, balsams, buds, bulbs, bulbous roots, excrescences, fruits, flowers, dried fibres, dried insects, grains, gums and gum resin, herbs, leaves, lichens, mosses, nuts, nutgalls, roots, stems, spices, vegetable seeds (aromatic, not garden seeds), seeds of morbid growth, weeds, and woods used expressly for dyeing; any of the foregoing which are drugs and not edible, but which are advanced in value or condition by refining, grinding or other process, and not specially provided for in this Act, one-fourth of one cent per pound, and in addition thereto ten per centum ad valorem.
- 21 Ethers: Sulphuric, forty cents per pound; spirits of nitrous ether, twenty-five cents per pound; fruit ethers, oils, or essences, two dollars per pound; ethers of all kinds not specially provided for in this Act, one dollar per pound; provided, that no article of this paragraph shall pay a less rate of duty than twenty-five per centum ad valorem.
- 22 Extracts and decoctions of logwood and other dyewoods, and extracts of barks, such as are commonly used for dyeing or tanning, not specially provided for in this Act, seven-eighths of one cent per pound; extracts of Quebracho and of hemlock bark, one-half of one cent per pound; extracts of sumac, and of woods other than dyewoods, not specially provided for in this Act, five-eighths of one cent per pound.
- 23 Gelatine, glue, isinglass or fish glue, and prepared fish bladders or fish sounds, valued at not above ten cents per pound, two and one-half cents per pound; valued at above ten cents per pound and not above thirty-five cents per pound,

ESTABLISHED  
1860.

# ENAMELLED WARE

INCORPORATED  
1895.

And TINWARE of Every Description.



Our Brands of Enamelled Ware are:—

“Crescent” Steel Agate Ware

“Premier” “Princess”

“White” “Blue and White”

and “Star” Decorated.

ALL GUARANTEED NOT TO CHIP OR BURN.

Sheet Iron and Galvanized Ware  
Copper and Wire Goods, Etc.

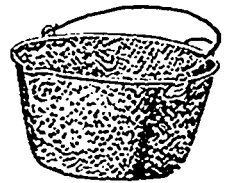

## The Thos. Davidson Mfg. Co., Limited

MONTREAL.

WORKS—Dominion, Albert, Vinet and Delisle St., STE. CUNEGONDE, QUE.

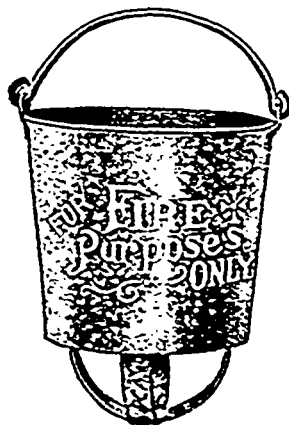

FIRE BUCKETS

For Factory, Warehouse,  
Mill or Store.

## Kemp Manufacturing Co.

TORONTO

.. MANUFACTURERS OF ..

“GRANITE,” “PEARL,” “DIAMOND” or “WHITE”  
ENAMELLED STEELWARE,

STAMPED TINWARE,

JAPANNED WARE,

PIECED TINWARE,

SHEET IRON WARE,

GALVANIZED IRON WARE,

COPPER WARE,

MACHINE OILERS,

ONE PIECE CORRUGATED  
ELBOWS,

PATENT NESTABLE STOVE  
PIPES,

LANTERNS,

DAIRY UTENSILS, ETC.



Galvanized Oily Waste Cans.



Seamless Wrought Steel Sinks.

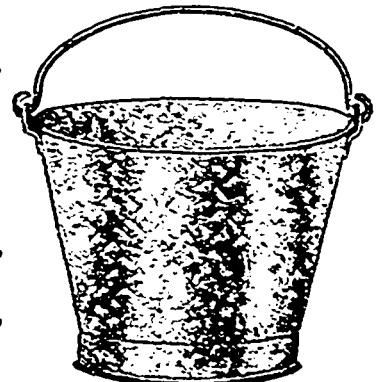

Galvanized Steel Buckets.

When writing to Advertisers kindly mention THE CANADIAN MANUFACTURER.

## The American Tariff.

twenty-five per centum ad valorem; valued above thirty-five cents per pound, fifteen cents per pound and twenty per centum ad valorem.

- 21 Glycerine, crude, not purified, one cent per pound; refined three cents per pound.
- 25 Indigo, extracts, or pastes of, three-fourths of one cent per pound; carmined, ten cents per pound.
- 26 Ink and ink powders, twenty-five per centum ad valorem.
- 27 Iodine, resublimed, twenty cents per pound.
- 28 Iodoform, one dollar per pound.
- 29 Licorice, extract of, in paste, rolls, or other forms, four and one-half cents per pound.
- 30 Chiclé, ten cents per pound.
- 31 Magnesia, carbonate of, medicinal, three cents per pound; calcined, medicinal, seven cents per pound; sulphate of, or Epsom salts, one-fifth of one cent per pound.

## Oils.

- 32 Alizarin, assistant, sulpho-ricinoleic acid, and ricinoleic acid, by whatever name known, whether liquid, solid, or in paste, in the manufacture of which fifty per centum or more of castor oil is used, thirty cents per gallon; in the manufacture of which less than fifty per centum of castor oil is used, fifteen cents per gallon; all other alizarin assistant, not specially provided for in this Act, thirty per centum ad valorem.
- 33 Castor oil, thirty-five cents per gallon.
- 34 Cod-liver oil, fifteen cents per gallon.
- 35 Cotton-seed oil, four cents per gallon of seven and one-half pounds weight.
- 36 Croton oil, twenty cents per pound.
- 37 Flaxseed, linseed, and poppy seed oil, raw, boiled or oxidized, twenty cents per gallon of seven and one-half pounds weight.
- 38 Fusel oil, or amylic alcohol, one-fourth of one cent per pound.
- 39 Hemp-seed oil and rape-seed oil, ten cents per gallon.
- 40 Olive oil, not specially provided for in this Act, forty cents per gallon; in bottles, jars, tins, or similar packages, fifty cents per gallon.
- 41 Peppermint oil, fifty cents per pound.
- 42 Seal, herring, whale, and other fish oil, not specially provided for in this Act, eight cents per gallon.
- 43 Opium, crude or unmanufactured, and not adulterated, containing nine per centum and over of morphia, one dollar per pound; in morphia or morphine, sulphate of, and all alkaloids or salts of opium, one dollar per ounce; aqueous extract of opium, for medicinal uses, and tincture of, as iaudanum, and other liquid preparations of opium, not specially provided for in this Act, forty per centum ad valorem; opium containing less than nine per centum of morphia, and opium prepared for smoking, six dollars per pound, but opium prepared for smoking and other preparations of opium deposited in bonded warehouses shall not be removed therefrom without payment of duties, and such duties shall not be refunded.

## Paints, Colors and Varnishes.

- 44 Baryta, sulphate of, or barytes, including barytes earth, unmanufactured, seventy-five cents per ton; manufactured, five dollars and twenty-five cents per ton.
- 45 Blues, such as Berlin, Prussian, Chinese, and all others, containing ferrocyanide of iron, in pulp, dry or ground in or mixed with oil or water, eight cents per pound.
- 46 Blanc-fixe, or artificial sulphate of barytes, and satin-white or artificial sulphate of lime, one-half of one cent per pound.
- 47 Black, made from bone, ivory, or vegetable substance, by whatever name known, including bone black and lampblack, dry or ground in oil or water, twenty-five per centum ad valorem.
- 48 Chrome yellow, chrome green, and all other chromium colors in the manufacture of which lead and bichromate of potash or soda are used, in pulp, dry, or ground in or mixed with oil or water, four and one-half cents per pound.
- 49 Ocher and ochery earths, sienna and sienna earths, and umber and umber earths, not specially provided for, when crude or not powdered, washed or pulverized, one-eighth of one cent per pound; if powdered, washed or pulverized, three-eighths of one cent per pound; if ground in oil or water, one and one-half cents per pound.
- 50 Orange mineral, three and three-eighths cents per pound.
- 51 Red lead, two and seven-eighths cents per pound.
- 52 Ultramarine blue, whether dry, in pulp, or mixed with water, and wash blue containing ultramarine, three and three-fourths cents per pound.
- 53 Varnishes, including so-called gold size or japan, thirty-five per centum ad valorem; spirit varnishes, one dollar and

## The American Tariff.

thirty-two cents per gallon and thirty-five per centum ad valorem.

- 54 Vermillion red, and other colors containing quicksilver, dry or ground in oil or water, ten cents per pound; when not containing quicksilver but made of lead or containing lead, five cents per pound.
- 55 White lead, white paint and pigment containing lead, dry or in pulp, or ground or mixed with oil, two and seven-eighths cents per pound.
- 56 Whiting and Paris white, dry, one-fourth of one cent per pound; ground in oil, or putty, one cent per pound.
- 57 Zinc, oxide of, and white paint or pigment containing zinc, but not containing lead, dry, one cent per pound; ground in oil, one and three-fourth cents per pound; sulphid of zinc white, or white sulphide of zinc, one and one-fourth cents per pound; chloride of zinc and sulphate of zinc, one cent per pound.
- 58 All paints, colors, pigments, lakes, crayons, smalts and frostings, whether crude or dry or mixed, or ground with water or oil or with solutions other than oil, not otherwise specially provided for in this Act, thirty per centum ad valorem; all paints, colors and pigments, commonly known as artists' paints or colors, whether in tubes, pans, cakes or other forms, thirty per centum ad valorem.
- 59 Paris green, and London purple, fifteen per centum ad valorem.
- 60 Lead: Acetate of, white, three and one-fourth cents per pound; brown, gray, or yellow, two and one-fourth cents per pound; nitrate of, two and one-half cents per pound; litharge, two and three-fourth cents per pound.
- 61 Phosphorus, eighteen cents per pound.

## Potash.

- 62 Bichromate and chromate of, three cents per pound.
- 63 Caustic or hydrate of, refined, in sticks or rolls, one cent per pound; chloride of, two and one-half cents per pound.
- 64 Hydriodate, iodide, and iodate of, twenty-five cents per pound.
- 65 Nitrate of, or saltpeter, refined, one-half cent per pound.
- 66 Prussiate of, red, eight cents per pound; yellow, four cents per pound; cyanide of potassium, twelve and one-half per centum ad valorem.

## Preparations.

- 67 Medicinal preparations containing alcohol, or in the preparation of which alcohol is used, not specially provided for in this Act, fifty-five cents per pound, but in no case shall the same pay less than twenty-five per centum ad valorem.
- 68 Medicinal preparations not containing alcohol or in the preparation of which alcohol is not used, not specially provided for in this Act, twenty-five per centum ad valorem; calomel and other mercurial medicinal preparations, thirty-five per centum ad valorem.
- 69 Plasters, healing or curative, of all kinds, and court-plaster, thirty-five per centum ad valorem.
- 70 Preparations used as applications to the hair, mouth, teeth or skin, such as cosmetics, dentifrices, pastes, pomades, powders, and other toilet articles, and articles of perfumery, whether in sachets or otherwise, not containing alcohol or in the manufacture of which alcohol is not used, and not specially provided for in this Act, fifty per centum ad valorem.
- 71 Santonin, and all the salts thereof containing eighty per centum or over of santonin, one dollar per pound.

## Soaps.

- 72 Castile soap, one and one-fourth cents per pound; fancy, perfumed, and all descriptions of toilet soap, including so-called medicinal or medicated soaps, fifteen cents per pound; all other soaps not specially provided for in this Act, twenty per centum ad valorem.

## Soda.

- 73 Bicarbonate of soda, or supercarbonate of soda, or saleratus, and other alkalies containing fifty per centum or more of bicarbonate of soda, three-fourths of one cent per pound.
- 74 Bicarbonate and chromate of soda, two cents per pound.
- 75 Crystal carbonate of soda, or concentrated soda crystals, or monohydrate, or sesquicarbonate of soda, three tenths of one cent per pound; chlorate of soda, two cents per pound.
- 76 Hydrate of, or caustic soda three-fourths of one cent per pound; nitrite of soda, two and one-half cents per pound; hyposulphite and sulphide of soda, one-half of one cent per pound.
- 77 Sal soda, or soda crystals, not concentrated, two-tenths of one cent per pound.
- 78 Soda ash, three-eighths of one cent per pound; arseniate of soda, one and one-fourth cents per pound.

**WE MANUFACTURE** 

**Light Machinery** and

**Special Tools** of Every Class.

**Brass Faucets**

OF ANY STYLE OR SIZE

Used on Milk Cans, Cream Separators, Milk  
Coolers, Oil Cans.

Brewery and Beer Faucets a Specialty.

We produce all kinds of work from Brass and Steel Rod, Sheet Metal, Brass  
and Iron Castings, and a general line of Screw Machine and Press Work.

PATTERN AND MODEL MAKING

We contract for the manufacture of all kinds of METAL SPECIALTIES

CORRESPONDENCE SOLICITED

**The CLARK KEROSENE OIL SYSTEM**

For Heating Soldering Coppers, Capping Steels, Etc.

ASK FOR CATALOGUE

**The Clark Novelty Company**

**ROCHESTER, N.Y., U.S.A.**

## The American Tariff.

- 79 Silicate of soda, or other alkaline silicate, one-half of one cent per pound.
- 80 Sulphate of soda, or salt cake, or nitre cake, one dollar and twenty-five cents per ton.
- 81 Sea moss, ten per centum ad valorem.
- 82 Sponges, twenty per centum ad valorem; manufactures of sponges, or of which sponge is the component material of chief value, not specially provided for in this Act, forty per centum ad valorem.
- 83 Strychnia, or strychnine, and all salts thereof, thirty cents per ounce.
- 84 Sulphur, refined or sublimed, or flowers of, eight dollars per ton.
- 85 Sumac, ground, three-tenths of one cent per pound.
- 86 Vanillin, eighty cents per ounce.

## SCHEDULE B.

Earths, Earthenware and Glassware.  
Brick and Tile.

- 87 Fire-brick, weighing not more than ten pounds each, not glazed, enamelled, ornamented, or decorated in any manner, one dollar and twenty-five cents per ton; glazed, enamelled, ornamented, or decorated, forty-five per centum ad valorem; brick, other than fire-brick, not glazed, enamelled, painted, vitrified, ornamented, or decorated in any manner, twenty-five per centum ad valorem; if glazed, enamelled, painted, vitrified, ornamented, or decorated in any manner, forty-five per centum ad valorem.
- 88 Tiles, plain, unglazed, one color, exceeding two square inches in size, four cents per square foot; glazed encaustic, ceramic, mosaic, vitrified, semi-vitrified, flint, spar, embossed, enamelled, ornamented, hand painted, gold decorated, and all other earthenware tiles, valued at not exceeding forty cents per square foot, eight cents square foot; exceeding forty cents per square foot, ten cents per square foot and twenty-five per centum ad valorem.

## Cement, Lime and Plaster.

- 89 Roman, Portland, and other hydraulic cement in barrels, sacks, or other packages, eight cents per one hundred pounds, including weight of barrel or package; in bulk, seven cents per one hundred pounds; other cement, twenty per centum ad valorem.
- 90 Lime, five cents per one hundred pounds, including weight of barrel or package.
- 91 Plaster rock or gypsum, crude, fifty cents per ton; if ground or calcined, two dollars and twenty-five cents per ton; pearl hardening for paper makers use, twenty per centum ad valorem.
- 92 Pumice stone, wholly or partially manufactured, six dollars per ton; unmanufactured, fifteen per centum ad valorem.

## Clays or Earths.

- 93 Clays or earths, unwrought or unmanufactured, not specially provided for in this Act, one dollar per ton; wrought or manufactured, not specially provided for in this Act, two dollars per ton; china clay or kaolin, two dollars and fifty cents per ton; limestone rock asphalt containing not more than fifteen per centum of bitumen, fifty cents per ton; asphaltum and bitumen, not specially provided for in this Act, crude, if not dried, or otherwise advanced in any manner, one dollar and fifty cents per ton; if dried or otherwise advanced in any manner, three dollars per ton; bauxite, or beauxite, crude, not refined or otherwise advanced in condition from its natural state, one dollar per ton; fullers' earth, unwrought and unmanufactured, one dollar and fifty cents per ton; wrought or manufactured, three dollars per ton.

## Earthenware and China.

- 94 Common yellow, brown, or gray earthenware, plain, embossed or salt-glazed common-stoneware, and crucibles, all the foregoing not decorated in any manner, twenty-five per centum ad valorem; Rockingham earthenware not decorated, forty per centum ad valorem.
- 95 China, porcelain, parian, bisque, earthen, stone, and crockery ware, including clock cases with or without movements, plaques, ornaments, toys, toy tea sets, charms, vases and statuettes, painted, tinted, stained, enamelled, printed, gilded, or otherwise decorated or ornamented in any manner, sixty per centum ad valorem; if plain white and without superadded ornamentation of any kind, fifty-five per centum ad valorem.
- 96 All other china, porcelain, parian, bisque, earthen, stone and crockery ware, and manufactures thereof, or of which the same is the component material of chief value, by whatever name known, not specially provided for in this Act, if

## The American Tariff.

- painted, tinted, stained, enamelled, printed, gilded, or otherwise decorated or ornamented in any manner, sixty per centum ad valorem; if not ornamented or decorated, fifty-five per centum ad valorem.
- 97 Articles and wares composed wholly or in chief value of earthy or mineral substances, or carbon, not specially provided for in this Act, if not decorated in any manner, thirty-five per centum ad valorem; if decorated, forty-five per centum ad valorem.
- 98 Gas retorts, three dollars each; lava tips for burners, ten cents per gross and fifteen per centum ad valorem; carbons for electric lighting, ninety cents per hundred; filter tubes, forty-five per centum ad valorem; porous carbon pots for electric batteries, without metallic connections, twenty per centum ad valorem.

## Glass and Glassware.

- 99 Plain green or colored, moulded or pressed, and flint, lime, or lead glass bottles, vials, jars, and covered or uncovered demijohns and carboys, any of the foregoing, filled or unfilled, not otherwise specially provided for, and whether their contents be dutiable or free (except such as contain merchandise subject to an ad valorem rate of duty, or to a rate of duty based in whole or in part upon the value thereof, which shall be dutiable at the rate applicable to their contents), shall pay duty as follows: If holding more than one pint, one cent per pound; if holding not more than one pint and not less than one-fourth of a pint, one and one-half cents per pound; if holding less than one-fourth of a pint, fifty cents per gross; provided that none of the above articles shall pay a less rate of duty than forty per centum ad valorem.
- 100 Glass bottles, decanters, or other vessels or articles of glass, cut, engraved, painted, colored, stained, silvered, gilded, etched, frosted, printed in any manner or otherwise ornamented, decorated or ground (except such grinding as is necessary for fitting stoppers), and any articles of which such glass is the component material of chief value, and porcelain, opal and other blown glassware; all the foregoing, filled or unfilled, and whether their contents be dutiable or free, sixty per centum ad valorem.
- 101 Unpolished, cylinder, crown, and common window glass, not exceeding ten by fifteen inches square, one and three-eighths cents per pound; above that, and not exceeding sixteen by twenty-four inches square, one and seven-eighths cents per pound; above that, and not exceeding twenty-four by thirty inches square, two and three-eighths cents per pound; above that, and not exceeding twenty-four by thirty-six inches square, two and seven eighths cents per pound; above that and not exceeding thirty by forty inches square, three and three-eighths cents per pound, above that and not exceeding forty by sixty inches square, three and seven-eighths cents per pound; above that, four and three-eighths cents per pound. Provided, That unpolished cylinder, crown, and common window glass, imported in boxes, shall contain fifty square feet, as nearly as sizes will permit, and the duty shall be computed thereon according to the actual weight of glass.
- 102 Cylinder and crown glass, polished, not exceeding sixteen by twenty-four inches square, four cents per square foot; above that, and not exceeding twenty-four by thirty inches square, six cents per square foot; above that, and not exceeding twenty-four by sixty inches square, fifteen cents per square foot; above that, twenty cents per square foot.
- 103 Fluted, rolled, ribbed, or rough plate glass, or the same containing a wire netting within itself, not including crown, cylinder, or common window glass, not exceeding sixteen by twenty-four inches square, three-fourths of one cent per square foot; above that, and not exceeding twenty-four by thirty inches square, one and one-fourths cents per square foot; all above that, one and three-fourths cents per square foot; and all fluted, rolled, ribbed or rough plate glass, weighing over one hundred pounds per one hundred square feet shall pay an additional duty on the excess at the same rates herein imposed: Provided, That all of the above plate glass, when ground, smoothed, or otherwise obscured, shall be subject to the same rate of duty as cast polished plate glass unsilvered.
- 104 Cast polished plate glass, finished or unfinished and unsilvered, not exceeding sixteen by twenty-four inches square, eight cents per square foot; above that, and not exceeding twenty-four by thirty inches square, ten cents per square foot; above that, and not exceeding twenty-four by sixty inches square, twenty-two and one-half cents per square foot; all above that, thirty-five cents per square foot.
- 105 Cast polished plate glass, silvered, cylinder and crown glass, silvered and looking-glass plates, exceeding in size one

# L. B. EDDY COMPANY

Business Founded 1844

Rochester (73, 75, 77, 79 South Avenue), New York

MANUFACTURERS OF

## FANCY QUALITY PURE FOOD PRODUCTS

American Fancy **FARINA MACARONI**

AND

**GENUINE EGG NOODLES** a Specialty.

---

The highest quality materials, competent workmen, absolute cleanliness, natural dry process, and attractive packing, tend to make our "WOODCOCK" Brands the most popular and finest flavored foods in the world. Their success is their recommendation.

---

*Every Package Thoroughly and Positively Guaranteed to all Dealers.*

WRITE FOR SAMPLES AND PRICES

**L. B. EDDY COMPANY, - Rochester, N.Y.**

## The American Tariff.

hundred and forty-four square inches and not exceeding sixteen by twenty-four inches square, eleven cents per square foot; above that, and not exceeding twenty-four by thirty inches square, thirteen cents per square foot; above that, and not exceeding twenty-four by sixty inches square, twenty-five cents per square foot; all above that, thirty-eight cents per square foot.

- 106 But no looking-glass plates or plate glass, silvered when framed, shall pay a less rate of duty than that imposed upon similar glass of like description not framed, but shall pay in addition thereto upon such frames the rate of duty applicable thereto when imported separate.
- 107 Cast polished plate glass, silvered or unsilvered, and cylinder, crown, or common window glass, silvered or unsilvered, when bent, ground, obscured, frosted, sanded, enamelled, bevelled, etched, embossed, engraved, flashed, stained, colored, painted, or otherwise ornamented or decorated, shall be subject to a duty of five per centum ad valorem in addition to the rates otherwise chargeable thereon.
- 108 Spectacles, eyeglasses and goggles, and frames for the same or parts thereof, finished or unfinished, valued at not over forty cents per dozen, twenty cents per dozen and fifteen per centum ad valorem; valued at over forty cents per dozen and not over one dollar and fifty cents per dozen, forty-five cents per dozen and twenty per centum ad valorem; valued at over one dollar and fifty cents per dozen, fifty per centum ad valorem.
- 109 Lenses of glass or pebble, ground and polished to a spherical, cylindrical, or prismatic form, and ground and polished plano or coquill glasses, wholly or partly manufactured, with the edges unground forty-five per centum ad valorem; if with their edges ground or beveled, ten cents per dozen pairs and forty-five per centum ad valorem.
- 110 Strips of glass, not more than three inches wide, ground or polished on one or both sides to a cylindrical or prismatic form, and glass slides for magic lanterns, forty-five per centum ad valorem.
- 111 Opera and field glasses, telescopes, microscopes, photographic and projecting lenses and optical instruments, and frames or mountings for the same; all the foregoing not specially provided for in this Act, forty-five per centum ad valorem.
- 112 Stained or painted glass windows, or parts thereof, and all mirrors, not exceeding in size one hundred and forty-four square inches, with or without frames or cases, and all glass or manufactures of glass or paste, or of which glass or paste is the component material of chief value, not specially provided for in this Act, forty-five per centum ad valorem.
- 113 Fusible enamel, twenty-five per centum ad valorem.
- Marbles and Stone, and Manufactures of.
- 114 Marble in block, rough or squared only, sixty-five cents per cubic foot; onyx in block, rough or squared, one dollar and fifty cents per cubic foot; marble or onyx, sawed or dressed, over two inches in thickness, one dollar and ten cents per cubic foot; slabs or paving tiles of marble or onyx, containing not less than four superficial inches, if not more than one inch in thickness, twelve cents per superficial foot; if more than one inch and not more than one and one-half inches in thickness, fifteen cents per superficial foot; if more than one and one-half inches and not more than two inches in thickness, eighteen cents per superficial foot; if rubbed in whole or in part, three cents per superficial foot in addition; mosaic cubes of marble, onyx, or stone, not exceeding two cubic inches in size, if loose, one cent per pound and twenty per centum ad valorem; if attached to paper or other material, twenty cents per superficial foot and thirty-five per centum ad valorem.
- 115 Manufactures of agate, alabaster, chalcedony, chrysolite, coral, cornelian, garnet, jasper, jet malachite, marble, onyx, rock crystal, or spar, including clock cases with or without movements, not specially provided for in this Act, fifty per centum ad valorem.

## Stone.

- 116 Burr stones, manufactured or bound up into millstones, fifteen per centum ad valorem.
- 117 Freestone, granite, sandstone, limestone, and other building or monumental stone, except marble and onyx, unmanufactured or undressed, not specially provided for in this Act, twelve cents per cubic foot.
- 118 Freestone, granite, sandstone, limestone, and other building or monumental stone, except marble and onyx, not specially provided for in this Act, hewn, dressed or polished, fifty per centum ad valorem.
- 119 Grindstones, finished or unfinished, one dollar and seventy-five cents per ton.

## The American Tariff.

## Slate.

- 120 Slates, slate chimney-pieces, mantels, slabs for tables, roofing slates, and all other manufactures of slate, not specially provided for in this Act, twenty per centum ad valorem.

## SCHEDULE C.

## Metals and Manufactures of.

- 121 Iron ore, including manganese iron ore, and the dross or residuum from burnt pyrites, forty cents per ton; provided, that in levying and collecting the duty on iron ore no deduction shall be made from the weight of the ore on account of moisture which may be chemically or physically combined therewith: basic slag, ground or unground, one dollar per ton.
- 122 Iron in pigs, iron kentledge, spiegelisen, ferro-manganese ferro-silicon, wrought and cast scrap iron, and scrap steel, four dollars per ton; but nothing shall be deemed scrap iron or scrap steel except waste or refuse iron or steel fit only to be remanufactured.
- 123 Bar iron, square iron, rolled or hammered, comprising flats not less than one inch wide nor less than three-eighths of one inch thick, round iron not less than seven-sixteenths of one inch in diameter, six-tenths of one cent per pound.
- 124 Round iron, in coils or rods, less than seven-sixteenths of one inch in diameter, and bars or shapes of rolled or hammered iron, not specially provided for in this Act, eight-tenths of one cent per pound; provided that all iron in slabs, blooms, loops, or other forms less finished than iron in bars, and more advanced than pig iron, except castings, shall be subject to a duty of five-tenths of one cent per pound provided further; that all iron bars, blooms, billets, or sizes or shapes of any kind, in the manufacture of which charcoal is used as fuel, shall be subject to a duty of twelve dollars per ton.
- 125 Beams, girders, joists, angles channels, car-truck channels, T. T. columns and posts or parts or sections of columns and posts, deck and bulb beams, and building forms, together with all other structural shapes of iron or steel, whether plain or punched, or fitted for use, five-tenths of one cent per pound.
- 126 Boiler or other plate iron or steel, except crucible plate steel and saw plates hereinafter provided for, not thinner than number ten wire gauge, sheared or unsheared, and skelp iron or steel sheared or rolled in grooves, valued at one cent per pound or less, five-tenths of one cent per pound valued above one cent and not above two cents per pound six-tenths of one cent per pound; valued above two cents and not above four cents per pound, one cent per pound; valued at over four cents per pound, twenty-five per centum ad valorem; provided, that all sheets or plates of iron or steel thinner than number ten wire gauge shall pay duty as iron or steel sheets.
- 127 Iron or steel anchors or parts thereof, one and one-half cents per pound; forgings of iron or steel, or of combined iron and steel, of whatever shape or whatever degree or stage of manufacture, not specially provided for in this Act, thirty-five per centum ad valorem; anti-friction ball forgings of iron or steel, or of combined iron and steel, forty-five per centum ad valorem.
- 128 Hoop, band, or scroll iron or steel, not otherwise provided for in this Act, valued at three cents per pound or less, eight inches or less in width, and less than three-eighths of one inch thick and not thinner than number ten wire gauge, five-tenths of one cent per pound; thinner than number ten wire gauge and not thinner than number twenty wire gauge, six-tenths of one cent per pound; thinner than number twenty wire gauge, eight-tenths of one cent per pound; provided, that barrel hoops of iron or steel, and hoop or band iron or hoop or band band steel flared, splayed or punched, with or without buckles or fastenings, shall pay one-tenth of one cent per pound more duty than that imposed on the hoop or band iron or steel from which they are made; steel bands or strips, untempered, suitable for making band saws, three cents per pound and twenty per centum ad valorem; if tempered, or tempered and polished, six cents per pound and twenty per centum ad valorem.
- 129 Hoop or band iron, or hoop or band steel, cut to lengths, or wholly or partly manufactured into hoops or ties, coated or not coated with paint or any other preparation, with or without buckles or fastenings, for baling cotton or any other commodity, five-tenths of one cent per pound.
- 130 Railway bars, made of iron or steel, and railway bars made in part of steel, T rails, and punched iron or steel flat rails, seven-twentieths of one cent per pound; railway



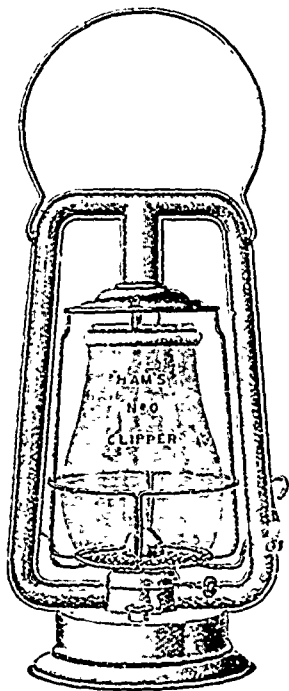

\$9.50 per doz., less 40, 10 and 5 per cent. discount.

Ham's are the finest tubular lanterns made, and are all guaranteed to be perfect burning and strictly

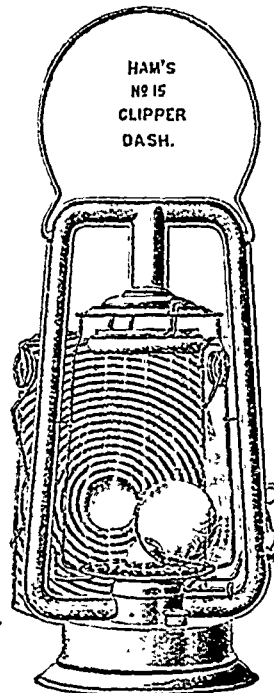

Jappaned and Plain Globe, \$13.00 doz.  
" Bullseye Globe, 13.50 "  
Less 40, 10 and 5 per cent. discount.

high grade in every respect. Nothing better to be had at any price. All Exporters like to furnish

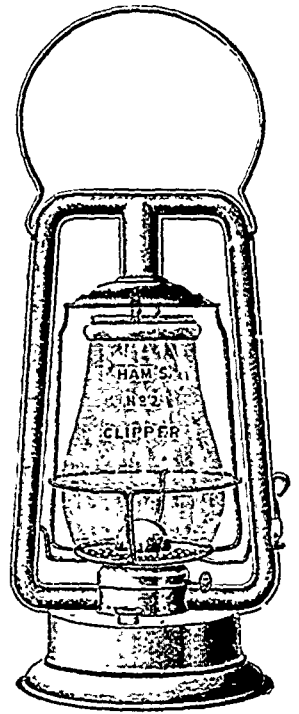

\$13.00 per dozen, less 40, 10 and 5 per cent. discount.

# Ham's Lanterns and Lamps

FOR THEY ALWAYS PLEASE.

Write for our Illustrated Catalogue.

Our Prices are no higher than others, and our Goods are best in the world.

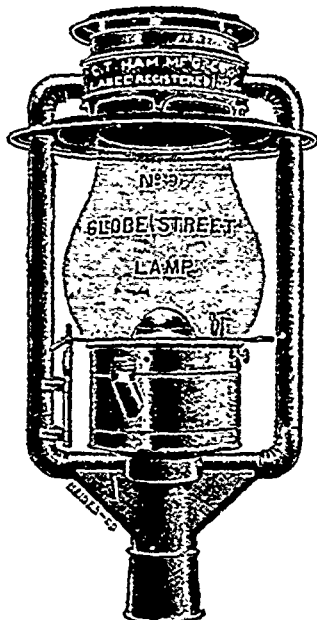

\$6.00 each, less 40, 10 and 5 per cent. discount.

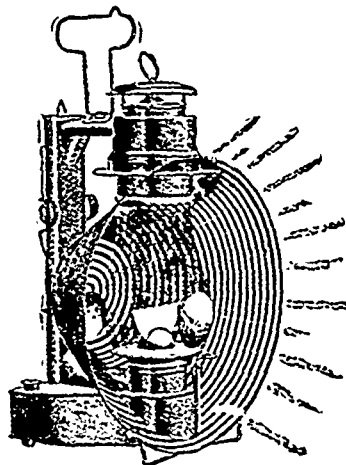

Ham's No. 20 Search Lamp.  
Jappaned and Plain Globe \$29.50 per doz.  
" Bullseye " 30.00 "  
Less 40, 10 and 5 per cent. discount.

## C. T. HAM MFG. CO.,

ROCHESTER, N.Y., U.S.A.

Our Street Lamp and Cold Blast Lantern, here shown, are made to burn in strong winds, and give a beautiful, large, steady light.

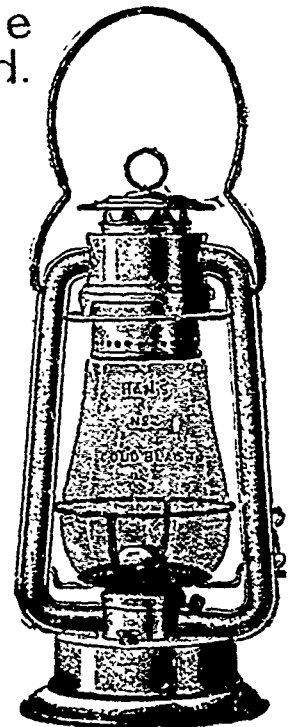

\$16.00 per doz. less 40, 10 and 5 per cent. discount.

When writing to Advertisers kindly mention THE CANADIAN MANUFACTURER.

## The American Tariff.

fish-plates or splice-bars, made of iron or steel, four-tenths of one cent per pound.

- 131 Sheets of iron or steel, common or black, of whatever dimension, and skelp iron or steel, valued at three cents per pound or less, thinner than number ten and not thinner than number twenty wire gauge, seven-tenths of one cent per pound; thinner than number twenty wire gauge and not thinner than number twenty-five wire gauge, eight-tenths of one cent per pound, thinner than number twenty-five wire gauge, and not thinner than number thirty-two wire gauge, one and one-tenth cents per pound, thinner than number thirty-two wire gauge, one and two-tenths cents per pound, corrugated or stamped, one and one-tenth cents per pound. Provided, That all sheets of common or black iron or steel not thinner than number ten wire gauge shall pay duty as plate iron or plate steel.
- 132 All iron or steel sheets or plates, and all hoop, band, or scroll iron or steel, excepting what are known commercially as tin plates, terne plates, and taggers tin, and hereinafter provided for, when galvanized or coated with zinc, spleter, or other metals, or any alloy of those metals, shall pay two-tenths of one cent per pound more duty than if the same was not so galvanized or coated.
- 133 Sheets of iron or steel, polished, planished, or glanced, by whatever name designated, two cents per pound: Provided, That plates or sheets of iron or steel, by whatever name designated, other than the polished, planished, or glanced herein provided for, which have been pickled or cleaned by acid, or by any other material or process, or which are cold-rolled, smoothed only, not polished, shall pay two-tenths of one cent per pound more duty than the corresponding gauges of common or black sheet iron or steel.
- 134 Sheets or plates of iron or steel, or taggers iron or steel, coated with tin or lead, or with a mixture of which these metals, or either of them, is a component part, by the dipping or any other process, and commercially known as tin plates, terne plates, and taggers tin, one and one-half cents per pound.
- 135 Steel ingots, cogged ingots, blooms, and slabs, by whatever process made; die blocks or blanks; billets and bars and tapered or beveled bars; mill shafting; pressed, sheared, or stamped shapes; saw plates, wholly or partially manufactured; hammer molds or swaged steel; gun-barrel molds not in bars; alloys used as substitutes for steel in the manufacture of tools; all descriptions and shapes of dry sand, loam, or iron-molded steel castings; sheets and plates and steel in all forms and shapes not specially provided for in this Act, all of the above valued at one cent per pound or less, three-tenths of one cent per pound; valued above one cent and not above one and four-tenths cents per pound, four-tenths of one cent per pound; valued above one and four-tenths cents and not above one and eight-tenths cents per pound, six-tenths of one cent per pound; valued above one and eight-tenths cents and not above two and two-tenths cents per pound, seven-tenths of one cent per pound; valued above two and two-tenths and not above three cents per pound, nine-tenths of one cent per pound; valued above three cents per pound and not above four cents per pound, one and two-tenths cents per pound; valued above four cents and not above seven cents per pound, one and three-tenths cents per pound; valued above seven cents and not above ten cents per pound, two cents per pound; valued above ten cents and not above thirteen cents per pound, two and four-tenths cents per pound; valued above thirteen cents and not above sixteen cents per pound, two and eight-tenths cents per pound; valued above sixteen cents per pound, four and seven-tenths cents per pound.

## Wire.

- 136 Wire rods: Rivet, screw, fence, and other iron or steel wire rods, whether round, oval, flat, or square, or in any other shape, and nail rods, in coils or otherwise, valued at four cents or less per pound, four-tenths of one cent per pound; valued over four cents per pound, three-fourths of one cent per pound: Provided, That all round iron or steel rods smaller than number six wire gauge shall be classed and dutiable as wire: Provided further, That all iron or steel wire rods which have been tempered or treated in any manner or partly manufactured shall pay an additional duty of one-half of one cent per pound.
- 137 Round iron or steel wire, not smaller than number thirteen wire gauge, one and one-fourth cents per pound; smaller than number thirteen and not smaller than number sixteen wire gauge, one and one-half cents per pound; smaller than number sixteen wire gauge, two cents per pound: Provided, That all the foregoing valued at more than four cents per

## The American Tariff.

pound shall pay forty per centum ad valorem. Iron or steel or other wire not specially provided for in this Act, including such as is commonly known as hat wire, or bonnet wire, crinoline wire, corset wire, needle wire, piano wire, clock wire, and watch wire, whether flat or otherwise, and corset clasps, corset steels and dress steels, and sheet steel in strips, twenty-five one-thousandths of an inch thick or thinner, any of the foregoing, whether uncovered or covered with cotton, silk, metal, or other material, valued at more than four cents per pound, forty-five per centum ad valorem: Provided, That articles manufactured from iron, steel, brass, or copper wire, shall pay the rate of duty imposed upon the wire used in the manufacture of such articles, and in addition thereto one and one-fourth cents per pound, except that wire rope and wire strand shall pay the maximum rate of duty which would be imposed upon any wire used in the manufacture thereof, and in addition thereto one cent per pound, and on iron or steel wire coated with zinc, tin, or any other metal, two-tenths of one cent per pound in addition to the rate imposed on the wire from which it is made.

## General Provisions.

- 138 No allowance or reduction of duties for partial loss or damage in consequence of rust or of discoloration shall be made upon any description of iron or steel, or upon any article wholly or partly manufactured of iron or steel, or upon any manufacture of iron or steel.
- 139 All metal produced from iron or its ores, which is cast and malleable, of whatever description or form, without regard to the percentage of carbon contained therein, whether produced by cementation, or converted, cast, or made from iron or its ores, by the crucible, Bessemer, Clapp-Griffith, pneumatic, Thomas-Gilbert, basic, Siemens-Martins, or open-hearth process, or by the equivalent of either, or by a combination of two or more of the processes or their equivalents, or by any fusion or other process which produces from iron or its ores a metal either granular or fibrous in structure, which is cast and malleable, excepting what is known as malleable-iron castings, shall be classed and denominated as steel.
- 140 No article not specially provided for in this Act, which is wholly or partly manufactured from tin plate, terne plate, or the sheet plate, hoop, band, or scroll iron or steel herein provided for, or of which such tin plate, terne plate, sheet plate, hoop, band, or scroll iron or steel shall be the material of chief value, shall pay a lower rate of duty than that imposed on the tin plate, terne plate, or sheet plate, hoop, band, or scroll iron or steel from which it is made, or of which it shall be the component thereof of chief value.
- 141 On all iron or steel bars or rods of whatever shape or section which are cold rolled, cold drawn, cold hammered, or polished in any way in addition to the ordinary process of hot rolling or hammering, there shall be paid one-fourth of one cent per pound in addition to the rates provided in this Act on bars or rods of whatever section or shape which are hot rolled; and on all strips, plates, or sheets of iron or steel of whatever shape, other than the polished, planished, or glanced sheet iron or sheet steel hereinbefore provided for, which are cold rolled, cold hammered, blued, brightened, tempered, or polished by any process to such perfected surface finish or polish better than the grade of cold rolled, smoothed only, hereinbefore provided for, there shall be paid one cent per pound in addition to the rates provided in this Act upon plates, strips, or sheets of iron or steel of common or black finish; and on steel circular saw plates there shall be paid one-half of one cent per pound in addition to the rate provided in this Act for steel saw plates.

## Manufactures of Iron and Steel.

- 142 Anvils of iron or steel or of iron and steel combined, by whatever process made, or in whatever stage of manufacture, one and seven-eighths cents per pound.
- 143 Axles, or parts thereof, axle bars, axle blanks or forgings for axles, whether of iron or steel, without reference to the stage or state of manufacture, valued at not more than six cents per pound, one cent per pound: Provided, That when iron or steel axles are imported fitted in wheels, or parts of wheels, of iron or steel, they shall be dutiable at the same rate as the wheels in which they are fitted.
- 144 Blacksmiths' hammers, and sledges, track tools, wedges and crowbars, whether of iron or steel, one and one-half cents per pound.
- 145 Bolts, with or without threads or nuts, or bolt-blanks, and finished hinges or hinge-blanks, whether of iron or steel, one and one-half cents per pound.
- 146 Card-clothing manufactured from tempered steel wire,

# CLARK METALLIC MFG. COMPANY . .

ROCHESTER, N.Y., U.S.A.

## METALLIC SPECIALTIES Small Tools, Etc.

MADE ON CONTRACT

MANUFACTURERS OF

### ALL KINDS OF FAUCETS

FOR ALL KINDS OF CANS

**Cream Separator and Oil Can Faucets**

A SPECIALTY

Also Manufacturers of **CLARK'S LIGHTNING BREAD CUTTER**

FOR USE IN EVERY LARGE DINING-ROOM

CIRCULARS SENT ON APPLICATION

**Clark Metallic Mfg. Company**  
ROCHESTER, N.Y., U.S.A.

## The American Tariff.

- forty-five cents per square foot; all other, twenty cents per square foot.
- 147 Cast-iron pipe of every description, four-tenths of one cent per pound.
- 148 Cast-iron vessels, plates, stove-plates, andirons, sad-irons, tailors' irons, hatters' irons, and casting of iron, not specially provided for in this Act, eight-tenths of one cent per pound.
- 149 Castings of malleable iron not specially provided for in this Act, nine-tenths of one cent per pound.
- 150 Cast hollow-ware, coated, glazed, or tinned, two cents per pound.
- 151 Chain or chains of all kinds, made of iron or steel, not less than three-fourths of one inch in diameter, one and one-eighth cents per pound; less than three-fourths of one inch and not less than three-eighths of one inch in diameter, one and three-eighths cents per pound; less than three-eighths of one inch in diameter and not less than five-sixteenths of one inch in diameter, one and seven-eighths cents per pound; less than five-sixteenths of one inch in diameter, three cents per pound; but no chain or chains of any description shall pay a lower rate of duty than forty-five per centum ad valorem.
- 152 Lap welded, butt welded, seamed, or jointed iron or steel boiler tubes, pipes, flues, or stays, not thinner than number sixteen wire gauge, two cents per pound, welded cylindrical furnaces, made from plate metal, two and one-half cents per pound; all other iron or steel tubes, finished, not specially provided for in this Act, thirty-five per centum ad valorem.

## Cutlery.

- 153 Penknives or pocketknives, clasp knives, pruning knives, and budding knives of all kinds, or parts thereof, and erasers or manure knives or parts thereof, wholly or partly manufactured, valued at not more than forty cents per dozen, forty per centum ad valorem; valued at more than forty cents per dozen and not exceeding fifty cents per dozen, one cent per piece and forty per centum ad valorem; valued at more than fifty cents per dozen and not exceeding one dollar and twenty-five cents per dozen, five cents per piece and forty per centum ad valorem; valued at more than one dollar and twenty-five cents per dozen and not exceeding three dollars per dozen, ten cents per piece and forty per centum ad valorem; valued at more than three dollars per dozen, twenty cents per piece and forty per centum ad valorem: Provided, That blades, handles or other parts of either or any of the foregoing articles, imported in any other manner than assembled in finished knives or erasers, shall be subject to no less rate of duty than herein provided for penknives, pocketknives, clasp knives, pruning knives, manure knives, and erasers valued at more than fifty and not more than one dollar and fifty cents per dozen. Razors and razor blades, finished or unfinished, valued at less than one dollar and fifty cents per dozen, fifty cents per dozen and fifteen per centum ad valorem; valued at one dollar and fifty cents per dozen and less than three dollars per dozen one dollar per dozen and fifteen per centum ad valorem; valued at three dollars per dozen or more, one dollar and seventy-five cents per dozen and twenty per centum ad valorem. Scissors and shears, and blades for the same, finished or unfinished, valued at not more than fifty cents per dozen, fifteen cents per dozen and fifteen per centum ad valorem; valued at more than fifty cents per dozen and not more than one dollar and seventy-five cents per dozen, fifty cents per dozen and fifteen per centum ad valorem; valued at more than one dollar and seventy-five cents per dozen, seventy-five cents per dozen and twenty-five per centum ad valorem.
- 154 Swords, sword blades, and side-arms, thirty-five per centum ad valorem.
- 155 Table, butchers', carving, cooks', hunting, kitchen, bread, butter, vegetable, fruit, cheese, plumbers', painters', palette, artists', and shoe knives, forks and steels, finished or unfinished, with handles of mother-of-pearl, shell or ivory, sixteen cents each; with handles of deer horn, twelve cents each; with handles of hard rubber, solid bone, celluloid or any pyroxyline material, five cents each; with handles of any other material than those above mentioned, one and one-half cents each, and in addition, on all the above articles, fifteen per centum ad valorem: Provided, That none of the above-named articles shall pay a less rate of duty than forty-five per centum ad valorem.
- 156 Files, file-blanks, rasps, and floats, of all cuts and kinds, two and one-half inches in length and under, thirty cents per dozen; over two and one-half inches in length and not over four and one-half inches, fifty cents per dozen; over four and one-half inches in length and under seven inches,

## The American Tariff.

seventy-five cents per dozen; seven inches in length and over, one dollar per dozen.

## Firearms.

- 157 Muskets, muzzle-loading shotguns, rifles, and parts thereof, twenty-five per centum ad valorem.
- 158 Double-barreled, sporting, breech-loading shotguns, combination shotguns and rifles, valued at not more than five dollars, one dollar and fifty cents each and in addition thereto fifteen per centum ad valorem; valued at more than five dollars and not more than ten dollars, four dollars each and in addition thereto fifteen per centum ad valorem each; valued at more than ten dollars, six dollars each; double-barrels for sporting breech-loading shotguns and rifles further advanced in manufacture than rough bored only, three dollars each; stocks for double-barreled sporting breech-loading shotguns and rifles wholly or partially manufactured, three dollars each; and in addition thereto on all such guns and rifles, valued at more than ten dollars each, and on such stocks and barrels, thirty-five per centum ad valorem; on all other parts of such guns or rifles, and fittings for such stocks or barrels, finished or unfinished, fifty per centum ad valorem: Provided, That all double-barrel sporting breech-loading shotguns and rifles imported without a lock or locks or other fittings shall be subject to a duty of six dollars each and thirty-five per centum ad valorem; single-barreled breech-loading shotguns, or parts thereof, except as otherwise specially provided for in this Act, one dollar each and thirty-five per centum ad valorem. Revolving pistols or parts thereof, seventy-five cents each and twenty-five per centum ad valorem.
- 159 Sheets, plates, wares or articles of iron, steel, or other metal, enamelled or glazed with vitreous glasses, forty per centum ad valorem.

## Nails, Spikes, Tacks and Needles.

- 160 Cut nails and cut spikes of iron or steel, six-tenths of one cent per pound.
- 161 Horseshoe nails, hob nails, and all other wrought iron or steel nails not specially provided for in this Act, two and one-fourth cents per pound.
- 162 Wire nails made of wrought iron or steel, not less than one inch in length and not lighter than number sixteen wire gauge, one-half of one cent per pound; less than one inch in length and lighter than number sixteen wire gauge, one cent per pound.
- 163 Spikes, nuts, and washers and horse, mule or ox shoes, of wrought iron or steel, one cent per pound.
- 164 Cut tacks, brads, or sprigs, not exceeding sixteen ounces to the thousand, one and one-fourth cents per thousand; exceeding sixteen ounces to the thousand, one and one-half cents per pound.
- 165 Needles for knitting or sewing machines, including latch needles, one dollar per thousand, and twenty-five per centum ad valorem; crochet needles and tape needles, knitting and all other needles, not specially provided for in this Act, and bodkins of metal, twenty-five per centum ad valorem.

## Plates.

- 166 Steel plates engraved, stereotype plates, electrotype plates, and plates of other materials, engraved or lithographed, for printing, twenty-five per centum ad valorem.
- 167 Rivets of iron or steel, two cents per pound.

## Saws.

- 168 Crosscut saws, six cents per linear foot, mill saws, ten cents per linear foot; pit and drag saws, eight cents per linear foot; circular saws, twenty-five per centum ad valorem; steel band saws, finished or further advanced than tempered and polished, ten cents per pound and twenty per centum ad valorem, hand, back, and all other saws, not specially provided for in this Act, thirty per centum ad valorem.
- 169 Screws, commonly called wood screws, made of iron or steel more than two inches in length, four cents per pound; over one inch and not more than two inches in length, six cents per pound, over one half inch and not more than one inch in length, eight and one-half cents per pound; one-half inch and less in length, twelve cents per pound.
- 170 Umbrella and parasol ribs and stretchers, composed in chief value of iron, steel, or other metal, in frames or otherwise, fifty per centum ad valorem.
- 171 Wheels for railway purposes, or parts thereof, made of iron or steel, and steel-tired wheels for railway purposes, whether wholly or partly finished, and iron or steel locomotive, car, or other railway tires or parts thereof, wholly or partly manufactured, one and one-half cents per pound; and

# The Niagara Metallic Furniture Company, Limited, NIAGARA FALLS, ONT.

MANUFACTURERS OF HIGH-CLASS

## ***Brass and Iron Bedsteads***

CHILDREN'S CRIBS,

WOVEN WIRE SPRINGS, HALL RACKS, Etc.

**ORIGINAL AND EXCLUSIVE DESIGNS.**

**Perfect Fit, Giving Strength and Rigidity to the Bed.**

**ENAMELLING AND LACQUERING UNSURPASSED.**

**The tendency of the times is toward Scroll Ornamentation.**

**Our Scrolls are one of our chief features.**

---

## **GLASS BALL CASTERS**

What dealer has not had complaints of casters cutting the carpet? Our **GLASS BALL CASTER** is not only free from this objection, but adds decidedly to the bed's appearance.

---

Our prices will in all cases be found reasonable, they are based on a moderate profit, and will compare favorably with those of other makes. We make no claim, however, of having the cheapest bed on the market, nor have we any desire for that distinction, but we do claim that in all that goes to make up a substantial, artistic and altogether desirable bed, we are not excelled.

When writing to Advertisers kindly mention THE CANADIAN MANUFACTURER.

## The American Tariff.

Ingots, clogged ingots, blooms or blanks for the same, without regard to the degree of manufacture, one and one-fourth cents per pound: Provided, That when wheels for railway purposes, or parts thereof, of iron or steel, are imported with iron or steel axles fitted in them, the wheels and axles together shall be dutiable at the same rate as is provided for the wheels when imported separately.

## Miscellaneous Metals and Manufactures of.

- 172 Aluminum, and alloys of any kind in which aluminum is the component material of chief value, in crude form, eight cents per pound: In plates, sheets, bars, and rods, thirteen cents per pound.
- 173 Antimony, as regulus or metal, three-fourths of one cent per pound.
- 174 Argentine, albata, or German silver, unmanufactured, twenty-five per centum ad valorem.
- 175 Bronze powder, twelve cents per pound; bronze or Dutch metal or aluminum, in leaf, six cents per package of one hundred leaves.
- 176 Copper in rolled plates, called braziers' copper, sheets rods, pipes, and copper bottoms, two and one-half cents per pound; sheathing or yellow metal of which copper is the component material of chief value, and not composed wholly or in part of iron ungalvanized, two cents per pound.

## Gold and Silver.

- 177 Gold leaf, one dollar and seventy-five cents per package of five hundred leaves.
- 178 Silver leaf, seventy-five cents per package of five hundred leaves.
- 179 Tinsel wire, lame or lahn, made wholly or in chief value of gold, silver or other metal, five cents per pound; bullions and metal threads, made wholly or in chief value of tinsel wire, lame or lahn, five cents per pound and thirty-five per centum ad valorem: laces, embroideries, braids, galloons, trimmings, or other articles, made wholly or in chief value of tinsel wire, lame or lahn, bullions, or metal threads sixty per centum ad valorem.
- 180 Hooks and eyes, metallic, whether loose, carded or otherwise, including weight of cards, cartons, and immediate wrappings and labels, five and one-half cents per pound and fifteen per centum ad valorem.

## Lead.

- 181 Lead-bearing ore of all kinds, one and one-half cents per pound on the lead contained therein: Provided, That on all importations of lead-bearing ores the duties shall be estimated at the port of entry, and a bond given in double the amount of such estimated duties for the transportation of appraised or unappraised merchandise to properly equipped sampling or smelting establishments, whether designated as bonded warehouses or otherwise. On the arrival of the ores at such establishments they shall be sampled according to commercial methods under the supervision of Government officers, who shall be stationed at such establishments, and who shall submit the samples thus obtained to a Government assayer, designated by the Secretary of the Treasury, who shall make a proper assay of the sample, and report the result to the proper customs officers, and the import entries shall be liquidated thereon, except in case of ores that shall be removed to a bonded warehouse to be refined for exportation as provided by law. And the Secretary of the Treasury is authorized to make all necessary regulations to enforce the provisions of this paragraph.
- 182 Lead dross, lead bullion or base bullion, lead in pigs and bars, lead in any form not specially provided for in this Act, old refuse lead run into blocks and bars, and old scrap lead fit only to be remanufactured, all the foregoing, two and one-eighth cents per pound: lead in sheets, pipe, shot, glaziers' lead and lead wire, two and one-half cents per pound.
- 183 Metallic mineral substances in a crude state, and metals unwrought, not specially provided for in this Act, twenty per centum ad valorem: monazite sand and thorite, six cents per pound.
- 184 Mica, unmanufactured, or rough trimmed only, six cent per pound and twenty per centum ad valorem: mica, cut or trimmed, twelve cents per pound and twenty per centum ad valorem.
- 185 Nickel, nickel oxide, alloy of any kind in which nickel is a component material of chief value, in pigs, ingots, bars, or sheets, six cents per pound.
- 186 Pens, metallic, except gold pens, twelve cents per gross.

## The American Tariff.

- 187 Penholder tips, penholders or parts thereof, and gold pens, twenty-five per centum ad valorem.
- 188 Pins with solid heads, without ornamentation, including hair, safety, hat, bonnet, and shawl pins, any of the foregoing composed wholly of brass, copper, iron, steel, or other base metal, not plated, and not commonly known as jewelry, thirty-five per centum ad valorem.
- 189 Quicksilver, seven cents per pound. The flasks, bottles, or other vessels in which quicksilver is imported shall be subject to the same rate of duty as they would be subjected to if imported empty.
- 190 Type metal, one and one-half cents per pound for the lead contained therein: new types twenty-five per centum ad valorem.
- 191 Watch movements, whether imported in cases or not, if having not more than seven jewels, thirty-five cents each; if having more than seven jewels and not more than eleven jewels, fifty cents each; if having more than eleven jewels and not more than fifteen jewels, seventy-five cents each; if having more than fifteen jewels, one dollar and twenty-five cents each; if having more than seventeen jewels, three dollars each, and in addition thereto, on all the foregoing, twenty-five per centum ad valorem; watch cases and parts of watches, including watch dials, chronometers, box or ship, and parts thereof, clocks and parts thereof, not otherwise provided for in this Act, whether separately packed or otherwise, not composed wholly or in part of china, porcelain, parian, bisque, or earthenware, forty per centum ad valorem: all jewels for use in the manufacture of watches or clocks, ten per centum ad valorem.
- 192 Zinc in blocks or pigs, one and one-half cents per pound; in sheets, two cents per pound, old and worn-out, fit only to be remanufactured, one cent per pound.
- 193 Articles or wares not specially provided for in this Act, composed wholly or in part of iron, steel, lead, copper, nickel pewter, zinc, gold, silver, platinum, aluminum or other metal, and whether partly or wholly manufactured, forty-five per centum ad valorem.

## SCHEDULE D.

## Wood and Manufactures of.

- 194 Timber hewn, sided, or squared (not less than eight inches square), and round timber used for spars or in building wharves, one cent per cubic foot.
- 195 Sawn boards, planks, deals, and other lumber of white-wood, sycamore, and basswood, one dollar per thousand feet board measure: sawed lumber, not specially provided for in this Act, two dollars per thousand feet board measure: but when lumber of any sort is planed or finished, in addition to the rates herein provided, there shall be levied and paid for each side so planed or finished fifty cents per thousand feet board measure; and if planed on one side and tongued and grooved, one dollar per thousand feet board measure; and if planed on two sides and tongued and grooved, one dollar and fifty cents per thousand feet board measure, and in estimating board measure under this schedule no deduction shall be made on board measure on account of planing, tonguing and grooving: Provided, That if any country or dependency shall impose an export duty upon saw logs, round unmanufactured timber, stave bolts, shingle bolts, or heading bolts, exported to the United States, or a discriminating charge upon boom sticks, or chains used by American citizens in towing logs, the amount of such export duty, tax, or other charge, as the case may be, shall be added as an additional duty to the duties imposed upon the articles mentioned in this paragraph when imported from such country or dependency.
- 196 Paving posts, railroad ties, and telephone, trolley, electric light and telegraph poles of cedar or other woods, twenty per centum ad valorem.
- 197 Kindling wood in bundles not exceeding one-quarter of a cubic foot each, three-tenths of one cent per bundle: if in larger bundles, three-tenths of one cent for each additional quarter of a cubic foot or fractional part thereof.
- 198 Sawed boards, planks, deals, and all forms of sawed cedar, lignum-vitae, lancewood, ebony, box, granadilla, mahogany, rosewood, satinwood, and all other cabinet woods not further manufactured than sawed, fifteen per centum ad valorem: veneers of wood, and wood, unmanufactured, not specially provided for in this Act, twenty per centum ad valorem.
- 199 Clapboards, one dollar and fifty cents per thousand.
- 200 Hubs for wheels, posts, heading bolts, stave bolts, last

# The Toronto Bedding Co., Limited.

TORONTO, CANADA.

## STEEL BEDSTEADS, BRASS TRIMMED.

STEEL CRIBS

SPIRAL SPRING BEDS

WOVEN WIRE SPRINGS—Wood Frame

WOVEN WIRE SPRINGS—Steel Frame

The "Foster Ideal" Spring is Peerless.

**P**eerless in Comfort.  
Peerless in Durability.  
Peerless in Quality.  
Peerless in Value.

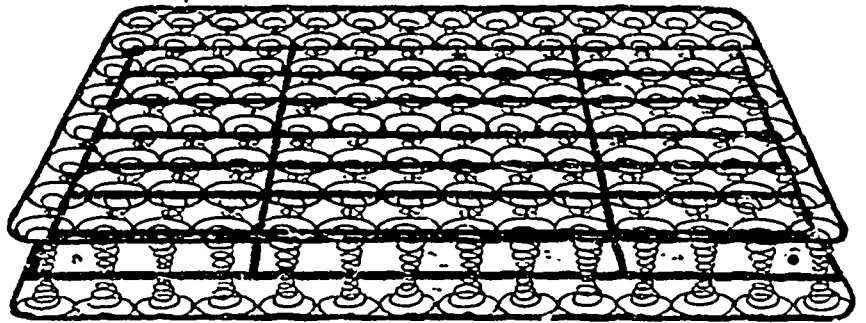

The Foster Ideal.

EVERY "FOSTER IDEAL" GUARANTEED.

JAPANNED STEEL FURNITURE and BED SPRINGS, EXTRA TEMPERED.

COPPERED STEEL FURNITURE and BED SPRINGS.

*...Mattresses of all Kinds...*

"Victor" Combination Mattress **TAKES THE LEAD.**

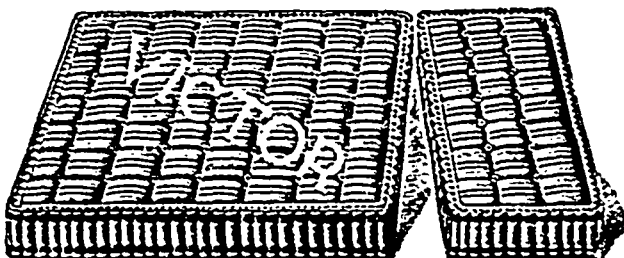

**H**AIR MATTRESSES, IMPERIAL EDGE,  
PLAIN EDGE.

ALL STYLES. BEST WORKMANSHIP.

**THREE-PIECE BEDSTEADS HEAD, FOOT and SPRING, OUR SPECIALTY**

When writing to Advertisers kindly mention THE CANADIAN MANUFACTURER.

## The American Tariff

- blocks, wagon-blocks, oar-blocks, heading-blocks and all like or sticks, rough-hewn, sawed or bored, twenty per centum ad valorem; fence posts, ten per centum ad valorem.
- 201 Laths, twenty-five cents per one thousand pieces.
- 202 Pickets, palings and staves of wood, of all kinds, ten per centum ad valorem.
- 203 Shingles, thirty cents per thousand.
- 204 Casks, barrels, and hogheads (empty), sugar-box shooks, and packing-boxes (empty), and packing-boxes shooks, of wood, not specially provided for in this Act, thirty per centum ad valorem.
- 205 Boxes, barrels, or other articles containing oranges, lemons, limes, grape fruit, shaddocks or pomelos, thirty per centum ad valorem: Provided, That the thin wood, so called, comprising the sides, tops and bottoms of orange and lemon boxes of the growth and manufacture of the United States, exported as orange and lemon box shooks, may be re-imported in completed form, filled with oranges and lemons, by the payment of duty at one-half the rate imposed on similar boxes of entirely foreign growth and manufacture.
- 206 Chair cane or reeds, wrought or manufactured from rattans or reeds, ten per centum ad valorem: osier or willow prepared for basket makers' use, twenty per centum ad valorem manufactures of osier or willow, forty per centum ad valorem.
- 207 Toothpicks of wood or other vegetable substance, two cents per one thousand and fifteen per centum ad valorem; butchers' and packers' skewers of wood, forty cents per thousand.
- 208 House or cabinet furniture, of wood, wholly, or partly finished, and manufactures of wood, or of which wood is the component material of chief value, not specially provided for in this Act, thirty-five per centum ad valorem.

## SCHEDULE E.

## Sugar, Molasses, and Manufactures of.

- 209 Sugars not above number sixteen Dutch standard in color, tank bottoms, sirups of cane juice, melade, concentrated melada, concrete and concentrated molasses, testing by the polariscope not above seventy-five degrees, ninety-five one-hundredths of one cent per pound, and for every additional degree shown by the polariscope test, thirty-five one-thousandths of one cent per pound additional, and fractions of a degree in proportion; and on sugar above number sixteen Dutch standard in color, and on all sugar which has gone through a process of refining, one cent and ninety-five one-hundredths of one cent per pound; molasses testing above forty degrees and not above fifty-six degrees, three cents per gallon; testing fifty-six degrees and above, six cents per gallon; sugar drainings and sugar sweepings shall be subject to duty as molasses or sugar, as the case may be, according to polariscope test: Provided, That nothing herein contained shall be so construed as to abrogate or in any manner impair or affect the provisions of the treaty of commercial reciprocity concluded between the United States and the King of the Hawaiian Islands on the thirtieth day of January, eighteen hundred and seventy-five, or the provisions of any Act of Congress heretofore passed for the execution of the same.
- 210 Maple sugar and maple sirup, four cents per pound; glucose or grape sugar, one and one-half cents per pound; sugar cane in its natural state, or unmanufactured, twenty per centum ad valorem.
- 211 Saccharine, one dollar and fifty cents per pound and ten per centum ad valorem.
- 212 Sugar candy and all confectionery not specially provided for in this Act, valued at fifteen cents per pound or less, and on sugars after being refined, when tintured, colored or in any way adulterated, four cents per pound and fifteen per centum ad valorem; valued at more than fifteen cents per pound, fifty per centum ad valorem. The weight and the value of the immediate coverings, other than the outer packing case or other covering, shall be included in the dutiable weight and the value of the merchandise.

## SCHEDULE F.

## Tobacco and Manufactures of.

- 213 Wrapper tobacco, and filler tobacco when mixed or packed with more than fifteen per centum of wrapper tobacco, and all leaf tobacco the product of two or more countries or dependencies when mixed or packed together, if unstemmed, one dollar and eighty-five cents per pound; if stemmed, two dollars and fifty cents per pound, filler tobacco not specially provided for in this Act, if unstemmed, thirty-five cents per pound; if stemmed, fifty cents per pound.

## The American Tariff.

- 214 The term wrapper tobacco as used in this Act means that quality of leaf tobacco which is suitable for cigar wrappers, and the term filler tobacco means all other leaf tobacco. Collectors of customs shall not permit entry to be made, except under regulations to be prescribed by the Secretary of the Treasury, of any leaf tobacco, unless the invoices of the same shall specify in detail the character of such tobacco, whether wrapper or filler, its origin and quality. In the examination for classification of any imported leaf tobacco, at least one bale, box, or package in every ten, and at least one in every invoice, shall be examined by the appraiser or person authorized by law to make such examination and at least ten hands shall be examined in each examined bale, box or package.
- 215 All other tobacco, manufactured or unmanufactured, not specially provided for in this Act, fifty-five cents per pound.
- 216 Snuff and snuff flour, manufactured of tobacco, ground dry, or damp, and pickled, scented, or otherwise, of all descriptions, fifty-five cents per pound.
- 217 Cigars, cigarettes, cheroots of all kinds, four dollars and fifty cents per pound and twenty-five cents per centum ad valorem; and paper cigars and cigarettes, including wrappers, shall be subject to the same duties as are herein imposed upon cigars.

## SCHEDULE G.

## Agricultural Products and Provisions.

## Animals, Live.

- 218 Cattle, if less than one year old, two dollars per head, all other cattle if valued at not more than fourteen dollars per head, three dollars and seventy-five cents per head, if valued at more than fourteen dollars per head, twenty-seven and one-half per centum ad valorem.
- 219 Swine, one dollar and fifty cents per head.
- 220 Horses and mules, valued at one hundred and fifty dollars or less per head, thirty dollars per head, if valued at over one hundred and fifty dollars, twenty-five per centum ad valorem.
- 221 Sheep, one year old or over, one dollar and fifty cents per head; less than one year old, seventy-five cents per head.
- 222 All other live animals, not specially provided for in this Act, twenty per centum ad valorem.

## Breadstuffs and Farinaceous Substances.

- 223 Barley, thirty cents per bushel of forty-eight pounds.
- 224 Barley-malt, forty-five cents per bushel of thirty-four pounds.
- 225 Barley, pearled, patent, or hulled, two cents per pound.
- 226 Buckwheat, fifteen cents per bushel of forty-eight pounds.
- 227 Corn or maize, fifteen cents per bushel of fifty-six pounds.
- 228 Corn meal, twenty cents per bushel of forty-eight pounds.
- 229 Macaroni, vermicelli, and all similar preparations, one and one-half cents per pound.
- 230 Cats, fifteen cents per bushel.
- 231 Oatmeal and rolled oats, one cent per pound; oat hulls, ten cents per hundred pounds.
- 232 Rice, cleaned, two cents per pound; uncleaned rice, or rice free of the outer hull and still having the inner cuticle on, one and one-fourth cents per pound; rice flour, and rice meal, and rice broken which will pass through a sieve known commercially as number twelve wire sieve, one-fourth of one cent per pound; paddy, or rice having the outer hull on, three-fourths of one cent per pound.
- 233 Rye, ten cents per bushel; rye flour, one-half of one cent per pound.
- 234 Wheat, twenty-five cents per bushel.
- 235 Wheat flour, twenty-five per centum ad valorem.

## Dairy Products.

- 236 Butter, and substitutes therefor, six cents per pound.
- 237 Cheese, and substitutes therefor, six cents per pound.
- 238 Milk, fresh, two cents per gallon.
- 239 Milk, preserved or condensed, or sterilized by heating or other processes, including weight of immediate coverings, two cents per pound, sugar of milk, five cents per pound.

## Farm and Field Products.

- 240 Beans, forty-five cents per bushel of sixty pounds.
- 241 Beans, pease, and mushrooms, prepared or preserved, in tins, jars, bottles, or similar packages, two and one-half cents per pound, including the weight of all tins, jars, and other immediate coverings; all vegetables, prepared or preserved, including pickles and sauces of all kinds, not specially provided for in this Act, and fish paste or sauce, forty per centum ad valorem.



# The NIAGARA FALLS METAL WORKS CO., Limited

— MANUFACTURERS OF —

Bits, Harness and Carriage  
Hardware, Wire Chains,

## Iron & Wood Hames.

BRASS and MALLEABLE FOUNDRY.

Close Plating & Electro Plating, Sheet Metal Cut, Stamped and Formed.

ESTIMATES GIVEN ON  
SPECIAL WORK.

Niagara Falls Centre, Ont.

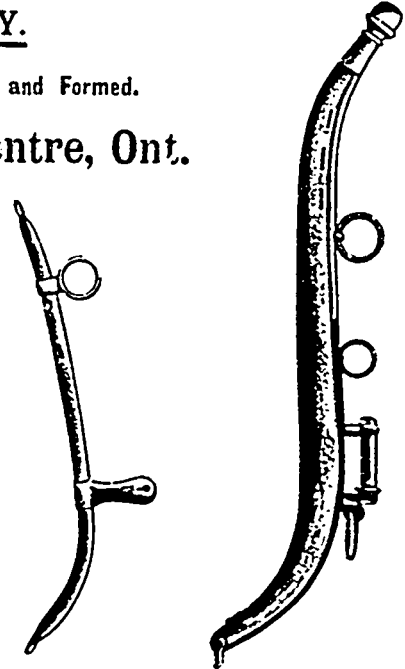
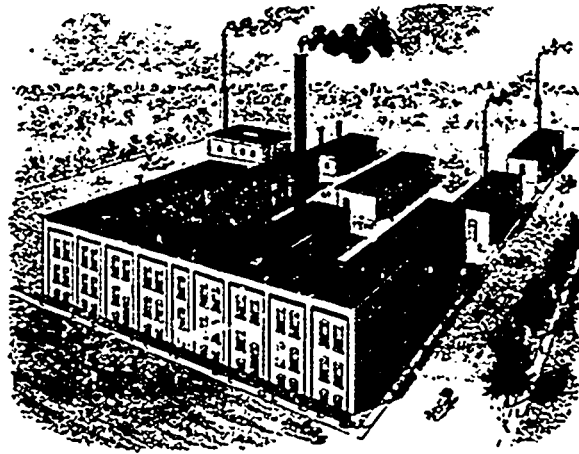
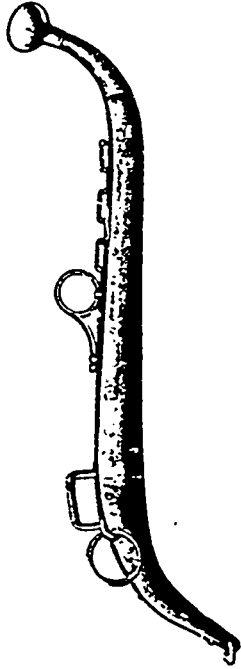

## One Agent Only in Each Town

# WANTED

WRITE US FOR PARTICULARS ABOUT

# “PERFECTION”

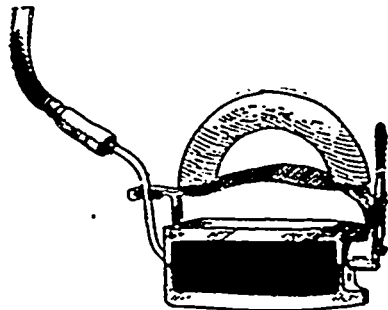

## Self-Heating Sad Iron

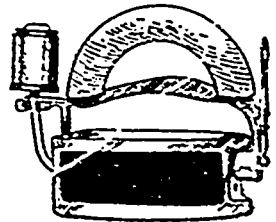

SOMETHING NEW. SELLS WELL.

# The Edwards Sad Iron Co., Confederation Life Building, Toronto.

When writing to Advertisers kindly mention THE CANADIAN MANUFACTURER.

## The American Tariff.

- 242 Cabbages, three cents each.  
 243 Cider, five cents per gallon.  
 244 Eggs, not specially provided for in this Act, five cents per dozen.  
 245 Eggs, yolk of, twenty-five per centum ad valorem; albumen, egg or blood, three cents per pound; dried blood, when soluble, one and one-half cents per pound.  
 246 Hay, four dollars per ton.  
 247 Honey, twenty cents per gallon.  
 248 Hops, twelve cents per pound; hop extract and lupulin, fifty per centum ad valorem.  
 249 Onions, forty cents per bushel; garlic, one cent per pound.  
 250 Pease, green, in bulk or in barrels, sacks, or similar packages, and seed pease, forty cents per bushel of sixty pounds; pease, dried not specially provided for, thirty cents per bushel; split pease, forty cents per bushel of sixty pounds; pease in cartons, papers, or other small packages, one cent per pound.  
 251 Orchids, palms, dracaenas, crotons and azaleas, tulips, hyacinths, narcissi, jonquils, lilies of the valley, and all other bulbs, bulbous roots, or corms, which are cultivated for their flowers, and natural flowers of all kinds, preserved or fresh, suitable for decorative purposes, twenty-five per centum ad valorem.  
 252 Stocks, cuttings, or seedlings of Myrobalan plum, Mahaleb or Mazzard cherry, three years old or less, fifty cents per thousand plants and fifteen per centum ad valorem; stocks cuttings or seedlings of pear, apple, quince and the Saint Julien plum, three years old or less, and evergreen seedlings, one dollar per thousand plants and fifteen per centum ad valorem; rose plants, budded, grafted, or grown on their own roots, two and one-half cents each; stocks, cuttings and seedlings of all fruit and ornamental trees, deciduous and evergreen, shrubs and vines, manetti, multiflora, and brier rose, and all trees, shrubs, plants and vines, commonly known as nursery or greenhouse stock, not specially provided for in this Act, twenty-five per centum ad valorem.  
 253 Potatoes twenty-five cents per bushel of sixty pounds.  
 254 Seeds: Castor beans or seeds, twenty-five cents per bushel of fifty pounds; flaxseed or linseed and other oil seeds not specially provided for in this Act, twenty-five cents per bushel of fifty-six pounds; poppy seed, fifteen cents per bushel; but no drawback shall be allowed upon oil cake made from imported seed, nor shall any allowance be made for the dirt or other impurities in any seed; seeds of all kinds not specially provided for in this Act, thirty per centum ad valorem.  
 255 Straw, one dollar and fifty cents per ton.  
 256 Teazles, thirty per centum ad valorem.  
 257 Vegetables in their natural state, not specially provided for in this Act, twenty-five per centum ad valorem.

## Fish.

- 258 Fish known or labelled as anchovies, sardines, sprats, brislings, sardel, or sardellen, packed in oil or otherwise, in bottles, jars, tin boxes or cans, shall be dutiable as follows. When in packages; containing seven and one-half cubic inches or less, one and one-half cents per bottle, jar, box or can; containing more than seven and one-half and not more than twenty-one cubic inches, two and one-half cents per bottle, jar, box or can; containing more than twenty-one and not more than thirty-three cubic inches, five cents per bottle, jar, box or can; containing more than thirty-three and not more than seventy cubic inches, ten cents per bottle, jar, box or can; if in other packages, forty per centum ad valorem. All other fish (except shellfish), in tin packages, thirty per centum ad valorem; fish in packages containing less than one-half barrel, and not specially provided for in this Act, thirty per centum ad valorem.  
 259 Fresh-water fish not specially provided for in this Act, one-fourth of one cent per pound.  
 260 Herrings, pickled or salted, one-half of one cent per pound; herrings, fresh, one-fourth of one cent per pound.  
 261 Fish, fresh, smoked, dried, salted, pickled, frozen, packed in ice or otherwise prepared for preservation, not specially provided for in this Act, three-fourths of one cent per pound; fish, skinned or boned, one and one-fourth cent per pound; mackerel, halibut or salmon, fresh, pickled or salted, one cent per pound.

## Fruits and Nuts.

- 262 Apples, peaches, quinces, cherries, plums, and pears, green or ripe, twenty-five cents per bushel, apples, peaches, pears, and other edible fruits, including berries, when dried, desiccated, evaporated or prepared in any manner, not

## The American Tariff.

- specially provided for in this Act, two cents per pound; berries, edible, in their natural condition, one cent per quart; cranberries, twenty-five per centum ad valorem.  
 263 Comfits, sweetmeats, and fruits preserved in sugar, molasses, spirits, or in their own juices, not specially provided for in this Act, one cent per pound and thirty-five per centum ad valorem. If containing over ten per centum of alcohol and not specially provided for in this Act, thirty-five per centum ad valorem and in addition two dollars and fifty cents per proof gallon on the alcohol contained therein in excess of ten per centum; jellies of all kinds, thirty-five per centum ad valorem; pineapples preserved in their own juice, twenty-five per centum ad valorem.  
 264 Figs, plums, prunes, and prunelles, two cents per pound; raisins and other dried grapes, two and one-half cents per pound; dates, one-half of one cent per pound; currants, Zante or other, two cents per pound; olives, green or prepared, in bottles, jars, or similar packages, twenty-five cents per gallon; in casks or otherwise than in bottles, jars, or similar packages, fifteen cents per gallon.  
 265 Grapes in barrels, or other packages, twenty cents per cubic foot of capacity of barrel or packages.  
 266 Oranges, lemons, limes, grape fruit, shaddocks or pomelos, one cent per pound.  
 267 Orange peel or lemon peel, preserved, candied, or dried, and coconut meat or copra desiccated, shredded, cut, or similarly prepared, two cents per pound; citron or citron peel, preserved, candied, or dried, four cents per pound.  
 268 Pineapples, in barrels and other packages, seven cents per cubic foot of the capacity of barrels or packages; in bulk, seven dollars per thousand.

## Nuts.

- 269 Almonds, not shelled, four cents per pound, clear almonds, shelled, six cents per pound.  
 270 Filberts and walnuts of all kinds, not shelled, three cents per pound; shelled, five cents per pound.  
 271 Peanuts or ground beans, unshelled, one-half of one cent per pound; shelled, one cent per pound.  
 272 Nuts of all kinds, shelled or unshelled, not specially provided for in this Act, one cent per pound.

## Meat Products.

- 273 Bacon and hams, five cents per pound.  
 274 Fresh beef, veal, mutton and pork, two cents per pound.  
 275 Meats of all kinds, prepared or preserved, not specially provided for in this Act, twenty-five per centum ad valorem.  
 276 Extract of meat, not specially provided for in this Act, thirty-five cents per pound; fluid extract of meat, fifteen cents per pound, but the dutiable weight of the extract of meat and of the fluid extract of meat shall not include the weight of the package in which the same is imported.  
 277 Lard, two cents per pound.  
 278 Poultry, live, three cents per pound; dressed, five cents per pound.  
 279 Tallow, three-fourths of one cent per pound; wool grease, including that known commercially as degrass or brown wool grease, one-half of one cent per pound.

## Miscellaneous Products.

- 280 Chicory root, raw, dried or undried, but unground, one cent per pound; chicory root, burnt or roasted, ground or granulated, or in rolls, or otherwise prepared, and not specially provided for in this Act, two and one-half cents per pound.  
 281 Chocolate and cocoa, prepared or manufactured, not specially provided for in this Act, valued at not over fifteen cents per pound, two and one-half cents per pound; valued above fifteen and not over twenty-four cents per pound, two and one-half cents per pound and ten per centum ad valorem; valued above twenty-four and not above thirty-five cents per pound, five cents per pound and ten per centum ad valorem; valued above thirty-five cents per pound, fifty per centum ad valorem. The weight and value of all coverings, other than plain wooden, shall be included in the dutiable weight and value of the foregoing merchandise; powdered cocoa, unsweetened, five cents per pound.  
 282 Cocoa-butter or cocoa-butterine, three and one-half cents per pound.  
 283 Dandelion-root and acorns prepared, and articles used as coffee, or as substitutes for coffee, not specially provided for in this Act, two and one-half cents per pound.  
 284 Salt in bags, sacks, barrels, or other packages, twelve cents per one hundred pounds. In bulk, eight cents per one hundred pounds. Provided, That imported salt in bond may be used in curing fish taken by vessels licensed to engage in

# THE ORIGINAL

## THE DODGE

# Patent Wood Split Pulley

WITH INTERCHANGEABLE BUSHING SYSTEM.

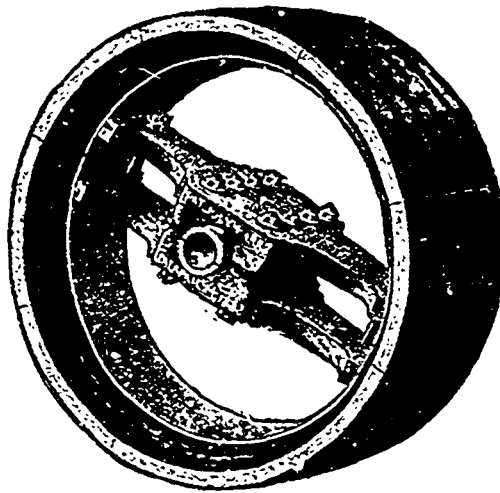

.....  
OURS IS  
THE ORIGINAL.  
.....

.....  
IMITATIONS  
FOLLOWED.  
.....

THIS IS THE PULLEY THAT REVOLUTIONIZED THE WORLD!

It was a good thing when it came fifteen years ago.

**IT IS BETTER TO=DAY.**

***We Manufacture 300 Pulleys per Day***

We publish an interesting Catalogue—Mail it Free.

# Dodge Mfg. Co., of Toronto

TORONTO, CANADA.

Limited.

When writing to Advertisers kindly mention THE CANADIAN MANUFACTURER.

## The American Tariff.

the fisheries, and in curing fish on the shores of the navigable waters of the United States, under such regulations as the Secretary of the Treasury shall prescribe, and upon proof that the salt has been used for either of the purposes stated in this proviso, the duties on the same shall be remitted: Provided further, That exporters of meats, whether packed or smoked, which have been cured in the United States with imported salt, shall, upon satisfactory proof, under such regulations as the Secretary of the Treasury shall prescribe, that such meats have been cured with imported salt, have refunded to them from the Treasury the duties paid on the salt so used in curing such exported meats, in amounts not less than one hundred dollars.

- 285 Starch, including all preparations, from whatever substance produced, fit for use as starch, one and one-half cents per pound.
- 286 Dextrine, burnt starch, gum substitute, or British gum, two cents per pound.
- 287 Spices; Mustard, ground or prepared, in bottles or otherwise, ten cents per pound, capsicum or red pepper, or cayenne pepper, two and one-half cents per pound; sage, one cent per pound. Spices not specially provided for in this Act, three cents per pound.
- 288 Vinegar, seven and one-half cents per proof gallon. The standard proof for vinegar shall be taken to be that strength which requires thirty-five grains of bicarbonate of potash to neutralize one ounce troy of vinegar.

## SCHEDULE H.

## Spirits, Wines, and Other Beverages.

## Spirits.

- 289 Brandy and other spirits manufactured or distilled from grain or other materials, and not specially provided for in this Act, two dollars and twenty-five cents per proof gallon.
- 290 Each and every gauge or wine gallon of measurement shall be counted as at least one proof gallon, and the standard for determining the proof of brandy and other spirits or liquors of any kind imported shall be the same as that which is defined in the laws relating to internal revenue. Provided, That it shall be lawful for the Secretary of the Treasury, in his discretion, to authorize the ascertainment of the proof of wines, cordials, or other liquors, by distillation or otherwise by the means prescribed by existing law or regulation, in cases where it is impracticable to ascertain such things: And provided further, That any brandy or other spirituous or distilled liquors imported in any size cask, bottle, jug, or other packages, of or from any country, dependency, or province under whose laws similar sized casks, bottles, jugs, or other packages of distilled spirits, wine, or other beverage put up or filled in the United States are denied entrance into such country, dependency, or province, shall be forfeited to the United States, and any brandy or other spirituous or distilled liquors imported in a cask of less capacity than ten gallons from any country shall be forfeited to the United States.
- 291 On all compounds or preparations of which distilled spirits are a component part of chief value, there shall be levied a duty not less than that imposed upon distilled spirits.
- 292 Cordials, liqueurs, arrack, absinthe, kirschwasser, ratafia, and other spirituous beverages or bitters of all kinds, containing spirits, and not specially provided for in this Act, two dollars and twenty-five cents per proof gallon.
- 293 No lower rate or amount of duty shall be levied, collected, and paid on brandy, spirits, and other spirituous beverages than that fixed by law for the description of first proof, but it shall be increased in proportion for any greater strength than the strength of first proof, and all imitations of brandy or spirits or wines imported by any names whatever shall be subject to the highest rate of duty provided for the genuine articles respectively intended to be represented, and in no case less than one dollar and fifty cents per gallon.
- 294 Bay rum or bay water, whether distilled or compounded, of first proof, and in proportion for any greater strength than first proof, one dollar and fifty cents per gallon.

## Wines.

- 295 Champagne and all other sparkling wines, in bottles containing each not more than one quart and more than one pint, eight dollars per dozen; containing not more than one pint each and more than one-half pint, four dollars per dozen; containing one-half pint each or less, two dollars per dozen;

## The American Tariff.

in bottles or other vessels containing more than one quart each, in addition to eight dollars per dozen bottles, on the quantity in excess of one quart, at the rate of two dollars and fifty cents per gallon, but no separate or additional duty shall be levied on the bottles.

- 296 Still wines, including ginger wine or ginger cordial and vermouth, in casks or packages other than bottles or jugs, if containing fourteen per centum or less of absolute alcohol, forty cents per gallon, if containing more than fourteen per centum of absolute alcohol, fifty cents per gallon. In bottles or jugs, per case of one dozen bottles or jugs, containing each not more than one quart and more than one pint, or twenty-four bottles or jugs containing each not more than one pint, one dollar and sixty cents per case; and any excess beyond these quantities found in such bottles or jugs shall be subject to a duty of five cents per pint or fractional part thereof, but no separate or additional duty shall be assessed on the bottles or jugs: Provided, That any wines, ginger cordial, or vermouth imported containing more than twenty-four per centum of alcohol shall be classed as spirits and pay duty accordingly. And provided further, That there shall be no constructive or other allowance for breakage, leakage, or damage on wines, liquors, cordials, or distilled spirits. Wines, cordials, brandy, and other spirituous liquors, including bitters of all kinds, and bay rum or bay water, imported in bottles or jugs, shall be packed in packages containing not less than one dozen bottles or jugs in each package, or duty shall be paid as if such package contained at least one dozen bottles or jugs, and in addition thereto, duty shall be collected on the bottles or jugs as the rates which would be chargeable thereon if imported empty. The percentage of alcohol in wines and fruit juices shall be determined in such manner as the Secretary of the Treasury shall by regulation prescribe.
- 297 Ale, porter, and beer, in bottles or jugs, forty cents per gallon, but no separate or additional duty shall be assessed on the bottles or jugs, otherwise than in bottles or jugs, twenty cents per gallon.
- 298 Malt extract, fluid, in casks, twenty cents per gallon, in bottles or jugs, forty cents per gallon, solid or condensed, forty per centum ad valorem.
- 299 Cherry juice and prune juice, or prune wine, and other fruit juices not specially provided for in this Act, containing no alcohol or not more than eighteen per centum of alcohol, sixty cents per gallon; if containing more than eighteen per centum of alcohol, sixty cents per gallon, and in addition thereto two dollars and seven cents per proof gallon on the alcohol contained therein.
- 300 Ginger ale, ginger beer, lemonade, soda water, and other similar beverages containing no alcohol, in plain green or colored, molded or pressed glass bottles, containing each not more than three-fourths of a pint, eighteen cents per dozen; containing more than three-fourths of a pint each and not more than one and one-half pints, twenty-eight cents per dozen, but no separate or additional duty shall be assessed on the bottles, if imported otherwise than in plain green or colored, molded or pressed, glass bottles, or in such bottles containing more than one and one-half pints each, fifty cents per gallon, and in addition thereto duty shall be collected on the bottles, or other coverings, at the rates which would be chargeable thereon if imported empty.
- 301 All mineral waters and all imitations of natural mineral waters, and all artificial mineral waters not specially provided for in this Act, in green or colored glass bottles, containing not more than one pint, twenty cents per dozen bottles. If containing more than one pint and more than one quart thirty cents per dozen bottles. But no separate duty shall be assessed upon the bottles. If imported otherwise than in plain green or colored glass bottles, or if imported in such bottles containing more than one quart, twenty-four cents per gallon, and in addition thereto duty shall be collected upon the bottles or other coverings at the same rates that would be charged thereon if imported empty or separately.

## SCHEDULE I.

## Cotton Manufactures.

- 302 Cotton thread and carded yarn, wraps or wrap yarn, in singles, whether on beams or in bundles, skeins or cops, or in any other form, except spool thread of cotton hereinafter provided for, not colored, bleached, dyed, or advanced beyond the condition of singles by grouping or twisting two or more single yarns together, three cents per pound on all numbers up to and including number fifteen, one-fifth of a cent per number per pound on all numbers exceeding number fifteen and up to and including number thirty, and one

# THE GUELPH CARRIAGE TOP AND HARDWARE COMPANY

Manufacturers of

GEARS, BODIES,  
WHEELS TIRED,  
SPRINGS,  
TRIMMINGS,  
TOPS, Etc.

BUGGIES in the White  
Ready to Paint.

And Dealers in

Carriage Material and  
Carriage Hardware  
OF ALL DESCRIPTIONS.

Write for Catalogue  
and Prices.

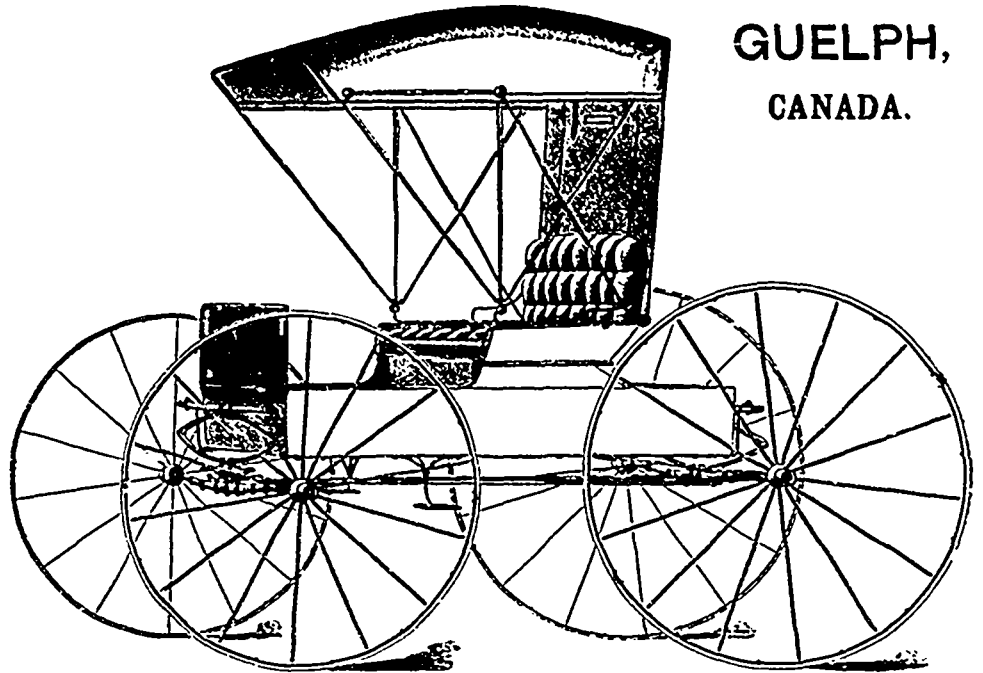

GUELPH,  
CANADA.

The Guelph Carriage Top & Hardware Co., Guelph, Canada.

# ANTELOPE

ONE AGENT WANTED IN  
EVERY TOWN

Are Made in Canada by  
Canadian Workmen,

# BICYCLES

AND WE ARE NOT CONTROLLED BY ANY  
BICYCLE TRUST

Can Make Prompt Deliveries.

Write for Catalogue and Full Particulars.

Manufactured by **JAMES LOCHRIE,**

PLEASE MENTION THIS PAPER

TORONTO

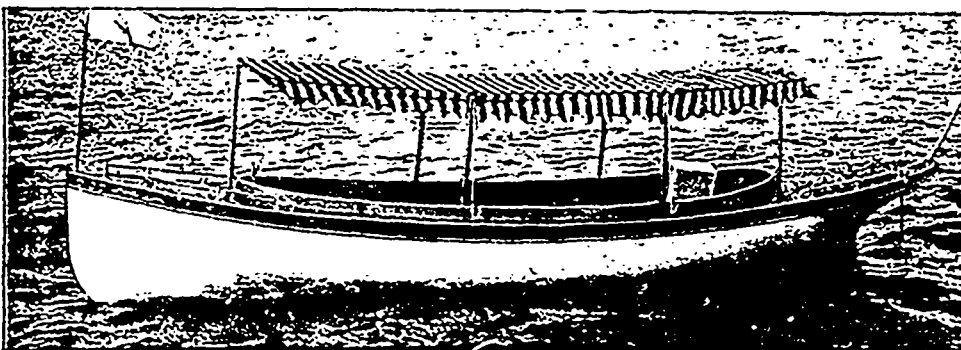

## Gasoline and Steam Launches

The latest styles. Ask for prices.

Dean's Canoes

are known the world over.

SEND FOR CATALOGUE.

WALTER DEAN, - Toronto.

When writing to Advertisers kindly mention THE CANADIAN MANUFACTURER.

The American Tariff.

fourth of a cent per number per pound on all numbers exceeding number thirty, colored, bleached, dyed, combed or advanced beyond the condition of singles by grouping or twisting 2 or more single yarns together, whether on beams or in bundles, skeins or cops, or in any other form, except spool thread of cotton hereinafter provided for, six cents per pound on all numbers up to and including number twenty, and on all numbers exceeding number twenty and up to number eighty, one-fourth of one cent per number per pound; on number eighty and above, three-tenths of one cent per number per pound; cotton card laps, roping, silver or roving, forty-five per centum ad valorem.

303 Spool thread of cotton, including crochet, darning, and embroidery cottons on spools or reels, containing on each spool or reel not exceeding one hundred yards of thread, six cents per dozen; exceeding one hundred yards on each spool or reel, for every additional hundred yards or fractional part thereof in excess of one hundred, six cents per dozen spools or reels; if otherwise than on spools or reels, one-half of one cent for each one hundred yards or fractional part thereof: Provided, That in no case shall the duty be assessed upon a less number of yards than is marked on the spools or reels.

304 Cotton cloth not bleached, dyed, colored, stained, painted, or printed, and not exceeding fifty threads to the square inch, counting the warp and filling, one cent per square yard; if bleached one and one-fourth cents per square yard; if dyed, colored, stained, painted, or printed, two cents per square yard.

305 Cotton cloth, not bleached, dyed, colored, stained, painted or printed, exceeding fifty and not exceeding one hundred threads to the square inch, counting the warp and filling, and not exceeding six square yards to the pound, one and one-fourth cents per square yard; exceeding six and not exceeding nine square yards to the pound, one and one-half cents per square yard, exceeding nine square yards to the pound, one and three-fourths cents per square yard; if bleached, and not exceeding six square yards to the pound, one and one-half cents per square yard; exceeding six and not exceeding nine square yards to the pound, one and three-fourths cents per square yard; exceeding nine square yards to the pound, two and one-fourth cents per square yard; if dyed, colored, stained, painted, or printed, and not exceeding six square yards to the pound, two and three-fourths cents per square yard; exceeding six and not exceeding nine square yards to the pound, three and one-fourths cents per square yard; exceeding nine square yards to the pound, three and one-half cents per square yard:

**Provided, that on all cotton cloth not exceeding one hundred threads to the square inch, counting the warp and filling, not bleached, dyed, colored, stained, painted, or printed, valued at over seven cents per square yard, twenty-five per centum ad valorem; bleached, valued at over nine cents per square yard, twenty-five per centum ad valorem; and dyed, colored, stained, painted, or printed, valued at over twelve cents per square yard, there shall be levied, collected, and paid a duty of thirty per centum ad valorem.**

306 Cotton cloth, not bleached, dyed, colored, stained, painted, or printed, exceeding one hundred and not exceeding one hundred and fifty threads to the square inch, counting the warp and filling, and not exceeding four square yards to the pound, one and one-half cents per square yard; exceeding four and not exceeding six square yards to the pound, two cents per square yard; exceeding six and not exceeding eight square yards to the pound, two and one-half cents per square yard; exceeding eight square yards to the pound, two and three-fourths cents per square yard; if bleached, and not exceeding four square yards to the pound, two and one-half cents per square yard; exceeding four and not exceeding six square yards to the pound, three cents per square yard; exceeding six and not exceeding eight square yards to the pound, three and one-half cents per square yard; exceeding eight square yards to the pound, three and three-fourths cents per square yard. If dyed, colored, stained, painted, or printed, and not exceeding four square yards to the pound, three and one-half cents per square yard; exceeding four and not exceeding six square yards to the pound, three and three-fourths cents per square yard; exceeding six and not exceeding eight square yards to the pound, four and one-half cents per square yard; exceeding eight square yards to the pound, four and one-half cents per square yard. Provided, That on all cotton cloth exceeding one hundred and not exceeding one hundred and fifty threads to the square inch, counting the warp and filling, not bleached, dyed, colored, stained, painted, or printed, valued at over nine cents per square yard, thirty

The American Tariff.

per centum ad valorem, bleached, valued at over eleven cents per square yard, thirty-five per centum ad valorem, dyed, colored, stained, painted, or printed, valued at over twelve and one-half cents per square yard, there shall be levied, collected, and paid a duty of thirty-five per centum ad valorem.

307 Cotton cloth not bleached, dyed, colored, stained, painted, or printed, exceeding one hundred and fifty and not exceeding two hundred threads to the square inch, counting the warp and filling, and not exceeding three and one-half square yards to the pound, two cents per square yard; exceeding three and one-half and not exceeding four and one-half square yards to the pound, two and three-fourths cents per square yard; exceeding four and one-half and not exceeding six square yards to the pound, three cents per square yard, exceeding six square yards to the pound, three and one-half cents per square yard; if bleached, and not exceeding three and one-half square yards to the pound, two and three-fourths cents per square yard; exceeding three and one-half and not exceeding four and one-half square yards to the pound, three and one-half cents per square yard; exceeding four and one-half and not exceeding six square yards to the pound, four cents per square yard; exceeding six square yards to the pound, four and one-fourths cents per square yard; if dyed, colored, stained, painted, or printed, and not exceeding three and one-half square yards to the pound, four and one-fourth cents per square yard; exceeding three and one-half, and not exceeding four and one-half square yards to the pound, four and one-half cents per square yard; exceeding four and one-half and not exceeding six square yards to the pound, four and three-fourths cents per square yard; exceeding six square yards to the pound, five cents per square yard: Provided, That on all cotton cloth exceeding one hundred and fifty and not exceeding two hundred threads to the square inch, counting the warp and filling, not bleached, dyed, colored, stained, painted or printed, valued at over ten cents per square yard, thirty-five per centum ad valorem; bleached, valued at over twelve cents per square yard, thirty-five per centum ad valorem; dyed, colored, stained, painted, or printed, valued at over twelve and one-half cents per square yard, there shall be levied, collected and paid a duty of forty per centum ad valorem.

308 Cotton cloth, not bleached, dyed, colored, stained, painted, or printed, exceeding two hundred and not exceeding three hundred threads to the square inch, counting the warp and filling, and not exceeding two and one-half square yards to the pound, three and one-half cents per square yard; exceeding two and one-half and not exceeding three and one-half square yards to the pound, four cents per square yard; exceeding three and one-half and not exceeding five square yards to the pound, four and one-half cents per square yard; exceeding five square yards to the pound, five cents per square yard. If bleached, and not exceeding two and one-half square yards to the pound, four and one-half cents per square yard; exceeding two and one-half and not exceeding three and one-half square yards to the pound, five cents per square yard; exceeding three and one-half and not exceeding five square yards to the pound, five and one-half cents per square yard; exceeding five square yards to the pound, six cents per square yard; if dyed, colored, stained, painted, or printed, and not exceeding three and one-half square yards to the pound, six and one-fourth cents per square yard; exceeding three and one-half square yards to the pound, seven cents per square yard: Provided, That on all such cotton cloths not bleached, dyed, colored, stained, painted, or printed, valued at over twelve and one-half cents per square yard; bleached, valued at over fifteen cents per square yard; and dyed, colored, stained, painted, or printed, valued at over seventeen and one-half cents per square yard, there shall be levied, collected, and paid a duty of forty per centum ad valorem.

309 Cotton cloth, not bleached, dyed, colored, stained, painted, or printed, exceeding three hundred threads to the square inch, counting the warp and filling, and not exceeding two square yards to the pound, four cents per square yard; exceeding two and not exceeding three square yards to the pound, four and one-half cents per square yard; exceeding three and not exceeding four square yards to the pound, five cents per square yard; exceeding four square yards to the pound, five and one-half cents per square yard; if bleached and not exceeding two square yards to the pound, five cents per square yard; exceeding two and not exceeding three square yards to the pound, five and one-half cents per square yard; exceeding three and not exceeding four square yards to the pound, six cents per square yard; ex-

# DAVIS & VANNIER

FLINT, MICH.

WHOLESALE DEALERS IN

Buggies, Road Wagons,  
Driving Wagons, Runabouts,  
Stanhopes, Surreys,  
Spring Wagons, Etc.

MORE THAN 100 STYLES TO CHOOSE FROM.

ALL WORK FULLY WARRANTED.

Write for Catalogues and Prices.

## The American Tariff.

ceeding four square yards to the pound, six and one-half cents per square yard; if dyed, colored, stained, painted or printed, and not exceeding three square yards to the pound, six and one-half cents per square yard; exceeding three square yards to the pound, eight cents per square yard; Provided, That on all such cotton cloths not bleached, dyed, colored, stained, painted, or printed, valued at over fourteen cents per square yard; bleached, valued at over sixteen cents per square yard; and dyed, colored, stained, painted, or printed, valued at over twenty cents per square yard, there shall be levied, collected, and paid a duty of forty per centum ad valorem.

- 310 The term cotton cloth, or cloth, wherever used in the paragraphs of this schedule, unless otherwise specially provided for, shall be held to include all woven fabrics of cotton in the piece or otherwise, whether figured, fancy or plain, the warp and filling threads of which can be counted by unraveling or other practicable means.
- 311 Cloth, composed of cotton or other vegetable fiber and silk, whether known as silk-striped sleeve linings, silk stripes, or otherwise, of which cotton is the component material of chief value, eight cents per square yard and thirty per centum ad valorem; Provided, That no such cloth shall pay a less rate of duty than fifty per centum ad valorem. Cotton cloth, filled or coated, three cents per square yard and twenty per centum ad valorem.
- 312 Handkerchiefs or mullers composed of cotton, whether in the piece or otherwise, and whether finished or unfinished, if not hemmed, or hemmed only, shall pay the same rate of duty on the cloth contained therein as is imposed on cotton cloth of the same description, weight, and count of threads to the square inch; but such handkerchiefs or mullers shall not pay a less rate of duty than forty-five per centum ad valorem. If such handkerchiefs or mullers are hemstitched or imitation hemstitched, or reversed, or have drawn threads, they shall pay a duty of ten per centum ad valorem in addition to the duty hereinbefore prescribed, and in no case less than fifty-five per centum ad valorem; if such handkerchiefs or mullers are embroidered in any manner, whether with an initial letter, monogram, or otherwise, by hand or machinery, or are tamboured, appliqued, or trimmed wholly or in part with lace or with tucking or insertion, they shall not pay a less rate of duty than sixty per centum ad valorem.
- 313 Cotton cloth in which other than the ordinary warp and filling threads have been introduced in the process of weaving to form a figure, whether known as lappets or otherwise, and whether unbleached, bleached, dyed, colored, stained, painted, or printed, shall pay, in addition to the duty herein provided for other cotton cloth of the same description, or condition, weight, and count of threads to the square inch, one cent per square yard if valued at not more than seven cents per square yard, and two cents per square yard if valued at more than seven cents per square yard.
- 314 Clothing, ready-made, and articles of wearing apparel of every description, including neck-ties or neckwear composed of cotton or other vegetable fiber, or of which cotton or other vegetable fiber is the component material of chief value, made up or manufactured, wholly or in part, by the tailor, seamstress, or manufacturer, and not otherwise provided for in this Act, fifty per centum ad valorem; Provided, That any outside garment provided for in this paragraph having india-rubber as a component material shall pay a duty of fifteen cents per pound and fifty per centum ad valorem.
- 315 Plushes, velvets, velveteens, corduroys, and all pile fabrics, cut or uncut; any of the foregoing composed of cotton or other vegetable fiber, not bleached, dyed, colored, stained, painted, or printed, nine cents per square yard and twenty-five per centum ad valorem; if bleached, dyed, colored, stained, painted, or printed, twelve cents per square yard and twenty-five per centum ad valorem; Provided, That corduroys composed of cotton or other vegetable fiber, weighing seven ounces or over per square yard, shall pay a duty of eighteen cents per square yard and twenty-five per centum ad valorem; Provided further, That manufactures of articles in any form including such as are commonly known as bias dress facings or skirt bindings, made or cut from plushes, velvets, velveteens, corduroys, or other pile fabrics composed of cotton or other vegetable fiber, shall be subject to the foregoing rates of duty and in addition thereto ten per centum ad valorem; Provided further, That none of the articles of fabrics provided for in this paragraph shall pay a less rate of duty than forty-seven and one-half per centum ad valorem.
- 316 Curtains, table covers, and all articles manufactured of cot-

## The American Tariff.

- ton chenille or of which cotton chenille is the component material of chief value, fifty per centum ad valorem.
- 317 Stockings, hose and half-hose, made on knitting machines or frames, composed of cotton or other vegetable fiber, and not otherwise specially provided for in this Act, thirty per centum ad valorem.
- 318 Stockings, hose and half-hose, selvaged, fashioned, narrowed, or shaped wholly or in part by knitting machines or frames, or knit by hand, including such as are commercially known as seamless stockings, hose and half-hose, and clocked stockings, hose or half-hose, all of the above composed of cotton or other vegetable fiber, finished or unfinished, valued at not more than one dollar per dozen pairs, fifty cents per dozen pairs, valued at more than one dollar per dozen pairs, and not more than one dollar and fifty cents per dozen pairs, sixty cents per dozen pairs; valued at more than one dollar and fifty cents per dozen pairs, and not more than two dollars per dozen pairs, seventy cents per dozen pairs; valued at more than two dollars per dozen pairs, and not more than three dollars per dozen pairs, one dollar and twenty cents per dozen pairs; valued at more than three dollars per dozen pairs and not more than five dollars per dozen pairs, two dollars per dozen pairs; and in addition thereto, upon all the foregoing, fifteen per centum ad valorem; valued at more than five dollars per dozen pairs, fifty-five per centum ad valorem.
- 319 Shirts and drawers, pants, vests, union suits, combination suits, tights, sweaters, corset covers and all underwear of every description made wholly or in part on knitting machines or frames, or knit by hand, finished or unfinished, not including stockings, hose and half-hose, composed of cotton or other vegetable fiber, valued at not more than one dollar and fifty cents per dozen, sixty cents per dozen and fifteen per centum ad valorem; valued at more than one dollar and fifty cents per dozen and not more than three dollars per dozen, one dollar and ten cents per dozen, and in addition thereto fifteen per centum ad valorem; valued at more than three dollars per dozen and not more than five dollars per dozen, one dollar and fifty cents per dozen, and in addition thereto twenty-five per centum ad valorem; valued at more than five dollars per dozen and not more than seven dollars per dozen, one dollar and seventy-five cents per dozen, and in addition thereto thirty-five per centum ad valorem; valued at more than seven dollars per dozen, two dollars and twenty-five cents per dozen, and in addition thereto thirty-five per centum ad valorem; valued above fifteen dollars per dozen, fifty per centum ad valorem.
- 320 Bandings, beltings, blindings, bone casings, cords, garters, linings, for bicycle tires, ribbons, suspenders and braces, tapes, tubing, and webs or webbing, any of the foregoing articles made of cotton or other vegetable fiber, whether composed in part of india-rubber or otherwise, and not embroidered by hand or machinery, forty-five per centum ad valorem; spindle banding, woven, braided or twisted lamp, stove, or candle wicking made of cotton or other vegetable fiber, ten cents per pound and fifteen per centum ad valorem; loom harness or healds made of cotton or other vegetable fiber, or of which cotton or other vegetable fiber is the component material of chief value, fifty cents per pound and twenty-five per centum ad valorem; boot, shoe, and corset lacings made of cotton or other vegetable fiber, twenty-five cents per pound and fifteen per centum ad valorem; labels, for garments or other articles, composed of cotton or other vegetable fiber, fifty cents per pound and thirty per centum ad valorem.
- 321 Cotton table damask, forty per centum ad valorem; cotton duck, thirty-five per centum ad valorem.
- 322 All manufactures of cotton not specially provided for in this Act, forty-five per centum ad valorem.

## SCHEDULE J.

## Flax, Hemp, and Jute, and Manufactures of.

- 323 Flax straw, five dollars per ton.
- 324 Flax, not hackled or dressed, one cent per pound.
- 325 Flax, hackled, known as "dressed line," three cents per pound.
- 326 Tow of flax, twenty dollars per ton.
- 327 Hemp, and tow of hemp, twenty dollars per ton; hemp, hackled, known as "line of hemp," forty dollars per ton.
- 328 Single yarns made of jute, not finer than five lea or number, one cent per pound and ten per centum ad valorem; if finer than five lea or number, thirty-five per centum ad valorem.
- 329 Cables and cordage, composed of Istle, Tampico fiber, ma-



# Pumps

"FOR ALL DUTIES"

We invite enquiries from engineers in need of any description of Pumping Machinery. We manufacture over five hundred varieties and sizes of Steam and Power Pumps for stationary and marine purposes. We will be pleased to furnish plans and specifications for any special types. Our Catalogue, giving a good idea of our standard patterns, sent free to all enquirers.

## Northey Gas and Gasoline Engines

To anyone requiring a compact, thoroughly reliable engine, especially suited for users of intermittent power, we recommend our Gas and Gasoline Engine. We shall be glad to furnish estimates for Gas or Gasoline operated pumps, electric light plants, etc., etc. Explanatory Booklet free on request.

**Northey Mfg. Co., Limited,** 1000 KING ST. SUBWAY, **Toronto, Ont.**

# THE ATLANTIC REFINING CO.

TORONTO, ONTARIO

MANUFACTURERS  
AND IMPORTERS  
OF ILLUMINATING  
AND LUBRICATING

## OILS, GREASES

## and SPECIALTIES

SEE THIS SPACE NEXT ISSUE.

Advertise in THE CANADIAN MANUFACTURER—Send for Rates.



# REFLECTORS, SHADES, LAMPS

We Stock a Large Variety of SHADES  
and REFLECTORS in

**ALUMINUM, MIRROR, CELLULOID, PAPER, PORCELAIN,**  
**FOR FACTORY AND OFFICE.**

**Imperial Lamps and Helios Upton Enclosed Arcs** Give **BEST LIGHT** with **LEAST CURRENT**  
ELBRIDGE Sparking Dynamos, SAMSON Batteries and IMPERIAL Salts, for Gas or Oil Engines.

Write us about Lighting  
your Factory or Office.

**JOHN FORMAN, 708 and 710 Craig St., MONTREAL**

When writing to Advertisers kindly mention THE CANADIAN MANUFACTURER.

## The American Tariff.

- nila, sisal grass or sunn, or a mixture of these or any of them, one cent per pound. cables and cordage made of hemp, tarred or untarred, two cents per pound.
- 330 Threads, twines, or cords, made from yarn not finer than five lea or number, composed of flax, hemp, or ramie, or of which these substances or either of them is the component material of chief value, thirteen cents per pound; if made from yarn finer than five lea or number, three-fourths of one cent per pound additional for each lea or number, or part of a lea or number, in excess of five.
- 331 Single yarns in the gray, made of flax, hemp, or ramie, or a mixture of any of them, not finer than eight lea or number, seven cents per pound; finer than eight lea or number and not finer than eighty lea or number, forty per centum ad valorem; single yarns, made of flax, hemp, or ramie, or a mixture of any of them, finer than eighty lea or number, fifteen per centum ad valorem.
- 332 Flax gill netting, nets, webs, and seines shall pay the same duty per pound as is imposed in this schedule upon the thread, twine, or cord of which they are made, and in addition thereto twenty-five per centum ad valorem.
- 333 Floor mattings, plain, fancy or figured, manufactured from straw, round or split, or other vegetable substances not otherwise provided for, including what are commonly known as Chinese, Japanese, and India straw mattings, valued at not exceeding ten cents per square yard, three cents per square yard; valued at exceeding ten cents per square yard, seven cents per square yard and twenty-five per centum ad valorem.
- 334 Carpets, carpeting, mats and rugs, made of flax, hemp, jute, or other vegetable fiber (except cotton), valued at not exceeding fifteen cents per square yard, five cents per square yard and thirty-five per centum ad valorem; valued above fifteen cents per square yard, ten cents per square yard and thirty-five per centum ad valorem.
- 335 Hydraulic hose, made in whole or in part of flax, hemp, ramie or jute, twenty cents per pound.
- 336 Tapes composed wholly or in part of flax, woven with or without metal threads, or reels, spools, or otherwise, and designed expressly for use in the manufacture of measuring tapes forty per centum ad valorem.
- 337 Oilcloth for floors, stamped, painted or printed, including linoleum or corticene, figured or plain, and all other oilcloth (except silk oilcloth) under twelve feet in width not specially provided for herein, eight cents per square yard and fifteen per centum ad valorem; oilcloth for floors and linoleum or corticene, twelve feet and over in width, inlaid linoleum or corticene, and cork carpets, twenty cents per square yard and twenty per centum ad valorem; waterproof cloth, composed of cotton or other vegetable fiber, whether composed in part of india-rubber or otherwise, ten cents per square yard and twenty per centum ad valorem.
- 338 Shirt collars and cuffs, composed of cotton, forty-five cents per dozen pieces and fifteen per centum ad valorem; composed in whole or in part of linen, forty cents per dozen pieces and twenty per centum ad valorem.
- 339 Laces, lace window curtains, tidies, pillow shams, bed sets, insertings, flouncings, and other lace articles; handkerchiefs, napkins, wearing apparel, and other articles, made wholly or in part of lace, or in imitation of lace, nets or nettings, veils and veillings, etamines, vitrages, neck ruffings, ruchings, tuckings, flutings, and quillings; embroideries and all trimmings, including braids, edgings, insertings, flouncings, gallons, gorings, and bands; wearing apparel, handkerchiefs, and other articles or fabrics embroidered in any manner by hand or machinery, whether with a letter, monogram, or otherwise; tamboured or appliqued articles, fabrics or wearing apparel; hemstitched or tucked flouncings or skirtings, and articles made wholly or in part of ruffings, tuckings, or ruchings; all of the foregoing, composed wholly or in chief value of flax, cotton, or other vegetable fiber, and not elsewhere specially provided for in this Act, whether composed in part of india-rubber or otherwise, sixty per centum ad valorem; Provided, That no wearing apparel or other articles or textile fabric, when embroidered by hand or machinery, shall pay duty at a less rate than that imposed in any schedule of this Act upon any embroideries of the materials of which such embroidery is composed.
- 340 Lace window curtains, pillow shams, and bed sets, finished or unfinished, made on the Nottingham lace-curtain machine or on the Nottingham warp machine, and composed of cotton or other vegetable fiber, when counting five points or spaces between the warp threads to the inch, one cent per square yard; when counting more than five square points or spaces to the inch, one-half of one cent per square yard in addition for each such point or space to the inch in excess

## The American Tariff.

- of five; and in addition thereto, on all the foregoing articles in this paragraph, twenty per centum ad valorem. Provided, That none of the above-named articles shall pay a less rate of duty than fifty per centum ad valorem.
- 341 Plain woven fabrics of single jute yarns, by whatever name known, not exceeding sixty inches in width, weighing not less than six ounces per square yard and not exceeding thirty threads to the square inch, counting the warp and filling, five-eighths of one cent per pound and fifteen per centum ad valorem; if exceeding thirty, and not exceeding fifty-five threads to the square inch, counting the warp and filling, seven-eighths of one cent per pound and fifteen per centum ad valorem.
- 342 All pile fabrics of which flax is the component material of chief value, sixty per centum ad valorem.
- 343 Bags or sacks made from plain woven fabrics, of single jute yarns, not dyed, colored, stained, painted, printed or bleached, and not exceeding thirty threads to the square inch, counting the warp and filling, seven-eighths of one cent per pound and fifteen per centum ad valorem.
- 344 Baggings for cotton, gunny cloth, and similar fabrics, suitable for covering cotton, composed of single yarns made of jute, late butte, or hemp, not bleached, dyed, colored, stained, painted, or printed, not exceeding sixteen threads to the square inch, counting the warp and filling, and weighing not less than fifteen ounces per square yard, six-tenths of one cent per square yard.
- 345 Handkerchiefs composed of flax, hemp, or ramie, or of which these substances, or either of them, is the component material of chief value, whether in the piece or otherwise, and whether finished or unfinished, not hemmed or hemmed only, fifty per centum ad valorem; if hemstitched, or imitation hemstitched, or covered, or with drawn threads, but not embroidered or initialed, fifty-five per centum ad valorem.
- 346 Woven fabrics or articles not specially provided for in this Act, composed of flax, hemp, or ramie, or of which these substances or either of them is the component material of chief value, weighing four and one-half ounces or more per square yard when containing not more than sixty threads to the square inch, counting the warp and filling, one and three-fourths cents per square yard; containing more than sixty and not more than one hundred and twenty threads to the square inch, two and three-fourths cents per square yard; containing more than one hundred and twenty and not more than one hundred and eighty threads to the square inch, six cents per square yard; containing more than one hundred and eighty threads to the square inch, nine cents per square yard and in addition thereto, on all the foregoing, thirty per centum ad valorem; Provided, That none of the foregoing articles in this paragraph shall pay a less rate of duty than fifty per centum ad valorem. Woven fabrics of flax, hemp, or ramie, or of which these substances or either of them is the component material of chief value, including such as is known as shirting cloth, weighing less than four and one-half ounces per square yard and containing more than one hundred threads to the square inch, counting the warp and filling, thirty-five per centum ad valorem.
- 347 All manufactures of flax, hemp, ramie, or other vegetable fiber, or of which these substances, or either of them, is the component material of chief value, not specially provided for in this Act, forty-five per centum ad valorem.

## SCHEDULE K.

## Wool and Manufactures of Wool.

- 348 All wools, hair of the camel, goat, alpaca, and other like animals shall be divided, for the purposes of fixing the duties to be charged thereon, into the three following classes:
- 349 Class one that is to say, merino, mestiza, metz, or metis wools, or other wools of Merino blood, immediate or remote. Down clothing wools, and wools of like character with any of the preceding, including Bagdad wool, China lamb's wool, Castel Branco, Adrianople skin wool or butchers' wool, and such as have been heretofore usually imported into the United States from Buenos Ayres, New Zealand, Australia, Cape of Good Hope, Russia, Great Britain, Canada, Egypt, Morocco, and elsewhere, and all wools not hereinafter included in classes two and three.
- 350 Class two, that is to say, Leicester, Cotswold, Lincolnshire, Down combing wools, Canada long wools, or other like combing wools of English blood, and usually known by the terms herein used, and also hair of the camel, Angora goat, alpaca and other like animals.
- 351 Class three, that is to say, Donskol, native South American,

# THE QUEEN CITY OIL CO. Limited.

SAMUEL ROGERS, - President.

Cor. KING & YONGE STS., Toronto.

SOLE PROPRIETORS OF THE



## "PEERLESS" Brands

CYLINDER, ENGINE AND DYNAMO OILS

### STANDARD BRANDS

"CAPITOL" CYLINDER

"RENOWN" ENGINE

"ATLANTIC" RED OIL

Raw and Boiled Linseed Oil, Spirits of Turpentine, Benzine and Gasoline.

### WE CARRY FULL LINES OF THE VACUUM OIL CO.'S

600 "W." Cylinder Vacuoline Engine and Spindle.

CYLINDER AND ENGINE OIL, Leather Oils and Greases.

## SOLID COMFORT FOR ENGINEERS SPOONER'S HONOR BRIGHT

NO HOT BOXES  
NON-FIBROUS  
ANTI-FRICTION  
BOX METAL

# "COPPERINE"

America's Largest,  
Best Engines  
USING IT.  
VERY HIGH-CLASS

Can't Get

# BOX-METAL

Too Good.

HOLDS TESTIMONIALS FROM THE BEST PRACTICAL MECHANICAL AUTHORITY.

Costs no more than the poor stuff you get.

Made scientifically from selected new materials.

No old scrap worn-out Babbitts used over again.

Secure the advantage of all that is in the very best that's made.

A purer, better metal is beyond the art of metal making.

Engines or Machines with poor Boxes are rotten rigs to lose money with.

They use too much oil and make men swear. Saving a few cents on the cost

of Babbit is penny wise and pound foolish. Contract for and always use

Copperine Boxes and you will have satisfaction in every case.

Five grades to choose from. Tough - Hard - Finest - No. 1 - No. 2.

Select a quality and price suitable for the job. Consider weight and speed.

Copperine is not rough, but wears fine silver bright One Box worth

four ordinary. Runs easy, with less power, less fuel, less and cheaper oil and

less stops. Never failed in any spot or place. No test too severe. Economy urges

DON'T CARRY TROUBLE ON YOUR FACE - USE "COPPERINE" - BOXES that stand up under any load.

HARDWARES ALL SELL IT. IF NOT SEND YOUR ORDER DIRECT TO

Name, Shape of Bar and Box  
Package covered by Letters Patent.  
All Infringements will be  
Prosecuted.

**Alonzo W. Spooner, Maker, Port Hope, Ont.**

"The Handsomest Town in Canada, and the only place in the world where 'COPPERINE' is made."

When writing to Advertisers kindly mention THE CANADIAN MANUFACTURER.

## The American Tariff.

Cordova, Valparaiso, native Smyrna, Russian camel's hair, and all such wools of like character as have been heretofore usually imported into the United States from Turkey, Greece, Syria, and elsewhere, excepting improved wools, hereinafter provided for.

- 352 The standard samples of all wools which are now or may be hereafter deposited in the principal custom-houses of the United States, under the authority of the Secretary of the Treasury, shall be the standards for the classification of wools under this Act, and the Secretary of the Treasury is authorized to renew these standards and to make such addition to them from time to time as may be required, and he shall cause to be deposited like standards in other custom-houses of the United States where they may be needed.
- 353 Whenever wools of class three shall have been improved by the admixture of Merino or English blood, from their present character as represented by the standard samples now or hereafter to be deposited in the principal custom-houses of the United States, such improved wools shall be classified for duty either as class one or as class two, as the case may be.
- 354 The duty on wools of the first class which shall be imported washed shall be twice the amount of the duty to which they would be subjected if imported unwashed; and the duty on wools of the first and second classes which shall be imported scoured shall be three times the duty to which they would be subjected if imported unwashed. The duty on wools of the third class, if imported in condition for use in carding or spinning into yarns, or which shall not contain more than eight per cent. of dirt or other foreign substances, shall be three times the duty to which they would otherwise be subjected.
- 355 Unwashed wools shall be considered such as shall have been shorn from the sheep without any cleansing; that is, in their natural condition. Washed wools shall be considered such as have been washed with water only on the sheep's back, or on the skin. Wools of the first and second classes washed in any other manner than on the sheep's back or on the skin shall be considered as scoured wool.
- 356 The duty upon wool of the sheep or hair of the camel, Angora goat, alpaca, and other like animals, of class one and class two, which shall be imported in any other than ordinary condition, or which has been sorted or increased in value by the rejection of any part of the original fleece, shall be twice the duty to which it would be otherwise subjected: Provided, That skirted wools as imported in eighteen hundred and ninety and prior thereto are hereby excepted. The duty upon wool of the sheep or hair of the camel, Angora goat, alpaca, and other like animals of any class which shall be changed in its character or condition for the purpose of evading the duty, or which shall be reduced in value by the admixture of dirt or any other foreign substances, shall be twice the duty to which it would be otherwise subject. When the duty assessed upon any wool equals three times or more that which would be assessed if said wool was imported unwashed, the duty shall not be doubled on account of the wool being sorted. If any bale or package of wool or hair specified in this Act, invoiced or entered as of any specified class, or claimed by the importer to be dutiable as of any specified class, shall contain any wool or hair subject to a higher rate of duty than the class so specified, the whole bale or package shall be subject to the highest rate of duty chargeable on wool of the class subject to such higher rate of duty, and if any bale or package be claimed by the importer to be shoddy, mungo, flocks, wool, hair, or other material of any class specified in this Act, and such bale contain any admixture of any one or more of said materials, or of any other material, the whole bale or package shall be subject to duty at the highest rate imposed upon any article in said bale or package.
- 357 The duty upon all wools, and hair of the first class shall be eleven cents per pound, and upon all wools or hair of the second class twelve cents per pound.
- 358 On wools of the third class and on camel's hair of the third class the value whereof shall be twelve cents or less per pound, the duty shall be four cents per pound.
- 359 On wools of the third class, and on camel's hair of the third class, the value whereof shall exceed twelve cents per pound, the duty shall be seven cents per pound.
- 360 The duty on wools on the skin shall be one cent less per pound than is imposed in this schedule on other wools of the same class and condition, the quantity and value to be

## The American Tariff.

ascertained under such rules as the Secretary of the Treasury may prescribe.

- 361 Top waste, stubbing waste, roving waste, ring waste and garnetted waste, thirty cents per pound.
- 362 Shoddy, twenty-five cents per pound; molls, wool extract, yarn waste, thread waste, and all other wastes composed wholly or in part of wool and not specially provided for in this Act, twenty cents per pound.
- 363 Woolen rags, mungo and flocks, ten cents per pound.
- 364 Wool and hair which have been advanced in any manner or by any process of manufacture beyond the washed or scoured condition, not specially provided for in this Act, shall be subject to the same duties as are imposed upon manufactures of wool not specially provided for in this Act.
- 365 On yarns made wholly or in part of wool, valued at not more than thirty cents per pound, the duty per pound shall be two and one-half times the duty imposed by this Act on one pound of unwashed wool of the first class; valued at more than thirty cents per pound, the duty per pound shall be three and one-half times the duty imposed by this Act on one pound of unwashed wool of the first class, and in addition thereto, upon all the foregoing, forty per centum ad valorem.
- 366 On cloth, knit fabrics, and all manufactures of every description made wholly or in part of wool, not specially provided for in this Act, valued at not more than forty cents per pound, the duty per pound shall be three times the duty imposed by this Act on a pound of unwashed wool of the first class; valued at above forty cents per pound and not above seventy cents per pound, the duty per pound shall be four times the duty imposed by this Act on one pound of unwashed wool of the first class, and in addition thereto, upon all the foregoing, fifty per centum ad valorem; valued at over seventy cents per pound, the duty per pound shall be four times the duty imposed by this Act on one pound of unwashed wool of the first class and fifty-five per centum ad valorem.
- 367 On blankets, and flannels for underwear, composed wholly or in part of wool, valued at not more than forty cents per pound, the duty per pound shall be the same as the duty imposed by this Act on two pounds of unwashed wool of the first class, and in addition thereto thirty per centum ad valorem; valued at more than forty cents and not more than fifty cents per pound, the duty per pound shall be three times the duty imposed by this Act on one pound of unwashed wool of the first class, and in addition thereto thirty-five per centum ad valorem. On blankets composed wholly or in part of wool, valued at more than fifty cents per pound, the duty per pound shall be three times the duty imposed by this Act on one pound of unwashed wool of the first class, and in addition thereto forty per centum ad valorem. Flannels composed wholly or in part of wool, valued at above fifty cents per pound, shall be classified and pay the same duty as women's and children's dress goods, coat linings, Italian cloths, and goods of similar character and description provided by this Act: Provided, That on blankets over three yards in length the same duties shall be paid as on cloths.
- 368 On women's and children's dress goods, coat linings, Italian cloths, and goods of similar description and character of which the warp consists wholly of cotton or other vegetable material with the remainder of the fabric composed wholly or in part of wool, valued at not exceeding fifteen cents per square yard, the duty shall be seven cents per square yard; valued at more than fifteen cents per square yard, the duty shall be eight cents per square yard; and in addition thereto on all the foregoing valued at not above seventy cents per pound, fifty per centum ad valorem; valued above seventy cents per pound, fifty-five per centum ad valorem: Provided, That on all the foregoing, weighing over four ounces per square yard, the duty shall be the same as imposed by this schedule on cloths.
- 369 On women's and children's dress goods, coat linings, Italian cloths, hunting, and goods of similar description or character composed wholly or in part of wool, and not specially provided for in this Act, the duty shall be eleven cents per square yard, and in addition thereto on all the foregoing valued at not above seventy cents per pound, fifty per centum ad valorem; valued above seventy cents per pound, fifty-five per centum ad valorem: Provided that on all the foregoing, weighing over four ounces per square yard, the duty shall be the same as imposed by this schedule on cloths.
- 370 On clothing, ready-made, and articles of wearing apparel of every description, including shawls, whether knitted or woven, and knitted articles of every description, made up

## **THE ROSSENDALE BELTING CO.**

# **Belting Belting Belting**

To MANUFACTURERS,  
ENGINEERS,  
SUPERINTENDENTS  
and MILL OWNERS:

Have you tried the  
**ROSSENDALE**  
"MAY"

Brand *SOLID WOVEN*  
*BELTING?*

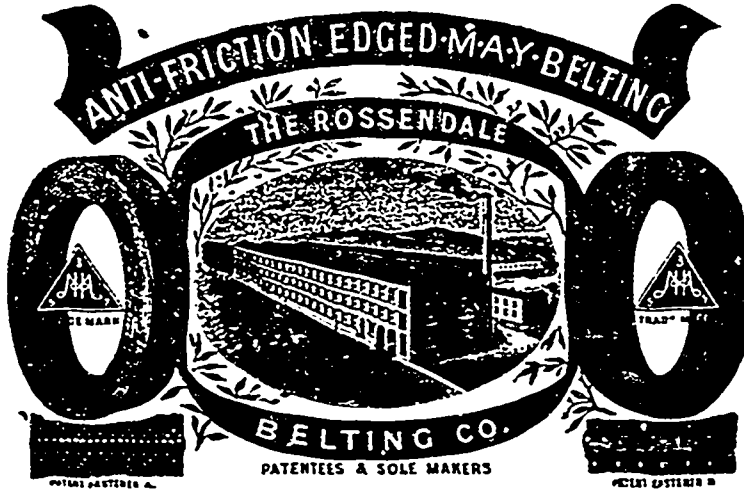

All sizes from 2 to 20 inches in stock.

Their "MAY" Belts are over double the strength of leather. Have very little stretch. Are good gripping belts. Impervious to the weather and will work in hot or cold, moist or dry atmospheres. Ask for a tin of our ROSSENDALE SPECIAL BELT DRESSING.

Good for all kinds of Belts.

## **R. H. BUCHANAN & CO.**

692 CRAIG STREET

AGENTS IN CANADA.

Samples and Quotations on Application

We are the Oldest Pump Concern in the DOMINION OF CANADA, and Every Pump sold by us is under the Fullest Guarantee.

Have on hand a full line of MACHINERY and SUPPLIES FOR MILLS

**PUMPING MACHINERY OF ALL KINDS.**

**Steam Pumps**

**Centrifugal Pumps**

**Mining Pumps**

**Bilge Pumps**

**Fire Pumps**

**Rotary Pumps**

**AIR LIFT PUMPING PLANTS.**

Rider and Ericsson Hot Air Pumping Engines for Farms, Hotels, Schools, Private Residences, Water Tanks, Hose, Piping, Valves, Etc.

**WIND MILLS, FIRE PROTECTION FOR MILLS AND FACTORIES**

**UNDERWRITER FIRE PUMPS**

**ROSSENDALE BELTING and BELT DRESSING, ETC.**

\*Estimates and Specifications Given.

## **R. H. BUCHANAN & CO.**

692 Craig St., - MONTREAL

When writing to Advertisers kindly mention THE CANADIAN MANUFACTURER.

## The American Tariff.

## The American Tariff.

- or manufactured wholly or in part, felts not woven and not specially provided for in this Act, composed wholly or in part of wool, the duty per pound shall be four times the duty imposed by this Act on one pound of unwashed wool of the first class, and in addition thereto sixty per centum ad valorem.
- 371 Webblings, gorings, suspenders, braces, bandings, beltings, bindings, braids, galloons, edgings, insertings, flouncing, fringes, gimps, cords, cords and tassels, laces, and other trimmings, and articles made wholly or in part of lace, embroideries and articles embroidered by hand or machinery, head nets, netting, buttons, or barrel buttons or buttons of other forms for tassels or ornaments, and manufactures of wool ornamented with beads or spangles of whatever material composed, any of the foregoing made of wool or of which wool is a component material, whether composed in part of India-rubber or otherwise, fifty cents per pound and sixty per centum ad valorem.
- 372 Aubusson, Axminster, moquette, and chenille carpets, figured or plain, and all carpets or carpeting of like character or description, sixty cents per square yard, and in addition thereto forty per centum ad valorem.
- 373 Saxony, Wilton, and Tournay velvet carpets, figured or plain, and all carpets or carpeting of like character or description, sixty cents per square yard, and in addition thereto forty per centum ad valorem.
- 374 Brussels carpets, figured or plain, and all carpets or carpeting of like character or description, forty-four cents per square yard, and in addition thereto forty per centum ad valorem.
- 375 Velvet and tapestry, velvet carpets, figured or plain, printed on the warp or otherwise, and all carpets or carpeting of like character or description, forty cents per square yard, and in addition thereto forty per centum ad valorem.
- 376 Tapestry Brussels carpets, figured or plain, and all carpets or carpeting of like character or description, printed on the warp or otherwise, twenty-eight cents per square yard, and in addition thereto forty per centum ad valorem.
- 377 Treble Ingrain, three-ply, and all chain Venetian carpets, twenty-two cents per square yard, and in addition thereto forty per centum ad valorem.
- 378 Wool Dutch and two-ply Ingrain carpets, eighteen cents per square yard, and in addition thereto forty per centum ad valorem.
- 379 Carpets of every description woven whole for rooms, and Oriental, Berlin, Aubusson, Axminster, and similar rugs, ten cents per square foot and in addition thereto, forty per centum ad valorem.
- 380 Druggists and bookings, printed, colored, or otherwise, twenty-two cents per square yard, and in addition thereto forty per centum ad valorem.
- 381 Carpets and carpeting of wool, flax, or cotton, or composed in part of either, not specially provided for in this Act, fifty per centum ad valorem.
- 382 Mats, rugs for floors, screens, covers, hassocks, bed sides, art squares, and other portions of carpets or carpeting made wholly or in part of wool, and not specially provided for in this Act, shall be subjected to the rate of duty herein imposed on carpets or carpetings of like character or description.
- 383 Whenever, in any schedule of this Act, the word "wool" is used in connection with a manufactured article of which it is a component material, it shall be held to include wool or hair of the sheep, camel, goat, alpaca or other animal, whether manufactured by the woolen, worsted felt, or any other process.

## SCHEDULE L.

## Silks and Silk Goods.

- dollars per pound and not exceeding two dollars and fifty cents per pound, sixty cents per pound and fifteen per centum ad valorem; but in no case shall the foregoing articles pay a less rate of duty than thirty-five per centum ad valorem.
- 386 Velvets, velvet or plush ribbons, chenilles, or other pile fabrics, cut or uncut, composed of silk, or of which silk is the component material of chief value, not specially provided for in this Act, one dollar and fifty cents per pound and fifteen per centum ad valorem; plushes, composed of silk, or of which silk is the component material of chief value, one dollar per pound and fifteen per centum ad valorem; but in no case shall the foregoing articles pay a less rate of duty than fifty per centum ad valorem.
- 387 Woven fabrics in the piece, not specially provided for in this Act, weighing not less than one and one-third ounces per square yard and not more than eight ounces per square yard, and containing not more than twenty per centum in weight of silk if in the gum, fifty cents per pound, and if dyed in the piece, sixty cents per pound; if containing more than twenty per centum and not more than thirty per centum in weight of silk, if in the gum, sixty-five cents per pound, and if dyed in the piece, eighty cents per pound; if containing more than thirty per centum and not more than forty-five per centum in weight of silk, if in the gum, ninety cents per pound, and if dyed in the piece, one dollar and ten cents per pound; if dyed in the thread or yarn and containing not more than thirty per centum in weight of silk, if black (except selvedges), seventy-five cents per pound, and if other than black, ninety cents per pound; if containing more than thirty and not more than forty-five per centum in weight of silk, if black (except selvedges), one dollar and ten cents per pound, and if other than black, one dollar and thirty cents per pound; if containing more than forty-five per centum in weight of silk, or if composed wholly of silk, if dyed in the thread or yarn and weighted in the dyeing so as to exceed the original weight of the raw silk, if black (except selvedges), one dollar and fifty cents per pound, and if other than black, two dollars and twenty-five cents per pound; if dyed in the thread or yarn, and the weight is not increased by dyeing beyond the original weight of the raw silk, three dollars per pound; if in the gum, two dollars and fifty cents per pound; if boiled off, or dyed in the piece, or printed, three dollars per pound; if weighing less than one and one-third ounces and more than one-third of an ounce per square yard, if in the gum, or if dyed in the thread or yarn, two and one-half dollars per pound; if weighing less than one and one-third ounces and more than one-third of an ounce per square yard, if boiled off, three dollars per pound; if dyed or printed in the piece, three dollars and twenty-five cents per pound; if weighing not more than one-third of an ounce per square yard, four dollars and fifty cents per pound; but in no case shall any of the foregoing fabrics in this paragraph pay a less rate of duty than fifty per centum ad valorem.
- 388 Handkerchiefs or mufflers composed wholly or in part of silk, whether in the piece or otherwise, finished or unfinished, if not hemmed or hemmed only, shall pay the same rate of duty as is imposed on goods in the piece of the same description, weight and condition as provided for in this schedule; but such handkerchiefs or mufflers shall not pay a less rate of duty than fifty per centum ad valorem; if such handkerchiefs or mufflers are hemstitched or imitation hemstitched, or reversed or have drawn threads, or are embroidered in any manner, whether with an initial letter, monogram, or otherwise, by hand or machinery, or are tamboured, appliqued, or are made or trimmed wholly or in part with lace, or with tucking or insertion, they shall pay a duty of ten per centum ad valorem in addition to the duty hereinbefore prescribed, and in no case less than sixty per centum ad valorem.
- 389 Bandings, including hat bands, beltings, bindings, bone casings, braces, cords, collars and tassels, garters, gorings, suspenders, tubings, and webs and webblings, composed wholly or in part of silk, and whether composed in part of India-rubber or otherwise, if not embroidered in any manner by hand or machinery, fifty per centum ad valorem.
- 390 Laces, and articles made wholly or in part of lace, edgings, insertings, pull-overs, chiffon or other flouncings, net or nettings and veilings, neck ruffings, ruchings, braids, fringes, trimmings, embroideries and articles embroidered by hand or machinery, or tamboured or appliqued, clothing ready-made and articles of wearing apparel of every description, including knit goods, made up or manufactured in whole or in part by the tailor, seamstress, or manufacturer; all of the above-named articles made of silk, or of which silk is

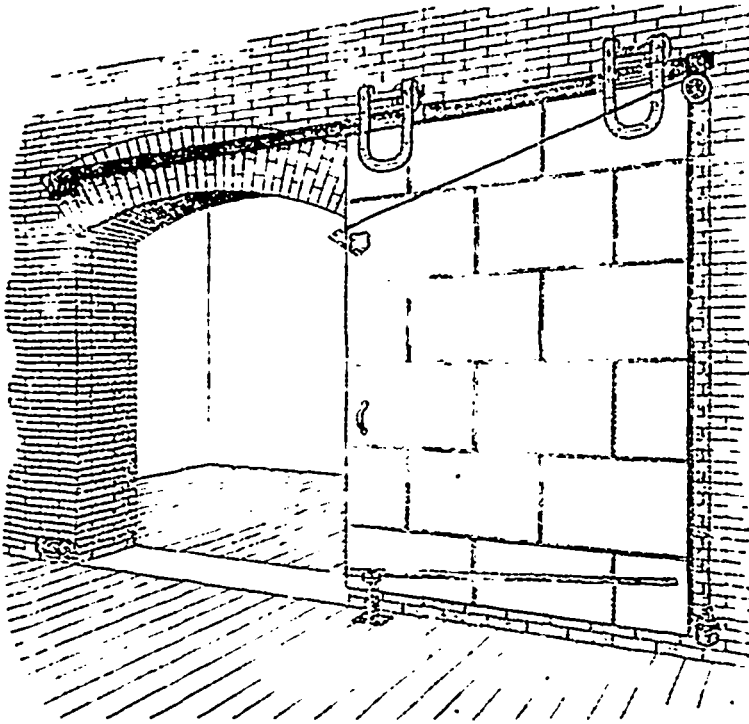

"ACME" AUTOMATIC FIRE DOOR FITTINGS, SET No. 99

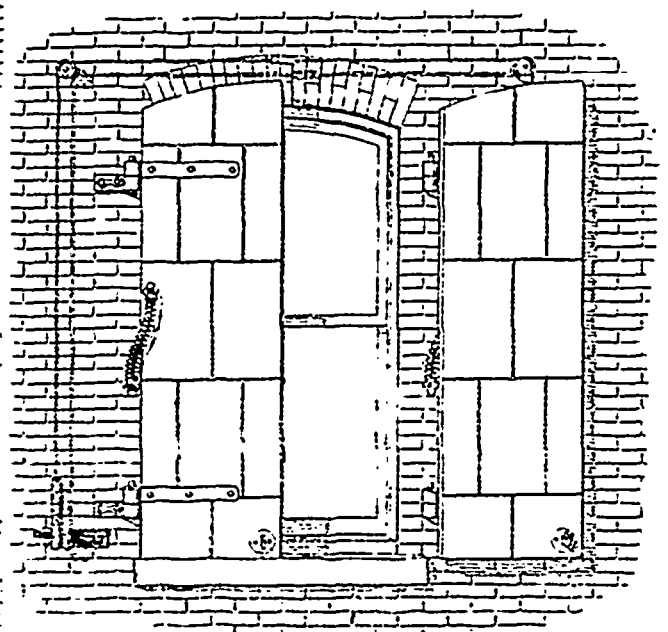

Double Swing Shutters.

SET No. 444

"ACME" AUTOMATIC FIRE SHUTTER FITTINGS

SELF-CLOSING BY HEAT.

We manufacture the Best Kinds made of Acme Automatic Self-Closing Fire Door and Shutter Fittings. Write us for Catalogue and Prices. Save Insurance.

**THE VOKES HARDWARE CO., Limited, Cor. Yonge and Adelaide Sts., - TORONTO.**

# The J. C. McLaren Belting Co.

ESTABLISHED 1856

MANUFACTURERS

## Genuine Oak Belting

"EXTRA" BRAND.

## Para Rubber Belting

"THISTLE" BRAND.

Card Clothing and General Mill Supplies.

**Montreal. Toronto. Vancouver.**

When writing to Advertisers kindly mention THE CANADIAN MANUFACTURER.

## The American Tariff.

the component material of chief value, not specially provided for in this Act, and silk goods ornamented with beads or spangles, of whatever material composed, sixty per centum ad valorem: Provided, That any wearing apparel or other articles provided for in this paragraph (except gloves) when composed in part of India-rubber, shall be subject to a duty of sixty per centum ad valorem.

391 All manufactures of silk, or of which silk is the component material of chief value, including such as have India-rubber as a component material, not specially provided for in this Act, and all Jacquard figured goods in the piece, made on looms, of which silk is the component material of chief value, dyed in the yarn, and containing two or more colors in the filling, fifty per centum ad valorem. Provided, That all manufactures, of which wool is a component material, shall be classified and assessed for duty as manufactures of wool.

392 In ascertaining the weight of silk under the provisions of this schedule, the weight shall be taken in the condition in which found in the goods, without deduction therefrom for any dye, coloring matter, or other foreign substance or material.

## SCHEDULE M.

## Pulp, Papers, and Books.

## Pulp and Paper.

393 Mechanically ground wood pulp, one-twelfth of one cent per pound, dry weight: chemical wood pulp unbleached, one-sixth of one cent per pound, dry weight: bleached one-fourth of one cent per pound, dry weight: Provided, That if any country or dependency shall impose an export duty on pulp wood exported to the United States, the amount of such export duty shall be added, as an additional duty, to the duties herein imposed upon wood pulp, when imported from such country or dependency.

394 Sheathing paper and roofing felt, ten per centum ad valorem.

395 Filter masse or filter stock, composed wholly or in part of wood pulp, wood flour, cotton or other vegetable fibre, one and one-half cents per pound and fifteen per centum ad valorem.

396 Printing paper, unsized, sized or glued, suitable for books and newspapers, valued at not above two cents per pound, three-tenths of one cent per pound; valued above two cents and not above two and one-half cents per pound, four-tenths of one cent per pound; valued above two and one-half cents per pound and not above three cents per pound, five-tenths of one cent per pound; valued above three cents and not above four cents per pound, six-tenths of one cent per pound; valued above four cents and not above five cents per pound, eight-tenths of one cent per pound; valued above five cents per pound, fifteen per centum ad valorem: Provided, That if any country or dependency shall impose an export duty upon pulp wood exported to the United States, there shall be imposed upon printing paper when imported from such country or dependency, an additional duty of one-tenth of one cent per pound for each dollar of export duty per cord so imposed, and proportionately for fractions of a dollar of such export duty.

397 Papers commonly known as copying paper, stereotype paper, paper known as bibulous paper, tissue paper, pottery paper, and all similar papers, white, colored or printed, weighing not over six pounds to the ream of four hundred and eighty sheets, on a basis of twenty by thirty inches, and whether in reams or any other form, six cents per pound and fifteen per centum ad valorem: if weighing over six pounds and not over ten pounds to the ream, and letter-copying books, whether wholly or partly manufactured, five cents per pound and fifteen per centum ad valorem: crepe paper and filtering paper, five cents per pound and fifteen per centum ad valorem.

398 Surface-coated papers not specially provided for in this Act, two and one-half cents per pound and fifteen per centum ad valorem: if printed, or wholly or partly covered with metal or its solutions, or with gelatin or flock, three cents per pound and twenty per centum ad valorem: parchment papers, two cents per pound and ten per centum ad valorem: plain basic photographic papers and for albumenizing, sensitizing, or baryta coating, three cents per pound and ten per centum ad valorem, albumenized or sensitized paper or paper otherwise surface-coated for photographic purposes, thirty per centum ad valorem.

## Manufactures of Paper.

399 Paper envelopes, plain, twenty per centum ad valorem, if bordered, embossed, printed, tinted or decorated, thirty-five per centum ad valorem.

## The American Tariff.

400 Lithographic prints from stone, zinc, aluminum, or other material, bound or unbound (except cigar labels, flaps, and bands, lettered, or otherwise, music and illustrations when forming a part of a periodical or newspaper and accompanying the same, or if bound in or forming part of printed books, not specially provided for in this Act), on paper or other material not exceeding eight one-thousandths of one inch in thickness, twenty cents per pound; on paper or other material exceeding eight one-thousandths of one inch not exceeding twenty one-thousandths of one inch in thickness, and exceeding thirty-five square inches, but not exceeding four hundred square inches cutting size in dimensions, eight cents per pound, exceeding four hundred square inches cutting size in dimensions, thirty-five per centum ad valorem; prints exceeding eight one-thousandths of one inch and not exceeding twenty one-thousandths of one inch in thickness, and not exceeding thirty-five square inches cutting size in dimensions, five cents per pound; lithographic prints from stone, zinc, aluminum or other material, on cardboard or other material, exceeding twenty one-thousandths of one inch in thickness, six cents per pound; lithographic cigar labels, flaps and bands, lettered or blank, printed from stone, zinc, aluminum or other material, if printed in less than eight colors (bronze printing to be counted as two colors), but not including labels, flaps and bands, printed in whole or in part in metal leaf, twenty cents per pound. Labels, flaps and bands, if printed entirely in bronze printing, fifteen cents per pound; labels, flaps and bands printed in eight or more colors, but not including labels, flaps and bands printed in whole or in part in metal leaf, thirty cents per pound; labels, flaps and bands printed in whole or in part in metal leaf, fifty cents per pound. Books of paper or other material for children's use, containing illuminated lithographic prints, not exceeding in weight twenty-four ounces each, and all booklets and fashion magazines or periodicals printed in whole or in part by lithographic process or decorated by hand, eight cents per pound.

401 Writing, letter, note, hand-made, drawing, ledger, bond, record, tablet, and typewriter paper, weighing not less than ten pounds and not more than fifteen pounds to the ream, two cents per pound and ten per centum ad valorem; weighing more than fifteen pounds to the ream, three and one-half cents per pound and fifteen per centum ad valorem; but if any such paper is ruled, bordered, embossed, printed, or decorated in any manner, it shall pay ten per centum ad valorem in addition to the foregoing rates: Provided, That in computing the duty on such paper every one hundred and eighty thousand square inches shall be taken to be a ream.

402 Paper hangings and paper for screens or fireboards, and all other paper not specially provided for in this Act, twenty-five per centum ad valorem: all Jacquard designs of one-line paper, or parts of such designs, finished or unfinished, thirty-five per centum ad valorem: all Jacquard designs cut on Jacquard cards or parts of such designs, finished or unfinished, thirty-five per centum ad valorem.

## Manufactures of Paper.

403 Books of all kinds, including blank books and pamphlets, and engravings, bound or unbound, photographs, etchings, maps, charts, music in books or sheets, and printed matter, all the foregoing not specially provided for in this Act, twenty-five per centum ad valorem.

404 Photograph, autograph, and scrap albums, wholly or partly manufactured, thirty-five per centum ad valorem.

405 All fancy boxes made of paper, or of which paper is the component material of chief value, or if covered with surface-coated paper, forty-five per centum ad valorem.

406 Playing cards, in packs not exceeding fifty-four cards and at a like rate for any number in excess, ten cents per pack and twenty per centum ad valorem.

407 Manufactures of paper, or of which paper is the component material of chief value, not specially provided for in this Act, thirty-five per centum ad valorem.

## SCHEDULE N.

## Sundries.

408 Beads of all kinds, not threaded or strung, thirty-five per centum ad valorem, fabrics, nets or nettings, laces, embroideries, galloons, wearing apparel, ornaments, trimmings, and other articles not specially provided for in this Act, composed wholly or in part of beads or spangles made of glass or paste, gelatin, metal, or other material, but not composed in part of wool, sixty per centum ad valorem.

409 Braids, plaits, laces and willow sheets or squares, composed wholly of straw, chip, grass, palm-leaf, willow, osier, or



# WATER WHEELS

We are Sole Agents and Manufacturers

in Canada for THE

## “Samson” Leffel Turbine.

WE ALSO MANUFACTURE

*SAW MILL MACHINERY, MINING MACHINERY, SHAFTING,*

*GEARING of every description, ENGINES, BOILERS, etc.*

WRITE US FOR CATALOGUES

The **Wm. Hamilton Mfg. Co.,** Limited, PETERBOROUGH, CANADA

## MANUFACTURERS

For complete satisfaction in every respect use  
“THE REEVES” Wood Split Pulley. No trouble,  
no bother.

**STRONG! DURABLE! LIGHT!**

MADE IN ALL SIZES FOR ALL PURPOSES.

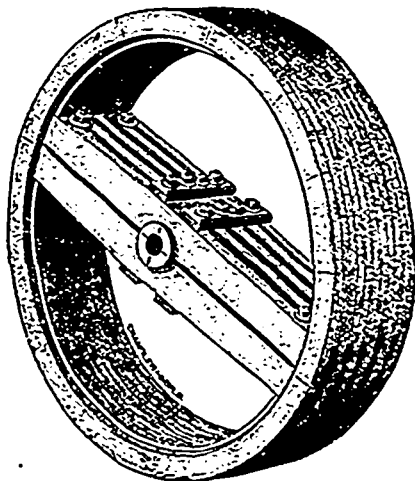

The **Reeves Pulley Mfg. Co.**

Limited

14 PEARL ST.,

TORONTO, ONT.

SEND FOR BOOKLET.

When writing to Advertisers kindly mention THE CANADIAN MANUFACTURER.

## The American Tariff.

rattan, suitable for making or ornamenting hats, bonnets, or hoods, not bleached, dyed, colored or stained, fifteen per centum ad valorem; if bleached, dyed, colored or stained, twenty per centum ad valorem; hats, bonnets, and hoods, composed of straw, chip, grass, palm leaf, willow, osier, or rattan, whether wholly or partly manufactured, but not trimmed, thirty-five per centum ad valorem, if trimmed, fifty per centum ad valorem. But the terms "grass" and "straw" shall be understood to mean these substances in their natural form and structure, and not the separated fiber thereof.

410 Brushes, brooms and feather dusters of all kinds, and hair pencils in quills or otherwise, forty per centum ad valorem.

411 Bristles, sorted, bunched or prepared, seven and one-half cents per pound.

## Buttons and Button Forms.

412 Trousers buckles made wholly or partly of iron or steel, or parts thereof, valued at not more than fifteen cents per hundred, five cents per hundred; valued at more than fifteen cents per hundred and not more than fifty cents per hundred, ten cents per hundred; valued at more than fifty cents per hundred, fifteen cents per hundred; and in addition thereto on each and all of the above buckles or parts of buckles, fifteen per centum ad valorem.

413 Button forms: Lastings, mohair, cloth, silk, or other manufactures of cloth, woven or made in patterns of such size, shape, or form, or cut in such manner as to be fit for buttons exclusively, ten per centum ad valorem.

414 Buttons or parts of buttons and button molds or blanks, finished or unfinished, shall pay duty at the following rates, the line button measure being one-fortieth of one inch, namely: Buttons, known commercially as agate buttons, metal trousers buttons (except steel), and nickel bar buttons, one-twelfth of one cent per line per gross; buttons of bone, and steel trousers buttons, one-fourth of one cent per line per gross; buttons of pearl or shell, one and one-half cents per line per gross; buttons of horn, vegetable ivory, glass, or metal, not specially provided for in this Act, three-fourths of one cent per line per gross, and in addition thereto, on all the foregoing articles in this paragraph, fifteen per centum ad valorem; shoe buttons made of paper, board, papier mache, pulp or other similar material, not specially provided for in this Act, valued at not exceeding three cents per gross, one cent per gross; buttons not specially provided for in this Act, and all collar or cuff buttons and studs, fifty per centum ad valorem.

415 Coal, bituminous, and all coals containing less than ninety-two per centum of fixed carbon, and shale, sixty-seven cents per ton of twenty-eight bushels, eighty pounds to the bushel; coal slack or culm, such as will pass through a half-inch screen, fifteen cents per ton of twenty-eight bushels, eighty pounds to the bushel: Provided, That on all coal imported into the United States, which is afterwards used for fuel on board vessels propelled by steam and engaged in trade with foreign countries, or in trade between the Atlantic and Pacific ports of the United States, and which are registered under the laws of the United States, a drawback shall be allowed equal to the duty imposed by law upon such coal, and shall be paid under such regulations as the Secretary of the Treasury shall prescribe: coke, twenty per centum ad valorem.

416 Cork bark, cut into squares or cubes, eight cents per pound; manufactured corks over three-fourths of an inch in diameter, measured at larger end, fifteen cents per pound; three-fourths of an inch and less in diameter, measured at larger end, twenty-five cents per pound; cork waste, artificial, or cork substitutes, manufactured from cork waste and not otherwise provided for, eight cents per pound.

417 Dice, draughts, chessmen, chess balls, and billiard, pool and bagatelle balls, of ivory, bone, or other materials, fifty per centum ad valorem.

418 Dolls, doll heads, toy marbles of whatever materials composed, and all other toys not composed of rubber, china, porcelain, parian, bisque, earthen or stone ware, and not specially provided for in this Act, thirty-five per centum ad valorem.

419 Emery grains, and emery manufactured, ground, pulverized, or refined, one cent per pound, emery wheels, emery files, and manufactures of which emery is the component material of chief value, twenty-five per centum ad valorem.

## Explosive Substances.

420 Firecrackers of all kinds, eight cents per pound, the weight to include all coverings, wrappings, and packing material.

421 Fulminates, fulminating powders, and like articles, not specially provided for in this Act, thirty per centum ad valorem.

## The American Tariff.

422 Gunpowder, and all explosive substances used for mining, blasting, artillery, or sporting purposes, when valued at twenty cents or less per pound, four cents per pound; value above twenty cents per pound, six cents per pound.

423 Matches, friction or lucifer, of all descriptions, per gross of one hundred and forty-four boxes containing not more than one hundred matches per box, eight cents per gross, when imported otherwise than in boxes containing not more than one hundred matches each, one cent per one thousand matches.

424 Percussion caps, thirty per centum ad valorem; cartridges, thirty-five per centum ad valorem; blasting caps, two dollars and thirty-six cents per one thousand caps.

425 Feathers and down of all kinds, including bird skins or parts thereof with the feathers on, crude or not dressed, colored, or otherwise advanced or manufactured in any manner, not specially provided for in this Act, fifteen per centum ad valorem; when dressed, colored, or otherwise advanced or manufactured in any manner, including quilts of down and other manufactures of down, and also dressed and finished birds suitable for millinery ornaments, and artificial or ornamental feathers, frills, grains, leaves, flowers or stems or part thereof, of whatever material composed, not specially provided for in this Act, fifty per centum ad valorem.

426 Furs, dressed on the skin but not made up into articles, and furs not on the skin, prepared for hatters' use, including fur skins carotod, twenty per centum ad valorem.

427 Fans of all kinds, except common palm leaf fans, fifty per centum ad valorem.

428 Gun wads of all descriptions, twenty per centum ad valorem.

429 Hair, human, if clean or drawn but not manufactured, twenty per centum ad valorem.

430 Hair, curled, suitable for beds or mattresses, ten per centum ad valorem.

431 Haircloth, known as "erinoline" cloth, ten cents per square yard; haircloth, known as "hair-seating," and hair press cloth, twenty cents per square yard.

432 Hats, bonnets, or hoods, for men's, women's, boys', or children's wear, trimmed or untrimmed, including bodies, hoods, plateaux, forms, or shapes, for hats or bonnets, composed wholly or in chief value of fur of the rabbit, beaver or other animals, valued at not more than five dollars per dozen, two dollars per dozen; valued at more than five dollars per dozen, and not more than ten dollars per dozen, three dollars per dozen; valued at more than ten dollars per dozen and not more than twenty dollars per dozen, five dollars per dozen; valued at more than twenty dollars per dozen, seven dollars per dozen; and in addition thereto on all the foregoing, twenty per centum ad valorem.

433 Indurated fiber ware and manufactures of wood or other pulp, and not otherwise specially provided for, thirty-five per centum ad valorem.

## Jewelry and Precious Stones.

434 Articles commonly known as jewelry, and parts thereof, finished or unfinished, not specially provided for in this Act, including precious stones set, pearls set or strung, and cameos in frames, sixty per centum ad valorem.

435 Diamonds and other precious stones advanced in condition or value from their natural state by cleaving, splitting, cutting, or other process, and not set, ten per centum ad valorem; imitations of diamonds or other precious stones composed of glass or paste, not exceeding an inch in dimensions, not engraved, painted, or otherwise ornamented or decorated, and not mounted or set, twenty per centum ad valorem.

436 Pearls in their natural state, not strung or set, ten per centum ad valorem.

## Leather, and Manufactures of.

437 Hides of cattle, raw or uncured, whether dry, salted, or pickled, fifteen per centum ad valorem: Provided, That upon all leather exported, made from imported hides, there shall be allowed a drawback equal to the amount of duty paid on such hides, to be paid under such regulations as the Secretary of the Treasury may prescribe.

438 Band or teltting leather, sole leather, dressed upper and all other leather, calfskins tanned or dressed, kangaroo, sheep and goat skins (including lamb and kid skins) dressed and finished, chamois and other skins and bookbinders' calfskins, all the foregoing not specially provided for in this Act, twenty per centum ad valorem; skins for morocco, tanned but unfinished, ten per centum ad valorem; patent, japanned, varnished or enamelled leather, weighing not over ten pounds per dozen hides or skins, thirty cents per pound and twenty per centum ad valorem;

# ROBT. GARDNER & SON, Montreal

Manufacturers and Dealers in every description of

**Bread, Biscuit and Confectioners' Machinery**

Also Army Bread Outfits, Mechanical Ovens, Travelling Ovens, Reel Ovens, Etc.

MAKERS OF

**Lathes, Planers, Shafting, Hangers, Pulleys, Fine Tools**

OF EVERY DESCRIPTION

**And General Machinists, Etc., Etc.**

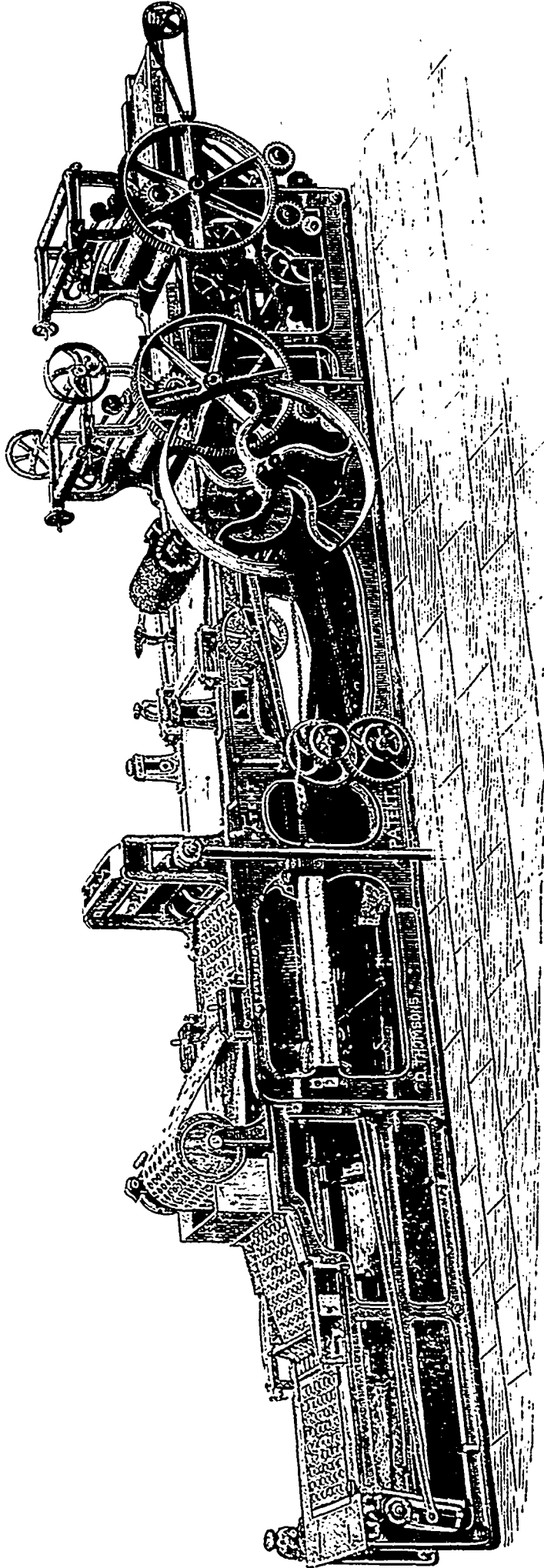

PATRONIZED BY THE LEADING GOVERNMENTS OF THE WORLD.

**ROBT. GARDNER & SON, - MONTREAL.**

When writing to Advertisers kindly mention The Canadian Manufacturer.

## The American Tariff.

If weighing over ten pounds and not over twenty-five pounds per dozen, thirty cents per pound and ten per centum ad valorem; If weighing over twenty-five pounds per dozen, twenty cents per pound and ten per centum ad valorem, pianoforte leather and pianoforte action leather, thirty-five per centum ad valorem; leather shoe-laces, finished or unfinished, fifty cents per gross pairs and twenty per centum ad valorem; boots and shoes made of leather, twenty-five per centum ad valorem; Provided, That leather cut into shoe uppers or vamps or other forms, suitable for conversion into manufactured articles, shall be classified as manufactures of leather and pay duty accordingly.

## Gloves.

- 439 Gloves made wholly or in part of leather, whether wholly or partly manufactured, shall pay duty at the following rates, the lengths stated in each case being the extreme length when stretched to their full extent, namely:
- 440 Women's or children's "glace" finish, Schmaschen (of sheep origin), not over fourteen inches in length, one dollar and seventy-five cents per dozen pairs; over fourteen inches and not over seventeen inches in length, two dollars and twenty-five cents per dozen pairs; over seventeen inches in length, two dollars and seventy-five cents per dozen pairs; men's "glace" finish, Schmaschen (sheep), three dollars per dozen pairs.
- 441 Women's or children's "glace" finish, lamb or sheep, not over fourteen inches in length, two dollars and fifty cents per dozen pairs; over fourteen and not over seventeen inches in length, three dollars and fifty cents per dozen pairs; over seventeen inches in length, four dollars and fifty cents per dozen pairs; men's "glace" finish, lamb or sheep, four dollars per dozen pairs.
- 442 Women's or children's "glace" finish, goat, kid, or other leather than of sheep origin, not over fourteen inches in length, three dollars per dozen pairs; over fourteen and not over seventeen inches in length, three dollars and seventy-five cents per dozen pairs; over seventeen inches in length, four dollars and seventy-five cents per dozen pairs; men's "glace" finish, goat, or other leather than of sheep origin four dollars per dozen pairs.
- 443 Women's or children's, of sheep origin, with exterior grain surface removed, by whatever name known, not over seventeen inches in length, two dollars and fifty cents per dozen pairs; over seventeen inches in length, three dollars and fifty cents per dozen pairs; men's, of sheep origin, with exterior surface removed, by whatever name known, four dollars per dozen pairs.
- 444 Women's or children's kid, goat, or other leather than of sheep origin, with exterior grain surface removed, by whatever name known, not over fourteen inches in length, three dollars per dozen pairs; over fourteen inches and not over seventeen inches in length, three dollars and seventy-five cents per dozen pairs; over seventeen inches in length, four dollars and seventy-five cents per dozen pairs; men's goat, kid, or other leather than of sheep origin, with exterior grain surface removed, by whatever name known, four dollars per dozen pairs.
- 445 In addition to the foregoing rates there shall be paid the following cumulative duties: On all leather gloves, when lined, one dollar per dozen pairs; on all plique or prix seam gloves, forty cents per dozen pairs; on all gloves stitched or embroidered, with more than three single strands or cords, forty cents per dozen pairs.
- 446 Glove trunks with or without the usual accompanying pieces, shall pay seventy-five per centum of the duty provided for the gloves in the fabrication of which they are suitable.
- 447 Harness, saddles and saddlery, or parts of either, in sets or in parts, finished or unfinished, forty-five per centum ad valorem.

## Miscellaneous Manufactures.

- 448 Manufactures of amber, asbestos, bladders, corks, catgut or whip gut or worm gut, or wax, or of which these substances or either of them is the component material of chief value, not specially provided for in this Act, twenty-five per centum ad valorem.
- 449 Manufactures of bone, chip, grass, horn, india-rubber, palm leaf, straw, weeds, or whalebone, or of which these substances or either of them is the component material of chief value, not specially provided for in this Act, thirty per centum ad valorem; but the terms "grass" and "straw" shall be understood to mean these substances in their natural form and structure, and not the separated fiber thereof.
- 450 Manufactures of leather, finished or unfinished, manufac-

## The American Tariff.

- tures of fur, gelatine, gutta-percha, human hair, ivory, vegetable ivory, mother-of-pearl and shell, plaster of paris, papier mache, and vulcanized india-rubber known as "hard rubber," or of which these substances or either of them is the component material of chief value, not specially provided for in this Act, and shells engraved, cut, ornamented, or otherwise manufactured, thirty-five per centum ad valorem.
- 451 Masks, composed of paper or pulp, thirty-five per centum ad valorem.
- 452 Matting made of cocoa fibre or rattan, six cents per square yard; mats made of cocoa fibre or rattan, four cents per square foot.
- 453 Musical instruments or parts thereof, pianoforte actions and parts thereof, strings for musical instruments not otherwise enumerated, cases for musical instruments, pitch pipes, tuning forks, tuning hammers, and metronomes; strings for musical instruments, composed wholly or in part of steel or other metal; all the foregoing, forty-five per centum ad valorem.
- 454 Paintings in oil or water colors, pastels, pen and ink drawings, and statuary, not specially provided for in this Act, twenty per centum ad valorem; but the term "statuary" as used in this Act shall be understood to include only such statuary as is cut, carved, or otherwise wrought by hand from a solid block or mass of marble, stone or alabaster, or from metal, and as is the professional production of a statuary or sculptor only.
- 455 Peat moss, one dollar per ton.
- 456 Pencils of paper or wood filled with lead or other material, and pencils of lead, forty-five cents per gross and twenty-five per centum ad valorem; slate pencils, covered with wood, thirty-five per centum ad valorem; all other slate pencils, three cents per one hundred.
- 457 Pencil leads not in wood, ten per centum ad valorem.
- 458 Photographic dry plates or films, twenty-five per centum ad valorem.
- 459 Pipes and smokers' articles: Common tobacco pipes and pipe bowls made wholly of clay, valued at not more than forty cents per gross, fifteen cents per gross; other tobacco pipes and pipe bowls of clay, fifty cents per gross and twenty-five per centum ad valorem; other pipes and pipe bowls of whatever material composed, and all smokers' articles whatsoever, not specially provided for in this Act, including cigarette books, cigarette book covers, pouches for smoking or chewing tobacco, and cigarette paper in all forms, sixty per centum ad valorem.
- 460 Plows, tooth and disk harrows, harvesters, reapers, agricultural drills, and planters, mowers, hoes, cultivators, threshing machines and cotton gins, twenty per centum ad valorem.
- 461 Plush, black, known commercially as hatters' plush, composed of silk, or of silk and cotton such as is used exclusively for making men's hats, ten per centum ad valorem.
- 462 Umbrellas, parasols, and sun shades covered with material other than paper, fifty per centum ad valorem. Sticks for umbrellas, parasols, or sun shades, and walking canes, finished or unfinished, forty per centum ad valorem.
- 463 Waste, not specially provided for in this Act, ten per centum ad valorem.

## FREE LIST.

Sec. 2. That on and after the passage of this Act, unless otherwise specially provided for in this Act, the following articles when imported shall be exempt from duty.

- 464 Acids: Arsenic or arsenious, benzoic, carbolic, fluoric, hydrochloric or muriatic, nitric, oxalic, phosphoric, phthalic, picric or nitropicric, prussic, silicic, and valerianic.
- 465 Aconite.
- 466 Acorns, raw, dried, or undried, but unground.
- 467 Agates, unmanufactured.
- 468 Albumen, not specially provided for.
- 469 Alizarin, natural or artificial, and dyes derived from alizarin or from anthracin.
- 470 Amber, and amberlod unmanufactured, or crude gum.
- 471 Anbergris.
- 472 Aniline salts.
- 473 Any animal imported specially for breeding purposes shall be admitted free: Provided, That no such animal shall be admitted free unless pure bred of a recognized breed, and duly registered in the book of record established for that breed: And provided further, That certificate of such record and of the pedigree of such animal shall be produced and submitted to the customs officer, duly authenticated by the proper custodian of such book of record, together with the affidavit of the owner, agent, or importer that such animal is the identical animal described in said



Manufacturers of

Cotton, Jute, Hemp and Flax  
Twines and Cordage  
Mill Banding and Driving Ropes  
Chalk and Fishing Lines  
Seine Twine, Hammocks, Tennis  
Cricket and Fly Nets  
Cotton Rope and Clothes Lines  
Plough Lines, etc.

**HUTCHISON,  
SHURLY & DERRETT**

1078 Bloor Street West, TORONTO.

IT PAYS TO BUY THE BEST

**Cordage**

Manila - Sisal - Jute.

LATHYARN - Clothes Lines - PACKINGS

Halters, Plow Lines, Parcelling and Mill Twines,  
Tarred Russia, Special Hemp Ropes, Marine, Houseline, etc.

"FIRMUS" TRANSMISSION ROPE, Tallow Laid.

All Leading BINDER TWINE Brands

MANUFACTURED BY

**Consumers Cordage Company, Limited,**

HEAD OFFICE, MONTREAL

WORKS: MONTREAL

BRANCHES: TORONTO, QUEBEC, WINNIPEG and VANCOUVER

No other Manufacturer on this Continent produces such a variety of Goods.

**Paper Mills and Pulp Mills**

And all users of ENDLESS FELTS get the best value by ordering from

**HAMELIN & AYERS**

*Lachute Mills, P.Q.*

We are now prepared to make all grades from the finest Bristol Board to the coarsest Sulphite Fibre. With our 24 looms, and all other machinery to match, we are in a position to fill all orders promptly. When ordering state kind of Paper or Board made, and speed of machine.

You will not be asked to pay for Felts that are not satisfactory. Every felt is tested in our factory, and is shipped with our guarantee.

*Capacity, 1,000 Square Yards Daily.*

ADDRESS....

**HAMELIN & AYERS**

**Lachute Mills, P.Q., Canada.**

**BAYLIS MANUFACTURING CO'Y.**

16 to 30 Nazareth Street,

**MONTREAL.**

**Varnishes**

**Japans**

**Lacquers**

**WOOD FILLERS.**

**WHITE LEAD, PAINTS, OILS, AXLE GREASE, ETC.**

## The American Tariff.

- certificate of record and pedigree. And provided further, That the Secretary of Agriculture shall determine and certify to the Secretary of the Treasury what are recognized breeds and pure bred animals under the provisions of this paragraph. The Secretary of the Treasury may prescribe such additional regulations as may be required for the strict enforcement of this provision. Cattle, horses, sheep, or other domestic animals straying across the boundary line into any foreign country, or driven across such boundary line by the owner for temporary pasturage purposes only, together with their offspring, may be brought back to the United States within six months free of duty, under regulations to be prescribed by the Secretary of the Treasury.
- 474 Animals brought into the United States temporarily for a period not exceeding six months, for the purpose of exhibition or competition for prizes offered by any agricultural or racing association; but a bond shall be given in accordance with regulations prescribed by the Secretary of the Treasury, also teams of animals, including their harness and tackle and the wagons or other vehicles actually owned by persons emigrating from foreign countries to the United States with their families, and in actual use for the purpose of such emigration under such regulations as the Secretary of the Treasury may prescribe; and wild animals intended for exhibition in zoological collections for scientific and educational purposes, and not for sale or profit.
- 475 Annatto, roucou, rocoa, or orleans, and all extracts of.
- 476 Antimony ore, crude sulphite of.
- 477 Apatite
- 478 Arrowroot in its natural state and not manufactured.
- 479 Arsenic and sulphide of, or orpiment.
- 480 Arseniate of aniline.
- 481 Art educational stops, composed of glass and metal and valued at not more than six cents per gross.
- 482 Articles in a crude state used in dyeing or tanning not specially provided for in this Act.
- 483 Articles the growth, produce, and manufacture of the United States, when returned after having been exported, without having been advanced in value or improved in condition by any process of manufacture of other means; casks, barrels, carboys, bags, and other vessels of American manufacture exported filled with American products, or exported empty and returned filled with foreign products, including shoosks and staves when returned as barrels or boxes; also quicksilver, flasks, or bottles, of either domestic or foreign manufacture, which shall have been actually exported from the United States; but proof of the identity of such articles shall be made, under general regulations to be prescribed by the Secretary of the Treasury, but the exemption of bags from duty shall apply only to such domestic bags as may be imported by the exporter thereof, and if any such articles are subject to internal tax at the time of exportation, such tax shall be proved to have been paid before exportation and not refunded: Provided, That this paragraph shall not apply to any article upon which an allowance of drawback has been made, the reimportation of which is hereby prohibited except upon payment of duties equal to the drawbacks allowed; or to any article manufactured in bonded warehouse and exported under any provision of law; and provided further, that when manufactured tobacco which has been exported without payment of internal revenue tax shall be reimported, it shall be retained in the custody of the collector of customs until internal revenue stamps in payment of the legal duties shall be placed thereon.
- 484 Asbestos, unmanufactured.
- 485 Ashes, wood and lye of, and beet-root ashes.
- 486 Asafetida.
- 487 Balm of Gilead.
- 488 Barks, cinchona or other from which quinine may be extracted.
- 489 Paryta, carbonate of, or witherite.
- 490 Beeswax.
- 491 Binding twine: All binding twine manufactured from New Zealand hemp istle or Tampico fiber, sisal grass, or sunn, or a mixture of any two or more of them, of single ply and measuring not exceeding six hundred feet to the pound: Provided, That articles mentioned in this paragraph if imported from a country which lays an import duty on like articles imported from the United States, shall be subject to a duty of one-half of one cent per pound.
- 492 Bells, broken, and bell metal broken and fit only to be remanufactured.
- 493 Birds, stuffed, not suitable for millinery ornaments.
- 494 Birds and land and water fowls.
- 495 Bismuth.

## The American Tariff.

- 496 Badders and all integuments and intestines of animals and fish sounds, crude, dried or salted for preservation only, and unmanufactured, only specially provided for in this Act.
- 497 Blood, dried, not specially provided for.
- 498 Bolted cloths composed of silk, imported expressly for milking purposes, and so permanently marked as not to be available for any other use.
- 499 Bones, crude, or not burned, calcined, ground, steamed, or otherwise manufactured, and bone dust or animal carbon, and bone ash, fit only for fertilizing purposes.
- 500 Books, engravings, photographs, etchings, bound or unbound, maps and charts imported by authority or for the use of the United States or for the use of the Library of Congress.
- 501 Books, maps, music, engravings, photographs, etchings, bound or unbound, and charts, which shall have been printed more than twenty years at the date of importation, and all hydrographic charts, and publications issued for their subscribers or exchanges by scientific and literary associations and academies or publications of individuals for gratuitous private circulation, and public documents issued by foreign Governments.
- 502 Books and pamphlets printed exclusively in languages other than English; also books and music, in raised print, used exclusively by the blind.
- 503 Books, maps, music, photographs, etchings, lithographic prints, and charts, specially imported, not more than two copies in any one invoice, in good faith, for the use or by order of any society or institution incorporated or established solely for religious, philosophical, educational, scientific, or literary purposes, or for the encouragement of the fine arts, or for the use or by order of any college, academy, school, or seminary of learning in the United States, or any State or public library, and not for sale, subject to such regulations as the Secretary of the Treasury shall prescribe.
- 504 Books, libraries, usual and reasonable furniture, and similar household effects of persons or families from foreign countries, all the foregoing if actually used abroad by them not less than one year, and not intended for any other other person or persons, nor for sale.
- 505 Brass, old brass, clippings from brass or Dutch metal, all the foregoing, fit only for remanufacture.
- 506 Brazil paste.
- 507 Brazilian pebble, unwrought or unmanufactured.
- 508 Breccia, in blocks or slabs.
- 509 Bristles, crude, not sorted, bunched, or prepared.
- 510 Broom corn.
- 511 Bullion, gold or silver.
- 512 Burgundy pitch.
- 513 Cadmium.
- 514 Calamine.
- 515 Camphor, crude.
- 516 Castor or castoreum.
- 517 Cat gut, whip gut, or worm gut, unmanufactured.
- 518 Cerium.
- 519 Chalk, crude, not ground, precipitated, or otherwise manufactured.
- 520 Chromate of iron or chromic ore.
- 521 Civit crude.
- 522 Clay: Common blue clay in casks suitable for the manufacture of crucibles.
- 523 Coal, Anthracite, not specially provided for in this Act, and coal stores of American vessels, but none shall be unloaded.
- 524 Coal tar, crude, pitch of coal tar, and products of coal tar known as dead or creosote oil, benzol, toluol, naphthalin, xylool, phenol, cresol, toluidine, xyldin, cumidin, bininitrotolol, binitrobenzol, benzidin, toldin, dianisidin, naphthol, naphthylamin, diphenylamin, benzaldehyde, benzyl chloride, rosolin, nitro-benzol, and nitro-toluol; all the foregoing not medicinal and not colors or dyes.
- 525 Cobalt and cobalt ore.
- 526 Cocculus Indicus.
- 527 Cochineal.
- 528 Cocoa, or cacao, crude, and fibre, leaves and shells of.
- 529 Coffee.
- 530 Coins, gold, silver, and copper.
- 531 Colr, and colr yarn.
- 532 Copper in plates, bars, ingots, or pigs, and other forms, not unmanufactured or specially provided for in this Act.
- 533 Cold copper, fit only for manufacture, clippings from new copper, and all composition metal of which copper is a component material of chief value not specially provided for in this Act.
- 534 Copper, regulus of, and black or coarse copper, and copper cement.

# DOMINION COPPER AND BRASS WORKS

Established 1836

Manufacturers of  
*DISTILLERS',  
BREWERS',  
CONFECTIONERS'  
and MARINE*

**COPPER**  
AND  
**BRASS**  
...**WORK**

Varnish Kettles,  
Dyers, Cylinders,  
Baths, Boilers, Fire  
Extinguishers, Brass  
Railing, Metal Spin-  
ning and Brass  
Castings.

**VACUUM PANS**  
A Specialty.

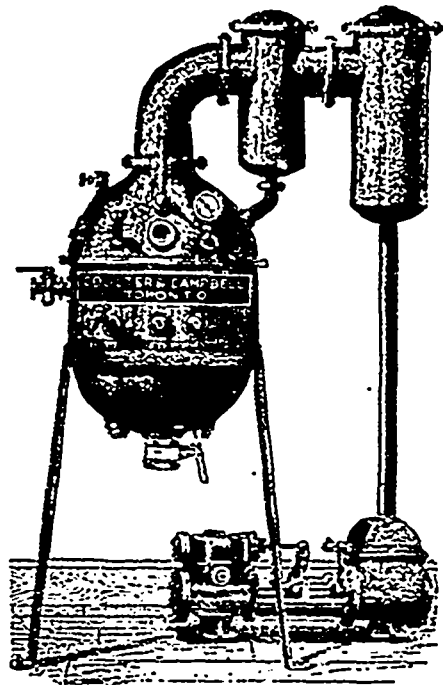

**Coulter & Campbell,** 155 & 157 GEORGE ST.  
& 2 to 10 BRITAIN ST.  
TORONTO, CANADA.

# The Canada Metal Co.

W. G. HARRIS, Proprietor

William St., - TORONTO, ONT.

MAKE A SPECIALTY OF

Babbit Metals,  
Stereotype and Linotype  
Metals

1-2 and 1-2 Wire Solder,  
Piano Key Leads.

ALSO DEALERS IN

**TIN, LEAD AND ANTIMONY.**

Telephone 1729.

# THE PRESTON BOILER

Combines in itself all the Latest  
Improvements in the  
Construction of

## HOT WATER BOILERS

READ WHAT A CUSTOMER SAYS:

Concord, March 10, 1899.

Messrs. Clare Bros. & Co.

Preston, Ontario.

Gentlemen,—I bought a Preston Boiler for my house because the whole inner heating surface is exposed to the direct action of the fire, and the outer surface is utilized as a heating surface by the products of combustion being made to pass over it in its full volume. There being no horizontal surfaces to speak of, it is comparatively easy to keep clean. The water circulation is vertical, and therefore natural. The construction is simple, being complete in one casting. There are no joints requiring bolts, and as an economical house warmer it stands in the front rank.

Yours truly, W. R. WHITLAW.

MORE THAN THIS—

- WE MAKE Hot Water Boilers for Coal and Wood.
- WE MAKE Combination Heaters for Coal and Wood.
- WE MAKE Warm Air Furnaces for Coal and Wood.
- WE MAKE Radiators and Registers and Everything in the Heating Line.
- WE MAKE all kinds of Stoves and Ranges.



**CLARE BROS & CO., - - Preston, Ont.**

When writing to Advertisers kindly mention THE CANADIAN MANUFACTURER.

## The American Tariff.

- 535 Coral, marine, uncut, and unmanufactured.  
 536 Cork wood, or cork bark, unmanufactured.  
 537 Cotton, and cotton waste or locks.  
 538 Cryolite, or kryolith.  
 539 Cudbear.  
 540 Curling-stones, or quoits, and curling-stone handles.  
 541 Curry, and curry powder.  
 542 Cutch.  
 543 Cuttlefish bone.  
 544 Dandelion roots, raw, dried, or undried, but unground.  
 545 Diamonds and other precious stones, rough or uncut, and not advanced in condition or value from their natural state by cleaving, splitting, cutting, or other process, including miners', glaziers' and engravers' diamonds not set, and diamond dust or bort.  
 546 Divi-divi.  
 547 Dragon's blood.  
 548 Drugs, such as barks, beans, berries, balsams, buds, bulbs, and bulbous roots, excrescences, fruits, flowers, dried fibres, and dried insects, grains, gums, and gum resin, herbs, leaves, lichens, mosses, nuts, nutgalls, roots, and stems, spores, vegetables, seeds aromatic, and seeds of morbid growth, weeds, and woods used expressly for dyeing; any of the foregoing which are drugs and not edible and are in a crude state, and not advanced in value or condition by resining or grinding, or by other process, and not specially provided for in this Act.  
 549 Eggs of birds, fish, and insects: Provided, however, That this shall not be held to include the eggs of game birds or eggs of birds not used for food, the importation of which is prohibited except specimens for scientific collection, nor fish toe preserved for food purposes.  
 550 Emery ore.  
 551 Errot.  
 552 Fans, common palm-leaf, plain and not ornamented or decorated in any manner, and palm-leaf in its natural state not colored, dyed, or otherwise advanced or manufactured.  
 553 Felt, adhesive, for sheathing vessels.  
 554 Fibrin, in all forms.  
 555 Fish, fresh, frozen, or packed in ice, caught in the Great Lakes or other fresh waters by citizens of the United States.  
 556 Fish skins.  
 557 Flint, flints, and flint stones, unground.  
 558 Fossils.  
 559 Fruits or berries, green, ripe or dried, and fruits in brine, not specially provided for in this Act.  
 560 Fruit plants, tropical and semi-tropical, for the purpose of propagation or cultivation.  
 561 Furs undressed.  
 562 Fur skins of all kinds, not dressed in any manner, and not specially provided for in this Act.  
 563 Gambier.  
 564 Glass enamel, white, for watch and clock dials.  
 565 Glass plates or discs, rough-cut or unwrought, for use in the manufacture of optical instruments, spectacles, and eye glasses, and suitable only for such use. Provided, however, that such discs exceeding eight inches in diameter may be polished sufficiently to enable the character of the glass to be determined.  
 566 Grasses and fibres: Istle or Tampico fibre, jute, jute butts, manilla, sisal grass, sunn, and all other textile grasses or fibrous vegetable substances, not dressed or manufactured in any manner, and not specially provided for in this Act.  
 567 Gold-beaters' molds, and gold-beaters' skins.  
 568 Grease and oils (excepting fish oils), such as are commonly used in soap making or in wire drawing, or for stuffing or dressing leather, and which are fit only for such uses, and not specially provided for in this Act.  
 569 Guano manures, and all substances used only for manure.  
 570 Gutta percha, crude.  
 571 Hair of horse, cattle, and other animals, cleaned or uncleaned, drawn or undrawn, but unmanufactured, not specially provided for in this Act; and human hair, raw, uncleaned, and not drawn.  
 572 Hide cuttings, raw, with or without hair, and all other glue stock.  
 573 Hide rope.  
 574 Hones and whetstones.  
 575 Hoofs, unmanufactured.  
 576 Hop roots for cultivation.  
 577 Horns and parts of, unmanufactured, including horn strips and tips.  
 578 Ice.  
 579 India rubber, crude, and milk of, and old scrap or refuse India rubber, which has been worn out by use and is fit only for remanufacture.

## The American Tariff.

- 580 Indigo.  
 581 Iodine, crude.  
 582 Ipecac.  
 583 Iridium.  
 584 Ivory tusks in their natural state or cut vertically across the grain only, with the bark left intact, and vegetable ivory in its natural state.  
 585 Jalap.  
 586 Jet, unmanufactured.  
 587 Joss stick, or Joss light.  
 588 Junk, old.  
 589 Kelp.  
 590 Kieserite.  
 591 Kyanite, or cyanite, and kaimite.  
 592 Lac dye, crude, seed, button, stick, and shell.  
 593 Lac spirits.  
 594 Lactarene.  
 595 Lava, unmanufactured.  
 596 Leeches.  
 597 Lemon juice, lime juice, and sour orange juice.  
 598 Licorice root, unground.  
 599 Lifeboats and life-saving apparatus specially imported by societies incorporated or established to encourage the saving of human life.  
 600 Lime, citrate of.  
 601 Lithographic stones, not engraved.  
 602 Lintus, prepared or not prepared.  
 603 Loadstones.  
 604 Madder and munjeet, or Indian madder, ground, or prepared and all extracts of.  
 605 Magnesite crude, or calcined, not purified.  
 606 Magnesium, not made up into articles.  
 607 Manganese, oxide and ore of.  
 608 Manna.  
 609 Manuscripts.  
 610 Marrow, crude.  
 611 Marshmallow or althea root, leaves or flowers, natural or unmanufactured.  
 612 Medals of gold, silver, or copper, and other metallic articles actually bestowed as trophies or prizes, and received and accepted as honorary distinctions.  
 613 Meerschaum, crude or unmanufactured.  
 614 Minerals, crude, or not advanced in value or condition by refining or grinding, or by other process of manufacture not specially provided for in this Act.  
 615 Mineral salts obtained by evaporation from mineral waters, when accompanied by a duly authenticated certificate and satisfactory proof, showing that they are in no way artificially prepared, and are only the product of a designated mineral spring.  
 616 Models of invention and of other improvements in the arts, including patterns for machinery, but no article shall be deemed a model or pattern which can be fitted for use otherwise.  
 617 Moss, seaweeds, and vegetable substances, crude or unmanufactured, not otherwise specially provided for in this Act.  
 618 Musk, crude, in natural pods.  
 619 Myrobolans.  
 620 Needles, hand-sewing, and darning.  
 621 Newspapers and periodicals: but the term "periodicals" as herein used shall be understood to embrace only unbound or paper-covered publications, issued within six months of the time of entry, containing current literature of the day and issued regularly at stated periods, as weekly, monthly, or quarterly.  
 622 Nuts, Brazil nuts, cream nuts, palm nuts and palm-nut kernels, cocoanuts in the shell and broken cocoanut meat or copra, not shredded, desiccated, or prepared in any manner.  
 623 Nux vomica.  
 624 Oakum.  
 625 Oil cake.  
 626 Oils: Almond, amber, crude and rectified ambergris, anise or anise seed, aniline, aspic or aspike lavender, bergamot, cajuput, caraway, cassia, cinnamon, cedar, chamomile, citronella or lemon grass, civet, cocoanut, fennel, ichthyol, jasmine or jasimine, Juglandium, juniper, lavender, lemon, limes, mace, neroli or orange flower, entourage grease, nut oil or oil of nuts not otherwise specially provided for in this Act, orange oil, olive oil for manufacturing or mechanical purposes fit only for such use and valued at not more than sixty cents per gallon, oil of roses, palm, rosemary or anthesis, sesame or sesamum seed or bean, thyme, organum red or white, valerian; and also spermæol, whale, and other fish oils of American fisheries, and all fish and other



**BRUNNER MOND & CO., Limited,**  
NORTHWICH, ENGLAND.

**PURE ALKALI**

48% and 58% (Light and Heavy)

**BLEACH<sup>G</sup> PWD.**

35% to 37% (Hardwood Casks)

**CAUSTIC SODA**

60% to 77%



TRADE MARK.

Winn & Holland,

MONTREAL,

Sole Agents for Canada.

**SODA CRYSTALS**

Lump and Crushed. Brls. and Bags.

**CON<sup>CTD</sup> SAL SODA**

DOUBLE STRENGTH

**BIGARBONATE SODA**

ABSOLUTELY PURE

Also for Mineral Water Manufacturers.

**Wm. J. MATHESON & CO., LIMITED**

NEW YORK

BOSTON

PHILADELPHIA

PROVIDENCE

CHARLOTTE, N.C.

MONTREAL, CANADA

**DYE . . .**

**STUFFS**

**CANADA CHEMICAL MANUFACTURING CO.**

Manufacturers of Sulphuric, Nitric and Muriatic Acids—Commercial  
and Chemically Pure. Mixed Acids for Explosives.

Liquid Ammonia, Glauber Salts, Copperas, Muriate Tin, Tin Crystals, Acetic Acid, Nitrate Iron,  
Bisulphite Soda, Acid Phosphate for Baking Powders and General Chemicals. Fertilizers, etc. London, Ont.

**HAEMOTOL**

FOR  
WOOL

Dyed over a Chrome and Tartar Mordant pro-  
duces a black on wool equal to Alizarine Black  
for fastness, but at a much lower cost.

Sole Manufacturers, **F. E. ATTEAUX & CO.,** 53 Colborne St., TORONTO, ONT.  
13 Lemoine Street, MONTREAL

Main Office and Works—BOSTON, MASS., U.S.A.

**JOHN J. KELLER & CO.,** 104 and 106 MURRAY ST., NEW YORK. 135 PEARL ST., BOSTON,  
220 CHURCH ST., PHILADELPHIA. 18 PRYOR ST., ATLANTA, GA.

Aniline Colors, Dyewood Extracts, Sumac and Nutgall Extracts.

FAST COLORS for Wool Dyeing, One Dip Cotton Colors. Novelties and  
Specialties for Calico Printing.

Manufactured by **JOHN R. GEIGY & CO.,** Basle, Switzerland.

**A. KLIPSTEIN & CO.** 122 Pearl St.  
NEW YORK

Anilines, Dyestuffs and Chemicals.

DELIVERY MADE AT NEW YORK,  
MONTREAL or HAMILTON.

**WRIGHT & DALLYN,** Agents, Hamilton, Ont.

When writing to Advertisers kindly mention THE CANADIAN MANUFACTURER.

## The American Tariff.

- products of such fisheries: petroleum, crude or refined: Provided, That if there be imported into the United States crude petroleum, or the products of crude petroleum produced in any country which imposes a duty on petroleum or its products exported from the United States, there shall in such cases be levied, paid, and collected a duty upon said crude petroleum or its products so imported equal to the duty imposed by such country.
- 627 Orange and lemon peel, not preserved, candied, or dried.
- 628 Orchil, or orchil liquid.
- 629 Ores of gold, silver, copper, or nickel, and nickel matte; sweepings of gold and silver.
- 630 Osmium.
- 631 Palladium.
- 632 Paper stock, crude, of every description, including all grasses, fibres, rags (other than wool), waste, including lute waste, shavings, clippings, old paper, rope ends, waste rope, and waste baggings, including old gunny cloth and old gunny bags, fit only to be converted into paper.
- 633 Paraffin.
- 634 Parchment and vellum.
- 635 Pearl, mother-of, and shells, not sawed, cut, polished or otherwise manufactured, or advanced in value from the natural state.
- 636 Personal effects, not merchandise, of citizens of the United States dying in foreign countries.
- 637 Pewter and britannia metal, old, and fit only to be remanufactured.
- 638 Philosophical and scientific apparatus, utensils, instruments, and preparations, including bottles and boxes containing the same, specially imported in good faith for the use and by order of any society or institution incorporated or established solely for religious, philosophical, educational, scientific, or literary purposes, or for the encouragement of the fine arts, or for the use or by order of any college, academy, school, or seminary of learning in the United States, or any State or public library, and not for sale, subject to such regulations as the Secretary of the Treasury shall prescribe.
- 639 Phosphates, crude.
- 640 Plants, trees shrubs roots, seed-cane and seeds, imported by the Department of Agriculture or the United States Botanic Garden.
- 641 Platina, in ingots, bars, sheets, and wire.
- 642 Platinum, unmanufactured, and vases, retorts, and other apparatus, vessels, and parts thereof composed of platinum, for chemical uses.
- 643 Plumbago.
- 644 Potash, crude, or "black salts": carbonate of potash, crude or refined: hydrate of or caustic potash, not including refined in sticks or rolls: nitrate of potash or saltpeter, crude: sulphate of potash, crude or refined, and muriate of potash.
- 645 Professional books, implements, instruments, and tools of trade, occupation, or employment, in the actual possession at the time, of persons emigrating to the United States: but this exemption shall not be construed to include machinery or other articles imported for use in any manufacturing establishment, or for any other person or persons, or for sale, nor shall it be construed to include theatrical scenery, properties, and apparel: but such articles brought by proprietors or managers of theatrical exhibitions arriving from abroad, for temporary use by them in such exhibitions, and not for any other person, and not for sale, and which have been used by them abroad, shall be admitted free of duty under such regulations as the Secretary of the Treasury may prescribe: but bonds shall be given for the payment to the United States of such duties as may be imposed by law upon any and all such articles as shall not be exported within six months after such importation. Provided, That the Secretary of the Treasury may in his discretion extend such period for a further term of six months in case application shall be made therefor.
- 646 Pulu.
- 647 Quinia, sulphate of, and all alkaloids or salts of cinchona bark.
- 648 Rags, not otherwise specially provided for in this Act.
- 649 Regalia and gems, statuary, and specimens or casts of sculpture, where specially imported in good faith for the use and by order of any society incorporated or established solely for religious, philosophical, educational, scientific, or literary purposes, or for the encouragement of the fine arts, or for the use and by order of any college, academy, school, seminary of learning in the United States or any state or public library, and not for sale: but the term "regalia" as herein used shall be held to embrace only such insignia of

## The American Tariff.

- rank or office or emblems as may be worn upon the person or borne in the hand during public exercises of the society or institution, and shall not include articles of furniture or fixtures, or of regular wearing apparel, nor personal property of individuals.
- 650 Rennets, raw or prepared.
- 651 Saffron and safflower, and extract of, and saffron cake
- 652 Sago, crude.
- 653 Salacin.
- 654 Salep, or salop.
- 655 Sausages, bologna.
- 656 Seeds: Anise, caraway, cardamon, cauliflower, coriander, cotton, cummin, fennel, fenugreek, hemp, hoarhound, mangel-wurzel, mustard, rape, Saint John's bread or beans, sugar beet, sorghum or sugar cane for seed; bulbs and bulbous roots, not edible and not otherwise provided for: all flower and grass seeds: all the foregoing not specially provided for in this Act.
- 657 Sheep dip, not including compounds or preparations that can be used for other purposes.
- 658 Shotgun barrels, in single tubes, forged, rough bored.
- 659 Shrimps and other shell fish.
- 660 Silk, raw, or as reeled from the cocoon, but not doubled, twisted, or advanced in manufacture in any way.
- 661 Silk cocoons and silk waste.
- 662 Silkworm's eggs.
- 663 Skeletons and other preparations of anatomy.
- 664 Skins of all kinds, raw (except sheepskins with the wool on), and hides not specially provided for in this Act.
- 665 Soda, nitrate of, or cubic nitrate.
- 666 Specimens of natural history, botany, and mineralogy, when imported for scientific public collections, and not for sale.
- 667 Spices: Cassia, cassia vera, and cassia buds: cinnamon and clips of: cloves and clove stems: mace: nutmegs: pepper, black or white, and pimento: all the foregoing when unground: ginger root, unground and not preserved or candied.
- 668 Spunk.
- 669 Spurs and stilts used in the manufacture of earthen, porcelain and stone ware.
- 670 Stamps: foreign postage or revenue stamps, cancelled or uncancelled.
- 671 Stone and sand: Burrstone in blocks, rough or unmanufactured: cliff stone, unmanufactured: rotten stone, tripoli, and sand, crude or manufactured, not otherwise provided for in this Act.
- 672 Storax, or styrax.
- 673 Strontia, oxide of, and protoxide of strontian and strontianite, or mineral carbonate of strontia.
- 674 Sulphur, lac or precipitated, and sulphur or brimstone, crude in bulk, sulphur ore as pyrites, or sulphuret of iron in its natural state, containing in excess of twenty-five per centum of sulphur, and sulphur not otherwise provided for.
- 675 Sulphuric acid which at the temperature of sixty degrees Fahrenheit does not exceed the specific gravity of one and three hundred and eighty thousandths, for use in manufacturing superphosphate of lime or artificial manures of any kind, or for any agricultural purposes: Provided, That upon all sulphuric acid imported from any country, whether independent or a dependency, which imposes a duty upon sulphuric acid imported into such country from the United States, there shall be levied and collected a duty of one-fourth of one cent per pound.
- 676 Tamarinds.
- 677 Tapioca, cassava or cassady.
- 678 Tar and pitch wood.
- 679 Tea and tea plants.
- 680 Teeth, natural, or unmanufactured.
- 681 Terra alba, not made from gypsum or plaster rock.
- 682 Terra Japonica.
- 683 Tin ore, cassiterite or black oxide of tin, and tin in bars, blocks, pigs, or grain or granulated.
- 684 Tobacco stems.
- 685 Tonquin, tonqua, or tonka beans.
- 686 Turmeric.
- 687 Turpentine, Venice.
- 688 Turpentine, spirits of.
- 689 Turtles.
- 690 Types, old, and fit only to be remanufactured.
- 691 Uranium, oxide and salts of.
- 692 Vaccine virus.
- 693 Valonia.
- 694 Verdigris, or subacetate of copper.
- 695 Wax, vegetable or mineral.
- 696 Wafers, unleavened or not edible.

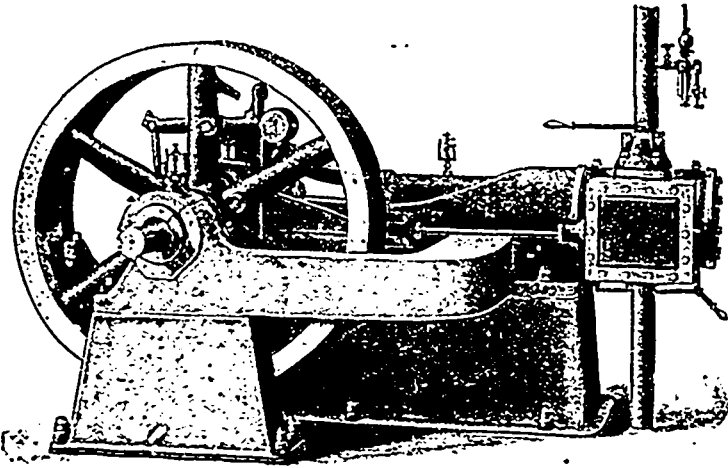

# ROBB-ARMSTRONG Automatic Engines...

We are selling our engines in England, South America and Australia, which shows their high quality. The Tandem Compound Engines have the high-pressure cylinder next the frame, and both pistons may be withdrawn through the low-pressure cylinder without disturbing it: both valves are connected with the governor, and are arranged to divide the load equally between the cylinders. In sizes up to 100 horse-power the outboard bearing is attached to the frame, as shown in cut, keeping it perfectly in line.

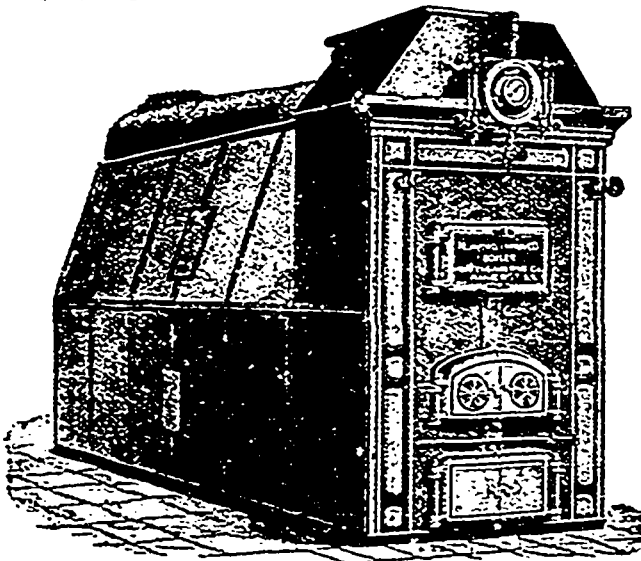
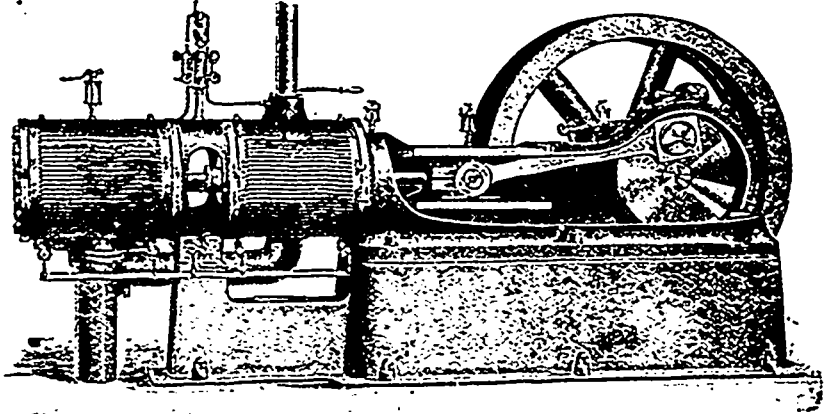

## The Mumford Improved Boiler

This boiler is built with sheet steel case, as shown in cut, or for brick casing, as desired. It is internally fired, has perfect water circulation, is a quick steamer, and gives the highest economy. Two settling chambers are provided for catching deposits of scale, and every part of the boiler is accessible for cleaning.

**ROBB  
ENGINEERING  
COMPANY, Limited,**  
**AMHERST,  
NOVA SCOTIA.**

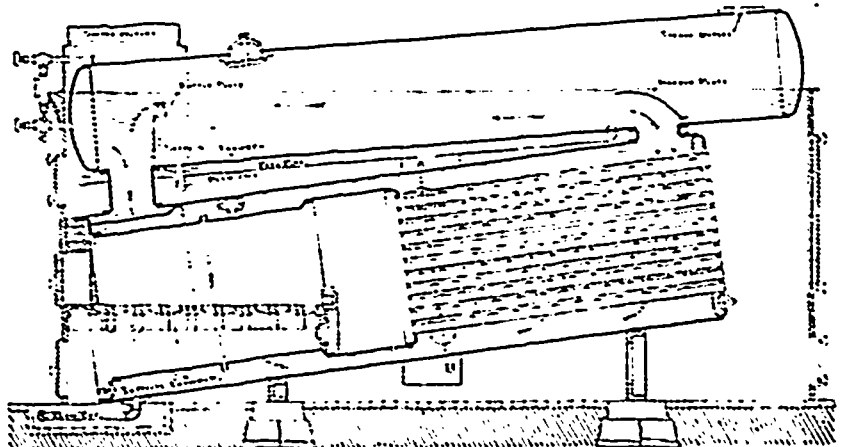

When writing to Advertisers kindly mention THE CANADIAN MANUFACTURER.

## The American Tariff.

697 Wearing apparel, articles of personal adornment, toilet articles, and similar personal effects of persons arriving in the United States; but this exemption shall only include such articles as actually accompany and are in the use of, and as are necessary and appropriate for the wear and use of such persons, for the immediate purposes of the journey and present comfort and convenience, and shall not be held to apply to merchandise or articles intended for other persons or for sale: Provided, That in case of residents of the United States returning from abroad, all wearing apparel and other personal effects taken by them out of the United States to foreign countries shall be admitted free of duty, without regard to their value, upon their identity being established, under appropriate rules and regulations to be prescribed by the Secretary of the Treasury, but no more than one hundred dollars in value of articles purchased abroad by such residents of the United States shall be admitted free of duty upon their return.

698 Whalebone, unmanufactured.

699 Wood: Logs and round unmanufactured timber, including pulp-wood, firewood, handle-bolts, shingle-bolts, gun-blocks for gun-stocks, rough-hewn, or sawed or planed one side, hop-poles, ship-timber and ship-planking; all the foregoing not specially provided for in this Act.

700 Woods: Cedar, lignum-vitae, lance-wood, ebony, box granadilla, mahogany, rosewood, satin-wood and all forms cabinet woods, in the log, rough, or hewn only; briar root or briar wood and similar wood unmanufactured, or not further advanced than cut into blocks suitable for the articles into which they are intended to be converted: bamboo, rattan, reeds unmanufactured, India malacca, joints, and sticks of partridge, hair wood, pimento, orange, myrtle, and other woods not specially provided for in this Act, in the rough, or not further advanced than cut into lengths suitable for sticks for umbrellas, parasols, sunshades, whips, fishing rods, or walking canes.

701 Works of art, drawings, engravings, photographic pictures, and philosophical and scientific apparatus, brought by professional artists, lecturers, or scientists arriving from abroad for use by them temporarily for exhibition and in illustration, promotion and encouragement of art, science, or industry in the United States, and not for sale, shall be admitted free of duty, under such regulations as the Secretary of the Treasury shall prescribe; but bonds shall be given for the payment to the United States of such duties as may be imposed by law upon any and all such articles as shall not be exported within six months after such importation: Provided, That the Secretary of the Treasury may, in his discretion, extend such period for a further term of six months in cases where applications therefor shall be made.

702 Works of art, collections in illustration of the progress of the arts, sciences, or manufactures, photographs, works in terra cotta, porcelain, pottery, or porcelain, antiquities and artistic copies thereof in metal or other material, imported in good faith for exhibition at a fixed place by any State or by any society or institution established for the encouragement of the arts, science, or education, or for a municipal corporation, and all like articles imported in good faith by any society or association, or for a municipal corporation for the purpose of erecting a public monument, and not intended for sale, nor for any other purpose than herein expressed, but bonds shall be given under such rules and regulations as the Secretary of the Treasury may prescribe, for the payment of lawful duties which may accrue should any of the articles aforesaid be sold, transferred, or used contrary to this provision, and such articles shall be subject, at any time, to examination and inspection by the proper officer of the customs: Provided, That the privileges of this and the preceding section shall not be allowed to associations or corporations engaged in or connected with business of a private or commercial character.

703 Works of art, the production of American artists residing temporarily abroad, or other works of art, including pictorial paintings on glass, imported expressly for presentation to a national institution, or to any State or municipal corporation, or incorporated religious society, college, or other public institution, except stained or painted window glass, or stained or painted glass windows; but such exemption shall be subject to such regulations as the Secretary of the Treasury may prescribe.

704 Yarns.

705 Zaffer.

Sec. 3 That for the purpose of equalizing the trade of the United States with foreign countries, and their colonies, producing and exporting to this country the following articles:

## The American Tariff.

Argols, or crude tartar, or wine lees, crude, brandies, or other spirits manufactured or distilled from grain or other materials; champagne and all other sparkling wines; still wines and vermouth, paintings and statuary; or any of them, the President be, and he is hereby, authorized, as soon as may be after the passage of this Act, and from time to time thereafter, to enter into negotiations with the governments of those countries exporting to the United States the above-mentioned articles, or any of them, with a view to the arrangement of commercial agreements in which reciprocal and equivalent concessions may be secured in favor of the products and manufactures of the United States, and whenever the government of any country or colony, producing and exporting to the United States the above-mentioned articles, or any of them, shall enter into a commercial agreement with the United States, or make concessions in favor of the products or manufactures thereof, which, in the judgment of the President, shall be reciprocal and equivalent, he shall be, and he is hereby, authorized and empowered to suspend, during the time of such agreement or concession, by proclamation to that effect, the imposition and collection of the duties mentioned in this Act, on such article or articles so exported to the United States from such country or colony, and thereupon and thereafter the duties levied, collected and paid upon such article or articles shall be as follows, namely:

Argols, or crude tartar, or wine lees, crude, five per centum ad valorem.

Brandies or other spirits manufactured or distilled from grain or other materials, one dollar and seventy-five cents per proof gallon.

Champagne and all other sparkling wines, in bottles containing not more than one quart and more than one pint, six dollars per dozen, containing not more than one pint each and more than one-half pint, three dollars per dozen; containing one-half pint each or less, one dollar and fifty cents per dozen; in bottles or other vessels containing more than one quart each, in addition to six dollars per dozen bottles on the quantities in excess of one quart, at the rate of one dollar and ninety cents per gallon.

Still wines and vermouth, in casks, thirty-five cents per gallon; in bottles or jugs, per case of one dozen bottles or jugs containing each not more than one quart and more than one pint, or twenty-four bottles or jugs containing each not more than one pint, one dollar and twenty-five cents per case, and any excess beyond these quantities found in such bottles or jugs shall be subject to a duty of four cents per pint or fractional part thereof, but no separate or additional duty shall be assessed upon the bottles or jugs.

Paintings in oil or water colors, pastels, pen and ink drawings, and statuary, fifteen per centum ad valorem.

The President shall have power, and it shall be his duty, whenever he shall be satisfied that any such agreement in this Section mentioned is not being fully executed by the Government with which it shall have been made, to revoke such suspension and notify such Government thereof.

And it is further provided that with a view to secure reciprocal trade with countries producing the following articles, whenever and so often as the President shall be satisfied that the Government of any country, or colony of such Government, producing and exporting directly or indirectly to the United States, coffee, tea, and tonquin, tonqua or tonka beans, and vanilla beans, or any of such articles, imposes duties or other exactions upon the agricultural, manufactured, or other products of the United States, which, in view of the introduction of such coffee, tea, and tonquin, tonqua or tonka beans, and vanilla beans, into the United States, as in this Act hereinbefore provided for, he may deem to be reciprocally unequal and unreasonable, he shall have the power and it shall be his duty to suspend, by proclamation to that effect, the provisions of this Act relating to the free introduction of such coffee, tea, and tonquin, tonqua or tonka beans, and vanilla beans, of the products of such country or colony for such time as he shall deem just, and in such case and during such suspension duties shall be levied, collected, and paid upon coffee, tea, and tonquin, tonqua or tonka beans, and vanilla beans, the products or exports, direct or indirect, from such designated country, as follows:

On coffee, three cents per pound.

On tea, ten cents per pound.

On tonquin, tonqua, or tonka beans, fifty cents per pound; vanilla beans, two dollars per pound; vanilla beans, commercially known as cuts, one dollar per pound.

Sec. 4. That whenever the President of the United States, by

# The Robert Mitchell Co., Limited

MONTREAL

MANUFACTURERS OF

## GAS and ELECTRIC LIGHT FIXTURES

Engineers', Plumbers', Gas and Steamfitters'  
SUPPLIES

Write for Catalogue and Prices.

Gas Meters.

WRITE TO

## Mica Boiler Covering Co. Limited

FOR PARTICULARS AND SAMPLES

LIMITED

—OF—

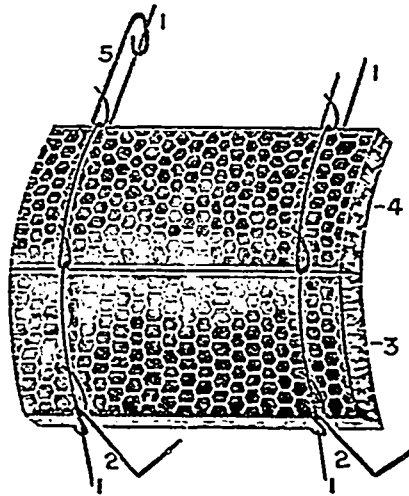

MICA BOILER COVERING,  
MICA PIPE COVERING,  
MICA SECTIONAL COVERING  
MICA CEMENT,

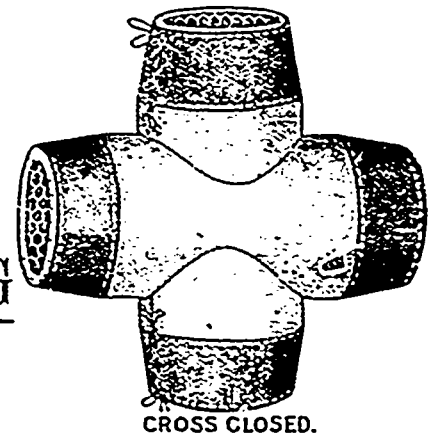

CROSS CLOSED.

Engine Packings, Oils, Waste, Engineers' Supplies.

Address **Mica Boiler Covering Co. Limited,**

86-92 Ann Street,  
MONTREAL.

UNION BANK CHAMBERS, 19 WELLINGTON ST. W.,  
TORONTO.

24 Old Broad St.,  
LONDON, ENG.

When writing to Advertisers kindly mention THE CANADIAN MANUFACTURER.

## The American Tariff.

and with the advice and consent of the Senate, with a view to secure reciprocal trade with foreign countries, shall, within the period of two years from and after the passage of this Act, enter into commercial treaty or treaties with any other country or countries concerning the admission into such country or countries of the goods, wares, and merchandise of the United States and their use and disposition therein, deemed to be for the interests of the United States, and such treaty or treaties, in consideration of the advantages accruing to the United States therefrom, shall provide for the reduction during a specified period, not exceeding five years, of the duties imposed by this Act, to the extent of not more than twenty per centum thereof, upon such goods, wares, or merchandise as may be designated therein of the country or countries with which such treaty or treaties shall be made as in this section provided for; or shall provide for the transfer during such period from the dutiable list of this Act to the free list thereof of such goods, wares, and merchandise, being the natural product of such foreign country or countries and not of the United States; or shall provide for the retention upon the free list of this Act during a specified period, not exceeding five years, of such goods, wares and merchandise now included in said free list as may be designated therein; and when any such treaty shall have been duly ratified by the Senate and approved by Congress, and public proclamation made accordingly, then and thereafter the duties which shall be collected by the United States upon any of the designated goods, wares, and merchandise from the foreign country with which such treaty has been made shall, during the period provided for, be the duties specified and provided for in such treaty, and none other.

Sec. 5. That whenever any country, dependency, or colony shall pay or bestow, directly or indirectly, any bounty or grant upon the exportation of any article or merchandise from such country, dependency, or colony, and such article or merchandise is dutiable under the provisions of this Act, then upon the importation of any such article or merchandise into the United States, whether the same shall be imported directly from the country of production or otherwise, and whether such article or merchandise is imported in the same condition as when exported from the country of production or has been changed in condition by remanufacture or otherwise, there shall be levied and paid, in all such cases, in addition to the duties otherwise imposed by this Act, an additional duty equal to the net amount of such bounty or grant, however, the same be paid or bestowed. The net amount of all such bounties or grants shall be from time to time ascertained, determined and declared by the Secretary of the Treasury, who shall make all needful regulations for the identification of such articles and merchandise and for the assessment and collection of such additional duties.

Sec. 6. That there shall be levied, collected, and paid on the importation of all raw or unmanufactured articles, not enumerated or provided for in this Act, a duty of ten per centum ad valorem, and on all articles manufactured, in whole or in part, not provided for in this Act, a duty of twenty per centum ad valorem.

Sec. 7. That each and every imported article, not enumerated in this Act, which is similar, either in material, quality, texture or the use to which it may be applied, to any article enumerated in this Act as chargeable with duty, shall pay the same rate of duty which is levied on the enumerated article which it most resembles in any of the particulars before mentioned; and if any non-enumerated article equally resembles two or more enumerated articles on which different rates of duty are chargeable, there shall be levied on such non-enumerated articles the same rate of duty as is chargeable on the article which it resembles paying the highest rate of duty; and on articles not enumerated, manufactured of two or more materials, the duty shall be assessed at the highest rate at which the same would be chargeable if composed wholly of the component material thereof of chief value; and the words "component material of chief value" wherever used in this Act, shall be held to mean that component material which shall exceed in value any other single component material of the article; and the value of each component material shall be determined by the ascertained value of such material in its condition as found in the article. If two or more rates of duty shall be applicable to any imported article, it shall pay duty at the highest of such rates.

Sec. 8. That all articles of foreign manufacture, such as are usually or ordinarily marked, stamped, branded, or labelled,

## The American Tariff.

and all packages containing such or other imported articles, shall, respectively, be plainly marked, stamped, branded, or labelled in legible English words in a conspicuous place, so as to indicate the country of their origin and the quantity of their contents; and until so marked, stamped, branded, or labelled they shall not be delivered to the importer. Should any article of imported merchandise be marked, stamped, branded, or labelled, so as to indicate a quantity, number, or measurement in excess of the quantity, number, or measurement actually contained in such article, no delivery of the same shall be made to the importer until the mark, stamp, brand, or label, as the case may be, shall be changed so as to conform to the facts of the case.

Sec. 9. That section thirty-three hundred and forty-one of the Revised Statutes of the United States be, and hereby is, amended to read as follows:

"Sec. 3341. The Commissioner of Internal Revenue shall cause to be prepared, for the payment of such tax, suitable stamps denoting the amount of tax required to be paid on the hogshead, barrels, and halves, thirds, quarters, sixths, and eighths of a barrel of such fermented liquors (and shall also cause to be prepared suitable permits for the purpose hereinafter mentioned), and shall furnish the same to the collectors of internal revenue, who shall each be required to keep on hand at all times a sufficient supply of permits and a supply of stamps equal in amount to two months' sales thereof, if there be any brewery or brewery warehouse in his district; and such stamps shall be sold, and permits granted and delivered by such collectors, only to the brewers of their district, respectively.

"Such collectors shall keep an account of the number of permits delivered and of the number and value of the stamps sold by them to each brewer.

Sec. 10. That section thirty-three hundred and ninety-four of the Revised Statutes of the United States, as amended, be and the same is hereby, further amended, so as to read as follows:

"Upon cigars which shall be manufactured and sold, or removed for consumption or sale, there shall be assessed and collected the following taxes, to be paid by the manufacturer thereof: On cigars of all descriptions made of tobacco, or any substitute therefor, and weighing more than three pounds per thousand, three dollars per thousand; on cigars, made of tobacco or any substitute therefor, and weighing not more than three pounds per thousand, one dollar per thousand; on cigarettes, made of tobacco, or any substitute therefor, and weighing more than three pounds per thousand, three dollars per thousand; on cigarettes, made of tobacco, or any substitute therefor, and weighing not more than three pounds per thousand, one dollar per thousand: Provided, That all rolls of tobacco, or any substitute therefor, wrapped with tobacco, shall be classed as cigars, and all rolls of tobacco, or any substitute therefor, wrapped in paper or any substance other than tobacco, shall be classed as cigarettes.

"And the Commissioner of Internal Revenue, with the approval of the Secretary of the Treasury, shall provide dies and adhesive stamps for cigars weighing not more than three pounds per thousand. Provided, That such stamps shall be in denominations of ten, twenty, fifty, and one hundred, and the laws and regulations governing the packing and removal for sale of cigarettes, and the affixing and cancelling of the stamps on the packages thereof, shall apply to cigars weighing not more than three pounds per thousand.

"None of the packages of smoking tobacco and fine-cut chewing tobacco and cigarettes prescribed by law shall be permitted to have packed in, or attached to, or connected with them, any article or thing whatsoever, other than the manufacturers' wrappers and labels, the internal revenue stamp and the tobacco or cigarettes, respectively, put up therein, on which tax is required to be paid under the internal revenue laws; nor shall there be affixed to, or branded, stamped, marked, written, or printed upon, said packages, or their contents, any promise or offer of, or any order or certificate for, any gift, prize, premium, payment, or reward.

Sec. 11. That no article of imported merchandise which shall copy or simulate the name or trade-mark of any domestic manufacture or manufacturer, or which shall bear a name or mark, which is calculated to induce the public to believe that the article is manufactured in the United States, shall be admitted to entry at any custom-house of the United States. And in order to aid the officers of the customs in enforcing this prohibition, any domestic manufacturer who has adopted trade-marks may require his name and residence and a description of his trade-marks to be recorded

# Bellhouse, Dillon & Co.

SOLE AGENTS IN CANADA FOR

**THE WEST INDIES CHEMICAL WORKS, Limited,**  
SPANISH TOWN, JAMAICA, W. I.

**PURE  
EXTRACTS**

Trade Mark



ALLIGATOR BRAND

**LOGWOOD**

FOR COTTON, WOOL and SILK.

Write for Samples and Prices.

Toronto Office—30 Wellington Street East.

30 St. Francois Xavier St., - **MONTREAL.**

New York Office, 20 Cedar Street.

**HAMILTON COTTON CO.,**  
HAMILTON, ONTARIO.

**Yarn Manufacturers,**  
**DYERS AND BLEACHERS.**

Warp Yarns of all descriptions, in Skein, Chain or on Beams.  
Hosiery Yarns in single or double, in Cop, Skein or Cone.  
Yarns of all kinds for Manufacturers' use.

**Twines, Lampwicks, Webbing, Etc.**

Dyeing of all Colors, including **GENUINE FAST BLACK.**

# ANILINES

**St. Denis Dyestuff and Chemical Co.,**  
(A. POIRRIER), of Paris, France.  
Manufacturers of

Aniline Colors, Aniline Oil and Salt, Archil Extracts  
Cudbear, Cachou de Laval, Thiocatechines, etc.

A Complete Assorted Stock of the above always on hand.

**W. T. Benson & Co.,**

Sole Agents for Canada.

164 St. James St., MONTREAL.

Twenty-eighth Annual Report  
OF

## The Economical

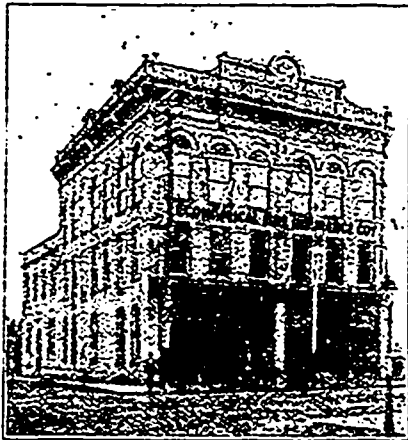

**Fire Insurance Company of Berlin**

For the Year ending December 31, 1899.

Total Net Assets ... \$300,089 22	Amount at Risk ... \$15,307,774 51
Net Cash Assets ... 114,333 87	Government Deposit ... 36,300 00

**BOARD OF DIRECTORS**

John Fennell ... Berlin	L. J. Breithaupt, Pres. Breit-
G. Lang, Pres. Lang Tang Co. ...	haupt Leather Co. ... Berlin
W. H. Bowby, Q.C. ...	P. Jacobi ... Toronto
Fr. Snyder ...	Hon. Sam. Merner ... Berlin
H. Knell ...	G. Pabst ... Hespeler
J. A. Mackie, J.P. ...	Frank Turner, C.E. ... Toronto
H. L. Janzen ...	Geo. Pattinson, Woolen Mfr. Preston
P. S. Lautenschlager ...	Jos. E. Seagram, M.P. ... Waterloo

**JOHN FENNEL, Pres.**  
**W. H. SCHMALZ, Secretary.**

**G. LANG, Vice-Pres.**  
**HUGO KRANZ, Manager.**

# BLACK IS BLACK

**Extra C is our best grade. We cannot make anything better than the best. You cannot buy anything better, try where you will. When you buy, see that our Trade Mark and grade are stamped on it and quality will be there.**

**D. K. McLAREN**

Mfr. "GENUINE OAK" BELTING

88 Bay St., TORONTO

Factory, MONTREAL

When writing to Advertisers kindly mention THE CANADIAN MANUFACTURER.

## The American Tariff.

in books which shall be kept for that purpose in the Department of the Treasury, under such regulations as the Secretary of the Treasury shall prescribe, and may furnish to the Department facsimiles of such trade-marks; and thereupon, the Secretary of the Treasury shall cause one or more copies of the same to be transmitted to each collector or other proper officer of the customs.

Sec. 12. That all materials of foreign production which may be necessary for the construction of vessels built in the United States for foreign account and ownership, or for the purpose of being employed in the foreign trade, including the trade between the Atlantic and Pacific ports of the United States, and all such materials necessary for the building of their machinery, and all articles necessary for their outfit and equipment, may be imported in bond under such regulations as the Secretary of the Treasury may prescribe, and upon proof that such materials have been used for such purposes no duties shall be paid thereon. But vessels receiving the benefit of this section shall not be allowed to engage in the coastwise trade of the United States more than two months in any one year except upon the payment to the United States of the duties of which a rebate is herein allowed: Provided, That vessels built in the United States for foreign account and ownership shall not be allowed to engage in the coastwise trade of the United States.

Sec. 13. That all articles of foreign production needed for the repair of American vessels engaged in foreign trade, including the trade between the Atlantic and Pacific ports of the United States, may be withdrawn from bonded warehouses free of duty, under such regulations as the Secretary of the Treasury may prescribe.

Sec. 14. That the sixteenth section of an Act entitled "An Act to remove certain burdens on the American merchant marine and encourage the American foreign carrying trade, and for other purposes," approved June twenty-sixth, eighteen hundred and eighty-four, be amended so as to read as follows:

"Sec. 16. That all articles of foreign or domestic production needed and actually withdrawn from bonded warehouses and bonded manufacturing warehouses for supplies (not including equipment) of vessels of the United States engaged in foreign trade, or in trade between the Atlantic and Pacific ports of the United States, may be so withdrawn from said bonded warehouses free of duty or of internal-revenue tax, as the case may be, under such regulations as the Secretary of the Treasury may prescribe; but no such articles shall be landed at any port of the United States."

Sec. 15. That all articles manufactured in whole or in part of imported materials, or of materials subject to internal-revenue tax, and intended for exportation without being charged with duty, and without having an internal-revenue stamp affixed thereto, shall under such regulations as the Secretary of the Treasury may prescribe, in order to be so manufactured and exported, be made and manufactured in bonded warehouses similar to those known and designated in Treasury Regulations as bonded warehouses, class six: Provided, That the manufacturer of such articles shall first give satisfactory bonds for the faithful observance of all the provisions of law and of such regulations as shall be prescribed by the Secretary of the Treasury: Provided further, That the manufacture of distilled spirits from grain, starch, molasses or sugar, including all dilutions or mixtures of them or either of them, shall not be permitted in such manufacturing warehouses.

Whenever goods manufactured in any bonded warehouse established under the provisions of the preceding paragraph shall be exported directly therefrom or shall be duly laden for transportation and immediate exportation under the supervision of the proper officer who shall be duly designated for that purpose such goods shall be exempt from duty and from the requirements relating to revenue stamps.

Any material used in manufacture of such goods, and any packages, coverings, vessels, brands, and labels used in putting up the same may, under the regulations of the Secretary of the Treasury, be conveyed without the payment of revenue tax or duty into any bonded manufacturing warehouse, and imported goods may, under the aforesaid regulations, be transferred without the exaction of duty from any bonded warehouse into any bonded manufacturing warehouse; but this privilege shall not be held to apply to implements, machinery, or apparatus to be used in the construction or repair of any bonded manufacturing warehouse or for the prosecution of the business carried on therein.

No articles or materials received into such bonded manufac-

## The American Tariff.

turing warehouse shall be withdrawn or removed therefrom except for direct shipment and exportation or for transportation and immediate exportation in bond under the supervision of the officer duly designated therefor by the collector of the port, who shall certify to such shipment and exportation, or lading for transportation, as the case may be, describing the articles by their mark or otherwise, the quantity, the date of exportation, and the name of the vessel. All labor performed and services rendered under these provisions shall be under the supervision of a duly designated officer of the customs and at the expense of the manufacturer.

A careful account shall be kept by the collector of all merchandise delivered by him to any bonded manufacturing warehouse, and a sworn monthly return, verified by the customs officers in charge, shall be made by the manufacturers, containing a detailed statement of all imported merchandise used by him in the manufacture of exported articles.

Before commencing business the proprietor of any manufacturing warehouse shall file with the Secretary of the Treasury a list of all the articles intended to be manufactured in such warehouse, and state the formula of manufacture and the names and quantities of the ingredients to be used therein.

Articles manufactured under these provisions may be withdrawn under such regulations as the Secretary of the Treasury may prescribe for transportation and delivery into any bonded warehouse at an exterior port for the sole purpose of immediate export therefrom.

The provisions of Revised Statutes thirty-four hundred and thirty-three shall, so far as may be practicable, apply to any bonded manufacturing warehouse established under this Act and to the merchandise conveyed therein.

Sec. 16. That all persons are prohibited from importing into the United States from any foreign country any obscene book, pamphlet, paper, writing, advertisement, circular, print, picture, drawing, or other representation, figure or image on or of paper or other material, or any cast, instrument, or other article of an immoral nature, or any drug or medicine or any article whatever for the prevention of conception or for causing unlawful abortion, or any lottery ticket or any advertisement of any lottery. No such articles, whether imported separately or contained in packages with other goods entitled to entry, shall be admitted to entry; and all such articles shall be proceeded against, seized, and forfeited by due course of law. All such prohibited articles and the packages in which they are contained in the course of importation shall be detained by the officer of customs, and proceedings taken against the same as hereinafter prescribed, unless it appears to the satisfaction of the collector of customs that the obscene articles contained in the package were enclosed therein without the knowledge or consent of the importer, owner, agent, or consignee: Provided, That the drugs hereinbefore mentioned, when imported in bulk and not put up for any of the purposes hereinbefore specified, are excepted from the operation of this section.

Sec. 17. That whoever, being an officer, agent, or employee of the Government of the United States, shall knowingly aid or abet any person engaged in any violation of any of the provisions of law prohibiting importing, advertising, dealing in, exhibiting, or sending or receiving by mail obscene or indecent publications or representations, or means for preventing conception or procuring abortion, or other articles of indecent or immoral use or tendency, shall be deemed guilty of a misdemeanor, and shall for every offense be punishable by a fine of not more than five thousand dollars, or by imprisonment at hard labor for not more than ten years, or both.

Sec. 18. That any judge of any district or circuit court of the United States, within the proper district, before whom complaint in writing of any violation of the two preceding sections made, to the satisfaction of such judge, and founded on knowledge or belief, and if upon belief, setting forth the grounds of such belief, and supported by oath or affirmation of the complainant, may issue, conformably to the Constitution, a warrant directed to the marshal or any deputy marshal in the proper district, directing him to search for, seize, and take possession of any such article or thing mentioned in the two preceding sections, and to make due and immediate return thereof to the end that the same may be condemned and destroyed by proceedings, which shall be conducted in the same manner as other proceedings in the case of municipal seizure, and with the same right of appeal or writ of error.

Sec. 19. That machinery for repair may be imported into the United States without payment of duty, under bond, to be given in double the appraised value thereof, to be with-





## Circular Wheel Brushes

We will be pleased to give quotations upon receipt of specification giving diameter and width of block, length, quality and kind of material. We keep all kinds of bristles, brass and steel wire in stock, being the largest assortment in Canada.

# Boeckh's Brushes and Brooms

are made to last and have a record of always attaining their aim.

## Factory or Warehouse Brooms

Contain only the best selected heavy brush, and are sewn with heavy twine, making them the strongest broom on the market. It is sure to give you satisfaction.

WRITE FOR OUR PRICES.

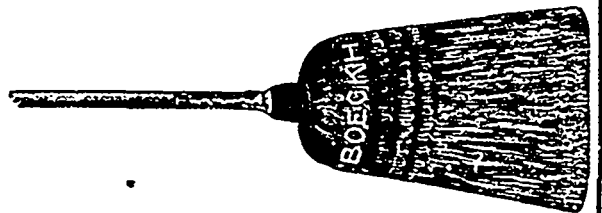

80 YORK STREET,  
TORONTO

# The Wm. Cane & Son Mfg. Co.

OF NEWMARKET, Limited.

MANUFACTURERS OF

## Pails, Tubs, Pickle Kegs, Syrup Kegs,

LARD TUBS, LARD PAILS,

## CANDY PAILS, CLOTHES PINS, WASHBOARDS

ALSO

## SASH; BLINDS, MOULDINGS

Base and Casings and Dressed Lumber of all kinds.

When writing to Advertisers kindly mention THE CANADIAN MANUFACTURER.

## The American Tariff.

- drawn and exported after said machinery shall have been repaired; and the Secretary of the Treasury is authorized and directed to prescribe such rules and regulations as may be necessary to protect the revenue against fraud and secure the identity and character of all such importations when again withdrawn and exported, restricting and limiting the export and withdrawal to the same port of entry where imported, and also limiting all bonds to a period of time of not more than six months from the date of the importation.
- Sec. 20. That the produce of the forests of the State of Maine upon the Saint John River and its tributaries, owned by American citizens, and sawed or hewed in the Province of New Brunswick by American citizens, the same being otherwise unmanufactured in whole or in part, which is now admitted into the ports of the United States free of duty, shall continue to be so admitted, under such regulations as the Secretary of the Treasury shall from time to time prescribe.
- Sec. 21. That the produce of the forests of the State of Maine upon the Saint Croix River and its tributaries owned by American citizens, and sawed or hewed in the Province of New Brunswick by American citizens, the same being otherwise unmanufactured in whole or in part, shall be admitted into the ports of the United States free of duty, under such regulations as the Secretary of the Treasury shall from time to time prescribe.
- Sec. 22. That a discriminating duty of ten per centum ad valorem, in addition to the duties imposed by law, shall be levied, collected, and paid on all goods, wares, or merchandise which shall be imported in vessels not of the United States or which being the production or manufacture of any foreign country or contiguous to the United States, shall come into the United States from such contiguous country; but this discriminating duty shall not apply to goods, wares, or merchandise which shall be imported in vessels not of the United States, entitled at the time of such importation by treaty or convention to be entered in the ports of the United States on payment of the same duties as shall then be payable on goods, wares, and merchandise imported in vessels of the United States, nor to such foreign products or manufactures as shall be imported from such contiguous countries in the usual course of strictly retail trade.
- Sec. 23. That no goods, wares, or merchandise, unless in cases provided for by treaty, shall be imported into the United States from any foreign port or place, except in vessels of the United States, or in such foreign vessels as truly and wholly belong to the citizens or subjects of that country of which the goods are the growth, production or manufacture, or from which such goods, wares, or merchandise can only be, or most usually are, first shipped for transportation. All goods, wares, or merchandise imported contrary to this section, and the vessel wherein the same shall be imported, together with her cargo, tackle, apparel and furniture, shall be forfeited to the United States; and such goods, wares, or merchandise, ship, or vessel, and cargo shall be liable to be seized, prosecuted, and condemned in like manner, and under the same regulations, restrictions, and provisions as have been heretofore established for the recovery, collection, distribution, and remission of forfeitures to the United States by the several revenue laws.
- Sec. 24. That the preceding section shall not apply to vessels or goods, wares or merchandise imported in vessels of a foreign nation which does not maintain a similar regulation against vessels of the United States.
- Sec. 25. That the importation of neat cattle and the hides of neat cattle from any foreign country into the United States is prohibited: Provided that the operation of this section shall be suspended as to any foreign country or countries, or any parts of such country or countries, whenever the Secretary of the Treasury shall officially determine, and give public notice thereof that such importation will not tend to the introduction or spread of contagious or infectious diseases among the cattle of the United States; and the Secretary of the Treasury is hereby authorized and empowered, and it shall be his duty, to make all necessary orders and regulations to carry this section into effect, or to suspend the same as herein provided, and to send copies thereof to the proper officers in the United States, and to such officers or agents of the United States in foreign countries as he shall judge necessary.
- Sec. 26. That any person convicted of a wilful violation of any of the provisions of the preceding section shall be fined not exceeding five hundred dollars, or imprisoned not exceeding one year, or both, in the discretion of the court.
- Sec. 27. That upon the reimportation of articles once exported, of the growth, product, or manufacture of the United States upon which no internal tax has been assessed or paid, or

## The American Tariff.

- upon which such tax has been paid and refunded by allowance or drawback, there shall be levied, collected and paid a duty equal to the tax imposed by the Internal revenue laws upon such articles, except articles manufactured in bonded warehouses and exported pursuant to law, which shall be subject to the same rate of duty as if originally imported.
- Sec. 28. That whenever any vessel laden with merchandise, in whole or in part subject to duty, has been sunk in any river, harbor, bay, or waters subject to the jurisdiction of the United States, and within its limits, for the period of two years, and is abandoned by the owner thereof, any person who may raise the vessel shall be permitted to bring any merchandise recovered therefrom into the port nearest to the place where such vessel was so raised free from the payment of any duty thereupon, but under such regulations as the Secretary of the Treasury may prescribe.
- Sec. 29. That the works of manufacturers engaged in smelting or refining metals, or both smelting and refining, in the United States may be designated as bonded warehouses under such regulations as the Secretary of the Treasury may prescribe: Provided that such manufacturers shall first give satisfactory bonds to the Secretary of the Treasury. Ores or metals in any crude form requiring smelting or refining to make them readily available in the arts, imported into the United States to be smelted or refined, and intended to be exported in a refined but unmanufactured state, shall, under such rules as the Secretary of the Treasury may prescribe, and under the direction of the proper officer, be removed in original packages or in bulk from the vessel or other vehicle on which they have been imported, or from the bonded warehouse in which the same may be, into the bonded warehouse in which such smelting or refining, or both, may be carried on, for the purpose of being smelted or refined, or both, without payment of duties thereon, and may there be smelted or refined, together with other metals of home or foreign production: Provided, That each day a quantity of refined metal equal to ninety per centum of the amount of imported metal smelted or refined that day shall be set aside, and such metal so set aside shall not be taken from said works except for transportation to another bonded warehouse or for exportation, under direction of the proper officer having charge thereof as aforesaid, whose certificate, describing the articles by their marks or otherwise, the quantity, the date of importation, and the name of vessel or other vehicle by which it was imported, with such additional particulars as may from time to time be required, shall be received by the collector of customs as sufficient evidence of the exportation of the metal, or it may be removed under such regulations as the Secretary of the Treasury may prescribe, upon entry and payment of duties, for domestic consumption, and the exportation of the ninety per centum of metals hereinbefore provided for shall entitle the ores and metals imported under the provisions of this section to admission without payment of the duties thereon: Provided further, that in respect to lead ores imported under the provisions of this section the refined metal set aside shall either be re-exported or the regular duties paid thereon within six months from the date of the receipt of the ore. All labor performed and services rendered under these regulations shall be under the supervision of an officer of the customs, to be appointed by the Secretary of the Treasury, and at the expense of the manufacturer.
- Sec. 30. That where imported materials on which duties have been paid are used in the manufacture of articles manufactured or produced in the United States, there shall be allowed on the exportation of such articles a drawback equal in amount to the duties paid on the materials used, less one per centum of such duties: Provided, That when the articles exported are made in part from domestic materials the imported materials, or the parts of the articles made from such materials shall so appear in the completed articles that the quantity or measure thereof may be ascertained: And provided further, That the drawback on any article allowed under existing law shall be continued at the rate herein provided. That the imported materials used in the manufacture or production of articles entitled to drawback of customs duties when exported, shall, in all cases where drawback of duties paid on such materials is claimed, be identified, the quantity of such materials used and the amount of duties paid thereon shall be ascertained, the facts of the manufacture or production of such articles in the United States and their exportation therefrom shall be determined, and the drawback due thereon shall be paid to the manufacturer, producer, or

# THE NOVA SCOTIA STEEL CO., LIMITED

MANUFACTURERS OF

## BRIGHT COMPRESSED STEEL SHAFTING

FROM  $\frac{1}{2}$  TO 6 INCHES IN DIAMETER. GUARANTEED STRAIGHT AND TRUE TO WITHIN  $\frac{1}{32}$  OF AN INCH.

Spring, Reeled Machinery, Tire, Toe Caulk, Sleigh Shoe, Angles, Special Sections and all Merchant Bar Steel. Sheet Steel up to 48 Inches wide.

**RAILWAY AND ELECTRIC RAILWAY CAR AXLES**

**FISH PLATES, SPIKES AND TRACK BOLTS**

Tee Rails, 12, 18, 24 and 28 lbs. per yard

**HEAVY FORGINGS a SPECIALTY.**

**"FERRONA" PIG IRON, For Foundry Use.**

Works—NEW GLASGOW, N.S., and FERRONA, N.S.

Head Office—NEW GLASGOW, NOVA SCOTIA

## GALT Machine Knife Works

PETER HAY,



GALT, ONT.

Manufacturers of Every Description of.....

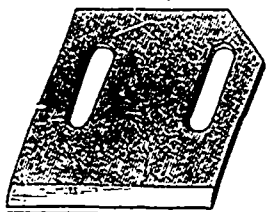

### KNIVES,

For Wood-Working, Paper Cutting and Leather-Splitting Machines

BARK KNIVES  
PULP KNIVES  
RAQ KNIVES  
Etc., Etc.



Shear Blades, Straw Knives, Paper Knives, Etc., Etc.

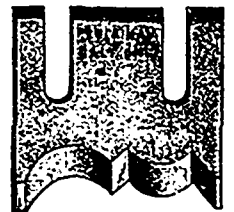

Quality Guaranteed.

Special Knives Made to Order.

Send for Price List

## DOMINION BRIDGE CO., Limited,



MONTREAL AND  
LACHINE LOCKS, P.Q.

Steel Bridges for Railways and Highways,  
Steel Piers and Trestles, Steel Water Towers and Tanks,  
Steel Roofs, Girders, Beams, Columns for Buildings.

A large Stock of ROLLED STEEL BEAMS, JOISTS, GIRDERS, CHANNELS, ANGLES, TEES, Z BARS and PLATES

Tables, giving Sizes and Strength of Rolled Beams on application.

**ALWAYS ON HAND** IN LENGTHS TO THIRTY-FIVE FEET.

Post Office Address,  
MONTREAL.

**GEORGE E. EVANS,** Agent, 38 Canada Life Building,  
TORONTO, ONT.

When writing to Advertisers kindly mention THE CANADIAN MANUFACTURER.

## The American Tariff.

exporter, to the agent of either, or to the person to whom such manufacturer, producer, exporter or agent shall in writing order such drawback paid, under such regulations as the Secretary of the Treasury shall prescribe.

- Sec. 31. That all goods, wares, articles, and merchandise manufactured wholly or in part in any foreign country by convict labor shall not be entitled to entry at any of the ports of the United States, and the importation thereof is hereby prohibited, and the Secretary of the Treasury is authorized and directed to prescribe such regulations as may be necessary for the enforcement of this provision.
- Sec. 32. That sections seven and eleven of the Act entitled "An Act to simplify the laws in relation to the collection of the revenues," approved June tenth, eighteen hundred and ninety, be, and the same are hereby, amended so as to read as follows:
- Sec. 7. That the owner, consignee or agent of any imported merchandise which has been actually purchased, may at the time when he shall make and verify his written entry of such merchandise, but not afterwards, make such addition in the entry to the cost or value given in the invoice or pro-forma invoice or statement in form of an invoice, which he shall produce with his entry, as in his opinion may raise the same to the actual market value or wholesale price of such merchandise at the time of exportation to the United States, in the principal markets of the country from which the same has been imported; but no such addition shall be made upon entry to the invoice value of any imported merchandise obtained otherwise than by actual purchase, and the collector within whose district any merchandise may be imported or entered, whether the same has been actually purchased or procured otherwise than by purchase, shall cause the actual market value or wholesale price of such merchandise to be appraised; and if the appraised value of any article of imported merchandise subject to an ad valorem duty or to a duty based upon or regulated in any manner by the value thereof shall exceed the value declared in the entry, there shall be levied, collected and paid, in addition to the duties imposed by law on such merchandise, an additional duty of one per centum of the total appraised value thereof for each one per centum that such appraised value exceeds the value declared in the entry, but the additional duties shall only apply to the particular article or articles in each invoice that are so undervalued, and shall be limited to fifty per centum of the appraised value of such article or articles. Such additional duties shall not be construed to be penal, and shall not be remitted, nor payment thereof in any way avoided, except in cases arising from a manifest clerical error, nor shall they be refunded in case of exportation of the merchandise, or on any other account, nor shall they be subject to the benefit of drawback: Provided, That if the appraised value of any merchandise shall exceed the value declared in the entry by more than fifty per centum, except when arising from a manifest clerical error, such entry shall be held to be presumptively fraudulent, and the collector of customs shall seize such merchandise and proceed as in case of forfeiture for violation of the customs laws, and in any legal proceeding that may result from such seizure, the undervaluation, as shown by the appraisal, shall be presumptive evidence of fraud, and the burden of proof shall be on the claimant to rebut the same and forfeiture shall be adjudged unless he shall rebut such presumption of fraudulent intent by sufficient evidence. The forfeiture provided for in this section shall apply to the whole of the merchandise, or the value thereof, in the case or package containing the particular article or articles in each invoice which are undervalued: Provided further, That all additional duties, penalties or forfeitures applicable to merchandise entered by a duly certified invoice, shall be alike applicable to merchandise entered by a pro-forma invoice or statement in the form of an invoice, and no forfeiture or disability of any kind, incurred under the provisions of this section, shall be remitted or mitigated by the Secretary of the Treasury. The duty shall not, however, be assessed in any case upon an amount less than the invoice or entered value.
- Sec. 11. That, when the actual market value as defined by law, of any article of imported merchandise, wholly or partly

## The American Tariff.

manufactured and subject to an ad valorem duty, or to a duty based in whole or in part on value, cannot be otherwise ascertained to the satisfaction of the appraising officer, such officer shall use all available means in his power to ascertain the cost of production of such merchandise at the time of exportation to the United States, and at the place of manufacture; such cost of production to include the cost of materials and of fabrication, all general expenses covering each and every outlay of whatsoever nature incident to such production, together with the expense of preparing and putting up such merchandise ready for shipment, and an addition of not less than eight nor more than fifty per centum upon the total cost as thus ascertained; and in no case shall such merchandise be appraised upon original appraisal or reappraisal at less than the total cost of production as thus ascertained. It shall be lawful for appraising officers, in determining the dutiable value of such merchandise, to take into consideration the wholesale price at which such or similar merchandise is sold or offered for sale in the United States, due allowance being made for estimated duties thereon, the cost of transportation, insurance, and other necessary expenses from the place of shipment to the United States, and a reasonable commission, if any has been paid, not exceeding six per centum.

- Sec. 33. That on and after the day when this Act shall go into effect, all goods, wares and merchandise previously imported, for which no entry has been made, and all goods, wares, and merchandise previously entered without payment of duty and under bond for warehousing, transportation, or any other purpose, for which no permit of delivery to the importer or his agent has been issued, shall be subjected to duties imposed by this Act and to no other duty, upon the entry or the withdrawal thereof: Provided, That, when duties are based upon the weight of merchandise deposited in any public or private bonded warehouse, said duties shall be levied and collected upon the weight of such merchandise at the time of its entry.
- Sec. 34. That sections one to twenty-four, both inclusive, of an Act entitled "An Act to reduce taxation, to provide revenue for the Government, and for other purposes," which became a law on the twenty-eighth day of August, eighteen hundred and ninety-four, and all acts and parts of acts inconsistent with the provisions of this Act are hereby repealed, said repeal to take effect on and after the passage of this Act, but the repeal of existing laws or modifications thereof embraced in this Act shall not affect any act done, or any right accruing or accrued, or any suit or proceeding had or commenced in any civil cause before the said repeal or modifications; but all rights and liabilities under said laws shall continue and may be enforced in the same manner as if said repeal or modifications had not been made. Any offences committed and all penalties or forfeitures or liabilities incurred prior to the passage of this Act under any statute embraced in or changed, modified, or repealed by this Act may be prosecuted or punished in the same manner and with the same effects as if this Act had not been passed. All Acts of limitation, whether applicable to civil causes and proceedings or to the prosecution of offenses or for the recovery of penalties or forfeitures embraced in or modified, changed, or repealed by this Act shall not be affected thereby; and all suits, proceedings, or prosecutions, whether civil or criminal, for causes arising or acts done or committed prior to the passage of this Act may be commenced and prosecuted within the same time and with the same effect as if this Act had not been passed: And provided further, That nothing in this Act shall be construed to repeal the provisions of section three thousand and fifty-eight of the Revised Statutes as amended by the Act approved February twenty-third, eighteen hundred and eighty-seven, in respect to the abandonment of merchandise to underwriters or the salvors of property, and the ascertainment of duties thereon: And provided further, That nothing in this Act shall be construed to repeal or in any manner affect the sections numbered seventy-three, seventy-four, seventy-five, seventy-six, and seventy-seven of an Act entitled "An Act to reduce taxation, to provide revenue for the Government, and for other purposes," which became a law on the twenty-eighth day of August, eighteen hundred and ninety-four.



FOR  
**Mechanically Drying Everything**

THE F. D. CUMMER & SON CO.,  
HUNDREDS IN OPERATION. CLEVELAND, OHIO.

**THE BEST** *PIPE THREADING and CUTTING-OFF* **MACHINES**

Are Made by the **ARMSTRONG MFG. CO., BRIDGEPORT, CONN.**

Also Manufacturers of a FULL LINE of **ADJUSTABLE STOCKS and Dies** and Water, Gas and Steam Fitters' Tools.  
Send for Catalogue 27. Factory: BRIDGEPORT, CONN. New York Office: 139 CENTRE STREET.

**INGERSOLL-SERGEANT Rock Drills**  
FOR MINES, TUNNELS AND QUARRIES

**PISTON INLET Air Compressors** STRAIGHT LINE  
DUPLEX and COMPOUND.  
FOR ALL DUTIES.

**... COMPLETE MINE EQUIPMENT ...**

**JAMES COOPER MANUF'G CO., Limited, - 299 St. James St., Montreal.**

Other Offices - - - ROSSLAND, B.C. RAT PORTAGE, ONT. HALIFAX, N.S.

**CANADIAN RUBBER CO.,**

OF MONTREAL,

Manufacturers of High-Grade Rubber Goods  
of all Descriptions.



*BELTING, HOSE, PACKING,*  
*VALVES, BOOTS, Etc., Etc.*



Factories and Head Office. - - MONTREAL.  
Ontario Branch, - - - TORONTO.  
Western Branch, - - - WINNIPEG.

Orders Filled with Despatch from Head Office or Branch Warehouses.

**THE IMPERIAL OIL COMPANY, Limited:**

Highest Awards at the World's Fair, Chicago, upon

**Lubricating, Water White Illuminating Oils,  
Paraffine Wax, Etc.**

We manufacture all grades of oils, greases, soap stocks, candles, wool stocks, leather and tanners' oils, fuel gas, machinery, cylinder oils, &c. And solicit opportunity to compete against any oil on the market. Write for prices and samples.

Refineries at SARNIA and PETROLIA, CANADA. Merchandising Branches at:

HALIFAX, N. S. HAMILTON, ONT. QUEREQ, QUE. LONDON, ONT. TORONTO, ONT. WINNIPEG, MAN. ST. JOHN, N. B. GUELPH, ONT.  
MONTREAL, QUE. CHEATHAM, ONT. PETERBORO, ONT. VANCOUVER, B. C. MONCTON, N. B. STRATFORD, ONT. KINGSTON, ONT. WINDSOR, ONT.

When writing to Advertisers kindly mention THE CANADIAN MANUFACTURER.

# Index to American Tariff.

A	No. of Item.	No. of Item.	No. of Item.
Abortion, articles for causing, importa- tion prohibited.....sec. 16, 17, 18	292	Ambergris.....	471
Absinthe.....	292	oil, crude and rectified.....	628
Acetate, lead.....	69	Amberoid.....	476
Acetic acid.....	1	American:	
Acids:		artists, works of.....	702
acetic.....	1	fisheries, products of.....	626
arsenic.....	464	goods exported and returned.....	482
arsenious.....	464	goods exported and returned, inter- nal revenue tax on.....sec. 27	
benzolic.....	464	vessels built for foreign ownership, or for foreign trade.....sec. 12	
boracic.....	1	vessels, coal stores of.....	527
carbolic.....	464	Ammonia:	
chromic.....	1	carbonate of.....	513
citric.....	1	nitrate of.....	513
fluoric.....	504	sulphate of.....	513
gallic.....	1	Amylic alcohol.....	38
hydrochloric.....	464	Anatomy, preparations of.....	623
lactic.....	1	Anchors or parts of.....	127
marlic.....	464	Anchovies.....	148
nitric.....	464	Andfous.....	148
nitro-perlic.....	464	Angora goat, hair of.....	350, 354
not specially provided for.....	1	Angles, iron and steel.....	125
oxalic.....	464	Anhydrous boracic acid.....	11
phosphoric.....	464	Aniline:	
phthalic.....	464	arseniate of.....	499
picric.....	464	oil.....	629
prussic.....	464	salts.....	472
pyrroligenous.....	1	Animal bladders, integuments and in- testines.....	496
ricinoleic.....	1	Animal carbon.....	499
salicylic.....	1	Animals.....218, 219, 220, 221, 222, 473	474
silicic.....	464	for breeding purposes.....	473
sulpho-ricinoleic.....	1, 612	exhibition, etc.....	474
sulphuric.....	1, 612	for immigrants.....	474
tannic.....	1	racine.....	474
tartaric.....	1	hair of.....	378, 380, 381
valerianic.....	464	286, 337, 338, 350, 364, 450, 571	571
Acorns.....	464	Integuments and intestines of.....	496
Acorns.....	287, 491	live.....	218, 222
Administrative act amended.....	sec. 32	teams of.....	474
Agate buttons.....	474	wild, for exhibition, etc.....	474
Agate, manufactures of.....	115	Anise oil.....	626
Agates.....	475	seed.....	626
Agricultural drills.....	460	seed oil.....	626
Agriculture, Department of, seeds, etc. for.....	640	Anatto, and ex acis of.....	475
Alabaster, manufactures of.....	115	Anthracite coal.....	626
Albata.....	174	Anthracite coal.....	626
Albumen.....	245	Antifriction ball forgings.....	147
Albumenized paper.....	178	Antimony:	
Albums:		metal.....	173
autograph.....	404	ore.....	476
photograph.....	404	regulus of.....	173
scrap.....	404	sulphite of, crude.....	476
Alcohol, amylic.....	38	Antiquities, for exhibition.....	702
Alcoholic compounds.....	38	Anvils.....	142
Alcoholic preparations, medicinal.....	38	Apatite.....	477
perfumery.....	38	Apparatus:	
Ale.....	318, 319, 320, 321, 322, 323, 324, 325, 326, 327, 328, 329, 330, 331, 332, 333, 334, 335, 336, 337, 338, 339, 340, 341, 342, 343, 344, 345, 346, 347, 348, 349, 350, 351, 352, 353, 354, 355, 356, 357, 358, 359, 360, 361, 362, 363, 364, 365, 366, 367, 368, 369, 370, 371, 372, 373, 374, 375, 376, 377, 378, 379, 380, 381, 382, 383, 384, 385, 386, 387, 388, 389, 390, 391, 392, 393, 394, 395, 396, 397, 398, 399, 400, 401, 402, 403, 404, 405, 406, 407, 408, 409, 410, 411, 412, 413, 414, 415, 416, 417, 418, 419, 420, 421, 422, 423, 424, 425, 426, 427, 428, 429, 430, 431, 432, 433, 434, 435, 436, 437, 438, 439, 440, 441, 442, 443, 444, 445, 446, 447, 448, 449, 450, 451, 452, 453, 454, 455, 456, 457, 458, 459, 460, 461, 462, 463, 464, 465, 466, 467, 468, 469, 470, 471, 472, 473, 474, 475, 476, 477, 478, 479, 480, 481, 482, 483, 484, 485, 486, 487, 488, 489, 490, 491, 492, 493, 494, 495, 496, 497, 498, 499, 500, 501, 502, 503, 504, 505, 506, 507, 508, 509, 510, 511, 512, 513, 514, 515, 516, 517, 518, 519, 520, 521, 522, 523, 524, 525, 526, 527, 528, 529, 530, 531, 532, 533, 534, 535, 536, 537, 538, 539, 540, 541, 542, 543, 544, 545, 546, 547, 548, 549, 550, 551, 552, 553, 554, 555, 556, 557, 558, 559, 560, 561, 562, 563, 564, 565, 566, 567, 568, 569, 570, 571, 572, 573, 574, 575, 576, 577, 578, 579, 580, 581, 582, 583, 584, 585, 586, 587, 588, 589, 590, 591, 592, 593, 594, 595, 596, 597, 598, 599, 600, 601, 602, 603, 604, 605, 606, 607, 608, 609, 610, 611, 612, 613, 614, 615, 616, 617, 618, 619, 620, 621, 622, 623, 624, 625, 626, 627, 628, 629, 630, 631, 632, 633, 634, 635, 636, 637, 638, 639, 640, 641, 642, 643, 644, 645, 646, 647, 648, 649, 650, 651, 652, 653, 654, 655, 656, 657, 658, 659, 660, 661, 662, 663, 664, 665, 666, 667, 668, 669, 670, 671, 672, 673, 674, 675, 676, 677, 678, 679, 680, 681, 682, 683, 684, 685, 686, 687, 688, 689, 690, 691, 692, 693, 694, 695, 696, 697, 698, 699, 700, 701, 702, 703, 704, 705, 706, 707, 708, 709, 710, 711, 712, 713, 714, 715, 716, 717, 718, 719, 720, 721, 722, 723, 724, 725, 726, 727, 728, 729, 730, 731, 732, 733, 734, 735, 736, 737, 738, 739, 740, 741, 742, 743, 744, 745, 746, 747, 748, 749, 750, 751, 752, 753, 754, 755, 756, 757, 758, 759, 760, 761, 762, 763, 764, 765, 766, 767, 768, 769, 770, 771, 772, 773, 774, 775, 776, 777, 778, 779, 780, 781, 782, 783, 784, 785, 786, 787, 788, 789, 790, 791, 792, 793, 794, 795, 796, 797, 798, 799, 800, 801, 802, 803, 804, 805, 806, 807, 808, 809, 810, 811, 812, 813, 814, 815, 816, 817, 818, 819, 820, 821, 822, 823, 824, 825, 826, 827, 828, 829, 830, 831, 832, 833, 834, 835, 836, 837, 838, 839, 840, 841, 842, 843, 844, 845, 846, 847, 848, 849, 850, 851, 852, 853, 854, 855, 856, 857, 858, 859, 860, 861, 862, 863, 864, 865, 866, 867, 868, 869, 870, 871, 872, 873, 874, 875, 876, 877, 878, 879, 880, 881, 882, 883, 884, 885, 886, 887, 888, 889, 890, 891, 892, 893, 894, 895, 896, 897, 898, 899, 900, 901, 902, 903, 904, 905, 906, 907, 908, 909, 910, 911, 912, 913, 914, 915, 916, 917, 918, 919, 920, 921, 922, 923, 924, 925, 926, 927, 928, 929, 930, 931, 932, 933, 934, 935, 936, 937, 938, 939, 940, 941, 942, 943, 944, 945, 946, 947, 948, 949, 950, 951, 952, 953, 954, 955, 956, 957, 958, 959, 960, 961, 962, 963, 964, 965, 966, 967, 968, 969, 970, 971, 972, 973, 974, 975, 976, 977, 978, 979, 980, 981, 982, 983, 984, 985, 986, 987, 988, 989, 990, 991, 992, 993, 994, 995, 996, 997, 998, 999, 1000		

**FINELY LITHOGRAPHED - -**  
**AND**  
**- - DECORATED TINWARE**

Tea Chests, Tea Caddies, Biscuit Boxes, Shelf Cannisters. Cough Drops, Coffee, Spice, Mustard, Ointment and Baking Powder Tins. Show Cards, Blacking Boxes, Tobacco Boxes, Stove Polish Boxes, Axle Grease Boxes, Lard Pails, etc.

TIN SIGNS, ADVERTISING CARDS AND NOVELTIES.

**Macdonald Mfg. Co.**

Catherine St. - TORONTO.

**GANANOQUE**  
**SPRING & AXLE CO.**

MANUFACTURERS OF

**BEST QUALITY**

Carriage, Wagon and Seat . . . **SPRINGS.**

Collerige Mail and Carriage **AXLES.**

ALSO

. . **Wagon Skeins** . .



Factory and Wareroom—

**GANANOQUE, ONT.**

Wareroom—

**377 ST. PAUL ST., MONTREAL.**

**The Imperial**  
 REVOLVING AND TILTING  
**Display Stand and Table**

Patented in Canada, Great Britain and Foreign Countries.

**For Druggists  
 Grocers  
 Hardware  
 Dry Goods  
 Fancy Goods  
 and  
 Any Fine Display.**

**SEVEN POINTS OF SUPERIORITY  
 OVER ALL OTHER TABLES**

- 1—Revolving Standard.
- 2—Open Side Shelves.
- 3—Double-width Leaf on Top Shelf.
- 4—Brackets located underneath Shelves.
- 5—Accurate Screw-locking Device.
- 6—Curved Leaves.
- 7—Fifty per cent. better in appearance.

**WE  
 MANUFACTURE**

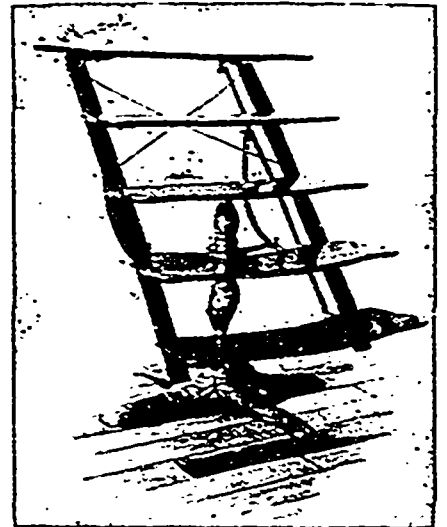

**UNDERTAKERS' SUPPLIES**

All Kinds

**CLOSET WOOD WORK.**

**SEMMENS & EVEL**

Hamilton, Canada.

ASK FOR CATALOGUES AND PRICES.

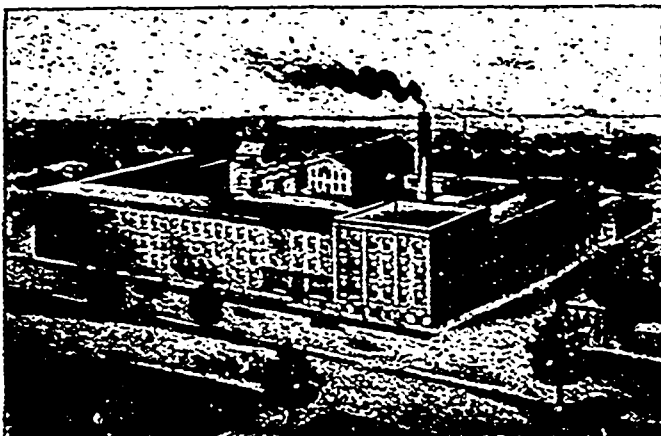

When writing to Advertisers kindly mention THE CANADIAN MANUFACTURER.

Index to the American Tariff.

	No. of Item.		No. of Item.		No. of Item.
Barley	224	Black oxide of tin	683	Box shooks	201, 205
hulled	224	plush, hatters'	461	Boxwood	198, 700
malt	225	salts	611	Boxes	
patent	225	sheet iron and steel	131	American shooks returned as boxes	
pearled	225	taggers iron and steel	131	containing foreign products	483
Barrel buttons, wool	371	Blackening of all kinds	7	containing oranges, lemons, limes,	
Barrel hoops, iron or steel	128	Blacksmiths' hammers and sledges	141	grapefruit, shaddock or pomelos	205
Barrels		Bladders:		shooks returned as boxes containing	
containing oranges, limes and lem-		crude	496	oranges and lemons	205
ons	205	fish, prepared	23	packing	201
domestic, returned	483	manufactures of	445	paper, fancy	405
empty	201	Blades, knife	153	Brics:	
for shot guns, rough bored	658	Blank flax	46	cotton or other vegetable fiber	320
Bars	135	Blank books	403	silk	359
axle	143	Blankets, wool	267	wool	371
copper	522	Blanks:		Brads	161
iron, rolled or hammered	121	axle	143	Brails:	
lead	182	bolt	115	of flax, cotton or other vegetable	
platina	611	button	411	fiber	329
railway	130	for railway tires	171	of straw, etc., for making hats,	
splice	130	hinge	115	of tinzel wire	409
Baryta	44	Blasting caps	421	silk	179
carbonate of	189	Bleaching powder	8	wool	399
sulphate of	41	Blocks:		wool	371
Barytes earth	44	last, gun, waggon, oar, heading, and		Branding and marking	sec. 8
manufactured	44	all like	206, 429	ascertainment of proof of	293
unmanufactured	44	lead	182	coloring for	290
Basic slag	121	marble	114	brass	18
Basswood lumber	195	onyx	114	clippings from	305
Bauxite or beauxite	1, 15	zinc	192	old	305
Bay rum	2, 1, 296	Bleed, dried	245, 497	Brazier's copper	176
Bay water	2, 1, 296	Blooms:		Brazil nuts	176
Beaded silk goods	340	iron or steel	124	Brazil paste	622
Beads	468	for railway tires	171	Brazilian pebble	507
articles composed wholly or in part		Blue:		Bread knives	155
of	408	Berlin	45	Breela, in blocks	588
Beans	125	Chinese	45	Breec-loading firearms and parts	158
bulb	125	containing ferro-cyanide of iron	45	Briar wood and briar root	700
deck	125	Prussian	15	Brick	87
iron or steel	125	ultramarine	52	encaustic	87
Bean seed	2, 1, 296	vitrul	9	fire	87
Beans	2, 1, 296	wash	52	Brinstone, crude	674
castor	2, 1, 296	Boards, planks and deals sawed	198	Birds	258
drugs	2, 1, 296	Bodkins	389	Bodkins	165
ground, or peanuts	2, 1, 296	Bodkins	165	Britannia metal, old	411, 502
prepared, etc.	2, 1, 296	Boller tubes, pipes, flues or stays	152	British gum	286
tonquin, tonqua or tonka	2, 1, 296	plate, iron or steel	126	Bronze metal leaf	175
Beauxite	4, 97	Bologna sausages	655	powder	175
Beds:		Bolt blanks	145	Broom corn	510
carpeting sides of	482	Boiling cloths for milling use	478	Brooms	410
curled hair for	430	Bolts:		Brown wool grease	279
Bed sets	2, 1, 296	iron or steel	115	Brushes	410
Beef, fresh	2, 1, 296	shingle, handle	629	Brushes	410
Beer	377	heading and stave	290	Brazzels carpets	374, 376
coloring for	18	Bond paper	401	Buckles, trousers	412
ginger	300	Bonded manufacturing warehouses, sec. 15		Buckwheat	226
Beeswax	450	Bonded warehouses:		Bedding knives and parts	153
Beet root ashes	425	for smelting and refining metals, sec. 21		Beds, as drugs	29, 296
Beet, sugar seed	655	removal of opium from	43	Building forms	125
Beil metal and bells, broken	472	withdrawals from	secs. 14, 15, 33	stone	117, 118
Belling:		Bone:		Bulb beams	125
cotton	472	ash	429	Bulbous roots	20, 251, 548, 656
leather	472	bagatello balls	417	Bulbs	20, 251, 548, 656
silk	472	billiard balls	417	Bullion, gold or silver	511
wool	472	black	47	lead	182
Benzaldehyde	426	buttons	414	Bullions, or metal thread	179
Benzidin	426	casings, cotton	429	Bunting, wool	369
Benzole acid	426	casings, silk	429	Burgundy pitch	512
Benzol	426	char	10	Burnt starch	286
Bergamot oil of	426	chess balls	417	Burstones	116, 671
Benzyl chloride	426	chessmen	417	Butchers' knives	155
Berlin blue	426	cattle fish	543	skewers	297
rugs	426	dice	417	Butter	296
Berries		draughts	417	cocoa	296
cranberries	426	dust or animal carbon	429	knives	155
desiccated	426	manufactures of	429	substitutes for	296
dried	426	pool balls	417	Butterine (cocoa)	282
drugs	426	Bores, crude	429	Button blanks	414
evaporated	426	Bonnet and hat plus	188	forms	413
green	426	Bonnet wire	177	molds	414
ripe	426	Bonnet brads, plaits, and laces	409	Buttons:	
Beverages, spirituous	426	Bonnets	409, 472	agate	414
other	426	Bookbinders' calfskins	478	barrel, and other parts for tassel	371
Bibulous paper	426	Booklets, lithographic	400	bone	414
Bicarbonate of soda	426	Books	403, 500, 501	collar	414
Bichromate of potash	426	blank books, all kinds	403	cuff	414
soda	426	professional	645	glass	414
Billets, iron or steel	124, 125	Bicot, shoe and corset lacings of cot-		horn	414
Billiard balls	417	ton, flax, etc.	320	Ivory, vegetable	414
Billiard chalk	417	Boots, leather	478	metal	414
Binding twine	411	Boric acid	1	metal trousers (except steel)	414
Bindings:		Borate:		nickle bar	414
cotton	411	of lime	11	n. s. p. f.	414
silk	411	material u.s.p.f.	11	pearl	414
wool	411	of soda	11	shell	414
Binitrobenzol	424	Borax	11	shoe, of paper, etc.	414
Binitrobenzol	424	Bort or diamond dust	545	steel trousers	414
Birds	424	Botanic Garden, U.S. plants, trees,		trousers, metal (except steel)	414
dressed and finished	424	etc., for	660	wool	371
eggs	424	Botany, specimens of	624	vegetable ivory	414
skins, with feathers	424	Bottles:		Butts, jute, unmanufactured	566
stuffed, not suitable for millinery	424	containing quicksilver	189		
ornaments	424	filled with wine	235, 236		
Bismuth	424	filled with beverages containing no			
Bisque ware	424	alcohol	300		
Bitters	424	filled with mineral waters and ar-			
Bitumen	424	tificial mineral waters	501		
Bitternious coal	415	glass	100, 100		
Black, bone	47	quicksilver, returned	483		
copper	47	Bottoms, copper	176		
ivory, bone or vegetable	47	Bounty, additional duty required, sec. 5			
lamp	47	Box chronometers and parts	191		

C

Cabbages	242
Cabinet furniture	208
woods in the log	700
sawed	188
Cables:	
hemp	320
latic, Tampico fiber, manilla, sisal	320
grass or sunn	320
Cacao, crude	328



JOHN HANCOCK BLDG., BOSTON, November 6, 1899.

N. ENG. BRANCH CLING-SURFACE MFG. CO.

We have been using Cling-Surface for seven months and are now running our dynamo and other belts slack. We take pleasure in saying that Cling-Surface is giving the best satisfaction.

JAMES STACKHOUSE, Supt.

**Cling-Surface Does These Four Things :**

- 1.—STOPS SLIPPING.
- 2.—INCREASES POWER.
- 3.—RELIEVES INITIAL TENSION.
- 4.—PRESERVES THE BELT.

If it fails to do these you Pay Us Nothing.

**CLING-SURFACE MFG. CO.**

N. Eng. and E. Can. Branch: 120-126 Virginia Street:  
170 Summer St., Boston. BUFFALO, N.Y.  
New York Branch: Chicago Branch:  
253 Broadway. 225 Dearborn St.

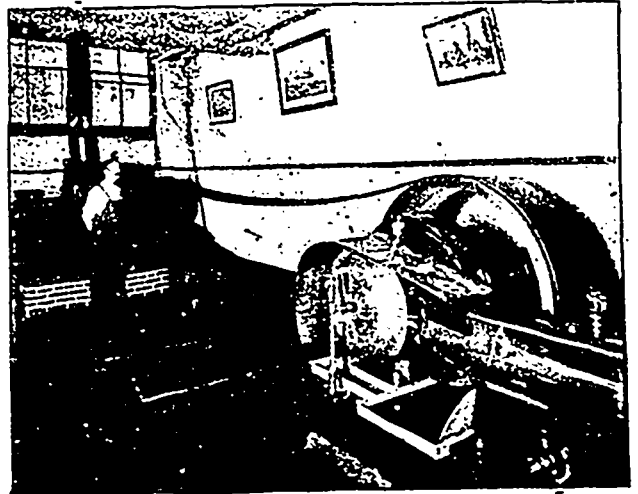

**W. A. FLEMING & CO.**

**MILL SUPPLIES CAMEL BRAND BELTING**  
**HOSE of all kinds**  
**DRIVING ROPE**  
**BELTING of all kinds**

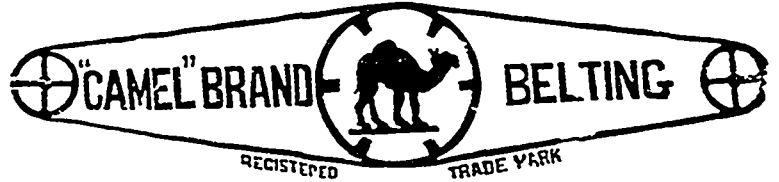

771 CRAIG STREET, MONTREAL.

Manufacturers of  
A FULL LINE OF

**Engineers' Brass Goods**

**Steam Specialties and Supplies....**

The **J.M.T.** Valve enjoys the reputation as "THE STANDARD FOR EXCELLENCE." Material and Workmanship the best that can be had. Symmetrical in construction. Rich in color. Trade Mark on every valve. All Dealers Handle Them.

If interested in saving steam in your plant enquire for the **Heintz** Steam Saver. Costs you nothing to try it. Particulars gladly mailed on receipt of post card.

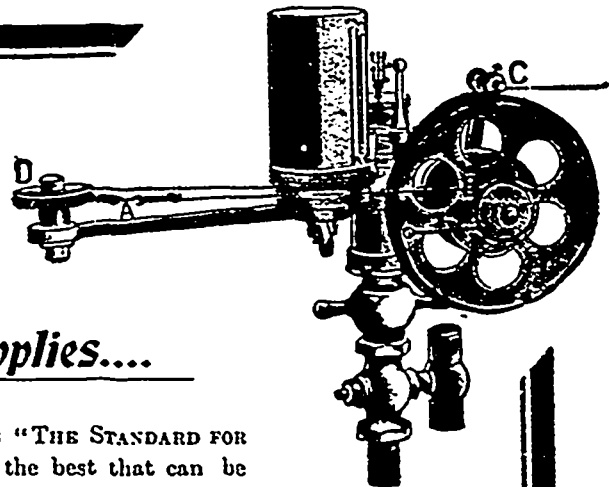

The Improved Thompson Engine Indicator with Reducing motion.



**The James Morrison Brass Mfg. Co.**

TORONTO.

Limited.

Index to the American Tariff.

	No. of Item		No. of Item		No. of Item
Cadmium	513	Cast-rod irons	115	Cinnamon, and chips of	607
Calcined bones	439	stove plates	115	oil	626
Calicut oil	439	tailor's irons	115	Circular saws	168
Cake alum	439	vessels	115	Citric acid	1
aluminous	439	scraps	122	Citronella oil	626
salt or filter cake	439	Castor	516	Citron or citron peel	267
Calamine	511	beans or seeds	516	Civet, crude	521
Calcined magnesias	31	oil	516	oil of	626
Calfskins:		Castoreum	516	Clapboards	139
bookbinders'	435	Catgut:		Claspknives	133
tanned and dressed	435	manufactures of	445	Clay:	
Calome	435	unmanufactured	445	china or kaolin	30
Camel hair of	348, 351, 356	Cattle	215, 473	common blue, for enamele	522
hair, manufactured	435	hair	571	pipes and pipe bowls	430
Camoes, in frames	435	hides of	437	wrought and unwrought	43
Camphor:		neat, hides of	435	Clippings:	
crude	515	neat, importation of, prohibited, sec.	435	as paper stock	602
refined	515	Caunflower seed	656	from new copper	531
Candle wicking, cotton or other vege-		Caustic potash	64	Clock cases	115
table fiber	435	soda	76	Clock wire	137
Candy, sugar	435	Cayenne pepper	271	Clocks, jewels for	191
Cane, chair	435	Cedar:		Clocks, or parts of	191
Caps:		in the log	198, 199	Cloth:	
blasting	435	lumber	198	bolting, silk	498
percussion	435	Cedar, sawed	198	cotton	301, 311, 312
Capsicum	435	Cedrat oil	625	hair, known as hair seating	431
Caraway seed	435	Celluloid, and articles of	17	hair ermine cloth	431
oil	435	Cement:		hair press cloth	431
Carbolic acid	435	copper	334	oil for floors	337
Carbon, animal	435	hydraulic	282	waterproof	337
Carbon articles and wares	435	Portland	282	woollen	336, 368, 369
Carbon pots for electric batteries	435	Roman	282	Clothing:	
Carbonate:		Ceramic mosaic tiles	435	card	146
of ammonia	435	Cerium	518	ready-made	314, 370, 390
of baryta	435	Chain of all kinds	151	Cloths,	
of magnesias, medicinal	435	Chain cane	285	gunny	344
of potash	435	Chalcedony, manufactures of	115	Italian	368, 369
of soda, bl and crystal	435	Chalk:		cloves and clove stems	607
of strontia, or strontianite	435	billiard	13	Coal:	
Carbons for electric lighting	435	crude, not ground, precipitated or		anthracite	415
Carboys:		manufactured	519	bituminous	415
American manufacture	435	French	13	cok	415
glass	435	ground	13	cotton	415
Cardamom seed	435	manufactures of	13	fuel for vessels	415
Card clothing	435	precipitated	13	shale	415
lap, cotton	435	prepared	13	stack	415
Carded or combed silk	435	red	13	stores of American vessels	521
Carded yarn	435	tailors'	13	Coal tar:	
Cards:		Champagne	285	colors	15
playing	435	Chamomile oil	435	crude	15
internal revenue tax on (Sec. 28, act		Channels	155	dyes	15
Aug. 28, 1894)		Channels, car-truck	155	pitch of	15
Cermined indigo	435	Charms	401	preparations, not medicinal, not col-	
Carpet:		Charts	401	ors or dyes	15
art squares	435	Charts for societies	401	products of	15
bedsides	435	hydrographic	401	products or preparations, n. s. p. f.	15
covers	435	printed over twenty years	401	Coat linings of wool	368
hassocks	435	Chess, and substitutes therefor	155	Cobalt:	
mats	435	knives	155	ore	435
rugs for floors	435	Chemical compounds	435	oxide of	435
sevens, wool	435	salts	435	Cocculus indicus	435
Carpets:		wood pulp	435	Cochineal	435
Andusson	435	Chemille carpets	435	Cocoa:	
Axminster	435	curtains	435	crude	435
backings	435	silk	435	butter	435
Brussels	435	table covers	435	butterine	435
tapestry	435	Cheroots	435	fiber	435
chain Venetian	435	Cherry juice	435	leaves and shells of	435
chenille	435	Cherries	435	nut meat, prepared	435
cork	435	Chessmen and chess balls	435	nuts in the shell	435
cotton	435	Chicory root	435	nuts, prepared	435
drumsets	435	Chicle	435	nuts, crude, fiber leaves and shells	435
Dutch wool	435	Chiffon	435	of	435
flax	435	Chimney-pieces, slate	435	all of	435
hemp	435	China clay	435	prepared or manufactured	435
Ingrain—		Chinese blue	435	powdered	435
three-ply	435	Chinese matting	435	Cocoons, silk	435
trelle	435	Chip brads, plates, etc., for ornament-		Cod-liver oil	435
two-ply	435	ing hats	435	Coffee:	
jute	435	hats of	435	substitutes for	435
moquette	435	manufactures of	435	Coined ingots	135, 171
velvet	435	Chlorate of potash	435	Colts:	
Saxony	435	soda	435	foreign values of, sec. 25, act Aug.	
tapestry	435	Chloride of lime	435	28, 1894.	
Tournay	435	Chloroform	435	gold, silver and copper, free	150
Wilton	435	Chocolate	435	Cold and cold yarn	435
wool	435	prepared or manufactured	435	Coke	415
woven whole for rooms	435	Chromate of iron	435	Collar and cuff buttons	414
Cartridges	435	potash	435	Collars and cuffs	414
Car-truck channels	435	soda	435	Collections of antiquities for exhibition	702
Carving knives and forks	435	Chromic green	435	Colloidal and all compounds thereof	17
Casks (empty)	435	yellow	435	articles of	17
of American manufacture, returned	435	Chromic acid	435	rolled or in sheets	17
Cases, musical instrument	435	ore	435	Cologne water	18
Casings, bone, cotton or other vege-		Chromium colors	435	Coloring for beer	18
table fiber	435	Chromometers:		brandy	18
Cassings, bone, silk	435	box or ship, and parts of	191	other liquors	18
Cassava or cassady	435	Chrysolite, manufactures of	115	wine	18
Cassia, cassia buds and cassia vera	435	Cider	435	Colors and paints, (See paints and	
Cassia, oil of	435	Clear boxes (sec. 26, act August 28,		colors.)	
Cassiterite	435	1894)	400	coal tar	15
Castle soap	435	Clear labels, lithographic	400	Columns and posts	155
Cast hollow ware	435	Cigarette books and book covers	435	Combination guns	158
Castings:		Cigarette paper	435	Combination suits	319
iron, n.s.p.f.	137	Cigarettes	435	Comfits	231
malleable iron, n.s.p.f.	137	Cigars	435	Compounds, alcoholic	61
Cast:		internal revenue tax on	sec. 10	alcoholic, medicinal	61
hollow ware	150	stamps	sec. 10	chemical	3
iron andirons	148	Cinchona bark	435	of pyroxiline	17
hatters' irons	148	alkaloids of	647	or preparations, distilled spirits	201
pipe	148	salts of	647	Component material of chief value, sec. 7	
plates	148				

**THE Electrical Construction  
Co. of London, Limited.**

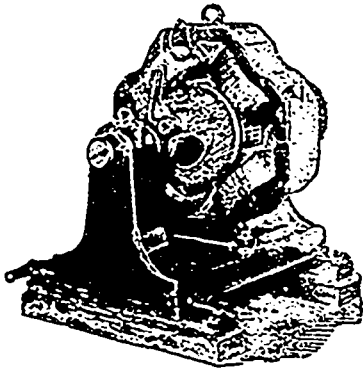

**MULTIPOLAR MOTORS & DYNAMOS**  
And Direct Connected Plants  
for Isolated Lighting.  
Repair Work a Specialty.  
HEAD OFFICE AND FACTORY:  
No. 90 YORK STREET, London, Canada.  
700 Main St., Winnipeg.  
42 York St., Toronto. 131 Granville St., Halifax.

**The Jones & Moore  
ELECTRIC CO.**  
ELECTRICAL CONTRACTORS

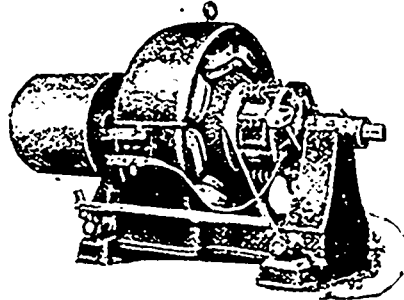

DYNAMOS, TELEPHONES, SLOW  
SPEED MOTORS, MOTORS, SUPPLIES,  
DIRECT CONNECTED DYNAMOS.  
We manufacture Direct Current Machinery in  
all sizes and for any purpose.  
**20 and 22 ADELAIDE W.,  
TORONTO.**

**Toronto and Hamilton  
ELECTRIC CO.**

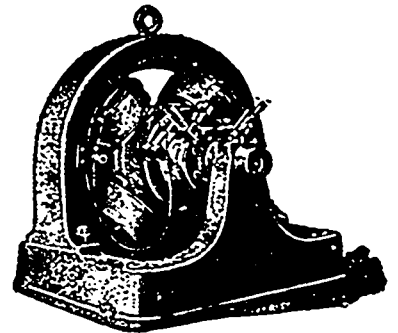

**Motors and Dynamos**  
COMMUTATORS REFILLED.  
**99-103 McNab St. N., Hamilton**  
Phone 958.

**THE PACKARD ELECTRIC CO. LIMITED**

Makers  
.. of .. **Lamps and Transformers.**

Sole Agents for SCHEEFFER RECORDING WATT METERS.

**ST. CATHARINES, ONT.**

Current  
Completely  
Registered

No  
Current  
Lost

Entire  
Revenue  
Secured

No Friction

**ABSOLUTELY ACCURATE**

From Less than 5 c.p. to Full Capacity. Guaranteed for Three Years.

**METERS**

Air Tight

Moisture  
Proof

Dust Proof

Insect  
Proof

Magnetic  
Suspension

No Wear

MADE BY... **STANLEY INSTRUMENT CO.,** GREAT BARRINGTON, MASS., U.S.A.

FOR SALE IN CANADA EXCLUSIVELY BY

**The Royal Electric Co'y**  
MONTREAL, QUE. TORONTO, ONT.

When writing to Advertisers kindly mention THE CANADIAN MANUFACTURER.

Index to the American Tariff.

	No. of item.
Composition metal, copper.....	533
Conception, articles for preventing, importation prohibited.....secs.	16 18
Concentrated melada and molasses.....	209
Concrete molasses.....	209
Condensed milk.....	210
Confecionery.....	212
Convict labor, products of, importation prohibited.....sec.	31
Cooks' knives, forks and steels.....	153
Copper:	
black or coarse.....	711
bottoms.....	176
braziers.....	176
cement.....	531
clippings from new.....	530
colus.....	530
composition metal.....	533
manufactures of.....	193
medals.....	612
old.....	621
ores.....	621
plates, bars, ingots, pigs and other forms.....	622
regulus of.....	531
rolled plates of.....	176
rods.....	176
sheathing.....	176
sheets of.....	176
subacetate of.....	634
sulphate of.....	19
Copperas.....	19
Copra.....	307
Copying books.....	307
paper.....	307
Coral:	
marine.....	332
manufactures of.....	115
Cordage:	
henp.....	329
istle or Tampico fiber, manilla, sisal grass or sunn.....	329
Cordials.....	329
gluger.....	329
Cords:	
and tassels, silk.....	329
wool.....	371
cotton.....	329
flax.....	329
ramie.....	329
silk.....	329
wool.....	371
Corduroys, cotton, etc.....	315
Coriander seed.....	636
Cork:	
artificial.....	416
bark cut into squares.....	416
carpets.....	337
manufactures of.....	448
wood or bark, unmanufactured.....	536
Corks.....	416
Corn.....	251
broom.....	510
meal.....	228
Cornelian, manufactures of.....	115
Corporations, works of art imported specially for.....	702
Corrugated sheets, iron.....	131
Cosmet.....	137
covers, cotton or other vegetable fiber.....	310
lacings, cotton or other vegetable fiber.....	320
steels.....	137
wire.....	137
Corticene.....	327
Cosmetics.....	70
Cotton:	
applied articles.....	312, 329
bagging for.....	312
handlings and bands.....	320
bed sets.....	320
beltings.....	320
bias dress facings.....	315
blindings.....	320
bone casings.....	320
boot lacings.....	320
braces.....	320
braids.....	320
card taps.....	302
carpets.....	321
chenille articles.....	316
cloth.....	301-302, 313
containing silk.....	311
definition of.....	310
clothing, ready-made.....	314
collars.....	328
combination suits.....	319
corus.....	321
corduroys.....	315
corset covers.....	319
corset lacings.....	320
crochet.....	325
cuffs.....	328
curtains.....	316, 320, 349
damask.....	321
drawing.....	303
drawers.....	313
duck.....	321
edgings.....	320

	No. of item.
Cotton embroideries.....	339
embroidered articles.....	339
handkerchiefs.....	312, 329
embroidery.....	341
enamels.....	329
flocks.....	347
punchings.....	329
hatings.....	329
galloons.....	329
garters.....	329
gloes.....	349
gorings.....	329
half-hose.....	317, 318
heads.....	329
hose.....	311, 318
handkerchiefs.....	312, 329
hemstitched handkerchiefs.....	712
insertings.....	329
knitted articles.....	317, 318, 319
labels.....	120
laces.....	329
window curtains.....	320, 710
lacings.....	320
lappets.....	313
lacings for bicycle tires.....	320
loom harness.....	320
manufactures of.....	322
mufflers.....	322
napkins.....	329
neck ruchings and ruffings.....	320
ties.....	314
wear.....	311
nets or nettings.....	329
outside garments having india rubber as a component material.....	314
pants.....	319
pile fabrics.....	315
pillow shams.....	339, 340
plushes.....	315
quillings.....	329
raw.....	329
ready-made clothing.....	314
ribbons.....	329
roping.....	302
roving.....	302
ruchings.....	329
ruffings.....	329
sced.....	625
oil.....	325
shirt collars and cuffs.....	328
shirts.....	319
shoe lacings.....	320
skirt blindings.....	315
skirtings.....	329
sleeve linings.....	311
silver.....	302
spindle banding.....	329
stockings.....	317, 318
suspenders.....	329
sweaters.....	319
table covers.....	316
damask.....	321
tamboured articles.....	312, 320
tapes.....	320
thread.....	302
spool.....	301
tides.....	329
ties of iron or steel.....	129
tights.....	319
trimmings.....	329
tubing.....	320
tuckings.....	329
underwear.....	319
union suits.....	319
vels or vellings.....	329
velveteens.....	315
velvets.....	315
vests.....	327
vitrages.....	329
warps or warp yarn.....	302
waste.....	327
wearing apparel.....	314, 329
webbing.....	329
webs.....	329
wicking.....	329
yarns.....	302
Court plaster.....	69
Cranberries.....	262
Crayons.....	58
Cream of tartar.....	6
nuts.....	622
Cresote oil.....	324
Crespe paper.....	327
Cresol.....	324
Crimped iron or steel sheets.....	131
Criollo cloth, hair.....	311
Criollo wire.....	137
Crochet cotton.....	301
needles.....	105
Crockery ware:	
decorated.....	35, 96
not decorated.....	95, 96
Crosscut saws.....	108
Crotan oil.....	36
Crotous.....	251
Crown bars, iron or steel.....	144
Crown glass.....	101, 102, 105, 107
Crucibles.....	94
Crude minerals, n.s.p.f.....	614
tartar or wine lees.....	6
Cryolite or kryolith.....	538
Crystal, rock, manufactures of.....	115

	No. of item.
Crystals:	
alum.....	4
lees.....	6
soda.....	71
Cubic nitrate of soda.....	665
Cudbear.....	539
Cuffs.....	328
Culm of coal.....	415
Cultivators.....	160
Cumin.....	524
Cuminum seed.....	656
Curled hair.....	130
Cutting stones and handles.....	540
Curants, Zante or other.....	261
Curtain plasters.....	69
Curry and curry powder.....	511
Curtains:	
chenille, cotton.....	316
lace, window.....	329, 340
Cutch.....	512
Cutlery.....	153, 155
Cut glass.....	100
Cuttings, hide.....	572
nursery stock.....	252
Cuttle-fish bone.....	513
Cyanide or cyanite.....	591
Cyanide of potassium.....	66
Cylinder and crown glass.....	101, 102, 105
Cylindrical furnaces.....	152
<b>D</b>	
Damask, cotton.....	321
Dandelion root.....	283, 514
Darning cotton.....	303
Darning needles.....	620
Dates.....	264
Dead oil.....	521
Deals.....	195, 198
Decanters.....	100
Deck beams.....	125
Decoctions of logwood and dyewoods.....	22
Degras.....	270
Demijohns.....	99
Derivatives.....	70
Desigins, Jacquard.....	402
Dextrine.....	286
Diamonds:	
cut.....	435
best.....	545
dust.....	545
engravers.....	545
glaziers.....	545
imitations.....	425
miners.....	545
not set.....	435
rough and uncut.....	545
watch or clock jewels.....	191
Dianthidin.....	524
Dice.....	417
Die blocks, steel.....	135
Diphenylamine.....	524
Disserminating duty.....sec.	22
Dises, glass or plates, rough cut, for optical instruments.....	565
Distilled oils.....	3
spirits, compounds, or preparations of.....	289, 291
spirits, internal revenue tax (act August 28, 1891).....secs.	48-68
Divi-divi.....	546
Dolls and doll heads.....	418
Domestic articles returned.....	483
Down quilts.....	425
Downs.....	425
Dracenas.....	251
Drag saws.....	168
Drawings, sugar.....	269
Dragon's blood.....	547
Draughts.....	417
Drawback:	
coal as fuel for vessels.....	415
on exported merchandise.....sec.	50
reimported domestic articles (sec. 21).....	483
supplies for vessels of United States.....sec.	...
Drawers, cotton, or other vegetable fiber.....	319
Drawing paper.....	401
Drawings for exhibition.....	701
pen and ink.....	454
Dress:	
facings, bias.....	315
goods, wool.....	368, 369
steels.....	137
Dressed line, flax.....	325
Dried acorns.....	469
apples.....	262
berries.....	262
blood.....	145
citron root.....	250
citron or citron peel.....	267
fibers, insects, etc.....	20, 548
Dried fish.....	261
fruits, edible.....	262
or berries, n.s.p.f.....	559
grapes.....	264
lemon peel.....	267
pease.....	250
peaches.....	262
pears.....	262
orange peel.....	267
Drills, agricultural.....	460

**AN ENGINE** with good regulation, using the least fuel, keeping in repair longest, is the kind sought for by manufacturers.

The requirements are not filled by any engines better than by

**The WHEELLOCK AND IDEAL ENGINES**

BUILT BY

**The Goldie & McCulloch Co., Limited, Galt, Ont.**

**WE ALSO MAKE** GAS AND GASOLINE ENGINES, BOILERS, PUMPS, WATER WHEELS, FLOUR MILL MACHINERY, OATMEAL MILL MACHINERY, OATMEAL STEAM PAN KILNS, WOODWORKING MACHINERY, IRON PULLEYS, WOOD RIM SPLIT PULLEYS, SHAFITNG, HANGERS, GEARING, FRICTION CLUTCH PULLEYS, Etc., Etc. SAFES, VAULTS and VAULT DOORS.

**The Polson Iron Works, TORONTO CANADA.**

THE BEST EQUIPPED BOILER AND ENGINE WORKS IN CANADA.

We Manufacture—

**STEEL BOILERS**

The BROWN AUTOMATIC ENGINE, MARINE ENGINES (SINGLE COMPOUND AND TRIPLE), Hoisting and Mining Engines

STEEL STEAM VESSELS OF EVERY DESCRIPTION.

STEAM YACHTS AND LAUNCHES.

GET OUR PRICES BEFORE ORDERING.

ESPLANADE EAST, Foot of Sherbourne St., - - Toronto, Canada

Branch Offices and Agencies:

Vancouver, B.C., Wm. Hamilton Mfg. Co.

Winnipeg, Robt. Douglas, 94 Alexander Avenue.

Montreal, 321 St. James Street.

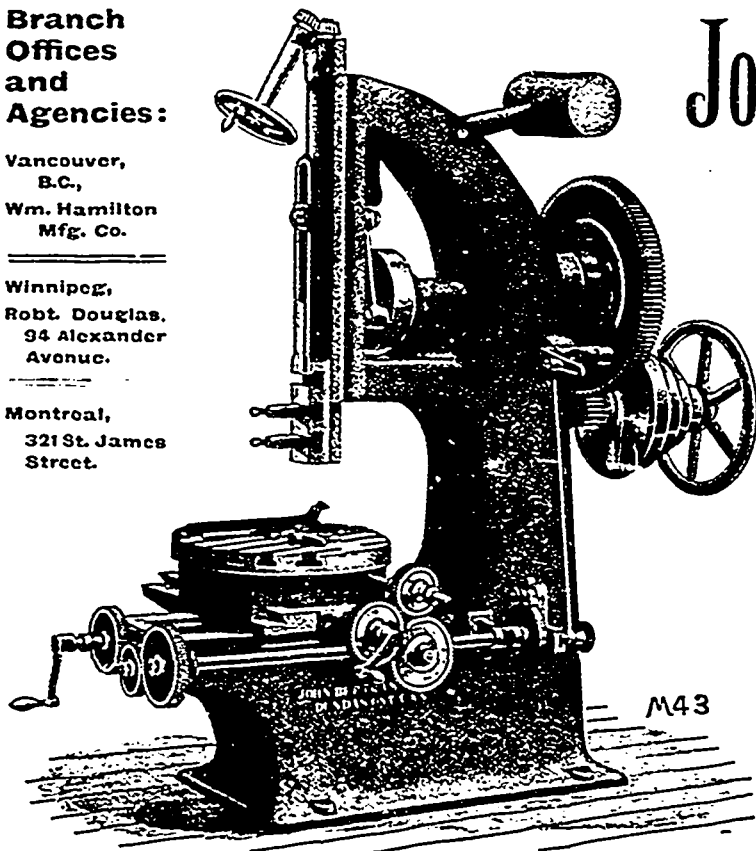

**John Bertram & Sons**

DUNDAS, ONTARIO.

Canada Tool Works

MANUFACTURERS AND BUILDERS OF

**METAL-WORKING MACHINE TOOLS**

—FOR—

Machine Shops, Ship Yards, Boiler Shops, Rolling Mills, Locomotive and Car Shops, Brass Shops.

**PAPER MILL MACHINERY.**

When writing to Advertisers kindly mention THE CANADIAN MANUFACTURER.

Index to the American Tariff.

	No. of Item.
Dross from burnt pyrites	121
lead	182
Druggists	380
Drugs	20, 518
prohibited	secs. 16, 17, 18
Dry plates or films, photographic	458
duck, cotton	321
Dust, diamond	545
Dusters, feather	110
Dutch Ingrain carpets	328
metal, in leaf	170
Dye, lac, crude, seed, button, stick, shell	522
Dyeing:	
articles used for, crude	482
drugs, etc., for, advanced	20
crude	518
extracts and decoctions for	22
Dyes:	
all coal-tar, n. s. p. f.	15
alizarin, natural and artificial	489
extract of logwood	22
lac	522
dyewoods, extracts of	22
E	
Earth, barytes	11
Earthenware	94, 98
carbon pots, porous	98
carbons for electric lighting	98
common yellow, brown or gray	94
crucibles	97
decorated	95, 96, 97
filter tubes	98
gas retorts	98
lava tips	98
manufactures of	95, 96, 97
plain	94, 95, 96, 97
ornamented	95, 96, 97
steckingham	91
tiles	88
Earths:	
fullers'	93
ochery	49
wrought or manufactured	94
slenna	49
umber	49
unwrought and unmanufactured	94
Ebony wood	198, 700
Egdlings:	
cotton or other vegetable fiber	359
silk	380
wool	311
Educational stops, art	481
Effects:	
household, of persons emigrating to the United States	501
of citizens of the United States	480
dying abroad	480
personal, of passengers	480
Egg albumen	243
Eggs	214, 215, 549
birds'	549
fish	549
insects'	549
silk worms'	662
yolk of	243
Electrotype plates	105
Embossed tiles	88
Embroidered articles:	
flax, cotton or other vegetable fiber	339
handkerchiefs	312
wool	371
silk	370
Embroideries	329, 371, 380
lead	405
metal	170
Emery:	
files	419
grains	419
ground	419
manufactures of	419
ore	550
pulverized	419
refined	419
wheels	419
Enamel:	
fusible	113
glass, white	361
Enamelled iron, steel, or other metal plates or wares	159
brick	51
china or earthenware	15, 16
leather	438
tiles	88
Encaustic tiles	88
Enfleurage grease	626
Engraved steel plates	109
glass bottles or articles	109
Engravers' diamonds	545
Engravings, bound or unbound	403, 501
Envelopes	329
Epsom salts	31
Equipment of vessels, articles imported for	secs. 12, 13
Erasers, or parts thereof	158
Ergot	551
Essences, fruit	21
Essential oils	4
Etamines	329
Etchings	404
printed more than twenty years	501

	No. of Item.
Ethers	21
fruit	21
nitrous, spirits of	21
n. s. p. f.	21
sulphuric	21
Exercences	20, 518
Explosive substances	422
Expressed oils	3
Extracts of:	
barks	22
dyewoods	22
hemlock bark	22
hops	22
indigo	22
licorice, in paste, rolls, etc.	22
logwood	22
madder	604
meat	276
mulleet	601
quebracho	22
safflower	651
saffron	651
sanna	22
woods other than dyewoods	22
wool	362
Eye-glasses	108
F	
Fancy soap	72
Fans of all kinds, except common palm leaf	427
common palm leaf	552
Feather dusters	410
Feathers:	
artificial	425
crude	425
dressed	425
ornamental	425
Felt:	
adhesive, for sheathing vessels	533
roofing	391
wool, not woven	370
Fence posts	200
rods of iron or steel	136
Fennel oil	626
seed	656
Fenugreek seed	656
Ferro Manganese	122
silicon	122
Fiber:	
Tampico oristle	566
Tampico cables and cordage	529
ware, indurated	427
Fibers dried	20, 548
Filum	551
Fibrous substances, vegetable	593
Fish glasses	111
Flax	264
Filberts, shelled and not shelled	270
File blanks	156
Files	156
emery	419
Films, photographic	458
Filter masse or stock	335
paper	337
tubes	98
Firearms:	
combination shotguns and rifles	158
muskets, muzzle-loading shotguns, rifles, and parts thereof	157
sporting	158
Fireboards, paper for	402
Fire brick	87
Firecrackers	629
Firewood	629
Fish:	
American caught	555, 626
anchovies	258
bladders	258
bristlings	258
canned	258
dried	258
eggs	549
fresh	258
fresh, frozen, or packed in ice	261, 555
fresh water	258
glue	258
halibut	258
herrings	258
mackerel	258
oil, American fisheries	626
n. s. p. f.	42
packed in oil	258
paste	241
pickled	258
products of American fisheries	555, 626
plates	150
salmon	258
salted	258
salt water	258
sardels or sardellen	258
sardines	258
sauce	629
shell	629
shrimps	629
skinned or boned	258
skins	258
sprats	258
smoked	258
sounds	27, 496
Fishing rods, sticks for	700

	No. of Item.
Flannel for underwear	367
Flasks containing quicksilver	189
Flat rails	120
wire rods	126
Flats, bar iron	123
Flax:	
articles, n. s. p. f.	316, 347
carpets and carpeting	331, 381
cords	330
"dressed line"	325
embroideries	329
gill netting	322
hacked	325
handkerchiefs	315
hydraulic hose	325
laces	329
manufactures of	317
mats	334
nets	332
not hacked or dressed	324
oil cloth for floors	327
pile fabrics	322
rugs	324
selmes	322
shirt collars and cuffs	328
shirting cloth	316
straw	327
tapes	326
threads	326
tow of	320
trimmings	320
twines	320
webs	322
waterproof cloth	327
woven fabrics	316
yarns, single	321
Flaxseed	254
Flaxseed oil	37
Flint	544
flint, lime, or lead glass bottles	99
stones, unground	557
tiles	88
Floats, metal, of all cuts and kinds	156
Flocks, cotton	537
wool	363
Floor matting	313, 452
oil cloth	337
tiles	88
Floss, silk	385
Floumeluz:	
cotton or vegetable fiber	339
silk	396
wool	371
Flour:	
rice	222
rye	222
suuff	216
wheat	225
Flower seeds	656
Flowers:	
artificial or ornamental	425
as drugs	20, 548
natural	251
of sulphur	84
Flues, boiler	152
Fluoric acid	461
Fluted glass	103
Flutings, flax or cotton	359
Forgings of iron or steel	127, 143
Forks	155
tuning	453
Forms, iron or steel	125
Fossils	555
Fowls:	
land	494
poultry	278
water	494
Frames for optical instruments	111
Frames for spectacles, eyeglasses and goggles	108
Frames of looking-glass plate	106
Freestone	117, 118
French chalk	13
Fresh beef, veal, mutton and pork	274
Friction matches	423
Fringes:	
silk	390
wool	371
Fruit essences	21
others	21
grape	266
juice	266
kulfes	155
oil	21
plants, tropical and semi-tropical	599
Fruits	262, 559
apples	262
artificial or ornamental	425
as drugs	20, 548
berries	262, 559
cherries	262
citron	262
cranberries	262
currants	264
currants, Zante	264
dates	264
dried, n. s. p. f.	359
figs	264
grapes	264, 265
green	264
in brine	269

# F. E. ATTEAUX & CO.

## MANUFACTURING CHEMISTS

**IMPERIAL BLACK POWDER,** Fast to Sunlight and Soap.

Dyes in "ONE DIP." More economical to use than Logwood or Haematine. Can be used to advantage on Yarn, Slubbing, Pieces, Rags and Shoddy.

**HAEMOTOL** FOR WOOL—Dyed over a Chrome and Tartar Mordant produces a black on wool equal to Alizarine Black for fastness, but at a much lower cost.

**Dyewoods**

AND

**Extracts**

# ALIZARINE and ANILINE COLORS

**F. E. ATTEAUX & CO.,** 53 COLBORNE ST. TORONTO, ONT. 13 LEMOINE ST. MONTREAL

Main Office and Works—BOSTON, MASS., U.S.A.

THERE IS ONLY ONE PROFITABLE PLAN—Buy Northrop Looms

With them the Future is Assured. They are no Experiment.

Thousands have been running in the United States, and a large number are now in Canada. Sales steadily on the increase.

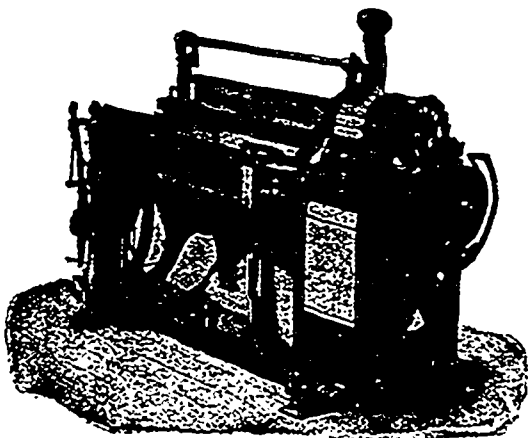

THE NORTHROP LOOM

BEST WARPER AT PRESENT KNOWN—also SPOOLERS.

Write for particulars and quotations. Address

**The Northrop Loom Co. of Canada,**  
LIMITED,  
VALLEYFIELD, P.Q.

"The Mills that refuse their opportunities will find their future utility serving as picturesque ruins in the landscape."

We also Manufacture the

# The Standard Chemical Company

of TORONTO, Limited.

Head Office—GOODERHAM BUILDING, TORONTO, CANADA.

We Manufacture

- Wood Alcohol
- Acetate of Lime (Grey)
- Acetic Acid (Glacial, Commercial, Crude)
- Paris Green (Government Standard)
- Tar Oil
- Wood Pitch
- Wood Creasote
- Black Iron Liquor
- Hardwood Charcoal

Factories :—DESERONTO, FENELON FALLS, TORONTO, LONGFORD

Address all Correspondence to the Head Office.

When writing to Advertisers kindly mention THE CANADIAN MANUFACTURER.

Index to the American Tariff.

	No. of Item.
Fruits, lemons	266
limes	266
olives	264
oranges	266
peaches	262
pears	262
pineapples	263, 268
plums	262, 264
pomeles	266
preserved in sugar, molasses, spr-	
its, or in their own juices	263
prunes	264
prunelles	264
quinces	262
raisins	264
ripe	559
shaddocks	266
tamarinds	676
Zante currants	264
Fullers' earth	93
Fulminates	421
Fulminating powders	521
Furnaces, cylindrical	152
Furniture :	
house or cabinet	208
household, of persons from foreign	
countries	504
Fur :	
dressed	426
for hatters' use	426
hats	432
manufactures of	450
skins carotted	426
skins not dressed in any manner	562
Furs, undressed	561
Fusel oil	58
Fusible enamel	118
<b>G</b>	
Galle acid	1
Galloons :	
cotton or other vegetable fiber	339
silk	390
wool	371
Galvanized iron	132
Gambler	563
Garden seeds	254
Garlic	219
Garnet, manufactures of	115
Garnetted waste	361
Garters	320, 389
Gas retorts	98
Gelatin	21
manufactures of	450
Gems	435
German silver	174
Gilead, balm of	487
Gill netting, flax	332
Glamps, wool	371
Ginger :	
ale	300
beer	300
cordial	296
root, unground	667
wine	296
Gins, cotton	460
Girders, iron or steel	125
Glass :	
articles of, cut, engraved, painted,	
stained, etc.	100
beads	408
bent	107
bottled	107
bottles, filled or unfilled	91, 100
containing wines	295, 296
containing ale or beer	297
containing gluger ale	300
containing mineral water	301
buttons	414
carboys	39, 482
cast polished plate	104, 105, 107
colored	90, 100, 107
common window	101, 107
coquill	109
crown	101, 102, 105, 107
cut	100
cylinder	101, 102, 105, 107
decanters	100
decorated	107
demijohns	39
diamonds, imitation	435
discs for optical instruments	565
embossed	107
enamel for watch dials	564
enameled	107
engraved	100, 107
etched	100, 107
flashed	107
flint, lime or lead bottles	99
fluted	103
frosted	107
glided	100
green, plain	90
ground	100, 107
jars	39
lenses	109, 111
looking-glass plates	105, 106
manufactures of, or paste, n.s.p.f.	112
microscopes	111
mirrors	112
obscured	107
optical instruments	111

	No. of Item.
Glass, ornamented	107
painted	100, 107
paste, manufactures of, n.s.p.f.	112
plain green	99
plano or coquill	109
plate	103, 107
plates or discs, for optical instru-	
ments	565
pressed	99
printed	100
rolled	103
rough plate	103
sanded	107
silvered	100, 105, 106, 107
slides for magic lanterns	110
spectacles	108
stained	107
stained or painted windows or	
parts	112
strips	110
telescopes	111
unpolished, contents of boxes	101
vessels, filled or unfilled	100
viols	99
window	101, 107
windows	112
Glasses :	
coquill	109
eye	108
discs for	565
field	111
goggles	108
opera	111
piano	109
Glassware :	
blown	100
colored	100
opal	100
porcelain	100
Glazed common stoueware	94
Glaziers' diamonds	545
lead	182
Gloves :	
kid or goat	442, 444
lamb or sheep skin	441, 443
leather	439, 442, 444, 445
Schmussen	440
Glove trunks	446
Glucose	210
Glee, crude and refined	23
fish or isluglass	23
stock	572
Glycerin	24
Goat hair	348, 350, 356
skins	438
Goggles	108
Gold :	
beaters' molds	567
skins	567
bullion	511
bullions and metal threads	179
coins	530
leaf	177
manufactures of	193
medals	612
ores	629
pens	187
size or japan	53
sweepings	629
tinsel wire, lame or lalm	179
Goods :	
knit silk	390
liable to two or more rates of	
duty	sec. 7
manufactured in bonded ware-	
houses for exportation	sec. 15
product of convict labor, importa-	
tion prohibited (sec. 4, act Aug.	
28, 1894)	
taken from sunken vessels	sec. 28
Gorings :	
cotton	389
silk	389
wool	371
Grain bags, exported filled	483
Grains, as drugs	20, 548
Gracillia Wood	198, 700
Granite	117, 683
Granulated tin	683
Grape fruit	286
sugar	210
Grapes	285
Grass braids, etc., for making or orna-	
menting bonnets, etc.	409
hats of	409
manufactures of	72, 449
seeds	656
sisal	564
Grasses and fibers not dressed	566
for paper	632
Grease from wool	279
used for soap making, wire draw-	
ing, or stuffing for dressing	
leather	568
Green, chrome	48
fruits	262, 559
paris	59
Grindstones, finished or unfinished	119
Ground alum	4
beans or peanuts	271
bones	409
chalk	13

	No. of Item.
Ground chicory root	289
mustard	287
plaster of paris	91
sumac	85
Guano	569
Gum :	
amber or amberoid	170
British	286
resin	20, 518
shellac	592
substitute or dextrine	286
Gums :	
advanced	20
crude	548
Gun-barrel molds	135
barrels	158
for shot-guns	658
blocks	699
powder	422
wads	428
Gunny cloth and bags	341
old, for paper stock	632
Guns, shot	157, 158
Gutta-percha, manufactures of	150
crude	570
Gut :	
cat	448, 517
whip	448, 517
worm	448, 517
Gypsum, ground and unground	91
<b>H</b>	
Hacked flax	325
hemp	327
Hair :	
advanced, beyond the washed or	
scoured condition	364
alpaca	348, 350, 356
Angora goat	350, 356
animals	348, 350, 356
enamels	348, 350, 356, 358
cattle	571
cloth	431
curled	430
goat	348
horse	571
human	429
cleaned or drawn	429
human, manufactures of	450
raw, uncleaned	571
manufactures of (See Woolen)	363, 383
on the skin	360
penicils	410
plus	188
preparations and applications for	
the	70
press cloth	431
Russian camel's	351
scanting	431
wood sticks	760
Half hose, cotton	317, 318
Hallbut	261
Hammered iron or steel	124
Hammer molds	135
Hammers, blacksmiths'	144
Hams	273
Handkerchiefs :	
cotton	312
embroidered	339
hemp	345
lace	339
silk	388
Handle bolts	699
Handles for curling stones	540
knives or erasers	153, 155
parasols or umbrellas	462
Handsaws	168
Hangings, paper	402
Hard rubber, manufactures of	450
Harness, leather	447
loom	320
Harrows	460
Harvesters	460
Hassocks made of carpeting	382
Hat bands	389
braids	409
pins	188
wire	137
Hats, felt	409, 432
Hatters' irons	148
plush	461
Hawaiian Islands, treaty	269
Hay	246
Head nets	571
Heading bolts	200
blocks	418
Heads, dolls	320
Heads	69
Healing plasters	22
Hemlock bark, extracts of	22
Hemp :	
articles, n. s. p. f.	347
bagging for cotton	344
cables and cordage	329
carpets and carpetings	334
cards	330
coverings for cotton	344
"dressed line"	327
hacked	327
hydraulic hose	355
handkerchiefs	345



Mill... **GEORGE REID & CO.** Textile...  
Supplies Machinery

SOLE AGENTS FOR THE  
**HAMILTON COTTON CO'S  
WARPS**  
**SAMUEL LAW & SONS  
ENGLISH CARD  
CLOTHING**

Valuations made  
on applica-  
tion.

AND  
**FRANCIS WILEY & CO.**  
BRADFORD, ENG.  
WOOL NOILS,  
WOOLEN  
MACHINERY  
Etc.

Telephone  
8391

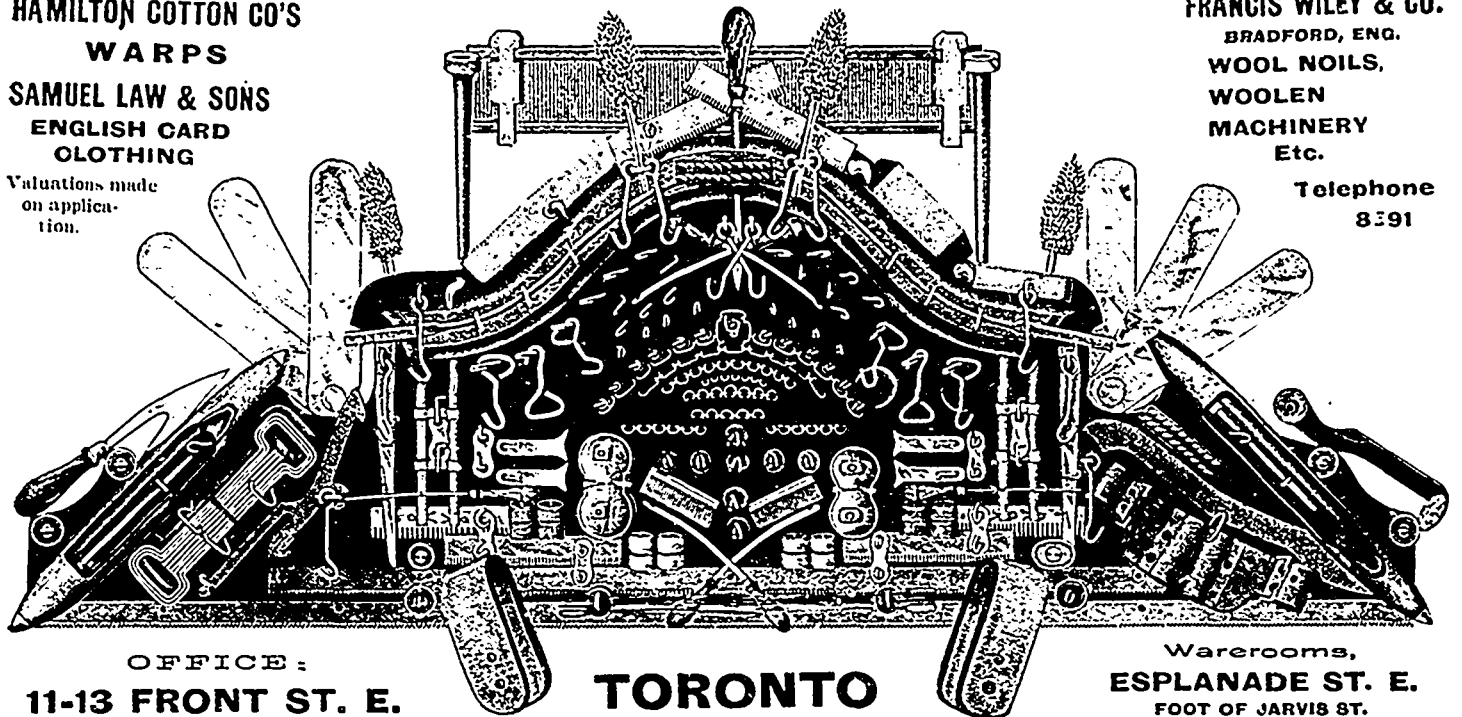

OFFICE:  
11-13 FRONT ST. E.

**TORONTO**

Warerooms,  
ESPLANADE ST. E.  
FOOT OF JARVIS ST.

**Protection**  
**Against Fire**

Apart from the protection it affords, it pays as  
an investment to use the

**GRINNELL AUTOMATIC SPRINKLER**

From 40 to 70 per cent. of cost  
of insurance saved by putting in a

**GRINNELL  
AUTOMATIC  
SPRINKLER  
EQUIPMENT**

Over 3,990 Fires—  
—NO FAILURES

No charge for estimating.  
Endorsed by Insurance Companies. "THE GRINNELL"



**The General Fire Equipment Company,**  
72 Queen St. East, Toronto.



PLAIN FANCY CEILINGS.

**Sheet  
Metal**

ROCKFACE BRICK & STONE.

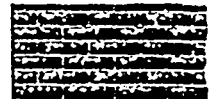

**For BUILDINGS**

**Fire-Proof  
Lightning-Proof  
Weather-Proof**

**NEAT and  
DURABLE.**

... WE MANUFACTURE ...

**Metal SHINGLES, SIDING CEILINGS**

Standing Seam Roofing for Flat Roofs  
Cornices, Ventilators, Finials, Etc.

Manufacturers desiring inexpensive building plants should  
use Metal Roofs and Sides. They are warm and  
neat and answer every requirement.

ASK FOR CATALOGUE.

**The METAL SHINGLE & SIDING CO.,**  
Limited  
**PRESTON,  
ONT.**

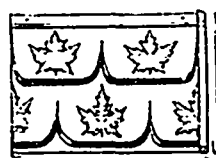

SAFE LOCK SHINGLE

SKYLIGHTS VENTILATORS



When writing to Advertisers kindly mention THE CANADIAN MANUFACTURER.



# Toronto Woolen Machinery Co.

DEALERS IN ALL KINDS OF

## WOOLEN MACHINERY and MILL SUPPLIES

MANUFACTURERS OF

**Baling Machinery for Baling Paper, Rags,  
Shoddy or Wool, Hand or Power.**

Office and Machine Shops, - 118 Duke Street, Toronto.

Having rented the premises lately occupied by Geo. Reid & Co., No. 118 Duke Street, we intend carrying on business under the name of the **Toronto Woolen Machinery Co.**, as Builders of **Machinery and Machinery Supplies**.

We are prepared to buy or handle on commission all kinds of **Woolen and Cotton Machinery**, of which a large assortment will always be found in our warehouse.

We also intend keeping in stock a full line of **Mill and Machinery Supplies**, such as Headles, Shuttles, Bobbins, Belting, Card Clothing, etc., **Machinery Supplies**, Picking Balls and Studs, Shoes, Box Swells and Springs, Brass Steps, Packing Collars, Collar Plates, both concave and straight, etc.

Our Machine Shop is under the management of **Mr. Louis Bredannaz**, who has had a number of years' experience in looking after the wants and supplies of the different branches in the above business. We are confident we can give satisfaction both in workmanship and price.

As we are practical woolen men and workers, and intend to carry on business on business principles, we ask you for a share of the trade.

# Preston Furniture Co., Limited

of PRESTON, ONTARIO.

We are Cabinet Makers and Manufacturers of

## ROLL and FLAT TOP DESKS

— AND —

## SECRETARIES of all kinds.

Our line will be found replete with up-to-date goods, well designed and well manufactured. We are making a few very nice and salable Ladies' Desks as well as Ladies' Dressing Cases, besides Book Cases, Office and Standing Desks of all kinds, both for home and export trade.

Correspondence Solicited. Catalogues on Application.

**PRESTON FURNITURE CO., Limited,**  
PRESTON, ONTARIO, CANADA.

When writing to Advertisers kindly mention THE CANADIAN MANUFACTURER.

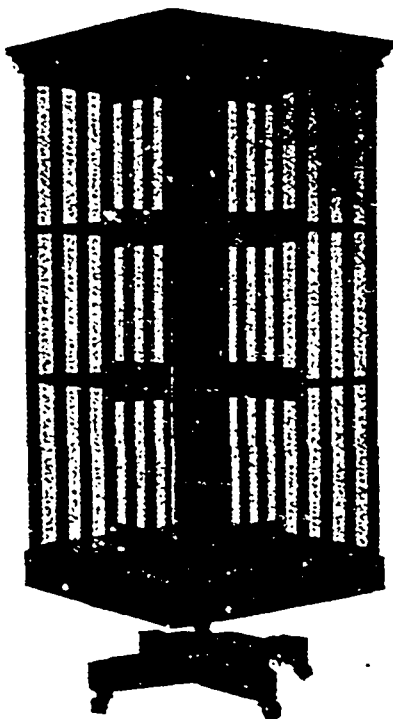

Index to the American Tariff.

	No. of Item.
Iron shoe knives	157
shoes, horse, mule or ox	163
shotgun barrels	158, 658
shotguns and rifles	158
slide arms	154
silicon, ferro	122
skelp	120, 131
slabs	124
slag, basic	124
sledges, blacksmiths	114
spiegeleisen	122
spikes, cut	130
spikes, nuts and washers	133
splice bars	130
spring	164
square	124
stays, boiler	152
steel skelp, sheared and rolled	126
stereotype plates	166
stove plates, cast	148
stretchers and frames for umbrellas and parasols	170
strip steel	128
structural shapes	125
swaged steel	135
sword blades	154
swords	154
T rails	150
T T column	126
table and carving knives and forks	155
tacks	161
tappers	154
tailors' irons	148
tape needles	165
terneplates	134
ties, cotton	129
tin plates	134, 140
tires, locomotive, car or other railway	171
track tools	144
trousers buckles	412
tubes	152
umbrella and parasol ribs and stretchers	170
vegetable knives	155
wares or articles enameled or glazed	159
washers	163
waste and refuse	162
watch wire	157
wedges	144
wheels for railway purposes and parts thereof	171
wire	157
wire nails	167
rods	156
rope	158
round	157
strand	157
wood screws	168
wrought horseshoes	163
nails	161
scrap	164
spikes, nuts and washers	133
Isinglass	325
Istle	325
cables and cordage	325, 329
Italian cloths	325, 329
Ivory:	
bagatelle balls	417
billiard balls	417
black	417
buttons	414
chess balls	417
chessmen	417
dice	417
draughts	417
manufactures of	450
pool balls	417
tusks, natural or cut vertically	424
vegetable	417
buttons	417
J	
Jacquard designs	407
figured goods	407
Jalap	407
Japan varnish	407
Japanese straw matting	407
Japanized leather	407
Japonica, terra	407
Jars	407
Jasmine or jasmin, oil of	407
Jasper, manufactures of	415
Jellies	415
Jet, manufactures of	415
unmanufactured	434, 435
Jewellery	434, 435
imitations of	435
Jewels, watch or clock	434
Jolists	434
Jonquills	434
Joss light or Joss stick	434
Juglandium oil	434
Jugs containing ale, porter or beer	434
still wines	434
Julep:	
cane, syrups of	434
cherry	434
fruit, n. & p. f.	434
fruits, preserved in	434
lemon	434
lime	434

	No. of Item.
Julep, orange, sour	597
prune	599
Juniper, oil of	626
Junk, old	588
Jute	586
bagging for cotton	314
bags	313
bits	313
carpets and carpetings	311
hydraulic hose	315
mats	314
rugs	314
sacks	313
waste	313
woven fabrics	311
yarns, single	313
K	
Kalinite	291
Kangaroo skins	458
Kaolin	292
Kelp	292
Kentledge	292
Kid skins	292
Kieserite	292
Knitting wood	292
Kirschwasser	292
Kitchen knives	292
Knitted articles of wearing apparel	317, 318
woolen	317, 318
Knitted articles, cotton	317, 318
Knitted fabrics	317, 318
goods, silk	317, 318
wearing apparel, woolen	317, 318
Knitting needles	317
Knives:	
artists	157
bread	157
budding	157
butchers	157
butter	157
carving	157
chinese	157
clasp	157
cooks	157
erasers	157
fruit	157
hunting	157
kitchen	157
manteau	157
painters	157
palette	157
pen	157
plumbers	157
pocket	157
pruning	157
shoe	157
Kryolith	292
Kyanite	292
L	
Labeling goods	434
Labels, cigar	434
cotton	434
Lac dye, crude, seed, buttons, stick and shell	434
spirits	434
Lace:	
bands	434
bead	434
bed sets	434
braids	434
children	434
chip	434
cotton	434
curtains	434
edgings	434
embroideries	434
etamines	434
flax	434
founcings	434
flutings	434
fringes	434
galloons	434
zoolings	434
grass	434
handkerchiefs	434
imitation	434
insertings	434
knit goods	434
linen	434
lappkins	434
nets or nettings	434
neck ruchings	434
ruffings	434
osier	434
palm leaf	434
pillow shams	434
quillings	434
rattan	434
silk	434
straw	434
tildes	434
tinsel wire, lame or tahn	434
trimmings	434
tuckings	434
velis and veillings	434
vitrages	434
wearing apparel	434
willow	434
window curtains	434

	No. of Item.
Lace, woolen	371
lacings, boot, shoe and corsets	370
Lactarene	594
Lactic acid	1
Lahn	179
Lakes	58
Lambskins	458
Lame	179
Lampblack	47
Land and water fowls	491
Lanewood	188, 700
Lanterns, magic, slides for	110
Lappets, cotton	313
Lard	277
Lastblocks	300
Lastings, for buttons	413
Latch needles	165
Laths	291
Laudanum	43
Lava tips for gas burners	28
unmanufactured	28
Lavender, oil of	626
Lead:	
acetate of	60
articles of	181
bars	182
bullion	182
dross	182
glaziers	182
litharge	60
manufactures of	181
nitrate of	60
not specially provided for	182
old refuse	182
ore	181
ore	181
penicils	456
pigments	456
pipe	182
red	51, 54
scrap, old	182
sheets	182
shot	182
type metal	180
white	182
wire	182
aluminum	175
Dutch metal	175
gold	177
silver	175
tobacco	215, 214
Leather:	
band	438
belting	438
bookbinders' calfskins	438
boots	438
calfskins	438
chamois skins	438
cut into shoe uppers	438
dressed, upper and all other	438
enameled	438
goatskins	438
gloves	438, 443
glove trunks	443
harness or parts of	447
hides of cattle	437
Japanese	438
kangaroo skins	438
kid skins	438
lambskins	438
manufactures of	438
morocco skins for	438
patent	438
planoforte and pianoforte action	438
saddles and saddlery, or parts of	437
sheepskins	438
shoe laces	438
shoes	438
sole	438
vamps	438
varnished	438
Leaves:	
artificial	435
as drugs	435
Leeches	435
Lees:	
crystal	435
wine, crude	435
Leakage of wine, no allowance for	435
Lemonade	435
Lemon boxes	435
grass, oil of	435
juice	435
oil of	435
peel	435
Lemons	435
Lenses	109, 111
lenses, discs for	111
projecting	111
Letter copying books	435
Libraries of persons from foreign countries	501
Lichens, as drugs	29, 544
Licorice and extracts of	435
in paste	435
rolls	435
other forms	435
root, unground	435
Lifelines and life-saving apparatus	435
Lignum-vitae	188, 200
Lilies	435
Lilies of the valley	435

# Transfer Ornaments, AMERICAN MADE.

TRADE MARKS, DECORATIONS, NAME PLATES, ETC.

For **HARDWARE, BICYCLES, VEHICLES, POTTERY, FURNITURE, etc.**

Sketches submitted free of charge. Being home makers can deliver promptly. Write us.

**THE MEYERCORD CO., Inc.,** MAIN OFFICE-- CHAMBER OF COMMERCE, - CHICAGO.

Canadian Travelling Representative,  
CHAS. H. JAGGAR, Buffalo, N.Y.

Largest Makers in the World Guaranteed Decalcomania Transfers.

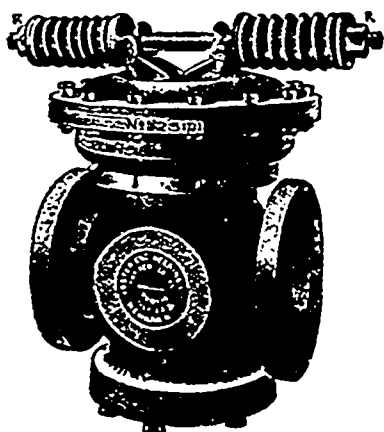

## FOSTER PRESSURE REGULATING VALVES.

*Automatically Control the Delivery Pressure of  
Steam, Gas, Air or Water, regardless of Variation in Initial Pressure.*

SEND FOR CIRCULARS AND PRICES.

**THE FAIRBANKS COMPANY,**

749 CRAIG STREET, MONTREAL.

# ARTHUR P. TIPPET & CO.

8 Place Royale  
MONTREAL

AGENTS FOR  
CANADA FOR

23 Scott Street  
TORONTO

SULPHUR all kinds.

CRYSTAL CARBONATE.

Hyposulphite of Soda  
Sulphite of Soda, Epsoms  
Sulphide of Sodium.

} Bramwells  
Scotch Glue.

## French Glues and Gelatines.

CHINA CLAY.

SULPHITE OF ALUMINA.

SAL-AMMONIAC, Etc., Etc.

**Correspondence Promptly Attended to.**

When writing to Advertisers kindly mention THE CANADIAN MANUFACTURER.

Index to the American Tariff.

	No. of Item.
Lime	30
borate of	11
chloride of	8
citrate of	609
juice	597
sulphate of, artificial	48
Limes	268
oil of	628
Limestone	117, 118
rock asphalt	43
Linen :	
collars	328
cuffs	328
manufactures of (see Flax)	347
Linings for bicycle tires	329
woolen	368, 329
Litholeum	337
Linseed	254
oil	37
Liqueurs	282
Liquors	280
coloring for	18
internal revenue stamps for	sec. 9
Litharge	60
Lithographed plates	100
Lithographic :	
elgar labels, flaps and bands	400
periodicals	400
prints	400
prints for institutions	503
illuminated, for children's books	400
stones	401
Litmus	602
Live animals	218, 222
Lodestones	605
Logs	629
Logwood, extracts of	22
London purple	59
Looking-glass plate	100, 106
Loom harness	320
Loops, iron or steel	124
Lottery tickets and advertisements	
importation prohibited	secs. 16, 18
Lumber	195
produce of forests on St. Croix	
River	sec. 21
produce of forests on St. John	
River	sec. 20
Lupulin	248
Lye of wood ashes	485
M	
Macaroni	220
Maer, oil of	628
Machinery :	
imported for repair	sec. 19
patterns for	261
Mackerel	604
Madder	604
Indian	604
Magic lanterns, glass slides for	110
Magnesia :	
calcined	31
carbonate of	31
medicinal	31
Magnesia, sulphate of	31
Magnesite	605
Magnesium, unmanufactured	606
Mahogany wood	198, 700
Malice or corn	227
Malacca joints, Indian	700
Malachite, manufactures of	115
Malt, barley	224
extract	228
Manganese, ferro	121
ore	607
oxide	607
Manganiferous iron ore	721
Mangel-wurzel seed	656
Manicure knives	153
Manila cables and cordage	329
unmanufactured or undressed	326
Manna	608
Mantels, slate	120
Manufactured articles :	
component material of chief value	sec. 7
convict labor, products of, prohibi-	
ted	sec. 31
nonenumerated	sec. 6
of the United States, exported and	
returned	482
similitude clause	sec. 7
Manufacturing, bonded warehouse	sec. 15
Manures	529
Manuscripts	600
Maps	403
for schools and institutions	503
for use of the United States	500
paper	403
printed more than twenty years	
free	501
Maple syrup	210
Maple sugar	210
Marble :	
in block, rough or squared only	114
manufactures of	115
mosaic cubes	114
paving tiles	114
sawed or dressed	114
slabs	114
Marbles, toys	418

Market value :	No. of Item.
additions to make	sec. 32
ascertainment of	sec. 32
Marine coral	535
Marking imported goods	sec. 8
Marrow, crude	610
Marshmallow root, leaves, or flowers	311
Masks	151
Matches, fection or lucifer	424
Materials for construction of vessels	sec. 12
Mats :	
flax or hemp	334
made of cocoa fiber or rattan	452
made of carpeting	382
Matings, Chinese, Japanese, etc.	333
floor, straw	333
Matting, made of cocoa fiber or rattan	452
Mattresses, hair, curled, suitable for	430
Meal :	
corn	228
oat	231
Meal, rice	222
Measuring tapes, tapes for use in man-	
ufacture of	336
Meat, extract of	276
Meats	275
Medals, of gold, silver or copper	612
Medicinal drugs, vegetable	20, 548
or medicated soap	72
preparations	67, 68
Meerschaum, crude	613
Melada, sirup of	209
Men's hats of fur	432
Mercurial preparations	68
Metal articles, n.s.p.f.	191
bookings	195
britannia	537
composition	537
Dutch, clippings from	295
Dutch, in leaf	175
manufactured articles and wares of	
sheet, enamelled	193
threads, gold and silver	193
type	190
umbrella and parasol ribs and	
stretchers	170
yellow	176
Metallic articles bestowed as trophies	
or prizes	612
hooks and eyes	190
mineral substances in a crude state	193
penholders	197
pens, except gold	196
plus	188
Metals, unwrought	183
Metronomes	423
Mica	184
Microscopes	111
Milk :	
fresh	228
of India rubber	579
preserved or condensed or sterilized	229
sugar of	229
Mill saws	168
shafting	125
stones and burr stones	116, 671
Millinery ornaments, feathers, flowers,	
birds, etc.	425
Mineral, metallic substances	181
Mineral, orange	50
salts of natural mineral waters	615
substances, articles composed of	187
waters	391
waters, bottles and jugs containing	391
waters, artificial and imitations of	
natural	391
wax	625
Minerals, crude	614
Mineralogy, specimens of	626
Mining explosives	422
Mirrors	112
Models of inventions	616
Mohair for buttons	413
Molasses	280
concentrated	280
concrete	280
sugar drainings or sweepings	280
Molded glassware and glass bottles	120
Molds :	
button	414
hammer	125
gold beaters	367
gun barrel	125
Monazite sand	183
Monohydrate of soda	75
Monumental stone	117, 118
Moquette carpets	372
Morocco, skins for	424
Morphia	42
sulphate	42
Morphine	42
sulphate of	42
Mosaic cubes of marble, onyx or stone	114
Moss	617
sea	81
Mosses as drugs	20, 548
Mother-of-pearl, manufactures of	450
Mowers	400
Muffers	312
Mule shoes	161
Mules	253
Mungo	373

	No. of Item.
Musket	604
Muriate of ammonia	5
Muriatic acid	464
Mushrooms	241
Muslin	403
for institutions	503
printed more than twenty years	501
raised print for the blind	502
Musical instruments or parts	453
Musk	618
Muskets	157
Mustard	157
seed	626
Mutton	274
Muzzle-loading shotguns	157
Myrobolans	619
Myrtle sticks	700
N	
Nail rods	136
Nails :	
cut	160
hub	161
horseshoe	161
wire	162
wrought iron or steel	161
Naphthol	524
Naphthalin	524
Naphthylamin	524
Napkins	339
Natural history, specimens of	626
Neat cattle :	
importation prohibited	sec. 19
hides of	sec. 19
Neck ruckings	329, 330
ruffings	329, 330
ties	314
wear	314
Needle wire	137
Needles :	
crochet	165
darning	620
hand sewing	620
kulting	165
kulting machine	165
latch	165
sewing machine	165
tape	165
Neroli oil	625
Nets :	
gill, flax	371
wool	371
Netting :	
cotton	371
flax, gill	371
silks	371
wool	371
Newspapers	621
Nickel :	
alloy	120
plgs, ingots, bars or sheets	120
manufactures of	120
inatte	120
ores of	120
oxide	120
Niter cake	626
Nitrate of lead	626
potash	626
soda or cubic nitrate	626
Nitric acid	626
Nitro-licric acid	626
Nitro-benzol	626
Nitro-toloul	626
Nitrous ether, salts of	626
Nolls, wool or hair	626
Nonenumerated articles	secs. 6, 19
Nottingham bed sets	316
curtains	316
pillow shams	316
Nursery stock	316
Nutgalls	316
Nutmegs	316
Nuts :	
almonds	20
as drugs	20
Brazil	20
cocoanuts in the shell	20
cream	20
filberts	20
iron	20
n. s. p. f.	20
palm	20
kernel	20
peanuts	20
steel	20
walnuts	20
Nut oil	20
Nux vomica	20
O	
Oakum	20
Oar blocks	20
Oatmeal and oatmilk	20
Oats	20
Obscene articles	secs. 16-18
Ocher	45
ground in oil	45
Ochery earths	45
Oil :	
almond	20
amber	20

# RAYMOND SEWING MACHINES

THESE MACHINES

*HAVE A WORLD-WIDE REPUTATION*

-FOR-

Durability and Utility,

AND ARE UNSURPASSED FOR NEATNESS OF DESIGN AND FINISH.

## ...THE RAYMOND...

has been the leading Canadian Sewing Machine for the past 30 years, and is still at the head.

The wood work this season is of entirely new and beautiful design, and makes a handsome piece of furniture in any of the numerous styles in which it is produced, especially in the Drop Head Style.

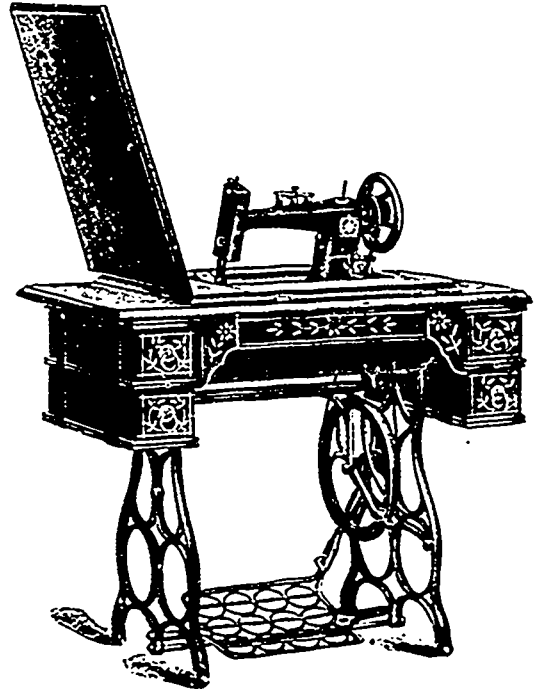

DROP HEAD.

Send for Illustrated Catalogue  
and Prices.

## THE "NATIONAL" CREAM SEPARATOR

Is especially adapted to farm use, having a capacity of 330 to 350 lbs. per hour. Although we have turned out double the number we expected to during this the first year in which we have engaged in the manufacture of Cream Separators, yet the demand has been so great that three times our output could easily have been disposed of.

On account of this increasing demand we find it necessary to enlarge our manufacturing capacity, and have decided to build a large factory especially for Cream Separators, work on which has already commenced, and we expect to have the largest and most modern factory of the kind in the Dominion in operation this fall.

The "National" is the farmer's favorite because it runs easy, skims fast and clean, and makes a perfect cream containing any per cent. of butter-fat desired; it is also easier to clean than any other.

The CREAMERY SUPPLY Co., GUELPH, ONT.  
AGENTS FOR ONTARIO

MANUFACTURED BY

The RAYMOND MFG. CO. of GUELPH, Limited,  
GUELPH, ONT., CAN.

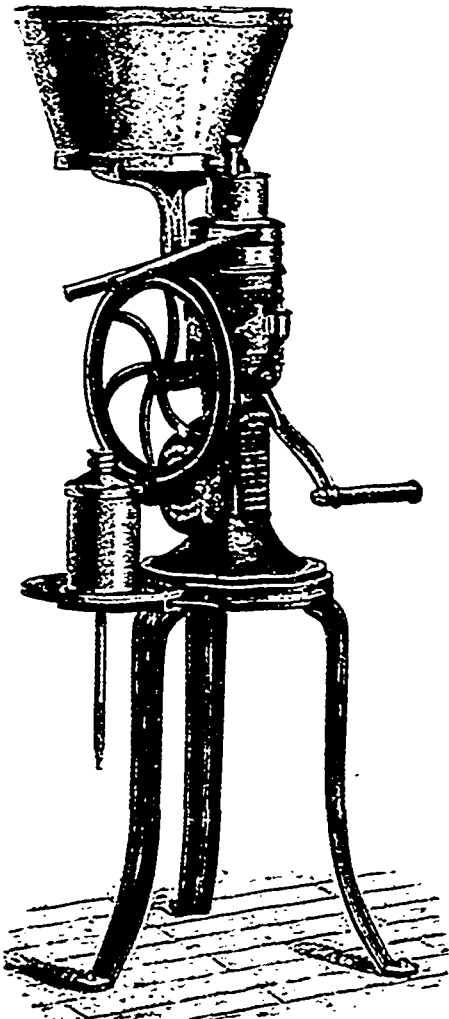

"NATIONAL" No. 1 HAND-POWER.  
Capacity, 330 to 350 lbs. per hour.

When writing to Advertisers kindly mention THE CANADIAN MANUFACTURER.

Index to the American Tariff.

	No. of Item.
Oil, ambergris	626
American fisheries	626
aniline	626
anise	626
anise seed	626
anthus	626
aspic	626
attar of roses	626
bean	626
bergamot	626
cajeput	626
cake	626
caraway	626
cassia	626
castor	33
cedrat	626
chamomile	626
clunamon	626
citronella	626
civet	626
cloth	626
coconut	626
cod-liver	34
colors	34
cotton-seed	35
croscote	524
croton	36
dead	524
distilled	3
emulsiage grease	626
essential or expressed	3
fennel	626
fish	12
of American fisheries	626
flaxseed	37
fruit	21
fusel	38
hempseed	39
herring	42
lethylol	626
jasmine or jasmine	626
juglandium	626
juniper	626
lavender	626
lemon	626
grass	626
lime	626
linseed	37
mace	626
neroll	626
nut	626
olive	40
olive, for manufacturing or mechanical purposes	626
orange	626
flower	626
origanum	626
ottar of roses	626
palm	626
peppermint	41
petroleum	626
poppy-seed	37
rape seed	39
rendered	3
rosemary	626
seal	42
sesame	626
sesamum seed	626
soluble or alizarin assistant	32
spermaceti	626
spike lavender	626
thyme	626
used for dressing or stuffing leather, soap making or wire drawing	368
valerian	626
vitriol	1
whale	42
of American fisheries	626
Oils	626
Old brass	505
colos	530
Old copper	521
gunny bags and gunny cloths	632
India rubber	579
junk	588
pewter and britannia	637
paper	632
refuse and scrap lead	182
types	630
zinc	182
Olive oil	40
for manufacturing or mechanical purposes	626
Olives	264
Onions	249
Onyx	
block, rough, or squared	114
manufactures of	115
mosaic cubes	114
paving tiles	114
sawed or dressed	111
slabs	114
Opal glassware	100
Opera glasses	111
Opium	
alkaloids or salts of	43
aqueous extracts of	43
containing less than 9 per cent. of morphia	43

	No. of Item.
Opium, containing 9 per cent. and over	
of morphia	43
crude	43
for smoking	43
liquid preparations of	43
other preparations of	43
regulations concerning stamping, etc. (See sec. 38 to 40, act Oct. 1, 1890).	
removal from bonded warehouses	43
texture of	43
Optical Instruments	111
discs for	565
Orange Juice, sour	597
mineral	50
oil	626
peel	267
stick	700
wood	700
Oranges	266
boxes and barrels containing	265
Orchids	251
Orchid or orchid liquid	628
Ore:	
antimony	476
chrome	520
cobalt	525
copper	629
emery	550
gold	629
iron	121
lead	181
manganese	607
manganiferous iron	121
nickel	629
nickel matte	629
silver	629
sulphur	674
tin	683
Organzine silk	583
Oriental rugs	379
Origanum oil	626
Orleans and all extracts of	475
Ornamental feathers	425
Ornaments, chinaware	35
millinery	425
Orpiment	479
Oster:	
hats of	409
manufactures of	206
prepared for basket-makers use	206
sheets or squares for making hats	409
Oxmium	629
Oxalic acid	464
Oxide:	
cobalt	16
manganese	607
nickel	185
strontia	673
tin, black	683
uranium	621
zinc	57
Ox shoes	163
P	
Packers' skewers of wood	207
Packages, marking and stamping, Sec. 8 of wine in bottles	206
Packing boxes and shooks	201
Paddy	262
Painted glass windows	112
Painters' knives	155
Paintings, not otherwise provided for:	
for colleges	702
for exhibition	701
for presentation	702
oil	454
on glass	703
water color	454
Paints:	
artists'	58
baryta, sulphate of, or largite	44
black bone, ivory or vegetable	47
blanc fixe	46
blue, Berlin, Prussian or Chinese	45
all containing ferro-cyanide of iron	45
ultramarine	52
wash, containing ultramarine	52
brown or grey acetate of lead	60
chrome green	48
yellow	48
chromium colors	48
cobalt	525
cochineal	527
colors containing quicksilver	51
cravos	58
frostings	58
in tubes	58
lakes	58
litharge	60
London purple	59
ocher and ochery earths	49
orange mineral	56
or pigments containing zinc	57
oxide of zinc	57
Paris green	59
pigments	55, 57, 58
red lead	51
sienna and sienna earths	49
smalts	58
umber and umber earths	49

Paints, verdigris	634
verdigris	634
vermillion	54
wash blue	52
white	57
white acetate of lead	60
Paris	56
phigment containing lead	55
satin	46
sulphate of zinc	57
sulphide of zinc	57
whiting	56
yellow acetate of lead	60
zinc, chloride of	57
oxide of	57
Palette knives	153
Palings	202
Palladium	631
Palm-leaf braids, etc.	409
hats, common	552
hats of manufactures of	409
unmanufactured	449
Palm-nut kernels	552
Palm nuts	622
oils	626
Palmus	251
Pamphlets	403, 502
Pants, cotton	319
Paper:	
albumentized	398
albums	404
all not specially provided for	402
bibulous	397
blank books	403
bond	401
booklets	400
books	400
cigarette and covers	459
boxes	405
cards, playing	406
charts	403
cigarette	459
copying	397
books	397
crepe	397
drawing	401
engravings	405
envelopes	399
etchings	401
felt, roofing	394
filtering	397
for sercus or fireboards	402
handmade	401
hangings	402
Jacquard designs	402
ledger	401
letter	401
lithographic bands	400
books and booklets	400
clear labels	400
fashion magazines	400
flaps	400
flaps	400
periodicals	400
prints	400
maps	403
manufactures of	407
masks of	451
music	403
old	632
pamphlets	403
par-ment	398
penicils	456
periodicals	400
photographic	398
photographs	403
playing cards	406
pottery	397
printed matter	403
printing	396
record	401
roofing felt	394
sensitized	398
sheathing	394
shoe buttons made of	414
stamps	670
stereotype	397
stock	632
surface-coated	398
tablet	401
tissue	397
typewriting	401
writing	401
Paper mache, manufactures of	450
shoe buttons	414
Paraffin	631
Parasol sticks	700
ribs and stretchers	170
Parasols	462
Parclment	634
paper	398
Parian ware	95, 96
dials	191
works in	702
Paris green	59
white	56
plaster of	456
Partridge, silks of	700
Paste:	
alizarin assistant	32
Brazil	506
diamonds	435



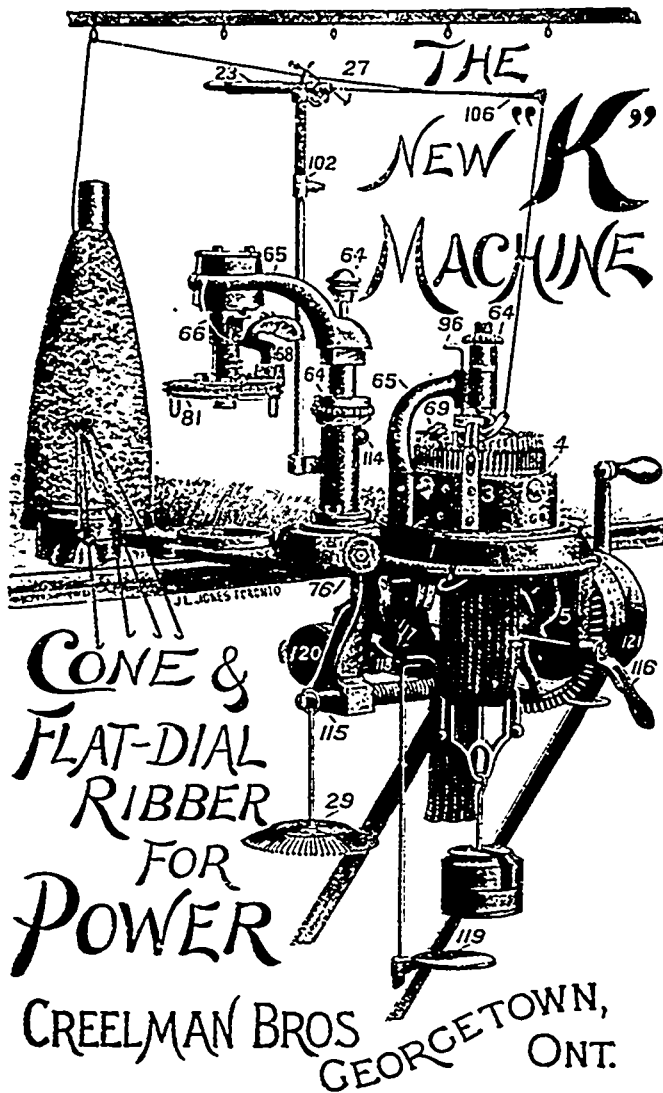

**We Are** —  
*The Pioneer Manufacturers*

.. OF ..

SEAMLESS-HOSIERY, Hand and Power

# Knitting Machines.

HAVE KEPT RIGHT AT IT FOR

**OVER 28 YEARS.**

KNOW WHAT WE'RE TALKING ABOUT  
 AND LIKE TO TALK.

**Our Experience is Yours**

— for the asking.

We can Save You Money and give you Pointers  
 Invaluable to you as Hosiery Manufacturers.

## **WE MAKE** —

Automatic Rib-Jersey and Sweater Machines.

Automatic Rib-Top Machines.

Bicycle Hose Designers.

Lumbermen's Plain Hose Leg Designers.

Looped Mitt Machines.

Power Winders, Fullers, Dryers, Steam Presses.

IN FACT EVERYTHING ESSENTIAL FOR HOSIERY MANUFACTURING  
 ON A SMALL OR LARGE SCALE.

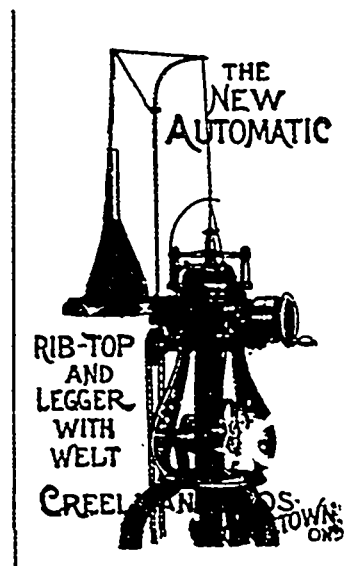

WRITE FOR FREE ILLUSTRATED CATALOGUE TO

# Creelman Bros.,

GEORGETOWN, ONT.

DO YOU WANT  
 A VISIBLE WRITING  
 TYPEWRITER?

WRITE US FOR CATALOGUE

When writing to Advertisers kindly mention THE CANADIAN MANUFACTURER.

Index to the American Tariff.

	No. of Item.		No. of Item.		No. of Item.
Paste, licorice manufactures of.	112	Pipes...	117, 152, 182, 468	Powders :	
Pastels.	451	boller.	152	for the hair, teeth, or skin.	70
Pastes of indigo.	25	cast-iron.	147	fulminating.	430
toilet.	70	clay smoking.	439	ink.	26
Patent alum.	4	copper.	176	toilet.	70
barley.	225	lead.	182	Precious stones.	435, 545
leather.	438	pl. ch.	433	Precipitated chalk.	14
turiar.	6	tobacco.	459	Preparations :	
Patterns for machinery.	616	Plstols.	158	anatomical.	669
Paving tiles, marble.	114	Plt saws.	168	chalk.	17
posts.	196	Pitch:		coal tar.	15
Peaches.	262	Burgundy.	512	macaroul and vermicell.	229
Peanuts.	271	of coal tar.	524	medicinal.	67, 68
Pear seedlings.	252	of wood.	675	of which distilled spirits are a part.	220
Pears.	262	pipes, pitch, metal.	455	opium.	43
Pearl buttons.	414	Platts.	409	toilet.	270
hardening.	91	Planking, ship.	699	Printed matter.	403
mother of.	450, 635	Planks.	195, 138	Printing paper.	396
shells.	635	Plano or coquill glasses.	101	Prints, lithographic.	400, 503
Pearled barley.	225	Planters.	400	Prizes or trophies.	612
Pearls.	434, 436	Plants and vines.	222	Products of coal tar.	15, 524
Pease:		cuttings and seedlings.	232	Professional books.	645
dried.	250	for United States.	640	instruments.	645
green.	250	Plants, fruit, tropical and semi-tropi- cal.	500	instruments.	645
in cartons or papers.	250	rose.	232	Projecting lenses.	111
prepared or preserved.	241	Plaques.	95	Protoside of strontian.	673
split.	250	Plaster:		Prune juice or wine.	229
Peat, moss.	455	rock or gypsum.	91	Prunes.	294
Pebble, unwrought Brazilian.	507	of paris, manufactures of.	450	Prunelles.	294
lenses of.	109	Plasters, healing, curative, and court.	69	Proning knives.	153
Peel:		Plate glass, cast, polished, looking.		Prussian blue.	45
citron, preserved.	267	glass, or plate glass, silvered and fluted.	103, 104, 105, 106, 107	Prussiate of potash.	66
lemon and orange.	267, 627	Plates:		Prussic acid.	464
Penalty for undervaluation.	see 32	boller or other, of iron or steel.		Public monuments, articles intended for.	702
Pencil leads.	457	126, 131, 132, 133, 134, 135, 140.	141	Pulp, blue.	45
Pencils:		cast-iron stove.	148	all manufactures of.	433
hair.	410	copper.	532	masks.	451
lead.	456	copper rolled.	176	shoe buttons.	414
paper.	456	electrotype.	166	wood.	393, 395, 639
slate.	456	engraved or lithographed.	163	ultramarine, blue.	52
wood.	456	glass, or discs.	505	yellow chryme.	48
Penholder tips.	187	of iron or steel, coated with tin or lead.	134	Pulu.	646
Penholders and parts thereof.	187	of metal, enameled or glazed.	159	Pumice stone, manufactured and un- manufactured.	92
Pen knives.	132	photographic, dry or films.	458	Purple, London.	59
Pens:		railway fish.	120	Putty.	56
gold.	187	saw.	135, 141	Pyrites, dross or residuum from.	121
metallie.	186	steel engraved.	166	Pyrites, sulphur ore.	674
Pepper:		stereotype.	162	Pyroligneous acid.	1
black or white.	647	tin and terne.	134, 140	Pyroxylin, compounds of.	17
cayenne or red.	287	Plateaux for hats, etc.	422	knife handles.	155
Peppermint oil.	41	Platina.	641	manufactures of.	17
Percentage of alcohol in wines, etc.	296	Platinum.	642	rolled or in sheets.	17
Percussion caps.	424	manufactures of.	103	Q	
Perfumed soap.	70	Playing cards.	406	Quebracho, extracts of.	22
Perfumery.	70	Plows.	460	Quicksilver.	189
Periodicals.	400, 621	Plumbago.	642	colors containing.	54
Personal effects:		Plumbers' knives.	155	flasks or bottles.	189
accompanying passenger.	697	Plums.	262, 264	flasks or bottles returned.	483
of citizens of United States dying in foreign countries.	636	Plum seedlings.	232	Quillings, cotton.	359
Petroleum.	626	Push, hatters'.	461	Quills of down.	425
Pewter, old.	457	ribbons.	286	Quince stocks.	232
manufactures of.	187	Plushes:		Quincees.	262
Phenol.	524	cotton.	315	Quintals :	
Philosophical apparatus brought by professional artists, lecturers, or scientists.	701	silk.	286	barks of.	647
Philosophical apparatus for societies, etc.	638	Pocket knives.	153	sulphate and alkaloids of.	647
Phosphates.	639	Poles, telegraph.	196	Quilts.	540
Phosphoric acid.	464	Poles, hop.	620	R	
Phosphorus.	61	Pomades.	70	Rabbits' fur, hats composed of.	432
Photograph albums.	404	Poincelos, or shadoocks.	287, 298	Rags.	632, 633, 634
Photographic dry plates and films.	458	Pool halls.	417	wool.	363
Photographic lenses.	111	Poppy seed.	254	Railroad ties.	196
Photographs.	403, 500, 501, 503, 701	oil.	37	Rails :	
Phthalic acid.	464	Porcelain glassware.	100	flat.	130
Planoforte action leather.	438	dials.	191	T.	130
leather.	438	ware.	35, 36	Railway bars.	130
actions and parts.	433	Porcelain, works in, free.	702	fish plates.	130
Plano wire.	137	Pork, fresh.	274	tires.	171
Pickles.	241	Porous carbon pots.	38	wheels.	171
Pickled fish.	261	Porter.	227	splice bars.	130
herrings.	260	Portland cement.	80	Rails.	264
Pickets.	202	Posts of wood.	196, 200	Rakes, horse.	400
Picric acid.	464	and columus, iron.	125	Ramie :	
Pig iron.	132	Potash :		articles of, n.s.p.f.	346
Pigments.	55, 57, 58	bichromate of.	62	cords.	330
Pigs of copper.	53	carbonate of.	644	handkerchiefs.	345
iron.	132	caustic.	63, 644	hydraulic hose.	335
lead.	182	chlorate of.	63	manufactures of.	347
tin.	63	chromate of.	62	shirting cloth.	348
zinc.	192	crude or black salts.	614	threads.	330
Pile fabrics.	315, 342, 356	hydriodate of.	64	twines.	330
Pillow shams.	340	hydrate of, or caustic potash.	644	woven fabrics.	346
Pimento:		iodate of, refined.	63	yarns, single.	331
unground.	667	iodide of.	64	Rape seed.	656
wood.	709	muriate of.	644	oil.	39
Pineapples.	267, 268	nitrate of.	65, 634	Rasps.	156
Pine kindling wood.	197	prussiate of, red and yellow.	66	Ratada.	222
Pins:		sulphate of.	644	Rattan.	700
bonnet.	188	Potassa.	6	for hats, bonnets or hoods.	409
hair.	188	Potassium, cyanide of.	66	mats and matting.	452
hat.	188	Pottery, works in.	702	unmanufactured.	700
metal.	188	Pouches for tobacco.	459	Raw or unmanufactured articles.	see 6
solid head.	188	Poultry, live or dressed.	275	Raw skin.	654
safety.	188	Powder :		Razors and razor blades.	153
shawl.	188	bleaching.	8	Ready-made clothing :	
Pipe bowls.	459	bronze.	175	cotton.	314

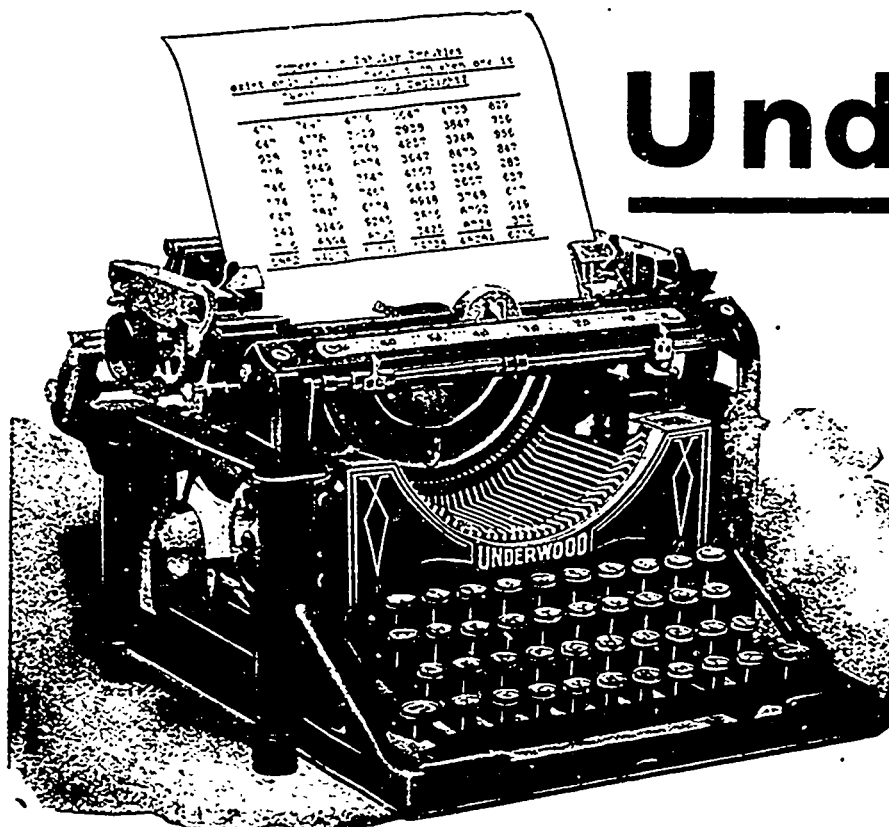

THE  
**Underwood**  

---

**TYPE-**  
**WRITER**

.....

*The Outcome of 25 Years' Experience and Study.*

Adopted by the leading Governments, large Railroad, Telegraph and Financial Institutions, and the Leading Legal and Commercial Offices on the Continent.

**WHY ?** Because it has distinct features contained by no other machine made. One glance at the **Underwood** Typewriter convinces the operator that the writing is always in front, in full view. The writing of one line forces the conviction that it is the speediest machine ever written upon ; that the touch is light and elastic ; that corrections can be inserted quicker, easier and better than ever before, and that fewer errors will be made.

By the time half a page has been written, there will have been discovered the additional advantages of the tabulating stops and key, which open a new field of usefulness in billing, etc. ; the ease, positiveness and joy of using the marginal stops, writing outside the marginal line whenever necessary ; the wonderful accuracy of the paper-feed ; the simple operation of the line spacing ; the reduction in noise ; and the beauty of the machine. Write or call for Catalogue.

SOLE CANADIAN AGENTS :

# CREELMAN BROS. TYPEWRITER CO.,

HEAD OFFICE:

15 ADELAIDE STREET EAST, TORONTO, ONT.

BRANCHES :

97 St. Francois Xavier St., Montreal, P.Q.

36 Elgin St., Ottawa, Ont.

28 King St. West, Hamilton, Ont.

436 Richmond St., London, Ont.

When writing to Advertisers kindly mention THE CANADIAN MANUFACTURER.

Index to the American Tariff.

	No. of Item.
Reapers	160
Reciprocal commercial arrangements	3, 4
Reciprocity treaty with Hawaii	399
Red chalk	13
lead	54
pepper	287
prussiate of potash	66
vermillion	54
Reeds:	
chair	206
unmanufactured	700
Refined bauxite	4
Regalia, free	649
Regulus, antimony	173
Regulus, copper	371
Reimportation of articles	183, sec. 24
Rendered oils	3
Remnets	650
Repairs to American vessels	13
machinery	19
provisions	34
Residium from burnt pyrites	121
Resin gum, as drugs	20, 548
Resorcin	524
Revolving pistols	153
Retorts:	
gas	97
platinum	642
Revenue stamps	670
Ribbons	320, 386
Ribs for parasols and umbrellas	170
Rice:	
broken	232
cleaned	232
flour	232
hulled and not hulled	232
meal	232
paddy	232
uncleaned	232
Ricinoleic acid	32
Rifles	157, 158
Ring waste	361
Rivet rods	136
Rivets	167
Rochelle salts	6
Rock asphalt, limestone	93
crystal, manufactures of	115
Rocoon, and extracts of	475
Rods:	
aluminum	172
copper	176
iron	136, 141
steel	136, 141
Rolls, lardice	29
Roman cement	89
Roofing felt	394
slates	120
Root:	
a.ow, not manufactured	478
briar	790
chicory	286
dandelion	283
ginger	667
Roots:	
as drugs	20, 548
bulbous	20, 251, 548
hop, for cultivation	576
Rope ends	632
hide	573
waste	632
Roping, cotton	302
Rosemary, oil of	426
Rose plants	252
Rosewood	198, 700
Roses, attar or oil of	626
Rotten stone	671
Rough iron or steel	302
Roving, cotton	361
waste wool	475
Roucou and extracts of	671
Rough hurr stones	123, 124
Round iron or steel	123, 124
Ruchings and rufflings:	
flax or cotton	379
silk	390
Rugs:	
Aubusson	379
Axminster	379
Berlin	379
carpeting	382
oriental	379
Rust, no allowance for	138
Rye flour	233
Rye	233

S

	No. of Item.
Salmon	261
Sal soda	77
Salt:	
cake	50
for curing meats and fish	284
in bags, sacks, barrels or other packages	284
in bulk	284
Salted fish	261
Salted herrings	260
Salted mackerel, halibut or salmon	261
Saltwater:	
crude	611
refined	65
Salts:	
amllue	472
black	614
chemical	3
epsom	31
mneral	615
of cinchona bark	647
of opium	43
rochelle	6
santonin	71
strychnia	83
urarium	691
Sand	671
Sandstone	117, 118
Santouin	71
Sardels, or sardellen	258
Sardines	258
Satin white	46
wood	198, 700
Sauce, fish	241
Sauces, all h. s. p. f.	241
Sausage, bologna	655
Saw plates, steel	135, 141
Sawed boards, plank, deals, etc.	195, 198
Sawed cabinet woods	195
Sawed lumber	195
Saws	168
Saxony velvet carpets	373
Scenery, theatrical	645
Scientific apparatus for institutions	638
Scissors, steel	153
Scoured wool	354
Scrap, albume	404
India rubber	579
iron	122
lead	182
steel	122
Screens of carpeting	382
paper for	402
Screw wire rods	136
Screws, wood	169
Scroll iron	128, 132
Sculpture, casts of	649
Sea moss	81
Seal oil	42
Seating, hair	431
Sea weeds	617
Sections of columns or posts, iron or steel	125
Seed, lac	382
Seedlings	232
Seeds:	
anise	656
aromatic, as drugs	20, 548
bean	656
beet	656
caraway	656
cardanum	656
castor, or castor beans	254
cauliflower	656
coriander	656
cotton	656
cummin	656
fennel	656
fengreek	656
flax	254
flower	656
grass	656
hemp	656
horhound	656
imported by Department of Agriculture or United States Botanic Garden	640
linseed	254
mangel-wurzel	656
moribid growth	20, 548
mustard	656
not specially provided for	254
oil	254
poppy	254
rape	656
sorghum	656
St. John's bread	656
sugar-beet	656
sugar-cane	656
Selnes, flax	332
Sensitized paper	398
Sesame, or scamum seed oil	626
Sesquicarbonate of soda	75
Sewing machine needles	163
Sewing silk	385
Shaffing, steel	125
Shale	415
Shapes, steel	124, 135
Shawl plus	188
Shawls, woolen	370
Shavings for paper stock	632

	No. of Item.
Shears	153
Sheathing felt	353
paper	391
or yellow metal	178
Sheep dip	221
Sheep dip	657
Sheepskins	435
Sheets of aluminum	172
copper	176
iron or steel, 131, 132, 133, 134, 135, 136, 137, 138, 139, 140, 141	150
lead	182
metal, enamelled or glazed	150
platina	641
zinc	192
Shellfish	659
Shell:	
buttons	414
manufactures of	450
Shells	635
cocoa or cacao	328
engraved, cut or ornamented	450
Shingle bolts	620
Shingles	203
Ship chronometers	191
planking	620
lumber	620
Shirt collars and cuffs	338
Shirts, cotton	310
Shoddy	362
Shoe buttons	414
knives	155
lacings	320
leather	438
Shoes:	
horse, mule or ox	161
leather	438
Shooks:	
of American manufacture	205, 483
packing box	204
sugar box	204
Shot, lead	182
Shotgun barrels	158, 688
Shotguns	157, 158
Shrimps	639
Shubs	252, 640
Slide arms	154
Sienna	49
carth	49
Silicete, alkaline	79
of soda	79
Silk:	
all manufactures of, not specially provided for	391
applied articles	390
ascertainment of weight	382
bandings	389
beaded goods	390
beltings	389
bindings	389
bolting cloths	489
bone casing	389
braces	389
braids	389
button forms	413
carded or combed	384
chenilles	384
chiffon	390
clothing, ready-made	390
cocoon	601
cords	389
edgings	390
embroidered articles	390
floss	385
founcings	390
fringes	390
galleons	390
garters	389
goods, ornamented with beads or spangles	390
gorings	389
handkerchiefs	388
hat bands	389
hatters' plush	461
insertings	390
Jacquard figured goods	391
knit goods	390
laces	390
manufactures of	391
manufactures of, and India rubber	391
mufflers	388
nettings or nets	390
organzine	385
pile fabrics	386
plush ribbons	386
plushes	386
raw or reeled	600
ready-made clothing	390
ribbons, plush or velvet	386
ruchings	390
ruffings	390
sewing	385
singles	385
sleeve linings	311
spun in skeins	385
stripes	311
suspenders	389
tamboured articles	390
tassels	389
thread	385
thrown	385
tram	385

# THE CANADA SUGAR REFINING CO.,

Limited

MONTREAL

Manufacturers of Refined Sugars of the well known Brand

## Redpath

Of the Highest Quality and Purity

Made by the Latest Processes, and Newest and Best Machinery, not surpassed, and

### LUMP SUGAR

In 50 and 100 lb. boxes.

### "CROWN" GRANULATED

Special Brand, the finest that can be made.

### EXTRA GRANULATED

Very Superior Quality.

### CREAM SUGARS

(Not Dried).

### YELLOW SUGARS

Of all Grades and Standards.

### SYRUPS

Of all Grades in Barrels and Half-Barrels

### SOLE MAKERS

Of high-class syrups, in tins 2 pounds and 8 lbs. each.

## The Yeakley Vacuum Hammer.

Canadian Patent November 9, 1897.

Is now Manufactured and for Sale by the undersigned Sole Proprietors of the Canadian Patent:

### George Brush

EAGLE FOUNDRY,

MONTREAL.

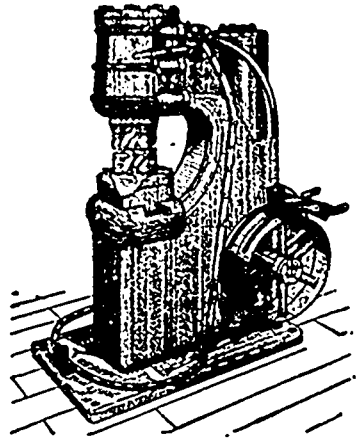

## THE ... A. R. WILLIAMS MACHINERY CO. (Limited)

Head Office, - SOHO MACHINE WORKS, TORONTO

Manufacturers of and Dealers in

High-Class Iron Tools,  
Wood-working Machinery,  
Engines, Boilers,  
Motors, Water Wheels,  
General Machinery  
and Supplies.



WE ARE THE EXCLUSIVE AGENTS OF THE

McGregor-Gourlay Co. Limited, GALT, ONT.

### IRON WORKING MACHINERY.

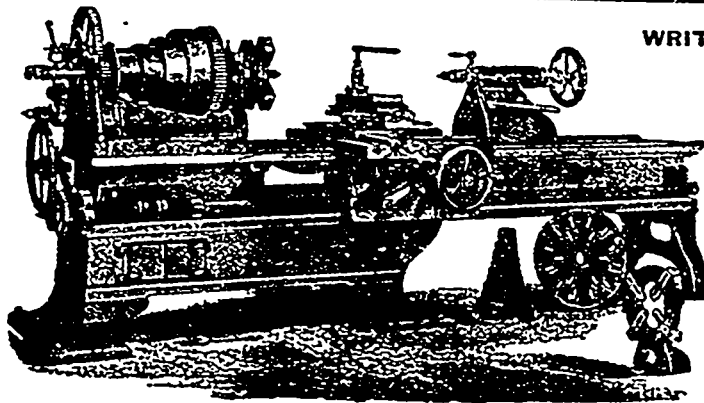

WRITE TO US FOR PRICES.

BRANCHES  
193 Colborne St.,  
BRANTFORD  
345 and 347  
St. James St.,  
MONTREAL

Send for Circulars, Referring to this Advt.

# PITT & SCOTT

ESTABLISHED 1876.

## Foreign Freight Brokers and Express Carriers TO ALL PARTS OF THE WORLD.

THROUGH BILLS OF LADING ISSUED AND RATES QUOTED TO ALL PARTS OF EUROPE, ASIA AND OCEANICA.

SENDERS INVOICES COLLECTED AGAINST DELIVERY OF GOODS ANYWHERE ABROAD.

PITT & SCOTT, - - 39 Broadway, NEW YORK.—121 Water Street, BOSTON.

ALSO AT..... LONDON, LIVERPOOL; PARIS, HAMBURG.

AND AGENCIES EVERYWHERE ABROAD.

When writing to Advertisers kindly mention THE CANADIAN MANUFACTURER.

Index to the American Tariff.

	No. of Item		No. of Item		No. of Item
Silk trimmings	390	Spars, timber used for	191	Stones, precious and imitations of	435
tubing	389	Specimens of natural history, botany, mineralogy	606	whet	574
twist	385	or casts of sculpture	649	Stops, art educational	481
veiling	390	Spectacle frames	108	STOAX, or STYAX	672
velvet ribbons	286	Spectacles	198	Stove plates	118
velvets	387	glass plates or disks for	555	Straw	255
waste	661	Spermocetl oil	626	braids	409
wearing apparel	390	Spices :		flax	323
webbing and webs	389	as drugs	20, 578	hats, bonnets and hoods	109
worm's eggs	662	capsicum	29	manufactures of	119
woven fabrics not specially provided for	387	cassa, cassaveta and buds	661	matting for floors	333
yarns	385	cinamon and chips	667	Stretchor frames for umbrellas and parasols	170
Silver :		cloves and clove stems	667	Strings for musical instruments	433
bullions	179	ginger root	667	Strip steel	128
bullion	511	nutmeg	667	Strontia, mineral carbonate of	673
coins	530	not specially provided for	287	oxide of	673
German	174	nutmegs	667	Strontian, protoxide of	673
leaf	178	pepper, black or white	667	Strontianite	673
manufactures of	184	red	287	Structural shapes or iron or steel	127
medals	612	plumeto	667	Studs	114
ores	629	sage	287	Sty'nia or styeoline	83
sweepings	629	Spiegel Eisen	122	STYAX	672
tinsel wire	179	Spices :		Subacetate of copper	694
Singles, silk	385	cut	100	Substances, explosive	422
Sirups :		wrought	163	used for manure	569
of cane juice	200	ascertainment of proof of	290	vegetable	617
maple	210	distilled from grain	289	Substitutes for butter	236
Sisal grass :		distilled, compounds of	291	cheese	237
binding twine	191	of nitrous ether	21	coffee	283
grass cables, cordage	329	of turpentine	688	steel	135
Sisal grass, unmanufactured	566	Spirituons beverages	289, 296	Sugar :	
Size, gold	33	Spirit vanishes	53	beet, seed	656
Skeletons	663	Splice-bars	130	box-shooks	204
Skep, iron or steel	131	Split pease	250	candy	212
Skewers	207	Sponges	82	can	210
Skin, preparations for the	70	manufactures of	82	colored	212
Skins :		Spool thread, cotton	303	confectionery	212
bird	42	Sporting rifles	157, 158	draughts	303
bookbinders' calf	438	Sprats	258	glucose	210
calf	438	Sprigs	164	grape	210
chamois	438	Spin silk	385	maple	210
fish	556	Spuak	668	of milk	239
for morocco	438	Spurs and stils used in the manufacture of earthenware	669	saccharine	211
fur, carotted	426	Stained glass articles	100	sweepings	209
not dressed	562	windows	112	tank bottoms	209
goat	438	Stamping of lugorted goods	see 8	tintured	212
goldbeaters'	567	Stamps :		Sulfide of zinc, white	57
kangaroo	438	foreign postage or revenue	670	Sulphate of alumina	4
kid	438	internal revenue, for-		ammonia	5
lamb	438	cigars	see 10	baryta or barytes	44, 46
n.s.p.t.	664	liquors	see 9	copper	9
raw	664	Standard samples of wool	352	iron	19
sheep	438	Starch	283	lime, artificial	16
wools on	399	burned	286	magnesia	31
Skit bindings, bias	315	Statutory	451	morphta	43
Slabs for tables, slate	120	for colleges, etc	649	Sulphate of morphine	43
Slack coal	115	Statuettes, chinaware	95	gotash	611
Slag, basic	121	State bolts	200	quiba	617
Slate :		Staves of wood	202	soda	80
all manufactures not specially provided for	120	Stays, boiler	152	zinc	57
chimney pieces	120	Steel or iron (see iron or steel, 121-170)	193	Sulphide of arsenic	479
mantels	120	in all forms n. s. p. f.	137	zinc	51
pencils	120	strip	135	Sulphite of antimony, crude	476
roofing	120	substitutes for	137	Sulpho ricinoleic acid	32
slabs for tables	120	steel trousers buttons	111	Sulphur :	
Slates	120	Stems, artificial	425	crude	674
Sledges, blacksmiths'	111	as drugs	20, 578	lac or precipitated	671
Sleeve linings	311	Sterotype paper	397	not otherwise provided for	671
Slices, glass, for magic lanterns	110	plates	166	ore	671
Silver, cotton	302	Sterilized milk	391	refined	84
Slubbing waste	361	Stiek, lac	392	flowers of	84
Smalts	58	Sticks :		sublimed	84
Smelting and refining ores and metals	see 29	for umbrellas, parasols and sun shades	62, 700	Sulphuret of iron	674
Smokers' articles	459	for whips, fishing rods or walking canes	700	Sulphuric acid	1, 675
Snuff and snuff flour	216	hair wood	700	Sulphuric ether	21
Soap :		myrtle wood	700	Sunac	
castile	72	orange wood	700	extract of	22
toilet and all other	72	partridge wood	700	ground	85
Soda :		pimento wood	700	Sun-binding twine	491
arseniate of	75	Still wines	296	cables and cordage	329
ash	75	Stock, glue	372	unmanufactured	366
bicarbonate of	71	nursery or greenhouse	372	Sun-shades	462
borates of	11	paper	632	sticks for	462, 700
caustic	76	Stockings, hose and half-hose, cotton	317, 318	Supercarbonate of soda	73
carbonate of	75	Stocks for shotguns	158	Surface-coated papers	398
chlorate of	25	Stone :		Suspenders	320, 371
chromate of	74	building	117, 118	Swarzed steel	155
concentrated crystals	75	burr	116, 671	Sweaters	319
crystals	77	cliff	671	Sweepings or silver or gold	629
cubic nitrate	65	freestone	117, 118	Sweetmeats	263
hydrate of	76	granite	117, 118	Swine	219
hypophosphite of	26	lime	117, 118	Sword blades	151
monohydrate of	68	monumental	117, 118	Swords	154
nitrate of	76	pumice	92		
sal	77	rotten	671		
sesquicarbonate	75	sand	117, 118		
silicate of	76	tripoli	671		
sulphide of	76	ware	91, 95, 96		
sulphate of	80	Stones :			
supercarbonate of	77	curling	510		
tartrate of	6	flint	537		
water	300	grind	119		
Sole leather	438	lithographic	601		
Sounds, fish	23	load	603		
Spar, manufactures of	115	mill	116		
Sparkling wines	295				

T

T rails	150
Table covers	316
damasks	321
knives and forks	155
Tables, slate slabs for	120
Tacks, cut	164
Taggers iron or steel	134
tin	132, 154
Tailors' chalk	13
irons	148
Tallow	279
Tamarinds	656
Tanned articles	312, 339, 390

# .. SAFES ..

Fire-Proof,  
Burglar-Proof,  
Fire and  
Burglar-Proof,

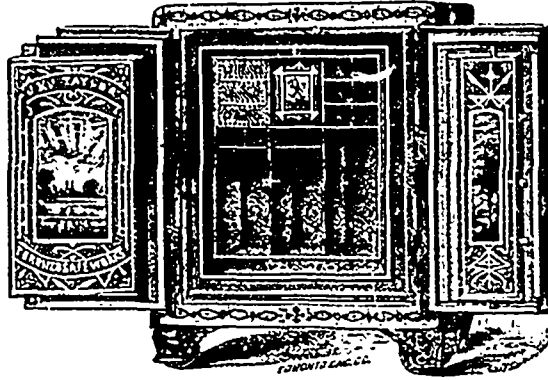

Vault Linings,  
Vault Doors,  
Jail Work and  
All kinds of Iron Work

**J. & J. TAYLOR,** Toronto Safe Works,

145 and 147 Front St. East, **TORONTO,** Canada.

## Railway Signals and Lamps, Ship Lamps and Supplies

### RAILWAY

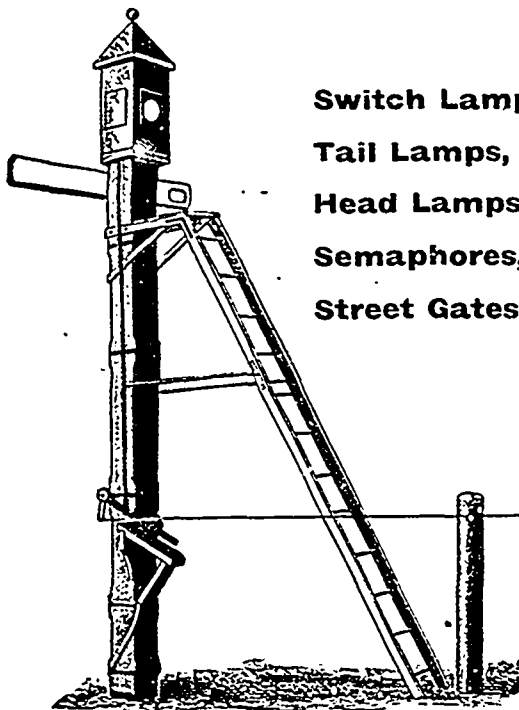

Switch Lamps,  
Tail Lamps,  
Head Lamps,  
Semaphores,  
Street Gates.

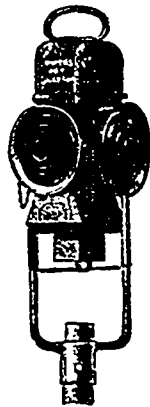

Telegraph  
Signals,  
Burners,  
Chimneys,  
Lanterns,  
etc., etc.

Send for Catalogue

No. 4,  
RAILWAY SUPPLIES.

No. 5,  
ELECTRIC SUPPLIES.

No. 31,  
SHIP LAMPS and  
SUPPLIES.

### SHIP LAMPS



Mast Head,  
Anchor,  
Side Lights,  
Binnacle,  
Cabin,  
Electric or Oil.

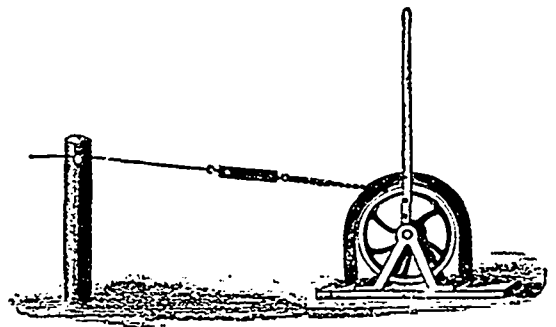

**The N. L. PIPER RAILWAY SUPPLY CO., Limited,**  
Manufacturers, 314 FRONT ST. W., Toronto.

When writing to Advertisers kindly mention THE CANADIAN MANUFACTURER.

Index to the American Tariff.

No. of Item.		No. of Item.		No. of Item.	
Tampico fiber:		Toys	418	Vessels, supplies for	sec. 14
binding twine	491	china-ware	95	United States, importations in	sec. 23
cables and cordage	329	Trade-marks	sec. 11	wrecked in waters of the United States	sec. 28
unmanufactured	568	Track tools	144	Vials	99
Tank bottoms	209	Tram silk	385	Vinegar	288
Tanned and dressed calfskins	438	Trunks, glove	446	Vines	252
Tannic acid	1	Trebble Ingrala carpets	377	Vitrages	339
Tannin	1	Trees, nursery stock	252	Vitrified, blue	9
Tanning, articles used for	482	Trimmings:		of oil	1
Tape needles	165	bead or beaded	408	Vitrified brick	87
Tapes of cotton	320	silk	390	tiles	88
flax	336	flax, cotton or other vegetable fiber	339	Vulcanized India rubber, manufactures of	460
Tapestry brussels carpet	376	wool	371		
velvet carpets	375	Tripoli	671		
Taploca	677	Trophies	612		
Tar:		Tropical and semitropical fruit plants	560		
coal, crude	524	Trousers buttons	414		
coal, dyes or colors	15	Trousers buckles	412		
coal, pitch of	524	T T columns	125		
coal products	15	Tubes:			
of wood	678	boiler	152		
Tartar, cream of	6	iron or steel	152		
Tartar, crude	6	Tackings, fax and cotton	339		
patent	6	Tulips	251		
Tartars	6	Tuning forks and hammers	453		
Tartaric acid	1	Turmeric	686		
Tartrate of soda or potassa	6	Turpentine, spirits of	688		
Tarsals	371, 389	venice	687		
Tea	679	Turtles	9		
plants	679	Twine	50		
Teams of immigrants	474	binding	491		
Teasels, toy	95	Twist, silk	385		
Teazles	256	Type metal	190		
Teeth	680	Types:			
Teeth, preparations for	70	new	190		
Telegraph and trolley poles	196	old	690		
Telescopes	111	Typewriter paper	401		
Terne plates	132, 134, 140				
Terra alba	681				
japonica	682				
Textile grasses	566				
Theoretical properties	645				
Thortite	183				
Thread:					
cotton	302, 303				
flax, hemp or ramie	350				
silk	385				
waste	362				
Threads of gold, silver or other metals	179				
Threshing machines	460				
Thrown silk	385				
Thyme, oil of	626				
Tides	339				
Ties, cotton	129				
railroad	196				
Tights	319				
Tiles, plain and ornamented	88				
marble paving	114				
onyx paving	114				
Timber:					
hewn	194				
sided	194				
squared	194				
round, for spars, or in building wharves	194				
round, unmanufactured	689				
Tin:					
bars, block, pigs, or grain or granulated	683				
black oxide of	683				
taggers	134				
ore, cassiterite or black oxide	683				
plate	134, 140				
plates	132				
manufactures of	140				
Tincture of opium	43				
Tinsel wire	179				
Tips, for penholders	187				
lava, for burners	98				
Tires	117				
Tires, bicycle, linings for	320				
Tissue paper	397				
Tobacco:					
cigars, cigarettes and cheroots	217				
filler	213, 214				
Internal Revenue Stamps	sec. 10				
leaf	213, 214				
manufactured	215				
n. s. p. f.	215				
pipes	459				
snuff and snuff flour	216				
stems	684				
unmanufactured	215				
wrapper	213, 214				
Toilet articles	70, 637				
preparations	2, 70				
soap	72				
waters	2				
Toluol	524				
Toluidine	524				
Tollidin	524				
Tongva, tonguin, or tonka beans	685				
Tools of trade of persons emigrating to the United States	645				
track	144				
Tooth and disk harrows	460				
Toothpicks	207				
Top waste	361				
Tow					
of flax	326				
of hemp	327				
Tournay velvet carpets	373				



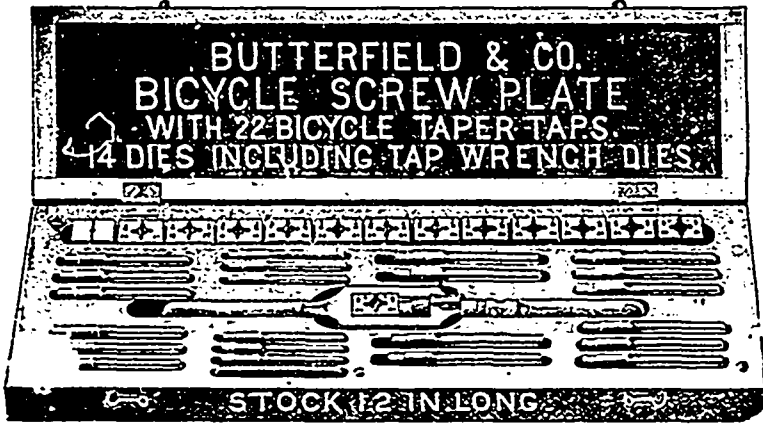

# CHEAPEST AND BEST

## Bicycle Screw Plate

14 PAIRS DIES—22 TAPS

...A Complete Repair Shop in Itself...

**BUTTERFIELD & CO.**  
Rock Island, P.Q.

If your Dealer Does not Keep Them Send to Us.

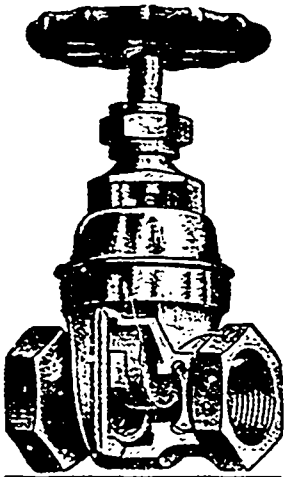

The WEBBER Patent  
**STRAITWAY VALVE**

For  
...Steam, Water or Gas...

EVERY VALVE TESTED.

The Kerr Engine Co., Limited

WALKERVILLE, ONT.

Sole Manufacturers for Canada. Send for Price List.

The Wellington Mills, LONDON, ENG.  
**GENUINE EMERY**

Oakey's Flexible Twilled Emery Cloth.  
Oakey's Flint Paper and Glass Paper.  
Oakey's Emery Paper, Black Lead, Etc.  
Prize Medal and Highest Award Philadelphia, 1876, for Superiority of Quality, Skilful Manufacture, Sharpness, Durability, and Uniformity of Grain.

Manufacturers **JOHN OAKEY & SONS, LIMITED**, Wellington Mills,  
Westminster Bridge Road, London, Eng.

Inquiries should be addressed to

**JOHN FORMAN**, 650 CRAIG ST., MONTREAL.

John R. Barber, Pres. & Genl.

Geo. E. Challes, Sec. & Treas.

Henry Truscott, Bus. Man.

# THE CYCLONE GRATE BAR

Economy of Fuel and Increased Boiler Efficiency Guaranteed.

Cut shows construction of the Grate. No alteration of Plant necessary.

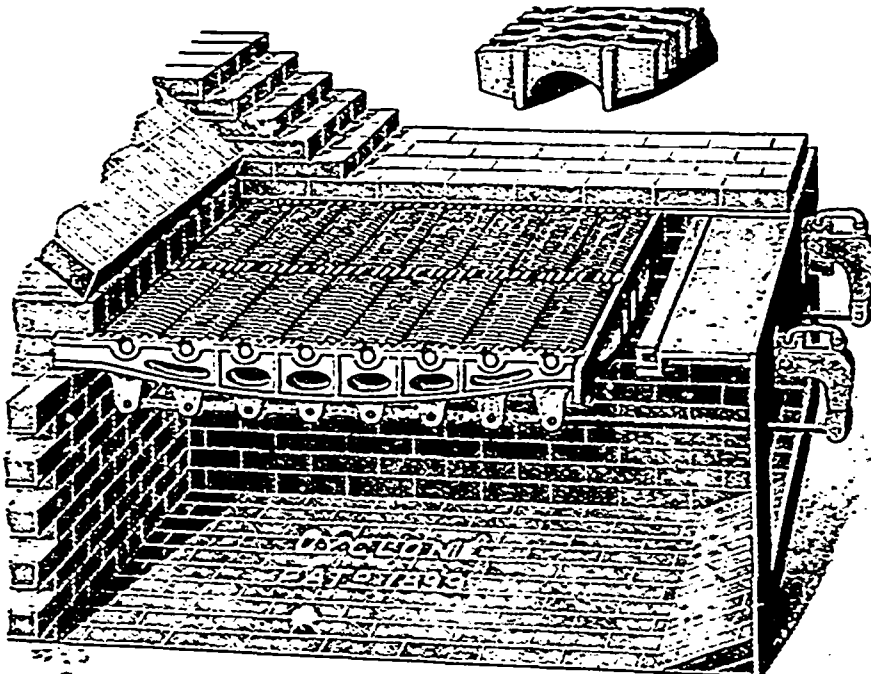

**Simplicity,  
Durability,  
Economy.**

Burns the Cheapest Fuel with the Best Results.

**A BOY CAN OPERATE IT.**

Send for Descriptive Circulars and Testimonials.

COPY OF TESTIMONIALS.

TORONTO, Jan. 12, 1900.

THE CYCLONE GRATE BAR Co., (Limited), Toronto.

DEAR SIRS.—We deem it only fair to you to express the appreciation and satisfaction which we have in using your Grate Bar.

As a fuel saver we think it is the only Grate with any merits in this respect, and for operating it is perfect.

Wishing your Company every success.

We are, yours truly,

"SEAMAN, KENT & Co.

**W. G. BLACKGROVE,**

Gen'l Agent for Ontario,  
Office, 10 KING ST. WEST,  
TORONTO, CAN.

Manufactured by...

**Cyclone Grate Bar Co. Limited,**

When writing to Advertisers kindly mention THE CANADIAN MANUFACTURER.

Index to the American Tariff.

Wire :	No. of Item.
articles manufactured from.....	13
bonnet.....	134
card clothing from.....	146
clock.....	157
corset.....	157
erholine.....	154
hat.....	134
iron or steel.....	137
lead.....	182
nails.....	192
needle.....	137
plano.....	134
platina.....	611
rods.....	136
rope.....	137
round iron or steel.....	137
strand.....	137
thrust.....	139
watch.....	157
Witberite.....	489
Wood :	
ashes.....	485
bamboo.....	700
barrels.....	201, 285
bass.....	135
blocks of various kinds.....	280, 620
bolts.....	209, 623
box.....	138, 700
boxes.....	291, 205
brlar.....	700
cabinet.....	138, 700
furniture.....	288
casks.....	201
cedar.....	138, 138, 700
chair cane.....	296
chairs.....	292
cork, unmanufactured.....	255
ebony.....	138, 700
fence posts.....	240
fire.....	620
foreign export duties.....	3
granadilla.....	138, 700
hair.....	700
hogsheds.....	201
hubs.....	700
India mallee joints.....	700
kindling.....	137
lance.....	138, 700
laths.....	201
lignum-vitae.....	138, 700
logs.....	620
lumber.....	135
mahogany.....	138, 700
manufactures of.....	208
myrtle.....	700
orange.....	700
osher prepared for basketmakers.....	
use.....	205
manufactures of.....	205
packing boxes.....	291
box shooks.....	291
palings.....	202
partridge.....	700
paving posts.....	136
pickets.....	202
plimento.....	700
pitch of.....	628
planking, ship.....	629
poles.....	136, 629
posts, paving.....	136
pulp, bleached.....	202
chemical.....	202
ground.....	202
railroad ties.....	136
rattan.....	700
reeds.....	202
unmanufactured.....	700
rose.....	138, 700
satin.....	138, 700
serews.....	137
shingles.....	202
skewers.....	202
staves.....	202
sticks for umbrellas, parasols, etc.....	462, 700
sugar-box shooks.....	201
synon re.....	135
tar of.....	628
timber.....	134, 629
toothpicks.....	202
unmanufactured.....	138

Wood, veneers of.....	No. of Item.
white.....	135
willow, prepared for basketmakers' use.....	205
manufactures of.....	205
Woods :	
dye, extracts of.....	72
other than dyewoods.....	20, 518
used expressly for dyeing.....	20, 518
Wool :	
advanced beyond the washed or scoured condition.....	354
classification of.....	318, 349, 350, 351
class one.....	349, 351, 355, 356
two.....	350, 351, 355, 356
three.....	351, 353, 354, 358
fellation of.....	353
extract of.....	352
locks, mungo and rags.....	353
grease.....	370
manufactures of.....	353, 352
on the skin.....	354
scoured.....	354
skirted (excepted).....	354
standard samples of.....	352
unwashed.....	352
washed.....	351
waste.....	351, 352
Woolen art squares.....	352
bandings.....	371
barrel buttons.....	371
beltings.....	371
bindings.....	371
blankets.....	357
bookings.....	370
braces.....	371
brads.....	371
buttoning.....	371
buttons.....	371
carpets.....	372, 372
clothing, read-made.....	350
cloths.....	350, 358, 359
coat linings.....	358, 359
coats and cords and tassels.....	371
dress goods.....	358, 359
druggets.....	371
edgings.....	371
embroideries.....	371
fabrics having India rubber as a component material.....	371
knit.....	357
felts.....	350
flannels.....	357
flocks.....	357
floodings.....	351
fringes.....	351
galloons.....	351
garnetted waste.....	351
gimps.....	351
gorings.....	351
grease.....	351
head nets.....	351
insertings.....	351
Woolen Italian cloths.....	358
knitted articles of wearing apparel.....	358
knit fabrics.....	357
laces.....	351
linings.....	358
manufactures of, ornamented with beads or sequels.....	351
mats.....	351
muzzes.....	351
netting.....	351
nets.....	351
nolls.....	351
rags.....	351
ready made clothing.....	350
ring waste.....	351
roving waste.....	351
rugs.....	351
shawls.....	351
shoddy.....	351
shibling waste.....	351
suspenders.....	351
tassels.....	351
thread waste.....	351
top waste.....	351
trammings.....	351
wastes.....	351
wearing apparel.....	350
weavings.....	351

Woolen yarn waste.....	No. of Item.
yarns.....	302
Works of art.....	701, 702, 703
for exhibition.....	701, 702
for presentation.....	703
Worm gut.....	
manufactures of.....	448
unmanufactured.....	517
Worms, silk, eggs of.....	622
Wrapper tobacco.....	213, 214
Wrecked or sunken vessels.....	28
Wrought iron or steel.....	122, 162, 163

X

Nyldm.....	521
Nyol.....	521

Y

Yarns.....	701
Yarns.....	
cotton.....	331
cotton, carded.....	332
flax.....	331
hemp.....	331
jute.....	331
ramie.....	331
silk.....	332
waste, woolen.....	332
woolen.....	335
Yellow chrome.....	48
metal.....	176
prussiate of potash.....	63
Yolks of eggs.....	215

Z

Zaffer.....	705
Zante currants.....	201

Zinc.....	
articles or wares of, not specially provided for.....	102
blocks or pigs of.....	102
chloride of.....	102
dry.....	102
ground in oil.....	102
old and worn out.....	102
oxide of.....	102
sheets of.....	102
sublime of.....	102
sulphate of.....	102
white paint or pigment containing.....	102
white sulphide of.....	102

Articles Specified in Reciprocity Sections 3 and 4 of Tariff Act of July 24, 1897.

Argols.....	sec.
Beans, tonquin, tonqua or tonka.....	sec.
Beans, vanilla.....	sec.
Brandles.....	sec.
Champagne.....	sec.
Coffee.....	sec.
Crude tartar.....	sec.
Cuts, vanilla beans.....	sec.
Distilled spirits.....	sec.
Drawings, pen and ink.....	sec.
Levs, wine, crude.....	sec.
Oil paintings.....	sec.
Paintings.....	sec.
Pastels.....	sec.
Pen and ink drawings.....	sec.
Sperking wibes.....	sec.
Spirits manufactured or distilled from grain.....	sec.
Statuary.....	sec.
Still wibes.....	sec.
Tartar, crude.....	sec.
Tea.....	sec.
Tonquin, tonqua, or tonka beans.....	sec.
Vanilla beans.....	sec.
Vermoth.....	sec.
Wine lees, crude.....	sec.
Water, color painting.....	sec.
Wines, sparkling.....	sec.
Wines, still.....	sec.

Wen man mit Anzeiger dieses Journal Correspondirt, wird es von besonderen Vorthail sein, die Anzeige des CANADIAN MANUFACTURER zu erwaehnen, selbes wird schnelle Aufmerksamkeit versichern, und uns dienstlich sein.

**A. C. NEFF**  
**CHARTERED ACCOUNTANT**  
 Room 500 McKinnon Bldg.,  
 Tel. 1330. — TORONTO.  
 Audits and Investigations a Specialty.

THE.....  
**Toronto Paper Manufacturing Co.,**  
 Cornwall, Ont.

Manufacturers of Engine Sized Superfine Papers, White and Tinted Book Papers, Blue and Cream Laid and Wove Foolscap, Account, Envelope and Lithographic Papers, etc.

**PATENTS**  
 TRADE MARKS, Etc.  
**HANBURY A. BUDDEN**  
 NEW YORK LIFE BUILDING,  
 MONTREAL.

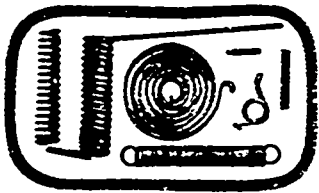

**ST. JOHNS SPRING CO.**  
 St. Johns, Mich.

Manufacturers of  
**OIL TEMPERED,  
 TORSION,  
 EXTENSION,  
 COMPRESSION SPRINGS.**

**All Shapes and Sizes.**

**JOHN J. GARTSHORE,**  
 51 Front St. West, Toronto.  
 RAILWAY, TRAMWAY, and  
**Contractors' Supplies**  
 METALS and SCRAP IRON  
 Bought and Sold.

**C. B. THISTLETHWAYTE,**  
 Manufacturers' Agent,  
 (Canadian Lines).

31 VICKERY'S CHANNERS,  
 76 PITT STREET, SYDNEY, N.S.W.  
 Will be pleased to communicate with Manufacturers seeking the extension of their trade to Australia.

**CANADIAN OFFICE & SCHOOL FURNITURE CO. LIMITED**  
 PRESTON ONT.  
 FINE BANK OFFICE, OFFICE, SCHOOL, CANTONAL OFFICE FURNITURE  
 (GIVEN HOUSE & GIVE SIZE FITTINGS). SEND FOR CATALOGUE

**F. W. Hore's Sons,** HAMILTON, ONT.  
 Manufacturers of  
**Wheels, Wheel Materials, Shafts, etc.**

Advertise in  
 The Canadian Manufacturer.  
 Send for Rates.

# The Underwood Typewriter



Visible Writing from start to finish.

The descriptive pamphlet, or any stenographer using the Underwood Typewriter, will explain why 1,000 of these machines have been sold in Canada in one year—more than all others put together.—Visible writing and the tabulator are winners.

SOLE CANADIAN AGENTS.

**Creelman Bros. Typewriter Co.,**  
 15 Adelaide St. East, TORONTO, ONT.

## Cheap . . . . Typewriters

The following cash prices are the best values that have ever been offered in rebuilt typewriters. All machines are in the very best of order, and sample of any machine selected will be sent on application.

Remington, - \$50 00	Smith Premiers, \$50 00
Caligraphs, - \$25 00	Yosts, - - - \$25 00
New Franklins, \$20 00	Nationals, - - \$17 50
Remington-Scholes, - \$30 00	Hammonds, - \$25 00
Empires, - - \$35 00	Williams, - - \$30 00

Special Rental Terms on above Typewriters.

**The Canadian Typewriter Exchange**  
 45 Adelaide St. East, TORONTO.

## FOR SALE

- Two Complete Flour and Grist Mills.
- Two 45" Lefel Water Wheels.
- One 17" " " "
- Two Run 51" Stone.
- One Run 45" Stone.
- One Track Scale.
- One Barrel Scale.
- One Wheat Scourer and Smutter.
- One Half chert of Reel, 15" x 37".
- One Hunter, Holamb & Hene Purrier.
- One Reel, 15" x 37".
- One Wheat Scourer.

ADDRESS .....

**THE BRANTFORD ELECTRIC & OPERATING CO., Limited,**  
 BRANTFORD, ONT.

I BUY all Minerals at Mines by contract or otherwise. Mineral Lands and Timber Properties bought and sold.  
**H. FAWCETT HARTLAND,**  
 Room 303-310 Merchants Bank Chambers,  
 205 St. James Street, - Montreal.  
 Correspondence Solicited.

**WILSON & BURNIE,**  
 FLOUR, OATMEAL,  
 and COMMISSION AGENTS.  
 Also at GLASGOW. LEITH.  
 Advances on Consignment.

**Paris Electro Plating Co.**  
 PARIS STATION, ONT.  
 Manufacturers of  
 Stove and Piano Trimmings and Novelties  
 Fine Grey Iron Castings a Specialty.  
 Nickel, Copper and Brass Electro Plating.  
 WRITE FOR PRICES.

**TORONTO MACHINE SCREW CO.**  
 Manufacturers of  
 Hexagon AND Square Head Cap Screws.  
 Steel and Iron Set Screws, Hanger and Planer Bolts, Studs, etc.  
 Send for Price List and Discounts.  
 109 1/2 Adelaide St. W. - TORONTO.

**WOOD ENGRAVING.**  
**PHOTO ENGRAVING.**  
**HALF TONES**  
 OR ANY CLASS OF ENGRAVING FOR ADVERTISING PURPOSES. CATALOGUES, MAGAZINES, &c  
**J. L. JONES ENG. CO**  
 6-8-10  
 Adelaide St. W. **TORONTO.**

# THE BRITISH TARIFF.

## CUSTOMS TARIFF OF THE UNITED KINGDOM WHICH WENT INTO OPERATION JULY 1, 1899

A True Copy From the Official Text.

### CUSTOMS TARIFF OF THE UNITED KINGDOM.

Return (\*) showing the several articles subject to Import Duties in the United Kingdom, and the Rate of Duty levied upon each article, according to the tariff in operation upon July 1, 1899, distinguishing the Duties levied to countervail excise and other Inland Revenue Duties upon British productions.

#### NO EXPORT DUTIES ARE LEVIED IN THE UNITED KINGDOM. ORDINARY IMPORT DUTIES.

ARTICLES.	Rate of Duty.		
	£.	s.	d.
<b>Cocoa.</b>			
1 Cocoa, raw.....lb.	0	0	1
2 Cocoa, husks and shells.....cwt.	0	2	0
3 Cocoa or chocolate, ground prepared or in any way manufactured.....lb.	0	0	2
(For additional duty if spirit has been used in the manufacture, see item 37.)			
4 Cocoa butter.....lb.	0	0	1
<b>Coffee.</b>			
5 Coffee, raw.....cwt.	0	14	0
6 Coffee, kiln-dried, roasted or ground.. ....lb.	0	0	2
<b>Chicory.</b>			
7 <sup>2</sup> Chicory, raw or kiln-dried.....cwt.	0	13	3
8 Chicory, roasted or ground.....lb.	0	0	2
9 Chicory (or other vegetable substances) and coffee roasted and ground; mixed.. ....lb.	0	0	2
<b>Fruit, Dried.</b>			
10 Fruit, dried; currants.....cwt.	0	2	0
11 Fruit, dried; figs, fig cake, plums not preserved in sugar, prunes and raisins.....cwt.	0	7	0
<b>Tea.</b>			
12 Tea.....lb.	0	0	4
<b>Tobacco.</b>			
13 Tobacco, unmanufactured, containing 10 lbs or more of moisture in every 100 lbs weight, thereof..lb.	0	2	8
14 Tobacco, unmanufactured, containing less than 10 lbs. of moisture in every 100 lbs weight thereof..lb.	0	3	0
15 Tobacco, manufactured, cigars.....lb.	0	5	0
16 Tobacco, Cavendish or Negrohead.....lb.	0	3	10
17 Tobacco, snuff, containing in every 10 lbs weight thereof, more than 13 lbs. of moisture.....lb.	0	3	2
18 Tobacco, snuff, containing in every 100 lbs. weight thereof, not more than 13 lbs. of moisture....lb.	0	3	10

\* In this return, sub divisions of articles of a similar nature and subject to the same rate of duty are classed under one head.

	Rate of Duty.		
	£.	s.	d.
<b>Tobacco.—Continued.</b>			
19 Tobacco, other manufactured tobacco, and Cavendish or Negrohead, manufactured in bond from unmanufactured tobacco.....lb.	0	3	5
<b>Wine.</b>			
20 Wine, not exceeding 30 degrees of proof spirit.gallon	0	1	3
21 Wine, exceeding 30 but not exceeding 42 degrees of proof spirit.....gallon	0	3	0
22 Every degree or part of a degree beyond the highest above charged, an additional duty of.....gallon	0	0	3
Degree not to include fractions of the next higher degree.			
23 Wine includes lees of wine.			
24 Additional duty on sparkling wine imported in bottle.....gallon	0	2	6
25 Additional duty on still wine imported in bottle.....gallon	0	1	0
<b>Import Duties to countervail Excise Duty upon British Beer.</b>			
<b>Beer.</b>			
Beer called mum, spruce or black beer, and Berlin white beer, and other preparations, whether fermented or not fermented, of a character similar to mum, spruce or black beer, the worts of which were before fermentation, of a specific gravity:			
26 Beer, not exceeding 1,215 deg....for every 36 gals.	1	8	0
27 Beer, exceeding 1,215 degrees.... " "	1	12	10
28 Beer, of any other description the worts of which were, before fermentation, of a specific gravity of 1,055 degrees.....for every 36 gals.	0	7	0
And so in proportion for any difference in gravity.			
<b>Import Duties to countervail Excise Duty upon British spirits.</b>			
<b>Spirits and Strong Waters.</b>			
29 Spirits and strong waters, for every gallon, computed at hydrometer proof, of spirits of any description (except perfumed spirits), including naphtha or methylic alcohol purified so as to be potable, and mixtures and preparations containing spirits.....proof gallon	0	10	10
30 Additional on spirits imported in bottle, enumerated and tested, and sweetened spirits imported in bottle, unenumerated and tested... proof gallon	0	1	0
31 Liquors, cordials, or other preparations containing spirits, in bottle, entered in such a manner as to indicate that the strength is not to be tested.gal.	0	15	8
32 Perfumed spirits..... " "	0	17	3
33 Additional if imported in bottle..... " "	0	1	0
34 Spirits, methylated in bond.....proof gal.	0	0	4

**RICE LEWIS & SON, LIMITED**  
**HARDWARE and METAL**  
 Bar Iron, Steel,  
 Boiler Plate Tubes.  
**MACHINIST TOOLS,  
 PIPE FITTINGS.**  
 A COMPLETE STOCK OF  
**STOCKS and DIES. PIPE VICES.**  
 STILLSON & TRIMO  
**WRENCHES.**  
**STEAM PIPE.**

Cor. King and Victoria, TORONTO

**Sun Lighting Machine.**

ACETYLENE GAS.

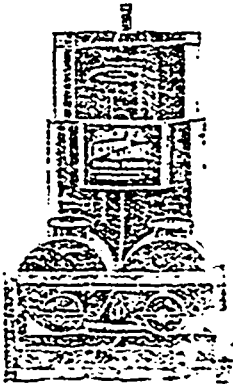

*The Acme of Perfection in Lighting.*

At the Minimum of Cost.

Suitable for any place where Artificial Light is required. Dwellings, Stores, Churches, Factories, Hotels, Street Lighting, etc.

Write for Catalogue.

THE  
**Acetylene Lighting Co.**  
 (LIMITED).  
 LONDON, ONTARIO.

**Dominion Oil Cloth Co.**

(LIMITED)

Manufacturers of...

**OIL-CLOTHS** Of Every Description

Floor Oil-Cloth. Table Oil-Cloth.  
 Carriage Oil-Cloth.

Enamelled Oil-Cloth.

Stair Oil-Cloth, etc.

Office and Works

Cor. St. Catherine and Parthenais Sts  
 MONTREAL, Que.

ESTABLISHED 1823.

Telegrams:—"WILSONS, CORNHOLME."—A.B.C. Code Used.

**WILSON BROS. BOBBIN CO.**  
 (LIMITED)

CORNHOLME MILLS, TODMORDEN, ENGLAND.

*BOBBIN AND SHUTTLE MANUFACTURERS.*

FORTY PRIZE MEDALS AWARDED.

HIGH-CLASS WORKMANSHIP. SEVENTY YEARS' REPUTATION.

LARGEST BOBBIN MAKERS IN THE WORLD.—(Over 1,400 Workmen).

Address—

**CORNHOLME MILLS, TODMORDEN, ENG.**

BRANCH ESTABLISHMENT:

ATLAS BOBBIN WORKS, GARSTON, LIVERPOOL.

OFFICE AND SHOWROOMS:

14 MARKET PLACE, MANCHESTER.

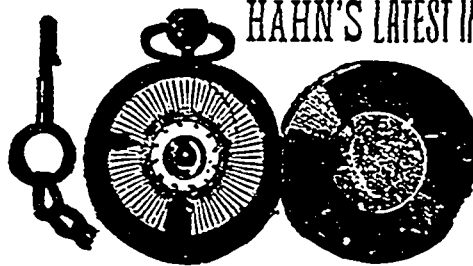

**HAIN'S LATEST IMPROVED WATCHMAN'S TIME DETECTOR**

This Clock is adapted for six or twelve stations, and the keys are all different, ranging from 1 to 6, and 1 to 12, instead of as in the old style Time Detectors, which mark either by holes or an impression on the dial, being the same for all stations.

For Circulars, prices and further information address

**A. HANZ & CO.,** Room No. 45, Graham Building, 127 Duane St. NEW YORK

This Clock received the First Prize at World's Fair.

**The Canadian Canoe Co., Limited,** P.O. BOX 107, PETERBOROUGH, ONT.

Manufacturers of all kinds of

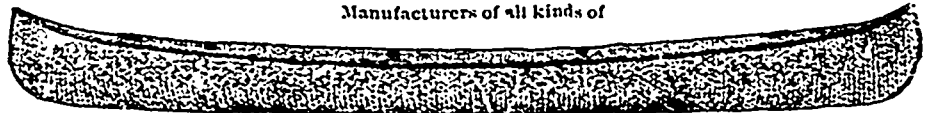

**CANOES AND SKIFFS** Canoes for Paddling, Sailing, Rowing and Prospecting. Skiffs for Rowing and Sailing.

A FULL STOCK OF PADDLES, OARS, FITTINGS, ETC.

Write for Catalogue J.

Correspondence Solicited.

**DAYLIGHT DISCOUNTED.**

**ACETYLENE GAS**

Does it when made by the

**"SAFETY"**

200 MACHINES IN OPERATION AND NO ACCIDENTS SPEAKS VOLUMES.

SIMPLICITY—SAFETY—ECONOMY the Leading Features.

Manufactured by

**THE SAFETY LIGHT AND HEAT CO.,**

Send for Booklet.

DUNDAS, ONT.

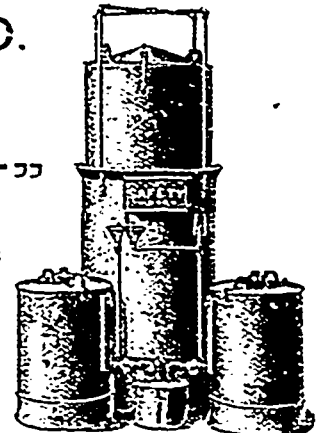

**THE ABBEY IMPROVED CHILLED SHOT COMPANY, Limited, Newcastle.**

What better testimonials do Sportsmen require than the following, viz.:

Output of Shot in 1887 exceed 1 1/2 by 5,000 cwt., or equal to the loading in (at 1 oz per load) 9,000,000 Cartridges.

The winner of the All-England Championship Cup in December, 1898, fired with 227 shot, and speaks highly of it.



**VANDUZEN'S STEAM-JET PUMPS**

Fully guaranteed. Especially serviceable for elevating or forcing sandy or muddy water from Mines, Quarries, Wells, Excavations, etc. Simple, portable, cheap. Requires no skill or attention. *13 sizes, ranging from \$7 to \$75.* Send for Catalogue No. 81.

E. W. VANDUZEN Co., Cincinnati, O.

When writing to Advertisers kindly mention THE CANADIAN MANUFACTURER.

	Rate of Duty.				Rate of Duty.		
	£.	s.	d.		£.	s.	d.
35 Chloroform.....lb.	0	3	1	43 Ethyl, bromide.....lb.	0	1	0
Chloral Hydrate.				41 Ethyl, chloride.....gallon	0	15	8
36 Chloral hydrate.....lb.	0	1	3	45 Ethyl, iodide of.....gallon	0	13	7
Cocoa or Chocolate.				Methylic Alcohol.			
37 Cocoa or Chocolate, in the manufacture of which spirit has been used, in addition to any other duty to which such cocoa or Chocolate is at present liable.....lb.	0	0	0½	46 Methylic Alcohol, purified so as to be potable (see Spirits and Strong Waters).			
Collodion.				Naphtha Alcohol.			
38 Collodion.....gallon	1	5	0	47 Naphtha Alcohol, purified so as to be potable (see Spirits and Strong Waters).			
Confectionery				Soap.			
39 Confectionery, in the manufacture of which spirit has been used, in addition to any other duty to which such confectionery is at present liable..lb.	0	0	0½	48 Soap, transparent, in the manufacture of which spirit has been used.....lb.	0	0	3
Ether.				Import Duties to countervail Stamp Duties on British-made Articles.			
40 Ether, acetic.....lb.	0	1	10	Playing Cards.			
41 Ether, butyric.....gallon	0	15	8	49 Playing cards.....doz. packs	0	3	9
42 Ether, sulphuric.....gallon	1	6	2				

INDEX OF BRITISH TARIFF.

	No. of Item.		No. of Item.		No. of Item.
Beer.....	26, 27, 28	Collodion.....	38	Playing Cards.....	49
Chloroform.....	35	Confectionery.....	39	Soap.....	48
Chicory.....	7, 8, 9	Ether.....	10, 11, 42, 43, 44, 45	Spirits.....	29, 30, 31, 32, 33, 34
Chloral Hydrate.....	36	Fruits, dried.....	10, 11	Tea.....	12
Cocoa.....	1, 2, 3, 4, 37	Methylic Alcohol.....	46	Tobacco.....	13, 14, 15, 16, 17, 18, 19
Coffee.....	5, 6	Naphtha Alcohol.....	47	Wine.....	20, 21, 22, 23, 24, 25

The  
**McLACHLAN**  
**ELECTRIC** and  
**GASOLINE**  
**MOTOR CO. Limited**  
**TORONTO,**  
**CANADA.**

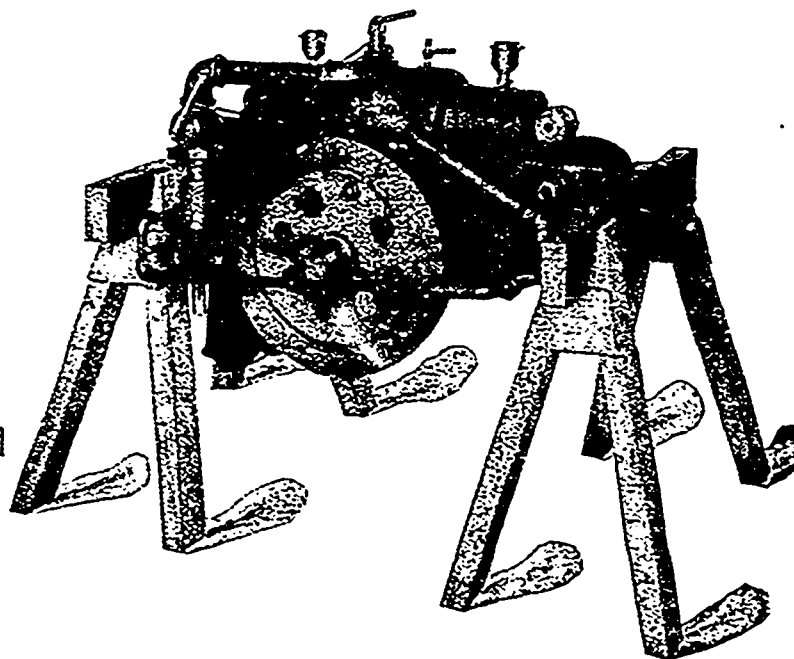

**MAKERS**  
 OF  
**GAS**  
 AND  
**GASOLINE**  
**ENGINES**  
 —  
**ABSOLUTELY**  
**NO**  
**VIBRATION**

The above cut represents a new invention in Gasoline Engines. It has taken a great deal of time and money to perfect this machine, and we claim that we have the best and only Gasoline Engine on earth that will run without vibration,

It can be run from 100 to 1000 revolutions per minute with no other foundation than as represented in the cut, and without any fastening to the floor or otherwise. For Boats or Horseless Carriages or any other Power where vibration or jar is the great objection, this Engine becomes an absolute necessity. We guarantee as little vibration as in an Electric Motor. We may here say that vibration means lost power. Our Engine saves this loss of power, thereby adding from 25 to 30 per cent. to its strength, and consequently consuming very much less fuel for given power.

When writing to Advertisers kindly mention THE CANADIAN MANUFACTURER.

**Smith Wool-Stock Co.**  
219 FRONT ST. E., TORONTO.  
Makers of  
**WOOL STOCK,  
SHODDIES, Etc.**

W. H. PARKER J. H. PARKER  
**NEW TORONTO WOOL STOCK CO.**  
MANUFACTURERS OF  
WOOL STOCK and SHODDIES  
Write for Samples and Prices.  
**NEW TORONTO, - ONTARIO, CANADA.**

**GEO. PATTINSON & CO.**  
PRESTON, - ONTARIO.  
Manufacturers of

FINE AND MEDIUM **TWEEDS**

**PENMAN MANUFACTURING CO.**  
PARIS, ONT. LIMITED.  
Manufacturers of

Hosiery, Shirts, Drawers,  
Glove Linings and Yarns.

Selling Agents—D. Morrice, Sons & Co.,  
Montreal and Toronto.

**ROSAMOND  
WOOLEN CO.**  
ALMONTE, ONT.

Fine Tweeds, Cassimeres,  
and Fancy Worsted  
Suitings and Trouserings.

**LEITCH & TURNBULL,** Canada Elevator Works,  
Queen and Peter Sts.,  
HAMILTON, ONT. Patent Safety Hydraulic,  
Hand and Power ELEVATORS.  
.....Telephone Connection.

**W. H. Storey & Son, ACTON, ONT.,**  
Manufacturers of..... FINE GLOVES AND MITTS  
In every variety and style. Moccasins.

**WM. BARBER & BROS.**  
Georgetown, Ont.

Manufacturers of.....  
**Book and Fine Papers.**

Reproductions Made for Eight  
Cents per Square Inch.



Half Tones Made Direct from  
Photos.

**PHENIX ASSURANCE COMPANY**  
OF LONDON, ENGLAND.

ESTABLISHED 1782.  
AGENCY ESTABLISHED IN CANADA, 1804.

**PATERSON & SON,** GENERAL AGENTS FOR THE  
DOMINION.  
London and Lancashire Insurance Buildings,  
164 St. James Street, } - - MONTREAL, QUE.  
Agent at Toronto, - 20 Toronto Street.

**BELL  
PIANOS and ORGANS**  
BUILT TO LAST A LIFETIME  
AND USED THE WORLD OVER

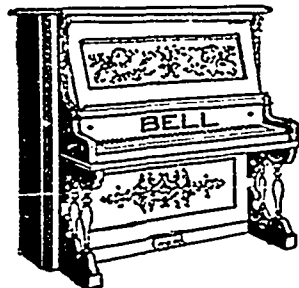

Send for Catalogue No. 47 to  
**THE BELL ORGAN AND PIANO CO., LIMITED**  
QUELPH, - - ONTARIO.  
LARGEST MAKERS IN CANADA.

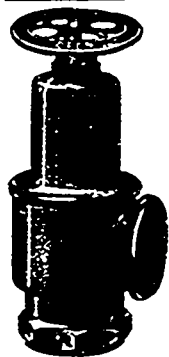

**CROSBY STEAM GAGE  
AND VALVE CO.**

Sole Proprietors and Manufacturers of  
Crosby Pop Safety Valves, for all kinds of Boilers, Water Relief Valves including  
the Underwriter, which is fully approved by the Associated Factory Mutual  
Insurance Companies; Crosby Steam Engine Indicators, with Sar-  
gent's Electrical Attachment; Crosby Improved Steam  
Gages, Recording Gages and Patent Gage Testers.  
Original Single Bell Chime Whistles.

BRANDEN PATENT PUMP VALVES  
CLARK'S LINEN FIRE HOSE AND ADJUSTABLE COUPLINGS  
All Kinds of Pressure and Vacuum Gages used in the Various Arts

Gold Medal Paris Exposition, 1889  
Ten Highest Awards Columbian Exposition, 1893

Main Office and Works..... BOSTON, MASS., U.S.A.  
Branch Offices at New York, Chicago, and London, Eng.

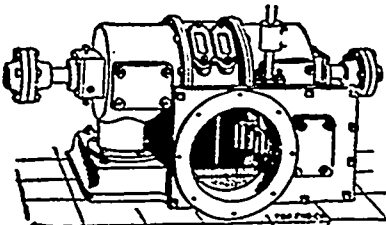

Horizontal Type.

**"LITTLE GIANT"  
TURBINE**  
....FOR ALL PURPOSES....

HORIZONTAL AND VERTICAL  
BUILT IN 44 SIZES.

We guarantee a higher percentage of power from  
water used than any other wheel on the market.

Water Wheel Governors, Machine Dressed Gearing, Pulleys, Shafting and Bearings.  
Catalogue and Gear List mailed on application. Correspondence Solicited.

**J. C. WILSON & CO., - - GLENORA, ONT.**

**ROLLED THREAD MACHINE SCREWS**

Equal to CUT  
THREAD  
COST LESS.



**HARVEY HUBBELL, BRIDGEPORT, CONN.**

**WELLAND VALE MANUFACTURING CO.**

Limited, ST. CATHARINES, ONT.  
Manufacturers of....  
Axes, Edge Tools, Saws,  
Farming Implements  
and Bicycles.

**The Firstbrook Box Co. Limited**

PACKING CASES.  
DOVETAIL BOXES.  
Bottlers' SHIPPING CASES.  
BOX SHOOKS, Etc.  
TOP PINS, SIDE-BLOCKS & CROSS-ARMS  
Write for prices. TORONTO, Canada.

**CARBONIZER**

A neutral sub-  
stance, harmless  
to animal fibro  
tissue, while it destroys burrs, etc., as  
efficiently as acid. It leaves the wool in  
fine condition. Manufactured by the  
Merrimac Chemical Co., 13 PEARL ST.  
BOSTON.

# NEWFOUNDLAND TARIFF.

An Act for Granting to Her Majesty Certain Duties on Goods, Wares and Merchandise Imported into the Colony of Newfoundland and Its Dependencies.

This Act may be cited as the "Revenue Act, 1898."

PASSED AND ASSENTED TO MARCH 11, 1898.

A TRUE COPY FROM THE OFFICIAL TEXT.

In this Act, unless the contents otherwise requires,—  
 The initials "N.E.S." represent and have the meaning of the words "not elsewhere specified";  
 The initials "N.O.P." represent and have the meaning of the words "not otherwise provided."  
 The expression "gall." or "gallon" means an imperial gallon.  
 The expression "ton" means two thousand, two hundred and forty pounds avoirdupois, except where otherwise defined :  
 The letters "cwt." mean one hundred and twelve pounds avoirdupois ;

The letters "qtl." mean one hundred and twelve pounds avoirdupois ;  
 The letter "M." means one thousand.  
 The expression "proof" or "proof spirits," when applied to wines or spirits of any kind, means spirits of a strength equal to that of pure ethyl alcohol compounded with distilled water in such proportions that the resultant mixture shall, at a temperature of sixty-five degrees Fahrenheit, have a specific gravity of 0.9198 as compared with that of distilled water at the same temperature.

## Amendments to the Revenue Act.

Passed July 19, 1899.

On July 19, 1899, "The Revenue Act, 1898," Schedules A and B, were amended as follows:—

In addition to the duties imposed and contained and set forth by and in "The Revenue Act, 1898," and the schedules thereto, there shall be paid ten per cent. upon the amount payable as such duties, in respect of the several articles therein enumerated, save and except the duties upon flour, molasses and coal, upon which articles the additional ten per cent. shall not be levied or collected.

On such articles of machinery, implements or materials as are necessary to the initiation and installation of any manufacture or industry in this colony, or in connection therewith and used therein, there shall be levied and collected such less duties than the rate prescribed as the Governor-in-Council may from time to time fix by order-in-Council: Provided that such order may prescribe such conditions and regulations concerning the said importations as he may deem wise, and that the said conditions shall have as full force and effect as if herein enacted.

The foregoing provisions went into force July 11, 1899.

Upon oleomargarine, butterine, or similar substitutes for butter, and upon tobacco, imported into this colony, being reported at the Custom House, and before being entered for

consumption, the packages in which such article is contained shall be stamped or marked by a Customs' officer with the name of the article or with some distinguishing mark.

The importation of any such article into consumption before the package containing it is marked as aforesaid, is hereby prohibited, and any such goods so imported shall be and become forfeited to the Crown, and may be seized by a Customs' officer and sold, after stamping or marking, one-half the proceeds being paid to the informer and seizing officer, one moiety to each, the other half being paid into the consolidated revenue.

The foregoing provisions went into force August 1, 1899, upon and after which date articles imported into bond, for use in the factory as part of the product, except butter, shall be admitted free of duty, under regulations approved by the Governor-in-Council.

### SCHEDULE A.

Amendment Passed July 19, 1899.

Goods Subject to Duty.

Pigs and lambs, under three months of age, each.....	\$ 50
Chicory, raw or green, per lb. ....	02
Chicory, kiln dried, roasted or ground, per lb.....	03
Jelly powders, Jelly tablets, calves' feet jelly, and such like preparations, N.E.S., ad val. ....	30 p. c.
Pig's heads, hocks, feet and ribs, per brl. ....	1.00
Barley, when imported for seed or for brewing purposes, ad val. ....	10 p. c.
Rhubarb, ad val. ....	30 p. c.
Aerated waters, of all descriptions, and non-alcoholic drinks, N.E.S., not to include natural mineral waters, ad val. ....	35 p. c.



# ALBERT MANUFACTURING CO.

MANUFACTURERS OF THE  
WELL-KNOWN

"HAMMER BRAND"

# Calcined Plaster

AND

## Patent Rock Wall Plaster

HILLSBOROUGH, N. B.,  
CANADA.

# KEMP MNFG. CO.

TORONTO.

## Galvanizing

DONE FOR THE TRADE.

GET OUR PRICES.



For IRON FENCING,  
BANK and OFFICE RAIL-  
INGS and all kinds  
of IRONWORK

Address:

Toronto Fence & Ornamental Iron Works  
59 Queen St. East, Toronto.

# BROWN & CO.

Manufacturers of

Square and Hexagon  
HOT PRESSED NUTS.

PARIS, - ONT.



Send for Catalogue and Price  
List to



Mfrs. of Set, Cap and Special  
Screws, Studs, Finished Nuts, &



Advertise in The Canadian Manufacturer

When writing to Advertisers kindly mention THE CANADIAN MANUFACTURER.

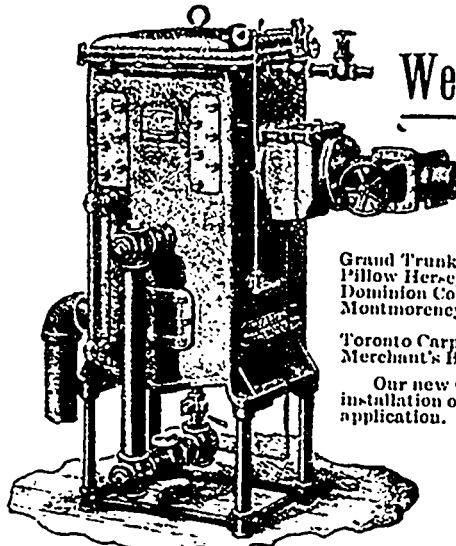

## ORDERS for the Webster Feed Water Heater

are increasing every day.

The following well-known firms have recently  
ordered the "WEBSTER" Heater

Grand Trunk Ry. Co. (Car Shops), Montreal	(1)	800 h p. Heater.
Pillow Hecsey Mfg. Co., Montreal	(1)	1000 "
Dominion Cotton Mills Co., Montreal	(5)	200 "
Montmorency Cotton Mills, Montmorency, Que.	(1)	200 "
Toronto Carpet Co., Toronto, Ont.	(1)	400 "
Merchant's Bank of Canada, Montreal	(1)	150 "

Our new Catalogue explains the saving to be effected by the  
installation of the "Webster" Heater, and will be mailed free on  
application.

**DARLING BROTHERS,**  
Reliance Works, MONTREAL.



SEND FOR CATALOGUE AND  
PRICE LIST

The Diamond Machine & Screw Co.

Manufacturers of TORONTO. Limited.

MACHINE SCREWS and  
BICYCLE PARTS OF EVERY  
DESCRIPTION.

## The London Machine Tool Co., LONDON, ONT.

LATHES,  
PLANERS,  
DRILLS,  
SLIDERS,

MANUFACTURERS OF

# General Machinery

HAMMERS,  
BULL DOZERS  
PUNCHES,  
PRESSES.

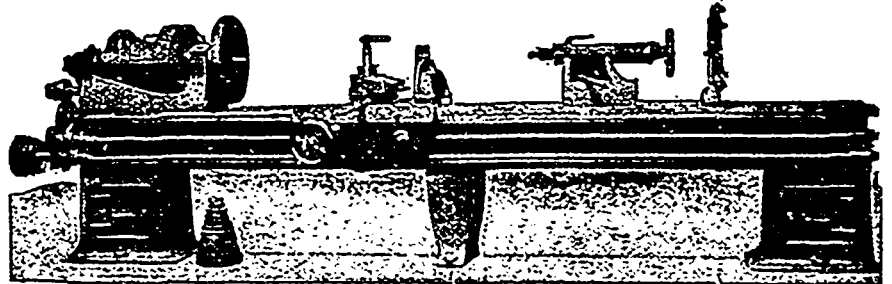

ALEX. GARTSHORE, President. J. G. ALLAN, Sec.-Treas. JAS. THOMSON, Vico-Pres. and Gen. Mngr.

## THE GARTSHORE-THOMSON PIPE & FOUNDRY CO. Limited

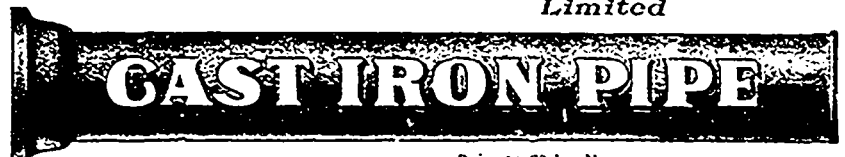

3 in. to 60 in. diameter.

For Water, Gas, Culverts and Sewers

Special Castings and all kinds of  
WATER WORKS SUPPLIES

FLEXIBLE AND FLANGE PIPE.  
HAMILTON, ONT.

Advertise in The Canadian Manufacturer

Newfoundland Tariff.

Confectionery of all kinds, including sugar candy, sweetened gums (excepting gums known as chewing gums), and pop corn, per 100 lbs. ....	6.00
Chewing gums, of all kinds, ad val. ....	35 p. c.
Spirits and strong waters, of any kind, mixed with any ingredient or ingredients, not being known or designated as anodynes, elixirs, essences, extracts, lotions, tinctures or medicines, or medical wines (so-called), and ethereal and spirituous fruit essence, N.E.S., ad val. ....	30 p. c.
Eider down quilts, ad val. ....	35 p. c.
Brick, fire, ad val. ....	10 p. c.
Buttons, of all kinds, ad val. ....	25 p. c.
Silver heading, ad val. ....	25 p. c.
Damask of linen, stair linen, diaper, sheets and sheetings, quilts, towels and towelling and like articles of linen or cotton, or of linen and cotton combined, made up or not, N.E.S., ad val. ....	35 p. c.
Art muslin, ad val. ....	35 p. c.
Gloves and mitts, N.E.S., ad val. ....	30 p. c.
Gloves and mitts of calf, kid or fur, and imitations thereof, including gloves known as suede and tan gloves, ad val. ....	35 p. c.
Hair, spring and other mattresses, hair bolsters and pillows, including furniture springs and carpet sweepers, ad val. ....	30 p. c.
Axe handles, ad val. ....	25 p. c.
Lumber under one inch in thickness (not grooved, tongued or planed), per M. ....	3.00
Lumber, viz. :—	
Oak, pitch pine, elm, greenheart, beech, wych hazel and ironwood, N.E.S., per M. ....	1.00
Mariner's compasses, and cards for same, ad val. ....	20 p. c.
Nails (wrought) when handmade, and brads used by broom-makers for fastening wire, ad val. ....	10 p. c.
Readymade clothing composed wholly or in part of wool, worsted, the hair of the Alpaca goat, or other like animals, N.E.S., linen silk, cotton, velvet or velveteen or mixtures thereof, ad val. ....	40 p. c.
Readymade clothing composed chiefly of canvas, moleskin or corduroy, ad val. ....	35 p. c.
Corsets, of all kinds, ad val. ....	35 p. c.
Collars and cuffs, scarfs and ties, N.E.S., ad val. ....	40 p. c.
Sewing and embroidery silk, silk twist, cotton sewing thread, crochet cotton, knitting cotton, and all other cotton and linen thread, ad val. ....	25 p. c.
Soda, caustic, potash and lye, ad val. ....	30 p. c.
Catalogues and price lists, N.E.S., ad val. ....	50 p. c.
Christmas, New Year, Easter, birthday, and all similar cards, ad val. ....	30 p. c.
Excelsior, and other material for making mattresses or stuffing furniture, ad val. ....	20 p. c.
Blocks, for ships, and block sheaves, N.E.S., ad val. ....	40 p. c.
Blocks, for ships, and block sheaves of galvanized iron, ad val. ....	30 p. c.
Brin, known as bread-bag brin, when imported by local manufacturers of bread, rope or nails in which to enclose their manufactures, ad val. ....	10 p. c.
Canvas of hemp, cotton or flax, known as sail and tarpaulin canvas, not including cotton drill, ad val. ....	5 p. c.
Cotton fabrics, white or grey, bleached or unbleached, plain or twilled, N.E.S., ad val. ....	30 p. c.
Leather, rough, split, undressed, when imported by tanners for further dressing, ad val. ....	20 p. c.
Pegs and pegwood, ad val. ....	25 p. c.
Tar and tar mixtures, in cans; for roofing purposes, roofing pitch, asphalt and asphaltum, and like preparations, ad val. ....	25 p. c.
Machines for carding wool, and spinning wheels, ad val. ....	10 p. c.
Mowing, self-binders, reapers, sulky and walking plows, harrows, horse rakes, grain and seed drills, stumping machines, thrashers and separators, hay and feed cutters, bone crushers and air motors, ad val. ....	10 p. c.
Patent and proprietary preparations, tinctures, pills, powders, troches, lozenges, syrups, cordials,	

Newfoundland Tariff.

bitters, anodynes, tonics, plasters, liniments, salves, ointments, pastes, drops, waters, essences and oils, N.E.S., ad val. ....	30 p. c.
All medicinal preparations containing over thirty per cent. of alcohol, ad val. ....	50 p. c.
Oysters or clams in the shell, ad val. ....	25 p. c.
Coals, when imported or brought into the ports of St. John's, Harbor Grace or Carbonate, per ton ..	50
Wire fencing, ad val. ....	10 p. c.

SCHEDULE B.

Table of Exemptions.

- Animals, imported by Agricultural societies or by private persons under the approval of the Governor-in-Council, for the improvement of stock, and Sable Island ponies.
- Articles imported for religious purposes, and used in the worship of the denominations requiring the same, and bells, musical instruments, stained glass windows, statuary, paintings, carpets, chandeliers, lamps and fancy hard wood for interior finishing, when imported solely for use in churches or chapels.
- Requisites for kindergarten schools.
- Catalogues and price lists of persons, firms or companies, domiciled elsewhere, and not personally doing business here.
- Gold and brillon, and medals when imported by schools or associations to be distributed as prizes.
- Dynamite, detonators, blasting powder and fuse.
- Equipments, accoutrements and musical instruments for Boys' Brigades and Salvation Army.
- Eggs of fish or game birds, when imported for propagation.
- Printing paper, printing presses, printing types, printers' ink and printers' office furniture when imported by printers for use in the business.
- Samples of no commercial value.
- Sand and fire clay.
- Photo engraving machinery, viz: Router, bevelling and squaring machines, screen holders, cross line screens, chemicals for use in engraving, wood for blocking, engraving tools and process plates.
- Wheat, whole, not ground or crushed.
- Hay-binders.
- Lignum-vitae.
- Bicycling, anglers' outfits, troutng gear, fire-arms and ammunition, tents and implements of tourists, when in the custody of tourists, and under conditions made by the Ministers of Finance and Customs to secure the export of such articles, or the payment of the regular rate of duty on such articles when otherwise imported, if the articles are sold or left in the colony.

Amendments to the Revenue Act.

Passed May 4, 1900.

On May 4, 1900, Schedules "A and B of The Revenue Act, 1898," were amended as follows:—

1. Schedule A to the Revenue Act, 1898, was amended by striking out therefrom the items, rates of duty, words and figures following, that is to say:—

Lines known as fishing lines and not including sporting tackle, ad valorem—fifteen per cent.

Twines, hemp or cotton, for fishing purposes, and known as ganging; herring, caplin, mackerel, salmon twine, salmon trawl, seal twine and seal trawl, ad valorem—ten per cent.

2. Schedule B to the said Act was amended by the insertion therein and addition thereto of the words following, that is to say:

Lines and twines used in connection with the fisheries, not including sporting tackle.

3. The foregoing provisions went into force April 25, 1900.

Send for Booklet—"A Study in Black"—it is a Work of Art.

MADE TO ENDURE

# ZANZIBAR ANTI-RUST

The Best **ROOF** and **IRON** Paint made **PAINT**

For **ROOFS** of all kinds. Guaranteed 5 Years.

Black "Zanzibar Anti-Rust" Roof Paint

Has no equal for general use. Heat or cold does not affect it.

**IT IS ELASTIC**, one important quality essential to a good Roof Paint. By a special chemical process, the ingredients in **BLACK ZANZIBAR ROOF PAINT** are so combined as to produce the highest possible elasticity, making the Paint **ABSOLUTELY FREE FROM CRACKING** and preventing any separation of the ingredients. It will not **scale, peel off, chalk or crack**.

**IT IS SPARK PROOF**, especially desirable, therefore, for use on **GRAIN ELEVATORS, MILLS, FACTORIES** and **BUSINESS BLOCKS** of all kinds, **SMOKE STACKS**, etc. Practically an absolute security from fire.

Nothing so good for **FIRE ESCAPES, BRIDGE AND STRUCTURAL IRON WORK** and **ROOFS** of all kinds.

**IN USE** throughout **Canada and United States.**

**Manufactured only by**

**THE GARFIELD OIL CO.,**

**CLEVELAND, OHIO, U.S.A.**

**WINDSOR, ONT.**

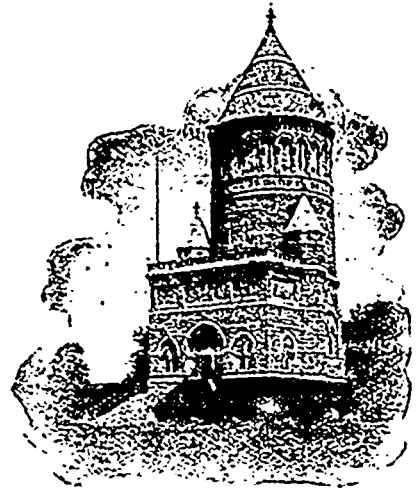

**THE CANADIAN SEWER PIPE CO.**  
Manufacturers of



**ST. JOHNS,**  
P.Q.

**HAMILTON,**  
ONT.

**TORONTO,**  
ONT.

**Aug. Newell & Co.**  
*Mechanical Experts*

**SPECIAL AND AUTOMATIC MACHINERY.**

Manufacturers of

**ORGAN REEDS AND BOARDS**

**PIANO AND ORGAN KEYS**

**29-31 HAYTER STREET, - TORONTO.**

Phone 1649.

**PORTLAND CEMENT SAMSON BRAND MAGNET BRAND**

Made at **SHALLOW LAKE, ONT.**

Our Celebrated **SAMSON BRAND** has been before the Public for many years, and has made hosts of friends among Contractors and Municipal Corporations until it has become one of the leading Cements on the market to-day, being excelled by none. This year we have decided to place the **MAGNET** on the market, and respectfully ask consumers to give it a trial. It will, we think, do its own advertising.

**The OWEN SOUND PORTLAND CEMENT CO., Limited**

Correspondence invited.

**GEO. S. KILBOURN, Sec'y-Treas.**

Works, **SHALLOW LAKE, Ont.**

Head Office, **OWEN SOUND, Ont.**

Engine Paeking,

Magnesia Pipe Covering

Lubricating Oils and Grease.

**The WILLIAM C. WILSON CO.,**  
LIMITED.

24 Front Street East,

**TORONTO, ONTARIO.**

When writing to Advertisers kindly mention **THE CANADIAN MANUFACTURER.**

Newfoundland Tariff.

SCHEDULE A.

Goods Subject to Duty.

Food Stuffs.

1. Animals, living, viz :—	
Calves, each.....	\$1.00
Pigs, each.....	1.00
Sheep, each.....	1.00
2. Apples, per brl.....	50
3. Apples, dried, per lb.....	02
4. Bacon, Hams, Tongues and Beef, smoke cured per lb.....	03
ad val.....	10 p. c.
5. Bacon, Hams, and Tongues, dry salted or pickled, per lb.....	02
6. Beans, per lb.....	00½
7. Beef, when salted in barrels, including duty on barrels, per brl.....	1.00
8. Biscuits, known as Ships' Biscuits, per cwt.....	10
9. Biscuits, viz : Soda, Water, Butter, Pilot, and any Biscuit of that description not sweetened, per lb.....	03
10. Biscuits and Bread, N.E.S., ad val.....	40 p. c.
11. Buckwheat, Meal or Flour, per lb.....	01
12. Butter, per lb.....	03
13. Canned Meats, Canned Poultry and Game, Extracts of Meats and Fluid Beef not medicated, and Soups, ad val.....	70 p. c.
14. Cheese, per lb.....	03
15. Chicory, raw or green, per lb.....	03
16. Chicory, kiln dried, roasted or ground, per lb.....	04
17. Cocoa, shells and nibs, Chocolate and other preparations of Cocoa, ad val.....	10 p. c.
per lb.....	05
18. Coffee, green, per lb.....	05
19. Coffee, roasted, or ground, per lb.....	07
20. Coffee, preparations or mixtures to resemble Coffee, per lb.....	07
Extracts of Coffee or substitutes of all kinds, ad val.....	30 p. c.
21. Condensed Milk, ad val.....	30 p. c.
22. Flour, wheaten, including duty on barrel, per brl.....	25
23. Fruits, in air-tight cans or other packages, ad val.....	30 p. c.
24. Fruits, preserved in brandy or other spirits, ad val.....	40 p. c.
25. Groceries, not otherwise specified, ad val.....	30 p. c.
26. Indian Meal, bolted, including duty on barrel, per barrel.....	30
27. Jellies, Jams and Preserves, including duty on ordinary crocks and bottles, ad val.....	30 p. c.
per pound.....	05
28. Maple Sugar, Maple Syrup, Syrups and Molasses of all kinds N.E.S., the product of the sugar cane or beet, N.E.S., and all imitations thereof, ad val.....	35 p. c.
29. Meats fresh per lb.....	02
30. Molasses, produced in the process of the manufacture of cane sugar from the juice of the cane, per gal.....	07
31. Oleomargarine, Butterine, or other similar substitute for Butter, per lb.....	03
32. Oatmeal and Rolled Oats, in bags or barrels, including duty on barrels and bags, per 100 lbs.....	20
33. Pease, Round, including duty on barrels, per lb.....	00½
Do., Split, do do, per lb.....	00½
34. Pigs' Heads, Hocks and Feet, do, per brl.....	1.00
35. Pigs' Jowls and Tongues, do do, per brl.....	1.00
36. Pork, in barrels, viz : Mess, Family, Prime Mess, Rump, Extra Prime, Bean, Clear Butt and Ham, including duty on barrels, per brl.....	1.50
Belly, Back, or Family Mess and Loin Pork, including duty on barrels, per brl.....	2.00
37. Poultry and Game, dead, per lb.....	03
38. Rice, cleaned, per lb.....	00½
39. Rice and Sago Flour, and Sago and Tapioca, ad val.....	30 p. c.
40. Rolled Oats, Farina, Corn Flour, and similar preparations of cereals, N.E.S., when put up in packages of less weight than 28 lbs. ad val.....	30 p. c.
41. Salt, Dairy and Table Salt, N.E.S., ad val.....	10 p. c.
42. Sausages, per lb.....	05
43. Sugar : Loaf, Cut Loaf, Cube and Castor or Icing Sugar, per lb.....	04
All other Sugars, per lb.....	02
44. Tea, ad val.....	30 p. c.

Newfoundland Tariff.

45. Tomatoes and other Vegetables, including Corn and Baked Beans, in cans or other packages, ad val.....	30 p. c.
46. Vinegar, when imported in casks, per gall.....	15
Farm Produce.	
47. Barley, ad val.....	10 p. c.
48. Cabbages, 1st May to 31st July, both inclusive per lb.....	\$ .00½
Do. 1st Aug. to 30th April, both inclusive per lb.....	01
49. Eggs, per doz.....	05
50. Feathers, per lb.....	07
51. Foals, ad val.....	20 p. c.
52. Hay, per ton of 2,000 lbs.....	3.00
53. Horses, Mares and other draft animals, N.E.S., ad val.....	20 p. c.
54. Lard Compound and similar substances, Cottolene and Stearine of all kinds, N.E.S., ad val.....	30 p. c.
55. Lard and neutral Lard Oil when imported by Biscuit and Bread Manufacturers, to be used in the manufacture of Bread and Biscuits, ad val.....	15 p. c.
56. Oats, per bushel of 34 lbs.....	05
57. Oxen, Cows and Bulls, ad val.....	20 p. c.
58. Poultry, alive, ad val.....	20 p. c.
59. Potatoes, per bushel.....	10
60. Straw, per ton of 2,000 lbs.....	2.00
61. Tallow and Grease, N.E.S., ad val.....	10 p. c.
62. Tomatoes, Cucumbers, Onions, Squashes, Pumpkins and other Vegetable, N.E.S., ad val.....	30 p. c.
63. Turnips, Carrots, Parsnips, Beets, Sweet Potatoes and Yams, per bushel.....	20
Luxuries.	
64. Ale, Porter and Beer, when imported in casks or otherwise than in bottles, per gall.....	35
65. Ale, Porter and Beer, when imported in bottles (six reputed quarts or twelve reputed pint bottles to be held to contain one gallon), per gall.....	40
66. Artificial Flowers, ad val.....	30 p. c.
67. Billiard Tables and Bagatelle Boards, or Tables, Cues, Balls, Cue Racks and Cue Tips, ad val.....	35 p. c.
68. Cake, not cut by machinery, per lb.....	07
69. Cider and Perry, per gall.....	20
70. Cigars, ad val.....	20 p. c.
per Million.....	9.00
71. Cigarettes, ad val.....	30 p. c.
per Million.....	5.00
72. Clocks, Watches, Watch Glasses, Clock and Watch Keys, Clock and Watch Movements, ad val.....	30 p. c.
73. Confectionery of all kinds, including Sugar Candy, Sweetened Gums and Pop Corn, per 100 lbs.....	\$6.00
74. Confectioners' Ornaments, ad val.....	30 p. c.
75. Fancy Writing Desks, Fancy Cases for Jewellery, Silver Ware, Watches, Plated Ware and Cutlery; Glove, Handkerchief and Collar Boxes or Cases, Brush or Toilet Cases and all fancy cases for similar fancy articles of any material; Fans, Dolls, and Toys of all kinds, Ornaments of Alabaster, Spar, Amber, Terra-Cotta or Composition; Statuettes and Bead Ornaments, N.E.S., ad val.....	35 p. c.
76. Fruits, viz :—Oranges, Lemons, Limes, Grapes, Peaches and Pears, Blackberries, Gooseberries, Strawberries, Raspberries, Plums, Cherries, Quinces, Damsons, Bananas, Plantains, Pine-Apples, Pomegranates, Cuava-Mangoes, Shaddock and other green fruits, ad val.....	10 p. c.
Dried Raisins, Currants, Prunes, Apricots, Dates, Candied Peel Citron, Figs, and other Dried, Candied or Dessicated Fruit, N.E.S., per lb.....	03
77. Gold, Silver and Aluminum Leaf, Dutch or Schlag Metal Leaf, Brocade and Bronze Powders, and Gold Liquid Paint, ad val.....	35 p. c.
78. Honey in the comb or otherwise, and imitations thereof, ad val.....	20 p. c.
79. Hops, ad val.....	10 p. c.
80. Hammocks, Lawn Tennis Nets, Sportmen's Fish Nets, and other articles manufactured of twines and N.E.S., ad val.....	35 p. c.

## Useful Books

**Chairman's Handbook or Manual for the Procedure at Meetings of Shareholders and Directors of Companies, Conventions, Societies, etc., etc.** By Sir. J. G. Bourinot, K.C.M.G., LL.D. Cloth, \$3.00; half-calf, \$3.75.

A cheap edition, which omits the Rules of Municipal and Church bodies; but otherwise the same as the full work. Paper, 50c.; cloth, \$1.00.

**The Dominion Conveyancer, or Forms for drawing Deeds, Agreements, etc.** New edition, \$4.00.

**Ontario Assignments and Preferences Act.** By R. S. Cassels, Barrister, etc. 3rd edition, \$1.00.

**Hand Book on Fire Insurance Law in Ontario.** By R. J. Maclellan, Barrister, etc. \$1.50.

**Bills, Notes and Cheques, Law of.** By J. J. MacLaren, Q.C., LL.D., etc., 2nd edition. Half-calf, \$5.50.

**Bank Act of Canada, and the Law relating to Banks and Banking, Warehouse Receipts, Bills of Lading, etc.** By J. J. MacLaren, Q.C., LL.D. \$4.50.

**Succession Duty in Canada.** By R. A. Bayly, Barrister, etc. Nearly ready, \$1.50.

**The Georgian Bay, with Maps and Illustrations, Early History, Legends, etc.** By J. C. Hamilton, Q.C., LL.B. \$1.00.

ADDRESS ORDERS TO

**Carswell Co., Limited.**

TORONTO, CANADA.

## The VALLEY CITY SEATING COMPANY

LIMITED

DUNDAS, CANADA.

Manufacturers of all kinds of Seating and Furnishings for **CHURCHES, SUNDAY SCHOOLS, MUSIC and ASSEMBLY HALLS,** and all **PUBLIC BUILDINGS.**

Also the "**NEW CENTURY**" REFRIGERATOR (Patents Pending), in six sizes. Can be shipped in sections (or K.D.) and put together without tools or skilled labor. The best **DOMESTIC REFRIGERATOR** in the world. Any woman can take it apart and clean it and put it together again without any help.

Also we make **SPECIAL LINES** of **SANITARY OFFICE and HOUSEHOLD FURNITURE** for **EXPORT.** From samples or drawings, finished or "**IN THE WHITE**" ready to put together.

Correspondence Solicited.

J. D. PENNINGTON,

*Managing Director.*

THE

# MONOLINE

## Composing Machine

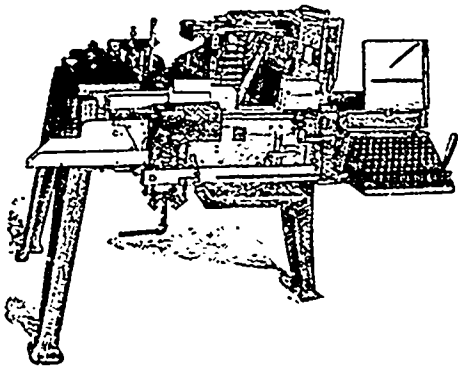

BEST AND CHEAPEST

Manufactured by

## The Canadian Composing Co.

LIMITED

587-607 BEAUDRY ST., MONTREAL, CANADA.

Guaranteed to be the Best and Cheapest Line Casting Machine for Composing Type in the World. Catalogue and Terms on Application.

When writing to Advertisers kindly mention THE CANADIAN MANUFACTURER.

Newfoundland Tariff.

81. Jewellery of all kinds including ornamental Hat Pins, Hair Pins, Belt or other Buckles and similar ornamental articles known as Jewellery, N.E.S., and all manufactures of gold and silver, N.E.S., ad val. ....	35 p. c.
82. Lime Juices and Fruit Juices fortified with or containing not more than twenty-five per cent. of proof spirits, per gall. ....	60
And when containing more than 25 per cent. of proof spirits, per gall. ....	2.00
83. Lime Juice and other Fruit Syrups and Fruit Juices, N.E.S., ad val. ....	20 p. c.
84. Magic Lanterns and Slides therefor, philosophical, photographic, mathematical and optical instruments, N.E.S., Cyclometers, Pedometers, tapes of any material and photographic dry plates, ad val. ....	35 p. c.
85. Malt, ad val. ....	10 p. c.
86. Nuts, viz : Almonds, Walnuts, Brazilnuts, Pecans, Peanuts, Filberts, Hickory and other kinds of nuts, N.E.S., per lb. ....	02
Nuts, shelled, per lb. ....	04
Cocoanuts, N.E.S., per 100. ....	1.00
Cocoanuts, when imported from the place of growth, by vessel direct to a Newfoundland port, per 100. ....	50
Cocoanuts, dessicated, sweetened, or not, per lb. ....	03
87. Perfumery, including Toilet Preparations (non-alcoholic), viz : Hair Oils, Tooth and other Powders, Washes, Pomatums, Pastes, and all other perfumed preparations, N.E.S., used for the hair, mouth or skin, ad val. ....	35 p. c.
88. Pickles, Sauces and Catsups, including Soy, ad val. ....	30 p. c.
89. Picture Frames and Photo Frames, of any material, ad val. ....	40 p. c.
90. Pomades, French or flower odors, preserved in fat or oil, ad val. ....	35 p. c.
91. Preserved Ginger, ad val. ....	30 p. c.
92. Spices, viz : Ginger and Spices of all kinds, unground, N.E.S., ad val. ....	10 p. c.
93. Spices, ground, N.E.S., ad val. ....	30 p. c.
94. Spices, Nutmegs and Mace, ad val. ....	30 p. c.
95. Spirits, viz : Spirituous or alcoholic, distilled from any material, or containing or compounded from or with distilled spirits of any kind, and any mixture thereof with water, for every gallon thereof; and when of a greater strength than that of proof, at the same rate of the increased quantity that there would be if the liquors were reduced to the strength of proof, as follows, viz :—	
Alcohol, Ethyl Alcohol, or the substance commonly known as Alcohol, Hydrated Oxide or Ethyl, or Spirits of Wine, per gall. ....	3.20
Alcohol, Methyl Alcohol, Wood Alcohol, Wood Naptha, Pyroxylic Spirits or any substance known as Wood Spirit or Methylated Spirit, ad val. ....	50 p. c.
Alcohol, Amyl. Alcohol or Fusil Oil, or any substance known as Potato Spirit or Potato Oil, per gall. ....	3.20
Absinthe, Arrack or Palm Spirits, per gall. ....	3.20
Brandy, including Artificial Brandy and imitation of, per gall. ....	3.20
Cordials and Liquors of all kinds, N.E.S., viz : Mescal, Pulque, Rum Shrub, Schiedam and other Schnapps, Tafia, Angostura and similar alcoholic bitters or beverages, per gall. ....	2.40
Ether, Nitrous Ether, sweet spirits of Nitre and Aromatic Spirits of Ammonia, ad val. ....	50 p. c.
Gin of all kinds, per gall. ....	2.40
Methylated Spirits, ad val. ....	50 p. c.
Perfumes, Alcoholic Perfume and Perfumed Spirits, Bay Rum, Cologne and Lavender Waters, Hair, Tooth and Skin Washes, and other toilet preparations containing spirits of any kind, ad val. ....	50 p. c.
Rum, per gall. ....	2.20
Spirits, and strong waters of any kind mixed with any ingredient or ingredients, as being or known or designated as Anodynes, Elixirs, Essences, Extracts, Lotions, Tinctures or Medicines, or Medicinal Wines (so-called), or	

Newfoundland Tariff.

Etherial and Spirituous Fruit Essences, N.E.S., ad val. ....	50 p. c.
Spirits N.E.S., per gall. ....	2.40
Spirits over 43 per cent. over proof and so in proportion for any greater strength, per gall. ....	3.20
Whiskey, per gall. ....	2.80
In all other cases where the strength of any of the foregoing articles cannot be ascertained by the direct application of the hydrometer, it shall be ascertained by the distillation of a sample, or in such other manner as the Receiver-General directs. When spirits are imported in bottles, six reputed quarts or 12 reputed pints shall be held to contain one gallon, and so for any smaller bottle or flask that may be imported.	
96. Snuff, per lb. ....	50
97. Tobacco Pipes of all kinds, Pipe Mounts, Cigar and Cigarette Cases, Cigar and Cigarette Holder and Cases for same, Smokers' Sets and Cases therefor, and Tobacco Pouches, ad val. ....	35 p. c.
98. Tobacco, manufactured, ad val. ....	5 p. c.
Do., per lb. ....	30
99. Tobacco, leaf, stripped or partly manufactured ad val. ....	5 p. c.
Do., per lb. ....	40
100. Tobacco, leaf and stems, per lb. ....	40
101. Tobacco, stems for manufacturing snuff, per 100 lbs. ....	50
102. Torpedoes, Fire Crackers, and Fire works of all kinds, ad val. ....	35 p. c.
103. Vinegar, in bottles, ad val. ....	30 p. c.
104. Wines, viz :—	
Champagne, per gall. ....	4.20
Claret, per gall. ....	55
Hock, Burgundy and Light Rhenish Wine, per gall. ....	1.00
Malaga and Montilla costing at the place of shipment 80 cents per gall., and any other above that price, ad val. ....	12½ p. c.
per gall. ....	1.00
Malaga and Montilla costing at the port of shipment less than 80 cents per gall., per gall. ....	35
Port and Madeira, per gall. ....	1.65
Sherry and Manzanilla, 12½ per cent. ad val., and per gall. ....	1.00
Spanish Red, Denia, Seillian, Figuera, Red Lisbon, Cape and Common Lisbon, per gall. ....	35
Ginger Wine, containing not more than 25 per cent. of proof spirits, per gall. ....	90
Ginger Wine, containing over 26 per cent. of proof spirits, per gall. ....	2.40
Vermouth Wine, containing not more than 36 per cent. of proof spirits, per gall. ....	90
Vermouth Wine, containing over 36 per cent. of proof spirits, per gall. ....	2.40
All other Wine, ad val. ....	15 p. c.
Do., per gall. ....	1.10
When Wines of any kind are imported in bottles, six reputed quarts, or twelve reputed pints, shall be held to contain one gallon. ....	
105. Yeast compressed, Yeast Cakes and Baking Powders, ad val. ....	30 p. c.
Manufactures.	
106. All manufactures of Hemp, Flax or Jute, N.E.S., or of Flax, Hemp and Jute combined, N.E.S., ad val. ....	30 p. c.
107. Bags, or sacks made up of Jute, Hemp, Linen or Cotton, including Seamless Bags, ad val. ....	30 p. c.
108. Baths, Tubs and Wash Stands of earthenware, stone, cement or clay or of other material, N.E.S., ad val. ....	35 p. c.
109. Bicycles and Tricycles and parts thereof, N.E.S., ad val. ....	35 p. c.
Bicycle parts, when imported by manufacturers and repairers of Bicycles, ad val. ....	20 p. c.
110. Blankets and Bed Comforters, or Counterpanes, N.E.S., ad val. ....	30 p. c.
111. Boot, Shoe and Stay Laces of any material, ad val. ....	30 p. c.
112. Braces or Suspender, ad val. ....	35 p. c.

**L. P. BOUVIER**

**Envelope  
Manufacturer**

**All Styles of Envelopes**

**FOR THE TRADE ONLY.**

**31 Lombard St., = TORONTO**

**W. Barber & Bros.**

**PAPER MAKERS**

MAKE A SPECIALTY OF

**GEORGETOWN, ONT.**

**Machine-Finished Book Papers, Colored Specialties**

.....AND.....

**HIGH-GRADE WEEKLY NEWS**

**GEO. E. CHALLES, Selling Agent, Mail Building, Toronto.**

When writing to Advertisers kindly mention THE CANADIAN MANUFACTURER.

Newfoundland Tariff.

113. Bricks, Stock or Common, per M. ....	2.00
ad val. ....	30 p. c.
Do., Facing, ad val. ....	20 p. c.
114. Brooms, and Whisks of Corn, ad val. ....	50 p. c.
115. Brushes, ad val. ....	35 p. c.
116. Buttons of all kinds, ad val. ....	20 p. c.
117. Cabinet Wares, viz. :- House, Office, Cabinet or Store Furniture of Wood, Iron or other material in parts or fin- ished; Blinds of wood, metal, or other material not textile or paper, Window Shades or Blind Rollers, ad val. ....	35 p. c.
118. Cans, imported in a manufactured state for put- ting up hermetically sealed goods, including the packages or cases in which they are im- ported, ad val. ....	40 p. c.
119. Canoes, Ships' Boats, Skiffs, or open or decked Pleasure Sail-boats of any material, ad val. ....	55 p. c.
120. Candles, N.E.S., ad val. ....	35 p. c.
121. Candles, made of Paraffine wax, ad val. ....	30 p. c.
122. Carriages, viz. :- Carriages, Express and other Waggons, Bug- gies, Carts and Sleighs and other ready-made Vehicles, when costing at the port of shipment not more than \$50 each, \$10 and ad val. ....	30 p. c.
When costing more than \$50 each, but not ex- ceeding \$100 each, \$30 and ad val. ....	30 p. c.
Costing over \$100 each, \$30 and ad val. ....	30 p. c.
Carriages, Waggons, Buggy, Hearse or Express Bodies: Purchases, Gears, Hoods, Poles, or Seats, made up, or part made up, ad val. ....	50 p. c.
Wheelbarrows, Handbarrows, Star Carts, Trucks, Trolleys, or Sainsons, ad val. ....	75 p. c.
Wheels, ready-made or part made, that is with spokes in hub, \$1 each, and ad val. ....	30 p. c.
Wheel Spokes for Carriages, any size up to 1 1/2 inches, ad val. ....	25 p. c.
Wheel Spokes for Vehicles and Carriages, over 1 1/2 inches, ad val. ....	50 p. c.
Wooden Rims for wheels, all sizes, ad val. ....	25 p. c.
Carriage Shafts, not trimmed, ad val. ....	25 p. c.
Carriage Shafts, trimmed, ad val. ....	50 p. c.
Hubs for Carriage Wheels, or blocks to make such hubs, up to 8 inches in diameter, ad val. ....	25 p. c.
Hubs for Vehicles, or blocks to make such hubs, over 8 inches in diameter, ad val. ....	50 p. c.
Whitewood, Basswood, Ash, Hickory, and Oak, not planed or dressed, when imported by Wheelwrights and Carriage Builders to be manufactured by them, per M. ....	2.00
Bows for Hoods, Springs, Axles, Shaft and other Clips, Bolts, Circles, Stamp Joints and off-sets, Swing-Hooks, Swing-Rings and Plates, Spring Shackles, Links, Felloc-Plates, Axle Boxes, Spring Steel, when imported by wheelwrights and carriage builders, to be used by them in the manufacture of vehicles, ad val. ....	25 p. c.
When the foregoing articles (paying 25 per cent. ad val.) are imported by persons who are not carriage builders or wheelwrights, a duty of 50 per cent. ad val. shall be paid thereon.	
Carriage Paints and Varnish, Leathers, Cloth, Duck, Drill and Plush; Carriage Trimmings, such as Tufts, Tacks, Whip- Sockets, Lace, Shaft-Tips, Swing Ends and Silver Heading, Carriage Lamps, ad val. ....	25 p. c.
Malleable Seat Irons, and other Malleable Carriage Parts, ad val. ....	50 p. c.
Steel Tires, Sleigh Runners, Steps or Step Pads, ad val. ....	50 p. c.
123. Carpetings, Rugs, Mats and Matting of Cocoa, Straw, Hemp or Jute; Carpet Linings and Stair Pads, ad val. ....	35 p. c.
Carpets, Turkish or Imitation Turkish, or other Rugs or Carpets, and Carpets' N.E.S., ad val. ....	35 p. c.
124. Cash Registers, ad val. ....	35 p. c.
125. Casks empty (second-hand), 45 Gallons and under each ....	50
126. Casks, empty, (second-hand), over 45 Gallons each ....	1.50
127. Cask Staves, (second-hand), to make Casks of 45 Gallons and up, per 100 ....	6.00
Cask Staves (second-hand), to make Casks under 45 Gallons, per 100 ....	1.50

Newfoundland Tariff.

128. Casks in which Dry Goods are imported, which are capable of containing Liquids, each ....	1.50
129. China and Porcelain Ware, also Earthenware and Stoneware, brown or colored Rockingham Ware, White Granite or Ironstone Ware, C.C. or Cream Colored Ware, Decorated, Printed or Spangled, and all Earthenware, N.E.S., ad val. ....	35 p. c.
130. Combs, Curry Combs and Curry Combs, ad val. ....	35 p. c.
131. Composition Metal for the manufacture of jew- ellery, ad val. ....	25 p. c.
132. Crapes, Black, ad val. ....	30 p. c.
133. Damask of Linen, Stair Linen, Diaper, Naplins, Doilies, Table and Tray Cloths, Sheets and Quilts, Towels and like articles of Linen or Cotton, or of Linen and Cotton combined, made up or not, N.E.S., ad val. ....	35 p. c.
134. Drain Pipes, Sewer Pipes, Chimney Linings of Vents, Chimney Tops and Inverted Blocks glazed or unglazed, Earthenware Tiles, Stove Linings and Fire Brick and manufactures of Clay or Cement, ad val. ....	30 p. c.
135. Earthenware and Stoneware, viz. :- Demi-johns, Churns, Crocks or Jars, ad val. ....	30 p. c.
136. Embroideries, Laces, Braids, Frizzes, Cords, Elastic, round or flat, Garter Elastic, Tassels and Bracelets, N.E.S., Braids, Chains, Cords, N.E.S., Handkerchiefs of all kinds, Lace Collars and all similar Lace Goods, Lace Nets and Netting of Cotton, Linen, Silk, or other material, Shams, Curtains, trimmed or untrimmed, Regalia of Societies (including Jewels), Badges and Belts of all kinds, N.E.S., ad val. ....	35 p. c.
137. Fabrics or Clothing which have been exported to be dyed or cleaned, when re-imported, ad val. ....	30 p. c.
138. Feathers, dressed, ad val. ....	40 p. c.
139. Floor, Shelf, Stair, Enamelled and Table Oil- cloth, Linoleum and Cork Matting or Cork Carpets, ad val. ....	35 p. c.
140. Glassware, viz. :- Glass Demi-johns or Carboys empty or filled, Bottles, Decanters, Flasks, Phials, Glass Jars and Glass Balls, Lamps, Chimneys, Glass Shades or Globes, Cut, Pressed or Moulded Crystal or Glass Tableware, decorated or not, and Blown Glass Tableware, ad val. ....	35 p. c.
Common and Colorless Window Glass, and Plain Colored, Opaque Stained or Tinted or Muffled Glass in sheets, ad val. ....	30 p. c.
Ornamental, Figured and Enamelled Colored Glass, Vitrified or Painted, Chipped, Figured, Enamelled and Obscured White Glass, Stained Glass Windows and Memorial or Ornamental Window Glass, N.E.S., and Plate Glass in sheets or squares, ad val. ....	35 p. c.
Silvered Glass, framed or not framed, ad val. ....	30 p. c.
Spectacles and Eyeglasses and Frames and metal parts thereof, ad val. ....	30 p. c.
All other Glassware, N.E.S., ad val. ....	30 p. c.
141. Gloves and Mitts of all kinds, ad val. ....	30 p. c.
142. Hair Cloth of all kinds and Felt Pressed of all kinds, N.E.S., ad val. ....	30 p. c.
143. Hair Spring and other Mattresses, Bolsters and Pillows, including Furniture, Springs and Carpet Sweepers, ad val. ....	30 p. c.
144. Hardware, viz. :- Adzes, Axes, Cleavers, Hatchets, Saws, Wedges, Sledges, Hammers, Crowbars, Cant- dogs and Track Tools; Picks, Mattocks and Eyes or Poles for same, Anvils, Vises and tools of all kinds for hand or for machine use, including shoemakers' and tinsmiths' tools or bench machines, N.E.S., ad val. ....	25 p. c.
Scythes, Sickles or Reaping Hooks, Hay or Straw Knives, Hedging Knives, Hoes, Rakes, Pronged Forks, Snaths, Farm, Road or Field Mowers, and other agricultural Implements, N.E.S., ad val. ....	25 p. c.
Shovels and Spades of Iron or Steel, ad val. ....	25 p. c.
Lawn Mowers, Carvers, Knives and Forks of Steel, Butcher and Table Steels, Oyster, Bread, Kitchen and Cooks' Knives, ad val. ....	35 p. c.



# THE Canadian Manufacturer

ESTABLISHED IN 1880.

Is Devoted to the Development of Canadian Trade,  
Foreign and Domestic.

Some of the measures which are most pressing upon Canada and  
which are advocated and most vigorously supported by

## THE CANADIAN MANUFACTURER Are:

The enactment of uniform laws relating to bankruptcy throughout the whole Dominion.

The improvement and simplification of our patent laws and laws relating to trade marks and copyright.

The uniform customs appraisement of merchandise.

The uniform classification of freights on all routes of transportation.

The establishment and maintainance of cold storage systems in important commercial centres, and on railroads and steamships.

The improvement of the facilities for transportation by the extension of railroads and canals according to the requirements of the country.

The taking of such measures as may tend to extend our trade relations with the Mother Country, Sister Colonies and Foreign Lands.

## ASK FOR INFORMATION.

Any enquiry addressed to THE CANADIAN MANUFACTURER will result in placing the writer, if he so desires, in communication with Manufacturers, Buyers or Sellers of any sort of merchandise in Canada or any other country.

Merchants, Importers, Exporters, Boards of Trade, Chambers of Commerce and Commercial Organizations in any part of the world are invited to make full use of the facilities afforded by THE CANADIAN MANUFACTURER whenever they may desire information about any article produced in Canada, Tariff Laws, Customs Regulations, Routes of Transportation, etc.

**If You Want Information, Ask for It.**

Address,

**THE CANADIAN MANUFACTURER.**

TORONTO, CANADA.

Newfoundland Tariff.

Butchers, Shoe, Farrier, Putty, Sheath, Splitting, Hacking and Glaziers' Knives, Spatulas or Paint Knives, ad val. .... 25 p. c.

Cigar Knives, Razors, Erasers or Office Knives, Pen, Pocket, Pruning, Sportsmen's, Hunters' Knives, ad val. .... 35 p. c.

Barbers' and Tailors' Shears, ad val. .... 25 p. c.

Manicure Files, Scissors, Trimmers, Lamp Shears, Horse and Toilet Clippers, and all like Cutlery plated or not, N.E.S., ad val. .... 35 p. c.

When any of the above articles are imported in Cases or Cabinets, the Cases or Cabinets shall be dutiable at the same rate as their contents.

Builders', Cabinet Makers', Upholsters', Harness Makers' and Saddlers' Hardware, including Hinges and Locks, N.E.S., ad val. .... 30 p. c.

Skates of all kinds, ad val. .... 35 p. c.

Gas Meters, ad val. .... 30 p. c.

Safes and Doors for Safes or Vaults, ad val. .... 35 p. c.

Scales, Balances, Weighing Beams and Strength-testing Machines of all kinds, ad val. .... 30 p. c.

Lead Pipe, Lead Shot, Lead Bullets and all manufactures of Lead, N.E.S., ad val. .... 30 p. c.

Lead in Bars and Sheets, ad val. .... 10 p. c.

Brass and Copper Nails, Tacks, Rivets and Burs, or Washers, Brass Pumps of all kinds and Garden and Lawn Sprinklers; Brass and Copper Wire, plain turned or plated, Bells and Gongs and all manufactures of Brass and Copper, N.E.S., ad val. .... 30 p. c.

Bird, Parrot, Squirrel and Rat Cages of Wire or other material. Rat and Mouse Traps, ad val. .... 35 p. c.

Files and Rasps, ad val. .... 25 p. c.

Screws, commonly called "Wood Screws," of Iron, Steel, Brass or other metal, plated or not, and machine or other Screws, N.E.S., ad val. .... 30 p. c.

Barbed Wire and Galvanized Wire for Fencing, Woven Wire Fencing and Wire Fencing of Iron or Steel, Wire Cloth or Woven Wire and Netting of Brass, Copper or Steel, ad val. .... 30 p. c.

Wire, of all kinds of metals, N.E.S., ad val. .... 30 p. c.

Fencing of iron or steel, ad val. .... 40 p. c.

Needles of any material or kind and pins manufactured from Wire of any metal, N.E.S., ad val. .... 30 p. c.

Wire Rope, for Rigging Vessels, ad val. .... 10 p. c.

Wire Rope, N.E.S., ad val. .... 50 p. c.

Fire Extinguishing Machines, ad val. .... 30 p. c.

Boiler Rivets and Coopers' Rivets, N.E.S., ad val. .... 20 p. c.

Iron or Steel Nuts, Washers, Rivets, N.E.S., and Bolts with or without threads, and Nut Bolts and Hinge Blanks, N.E.S., ad val. .... 30 p. c.

Sterling or other Silver Ware, Nickel Plated Ware, Gilt or Electro Plated Ware, wholly or in part, of all kinds, ad val. .... 35 p. c.

Britannia Metal, Nickel, Silver, Nevada and German Silver, Manufactures of, not plated, and Manufactures of Aluminum, N.E.S., ad val. .... 35 p. c.

Telephone and Telegraph Instruments, Electric and Galvanic Batteries, ad val. .... 30 p. c.

Electric Motors, Dynamos, Generators, Sockets, Insulators of all kinds, and Electric Apparatus, N.E.S., ad val. .... 20 p. c.

Electric Light Carbons and Carbon points, of all kinds, N.E.S., ad val. .... 30 p. c.

Lamps, Side-Lights and Head-Lights, Lanterns, Chandellers, Gas, Coal, or other oil fixtures, and Electric Light Fixtures, or Metal parts thereof, including Lava or other Tips, Burners, Collars, Galleries, Shades and Shade Holders, ad val. .... 30 p. c.

Lamp Springs and Glass Bulbs, for Electric Lights, ad val. .... 30 p. c.

Babbit Metal, Type Metal, Phosphor Tin and Phosphor Bronze, in blocks, Bars, plates, Sheets and Wire, N.O.P., ad val. .... 10 p. c.

Stereotypes, Electrotypes and Celluloids of Newspaper Columns and Bases for the same composed wholly or partially of metal or Cell-

Newfoundland Tariff.

oid, and Matrices or Copper Shells for the same, N.O.P., ad val. .... 30 p. c.

Clothes Wringers, for domestic use and parts thereof, ad val. .... 30 p. c.

Buckles of Iron, Steel, Brass, or Copper, of all kinds, N.E.S., (not being Jewellery), ad val. .... 30 p. c.

Guns, Rifles, including Air Guns and Air Rifles, not being Toys, Muskets, Cannons, Pistols, Revolvers or other Firearms; Cartridge Cases, Cartridges, Primers, Percussion Caps, Wads or other Ammunition, N.E.S.; Bayonets, Swords Fencing Foils and Masks, Gun or Pistol Covers or Cases, Game Bags, Loading Tools and Cartridge Belts of any material, ad val. .... 35 p. c.

Signs of any material, framed or not; Letters of any material for Signs or similar use, ad val. .... 35 p. c.

Trawls, Trawling Spoons, Fly Hooks, Sinkers, Swivels, Floats and Sportsmen's Fishing Bait, Fish Hooks and other Anglers' Requisites, N.E.S., ad val. .... 35 p. c.

Wool Cards, ad val. .... 10 p. c.

Patterns of Brass, Iron, Steel or other metal not being metals, ad val. .... 10 p. c.

Manufactures, Articles or Wares not specially enumerated or provided for, composed wholly or in part of Iron, Steel or other metal, and whether wholly or partly manufactured ad val. .... 30 p. c.

145. Harness, including Horse Boots and Saddlery of every description, ad val. .... 40 p. c.

146. Harness Findings, viz. :-  
Loops, Winkers, Eyes or Blinds, Metallic and Wood Findings for Harness Making and imported by Harness Makers, ad val. .... 25 p. c.

147. Hats, Caps and Bonnets, and Hat, Cap and Bonnet Shapes, ad val. .... 35 p. c.

148. Hats, Caps, Muffs, Tippets, Capes, Cloaks and other Manufactures of Fur, N.E.S., ad val. .... 35 p. c.

149. Herring Barrels, each ..... 25

150. Indian Rubber Boots and Shoes, and all Manufactures in part or in whole of Indian Rubber and Gutta-percha, N.E.S., ad val. .... 35 p. c.

151. Indian Rubber Clothing and Clothing made Water-proof with Indian Rubber or like substances, Rubber or Gutta-percha Hose and Cotton or Linen Hose lined with Gutta-percha or Indian Rubber, ad val. .... 35 p. c.

152. Indian Rubber Mats or Matting and Rubber Packing, ad val. .... 35 p. c.

153. Knife Brick, Knife Polish, and other Metal Polish or Composition for polishing metal, ad val. .... 30 p. c.

154. Lamp Wicks, ad val. .... 30 p. c.

155. Laundry Blueing of all kinds, ad val. .... 30 p. c.

156. Leatherware, viz. :-  
Boots and Shoes, and Slippers, Gaiters or Leggings of leather, leatheroid or other material N.E.S., ad val. .... 35 p. c.

157. Lumber, 1 inch in thickness, and so in proportion for any greater thickness, N.E.S., per M. .... 3.50

158. Lumber, grooved, tongued or planed, 1 inch thick or so, in proportion for any greater thickness, per M. .... 5.00

159. Lumber, viz. :-  
Oak, Pitch Pine, Elm, Greenheart and Ironwood, N.E.S., per M. .... 2.00

160. Matches of all kinds, ad val. .... 40 p. c.

161. Mustard, ground, ad val. .... 30 p. c.

162. Nails, viz. :-  
Iron or Steel, Cut Nails and Spikes (ordinary builders), ad val. .... 35 p. c.

Wrought, when hand-made, ad val. .... 10 p. c.

Horse-Shoe Nails, ad val. .... 10 p. c.

Pressed Nails and pressed Spikes of all kinds, and Wire Nails of all kinds, ad val. .... 35 p. c.

Galvanized Nails and Spikes, and Sheathing Nails, N.E.S., ad val. .... 10 p. c.

Galvanized Cut Nails and Spikes, ad val. .... 35 p. c.

Iron or Steel Tacks of all descriptions, leathered or not, N.E.S., ad val. .... 35 p. c.

Iron or Steel Shoe Tacks, Brads, Springs and Shoe Nails, ad val. .... 25 p. c.



CATALOGUE AND PRICE LIST of Some of Our Works.

# KELLY'S DIRECTORY

OF THE

.. MERCHANTS, MANUFACTURERS and SHIPPERS OF THE WORLD ..

The Standard Export Medium. Endorsed by the  
British Government. Published Annually. Price \$ 9 00

## Trade Directories of Great Britain.

	PRICE
Cabinet Furniture and Upholstery Trades.....	\$ 6 00
Grocery and Oil and Color and Provision Trades ....	10 00
Leather Trades .....	8 00
Stationers, Publishers, Printers, Booksellers and Paper Makers.....	7 00
Chemists and Druggists and Chemical Manufacturers	7 00
Engineers, Iron and Metal Trades.....	9 00
Manufacturers of Textile Fabrics.....	10 00
Watch and Clock, Goldsmith and Jewellers Trades. .	6 00
Building Trades.....	9 00
Wine and Spirit Trades, Brewers and Maltsters.....	7 00
Post Office London Directory (100th annual edition) ..	10 00
Titled, Landed and Official Classes .....	5 00
Clergy List .....	5 00
Royal Blue Book.....	3 00

## COLONIAL DIRECTORIES

	PRICE
Queensland Official Directory.....	\$12 00
Post Office Directory of Victoria.....	13 00
.. .. New Zealand.....	13 00
.. .. New South Wales....	13 00
.. .. Western Australia .....	8 00
.. .. South Australia.....	8 00
.. .. Tasmania .....	8 00
Directory of Belgium .....	7 00
General Directory of South Africa .....	7 00

## County Directories.

Thirty-five of these are published, including all the coun-  
ties. Prices on application.  
All these Directories contain a classified Business List.

## National Directories.

	PRICE
Royal National Directory of Scotland... ..	\$14 00
Royal National Directory of Ireland.....	11 00

Prospectus with Advertising Rate and full particulars on application.

## WE HAVE OPENED AN ADDRESS DEPARTMENT

in connection with our business here, and are prepared to furnish lists of all Professions, Trades and Industries, throughout the world, at the following reasonable rates, viz.: Lists of 50,000 or over at \$1.50 per 1,000; lists of 25,000 or over at \$2.00 per 1,000; lists up to 5,000 at \$2.50 per 1,000, and 1,000, \$3.00.

These lists are **GUARANTEED**, i. e., we will re-imburse you the amount paid us, and the cost of postage on all envelopes returned to us post-marked "can't find."

We can also supply you with Duplications of Letters or Circulars, imitation of typewriting, for \$3.50 per 1,000, or in quantities of 5,000 or over at \$3.00 per 1,000.

Recognizing also the importance of **EXPORT TRADE** to the Manufacturers of the Dominion, we have availed ourselves of our many offices and employees, in the principal cities of the world, and have opened a Bureau of Enquiry, designed to put in direct communication the Producers of Canada and the **ACTUAL FOREIGN BUYER**. Enquiries are received at this office weekly, and are at once forwarded **FREE** to our Subscribers and Advertisers.

Patrons are also invited to make use of our Library of Directories (mostly our own publica-  
tions), and to the use of our offices when travelling abroad.

## KELLY'S DIRECTORIES, Limited,

Branch of London, England.

71 Victoria Street, Toronto.

When writing to Advertisers kindly mention THE CANADIAN MANUFACTURER.

Newfoundland Tariff.

163. Mats, door or carriage, N.E.S., ad val. ....	25 p. c.
164. Oiled Clothes, ad val. ....	30 p. c.
165. Oiled Silk and Oiled Cloth, ad val. ....	35 p. c.
166. Paper Hangings and Borderings, ad val. ....	30 p. c.
167. Pianofortes, Organs and Musical Instruments of all kinds and parts thereof, including catgut and other strings, provided that Musical Instrument Cases shall be dutiable at the same rate as their contents, when imported containing the Instrument, ad val. ....	30 p. c.
168. Ploughs and Harrows not patented, ad val. ....	20 p. c.
Ploughs and Harrows when patented, ad val. ....	10 p. c.
169. Putty of all kinds, ad val. ....	30 p. c.
170. Ready-Made Clothing, composed wholly or in part of wool, worsted, the hair of the alpaca, goat or other like animals, N.E.S., ad val. ....	40 p. c.
Linen, Silk and Cotton Clothing, and all other articles made up by the seamstress from Linen or Cotton fabrics, ad val. ....	35 p. c.
Corsets of all kinds, Collars and Cuffs, of cotton, linen, xylonite, xyllite, celluloid or paper, ad val. ....	35 p. c.
Shirts and Underclothing of cotton, linen or silk N.E.S., ad val. ....	40 p. c.
Shirts and Underclothing of wool, or of cotton and wool, knitted or woven by machinery and not hand-made, ad val. ....	30 p. c.
Stockings, Shirts and Drawers, made by hand, ad val. ....	35 p. c.
Ladies' and Misses' Blouses or Shirt Waists, ad val. ....	35 p. c.
Socks and Stockings of all kinds, N.E.S., ad val. ....	30 p. c.
171. Ribbons of all kinds and materials, and manufactures of Silk, or which Silk is the component part of chief value, ad val. ....	35 p. c.
172. Rivets and Patent Bushings for Ships' Blocks, when imported by block-makers, ad val. ....	20 p. c.
173. Sails for boats and ships, tarpaulins, tents and awnings, ad val. ....	40 p. c.
174. Sewing and Embroidery Silk, Silk Twists, Cotton Sewing Thread, Crochet Cotton, Knitting Cotton, and all other Cotton Thread, and White Cotton Embroideries, ad val. ....	25 p. c.
175. Shawls of all kinds; railway or travelling Rugs and Lap Dusters of all kinds, ad val. ....	35 p. c.
176. Shingles and Laths, per M. ....	60
177. Shoe Blacking, Shoe Polish and Shoe Dressing, ad val. ....	30 p. c.
178. Soap, Common or Laundry, Castile Soap, Mottled or White Soap, N.E.S., ad val. ....	35 p. c.
Pearline and other soap powders, ad val. ....	30 p. c.
179. Soda, Bi-carbonate, ad val. ....	20 p. c.
Do., Washing (sodium carbonate), ad val. ....	30 p. c.
180. Starch, and all preparations having the qualities of starch, N.E.S., ad val. ....	30 p. c.
181. Stationery, viz. :—Albumenized and other papers and films chemically prepared for photographers' use, ad val. ....	30 p. c.
Books, viz. :—Novels or works of fiction, or literature of a similar character, unbound or bound or in sheets, and all printed Books, Periodicals and Pamphlets, or parts thereof, N.E.S., ad val. ....	10 p. c.
Books to be written or drawn upon, Blank Account Books and Copy Books, N.E.S., ad val. ....	35 p. c.
Advertising and printed matter, viz. :—Advertising Pamphlets, advertising Pictorial Show Cards, illustrated advertising Periodicals, illustrated Price Books, Catalogues and Price Lists, advertising Almanacs and Calendars, Patent Medicine or other advertising Circulars, Fly Sheets or Pamphlets advertising Chromos, Chromotypes, Oleographs, or like work produced by any process other than hand painting or drawing, and having any advertisements or advertising matter printed, lithographed, or stamped thereon, or attached thereto, including Advertising Bills, Folders and Posters, or other similar artistic work, lithographed, printed or stamped on paper or card board for business or advertisement purposes, N.O.P., ad val. ....	50 p. c.

Newfoundland Tariff.

Labels of all kinds, Shipping, Price or other tags, Tickets of all kinds when printed upon or lithographed or partly printed, N.E.S., ad val. .	50 p. c.
When imported by printers to be printed on in this Colony, ad val. ....	25 p. c.
Bank Notes, Bonds, Bills of Exchange, Cheques, Promissory Notes, Drafts and all similar work unsigned, Bill Heads, Forms and Cards or other commercial Bank Forms, printed or lithographed, or printed from steel or copper or other plates, and other printed matter, N.E.S., ad val. ....	50 p. c.
Printed music, bound or in sheets, ad val. ....	10 p. c.
Photographs, Chromos, Chromotypes, Artotypes, Oleographs, Paintings, Drawing, Pictures, Engravings or Printed or Proofs therefrom, and similar works of art, N.O.P., Blue Prints, Building Plans, ad val. ....	25 p. c.
Maps and Charts, N.E.S., ad val. ....	10 p. c.
Newspapers or Supplemental Editions or Parts thereof, partly printed and intended to be completed and published in Newfoundland, N.E.S., ad val. ....	25 p. c.
Wrapping Paper, Toilet Paper, Sand Paper, Glass or Flint Paper, and Emery Paper and Emery Cloth, N.E.S., ad val. ....	30 p. c.
Mill Board, not straw board, ad val. ....	30 p. c.
Straw Board, in sheets or rolls, Tarred Paper, Felt, or Straw Board, or Sheathing Paper, N.E.S., ad val. ....	30 p. c.
Paper Sacks or Bags, not printed on, ad val. ....	35 p. c.
Paper Sacks or Bags when printed on, ad val. ....	50 p. c.
When imported by printers to be printed on (regulations to be made by the Receiver-General), ad val. ....	25 p. c.
Playing Cards, ad val. ....	40 p. c.
Paper, of all kinds, N.E.S., ad val. ....	30 p. c.
Ruled, Bordered and Coated Papers, Paperies, Boxed Papers, Pads not printed on, Papier Mache-ware, N.O.P.; Envelopes, and all manufactures of Paper, N.E.S., ad val. ....	30 p. c.
Lead Pencils, Pencils of all kinds, Pens, Penholders, and Rulers of all kinds, ad val. ....	35 p. c.
Inks for writing, ad val. ....	30 p. c.
Artists' Paints and Colors, Brushes, and other Drawing Requisites, ad val. ....	35 p. c.
Erasing Rubbers of all kinds, ad val. ....	30 p. c.
Mucilage and other Liquid Gums, ad val. ....	30 p. c.
182. Stove Plates, Stoves of all kinds for coal or wood, or parts thereof, ad val. ....	30 p. c.
Gas or Oil Stoves, ad val. ....	30 p. c.
183. Timber, squared or partly squared, measuring 5 inches square and over, N.O.P., and not to include mast pieces, wharf shores, or logs undressed, per ton ....	60
184. Tinware, Plain, Japanned or Lithographed, and all manufactures of tin, and manufactures of Galvanized Sheet Iron and Sheet Steel, N.O.P., ad val. ....	35 p. c.
Agate, Granite or Steel Hollow Ware, Plain Black, Tinned or coated, and Nickel and Aluminum kitchen or household Hollow Ware, ad val. ....	35 p. c.
185. Trunks, Valises, N.E.S., Hat Boxes, Carpet Bags, Tool Bags or Baskets, Satchels, Reticules, Musical Instrument Cases, Purses, Portmanteaux, Pocket Books, Fly Books, and parts thereof, N.E.S., and Baskets of all kinds, ad val. ....	35 p. c.
186. Umbrellas, Parasols and Sunshades of all kinds and materials, ad val. ....	35 p. c.
187. Velvets, Velvetens, Silk Velvets, Plush and Silk Fabrics, ad val. ....	35 p. c.
188. Webbing, Elastic and non-Elastic, ad val. ....	30 p. c.
189. Whips of all kinds, including Thongs and Lashes ad val. ....	35 p. c.
190. Window Shades in the piece, or Cut and Hemmed, or Mounted on Rollers, N.E.S., ad val. ....	35 p. c.
191. Wood, Manufactures of, viz. :—Manufactures of Corkwood other than Cork Stoppers for Bottles and Jars, N.E.S., ad val. ....	35 p. c.
Pails and Tubs of Wood, Churns, Wash Boards, Pounders, Rolling Pins, Mouldings of Wood, plain, gilded or otherwise manu-	

# HENRY'S BUYERS' 1900-5 GUIDE ...Up to Date...

WILL BE READY FOR DELIVERY OCTOBER 1st, 1900.

The Only Buyers' Guide Published in Canada that is Strictly  
CANADIAN.

We have spent Thousands of Dollars to gather information for  
THE BUYER.

## FOR ADDRESSING PURPOSES

The Names and Addresses of all Manufacturers who produce more than for local consumption are arranged alphabetically, each having a COMPREHENSIVE HEADING SHOWING KIND OF BUSINESS. Also a full list of Strictly Hardware Merchants in the Dominion.

Subscription \$5.00.

# The Manufacturers' List Co.

**TORONTO AND MONTREAL**

**CANADA.**

When writing to Advertisers kindly mention THE CANADIAN MANUFACTURER.

Newfoundland Tariff.

factured, Fishing Rods of all kinds, Walking Sticks and Walking Canes of all kinds, ad val. ....	35 p. c.
Coffins and Caskets, ad val. ....	35 p. c.
Metal parts of Coffins and Caskets for use by manufacturers, ad val. ....	20 p. c.
Show Cases, ad val. ....	35 p. c.
Metal part thereof, ad val. ....	20 p. c.
Window Cornices and Cornice Poles of all kinds ad val. ....	35 p. c.
Any other Manufactures of Wood, N.E.S., ad val. ....	35 p. c.
Trunks and Valises in part or in whole of Wood ad val. ....	40 p. c.
Hoops for Masts, ad val. ....	20 p. c.
Rushes, for Coopers' Use, ad val. ....	20 p. c.
Hoops for Coopers, ad val. ....	35 p. c.
192. Zinc and Manufactures of Zinc, N.E.S., ad val. ....	30 p. c.
Raw Material, Etc.	
193. Anchors, Coll Chain, Coll Chain Links and Chain Shackles, ad val. ....	10 p. c.
194. Belting of Leather or other material for Machinery, ad val. ....	10 p. c.
195. Blocks for Ships and Block Sheaves, ad val. ....	40 p. c.
196. Brin, known as "Bread Bag Brin," when imported by local Manufacturers of Bread or Rope in which to enclose their manufactures, ad val. ....	10 p. c.
197. Broom Handles, ad val. ....	20 p. c.
198. Canvas known as Sall and Tarpaulin, Canvas of Hemp, Cotton or Flax, ad val. ....	5 p. c.
199. Cast Iron Pipes, ad val. ....	30 p. c.
200. Cement, viz. :— Portland, Roman and Hydraulic Water Lime, in Bags, Barrels or Casks, ad val. ....	20 p. c.
201. Chemicals and paper, when imported by Manufacturers of Matches for the Manufacture of Matches, ad val. ....	20 p. c.
202. Cotton Batts, Battling and Sheet Wadding, Cotton Warps and Cotton Yarns, dyed or not, N.E.S., ad val. ....	30 p. c.
203. Cotton Fabrics, White or Grey, Bleached or Unbleached, N.E.S., ad val. ....	30 p. c.
204. Cotton Fabrics, Printed, Dyed, or Colored, N.E.S., ad val. ....	30 p. c.
205. Cotton, Duck, colored or striped, ad val. ....	30 p. c.
206. Copper and Composition Metal, including Sheets, Bars, Bolts, Sheathing Paper and Nails of Copper or Composition, N.E.S., ad val. ....	20 p. c.
207. Copper Paint, ad val. ....	30 p. c.
208. Cordage of all kinds, N.E.S., per lb. ....	0 1/2
209. Corks and Corkwood, ad val. ....	10 p. c.
210. Curling Stones, and Fittings for, ad val. ....	30 p. c.
211. Diving Apparatus, ad val. ....	10 p. c.
212. Dories and Dory Oars, ad val. ....	20 p. c.
213. Dyes of all kinds, N.E.S., ad val. ....	30 p. c.
214. Explosive, viz. :— Blasting and Mining Powder, Nitro-Glycerine, Giant Powder, Nitro and other Explosive, N.E.S., ad val. ....	36 p. c.
Cannon, Musket, Rifle, Gun and Sporting Powder, and Cannister Powder, ad val. ....	30 p. c.
215. Findings for Boots and Shoes, when imported by Boot and Shoe Makers, viz. :— Eyelets, Hooks, Linings, Silk Twist, Machine Thread, Cotton, Nails, Counters, Elastic Web, Sand Paper, Buttons, Glue, Tacks, Wire, Cardboard, Paper, Dressing, Box Toe Tips, Steel and Wooden Shanks, Bees-wax, Buttons and Fasteners, Gum, Pegs and Pegwood, Lasts, Patterns, Heel Plates and Crimp Irons ad val. ....	25 p. c.
216. Fish Hooks, not including Hooks or Fly Hooks for Anglers, ad val. ....	10 p. c.
217. Flagstones and all other Building Stone Dressed, N.E.S., ad val. ....	30 p. c.
218. Flannels, Serges, N.E.S., Swanskins, Kerseys, ad val. ....	30 p. c.
219. Forgings of Iron or Steel, of whatever shape or size, or in whatever stage of manufacture, When weighing under 5 cwt., ad val. ....	30 p. c.
When weighing over 5 cwt., ad val. ....	10 p. c.

Newfoundland Tariff.

220. Freestone, Flagstone, Sandstone, and all Building Stone, not hammered or dressed, and Marble and Granite rough, not hammered or dressed, ad val. ....	30 p. c.
221. Galvanized Iron, in bolts, bars, strips or sheets, N.E.S., ad val. ....	10 p. c.
222. Grindstones, ad val. ....	30 p. c.
223. Hair, curled or dyed, ad val. ....	30 p. c.
224. Heading, for coopers' use, dressed or partly dressed, per pair ....	05
225. Hoop, Iron and Steel Strips, for making hoops, N.E.S., ad val. ....	5 p. c.
Punched, Splayed or Nosed, over sixty-eight inches in length, ad val. ....	5 p. c.
226. Iron of all kinds, in bolts, bars, sheets, plates and pieces, N.E.S., ad val. ....	10 p. c.
227. Iron and Steel Railway Bars, or rails of any form, punched or not, ad val. ....	20 p. c.
228. Iron or Steel Bridges, or parts thereof; Iron or Steel Structural Work, Columns, Girders, Shapes or Sections, ad val. ....	20 p. c.
229. Iron or Steel Pipe or Tubing, plain or galvanized, riveted, corrugated, or otherwise specially manufactured, N.E.S., ad val. ....	20 p. c.
230. Iron or Steel Fittings, for iron or steel pipe, of every description, ad val. ....	30 p. c.
231. Lamp Black and Ivory Black, ad val. ....	30 p. c.
232. Leather, known as "sole leather," ad val. ....	20 p. c.
233. Leather, viz. :— Glove Grain, Boot Grain, Oil Grain, Buff, Split, Imitation Goat, Polished Pebble, and Waxed Calf, when bark tanned, ad val. ....	30 p. c.
All other Upper Leathers, N.E.S., ad val. ....	20 p. c.
Harness Leather, N.E.S., ad val. ....	25 p. c.
Janned, Patent, or Enamelled Leather, ad val. ....	20 p. c.
Chamois Skins, and Morocco Leather, N.O.P., ad val. ....	25 p. c.
234. Leather, rough, undressed, when imported by tanners for further dressing, ad val. ....	10 p. c.
235. Lines, known as Fishing Lines, and not including sporting tackle, ad val. ....	15 p. c.
236. Leather Board, Leatheroid, and manufactures thereof, N.E.S., ad val. ....	30 p. c.
237. Lime (oxide of calcium), per bus. ....	15
238. Lime-stone, per ton ....	50
239. Marble, Granite and Freestone, sawn only, N.E.S., ad val. ....	30 p. c.
240. Marble, Freestone and Granite, N.E.S., and all manufactures of marble, freestone or granite, N.E.S., ad val. ....	50 p. c.
241. Marline for making lobster pots, ad val. ....	10 p. c.
242. Mast Pieces and Spars dressed, or partly dressed, 60 ft. or over in length, N.E.S., ad val. ....	20 p. c.
243. Mast Pieces and Spars, dressed, or partly dressed, under 60 ft. or over in length, N.E.S., ad val. ....	30 p. c.
244. Mast Pieces, undressed, including Wharf, Shores, 60 ft. or over in length, N.E.S., per ton ....	1.20
245. Mast Pieces, undressed, including Wharf Shores, under 60 ft. in length, N.E.S., per ton ....	2.40
246. Mosaic Flooring of any material, ad val. ....	35 p. c.
247. Nets, Netting, Traps and Selnes, for use in sea and salmon fisheries, ad val. ....	20 p. c.
248. Oakum, per lb. ....	01
249. Paints and Colors dry Whiting and Chalk, ad val. ....	30 p. c.
250. Paints and colors, ground in oils, ad val. ....	30 p. c.
251. Paints and colors, liquid, prepared for use, ad val. ....	40 p. c.
252. Paris Green, dry, ad val. ....	20 p. c.
253. Pitch, viz. :—Resin or Rosin, ad val. ....	10 p. c.
254. Plaster of Paris or Gypsum, ground, manufactured or calcined, ad val. ....	20 p. c.
255. Roofing Slate, ad val. ....	35 p. c.
256. Saws, when used as a part of the original construction of mills and factories, and N.E.S., ad val. ....	10 p. c.
257. Scythe and other Sharpening Stones, ad val. ....	20 p. c.
258. Shoemakers' Ink, Harness and Leather Dressing, Harne.s Soap, ad val. ....	20 p. c.
259. Slate Mantels and other manufactures of Slate, N.E.S., ad val. ....	35 p. c.
260. Slate Pencils and school writing Slates, ad val. ....	20 p. c.
261. Staves of Oak, undressed, ad val. ....	5 p. c.
262. Staves of other woods, undressed, ad val. ....	25 p. c.
263. Staves, manufactured and dressed or partly manufactured and dressed, per 1000 ....	5.00

**The Most Modern Equipped Printing  
Establishment in Canada**



**MURRAY PRINTING CO.**

**GLOBE BUILDING**

**Telephone 1226**

**TORONTO**



**Estimates Cheerfully Furnished**

Newfoundland Tariff.

264. Steel, Mild, in Bolts, Bars, Sheets, Plates and Pieces, N.E.S., ad val .....	10 p. c.
265. Steel, known as "Blister Steel," Chrome Steel, and Hard or Cast, ad val .....	30 p. c.
266. Steel Shafting, turned compressed or polished, when measuring under 5 inches in diameter, N.E.S., ad val. ....	30 p. c.
When measuring over 5 inches in diameter, N.E.S., ad val. ....	10 p. c.
267. Stoppers for Bottles, when imported by Brewers, Distillers and Manufacturers of aerated waters, ad val. ....	10 p. c.
268. Tar, Stockholm, American and Coal Tar in barrels, ad val. ....	10 p. c.
269. Tar and Tar Mixtures, in cans, for roofing purposes, Asphalt and Asphaltum and like preparations, ad val. ....	30 p. c.
270. Tin, in sheets and blocks and solder, N.E.S., ad val. ....	10 p. c.
Stamped Tin, Paper, Locks, Hinges and Clamps, when imported by manufacturers of trunks for the manufacture of trunks, ad val. ....	20 p. c.
271. Turpentine, Spirits of, ad val. ....	10 p. c.
272. Tweeds, Cloths, Doe-skins, Felt Cloth and Fabrics, composed wholly or in part of wool, worsted, the hair of the Alpaca goat or other like animals, N.E.S., ad val. ....	30 p. c.
273. Twines, Hemp or Cotton, for fishery purposes and known as gencing, herring, caplin, mackerel, salmon twine, salmon trawl, seal twine and seal trawl, ad val. ....	10 p. c.
274. Twines, for sail making, viz.:—Hemp Roping and Seaming and Cotton Sail Twine, ad val. ...	30 p. c.
275. Twines, N.E.S., ad val. ....	30 p. c.
276. Varnishes, Lacquers, Japans, Japan Driers, Liquid Driers, Oil Finish, British Gum, Dextrine, Glue, Sizing Cream and Sizing of all kind, ad val. ....	30 p. c.
277. Women's and Children's Dress Goods, Coat Linings, Italian Cloths, Alpaca, Orleans, Cashmeres, Henrietts, Coburgs, Serges, Buntings, Nuns' Cloth, Bengalines, Whipcords, Winceys, Linseys, Twills, plain or jacquard of similar fabrics, composed wholly or in part of wool, worsted, the hair of the camel, Alpaca, goat or like animals, N.E.S., ad val. ...	30 p. c.
278. Wrought Iron or Steel Boiler Tubes, including Flues and Corrugated Tubes for marine boilers, ad val. ....	10 p. c.
279. Wrought Iron or Steel Tubing, plain or galvanized, threaded and coupled or not, ad val. ...	10 p. c.
280. Yarns, Woolen and Worsted, ad val. ....	20 p. c.
Machinery.	
281. Boilers for Locomotives, ad val. ....	30 p. c.
282. Dating, Ruling, Cutting, Paging or Perforating Machines, ad val. ....	30 p. c.
Ruling Machines, Book-Binders' Tools and Implements, Leather, Book-Binders' Cloth, Marble Paper and Paper Board, when imported direct by book-binders for use in the trade, and not for sale, ad val. ....	10 p. c.
283. Electric Light Material of every description, N.E.S., ad val. ....	30 p. c.
284. Elevators, ad val. ....	30 p. c.
285. Fanning Mills, ad val. ....	30 p. c.
286. Gas Engines, ad val. ....	20 p. c.
287. Horse-Power Machines and Portable Saw Mills, ad val. ....	30 p. c.
288. Locomotives and Tenders, ad val. ....	30 p. c.
289. Machinery, N.E.S., ad val. ....	30 p. c.
290. Machinery, patented and of a kind not manufactured in the Colony, N.E.S., including Typewriters, ad val. ....	20 p. c.
291. Machines for the manufacture of boots and shoes, when imported by manufacturers, ad val. ....	20 p. c.
292. Machines for Carding Wool, ad val. ....	10 p. c.
293. Mowing, Self-binders, Reapers, Sulky and Walking Plows, Harrows, Horse Rakes, Grain and Seed Drills, Stumping Machines, Thrashers and Separators, Hay and Feed Cutters, and Bone Crushers, ad val. ....	10 p. c.

The American Tariff.

294. Planing, Boring, Morticing, Moulding and other Machines for Builders' Purposes, N.E.S., ad val. ....	20 p. c.
295. Power Machines for the Manufacture of Steam and other Engines and Boilers, ad val. ....	20 p. c.
296. Railway Cars of all descriptions, ad val. ....	30 p. c.
297. Railway Fish Plates, Switches, Frogs, Crossings and intersections for Railways, ad val. ....	30 p. c.
298. Sewing and Knitting Machines, ad val. ....	20 p. c.
299. Steam Boilers and Engines, Propellers and Parts of Machinery for use in ships, N.E.S., ad val. ....	20 p. c.
300. Steam Boilers, when used for heating purposes, Radiators and Fan blowers, ad val. ....	30 p. c.
301. Steam Engines to be used in local industries, and Steam Boilers not to be used for heating purposes, N.E.S., ad val. ....	20 p. c.
302. Steel Propellers, N.E.S., ad val. ....	10 p. c.
303. Turning Lathes, Fret Saw Machines, Scroll Saw Machines, N.E.S., costing at place of Shipment over \$6, and to be driven by steam, water or electric power, ad val. ....	20 p. c.
When costing less than \$6, and to be driven by hand or foot power, N.E.S., ad val. ....	30 p. c.
304. Water Wheels, ad val. ....	10 p. c.
Oils.	
305. Coal Oil, Kerosene Oil, Naptha, N.E.S., Gasoline, Benzine and all Illuminating Oils, N.E.S., per gall. ....	96
306. Essential Oils, ad val. ....	20 p. c.
307. Linseed or Flaxseed Oil, raw or boiled, N.E.S., ad val. ....	10 p. c.
308. Lubricating Oil and Axle Grease, ad val. ....	20 p. c.
309. Neats' Foot Oil, Lard Oil, Sesame Oil, N.E.S., ad val. ....	20 p. c.
310. Olen Beef Oil, Neutral Lard Stock, Cotton Seed Oil, Sesame and other Oils to be used in manufacturing, N.E.S., and Butter Coloring, ad val. ....	15 p. c.
311. Olive Oil, N.E.S., ad val. ....	20 p. c.
312. Olive Oil or Salad Oil in bottles, ad val. ....	30 p. c.
313. Vaseline and all similar preparations of petroleum for toilet, medicinal or other purposes, ad val. ....	30 p. c.
Chemicals and Drugs.	
314. Acid, Muriatic and Nitric, and all mixed or other acids, N.E.S., ad val. ....	30 p. c.
315. All Medicinal, Chemical and Pharmaceutical preparations, when composed of one or more than one substance, N.E.S., ad val. ....	30 p. c.
Patent and Proprietary Preparations, Tinctures, Pills, Powders, Troches, Lozenges, Syrups, Cordials, Bitters, Anodynes, Tonics, Plasters, Liniments, Salves, Ointments, Pastes, Drops, Waters, Essences and Oils, N.E.S., all liquids not containing alcohol, ad val. ....	30 p. c.
316. All Medicinal Preparations containing alcohol, ad val. ....	50 p. c.
317. Antiseptic Surgical Dressing, such as Absorbent Cotton, Cotton Wool, Lint, Lamb's Wool, Tow, Jute, Gauze and Oakum, prepared for use as surgical dressing, plain or medicated surgical belts, pessaries and suspensory bandages of all kinds, ad val. ....	30 p. c.
318. Ceresene, Chloridi Nitro, Bensole and Nitro of Ammonia, ad val. ....	30 p. c.
319. Codliver Oil and Compounds of which Codliver Oil forms a prominent part, ad val. ....	30 p. c.
320. Liquorice Paste, Liquorice in Rolls and Sticks, ad val. ....	30 p. c.
321. Medicated Beef Fluids, such as Beef Iron and Wine, ad val. ....	30 p. c.
322. Paraffine Wax, Bees Wax and Burgundy Pitch, ad val. ....	30 p. c.
323. Sulphuric Ether, Chloroform and Solutions of Peroxides of Hydrogen, ad val. ....	30 p. c.
Sundries.	
324. Asbestos and all manufactures thereof, ad val. ...	30 p. c.
325. Coals, when imported or brought into the port of St. John's, Harbor Grace, or Carbonear, per ton .....	40
When brought into or imported into the port of Placentia, provided, that duties shall not be	



**ONLY  
\$1.00  
DOWN**

**WHEN  
YOU  
.. BUY ..**

Balance in Small  
Monthly Pay-  
ments at the easy  
rate of only 10c.  
. . . a day. . . .

*A WORK OF REFERENCE*

YOU WANT THE



**BEST**



That's THE NEW WERNER EDITION

OF THE

**ENCYCLOPÆDIA  
BRITANNICA**

BECAUSE

It's the most **Up-to-Date**, the most **Complete**, the **Largest**  
Reference Library on the market to-day. Compared  
with others it is also by far the **Cheapest**.

**31 Large Quarto Volumes.**

**A BOOKCASE FREE**

**FOR FULL PARTICULARS WRITE TO**

**THE NEWS, Educational Department,**

**TORONTO, ONT.**

Newfoundland Tariff.

	levied on any greater quantity than four hundred tons of coal imported annually into Placentia by any person or Corporation for the purpose of Railway operations, per ton .....	30
326.	Glucose, ad val. ....	30 p. c.
327.	Salt in Bulk, when imported for the use of the Sea Fisheries, per ton .....	20
Products of the Fishery.		
328.	Anchovies and Sardines, packed in oil or otherwise, ad val. ....	35 p. c.
329.	Codfish, Haddock and Ling, N.O.P., per qtl. ....	1.50
330.	Fish, preserved in oil, except Anchovies and Sardines, ad val. ....	35 p. c.
331.	Fish, smoked and boneless, N.O.P., ad val. ....	35 p. c.
332.	Herring, Salmon, Turbot, Halibut and Mackerel, N.O.P., per brl. ....	1.00
333.	Oysters or Clams, in the shell, ad val. ....	35 p. c.
334.	Oysters or Clams, shelled, in packages not hermetically sealed, ad val. ....	35 p. c.
335.	Oils, Spermaceti, Whale and other Fish Oils, and all other articles, the produce of the fisheries, not specially provided for, ad val. ....	35 p. c.
336.	Salmon, and all other Fish prepared or preserved, including Oysters and Clams, N.E.S., ad val. ....	35 p. c.
337.	All goods not enumerated in this Act as subject to any other rate of duty, nor declared free of duty by this Act, and not being goods, the importation whereof is by this Act or any other Act prohibited, shall be subject to a duty of, ad val. ....	35 p. c.

SCHEDULE B.

Table of Exemption.

- 338. Admiralty Charts.
- 339. Agricultural Implements and Machinery, imported by Agricultural Societies for the promotion of Agriculture, under the approval of the Governor in Council.
- 340. Animals, imported by Agricultural Societies, under the approval of the Governor in Council, for the improvement of stock and Sable Island ponies.
- 341. Apparel, wearing and other personal and household effects not merchandize, of British subjects dying abroad, but domiciled in Newfoundland; books, pictures, family plate or furniture, personal effects and heirlooms left by bequest.
- 342. Articles, for the use of the Governor.
- 343. Articles, when imported by and for the use of the Army and Navy; also articles consigned direct to officers and men on board vessels of Her Majesty's Navy, for their own personal use or consumption.
- 344. Articles, imported by or for the use of the Government or any of the Departments thereof.
- 345. Articles, imported for the use of the Municipal Council (excepting cast iron pipes).
- 346. Articles, for the official use of Consuls.
- 347. Articles, imported for religious purposes, and used in the worship of the denomination requiring the same.
- 348. Artificial limbs.
- 349. Bait.
- 350. Bags, barrels, boxes, casks, and other vessels exported filled with Newfoundland products, or exported empty and returned filled with foreign products, and articles the growth, produce and manufacture of Newfoundland, when returned after having been exported; provided that proof of the identity of such articles and goods shall be made, under regulations to be prescribed by the Governor in Council, and that such articles and goods are returned within one year from the time of exportation, without having been advanced in value or improved in condition by any process of manufacture or other means provided further that this item shall not apply to any article or goods upon which an allowance or drawback has been made, the re-importation of which is hereby prohibited except upon payment of duties equal to the drawback allowed; nor shall this item apply to any article of goods which has paid an excise duty.
- 351. Bark, Extract of Bark, Cutch and Logwood.
- 352. Boller and Ships' Plates.
- 353. Books and supplements for periodicals, specially imported for the bona-fide use of incorporated institutes, public libraries, libraries of colleges or schools, school books of all description, theological works, law books, medical works, books on the application of science to industries of all kinds, including books on agriculture, horticulture, forestry, fish and fishing, mining, metallurgy, architecture, electric and other engineering

Newfoundland Tariff.

- carpentry, ship-building, mechanism, dyeing, bleaching, tanning, weaving, and other mechanic arts; Bibles, prayer-books, psalm and hymn-books, religious tracts, supplements and Sunday School library books and lesson pictures; also specimens, models and wall diagrams illustrative of natural history and the sciences, imported for colleges, schools and public libraries.
- 354. Books printed by any Government, being official reports or printed by any Government or any association for the promotion of science or letters; official annual reports issued by religious, benevolent or other societies, and not for the purpose or sale or trade; newspapers, and quarterly, monthly and semi-monthly magazines, and weekly library papers, unbound; Christmas annuals, or publications commonly known as juvenile and toy books, tailors', milliners' and mantle makers' fashion plates.
- 355. Books written by authors, resident in Newfoundland and printed and bound outside of the Colony.
- 356. Chair cane, or reeds of withrod, when imported in an unmanufactured state.
- 357. Clothing and books, donations of, for charitable purposes, and photographs sent by friends and not intended for sale.
- 358. Coals, when not imported or brought into the ports of St. John's, Harbor Grace, Carbonear or Placentia.
- 359. Coin and Bullion.
- 360. Copper, bitumen, naphtha and iron oxide to be used by manufacturers in the manufacture of copper paint.
- 361. Corn for the manufacture of brooms and whisks.
- 362. Cotton yarn, raw cotton and coke.
- 363. Cotton seed oil, olive oil, boracic acid, acetic acid, preservative, when imported by manufacturers to be used in the preserving of fish or fish glue.
- 364. Cranes, derricks, fire-clay, fire-brick, rock drills, rolling mills, crushing mills, separators, drill-steel, machinery of every description for mining and smelting purposes, fuse and dynamite when imported directly by persons engaged in mining to be used in their mining operations and not for sale.
- 365. Fish of British catch and cure, and oil the produce of such fish (not to include preparations of codliver oil).
- 366. Globes, geographical, topographical and astronomical maps and charts, for the use of schools; pictorial illustrations of insects or similar studies, when imported for the use of colleges, schools, and library associations; manuscripts and insurance maps.
- 367. Hemp, Hemp Yarn, Coir Yarn, Sisal, Manilla, Flax and Tow.
- 368. Hides, or pieces of Hides, not tanned, curried or dressed.
- 369. Hoop Iron or Hoop Steel, splayed, punched or nosed and cut in lengths not to exceed sixty-eight inches, to be used in making Herring Barrels.
- 370. Indian Corn.
- 371. Junk, Old Iron, Old Copper and old Composition Metal.
- 372. Manures and Fertilizers of all kinds.
- 373. Material for sheathing the bottoms of Vessels, such as Zinc, Copper and Composition Metal, together with Nails and Paper or Felt, which may be used for or under such sheathing when used for sheathing Vessels, under regulations to be made by the Governor in Council.
- 374. Music, written.
- 375. Oil Cake, Oil Cake Meal, Cotton Seed Cake, Cotton Seed Meal, Pease Meal, Bran, Unbolted Indian Meal and other preparations for Cattle Feed.
- 376. Ores to be used as Flux.
- 377. Parchment or Wax Paper, when imported direct for wrapping Boneless Fish, or for lining tins used in the Lobster Packing Industry in this Colony.
- 378. Pig-Iron, Nail Strips of Iron, Steel, Zinc or Brass, to be used in the manufacture of Cut Nails in this Colony.
- 379. Plants, Trees and Shrubs.
- 380. Plates, engraved on Wood, Steel or other metal and transfers taken from the same, including engravers' plates of steel polished, engraved or for engraving thereupon.
- 381. Printing Paper, Printing Presses, Printing Types and Printers' Office Furniture, when imported by Printers' for use in their business.
- 382. Rice uncleaned or Refuse Rice.
- 383. Sand.
- 384. Sausage Skins or Casings.
- 385. Scrap Iron and Scrap Steel, old, and fit only to be re-manufactured, being part of or recovered from any vessel wrecked in waters subject to the jurisdiction of Newfoundland.
- 386. Steel Shafting, when imported for use in steam vessels not owned, in whole or in part by persons in this Colony, and here for repairs solely.

ASSESSMENT SYSTEM.



TEMPLE BUILDING,

RICHMOND AND BAY STREETS, TORONTO, CANADA.

Headquarters OF THE **Independent Order of Foresters**

"THE BEST FRATERNAL BENEFIT SOCIETY IN EXISTENCE."

For full information regarding this Great Fraternal Organization consult any Officer or Member, or write to

**ORONHYATEKHA, M.D.,**  
Supreme Chief Ranger.

**JOHN A. MCGILLIVRAY, Q.C.,**  
Supreme Secretary. **Toronto, Can.**



AMERICAN OFFICE—  
6436 Kimbark Avenue, Chicago.  
EUROPEAN OFFICE—  
24 Charing Cross, London, England.  
INDIA OFFICE—6 Park Street, Calcutta.  
AUSTRALASIAN OFFICE—  
71 Temple Court, Melbourne.

When writing to Advertisers kindly mention THE CANADIAN MANUFACTURER.

Newfoundland Tariff.

387. Sulphuric Acid, when imported to be used in the manufacture of Manures.

388 Seed for Agricultural Purposes including Florists Seeds.

389 Settlers' effects, viz -Wearing Apparel, Household Furniture Books, Implements and Tools of trade, Occupation or Employment, Guns, Musical Instruments, Domestic Sewing Machines Typewriters Live Stock, Bicycles, Carts and other Vehicles and Agricultural Implements in use by the Settler for at least six months before removal to his colony, not to include machinery, or articles imported for use in any manufacturing establishment, or for sale. Provided that any dutiable article entered as Settlers' Effects may not be so entered unless brought with the Settler on his first arrival, and shall not be sold or otherwise disposed of without payment of duty, until after twelve months' actual use in this Colony.

390. Scientific Instruments and Apparatus, when imported for use in collegez, schools, and scientific or library societies.

391. Stereotypes, Electrotypes and Celluloids for Almanacs, Calendars, Illustrated Pamphlets, Newspaper Advertisements or Engravings and all other like work for Commercial Trade or other purposes, and Matrices or Copper Shells for the same.

392. Surgical and Dental Instruments (not being furniture) and Surgical Needles.

393. Specimens, illustrative of natural history.

394. Travellers' Baggage, under regulations prescribed by the Governor in Council.

395. Unmanufactured Wool.

396. Wire, of brass, zinc, iron or steel, screwed or twisted or flattened or corrugated, when imported by manufacturers of boots and shoes, for use in connection with nailing machines for the manufacture of boots and shoes, to be used for such purposes only in their own factories.

397. Wheat.

398. Works of Art, viz. :-Paintings in oil or water colors, by artists of well-known merit, or copies of the old masters by such artists; and paintings in oil and water colors, the production of Newfoundland artists, under regulations prescribed by the Governor in Council.

Newfoundland Tariff.

SCHEDULE C.

Prohibited Goods.

399. Books, Printed Paper, Drawings, Paintings, Prints, Photographs or Representations of any kind of a treasonable or seditious or of an immoral or indecent character.

400. Coin, base or counterfeit.

401. Goods, manufactured or produced wholly or in part by prison labor, or which have been made within or in connection with any prison, gaol or penitentiary, shall not be imported into this Colony under a penalty of two hundred dollars, and, if imported, such goods and the packages in which they are contained shall be forfeited.

402. Reprints of Newfoundland copyright works, and reprints of British copyright works, which have been copyrighted in Newfoundland also.

403. Tea, adulterated with spurious leaf or with exhausted leaves, or containing so great an admixture of chemical or other deleterious substance as to make it unfit for use.

SCHEDULE D.

Local Distillation.

The following duties shall be raised, levied and collected on the following articles distilled or brewed in this Colony, viz. :-

404. Brandy, not exceeding the strength of proof by Sykes' hydrometer, and so in proportion for any greater strength than the strength of proof, the gall. ....	2. 35
405. Whiskey, not exceeding the strength of proof by Sykes' hydrometer, and so in proportion for any greater strength than the strength of proof, the gall. ....	1.85
406. Gin, not exceeding the strength of proof by Sykes' hydrometer, and so in proportion for any greater strength than the strength of proof, the gall. ....	1.75
407. Rum, not exceeding the strength of proof by Sykes' hydrometer, and so in proportion for any greater strength than the strength of proof, the gall. ....	1.50
408. Ale, Porter, Bavarian Beer, Botanic Beer, and all other small and dextrinous liquors, the gall. ....	05

**BEST QUALITY**

**COAL AND WOOD**

**AT LOWEST PRICES**

**OFFICES:**

- 20 King St. West
- 413 Yonge St.
- 793 Yonge St.
- 306 Queen St. East
- 578 Queen St. West
- 1352 Queen St. West
- 202 Wellesley St.
- 413 Spadina Avenue



**OFFICES:**

- Esplanade St. East, near Berkeley St.
- Esplanade St. East, foot of Church St.
- Bathurst St., Opp. Front St.
- 369 Pape Ave., at G.T.R. Crossing
- 1131 Yonge St., at C.P.R. Crossing

**THE ELIAS ROGERS CO., Limited**

**Horse Owners! Use**

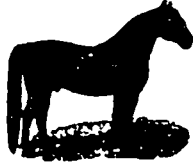

GOMBAULT'S

**Caustic Balsam**

A Safe Speedy and Positive Cure

The Safest, Best BLISTER ever used. Takes the place of all liniments for mild or severe action. Removes Bunches or Blemishes from Horses and Cattle. **SUPERSEDES ALL CAUTERY OR FIRING.** Impossible to produce scar or blemish. Every bottle sold is warranted to give satisfaction. Price \$1.50 per bottle. Sold by druggists, or sent by express, charges paid, with full directions for its use. Send for descriptive circular. **THE LAWRENCE-WILLIAMS CO., Cleveland O.**

Supersedes all Caution or Firing, and Cures

**Founder, Wind Puffs, Thrush, Diphtheria, Skin Diseases, Removes Bunches**

-OR-

**Blemishes, Splints, Capped Hock, Strained Tendons, Ring Bone, Pink Eye, Sweeney, Boney Tumors, All Lameness from Spavin, Quarter Cracks, Scratches, Poll Evil, Spavin, Parasites.**

**THE MOST POPULAR VETERINARY REMEDY...**

Always Reliable.

Sure in Results.

Safe for Anyone to Use.

**Gombault's Caustic Balsam.**

**A SAFE, SPEEDY and POSITIVE CURE.**

We guarantee that **ONE TABLESPOONFUL OF CAUSTIC BALSAM** will produce more actual results than a whole bottle of any liniment or spavin mixture ever made. Every bottle is warranted to give satisfaction. Write for testimonials, showing what the most prominent horsemen say of it.

Price \$1.50

per Bottle.

Sold by Druggists, or sent Express paid on receipt of price.

**HORSEMEN! THE ONLY GENUINE IS**

**GOMBAULT'S CAUSTIC BALSAM.**

*Not genuine without the signature of*  
*The Lawrence-Williams Co.*  
*Sole Agents & Proprietors for the*  
**U.S. & CANADAS. CLEVELAND, O.**

The Safest, Best BLISTER ever used. Takes the place of all liniments for mild or severe action. Removes all Bunches or Blemishes from Horses and Cattle. **SUPERSEDES ALL CAUTERY OR FIRING.** Impossible to produce scar or blemish. Every bottle is warranted to give satisfaction. Price \$1.50 per bottle. Sold by Druggists, or sent by Express, charges paid, with full directions for its use. Send for free descriptive circular. **THE LAWRENCE-WILLIAMS CO., Toronto, Ont.**

<p><b>CURED THOROUGHPIN.</b> DETROIT, Mich. I have used your Caustic BALSAM for thoroughpin and find it the best remedy. A doctor told me that it could not be cured, but I have given five applications and I find that it has entirely disappeared and the lameness all gone. <b>GEO. W. PASSEE.</b></p>	<p><b>THE GREATEST REMEDY HE EVER USED.</b> TOWNSEND, Mass. The Lawrence-Williams Co., Cleveland, O.: Please send me one-half dozen bottles "Gombault's Caustic Balsam," and send at once. It is the greatest remedy that ever I used on a horse in my life. <b>J. D. FARRAR.</b></p>
<p><b>USED SUCCESSFULLY.</b> WEST POINT, Tenn. The Lawrence-Williams Co., Cleveland, O.: I bought a bottle of "Gombault's Caustic Balsam" two years ago, for a spavined horse. I cured him without any trouble. Have since cured a horse of poll evil. <b>E. W. GRAVES.</b></p>	<p><b>USES CAUSTIC BALSAM TO BLISTER.</b> LYNN, Mass. The Lawrence-Williams Co., Cleveland, O.: I have used your "Gombault's Caustic Balsam" for the past four years, and it is one of the best liniments for blister that I ever used. <b>DR. McJUE, V.S.</b></p>

**The Lawrence-Williams Co., CLEVELAND, Ohio. TORONTO, Can.**

*Sole Agents for the United States and Canada.*

When writing to Advertisers kindly mention THE CANADIAN MANUFACTURER.

# Index to Newfoundland Tariff.

A	No. of Item.
Absorbent	35
Absorbent Cotton	317
Account books	181
Acids	314
boracic, N.E.S.	363
sulphuric, for manufacture of manure	387
Acetic acid, N.E.S.	314
for fish glue	363
Admiralty charts	328
Adulterated tea	405
Advertising matter	181
Adzes	111
Agate ware	181
Agricultural seeds	388
implements	141
imported by agricultural societies	339
Air guns	141
Air rifles	141
Alabaster ornaments	75
Alcohol, of all kinds	95
Alcoholic preparations of medicines	316
Alc. bottles	65
casks	61
local brew	498
Alcoholics, advertising	181
Almond nuts	86
Alpaca	277
Aluminium, leaf	77
manufactures	144
holloware	181
Amber ornaments	75
American tar	268
Alumina, ultra of	78
Amunition, N.E.S.	141
Anchors	181
Anchovies	228
Anglers' requisite	141
trawls	141
trawling spoons	141
Angostura	95
Animals, living	1
draft	33
imported by agricultural societies	340
Animals, Christmas	354
Anedynes, alcoholic	95
non-alcoholic	315
Antiseptic surgical dressing	317
Anvils	144
Apparatus, electric	111
Apparel, of British subject dying abroad	341
Apples	2
dried	2
Apricots	76
Arms, fire	144
Army and navy, articles for use of	343
Aromatic spirits of ammonia	95
Arnica or palm spirits	95
Articles, for use of the Governor	342
Government	344
municipal council	345
for army and navy	343
for official use of Consuls	346
for religious purposes	347
prohibited	349
Artificial flowers	96
limbs	348
Artists' brushes	181
colors	181
drawing requisites	181
paints	181
Artotypes	181
Arts, works of	348
Azbestos	324
manufactures of	321
Ash	122
Asphalt	289
Asphaltum	289
Axlings	173
Axe poles or handles	144
Axes	144
Axle boxes	122
grease	308
Axles	122
<b>B</b>	
Rabbit metal	144
Bacon, smoke cured	4
when dry salted or pickled	5
Badges	136
Bagatelle-boards	67
tables	67
Baggage, travellers'	344
Bag, paper	181
game	144
seamless	107

	No. of Item.
Bag of jute, hemp, linen or cotton	107
carpet	185
tool	185
etc., exported and returned	350
Bait	319
Baked beans, canned	45
Baking powder	165
Balances	141
Balls, billiard	67
glass	110
Bananas	76
Bank notes	181
Bankets sheats	141
Bank	254
extract of	351
Barley	47
Barrels, herring	141
exported and returned	349
Bars, of lead	141
Base coin	100
Baskets, tool	181
of all kinds	185
Bass wood	122
Barbs, stone, earthenware, cement or clay, n.e.s.	14
Batteries, electric	144
galvanic	141
Battling	292
Batts, cotton	262
Byzantine beer, local brew	498
Bay rum	35
Bayonets	141
Bead ornaments	75
Beans, weighing	144
Beans	7
Bed comforters	110
Bed, when salted in barrels	7
oil	310
iron and wine	321
Beer, in bottles	65
in casks	61
Bees wax	322
Beds	65
Bells, of brass	144
Belting	191
Belts	136
cartridge	141
Bench machines for turnstills	144
Bengalines	277
Ben-zoline	318
Benzine	305
Bestonets	311
Bicarbonate soda	179
Bicycles and parts thereof, N.E.S.	100
parts, when imported by manufacturers or repairers of bicycles	101
Billiard tables	67
Bills, of brass	144
advertising	181
of exchange	181
heads	181
Blind eyes	144
Biscuits, known as ships' biscuits	8
Biscuits, viz.: soda, water, butter, pilot, and any biscuit of that description, not sweetened	9
Biscuits and bread, N.E.S.	10
Bitters, medicinal	315
Blotmen, for copper paint	320
Black holloware	181
Blackberries	76
Blacking, shoe	177
Blank forms	181
Blankets	110
Blasting powder	214
Blind, rollers	117
Blinds	117
Blocks, sheaves	195
tin	289
Blocks	195
Blouses	170
Blown glass tableware	140
Blue prints	181
Bluing, laundry	155
Boats, ships'	119
pleasure	119
sail	119
sails	173
Bodies-carriage, waggon, hearse, buggy and express	122
Boller rivets	144
tubes	278
plates	352
Bollers	144
for locomotives	281
for ships	289
for local industries	301

	No. of Item.
Bollers for heating purposes	309
Bolsters	143
Bolts, carriage	122
iron	141
steel	141
nuts	144
Bombs	181
Bone crushers	293
Boneless fish	332
Bonnets	147
shapes	147
Books, N.E.S.	181
printed	181
to be written on	181
blank account	181
copy, N.E.S.	181
packet	185
By	185
school	353
C. w. (theological, medical, scientific, etc.)	353
Books, Bible, prayer, psalm and hymn	353
Sunday School	353
for incorporating Institutes, colleges, schools, public libraries	353
printed by any government or association for the promotion of learning, etc.	354
toy	354
by authors in Newfoundland	355
donations of	357
prohibited	359
Bookbinders' tools and implements	282
Book faces	111
grain leather	233
making machines	294
Boots, India rubber	150
leather	156
Borneo held, N.E.S.	363
Borings, paper	166
Boring machines	294
Botanic beer, local brew	498
Bottles, glass	140
Bows, for hoods	152
Box toe tips	215
Boxes, toilet, glove, handkerchief, collar	75
hat	185
exported and returned	350
Bracelets, N.E.S.	136
Braces	112
Brads, shoe	162
Brands	136
Bran	375
Brandy	95
artificial	95
local distillation	404
Brass pumps	144
wire	144
manufactures of	144
washers	144
Bells	144
zongs	144
screws	144
nails, tacks, rivets, burrs and washers	144
Brass for nails	378
Brass nuts	86
Brick, stock or common	113
facings	113
fire	134
knife	153
Brim, for bread bags	196
Britannia metal	144
British gum	276
Brocade powders	77
Bronze, powder	77
phosphor	144
Brooms, of corn	114
handles	197
Brown sugar	43
Brushes	115
artists'	181
Buckles	144
ornamental	81
Buckwheat, meal or flour	11
Buff leather	283
Buggies	122
Builders' hardware	144
Building plans	181
stone, dressed	217
undressed	220
Bulbs, glass, for electric light	144
Bullets, lead	144
Bullion	359
Bulls	57
Buntings	277



Index to Newfoundland Tariff.

	No. of Item.
Burgundy	104
pitch	322
Burners-gas, etc.	144
Burrs, copper	144
brass	144
Bushings, for blocks	172
Butchers' steels	144
knives	144
Butter	12
coloring	310
Butterline	31
Buttons	116
<b>C</b>	
Cabbages	48
Cabinet wares, viz. house, etc.	117
makers' hardware	144
Cabinets or cases	144
Cages, bird, parrot, rat and squirrel	144
Cake, not cut by machinery	68
Calendars, advertising	181
Calves, alive	1
Canned peel	76
fruit	76
Caniles, N.E.S.	120
wax and paraffine	121
Candy, sugar	73
Canes, walking	191
for chairs	353
Canned meats, etc.	13
poultry and game	13
Canister powder	214
Canions	144
Canon powder	214
Canoes	119
Cans, imported in a manufactured state	
for putting up hermetically sealed	
goods, including packages, etc.	118
Cant dogs	144
Canvas	198
Carp shapes	147
Capes, fur	148
Caplin twine	273
Caps, gun	144
N.E.S.	147
fur	148
Carbons, electric light	144
points, N.E.S.	144
Carboys, glass	140
Cards, wool	144
commercial	181
playing	181
Carpet linings	123
Turkish	123
imitation Turkish	123
N.E.S.	123
sweepers	148
bags	123
Carpetings	123
Carriage paints	123
mats	123
Carriages, etc.	123
Carrots	206
Cars, railway	144
Cartridge cases	144
belts	144
Cartridges	144
Carts	122
Carvers	144
Cases or cabinets	144
gun and pistol	
watch, jewellery, silverware, plated	
ware, cutlery, glove, handker-	
chief, collar, fancy for jewellery,	
brush, toilet	75
show	191
Cash registers	124
Cashmeres	277
Casings, sausage	284
Caskets	191
Casks, empty, second-hand, 45 gallons	
and under	125
empty, second-hand, over 45 gallons	
staves, second-hand, to make casks	
of 45 gallons and up	127
staves, second-hand, to make casks	
under 45 gallons	127
in which dry goods are imported,	
capable of containing liquids..	
exported and returned	128
Cast iron pipes	191
Castor sugar	43
Cat-gut and other strings	167
Catalogues	181
Catsups	88
Cattle feed	375
Celluloids	141
Cement	200
Cerese	318
Chains, hair	136
wool	136
iron	183
shackles	183
Chair cane	356
Chalk	249
Chamels skin	273
Champagne	104
Chandlers	144
Charts	181
admiralty	358
Cheese	14
Chemicals, for matches	201

	No. of Item.
Cheques	181
Cherries	76
Chickory, raw or green	15
kidney dried	16
Chimney linings	134
vents	131
tops	131
glass	119
China ware	129
Chloro di utero	318
Chloroform	323
Chocolate, etc.	17
Christmas annuals	354
Chronos, advertising	181
N.O.P.	181
Chromotypes, advertising	181
N.O.P.	181
Churns, earthenware	135
wood	191
Cider	185
Cigarette cases	97
holders	97
Cigarettes	97
Cigar cases	97
holders	97
knives	111
Cigars	79
Circles	122
Circulars, advertising	181
Citric acid	311
Citron	76
Clams, in shell	333
shelled	334
in tin	336
Claret	101
Cleavers	144
Clippers, horse and toilet	141
Clips	122
Clonks, fur	148
Clocks	72
movements	72
Clothes wringers	144
oiled	164
Clothing, dyed	127
Indian rubber	151
ready-made	170
linen, silk and cotton	170
donations of	357
Cloths	272
hair	142
oiled	165
table	123
tray	123
carriage	122
felt	272
Italian	271
ruas	277
Coal oil fixtures	144
tar	283
oil	305
N.E.S.	325
for other ports than St. John's,	
Harbour Grace, Carbonear and	
Placentia	258
Coat linings	277
Coburgs	277
Cocoa, shells and nibs	17
mats	123
matting	123
Cocoanuts, N.E.S.	86
desiccated, sweetened or not	
imported from the place of growth	
by vessel direct to a Newfound-	
land port	86
Cod liver oil	319
Codfish, N.O.P.	329
Coffee, green	18
roasted or ground	19
preparations, etc.	20
extracts	20
Coffins	191
Coll chain	183
links	193
Coln	359
base or counterfeet	399
Colt yarn	397
Coke	392
Collars	170
for fixtures	144
Cologne water	95
Coloring, butter	310
Colors, dry	249
ground in oil	250
liquid, prepared for use	251
Combs	180
Composition metal, for the manufac-	
ture of jewellery	131
Composition metal	206
nails	206
metal, old	371
Condensed milk	21
Confectioners' ornaments	73
Confectionery	73
Consule, articles for official use of	346
Cooks' knives	144
Coopers' rivets	144
wooden hoops	191
heading	221
Copper	200
manufactures of, N.E.S.	144
nails, tacks, rivets, burrs, washers	
and wire	144

	No. of Item.
Copper screws	144
sheets	203
bars	203
bolls	203
nails	203
paint	207
for copper paint	300
old	371
and composition metal, for sheath-	
ing vessels	373
Copy books, N.E.S.	181
Copyright works, reprints	492
Cottage	208
Cordials	95
medicinal	315
Cords	139
hair	139
wool	139
Cork matting	139
carpet	139
wool	200
manufactures of	191
Corks	200
Corn flour, etc.	40
preserved	45
Indian	370
for brooms and whisks	370
Cornice poles	191
Cornices, window	191
Corrugated tubes, for boilers	278
Corsets	170
Cottolene	54
Cotton clothing	170
sewing thread	171
knitting	174
thread	174
embroideries	174
canvas	198
Cotton batts	202
warps	202
yarns	202
fabrics, N.E.S.	201
printed or dyed	201
duck, colored	205
salt twine	274
seed oil	310
for fish glue	353
cake	375
meal	375
yarn	382
raw	382
waste	382
Counterfeit coin	400
Counterpanes, N.E.S.	110
Cows	57
Cranes, for mining	384
Crapes, black	122
Cream colored ware	171
Crimp forms	215
Crochet cotton	125
Crocks	257
Crossings, railway	111
Crowbars	282
Crushers, bone	384
Crushing mills, for mining	43
Crystallized sugar	43
Cube sugar	62
Cucumbers	67
Cue racks	67
tips	67
Cues	67
Cuffs	170
Curling stones	210
Currants	76
Curry combs	139
cards	136
Curtains	136
Cut glass tableware	140
Cutch	351
Cutlery, plated	141
cutters, hay and feed	231
Cutting machines	232
Cyclometers	24
<b>D</b>	
Dairy salt	41
Damask, of linen, etc.	123
Dansons	76
Dates	76
Dating machines	140
Decanters	123
Decorated ware	125
Demijohns	140
glass	104
Donia wine	391
Dental instruments	394
Derricks, for mining	75
Desks, writing, fancy	75
Desiccated fruits	75
cocoanut, sweetened or not	86
Dextrine	276
Diaper	133
Diving apparatus	211
Doeskins	272
Dolls	75
Donations of clothing	357
Door mats, N.E.S.	191
doors, for safes or vaults	144
Dories	212
Dory bars	212
Doyles	133
Drafts	131



**ONTARIO GOLD MINING DISTRICT :**

- Sultana Mine.
- Foley Mine.
- Mikado Mine.
- Olive Gold Mine.
- Cameron Island Mine.
- Hammond Reef Mine.

**A Few Mines**



WHO USE

**BRITISH COLUMBIA :**

- Le Roi Mine.
- War Eagle Mine.
- Old Ironsides Mine.
- Centre Star Mine.
- Crown Point Mine.
- Knob Hill Mine.

**CANADIAN RAND DRILL COMPANY, Montreal**

*Awarded Gold Medal at Chicago World's Fair*

**Wilson's Improved SCALES**

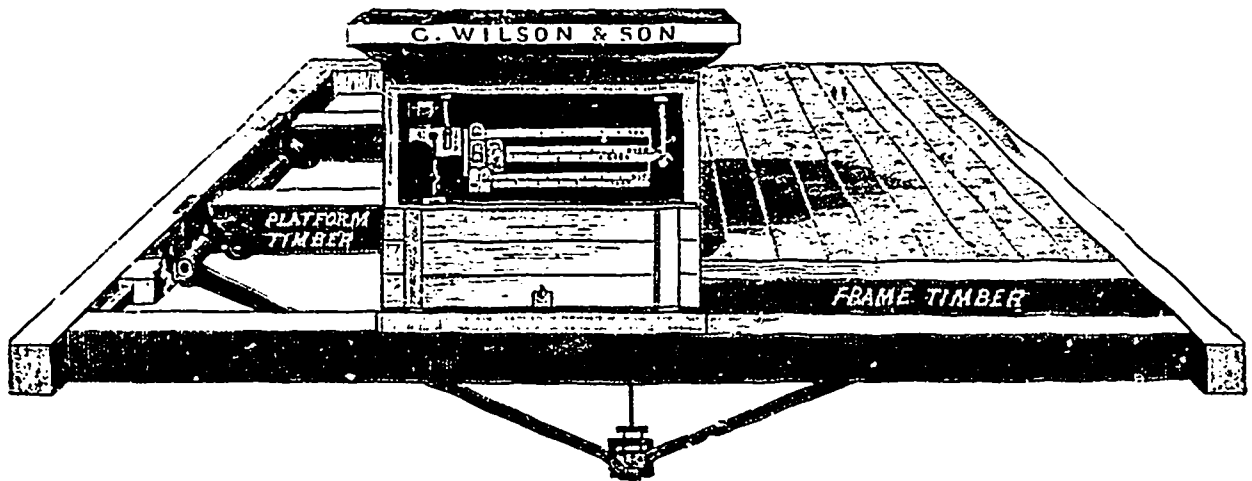

**Used by the Principal Corporations and Coal Dealers.  
No Loose Weights Required.**

Liberal Allowance for Old Scales.

Write for Prices.

**C. WILSON & SON, 94 Esplanade St. E., TORONTO, ONT.**

**G. H. Adams & Co.**

**MANUFACTURERS' AGENTS and COMMISSION MERCHANTS**

Flinders Lane, MELBOURNE,  
Clarence Street, SYDNEY,  
and at FREMANTLE, ADELAIDE,  
BRISBANE and N.Z.

Will be pleased to correspond with Canadian Manufacturers and Exporters desirous of opening up direct relations with Australia.

**McLachlan Electric & Gasoline Motor Co., LIMITED, 94 ADELAIDE ST. WEST. TORONTO**

**MAKE** Gas or Gasoline Engines from 1 h.p. to 6 h.p.  
Stationary or Marine and Electric Motors from 1/2 h.p. up.  
Motor Carriages for Pleasure or Business. One cent spent for a postal will bring you any information you wish.

**THE SMART-EBY MACHINE CO., LIMITED**

**Steam and Gas Engines, Pumping Machinery, General Machinery.**

**193 BARTON STREET EAST HAMILTON, ONT.**

CITY AGENTS WANTED.

**WRITE US BEFORE PLACING YOUR ORDER.**



ESTABLISHED 1852

CABLE ADDRESS: A. R. O., TORONTO

# A. R. CLARKE & CO., Limited.

MANUFACTURERS OF

**GLAZED, BOXED and DULL CHROMO TAN CALF and KID,**  
**Black and Colors, for Boot and Shoe Manufacturers.**

**BRANCHES:**

22 Lemoine St., Montreal,  
 G. S. HUBBELL, Agent.  
 493 St. Valier St., Quebec,  
 GALE BROS., Agents.

**GLOVES, MITTS AND  
 MOCCASINS.**

Office and Works: **TORONTO**

**A. S. PARKER, NEW TORONTO**

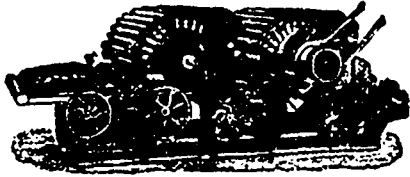

Dealer in Woolen Waste. Carpeting a Specialty

Hardware Manufacturers  
 and Capitalists

**ATTENTION!**

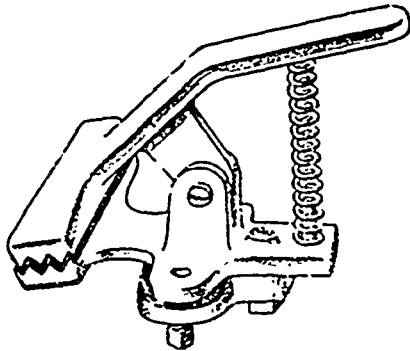

The Canadian patent, No. 62,117. Bed Clothes  
 Clamp, for sale, or will place on Royalty.

**I MEAN BUSINESS**

Awarded first prize at National Export Ex-  
 position, Philadelphia, 1892.

For full particulars address at once

**L. M. Lownes,**  
 Norristown, Penn.

**SPECIAL MACHINE**

For Packing Soda, Baking Powder,  
 Coffee, Chicory and all Powdered

or Granulated  
 Materials,

In Packages of from  
 half ounce to six lbs.

For Flour and Other

Cereals,

Six to fourteen lbs.

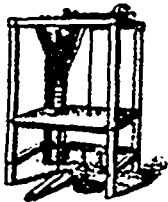

Ask us about this Machine.

**T. H. & A. H. DRYDEN**  
 TORONTO

**W. R. PERRIN & CO.**

122 Church St., Toronto.

MANUFACTURERS

**Hydraulic Presses,  
 Screw Presses,  
 Filter Presses.**

SEND FOR CATALOGUE.

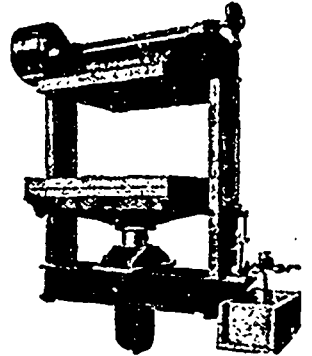

CHARLES F. CLARK, President. JARED CHITKENDEN, Treasurer.

Established 1849.

**BRADSTREET'S**

Capital and Surplus, \$1,500,000

Offices Throughout the Civilized World.

EXECUTIVE OFFICES,

346 & 348 Broadway, New York City, U.S.A.

Correspondence Invited.

Toronto Office, - Cor. Jordan and Melinda Sts.

Hamilton " - 39 James Street South.

London " - 365 Richmond Street.

Winnipeg Office, - 398 Main Street.

Vancouver " - Cor. Hastings and Hamilton Sts.

Victoria " - Board of Trade Building.

THOMAS C. IRVING, Gen'l Manager Western Canada,  
 TORONTO.

**SAVE THE DROPS**

THE U. S. NAVY YARD

At San Francisco has just installed  
 six of our

**CROSS OIL FILTERS.**

Uncle Sam's oil bill should be cut  
 down considerably. Cross Filters  
 save 5%.

Can we send you one on approval?

**THE BURT MFG. CO.,**  
 Akron, Ohio, U.S.A.

Largest Mfr. of OIL FILTERS in  
 the world. Catalogue 25.



FREE—The services of our trained staff  
 are free to our customers. We prepare  
 plans and advertising copy without  
 charge. Correspondence with intending  
 advertisers solicited. The E. DESBARATS  
 ADVERTISING AGENCY, MONTREAL.

**OPEN FOR AN**

**ENGAGEMENT.**

AN Englishman—at present in  
 charge of the interests of a  
 large British House in Canada,  
 desiring to return to England, is  
 open to associate himself with a  
 reliable Canadian firm, seeking  
 representation in Great Britain  
 Party is thoroughly trustworthy,  
 intelligent and conversant with  
 British trade, Address,

**EXPORT,**

CARE OF

The Canadian Manufacturer, Toronto.

**WOOL WM. GRAHAM,**  
 54 and 56  
 Wellington St. E., TORONTO

DEALER IN  
**FOREIGN and DOMESTIC WOOLS**

My manufacturing experience assists me in im-  
 porting wool for any desired goods.

**GALVANIZING**

We are prepared to attend to all  
 orders Promptly and  
 Economically.

**WINDMILLS, PUMPS, TANKS, Etc.**  
**ONTARIO WIND ENGINE and PUMP CO.**  
 LIMITED,

95 ATLANTIC AVE., TORONTO.

Index to Newfoundland Tariff.

	No. of Item.
Horseshoe hollow ware	184
effects of British subject dying abroad	341
Hubs	122
limb's knives	141
hydraulic water line	280
Hymn books	333
<b>I</b>	
icing sugar	43
illuminating oils, N.E.S.	305
illustration, pictorial, etc.	306
imitation goat leather	283
implements, agricultural imported by agricultural societies	144
Indian meal, bolted	24
corn	370
meal, unbolted	375
India rubber boots	150
shoes	150
manufactures	169
clothing	151
mats	151
inks, writing	181
shoemakers	258
instruments, philosophical, photographic, mathematical and optical	84
instruments, telephone, etc.	144
scientific	390
surgical	391
dental	391
insulators	144
insurance maps	366
inter-sections, railway	207
inverted blocks, glazed and unglazed	131
iron bars	226
bolt	226
bolts	144
bridges	228
columns	228
fencing	144
fittings	229
forgings	219
girders	219
hoop, splayed, etc.	363
hoops	228
kettles	144
N.E.S.	228
nuts	144
old	371
oxide for copper palats	226
pieces	226
plg	378
pipe	226
plates	226
rails	227
sad	144
scrap, old	28
screws	144
shapes or sections	228
sheets	228
shovels	144
spades	144
stoneware	123
strips for nails	378
tubes	278
tubing	279
washers	144
Italian cloths	277
Ivory, black	211
<b>J</b>	
Japan driers	276
Japaned (tinware)	184
leather	223
Japans	276
Jars	153
glass	140
Jellies and jams	27
Jewellery, etc.	81
Jewels of regalia	130
Jowls, pigs	25
Juices, fruit	82
Junk	371
Jute, manufactures of, N.E.S.	106
mats	123
matting	123
<b>K</b>	
Kerosene oil	305
Kerseys	218
Kettles, iron	144
Keys, watch and clock	72
Kitchen hollow ware	184
Knife brick	133
polish	153
Knitting cotton	174
machines	208
Knives	144
ing, straw, hedging	144
and forks of steel	144
<b>L</b>	
Labels	181
Lace collars	136
nets	136
netting	136
goods	136
Laces	136
boot, shoe and stay	111
Lacquers	276

	No. of Item.
Lamp shears	114
slings	114
wicks	154
Lamp black	241
Lamps, carriage	122
glass	110
N.E.S.	114
Lanterns	144
Lap dusters	175
Lard	51
compound	51
neutral, for bread manufacturers	55
oil	303
for bread manufacturers	55
neutral	310
Lashes, whip	189
Baths	219
baths, turning	303
laths	116
Laundry blueing	155
Lava tips	114
Lavender water	95
Law books	353
Lawn tennis nets	80
mowers	144
sprinklers	144
Lead pipe	114
sheets	144
shot	114
bullets	114
manufactures of	144
in bars	114
pencils	184
Leather belting	194
board	226
boot grain	223
buff	223
dressing	228
embossed	223
glove grain	223
harness	223
imitation goat	223
japaned	223
morocco	223
oil grain	223
patent	223
pebble	223
polished	223
tough, undressed	224
sole	222
split	223
upper, N.E.S.	223
waxed calf	224
Leatheroid	226
boots and shoes	156
Leathers, carriage	122
Leatherware	156
Leggings, leather	156
Lemons	76
Lesson, pictures	350
Letters, for sign	144
Lights, slide	141
board	141
Lime	227
Limes	76
Limestone	228
Linen, damask	133
stair	133
clothing	170
Lines, fishing	225
linings, carpet	121
stove and chimney	174
coat	371
Links, carriage	122
Linoleum	139
Linsed oil	207
Linsys	277
Limbs, artificial	348
Lime juices and fruit juices, fortified with spirits	82
Juice and other fruit syrups and other fruit juices, N.E.S.	82
Liniments	315
Ling, N.O.P.	329
Liquid gums	181
driers	276
Liquorice paste	320
rolls and sticks	320
Liquors	95
Lisbon, red, etc., wine	104
Loading tools	144
Loaf sugar	43
cut sugar	43
Lobsters in tins	336
Local distillation	404
brew	408
Locomotives and tenders	288
Logs, undressed	183
Logwood	351
Looking glasses	140
Lotions, alcoholic	37
Lozenges	315
Lubricating oil	157
Lumber	158
planed, etc.	159
oak, etc.	159
<b>M</b>	
Mace	94
Machin screws	144
Machinery, N.E.S.	289
patented	290

	No. of Item.
parts of for ships	299
for milling	304
Machines, dating, cutting, ruling, punching, perforating	282
horse power	287
Machines when imported by manufacturers of boots and shoes	291
for carding wool	292
mowing	293
self blading	293
reaping	293
raking	293
stamping	293
threshing	293
planing	294
boiling	294
mortling	294
moulding	294
other, for builders	294
power	295
sewing	298
knitting	298
ret saw	303
scroll saw	303
bench for thinning	144
strength testing	144
Mackerel	302
twine	273
Madeira wine	104
Magazines, unbound	351
Mag lanterns	84
lantern slides	84
Mahaga wine	104
Malleable cast iron and other malleable parts	122
Malt	75
Mangles	70
Manganese files	144
Manilla	307
Mantlemakers' fashion plates	354
Manufacture of trunks, articles for	270
aluminium, N.E.S.	144
Manufactures of wood	191
wood, N.E.S.	191
clay and cement	191
corkwood	191
zinc	192
asbestos	324
brass and copper	144
lead	144
Manures	372
Manuscripts and insurance maps	366
Manzanilla wine	104
Maple sugar	28
syrup	28
Maps, N.E.S.	181
and charts, for use of schools	366
Marble, undressed	220
sawn only	220
dressed	220
manufactures of	240
Maros	53
Marline	241
Masks, fencing	144
Mast pieces	183
60 feet or over in length, dressed	212
under 60 feet in length, dressed	211
60 feet or over in length, undressed	211
pieces, under 60 feet in length, undressed	215
hoops	191
Matches	160
Material for sheathing vessels	373
Mathematical instruments	84
Mats, cocoa	123
straw	123
hump	123
jute	123
Indian rubber	152
door or carriage, N.E.S.	163
Matting, cocoa	123
straw	123
jute	123
Indian rubber	152
Mattocks	144
Mattresses	143
hair	143
spring	143
Meal, Indian, unbolted	375
oil cake	375
Meats, fresh	29
Medical books	353
Medicated beef fluids	321
Medicinal wheat	95
Medicines, alcoholic	95
Medicines and drugs	315
patent	315
Mescal	95
Metal parts for coffins, etc.	191
show cases	191
Metal, copper	207
composition	207
Britannia	141
polish	173
type	141
babbit	144
composition for manufacture of jewellery	131
Methylated spirits	35
Milk, condensed	21

Index to Newfoundland Tariff.

	No. of Item.
Milk board.....	181
Miliners' fashion plates.....	344
Mining powder.....	214
Machinery.....	594
Mits.....	141
Moist sugar.....	17
Molasses of sugar cane and beet, N.E.S.	28
Jule of sugar cane.....	30
Montilla wine.....	101
Morooco leather.....	245
Mortising machines.....	291
Mosely flooring.....	216
Motors, electric, N.E.S.....	111
Moulded glass tableware.....	130
Moulding machines.....	291
Mouldings of wood, plain or gilded.....	191
Mouse traps.....	144
Mowers, lawn.....	144
Mowing machines.....	293
Mucilage.....	181
Muffs, fur.....	148
Municipal Council, articles for use of.....	315
Muriatic acid.....	314
Muscle, printed.....	181
written.....	374
Musical instrument cases.....	185
Instruments.....	167
Musket powder.....	211
Muskets.....	114
Mustard, ground.....	161
N	
Nails, strips, of iron, steel, zinc or brass.....	78
Nails.....	162
copper.....	141
brass.....	144
Naphthalene.....	121
Naphthol, N.E.S.....	70
for copper paint.....	70
Neats' foot oil.....	369
Needles, of all kinds, N.E.S.....	34
surgical.....	391
Nets.....	24
lawn tennis.....	80
sportsmen's fish.....	80
lace.....	136
Netting.....	136
fishing.....	27
Neutral lard, for bakers.....	74
stock.....	210
Nevada silver.....	141
Newspapers, partly printed, N.E.S.....	181
unbound.....	374
Nickle-plated ware.....	141
silver.....	141
hollow ware.....	181
Nitric acid.....	314
Nitro.....	214
glycerine.....	314
of ammonia.....	318
Novels.....	181
Nuns' cloth.....	277
Nut boxes.....	144
Nutmegs.....	91
Nuts.....	86
shelled.....	86
steel or iron.....	141
O	
Oak.....	122
staves.....	24
Oakum.....	218
Oatmeal.....	72
Oats.....	56
rolled, in bags or barrels.....	32
small packages.....	40
Office furniture.....	117
for printers.....	381
knives.....	144
Official reports.....	354
Offsets.....	122
Oil cake.....	375
meal.....	375
cloths-door, shelf, stair, enamelled and table oil cloths, cork matting or carpet, and linoleum.....	139
coal.....	395
cod-liver.....	319
cotton seed.....	310
cotton seed, for fish glue.....	363
fish.....	276
flaxseed.....	397
grain leather.....	283
illuminating.....	309
kerosene.....	395
lard.....	395
linseed.....	397
lubricating.....	398
neats' foot.....	391
of fish of British catch and cure.....	395
olein or beef.....	310
olive, for fish glue.....	363
N.E.S.....	311
in bottles.....	312
ether, for manufactures.....	310
other fish, N.O.P.....	315
salad, in bottles.....	312
sesame, for manufacture.....	310
sesame, N.E.S.....	309
spermacete.....	335
stoves.....	182
whale.....	335
Oiled clothes.....	104

	No. of Item.
Oiled clothes, silk.....	105
cloth.....	105
Oils, essential.....	399
medicinal, N.E.S.....	315
ointments.....	316
Old iron.....	371
copper.....	344
composition metal.....	344
Oleographs, advertising.....	181
N.O.P.....	181
Oleomargarine.....	31
oil.....	62
Optical instruments.....	84
Oranges.....	70
Ores to be used as flux.....	370
Organs.....	107
Organs.....	217
Ornaments, confectioners of spar, alabaster, amber, terra-cotta or composition.....	74
Oxen.....	27
Oysters in shell.....	393
shelled.....	334
in tins.....	336
P	
Packing, rubber.....	152
Pads, paper, not printed.....	181
Paging machines.....	282
Palls of wood.....	191
Paint, gold liquid.....	77
knives.....	181
Paints, artists'.....	141
copper.....	297
dry.....	219
ground in oil.....	250
liquid prepared for use.....	251
Paintings.....	181
Paints, bound.....	181
advertising.....	181
Paper hangings.....	166
borderings.....	166
for manufacture of matches.....	201
of all kinds, N.E.S.....	181
ruled, bordered or coated.....	181
sacks or bags.....	181
tarred and sheathing, N.E.S.....	181
wax.....	377
wrapping, toilet, sand, glass or flint and emery.....	181
Paperies.....	181
Paper mache ware.....	181
Papers, boxed.....	181
Paraffine wax.....	322
Parasols.....	185
Parachut, N.E.S.....	374
Paris green.....	252
Parrot cages.....	34
Partships.....	34
Parts of machinery for ships.....	291
Pastes.....	87
medicinal.....	315
Patent medicine circulars.....	181
leather.....	234
medicines.....	315
Patented machinery.....	290
Patterns.....	144
Patterns for shoemakers.....	215
Peaches.....	76
Pennants.....	86
Pearline powders.....	178
Pears.....	76
Pens, round.....	33
split.....	33
Pease meal.....	375
Pecans.....	86
Pedometers.....	84
Pegs.....	215
Pegwood.....	215
Pen holders.....	181
Pen knives.....	144
Penicils, lead.....	181
of all kinds.....	181
slat.....	290
Pens.....	181
Perussion caps.....	144
Perforating machines.....	282
Perfumed preparations.....	87
Perfumery, including toilet preparations, viz.: Hair oils, tooth and other powders, washes, pomatums, pastes, and all other perfumed preparations, N.E.S., used for the hair, mouth or skin.....	87
Perfumes, alcoholic.....	95
Perfolicais, bound.....	181
illustrated advertising.....	181
unbound.....	351
Peroxides of hydrogen, solutions of.....	325
Pery.....	69
Personal effects of British subject living abroad.....	341
Pials, glass.....	140
Philosophical instruments.....	84
Phosphor, in.....	144
bronze.....	141
Photographic instruments.....	84
Photographs.....	181
not intended for sale.....	357
Pianosfortes.....	167
Pickles.....	88
Picks.....	144
Pictorial show cards, advertising.....	181
illustrations for schools, etc.....	368

	No. of Item.
Picture frames and photo frames.....	89
Pictures.....	181
Pig iron.....	68
Plgs, alive.....	1
feet.....	31
heads.....	31
hooks.....	31
jaws.....	35
tongues.....	35
Pillows.....	143
Pills.....	215
pine apples.....	76
Pins.....	111
Pipe mounts.....	97
lead.....	194
Pipes, drain.....	194
cast iron.....	199
sewer.....	191
tobacco.....	97
Pistols.....	134
Pistol covers.....	111
cases.....	111
Pitch.....	243
Burgundy.....	322
Plain (hardware).....	181
hollow ware.....	181
Phuing machines.....	291
Plantains.....	76
Plants.....	80
Plaster of Paris.....	251
Plasters.....	315
Plated screws.....	144
Plates, boiler.....	352
ships.....	352
Plates, engraved.....	319
for engraving.....	319
Playing cards.....	181
Pleasure boats.....	119
Ploths, patented.....	18
not patented.....	168
sulph.....	24
walling.....	243
Plums.....	76
Plush.....	122
and silk fabrics.....	187
Pocket books.....	181
Pocket knives.....	144
Poles, carriage.....	122
Pokes or eyes.....	141
Polish, knife.....	181
metal.....	159
stove.....	171
Polished pebble leather.....	243
Pomades.....	80
Pomatums.....	87
Pomegranates.....	76
Ponies, Sable Island.....	30
Pop corn.....	73
Porcelain ware.....	129
Pork, mess.....	36
belly back.....	36
bean.....	36
clear butt.....	36
extra prime.....	36
family.....	36
Pork, family mess.....	36
ham.....	36
lole.....	36
prime mess.....	36
tump.....	36
Port wine.....	104
Portable saw mills.....	287
Portland cement.....	206
Porter, local brew.....	408
in casks.....	61
in bottles.....	65
Portmanteau.....	185
Posters, advertising.....	181
Potatoes.....	59
sweet.....	6
Pouches, tobacco.....	97
Poultry, dead.....	37
alive.....	58
founders.....	191
Power machines.....	295
Powder, blanking.....	105
blasting.....	214
emulster.....	214
glant.....	214
cannon.....	214
gun.....	214
miling.....	214
musket.....	214
rifle.....	214
sporting.....	214
Powders, medicinal.....	315
Prayer books.....	353
Preparations of petroleum, for toilet and other purposes.....	313
Preservalline.....	363
Preserved ginger.....	91
Preserves.....	27
Pressed glass tableware.....	140
felt.....	142
Price Books, illustrated.....	181
lists.....	181
tags.....	181
Printed ware.....	129
Printers' office furniture.....	381
Printing paper for printers.....	381
presses for printers.....	381
types for printers.....	381
Prohibited articles.....	296
books.....	296

Index to Newfoundland Tariff.

	No. of Item.
Prison labor manufactures	361
Promissory notes	181
Pronged forks, farmers	144
Propellers	280
steel, N.E.S.	302
Proprietary preparations	315
Prunes	76
Primers, gum	144
Prism books	353
Pruning knives	194
Pulque	95
Pumpkins	62
Pumps, brass	144
Purchasers	122
Purses	185
Putty	169
Putty knives	144
<b>Q</b>	
Quilts	133
Quilnces	76
<b>R</b>	
Radiators	300
Railway bars	227
curs	296
crossings	297
fish plates	297
frogs	297
intersections	297
switches	297
Raisins	76
Rakes, horse	243
Raspberries	76
Rasps and files	144
Rat cages	144
traps	144
Raw cotton	362
Razors	144
Ready-mades	170
Reaping hooks	144
Reeds, or whitrod, unmanufactured	356
Regalia	136
Registers, cash	124
Religious purposes, articles for	347
Reports, official	354
Reprints of copyright works	402
Resin or rosin	253
Retticles	185
Revolvers	144
Rhenish light wine	104
Ribbons	171
Rice, cleaned	38
flour	382
uncleaned or refuse	144
Rifles	144
rifle powder	214
Rims, wooden	122
Rivets, N.E.S.	144
holler	144
coopers	144
copper	144
brass	144
for blacks	172
Road rollers	144
Rock drills	364
Rockingham ware, brown or colored	129
Rods, fishing	191
Rolling pins	191
Rolling mills, for mining	364
Rollers, farm, road or field	144
Rolled oats, in bags or barrels	32
in small packages	40
Rope wire, N.E.S.	144
for vessels	144
Roping twine, of hemp	274
Roofing slate	255
Roman cement	260
Rubber hose	151
packing	152
Rubbers, erasing	181
Rugs	122
N.E.S.	122
rill or travelling	177
Turkish	122
Rum	95
local distillation	407
shrub	95
Rulers	181
Rolling machines	262
for bookbinders	262
Rushes, for coopers' use	101
<b>S</b>	
Sable Island ponies	340
Sacks paper	181
Sad irons	144
Saddlers' hardware	144
Saddlery	144
Safe doors	144
Safes	144
Sago	39
flour	39
Sail canvas	108
twine	274
Sails	173
Solid oil	310
Salmon	352
twine	274
trawl	274
in tins	300
Salt, dairy and table	40
in bulk	227
Salves	315

	No. of Item.
Sansons	122
Sand	383
paper	181
Sandstone, undressed	229
Sardines	329
Satchels	185
Saucepans	144
Sausages	89
Sausage skins or coverings	384
Sausages	42
Saw mills, portable	287
Saws	144
N.E.S.	256
Seales	144
Sealdam	95
Schnapps	95
School slates	260
books	353
maps and charts	360
Scientific books	353
instruments	380
apparatus	380
Seabroars	144
Scrap iron, old	385
steel, old	385
Screws of all metals	144
Scroll saw machines	303
Scythes	144
stones	257
Seal twine	273
trawl	274
Seaming twine hemp	274
Seamless bags	107
Seats, carriage	122
Seed drills	283
for agricultural purposes	384
Selva	217
Self binders	283
Separators	283
for mining	364
Serges, N.E.S.	218
for dresses	277
Sesame oil, N.E.S.	360
for manufacturing	310
Settlers' effects	383
Sewer pipes	134
Sewing machines	298
silk	174
thread cotton	174
Shackles, chain	193
Shaddocks	76
Shade holders	144
Shades, glass	140
gas, etc	144
Shafting of steel for vessels being re- paired	389
Shafts, carriage	122
Shims	136
Shanks, steel and wooden	215
Sharpening stones	257
Shawls	175
Shears, habers' and tailors'	144
Sheath knives	144
Sheathing paper	206
N.E.S.	181
materials for vessels	373
Sheaves for blocks	195
Sheep, alive	1
Sheet steel	181
manufactures of	184
wadding	202
tin	269
plus	144
Sheets	133
lead	144
Shelf oil cloth	139
Sherry	104
Shingles	176
Shipping labels	181
Ships' boats	119
plates	352
Shirt waists	170
Shirts, cotton, linen or silk	170
wool or cotton and wool	170
hand-made	170
Shoe laces	111
knives	144
tacks	162
brads	162
blacking	177
dressing	177
making machines	291
Shoemakers' ink	258
tools	144
Shoes, Indian rubber	150
leather	156
Shores, wharf	183
Shot, lead	144
Shovels, iron or steel	144
Show cases	191
cards, advertising	184
Shrubs	380
Siellan wine	104
Sickles	144
Side lights	144
Signs	144
Silk velvets	187
fabrics	187
olled	165
clothing	170
twist	174
embroidery	174

	No. of Item.
Silver leaf	77
ware	144
Silvered glass	140
Sliders, anglers'	144
Sisal	307
Sking cream	276
of all kinds	276
Skates	144
Skiffs	119
Skins, sausage	384
Slate roofing	255
Slate mantels	259
manufactures of	259
pencils	260
Slates for writing on	260
Sledges	144
Sleigh runners	122
Sleighs	122
Slides for angle lanterns	84
Slippers, leather	156
Smoked fish	351
Smokers' sets	97
Snaths	144
Snuff	96
Soap, harness	258
common	178
laundry	178
castle	178
mottled	178
white	178
fancy	87
tar	87
tollit	87
powders	178
Sockets, electric	144
Socks, N.E.S.	170
Soda bicarbonate	170
washing	170
Solder	270
Solutions of peroxides of hydrogen	321
Soups	13
Soy	88
Spades, iron or steel	144
Spanish red wine	104
Spar ornaments	75
Spatulas	144
Specimens illustrating natural history	382
Spectacles	140
Sperm oil	355
Spices	94
unground	92
ground	93
Spirits	95
of turpentine	271
Spilt leather	258
Spitting knives	144
Spokes	122
Spongeware	129
Sporting powder	214
Sportsmen's fish nets	80
knives	144
fishing bait	144
Spring shackles	122
steel	122
mattresses	173
Springs, carriage	122
lamp	141
Sprinklers, brass	144
Squashes	62
Squirrel cages	144
Stair pads	122
linen	133
oil cloth	139
Stamp joints	122
Stamped tin	270
Stand carts	122
Starch	180
Stationery	181
Statuettes	75
Staves of oak, undressed	261
other woods, undressed	262
manufactured or partly manufac- tured	263
second-hand	127
Stay laces	111
Steam boilers for ships	300
for local industries	301
engines for ships	301
for local industries	301
Stearine	54
Steel bars of	264
bilster	265
bolts of	264
bridges	228
chrome	265
columns	228
fencing	144
fittings	230
forgings	219
forks	144
girders	228
hard or cast	265
hollow ware	184
hoop, splayed, etc	363
knives	144
mild	264
nuts	144
pieces of	264
pipe	252
plates of	261
propellers	301
railway bars	227
screws	144



# Index to Advertisers.

Those marked (\*) are members of The Canadian Manufacturers' Association.

	PAGE		PAGE
Abbey Improved Chilled Shot Co., Newcastle-on-Tyne, England.....	164	*Consumers Cordage Co., Montreal, Que.....	116
*Abbott-Mitchell Iron & Steel Co., Belleville, Ont.....	52	Cooper, Jas. Mfg. Co., Montreal, Que.....	132
*Acetylene Lighting Co., London, Ont.....	164	*Coulter & Campbell, Toronto, Ont.....	118
Adams, G. H. & Co., Melbourne, Victoria, Aus.....	192	Cowan & Co., Galt, Ont.....	20
*Albert Mfg. Co., Hillsborough, N.B.....	168	Creelman Bros., Georgetown, Ont.....	152
American Impulse Wheel Co., New York, N.Y.....	66	*Creelman Bros. Typewriter Co., Toronto, Ont.....	154-162
American Steam Gauge Co., Boston, Mass.....	38	Crosby Steam Gage & Valve Co., Boston, Mass.....	166
Armstrong Mfg Co., Bridgeport, Conn.....	132	Cummer, F. D. & Son Co., Cleveland, Ohio.....	132
Aspinwall Mfg. Co., Jackson, Mich.....	62	*Cyclone Grate Bar Co., Toronto, Ont.....	160
Atlantic Refining Co., Toronto, Ont.....	140	Darling Bros., Montreal, Que.....	168
Atteaux, F. E. & Co., Boston, Mass., and Toronto, Ont.....	120-142	*Davidson, Thos. Mfg. Co., Montreal, Que.....	82
Austin Separator Co., Detroit, Mich.....	76	Davis & Vannier, Flint, Mich.....	102
Babcock & Wilcox Limited, Montreal, Que.....	2	Dean, Walter, Toronto, Ont.....	100
Ballantine, John & Co., Preston, Ont.....	22	Desham's Advertising Agency, Montreal, Que.....	194
*Barber, Wm., & Bro., Georgetown, Ont.....	166-174	Diamond Machine & Screw Co., Toronto, Ont.....	168
Baylis Mfg. Co., Montreal, Que.....	116	*Dodge Mfg. Co., Toronto, Ont.....	98
*Bell Organ & Piano Co., Guelph, Ont.....	166	*Dominion Bridge Co., Montreal, Que.....	130
Bellhouse, Dillon & Co., Montreal, Que.....	126	*Dominion Dyewood & Chemical Co., Toronto, Ont.....	o.f.c.
Benson, W. T. & Co., Montreal, Que.....	126	Dominion Engraving Co., Toronto, Ont.....	166
*Bertram, John & Sons, Dundas, Ont.....	18-140	Dominion Leather Co., Toronto, Ont.....	o.b.c.
*Boeckh, Bros. & Co., Toronto, Ont.....	128	*Dominion Oilcloth Co., Montreal, Que.....	164
Bouvier, L. P., Toronto, Ont.....	174	*Dominion Radiator Co., Toronto, Ont.....	80
Bradstreet's, Toronto, Ont.....	194	Dovercourt Twine Mills, Toronto, Ont.....	116
Brantford Electric & Operating Co., Brantford, Ont.....	162	Dryden, T. H. & A. H., Toronto, Ont.....	194
Bristol Co., Waterbury, Conn.....	o.b.c.	Economical Fire Insurance Co., Berlin, Ont.....	126
Brown & Co., Paris, Ont.....	168	Eddy, L. B. Co., Rochester, N. Y.....	86
Brown, Boggs & Co., Hamilton, Ont.....	78	Edwards Sad Iron Co., Toronto, Ont.....	96
Brunner, Mond & Co., Northwich, England.....	120	Electrical Construction Co., London, Ont.....	138
Brush, Geo., Montreal, Que.....	156	Encyclopedia Britannica, Toronto, Ont.....	184
Buchanan, R. H. & Co., Montreal, Que.....	108	Engineering Contract Co., Toronto, Ont.....	o.b.c.
Budden, Hanbury A., Montreal, Que.....	162	*Eureka Mineral Wool & Asbestos Co., Toronto, Ont.....	50
Buffalo Forge Co., Buffalo, N. Y.....	26	Fairbanks Co., Montreal, Que.....	148
Burt Mfg. Co., Akron, Ohio.....	194	*Fensom Elevator Co., Toronto, Ont.....	o.f.c.
Butterfield & Co., Rock Island, Que.....	160	*Fetherstonhaugh & Co., Toronto, Ont.....	o.f.c.
*Canada Chemical Mfg. Co., London, Ont.....	120	*Firstbrook Box Co., Toronto, Ont.....	166
*Canada Iron Furnace Co., Montreal, Que.....	76	Fleming, W. A. & Co., Montreal, Que.....	136
Canada Machinery Agency, Montreal, Que.....	72	Forman, John, Montreal, Que.....	104-160
Canada Metal Co., Toronto, Ont.....	118	Frick, H. C. Coke Co., Pittsburgh, Pa.....	o.b.c.
*Canada Paint Co., Montreal, Que.....	62	Frost, W. H., Smith's Falls, Ont.....	o.b.c.
Canada Sugar Refining Co., Montreal, Que.....	156	*Gananoque Spring & Axle Co., Gananoque, Ont.....	134
Canada Switch & Spring Co., Montreal, Que.....	34-o.b.c.	Gardner, Robt. & Son, Montreal, Que.....	114
Canadian Canoe Co., Peterborough, Ont.....	164	Garfield Oil Co., Cleveland, Ohio and Windsor, Ont.....	170
*Canadian Composing Co., Montreal, Que.....	172	Gartshore, John J., Toronto, Ont.....	162-190
*Canadian General Electric Co., Toronto, Ont.....	6	*Gartshore-Thomson Pipe & Foundry Co., Hamilton, Ont.....	168
Canadian Manufacturer, Toronto, Ont.....	72-176	Geigy, John R., Basle, Switzerland.....	120
*Canadian Office & School Furniture Co., Preston, Ont.....	162	*Gendron Mfg. Co., Toronto, Ont.....	70
Canadian Rand Drill Co., Montreal, Que.....	192	General Fire Equipment Co., Toronto.....	144
Canadian Rubber Co., Toronto, Ont., & Montreal, Que.....	132	*Goldie & McCulloch Co., Galt, Ont.....	140
*Canadian Sewer Pipe Co., St. John's Que., & Hamilton, Ont.....	170	Graham, Wm., Toronto, Ont.....	194
Canadian Typewriter Exchange, Toronto, Ont.....	162	*Gray, R. A. L., Toronto, Ont.....	16
*Cane, Wm. & Sons Mfg. Co., Newmarket, Ont.....	128	Green Fuel Economizer Co., Montreal, Que.....	56
Carrier Laine & Co., Levis, Que.....	o.b.c.	*Greening B. Wire Co., Hamilton, Ont.....	74
Carswell Co., Toronto, Ont.....	172	*Griffin, P. & P.....	190
*Clare Bros. & Co., Preston, Ont.....	118	Guelph Carriage Top and Hardware Co., Guelph, Ont.....	100
Clark Metallic Mfg. Co., Rochester, N.Y.....	90	*Gutta Percha & Rubber Mfg. Co., Toronto, Ont.....	o.f.c.
Clark Novelty Co., Rochester, N.Y.....	84	Hau, C. T. Mfg. Co., Rochester, N.Y.....	88
*Clarke, A. R. & Co., Toronto, Ont.....	134	*Hamelin & Ayers, Lachine Mills, Que.....	116
Cling-Surface Mfg. Co., Buffalo, N.Y.....	136	*Hamilton Cotton Co., Hamilton, Ont.....	126
		Hamilton Facing Mill Co., Hamilton, Ont.....	o.f.c.



	PAGE		PAGE
Hamilton, Wm. Mfg. Co., Peterborough, Ont.....	112	Packard Electric Co., St. Catharines, Ont.....	138
Harris, W. G., Toronto, Ont.....	118	Parke, Roderick J., Toronto, Ont.....	16
Hartland, H. Fawcett, Montreal, Que.....	1162	Parker, Alfred S., New Toronto, Ont.....	194
Hay, Peter, Galt, Ont.....	30	Paris Electro Plating Co., Paris, Ont.....	162
Henry, M. J., Montreal, Que., and Toronto, Ont.....	180	Parmenter & Bullock Co., Gananoque, Ont.....	54
Hore's, F. W. Sons, Hamilton, Ont.....	162	Paterson & Son, Montreal, Que.....	166
Hubbell, Harvey, Bridgeport, Conn.....	166	*Pattinson, Geo. & Co., Preston Ont.....	166
Hutchison, Shurly & Derrett, Toronto, Ont.....	116	*Penman Mfg. Co., Paris, Ont.....	166
Hyde, F. & Co., Montreal, Que.....	46	Perrin, W. R. & Co., Toronto, Ont., and Chicago, Ill.....	194
Imperial Oil Co., Petrolia, Ont.....	132	Peterborough Canoe Co., Peterborough, Ont.....	168
*Imperial Varnish & Color Co., Toronto, Ont.....	30	Phillips, E. F. Electric Co., Montreal, Que.....	14
Independent Order of Foresters, Toronto, Ont.....	186	*Piper, N. L., Railway Supply Co., Toronto, Ont.....	158
*Inglis, John & Son, Toronto, Ont.....	76	Pitt & Scott, New York, N.Y.....	156
*Ives, H. R. & Co., Montreal, Que.....	52	*Polson Iron Works, Toronto, Ont.....	140
Jardine, A. B. & Co., Hespeler, Ont.....	o.f.c.	Pratt & Letchworth Co., Buffalo, N.Y.....	28
Jenckes Machine Co., Sherbrooke, Que.....	40	Preston Furniture Co., Preston, Ont.....	146
Johnston, C. K. & Co., Toronto, Ont.....	2	Queen City Oil Co., Toronto, Ont.....	106
Jones & Moore Electric Co., Toronto, Ont.....	138	*Raymond Mfg. Co., Guelph, Ont.....	150
Jones, J. L. Engraving Co., Toronto, Ont.....	162	Reeves Pulley Mfg. Co., Toronto, Ont.....	112
Keller, John J. & Co., New York, N.Y.....	120	Reid, George & Co., Toronto.....	144
Kelly's Directories, Toronto, Ont., and London, Eng.....	178	Rice Lewis & Son, Toronto, Ont.....	40-160
*Kemp Mfg. Co., Toronto, Ont.....	82-168	Richelieu & Ontario Navigation Co., Montreal, Que.....	42
*Kerr Engine Co., Walkerville, Ont.....	160	*Ritchie & Ramsay, New Toronto, Ont.....	9-10
Klipstein, A. & Co., New York, N.Y.....	120	*Robb Engineering Co., Amherst, N.S.....	122
Laurie Engine Co., Montreal, Que.....	36	Rogers, Elias Co., Toronto.....	187
Lawrence-Williams Co., Cleveland, Ohio.....	188	*Rosamond Woolen Co., Almonte, Ont.....	166
Leitch & Turnbull, Hamilton, Ont.....	166	Royal Oil Co., Toronto, Ont.....	o.f.c.
Leslie, A. C. & Co., Montreal, Que.....	o.f.c.-34	*Royal Electric Co., Montreal, Que.....	2-1-5-138
Lewis, Rice & Son, Toronto, Ont.....	40-164	*Sadler & Haworth, Toronto and Montreal.....	44
Lochrie, James, Toronto, Ont.....	100	Safety Light and Heat Co., Dundas, Ont.....	161
London Machine Tool Co., London, Ont.....	168	*Sammens & Evel, Hamilton, Ont.....	134
Lownes, L. M., Norristown, Penn.....	194	Smart-Eby Machine Co., Hamilton, Ont.....	192
*Macdonald Mfg. Co., Toronto, Ont.....	134	*Smart, James Mfg. Co., Brockville, Ont.....	54
Magnolia Metal Co., New York, N.Y.....	o.f.c.	*Smith Woolstock Co., Toronto, Ont.....	166
Manufacturers' List Co., Montreal, Que. and Toronto, Ont.....	180	*Spooner, A. W., Port Hope, Ont.....	106
Marion & Marion, Montreal, Que.....	o.h.c.	*Standard Chemical Co., Toronto, Ont.....	142
Matheson, Wm. J. & Co., New York, and Montreal, Que.....	120	Stilwell-Bierce & Smith-Vaile Co., Dayton, Ohio.....	70
Merrimac Chemical Co., Boston, Mass.....	166	*Storey, W. H. & Son, Acton, Ont.....	166
Metal Shingle & Siding Co., Preston, Ont.....	144	Sturtevant, B. F. Co., Boston, Mass.....	24
*Metallic Roofing Co., Toronto, Ont.....	58	Sturtevant, Mill Co., Boston, Mass.....	40
Meyercord Co., Chicago, Ill.....	148	St. Johns Spring Co., St. Johns, Mich.....	162
*Mica Boiler Covering Co., Montreal Que., and Toronto, Ont.....	124	Swansea Forging Co., Swansea, Ont.....	78
*Mitchell, The Robert Co., Montreal, Que.....	124	*Syracuse Smelting Works, Montreal, Que.....	74
*Montreal Pipe Foundry Co., Montreal, Que.....	76	Taber Pump Co., Buffalo, N.Y.....	64
*Morrison, James, Brass Mfg. Co., Toronto, Ont.....	136	Taylor, J. & J., Toronto, Ont.....	158
*Morrow Machine Screw Co., Ingersoll, Ont.....	168	Thistlethwayte, C. Bows, Sydney, N.S.W.....	162
Munderloh & Co., Montreal, Que.....	50	Tippet, A. P. & Co., Montreal, Que.....	148
*Murray Printing Co., Toronto, Ont.....	182	Toronto & Hamilton Electric Co., Hamilton, Ont.....	14-138
Myers, F. E. & Bro., Ashland, Ohio.....	68	Toronto Bedding Co., Toronto, Ont.....	94
*McArthur, Cornelle & Co., Montreal, Que.....	o.h.c.	Toronto Electrical Works, Toronto, Ont.....	14
McDougall, John, Montreal, Que.....	74	Toronto Fence & Ornamental Iron Works, Toronto.....	168
McEachren Heating & Ventilating Co., Galt, Ont.....	45	Toronto Foundry Co., Toronto, Ont.....	43
*McKinnon Dash & Hardware Co., St. Catharines, Ont.....	i.h.c.	Toronto General Trusts Corporation, Toronto, Ont.....	190
McLachlan Electric & Gasoline Motor Co., Toronto.....	165-192	Toronto Machine Screw Co., Toronto, Ont.....	162
McLaren, D. K., Montreal, Que.....	126	*Toronto Paper Mfg. Co., Cornwall, Ont.....	162
McLaren, J. C. Belting Co., Montreal, Que.....	o.f.c.-110	Toronto Woolen Machinery Co., Toronto, Ont.....	146
Nanz, A. & Co., New York, N. Y.....	164	United Electric Co., Toronto, Ont.....	8-9-o.h.c.
Neff, A. C., Toronto, Ont.....	162	*Valley City Seating Co., Dundas, Ont.....	172
*Newell, August & Co., Toronto, Ont.....	170	Vanduzen, E. W. & Co., Cincinnati, Ohio.....	164
New Toronto Woolstock Co., New Toronto, Ont.....	166	Vokes Hardware Co., Toronto, Ont.....	110
Niagara Falls Metal Works Co., Niagara Falls Centre, Ont.....	96	Volta Electric Storage Co., Hamilton, Ont.....	12
Niagara Metallic Furniture Co., Niagara Falls, Ont.....	92	*Walkerville Malleable Iron Co., Walkerville, Ont.....	o.f.c.
*Northey Mfg. Co., Toronto, Ont.....	104	*Welland Vale Mfg. Co., St. Catharines, Ont.....	166
Northrop Loom Co., Valleyfield, Que.....	142	*Wilkinson Plough Co., Toronto Junction, Ont.....	60
Norton Emery Wheel Co., Worcester, Mass.....	32	Williams, A. R. Machinery Co., Toronto, Ont.....	156
*Nova Scotia Steel Co., New Glasgow, N.S.....	130	Winn & Holland, Montreal, Que.....	120
Oakey, John & Sons, London, England.....	160	Wilson & Burnie, Leith, Scotland.....	162
*Ontario Malleable Iron Co., Oshawa, Ont.....	o.h.c.	Wilson Bros. Bobbin Co., Tadmorden, England.....	164
*Ontario Wind Engine & Pump Co., Toronto, Ont.....	78-194	Wilson, C. & Son, Toronto, Ont.....	192
Owen Sound Portland Cement Co., Owen Sound, Ont.....	170	Wilson, J. C. & Co., Glenora, Ont.....	166
		Wilson, Wm. C. & Co., Toronto, Ont.....	170
		Wright & Dallyn, Hamilton, Ont.....	120

# McKINNON DASH and HARDWARE Co.

OF ST. CATHARINES, LIMITED

MANUFACTURERS OF

## Carriage Dashes and Fenders (Mud Guards)

OF ALL KINDS

Prop Nuts, Buckle Loops, Curtain Lights,  
Whip Sockets and Bicycle Chains.

We Make **SPECIAL STYLES** to Suit Customers.

ORDERS ACCEPTED THROUGH ANY REPUTABLE HARDWARE, IRON-MONGER,  
LONDON or NEW YORK COMMISSION HOUSE.



WHIP SOCKET  
No. 113



No. 14—RAIL DASH, FEET SOLID.



No. 13—RAIL DASH, FEET ADJUSTABLE

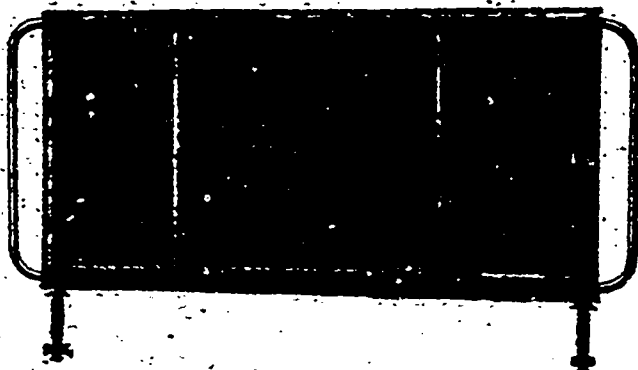

B. PATENT 3-8 SIL HANDLE LUG CART DASH



CORNING, OR ABBOTT DASH. RAIL AND FLAP.  
FEET SOLID

U.S. Factories: Buffalo, N.Y., Syracuse, N.Y., Troy, Ohio.

## ST. CATHARINES, ONTARIO, CANADA

When writing to Advertisers kindly mention THE CANADIAN MANUFACTURER.

BRIDGE SUB-STRUCTURES, WATER POWER DAMS, CANAL WORK and CAISSON FOUNDATIONS a Speciality.

Main Office! Empire Building, 71 Broadway, New York Canadian Office: Temple Building, Toronto, Ont. HENRY F. DUCK, MANAGER FOR CANADA.

Engineering Contract Company

**McARTHUR CORNELL & CO.,**  
 OFFICES:  
 318 St. Paul Street.  
 WAREHOUSES:  
 151 Commissioners Street.  
 ...MONTREAL...  
 AGENTS FOR . . .  
 Berlin Aniline Co.,  
 Aniline Colors and other Coal Products.  
 Stamford Manufacturing Dyewoods and Extracts.  
 Coez, Langlois & Co., French Extracts.  
 Miller Extract Co., Herb and Fruit Extracts.  
 British Alizarine Co., Alizarine.  
 J. H. Heald & Co., Extracts Oak, etc.



**The Ontario . . . Malleable Iron Co.**  
 (Limited)  
 ....Manufacturers of....  
**MALLEABLE IRON . . . . .** Castings to Order for all kinds of  
**AGRICULTURAL IMPLEMENTS .**  
 ....AND....  
**Miscellaneous Purposes . . . . .**  
 OSHAWA, - - ONT.

**THE UNITED ELECTRIC CO. Limited.**

SUCCESSORS TO  
**W. A. JOHNSON ELECTRIC CO.**  
**THE TORONTO ELECTRIC MOTOR CO., Limited.**  
**THOMPSON ELECTRIC**

We Manufacture a complete line of **Electric Light and Power Apparatus**

**ARE PREPARED TO CONTRACT FOR COMPLETE INSTALLATIONS**

Head Office **134 KING ST. W., TORONTO, ONT.**

**THE CANADA SWITCH & SPRING CO., LIMITED.**

Manufacturers of  
 .....SPECIALTIES FOR.....  
**Steam and Electric Railways,**  
 SPRINGS, STEEL CASTINGS,  
 FROGS, FORGINGS,  
 TRUCKS FOR ELECTRIC RAILWAYS, ETC.  
**INTERLOCKING SWITCH and SIGNAL PLANTS,**  
 (Under patents of Messrs. Saxby & Farmer, Limited, of London, Eng.)

CANAL BANK, POINT ST. CHARLES, MONTREAL.

**BRISTOL'S Recording Instruments**

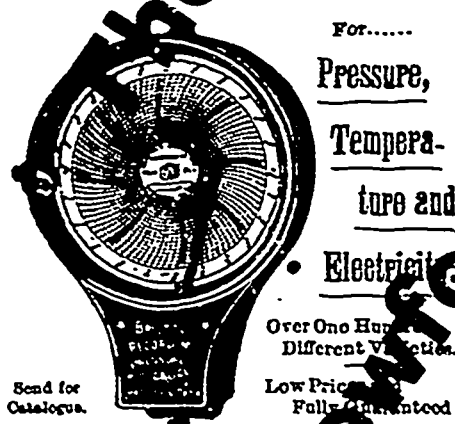

Send for Catalogue.

**THE BRISTOL CO.**  
 WATERBURY, CONN., U.S.A.

For.....  
 Pressure,  
 Tempera-  
 ture and  
 Electrical  
 Over One Hundred Different Varieties.  
 Low Price Fully Guaranteed

**SMITH'S FALLS**

**Malleable Iron Works . . .**

00000  
**CAPACITY 2,000 TONS**  
 00000

**WILLIAM H. SMITH**  
 PROPRIETOR  
**SMITH'S FALLS,**  
 ONTARIO, CANADA.

**CARRIER, LAINE & CO.**  
 LEVIS, P.Q.

**ENGINEERS, FOUNDERS, MACHINISTS, BOILER MAKERS AND GENERAL CONTRACTORS.**

Montreal Branch....  
 147 St. James St.  
 Quebec Branch....  
 263 St. Joseph St.

The Canadian Patent Index  
 The United States Patent Index  
 The British Patent Index  
 The Ontario Patent Index  
 The Montreal Patent Index

LARGE LEATHER BRAND DOMESTIC LEATHERS, UNUSUAL QUALITY, IN QUANTITIES, PRICES, BLACKSMITH'S APPLIANCE