

[Dec. 8, 1898.

WILLIS

urniture
ers

Stone and
abrics

ect, Opposite the
British
Museum

MINGHAM, Eng.
LIVERPOOL

es' College,
Music
rt.

ntsville, Ont.

Leon Llwyd, Algoma,
L.C.M., A. Mus. L.
e London College of
Ballist for Painting,
Davidson, M.L.A.,
ial Normal School,
Prize Essayist, etc.
D. Chown, Miss V.
Professor of Greek
Graduate of Tain-

ool for young ladies,
ary, Junior Leaving
for Toronto Univer-
A thorough English
ll be given to those
certificates, French
Special advantages
Languages, FALL
th. To fill vacancies
at reduced terms.
iculars on applica-

ASS WORK

Altar Vases, Ewers,
s, Crosses, Vesper
etc. Chande-
xtures.

BROTHERS
Chadwick)

HAMILTON, Ont.

MEMORIAL
STAINED
GLASS IN
HIC OR CLASSIC
YLES + +
CAUSLAND
76 KINGST
ORONIO

A NEW

CARD

aintiest, and
hich is printed
eries" of type.
-free to any

ry Times
Canada,
to
nt "Three."

Laundry

TREET

Proprietor
1580'

CANADIAN CHURCH

VIRGO CONCIPIT ET PARIET FILIUM ET VOCABITUR WOMEN EIUS EMMANUEL

MR OV

CHRISTMAS, A.D. 1898.

Established 1860

Affiliated
with the Institute
of Chartered
Accountants, 1896

Incorporated 1895

British American Business College Company, Limited

Y.M.C.A. Building,
Cor. Yonge and McGill Sts.,

Toronto, Ont.

THREE COURSES:

1. Shorthand and Typewriting
2. General Commercial
3. Expert Accountancy

owned and controlled by the following well known business men of Toronto:

FRED. WYLD, Esq., Wholesale Dry Goods Merchant.

E. R. C. CLARKSON, Esq., F.C.A., Chartered Accountant.

EDWARD TROUT, Esq., President of the Monetary Times Printing Co.

WM. McCABE, Esq., F.C.A., Manager North American Life Assurance Co.

S. F. McKINNON, Esq., Wholesale Milliner.

Write for Free Prospectus containing full information to

DAVID HOSKINS,

Chartered Accountant,
Principal

New Term begins TUESDAY, JANUARY 3, 1899

JOHN KAY, SON & CO.

TAPESTRY PANELS

This is one of many novelties we are finding large sale for as the Christmas season approaches. They win your taste as works of art. They are French goods, and possess that degree of fineness that is characteristic of French art.

They make up beautifully for screens and cushions for the floor, the couch or the divan. You can buy one or more panels and make up as you may wish yourself—the prices ranging from 40c. to \$12.50—or in our upholstery department we will make up cushions or screens or other specialties for you.

Oriental Cushions, a special line—fine for knock-about cushions in the living room, \$1.50 and \$2.00.

Passing along King St. West, it will be worth your time to take a view of the new carpet for the Council Chamber in the new City Hall—now on exhibition in our west window. It is, perhaps, the handsomest carpet of this particular kind ever imported into Toronto.

John Kay, Son & Co.

34 King Street West, TORONTO

ESTABLISHED 1882

The Toronto General Trusts Co.

Cor. Yonge & Colborne
Streets
TORONTO, Ont.

**Capital
\$1,000,000
Reserve Fund
\$250,000**

JOHN HOSKIN, Q.C., LL.D., President

W. H. PEATTY, E. A. MEREDITH, LL.D., Vice-Presidents

CHARTERED to act as an Executor, Administrator, Trustee, Guardian, Assignee, Committee, Receiver, Agent, etc., and for the faithful performance of such duties its capital and surplus are liable.

All Securities and Trust Investments are inscribed in the Company's Books in the Names of the Estates or Trusts to which they belong, and are kept Separate and Apart from the Assets of the Company.

The Company also acts as Agent or Executors and Trustees, and for the transaction of all Financial Business; invests money at best rates in first mortgages and other securities; issues and countersigns bonds and debentures; collects rents, interests, dividends, etc. It obviates the need of security for Administrations, and relieves the individual from responsibility as well as from onerous duty.

SAFE DEPOSIT DEPARTMENT.

SECURITIES and VALUABLES of every description, including BONDS, and STOCKS, PLATE, JEWELRY, DEEDS, etc. taken for Safe Keeping on Special Guarantee, at the lowest rates.

Deposits of WILLS received upon the Company's certificate WITHOUT CHARGE.

The Company also rents Safes inside of their Burglar proof Vaults at prices varying from \$5 to \$50 per annum, according to size. Special size for Corporations and Bankers. Rooms and Desks adjoining Vaults provided for Safe-renters.

**Vault Doors and Offices Guarded by Holmes' Electric Protection
Security from Losses by Burglary, Robbery, Fire or Accident**

A. D. LANGMUIR, ASSISTANT MANAGER J. W. LANGMUIR, MANAGING DIRECTOR

INCORPORATED 1833

BRITISH AMERICA

FIRE AND MARINE Assurance Co.

HEAD OFFICE:

British America Buildings, Cor. Front
and Scott Streets, TORONTO

**Cash Capital,
\$750,000.00**

**Total Assets, Over
\$1,510,827.88**

**Losses Paid
Since Organization
\$17,693,159.11**

Board of Directors:

HON. GEO. A. COX
J. J. KENNY, Esq.
ROET, JAFFRAY, Esq.
HON. S. C. WOOD
JOHN HOSKIN, Q.C., LL.D.
AUGUSTUS MYERS, Esq.
S. F. McKINNON, Esq.
THOS. LONG, Esq.
H. M. PELLAT, Esq.

HON. GEO. A. COX, President

J. J. KENNY, Esq., Vice-President

P. H. SIMS, Secretary

Canadian Churchman

DOMINION CHURCHMAN AND CHURCH EVANGELIST.
The Church of England Weekly Family Newspaper.
ILLUSTRATED.

Vol. 24]

TORONTO, CANADA, THURSDAY, DEC. 15, 1898.

[No. 49. 50

Christmas Brass Work



Memorial Pulpits, Vases, Crosses, &c.
Order in good time.

The Keith & Fitzsimons Co., Limited
111 King St. West, Toronto

An English Baker

We have secured the services of a first-class baker from the Old Country one who has served Whitley (the Universal Provider) and Buzzard. Anything you want that is thoroughly English he will make for you. Leave your orders.

A. J. STEWART
402 Yonge St., 28 & 410 Queen West

COWAN'S **Healthful and Nutritious Hygienic Cocoa...**
Sold in 1/4 lb., 1/2 lb., and 1 lb. Tins only. Absolutely Pure.

DALE'S BAKERY

Cor. Queen & Portland Sts.
Best quality of Bread. Brown Bread, White Bread. Full Weight. Moderate price. Delivered daily. Send us card.

Casavant Brothers (Established 1879)

Church Organ Builders

ST. HYACINTHE, BUILDERS
Organs built with all the latest improvements. Electric Organs a specialty. Builders of the organs in: Notre Dame Church (largest organ in Canada); St. James Cathedral and St. George's Church, Montreal. St. Hyacinthe, Ottawa and Pembroke Cathedrals; First Methodist Church, London, Ont., etc., etc.

St. Augustine Wine

\$1.50 per Gallon
Direct Importer of High Grade Foreign Wines, &c.
All goods guaranteed pure and genuine.
J. C. MOOR 433 Yonge Street, Toronto. Tel. 625

Foreign Stamps
Bought, Sold and Exchanged. High est prices paid for old collections or rare loose stamps. We particularly want penny issues—Canada, Newfoundland, Nova Scotia, New Brunswick, old U.S. Selections of rare or medium stamps sent on approval to all parts on receipt of reference. Special offer—1,000 all different; no post cards, envelopes, fiscals or reprints. Every stamp guaranteed genuine and original. Price 20/- post free. H. A. KENNEDY & CO., 39 Hart Street, New Oxford St., London, W.C.

High Class Dentistry

DR. CHAS. W. LENNOX
Rooms C and D Confederation Life Building, Yonge & Richmond Sts. Tel. 1846.

Albion Hotel

Accommodation for 300 Guests
Heated by steam; electric bells and lights; baths and all modern conveniences. Rates from \$1.00 up. Take Parliament Street cars to E. Market Square, Toronto, Ont.
JOHN HOLDERNESS, Prop.

Clarendon Hotel WINNIPEG

A first-class Family and Commercial Hotel—with every modern comfort and convenience. Accommodation for 300 guests. Rates from \$1.50 a Day and upwards.
C. F. BUNNEL, Proprietor

Eyeglasses and Spectacles

Only the most modern and up-to-date styles kept, and all our goods are sold at very reasonable prices. Our opticians give your eyes a thorough examination free of charge. Come and consult them.

Headaches are in most cases caused by perhaps only a slight defect of the eyes.

Nervousness can in many cases be cured by wearing glasses. No charge to consult our expert opticians.

New York Optical Co.

Corner Yonge and Richmond Streets, Toronto

Fred J. Goodman
CARPENTER AND BUILDER
Church Wood Work a specialty. 1050 Bloor St. West. TORONTO.

Many Ladies go on wearing a tight corset in direct opposition to the advice of their physician simply because they dread ill-fitting costumes.



Hygeian Waists insure comfort as well as beauty of figure. Giving the greatest freedom to their wearers, the convenience and healthfulness of these peerless garments make them the ideal wear for the delicate woman, the business girl or the cyclist. Sold in all the stores. Manufactured by

THE CROMPTON CORSET CO., Limited, TORONTO, ONT.

SPECIALISTS IN CLERICAL DRESS

Made to order by a Clerical tailor is the secret of every well-fitting clerical suit you ever saw, and the consciousness of feeling properly dressed is worth more than the difference in cost. Others might do as well as we do, if they had the experience. We make a specialty of clerical tailoring.

Geo. Harcourt & Son,
57 King-street W., Toronto

The York County LOAN & SAVINGS CO.

Plans suitable for those desiring to own their homes instead of continuing to pay rent. Literature free.
Head Office—Confederation Life Building, Toronto.
JOSEPH PHILLIPS, President

Our Full Dress Suit

AT \$25.00
Cannot be equalled in the city—made of fine finished worsted and cheviot cloth, lined throughout with satin—excellent goods.
NOBBY, LIGHTWEIGHT OVERCOATS
to order, \$15.00 and \$16.00
BERKINSHAW & GAIN
348 Yonge St., Toronto.

Catalogue 12 years for the asking.

There is no Limit

to our ability to supply our patrons with
Rings

Our stock is large—ability to manufacture new designs is unlimited—no matter what price you wish to pay, there's a saving of money and a gain in satisfaction for you in our stock.

AMBROSE KENT & SONS
Ring Manufacturers
156 Yonge Street, Toronto

The Curly Richness

and the deep, jetty gloss of the fur in our

- Persian Lamb Jackets for Ladies -
bear the unmistakable proof of fine quality. All our Persian Lamb is Leipsic-dressed and dyed, and the Jackets are fashioned to the latest styles. They are among the choice ideals in Dineens' Christmas display.

Dineens

Dineens' New Building, 140 Yonge St., Cor. Temperance.

Want a Good Roof ?

That will give Fire, Rust, Leak and Lightning proof protection, and last indefinitely—Then use

Eastlake Shingles

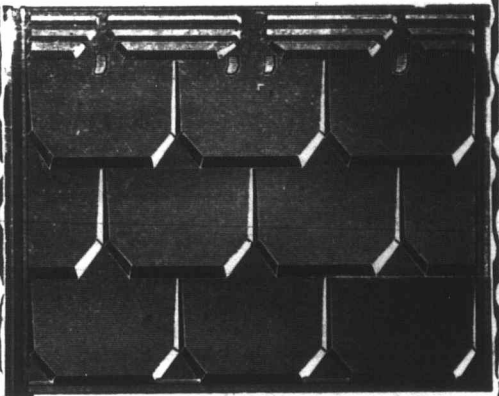

They have a patent side lock and water gutter found in no other shingles—are quicker laid than others—and can't be equalled for reliable, economical worth. Write us—we'll tell you all about them.

Metallic Roofing Co'y,
Limited,
1194 King St. West, Toronto.

Books.

- Life of Cardinal Manning. By Edmund Sheridan Purcell. Two vols. \$3.50.
- Life of Dr. Pusey. By Cannon Liddon. 4 vols. \$20.00.
- Edersheim's "Life and Times of Jesus the Messiah." 2 vols. \$2.00.
- Village Sermons. By Dean Church. 3 Series. Each, \$1.75.
- Cambridge and other sermons. By Dr Hort. \$1.75.
- Christus Consummator. By Bishop Westcott. \$1.50.
- The Makers of Modern Rome. By Mrs. Oliphant. \$3.00.
- Jerusalem the Holy City, Its History and Hope. By same author. \$2.50.
- Afterwards, and other stories. By Ian Mac-laren, author of Beside the "Bonnie Brier Bush." \$1.25.

ROWSSELL & HUTCHISON
76 King Street East,
TORONTO

The Best COMPANY for
the Best Risks
is what

**THE
TEMPERANCE
AND GENERAL
LIFE ASSURANCE
COMPANY**

Claims to be.
Its record justifies this claim.
Its paper entitled **Our Advocate** is sent to
any address free on request.

HON. G. W. ROSS, President.
H. SUTHERLAND, Man. Director.
Head Office,
Globe Building, Toronto.

Western Assurance and Marine Co's

FIRE -- Assurance
and MARINE Co's

Assets, over \$2,300,000
Annual Income, over \$2,400,000

HEAD OFFICE,
Cor. Scott & Wellington Streets,
TORONTO

GEORGE A. COX, President.
J. J. KENNY, Managing Dir.
C. C. FOSTER, Secretary.

GEO. W. COOLEY
Importer of 567 Yonge St
**High-Class Wines &
Spirits** for Medicinal
use. **Sacramental Wine**

Telephone 3089.

We know how



ND
WE
DO
IT

Our celebrated Finish on Linen has made
us the Leading Launderers in Canada.

OUR MOTTO:
GOOD WORK PROMPT DELIVERY

The PARISIAN
Steam Laundry Co., of Ontario,
Limited
67 Adelaide St. West, Toronto
Phone 11 E. M. MOFFATT, Manager



ENGRAVINGS OF EVERY
DESCRIPTION.
BEST METHODS
BEST WORK
SEND FOR SAMPLES
16 ADELAIDE ST WEST
TORONTO

Dunlop's
FLORIST

45 Yonge St., 5 King
St. West.
Tel. 4192. Tel. 1424.

W. H. Stone
UNDERTAKER
343 Yonge Street
PHONE 932

N. B.—Our charges have been greatly re-
duced in order to meet the popular demand for
moderate-priced funerals.

Labatt's India Pale Ale

Is an excellent nutrient tonic. Physicians desiring to prescribe will
hardly find anything superior to this.—*Health Journal.*

"We find that the Ale uniformly well agreed with the patients,
that it stimulated the appetite, and thereby increased nutrition. The
taste likewise was always highly spoken of. In nervous women, we
found that a glass at bedtime acted as a very effective and harmless
hypnotic."—Superintendent of large United States hospital.

Order It from your Merchant and see that you get it

JOHN LABATT, BREWER, LONDON

Toronto—James Good & Co., corner Yonge and Shuter Sts.
Montreal—P. L. N. Beaudry, 127 De Lorimier Ave. Quebec—N. Y. Montreuil, 277 St. Paul St

J. YOUNG
THE LEADING Undertaker and
359 YONGE ST. Embalmer
Telephone 679

FAVORABLY KNOWN SINCE 1826 BELLS
HAVE FURNISHED \$5,000
CHURCH, SCHOOL & OTHER
MENEELY & CO. PUREST BEST
WEST-TROY, N. Y. GENUINE
BELL-METAL
CHIMES. Etc. CATALOGUE & PRICES FREE

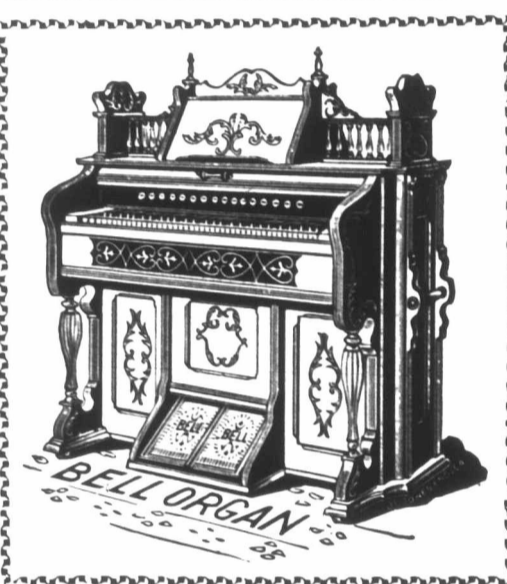

**BELL
ORGANS**

Are Supreme

Style 500, Cathedral Model

Is the finest example of Organ
for Church or Chapel use ever produced. Special
Discount to Church Committees

**THE BELL ORGAN AND PIANO CO.
GUELPH, ONTARIO**

Office and Yard,
FRONT ST., NEAR BATHURST.
Telephone No. 132.

Established 1856.

Office and Yard,
PRINCESS STREET DOCK
Telephone No. 190

P. BURNS & CO.
Wholesale and
Retail
Dealers in -- **Coal and Wood**

Head Office, 38 King St. East, Toronto.
Telephone 131

BRANCH OFFICES
338 1/2 Yonge st.—Telephone 151
546 Queen st. west—Telephone 139
99 Wellesly st.—Telephone 4483
04 Queen st east—Telephone 134

TALENT

is a divine gift and should be de-
veloped under the most favourable
conditions.
Musical talent will find in

**THE KARN
PIANO**

an affinity of genius able to re-
ceive and express the feelings and
passions of the performer.

KARN IS KING
Sole Canadian Agents of Re-
gina Musical Boxes.

The D. W. Karn Co.
Limited, Piano & Organ Mfrs.
Woodstock, Ont.

CLARET

"CHATEAU PELEE"
MEDOC

Cases, 12 Quarts, \$3.75
Cases, 24 Pints, \$4.75

Equal to imported claret at double the
price. If your wine merchant does not
keep our claret send order direct. For
sale in Toronto by J. C. Moor and C. J.
Kean.

J. S. HAMILTON & CO.,
Brantford, Ont.

General Agents Pelee Island Wine Co.,
Limited, Proprietors St. Augustine
and "Chateau Pelee" Wines.

**Brass and Iron
Bedsteads
Tiles
Grates
Hearths
Mantels**

**RICE LEWIS & SON
LIMITED**
Cor. King and Victoria Sts., Toronto



We have arranged for some grand Christmas
offerings in our celebrated Linen Damask de-
partment. Tablecloths 2 by 2 1/2 yds. at \$2.00, \$2.25,
\$2.50; 2 by 3 yds., \$2.50, \$3.00, \$4.50; 2 1/2 yds. by 3
yds., \$3.50, \$4.00, \$5.00, and all sizes up to 6 yds.
long at special prices. Table Napkins to match
in 5 8 size at \$1.75, 2.00, 2.50; 3 4 size at \$3, 3.50,
4.50 per dozen. Fringed Doilies, all sizes.
Linen Tea Cloths, hemstitched and embroidered
with open work at 75c., \$1.10, 1.50, 1.75 to 5.00
each. Damask Tea Cloths, all sizes. Tray
Cloths, hemstitched, plain and damask, from
50c. to \$1.50 each. Fringed Huck Towels, special
at \$2.50 per dozen. Linen Pillow Shams
hemstitched and embroidered with open work,
at \$1.50, 3.00, 3.50, 4.00, 4.50 per pair. Linen Centre
Pieces, hemstitched and embroidered.
Hemstitched Linen Quilts, handsomely em-
brothered. Hemstitched Pillow Cases and
Sheets. Mail orders to the Linen Department
are given every possible attention.

JOHN CATTO & SON
King St., opposite the
Post Office. TORONTO

**It's a
Mistake**

to say you cannot afford to buy
your shoes at Blachford's. It is
true we sell the very finest and
best shoes that can be procured,
but our prices notwithstanding
—when quality is considered—
are lower than you have to pay
elsewhere for inferior goods.

We are selling a Ladies' Vi-
Kid Button, Goodyear welt or
turn, at \$3.00, that will make you
wonder where our profit comes
in. Half sizes and different
widths in these shoes.

H. & C. BLACHFORD
114 Yonge Street

STAMMERERS!

Address Church's Auto-Voice Institute
9 Pembroke Street, Toronto. Established 1890.
Only institution in Canada for the cure of every
phase of defective speech. Open continually.
Prospectus free.

CHURCH & BYRNE, Principals

Iron
ads

ites

tels

SON

., Toronto



S

rand Christmas
en Damask de-
ds. at \$2.00, \$2.25,
.50; 2 1/2 yds. by 3
izes up to 6 yds.
apkins to match
size at \$3, 3.50,
yilies, all sizes.
land e. a. broider-
1.50, 1.75 to 5.00
all sizes. Tray
1 damask, from
ick Towels, spe-
n Pillow Shams
with open work,
air. Linen Cen-
d embroidered.
handsomely em-
llow Cases and
nen Department
tion.

& SON
the
ONTO

afford to buy
ford's. It is
y finest and
be procured
withstanding
considered—
have to pay
for goods.

a Ladies' Vie-
lyear welt or
will make you
profit comes
and different
es.

FORD
et

ERS!

Voce Institute
Established 1890.
the cure of every
Open continually.

RNE, Principals

Canadian Churchman.

TORONTO, THURSDAY, DEC. 15, 1898.

Subscription, - - - - Two Dollars per Year.
(If paid strictly in Advance, \$1.00.)

ADVERTISING RATES PER LINE - - 10 CENTS

ADVERTISING.—The CANADIAN CHURCHMAN is an excellent medium for advertising, being by far the most widely circulated Church Journal in the Dominion.

BIRTHS, MARRIAGES, DEATHS.—Notices of Births, Marriages, Deaths, etc., two cents a word prepaid.

THE PAPER FOR CHURCHMEN.—The CANADIAN CHURCHMAN is a Family Paper devoted to the best interests of the Church in Canada, and should be in every Church family in the Dominion.

CHANGE OF ADDRESS.—Subscribers should be careful to name not only the Post-Office to which they wish the paper sent, but also the one to which it has been sent.

DISCONTINUANCES.—If no request to discontinue the paper is received, it will be continued. A subscriber desiring to discontinue the paper must remit the amount due at the rate of two dollars per annum for the time it has been sent.

RECEIPTS.—The label indicates the time to which the subscription is paid, no written receipt is needed. If one is requested, a postage stamp must be sent with the request. It requires three or four weeks to make the change on the label.

CHECKS.—On country banks are received at a discount of fifteen cents.

CORRESPONDENTS.—All matter for publication of any number of the CANADIAN CHURCHMAN, should be in the office not later than Friday morning for the following week's issue.

AGENT.—The Rev. J. Dagg Scott is the only gentleman travelling authorized to collect subscriptions for the CANADIAN CHURCHMAN.

Address all communications,

FRANK WOOTTON

Box 2640, TORONTO.

Offices—Cor. Church and Court Streets.
Entrance on Court Street.

NOTICE.—Subscription price to subscribers in the City of Toronto, owing to the cost of delivery, is \$2.50 per year, if paid strictly in advance \$1.50.

LESSONS FOR SUNDAYS AND HOLY DAYS.

December 18—4th SUNDAY IN ADVENT.

Morning—Isaiah 30, to 27. Rev. 2, 18—3, 7.

Evening—Isaiah 32, or 33, 2 to 23. Rev. 3, 7.

Appropriate Hymns for Fourth Sunday in Advent and Christmas Day, compiled by Dr. Albert Ham, F.R.C.O., organist and director of the choir of St. James' Cathedral, Toronto. The numbers are taken from Hymns Ancient and Modern, many of which may be found in other hymnals:

FOURTH SUNDAY IN ADVENT.

Holy Communion: 191, 307, 315, 321, 322.

Processional: 215, 242, 268, 306, 444, 447.

Offertory: 52, 53, 203, 223, 534, 550.

Children's Hymns: 47, 333, 337, 338, 340.

General Hymns: 49, 50, 51, 205, 551.

CHRISTMAS DAY.

Holy Communion: 179, 180, 316, 324.

Processional: 56, 58, 59, 482.

Offertory: 62, 483, 484.

Children's Hymns: 62, 329, 330, 341.

General Hymns: 55, 57, 61, 464.

OUTLINES OF TEXTS FROM THE FIRST SUNDAY LESSONS.

BY REV. PROF. CLARK, LL.D., TRINITY COLLEGE

Christmas Day.

Isaiah ix., 6. "His Name shall be called Wonderful."

Surely with full right, this Name, assigned to the Child, whose birthday we are this day celebrating. He is at once Son of God and Son of Man. The very Name of Jesus transcends in its application to Him all other—attains the fullness of its meaning. Text true whether we consider the circumstances of His Birth, the Constitution of His Person, or the work He accomplished.

i. It was no ordinary Birth.

1. Heaven and earth alike interested. (1) No mere earthly splendour attended. No mere birth to an earthly throne. (2) But a moral and spiritual glory—shown by many signs.

2. Note the accompaniments. (1) A light from heaven. (2) Heavenly visitants. Angel. Heavenly Host. (3) Sages from the East, guided by a miraculous star. (4) Herod and Jerusalem trembling because of the birth of the child of a poor maiden.

ii. The Constitution of His Person may well account.

1. No common child born this day. Child of prophecy.

2. More than this. This true of the Baptist who was only the forerunner. Consider His Greatness: in Word and Deed. (1) Never man spake. (2) Done all things well. (3) Word made flesh. (4) Brightness.

iii. Well, then, might His work be wonderful.

1. Only a tremendous work worthy of such a worker.

2. And such the deliverance of man from (1) A fearful bondage and (2) A bondage into which man had voluntarily entered. Not children torn from Father, but become slaves by their own act.

3. A deliverance effected at a great cost.

4. After this nothing can be thought wonderful. "Behold, what manner of love the Father, etc. This the result. Children of a King. Heirs of glory. Yet all the wonder contained in the gift of this day. A day of love. A day of joy. "This day hath God fulfilled His promised word. This day is born a Saviour, Christ the Lord."

CHRISTMAS.

Christmas; the Festival of Christ! The Birthday of Christ! It comes again with its blessed and hallowing message: "Glory to God in the Highest and on Earth peace to men of Good-Will." Peace! and the terrible cannon have not many weeks been silent; and the great nations of Europe are arming, and preparing for the deadly conflict! Yet He, the Child of Bethlehem, Who was as at this time born into the world, was and is and ever will be the Prince of Peace. Did He not leave this special benediction to His disciples: "Peace I leave with you. My peace I give unto you, not as the world giveth, give I unto you: Let not your hearts be troubled." Yes, but there is another side to His work on earth. There is a warfare to be waged before the solid peace of the world can be secured. Where the spirit of evil is not yet subdued, there must be discord and warfare; but the end is not uncertain. The Victory of Truth and Righteousness and Peace is assured although its realization may be long delayed. The Lord of Hosts is a man of war, and many foes have dared to oppose his onward march in righteousness; but the right hand of the Lord

hath done terrible things. He will triumph gloriously. Yet, for all this, He giveth peace—peace in our borders and peace in our hearts. At this very moment, when we cannot be sure that a demand will not be made upon the whole resources of the empire, we can put our trust in the Most High, assured that, however mysterious may be the ways of Providence, all is right in His government. Clouds and darkness may be round about Him; but righteousness and truth are the habitation of His throne. Yet in another sense also He is Prince of Peace. We have peace with God through our Lord Jesus Christ. There is no condemnation to them that are in Christ Jesus. That Blessed Voice has spoken the words of absolution: "Son, be of good cheer; Thy sins are forgiven thee." The Child of Bethlehem became the carpenter of Nazareth, the Preacher of the Beatitudes, the worker of mighty works of beneficence and power, the Victim on the Cross, the Conqueror of death and the grave, the Ruler of the world, to whom all power is given in heaven and in earth, who is seated at the right-hand of God, pouring down His benediction upon humanity. Yes, His work on earth is done, and it is now carried on within the veil—for us men and for our salvation, and the peace of God which passeth all understanding descends upon us, and keeps our hearts and minds in the knowledge of God and of Jesus Christ His Son, our Lord. Love and Peace descend and dwell with men upon the earth. God Himself is with us—Emanuel; and therefore it is that no hatred or strife can find place in our hearts in this blessed Christmas season. Hate is driven forth, Anger is put to shame, Self is silent in the presence of Divine Love. Gathering as a family round the throne of our Father in heaven, represented before that Father by our great elder Brother, how can our thoughts be other than thoughts of love to God, to man, to friend, to foe? A happy Christmas! A happy New Year!

TO OUR FRIENDS.

To our friends, and they are many, and staunch, and constant, we offer the best wishes of this sacred season, with gratitude for their goodness in the past, with confidence in regard to the future. No Christmas has risen upon our labours with happier omens than this one. We have done our best to produce a weekly paper not altogether unworthy of the great Communion to which we belong. In this effort we have able, willing, and cheerful helpers. Nor is our labour in vain. Our circulation increases, and we receive frequent assurances of satisfaction from our subscribers and readers. We can assure them of our gratitude and of our determination to do still better in the future, if that should be possible for us. We may point to our Christmas number as a

not unworthy successor to those previous Christmas and Easter numbers which have been received with so much favour in the past. We have said, we will do our best; and we doubt not that our friends will remember us and do their best for us, as they have done so often. Thus may we hope to do even more satisfactorily the work which we have taken in hand.

CHRISTMAS CHARITY.

Charity means love, and Christmas is the time of love. How has this word come to signify Almsgiving? It is not very difficult to answer the question. "Whoso," says St. John, "hath this world's goods, and seeth his brother have need, and shutteth up his compassion from him, how dwelleth the love of God in him?" Yes. Love is not a fountain sealed, it is a flowing stream; and one who truly loves will give. Yet we must distinguish between mere giving and the giving of love. We remember the noble saying of Augustine, which so angered Pelagius: Love, and do what thou wilt. Yes, love is King of all; for he that loveth dwelleth in God and God in him; and that heart which truly loves will act, will go forth in beneficence, in good deeds, as well as in good will, according to its opportunities. These are commonplaces, yet ever needing to be repeated again and again. Would to God that the fruits of these commonplaces were as abundant and manifest as the maxims themselves are true self-evident. And there are abundant opportunities of exercising this "most excellent gift." In the first place, we have our clergy. How many of them are miserably remunerated for their arduous and self-denying labours! Christmas Day affords an opportunity of showing our appreciation of their toils. Shall we not embrace it? How little have most of us done in the past? Shall we not help to carry joy into some families only too familiar with need and sorrow? Then there are the poor and institutions established for their relief. "Indiscriminate charity," as it is not improperly called, seldom does much good; but there are ways of reaching the indigent and needy, whereby they are not only provided with momentary relief, but helped to their feet again, and strengthened to go on their way. But why go further into details? If the Spirit of Him Who came to heal the broken-hearted, to preach deliverance to the captive, and recovering of sight to the blind, to set at liberty them that are bruised—if that Spirit is in us, it will go out from us, it will find objects for its exercise, and it will not gain satisfaction until it has done its best to become feet to the lame and eyes to the blind. May we have part in this blessing!

CHRISTMAS AND ASSOCIATIONS.

The poetry of Allan Cunningham is greatly to be admired. Nothing finer has been written on a like subject, than his Sabbath Morning, nor is there a more lovely pastoral than his Morning, Noon, and Evening. Singing of the latter part of the Ode, and

describing its ineffable tranquility, he speaks of the slight disturbance made on the water's surface by the leap of a fish, and says:

See the trout in sportive pride
From its placid bosom springs,
To the shore a ruffled tide,
Verges in successive rings.

This familiar incident, so frequently witnessed by brook and stream, but rarely so sweetly recorded, affords a capital figure illustrative of the broadening of reminiscence from a central thought. The panorama, which Time paints for us all, has become in some instances a picture of magnitude. Much of it is too dim to distinguish clearly, but there are places where the colours look as bright as if they had been laid on but a week or two ago, although a few of such scenes were sketched for us when the painter and ourselves were but newly acquainted. Since that blessed period, when Time like a spirit drew pictures for me from an enchanted box of colours, which never fade, a good many things have happened, are happening still; among others, the doctrines of utilitarianism, and progress, are being preached so vehemently, indeed, and so readily is it all accepted, that there is not much inclination to look back on anything. The rapture of retrospection is decried by doctrinaires, and some of the poets, who ought to know better, have, within the last few years, spoken disparagingly of that wistful looking back to scenes whose memories cling to us so fondly, and attacked the sentiment with verse severe. Here I speak of sentiment in its wholesome form, and not an unavailing regret for "departed joys," "departed never to return," although a sigh on that account may well be excused. And what of Christmas, and all the blessed associations connected therewith, and how is it possible to refrain from calling up some one of the Christmas days we remember so well, and which reappears so readily? So many simple objects are associated with the Festival, that it is difficult, as the sere leaves lie strewn around, to keep its memories away. A spray of holly, reflected in the retina, opens an instant communication with memory, and the veil of many years vanishes like that of a dissolving view, and one of those bright spots on the panorama mentioned above presents itself, and all the day of long ago is unfolded. We hear again the awakening peal of the herald bells. Welcome the shy entrance of the gray dawn, anon the broadening light of day, revealing the hills but lightly veiled, as if the snow had been doled by a sparing hand. The enraptured walk to church with other youth—when faith, hope and fervour were not merely visitors, but dwelt within us—when there was deep and sincere piety, and "the freshness of the heart fell like dew." When there were no doubts, and few fears; when the Bible was a sacred book, a radiant sun without spots. How the tunes and anthems we sang at that time have clung to us during the fleeting years, one has only to hum one of them (a bar will do), and from that simple stave the association of ideas develops a mental picture seen as clearly in the mind's eye as if we were again in church listening

to our beloved friends, the singers, and the rector's Christmas sermon, and what a halo of delight surrounds the remembrance, and yet we are told that it is necessary to exercise philosophical restraint, lest such reveries unman one. "When I remember these things, I pour out my soul in me. I went with them to the house of God, with the voice of joy and praise, with them that kept Holy Day." R.P.C.

CHRISTMAS.

Hail, happy morn, blest day divine,
The great exalted theme be thine,
To sing Messiah's birth,
That saw Him leave His throne above,
And saw Him condescend in love
To come down to our earth.

An angel does His birth proclaim,
To shepherds poor, on Bethlehem's plain,
Tending their flocks by night,
Behold to you good news I bring
Glad tidings of a new-born king,
The glorious Prince of Might.

To David's city straight repair,
The promised Saviour you'll find there,
In swaddling clothes array'd;
Go see the Blessed Babe Divine,
And this to you shall be a sign,
He's in a manger laid.

Musick the skies above did ring,
A choir of angels thus did sing,
Glory to God on high,
Good-will to men, we now proclaim,
Sinners adore the Saviour's name,
Salvation now is nigh.

Behold, the offended God appeas'd,
Through Christ His Son, in Him well pleas'd,
Hostilities do cease,
Tow'rd sinful man He's reconciled
Through Jesus Christ the Holy Child,
The blessed Prince of Peace.

The kind Redeemer doth appear,
Mortals your nature He doth wear;
Then join to spread His fame,
Praise ye the Lord that lov'd you so,
Before His sacred footstool bow,
And sing His wondrous name.

The above devotional lyric appeared anonymously in an English magazine of Christmas, 1792. At that time France was in the throes of her revolution, and about a year later beheaded her king, Louis XVI. When one compares the highest social ideals, or the most popular forms of government, where God is not, with the simple piety of the author of the verses, what a mighty contrast there is; can there be a stronger proof of the comforting, humanizing and elevating influence of the Gospel? Well may one repeat with all humility: "Let this mind be in you, which was also in Christ Jesus."—R. P. C.

THE LIGHT OF DAY.

The power of light is not among us in nearly its full splendour, even in that part of Christendom which prides itself in worshipping Christ most purely and simply. If the light were rightly comprehended, then everything would of necessity take a different form. How many there are who have scarcely comprehended anything of it; and those also who joyfully reach out after this light will confess that even if they do comprehend this light, if it is shining in their darkness, it is still far from warming them.

A CHRISTMAS MEDITATION.

Christmas Day, the birthday of our Saviour, the Festival of the Incarnation. How infinite are the lessons which cluster round the manger of Bethlehem! From the time when God created man in His own image, and imparted something of His Divinity to the father of the human race, and the first voluntary act of man was a direct violation of the Creator's command, the Father and the Son, Who had existed with the Father from the eternal beginning, willed that humanity must be redeemed from the penalty of sin. The result was that the Divine Son emptied Himself of His glory, and took upon Him the likeness of men. He was born of a human mother—born in poverty, unknown, unwelcomed. The Jewish nation had long looked forward to the coming of Messiah, the Anointed One. They knew every prophecy which told of His advent. And yet they could not recognize Him when, in the fulness of time, He was born into the world. They knew that He would come as Prophet, Priest and King. But they failed to understand that His sovereignty would be over the hearts of men, and that He would rule by more powerful weapons than the sword. The strange, impressive scene; the busy tourists bound for Jerusalem; the Virgin Mary and Joseph, toiling painfully southward from their Galilean home; the enforced halt at Bethlehem; the crowded village inn; the necessity for some quiet spot where the Child could be born; the stable, with its manger; and the Incarnation of the God-man—every detail, so far as we are privileged to witness this mighty fact, is familiar to us. We need not be

troubled by the criticisms and cavillings of unbelievers. It is enough for the disciple of Jesus to take the truths of Revelation, and offer up a tribute of thankful praise for the privilege of knowing this—the essence of our salvation. At the manger-throne of the infant Jesus, peasant and prince, young and old, ignorant and learned, all kneel together in homage to the Saviour of the world.



THE HOLY FAMILY.

Christmas! How much the term conveys to those who are on the threshold of life, full of brightness and hope, undeterred as yet by the failures and disappointments, which so soon overtake us, as we attain to manhood and womanhood. Christmas is the time, above all others, for family reunions. The absent members of the family; those who have already embarked on the voyage of independent work; those who are scatter-

ed far and wide; all, unless absolutely prevented, return to the old home for the joyous Christmas gathering. At Christmas, too, more than at any other season, the sympathies of those who are blessed with some measure of this world's goods, go out to those in poverty and distress. In the midst of their innocent mirth, surrounded by all that can make them bright and free from care, they must, if they do not shut out from their gaze the picture of the manger at Bethlehem, think of those who are suffering from poverty and privation, and gladly, joyfully, give of their abundance to their suffering fellow-creatures. Every Christmas there are thousands upon thousands of men, women and children, half dead with cold, scantily clothed, and without sufficient bread to sustain their poor, emaciated forms. Many of these might be relieved if the attention of their more favoured brethren were directed to their claims. There is another class, too, who need special consideration and sympathy at this festive season. These are the men and women who are travelling down, on the last stages of the journey of life, alone. They can remember the time when their hearts were full of joy and gladness, when they were the merriest of the happy home circle. But one by one the companions of their earlier days have fallen out of the ranks. As Christmas comes round, another and another empty chair stands waiting for one who will never return; and at last they are left to brood over the past. They live in the days that are gone, until the present, with its aching voids, shows them the loneliness of the evening of their life. To the young and innocent, happy in the enjoyment of the present; to the poor

and suffering, for whom grinding poverty or wasting disease darkens with cruel shadows the very fact of existence; to the desolate and bereaved, whose lot is dark indeed; to one and all the arms of the infant Christ are stretching forth, beckoning them to take refuge in the brightness of His infinite Love. Love—the attribute of Divinity—can check the boisterous mirth, can bring a smile to the pain-drawn face, can call up the soothing tears of remembrance. Love can draw out the generosity and sympathy of the weak to the strong, of the happy to the sorrowing, of the rich to the poor. The God of love proclaims His message to the world—"Peace on earth, goodwill towards men."—Montague Fowler, in Church Bells.

YULE-TIDE.

Heap on more wood! the wind is chill;
But let it whistle as it will,
We'll keep our merry Christmas still;
Each age has deemed the new-born year
The fittest time for festal cheer.

And well our Christian sires of old
Loved, when the year its course had rolled,
And brought blithe Christmas back again,
With all its hospitable train.
Domestic and religious rite
Gave honour to the holy night;
On Christmas eve the bells were rung;
On Christmas eve the mass was sung:
That holy night in all the year,
Saw the stoled priest the chalice rear,
The damsel donned her kirtle sheen;
The hall was dressed with holly green;
Forth to the wood did the merry men go,
To gather in the mistletoe.
Then opened wide the baron's hall,
To vassal, tenant, serf and all;
Power laid his rod of rule aside;
And ceremony doffed his pride;
The heir, with roses in his shoes,
That night might village partner choose;
The lord, underogating, share
The vulgar game of "post and pair."
All hailed with uncontrolled delight
And general voice the happy night,
That to the cottage, as the crown,
Brought tidings of salvation down.
—Sir Walter Scott.

CHRISTMAS IN ENGLAND—THEN
AND NOW.

In some respects this may be read as the second part of my article, bearing the same or similar title, which appeared in last year's special Christmas number of *The Canadian Churchman*. It is only those who, like myself, have passed by a few years even the sear and yellow leaf period of life, who can at all realize the contrast in so many respects, in the way and manner of observing the Christmas festival during the somewhat earlier part of this century and the present time. There never was a time, since I can remember, when the rich did not remember the poor at Christmas-tide. When in every poor man's cottage, as well as the rich man's hall or nobleman's castle, it was the rule to find the roast beef and plum-pudding of Old England—the genuine, delicious plum-pudding—not the miserable caricature of it such as it was represented to be in one of Uncle Sam's publications not long ago, evidently from the pen of a writer too smart to be accurate, and

too wise to know anything about it; and it sometimes happened "Then" under a mistaken idea, that neither too much in vogue, that neither rich nor poor people could enjoy themselves in a becoming manner without alcoholics of some kind, and that at least on Christmas Day. Beer was added to beef and pudding, and too often anything but a devout spirit of thanksgiving was the result. With or without these drinks mere creature comforts were well supplied. But, alas, for the spiritual part of the feast. The Church had "Then" as she has "Now," and always will—made ample provision for her family and household. But the members of her household and family like those mentioned in the Gospel, while ready enough to partake of mere carnal things, specially the Christmas feast, were in very many instances only too ready to make excuses for neglecting the spiritual feast provided. Every careful reader of the history of the Church from the days of Queen Elizabeth to the present time will know how true it is she has been—

"By schisms rent asunder, by heresies distressed."

First, by various forms of Jesuitical machinations, their emissaries coming into this country in the days of good Queen Bess, as public records will show, with the highest testimonials, as persecuted Protestant clergymen—of whom Faithful Cumyn and Nicholas Heth are sorry samples—who with many others, under the pretense of making the services of the Church purer, became the progenitors of the Puritans and Puritanism of whom ultra-Protestants are ever ready to make their boast, specially so of the so-called Pilgrim Fathers, though Calvin and John Knox preceded Cumyn, Heth, etc., on the same lines I have not met with the term Puritan or Puritanism earlier than the days of the Jesuit emissaries I have mentioned. In their eyes the Church was looked upon as a mere rag of Popery or worse, as the "old Scarlet Woman" herself. Fancy the Jesuits starting the rag of Popery hue and cry, which for a time served their purpose, culminating in the proscribing of the Book of Common Prayer as being no better than the Popish mass-book—a good stroke of Jesuitical business—and in either closing the churches altogether or placing soldiers, Roundheads or Ironsides therein with loaded carbines, ready to shoot bishops, priests and deacons, who dared by performing the divine services of the Church, to obey God rather than men. Practically as well as theoretically with a prohibition of divine service all the holy days of the Church, and Christmas among them, were for the time abolished. In Scotland where John Knox had succeeded in establishing his Presbyterian system, up to a very recent period, at least, the keeping of Christmas was denounced, as his followers did in England—as Papistical—when heretics and schismatics were found usurping the places and functions of the regular and Apostolical order of clergy in our "Then" desecrated "Holy and beautiful houses of God in the land." The baneful effects of Jesuitical Cromwellian Puritanism; the corrupting influences of the court in the time of Charles II.; the secret at first, as some

say, then open apostacy of James II.; the principles of Erastianism introduced into the government of the Church; the appointment of courtiers rather than divines to fill the highest and the most sacred of her offices by or on the nomination of William III. during his reign. The torpitude of the Church during the time of the Georges, and where it exists even to this day, was mainly due to the influence of men imbued with the Jesuitical fanaticisms of the Puritans on the one hand, and of Erastian worldliness on the other, that but for the divine blessing on the efforts of a comparatively small number of clergy and laity, who, like the seven thousand men in Israel, were always faithful, ever true, would neither bow the knee to nor kiss the image of the Baals set up for the purpose—the Church's light must have gone out, and her candlestick been removed out of its place. Thank God this was not, could not be so. See St. Matt., xvi., 18; xxviii., 20.

The Oxford Movement.—How much the Church has lost or gained by this movement is a subject for impartial discussion, and will be estimated by men who may be equally fair and honest in their estimate of it, as the results appear to them viewed from their different standpoints. From my own point of view it is neither the unmitigated evil some would have us believe, nor the unmixed good others imagine it to be. But in spite of the apostasy of Manning, Newman and some minor prophets, and if I may say it without offence, the influence of Jesuitical professors in disguise upon some of the weaker or more enthusiastic students of our universities, who are by their means prepared to rush into and adopt what must be called, to be honest, Romish, or at least, semi-Romish practises, such as we frequently read of; such men being in, but evidently not of, the Church. While allowing a liberal margin for the real or supposed losses, the balance, so far as my experiences go, of the good resulting from this movement; specially in the conduct of divine service generally, and especially so in the celebration of Christmas. Much saying and little singing and less earnest devotion had previously been the rule. In nearly every church I remember as a boy the services were too often a hurried duetto between the parson and the parish clerk. There are now surplice choirs, and an earnest devotional tone throughout the service, while the parish clerk is an institution of the comparatively remote past. Space forbids or illustrative cases could be given ad lib. to demonstrate the advantages "Now" has over "Then." Perhaps the following may serve in some degree not only as a change in the form of writing, but also indicate the spirit in which Christmas with its sacred and joyous festival was "Then" and is "Now" realized.

THEN.

O give us fresh garlands of Holly, of Mistletoe,
Ivy and Bays,
For lessons we look on as folly till after the Christmas days;
Let us use our exuberant forces in sliding on
smoothest of ice,

(Continued on page 764.)

A CHRISTMAS LESSON.

Christmas is essentially a heart festival. It is a time not only for recalling the birth of Bethlehem's babe, but for dwelling upon the wonderful significance of the Incarnation. "God manifest in the flesh," is the way the Apostle puts it. What a condescension that God should stoop to earth and assume a human form and become partaker of our nature! When Webster read Chalmers' sermon on "The Wonders of the Telescope," his reason and his faith were shaken; how could a Divine Being, who created unnumbered systems of worlds, each circling around a central sun, stoop to one of the smallest of the planets and concern himself with our petty cares? But the great preacher delivered another sermon, in which he dwelt upon the wonders of the microscope showing that in the little rolled up searied leaf of Winter blown hither and you, there lay securely wrapped and protected from the snow and the cold a miniature world that should awaken and increase at the coming of Spring. Then the great statesman concluded that if God could care for the little insects, that glitter in the sun and protect them in their long Winter sleep, He could care for immortal man; and so his faith came back to him. Even so, God who regardeth the sparrow's fall and clothes the lilies of the field, will not lose sight of man, who is "of more value than many sparrows." The infinite condescension!—think of it, bereaved one, who misses a familiar voice and a vanished hand at the Christmas table. He took the beloved one, but not for one moment has He forgotten you; He will come in and be your Christmas guest if you will permit Him. Think of it, aged one with bent form and dimmed eyes looking to-

wards sunset—He knows your weakness, He sees your failing strength; lean upon Him and find Him your perfect strength. The infinite condescension! think of it young man and young maiden; ponder it, old, and middle-aged, and young. Let us appropriate the lesson—the lesson of humility and self-abnegation and trust. Let us learn to sink self in the work before us; to work unflinchingly along the line marked for us, seeking



O COME, ALL YE FAITHFUL.

not our own but what is God's; we have but to do and leave results with Him. So doing we shall fulfil the noblest purpose of living, and fit ourselves to be inhabitants of eternal mansions in the heavens—for a home in the skies.

—To many weary toilers in stores, etc., Christmas is a time, not of rejoicing and enjoyment, but of long working hours, endangering health and life.

EARLY COMMUNION.

Its value is thus beautifully expressed by the late Canon Liddon: "A Christian of the first or second century would not have understood a Sunday in which, whatever else might be done, the Holy Communion was omitted; and this great duty is best complied with as early in the day as possible, when the natural powers of the mind have been lately refreshed by sleep, when as yet the world has not taken off the bloom of the soul's self-dedication to God, when thought, and feeling, and purpose are still bright and fresh and unembarrassed; then is the time, for those who would reap the full harvest of grace, to approach the altar. It is quite a different thing in the middle of the day; even when serious efforts are made to communicate reverently. Those who begin their Sunday with the Holy Communion, know one of the deepest meanings of that promise, 'They that seek Me early shall find Me.'"

LOVE OF CHRIST.

What else should be in our thoughts at this most holy time, except the love of Christ. Of all the news that could be brought to you or me, what so good as this, that unto us was born, as at this time, "a Saviour which is Christ the Lord?" If the news came that all the world

was yours, all the wealth, all the money, all the farms, all the houses, all the shops, all the corn, ought such news to make your soul so glad as the tidings that you had a Saviour? Which would be worth most, the tidings that you had all the world and all that was in it, or the tidings that you had the hope of eternal life. This is the glad, good tidings of Christmas. Rejoice then, and believe.

—Nothing is more dangerous than a friend without discretion.

In skating or riding ice-horses we'll bound o'er a mile in a trice.
O, turkeys and geese and mince-pies, roast beef and plum-pudding, and all
The good things the season supplies to cottage and castle and hall;
Ye oranges, raisins and nuts we salute you with good appetites.
Regardless of "ifs" and the "buts" we'll enjoy e'en ambrosial delights.
Hurrah for our hoary December, he brings us our glad Christmas Day;
But then we must always remember not to spend all our spare time in play

NOW.

While we join in the mirth of the merry, we must endeavour also to be wise
And wisdom must be of the very best type unstanding supplies,
But hearken the church bells are ringing to welcome the gladdest of days;
Let us haste where the choirs are singing, and join in the service of praise,
With angels who sang in their glory, told the shepherds that Jesus was born;
Who listened with joy to the story angels told on the first Christmas morn.
Having joined in the praises and prayer, and shared in the holiest rites,
How poor must the feasting appear if it ends in ambrosial delights;
Still hail joyous Christmas, "All Hail," ever welcome to people and priest;
May love and all virtues prevail throughout all this grand Christmas feast.

Santa Claus.—Santa Claus was then almost if not quite an unknown and unheard of personage. Christmas was not kept green in the memories of ten thousand times ten thousand little ones in delightful anticipation of his very benevolent visits. His mysterious coming and going had not then mystified the lambs of the fold. As I know the little people dearly love a bit of rhyming as a rule, I have penned the following lines, hoping they may please and edify them:

Dear Santa Claus is coming—is coming here to-night—
This blessed Christmas Eve in which he takes delight,
So let us put our stockings in a row upon the chairs,
And keep our eyes wide open, and then when he appears
We shall see what he is like, and thank him for the toys,
And all the nice and pretty things he brings for girls and boys.
Now that all is ready let's say our prayers, and go to bed;
But while I say "Our Father" Santa Claus comes in my head;
Perhaps it will be better if I first put out the light;
But can he see the stockings? 'Tis very dark to-night—
Perhaps he has a lantern, just as the pictures show;
And Christmas tree, as well, all sprinkled with the snow.
He is very late in coming and my sleepy eyes do ache;
No matter how I rub them I cannot keep awake.
Did you not hear his footsteps, treading softly on the snow?
Or hear his welcome whisper in accents sweet and low;
Lest he should wake you little ones, now so gently sleeping.
O'ercome by old Somnolis, though you intended keeping
The eve of Christmas vigil, but failed in this, alas!
That is why you missed observing just how it came to pass,
You did not hear his whisper, nor heed him in his knocking
At your bedroom door, e'er he filled your largest stocking,
With toys, and tools, which clever boys find handy—
For little girls he brought new dolls and bags of sugar candy;
And such lots of pretty things too various to mention,
Although to do the same was at first my full intention.

But now you are awake again, and having rubbed your eyes,
And Santa Claus will hear you shout in very glad surprise.
Oh, what a dear old fellow, Father Christmas, you must be
To bring so many and nice presents every Christmas Day to me!
And oh, how many children in their joy of heart will pray
They may be more like Jesus each returning Xmas day.

As I have said, then Santa Claus was a stranger quite unknown, now, at least to the little ones, he is not only well known, but is the persona grata without whom Xmas would be shorn of one if not the most innocent attractions. While repudiating most emphatically the fallacious, but too oft repeated assertion, that Germany is the Fatherland of our race, for though our Anglo-Saxon forefathers were a long time in, they were not of, Germany (see Charon Turner's History of Anglo-Saxons), at the same time I willingly and gratefully acknowledge our indebtedness to Germany for the gift of Santa Claus and the Xmas tree, by which the dangerous and sometimes disgusting snap-dragon amusement of snatching raisins steeped in brandy, all ablaze, has been driven very nearly from juvenile Xmas amusements. Here I desire to say, and I think it quite ad rem, that however strange and contradictory it may appear to those who do not know the seizure and modus operandi as disclosed by history to ascribe to Jesuits, all or nearly all, the evils wrought against the Church from within as well as without her sacred enclosure. But State papers bear such undoubted evidence of the fact, that none but those who see everything papal colour de rose, or are wilfully blind, can have any reasonable doubt as to their progenitorship of the hun-

RENFREW'S

Importers and Manufacturers of

FINE FURS

Our display of Seal Skin and Persian Lamb Jackets is immense. There is a style and character about our furs that gives them a superiority over all others. **Men's Fur and Fur-lined Overcoats, Fur Caps, Gauntlets, &c.** Pattern Book and Price List sent on application.

G. R. RENFREW & CO.

5 KING STREET EAST, TORONTO

35 & 37 BUADE STREET, QUEBEC



THE "ANGELEE."

dreds of schismatic sects from John Calvin and John Knox down to the last split among them. It is a well-known fact that, however divided and sub-divided the various sects and parties or orders as they are called may be in the Papal Church, on many and very important points to the outside world they endeavour to appear as one and indivisible. In the matter of observing saints' or so-called saints' days, more especially the great festivals such as Christmas, Easter, etc., were and are still observed by the Papal Church, often with unjustifiable ceremony, and by none more so than by the Jesuits, now undoubtedly the dominant sect or order in that heterogeneous though seeming homogeneous body, the

the Book of Common Prayer as nothing better than the Popish mass-book, and the observance of festivals, and it may be fasts, as a kind of double distilled Popery. They "Then" lived as they "Now" live—moved and had their being for the purpose of sowing the seeds of discord, envy, hatred and malice—and are as busy "Now" as they were "Then," and the existence to-day of some say four hundred, and an ever increasing number of schismatic sects, shows how abundantly they have succeeded in their evil work. But in spite of Jesuitical-Puritanism, in spite of wolves in sheep's clothing, in spite of Erastianism and false brethren within and open rentless and relentless foes of all sorts

fat things" by the rich to the poor nor the mere enjoyment of special creature comforts by all classes in the community—the real contrast lies in a much more exalted realization of the blessedness of the privileges conferred upon us by the birth of Christ, producing a much more true religious life, a deep spiritual-mindedness which enables the happy possessor of the new state of things the more readily and gladly to exclaim:

Let us go into His gates with thanksgiving,
And into His courts with praise.

on each returning Christmas Day, and with a merry jest on his returning to his home to partake of the temporal as he has just taken of the spiritual feast, he will then show his



WINTER SCENE.—LODGE, ENTRANCE TO GOVERNMENT HOUSE, ST. JOHN'S, NEWFOUNDLAND.

Papal Church. As is believed, the Order or Sect of the Jesuits was founded by Ignatius for the express purpose, and generally understood to be a cardinal point with them, has been, "the end justifies the means" and as the purpose for which they were instituted was to counteract the influence of the reformed and homogeneous Church of England, they adopted, as it seemed to them, such methods and means as best suited the end they had in view—to bring into utter contempt, if they could not destroy, the Church of England by any and every means in their power. They even denounce the Pope with ultra-Protestant vehemence to lend seeming sincerity and force to their denunciations of

and conditions without her pale, our dear old Church of England, and her healthy and vigorous daughters spread o'er all the earth—has fought and is fighting a good fight, and is still, though Genevan and Roman adversaries are prowling around and about her, marching on bright as the sun, fair as the moon and glorious as an invincible army clad in the panopy of war, conquering and to conquer in the might and power of her Lord and Master. Let me say in conclusion that the contrast between the "Then" and the "Now" in the celebration of this to every Christian glorious festival of our Blessed Redeemer's nativity, does not consist so much if at all, in the supply of the "feast of

Thankfulness unto Him
By speaking good of His Name
for the blessings wherewith He hath blessed
mankind, inasmuch as on this day

Unto us a Child was born;
Unto us a Son was given;
Whose name was to be called JESUS.

Note.—For confirmation of my statements (a) re Jesuits and Puritanism, see "Foxes and Firebrands" (a scarce work), and (b) as to the closing of churches, proscription of the Book of Common Prayer, and the persecution of the clergy, etc., etc., see "Walker's Sufferings of the Clergy" at the hands of Oliver Cromwell and the so-called Puritans.—George Ward, Toronto.

—A man of principle is a man of power.

"A MERRIE CHRISTMAS"

A Merrie Christmas to you!
For we "serve the Lord with mirth,"
And we carol forth glad tidings
Of our holy Saviour's birth.
So we keep the olden greeting
With its meaning deep and true,
And wish "a Merrie Christmas
And a Happy New Year to you!"

Oh, yes! "a Merrie Christmas,"
With blithest song and smile,
Bright with the thought of Him who dwelt
On earth a little while,
That we might dwell for ever
Where never falls a tear:
So "a Merrie Christmas" to you,
And a Happy, Happy Year!

—Frances Ridley Havergal.

Home & Foreign Church News

FROM OUR OWN CORRESPONDENTS.

NOVA SCOTIA.

St. Eleanor's.—St. John's.—The Lord Bishop of the diocese held a confirmation in this church on Sunday morning, Dec. 4th. Nineteen candidates received the Apostolic rite of the laying on of hands. Immediately after the close of the confirmation service there was a celebration of the Holy Eucharist, at which all the newly-confirmed partook of their first Communion. A large number of others in the congregation received also. In the afternoon of the same day at 3.30, his Lordship held a confirmation in St. Mary's

church, where seventeen candidates were presented, which made a total in all for the whole parish of 36. There were large congregations in both churches, and the Bishop's addresses to the confirmees were listened to throughout by all with reverence and attention. In the evening, at 6.30, this church was again well filled, when, immediately after the processional hymn, the Rev. J. M. Withycombe, the rector-elect of the parish, was duly inducted and instituted into the benefice by the Bishop. After evening prayer had been said his Lordship occupied the pulpit, and preached a most lucid discourse, taking for his text, Heb. vii., 25.

FREDERICTON.

Fredericton.—As much as there is to justify our self-congratulations upon the steady advancement of the Church's interests in this diocese, there is one duty which the Church is not attending to. It is now many years since King's College, Fredericton, was lost to the Church, and its course of instruction altogether secularized. Before this, she was the collegiate institution of the diocese, and the earliest men of the province to take Orders were educated there. Since the date of her loss, King's College, Windsor, Nova Scotia, has received diocesan recognition. The Bishop of the diocese is ex-officio a member of the Board of Governors for this institution, and every year, at the meeting of the Diocesan Synod, two are elected as Gov-

ernors to represent the Synod. More than this every deanery in the diocese has the right to elect one, and represent it on the Board of Governors. The Diocese of Fredericton is given the same privileges that the Diocese of Nova Scotia enjoys, and so far as the government of King's College is concerned given an equal interest in it. I notice, too, that so far as taking advantage of what the law allows which governs that institution of learning—so far as the concern of electing representatives on the Board, etc.—the diocese expresses its interest. From the new calendar of King's College we learn that every deanery has elected a representative. The precious hours of Synod are not considered wasted when the "Report of the Governor of King's College" is read and discussed with the other reports. But beyond this this diocese renders no assistance. Individuals may give, and probably do give, but that is an individual matter, which cannot be taken into consideration. While in Nova Scotia every parish is asked to contribute to King's College, in this diocese, after all the recognition which is given to that institution in other ways, not a parish is asked to give. Sixty parishes in Nova Scotia respond with an offertory amounting in all to nearly \$500; not a parish in this diocese is asked for a contribution and there is not a parochial offering of a single dollar. Now the thought suggests itself, what is the reason. Surely the educational work

(Continued on page 768.)

Choice Holiday Books



JUST PUBLISHED.

Ian Maclaren's New Book

AFTERWARDS.

and other sketches, 12mo, cloth, \$1.25.

These sketches are in the same style as the famous "Bonnie Brier Bush," but with the exception of two are in English. In these two the author takes his readers back to Drumtochty, and in his inimitable style tells of the passing of Domsie, and of Dr. Davidson's last Christmas. These sketches are equal in pathos and humor to anything Ian Maclaren has written.

NOW READY.

OUR TWO NEW GIFT BOOKS.

Hugh Black, M. A.

FRIENDSHIP.

With marginal and other decorations by T. Berkeley Smith. Printed in two colors, 12mo, decorated cloth, gilt top, boxed, \$1.25.

Dr. W. Robertson Nicol, says: "Mr. Hugh Black, of Free St. George's, Edinburgh, is now—we suppose—the most popular preacher in

Scotland. His wise and charming book, 'Friendship,' is full of good things winningly expressed, and though very simply written, is the result of real thought and experience."

New Booklet by Dr. J. R. Miller.

"The Secret of Gladness"
Beautifully illustrated. Small 4to, artistic paper cover. 35 cents.

JERUSALEM the HOLY

By HON. EDWIN S. WALLACE.

With maps and diagrams drawn especially for this work by Archibald Dickie, of the Palestine Exploration Society; and other illustrations. 12mo, cloth, \$1.50.

The author of this work has resided in Jerusalem for four or five years as United States Consul for Palestine. His opportunities for daily personal observation, combined with extensive reading, have qualified him to write a brief, popular description of the Holy City. It finds a place awaiting it, for of the works on the same subject already produced, those in any degree authoritative are commonly too exhaustive for general reading, while the briefer works are usually the impressions of tourists or transient visitors.

Dr. J. R. Miller's New Book

The Master's Blesseds.

A Devotional Study of the Beatitudes
Decorated margin, 16mo, cloth, gilt top, boxed, \$1.00.

In its mechanical details—deckel-edged paper, ample margins with artistic illuminations, ornamental chapter headings, decorated covers—the book is worthy of subject and author.

New Volumes by the Author of "Probable Sons" (Amy Le Feuvre).

A Puzzling Pair.

With illustrations on every page. By EVELINE LANCE. 4to, cloth, \$1.00. Cheaper edition, small 4to, cloth, 50c.

Written in the best manner of this popular author, and uniform in mechanical details, with the much appreciated "The Odd One," this new volume is certain to attain a popularity equal to that of its companion. The story deals with the adventures of two small seekers after truth—Guy, the artist, and his extremely practical twin sister, Beryl—who live in an old manor-house by the seashore.

Left almost entirely to themselves, they find employments for their leisure which are quite out of the ordinary and full of incident.

His Big Opportunity.

Illustrated. 12mo, cloth, \$0.75.

Dudley and Roy, otherwise known as "David and Jonathan," are cousins, and live with their grandmother. A strenuous soul in a frail body, Roy burns with the desire to do some great deed, and feels that all he lacks is opportunity. After many mistakes, leading to mishaps, amusing and serious, his opportunity comes to him. The narrative inculcates many useful lessons.

New Book by the Very Rev. Dean Farrar.

GREAT BOOKS

16mo, cloth, gilt top, \$1.25. Also by the same author, "Men I Have Known." Illustrated with numerous letters and portraits. 12mo, cloth, gilt top, \$1.75.

NOTE—Our Holiday List of Books, Booklets, Calendars, &c., for 1899, is now ready.

SEE OUR SPECIAL OFFER

Send us your name and we will mail you a copy.

FLEMING H. REVELL COMPANY

Also NEW YORK and CHICAGO.

154 Yonge Street, TORONTO.

PEACE ON EARTH.

For any true peace on earth, there must be peace with God. God has said it universally: "There shall be no peace, saith my God, to the wicked." How can there be peace in the soul so long as man is not reconciled to his Maker? Strange word—"Peace with God!" Then, if there is now peace, there has been war. War with God! War of a worm with Omnipotence! Yet so it was, and so it is and so it would be forever, if the Day-spring had not come and laid his hand upon us, both. He, and He only, is "Peace." And he who has Him has peace. People say: "Make your peace with God." Make your peace with God! You can never make your peace with God. But accept Christ and you accept Peace. The Gospel is the treaty; the angel's song, echoed now, was its herald; that light upon the hills was its flag of truce; the love of the Father drew the treaty; the blood of Christ sealed the treaty, and the contracting parties are an eternal God of truth, and every rebel man who lays down his arms, and puts his hand to the contract and professes "Jesus only." Made by that peace with God—within it, and a part of it, is the peace of the conscience, a sprinkled conscience. The language of that conscience is: "I believe—I feel—I know that I am forgiven. I am simply nothing but a poor, poor sinner, forgiven; but whatever happens to me now, my affairs stand right with God." He has said it and I take it. "There is now no condemnation to them who are in Christ Jesus;" and there, by the infinite grace of God, I have placed myself, and I now am. They talk of "Christmas pleasures!" What are they all to that sense of safety, that deep, inward peace? Can there be "pleasure" if there is no peace? Could the Israelites sit down to the Paschal ban-

quet, with the angel of death in the air, and no blood upon the door? Can you enjoy life if you are not ready to "meet with God," who may come in upon the Christmas revel? Be sure that you have peace with your own conscience—the peace of a witness within that you are in Christ—that you love Christ—that you would not willingly do anything to grieve Christ; that your own heart knows, in your own poor way, your first wish, your great end in life, is to please and serve and glorify Christ. Oh that this "peace" may be

given over to them, therefore, without stint or reservation. And I think sometimes that parents do not always understand this. It is right and all-essential that restrictions upon the amusements of the young should prevail in every home. But Christmas Day is the one day when these barriers ought to be lifted, and the young given free play. No wholesome liberty nor indulgence should be withheld from a boy or girl on that day. What of it, my dear friend, if such liberties do mean a tear here, or a broken chair there?

Suppose the boy is particularly noisy on Christmas. What of it? Tell me, if you can, a better sign of strong, young health than the noise from a boy's lungs! Suppose he does throw himself, or even jump or stand, on your best lounge, and soil or rumple your pet tidy! Pass over it, don't notice it, but let the boy have his Christmas Day. And if the little girl does insist upon putting her sticky candy fingers on your dress, what of it? Let her romp and tear all over the house. Give her the joy of feeling that for one day the house is hers in every nook and corner of it. Let her put her smutchy little hands on the white paint of the door or wall. I know a home, my dear woman where marks of four little smutchy fingers may be seen any day on the white paint of a door, and they are treasured above

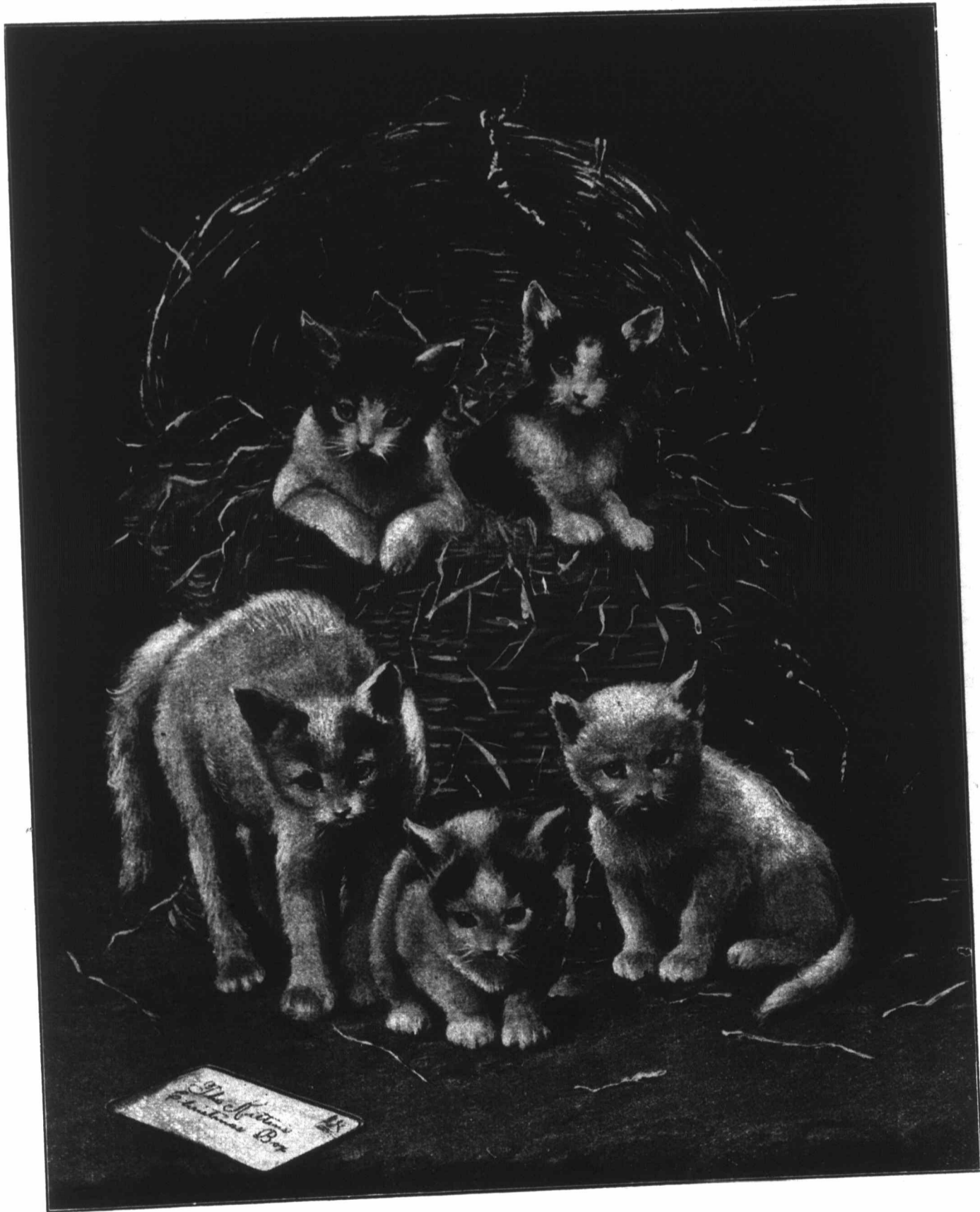

THE KITTEN'S CHRISTMAS BOY.

God's own Christmas gift—the peace of a Christ born in the low places of your own poor, mean, wicked heart; a Christ known—a Christ consciously your own—a Christ reflected in a life of self-sacrificing forgiveness and love to everyone. Put peace into your motto.—Canon J. Vaughan.

CHILDREN AT CHRISTMASTIDE.

"If there is one day in the year which rightly belongs to the young it is Christmas Day," writes Edward W. Bok, in the Christmas Ladies' Home Journal. "It should be

the costliest ornaments in that house. Nothing could induce the mother of that home to wipe off those finger-marks, and gaily would her heart sing if the little fingers that put them there could make others all over the doors and windows of that house. . . . Let each one of us, who can, give freedom and zest to the dearest treasures of the Christmastide; the young barbarians of our homes. God bless them, I say. May each child in this land of ours have a Christmas Day this year fashioned after his own heart."

—Man's greatest treasure is time.

of the Church is of first importance. If there is any reason whatever why we should not as a diocese be contributing to the support of King's, there is no reason why the diocese either unitedly, or, perchance, divided, should not be giving to other institutions in the Dominion. Every clergyman of the Church surely must feel it a duty to speak to his congregations upon the subject of education, and to ask them to give for the support of some Church College. And few earnest Churchmen but would esteem it a privilege to help in this work if it were held up before them. King's College having our recognition and sympathy in one way it is natural that our contributions should be for her. If she is not worthy of financial support let the diocese throw her off altogether. It is hardly just to encourage the diocese of Nova Scotia to look for financial support when that support is not given, and it is humiliating for men to receive an education at King's which fits them for the ministry and then feel that the liberty or license is not given to ask that their Alma Mater should be supported. Especially is this the case when the work which her graduates are doing in the priesthood is judged as being up to the standard. King's College is embarrassed financially; but how could it be expected to be otherwise? Her students are few, but there is hardly a man who is a graduate, and who has taken Orders for work in this diocese for the last several years who has not come from her. There are few men preparing for the

ministry in this province and only too few of the young men of the Church taking advantage of a college course. This, as much as anything, is the reason why King's is not filled. It might help the members of the Church in this diocese to realize how much we are indebted to King's College to count those who for the last few years have gone to college elsewhere, or at least prepared themselves for Church work in this diocese at another college. A glance at the Clergy List will show how much we are to-day indebted to King's College. Out of 80 clergy working now in the diocese, 10 received their education in England. Of the remaining number, 38 have degrees in arts, but of these 38, 21 either received both arts and divinity at King's, or having graduated in arts at the University of New Brunswick went afterwards to King's to receive instruction in divinity and to prepare for Orders. This leaves only 14 graduates in arts, who are not identified with King's, and with the exception of four or five these are graduates of the University of New Brunswick. The majority of these graduated before she became lost to the Church and are favouring King's to-day. This shows the indebtedness of the diocese. The Governors elected by the Synod state in their last report: "We have satisfaction in reporting favourably of the general condition of the college. . . . A resolution was passed by the Board of Governors requesting the Bishop of Fredericton to ask the clergy in

charge of parishes to have a collection annually in behalf of King's College. We hope this may be done." All your correspondent has said is without any reflection upon the Bishop. He would maintain a silence rather than to make this. The Governors in their report express the hope that the Bishop will ask for an offering for King's. If the King's men express the desire they should, there is no doubt that the Bishop will give them liberty. Let them try it and see. When the Bishop does not ask his clergy generally to do this there must be some good reason for not doing so. I think the clergy generally feel sure of this. But if King's men were united in their interest in their Alma Mater they would find, no doubt, that there are very few of the clergy who are not ready to help as much as they, and that the Bishop would only too gladly give them liberty to appeal to their congregations with his consent. Then our encouragement of educational matters would be real, and our recognition of King's College practical, and that institution would receive from us in the present hour of her financial distress what she may well expect from true Churchmen, and loyal graduates.

St. John.—The annual sale of St. John's (stone) church was held one day last week and proved quite as successful as usual. On Dec. 8th St. Mary's church held a sale and
(Continued on page 770.)

HOLIDAY HINTS

Upper Canada Tract Society

102 YONGE STREET, TORONTO

Great Books. By Very Rev. F. W. Farrar, D.D. With portraits. 16mo, gilt top, \$1.25.

The Anglican Reformation. Rev. Prof. Clark, D.D. \$2.00.

Friendship. Hugh Black, M. A. Decorated cloth, gilt top, boxed, \$1.25.

Men I Have Known. Dean Farrar. \$1.75.

Jerusalem the Holy. By Hon. Edwin S. Wallace. A Brief History of Ancient Jerusalem; with an account of the Modern City and its Conditions, Political, Religious and Social. 15 illustrations and 4 maps. 8vo, cloth, \$1.50.

A Man's Value to Society. Studies in Self-Culture and Character. By N. Dwight Hillis. \$1.25.

"We say with emphasis that wherever good literature, charming for its style, refinement and force is appreciated, this little volume will have a hearty welcome."—Public Opinion.

The Investment of Influence. A Study of Social Sympathy and Service. By N. Dwight Hillis. \$1.25.

"From the literary point of view the essays are choice productions, and the dignity, sincerity, impressiveness, and moral and spiritual uplift of their thought are conspicuous."—Congregationalist.

The Wonderful Century. By Alfred Russell Wallace, author of "Malay Archipelago," "Darwinism," etc. crown 8vo, about 400 pp., \$2.00.

Contents: Modes of travelling, Labor saving machinery, The conveyance of Thought, Fire and Light, Photography, Spectrum Analysis, Physics, The Minor Application of Physical Principles, Dust, Chemistry, Astronomy, Geology, Natural Selection, Physiology, Phrenology, Hypnotism, Vaccination, the War Spirit, The Demon of Greed, The Plunder of the Earth, Conclusion.

Daily Strength for Daily Needs. By Mary W. Weston. 16mo cloth, \$1.00. White and Gold, \$1.25.

Stories from Starland. By Mary Proctor, daughter of the famous astronomer. A capital book of astronomy and stories for children. 75c.

Books by Author of "Probable Sons."

A Puzzling Pair. By Amy le Fenve. With illustrations on every page by Evelline Lance. 4to, decorated cloth, \$1.00. Written in the best manner of this popular author, and uniform in mechanical details with the much appreciated "The Odd One," this new volume is attaining a popularity equal to that of its companion. Cheap edition, no illustrations, 50 cents.

The Odd One. With illustrations on every page by Mary A. Lathbury. Small 4to, decorated cloth, \$1.00. Cheap edition, no illustrations, 50 cents.

"It is written in the same charming and engrossing style which the readers of 'Probable Sons' will remember. It is longer and more elaborate, but the quality holds out to the end. It is daintily illustrated."—The Congregationalist.

His Big Opportunity. Illustrated. 12mo, cloth 75 cents.

Dudley and Roy, otherwise known as "David and Jonathan," are cousins and live with their grandmother. A strenuous soul in a frail body, Roy burns with the desire to do some great deed, and feels that all he lacks is opportunity. After many mistakes, leading to mishaps amusing and serious, his opportunity comes to him. The narrative inculcates many useful lessons.

Teddy's Button. Illustrated. Small 4to, decorated cloth, 50 cents.

"Teddy's Button" was taken from the coat of his dying soldier father, and in the hands of the boy became a sort of talisman and incentive to valiant service as a soldier of Jesus Christ. The story is one of fascinating interest, and the moral of it is not far to seek. The little folks will need no urging to read it."—The Evangelist.

A Thoughtless Seven. Illustrated. Small 4to, decorated cloth, 50 cents.

SOCIAL EQUIPMENT



FEW things are more indispensable to the social equipment than a Piano. That it should be a good one goes without saying. Nothing shows worse taste than to ask a musically-cultivated guest to play upon or sing to a poor Piano. People of taste and tact fully appreciate this fact, which may explain the large number of Mason & Risch Pianos in the homes of the cultured. There is another point about them, namely, that not only are they beautiful when new, but they retain their beauty of tone and elegance of appearance for years after instruments of inferior character are worn out.

The  MASON & RISCH
Piano Company, Limited

32 KING ST. WEST, TORONTO

ection an-
 We hope
 respondent
 upon the
 nce rather
 in their re-
 Bishop will
 the King's
 ld, there is
 e them lib-
 When
 enerally to
 reason for
 generally
 men were
 Alma Mater
 there are
 ot ready to
 the Bishop
 a liberty to
 th his con-
 of educa-
 our recog-
 al, and that
 us in the
 stress what
 Churchmen.

St. John's
 y last week
 usual. On
 a sale and
 D.)

e social
 ould be
 Nothing
 ultivated
 People
 which
 z Risch
 e is an-
 only are
 r beauty
 after in-



Taken from "Black and White."

MAMMA'S DARLING UNDER THE MISTLETOE.

5 o'clock tea in the Sunday school room. St. Andrew's day was observed in Trinity church as the day of Intercession for Missions. Litany and Holy Communion at 11 a.m. Evening Prayer and address at 5 p.m. There was a corporate Communion for the members of the Brotherhood of St. Andrew in this church at 7.30 a.m. There was a Brotherhood service in St. Paul's in the evening at 7.30. The Ven. Archdeacon Phair of Winnipeg visited St. John last week in the interest of missions in the West.

St. Stephen.—Trinity.—This church held a sale and tea in their Sunday school room a fortnight ago.

St. Andrews.—All Saints.—The rector of this parish has been interesting himself of late in the repair of the old burying ground. He has succeeded in collecting something like \$150 from absent friends or relations of those who are buried there. This will be quite sufficient to put the ground in a good condition, replace the stones, and to put a hedge about the property. The Men's Association of this church have opened a club-room for its members during the winter. They have secured a room in the business part of the town and furnished it with games of different kinds, and a reading table, and have this open three evenings in the week. At present there are between 20 and 30 members in the club, and it promises to be a very successful undertaking.

MONTREAL.

Montreal. St. George's.—The Rev. O. W. Howard, B.A., Toronto University, and at present the principal of Rothesay College, N.B., has been appointed curate of this church in the place of the Rev. C. J. James, the new rector of St. Thomas', Hamilton. Mr. Howard, when at Toronto University, won the Governor-General's gold medal. He also took first-class honours in philosophy. The new curate, who is 28 years of age, will commence his work in the parish on New Year's Day.

St. Stephen's.—The Ven. Archdeacon Evans last week completed his 25th year as rector of this parish. The present is also the 25th year of the marriage of the Archdeacon and Mrs. Evans. To commemorate the dual event an "At Home" was held at Elm Hall, and upwards of 400 guests, members of the congregation of St. Stephen's Chapel, were present. A pleasant surprise was given to the Archdeacon by his congregation, in the shape of a presentation of a Queen Anne solid silver tea service, bearing the following inscription: "To the Ven. Lewis Evans, M.A., D.C.L., Archdeacon of Montreal, on the completion of his twenty-fifth year as rector of the parish of St. Stephen's, this souvenir is presented by the members of his congregation as an expression of their high esteem and regard. Nov. 20, 1898." The presentation was made by Mr. Charles E. Cook. Among those who spoke briefly were Bishop Bond and Mr. R. Wilson-Smith.

ONTARIO.

Portsmouth.—St. John's.—The new school-house, built in connection with this church, was opened and dedicated by the rector, the Rev. O. G. Dobbs, on Wednesday, December 7th. The Rev. J. O. Crisp, the curate, assisted in the service. The building itself is of stone, fine handsome windows, a large hall inside, 30x45, and two rooms, thirteen feet square, adjoining. Mr. Power was the architect. The mason work was done by Mr. McCartney and the carpenter work by Joseph Hooper. Mr. Hooper's work has been most satisfactory, and the appearance of the school-house, both inside and out, is a credit to the architect and to the contractors. The cost of the building is about \$1,500, and this sum was subscribed by the members of the congregation and a few friends within \$200 or \$300 of the amount, so that the debt upon the building amounts to only about \$300. The Lord Bishop of Ottawa conducted a Confirmation service in this church on the evening of the 7th inst. Nineteen candidates, seven males and twelve females, were admitted to the full membership of the church. The Rev. J. O. Crisp, the curate-in-charge, presented the candidates to the Bishop, and the Revs. C. E. Cartwright and O. G. Dobbs, the rector, were also present.

Kingston.—The Executive Committee of this diocese held their bi-annual meeting in this city on Thursday, December 1, when a

(Continued on page 772.)

OVER 1,000,000 PACKAGES SOLD WEEKLY

DRINK **LIPTON'S**
 AWARDED THE HIGHEST HONORS AT THE WORLD'S FAIR
 SUPPLIED UNDER SPECIAL ROYAL WARRANT TO
 THE QUEEN OF ENGLAND.
TEAS



LIPTON'S
 Delicious Teas

possess that most delicate flavor and exquisite aroma peculiar to the choicest growths of Ceylon and India

They are put up in 1 pound and 1-2 pound airtight packages.

PRICES: 30c., 40c. and 50c.
 per Pound Package

LIPTON, Tea Planter, CEYLON

Lipton's Teas have the Largest Sale in the World.

U. S. Offices: 80 Front St., NEW YORK
 Chief Offices: City Road, LONDON, Eng.

Canadian Offices: 65 Front Street East, TORONTO.
 W. M. BOWIE, Agent.

Christmas and Easter Church Brass Work

Special discounts on all orders given between now and Easter. We have done some of the finest work in Canada. Testimonials on application.

CHURCH BRASS WORK

Memorials, Eagle and Rail Lecterns, Altar Vases, Ewers, Candlesticks, Altar Desks, Crosses, Vesper Lights, Altar Rails, etc. Chandelier and Gas Fixtures.

CHADWICK BROTHERS
 MANUFACTURERS

182 to 190 King William St., HAMILTON, ONT.

CHRISTMAS REVERIES.

What word in our language can possibly arouse in our minds such a mass of associations, joyful and painful, inspiring and depressing, as the word Christmas? First of all our thoughts rush back to the time of childhood, for in most households, even in those where stern work is the order of the day, and but little attention is paid to recreation, some thought and care are given to the task of making Christmas cheerful for the little ones. The name calls up recollection of festivities; the old oak-panelled dining-room—seen so many times in its ordinary dress—but changed into fairyland by the presence of three glittering Christmas trees; one very tall, one in the middle nearly touching the ceiling, and a smaller one on each side, lighted with Chinese lanterns and coloured tapers, and covered with wonders in the shape of coloured glass balls, silvered fir cones, and waxen princesses in muslin robes; while underneath the trees were white paper parcels containing long-coveted treasures to be opened by eager little fingers. Then there were the games of General Post, Blind-man's Buff, and Family Coach; the snapdragon, with wicked little flames curling round the hot raisins; and bran pies, for boys to plunge into with heads or hands, in search of apples and oranges. There was the brass band, which always came from the provincial town on the last day of the old year, and played with commendable persistency, year after year. "Hail, Smiling Morn," and the more appropriate "Mistletoe Bough." There was the village choir, singing carols in the frosty air with voices somewhat hoarse from over-exertion, but yet reminding even the most juvenile hearers of the deep reason for rejoicing, which underlay the general merry-making; and there were the handbells, most charming of all to childish ears, playing chimes in the half-lighted hall. There were plays and charades, written by the elder or more enterprising children, and acted by all, King Jamie being arrayed in the scarlet silk coat of an ancestor, and another hero having a moustache gummed on so tightly that he positively could not open his mouth to speak his part. Certainly the time for enjoying Christmas to the full is in early youth. In later life the recollections of sorrows gather round the season; some dearly loved one has perhaps been taken from us just when the joy-bells were ringing, and the remembrance comes back when the Christmas story is told again. Some cynical folk would intimate that to them the season brings nothing but bills, and the necessity for providing everybody

with Christmas-boxes; postman, dustman—no one must be forgotten. It is a significant fact how much the Christmas season has been shortened in modern times. In old days, the Lord of Misrule was appointed to preside over the accustomed festivities, and his reign actually lasted from All Hallow E'en, the last day of October—when mysterious ceremonies were conducted in connection with the burning of nuts, and with peering into a looking-glass at midnight for the tremulous pleasure of beholding the shadowed face of a future husband over the shoulder—until Candlemas Day. Even the most sanguine among us would not now attempt to prolong our merry-making for three months. In Scotland the same position was held by an official called the Abbot of Unrea-

time of the year, and try to forget differences of opinion, and to heal old feuds. At Christmas-time is seen the good side of the interest country people take in their neighbours, rich and poor. There is a heartiness if a certain shyness also, in the greetings exchanged between all ranks of people in the churchyard after the morning service, The school children all receive useful presents of clothes, as well as the more fascinating sweetmeats and crackers, and little bands of boys and girls go about together in their bright scarlet comforters and new frocks, singing, "Noel." So entirely is Christmas associated in our minds with the kind of snow scene which is represented on the conventional Christmas card, that a green Christmas appears quite an anomaly. The lighted and decorated shops, the pantomime and theatres, may appeal to the town mind, but to those who have been brought up in the country, it seems almost a necessity to return thither when the mystic season draws on; to steal into the moonlit garden while the chimes are ringing, and to see each branch and twig of the climbing roses, and each delicate fern-leaf outlined in frosty rime, and glistening in the faint, uncertain light; to gaze up into the deep-blue dome where:

"All heaven bursts her starry floors,
And strews her light below."
—A. Temple.



LOVING CHRISTMAS THOUGHT.

Beautiful lines are those that bless,
Silent rivers of happiness,
Whose hidden fountains few may guess.

Beautiful feet are those that go
On kindly ministries to and fro—
Down lowliest ways if God wills it so.

son, until the year 1555, when it apparently dawned upon the Scotch mind that the revels, under the Abbot's fostering care, were being carried to excess, and his office was summarily abolished by Act of Parliament. Early Christian preachers remonstrated with their flocks for paying too little heed to the solemn character of the festival, and giving too much attention to its lighter side. But surely there are many even now who are unsophisticated enough to love the old customs and to reverence the spirit that speaks through them; many who still decorate their rooms with the scarlet-berried holly, and hang a huge bunch of mistletoe in the hall, and who call their relations together at that

the festival of the Nativity, when he sent an order, to "shut the doors, and put fire to the church." This was done, and the whole congregation was burned to ashes. Thank God again that these times of trial are not sent to us; that we may sing, "Christ is born in Bethlehem," without dread of cruel rulers.

—The Christmas Globe is worthy of the reputation of the great newspaper to which it belongs. It is printed admirably on fine thick paper, and the engravings are of great excellence. The literary matter is quite worthy of the dress in which it is presented.

—Perseverance is of infinite length.

great deal of routine work was disposed of. The Ven. the Archdeacon of Kingston, (Dr. Bedford Jones), presided, and there were also present, the Very Rev. Dean Smith; Rural Deans Wright, Forneri, Loucks and Carey; the Revs. Messrs. Burke, Serson, Grant, Tighe, Emery, Lewin, Rayson, Worrell, Cooke, Spencer and Harris; their Honours Judges Wilkinson and Reynolds, and Messrs. Walkem, Pense, Shannon, Smythe, Rogers, Allan and Turner. The chancellor reported for the committee upon canvass in England, stating the recall of Rev. F. W. Armstrong, who sailed for home on November 26th. Letters from the canvasser detailed the disappointing results of the work. Expense summary was submitted, including a printing bill of \$560. Full financial reports will be made to members of committee upon Mr. Armstrong's return. Then the reports upon Rev. C. J. Hutton's canvass in the diocese for \$30,000 supplemental endowment were most cheering. The Church people are zealous in wishes and endeavours. In the last parish visited Mr. Hutton was given only one refusal. He now felt that \$50,000 would be necessary and that it can and will be collected, but he would require more time than anticipated. The feeling of the diocese was opposed to an interim assessment for coadjutor's salary. Over \$8,000 was subscribed already and \$2,000 was paid in. A return was asked by resolution of the proportion of allotment of subscriptions. The report of the committee upon a coadjutor bishop reported no action or progress, but repeated the Archbishop's willingness to act when the necessary funds are available. Messrs. Pense, Worrell, Wright and Smythe urged vigorous action for raising \$3,000 at once to secure the new Bishop, and provide \$2,500 a year for two years until the supplemental endowment is secured. Judge Reynolds, Rev. Mr. Harris and others urged action. The proposal of Mr. Pense at the June Synod for a conference with vestries and congregations was

generally approved, and the committee was reconstructed to act forthwith: The chancellor, the treasurer, two secretaries, the dean, Rev. Prof. Worrell and Mr. Pense. The chancellor submitted the special committee's report, giving a list of the clergy in the order of seniority. The regret was expressed that the records had been imperfectly kept, advising the printing of the list for opportunity of objection and advising the preparing of a book of record, that shall be properly attended to. This report was adopted. Rev. R. W. Rayson next reported for the Church depository committee and Rev. A. W. Cooke for the diocesan library. The committee on religious instruction, Rev. Prof. Worrell, convener, reported approving the scheme submitted by Rev. Mr. Symonds, of Peterboro, as a minimum, provided instruction be confined strictly to facts of Bible story; any further must be in the hands of accredited church teachers. Prof. Worrell reported for divinity students' fund, showing \$497 on hand, two students having retired, leaving only one assisted student. Rev. J. Lewin reported for finance committee, recommending payment of accounts. It was explained that the expenses of the Bishop of Ottawa on confirmation tours would be paid out of the fund voted to the Archbishop for such duties, \$200 a year. Arrangements were made for printing reports for Synod information in discussions in connection with the journal tenders. The audit committee, through Rev. S. Tighe, reported the finances of Synod most satisfactory. The report of the investment committee also reported that interest on loans and investments had come in freely, although the rate of interest earned was steadily declining. Dr. Smythe for See House Committee reported an increase of \$109 in overdraft to \$2,068, and the receiving back from the Archbishop the house, which had been offered for sale or lease. The domestic and foreign missions committee reported receipts for half year of \$674, including \$486 from the

Woman's Auxiliary. The latter Board was, in sympathy with a wish at Provincial Synod, asked to meet the committee prior to next Synod and to the half-yearly session of D. and F. M. Board. The report of the Diocesan Mission Board and of the committee on stipends of clergy were presented in the lines already reported in connection with their meetings. For rectory lands Rev. W. B. Carey reported receipts of \$5,321 for the half year, and a temporary increase of overdraft from \$50 to \$939. For widows and orphans' fund he reported payment of \$1,430 in pensions during the half-year and the decrease of overdraft from \$782 to \$933, the generosity of the Woman's Auxiliary having reduced the debt as well as assisting the payments Mrs. Moore and four children and Mrs. Stanton were added to the annuitants. The normal income is now about two-thirds of the necessary expenditure. For the clergy superannuation fund the receipts were: From last year, \$546; collections, \$205; interest, \$90. To capital \$250 was added and \$225 was paid to annuitants, leaving \$420 on hand. The case of Rev. F. Codd was referred to the Executive Committee. The lack of interest by the clergy in this fund was deplored. Before adoption of the report arrangements were made to pay Mr. Codd \$200 a year through the Mission Board. The clergy trust fund reported receipts of \$3,057 for six months, with payments to clergymen of \$2,712; the overdraft was reduced from \$667 to \$348. The Episcopal Fund reported normal receipts, and a recent impairment of capital on the Campbell farm was ordered to be assessed and written off. The business being finished the proceedings were brought to a close and the meeting adjourned.

—May this Christmas bring us more of love and holy joy than we have before known, and not to us only, but to the whole world.

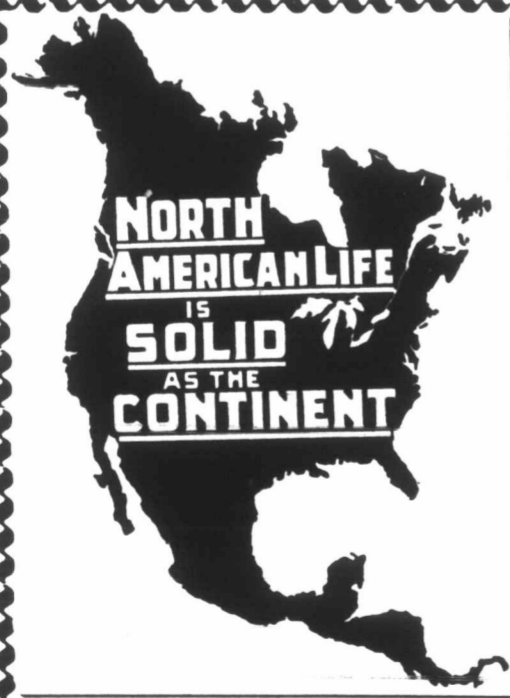

LIFE!

Your chief joy in life should not be the **narrow** one of satisfying your **selfish** desires, but the **broad** one of doing all the good you can for others. Then, make sure provision for loved ones by insuring in the North American Life. All that's best in life insurance, which is absolutely the only kind of property the law secures to "Preferred Beneficiaries," is given in the plans of the North American.

Write for information, and let us or our agents, who are almost everywhere, explain a plan to meet your needs.

L. GOLDMAN, *Secretary.* WILLIAM McCABE, *Managing Director.*

THE NORTH AMERICAN LIFE ASSURANCE COMPANY,
112-118 King Street West, Toronto, Ont.

REPUBLIC AND ROSSLAND MINING SHARES

Lone Pine, Black Tail, Sans Poil, Jim Blanie, Princess Maude and others, all at closest quotations.

Also Athabasca, Golden Cache, Deer Park, Salmo Consolidated, Van Anda, B. C. Gold Fields and all the standard stocks.

Write or wire for quotations.

The stocks of Republic Camp are engaging increased attention.

E. STRACHAN COX, 9 Toronto Street.



The Nordheimer
PIANO & MUSIC CO. LIMITED
MANUFACTURERS OF THE CELEBRATED

NORDHEIMER PIANOS.

15 KING ST. EAST TORONTO.

CHRISTMAS.

Christ healed the sick and helped the poor,
When He was on the earth.
Do what you can to be like Him
This morning of His birth;
Help someone to keep Christmas morn,
The day your Saviour, Christ was born.

And on this Christmas morning,
When the frost is at the door,
Dear child! in your warm, pleasant home,
Think of the sick and poor;
So shall you well keep Christmas morn,
The day our Saviour, Christ was born.

A CHRISTMAS STORY.

Old Father Christmas was sitting in his elbowchair. The curtains were drawn, the lamp was lit, and the fire was burning brightly. In spite of these comforts the old man was looking dreadfully troubled. He frowned and he sighed, and he sighed and he frowned; and then he looked up at his greatcoat, which was hanging on a nail on the door, and which, as every child in the town knew, was as full of pockets as it could be, and he shook his head very sadly. The fact was that he had given such a quantity of things away for so many, many years, that his stores had come to an end, and he had nothing at all left. In two days he would be expected by hundreds of children, he could not bear to disappoint them, and there were his pockets just as flat as pancakes. What should he do? A glass of hot elderberry wine was steaming away on the table by his side, and now and then he sipped a little, for the night was cold and frosty, and he was not so young as he had been. After a bit Father Christmas began to grow drowsy, and he nodded his head to the fire instead of shaking it at his great coat, with its flat pockets, and presently he fell fast asleep. And then he had a dream. He thought a beautiful lady came into the room, dressed in shining rose-coloured clothes. And she went no farther than the door, but stood by the old man's coat, and felt slowly in each of the pockets. When she had dived into them all she came up to Father Christmas. "You know what to do, of course?" said she. And before he had time to say that he was at his wits' end, and had no idea how his pockets were to be filled, she went on speaking: "There is no need for me to tell you how many children there are who would be glad and happy to give you what they can for the little ones who are looking forward to your coming, and who would be so much disappointed if you took them nothing." "Children who will give?" cried Father Christmas. "I thought children always wanted to have

things given to them. Why, I have been giving presents to children ever since I began, and that is a very long time ago, I can tell you." "Come with me," said the lady, and she took his hand in hers. At the same moment Father Christmas found himself standing with her by a little child's sick bed. The child was half awake and half asleep, and was cuddling a soft, woolly lamb. "She won't give me toys," said Father Christmas. "She wants them herself." "That is just why she will give," said the lady. Then she bent over the child and said something very softly, and the child opened her eyes quite wide, and they shone like stars. "The poor children have no presents," said she. "Oh, I am so sorry! Will you please give them my lamb? It is such a darling thing, and I love it so." Then the child kiss-

playing and looked at each other. "I oughtn't to give away my newest presents," said George, whose birthday it was. "But there is my old top, which is nearly as good as new." And then each child went to its treasure-box, and each took out something and laid it on the table by nurse. One or two gave their toys a kiss, and one had tears in her eyes, because she was so very fond of her old doll. Still they all gave willingly. "I should never have thought—" began Father Christmas; but before he had finished speaking he found himself in another home, and then another and another. And everywhere the children gave what they could, some more generously, some more cheerfully, but not one said "No." "What did I tell you?" said the lady, smiling. And just at that moment Father Christmas woke up and found himself in his own elbowchair, with the fire blazing merrily before him and the elderberry wine still steaming on the table by his side. The dream had seemed so real that he looked round for the lady in the rose-coloured dress. She was nowhere to be seen, but, wonderful to say, the poor flat pockets in his greatcoat were sticking out in every direction, and were just as full as they could be.—Cecil Medicott.

THE FATHER'S HOUSE.

Christ has taught us to call God "our Father" (Matt. vi., 9); therefore our Father's House is our home. Christmas always gathers around it the thought of home. What home is like this? All that earth can give is nothing compared to this. There was a New Zealand chief who visited England. He was a man whose heart was with God, and whose delight was in the Word of God. One day he was taken to see a beautiful mansion near London. The gentleman who took him expected to see him greatly astonished and charmed with its magnificence and splendour; but it seemed to excite little or no admiration in his mind. Wondering how this could be, he began to point out the beauty and grandeur of its costly furniture. Tamahama heard all silently; then, looking round upon the walls, replied: "Ah! my Father's house is finer than this." "Your father's house!" thought the gentleman, who knew his father's home was but a poor mud cottage. But Tamahama went on to speak in his own expressive language of the house above—the house of many mansions, the home of the redeemed. Tamahama, like his Saviour, had but a manger kind of home on earth, but he also had a mansion in the skies.

—The true Christmas spirit is the spirit of universal kindness, thoughtfulness and love.



THIS IS A LONELY CHRISTMAS.

ed her toy and held it out with a smile to the lady. "Did I not tell you?" said she, putting the gift into Father Christmas' hand. Before he had time to make any answer, he and the lady were entering a nursery full of noisy, romping children. The nurse was sitting by a lamp working, and she was just saying: "Another five minutes then, because it is Master George's birthday." The lady went up to the nurse and whispered in her ear, and then moved back and stood by Father Christmas, and no one in the room seemed to see them. "Listen, all of you, young ladies and gentlemen," said nurse. "Who is going to think of the poor children this year? You have plenty of nice presents given to you, but there are many homes where no child ever gets a present, even at Christmas time." The children all stopped

Board was
cial Synod,
or to next
sion of D.
f the Dio-
nmittee on
n the lines
with their
y. W. B.
or the half
f overdraft
d orphans'
30 in pen-
ie decrease
the gener-
having reg-
g the pay-
ildren and
annuitants.
two-thirds
the clergy
were: From
5; interest,
and \$225
g \$420 on
old was re-
e. The lack
nd was de-
report ar-
Codd \$200
oard. The
ts of \$3,057
clergymen
duced from
nd reported
pairment of
s ordered to
he business
ere brought
ned.

us more of
ave before
to the whole

AND

ss Maude and
olidated, Van

ention.

O LIMITED
CELEBRATED
ER
NTO.

HURON

Seaforth. The Bishop of Huron held a Quiet Day for the clergy of the rural deanery in this town on Friday, Dec. 2nd. Every clergyman in the deanery was present, eleven in all, two of them driving 60 miles, and two others 35 miles, in order to attend. The rector had made every arrangement for the comfort and convenience of his brother clergy, a large class-room having been fitted up with carpets, easy chairs, tables, etc., and an excellent luncheon was served at the rectory by the ladies of the parish. The day began with a celebration of the Holy Communion in St. Thomas' church, the rural dean being the celebrant, the Rev. T. L. Armstrong assisting, after which the Quiet Hours were held in the school-room. The Bishop addressed his clergy for two and a half hours on the "Priesthood of Christ." After adjournment he again spoke for two hours on "Growth in Grace." In the evening divine service was held in the church, all the clergy, with the Bishop, having a place in the chancel. St. Thomas' Church has one of the brightest services in the diocese, and it was heartily enjoyed by all. The Bishop again addressed the large congregation present for upwards of an hour on the Second Advent. The whole proceedings were deeply interesting to the many clergy present, and a unanimous vote of thanks was tendered the Bishop for his deeply spiritual explanation of the Word of God. His Lordship promised to make these Quiet Days an annual affair in

each deanery, and we have no doubt much good will result therefrom.

Millbank.—The Rev. J. H. Moorhouse, of London, visited this parish, Dec. 1st and 2nd, lecturing in Crosshill on "How to Make the Most of Life," and in Millbank on "Cultivating a Taste for Reading." He also preached at the annual meeting of the Millbank W.A. His lectures were very much appreciated, and would prove a splendid tonic for every parish who could secure the lecturer. Mr. Thompson, P.S. teacher (a Presbyterian), in moving a vote of thanks, said it was one of the best lectures he ever listened to. Mr. W. V. McMillan of Milverton, in seconding the motion, spoke in similar terms. Mr. Thomas Magwood, ex-M.P.P. (Methodist), very highly praised it from the chair.

—We have received very pretty calendars for 1899 from the Taber-Prang Art Company, of Boston and Springfield, Mass., which have been beautifully got up, and are real works of art in every way. The Bachelor Calendar is particularly pleasing, each page being beautifully illustrated with bunches of various wild flowers, in addition to some other appropriate illustration. The whole effect is most charming, and we heartily congratulate the Taber-Prang Company on the result of their work.

—In this world it is not what we take up, but what we give up, that makes us rich.

BELLS ACROSS THE SNOW.

O Christmas, Merry Christmas!
Is it really come again?
With its memories and its greetings:
With its joy and with its pain
There's a minor in the carol,
And a shadow in the light,
And a spray of cypress twining
With the holly wreath to-night;
And the hush is never broken
By laughter light and low,
As we listen in the starlight
To the "bells across the snow."

O Christmas, Merry Christmas
It is not so very long
Since other voices blended
With the carol and the song,
If we could but hear them singing
As they are singing now,
If we could but see the radiance
Of the crown on each dear brow;
There would be no sigh to smother,
No hidden tear to flow,
As we listen in the starlight,
To the "bells across the snow."

O Christmas, Merry Christmas!
This never more can be;
We cannot bring again the days
Of our unshadowed glee.
But Christmas, happy Christmas
Sweet herald of good will,
With holy songs of glory
Brings holy gladness still,
For peace and hope may brighten,
And patient love may glow,
As we listen in the starlight
To the "bells across the snow."

—Frances Ridley Havergal.

RELIGION IN THE KITCHEN

Wife's got a Souvenir Range

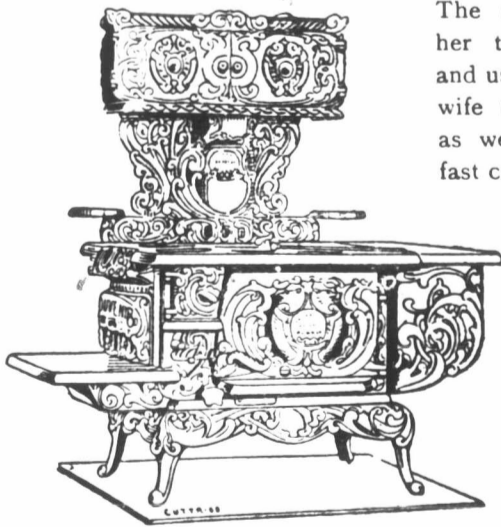

Men spend the larger part of a lifetime in store or office. The average woman must needs give a generous share of her time to the kitchen. The chief article of furniture—and usefulness—in the kitchen is the stove. Compel the good wife to worry along with a fifth-rate range, that is an eyesore as well as a mental anxiety day in and day out, and you are fast cutting short her lifetime.

When a SOUVENIR RANGE adorns the kitchen it is a thing of beauty and a joy forever. These stoves are beautifully finished and an ornament to any kitchen. Best of all—the only stove with the celebrated

AERATED OVEN

They perform every detail of kitchen work with a completeness that makes life in the kitchen a source of joy and happiness.

The bread in the oven; the roast of beef; the delicious turkey; the toothsome pudding, are never spoiled in the cooking if the good wife has a Souvenir Range installed in the kitchen.

Souvenirs are sold by reliable agents throughout Canada.

One will last a lifetime.

We guarantee absolute satisfaction to all our patrons.



An exclusive feature
and crowning point of
perfection is its
Unrivalled

AERATED OVEN

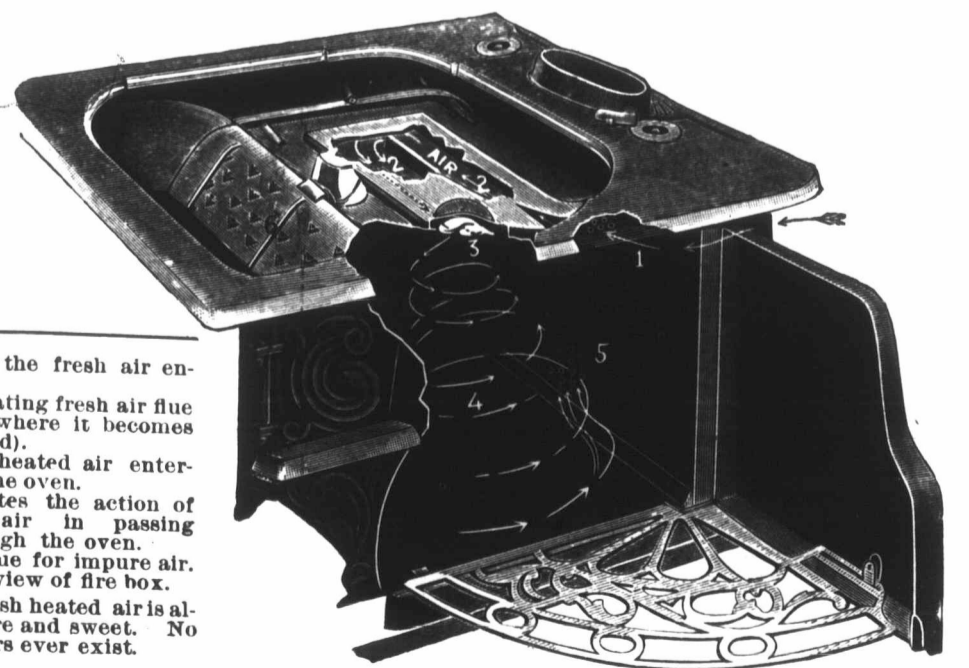

1. Where the fresh air enters.
 2. Circulating fresh air flue (and where it becomes heated).
 3. Fresh heated air entering the oven.
 4. Indicates the action of the air in passing through the oven.
 5. Exit flue for impure air.
 6. Back view of fire box.
- The fresh heated air is always pure and sweet. No foul odors ever exist.

THE GURNEY-TILDEN CO., Limited, Hamilton, Can.

Manufacturers of Stoves, Ranges and Radiators

A DOG'S CHRISTMAS TREE.

Yes; a Christmas tree just for a dog, and he liked it, too. Liked it, did I say? He thought it was the loveliest thing he had ever seen; and barking couldn't half begin to express his feelings. His eyes, his ears, his feet, his tail, all were animated to the last degree in his vain attempt to express his rapture. Shep's mistress didn't have any little boys and girls at her house, and I suspect that Shep got a good deal of the petting that would have belonged to them if they had been there. But it was Tina, the maid, who thought of a Christmas tree for his favoured dogship. She got a tiny green tree, and set it up in a box, and hung it with popcorns and Shep's favourite candies. Then she placed it in the corner of the parlour, and Shep's mistress invited him in, and explained all about the Christmas tree to him, that it was his very own. Don't you think he knew every word she said? Then why did he begin to bark with all his might and jump around the tree, and around his mistress, and race around the room as if he had lost his wits, and then go over to the tree, and, sitting down beside it, put his little paws together and beg for some of the goodies "this very minute"—that's what his eyes said? The tree lasted several days; for Shep's mistress dealt out the candies to him a few at a time. And how they did enjoy the fun. That was two years ago. Last year Tina got another little tree, and dressed it up in her room where no one could see it. When she had finished it, she opened the door and came out into the hall with it in her hands, intending to take it down into the parlour when no one was looking. But a pair of sharp eyes in the lower hall spied her the minute she started; and what an excitement there was! Don't you think a dog can remember such a splendid thing as a Christmas tree for a whole year? If you don't, you would have been convinced if you could have seen the rapture that was expressed in every motion of his elastic little body, as he scampered up the stairs and round and round Tina, barking with all his might, and almost upsetting her and her precious burden. He superintended the placing of the tree in the parlour; then he rushed off post-haste to tell his mistress. She was in her room; but a frantic barking outside the door told her that something important must be attended to at once. As soon as she appeared, Shep jumped upon her in wild delight, then rushed as fast as he could back to the parlour, barking to her all the way to come quick. She followed him in, and there stood Tina and the Christmas tree. "Why, Tina," said her mistress, "I had forgotten all about it!" But

Shep said, "Not I!" and he suddenly sat down before it and began to beg. Wasn't that a funny thing to please a dog? This is a true story; and you may be sure that there will be another tiny tree for a merry little dog when Christmas comes again.

HEAVENLY JOY.

We must, I suppose, often feel—it must be so in the average course of life with some or other of us—that we are hardly in tune for the rejoicing of Christmas. The rush of gladness, which it brings with it through a whole people, through all the wide realms of Christendom, deepens to many by sharp contrast, the bitterness of a recent bereavement, the sorrowful watch round a hopeless sick bed. Or it may be, while we are saluting our Lord's coming with hymns and carols



WALKING IN THE LIGHT.

Thy way, not mine, O Lord,
 However dark it be;
 Lead me by Thine own hand,
 Choose out the path for me.

of child-like exultation, and repeating the angelic welcome to the Prince of Peace, that by a terrible irony the heavens around us are black with storm and danger; that great nations are involved in the horrible death-struggle of war; that day by day men are perishing by every form of carnage, and suffering every form of pain, and that by each other's hands. Such Christmases we have known before, such a Christmas we are passing through now. We almost ask whether it is not mockery to think of gladness. Yet it is in place; yet Christmas claims it from us. Those great gospel songs which heralded the Incarnation of the son of God, the Magnificat, the Benedictus, the song of the angels, were themselves but the prelude to the life of the "Man of Sorrows." They

are followed immediately by Rachel weeping for her children at Bethlehem, and the flight from the sword of Herod. But yet in those dreadful days on earth, of blood and pain and triumphant iniquity, there was peace in heaven and the joy of the angels; for amid the clouds and storm of the conflict, which men could not see through, the angels knew who was conquering. He is conquering and to conquer still. All falsehood, all cruelty, all selfishness, all oppression and tyranny, are to fall before Him. Amid the darkness of our life, the hope of man is still on Him, as fixed and sure as it ever was. He will not disappoint man of his hope. Christmas bids us look up, in spite of everything, and lift up our heads. Come what may, nothing can efface the mark which Christmas has made in the rolls of time—"for us men and for our salvation, He was incarnate by the Holy Ghost, of the Virgin Mary, and was made man." Let us, in spite of noise and turmoil, or fear of sorrow, give that its due place in our hearts. Let not private trouble, nor the march of the world and the crash of its conflicting powers, drown its holy call. It speaks to us, if we will but listen; it speaks as it did on that first Birthday of our Lord, of the "peace beyond all understanding;" of the "joy unspeakable and full of glory," with which apostles, and saints, and martyrs went through life and death to God.

THE CHRISTMAS MESSAGE.

Cold must be the heart that has no response to this great Christmas sentiment, barren indeed the home into which no recognition of the Christ Child enters, no thought of the inestimable gift that has made all mankind brethren. To the poorest and humblest of us this Christmas message speaks. The wise men required the guidance of a star, but to the watching shepherds the angel spoke face to face; and there is a Christmas sentiment in all these gay streets and jostling crowds that the wise men of our own day are not always the first to understand. In a few days more the evergreens will have faded, and we shall be going about our business with all the stern realities of the new year before us. But we shall carry something over from this great holiday that will not fade, if we care to keep it green, a new impulse of faith and love that will keep the world still growing brighter and better because of Christmas Day.

—Saturday Night for Christmas is a pretty number of a publication which holds its own for ability and enterprise. Don and Mack are recognized leaders, and they have here able coadjutors.

OVEN

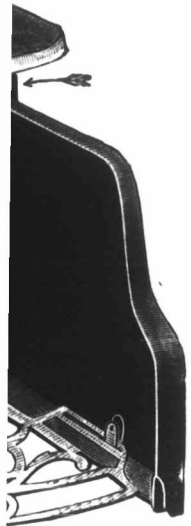

n.

MAMMA'S CHRISTMAS PRESENT.

"Oh Hetta!" cried little Rufie Ward, rushing into his sister's room like a great gust of wind, "see what I've got!" Brown-eyed Hetta looked up from the knitting she was doing carefully, at the letter he held in his hand. "What is it?" "A letter from the gentleman whose dog I saved when those bad boys were going to drown it; and he has sent me five dollars to get you and me a Christmas present. But—but, Hetta," repeating the word over in his eagerness, "I want to make a Christmas present for mamma instead." It was so many years since their father had died that "mamma" made all the children's home world. "Mamma said she would not have much money to buy us Christmas things this year," said Hetta. "She has been so sick. Oh, yes, Rufie dear, I'd rather mamma should have the presents than me." "We're getting so big," said Rufus, drawing himself up to his full height, "we don't want stockings any more. Let us hang up mamma's stocking. Shan't we?" "I'll knit a large one myself," said Hetta, delightedly, "and Mrs. Peters will teach me to turn the heel." "And don't let mamma know I've got the letter. It is directed all to myself, and she was not at home when the postman came," Rufus cried. Christmas Eve, mamma was very tired and went to bed early, and in the morning they were to have their little gifts. The first rays of the Christmas sun saw two small Santa Clauses hurrying downstairs. Then the large white stocking that Hetta had knit was drawn forth, and the good things were put into it. Little fingers had done the work, as the irregular stitches showed, but it was the prettiest stocking she had ever seen, I fancy, to Mrs. Ward. There was an orange and an apple, and a box of figs, which mam-

ma liked so much, and candy; and a little wooden case, which Rufus had made himself, with paper in it, for mamma wrote a great deal; and a pair of warm gloves; and hanging beside the stocking a pretty shawl, for which kind Mrs. Peters had bought the material and helped Hetta to make; and a pair of warm slippers, and a dear little blue book, gilt-leaved, with poetry in it, for mamma loved poetry—surely one five dollars had

mamma, you must look at your things." "Oh, my darlings!" said Mrs. Ward, after she had examined the gifts, with the tears shining in her eyes, as she drew them both to her in one fond embrace, "you have early learned that 'it is more blessed to give than to receive.'"

GRANDMA'S DOLLS.

The children were waiting to see the Christmas tree, and the time seemed so long that grandma had to tell them a story. "Well," she began, "when I was a little girl there were no toy-shops, and my mother used to make my dolls herself. I remember one Christmas Eve she was called away to see a sick neighbour, and left my big brother to keep house. 'I have nothing finished for Patty's Christmas stocking,' she said as she drove away. 'It's too bad.' That evening my brothers were in a great hurry to get me off to bed, and after I had gone up-stairs I could hear them whispering and fussing about a long while. Next morning, when I put my hand into my stocking, what do you think I found? First, a little doll cut out of a potato; its face was painted black, and with bead eyes and a bit of wool from our black sheep, it made the most comical little darkey that you ever saw. Then I pulled out a pretty little figure whittled from a shingle. My brother Ralph was something of an artist, and he had given her the blackest of hair and eyes, and the reddest of lips and cheeks. And last of all came an Indian doll made of corn cob and husk. The corn leaves were the Indian's long, flowing blankets, his head was covered with bright feathers, and his ink features were very fierce indeed. My brothers were quite proud of their work, and really," said grandma, "I have never seen any toys since, that seemed to me so pretty as those queer little dollies." Just then mamma opened the parlour door. All the children rushed to see the tree, so that was the end of grandma's story.



A HAPPY CHRISTMAS TO YOU ALL.

never bought so much; and last, but not least, a little paper book with a story in it that Rufus had written himself. All this took time to arrange. Then they got a nice breakfast ready, for Hetta could make very good coffee; and by-and-by mamma came down, looking very pale, but with a soft "Happy Christmas, my dears," and a book for Rufus and a work-box for Hetta in her hand. So many kisses and so many thanks and then two happy voices together: "Now

things," after she ears shin- a both to ave early give than

see the tree, and seemed so grandma ell them a Well," she hen I was girl there toy-shops, other used my dolls I remem- Christmas was called see a sick r, and left brother to se. "I have inished for Christmas she said ove away. bad." That ny brothers

HANG UP THE BABY'S STOCKING.

Hang up the baby's stocking,
Be sure you don't forget,
The dear little dimpled darling,
She never saw Christmas yet;
But I've told her all about it,
And she opened her big blue eyes;
And I'm sure she understands it,
She looks so funny and wise.

Dear! what a tiny stocking!
It doesn't take much to hold
Such little pink toes as baby's,
Away from the frost and cold.
But then, for the baby's Christmas
It will never do, at all;
Why Santa wouldn't be looking,
For anything half so small.

I know what we'll do for the baby,
I've thought of the very best plan;
I'll borrow a stocking from grandma,
The longest that ever I can;
And you'll hang it by mine, dear
mother,
Right here in the corner, so,
And write a letter to Santa Claus,
And fasten it on to the toe.

Write: "This is the baby's stocking
That hangs in the corner here.
You never have seen her, Santa,
For she only came this year;
But she's just the blissest baby!
And, now, before you go,
Just cram her stocking with goodies,
From the top, clear down to the
toe."

FREDDIE'S BROKEN PROMISE.

Meta and Jack were going for a walk on Christmas Eve. It was just such a day as Christmas Eve should be. The ground was white, the sky was blue, the air was frosty, and the sun shone brightly, making the snow and ice sparkle like diamonds and crystals. It was a cheerful, seasonable day. When little Freddie, who was just four years old, saw Meta and Jack starting for their walk, he said: "Oh! take me too, pray, and teach me how to skate."

Meta and Jack were a kind sister and brother. They laughed at Freddie for asking to be taught to skate, and Meta said: "You mean slide, little goose," but they agreed to take him a little way with them, and they walked one on each side of him, holding his

DYSPEPSIA

Horsford's Acid Phosphate reaches various forms of Dyspepsia that no other medicine seems to touch. It assists the weakened stomach, and makes the process of digestion natural and easy Pleasant to take.

For Sale by all Druggists

Ring Variety

Admitting that a lady has a nice ring or two, another one will always prove welcome.

There is such a variety of styles and so many combinations of stones that something new may always be forthcoming.

In styles there are the "Solitaire," "Twin," "Three-stone," "Half-hoop," and "Cluster."

We show a magnificent line of all the above styles in Diamonds, Pearls, Opals, Rubies, Emeralds, Sapphires, Turquoise, etc.

Ryrie Bros.

Cor. Yonge and Adelaide Sts., Toronto

Holiday Presents.

Leather Goods, Stationery, Novelties.

We Manufacture the finest line of Purses, Wallets, Portfolios, Bags, Letter and Card Cases, Photograph Cases, Diaries,

Equal to any foreign make and less in price.

We have a very large stock of new up-to-date Goods, suitable for the

HOLIDAY TRADE

A new line of

Inkstands

in Brass, Gold-Plated Crystal, Wood, &c.

Pencil Cases, Gold Pens, Fountain Pens, Photograph and Scrap Albums, Stationery Cabinets, Writing Desks, Dressing Cases.

New Fresh Goods. Close Prices.

THE BROWN BROS. LIMITED

Importing and Manufacturing Stationers, 64-68 King St. East, Toronto.

hand, and gave him a capital slide, which delighted the little man. When they thought he had had enough, Jack said: "Now, Freddie, Meta and I are going a little further, and we think you had better go back again, because

mother said you were not to be out late, so trot home; but mind, you must promise not to try and slide by yourself."

Freddie promised, and they watched him start off at a good pace back to the farm-house where they lived; then they turned round and went for their walk. Alas! little Freddie did not keep his promise. He walked very fast towards the farm-house while his brother and sister were in sight, and then turned back again to the slide, and with a brisk run started off. Once, twice, he went down the slide in safety, but the third time down he came with a terrible crash, and one little foot twisted under him. When poor Freddie tried to get up he found he could not stand, and oh! how his foot hurt him! So he had to lie there in the cold for nearly an hour, when Meta and Jack found him on their way home. He had sprained his ankle, and had to spend all Christmas Day in bed.

BOY LAWYERS.

Andrew played he was a lawyer. When any of the boys had any disputes, he would settle their troubles for them. They would not always like the way he settled them, yet they would always pay their fee—that is, the money he asked for his work. They used toy money, you see.

One day, Jim Custer and Tom Wood had a dispute. Jim said Tom had borrowed his slate pencil and broken it. Tom said:

"The old pencil was broken when you let me take it, and I'll get Frank Bates for my lawyer and prove it, and I'll get Charlie Baker for judge."

The five boys met on the veranda. Jim said: "I only bought that pencil yesterday. It cost me that cent I wanted to spend for candy. I only used it once—the pencil, I mean, not the cent."

"Yes, and he used it to cheat with," cried Tom. "When teacher asked Peter a question, he wrote it on his slate, so Peter could see. A pencil that cheats ought to be broken, so there! and it was broken before I had it."

"It wasn't," said Jim. "I'll ask my lawyer if it was. Tell them, Andrew."

"No, it wasn't broken," replied Andrew.

"How do you know?" asked

Enameline

when applied, is most BRILLIANT, and that is the effect you want when using a stove polish. When an old stove is polished it should look as bright as new—that is the result when you use Enameline. It is put up in paste, cake or liquid form. Remember that every package is guaranteed.

J. L. PRESCOTT & CO., New York

Presents for Smokers.

- Box of 25 choice Cigars From \$1.00 up
- A Fine Sterling Mounted B.B. B. Briar Pipe From 1.00 up
- A Fine Sterling Mounted G.B. D. Briar Pipe From 1.00 up
- Self-Sealing, Air-Tight Tobacco Jars From 1.50 up
- Cigar Cases—gun-metal, leather, &c. From 0.50 up
- Cigarette Cases—gun-metal, leather, &c. From 0.50 up
- Tobacco Pouches—rubber, leather, &c. From 0.25 up
- Cigar and Cigarette Holders From 0.15 up
- Pipe Racks, &c. From 0.50 up
- A Peterson Patent Pipe, coolest and cleanest pipe in the world. Small size, \$1.25; large size, \$1.50, including nickel cleaner.
- A Tin of Clubb's Dollar Mixture, guaranteed not to bite the tongue. 1/2 lb. tin, 50c.; 1 lb. tin, \$1.00.

and a hundred and one lines only to find in a well appointed store like ours.

If you cannot visit our store in person write us and say how much you wish to spend. We will select goods to the best of our ability, and guarantee to please you or refund your money.

A. CLUBB & SONS, Direct Importers

49 King St. West, Toronto Established 1878.

Judge Frank. "My father's a truly lawyer, and he won't say a thing is so unless he knows it, even if folks get angry and go to another lawyer. Now, I say, as long as no one knows for sure when the pencil was broken, you'd better take your case out of court, and put any hard feelings out of the way. I'd divide the pencil and be friends, if I were you."

"All right," cried Jim and Tom.

"All right," cried the lawyers.

"All right," echoed a voice.

GET THE GENUINE ARTICLE!

Walter Baker & Co.'s Breakfast COCOA

Pure, Delicious, Nutritious.

Costs Less than ONE CENT a cup.

Be sure that the package bears our Trade-Mark.

Walter Baker & Co. Limited, Dorchester, Mass. (Established 1780.)



The boys looked up, and there stood Andrew's father.

"I have heard what has been going on," he said, "and I was so pleased at the way this little trouble was settled, I am going to build a court house for you in my yard, where you can play you are lawyers all day long."

"Hurrah!" cried Andrew. "And will you build it out of the new kind of bricks you have just made?"

"Yes, and I have one in my hand. See, boys, this brick is hollow. If I make your house out of these bricks, the frost and moisture will not creep in; and these bricks cost one-third less than the solid bricks."

"I'm so glad my father has a brick-yard," said Andrew.

"We ought to have a name for our court house," proposed Charlie.

"Suppose you call it a court of arbitration," suggested Andrew's father. "Since you are to settle your troubles here, that will be the best name for it."

"We will, we will!" cried the boys. "But what does such a name mean?"

"It means that people who are tired of wars are trying to have such courts formed so that nations can settle their troubles in as sensible a manner as you boys did yours just now."

"Are there any such courts?" asked Charlie.

"Not a great many, I am sorry to say. Several states have Courts of Arbitration where labor difficulties are settled."

"Well, when I am a man," said Andrew, "I will do all I can to have the world full of courts of arbitration. But we must build our house, now."

THE BIRDS' CHRISTMAS TREE.

It was Christmas Day, 1806. Oh, how happy the children looked as the robins and the spar-

THE Illustrated Christmas number of the Canadian Churchman, which is exceedingly good this year, will be sent free to all new subscribers. Extra copies will be mailed to any place in Canada and the United States for 10 cents, to Great Britain 15 cents. Address all orders

Canadian Churchman,
Box 2640,
Toronto, Can.
Offices: 18 Court St.

rows and the thrushes and the starlings watched them going along the road to church! One little Robin Red breast followed the children as they made their way towards the old church porch. Of course he had to leave them there, but he had heard enough to make him linger near the door till they should come out of church again. He waited on the ledge of one of the church windows, where he could see through the glass all that was going on inside. It was rather cold for him waiting there, certainly, but Robin did not mind that. He ruffled his feathers round him and listened to the sweet singing from within. Now and again he joined his own lovely voice with those of the choristers singing their Christmas anthem. Then he thought again of the children, and of what he had overheard.

The conversation had been between little Lucy Forder and her brother, and this is what Robin had heard:

"I wonder what the birds will say, Charlie?"

"I expect they will be delighted," her brother answered.

"I think it was such a capital idea of father's; whatever made him think of it?" Lucy asked.

"Oh, don't you know? Father saw a picture in some magazine of Christmas Day in Norway; there the people put a sheaf of corn on the top of their houses for the birds. He said he did not see why the birds should not like a Christmas tree for themselves, as well as us children."

At this the robin pricked up his ears more than ever. All robins are inquisitive birds, and this one was more so than most of them. "They will be surprised," Lucy said; "the tree does look so pretty too, with the corn, and maize, and oats." "Yes, it does," her brother answered. "And it is not finished yet. Mother said we might finish it when we get home from church; there are the grapes, and the figs, and the dates, and the raisins to be tied on yet. What a surprise it will be for them! I wonder which of the birds will find it out first?"

"I will," thought Robin, though of course he could not say so.

"Oh, those cheeky sparrows, or the greedy starlings, I expect," Lucy said.

"Well, we shall see! I am so glad for them all that they will have a happy Christmas as well as we shall; but here we are at church."

The service over, little Robin Redbreast followed the children on their way home again. They did not live far from where his home was situated, in fact he lived

Our Union Jack

A Christmas remembrance to the nation of the uplifting power of the Cross through the Incarnation. Had at the Church Extension Association, or from Mrs. Fessenden, Hamilton.



Free for
Fifteen
Days

A SUPERB CHRISTMAS GIFT

HUDSON'S SHAKESPEARE,

INTERNATIONAL EDITION

Issued in 13 Artistic Volumes.

Illustrated with Photogravures.

Beautifully Printed.

Hudson's Shakespeare is a complete Shakespearian Library. The text is founded on the best authorities. The introductions to each play, the notes, analyses and glossaries are full and scholarly. The life of Shakespeare and the history of the older English dramas are probably the best ever written. One volume is given to a complete Topical Index of Shakespeare.

About Half Subscription Price.

We Pay Express Charges.

IT WILL COST YOU NOTHING to get these books into your home. You can then examine them for 15 days. If they are not satisfactory return at our expense.

A Magnificent Portfolio of Art Plates

six in number, for framing; size of sheet 16 by 20 ins. (all are photogravures from famous paintings, & all are Shakespearian subjects—is sent out free with each set.

Order Promptly. This Edition is Limited.

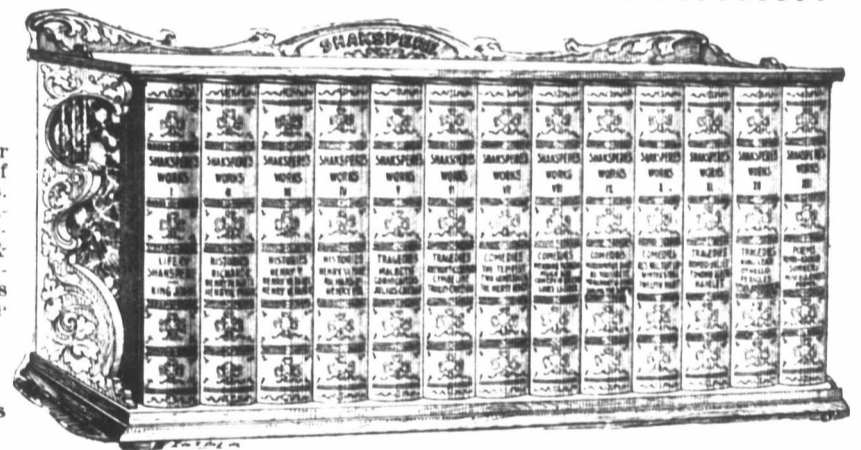

Special Terms Until January 1st.

Write us at once stating which style of binding you prefer—cloth or half-leather. We will forward the entire set of thirteen volumes, charges prepaid. You will be allowed 15 days for examination. If this edition is not exactly what you want, you can return the set at our expense. If satisfactory, you can make your first payment of \$1.00, and remit thereafter \$1.00 per month for 13 months, if cloth style is ordered, making a total payment of \$14. If you select the half-leather binding, which we recommend, there will be three more payments, making \$17 in all. This offer must be accepted on or before January 1st. If you want a fine edition of Shakespeare, this will suit you. We assume all risk. We suggest that you order promptly. This edition may be exhausted long before the holidays. Mention this paper. Address

THE UNIVERSITY SOCIETY, 78 Fifth Ave., NEW YORK

in one of the trees in Mr. Forder's garden.

Lucy and Charlie went into their house and Robin again waited to see what would happen. By-and-by the front door opened, and then Robin saw a sight he had never seen before. It was a birds' Christmas tree. Of course he had often seen the children's Christmas trees, the small fir trees being left at the houses on Christmas Eve, and some of them he had seen through the windows afterwards, all heavily laden with beautiful gifts, but he certainly had never seen such a sight as this before.

It was a bare tree with no leaves, so that the birds could easily see all that was upon it. It was decorated with flags, and oh, the good things! Robin felt hungry, but as he looked at that tree he saw there food enough and to spare to satisfy all his needs.

Mr. Forder carried the tree out to the centre of the lawn. There he placed the pot in which the tree was planted.

Lucy and Charlie simply danced with delight.

"You will see the birds here from your nursery window," he said.

"We wish all you little birds a very happy Christmas," Charlie shouted. They then scattered round the tree a whole ring of breadcrumbs, "just to tempt their appetites," their father said; then the children and their father returned to the house, and Lucy and Charlie went to the nursery window to watch what would happen.

Although Robin was rather inquisitive, he was not very selfish; he just flew down, much to Lucy and Charlie's delight, and pecked one or two of the crumbs of bread, and then he flew off to tell some of his companions of the treat in store for them. In a very

little time there were half a dozen birds round the birds' Christmas tree; and then more came, and more. Oh! what a Christmas those birds did have. They had a merry day as well as the children.

That afternoon, when it got dark, and the lamps were lighted, and when the birds had gone to bed, Lucy and Charlie had their Christmas tree. They had never had so many presents before, the very things they wanted most. Charlie had a train and a gun and a sword, and some bricks and a puzzle, and ever so many more things. And Lucy had just as many presents, a doll and a work-basket, and a paint-box, and a book and a thimble, besides ever so many more things.

"Well, it was kind of dear old Santa Claus," they said, when they had finished looking at their gifts.

"Well, it was kind of those children and their father," the birds tried to say, as they tucked their heads under their wings for the night.

Day after day the birds came back to their tree, till every grain of corn and all the fruit was gone. The children loved to watch them, and this Christmas Day they mean to have another Christmas tree for the birds, for they found that making the birds so happy, made them so happy too; and if some of you try having a Christmas tree in your garden for the birds, you will see like Lucy and Charlie did, how pleased the little birds will be.—J. C. Family Churchman.

LITTLE THINGS.

I cannot do great things for Him Who did so much for me; But I would like to show my love. Lord Jesus, unto Thee, Faithful in every little thing. O Saviour, may I be.

There are small crosses I may take, Small burdens I may bear, Small acts of faith and deeds of love, Small sorrows I may share; And little bits of work for Thee, I may do everywhere.

And so I ask Thee, give me grace, My little place to fill, That I may ever walk with Thee, And ever do Thy will; And in each duty, great or small, May I be faithful still.

—"Faith draws from sources untouched by circumstances."

STAMMERING CURED TO STAY CURED!

Linton Orthophonic Institute, Brockville, Canada. Established 1891. High-class. Fully endorsed. Open always. Larger regular attendance than all other schools of its kind in Canada combined. Permanent cures. No advance fees. Prospectuses.

Ask your grocer for

Windsor Salt For Table and Dairy, Purest and Best

WHILE YOU WORK.

We were visiting at the home of a friend not long ago, when the sixteen-year-old daughter looked up at the clock, and said ruefully: "I suppose I must study now." Then she took up her school-books, and to our surprise, instead of withdrawing to a quiet room, she resumed her former position, and joined in the conversation almost as freely as before. Her book was open on her lap, and she read paragraph after paragraph with her thoughts not upon the lesson, but following the talk of the family.

An hour passed, and it was time for supper. After the meal the girl continued her "study," till the clock struck ten. Then closing her book, she said, regretfully: "I don't believe I half know that lesson," an opinion we were quite inclined to accept.

You young people, who are beginning another school year, need to learn economy in habits of study. Half an hour of concentrated thought would have done more for the girl of whom we have spoken than her four hours of aimless study. We know of a man, a mechanic, who, beginning after he was forty years old, learned some dozen languages, giving only his evenings to the work. One of the greatest of American lawyers has said that he never studied but three hours a day, but we may be sure that those three hours represented more real brain-work than a week of such study as some of you put on your lessons.

The chief end of your school work is not to stow away a certain number of facts in your memory, but to train the mind. People of great ability frequently fail in life because they do not learn to concentrate their powers upon the thing in hand. It is poor economy to put four hours of study on a lesson which could be learned in three-quarters of an hour, but that is not so serious a matter as the fact that your mind is losing the power to apply itself. The old saying you learned so long ago: "Work while you work, and play while you play," would make a very good motto for this school year.

--God is not a distant friend who will help one after travelling a long way to reach Him. He is a very present helper and friend, and the sooner one learns to believe and feel this, the sooner will one know true companionship with Him.

BOOK AGENTS WANTED FOR the only Official and superbly Illustrated HISTORY OF OUR WAR WITH SPAIN ITS CAUSES, INCIDENTS, AND RESULTS. A reliable and exhaustive story of the war, Civil, Military, and Naval, from its beginning to the close. With many fine steel plates, maps, and choice engravings. By Hon. HENRY R. RUSSELL, assisted by SENATOR PROCTOR (Vt.) and SENATOR THURSTON (Neb.). One Agent cleared \$200.00 in first two weeks, another \$400.00 in three weeks. 1,000 more Agents wanted. Discharge no hindrance for we pay freight. Give Credit, Extra Terms, and Exclusive Territory. Write for terms to the exclusive publishers. A. D. WORTHINGTON & CO., Hartford, Conn.

Meneely Bell Company, CLINTON H MENEELY, Gen. Man. TROY, N.Y. and NEW YORK CITY. Manufacture superior Church Bells

"Discard the Old" Flavorless, nerve disturbing stuff that often masquerades as tea.

"SALADA"

CEYLON TEA IS THE VERY ESSENCE OF PURITY IS BENEFICENT TO THE HEALTH IS DELICIOUS TO THE TASTE

TORONTO OFFICE 32 YONGE STREET

MOST WELCOME WEDDING GIFT.

SIMPLE STRONG



SILENT SPEEDY

"Mother's Machine"

With Latest Improvements. Lightest Running, Easiest Managed.

Greatly aids domestic bliss.

SINGER MANUFACTURING CO.

The Home Savings & Loan Co., Ltd.

DIVIDEND No. 39.

Notice is hereby given that a dividend at the rate of 7 per cent. per annum has this day been declared on the paid up capital stock of the company for the half-year ending 31st December inst., and that the same will be payable at the office of the company, No. 78 Church St., Toronto, on and after 3rd January prox.

The transfer books will be closed from 16th to 31st December inst., both days inclusive. By order of the board. JAMES MASON, Toronto, Dec. 8th, 1898. Manager.

Boys & Girls

We are giving away watches, cameras, solid gold rings, sporting goods, musical instruments & many other valuable premiums to boys and girls for selling 18 packages of Royal English Ink Powder at 10c each. Every package makes 60c worth of fine ink. We ask no money—send your name and address, and we will forward you 18 packages with premium list and full instructions. When you sell the Ink Powder send the money to us and select your premium. This is an honest offer. We trust you. Don't lose this grand opportunity. Write for the outfit today. Address all orders to Imperial Ink Concern, 56 Adams St. Oak Park, Ill.

Ask your Dealer for RICE'S PURE SALT Best for Table and Dairy

ST. DENIS HOTEL

Broadway & Eleventh St.

EUROPEAN NEW YORK PLAN

WILLIAM TAYLOR & SON, Proprietors.

The Upper Canada Tract Society

Offers for sale a large, carefully selected stock of

Udenominational Religious Literature

Sunday-School Libraries A Specialty.

Catalogues free on application to

JOHN YOUNG, Depository 102 Yonge-st., Toronto

EMINENT MEN

Both in the professions and in business carry large amounts of insurance because they know it pays to do so. If you are thinking of putting on some insurance write to the

Confederation Life Association

Head Office, Toronto

for full particulars of the Unconditional Accumulative Policy, which guarantees extended insurance on a paid-up policy after two years, or a cash value after five years.

J. K. MACDONALD, Managing Director

W. C. MACDONALD, Actuary. Head Office, Toronto.

Eyeglasses and Spectacles



They help your eyes if right. They hurt them if wrong. I will give you an accurate examination by the most up-to-date methods free of charge. Glasses if you need them; none if you don't. I. B. ROUSE, Optical Specialist, 8 College St., Toronto.

Wedding... Cakes from Webb's

are made for people who want the best. For fifty years they have delighted Canadian brides and have been the chief ornament at fashionable weddings. We ship them by express to all parts of the Dominion. Catalogue and price on application.

The Harry Webb Co., Limited TORONTO



BUCKEYE BELL FOUNDRY E. W. VANBUZEN CO., Cincinnati, O., U. S. Only High Class, Best Grade Copper and Tin Full, Sweet Tone Cheapest for Price Fully Guaranteed and Chimes. No Common Grades. The Best Only.

OFFER NO. 3
Special \$10 Cash Offer

For the next thirty days, and with a view of helping Sunday Schools to a good library of Church Story Books, we make the third liberal offer of \$20 worth of Books, all in first-class order, for \$10, cash with order.

COMPRISING THE FOLLOWING:

- Five Books, at \$1 each.....\$5 00
- Five Books, at 90c. ".....4 50
- Five Books, at 75c. ".....3 75
- Ten Books, at 50c. ".....5 00
- Five Books, at 35c. ".....1 75

DO NOT DELAY. ORDER AT ONCE WHILE STOCK IS COMPLETE.

Books at \$1.00 Each

- 1 Perils of the Deep. By Edward N. Hoare.
- 2 What's Mine is Mine. By Geo. Macdonald.
- 3 Sir Gibbie. By Geo. Macdonald.
- 4 Donald Grant. By Geo. Macdonald.
- 5 Mysterious Island. By Jules Verne.
- 6 Michael Strogoff. By Jules Verne.
- 7 A Child's History of England. By Dickens.
- 8 Fifteen Decisive Battles. By Creasy.
- 9 Count Funnibos and Baron Stilkin; Their Travels and Adventures. By W. H. G. Kingston.
- 10 Elfin Hollow. By Scarlett Porter.

90 Cents

- Sweet Girl Graduate. By Meade.
- The Palace Beautiful. By Meade.
- Dove in the Eagle's Nest. By Charlotte M. Yonge.
- The Water Babies. By Kingsley.
- A World of Girls. By Meade.
- Six to Sixteen. By Ewing.
- Story of a Short Life. By Ewing.
- Jan of the Windmill. By Ewing.
- Alice in Wonderland. By Carroll.
- Polly. By Meade.

75 Cents

- Ben Hur, a Tale of Christ. By Lew Wallace.
- Exiled for the Faith. By Kingston.
- Swiss Family Robinson.
- The Pilgrim's Progress. By John Bunyan.
- Romance of Natural History. By P. H. Gosse.
- Mother's Recompense. By Grace Aguilar.
- Home Influence. By Grace Aguilar.
- Little Women and Good Wives. By Louisa M. Alcott.
- The Days of Bruce. By Grace Aguilar.
- A True Hero. By Kingston.

50 Cents

- The Young Buglers. By Henty.
- The Young Colonist. " "
- The Boy Knight. " "
- In Times of Peril. " "
- The Coronet of Horse. " "
- The Bride's Home. By Mrs Marshall.
- Three Little Brothers. " "
- Three Little Sisters. " "
- Master Martin. " "
- Michael Treasure. " "
- Two Years Before the Mast. Dana.
- A Thousand Miles up the Nile. Edwards.
- Crown of Wild Olives. Ruskin.
- The Pathfinder. Cooper.
- The Pilgrim's Progress. Bunyan.
- When I was Young. Mrs Marshall.
- My Lady Beautiful. " "
- Story of My Duty Towards My Neighbour. S. P. C. K.
- Story of My Duty Towards God. Peter Biddulph. Kingston.

35 Cents

- Little Peat Cutters. By Ballantyne.
- Chip of the Old Block. By Mrs. Marshall.
- Light on the Lily. By Mrs. Marshall.
- Violet in the Shade. " "
- Sam's Mission. By Beatrice Marshall.
- Heathercliffe. By Emma Marshall.
- Primrose. By Mrs. Marshall.
- Up in the Clouds. By Ballantyne.
- Fast in the Ice. " "
- Away in the Wilderness. By Ballantyne.

Bookbinding in all its branches. Choir Books, Library Books, &c., &c., rebound in every style. Gold Lettering on Pocket Books, &c. Write for prices.

It will be well to give number of a substitute at each price, in case any of the list should be sold out. Address

Church of England Publishing Co. LIMITED.
17 Richmond St. W., Toronto.

INCORPORATED TORONTO HON. G. W. ALLAN 1866 PRESIDENT

CONSERVATORY OF MUSIC
College St. & Queen's Ave.

EDWARD FISHER, Musical Director
Affiliated with the University of Toronto, and Trinity University.

Largest Music School and Strongest Faculty in Canada. Attendance 922 last year.

Artists' and Teachers' Graduating Courses, Scholarships, Diplomas, Certificates, etc.

CALENDAR and Syllabus mailed free.

Conservatory School of Elocution
H. N. Shaw, B.A., Principal

Oratory, Recitation, Reading, Acting, Voice Culture, Orthoepy, Delsarte and Swedish Gymnastics, Greek Art, Statue Posing, Literature, Class and Private Lessons

Edgehill, Church School for Girls
WINDSOR NOVA SCOTIA

Incorporated 1891.

Rt. Rev. Bishop Courtney, D. D., Chairman Board of Trustees.

Miss Lefroy, of Cheltenham Ladies' College, England, Principal.

Eight Resident Experienced Governesses from England. Housekeeper, Matron & Trained Nurse.

Board and Tuition Fees including French, Latin or German or Greek, Daily Calisthenics, Class Singing and Needlework. \$225 per annum.

Music, Singing, Painting, Drawing, &c., are extras. Preparation for the Universities.

Michaelmas Term begins Sept. 14th, 1898. For Calendar apply to DR. HIND.

Church - - Extension Association

341 Spadina Avenue, Toronto.

Open daily from 2 p.m. to 6.00 p.m. Saturdays 9.00 to 9.30. Surpluses made to order from \$3 up. Garments for Men, Women and Children, new and second-hand, at low prices. Also Books, Publications, Sacred Pictures.

Trinity College School PORT HOPE, ONT.

Michaelmas Term begins on Wednesday, September 14th.

The handsome new buildings are unsurpassed in the Dominion, and are provided with all modern appliances for the health and comfort of the boys. Two entrance Scholarships open for competition in September. A preparatory Form for little boys. For admission or further information address

REV. DR. BETHUNE, Head Master

Miss Dalton Dress and Mantle Making **Millinery**

All the season's goods now on view. The latest Parisian, London and New York styles.
356 Yonge St., Toronto

The Oxford Press

THE OLD-ESTABLISHED CHURCH PRINTING HOUSE.

ALPHABETS FOR CHURCH DECORATION.

TEXTS ETC., IN GOLD OR COLOR, TO ORDER.

ILLUMINATED CONFIRMATION, BAPTISMAL & MARRIAGE CERTIFICATES.

G. PARKER (Successor to Timms & Co.)
33 Adelaide St. W., Toronto, Ont.

33 Adelaide St. W., Toronto, Ont.

33 Adelaide St. W., Toronto, Ont.

33 Adelaide St. W., Toronto, Ont.

33 Adelaide St. W., Toronto, Ont.

33 Adelaide St. W., Toronto, Ont.

33 Adelaide St. W., Toronto, Ont.

33 Adelaide St. W., Toronto, Ont.

33 Adelaide St. W., Toronto, Ont.

33 Adelaide St. W., Toronto, Ont.

33 Adelaide St. W., Toronto, Ont.

33 Adelaide St. W., Toronto, Ont.

33 Adelaide St. W., Toronto, Ont.

33 Adelaide St. W., Toronto, Ont.

33 Adelaide St. W., Toronto, Ont.

Bishop Strachan School for Girls

President—The Lord Bishop of Toronto
Preparation for the Universities and all Elementary work. Re-open Sept. 7th.

Apply for Calendar to
MISS GRIER, Lady Principal,
Wvkeham Hall, Toronto.

The Church of England Day School 69 Baldwin Street Toronto.

This School provides the usual course of instruction in English subjects, together with the higher Mathematics, French, Physical Culture and Class Singing. Extras: Music, German, Latin and Dancing. Terms moderate. For particulars apply to the Sister-in-charge. Next term begins September 12th, 1898.

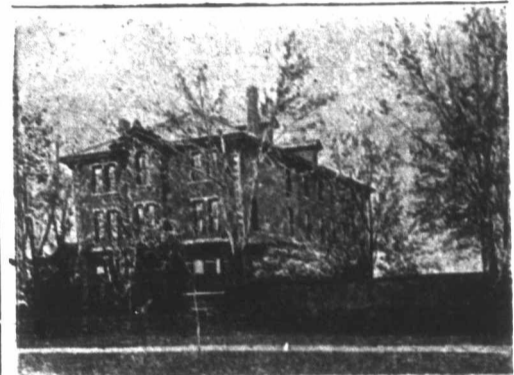

"Elen Mawr," MISS VEALS' SCHOOL
Cor. Spadina Ave. & Morris St., Toronto
PUPILS PREPARED FOR THE UNIVERSITIES.

Bishop Bethune College, Oshawa, Ontario

UNDER THE CHARGE OF

The Sisters of St. John the Divine

Visitor, the Lord Bishop of Toronto.

For terms and particulars apply to the SISTER IN CHARGE, or to

The Sisters of St. John the Divine

MAJOR STREET, TORONTO.

Michaelmas Term begins 7th Sept., 1898.

Hellmuth Ladies' College LONDON, ONT. CIRCULARS.

The London Society for Promoting Christianity among the Jews. Established A.D 1809

Patron—The Archbishop of Canterbury. Vice-Patron—The Archbishop of Ontario.

The Missionaries, including their wives, their assistants, the missionary physicians and the teachers, number altogether about 185; and are located in the chief centres of Jewish population and commerce in Europe, Asia and Africa

J. W. BEAUMONT, D. D. London, Ont. Sec'y for Canada.

To Make Home Pretty and Attractive

Is the wish of every lady. Perhaps we can help you a little by improving some unsightly arch, a nice piece over a bay window, a screen for a stairway, a cozy corner, a handsome stationary or folding screen. The expense will not be much and would add greatly to the appearance of the rooms. We make here in Moorish fret work, Japanese fret work, Scroll or Grille work, all combinations of the different styles and makes, finished in any kind of wood desired. For further particulars address

Otterville, Mfg. Co., Limited
Otterville Ont.

Presentation Addresses

Designed and Engraved by

A. H. HOWARD, R. C. A.

53 King St. East, Toronto

JONES & WILLIS

Church Furniture Manufacturers

ART WORKERS IN

Metal, Wood, Stone and Textile Fabrics

43 Great Russell Street, LONDON, W.C. (Opposite the British Museum)

And Edmund St., BIRMINGHAM, Eng. Concert St., Bold St., LIVERPOOL

The Morley Ladies' College, Conservatory of Music and School of Art.

Snelinton Manor, Huntsville, Ont.

Visitor—The Ven. Archdeacon Llwyd, Algoma. Principal—Miss Morley, L.L.C.M., A. Mus. I. C.M., Representative of the London College of Music, Eng.; Silver Medalist for Painting, Head Teacher—Miss Jenn Davidson, M.L.A., Gold Medalist of Provincial Normal School, Medalist in Mathematics, Prize Essayist, etc. Assistant Teachers—Miss D. Chown, Miss V. Goulding, Miss L. Hunter. Professor of Greek and Latin—A. Morley, Esq., Graduate of Taitton College, Eng.

A resident and day school for young ladies. Students prepared for Primary, Junior Leaving and Senior Matriculation for Toronto University and Trinity College. A thorough English course with Languages will be given to those who do not wish to take certificates. French conversation every day. Special advantages in Music, Art and Modern Languages. FALL TERM commences Sept. 14th. To fill vacancies six pupils will be received at reduced terms. Calendars and further particulars on application to the Principal.

CHURCH BRASS WORK

Eagle and Rail Lecterns, Altar Vases, Fwars, Candlesticks, Altar Deaks, Crosses, Vesper Lights, Altar Rails, etc. Chandelier and Gas Fixtures.

CHADWICK BROTHERS (Successors to J. A. Chadwick)

MANUFACTURERS

182 to 190 King William St., HAMILTON, Ont.



THERE IS A NEW STYLE OF VISITING CARD

It is the neatest, daintiest, and most correct that which is printed in the "Brandon Series" of type. Write for samples—free to any address.

The Monetary Times

Printing Co. of Canada, Limited, Toronto

Department "Three."

Department "Three."

Department "Three."

Department "Three."

Department "Three."

Department "Three."

Department "Three."

Department "Three."

Department "Three."

Department "Three."

Department "Three."

Department "Three."

Department "Three."

Department "Three."

Department "Three."

Department "Three."

Department "Three."

Department "Three."

Department "Three."

Department "Three."

LLIS

ire

ne and CS

Opposite the British Museum

HAM, Eng. BRPOOL

College, ic

ie, Ont. lwyd, Algoma. L. A. Mus. L. don College of for Painting. idson. M.L.A., ormal School, Essayist, etc. own. Miss V. essor of Gregk duate of Tain-

r young ladies. Junior Leaving ronto Unver- rough English given to those cates. French al advantages. FALL 'o fill vacancies. educed terms. rs on applica-

WORK

Vases, Fwers, asses, Vesper Chande- es.

HERS dwick)

LAMILTON, Ont.

RCH IDOWS ORNATE. DRIALS ECIALTY. /SLAND TORONTO

NEW

RD

tiest, and is printed " of type. se to any

Times ada,

"Three.

Laundry

EET

Proprietor

80'

FOUNDED A.D. 1710

SUN FIRE Insurance Office

Transacts Fire Business only, and is the oldest Purely Fire Office in the world

HEAD OFFICE: THREADNEEDLE STREET, LONDON, ENGLAND

SURPLUS, over Capital and all Liabilities, exceeds \$7,000,000

TORONTO AGENTS: Geo. M. Higinbotham and . . . Geo. S. Lyon Telephone 488

Canadian Branch 15 Wellington St. E. Toronto, Ont.

H. M. Blackburn, Manager H. F. Petman, Inspector

AGENTS WANTED IN ALL UNREPRESENTED DISTRICTS

INCORPORATED 1863.

Western Canada LOAN AND SAVINGS COMPANY

OFFICES:

No. 76 Church St., TORONTO

COMPANY'S BUILDING: WINNIPEG

DEPOSITS received. DEBENTURES issued. MONEY TO LEND on improved farms in Ontario and Manitoba.

PAID-UP CAPITAL \$1,500,000.00 RESERVE FUND \$770,000.00

DIRECTORS:

HON. GEO. W. ALLAN, President ALFRED GOODERHAM, Esq. GEO. GOODERHAM, Esq., Vice-President GEO. W. LEWIS, Esq. THOMAS H. LEE, Esq. GEO. F. GALT, Esq., Winnipeg

WALTER S. LEE, Managing Director.

W. BARBER & BROS.

JOHN R. BARBER Proprietor E. FINLAY Superintendent

GEORGETOWN, ONT.

Paper Makers

Make a Specialty of...

Machine-Finished Book Papers Colored Specialties and High-Grade Weekly News

The Paper used in the "CANADIAN CHURCH-MAN" is from the above Mills.

GEO. E. CHALLES, SELLING AGENT Mail Building, TORONTO

Advertisement for Canadian Photo-Engraving Bureau featuring a landscape illustration and text: 'CANADIAN PHOTO-ENGRAVING BUREAU', 'Adelaide, Ont. West Toronto', 'MOORE & ALEXANDER Prop.', 'Designers & Photo Engravers in HALF-TONE & LINE', 'TELEPHONE 2158'

The Anderson Furniture

Manufacturers
WOODSTOCK, ONT.,
CANADA

Company, Limited

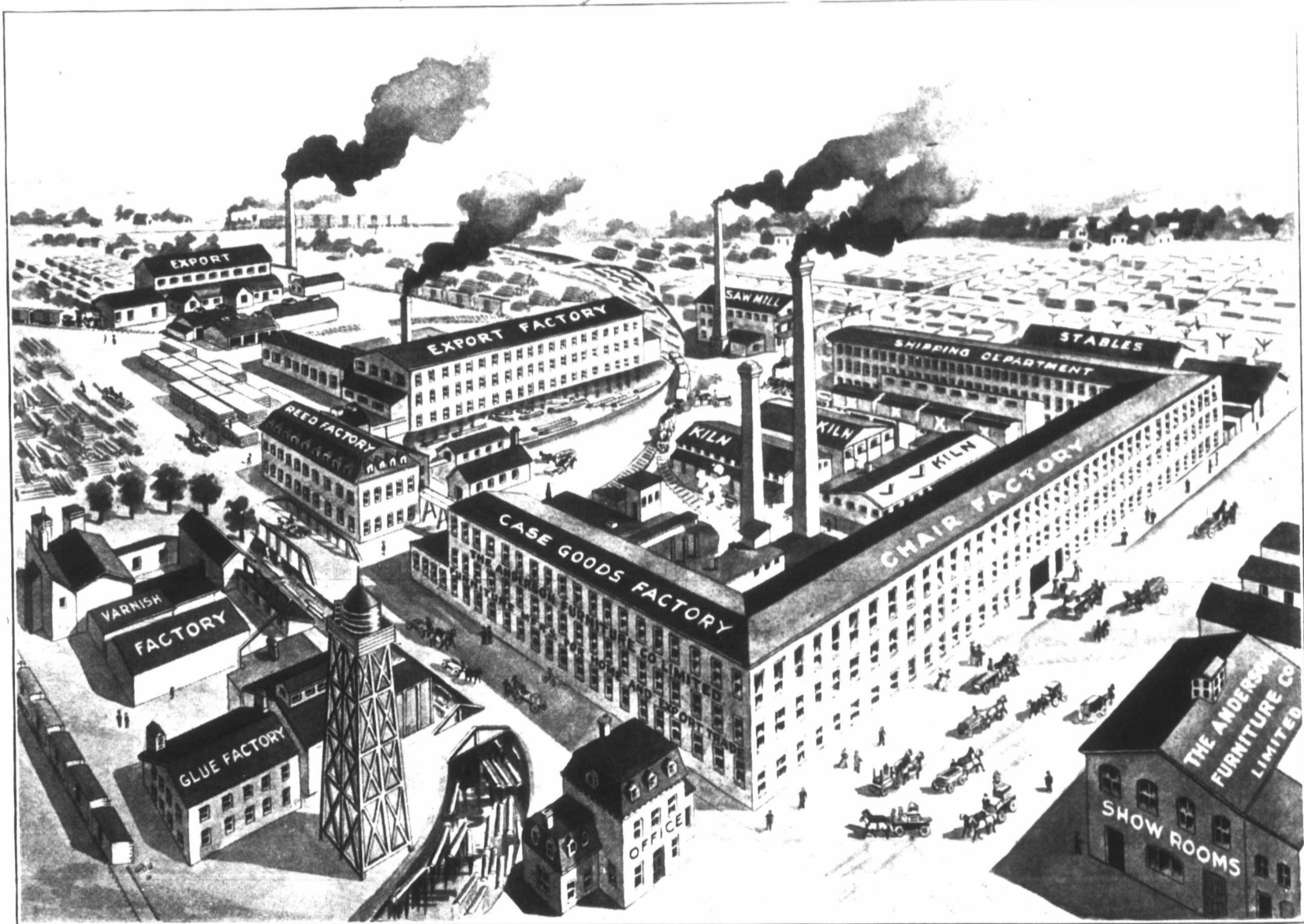

THE MAXIMUM OF VALUE

THE MINIMUM OF COST

The Largest Furniture Factory in Canada Site, 25 Acres

Household and
Office Furniture

Baby Carriages
Carts and
Reed Goods

Unequaled Facilities
Superior Goods



Ask your Dealer
for

Anderson's
Furniture

LOOK FOR OUR TRADE MARK

Our Name is a Guarantee of Good Quality and Value