

**CIHM
Microfiche
Series
(Monographs)**

**ICMH
Collection de
microfiches
(monographies)**



Canadian Institute for Historical Microreproductions / Institut canadien de microreproductions historiques

© 1996

Technical and Bibliographic Notes / Notes technique et bibliographiques

The Institute has attempted to obtain the best original copy available for filming. Features of this copy which may be bibliographically unique, which may alter any of the images in the reproduction, or which may significantly change the usual method of filming are checked below.

L'Institut a microfilmé le meilleur exemplaire qu'il lui a été possible de se procurer. Les détails de cet exemplaire qui sont peut-être uniques du point de vue bibliographique, qui peuvent modifier une image reproduite, ou qui peuvent exiger une modifications dans la méthode normale de filmage sont indiqués ci-dessous.

- | | |
|---|--|
| <p><input checked="" type="checkbox"/> Coloured covers /
Couverture de couleur</p> <p><input type="checkbox"/> Covers damaged /
Couverture endommagée</p> <p><input type="checkbox"/> Covers restored and/or laminated /
Couverture restaurée et/ou pelliculée</p> <p><input type="checkbox"/> Cover title missing / Le titre de couverture manque</p> <p><input type="checkbox"/> Coloured maps / Cartes géographiques en couleur</p> <p><input type="checkbox"/> Coloured ink (i.e. other than blue or black) /
Encre de couleur (i.e. autre que bleue ou noire)</p> <p><input type="checkbox"/> Coloured plates end/or illustrations /
Planches et/ou illustrations en couleur</p> <p><input type="checkbox"/> Bound with other material /
Relié avec d'autres documents</p> <p><input type="checkbox"/> Only edition available /
Seule édition disponible</p> <p><input type="checkbox"/> Tight binding may cause shadows or distortion
along interior margin / La reliure serrée peut
causer de l'ombre ou de la distorsion le long de
la marge intérieure.</p> <p><input type="checkbox"/> Blank leaves added during restorations may appear
within the text. Whenever possible, these have
been omitted from filming / Il se peut que certaines
pages blanches ajoutées lors d'une restauration
apparaissent dans le texte, mais, lorsque cela était
possible, ces pages n'ont pas été filmées.</p> <p><input checked="" type="checkbox"/> Additional comments /
Commentaires supplémentaires: Pagination is as follows : p. [8], 121-163, [18], [185]-242, [16]</p> | <p><input type="checkbox"/> Coloured pages / Pages de couleur</p> <p><input type="checkbox"/> Pages damaged / Pages endommagées</p> <p><input type="checkbox"/> Pages restored and/or laminated /
Pages restaurées et/ou pelliculées</p> <p><input checked="" type="checkbox"/> Pages discoloured, stained or foxed /
Pages décolorées, tachetées ou piquées</p> <p><input checked="" type="checkbox"/> Pages detached / Pages détachées</p> <p><input checked="" type="checkbox"/> Showthrough / Transparence</p> <p><input type="checkbox"/> Quality of print varies /
Qualité inégale de l'impression</p> <p><input type="checkbox"/> Includes supplementary material /
Comprend du matériel supplémentaire</p> <p><input type="checkbox"/> Pages wholly or partially obscured by errete
slips, tissues, etc., have been refilmed to
ensure the best possible image / Les pages
totalement ou partiellement obscurcies par un
feuillelet d'errata, une pelure, etc., ont été filmées
à nouveau de façon à obtenir le meilleure
image possible.</p> <p><input type="checkbox"/> Opposing pages with veying colouretion or
discolourations are filmed twice to ensure the
best possible image / Les pages s'opposent
ayent des colorations variables ou des décol-
orations sont filmées deux fois afin d'obtenir le
meilleur image possible.</p> |
|---|--|

This item is filmed at the reduction ratio checked below/
Ce document est filmé au taux de réduction indiqué ci-dessous.

10X	14X	18X	22X	26X	30X
<input type="checkbox"/>	<input type="checkbox"/>	<input type="checkbox"/>	<input type="checkbox"/>	<input checked="" type="checkbox"/>	<input type="checkbox"/>
12X	16X	20X	24X	28X	32X

The copy filmed here has been reproduced thanks to the generosity of:

National Library of Canada

The images appearing here are the best quality possible considering the condition and legibility of the original copy and in keeping with the filming contract specifications.

Original copies in printed paper covers are filmed beginning with the front cover and ending on the last page with a printed or illustrated impression, or the back cover when appropriate. All other original copies are filmed beginning on the first page with a printed or illustrated impression, and ending on the last page with a printed or illustrated impression.

The last recorded frame on each microfiche shell contain the symbol \rightarrow (meaning "CONTINUED"), or the symbol ∇ (meaning "END"), whichever applies.

Maps, plates, charts, etc., may be filmed at different reduction ratios. Those too large to be entirely included in one exposure are filmed beginning in the upper left hand corner, left to right and top to bottom, as many frames as required. The following diagrams illustrate the method:

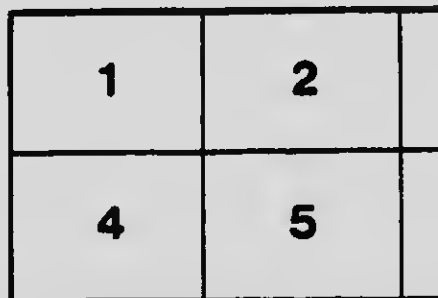

L'ex
géné

Les in
plus
de la
conf
filme

Les c
papie
par le
darni
d'impr
plet,
origin
prem
d'impr
le des
emp

Un de
derni
ces: l
symb

Les c
filmé
Lorsq
rapro
de l'a
et de
d'ima
Illist

L'exemplaire filmé fut reproduit grâce à la générosité de:

Bibliothèque nationale du Canada

Les images suivantes ont été reproduites avec le plus grand soin, compte tenu de la condition et de la netteté de l'exemplaire filmé, et en conformité avec les conditions du contrat de filmage.

Les exemplaires originaux dont la couverture en papier est imprimée sont filmés en commençant par le premier plat et en terminant soit par la dernière page qui comporte une empreinte d'impression ou d'illustration, soit par le second plat, selon le cas. Tous les autres exemplaires originaux sont filmés en commençant par la première page qui comporte une empreinte d'impression ou d'illustration et en terminant par la dernière page qui comporte une telle empreinte.

Un des symboles suivants apparaîtra sur la dernière image de chaque microfiche, selon le cas: le symbole \rightarrow signifie "A SUIVRE", le symbole ∇ signifie "FIN".

Les cartes, planches, tableaux, etc., peuvent être filmés à des taux de réduction différents. Lorsque le document est trop grand pour être reproduit en un seul cliché, il est filmé à partir de l'angle supérieur gauche, de gauche à droite, et de haut en bas, en prenant le nombre d'images nécessaire. Les diagrammes suivants illustrent la méthode.

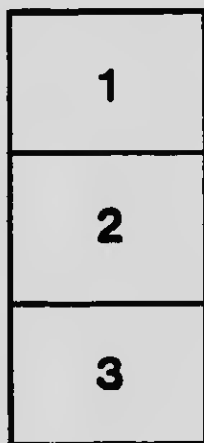

MICROCOPY RESOLUTION TEST CHART

(ANSI and ISO TEST CHART No. 2)

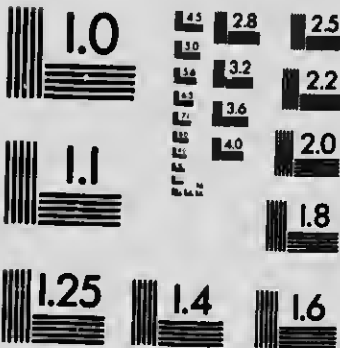

APPLIED IMAGE Inc

1653 East Main Street
Rochester, New York 14609 USA
(716) 482-0300 - Phone
(716) 298-5989 - Fax

Can:

dup

STEREOSCOPIC VISION

AND ITS RELATION TO INTENSITY AND QUALITY OF
LIGHT SENSATION

THESIS

PRESENTED TO THE UNIVERSITY OF TORONTO FOR THE
DEGREE OF DOCTOR OF PHILOSOPHY

BY

T. R. ROBINSON, B.A.

475
1930
1300
5***

Reprint from the University of Toronto Studies, Psychological Series

STEREOSCOPIC VISION

**AND ITS RELATION TO INTENSITY AND QUALITY OF
LIGHT SENSATION**

THESIS

**PRESENTED TO THE UNIVERSITY OF TORONTO FOR THE
DEGREE OF DOCTOR OF PHILOSOPHY**

BY

T. R. ROBINSON, B.A.

Reprint from the University of Toronto Studies, Psychological Series

QP475

R63

1906

P***

890321

TO THE REGISTRAR OF THE UNIVERSITY OF TORONTO.

I beg to state that the Rev. T. R. Robinson, B.A., has with regard to his major subject fulfilled all the conditions prescribed for the admission to the degree of Doctor of Philosophy. I hereby recommend that his Thesis entitled, "Stereoscopic Vision and its Relation to Intensity and Quality of Light Sensations," first and second article, be accepted for the degree.

A. KIRSCHMANN.

UNIVERSITY OF TORONTO,
PSYCHOLOGICAL DEPARTMENT,
April 2, 1906.

TO THE SENATE OF THE UNIVERSITY OF TORONTO.

I hereby certify that the Thesis above mentioned has been accepted by the Senate of the University of Toronto for the degree of Doctor of Philosophy, and that Mr. Robinson has complied with all the regulations in accordance with the statute in that behalf.

JAMES BREBNER,
Registrar.

THE UNIVERSITY OF TORONTO,
June 4, 1906.

89032

CONTENTS

FIRST ARTICLE

STEREOSCOPIC VISION AND INTENSITY

	PAGE
I. Introduction—Statement of the Problem.....	3
II. Comparison of Monocular and Binocular Intensities.....	8
III. Relation of Intensity to Stereoscopic Perception of Depth.....	12
IV. Binocular Synergies.....	26
V. Lustre—	
1. Theory of Lustre.....	30
2. Experiments on Intensity as a Condition of Lustre.....	39

PLATES 1—7

SECOND ARTICLE

STEREOSCOPIC VISION AND QUALITY OF LIGHT SENSATION

I. Comparison of Monocular and Binocular Intensities in Colored Light.....	23
II. Binocular Mixture of Colors—	
1. Plain Colored Surfaces Upon Dark Field.....	27
2. Stereoscopic Figures Upon Dark Field.....	32
3. Mixture of Colored and Uncolored Impressions.....	40
4. Mixture of Colors Covering the Entire Vision-Field.....	40
III. Stereoscopic Lustre from Differences of Intensity and of Color Between the Retinal Images.....	61

PLATES I—V.
CURVES I—VI.



STEREOSCOPIC VISION
AND ITS RELATION TO INTENSITY AND QUALITY OF
LIGHT SENSATION

FIRST ARTICLE

STEREOSCOPIC VISION AND INTENSITY

BY

T. R. ROBINSON, B.A.

STEREOSCOPIC VISION IN ITS RELATION TO INTENSITY OF LIGHT SENSATION

I. INTRODUCTION—STATEMENT OF THE PROBLEM

Experimental psychology no longer needs, as at an earlier day, to defend its claim to a place among the sciences. The fact is now generally and cordially recognized that even those phenomena of experience which are within the domain of physical science cannot be fully understood until they have been regarded, not only from the abstract point of view of the physical sciences, but also from the direct standpoint of psychology, i.e., the standpoint of immediate experience. The best proof of this fact, if proof were still needed, would be furnished by such subjects as that of which the following pages treat, subjects, namely, which lie on the borderland of the physical, the physiological and the mental, and are of about equal interest to each of these sciences. We are landed in glaring inconsistencies and contradictions of actual experience if we attempt to treat such a subject as visual perception of depth or distance from a purely physiological standpoint. An excellent illustration of this is afforded by a recent article of Storch.¹ In an earlier article, Dr. Storch had discussed the point that the perception of an object does not consist simply in a complex of sensations, but that in addition there is a spacial element which is essential to the perception of an object. This spacial element in all our perceptions, he now goes on to say, must rest on the same material process in the cortex: so that we have a nervous organ, the excitation of which comes into our consciousness as space. He calls this organ the stereo-psyche field, and its anatomical elements stereons. Each stereon sends its dendrites into our several sensoria, and stretches its neurites into the motorical zones. In the stereons three different chemical actions are going on, each of which is, as to its intensity, independent of the others. These processes we do not notice directly. We notice only the acceleration and retardation of them. To these three "chem-

¹ *Der Wille und die räumliche Moment in Wahrnehmung und Vorstellung.* (Pflüger's Archiv, XCV, 305 etc.)

isms," or chemical processes, corresponds the arrangement of the perceived points in the directions right and left, up and down, near and far. The orientation is not given alone by the sense of sight, but can be furnished just as well by the ear labyrinths and by all other sense-organs. "Whether the changes in the stereo-psychical field happen from inner or outer causes, they must always appear in our consciousness as one of the possible combinations of three elements, as line, surface or solid, as direction-complexes of one, two or three-dimensional nature."

Without entering into a discussion of this alleged "space-organ" it will suffice to point out some of the assumptions which Storch finds it necessary to make in the application of his theory to experience. In the first place, he distinguishes between what he calls the "visual form" and the "real form" of perceived objects. "Neither in monocular nor in binocular vision is the spacial arrangement and form of the things which we really perceive simply the subjective aspect which is given by the stimulus. Entirely without our will the visual form is suppressed by the real form of the object. . . . The spacial element of visual perception has two components, one, independent of all experience, is caused by the stimulus. This is the visual form, which comes into our consciousness as certain complexes of a two or three-dimensional nature." This visual form or space component furnished by the senses Storch calls the immediate element of visual perception. The other component, which partially or completely suppresses the former, is the real form of the thing, which Storch calls the mediate spacial element, or associative component of visual perception. This distinction of real form from visual form involves a strange confusion of thought, and is wholly inconsistent with Storch's theory. If the "form" given in the stimulus is not seen, but is suppressed or altered by something else called the "real form," why call the former "visual"? Again, on Storch's theory, since complexes of sensation have not spacial quality without the excitation of a special "space-organ," it must be through the excitation of that organ that we get the

form that we perceive ; else whence comes the "real" form ? For if the latter is furnished neither in the sensation complex nor by the stimulation of the "space-organ," whence, on this physiological basis, do we get it ?

Another curious expression employed in the development of this physiological theory, and one to which its author attaches much significance, is the "absolute size" of objects. It is clear, he says, that if we had nothing but visual perceptions we should never attain to the presentation of real object forms. There is another necessary property of objects seen, which cannot be explained by the perception simply ; it is the absolute size. "Halte ich meine Hand etwa 25 cm. von meinem Gesicht entfernt, so erscheint sie nun keineswegs doppelt so gross als in 50 cm. Entfernung. Ich sehe sie in beiden Fallen in ihrer wirklichen Grosse. Den Grössen der Netzhaut-bilder gemäss durfte das nicht der Fall sein." But on this point the author of the theory has simply allowed it to mislead him as to the facts. The experiment has but to be tried to show at once that the case is just exactly as he says it is not. The hands are somewhat too large to be conveniently compared at the distances at which they can be held. But if the experiment be made with two coins, say a ten-cent piece and a half-dollar, the former held about a foot from the eye, the latter about two feet, they appear equal in diameter. To perceive them so it is only necessary to pay attention to what is seen, and to avoid being influenced by what is known regarding the physical measurements of the objects. The same remark applies to the other case cited, that of a grown person on the opposite side of the street appearing larger than a child near to the observer, although the retinal image of the latter is greater. This would never occur if the grown person were dressed like a child, and had not about him any of the signs which in our past experience have been associated with larger size. What happens in this case is that we pay attention to the memory-image associated with a certain dress, etc., rather than to what we actually see. Dr. Storch, indeed, comes very near to acknowledging this in his remark about the necessity of learn-

ing perspective drawing, which he illustrates by the known fact that children drawing a face sometimes draw the nose as in profile and then add the two eyes and the mouth.¹

These examples of the facility with which the attempt to account for facts of visual perception upon a purely physiological basis leads to assumptions which are quickly disproved by reference to the facts themselves show the necessity for supplementing the physical and physiological investigations, by psychological experiment, i.e., by careful examination, under controllable conditions, of the facts as they are directly known to us. Storch's work having been referred to as an illustrative case, mention may be made of another assumption, which is common to him and to others who have dealt with this subject, viz., that in monocular vision we have only lines and surfaces, but no depth. This is very far from being in accordance with the facts. In monocular vision there are factors of depth perception the development of which in the case of persons who have suffered the loss of one eye may result in an estimation of distances no less accurate than that of people with two eyes. Indeed to speak of perceiving a surface without having the third dimension at all is obviously self-contradictory. If a person sees a surface, that surface must lie at some distance from him. For he would not even see a surface unless he himself were outside the surface. But in being outside the surface which he sees, he already has the third dimension.² The perception of depth is not entirely

¹ See, for a discussion of this latter subject from a more thorough standpoint, Kirschmann's *Die psychologisch-ästhetische Bedeutung des Licht- und Farben-contrastes* (Philos. Stud. VI, p. 362), and the book published under the pseudonym of C. E. Rasius, *Rechte und Pflichten der Kritik*, p. 91. Kirschmann points out that we need to learn perspective drawing only in order to undo the influence of prejudice or prepossession. He claims that a correct observer, who is able to separate that which he sees from that which he "knows" is there, is able to draw perspective correctly, without having ever learned perspective. The expert draughtsman needs the rules of perspective just as little as the philosopher or scientist the rules of formal logic.

² Vide Kirschmann, *Die Dimensionen des Raumes*, pp. 27 and 97 (Leipzig: Wilhelm Engelmann, 1902).

dependent upon the "double eye."¹ The purpose of binocular co-operation is not to give us the third dimension, but to facilitate the accurate measurement and comparison of distances.

In stereoscopic vision there are three elements which affect the completeness and mode of the combination of the impressions upon the two retinas. These are the similarity or dissimilarity of the two impressions, (1) spacially, i.e., in size, form and position-relations, (2) in quality of light sensations, or colour, (3) in intensity of light sensation, or brightness. When the two retinal impressions are exactly alike in all these respects the result is simple binocular combination: i.e., there is a single image, which has not the stereoscopic depth or distance effect, but is exactly similar to the monocular images, except in some cases in being brighter. (It is an interesting fact that there is no summation of saturations, as there is of intensities.) When the retinal images are *spacially* different there are two possibilities: (a) that though different in size, form, or position-relations they are stereoscopically combined into a single image with enhanced depth effect; (b) that they are so different as not to unite, in which case "double images" will result. Differences in *intensity* or *quality* of light between the two retinal images may result in a variety of ways. The images may combine; one may suppress the other; or there may appear the "competition" of the vision-fields, the images alternately replacing each other.

The object of the present investigation may in general terms be described as being to discover, (1) the limits of possibility of combination for images of different colour or bright-

¹ There are two views held with regard to the chief factor of monocular depth perception. The one claims that the muscular sensations which accompany the changes of accommodation are chiefly responsible for the perception of depth (Baird: *The Influence of Accommodation and Convergence upon the Perception of Depth*, in *Am. Journ. of Psych.*, XIV, 150-200). The other view, which admits, of course, that accommodation is a factor, though a subordinate one, claims that the chief data for depth-perception in monocular vision are, for the near surroundings, furnished by the parallax of indirect vision. This latter view is strongly supported by the fact that in very important parts of the vision field, where binocular vision is excluded, we have distinct and sharp depth perception, absolutely independent of accommodation. (Kirschmann, *Die Parallaxe des indirekten Sehens und die spaltförmigen Pupillen der Katze*, in *Philos. Stud.* IX, 447-495.)

ness; (2) the relation to combination of contours and to stereoscopic depth of such differences in the colour or the brightness of the images upon the respective retinas. In such an investigation the question of intensity naturally comes first. For in stereoscopic combination the effect of the co-operation of the two eyes is three-fold: (1) the images are combined so as to present the appearance of a single surface; (2) with regard to contours, there are, as mentioned before, three possibilities, (a) that they coincide, (b) that they are incongruent, but combine into a single three-dimensional image, (c) that they do not combine ("double images"); (3) there is frequently, though not always, a change of brightness from that of the monocular images. Our first investigation, therefore, will be concerning the relative brightness of monocular and binocular vision.

II. COMPARISON OF MONOCULAR AND BINOCULAR INTENSITIES

This question of the relative brightness of monocular and binocular vision at once opens up some very interesting problems. By the earliest investigators it was found that the same object appears brighter when looked at with both eyes than when regarded with only one. Jurin, in 1755, fixed the relation as 13:12. Valerius, in 1873, by a more accurate method of investigation, showed that the increase or decrease of brightness by the admission or exclusion of the second eye varied, with different absolute intensities, from about $\frac{1}{10}$ to $\frac{1}{4}$, though Valerius himself did not think the absolute brightness had anything to do with the result. These early investigations are not very conclusive, first, because the methods of experimenting were not sufficiently accurate, secondly, because they ignore the fact that it is not physical intensities but intensities of sensation that are being compared, and hence neglect the subjective conditions which must affect the results. The investigations of Fechner and Aubert upon this point have established two facts. They proved that by placing before one eye a smoked glass which absorbs comparatively little light there may be produced as great a darkening of the common vision-field as is produced by a glass which absorbs very much more light. For instance, if the light admitted to the unobscured eye be represented by 1000, the total intensity

[126]

is the same when the other eye looks through a glass which admits 55 parts of light as when it looks through a glass which admits 500; while the admission of 100 parts of light to the second eye has about the same effect as the admission of 200. The points of equal darkening are called by them "conjugate points," and between these points lies what they designate as the "minimum point," or point of greatest darkening of the common vision-field by the obscuration of one of the eyes. When this point has been reached a decrease of the light admitted to the second eye has the same effect as an increase, viz., it increases the total brightness. They also showed that when one eye is partly obscured by a smoked glass or episkotister, the closing of that eye, or the total cutting off of the light from it, may result, under certain conditions, in a brightening of the common vision-field. This latter is the phenomenon known as "Feclner's paradox," the paradox consisting in the fact that a decrease in the intensity of physical stimulus is followed by an increase in the intensity of sensation. With this "paradox" as a starting point, some experiments were made by the writer for the purpose of clearing up somewhat this question of the relation of binocular and monocular intensities. Before referring to the results of these experiments, however, it is necessary to define more closely their object. There are two questions which do not seem to have been very clearly distinguished by previous investigators. One is the question to what extent an object appears brighter or darker according as it is regarded continuously under similar conditions with one eye or with two. Here we have to do with a continuous state in co-operation or non-co-operation. The other question is, how much intensity is added to that of monocular vision by the addition of the second eye, or subtracted from that of binocular vision by the closing of one eye. The point here is the immediate effect of a change. Looking at it from the former standpoint we have to seek for an equation between binocular and monocular intensities. From the latter standpoint the question presents itself as follows: for every intensity in monocular vision there exists a certain intensity, the admission or non-admission of which

to the other eye has *no effect* on the total intensity. To find for some cases these physical intensities, which, as regards the intensity of light sensation, are entirely ineffective, was the purpose of the experiments. Fechner's paradox (that if one eye is partially obscured by a smoked glass or similar means, the closing of that eye is followed by brightening of the whole visual field) had been found to occur only when a glass or episkotister was used which absorbed most of the light. On the other hand, if one were used which absorbed comparatively little light, on the closing of the partially darkened eye the whole visual field appeared darker. Between these limits, therefore, there must be, in analogy to Fechner's and Aubert's "minimum point," an indifference point, where no difference will appear in the brightness of the common visual field on the closing of one eye. That point, then, is what the experiments sought to discover.

The apparatus used and the method of experimenting have been fully described elsewhere.¹ The results, however, are of such importance for the present investigation as to warrant the reproduction of the tables here in a modified form.

TABLE I. OBSERVER K. LEFT SIDE.

Description of Light Used	Photometrically Determined Intensity	Amount of Light for the Second Eye Inefficient for the Brightness of the Common Vision Field		
		a.	b.	c.
		In Degrees of the Episkotister	In Units of Intensity	Ratio of the Intensity for the Other Eye
32 c.p. lamp + 2 sheets of white paper and 10 tissue papers	1	127½°	.35	.35
32 c.p. lamp + 10 t.p.	12(?)	78°	2.60	.21
32 c.p. lamp + 6 t.p.	120	68°	22.66	.18
32 c.p. lamp + 4 t.p.	210	63°	36.75	.17
32 c.p. lamp + 2 t.p.	360	52°	52.00	.14

¹ *Experiments on Fechner's Paradoxon*, (Am. Jour. of Psych., vii, 9-25.)

TABLE II. OBSERVER K. RIGHT SIDE.

Description of Light Used	Photometrically Determined Intensity	Amount of Light for the Second Eye Inefficient for the Brightness of the Common Vision Field		
		a. In Degrees of the Episkotister	b. In Units of Intensity	c. Ratio of the Intensity for the Other Eye
32 c.p. lamp + 2 sheets of white paper and 10 tissue papers	1	132½°	.36	.36
32 c.p. lamp + 10 t.p.	12(?)	107°	3.56	.29
32 c.p. lamp + 6 t.p.	120	77°	25.66	.21
32 c.p. lamp + 4 t.p.	210	73°	42.58	.20
32 c.p. lamp + 2 t.p.	360	68°	68.00	.18

TABLE III. OBSERVER R. AVERAGE OF LEFT AND RIGHT SIDES.

Description of Light Used	Photometrically Determined Intensity	Amount of light for the second eye inefficient for the brightness of the common vision field.		
		a. In Degrees of the Episkotister	b. In Units of Intensity	c. Ratio of the Intensity for the Other Eye
32 c.p. lamp + 2 sheets of white paper and 10 tissue papers	1	165°	.45	.45
32 c.p. lamp + 10 t.p.	12(?)	122°	4.06	.33
32 c.p. lamp + 6 t.p.	120	100°	33.33	.27
32 c.p. lamp + 4 t.p.	210	77°	44.01	.21
32 c.p. lamp + 2 t.p.	360	64°	64.00	.17

Examination of Tables I-III will show that the results of the experiments which are significant for the present inquiry are two:

(1) The first is the dependence upon the absolute intensity of the proportion of the full light which can be admitted to the second eye without effect upon the total brightness. This dependence appears throughout the tables in such an obvious and regular manner that it is surprising that it has escaped the notice of previous investigators. But as regards the relative intensities of monocular and binocular vision, this dependence means that the ratio of those intensities to each other cannot be exactly determined, because it is not a con-

stant ratio. It varies with the absolute intensity. For small absolute brightness the proportion of the light admitted to the second eye without increasing the total brightness is much greater than for higher intensities.

(2) The second fact of especial interest is that the proportion of the full light which can be admitted to the second eye without effect upon the brightness of the common visual field is in all cases so large. The proportion, according to the above tables, varies from about one-seventh to nearly one-half, with different observers and under different conditions. In some subsequent experiments, it was found that with lower absolute intensities the proportion was more than one-half.

The bearing of the first of these results upon the theme of our inquiry will be more apparent when we come to discuss the relation of light intensity to stereoscopic depth perception. At present the second result seems to possess more direct interest. The reason (apart from the operation of Weber's law) for the relatively slight effect of the light admitted to the second eye upon the brightness of the common visual field is of course that the purpose of the co-operation of the two eyes is not to increase the brightness, but to accomplish those parallaxic relations which are the principal means of binocular depth perception. The question at once suggests itself, however,—is the amount of light in the second eye, which is ineffective as regards the total brightness, the same as the least amount necessary for the stereoscopic combination of the two retinal images? Thus we come to the second step in our investigation.

III. THE RELATION OF INTENSITY OF LIGHT SENSATION TO THE STEREOSCOPIC PERCEPTION OF DEPTH

This branch of the subject has also been investigated by an experimental method which is fully described in an earlier publication.¹ Those experiments had for their object to determine the least amount of light which must be admitted

¹*Light Intensity and Depth Perception.* (Am. Jour. of Psych., vol. VII, pp. 518-532.)

to the second eye in order to produce the stereoscopic effect, and to find whether or not that amount is the same as the amount of light which in the second eye is inefficient as regards the comparative light intensities of monocular and binocular vision. As in the present papers some further experiments upon this point, both with colourless and with coloured light, will be reported, the tabulated results of the former experiments are inserted here for the purpose of comparison.

TABLE IV.—OBSERVER R.

Description of Light Used	AMOUNT OF LIGHT IN THE SECOND EYE NECESSARY						AMOUNT OF LIGHT IN THE SECOND EYE WHICH HAS NO EFFECT ON THE BRIGHTNESS OF THE COMMON VISUAL FIELD		
	I For Complete Stereoscopic Effect			II For Any Stereoscopic Effect			a. Opening of the Disc in Degrees	b. Units of Intensity	c. Ratio of the Light in the Other Eye
	a. Opening of the Disc in Degrees	b. Units of Intensity	c. Ratio of the Light in the Other Eye	a. Opening of the Disc in Degrees	b. Units of Intensity	c. Ratio of the Light in the Other Eye			
8 c. p. lamp + 34 sheets of tissue paper	147 ^b	.41	.41	85	.18	.18	151	.41	.41
8 c. p. + 26 t. p.	85	.65	.23	48 ¹	.37	.13	158	1.21	.43
8 c. p. + 20 t. p.	65	.70	.18	32 ¹	.35	.09	156	1.68	.43
8 c. p. + 16 t. p.	66 ¹	1.31	.19	30 ¹	.55	.08	175	3.23	.48
8 c. p. + 12 t. p.	47 ¹	2.09	.12	14	.64	.03	107	9.12	.56
8 c. p. + 8 t. p.	20.16	2.59	.08	10 ¹	.85	.02	175	14.17	.48
8 c. p. + 4 t. p.	56.94	3.04	.05	5 ¹	.90	.01	174	27.51	.48
8 c. p.	100.00	3.47	.03	2 ¹	.74	.007	145	38.20	.38
16 c. p.	192.00	5.53	.02	1 ¹	.80	.004	127	67.69	.35
32 c. p. + 4 t. p.	527.70	17.59	.03	1 ¹	1.09	.002	103	145.91	.27
32 c. p.	1014.80	14.09	.01	* ¹	1.10	.001	117	330.54	.32
50 c. p.	1515.70	14.03	.009	* ¹	2.80	.001	01	381.93	.25
100 c. p.	3130.40	46.39	.01	* ¹	2.17	.0006	83	710.08	.22

*These figures represent the averages of a number of cases in some of which a partial effect remained with a smaller opening than the disc was graduated to measure exactly; the minimum point was, in those cases, taken as 0.

TABLE V.—OBSERVER L.

DESCRIPTION OF LIGHT USED	PHOTOMETRICALLY DETERMINED INTENSITY	AMOUNT OF LIGHT IN THE SECOND EYE NECESSARY						AMOUNT OF LIGHT IN THE SECOND EYE WHICH HAS NO EFFECT ON THE BRIGHTNESS OF THE COMMON VISUAL FIELD								
		I For complete Stereoscopic Effect			II For Any Stereoscopic Effect			a			b			c		
		a Opening of the Disc in Degrees	b Units of Intensity	c Ratio of the Light in the Other Eye	a Opening of the Disc in Degrees	b Units of Intensity	c Ratio of the Light in the Other Eye	a Opening of the Disc in Degrees	b Units of Intensity	c Ratio of the Light in the Other Eye	a Opening of the Disc in Degrees	b Units of Intensity	c Ratio of the Light in the Other Eye	a Opening of the Disc in Degrees	b Units of Intensity	c Ratio of the Light in the Other Eye
8 c. p. lamp + 34 sheets of tissue paper	I	225	.62	.62	114	.31	.31	.31	230	.63	.63	.63	230	.63	.63	.63
8 c. p. + 20 t. p.		170 $\frac{1}{2}$	1.35	.48	42	.32	.11	.11	160	1.26	1.26	.45	160	1.26	1.26	.45
8 c. p. + 20 t. p.		3.88	1.02	.26	26 $\frac{1}{2}$.28	.07	.07	177	1.91	1.91	.49	177	1.91	1.91	.49
8 c. p. + 16 t. p.		6.66	1.72	.25	16 $\frac{1}{2}$.30	.04	.04	157	2.89	2.89	.43	157	2.89	2.89	.43
8 c. p. + 12 t. p.		16.16	3.59	.22	9 $\frac{1}{2}$.43	.02	.02	176	7.21	7.21	.44	176	7.21	7.21	.44
8 c. p. + 8 t. p.		29.16	2.76	.09	10	.83	.02	.02	174	14.07	14.07	.48	174	14.07	14.07	.48
8 c. p. + 4 t. p.		56.94	6.70	.11	4 $\frac{1}{2}$.67	.01	.01	186	28.52	28.52	.50	186	28.52	28.52	.50
16 c. p.		100.00	7.87	.07	2 $\frac{1}{2}$.78	.007	.007	190	52.77	52.77	.52	190	52.77	52.77	.52
32 c. p.		192.00	12.00	.06	1 $\frac{1}{2}$.89	.004	.004	147	78.28	78.28	.40	147	78.28	78.28	.40
32 c. p. + 4 t. p.		527.70	7.32	.01	1	.73	.001	.001	198	142.91	142.91	.27	198	142.91	142.91	.27
50 c. p.		1014.80	19.73	.01	*1	.73	.0007	.0007	190	537.75	537.75	.52	190	537.75	537.75	.52
100 c. p.		1515.70	37.36	.02	*1	.84	.0005	.0005	156	657.50	657.50	.43	156	657.50	657.50	.43
100 c. p.		3130.40	136.95	.04	*1	7.61	.0002	.0002	173	1505.58	1505.58	.48	173	1505.58	1505.58	.48

*Sometimes the effect did not wholly disappear with the least amount of light that could be admitted.

†Result of only one series.

TABLE VI.—OBSERVER K.

DESCRIPTION OF LIGHT USED	PHOTOMETRICALLY DETERMINED INTENSITY	AMOUNT OF LIGHT IN THE SECOND EYE NECESSARY							
		I. For Complete Stereoscopic Effect			II. For any Stereoscopic Effect				
		a. Opening of the Disc in Degrees	b. Units of Intensity	c. Ratio of the Light in the other Eye	a. Opening of the Disc in Degrees	b. Units of Intensity	c. Ratio of the Light in the other Eye		
8 c. p. lamp + 34 sheets of tissue paper.	1	110	.30	.30	70	.19	†?		
8 c. p. + 26 t. p.	2.77	63	.45	.16	47	.36	104	1.44	.59
8 c. p. + 20 t. p.	3.88	50	.53	.13	31	.33	166	1.79	.46
8 c. p. + 16 t. p.	6.66	29	.55	.08	14	.25	180	3.33	.50
8 c. p. + 12 t. p.	16.16	23	1.03	.06	9	.40	172	7.73	.47
8 c. p. + 8 t. p.	20.16	15	1.21	.04	3	.24	246	19.92	.62
8 c. p. + 4 t. p.	50.94	15	2.37	.04	3	.55	171	27.02	.47
16 c. p.	100.00	11	3.05	.03	2	.60	132	36.57	.36
32 c. p. + 4 t. p.	192.00	11	6.13	.03	2	.26	148	79.11	.41
32 c. p.	527.70	3	3.66	.006	†	.73	135	197.88	.37
1014.80	3	8.45	.008		*	.70	114	320.88	.31
1515.70	2	8.42	.005		*o(?)		129	541.32	.35
100 c. p.	3130.40	1	10.86	.003	*o(?)		107	926.49	.29

*Opening could not be made small enough to completely destroy stereoscopic effect.
 †Light too dim and too much orange colour from the tissue papers for discrimination.

TABLE VII.—OBSERVER A.

Description of Light Used	Photometrically Determined Intensity	AMOUNT OF LIGHT IN THE SECOND EYE NECESSARY						AMOUNT OF LIGHT IN THE SECOND EYE WHICH HAS NO EFFECT ON THE BRIGHTNESS OF THE COMMON VISUAL FIELD		
		I. For Complete Stereoscopic Effect			II. For any Stereoscopic Effect			a. Opening of the Disc in Degrees	b. Units of Intensity	c. Ratio of the Light in the other Eye
		a. Opening of the Disc in Degrees	b. Units of Intensity	c. Ratio of the Light in the other Eye	a. Opening of the Disc in Degrees	b. Units of Intensity	c. Ratio of the Light in the other Eye			
8 c.p. + 16 t.p.	6.66	12	2.07	.31	32	.59	.08	*192 (?)	3.55	.53
8 c.p. + 12 t.p.	16.16	10	4.04	.25	22½	1.01	.06	*231 (?)	9.87	.01
8 c.p. + 8 t.p.	29.16	10	8.91	.30	32½	2.63	.08	217	17.59	.60
8 c.p. + 4 t.p.	59.94	90	14.23	.24	25	3.95	.06	187	29.61	.52
8 c.p.	100.00	22	6.11	.06	9	2.50	.02	98	27.31	.27
16 c.p.	192.00	22	11.73	.06	9	4.80	.02	131	70.00	.36
32 c.p. + 4 t.p.	527.70	55	75.06	.14	1	1.46	.002	116	243.08	.46
32 c.p.	1014.80	9	25.37	.02	3	8.45	.008	109	306.55	.30
50 c.p.	1515.70	10	42.10	.02	1½	6.31	.004	*210 (?)	884.15	.51
100 c.p.	3130.40	50	434.77	.13	½	4.34	.001	88	761.10	.24

*The "equal" limits had not been passed at 270°, more than which the sectors of the disc would not admit.

Remarks on the Tables: (1) Division I of the tables shows the lowest point for each absolute intensity at which the stereoscopic effect was complete, Division II the point at which it had entirely ceased. Between these points there was a region of partial or incomplete combination. Here the outlines were sometimes confusedly intermingled, sometimes the complete stereoscopic effect would alternately appear and disappear, and again there would occur the phenomenon of the competition of the vision-fields, first one and then another set of lines becoming distinct.

(2) In the last division of the tables, which gives for each absolute intensity the amount of light which can be admitted to one eye without producing any change in the brightness of the common vision-field, it will be observed that the results are less regular than in Tables I-III in the preceding section. But that is probably because these results represent the averages of a smaller number of trials. The judgments concerning light intensity are more difficult than those regarding the stereoscopic effect.

(3) All the results are slightly less regular with the highest intensities used, owing probably to those intensities being somewhat near the "upper limit" for the eyes adapted to the darkened room.

(4) Where fractions of degrees are given under "Opening of the disc" these are the result of averaging a number of cases. The disc was not graduated to measure less than half a degree with accuracy. In Tables I-III such fractions are not given, but when less than $\frac{1}{2}$ are disregarded, when more than $\frac{1}{2}$ are counted as 1° .

Summary of Results: (1) The amount of light in the second eye necessary to produce the stereoscopic effect varies, like the minimum of light required to increase the total brightness, in fairly regular correspondence with the absolute intensity. The correspondence is not such as to establish a proportionality between the quantities in question, but the amount, except with the highest intensities used, quite regularly be-

comes greater or less as the absolute intensity increases or diminishes.

(2) The amount of light required in the second eye to produce the stereoscopic effect seems, with most of the intensities used, surprisingly small. With very high intensities $\frac{1}{100}$ of the full light or less was sufficient to make the effect complete, while in many cases a partial effect remained with the very least amount which the disc could be adjusted to admit (estimated at $\frac{1}{1000}$ or less). On the other hand, with the lowest absolute intensities, about $\frac{1}{2}$ of the full light was necessary for the second eye in order to produce the complete stereoscopic effect, while for any effect at all, from about $\frac{1}{3}$ to $\frac{1}{5}$ of the full light was required.

(3) There is in all cases a noticeably wide range between the point where the objects begin to combine, and the point where the complete stereoscopic effect is obtained. The amount of light at the latter point is about from two to twenty times as great as at the former. Thus in Table V, with the absolute intensity 1, an opening of the episkotister disc of $22\frac{1}{2}^\circ$ is required for the complete stereoscopic effect, while a partial effect appears above 85° . With the absolute intensity 192 in this table a partial effect appears above $1\frac{1}{2}^\circ$, while for the full effect $22\frac{1}{2}^\circ$ was required. And in the other tables the case is similar.

(4) The "indifference point," or point of inefficiency as regards the comparative light intensities of monocular and binocular vision, varies also, as in the experiments on intensity referred to in the preceding section, in correspondence with the absolute intensity; the amount of light which can be admitted to the second eye without affecting the brightness of the common visual field increases with the increase of absolute intensity. The ratio of the amounts of light admitted to the obscured and the unobscured eyes shows, however, at this indifference point less variation than at the lowest point of effectiveness for the stereoscopic combination. It is noticeable also that while the amount of light for the second eye inefficient for the brightness of the combined visual field

increases in quite regular correspondence with the absolute intensity, the increase here, as with the light required in the second eye for the stereoscopic effect, is not proportional; for while the actual amount of light increases, the ratio to the full light continually decreases.

(5) The "indifference point" of light intensity and the lowest point of effectiveness for the stereoscopic effect do not coincide. The indifference point is very much higher in nearly all cases than the point below which the stereoscopic effect ceases to be good. The points approach nearer to each other, the lower the absolute intensity; but there is a region, which with higher absolute intensities becomes very great, where the "paradox" of Fechner occurs, while yet the stereoscopic effect is completely preserved.

Have we now in these results any data for the solution of the problem which emerged from our investigation regarding the relative intensities of monocular and binocular vision, viz., that so large a proportion of the full light can be admitted to the second eye without producing any effect upon the total brightness? That there is something more involved here than the general quantitative relation of stimulus and reaction, i.e., Weber's law, is apparent from the fact that the proportion changes with the changing of the absolute intensity. The fact that the chief purpose of the two eyes is not to increase the brightness, but to establish those parallaxic relations upon which binocular depth perception depends, suggests an easy solution of this problem. So much of the light admitted to the second eye goes to produce the stereoscopic effect, and the remainder, subject of course to Weber's law, to increase the total brightness. Our tables, however, show that the lowest point where the stereoscopic effect is produced is not the same as the "indifference point" of light intensity except in one or two cases, where their coincidence may be accidental. In nearly all cases the least amount of light required for the stereoscopic effect is less—sometimes a hundred times less—than the amount which is inefficient for the brightness of the common visual field.

A second question is whether our results throw any light upon Fechner's "paradox." Here also, prior to any experimental test, it might be thought that the explanation is quite simple. We have but to assume that where the "paradox" occurs it is due to the fact that the physical energy which reaches the retina of the partially obscured eye is less than is necessary to enable that eye to play its part in forming the combined impression and localizing it in the third dimension, and that in that case part of the energy of the free eye is subtracted to aid the other eye in the binocular combination (no. of course, the stereoscopic combination); then on the closing of the other eye, this part of the energy would be set free and the result would be an increase of the light intensity. To confirm this suggestion also, however, the results should show a practical coincidence of the indifference point of light intensity and the lowest point of effectiveness for the stereoscopic combination. Whereas, as we have seen, the indifference point is very much higher in nearly all cases than the point below which the stereoscopic effect ceases to be good; in other words the paradox occurs over a considerable region where the stereoscopic effect is complete.

With regard to Fechner's and Aubert's "minimum" and "conjugate points," our results have not much contact with the results of those investigators. They fixed the minimum point, i.e., the point of greatest darkening in the common visual field by the darkening of one eye definitely at the point where, the full light being represented by 1000, 122 represented the amount admitted to the partially-obscured eye. In our results, however, it appears: (1) that the ratio to the full light of the light required for the second eye to produce any effect on the total intensity is not a constant ratio, but varies with the absolute intensity; (2) that the indifference point is not usually a single definite point, but that there is commonly a considerable region within which no difference in the brightness of an object in the common visual field is observed when the object is regarded alternately with one eye and with two. The figures in the tables represent simply the averages of all

the equal cases. Some suggestions for a possible explanation of these results will be given in the next section.

Let us now revert for a moment to the second of the above-mentioned results, viz., the exceedingly small proportion of the full light which one eye may receive without the stereoscopic effect being destroyed or impaired. It might be thought that the result, in the experiments above referred to, was at least partially due to the very simple character of the outline drawings employed. Would the results have been similar had more complicated figures been used? That is a question somewhat difficult to investigate, because figures suitable for the purpose are not easily obtained. Ordinary stereoscopic photographs, for instance, will not do. For these have, even when regarded with one eye only, a certain depth effect, due to secondary factors of depth perception, from which it is difficult to abstract in judging of the stereoscopic effect. The solution of this difficulty was suggested by an article of Fuchs.¹ Dr. Fuchs refers to the experiments of Helmholtz² with tapestry patterns, etc., and of Meyer³ with objects such as wire screens, etc. Both these authors reported that by convergence of the lines of regard of the two eyes upon a point nearer to or further from the observer than the plane of the objects observed, certain parts of the pattern could be seen stereoscopically, i.e., superimposed upon one another, and at different distances from the eye, so that certain figures in the pattern seemed to be, as it were, suspended in the air before the others. Fuchs, however, pointed out that convergence or squinting would not produce the stereoscopic effect so long as the superimposed double images held exactly the same relative positions in the two eyes. This can be seen by reference to Fig. 1, where convergence results in the appearance of four or more rings in each row, which, however, are all in the same plane. The stereoscopic effect

¹ *Ueber die stereoskopische Wirkung der sogenannten Tapetenbilder* (Zeitschrift für Psychologie und Physiologie der Sinnesorgane, Bd. 32, Heft 2, 1903).

² *Handbuch der physiologischen Optik*, p. 799 (1896).

³ Rosers und Wunderlichs *Archiv für die physiologische Heilkunde*, 1841, I, 316 etc.

reported by earlier authors must therefore, according to Fuchs, be due to the repetition of the figures in the pattern not being exactly regular, so that the distance of identical points, and consequently the convergence conditions required for corresponding parts, are different. He employed, to demonstrate this, a complicated drawing, consisting of very simple and exactly similar parts, in the arrangement of which, however, such irregularities are purposely introduced in a somewhat exaggerated degree. This drawing is reproduced in Fig. 2 (Fuchs' Fig. 3). This figure appeared admirably suited to our purpose. It is a much more complicated one than the others employed in our experiments, and has very little in itself to suggest the perception of depth, but on the contrary requires special conditions and effort—unless the eyes are assisted by glasses—in order to be seen stereoscopically. Some experiments were accordingly made with copies of this figure of Fuchs' as objects to see if our results would be confirmed when such objects were substituted for the simpler ones used in the former experiments. The same apparatus could not be used as in the other experiments, because the visual angle subtended by the objects was greater than was provided for by the openings in the front screen, and the divisions between the double openings would conceal parts of the drawings. Accordingly, the apparatus used was a modification of the simpler one designed for the experiments in regard to the relative intensities of monocular and binocular vision. The lamps used were in this case fixed above and in front of the objects, and screened so as to prevent their light shining directly into the observer's eyes. In some cases the experiment was performed by squinting, without any glasses over the openings through which the eyes looked. In others, convergence was facilitated by the use of lenses, which were attached in such a way that they could be pushed aside when not in use. The results, as exhibited in Tables VIII and IX, completely confirm those given in the former tables. For the second eye $\frac{1}{30}$ of the full light was usually sufficient to give at least a partial stereoscopic effect, and with from $\frac{1}{150}$ to $\frac{1}{30}$ the effect was complete.

TABLE VIII.—OBSERVER K.

LEFT SIDE				RIGHT SIDE			
ILLUMINATION	CONVERGENCE	OPENING OF DISC	STEREOSCOPIC EFFECT	ILLUMINATION	CONVERGENCE	OPENING OF DISC	STEREOSCOPIC EFFECT
50 c.p.	Further away than plane of object...	*2°	Perfectly preserved.....	50 c.p.	Further.	*2°	Perfect.
"	"	1°	Slightly impaired.....	"	"	1°	"
"	Nearer, than plane of object.....	*2°	Fairly good.....	"	Nearer.	*2°	"
"	"	1°	Not so good as with further convergence.....	"	"	1°	Impaired.
8 c.p.	Further.....	*2°	Not quite good.....	8 c.p.	Further.	*2°	Perfect.
"	"	1°	Partial and inconstant.....	"	"	1°	Fair—inconstant.
"	Nearer.....	*2°	Not quite perfect.....	"	Nearer.	*2°	Not quite good—rings have a penumbra.
"	"	1°	Traces only on part of drawing	"	"	1°	Only a trace.

* In all cases the effect was perfectly preserved with any wider opening than 2°.

TABLE IX.—OBSERVER R.

LEFT SIDE				RIGHT SIDE			
ILLUMINATION	CONVERGENCE	OPENING OF DISC	STEREOSCOPIC EFFECT	ILLUMINATION	CONVERGENCE	OPENING OF DISC	STEREOSCOPIC EFFECT
8 c.p.	Further.	6°	Perfect.....	8 c.p.	Further.	2°	Completely preserved.
"	"	4°	Imperfect.....	"	"	1°	Fairly good
"	"	2°	Slightly impaired.....	"	Nearer.	2°	Completely preserved.
"	"	1°	Almost complete.....	"	"	1°	Very slight.
"	Nearer.	6°	Perfect.....				
"	"	4°	Good, but unsteady.....				
"	"	2°	Only a trace—much confusion.....				
"	"	1°	None.....				

IV. BINOCULAR SYNERGIES

In connection with previous reports of the writer's experiments¹ certain suggestions were made first by Professor Kirschmann and afterward developed more fully by the writer as to a possible explanation of certain phenomena of binocular co-operation, and particularly of Fechner's paradox. These were characterized by Professor A. Binet² as "bien hypothétiques." Their hypothetical character is, however, no disparagement, inasmuch as they were not meant, as Professor Binet apparently regarded them, as interpretations of the writer's results, but rather as tentative suggestions, the further questions to be investigated before any strong claim could be advanced for them being at the same time pointed out. The intimate character of the co-operation of the two retinas which our provisional explanation of the "paradoxical" phenomenon, especially, presupposes is such, however, as to raise the whole question of the reaction of one retina upon stimuli applied to the other; and it may, therefore, not be out of place to give briefly the gist of previous investigations and discussions of this subject. That having been done, the re-statement of the above mentioned suggestions regarding the phenomena of binocular co-operation and binocular intensities may be found to have some bearing on the question of the retinal transference of impressions.

That it is possible, under certain conditions, by the stimulation of one retina to produce an impression in the other, has been maintained by various investigators, from the time of Newton. Titchener, who has made elaborate series of experiments upon several phases of the problem, gives also in his article a comprehensive summary of previous discussions.³ A further discussion is given by Franz.⁴ Against the assumption of a functional interconnection of the retinas two positions

¹ *Am. Jour. of Psych.* vol. VII., 1895, pp. 9-25, 518-532.

² *L'Année Psychologique*, 1896, p. 381.

³ *Ueber binoculare Wirkungen monocularer Reize.* (*Philos. Stud.* VIII, 1893, pp. 231-310.)

⁴ *After Images* (*Psych. Review*, Mon. Sup. 12, 1899).

have been advanced, that in the cases adduced no real transference takes place, and that it is not the retina of the unstimulated eye, but the brain centre that is affected.

To the second of these claims very little importance in the present stage of the question need be attached. For how is the matter simplified by assuming that in certain cases the stimulation, say of the right retina, produces the same molecular activity in the visual cerebral centre usually produced by the stimulation of the left retina, rather than that in those cases an activity is started in the left retina by the stimulation of the right? The position that the impression is mistakenly referred to the unstimulated eye but that there is no real transfer of activity from one eye to the other is favoured by Franz. He supports it by the result of an experiment in which the light stimulus was applied to the portion of the right eye which corresponds to the blind spot of the left eye. On opening the left eye an image appeared. But since with the portion of the left eye corresponding to the stimulated part of the right, nothing can be seen, the conclusion is that the transfer in this case cannot be real, and, therefore, may not be in other cases. This does not, however, seem conclusive. For with the closed eye there is no question about the direction of light rays entering it, the question is whether the starting of a certain activity in one eye by an appropriate stimulus may be followed without direct stimulation by a similar activity in the other. Delabarre¹ had before come to the same conclusion, on account of the image apparently in the unstimulated eye changing or disappearing with a change in the objective conditions of the eye which received the stimulus. Against this are the results of Fechner² regarding binocular contrast, in which the one eye, while darkened or receiving only faint grey light, saw the complementary of the colour simultaneously presented to the other eye. That the transfer is real is also held by Titchener, the results of whose

¹ *The Seat of Optical After-Images.* (Am. Jour. of Psych., vol. II, 1889, pp. 326 etc.)

² *Ueber einige Verhältnisse des binocularen Sehens.* (Abh. d. k. Sach. Ges. d. Wiss., VII, 481, 1860.)

experiments showed marked differences between the images in the respective eyes with regard to duration, brightness, and changes of colour.

The results of our experiments, reported in the preceding section, touch the present discussion at two points:

1. The amount of light admitted to the second (the less stimulated) eye at the point where the objects begin to combine is but a small fraction of that required for the complete combination. This could easily be explained if we might assume that a part of the physical energy communicated to the retina of the unobscured eye is subtracted, when necessary, to aid the other eye in the binocular combination. Of course the factors of binocular depth perception are such that in it one eye cannot do any part of the work of the other. But for the production of the stereoscopic effect it is first necessary that the two retinal impressions should be combined so as to produce the impression of a single surface. This distinction of the simple binocular from the complete stereoscopic combination is not a merely hypothetical one. Throughout the experiments it was frequently noted that the surfaces would coincide where there was no depth perceptible. Now if where the objects begin to combine there is only the combination into a single surface, and in that the free eye can more largely aid the other, while in the complete stereoscopic combination the aid it can give is proportionately much smaller, that may account for the proportion of light required in the second eye in the latter case being enormously greater than where the objects combine only as a single surface.

2. The second point concerns the suggested explanation of the paradox of Fechner, that its occurrence is due to the energy communicated to the partially-obscured eye being too little to enable that eye to play its part in combining the images. Part of the energy communicated to the free eye is subtracted to aid the other, and the result is a darkening of the common field of vision. Then on the closing of the other eye that part of the energy of the free eye is liberated, and the common field becomes brighter. This suggestion seems to be negated

by the fact that the amount of light in the partially-obscured eye which has no effect upon the total brightness is very much greater than the amount required for the stereoscopic effect. The lower the absolute intensity, however, the nearer these amounts approach to each other, and at certain extremely low intensities they coincide. If this be taken as an indication that the explanation holds good for these low intensities, the question of course at once arises—why not for higher intensities? There is even for these, on the assumption of a functional interrelation of the retinas, a possible explanation, which is given here rather than in the discussion in the preceding section, because it can only be hypothetical until this whole question is more thoroughly cleared up. Let us assume that with the extremely low intensities in question the light which reaches the retina of the unobscured eye is only about enough to enable that eye to play its own part in the binocular combination. For example, where in Table IV the absolute intensity is 1, the light which must be admitted to the second eye to produce the complete stereoscopic effect is represented by .41, and .41 also represents for the absolute intensity 1 the amount of light in the second eye which has no effect on the brightness of the common visual field. If, therefore, less light than .41 is admitted to the second eye, we shall have the paradox and at the same time stereoscopic combination will be absent or only incomplete. This is perhaps because the stimulus applied to the second eye in this case is not sufficient to produce the energy required for the stereoscopic effect. Part of the energy may be subtracted from the other eye to aid in the binocular combination, and consequently the common visual field is darkened. But because the light admitted to the free eye is little more than the least amount needed to produce the required effect in it, while that eye continues to discharge its function there cannot be sufficient energy withdrawn from it to make up what is lacking in the other eye, and hence the stereoscopic effect remains incomplete. Then taking a higher absolute intensity, let us say that represented in the table by 100, we find that the amount of light required

in the second eye for the complete stereoscopic effect is 3.47, while the amount inefficient for the brightness of the combined visual field is 38.20. On the above suggested theory it might be held that the energy which reaches the retina of the free eye is in this case more than the least amount required for that eye to play its part in the co-operation of the two eyes, and where the other eye does not receive sufficient for that purpose, enough energy may be subtracted from the free eye to supplement that of the partially obscured eye and produce the complete stereoscopic effect. This would account for the fact that with all but the lowest intensities there is a region, growing more extended as the absolute intensity increases, where the paradox occurs, while yet the stereoscopic effect is completely preserved.

Our results, then, favour the view of a functional interconnection of the retinas to the extent that certain phases of them, otherwise unexplained, seem capable of explanation on this theory. Yet these results are by no means conclusive. It may yet be found that all the phenomena in question are not due to either retinal or cerebral processes, but are purely psychical.

V. LUSTRE.

1. *Theory of Lustre.* The phenomenon of lustre is discussed in connection with the problem of intensity because, although intensity is only one of the factors in the production of this phenomenon, the part which it plays is sufficiently important to warrant a careful investigation of its influence. Since, however, several of the authors who deal with this subject are not free from error or confusion regarding the importance of intensity or of intensity-contrast as a condition of the phenomenon of lustre, it is necessary, in the beginning, to devote a little space to clearing up this point.

Most of the investigators of the subject hitherto have not distinguished the physical and the psychological aspects of the matter with sufficient clearness. For the physicist the questions raised concern the movement processes which take

place in the reflection of light from surfaces under different conditions. For him the character of the sensation of sight is of interest only as indicating what physical process is going on. And if the characteristics of our light sensations were entirely different from what they are, that would not change the nature of the physicist's problem in the least. The psychologist, on the other hand, has to deal with what takes place in consciousness. For him the question is "What are the qualities or intensities or space and time relations of the sensations or complexes of sensation which take part in the impression of lustre?" And for the psychologist, therefore, the physical properties of the light are of only conditional importance. Failure to observe this distinction has led to much confusion of thought. Hering, for example, in common with several other writers, regards lustre as dependent upon high intensity. Now the intensity which can be a factor in the perception of lustre must be the intensity of light sensation. Yet Hering speaks of the lustre which belongs to self-luminous bodies as well as of that which appears on incompletely mirroring surfaces. But to be self-luminous is not a property of objects which is directly given to the sense of sight. To decide whether a body is self-luminous we must have other data than those which the sense of sight furnishes. Thus, for instance, it is quite easy to illuminate a red or orange paper in the daytime in such a manner that it looks exactly like a red-hot iron. Everybody has noticed, too, how impossible it is to decide, at the time of a brilliant sunset, whether the ruddy glow seen at certain windows is caused by a light or a fire within, or is simply the reflection of the sunshine. A very interesting, as well as very decisive experiment in this line has been made quite incidentally in the use of Professor Kirschmann's apparatus for obtaining spectrally pure light in larger surfaces. This apparatus is arranged so as to effect a two-fold selection of the rays; a surface which reflects one part of the spectrum chiefly is illumined by light which has passed through absorbing media of the opposite selective preference. The apparatus has been used by Messrs. Lane,

Paired and Richardson, and Miss Emma S. Baker, and is described in their articles in the University of Toronto Studies, Psychological Series. It shows a square, or two squares, one in the middle of the other, of light of high spectral saturation, and in any intensity desired. Observers who know nothing of the arrangement for the production of these colours are absolutely unable to say whether they see reflected light, transmitted light, or the source of light itself. This has been especially conspicuous in the experiments of Messrs. Hughes and Armstrong, to be elsewhere reported, in which only colourless light was employed. Certain observers, in order that they might be in complete ignorance of the instrumental arrangement, were brought blindfolded to the entrance of the observation tube. These actually did not realize that they were looking through a diaphragm of varying aperture, but thought they saw self-luminous or transparent objects. And they were moreover not sure whether the size of the object increased and decreased or whether its distance was changed. Such distinctions, then, as that of Hering referred to above denote a confusion of the physical properties of light with the characteristics of our light sensations. And it is just this confusion that prevents both Aubert and Hering from seeing that something more than brightness or brightness-contrast is required for lustre. Psychically there is not such a thing as light sensations of different quality or intensity which are coincident in both space and time. If several light stimuli of different quality and intensity are applied simultaneously to the same retinal points the accompanying sensation is always simple and single. Only when either spacially or temporally separated are the impressions not so combined. Wundt¹ first in 1861 showed conclusively that the characteristic of lustre, whether monocular or binocular, is incomplete mirroring, i.e., a combination of mirror reflection and diffuse light, which combination depends on the parallactic relations arising from movements of the eye or from binocular combination of

¹ *Ueber die Entstehung des Glanzes.* (Poggendorf's *Annalen*, Band 116, s. 627 etc.)

images upon the two retinas. Both these parallaxic relations (of the "double eye" and the moved eye) involve the third dimension, and the great contribution made by Wundt's work to the subject lay in showing that the space relations which are adequate for the explanation of lustre must be three-dimensional. Wundt shows also that strong contrast, whether of quality or intensity, favours the phenomenon.

The relation of differences of brightness to the phenomenon of lustre has been further elucidated by Kirschmann¹ who distinguishes the genuine or parallaxic lustre from an apparent or false lustre, the latter consisting in certain brightness relations which are unusual in pure diffuse reflection, but commonly accompany the true or parallaxic lustre. If we have two bodies with level upper surfaces, one of which is lustrous and the other is not, the former will from one direction appear brighter, from all others darker than the latter. If the surfaces are curved, there will be more than one direction from which the lustrous body appears brighter than the non-lustrous. But then also there will be adjacent parts of the curved lustrous surface which present differences of brightness such as do not occur on the dull surface, under the same conditions of illumination. Now having from experience learned that a continuously curved dull surface does not present strong contrast of intensity in constant illumination, if we see on a surface brightnesses near each other, such as according to our experience cannot occur on a dull surface, and if we are not upon any other ground doubtful about the spacial conditions, we conclude that there cannot be only diffuse light present, but that the surface is lustrous. But this apparent lustre can be produced artificially, apart from any parallaxic relations, by suitably illuminating the single parts of the surface independently of each other. Painters also, provided that the brightness differences of the lustrous bodies which they reproduce upon the canvas are not too great, can succeed to a certain extent in painting lustre. Really, it is only the accidental sign of

¹ *Der Metallglanz und die Parallaxe des indirecten Sehens.* (Philos. Studien, XI, 147.)

lustre, the brightness-contrast, which the painter puts on the canvas. But the beholder, in whose experience this sign has been the almost invariable accompaniment of the true lustre, supplies what is lacking from his imagination. These brightness relations, therefore, though regarded by Aubert, Brücke and others, as the characteristic sign of lustre, are in reality only an accidental accompaniment of it.

To complete the account of the factors of the perception of the various kinds of lustre phenomena further reference must be made to the above-cited work of Kirschmann on metallic lustre. Former writers had identified metallic with binocular lustre. This is expressly done by Aubert.¹ Metallic lustre, however, is perceived quite as well with one eye as with two. Moreover, in the stereoscopic combination of photographs there is never any trace of metallic lustre, even where the binocular lustre is most perfect. This is very strikingly shown in the accompanying stereoscopic picture (Fig. 3). When stereoscopically combined, the picture shows the lustre of porcelain, of wax, of glass, of water, of a mirror, of polished wood, and even the surface lustre of metallic objects, but no metallic lustre. It might be objected that a stereoscopic reproduction on paper has not intensity enough for metallic lustre. But the same photograph has been used with the same result in diapositives, and by Professor Kirschmann's method of exhibiting stereoscopic pictures in transmitted light of great intensity, superposed on a semi-transparent screen. (The screen is a large plate of ground glass, and the double lantern is on the opposite side from the observer, who combines the two pictures by the usual means of a pair of spectacles with red and green absorbing glasses.)

The fact that metallic lustre depends on conditions of monocular vision might be regarded as excluding it from the range of our discussion. But there are two reasons against its exclusion, first, that by earlier writers it was considered as at most a special case of binocular lustre; secondly and chiefly, that the factor to which it is so conclusively proved

¹ *Physiologische Optik*, p. 553.

by Professor Kirshmann to be referable—the parallax of indirect vision—is a supplement (and for one-eyed persons a substitute) to the conditions proved by Wundt to be essential for the perception of lustre, whether binocular or monocular. Inasmuch as this work on metallic lustre has been extensively discussed in French and German publications, but not hitherto in English, there is given here the summary with which the author concludes his exhaustive investigation of the subject. The summary is translated directly and in full in order to preserve the quasi-mathematical character of its demonstration *per exclusionem*.

1. Metallic lustre is a characteristic phenomenon which everybody distinguishes from other light phenomena independently of any previous knowledge of the objects, illumination, etc. A definition of metallic lustre can therefore claim no more value than a definition of the sensation red. The designation of the phenomenon is quite irrelevant. "Metal" and "metallic lustre" have psychologically nothing to do with each other.

2. For our consciousness light impressions are distinguished only with regard to intensity, quality (colour and saturation) and space and time relations. The phenomenon of metallic lustre must accordingly be referable to these four factors or a part of them.

3. As regards intensity there are three elements: (*a*) intensity of the whole surface, (*b*) intensity-relations of the parts of the surface to one another or of the whole surface to other impressions, (*c*) changes of intensity. The possibilities which come under (*b*) and (*c*) belong also under the space and time relations and will be discussed in connection with them. Since metallic lustre is entirely independent of the strength of the illumination, it cannot depend on the absolute intensity of the whole surface.

4. Since there are completely colourless metals, and since further metallic-lustrous surfaces retain their characteristic property in coloured, and even in approximately monochro-

matic light, the participation of the colour-tone and saturation in the essential conditions of metallic lustre is excluded.

5. As regards the time-relations metallic lustre is independent of the duration of the total impression of the surface concerned; it is perceived in very short, so-called instantaneous illumination. Moreover a change in the properties of the total impression cannot be the cause of metallic lustre, since the latter is perceived in demonstrable constancy of the optical relations between the surface in question and the eye. The temporal relations of single parts of the surface fall also under space relations, and will, therefore, be discussed in the following paragraphs.

6. The space relations are either those of the whole surface or those of the parts of the surface to one another. The space relations of the whole surface are form, size, and position relations to other surfaces in the vision-field. Form and size are quite irrelevant for metallic lustre. Since, moreover, the environment of the metallic-lustrous surface is without influence on the characteristic of the phenomenon, the metallic lustre cannot depend on the space-relations of the whole surface. The only condition with regard to the space-relations of the total impression is that there must be a surface. A point in the vision-field, i.e., a light impression not perceived as a surface, no matter what its intensity or its changes of intensity, never has the property of lustre.

7. There remains now as the only possibility the conclusion that metallic lustre depends on spacial or spacial-temporal relations of the parts of the impression to one another. These relations can only have a meaning if the parts of the impression which come in question show differences of quality or intensity. But since, as mentioned above, metallic lustre occurs in objects which reflect completely colourless light, and since, further, monochromatic illumination does not destroy metallic lustre, the quality of the parts of the impression cannot be influential. Metallic lustre must, therefore, depend on spacial or spacial-temporal relations of parts of the total impression which differ in intensity.

8. These relations of the parts of the impression or of the retinal images to one another are either constant, therefore spacial only, or changing, therefore spacial-temporal. If constant space relations were the basis of the phenomenon of metallic lustre, then it must be possible to reproduce this phenomenon through a certain arrangement of different intensities in the surface. But this is not the case. There can accordingly only be inconstant relations concerned. These may be: (a) intensity-changes with fixed space relations, (b) intensity-changes with changing space relations. The first case can occur only if the parts of the metallic-lustrous surface are either self-luminous or illuminated independently of each other by changing light-sources of different intensities. This case is, however, entirely excluded. The question must, therefore, be concerning changes of intensity with changing space relations.

9. The occurrences, which, so far as concerns the retinal image, play their part in two-dimensional space, must, so far as the objects are concerned, either be likewise of a two-dimensional nature or demand for their occurrence the depth dimension. In the former case a change of position of the points of different intensity in the surface must be assumed. This change of position cannot be caused by a change of the spacial relation of the object-surface to the eye; for through such a change nothing would be effected which could not also be produced by movement of objects with dull and not homogeneous surfaces. Since, however, in the metallic-lustrous objects known to us we cannot speak of an objective change of position of single reflecting parts, there remains then only the possibility that the objective arrangement of the light upon which metallic lustre depends is three-dimensional.

10. Inconstant three-dimensional relations in visual space with constant space-relations of the parts of the object to one another can only be parallaxic relations. Metallic lustre must accordingly have its cause in some parallaxic relation between sight-organ and object.

11. There are three parallaxic relations possible in three-dimensional visual space, (1) the binocular parallax, (2) the

movement parallax, (3) the parallax of indirect vision. The binocular parallax can have no influence upon the phenomenon, for the latter is quite as well perceived monocularly. It never seems to play even an auxiliary part. For in the binocular union of stereoscopic photographs, the surface lustre shows excellently, but there is no trace of metallic lustre. The parallaetic phenomena depending on the change of place of the object or of the eye have no meaning for metallic lustre for it is perceived with the unmoved eye and with complete rest of the object.

12. It follows then as the only possibility that metallic lustre depends on the parallax of indirect vision.

13. The phenomena of the parallax of indirect vision are, in apparently homogeneous surfaces, as the metallic-lustrous bodies seem to possess them, possible in the following cases:

(a) If the surface is not actually even or of constant curvature, but is made up of many small surfaces inclined to one another, which reflect regularly and are so small that they cannot be perceived separately. Since every one of these small mirror surfaces reflects the rays coming from the strongest light-source only in one direction, every change, even the slightest, of the position of the object or of the eye and every smallest fluctuation of the accommodation or fixation must produce a change in the position and brightness relations of the single light points. These changes or parallaetic displacements are indeed too small to be directly spatially perceived. But they are great enough, on the ground of the peculiar use of the parallax of indirect vision for depth perception, to give rise to a characteristic phenomenon which is not to be mistaken for any other.

(b) If the metallic-lustrous body consists of many small parts (crystals) which are separated by empty interstices (or interstices filled with an optically thin material) and which regularly transmit a large proportion of the light, and have mirroring (i.e., regularly reflecting) surfaces. The light re-

(¹) Vide article by the same author on *Die Parallaxe des indirecten Sehens und spaltförmigen Pupillen der Katze*. (*Philos. Studien*, ix, 447 etc.)

flected in a given direction consists then of several components, which, because of the different reflection-sources, have a more or less great path-difference. The components of one and the same ray, therefore, act as rays from different distances. Every change in the dioptric condition of the eye (change of the accommodation, displacement of the diaphragms in the rotation of the eye around its centre), even if it is extremely small and takes place quite unconsciously, must, therefore, entail the above-mentioned changes in the configuration of the bright and dark points of the retinal image, which are characteristic for the parallax of indirect vision.

Of these two possibilities the latter seems to be the more probable, inasmuch as it is confirmed by the results of physical investigations.

14. It must be possible to produce the phenomenon of metallic lustre artificially by wholly non-metallic means, so far as the conditions can be reproduced for the occurrence of the parallax of indirect vision in such a way that the parallactic displacements cannot be directly recognized as changes of position and distance. [This conclusion is experimentally completely confirmed by the preparations made by Professor Kirschmann and described in the article from which the above summary is translated.]

2. *Experiments on Intensity as a Condition of Lustre.* We return now to our subject proper, viz., the relation of intensity to the perception of stereoscopic lustre. The characteristic of lustre, as we have seen, is incomplete mirroring, or the combination of regular and diffuse reflection. A lustrous surface reflects the light which falls upon it partly diffusely, i.e., indifferently in all directions, and partly regularly, i.e., with a constant relation of the angles of incidence and of reflection. From a certain direction or directions, a lustrous surface, on account of this regular reflection, appears brighter than from all others. Therefore, in binocular vision a given point in a lustrous surface has never the same intensity for the two eyes; and the nearer the approach to complete mirroring the greater will be the difference. Now by making use of the stereoscope

we can construct the objects to be presented to the two eyes separately so as to produce by independent illumination of them those differences of brightness which in ordinary binocular vision are due to the spacial relations of the object to the respective eyes. Having the conditions thus under control we can vary the relation of the intensities at our will, and by this means can determine within what limits of brightness contrast between the retinal images the phenomenon of lustre occurs.

The lustre thus produced is sometimes called an "illusion" of shine or polish.¹ The difference, however, must be pointed out between this case and those referred to by Kirschmann, as cited above, where the appearance of lustre is produced in a painting by pigments of contrasting brightness or on a dull surface by appropriate independent illumination of adjacent parts. In the latter cases the same optical conditions do not exist as in the perception of genuine lustre, as may be seen by moving the head or closing the eyes alternately, when the brighter part of the surface does not change its relative position, as would be the case if the surface were lustrous. Such a case may be properly termed an illusion, because a characteristic that is taken for a sensational element is in reality supplied by memory or imagination. In the case of images of different intensity binocularly combined by the help of the stereoscope, however, the optical conditions are precisely those which exist in the ordinary binocular perception of lustre, although produced by different objective arrangements, and there is, therefore, psychologically no reason for calling it an illusion; it is real lustre.

For the purpose of determining the limits of intensity contrast for the production of stereoscopic lustre, some experiments were made with an apparatus the same in principle as that employed for the experiments in depth perception, referred to in a preceding section. As, however, the apparatus was re-constructed, introducing some improvements, a full description is here given, and a stereoscopic picture of it is

¹Sanford, *Experimental Psychology*, p. 172.

shown in Fig. 4. To the front of a table 68 cm. square, at a height of 35 cm. above it, are fixed two stereoscopes, the inner lens of each of which may be covered by a small shutter, which has a spring to keep it open when not in use. Behind the stereoscopes is an episkotister disc turned by an electric motor; this disc is constructed so as to vary the light transmitted from 0° to 320° . The stereoscopes are arranged before the episkotister in such a way that one eye looks through it, while the other is unobscured. Close behind the disc is a thin wooden screen of the width of the table and 60 cm. in height, painted a dead black. Through this screen are cut two openings on each side 50 mm. square, opposite the lenses of the stereoscopes. Behind this again is a second black wooden screen, attached to the table in such a way as to be easily moved backward or forward. On this screen the objects are fastened. Each set of objects was lighted by an electric lamp placed between the screens, and suspended from the front one. The motor which turned the disc was also placed between the screens. The adjusting of the disc was facilitated by the use of an incandescant lamp attached by a bracket to the front of the apparatus, which was turned off during observations, and when in use screened by a shade from the eye of the observer. The experiments were conducted in a dark room, and the apparatus covered with a black cloth, so that the eyes might be shaded as completely as possible from all light except that reflected from the objects to be observed. The objects used were of two kinds. Those shown in Fig. 5 were drawings on black and white paper respectively, having a back-ground of grey cardboard to which the drawings were fixed. The two drawings, when combined by means of the stereoscope, presented the appearance of a truncated hexagonal pyramid, with its apex projecting towards the observer. A modification of the drawings as shown in the cut was made by drawing the lines, both on the black and white, with gold bronze, the contrast between the black and white lines being so great as to cause strife of contours. The other objects used were also outline drawings,

which were etched upon small squares of thin plateglass, and placed over the openings in the front screen of the apparatus, squares of white cardboard and black velvet respectively being fixed behind them upon the screen at the back of the apparatus. These etchings are illustrated in Figs. 6 and 7. One pair of them forms, when combined stereoscopically, a truncated pyramid which projects toward the observer. The other pair forms a transparent octohedronal crystal. In the experiments the drawings were so placed at first that the one on the black ground was seen directly, that on the white through the episkotister disc. By diminishing the amount of light admitted through the episkotister the light reflected from the white surface was approximated to that reflected from the black, till at a certain point the intensities would be equal, and beyond that again the white surface would become the darker. Beginning then on the left hand with the left eye unobscured regarding the drawing upon the black surface, and the right eye looking through the episkotister at the drawing upon the white surface, the disc was set so as to admit only a single degree of light. The observer then looked through the stereoscope and reported the effect both as to lustre and as to the stereoscopic combination of the objects. Then changing over to the right stereoscope the observation was repeated, but this time with the obscured white object before the left eye and the unobscured black before the right eye. The disc was then adjusted to admit a little more light and the observations repeated, and so on until the point had been passed beyond which no difference was observable whether the one eye was obscured by the disc or received the full light. Then beginning at a point beyond this upper limit the light was gradually decreased to the least amount that the disc could be adjusted to admit. A second series of trials was then made with the objects transposed, so that the white was seen directly and the black obscured by the episkotister, the effect of which was of course to make the difference between the intensities of the two impressions greater than that between the black and white used in equal illumination, and

at each increase of the amount of light admitted through the disc to diminish instead of increasing the difference of intensity. The illumination used throughout was, with the drawings upon paper, that of a 32 c.p. electric lamp on each side; with the glasses 16 c.p. lamps were used. The results are given in Tables X-XII. The judgments were found to be somewhat difficult, and the results of other than trained observers were not, therefore, of much value. The number of observers whose results are given is small, but all had the advantage of much practice.

TABLE X. OBJECT, HEXAGONAL PYRAMID. AVERAGE OF FOUR OBSERVERS.

Opening of Disc		Ratio of White to Black	Lustre	Stereoscopic Effect
White Obscured	Black Obscured			
2½°31	None.	Partial.
12½°	1.53	Slight	Partial.
16°	2.00	Slight.	Complete.
50°	62.50	Good.	Complete.
....	55°	360.00	Good.	Complete.
....	43½°	375.69	Good.	Partial.
....	16½°	996.76	Slight.	Partial.
....	9½°	1705.26	None.	Partial.

TABLE XI. OBJECT, RECTANGULAR PYRAMID. AVERAGED RESULTS OF THREE OBSERVERS.

Opening of Disc		Ratio of White to Black	Lustre	Stereoscopic Effect
White Obscured	Black Obscured			
9°	2.89	None.	Partial.
10°	3.21	Slight.	Partial.
18°	5.78	Slight	Complete
42°	13.50	Good.	Complete.
....	110°	378.70	Good.	Complete.
....	71°	586.72	Imperfect	Complete.
....	23°	1811.18	Slight.	Partial.
....	*20°	2082.85	None.	Partial.

* Average of two observers only.

TABLE XII. OBJECT, CRYSTAL. AVERAGED RESULTS OF THREE OBSERVERS

Opening of Disc		Ratio of White to Black	Lustre	Stereoscopic Effect
White Obscured	Black Obscured			
5°	1.60	None	Partial.
8°	2.57	Slight.	Partial.
14°	4.50	Imperfect.	Complete.
30°	9.64	Good.	Complete.
....	55°	771.70	Good.	Complete.
....	45°	920.00	Good.	Complete.
....	25°	1666.28	Slight.	Partial.
....	21°	1983.66	Slight.	None.

The first column of the tables gives the openings of the disc (in degrees) when the drawings upon white were obscured by the episkotister. The second column gives the openings when the black is obscured by the disc. The third column shows the relation of the intensities of the white seen to those of the black. This is obtained by measuring photometrically the relative intensities of the black paper, the black velvet, and the white paper used, and from those measurements and the epistokister openings calculating the intensity in each case. The numbers given represent the intensity at each point where a change occurs, either as to the lustre or the stereoscopic combination of the objects. Beyond the limits of the numbers given, in either direction, there was neither lustre nor stereoscopic effect.

A curious phenomenon noticed by some observers in the course of these experiments was a sort of depth contrast. When the shutter on the front of the stereoscope was closed for the purpose of comparing the monocular with the binocular effect, the stereoscopic depth would first disappear, and then sometimes there would appear a distance effect the opposite of that seen with the shutter open; e.g., when stereoscopically there appeared a pyramid with the apex toward the observer, on the closing of the shutter there would be first a flat surface with lines upon it, and then in a moment came a hollow pyramidal box with the base toward the observer.

SUMMARY OF RESULTS.

1. For the production of any, even the slightest, degree of stereoscopic lustre, one retinal impression must be, on an average, from one and a half to three times as bright as the other, according to the objects observed.

2. Greater constancy is apparent regarding the upper limit of contrast, beyond which no lustre appears, which is, approximately, when one image is about 1900 times as bright as the other.

3. The figures regarding the limits for perfect lustre are the least regular, the lower limit ranging from a ratio of white to black of 9.64 to one of 62.50, and the ratio at the upper limit varying from 375.69 to 920.00. The reason for the greater variation here is no doubt the complexity of the judgments required. It is difficult to determine what is to be set down as perfect or imperfect, and probably no two observers would give the same decision upon that point, nor even the same observer at different times.



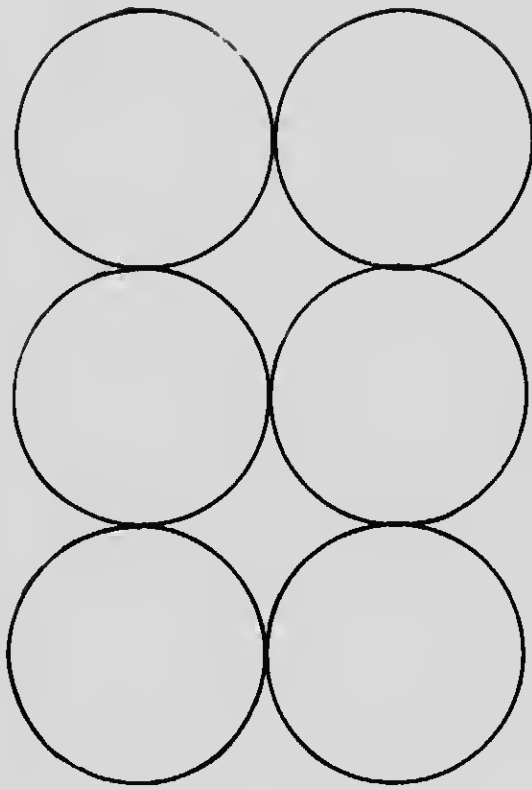

FIG. 1



1875

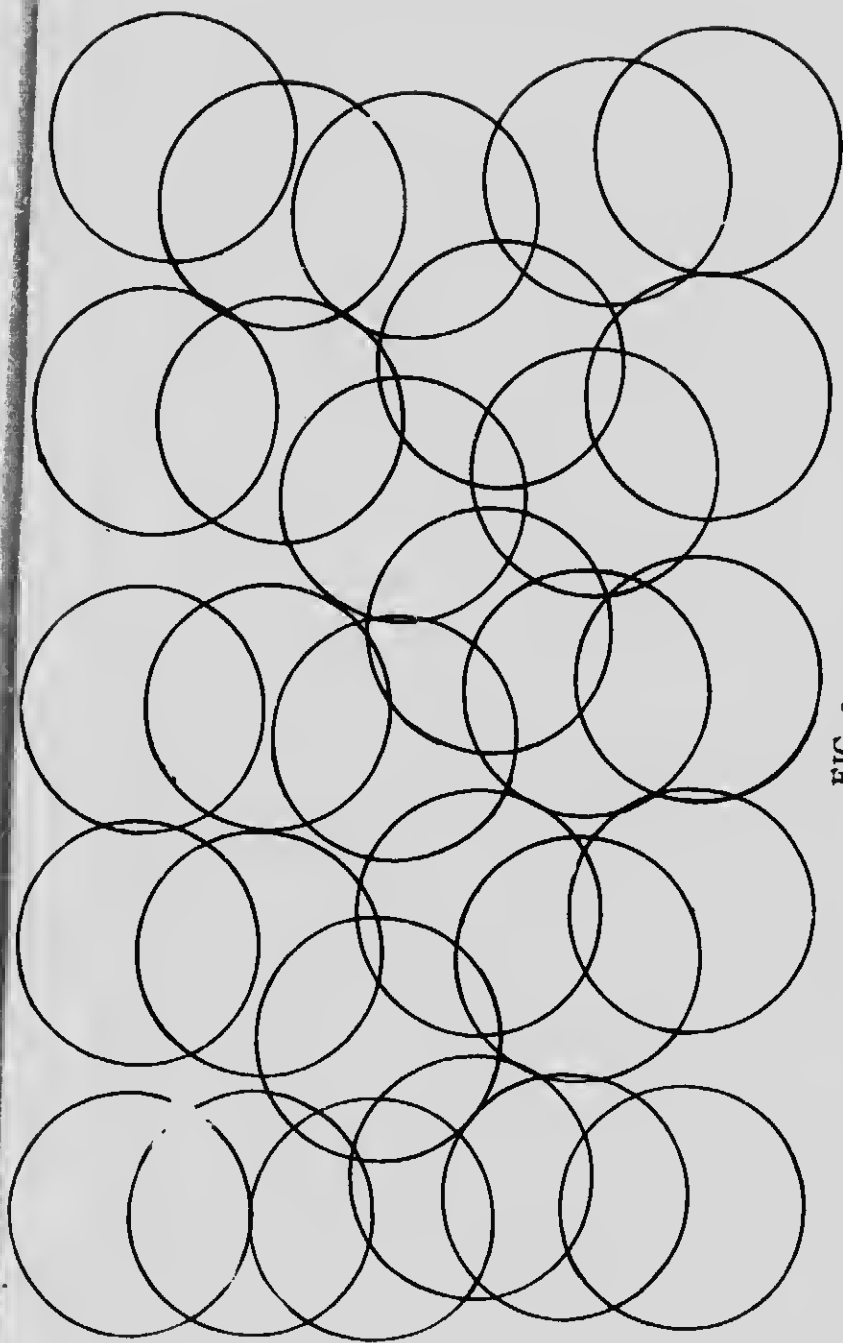

FIG. 2



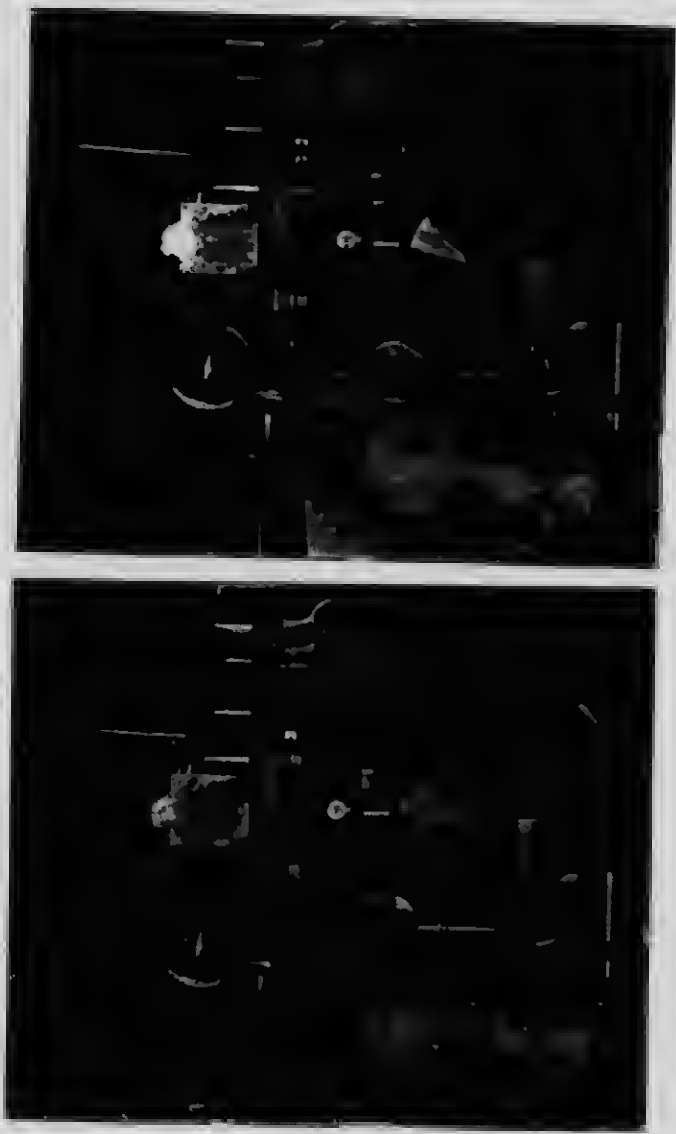

FIG. 3





FIG. 4

Vertical text or markings on the left edge of the page, possibly a page number or binding information.

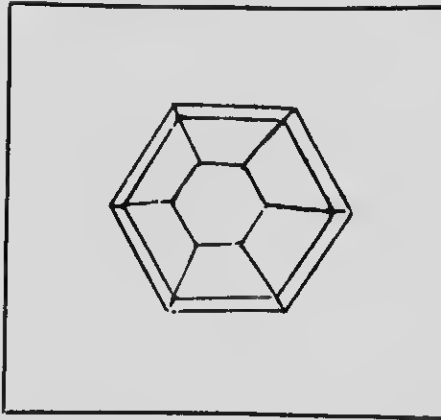

FIG. 5

Copyright © 2000 by Pearson Education, Inc. All rights reserved. Printed in the United States of America. This book is published by Pearson Education, Inc., 501 Boylston Street, Boston, MA 02116.

0-201-30000-0

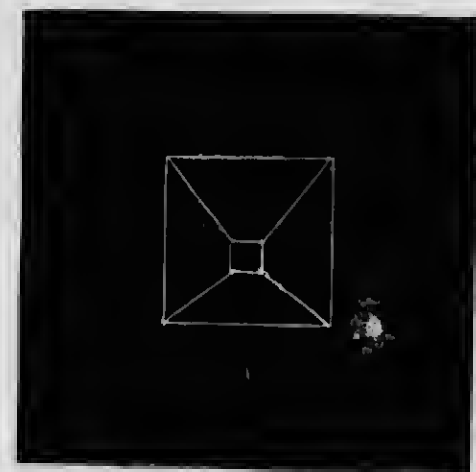
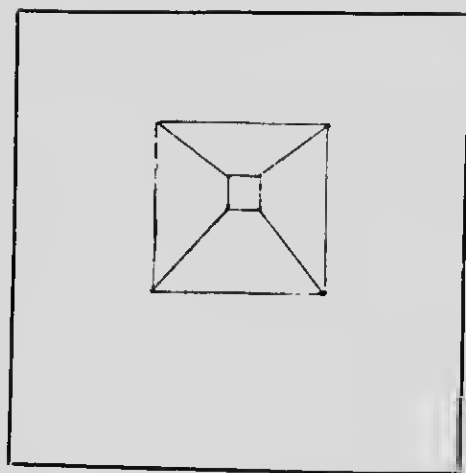

FIG. 6



111



FIG. 7

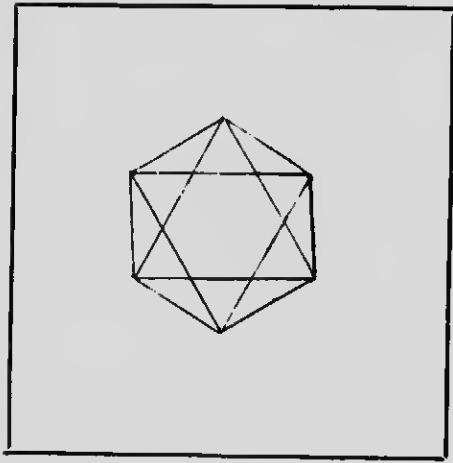

100%



Vertical text or markings on the left edge of the page.



STEREOSCOPIC VISION
AND ITS RELATION TO INTENSITY AND QUALITY OF
LIGHT SENSATION

SECOND ARTICLE

STEREOSCOPIC VISION AND QUALITY OF LIGHT SENSATION

BY

T. R. ROBINSON, B.A.

STEREOSCOPIC VISION IN ITS RELATION TO QUALITY OF LIGHT SENSATION.

In the former article¹ an account was given of some experiments upon the application to the two retinas of light stimuli of different *intensity*. There are some phenomena of equal interest which occur when the respective parts of the stimulus are of different *quality*. The presentation of different colour stimuli simultaneously to the two eyes may have various results, according to the degree of difference in the quality of the stimuli. In the experiments now to be described the following questions were kept in view :

(1) Will the results obtained by the previously reported experiments with uncoloured light be essentially altered by the introduction of the colour factor ?

(2) What are the limits of possibility for binocular mixture of qualitatively different retinal impressions ?

¹ University of Toronto Studies, Psychological Series, Vol. ii, No. 2.

(3) How is such binocular mixture of colours related to the stereoscopic combination of the retinal images, i.e., do differences of colour affect the stereoscopic combination, or, on the other hand, does the stereoscopic combination facilitate or hinder the binocular mixture of colours ?

I. COMPARISON OF MONOCULAR AND BINOCULAR INTENSITIES IN COLOURED LIGHT

A few experiments were made upon this point in the course of an investigation by the author in connection with Fechner's paradox,¹ referred to more fully in the preceding article. Those experiments, however, were comparatively few in number, and made with only one absolute intensity, so that the results were not conclusive. The chief differences from the results with white light were that the judgments were more difficult and less decided, and that the region of equality in intensity between monocular and binocular vision extended over a wider field. The differences between the results of the same two observers were noticeably greater than with

¹ American Journal of Psychology, Vol. vii, No. 1, pp. 9 etc.

uncoloured light, perhaps because the intensity values of the colours were not the same for different observers.

A further series of experiments has been made, following a modification of the former method. The apparatus was the same as that used for the experiments in binocular lustre,¹ except that the objects observed were plane coloured surfaces instead of stereoscopic objects. On each side were two brightly illuminated coloured surfaces, which were combined by means of the stereoscope. Before one of them the episkotister-disc was revolved, so that the surfaces differed in brightness, while remaining similar in all other respects. The difference in brightness could, of course, be varied by re-adjusting the disc. The colour was furnished by coloured gelatine or thin glass plates placed over the openings in the front screen of the apparatus, white paper being placed opposite them on the screen or wall at the back. The experiments were made in a dark room by two observers, who took turns in operating for each other. They began in each case with monocular vision, i.e., by looking through the stereoscope with the shutter covering the lens before which the disc revolved. Then, after the observer had looked for a few moments, the shutter was opened, and he at once reported whether the brightness was equal to, greater or less than that of monocular vision. A series was made by increasing the opening of the disc until the raising of the shutter plainly resulted in an increase of brightness, then by decreasing the opening until monocular and binocular intensities appeared equal, and still further until the opening of the shutter caused a just noticeable decrease of brightness. Then the opening of the disc was gradually widened till the equal region was reached again and still further till, on the opening of the shutter, there was a just noticeable increase of brightness. In the results of observer "J" the average of the "equal" judgments is given for each series. The results of observer "H" were calculated a little differently, taking the average of the degrees of opening of

¹ University of Toronto Studies, Psychological Series, Vol. ii. No. 2, p. 77.

the disc when the judgments were "brighter," "darker" and "equal," the values for "brighter" and "darker" being regarded as the limits for the region of equality. The colours used were from near the middle and ends of the spectrum, being respectively red, green and blue. Similar series were also made with white light for the purpose of comparison. The wave-lengths of the respective colours were approximately as follows : red 615-740 μ , green 480-560 μ , blue 440-500 μ .

Certain special difficulties were found in experimenting with coloured light. First, there was the necessity of abstracting intensity changes from saturation changes with increasing or decreasing illumination. This made the judgments in some cases very difficult, especially with the blue light. When the opening of the disc was very small there was competition of the vision fields, that of the darkened eye having either no colour, or a slight tinge of yellow, due to binocular contrast. Secondly, the disturbing effect of after-images had to be more carefully guarded against. Again, each observer found himself able to distinguish differences of brightness more readily with certain colours than with others. Thus the discrimination of "H" was best with green, that of "J" with red. A further obstacle in the way of comparing the results with different colours is that the same illumination could not be used for all the colours. With the red it was found necessary to use a 100 e.p. lamp, as with weaker illumination the "equal" limits could not be passed in both directions. On the other hand this very bright light had certain disturbing effects on account of which it was not used with the other colours; the fatigue of the eye was very great, and the after-images gave more trouble. Observer "J" noted, however, in spite of these hindrances, that discrimination was less difficult with red than with white light.

The results of these experiments are given in Tables I and II. They show the same general dependence of the relation of monocular to binocular intensity upon the absolute intensity of illumination as is shown in the experiments with uncoloured light. Difference of quality, therefore, does not apparently

affect the intensity relations. Where the brightness of the coloured light is approximately the same as with red and green, the results show very little difference. On the other hand, the very great difference of average values between blue and red or green may perhaps not be due solely to the difference of brightness. This indeed seems probable in view of the fact that in the former experiments, where the colours were of equal brightness, the values for blue were with both observers higher than those for red.

TABLE I.—OBSERVER H.

Light Used			Amount of Light in the Second Eye which has no effect on Brightness of Common Visual Field		
Quality	Illumination	Intensity Photo-metrically Measured	Opening of the Disc	Units of Intensity	Ratio of the Light in the Other Eye
Blue.....	50 c.p. lamp	1	90°	.25	.25
Green.....	50 c.p. lamp	9.69	253°	6.78	.70
Red.....	100 c.p. lamp	10.00	235°	6.50	.65
White.....	16 c.p. lamp.	22.50	267°	16.65	.74

TABLE II.—OBSERVER J.

Light Used			Amount of Light in the Second Eye which has no effect on Brightness of Common Visual Field		
Quality	Illumination	Intensity Photo-metrically Measured	Opening of the Disc	Units of Intensity	Ratio of the Light in the Other Eye
Blue.....	50 c.p. lamp.	1	114°	.31	.31
Green.....	50 c.p. lamp.	9.69	255°	6.86	.70
Red.....	100 c.p. lamp.	10.00	247	6.86	.68
White.....	16 c.p. lamp.	22.50	267	16.65	.74

II. BINOCULAR MIXTURE OF COLOURS

The experiments to be described in this section were conducted with the purpose of discovering the effects of various degrees of difference in quality between the two retinal impressions. There were four series of experiments : (1) the

first series was made with small coloured surfaces upon a dark field; (2) in the next series stereoscopic figures against a dark ground were observed, the impressions in the respective eyes being differently coloured; (3) in the third case, stereoscopic figures were employed, and one retinal image was coloured, the other uncoloured; (4) in the fourth series, an entirely different method was employed, and the colours occupied the whole vision field, instead of only a part of it.

(1) *Plane coloured surfaces upon a dark field.* The colours used were approximately spectrally pure, the surfaces observed being of Milton-Bradley coloured paper, illuminated by light which passed through combinations of coloured gelatines. A stereoscopic picture of the apparatus employed is shown in Fig. 1, and a schematic representation of it, as seen from above, is given in Fig. 2. Across the back of a table, A, 66 cm. long and 42 cm. wide, is fixed a screen, B, of the same width as the table and 65 cm. high; 18 cm. before this screen is another, C, of similar dimensions. Between these two screens, at the middle of the table there is a partition, D, to enable the right and left halves of the rear screen to be illuminated independently of each other. The top of the table and the surfaces of the screens and of the partition are a dead black. Upon the rear screen, two thin wooden discs, E, E, one on each side of the partition, are fastened by screws at the centre only, so that they may be turned at will. The surfaces of these discs are divided into seven sectors, covered with Milton-Bradley coloured papers. The discs are so placed that the inner edge of each comes close to the dividing partition. In the centre of the front screen, 25 mm. apart, and one on each side of the partition, are two openings, a, a, 45 mm. square, through each of which can be seen a portion of one sector only of the colour disc opposite it. Turning the discs thus brings each colour in succession before the openings. For illuminating the discs there are employed two sheet iron tubes, F, F, 15 cm. square, and 91 cm. long. The front ends of these tubes are inserted through openings which they exactly fit in the front screen. The inner edges of the tubes

tness of the
with red and
On the other
ues between
holely to the
able in view
the colours
e with both

Second Eye
Brightness of
Field

Ratio of the
Light in the
Other Eye

.25
.70
.65
.74

Second Eye
Brightness of
Field

Ratio of the
Light in the
Other Eye

.31
.70
.68
.74

were con-
of various
retinal im-
: (1) the

are 16 cm. apart, and they are on a level with the portion of the discs visible through the smaller openings before described. The latter are thus directly between the openings which admit the ends of the tubes. In order that the tubes may not interfere with the position of the observer before the apparatus, they are placed at an angle so that their outer ends are widely apart. In each tube is a moveable block fitting the inside of the tube, to the front of which is attached a socket for an incandescent electric lamp. The upper side of each tube has a narrow slit, *b, b*, running nearly its whole length, through which projects an attachment to the block for affixing the wires which connect with the light socket and a screw, *c, c*, for fixing the block at any desired distance from the ends of the tube. The front end of each tube is fitted with a groove, *d, d*, into which were slipped frames containing the combinations of gelatines through which the light passed before falling upon the sectors of the discs. During the experiments all other light was excluded from the room. By the use of varying combinations of papers and gelatines the spectrum was divided into twelve approximately equal divisions. These colours are the same as were used by Miss Baker in her work upon the aesthetics of colour combinations. Their spectroscopical analysis is given below.

SPECTROSCOPICAL ANALYSIS OF COLOURS.

NAME OF COLOUR	WITH NARROW SLIT		WITH WIDE SLIT	
	Visible part of Spectrum in $\mu\mu$	Region of greatest intensity in $\mu\mu$	Visible part of Spectrum in $\mu\mu$	Region of greatest intensity in $\mu\mu$
Red.....	665(?)—592.5	635—610	672.5(?)—580	657.5—615
Orange-Red...	622.5—582.5	612.5—592.5	635—580	622.5—592.5
Orange.....	607.5—552.5	585—562.5	622.5—547.5	607.5—562.5
Orange-Yellow.	587.5—547.5	562.5—557.5	617.5—537.5	602.5—555
Yellow.....	580—512.5	562.5—535	615—492.5	587.5—555
Yellow-Green...	565—497.5	535—525	580—480	555—530
Green.....	542.5—492.5	530—507.5	570—480	537.5—517.5
Green-Blue.....	525—472.5	512.5—495	550—447.5	525—502.5
Blue.....	570—460	492.5—475	535—445	572.5—492.5
Violet.....	482.5—432.5	470—462.5	497.5—430	475—455
Violet-Purple {	485—440	462.5—455	700—665	470—452.5
Purple {	680—645		487.5—430	
	480—430		680—635	
			497.5—430	475—460

Their complementary relations are also stated very fully in Miss Baker's article.¹ The purpose of the tubes containing the moveable lamps was to equalize the intensities of the two colours by adjusting the distances from them of the lamps. To facilitate this adjustment a certain intensity of the green-blue, a colour of medium intensity, was taken as the normal, and the positions of the lamps required for the various colours in order to give intensities equal to it were found and marked on the tubes. In a few cases, where one gelatine combination was very much more translucent than the other, the length of the tubes was found insufficient, and either a stronger light had to be used for the duller colour or a sheet of white tissue paper placed before the front of the other tube. The lamps commonly used throughout were 32 e.p. A moveable block was placed upon the front of the table in a groove which enabled it to slide backward and forward. To this block was attached an upright upon which was fixed, at the height of the openings in the screen, the hood of an ordinary stereoscope, G, in which the glasses had been replaced by others of a somewhat longer focal distance.

In the experiments the observer takes his seat in front of the apparatus. There are then before him in the darkened room two small square coloured surfaces, of different colours, but equally bright. Putting his head into the hood of the stereoscope, he adjusts the latter so that the two coloured surfaces completely coincide. All the facts regarding the colour of the surface seen are then noted, and the colour presented to one of the eyes remaining the same, that before the other is changed, and a new observation made. This is repeated till the constant colour has been combined with each of the other colours used. Then another colour is taken as the constant colour, and each of the others combined with it. To vary still further the conditions, with some observers each colour was presented to each of the eyes of the observer as the constant colour, so that it was twice combined with each

¹ University of Toronto Studies, Psychological Series, Vol. ii, No. 1, p. 16.

DE SLIT

Region of greatest intensity in $\mu\mu$

657.5-615
622.5-592.5
607.5-562.5
602.5-555
587.5-555
555-530
537.5-517.5
525-502.5
572.5-492.5
475-455
470-452.5

75-460

of the other colours. Four combinations of each colour with each other colour were thus effected for each observer, each colour being presented to each eye once as the constant colour, and once as one of the changing series. With other observers the position of the constant colour was changed from right to left or *vice versa* after each series, but only one series was made for each colour. So that with these observers only two combinations of each colour with each other colour were obtained. Tables III to VIII give the combined results of six observers, with four of whom the former method was followed, with two the latter; so that in the experiments which these tables summarize each of the twelve colours has been combined with each of the others twenty times.

TABLE III.—COMPLETE RIVALRY,
i.e., BOTH COLOURS UNCHANGED.

	R	OR	O	OY	Y	YG	G	GB	B	V	VP	P	
R.....		0	0	0	0	4	6	10	10	9	2	1	42
OR.....	0	..	0	0	1	2	4	10	7	7	2	2	35
O.....	0	0	..	0	0	1	3	6	8	3	4	3	28
OY.....	0	0	0	..	0	0	3	8	9	4	2	6	32
Y.....	4	2	1	0	..	0	0	4	7	2	1	6	23
YG.....	6	4	3	3	2	0	..	0	1	1	3	4	23
G.....	10	10	6	8	4	1	0	..	0	1	2	4	25
GB.....	10	7	8	9	7	7	1	0	..	0	0	1	40
B.....	9	7	3	4	2	1	2	0	0	..	0	3	52
V.....	2	2	4	2	1	3	0	0	0	..	0	0	28
VP.....	1	2	3	6	6	4	4	1	3	0	0	0	14
P.....													30
	42	35	28	32	23	23	25	40	52	28	14	30	372

TABLE IV.—PARTIAL RIVALRY,
i.e., RIVALRY OF THE VISION FIELDS, BUT WITH ONE OR BOTH
COLOURS MODIFIED OR WEAKENED.

	R	OR	O	OY	Y	YG	G	GB	B	V	VP	P	
R.....	..	0	0	0	7	14	11	10	9	10	4	1	66
OR.....	0	..	0	0	2	10	10	8	10	11	5	2	58
O.....	0	0	..	0	0	2	9	10	8	13	7	6	55
OY.....	0	0	0	..	0	0	7	7	7	9	9	5	44
Y.....	7	2	0	0	..	0	1	9	8	11	12	12	62
YG.....	14	10	2	0	0	..	0	3	7	10	13	11	70
G.....	11	10	9	7	1	0	..	1	8	8	17	13	85
GB.....	10	8	10	7	9	3	1	..	0	0	6	13	67
B.....	9	10	8	7	8	7	8	0	..	0	2	9	68
V.....	10	11	13	9	11	10	8	0	0	..	0	3	75
VP.....	4	5	7	9	12	13	17	6	2	0	..	0	75
P.....	1	2	6	5	12	13	13	13	9	3	0	..	75
	66	58	55	44	62	70	85	67	68	75	75	75	800

ROBINSON : STEREOSCOPIC VISION

TABLE V.—INCONSTANT MIXTURE.
COMBINATIONS YIELDING A COLOUR WHICH IS A MIXTURE OF THE
TWO MONOCULARLY SEEN, BUT INCONSTANT.

	R	OR	O	OY	Y	YG	G	GB	B	V	VP	P	
R.....	..	0	1	2	6	1	2	0	1	0	9	4	26
OR.....	0	..	1	1	3	2	5	1	2	2	7	4	28
O.....	1	1	..	0	1	4	2	2	4	3	5	2	27
OY.....	2	1	0	..	0	6	5	2	4	5	2	3	30
Y.....	6	3	1	0	..	2	5	4	5	4	5	2	37
YG.....	1	2	4	6	2	..	1	7	5	4	5	3	30
G.....	2	5	2	5	5	1	..	4	6	3	2	3	30
GB.....	0	1	2	2	4	7	4	..	0	0	5	4	38
B.....	1	2	4	4	5	5	6	0	..	0	4	3	33
V.....	0	2	3	5	4	5	3	5	0	..	1	5	36
VP.....	9	7	5	2	5	3	2	4	4	1	..	5	36
P.....	4	4	4	3	2	3	3	4	5	8	3	..	45
	26	28	27	30	37	39	38	33	36	36	45	43	418

TABLE VI.—COMPLETE MIXTURE.

	R	OR	O	OY	Y	YG	G	GB	B	V	VP	P	
R.....	..	20	19	18	7	1	1	0	0	1	5	14	86
OR.....	20	..	19	19	14	6	1	1	0	1	6	12	99
O.....	19	19	..	20	19	13	6	2	0	0	4	7	110
OY.....	18	19	20	..	20	14	5	3	0	2	7	6	114
Y.....	7	14	19	20	..	18	12	3	0	3	2	0	98
YG.....	1	6	13	14	18	..	9	1	1	4	1	2	88
G.....	1	1	6	5	12	19	..	15	5	7	1	0	72
GB.....	0	1	1	2	3	9	15	..	20	15	10	2	80
B.....	0	1	0	0	0	1	5	20	..	20	14	3	64
V.....	1	0	1	2	3	4	7	15	20	..	19	9	81
VP.....	5	6	4	7	7	1	1	10	14	19	..	17	86
P.....	14	12	7	6	0	2	0	2	3	9	17	..	72
	86	99	110	114	98	88	72	60	64	81	86	72	1050

TABLE VII.—SUMMARY OF NUMBER OF CASES OF THE RESPECTIVE
PHENOMENA FOR EACH COLOUR.

	Complete Rivalry.	Partial Rivalry.	Inconstant Mixture.	Complete Mixture.	
R.....	42	66	26	86	220
OR.....	35	58	28	99	220
O.....	28	55	27	110	220
OY.....	32	44	30	114	220
Y.....	23	62	37	98	220
YG.....	23	70	30	88	220
G.....	25	85	38	72	220
GB.....	40	67	33	80	220
B.....	52	68	36	64	220
V.....	28	75	36	81	220
VP.....	14	75	45	86	220
P.....	30	75	43	72	220
	372	800	418	1050	2640

TABLE VIII.—NUMBER OF OTHER COLOURS WITH WHICH THE VARIOUS PHENOMENA OCCUR FOR EACH COLOUR.

	Complete Rivalry.	Partial Rivalry.	Inconstant Mixture.	Complete Mixture.
R.....	7	8	8	9
OR.....	8	8	10	10
O.....	7	7	10	10
OY.....	5	6	9	10
Y.....	7	8	10	11
YG.....	8	8	11	10
G.....	8	10	11	10
GB.....	7	9	9	7
B.....	8	9	9	7
V.....	7	8	9	10
VP.....	6	9	11	11
P.....	9	10	11	9
	87	101	118	114

(2) *Stereoscopic figures upon a dark field.* In the experiments thus far recorded, the objects observed, though combined by means of the stereoscope, were simply plane surfaces differently coloured. The question naturally presented itself in connection with this method, whether the results would be different if three-dimensional figures were used instead of plane surfaces. There are, indeed, two questions of interest here, (1) whether the binocular mixture of colours is facilitated or impeded, the rivalry of the vision-fields intensified or lessened, by the effort of combining the outlines into a three-dimensional figure, (2) the question of the effect which differences of colour have upon the stereoscopic combination of the figures. In investigating these points, it was, of course, desirable that the method followed should conform as nearly as possible to that of the former series of experiments. Accordingly the same apparatus and the same colours were used, but over the openings for observation in the front of the apparatus small squares of thin plate glass were placed, upon which the stereoscopic figures were etched. The glass surrounding the drawing was blackened to prevent the transmission or reflection of light. Three pairs of outline drawings were used, one forming a transparent octahedral crystal, another

on opaque hexagonal crystal, and the third a truncated pyramid, with the summit projecting toward the observer. The etchings were made in two ways, some being on clear glass with frosted lines, others on frosted glass with the lines clear. These figures are reproduced, as nearly as possible as they were used, in Figs. 3 to 5. The experiments were conducted in the same manner as those with plane surfaces, the number of combinations of each colour with each other colour being in this case sixteen. The results as regards the mixture of colours are shown in Tables IX to XIV. Tables XV to XIX show the effect upon the stereoscopic combination of the differences in the colour of the objects.

TABLE IX.—COMPLETE RIVALRY—STEREOSCOPIC OBJECTS.

	R	OR	O	OY	Y	YG	G	GB	B	V	VP	P	
R.....	..	o	o	o	3	4	5	9	9	7	3	o	40
OR.....	o	..	o	o	o	3	2	9	10	8	4	o	36
O.....	o	o	..	o	o	o	2	3	7	6	2	o	20
OY.....	o	o	o	..	o	o	1	3	2	3	1	o	10
Y.....	3	o	o	o	..	o	o	1	1	1	o	o	7
YG.....	4	3	o	o	o	..	o	o	2	1	1	3	14
G.....	5	2	2	1	o	o	..	o	o	1	1	3	17
GB.....	9	9	3	3	1	o	o	..	o	o	1	3	26
B.....	9	10	7	2	1	2	o	o	o	o	o	o	33
V.....	7	8	6	3	1	1	1	o	o	o	o	o	28
VP.....	3	4	2	1	1	1	3	o	o	o	o	1	15
P.....	o	o	o	o	o	3	3	1	2	1	o	o	10
	40	36	20	10	7	14	17	26	33	28	15	10	256

TABLE X.—PARTIAL RIVALRY—STEREOSCOPIC OBJECTS.

	R	OR	O	OY	Y	YG	G	GB	B	V	VP	P	
R.....	..	o	o	o	1	10	11	7	5	4	6	o	44
OR.....	o	..	o	o	2	7	12	7	6	7	5	o	46
O.....	o	o	..	o	o	6	13	11	9	6	9	7	61
OY.....	o	o	o	..	o	2	9	12	14	8	12	9	66
Y.....	1	2	o	o	..	2	5	9	14	13	12	13	71
YG.....	10	7	6	2	2	..	o	5	11	11	15	13	82
G.....	11	12	13	9	5	o	..	1	2	6	10	12	81
GB.....	7	7	11	12	9	5	1	..	1	o	6	14	73
B.....	5	6	9	14	11	11	2	1	..	o	2	10	74
V.....	4	7	6	8	13	11	6	o	o	o	o	6	61
VP.....	6	5	9	12	12	15	10	6	2	o	o	o	77
P.....	o	o	7	9	13	13	12	14	10	6	o	o	84
	44	46	61	66	71	82	81	73	74	61	77	84	804

HICH THE
R.

Complete
Mixture.

- 9
- 10
- 10
- 10
- 11
- 10
- 10
- 7
- 7
- 10
- 11
- 9

114

the experi-
ough com-
e surfaces
nted itself
ould be
instead of
of interest
facilitated
nsified or
o a three-
ch differ-
ation of
of course,
as nearly
nts. Ac-
ere used,
e appar-
on which
rounding
ission or
ngs were
another

ROBINSON : STEREOSCOPIC VISION

TABLE XI.—INCONSTANT MIXTURE—STEREOSCOPIC OBJECTS

	R	OR	O	OY	Y	YG	G	GB	B	V	VP	P	
R.....	..	0	1	3	5	2	0	0	2	4	5	0	22
OR.....	0	..	0	0	2	5	0	0	0	1	6	0	18
O.....	1	0	..	0	2	6	2	0	0	4	5	0	28
OY.....	3	0	0	..	1	7	1	2	0	5	3	0	30
Y.....	5	2	2	0	..	1	4	6	1	5	3	0	28
YG.....	2	5	6	7	1	..	2	7	3	7	3	0	36
G.....	0	2	1	6	4	2	..	7	3	3	0	0	36
GB.....	0	0	2	0	6	7	2	..	3	7	3	0	35
B.....	2	0	0	0	7	3	2	..	3	9	8	1	38
V.....	4	1	4	5	3	..	7	3	2	2	8	4	30
VP.....	5	6	5	3	3	2	7	0	2	..	4	7	48
P.....	0	2	7	6	2	0	3	8	8	4	5	..	50
	22	18	28	30	30	35	38	30	48	50	55	..	398

TABLE XII.—COMPLETE MIXTURE—STEREOSCOPIC OBJECTS.

	R	OR	O	OY	Y	YG	G	GB	B	V	VP	P	
R.....	..	16	15	13	7	0	0	0	0	1	2	16	70
OR.....	16	..	16	16	12	4	0	0	0	0	1	14	76
O.....	15	16	..	16	14	1	0	0	0	0	0	2	67
OY.....	13	16	16	..	16	13	7	0	0	0	0	1	70
Y.....	7	12	14	16	..	7	0	0	0	0	0	1	70
YG.....	0	0	4	7	13	..	14	4	0	0	0	0	44
G.....	0	0	0	0	7	14	..	13	7	2	0	0	43
GB.....	0	0	0	1	0	4	13	..	12	7	2	0	30
B.....	0	0	0	0	0	0	7	12	..	14	6	0	39
V.....	1	0	0	0	0	1	2	7	14	..	12	2	39
VP.....	2	1	0	0	0	0	2	7	14	12	..	11	34
P.....	16	14	2	1	1	0	0	2	6	12	11	..	47
	70	76	67	70	70	44	43	39	39	39	34	47	638

TABLE XIII.—SUMMARY—NO. OF CASES—STEREOSCOPIC OBJECTS.

	Complete Rivalry.	Partial Rivalry.	Inconstant Mixture.	Complete Mixture.	
R....	40				
OR....	36	44	22		
O.....	20	46	18	70	176
OY....	10	61	28	76	176
Y.....	7	66	30	67	176
YG....	14	71	28	70	176
G.....	17	82	36	70	176
GB....	26	81	35	44	176
B.....	33	73	38	43	176
V.....	28	74	30	39	176
VP....	15	61	48	39	176
P.....	10	77	50	39	176
		84	35	34	176
	276	800	398	638	2142

TABLE XIV.—SUMMARY—NO. OF COLOURS—STEREOSCOPIC OBJECTS.

	Complete Rivalry	Partial Rivalry.	Inconstant Mixture.	Complete Mixture.
R.....	7	7	7	7
OR.....	6	7	6	7
O.....	5	7	8	6
OY.....	5	7	6	7
Y.....	5	9	10	7
YG.....	6	10	9	7
G.....	7	10	10	5
GB.....	6	10	8	6
B.....	7	10	8	4
V.....	8	8	11	7
VP.....	7	9	10	6
P.....	5	8	9	7
	74	102	102	70

TABLE XV.—OBJECT, TRANSPARENT CRYSTAL ON CLEAR GLASS.

Result of Colour Combination.	STEREOSCOPIC EFFECT.			
	Perfect.	Impaired.	Slight.	None.
Complete Rivalry....	0	5	9	7
Partial Rivalry.....	24	46	14	5
Inconstant Mixture...	25	21	5	0
Complete Mixture....	102	1	0	0
	151	73	28	12

TABLE XVI.—OBJECT, OPAQUE CRYSTAL ON GROUND GLASS.

Result of Colour Combination.	STEREOSCOPIC EFFECT.			
	Perfect.	Impaired.	Slight.	None.
Complete Rivalry....	1	1	1	14
Partial Rivalry.....	21	26	6	52
Inconstant Mixture...	35	21	4	3
Complete Mixture....	79	0	0	0
	136	48	11	69

TABLE XVII.—OBJECT, PYRAMID ON CLEAR GLASS.

Result of Colour Combination.	STEREOSCOPIC EFFECT.			
	Perfect.	Impaired.	Slight.	None.
Complete Rivalry....	27	2	2	1
Partial Rivalry.....	70	34	6	1
Inconstant Mixture...	39	2	0	0
Complete Mixture....	80	0	0	0
	216	38	8	2

TABLE XVIII.—OBJECT, PYRAMID ON GROUND GLASS.

Result of Colour Combination.	STEREOSCOPIC EFFECT.			
	Perfect.	Impaired.	Slight.	None.
Complete Rivalry....	2	15	18	17
Partial Rivalry.....	11	50	18	19
Inconstant Mixture...	20	17	3	0
Complete Mixture....	74	0	0	0
	107	82	39	36

TABLE XIX.—SUMMARY OF XV.—XVIII.

Result of Colour Combination.	STEREOSCOPIC EFFECT.			
	Perfect.	Impaired.	Slight.	None.
Complete Rivalry....	30	23	30	39
Partial Rivalry.....	126	136	44	77
Inconstant Mixture...	119	6	12	3
Complete Mixture....	335	1	0	0
	610	241	86	119

Remarks on the tables in sections (1) and (2). The tables group the results in four divisions, according to the activity of the colours, i.e., the liveliness and persistency of the rivalry of the vision-fields, the two extremes being "complete rivalry," where the impressions in the respective eyes have qualitatively no influence upon each other, and "complete mixture," where there is an entire fusion of the two impressions.

The cases of complete rivalry for plane surfaces and stereoscopic figures respectively are shown in Tables III and IX. These are the only cases where there is absolutely no mixture effect, and their numbers are comparatively quite small. They are much less numerous than the cases of complete mixture, and are not a large proportion of the total. This phenomenon, as might be expected, was most frequent where the colours were nearly complementary (there was not any pair of exact complementaries), where also the cases of complete mixture were least frequent. The proportion of cases of complete rivalry was on the whole, slightly greater with stereoscopic objects than with surfaces.

The cases classified as "partial rivalry," and exhibited in Tables IV and X are very interesting. They show that even when there is most pronounced strife of the vision-fields, there is frequently at the same time a certain mixture effect. Either one or each of the competing colours is modified in the direction of the other, (e.g., red and green being the colours, the red appearing more orange-red and the green nearer to yellow) or else, especially where the colours are nearly complementary, one or both will appear paler than when seen alone, i.e., of less saturation. Comparison of these two tables shows a marked difference between the results with three-dimensional objects and those with plane surfaces. The proportion of cases of partial rivalry is decidedly larger with the former than with the latter.

Tables V and XI, "inconstant mixture," represent a variety of cases, ranging from those where there was a single colour, which, when regarded for a time, changed slightly toward one or the other of the competing colours and back again,



MICROCOPY RESOLUTION TEST CHART

(ANSI and ISO TEST CHART No. 2)

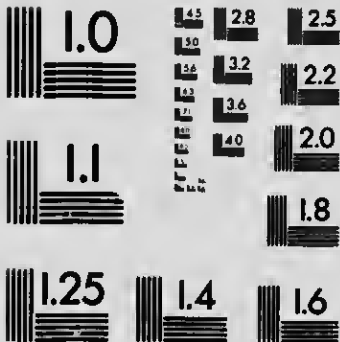

APPLIED IMAGE Inc

1653 East Main Street
Rochester, New York 14609 USA
(716) 482 - 0300 - Phone
(716) 285 - 5989 - Fax

or toward each in turn, to those in which there was a decided strife of the vision-fields, but with a mixed colour appearing between the alternation of the competing colours. These phenomena, as will be seen from the numbers in these tables, are comparatively infrequent. There is a decided difference between the proportion of cases of partial mixture with three-dimensional objects and that with plane surfaces, the proportion being greater with the former.

Tables VI and XII show the cases of complete mixture of the colours. These cases are more numerous than might have been expected, in fact they form a very much larger proportion of the total number of combinations than do any of the others. Complete mixture of colours is not nearly as common with stereoscopic objects as with plane surfaces, showing that the effort required for the stereoscopic combination interferes decidedly with the complete mixing of the colours, though it has been shown, on the other hand, to produce a partial mixture effect more frequently than that occurs with plane surfaces.

Four tables of summaries are added, giving the totals of the preceding tables in parallel columns for convenience of comparison. Tables VII and XIII give the total numbers of cases of the occurrence of the respective phenomena. They show that the phenomenon which occurred most frequently with surfaces was that of complete mixture, with stereoscopic objects that of partial rivalry. With surfaces rivalry of modified colours was the next in order of frequency, and rivalry of unmodified colours in both cases much the least frequent of all. The proportion of cases of complete mixture is larger in Table VII than in Table XIII, but the cases of complete rivalry are also more numerous here. These results have been noticed already in connection with the preceding tables. These combined tables, however, furnish in addition a basis for comparison of the various colours with respect to the facility or difficulty with which they mix with other colours. Tables VIII and XIV summarize the results from a slightly different view. They show, not the number of times each phenomenon

occurs with each of the colours, but the number of other colours the combination of which with each of the colours results in the production of the respective phenomena. These four tables of summaries are illustrated graphically in Curves I to IV, in which the abscissa lines represent the twelve spectral intervals and the ordinates represent respectively the number of cases and the number of colours. The results as to numbers of colours and numbers of cases of occurrence correspond quite well. The spectral colours near the purple end are, on the whole, shown to be somewhat more active, i.e., to mix less readily, than those at the opposite end. The regions of greatest and of least mixture, however, are found between the middle and the ends. The colour which mixes most frequently and with the greatest number of other colours is the same in all the curves, namely, orange-yellow. From that point the curve goes somewhat regularly and sharply upward to blue, whence it abruptly declines.

Tables XV to XIX show the effect upon the stereoscopic combination of the differences in the colour of the impressions in the respective eyes. The results for each of the pairs of drawings used are given in a separate table, and the combined results in Table XIX. From these tables it appears that the combination is seldom much impaired where the colours are not too different to admit of even partial mixture. With rivalry of modified colours the stereoscopic effect was often completely preserved, and even in a number of cases with rivalry of pure colours. The cases in which there was no stereoscopic effect were comparatively few. (They occurred for the most part only where the competing colours succeeded each other very rapidly). They occurred also mainly, as the tables show, with the etchings upon ground glass, where also the complete mixture of colours was less common. This is no doubt to be explained by the fact that in these cases the colour contrast was stronger upon the lines than upon the surfaces.

A fact worthy of note is that with all the observers there appeared occasionally a lustre similar to that produced by

the combining of black and white objects or surfaces. With this there appeared also usually a "transparence" effect, one colour being reported as "seen through" the other. Careful examination of these cases showed them to be due to slight differences of brightness between the two colours. Re-adjustment of the lights always caused the lustre or transparence to disappear. These cases, however, suggest an interesting question regarding the problem of binocular lustre, as they seem to indicate that that phenomenon may be produced with much smaller differences of intensity between the two retinal impressions, where there is also a marked difference of quality.

(3) *Mixture of coloured and uncoloured impressions.* The apparatus and method employed in this series of experiments were the same as in the two preceding, and the objects were the same as in the last series, except that while one of the colours before described was behind the drawing presented to one eye, behind that presented to the other was one of a series of greys. Only one pair of the drawings described in section (2) were used, namely, those etched upon clear glass, and forming a transparent octahedral crystal (Fig. 3). Six greys of the Prang series were used, selected so as to be about equally graduated in brightness. In experimenting, the colour in use was made of equal intensity with the grey by adjusting the position of the lamps, in the same manner as before described for equalizing the intensity of the two colours in the experiments where different colours were presented to the respective eyes. The light illuminating the grey was passed through a gelatine which excluded any trace of yellow, leaving the light as nearly as possible absolutely colourless. Each of the six greys was combined with each of the twelve colours, the greys being kept on one side. Then the grey and the colour were interchanged, bringing the grey before the other eye, and the series repeated. Such a double series was made by one observer only, and by another a single series. There were thus in all three combinations of each of the six greys with each of the twelve colours. The total number of experi-

ments was therefore not nearly so great as in the investigation regarding the mixture of coloured and uncoloured impressions. The results, however, are of decided interest. They are in some respects more regular than with combinations of two colours, and exhibit other marked differences from the former results. The results of one series are given in full in Tables XX to XXV. The results of all three series are summarized in Tables XXVI to XXVIII. They are also graphically represented in Curves V to VII. Curve V combines the results in Tables XXVI and XXVII—the results for one observer. Curve VI represents the results for the other observer, and Curve VII gives the combined results of the two observers.

TABLE XX.—OBSERVER P. T. GREY NO. 1 IN LEFT EYE.

COLOUR IN RIGHT EYE.	EFFECT OF COMBINATION.
Red.....	Rivalry at first of light grey and brilliant red, then of grey and dull orange, finally mixing to orange of low saturation, but high intensity.
Orange-Red.....	Slight rivalry, subsiding almost immediately into light brown mixture.
Orange.....	Less rivalry. Unsteady brown mixture.
Orange-Yellow.....	Same effect as with orange, only lighter brown.
Yellow.....	Mixture, saturation growing less till yellow becomes very faint.
Yellow-Green.....	Rivalry at first, then yellowish mixture.
Green.....	Mixture, green gradually fading. Final effect good pea-green.
Green-Blue.....	No rivalry. Grey-green, fading to greenish grey.
Blue.....	At first rivalry of blue and grey, then mixture, with blue predominating at centre and grey at periphery.
Violet.....	Rivalry of bluish grey and pale violet in outer portions; in centre, mixture, greyish violet.
Violet-Purple....	Strong rivalry of greyish yellow and purple.
Purple.....	At first rivalry between light grey and purple of less saturation than when seen alone, finally settling into a faint yellow, with at times a suggestion of pink.

TABLE XXI.—OBSERVER, P.T. GREY NO. 2 IN LEFT EYE.

COLOUR IN RIGHT EYE.	EFFECT OF COMBINATION.
Red	Strong rivalry at first between red and grey, then less pronounced rivalry between red and orange-red.
Orange-Red.....	Slight rivalry of grey and orange, then mixture, orange with decided red spots. Finally settles into a brown.
Orange.....	Light brown. No rivalry.
Orange-Yellow..	No rivalry. A light grey, with beautiful orange tinge in parts.
Yellow.....	Pale, slightly inconstant yellow.
Yellow-Green.....	Complete mixture, very slightly greenish grey.
Green.....	Complete mixture, light pea-green.
Green-Blue.....	Rivalry of grey and blue, settling down to a light grey with a tinge of blue.
Blue.....	Dark grey, with slight suggestion of blue at times.
Violet.....	Rivalry of violet and yellowish grey. Always some violet in places.
Violet-Purple	Rivalry of yellowish grey and purple. After a time grey lasts the longer.
Purple	Rivalry at first of light brown and purple, settling into an unsteady purplish brown.

TABLE XXII.—OBSERVER, P. T. GREY NO. 3 IN LEFT EYE.

COLOUR IN RIGHT EYE.	EFFECT OF COMBINATION.
Red	No rivalry. A light grey with slight pinkish tinge.
Orange-Red	No rivalry. Surface bright, with faint tinge of pink.
Orange	A faint pink, increasing in saturation. No rivalry;
Orange-Yellow	A pinkish white. No rivalry.
Yellow	No rivalry. Mixture appears like a dirty white.
Yellow-Green	Complete mixture, light green.
Green	A very light grey, with a suggestion of green.
Green blue	No rivalry. An agreeable light blue.
Blue	Light grey, with suggestion of blue.
Violet.....	Rivalry of violet and yellowish grey, the grey predominating.
Violet-Purple	Slight rivalry at first. Soon becomes a light grey, with suggestion of yellow. A portion of surface is covered with faint purple. Around periphery is dark blue.
Purple	Over a light brownish surface a slight and indefinite purple moves. Around periphery there is a bluish tinge.

TABLE XXIII.—OBSERVER P. T. GREY NO. 4 IN LEFT EYE.

COLOUR IN RIGHT EYE.	EFFECT OF COMBINATION.
Red.....	Rivalry of white with red which gradually becomes of less saturation.
Orange-Red.....	Faint orange. No rivalry.
Orange.....	Rivalry of white and pale red.
Orange-Yellow.....	Complete mixture, pinkish white.
Yellow.....	Mixture, very light br wn.
Yellow-Green.....	Perfect mixture, light green.
Green.....	Perfect mixture, pale pea-green.
Green-Blue.....	Complete mixture, very light blue.
Blue.....	Rivalry of white and very pale blue.
Violet.....	Continuous rivalry.
Violet-Purple.....	Rivalry. Grey appears white. Colour never covers whole surface, but is stronger around edges.
Purple.....	Continuous rivalry. The grey appears white.

TABLE XXIV.—OBSERVER, P.T. GREY NO. 5 IN LEFT EYE.

COLOUR IN RIGHT EYE.	EFFECT OF COMBINATION.
Red.....	Strong rivalry of red with white.
Orange-Red.....	Rivalry of white and dark brown, brown becoming fainter at each re-appearance.
Orange.....	No rivalry. Effect is yellowish grey.
Orange-Yellow.....	A distinct yellow. No rivalry.
Yellow.....	No rivalry. Very faint yellow.
Yellow-Green.....	Light green. No rivalry.
Green.....	No rivalry. Effect is pea-green.
Green-Blue.....	Mixture, varying from pale to very decided green. Centre is more green than periphery.
Blue.....	Inconstant mixture, varying from bluish-white to light blue.
Violet.....	Strong rivalry of white and violet ; violet never covers whole surface.
Violet-Purple.....	Rivalry ; grey seems white. Purple is dark, but only comes over half the surface.
Purple.....	Rivalry ; first white, then purple, which on disappearing leaves a yellowish tinge, then purple comes again, but disappears quickly.

TABLE XXV.—OBSERVER, P.T. GREY NO. 6 IN LEFT EYE.

COLOUR IN RIGHT EYE.	EFFECT OF COMBINATION.
Red.....	Rivalry of red and white.
Orange-Red.....	Rivalry of white and brownish red. the white predominating.
Orange.....	Rivalry, changes not very rapid. The appearance is alternately white and dark brownish.
Orange-Yellow.....	Rivalry of white and a brownish hue.
Yellow.....	Rivalry of light grey and very light brown, brown growing weaker.
Yellow-Green.....	Indefinite greyish effect, which passes into a white. No rivalry.
Green.....	No rivalry. A uniform pale pea-green.
Green-Blue.....	First white, then green, which remains, but grows less saturated.
Blue.....	Rivalry of white and blue, which settles into a white, with a strong tinge of blue.
Violet.....	Rivalry of white and violet. Some colour always remains around edges.
Violet-Purple.....	Strife between white and purple, white greatly predominating.
Purple.....	Rivalry; grey at first appears white, later yellow. Purple appears first as a faint red, later as a decided purple.

OBSERVER, P.T. GREY BEFORE LEFT EYE, COLOUR BEFORE RIGHT EYE.

	RED.						ORANGE-RED.						ORANGE.						ORANGE-YELLOW.					
	1	2	3	4	5	6	1	2	3	4	5	6	1	2	3	4	5	6	1	2	3	4	5	6
Permanent Rivalry.....	*	*	*	*	*	*																		
Rivalry Gradually Ceasing.....	*						*	*	*	*	*	*												
Rivalry Quickly Ceasing.....													*	*	*	*	*	*						
Inconstant Mixture.....																			*	*	*	*	*	*
Perfect Mixture.....							*	*	*	*	*	*												
YELLOW.																								
	YELLOW-GREEN.						GREEN.						GREEN-BLUE.											
	1	2	3	4	5	6	1	2	3	4	5	6	1	2	3	4	5	6	1	2	3	4	5	6
Permanent Rivalry.....																								
Rivalry Gradually Ceasing.....							*	*	*	*	*	*												
Rivalry Quickly Ceasing.....													*	*	*	*	*	*						
Inconstant Mixture.....	*	*	*	*	*	*													*	*	*	*	*	*
Perfect Mixture.....	*	*	*	*	*	*																		
BLUE.																								
	VIOLET.						VIOLET-PURPLE.						PURPLE.											
	1	2	3	4	5	6	1	2	3	4	5	6	1	2	3	4	5	6	1	2	3	4	5	6
Permanent Rivalry.....																								
Rivalry Gradually Ceasing.....							*	*	*	*	*	*												
Rivalry Quickly Ceasing.....	*	*	*	*	*	*													*	*	*	*	*	*
Inconstant Mixture.....	*	*	*	*	*	*							*	*	*	*	*	*						
Perfect Mixture.....	*	*	*	*	*	*																		

TABLE XXVII.
OBSERVER, P. T. GREY BEFORE RIGHT EYE, COLOUR BEFORE LEFT EYE.

	RED.						ORANGE-RED.						ORANGE.						ORANGE-YELLOW.					
	1	2	3	4	5	6	1	2	3	4	5	6	1	2	3	4	5	6	1	2	3	4	5	6
Permanent Rivalry.....	*	*	*	*	*	*	*	*	*	*	*	*	*	*	*	*	*	*	*	*	*	*	*	*
Rivalry Gradually Ceasing.....																								
Rivalry Quickly Ceasing.....												*				*							*	*
Inconstant Mixture.....																		*						
Perfect Mixture.....																								

	YELLOW.						YELLOW-GREEN.						GREEN.						GREEN-BLUE.					
	1	2	3	4	5	6	1	2	3	4	5	6	1	2	3	4	5	6	1	2	3	4	5	6
Permanent Rivalry.....						*											*						*	
Rivalry Gradually Ceasing.....																								
Rivalry Quickly Ceasing.....					*									*	*	*	*		*	*	*	*	*	
Inconstant Mixture.....						*																		
Perfect Mixture.....	*	*	*	*	*	*	*	*	*	*	*	*	*	*	*	*	*	*	*	*	*	*	*	

	BLUE.						VIOLET.						VIOLET-PURPLE.						PURPLE.					
	1	2	3	4	5	6	1	2	3	4	5	6	1	2	3	4	5	6	1	2	3	4	5	6
Permanent Rivalry.....	*	*	*	*	*	*	*	*	*	*	*	*	*	*	*	*	*	*	*	*	*	*	*	
Rivalry Gradually Ceasing.....	*	*	*	*	*	*	*	*	*	*	*	*	*	*	*	*	*	*	*	*	*	*	*	
Rivalry Quickly Ceasing.....	*	*	*	*	*	*	*	*	*	*	*	*	*	*	*	*	*	*	*	*	*	*	*	
Inconstant Mixture.....																								
Perfect Mixture.....																								

TABLE XXVIII.—OBSERVER, J. M.

	RED.						ORANGE-RED.						ORANGE.						ORANGE-YELLOW.							
	1	2	3	4	5	6	1	2	3	4	5	6	1	2	3	4	5	6	1	2	3	4	5	6		
Permanent Rivalry.....	*	*	*	*	*	*																				
Rivalry Gradually Ceasing.....						*																				
Rivalry Quickly Ceasing.....				*											*	*										
Inconstant Mixture.....												*						*						*		
Perfect Mixture.....						*						*			*	*	*	*			*	*	*	*		
YELLOW.																										
	YELLOW-GREEN.						GREEN.						GREEN-BLUE.													
	1	2	3	4	5	6	1	2	3	4	5	6	1	2	3	4	5	6								
Permanent Rivalry.....																										
Rivalry Gradually Ceasing.....																										
Rivalry Quickly Ceasing.....				*														*								
Inconstant Mixture.....																										
Perfect Mixture.....	*	*	*	*	*	*	*	*	*	*	*	*	*	*	*	*	*	*								
BLUE.																										
	VIOLET.						VIOLET-PURPLE.						PURPLE.													
	1	2	3	4	5	6	1	2	3	4	5	6	1	2	3	4	5	6								
Permanent Rivalry.....	*	*	*	*	*	*																				
Rivalry Gradually Ceasing.....						*																				
Rivalry Quickly Ceasing.....				*											*	*	*	*								
Inconstant Mixture.....																										
Perfect Mixture.....	*	*	*	*	*	*	*	*	*	*	*	*	*	*	*	*	*	*								

Results : 1. The character of the rivalry of the vision-fields differed in some important respects from that which occurred with two colours. (a) There were no cases of "complete rivalry," i.e., of rivalry of sensations of quite the same character as those in monocular vision. Either the grey was brighter or had some tinge of colour, or the colour was of less saturation or changed in tone, or several or all of these modifications occurred together. (b) Orange-red, orange, and orange-yellow very frequently, and even yellow and purple in some cases, became brown or brownish. This never occurred with red, which when modified appeared less bright, or of lower saturation (i.e., pinkish) or changed to orange-red or orange. It was noticeable that the brown effect came not less frequently with the brighter than with the darker greys. (c) The rivalry, even when very pronounced at first, very frequently subsided more or less quickly into an inconstant, or even a perfect mixture. (d) The phenomena are accordingly classified in the tables in this section upon a different basis from that adopted in the two preceding sections. Instead of the completeness of the rivalry, i.e., the absence of any modification of the competing colours, the criterion is its permanence, or the rapidity with which it subsides. The term "inconstant mixture" has also a slightly different significance from that attached to it in the former tables. There it was extended to include the cases where there was rivalry, sometimes even quite pronounced, but with a mixed colour appearing between the alternating colours. In the present tables it is used only for cases where there was no rivalry, beyond an unsteadiness of the mixed colour.

2. Complete mixture of the impressions was less common than with two colours. This was, of course, to be expected, as in many cases the two colours were much more alike than a coloured and an uncoloured impression.

3. Comparison of the various colours as to the facility with which they mix binocularly with uncoloured light shows that their relative quiescence is not quite the same when they are combined with uncoloured light as when they are combined

with one another. The regions of most strenuous rivalry, as will be seen by a glance at Curves V to VII, are at the very ends of the spectrum, and the region where most mixture occurs is about at the middle, the gradation between these extremes being on the whole quite regular. The colour with which most mixture occurred is in each of the curves shown to be yellow-green. Here the rivalry of the fields was scarcely ever very pronounced, and usually did not occur at all. With violet, violet-purple, and purple, which appear at or near the maximum, the rivalry was not, perhaps, so much more marked than with some other colours, but it was more persistent. The impression did not settle into any one colour so frequently as with other combinations.

4. The greys which mixed best were those of medium brightness. This was the case in spite of the fact that the intensities of the grey and the colour used in each experiment were always carefully equalized by the adjustment of the lamps.

5. The colours mostly tended to become fainter when regarded for a time. In some cases, however, they persisted, and in a few instances they even became more pronounced after a time than at first.

6. In a number of cases with violet, violet-purple and purple the competing grey had a yellow tinge. This occurred both with the deeper and the lighter greys. As, according to the results of Miss Baker,¹ who used the same colours, violet and yellow-green are about complementary, these are probably to be regarded as cases of binocular contrast.

7. The stereoscopic effect was found to be practically completely preserved in almost every case. The exceptions occurred near the beginning of the experiments when the eyes of the observer, being unused to the conditions, were probably more easily fatigued. When these experiments were repeated later it was found that in every case the stereoscopic effect was complete.

(4) *Mixture of colours covering the entire vision-field.* The experiments so far reported were all made with surfaces or

¹ University of Toronto Studies, Psychological Series, Vol. ii, No. 1, p. 16.

objects covering only a portion of the vision-field, the remainder being darkened. The following experiments were differently arranged, the colours covering the whole of the field of vision, so that not only were the colours more extended spacially, but also the possibility of comparison was lessened. The apparatus consisted simply of a large pair of goggles similar to those worn by automobilists, but with removable glasses. The frames of the goggles were fitted with grooves, closed at the bottom, but left open at the top, into which square glass slides could be easily inserted. The goggles were fitted closely to the face by means of some light fur attached to the back of the frames, so that they could be adjusted with comfort to the observer, and yet exclude all light. They were held snugly in place by an elastic band which went round the head. Two sets of coloured glass slides were used. One was of mineral-dyed glasses, five in number, the colours being red, yellow, green, blue and violet. The other set was composed of coloured gelatine combinations placed between thin sheets of plain glass. These were twelve in number, and divided the entire spectrum into approximately equal sections. Slides of uncoloured plate glass were also used. The spectroscopical analysis of the colours used is as follows :

SPECTROSCOPICAL ANALYSIS OF THE COLOURS USED.

I.—GELATINE COLOURS.

Colour.	Undiminished in Intensity.	Somewhat Weaker.	Very Weak.
Red (1).....	720—589	500—470
Orange (2).....	720—580	560—530	{ 580—560 }
Orange-Yellow (3)..	720—520	520—510	{ 470—440 }
Yellow (4).....	720—500	510—480	480—455
Yellow-Green (5)..	580—490	{ 650—580 }	
		{ 490—440 }	
Green (6).....	580—465	{ 730—680 }	{ 730—680 }
		{ 610—580 }	{ 450—435 }
		{ 465—450 }	
Green-Blue (7)....	570—440	{ 440—425 }	730—680
		{ 590—570 }	
Blue-Green (8)....	540—440	{ 570—540 }	730—690
		{ 440—430 }	
Blue (9).....	530—425	560—530	{ 425—410 }
			{ 720—665 }
Violet (10).....	470—V. end }	500—470	
	720—650 }		
Violet-Purple (11)..	510—V. end }	{ 620—590 }	
	710—620 }	{ 530—510 }	
Purple (12).....	720—590	480—V. end	590—480

II.—MINERAL COLOURS.

Colour.	Undiminished in Intensity.	Somewhat Weaker.	Very Weak.
Red.....	720—610	610—590	
Yellow.....	710—550	550—490	
Green.....	600—500	{ 630—600 }	490—460
		{ 500—460 }	460—440
Blue.....	{ 570—550 }	{ 640—600 }	{ 720—640 }
	{ 490—end }	{ 550—490 }	{ 660—570 }
Violet.....		{ 720—530 }	
		{ 450—V.end }	530—450

In experimenting, the goggles, without any glasses in, were first adjusted over the observer's eyes. He then closed his eyes, and a pair of differently coloured glasses were slipped into place by the experimenter. The observer was then told to open his eyes, being careful to open both at once, and not at any time to close one eye alone. Observations were then made regarding the colour of objects both within and without the room. In observing objects outside, care had to be exercised to seat the observer before the window so that there should be no interference from the bars of the window sash. If the vertical centre bar of the sash came in the middle of the field it was found that the colours on the two sides were more readily distinguished. The observer was seated at the window at the beginning of the experiments, and looking out reported the appearance of everything in the vision-field generally, i.e., whether darker or brighter than ordinary, or whether there was any definite prevailing colour tone. He then reported the appearance of prominent objects in the landscape, such as the sky, trees, a bright yellow house with dark green shutters, a red brick outhouse, snow and grass, grey brick and stonework of the University buildings, a slate roof just outside the window. After this some observation was made of objects within the room. Then the observer was handed two large cards, one black and one white, on each of which were arranged in a circle twenty small discs of coloured paper, mostly of the Milton-Bradley series, of approximately equal spectral differences, and he was asked to give his judgment of several of the colours. Then he was asked to raise

his eyes and tell, as nearly as he was able, what colours were before his eyes. Finally the observer closed his eyes, the goggles were removed and he was then directed to open his eyes, to look with crossed eyes, and to report what after-effect, if any, he saw. Two complete series of experiments were made with the gelatine colours, each for a different observer. In each series one constant colour was employed, with which each of the others was in turn combined. The series, however, was not carried on uninterruptedly, but other combinations were interspersed, so that the observer was not only ignorant of the actual colours of the glasses at any time before his eyes, but was not even aware of any constant colour being used. A series was also made with combinations of mineral-dyed and plain glasses, which was not, however, arranged in any definite order. The results of the three series are given fully in Tables XXIX to XXXI.

Three other observers also made series of experiments, using the six mineral-dyed glasses only. The results of these are not given *in extenso*, as their general character is similar to the results obtained by the former observers. None of the results lend themselves very readily to tabulation in more condensed form, owing to the irregularity of the effects of the combinations of colours upon the colour of objects in the vision-field. The appended summary of results, however, is based upon the reports of the five observers.

TABLE XXIX.—BLUE-GREEN (No. 8) BEFORE RIGHT EYE.

Colour Before Left Eye.	Subject of Report.	RESULTS.
Red (No. 1)	Colour of Surrounding Objects.	Everything looked red and brighter than normally. Red brick wall appeared brighter red. The hands had a suggestion of yellow over them. There was no rivalry of the vision fields.
	Colours on Card.	No good green seen at all. No. 15 (a dark blue) is the only good blue.
	Colour of Glasses.	Cannot tell what colours.
	After-Effect With Crossed Eyes.	From right eye red, from left greenish.

TABLE XXIX—(CONTINUED).

Colour Before Left Eye.	Subject of Report.	RESULTS.
Orange (No. 2)	Colour of Surrounding Objects.	Everything appeared a little darker.
	Colours on Card.	No good green or blue. Nos. 2 and 3 (dark and light red) had lustre.
	Colour of Glasses.	Yellow on right side and blue on left.
	After-Effect With Crossed Eyes.	From right eye bluish, from left eye no colour.
Orange-Yellow (No 3)	Colour of Surrounding Objects.	(This experiment was performed on a dark day.) Everything much darker. Yellow painted house had lost its yellow colour. Slight rivalry between yellow-green and violet. Snow had a yellow-green tinge. Trees and stone sills of buildings were tinged with violet, dingy white brick appeared purplish.
	Colours on Card.	No good blue. Nos. 1, 2, 3, 4 and 5 had lustre. 18 and 19 (violet and violet-purple) were brown with slight suggestion of violet.
	Colour of Glasses.	Could not tell at end of experiment, but from memory of first impressions judged violet on left and yellow-green on right.
	After-Effect With Crossed Eyes.	From right eye blue, from left no colour.
Yellow (No. 4)	Colour of Surrounding Objects.	Red brick building looked redder than it was remembered. Sky was blue-green. Yellow house was a mixture of yellow and pink. Hands and face of experimenter looked ghastly, with violet tinge around edges. Everything a little darker.
	Colours on Card.	No red. Red and orange discs appeared chocolate. 6 and 7 (orange-yellow and yellow-orange) were good browns. 17, 18 and 19 (blue-violet, violet, and violet-purple) were dark grey with a tinge of violet.
	Colour of Glasses.	Blue on right, green on left.
	After-Effect With Crossed Eyes.	From right eye blue, from left no colour.

TABLE XXIX—(CONTINUED).

Colour Before Left Eye.	Subject of Report.	RESULTS.
Yellow-Green (No. 5)	Colour of Surrounding Objects.	Everything a little darker. Yellow house appeared dirty yellow with a little green. Sky bluish-green. Face pallid, lips almost colourless. Not the least rivalry.
	Colours on Card.	No red. Red and orange appeared dark brown or chocolate. No. 14 (blue-green) appeared bluish-grey.
	Colour of Glasses.	Bluish on right, green on left.
	After-Effect With Crossed Eyes.	From right eye purplish, from left eye brownish.
Green (No. 6)	Colour of Surrounding Objects.	(No sun shining). Everything dark. Snow greenish. Yellow house appeared dirty yellow with a little green. Sky bluish-green. Face pallid, lips almost colourless. Not the least rivalry.
	Colours on Card.	No red. Reds were brown or chocolate.
	Colour of Glasses.	Could not tell at all.
	After-Effect With Crossed Eyes.	From right eye purple, from left no colour.
Green-Blue (No. 7)	Colour of Surrounding Objects.	Everything darker. Red brick wall greyish. Snow darker than usual. Sky had leaden appearance. Hand looked darker than usual with greenish lustre around edge.
	Colours on Card.	No red. Reds were dark brown. No. 13 (very greenish-blue) almost colourless.
	Colour of Glasses.	Blue, but could not distinguish sides.
Blue (No. 9)	Colour of Surrounding Objects.	Yellow house looked pink. White and red brick both appeared red. Snow and sky looked blue. Face pallid, and no colour in lips at all.
	Colours on Card.	Nos. 2-5 dark reddish-brown. No yellow on card. 6 and 7 (orange-yellow and yellow-orange) were dark brown. No. 9 (green-yellow) was pink. 8 and 10 (yellow and yellow-green) were dark brown. 11 and 12 (green) were dark grey.
	Colour of Glasses.	Blue on right. Could not tell what colour on left.
	After-Effect With Crossed Eyes.	From right eye green, from left no colour.

TABLE XXIX—(CONTINUED).

Colour Before Left Eye.	Subject of Report.	RESULTS.
Violet (No. 10)	Colour of Surrounding Objects.	Everything very dark. Red brick wall fiery red. Sky dark blue. Yellow wall had pinkish tinge. Hands were purplish.
	Colours on Card.	6, 7 and 8 (orange-yellow and yellow) varied between red and yellow. 2, 3 and 5 (red and orange) were very brilliant reds. 4 (orange-red) was a beautiful pink.
	Colour of Glasses.	Blue on left, on right could not tell.
	After-Effect With Crossed Eyes.	From right eye greenish, from left eye red.
Violet-Purple (No. 11)	Colour of Surrounding Objects.	Everything had purple tinge, and was much darker. Snow was bluish, hands reddish.
	Colours on Card.	No good red, yellow or blue.
	Colour of Glasses.	Left, blue or violet ; right, could not tell.
	After-Effect With Crossed Eyes.	From right eye faint red, from left eye green.
Purple (No. 12)	Colour of Surrounding Objects.	Shadows from trees and buildings were purple-violet. Everything darker. Sky pink and blue. Yellow house appeared as without glasses. Red brick wall had some yellow in it.
	Colours on Card.	Green entirely absent. Nos. 2 and 4 had slight lustre. No. 9 (green-yellow) appeared white. No. 13 (green-blue) appeared grey with a suggestion of blue.
	Colour of Glasses.	Blue on right, purple on left.
	After-Effect With Crossed Eyes.	From right eye green, from left eye brown.

TABLE XXX.—YELLOW-GREEN (No. 5) BEFORE LEFT EYE.

Colour Before Right Eye.	Subject of Report.	RESULTS.
Red (No. 1)	Colour of Surrounding Objects.	Whole vision field darker. Slight rivalry of green and pink, but green soon entirely disappeared. Dark yellow or brown leaves appeared bright yellow. Yellow house brighter. Green lines of note-book were purple. Sky had a purplish tinge, and darker than usual.
	Colours on Card.	Yellows less saturated. Most of the colours purplish.
	Colour of Glasses.	On right, purple, on left, could not tell, but thought yellow.
	After Effect With Crossed Eyes.	From right eye faint red, from left, green.
Orange (No. 2)	Colour of Surrounding Objects.	Everything darker. Some rivalry at first. Later, colours blended, and appeared something between red and purple. Yellow house was lighter yellow.
	Colours on Card.	18, 19, and 20 (violet, violet-purple and purple) had nearly lost their violet or purple tone, and were of a dingy hue. No. 6 (orange-yellow) was between brown and dark yellow.
	Colour of Glasses.	On right violet, on left could not say.
	After-Effect With Crossed Eyes.	From right eye violet, from left no colour.
Orange Yellow (No. 3)	Colour of Surrounding Objects.	(Sun shining brightly). Everything has a yellow tint. Slight rivalry at first, but soon ceased. Green fir-tree dark green, but more yellow-green where sun shines on it. Red brick wall appeared dull reddish-brown.
	Colours on Card.	Greens nearer yellow. Blues more purplish.
	Colour of Glasses.	Slight yellow tinge. Could not distinguish between the two sides.
	After-Effect.	None from either eye.
Yellow (No. 4)	Colour of Surrounding Objects.	Everything had bright yellow tint. Yellow house as usual. No rivalry.
	Colours on Card.	Greens more bluish. Nos. 2 and 3 had slight lustre.
	Colour of Glasses.	Both eyes had yellow glasses.

TABLE XXX—(CONTINUED)

Colour Before Right Eye	Subject of Report.	RESULTS.
Green (No. 6)	Colour of Surrounding Objects.	Sky dark blue. Hand pallid.
	Colours on Cards.	Red and orange appeared brownish. Two cards, one black, the other white, with the same colours on, being shown, the colours were observed to show up better on the dark card.
	Colour of Glasses.	On the right side light blue, on left, yellow.
	After-Effect.	From right side a slight pink, from left side yellow.
Green-Blue (No. 7)	Colour of Surrounding Objects.	(Experiment performed in bright sunshine.) Everything tinged with yellow-green, and seems dull. Yellow house appears as usual. Cannot distinguish red bricks of the barn as red.
	Colours on Card.	Discrimination much the same as without glasses.
	Colour of Glasses.	Could not say decidedly, but had a vague impression of green.
	After-Effect.	No after-effect.
Blue Green (No. 8)	Colour of Surrounding Objects.	Everything much darker, and had a slight yellow tinge. Yellow house was quite yellow. Snow where sun shining on it was bluish.
	Colours on Card.	Reds appeared dark brown, so dark as to be almost without colour.
	Colour of Glasses.	Blue on right, yellow on left.
	After-Effect.	From left eye vice et. No after-effect from right eye.
Blue (No. 9)	Colour of Surrounding Objects.	At first slight rivalry between blue and green, which soon ceased. Snow and yellow building had normal appearance. Sky appeared dark blue. (It was really light blue-grey.) Hand had a pallid appearance.
	Colours on Card.	No. 2 appeared dark brown. No. 1 dark dirty brown. No good red. 11 and 12 (green) were blue-green.
	Colour of Glasses.	Could not tell what colours he had on his eyes, but there seemed a tinge of blue over the vision-field.
	After-Effect.	No after-effect.

TABLE XXX—(CONTINUED).

Colour Before Right Eye	Subject of Report.	RESULTS.
Violet (No. 10)	Colour of Surrounding Objects.	Everything had a hazy appearance with a little violet tinge. Yellow leaves seemed very bright yellow. Yellow house had a slight tinge of green. Hands looked a little darker than usual. Occasionally, looking past the edge of any object, e.g., chimney, there appeared a purplish tinge approaching red. The violet tinge to everything disappeared and again re-appeared. On its re-appearance, the hands had a distinct purple tinge, and experimenter's lips were slightly blue.
	Colours on Card.	No. 12 (green) was yellow with slight greenish tendency. No. 17 (blue-violet) was "dark blue."
	Colour of Glasses.	On right, light blue, on left could not tell.
	After-Effect.	Violet from left eye, no effect from right eye.
Purple. (No. 12)	Colour of Surrounding Objects.	(Experiment performed on a dull day.) A purplish tinge over everything, gradually growing lighter; right side a little darker than left. Dark yellow leaves appeared bright yellow. Face looked death-like, lips as though almost bloodless.
	Colours on Card.	No. 1 appeared bronze or brownish-orange. No. 10 (yellow-green) was a pale yellow. No. 12 (green) was yellowish-blue. Slight lustre from Nos. 2 and 3.
	Colour of Glasses.	On right, light pink, on left, very light pink.
	After-Effect.	No after-effect.

TABLE XXXI.

Colour.		Subject of Report.	RESULTS.
Right Eye.	Left Eye.		
Mineral Violet.	Mineral Blue.	Colour of Surrounding Objects.	The whole vision-field had a purplish tinge, and the light was dimmer. Grass where sun shone on it was more yellowish than usual. The evergreen tree was almost black. The relation of white and yellow in the yellow house (cornice, etc., white) was about normal, the colour being darker than remembered. Sky appeared purplish, the colour being more prominent on suddenly turning to look up at it. Hands had an unnatural appearance, hardly describable.
		Colour of Glasses.	Cannot tell anything about colour of glasses.
		After-Effect.	Very bright, but no after-image.
Mineral Red	Mineral Yellow.	Colour of Surrounding Objects.	Sky seemed a brownish-red, getting darker. Yellow leaves seemed dark brown in centre.
		Colours on Card.	No. 20 (purple) was purplish-red. 11 (green) was normal.
		Colour of Glasses.	On right a shade of red, on left, green.
		After-Effect.	Indefinite impression of colour, quickly disappearing. No distinction between the sides.
Purple Gelatine (No. 12)	Yellow-Green Gelatine (No. 5)	Colour of Surrounding Objects.	This experiment was performed on a dark day. There was a pinkish tinge gradually growing lighter, the right eye being a little darker than the other. The dark yellow leaves appear light yellow. The experimenter's face appeared corpse-like, the lips bloodless.
		Colours on Card.	Nos. 2 and 3 had lustre.
		Colour of Glasses.	On right eye light pink, on left, very light pink.
		After-Effect.	Only effect is that on removing glasses everything is brighter.
Mineral Green	Uncoloured Glass	Colour of Surrounding Objects.	This experiment was performed on a dull day. On opening the eyes the right eye seemed to have a shade of yellow, the left having a very slight tinge of the same colour. The effect on the right eye seemed to be growing weaker.

TABLE XXXI.—CONTINUED.

Colour.		Subject of Report.	RESULTS.
Right Eye.	Left Eye.		
Mineral Green.	Uncoloured Glass.	Colour of Glasses.	In right eye light yellow, in left very indefinite, and could not tell what colour, if any.
		After-Effect.	After removing glasses and blinking, very faint tinge of purple (negative after-image).
Mineral Blue	Mineral Yellow.	Colour of Surrounding Objects.	On opening the eyes the vision-field seemed somewhat darkened. Rivalry of yellow and blue followed.
		Colours on Card.	No. 13 (green-blue) was a pale blue, but with no green in it. No. 13 (a green near to yellow) was quite yellow.
		Colour of Glasses.	On right violet or blue, on left, cannot tell.
Gelatine Orange (No. 4).	Mineral Green.	Colour of Surrounding Objects.	Everything appeared brighter, with pink shade. The yellow house is rather a dark yellow. The colour of the (green) shutters could not be determined. The experimenter's face had a bluish tinge, as if cold.
		Colours on Card.	Reds had lustre effect. No. 10 (yellow-green) was "light green." No. 13 (green-blue) was a greyish blue.
		Colour of Glasses.	On right eye blue, on left, green.

Summary of Results. 1. Competition or rivalry of the vision-fields is never prominent. In some cases, on first opening the eyes there was a slight struggle of the impressions, but this soon ceased, and after a few moments the competition was no longer observable. The observer was frequently unable to distinguish between the colours of the two glasses, even when attending exclusively to this point.

2. The result of the mixture of the two impressions was not usually, as with the former method of binocular mixture, to produce a colour midway between the two that were combined. Sometimes the total impression would be quite near

to the quality of one or other of the monocular colours, but even when it was quite unlike either of them the result was not always that produced by other methods of mixing.

3. The colour quality of the impression was usually very vague. Coloured objects in the field of vision were noticed to have a different appearance from that remembered, but the attempt to tell what was the colour of the glasses before the eyes was seldom successful. Often it was only concerning one side that the observer could give a decided opinion. Seldom did his judgment correspond to the objective facts. Sometimes he would be right as to one of the colours, but wrong as to the other. And even when approximately correct as to the colours of both glasses, he would often be mistaken regarding the eyes before which the respective colours were presented.

4. The rather frequent appearance of a lustre effect is noteworthy. This phenomenon appeared only upon red or orange-coloured surfaces (except once or twice with purple) of small area. It was mostly upon the small coloured discs on the card that it was noticed. It was, however, quite plainly seen upon the very small, bright red leaves of ivy, growing round a stone chimney just outside the window.

III. STEREOSCOPIC LUSTRE FROM DIFFERENCE OF INTENSITY AND OF COLOUR BETWEEN THE RETINAL IMAGES.

In the previous article, dealing with the intensity relations of stereoscopic vision¹ there were described some experiments upon the production of lustre by differences of brightness between the images in the two eyes. A further problem in that connection was suggested by the results of the experiments in binocular mixture of colours, reported in a preceding section of the present article. As mentioned there, there occurred quite frequently a lustre effect, which, upon closer examination, appeared to be due to differences of intensity so slight as to have otherwise been unnoticed. In the

¹ University of Toronto Studies, Psych. Series, Vol. ii, No. 2.

experiments upon stereoscopic lustre with uncoloured light, such very slight differences of brightness had not been found to produce the phenomenon, so that it seemed probable that the effect would appear with smaller differences of brightness where there is also a decided difference of colour. This question was investigated by a method similar to that employed in the experiments with white light, the only difference being that on the rear wall of the apparatus, in place of the squares of white paper and black velvet respectively, there were placed squares of differently coloured paper. The objects were, as before, etchings on plate glass (Fig. 4). The two pairs used both formed truncated pyramids with the apices toward the observer. Seven colours were used, chiefly of the Milton-Bradley series, viz., red, orange, yellow, green, blue, violet, and purple. These were illuminated by an 8 c.p. incandescent electric lamp on eachside of the apparatus. The colours obtained by this arrangement were of course by no means spectrally pure, but they possessed the additional interest of being more like the colours commonly seen. The spectra reflected by the papers under the prevailing conditions of illumination, and their comparative intensities, were as follows :—

Name of Colour.	Comparative Intensity.	Portion of Spectrum Visible in $\mu\mu$
Red.....	360	680-480 (640)
Orange.....	360	670-550 (590-600)
Yellow.....	310	670-500 (570)
Green.....	310	650-500 (530-540)
Blue.....	125	Whole spectrum dimly visible (500).
Violet.....	180	Whole spectrum visible—yellow and yellow-green very weak.
Purple.....	180	Whole spectrum visible—yellow and green weak

One colour being placed opposite the inner lens of the stereoscope, i.e., the one before which the episkotister disc revolved, and a different one opposite the other lens, the disc was then adjusted to admit only a single degree of light, and the amount gradually increased to the largest amount that

the disc was capable of admitting, viz. 320° , at which point no difference could be noticed between the effect and that of the full light. Then the colour on the unobscured side was replaced by another, and so on until all of the other six colours had been combined with the partially obscured one. Then another colour was placed behind the disc, and each of the others combined with it, as before. By this means each of the seven colours, in all degrees of brightness, was combined with each of the others. The results are summarized in Tables XXXII to XLV, which show also the amounts of light which had to be admitted through the disc for the production of any, and of complete stereoscopic combination. With regard to lustre also, the figures indicate the smallest opening of the disc with which it appears at all, and the least opening with which it is complete. Wherever the lustre was reported as "decided" or "perfect" it continued so, as the opening of the disc widened, even up to 360° . The colour named in the heading of the table is in each case the colour before which the episkotister was rotated; the colours indicated in the first column of the tables are those combined with it.

Two series were also made in the same way, combining white with coloured light. In one of these the white was behind the episkotister, and the colour remained constant in intensity, in the other the white was constant and the colours behind the disc. The results are shown in Tables XLVI-XLVII.

TABLE XXXII.—RED. OBSERVER, W.A.M.

Compared Colour.	Opening of the Episkotister Disc.	Ratio of the intensities of the objects presented to the respective Eyes.	Lustre.	Stereoscopic Effect.
Orange.	10°	36.00	None.	Partial.
	20°	18.00	Slight.	Do.
	40°	9.00	Brighter.	Good.
	60°	6.00	Good.	Do.
Yellow.	30°	10.33	None.	Imperfect.
	60°	5.16	Slight.	Good.
	100°	3.10	Decided.	Do.
Green.	8°	40.00	None.	Partial.
	10°	32.00	None.	Complete.
	60°	5.33	Slight.	Do.
	100°	3.20	Perfect	Do.
Blue.	10°	12.50	} None occurs.	Partial.
	20°	6.25		Good.
Violet	10°	18.00	} None occurs.	Partial
	30°	6.00		Good.
Purple	10°	18.00	} None occurs.	Partial.
	40°	4.50		Good.

TABLE XXXIII.—ORANGE. OBSERVER, W.A.M.

Compared Colour.	Opening of the Episkotister Disc.	Ratio of the intensities of the objects presented to the respective Eyes.	Lustre.	Stereoscopic Effect.
Red.	6°	60.00	None.	Poor.
	12°	30.00	Do.	Distinct.
	40°	9.00	Slight.	Do.
	160°	2.25	Distinct.	Do.
Yellow.	8°	38.75	} None } occurs.	With effort.
	20°	15.50		Good
Green.	10°	32.00	} None } occurs.	With effort.
	20°	16.00		With ease.
Blue.	8°	15.62	None.	Partial.
	50°	2.50	Do.	Good.
	60°	2.08	Slight.	Do.
	90°	1.38	Decided.	Do.
Violet	10°	18.00	None.	Poor.
	30°	6.00	Do.	Good.
	70°	2.57	Faint.	Do.
	120°	1.50	Uncertain.	Do.
Purple.	10°	18.00	None.	Partial.
	30°	6.00	Do.	Complete
	70°	2.57	Slight.	Do.
	100°	1.80	Decided.	Do.

TABLE XXXIV.—YELLOW. OBSERVER, W.A.M.

Compared Colour.	Opening of the Episkotister Disc.	Ratio of the intensities of the objects presented to the respective Eyes.	Lustre.	Stereoscopic Effect.
Red.	10°	41.80	None. Slight. Better. Good.	Partial.
	15°	24.64		Do.
	30°	13.93		Good.
	40°	10.45		Do.
Orange.	10°	41.80	} None } occurs.	Partial.
	30°	13.93		Good.
Green.	10°	37.16	Slight. Good.	None.
	30°	12.38		Partial. (Never becomes perfect)
Blue.	6°	24.19	None. Do. Slight. Decided.	Poor.
	15°	9.67		Good.
	60°	2.41		Do.
	90°	1.61		Do.
Violet	8°	25.80	} None } occurs.	Partial.
	15°	13.93		Good.
Purple	6°	34.83	None. Do. Slight. Good.	Partial.
	15°	13.93		Do.
	70°	3.15		Perfect.
	90°	2.03		Do.

TABLE XXXV.—GREEN. OBSERVER, W.A.M.

Compared Colour.	Opening of the Episkotister Disc.	Ratio of the intensities of the objects presented to the respective Eyes.	Lustre.	Stereoscopic Effect.
Red.	10°	39.75	None. Do. Slight. Perfect.	Partial. Complete. Do. Do.
	20°	19.87		
	60°	6.65		
	100°	3.97		
Orange.	10°	39.75	None. Do. Little. None.	Inconstant. Perfect. Do. Do.
	40°	9.95		
	60°	6.65		
	160°	2.49		
Yellow.	8°	43.60	} No decided } lustre appears	Partial. Good.
	15°	23.25		
Blue.	8°	17.57	} None } appears.	Complete effect appears at once.
Violet.	8°	25.31	} No appear- } ance of lustre } at all.	Imperfect. Complete.
	20'	10.12		
Purple.	15°	13.50	} None } appears.	With effort. With ease.
	40°	5.06		

TABLE XXXVI.—BLUE. OBSERVER, W.A.M.

Compared Colour.	Opening of the Episkotister Disc.	Ratio of the intensities of the objects presented to the respective Eyes.	Lustre	Stereoscopic Effect
Red.	15°	70.72	None.	Poor.
	50°	20.73	Do.	Partial.
	80°	12.96	Little.	With effort.
	90°	11.52	None.	Perfect.
Orange.	20°	51.84	None.	Partial.
	60°	17.28	Little.	Complete.
	90°	11.52	Better.	Do.
	220°	4.79	Very good.	Do.
Yellow	6°	148.80	None.	Partial.
	10°	89.28	Do.	Complete
	40°	22.32	Slight. (Never becomes good.)	Do.
Green.	15°	61.48	None.	With effort.
	60°	15.36	Little.	(Never combine perfectly.)
	140°	6.58	None.	
Violet.	6°	86.40	None appears.	Difficult.
	15°	34.56		Perfect.
Purple.	60°	8.64	None.	With effort, and so throughout.

TABLE XXXVII.—VIOLET. OBSERVER, W.A.M.

Compared Colour.	Opening of the Episkotister Disc.	Ratio of the intensities of the objects presented to the respective Eyes.	Lustre.	Stereoscopic Effect.
Red.	70°	10.28	} None.	Partial. Complete.
	140°	5.14		
Orange.	20°	36.00	} None.	Partial. Complete.
	70°	10.28		
Yellow.	40°	15.50	} None.	Partial. Complete.
	60°	10.36		
Green.	20°	32.00	} None.	Partial. Complete.
	30°	21.33		
Blue.	30°	8.33	} None.	Partial. Complete.
	85°	3.12		
Purple.	15°	24.00	None.	Partial. Better. Complete.
	40°	9.00	Slight.	
	90°	4.00	Very fair.	

TABLE XXXVIII.—PURPLE. OBSERVER, W.A.M.

Compared Colour.	Opening of the Episkotister Disc.	Ratio of the intensities of the objects presented to the respective Eyes.	Lustre.	Stereoscopic Effect.
Red.	20°	36.00	} None.	Partial. Good.
	90°	8.00		
Orange.	20°	36.00	None. Slight. Decided.	Imperfect. Complete. Do.
	60°	12.00		
	90°	8.00		
Yellow.	30°	20.66	None. None. Slight. (Never becomes good.)	Partial. Good. Do.
	70°	8.85		
	100°	6.20		
Green.	80°	8.00	} None.	Partial. Perfect.
	120°	5.33		
Blue.	60°	4.16	None.	At once complete.
Violet.	10°	36.00	None.	Partial. Do. Good. Do.
	20°	18.00	Slight.	
	30°	12.00	Do.	
	60°	6.00	Good.	

TABLE XXXIX.—RED. OBSERVER, P.B.T.

Compared Colour.	Opening of the Episkotister Disc.	Ratio of the intensities of the objects presented to the respective Eyes.	Lustre.	Stereoscopic Effect.
Orange.	10°	36.00	None.	Partial.
	12½°	29.60	Slight.	Do.
	30°	12.00	Good.	Complete.
Yellow.	10°	31.00	None.	Complete.
	20°	15.50	Slight.	Do.
	50°	6.20	Good.	Do.
Green.	12°	26.66	None.	Slight.
	20°	16.00	Do.	Good.
	80°	4.00	Partial.	Do.
Blue.	10°	12.50	None.	Partial.
	23°	5.43	Do.	Complete.
Violet.	6°	30.00	None.	Partial.
	17½°	10.28	Do.	Complete.
	70°	6.00	Good.	Do.
Purple.	15°	12.00	None.	Partial.
	30°	6.00	Do.	Complete.

TABLE XL.—ORANGE. OBSERVER, P.B.T.

Compared Colour.	Opening of the Episkotister Disc.	Ratio of the intensities of the objects presented to the respective Eyes.	Lustre.	Stereoscopic Effect.
Red.	6°	60.00	None.	Complete. Dg.
	150°	2.40	*Traces.	
Yellow.	10°	31.00	None.	Partial. Complete.
	20°	16.50	Do.	
Green.	10°	32.00	None.	Complete. Do.
	60°	5.33	Same, never becomes good.	
Blue.	6°	20.83	None.	Complete. Do. Do.
	12°	10.41	Fair.	
	20°	6.25	Good.	
Violet.	12°	15.00	None.	Complete. Do.
	200°	1.11	*Slight traces.	
Purple.	6°	30.00	None.	Slight. Fair. Good.
	15°	12.00	Do.	
	50°	3.60	Do.	
	60°	3.00	Slight.	

* Hard to distinguish lustre from brightness of the object.
 ** Increases with greater intensity of Orange, but never becomes very decided.

TABLE XLI.—YELLOW. OBSERVER, P.B.T.

Compared Colour.	Opening of the Episkotister Disc.	Ratio of the intensities of the objects presented to the respective Eyes.	Lustre.	Stereoscopic Effect.
Red.	8°	52.25	Slight.	Slight.
	40°	10.45	Good.	Complete.
	100°	4.18	Very good.	Do.
Orange.	6°	60.67	None.	Partial.
	15°	27.87	Do.	Complete.
Green.	12½°	20.72	None.	Complete.
Blue.	6°	24.19	None.	Imperfect.
	10°	14.51	*Slight.	Complete.
Violet.	6°	34.83	None.	Partial.
	10°	20.25	Do.	Complete.
	130°	1.55	Extremely Slight.	Do.
Purple.	8°	25.48	None.	Partial.
	30°	6.96	Do.	Good.
	50°	4.18	Slight.	Do.

* Above 10° there was lustre—sometimes more, sometimes less decided—but never perfect.

TABLE XLII.—GREEN. OBSERVER, P.B.T.

Compared Colour.	Opening of the Episkotister Disc.	Ratio of the intensities of the objects presented to the respective Eyes.	Lustre.	Stereoscopic Effect.
Red.	8°	50.62	None.	Partial.
	12°	33.74	Do.	Complete.
	160°	2.53	Very slight.	Do.
Orange.	12°	33.75	None.	Partial.
	40°	10.12	Do.	Complete.
Yellow.	15°	23.25	None.	Partial.
	40°	8.72	Do.	Complete.
Blue.	10°	14.06	None.	Complete.
Violet.	10°	20.25	None.	Imperfect.
	15°	13.50	Do.	Complete.
Purple.	12°	16.89	None.	Partial.
	20°	10.11	Do.	Complete.
	60°	3.37	Faint.	Do.

TABLE XLIII.—BLUE. OBSERVER, P.B.T.

Compared Colour.	Opening of the Episkotister Disc.	Ratio of the intensities of the objects presented to the respective Eyes.	Lustre.	Stereoscopic Effect.
Red.	8°	129.60	None.	Partial.
	30°	34.56	Do.	Complete.
Orange.	20°	51.84	None.	Partial.
	40°	25.92	Slight.	Complete.
	70°	14.83	Good.	
Yellow.	8°	111.60	None.	Partial.
	10°	89.28	Slight, never becomes good	Complete.
Green.	25°	36.80	None.	*Complete.
Violet.	20°	25.92	None.	*Partial.
	50°	10.36	Do.	Complete.
Purple.	50°	10.36	None.	*Slight.
	90°	5.76	Do.	Fair.

*Blue very dark, lines not clearly visible with smaller openings.

TABLE XLIV.—VIOLET. OBSERVER, P.B.T.

Compared Colour.	Opening of the Episkotister Disc.	Ratio of the intensities of the objects presented to the respective Eyes.	Lustre.	Stereoscopic Effect.
Red.	8°	90.00	None.	Imperfect.
	20°	36.00	"	Complete.
	60°	12.00	Slight.	Do.
Orange.	20°	36.00	None.	Imperfect.
	60°	12.00	Do.	Complete.
	100°-150°	7.20-4.50	*Faint.	Do.
Yellow.	8°	77.50	None.	Partial.
	20°	31.00	Do.	Complete.
	60°	10.33	Faint.	Do.
	190°	3.55	Disappears.	Do.
Green.	10°	64.00	None.	Partial.
	20°	32.00	Do.	Complete.
Blue.	15°	16.66	None.	Complete.
	80°	3.12	Very faint.	Do.
Purple.	15°	24.00	None.	Fair.
	70°	5.14	Do.	Perfect.

*Gradually fades as opening increases beyond 180 degrees.

TABLE XLV.—PURPLE. OBSERVER, P.B.T.

Compared Colour.	Opening of the Episkotister Disc.	Ratio of the intensities of the objects presented to the respective Eyes.	Lustr.	Stereoscope Effect.
Red.	12°	60.00	None.	Partial.
	70°	10.28	Do.	Complete.
Orange.	15°	48.00	None.	Partial.
	20°	36.00	Fair.	Do.
	60°	12.00	Do.	Complete.
Yellow.	12°	52.00	None.	Imperfect.
	17½°	36.51	Slight.	Do.
	20°	31.00	Do.	Complete.
Green.	12°	53.33	None.	Partial.
	20°	32.00	Do.	Complete.
	50°	12.80	Slight.	Do.
Blue.	20°	12.50	None.	Complete.
	120°	2.08	Do.	Do.
Violet.	20°	18.00	Faint.	Complete.
	240°	1.12	Increases, but still weak.	Do.

TABLE XLVI.—WHITE. OBSERVER, W.
(WHITE CHANGING IN INTENSITY, COLOUR CONSTANT.)

Compared Colour.	Opening of the Episkotister Disc.	Ratio of the intensities of the objects presented to the respective Eyes.	Lustre.	Stereoscopic Effect.
Red.	1°	300.00	None.	Partial.
	4°	90.00	Do.	Complete.
	28°	12.85	Faint.	Do.
	210°-270°	1.71-1.33	Good.	Do.
Orange.	2°	180.00	None.	Complete.
	9°	40.00	Faint (never becomes good)	Do.
Yellow.	2°	155.00	None.	Complete.
	10°	31.00	Slight.	Do.
Green.	4°	80.00	None.	Complete.
	10°	32.00	Faint.	Do.
	260°	1.23	Very good.	Do.
Blue.	2°	62.50	None.	Complete.
	6°	20.83	Slight.	Do.
	15°	8.33	Very fair.	Do.
Violet.	2°	90.00	None.	Partial.
	4°	45.00	Do.	Complete.
	7°	25.71	Slight.	Do.
	110°	1.63	Brighter	Do.
	250°	.72	Good.	Do.
Purple.	1°	180.00	None.	Partial.
	4°	45.00	Do.	Complete.
	8°	22.50	Slight.	Do.
	30°	6.00	Better.	Do.
	80°	2.22	Very good.	Do.

TABLE XLVII.—WHITE. OBSERVER, W.
(WHITE CONSTANT IN INTENSITY, COLOUR CHANGING).

Compared Colour.	Opening of the Episkotister Disc.	Ratio of the Intensities of the objects presented to the respective Eyes.	Lustre.	Stereoscopic Effect.
Red.	2°	180.00	None.	Imperfect.
	4°	90.00	Do.	Complete.
	8°	45.00	Slight.	Do.
	95°	3.78	Very good.	Do.
Orange.	2°	180.00	None.	Complete.
	8°	45.00	Slight.	Do.
	24°	15.00	Fair.	Do.
Yellow.	2°	200.03	None.	Complete.
	10°	41.80	Slight.	Do.
	130°	3.21	Fair.	Do.
Green.	2°	202.50	None.	Partial.
	4°	101.25	Do.	Complete.
	16°	25.31	Slight.	Do.
	65°	6.23	Fair.	Do.
Blue.	1°	1036.80	None.	Imperfect.
	3°	345.60	Do.	Complete.
	6°	172.80	Slight.	Do.
	100°	10.36	Fair.	Do.
Violet.	2°	360.00	None.	Complete.
	14°	51.42	Slight.	Do.
Purple.	1°	720.00	None.	Imperfect.
	4°	180.00	Extremely faint.	Complete.
	12°	60.00	Slight.	Do.
	100°	7.20	Good.	Do.

Results : Comparison of the results of these experiments with those of the similar experiments in white light shows some very interesting points of difference.

(1) With a considerable number of combinations no lustre appeared, no matter what the difference of intensity. (The limits were from equality to a ratio of 1 to 720). This seems difficult to account for, the more so as there is not very much regularity as to the colour combinations with which the lustre appears or fails. On the whole, it may perhaps be said that in most of the cases where no lustre appears the colours are either somewhat near each other in quality, so as to mix readily, or else are nearly complementary, so as to produce the strongest rivalry. The number of experiments, however, was not great enough, nor the regularity of the results sufficient, to make this induction conclusive.

2. Lustre does occur in many cases with smaller differences of brightness between the two retinal impressions than were required with uncoloured light to produce it. As before observed, when "good" lustre was once seen it continued till the disc was opened to its fullest extent. And in some cases, as when, for example, red was behind the disc and green on the other side, this meant that the intensities were practically equal. The lustre was frequently reported as "good" or "decided" when the intensities of the images were about as 3 or 4 to 1. With uncoloured light, on the contrary, no lustre at all appeared unless one retinal image was from $1\frac{1}{2}$ to 3 times as bright as the other; and "good" lustre required a ratio of at least 9 or 10 to 1.

3. Lustre does not occur with as great differences of intensity in coloured as in uncoloured light. That is to say, the upper limit is much lower with coloured light. The lustre was scarcely ever good when one impression was more than 10 or 12 times as bright as the other, and a ratio of about 50 to 1 is the extreme upper limit for the appearance of any lustre at all. With uncoloured light, on the other hand, the upper limit for good lustre varied from 375 to 920 to 1 and for any lustre at all the upper limit was about 1900 to 1.

4. The opening of the disc required for the production of the stereoscopic effect is greater when the images differ in both colour and brightness than when they differ in brightness only. The complete combination often required an opening of 30° or 40° , or even more, while not even a partial or inconstant combination in many cases appeared with an opening less than 15° or 20° ; whereas reference to the corresponding tables regarding uncoloured light shows that a partial stereoscopic effect appeared with an opening of $2\frac{1}{2}^\circ$ to 9° , and the complete effect did not require an opening greater than 14° to 18° . From Tables XLVI and XLVII it will be seen that this phenomenon re-appears even in the combination of white and coloured light. A partial stereoscopic effect was frequently seen with an opening of only 1° , and complete stereoscopic combination commonly did not require more than 4° .

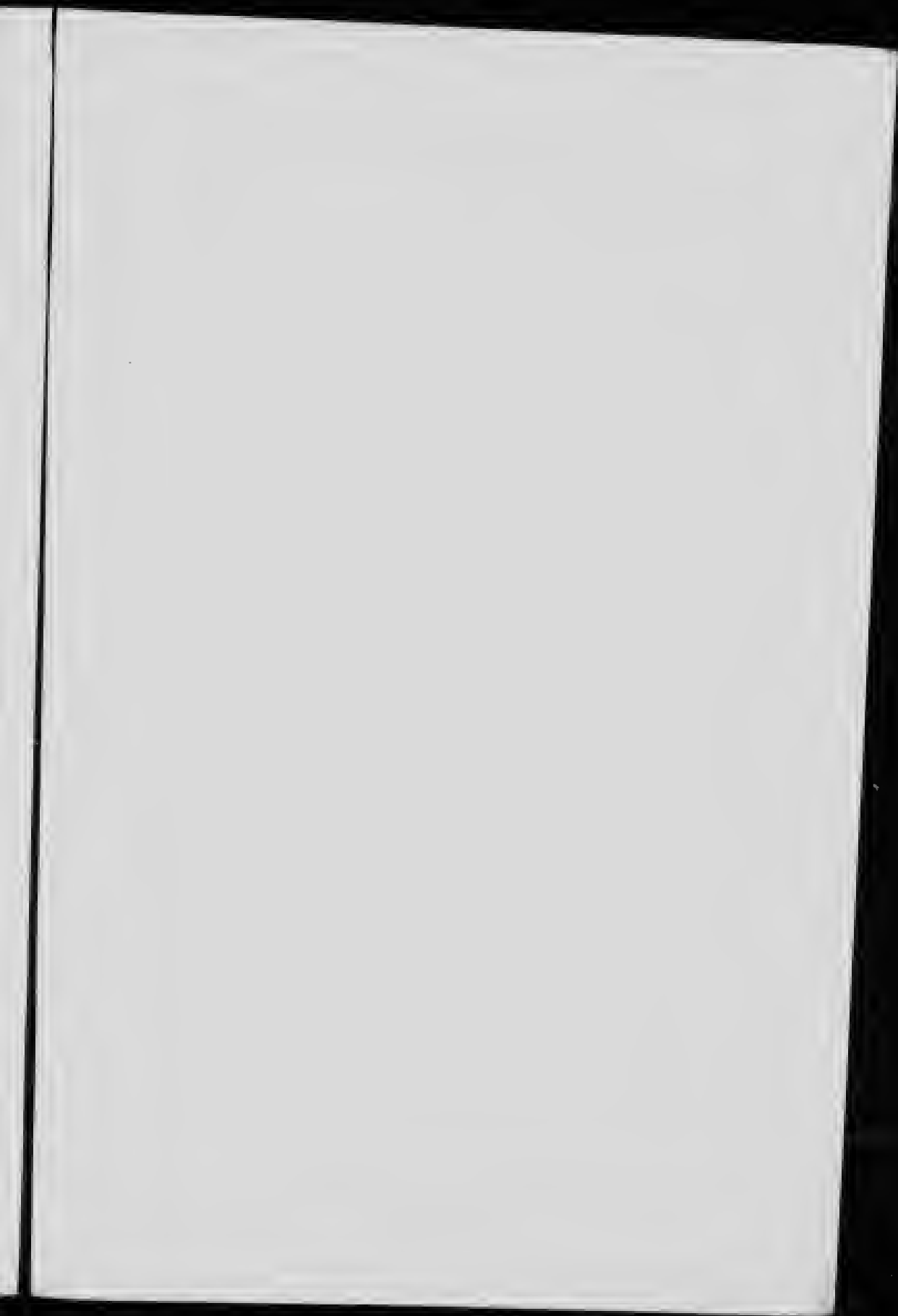

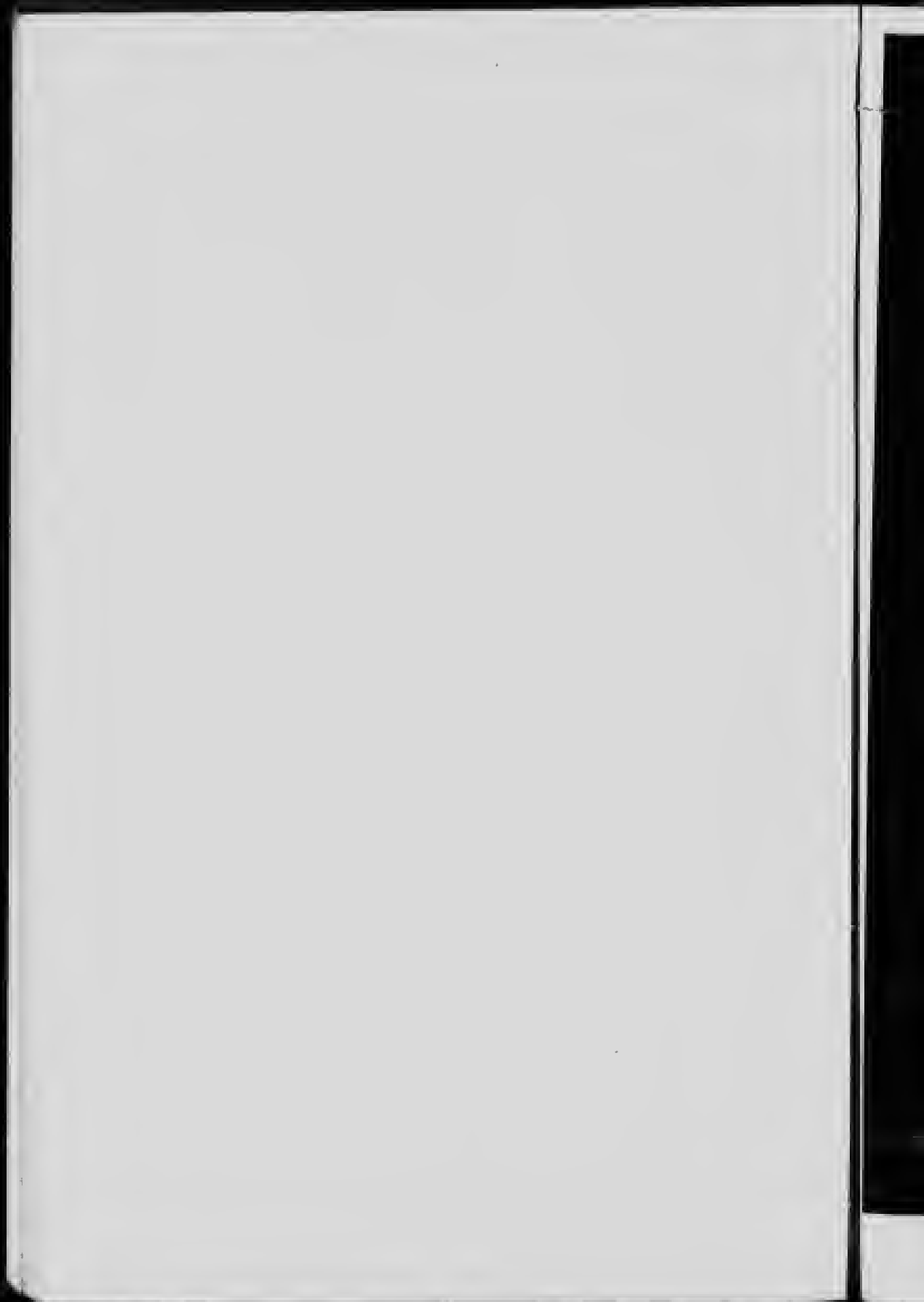
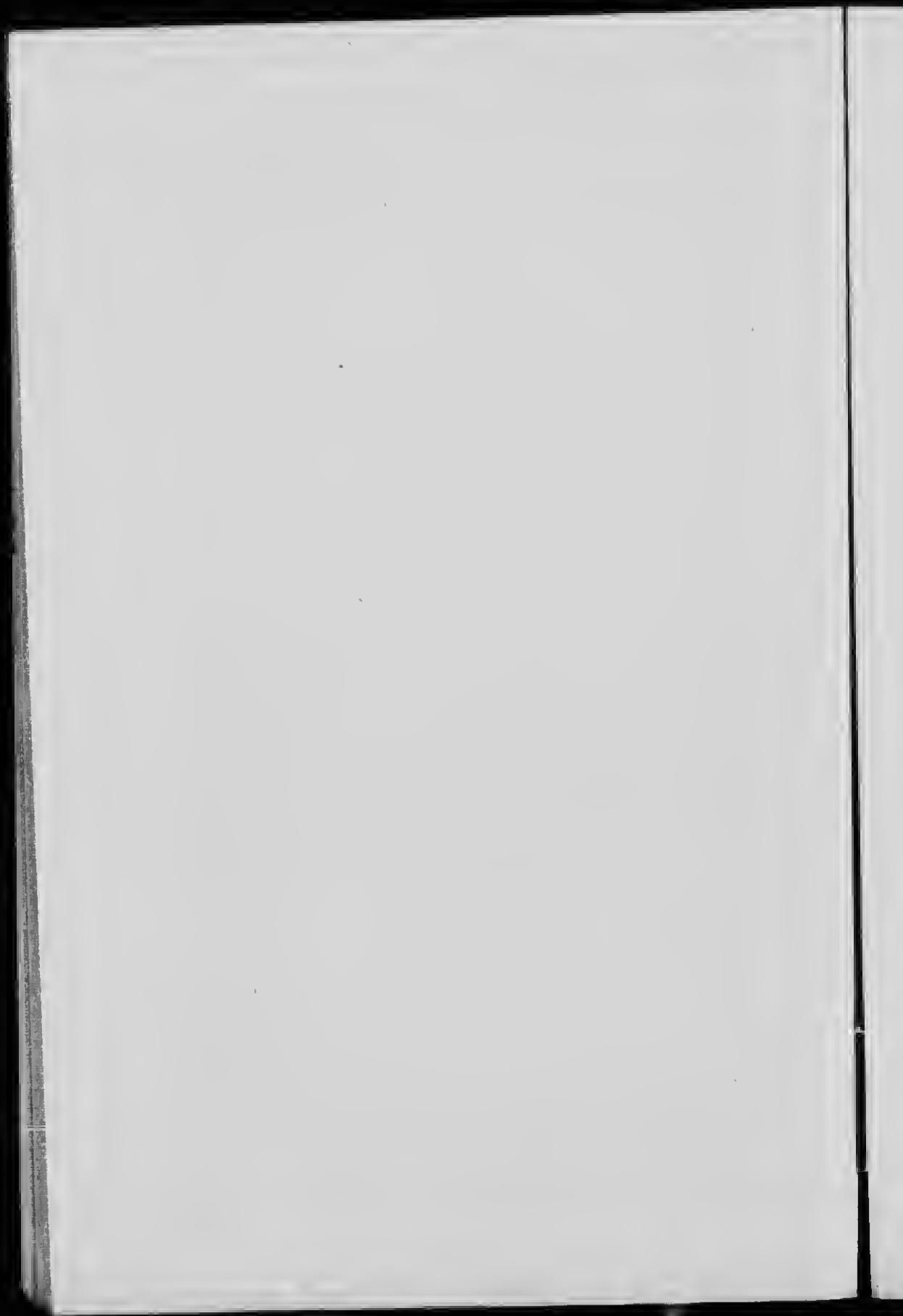



FIG. 1.



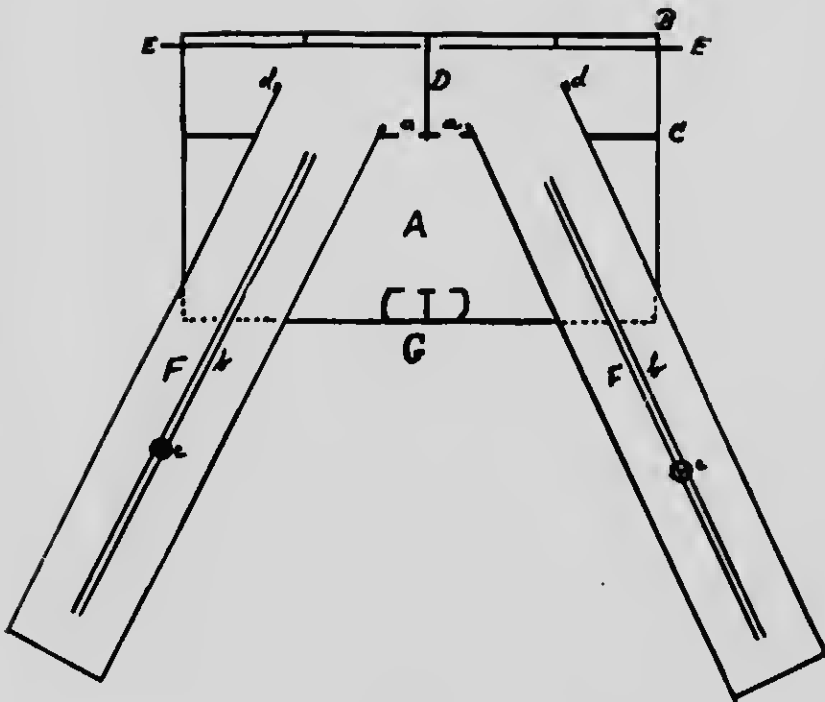

FIG. II

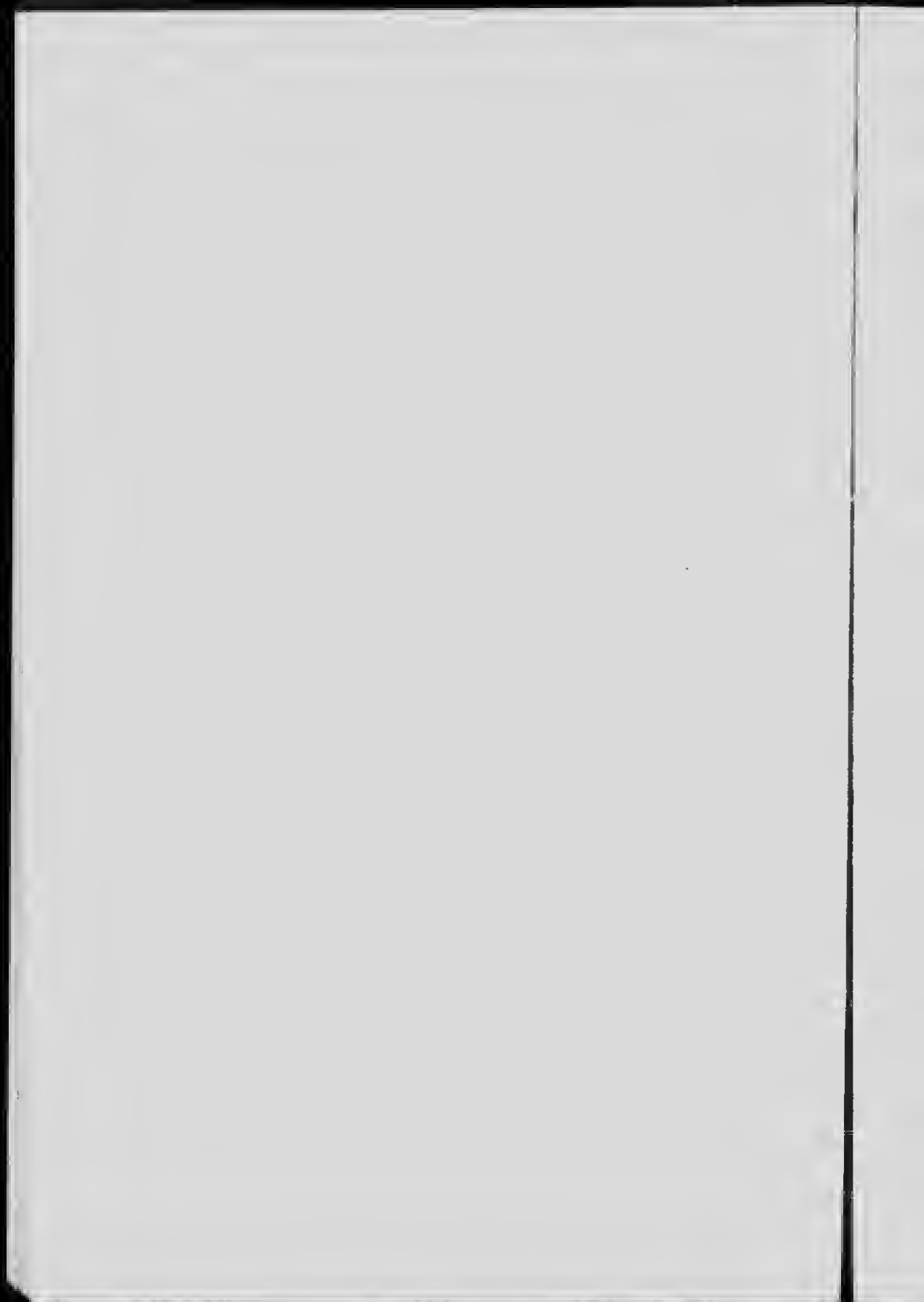



FIG. III

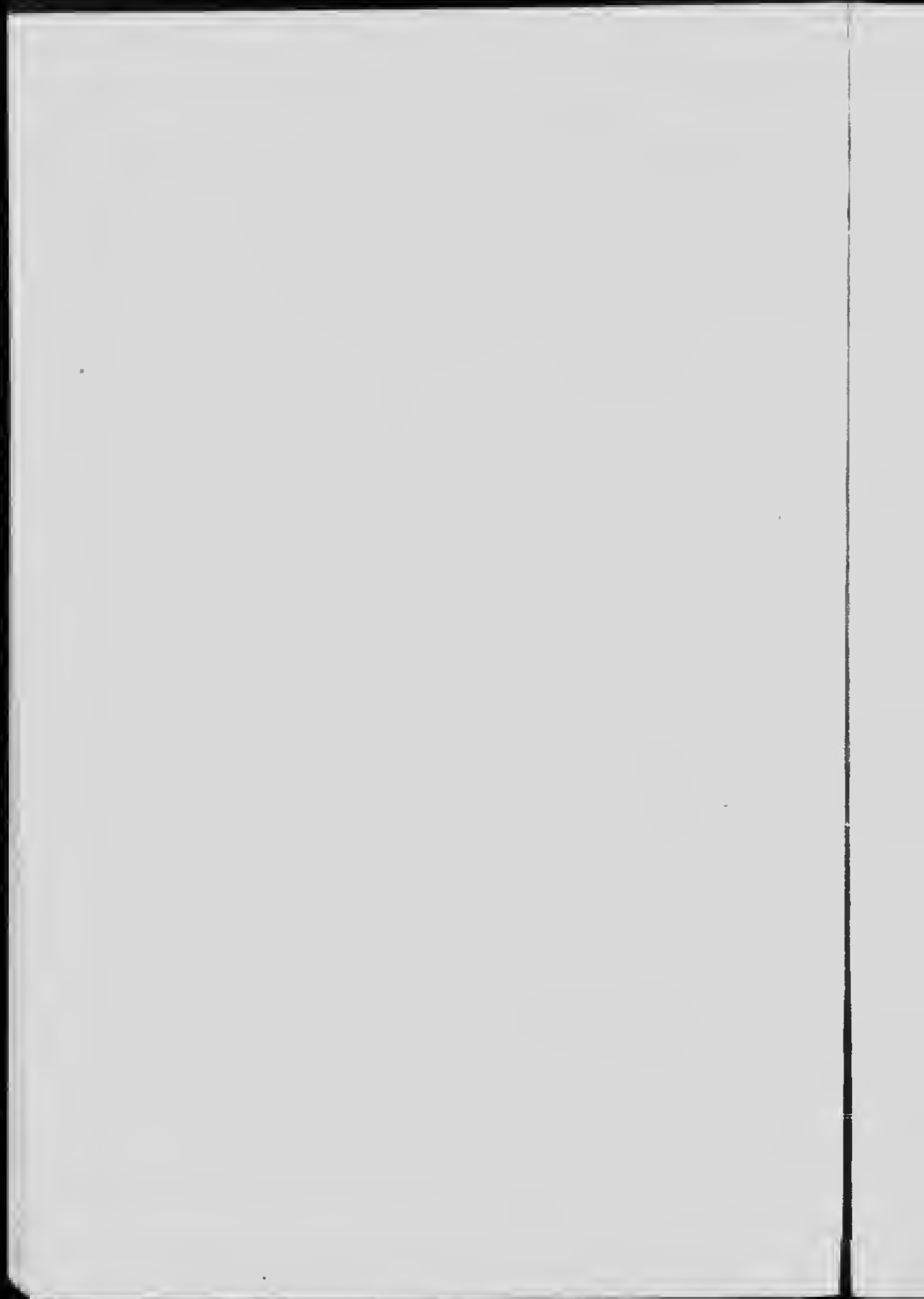



FIG. IV

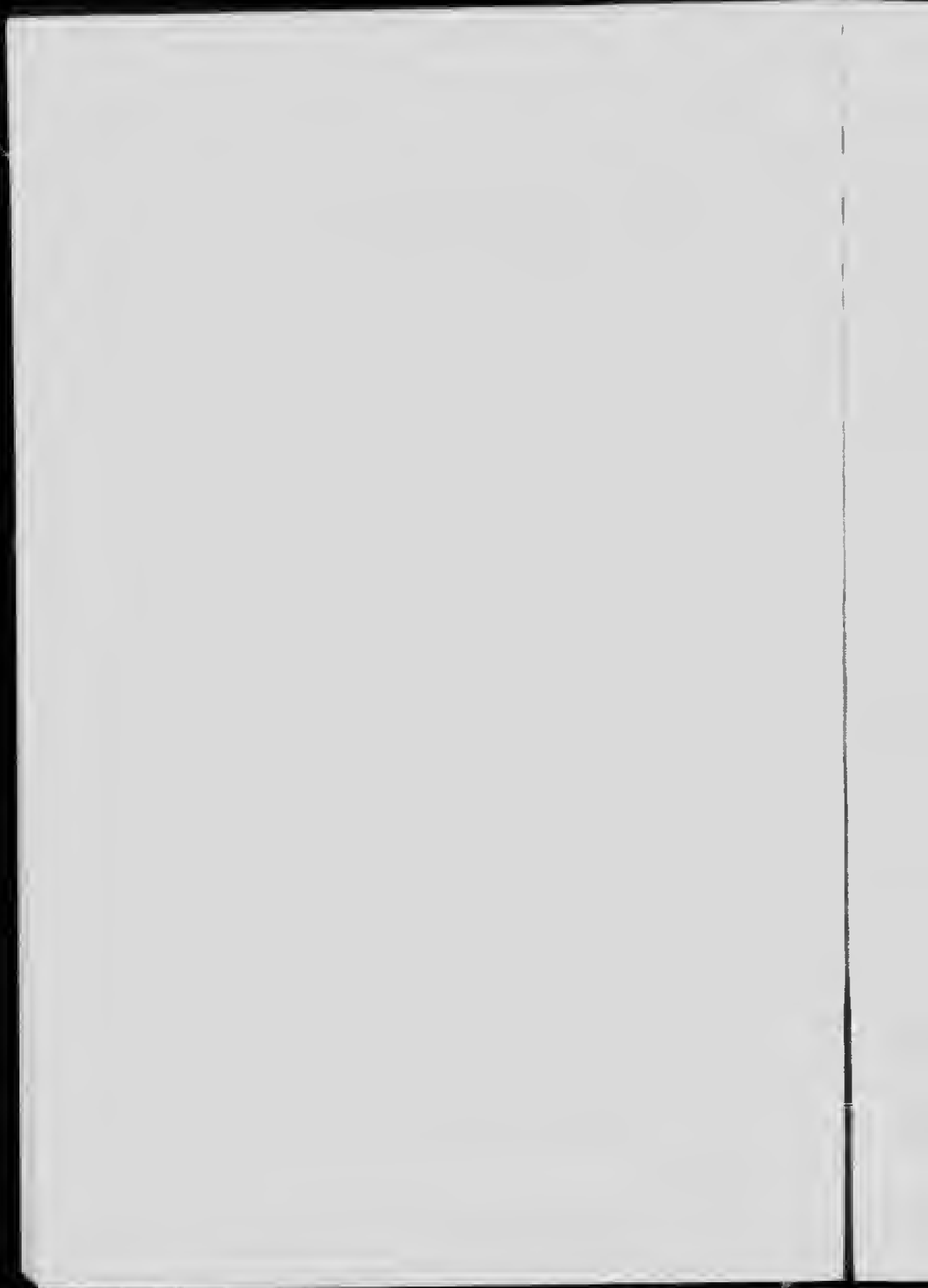
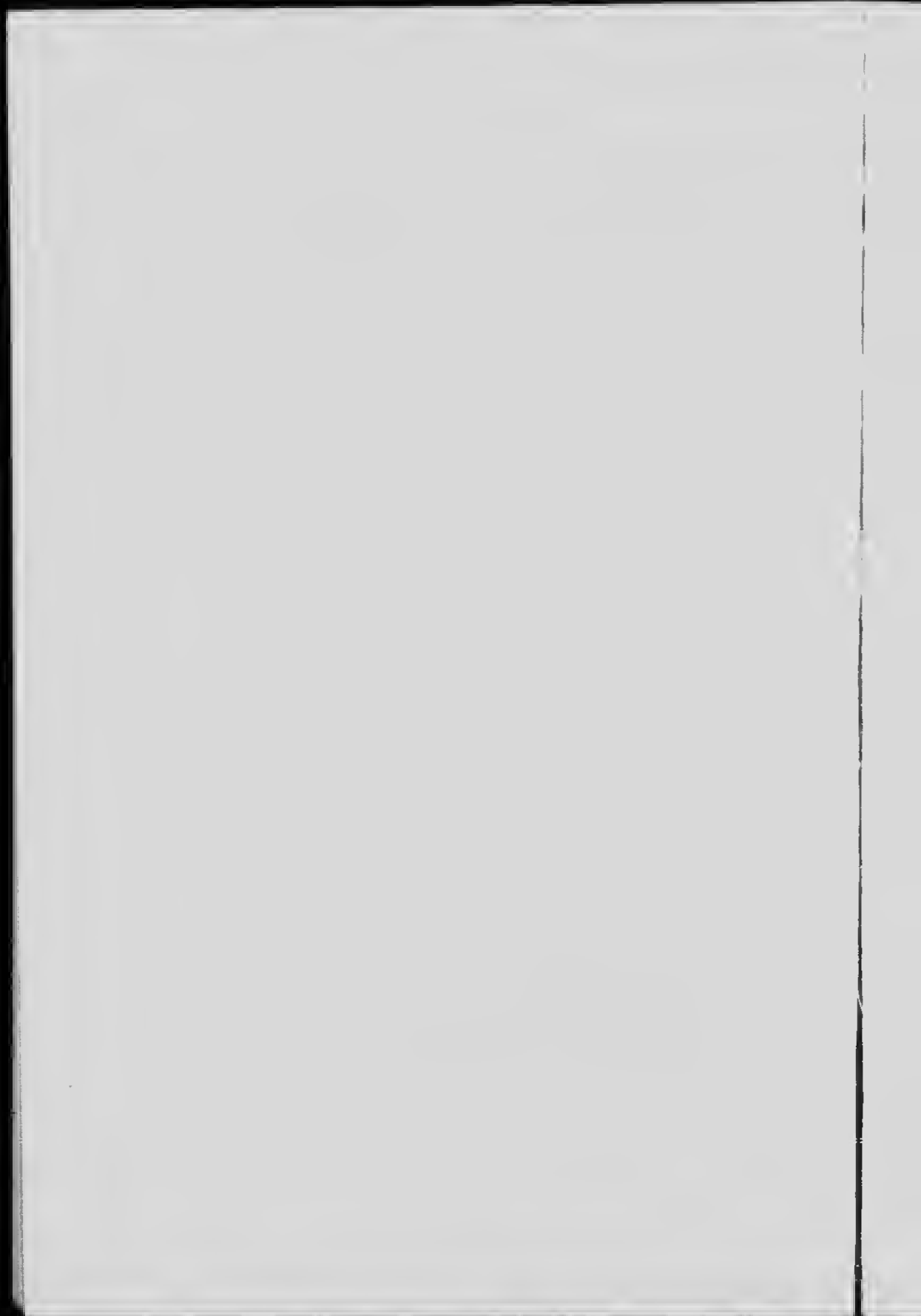
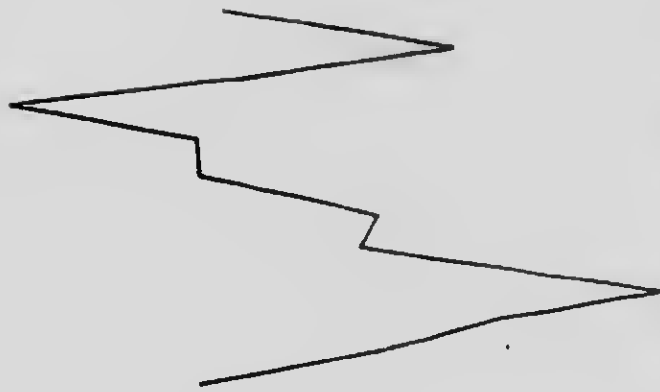



FIG. V





R O R O O Y Y Y G G G B B Y V P P R

CURVE I.—CASES
(Tables III VI)



K O K O O Y Y Y G G G B B Y V P P R

CURVE II.—COLOURS
(Tables III-VI)

PLANE SURFACES

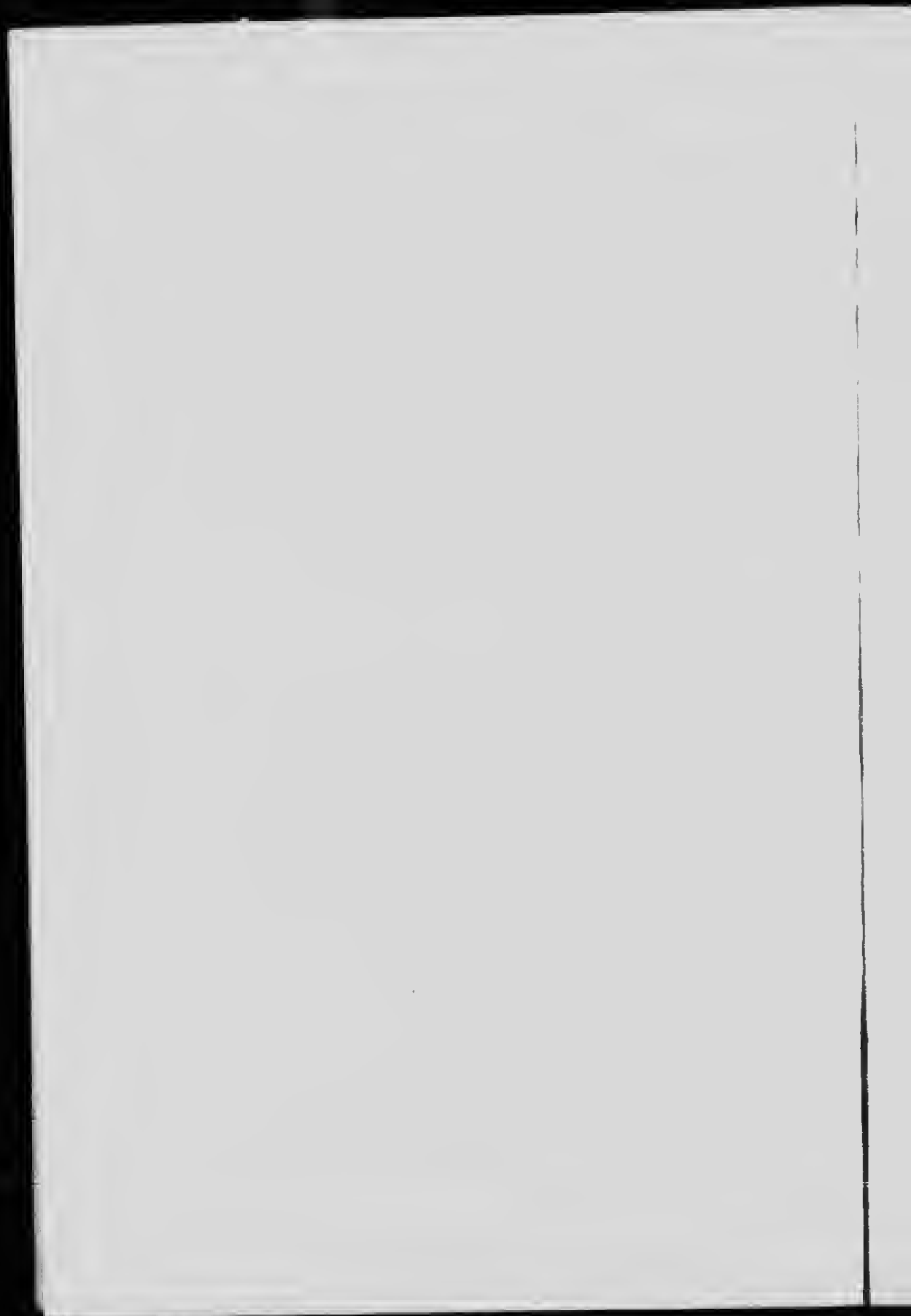

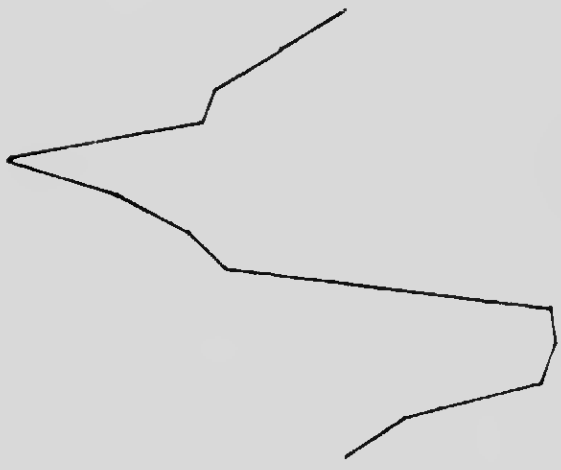

R O R O O Y Y Y G G G B B V V P P P R

CURVE III.—CASES
(Tables IX-XII)

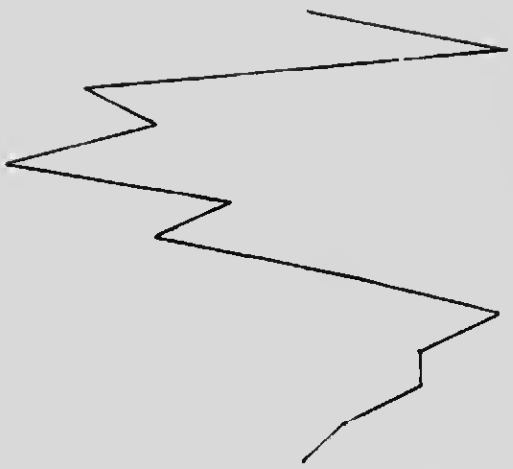

R O R O O Y Y Y G G G B B V V P P P R

CURVE IV.—COLOURS
(Tables IX-XII)

STEREOSCOPIC OBJECTS

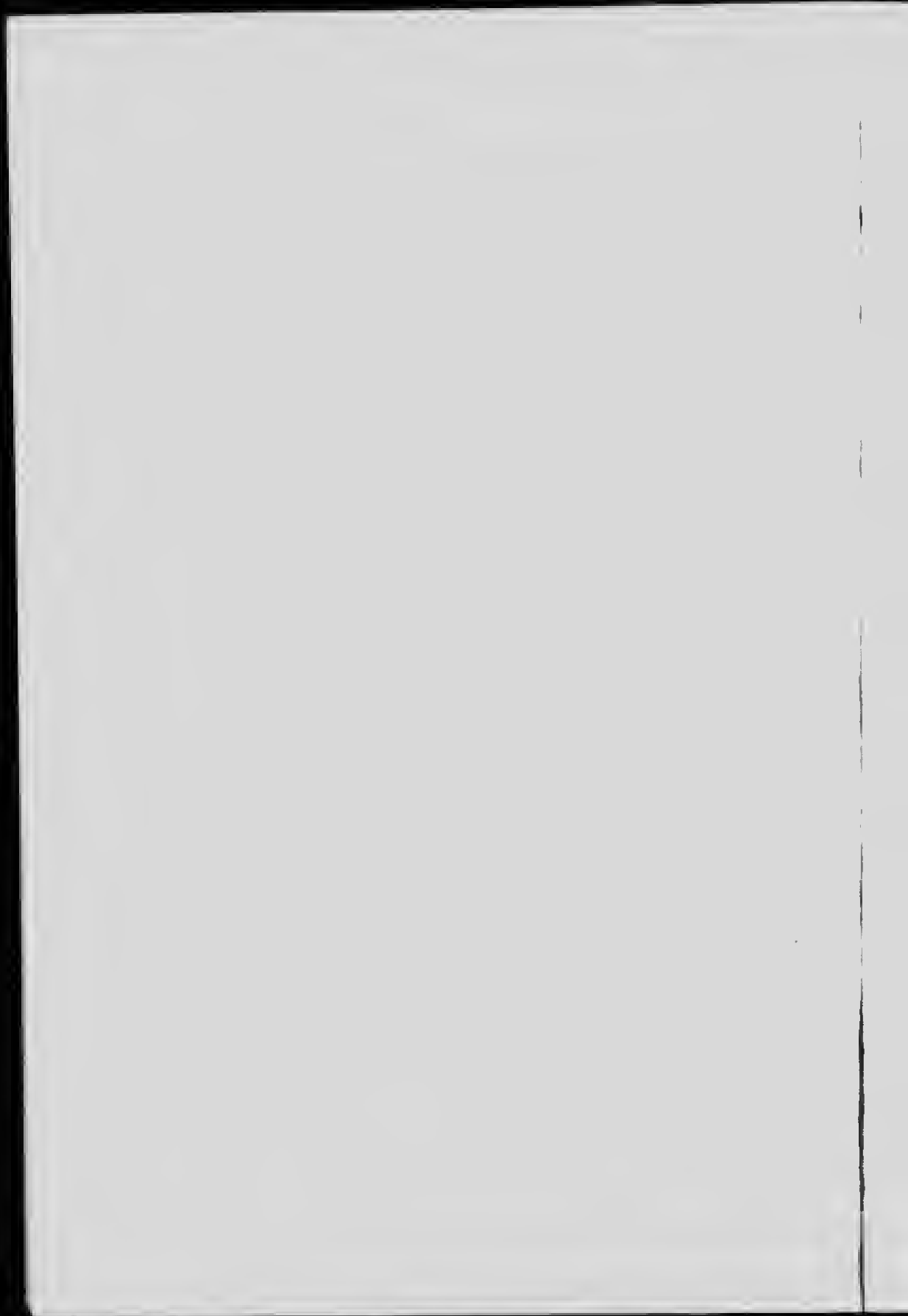

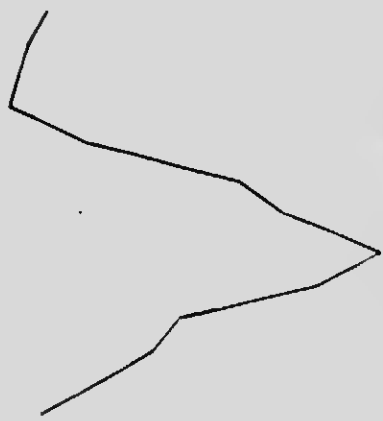

R O R O O Y Y Y G G G B B V V P P R

CURVE V

(Tables XXVI and XXVII)

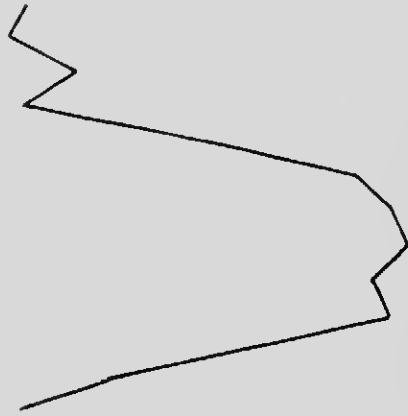

R O R O O Y Y Y G G G B B V V P P R

CURVE VI

(Table XVIII)

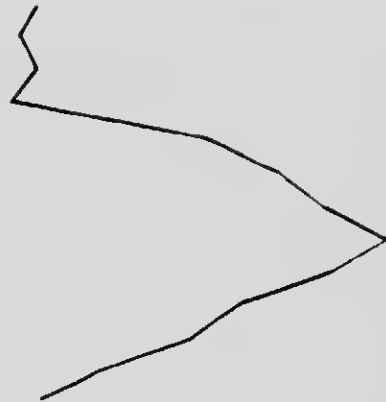

R O R O O Y Y Y G G G B B V V P P R

CURVE VII

(Tables XXVI-XXVIII)

COLOURED AND UNCOLOURED OBJECTS

