

Sept, 1884

CHAMPION!
THIS YEAR
wins every
and.
be the best
farmers,

and water.
in fire.
time and still
than ever.
9 ft. long.
t. long.

225-

E



GUINEA
ORGAN
Guelph.

FOR 20 YEARS.

214-y
L & CO.

TE & CO.

Montreal,

D SPRINGS.

ON HAND]

Blue Covers, Fire
Cement, Ro-
me, Plaster
biting,
etc.

210-y

ents
isers' Journal

Canada or United

JANUARY, 1885.

ing which paper you
214-y
Hamilton, Ont.

THE FARMER'S ADVOCATE

AND HOME MAGAZINE

FOUNDED, 1866.

VOL. XIX.

LONDON, ONT., OCTOBER, 1884.

Whole No. 226.

REGISTERED IN ACCORDANCE WITH THE COPYRIGHT ACT OF 1875.

Circulation over 20,000 Copies.

The FARMER'S ADVOCATE and HOME MAGAZINE

Is published on or about the 1st of each month, is handsomely illustrated with original engravings, and furnishes the most profitable, practical and reliable information for dairymen, for farmers, gardeners or stockmen, of any publication in Canada.

Any intending subscriber should send for a sample copy.

TERMS:

1. \$1.00 per year, in advance, postpaid; \$1.25 in arrears. Single copies, 10 cents each, postage prepaid.
2. Subscriptions can commence with any month.
3. Remittances at the risk of the subscriber unless made by registered letter or money order.
4. Subscribers who desire to change their P. O. address will send both old and new address.
5. The FARMER'S ADVOCATE is sent to subscribers until an explicit order is received for its discontinuance, and all payment of arrearages is made as required by law.
6. DISCONTINUANCES.—Remember that the publisher must be notified by letter when a subscriber wishes his paper stopped. All arrearages must be paid.
7. The date against your name shows to what time your subscription is paid.

THE FARMER'S ADVOCATE has the largest circulation among the best people in Canada. Its advertisements are reliable and are read. Send for copy of our Advertising Rates.

Address—
THE FARMER'S ADVOCATE,
360 Richmond Street,
LONDON, ONT., CANADA.

Choice Premiums.

Read our list of choice, new premiums offered in another column of this issue for sending in new subscribers.

FARMER'S HAND BOOK FOR 1885 will be issued early in December next; price, paper, 25c., and in cloth covers 50c. each. Orders can now be sent in.

1885.

The remaining numbers of the FARMER'S ADVOCATE for the present year will be sent free to those new subscribers for 1885 who send in their names now.

We want live, energetic agents in every county to canvas for subscribers to our paper. We pay a liberal commission to agents who devote their time to our work. Send for specimen copies. Address—

THE FARMER'S ADVOCATE,
London, Ont.

Our Monthly Prize Essay.

A prize of \$5.00 will be given for the best essay on "Women as Farmers." Essay to be handed in not later than Oct. 15.

A prize of \$5.00 will also be given for the best essay on "The best Methods of Encouraging Tree-Planting on Farms." Essay to be handed in not later than Nov. 15.

A prize of \$5.00 will be given for the best essay on "The Future Management of Agricultural Exhibitions." Essays to be in not later than the 10th December.

It is with a feeling of deep regret that we have to announce the death of one of our ablest assistants, who has been on our staff for a series of years.

His illness and demise, and our time spent in doing duty at the various exhibitions, have caused unavoidable delay in getting out our present issue, necessitating also alterations in our plans. We have been unable to get out the whole of our exhibition issue this month, but we shall make up the deficiency next month. During the remainder of this year we shall have a large number of specimen copies always on hand, so that subscribers who desire their friends to see copies of the ADVOCATE would greatly oblige by sending us their names.

Sheaves from Our Gleaner.

The best winter food is shelter.
An important point for this month—The plow-point.

If you judge the stockman, you also judge his stock.

Middle aged cattle yield the best flavored and most nutritious beef.

What, How, and Why, is the whole A. B. C. of agricultural science and practice.

Agriculture is the oldest of the avocations, but the youngest of the professions.

Practice is your own experience; science is the combined experience of others.

Of course you should have early lambs next spring; therefore, attend to the matter now.

How to draw a circle—Keep stock to make manure; save manure to feed crops, preserve crops to feed stock.

At the Sudbury dairy school in England, prizes are given for the best cows on the farms of these supplying the dairy with milk.

Editorial.

Farmers' Clubs.

If we were asked what the first duty of the farmer is, we would answer, organize; if we were asked for the second duty, we would answer, organize; and if we were called upon to pronounce an opinion as to the third requisite, we would answer, ORGANIZE. If we were asked, How many farmers' clubs should there be in the Province? our answer would be, Count the public school houses. This would give the number required. Members of the local clubs should meet weekly during the winter months; they should choose representatives to hold township meetings every month; at these meetings delegates should be chosen to meet quarterly in every county, and there should be a provincial meeting annually, composed of delegates from the county meetings. If we were asked to draw a line of distinction between farmers and the other portions of the community, we would answer, The farming body can neither move nor be moved. Winter is given for thought, summer for action; and it is only by concerted scheming that the height of mental development and business prosperity can be attained.

The clubs which already exist are fettered in many ways. Many useful and practical questions are discussed, the decisions being based on the personal experience of the members; but the results of individual experience differ, and very little attempt is made to investigate the principles or causes which lead to these differences. Many questions discussed have been settled by science, or, in other words, by practical experiments often repeated, and these questions are no longer debatable; indeed, there are now but few important questions in agriculture which cannot be traced to some firmly established principle.

The agricultural press is the chief educator of the farmers, and in it there will always be found a variety of subjects for debate. Let the club be first assured that its editor is the right man in the right place, and then his services can be greatly utilized through his columns, especially in aiding to decide what questions are debatable and what ones are not. Mechanics' Institutes should also be turned to account. Farmers being taxed for such institutions, they should derive all the advantages possible from them.

If there is a member of the club who has a special talent for mathematics or mechanics, he

should prepare papers on agricultural implements and machinery, and direct the requirements of the whole club in practical matters pertaining thereto, so as to prevent imposition by manufacturers or agents. Similarly all the departments of farming might be divided amongst the members; and the school teacher should be invited to lend a helping hand. A great deal of experimental work could be done in this manner. Some members should make a special study of the science of experimenting, and lay out such work as could be easily and inexpensively conducted by different members of the club.

Prizes at Exhibitions.

It would be too arduous a task, within the scope of an ordinary article, to inquire into the principles underlying all the prizes awarded at exhibitions.

A cattle beast, and especially a cow, has often been compared to a steam engine, and the more the comparison is studied, the more complete it is seen to be. There are high and low pressure cows, and even automatic cut-offs—that is, cows that will shut their valves when they have taken in enough. The fuel in the dead engine produces heat, and the surplus heat is expended in the production of mechanical force; just so with the live engine—with the slight exception that if all the fuel is not expended in mechanical force, the surplus is stored up as animal increase or reserved energy.

We now find that most of the portable engines built in this Province have been judged and prizes awarded. The judges being scientific men, the engines were, of course, judged by points or mechanical principles. It was hardly to be expected that one engine could be first in all the points—for example, that the engine imparting the greatest power, produced it with the least pressure or with the greatest relative economy in wood and water; but the combined efficiency of all the points was the crucial test; or, as applied to stock, one would say, the cost of production. The figures were checked by the best mathematicians, and prizes awarded accordingly. What we wish to urge by these awards is this, that if the same tests were made by any other judges in any part of the world, the results would be exactly the same, so that the justice of the awards is placed beyond all possibility of doubt. It is natural to suppose that such awards cause an incentive to improvement, or are at least in some way conducive to desirable ends. Can all this be said of live stock awards?

But the consideration of the question does not end here. In the test of the engines it was placed beyond dispute that the combined efficiency of the best engine was nearly fifty per cent. greater than that of the worst. Did this wide difference drive the inferior article out of the market? To our discredit it must be said that it produced no perceptible effect on the number of sales. Why? From the tables contained in the award each manufacturer had no difficulty in convincing himself, and especially his customers, that his engine produced the best results, and the number of sales depends upon the amount of talk and advertising, not upon the undoubted merits of the engines.

So it is with the breeders of live stock and their position in respect to their customers.

One breeder gains audience with the cry that his cow is a small consumer; another that his cow is a great consumer; another that his cow is big, slick, fat, or the reverse, and so on throughout all the points, regardless of the combined efficiency of all the points.

There is still another phase of the prize question. Take threshing machinery for example. There are machines which do fast and perfectly clean work with a small expenditure of power; there are other clumsy, heavy-running monsters which waste at least twenty per cent. of the grain. Would it not be a desirable aim to encourage economy in threshing? These machines can also be tested by points or mechanical principles, and their merits and demerits placed beyond dispute. Why then are there no prizes awarded? Because a majority of the manufacturers have protested against prize tests, knowing that such awards might prove fatal to their business, that the principles involved in the tests would be more easily understood by their customers, and that deception could not be so easily practiced.

Under our existing mode of awarding prizes very little regard is paid to principle, or attaining the encouragement of desirable ends; or, when the principles are sound, the ends so devoutly to be wished are frequently unattainable in practice—like the making of a good law, the observance of which is not practicable. That the exhibition managers are more deserving of censure than the farmers is questionable. The only hope for reform lies in the education of the farmers.

How to Save the Manure.

No. II.

In our No. 1 we showed that if the farmer had to buy in the commercial form the same quantity of fertilizing ingredients which are found in a ton of unleached farmyard manure, it would cost him \$3, and that the waste incurred under the ordinary treatment of the manure heap amounted to \$19 per cow, or her equivalent in other stock, during the seven stalling months. These figures are based on fair average conditions, so that the value and consequent loss will be higher or lower according as the circumstances are more or less favorable.

For example, the value of the manure heap depends (1) upon the age, breed and condition of the cow; (2) upon the quality of her food, and (3) upon the character of the litter. All other things being equal, the manure from an old cow is more valuable than that from a young one; for in the production of milk, young or growth, a great deal of substance is taken out of the food, which would otherwise have been voided. If there is no such increase all the nutritive substances of the food must be left in the voidings, bearing in mind that the carbonaceous compounds of the food which sustain the animal heat, are of no value as manure, as plants get their carbon from the atmosphere, not from the soil. The excrements being in a soluble condition, just almost ready for plant food, it will be seen that the cow-machine manufactures plant food at a much higher rate of speed than the soil and atmosphere machine. It takes a steam engine, a crusher, a boiler and a quantity of sulphuric acid to convert bones or apatite rock into soluble plant food, but the

animal is the machine used for making the vegetable kingdom readily soluble. With regard to the quality of the food, although some foods are more digestible than others, it is a safe rule to say—the richer the food, the richer the manure; and when it is considered that not more than about 5 per cent. of the nutriment of the food is stored up in animal increase, 95 per cent. being excreted, the importance of husbanding the excrement will at once appear plain. The question as to the effect of litter in affecting the quality of the manure is not so complicated. Straw is better adapted for food than for litter; it is a poor absorbent, except when put through the cutter, and when it is borne in mind that the use of straw necessitates the trouble and expense of fermenting the heap, its value as litter is considerably lessened; while as an article of food, if of good quality, it can be profitably fed in connection with rich foods. All these questions must be taken into consideration by the farmer when estimating the value of his manure heap.

There are many methods by which the manurial constituents of the heap may be preserved from waste; but we shall confine our observations to three, all of which are quite practicable under our conditions, and many a farmer would find it advantageous to make use of more than one method. They may be briefly mentioned as follows: 1. The use of straw as an absorbent, with fermentation of the heap under cover. 2. The use of other absorbents, as dry muck or earth, gypsum, saw dust, etc., without fermentation. 3. The construction of tanks to gather the liquid.

1. *The use of straw as an absorbent with fermentation of the heap under cover.* A sharp distinction must be drawn between a material used for litter and that used as an absorbent, although some beddings are used for both purposes. The primary idea of straw in the farmer's mind is its use as litter, not as an absorbent. Although straw makes a comfortable bed for stock, it must be used in great quantities in order to absorb all the liquids; and then, unless the liquids are retained, much straw is more injurious than beneficial to the heap; for, in the first place, fermentation cannot take place, and secondly, straw manure injures the texture of some soils, so that manure prepared in the ordinary way is often more injurious than beneficial. Coarse manure will not do for a loose soil. The heap should be fermented for the following reasons: (1) It gives the manure the proper mechanical texture; (2) It prepares the chemical constituents for plant food, and (3) It destroys the vitality of weed seeds; whereas without fermentation, it is in its worst condition as to texture; the juices are not retained in the heap; the soil has to prepare the remaining small quantities of food at the expense of nearly as many years as it would take months under systematic fermentation, and weed seeds are not destroyed. But there are also disadvantages under the fermentation system, which involve the combining of it with the other systems, if all the manurial constituents are to be retained. When straw is used for litter a pungent odor is often felt in the stables in the mornings when the manure is stirred; this is a loss of ammonia—the most valuable part of the dung, and it cannot be checked without the use of a better absorbent

added to the straw. Gypsum, or dry muck, will be found profitable under such circumstances, and will also add directly to the value of the manure. Charcoal and lime will also fix the ammonia.

Before commencing to build the heap, the physical character of the manure from the different classes of farm stock should be considered; also the causes which produce fermentation. Horse manure by itself is apt to ferment too rapidly; cattle manure is dead, cold, sluggish, and is apt to freeze in lumps—so is pig dung. The advantage of mixing the manures is therefore great; one plan of partially doing so is to put the horse or sheep manure into the pig pens or cow stables as litter. If the heap has the right consistency, not too heavily tramped, and has the benefit of the nitrogen and moisture of the liquid manure, with a free circulation of air, heat is produced and fermentation takes place.

(TO BE CONTINUED.)

Store Steers for England.

The demand for lean cattle in the British markets adds a new phase to our live stock industry. The exportation of prime steers is a demonstrated success, and immense profits have been made out of the shipments, the frozen and tierced meat trade still being doubtful enterprises. Whatever objections there may have been to live exportations, these are being gradually overcome, and it is an almost settled fact that the live form will be the future mode of supplying British consumers with beef, whether the stock be store or prime.

Ontario is destined to become more and more exclusively a beef and dairy country. We cannot much longer compete with our Northwest and with India in the production of wheat; these countries will be the granary of the future for the supply of the world's markets. But if we want to preserve our reputation for beef, we have a precious heritage to guard; we must not presume too much upon our climate in its relation to our vaunted freedom from disease, and the privilege we enjoy in the British markets therethrough. Let but a "scare" arise, similar to those which occur in the United States, and we may at once be scheduled, and our reputation damaged for all time to come. Attempting to suppress the truth will only aggravate matters in the end; we cannot permanently guard our good name by doing so.

If cattle are to be exported in store condition the growth of the trade will of necessity be gradual, and there is no danger of a perilous craze taking place in this direction. The question requires profounder thought than it appears to demand at a superficial glance. If our land continues to increase in value as rapidly as it has done, the time is not far distant when stock can be fed as cheaply in winter as in summer, unless the soiling system be extensively utilized, and this will give a powerful impetus to our beef industry.

It is demanded that we should build the framework and allow the British feeder to fill in the fat on his luxuriant pastures. This is too figurative by half. We are building too many frames already and of too small dimensions, and it has been placed beyond dispute that this is not the class of animals which

flourish on the green pastures of the "old sod." If by framework we mean well-graded animals which have been kept in a good thriving condition from calthood up, then we may lay some claim to our stock for the stalls and green herbage of Britain.

The practical question to be dealt with is, Shall we dispose of our steers in the fall, when they are 18 to 20 months old, or fatten them during the second winter and sell them the following spring? Experiments have proved that the younger the animal the more rapid the increase, and the declining rate of growth is made at the cost of an increasing rate of food consumed. The cost of the average daily ration during the second winter will be nearly 100 per cent. more than that of the average daily ration before the age of eighteen months, and the increase in weight will be correspondingly less during the second period. But there is no very marked decline before the age of 18 or 20 months, and this is therefore thought to be the most profitable time for selling. Superficially considered, it would seem that the younger the animal the greater the profit in selling; but let us see wherein resides the fallacy. This view would be entitled to consideration, if the value of the animals from a manurial point of view were totally ignored; and until the farmer begins to husband the manure heap and set some commercial value upon it, all hope of intelligent action will be in vain. It is as easy to allow valuable manure to run to waste as impoverished manure; hence the farmer does not get the benefit of feeding rich foods to animals that are past the period of their rapid growth. It is the frame of the animal that runs away with the money, leaving an impoverished manure heap and hence an impoverished soil.

Let us suppose that a farmer desires to pay exclusive attention to the raising of store steers. What are the preliminary requisities? A steer up to the age of 18 months should be kept in a thrifty condition on an average expenditure of 13 cents a day for food, whereas if he is crammed, as he should be for fattening, from the ages of 18 to 27 months, the daily outlay should be 25 cents; that is, during the fattening third of his days he is kept at double the daily cost as compared with the daily average of the framing two-thirds, or, the cost of food up to 18 months is the same as the cost during the remaining nine months. A good thriver will gain 2½ lbs. a day during the first period, and will therefore weigh about 1200 lbs. at 18 months, which, at 5½ cents a pound, would leave the manure to cover profit and labor; whereas if kept till the age of 27 months, even allowing a liberal gain of 1½ lbs. per day during the fattening period, the steer would then weigh about 1670 lbs., which, at 6 cents, would bring in round numbers \$100; but the whole cost of the steer for food alone during the two periods is \$140, leaving the manure to make up for the labor, profit, and \$40 cash outlay. The only answer which the feeder can make to justify himself is that the manure of the fattening period is of better quality, and this is no argument if he permits the juices of the heap to run to waste. These figures prove that the farmer in question should either raise store steers or change his method of stock husbandry.

But there are also other influences at work which necessitate even more radical changes under the store-steer system. The fertility of the soil must be kept up some way; and if the land has to carry double the number of store steers on the same quantity of food, as compared with the fattening system, the manure must be supplemented by commercial fertilizers, and unless the farmer is an expert in the knowledge of their composition and application, he will run a great risk. There is another influence which deals a serious blow to this business; that is, the cost of ocean shipment is rated per head, not by the weight, but this obstacle will be overcome if any active move is made in the store-steer enterprise. The coarse grains could be utilized more profitably with store than with prime steers.

The trade, if it takes place at all, must have a gradual rise; for the increased number of steers required cannot have instantaneous birth, and if some enterprising feeder should attempt to increase his stock on hand by purchasing, in dairying districts, calves which would otherwise have been destroyed, he would be unsuccessful from the fact that these calves are usually from "scrub" bulls, and would consequently not suit his purpose. Although the "scrub" cow is not defended enough for dairy purposes, the fact must be borne in mind that the breeder of store-steers cannot be too cautious in the selection of a sire from the best beefing breed. The least mistake in this direction might prove the ruination of his undertaking.

The late Wyoming sensation in the store-steer business should be a broad hint to our farmers. It is surprising to us that a Western live-stock king could be able to create such a furor on both sides of the Atlantic, bestriding the ocean, Colossus-like, as it were, under the apprehension that he was lord of both hemispheres. The press discussed the question in all seriousness, many editors, carrying companies, stockmen, and politicians exulting in the hope that the scheme was about to become the climax of modern enterprises. The fact that the smouldering embers of disease are liable at any time to break out amongst American cattle, should in itself be sufficient to blast all hope of obtaining a passport through Canadian territory. Even granting that the liability to disease could be removed, and thereby the same route and landing privileges accorded to Americans which we now enjoy, the question still arises, Can Western ranchmen compete with us in the production of beef frames for the British markets? Canada's greater proximity to England might not alone settle the issue for the present; but when the irregularities of the Western seasons are considered, so that ranch cattle have precarious seasons of growth, thereby jeopardizing their adaptability to the stalls or luxuriant pastures of England, while we are not affected by seasons so far as the growth of our young stock is concerned, the question assumes a different aspect. So long as cattle kings succeed in monopolizing vast tracts of land, driving back honest settlers at the muzzle of the gun, their hopes may not be entirely frustrated; but this state of affairs cannot last for an indefinite period. The truth is, western ranchmen cannot raise anything but ill-bred frames, improved stock being too weak to withstand their conditions, and the natives are not

the kind that will ever become popular in the English markets. Meanwhile if Mr. Moreton Frewen had confined his philanthropy to the southern moiety of this continent, it would have been sufficient for all practical purposes.

Our farmers will soon learn to adopt the most improved methods of raising grade steers in connection with butter making, so inexpensively that they need not fear competition. Butter making and frame building go hand in hand, the frame having the same analysis as the skim-milk, the fat being the butter, and it must therefore be borne in mind that there is a close relation between cheese-making and frame building, so far as soil exhaustion is concerned.

Farmers who feel aggrieved that they can find no staple market for their skim cheese, can take revenge by converting their skim milk into beef frames, whereby remunerative prices can always be obtained.

ON THE WING.

Agricultural Exhibitions.

These useful, entertaining, and instructive institutions deserve the fostering care of every advocate of agricultural progress. They are great schools in which every one can learn. They have done much good, and we should all endeavor to make them more beneficial. To increase their utility a fair criticism is necessary; fulsome praise becomes nauseous, and is apt to lead to deception. The officers and patrons of any exhibition do not relish disparagement in the slightest degree, and every crow thinks its own egg the whitest. It is our opinion that those who point out errors or suggest improvements do much more good to any institution than those who only laud merit and cloak defects. Institutions that receive Government money, or men whose bread and means are derived from taxation, should be open to honest criticism.

The first exhibition of the season was
THE PROVINCIAL EXHIBITION OF QUEBEC.

It is called in the posters the Dominion Exhibition. It was held in Montreal from September 5th to 13th. They have a very nice lot of spacious, neat buildings, and the grounds are convenient. The managers deserve credit for the selection of the site and the construction of the buildings. There was a marked deficiency in the quantity of the exhibits; a large number of our best manufacturers were not represented. In the horticultural department the display was very meagre. The exhibit of grain and roots was not half equal to the display to be seen at many township exhibitions, and the stock pens showed comparatively a mass of emptiness. Although there were animals to take the prizes in many sections of the Province, yet there was but little competition. There was a fair exhibit of horses. On inquiring as to the cause of the deficiency, we found that there was a serious disruption between the farmers and the officers. From what we heard, the difficulty appeared to arise principally from the Board of Directors persistently insisting that the live stock should be on the ground for ten days. The farmers not being willing to waste so much time, objected to the clause both before and after being introduced, but the Board of Management insisted that the stock should remain on the grounds.

A large number of the farmers united and refused to exhibit, thus the failure. By this step the lesson should be learned, that the farmers' interest should be first considered at an agricultural exhibition.

We went to the exhibition ring at 3 p. m. on Thursday, expecting to see the prize animals exhibited. There were officers in attendance, but no stock. The exhibitors under different pretences declined to come out, and the directors found it necessary to announce that the prizes would not be paid unless

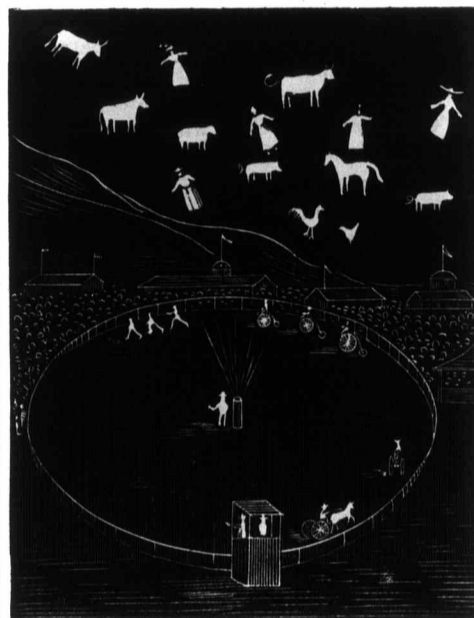

THE PRESENT STATE OF AGRICULTURAL EXHIBITIONS—AMUSEMENT RING CROWDED.

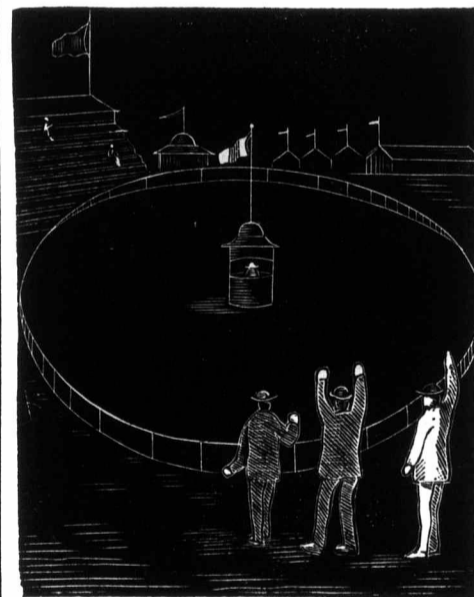

AGRICULTURAL RING VACATED.

some made their appearance. We then went to another part of the grounds. Here the amusements had drawn the concourse of people, and who would not be attracted to see the sights of Japanese fire-works shooting illustrations of elephants, horses, calves, sheep, pigs, etc., into the air? This was amusing to all who have not seen anything of the kind. We depict the two scenes. Both form subjects for debate.

This is the first time we have heard the word "Boycott" used in regard to agricultural proceedings in Quebec. We have heard it used at an agricultural meeting in Ontario, and by a Government official. Another important cause of the failure of this exhibition is the fact that the Horticultural Exhibition is held at the same time and in another part of the city. We do not think that one farmer in a hundred knew anything about it; if he did he did not see it. This exhibition (the horticultural) is perhaps the best of the kind held in Canada. The flowers, fruits and vegetables exhibited here were very fine. Mr. Evans, the seedsman, has the management of this exhibition, and it reflects great credit on him. If such men as Mr. Evans were placed on the Board of the Provincial Exhibition, and a few more really practical cultivators of the soil, and the exhibitions united, we think greater benefits would accrue to the citizens and to the farmers.

While examining the fruits, we met Mr. Gibb, who has devoted considerable time in furnishing information about the Russian varieties of apples. We were here introduced to Mr. Shighidi-Arakoneva, from Japan. He appears to be an intelligent gentleman, and was making inquiries about our fruits. We noticed that the Duchess of Oldenburg, Alexander, St. Lawrence and Fameuse apples arrive at better perfection when raised in this vicinity than those raised in Ontario. They are much finer in color and also in size; but the Russets, Spies, Greenings, etc., brought from Ontario were finer than those raised in Quebec.

THE INDUSTRIAL.

Influenced by the fine weather and the excellent management, the Industrial proved a grand success. It being held at a time when there was no colliding with other exhibitions, was also a fortunate circumstance. It not only eclipsed previous exhibitions of its own, but also possibly all others hitherto held in the Dominion. The means of communication to and from the grounds, by street cars, railway and steam boats, were complete, and no pains were spared in making everything convenient and attractive. The managers understood their business; they advertised liberally, and used every other means to induce people to make attractive exhibits, all of which has resulted in its success financially. There was no boisterous or unseemly conduct; the spectators were kept in a constant state of wonder and excitement. The grounds have been greatly improved, and still greater improvements are in contemplation. The new features, in the form of acrobatic feats, Oddfellows' drill, and theatrical performances, were introduced.

In the cattle exhibits the Durhams still kept the lead. Amongst fat grade cattle of all beef breeds, especially those of the Polled Angus, there was also a conspicuous gain over last year. There was also a very excellent collection of Herefords. The milking breeds were also well represented, and a notable feature was a largely increased exhibit of Holsteins, which were introduced last year for the first time. Many of the leading Jersey breeders of the Province were absent, although this breed was well represented. The sheep exhibit was a complete success. The South-downs and Shrops made an excellent display, but the Oxford Downs were not so strongly

represented as on previous occasions. The Leicesters sustained their reputation, and there were some fine lots of Cotswolds. In Lincolns and Merinos, although the exhibit was not large, it was choice. The display of horses appeared to be as good as usual, but it was very difficult to procure satisfactory information about them, as the owners and keepers were hard to find in the immense sporting crowd. The dairying interests were well represented, and were rendered more conspicuous by the operation of two cream separators of different manufacture. With reference to agricultural machinery, the main features were the increased number of self-binders over that of last year, and a lesser number of the ordinary harvesters, the hitherto cumbersome machinery of the former having been considerably simplified and reduced in weight. Haying machinery showed a rapid advancement in the constructive conveniences of the machines and their labor-saving properties. In portable engines and threshing machinery there were numerous improvements, usually of a minor character.

THE WESTERN FAIR.

This fair was well patronized by the citizens of London, as well as by farmers from the surrounding counties. It maintained the reputation it has acquired of being one of the best agricultural shows in the Province. Manufacturers and many other exhibitors assert that they transact more business at the Western than at any other fair. If business people do not make a sufficient number of sales of their goods to induce them to exhibit, they must be wheedled into exhibiting by an increased prize offering. During the four days over 53,000 people entered the grounds, making the total receipts \$13,150; and this is an excellent showing when it is considered that the Provincial Exhibition was taking place simultaneously. Although some of our leading manufacturers and stockmen were absent, yet it is surprising how many, by their patronage, showed partiality to the Western in preference to the Provincial. The exhibit of stock had been, on the whole, larger than at Ottawa, and a large number of the Dominion prizes would have been gained by the stock exhibited at London. It is a pity that these two great exhibitions were held on the same week, as it tended to the injury of both in the form of exhibits; but it would make scarcely any difference in the receipts, as but very few farmers ever go such distances unless they expect to receive prizes or some payment for their trouble. London has always been celebrated for its exhibit of horses. This year the horse ring was made unusually attractive.

In nearly all the classes of horses the number of entries was considerably greater than last year; and the new classification made, distinguishing between imported and Canadian bred stock, had the desired effect of making competition keener. In Shorthorns the exhibits were remarkably good, the competition close, and the number of entries showed great improvement over last year. In Aberdeen Polls and Jerseys there was also a marked increase; while in Herefords, Ayrshires and Devons there was a considerable diminution. Holsteins were on the list for the first time, numbering thirteen. The showing in grades was little inferior to last year. The

decline in the number of Cotswold sheep was very notable, while the entries in Leicesters, Lincolns and Southdowns compared fairly well with last year's figures. In Shrops there were over 60 more than last year, and in Oxfords, Merinos and fat sheep the figures were up to the usual mark. It was not to be expected that the fruits could come up to the average owing to the unfavorable season, but the exhibits were choice. In vegetables the best authorities assert that there was the best exhibit ever displayed in the Province, both as to quality and quantity. In cheese, both white and colored, the exhibits were very creditable. In the fine arts the display was grand, and was remarkable for the number of new aspirants who are boldly pushing their way to the front.

Numerous complaints were made by farmers around the live stock sheds and horse stalls. It should be borne in mind that the number of farmers who come to the fair is every year increasing, and it should not be expected that every farmer is able to distinguish all the breeds of horses, cattle, sheep and pigs. It is getting to be almost an imperative necessity that they should be systematically stalled off into groups, according to their respective breeds, and the buildings so labelled that everybody can readily learn the breeds and breeders without resort to the inquisitorial habit. For those who go to learn, the best facilities for the acquisition of knowledge should be placed within their reach; otherwise the practical usefulness of the exhibition will soon be gone.

ONTARIO PROVINCIAL AND DOMINION EXHIBITION AT OTTAWA.

We left the Western Fair grounds in London on Tuesday afternoon, and arrived in Ottawa on Wednesday morning. The weather was threatening in the morning, but the afternoon was fine, and Thursday and Friday were as fine as could be desired. The early part of the week there had apparently been about the same quantity of rain as in London.

We were informed that 27 car loads of exhibition goods had been sent from Toronto to London, and 29 to Ottawa. The exhibition was considered a good one generally speaking. The horticultural display we consider superior to previous exhibits in this city. The stock generally was very good; in the Polled Aberdeen and in the Jersey classes we consider it the best exhibition ever made in Canada. Kerry and Shetland cattle were exhibited here; also a number of the West Highland cattle. The exhibit of Herefords was good, and a very fair display of Devons was to be seen. The show of Shorthorns was good, but we do not consider there was any very marked improvement in the display of stock. There was a good exhibit of Ayrshires. The show of sheep, hogs and poultry was good, but the number in many classes appeared small. There was space to spare for more stock.

The Governor and suite appeared the greatest centre of attraction while on the ground. The amusements absorbed most attention during the afternoons, leaving the mornings for the implement and stock men to attend to their business. There was a very good display of implements and a fair display of dairy products.

Having seen the four great exhibitions, we must endeavor to turn our attention to your advancement, if possible. There has been a general satisfaction among the recipients of prizes and among the recipients of honors and funds, but it appears to us that we never heard of so much complaining among competitors. There always has been and always will be some. The public is discerning, and when intentional slights are perpetrated it tends to the injury of the morals and prosperity of our general interests. There is a right feeling among the population demanding amusement and recreation. It is beneficial to young and old. Exhibitions of art, feats of strength and skill are pleasing, and many are highly instructive. It is still a debatable question to what extent the Government should undertake to entertain, instruct and amuse the people, and what tends to improve and elevate the morals of the public, and what tends to degradation. The little boy that wins 25 cents at a game of chance is led on to speculate, perhaps to gamble. The little boy that wins a cigar requires a drink. - But many of the side shows are neither demoralizing nor injurious, but highly beneficial.

There was great dissatisfaction amongst the exhibitors of machinery on account of the lack of accommodation conveniences, their goods being all exposed to the weather. There were also complaints of general mismanagement on the grounds. The manure was not cleaned away during the whole week. When it is considered that this fair is aided by both Provincial and Dominion grants, we should naturally expect material improvements as compared with other fairs, and the entire rejection of demoralizing resorts to gain money. The managers have attempted to take pattern by Toronto's great fair, but they have fallen far below that standard. There is a general impression abroad that fairs have been greatly overboomed by the local press in the localities in which they have taken place, and there is a strong desire evinced to cloak every failing and every defect in management. One manufacturer complained to us that his goods were dispatched from Toronto as soon as practicable, and yet they did not arrive at Ottawa until Thursday afternoon—too late for the exhibition.

EXHIBITION NOTES.

From interviews we held with certain prominent men, we are constrained to the belief that our township exhibitions are to be doomed to oblivion unless some material change takes place in the management of our agricultural affairs. The Toronto Exhibition Grounds have passed from the farmers. The East Middlesex Agricultural Association have, we consider, lost control of the grounds which they held in this city. The citizens are anxious to have control and are manipulating matters in such a manner as to gain their desires. They are able to unite in a manner in which the farmers have not an opportunity of doing. County societies have more power and influence than township organizations, and are enabled by clubbing to purchase votes and outvote the farmers. It is of more advantage to railway authorities and to manufacturers to support large gatherings. Although we believe that the majority of practical farmers approve of our remarks, yet their influence is so infinitely

small in comparison with the united strength of the larger corporations, that we fear their interests are in jeopardy. We regret that there is such a strong feeling of reticence and avoidance of open discussion among some officials, whose duty should be to encourage rather than suppress discussion.

Toronto and London will add to their exchequers. The Provincial and Dominion Exhibitions will show very large deficits, despite the two large grants received from the Dominion and Provincial Governments; and it is to be regretted that they have departed quite as far from the regulations governing the Royal or the Model agricultural exhibition, as either of the other two fairs have done. In fact, the exhibitions of London and Toronto are called fairs; a fair admits all kinds of attractions. Agricultural exhibitions are now turned to fairs, and to make the whole thing complete, on the Provincial prize lists circulated in Ottawa an attraction page was bound on the volumes, and the last attraction advertised under their auspices was a grand dance. On the day before the dance was to take place we saw several drunken people sleeping on the grounds, and one drunken fight, or rather worse. At the annual meeting in Ottawa it was decided to ask for the continuation of the grant; but in talking with individuals we found the names of Chatham, St. Thomas, Belleville, etc., mentioned as being suitable places for the ensuing year. The fact is that the exhibition question was never in such a chaotic state as at the present, and very great caution should be taken, and open and free discussion encouraged before hasty or injurious conclusions are arrived at. We ask those who have suggestions to make to correspond and express their views if they have suggestions for improvement. We have to the present advocated the encouragement of township exhibitions. There are many who oppose this plan. We have also opposed improper and injurious attractions; others differ with us.

What Trees to Plant.

With the object of awakening greater interest in this important industry, we called on Mr. G. Leslie, sen., of Leslieville, near Toronto, as we believe him to be the oldest, most practical, reliable and experienced person in Canada in this line. He has tried all kinds of trees procurable, which are likely to be of advantage in Canada; he has the largest and oldest established plantation grounds for producing and trying all kinds of trees. He now cuts about fifty cords of wood a year from trees planted by himself. We walked over the grounds with him, and it was with great pleasure we elicited the following information from him. "This stump," said Mr. Leslie, pointing to the stump of a tree cut off close to the ground, "is nearly three feet across. I planted that tree 32 years ago. I cut it down last year and had it piled up in cordwood; there were two cords from that tree. It was a Silver Lobelia; some call it the Silver Poplar. The wood is soft when green, but when dry is hard and equal to the hard maple for fuel and other purposes." Mr. Leslie says this is the most valuable tree for the Northwest; it will grow anywhere. It should be planted on all waste lands in Ontario. It is easily propagated from cuttings. We saw several trees nearly as

large as the one described, that he had planted over thirty years ago. He says this is the tree of all trees for the Northwest. We instructed our artist to make a drawing of this venerable tree; see it on the left side of the engraving on page 297. The tree on the right represents the Ash-leaved Maple. This tree is as hardy as our common maple; it makes a very graceful change for ornamental and useful planting in Ontario and all parts of Canada. We saw this tree thriving, we thought, the best of any in Manitoba, and highly recommend all to procure a few trees of this very valuable and ornamental variety. They are not so much planted as they should be. We have gathered a lot of the seeds of this tree for dissemination; see our prize list. The centre tree in the engraving represents a Norway Maple. Mr. Leslie may be seen below it. This is a rapid growing and very hardy tree. It has a larger leaf than either the hard or soft maple; the leaf is of a dark green color, and the wood grows much denser. This makes it more valuable for a wind break. This is a hardier tree than our common maple, and will also thrive in more northern latitudes than our common maples. It deserves greater attention both for use and ornament. We hope by these means to awaken greater interest in arboriculture, and will speak of other varieties in future issues. Let us all plant more trees. This is the time to plant seeds.

Special Contributors.

A Chatty Letter from the States.

[FROM OUR CHICAGO CORRESPONDENT.]

The leading thoughts contained in the editorial of last month on pedigrees and pedigree worshippers are of particular interest now when we are hearing so much more about animal pedigrees than about animals themselves. We are governed by style, and the leading fashion now is, as it has been for a year or two, to pay first attention to the pedigree. If a Shorthorn has a fine pedigree and is of a rich, dark red color, who will be so particular as to demand that the animal be full of individual merit, and of a powerful, robust constitution? Of course it would be a statement too sweeping to say that these last but most essential qualities would be ignored in a large measure by the majority of breeders of the present day, but it must be remembered that while many men find a genuine pleasure in breeding and handling stock, and a few now and then can be found who follow the business purely to suit their own fancy, without regard to the pecuniary advantages of raising fine stock—while this be true, it must be remembered that after all said and done about men supporting certain breeds and certain strains, etc., simply because they regard them as the best extant, and therefore the only ones worthy to be perpetuated, at least ninety-nine men out of every hundred who engage in stock raising or any other pursuit, do it for the sake of the money there is in it, and each man stands up for the particular kind of stock which he thinks likely to make the most money in the long run. Therefore, as it is the business of breeders to have cattle, hogs, or sheep of the kinds mostly in demand, the pedigree worship and color folly are liable to be carried to an extreme that may be very hurtful to the best interests of our fine stock industry. It is one of the natural laws of trade that when

ever there is a demand there will immediately be forthcoming a supply. Take the case of a thoroughly practical and experienced cattle breeder; he recognizes the fact that a bull which is the very embodiment of sound constitution and high individual merit is better to breed from even if he does not happen to have a royal pedigree, than an animal whose chief qualities lie in the fact that he is the son of an illustrious sire. But why should not this practical man give the people what they want and are willing to pay most for? Is he a philanthropic reformer that he should ignore the popular demand, and teach his customers what they ought to want, or will he not rather make a study of what his customers do want? He is not breeding for principle, but for money, and if you see in his herd a lot of blue blooded pedigree aristocrats, without constitutional vigor, remember that the charge is to be laid at the door of those who think more of the animal's family than of the animal.

Popular fashion is responsible for many sins. It is said that one had as well be out of the world as out of fashion. And, unfortunately, it is seldom the substantial, common sense kind of people who set the fashions. Fine stock breeders, who make a business of breeding to sell to the public, must be expected to pander to the popular whims, no matter how absurd, for the reasons stated above. Like the evils of adulteration, artificial butter, etc., one must not go to the manufacturers and say: You ought not to manufacture an article that is not what it pretends to be. It is useless to appeal to him; the consumer must be reached and his perverted taste corrected. You must always go to the fountain-head to purify a stream.

Pedigrees certainly have their uses, and play a valuable part in the business of breeding, but the craze for certain kinds is very absurd and unreasonable. Let those who lay so much stress upon pedigree examine the history of the celebrated Shorthorn raiser, Col. J. D. Gillette, of Logan County, Illinois. Among his vast herds of prime breeding animals, and champion prize winners in the highest show rings for beef cattle, there will not be found a single recorded pedigree. The imperative rule of this noted Shorthorn raiser is that each animal must have fine individual merit; must carry its pedigree not in a written herd record, but indelibly stamped upon its own individuality.

At the Illinois State Fair the display of general agriculture, and of horses, sheep, swine, and poultry, was very large and fine, but in the cattle departments there was a conspicuous dearth. There was no competition whatever, and the usual battle of the breeds was not fought this year. The reason was that the fine stock interests were fairly by the ears over the report that pleuro-pneumonia had broken out in Illinois. It now seems that this is a blunder of the veterinary authorities as large as the one which they made last spring in declaring that foot-and-mouth disease had broken out in various parts of the West. The fact of the matter is, not a single authority who has taken an active part in the matter has ever seen a case of either disease, and of course blunders are to be expected from men who have no knowledge of these fatal scourges that they have not gained from books. Thus far the reports are confined to Jersey cattle, and for

the time at least that breed is in rather bad repute, and numerous fine stock sales have been completely knocked in the head. Men have dwelt upon the weakness of the constitution of the Jerseys, claiming that they have been in-and-in-bred so much that they are very susceptible to all such diseases, and all that. This has naturally raised the ire of the breeders of that strain, and altogether, we have been having rather lively times. The Holstein boom, which was already worked up to a pretty high pitch, has received something of an impetus by the defection for the time from the Jerseys.

The Chicago Live Stock Exchange proposed to the Commissioner of Agriculture to furnish ten head of sound cattle to be placed in the same lots and upon the same feed for ninety days with any herd of cattle in the west which the authorities claimed to be affected with contagious pleuro-pneumonia. This practical test was not accepted, and it is openly charged that the reports of the disease have been circulated for political purposes and to extract money from the treasury, but however the matter stands, Canada will do well to keep her skirts entirely clear by refusing to raise the embargo upon States cattle.

The fact of the matter is, importing fine stock from Europe is now attended with such heavy risks that a great many breeders on this continent think there should be no more of it. In reality there is no urgent need of bringing over more fine blood as yet, for we already have much of the very cream of the world's fine stock. It is true that the fine stock on this continent, in proportion to what it might be, is a mere drop in the bucket; but there is a powerful lever at work, and inside of a score of years it may be found that North America will be looked to as the source of the best bred stock. We have made good progress in the improvement of our stock. Let us not be impatient. There are other features which we have neglected more. In the matter of feeding, for instance, and caring for our stock, we are not so far advanced as in the improvement of blood. The science of feeding and caring for stock are most essential.

Skim-Milk Cheese.

BY MARSHFIELD.

One of my neighbors came to me a short time ago to tell me that he entertained a new idea. Just then there was a fierce discussion going on in the neighborhood with regard to what breed should be introduced for the purpose of improving native cows for the dairy. He said he had been talking the matter over with his wife and family, and they came to the conclusion to introduce the Jersey with a view to increasing the product of butter, and then they intended to make cheese of the skim milk. I smiled quite visibly at this "new idea," but said nothing just then, thinking it was a mere jest. Afterwards, however, I thought seriously over the matter, and now I consider it to be a question of great importance to every farmer in the Province. We have a cheese factory in this section, but my aforesaid neighbor, as well as a good many other farmers around here, wants to do his own dairy work, contending that it would be a means of keeping his boys and girls at home, as it would furnish plenty of work for them. At the same time my boy was threatening to leave me unless he got less to do, and I therefore felt disinclined to fall in with my neighbor's new idea.

Having weighed the question in all its bearings, I entertained a new idea too. I started thinking by asking myself, Why don't my neighbors eat cheese? I soon found out that most of them were loath to lay out the money while others didn't like cheese, declaring that the cheese from their factory wasn't good, that the milk from some of the patrons was unclean and that the stench from the hog pens in proximity to the factory was enough to turn their stomachs against cheese. In my anxiety to get at the root of the question, I even went so far as to say, for the sake of argument, that farmers, not being the cream of society, should learn to eat skim-milk cheese, it being good enough for them.

So far the consideration was entirely practical, and I then thought I could not do the question justice without also looking at it from a scientific standpoint.

What is cream, whether in the cheese or out of it? I asked myself. Butter is fat—a substance which, although useful in producing heat and adipose, takes no essential part in sustaining life. On the other hand, the skim-milk, or the cheese made therefrom, contains all the life-sustaining constituents of the body, forming bone, muscle, nerve, and all the other tissues, and will also produce heat and fat when fatty matter is absent in the food. Taking it for granted that fat is useful, although not essential, the next question to be decided was, Is a sufficiency of fat present in the usual diet of the farmer? For the sake of convenience and brevity, let me include in the word fat all the other carbonaceous compounds which serve the same purpose, such as starch, sugar, fibre, oils, etc. If farmers ate bread made from ground wheat, it would neither contain a deficiency of fat nor of tissue-forming substances, but bread from white flour contains an excess of fat. The pork which is so generally eaten contains a great excess of fat. Potatoes, corn, rice, and most vegetables, also contain great excesses of fat, while those articles of food which contain an excess of tissue-formers, such as beans, peas, lean meats, and cheese, are sparingly eaten by our farmers. With regard to milk it is usually in itself a perfect article of food for children, but for adults it contains an excess of tissue-formers, and cheese is therefore also too rich in these constituents.

From these circumstances it will be seen that the average farmer's diet is far too rich in fatty matters. One way of distinguishing fatty foods from others is by their comparative cheapness, so that farmers who live on cheap foods must eat prodigious quantities in order to get the necessary amount of nutriment. Although the price is only a general guide to the nutritive value of farm products, chemistry has established the intrinsic value; but cheese and butter have defied the laws which apply to the market price or the chemical analysis of other food stuffs raised on the farm.

The conclusions to be drawn from the above facts are these: As an article of food for farmers, when it is considered that their diet is usually of too fatty a nature, skim-milk cheese, although having no settled worth in the world's markets, is more valuable for them than whole-milk cheese, and being the most nutritive and concentrated of all their foods, is the best regulator of their diet.

I do not mean to discourage those to whom whole-milk cheese is more palatable than skim cheese; but I am convinced that as soon as people learn to distinguish between nutritious and non-nutritious foods, their tastes will begin to be regulated more by their judgment than by fashion.

Stock.

Standard Points of Beef Steers.

In many instances the feeder's whole profit depends upon his judgment in the selection of steers that have an aptitude to fatten. There are standard points which are unerring indications both of the quantity and the quality of the flesh which an animal will lay on, and should be diligently studied by every feeder who aims at success in his business. Different values are attached to these points according as the symmetry or constitution of the animal, or the prices of the butcher's cuts, are affected. We append hereto the main points:

MUZZLE.—Large; wide nostrils required for easy and vigorous breathing, indicating a strong constitution. Prominent lips indicate good grazing qualities.

EYE.—Full, bright, placid, indicating a gentle disposition, and therefore good fattening qualities. A vicious animal is seldom a good feeder.

EAR.—Medium size, fine, and covered inside with soft, silky hair.

HORN.—Fine, smooth; oval shape preferred. Large, coarse horns usually indicate a coarse frame and coarse bones.

HEAD.—Small or medium. A wide forehead is indicative of intelligence; hence, animal easily tamed or taught, indicating good thriving qualities. The poll should be prominent and the jaw wide and smooth.

NECK.—Medium length, gradually widening towards the shoulders—longer for a grazer than for a stall feeder; slightly arched; shoulder vein full.

CHEST.—Broad and full, indicating a good constitution.

BRISKET.—Well forward and wide, but not too deep—should be a little lower than the under line of body. Chest and brisket should be destitute of loose flesh (dewlap). From a butcher's standpoint this is an important though not a very valuable part, a small, skinny brisket having scarcely any value at all.

SHOULDERS.—Wide across, without a depression between. A depression indicates looseness of frame, and hence a lack of strength to carry weight of body. Should not be set too perpendicularly.

RIBS.—Should be well sprung, forming a wide back and a capacious barrel. Should be well ribbed home.

CROPS.—Here great fullness and girth are required, indicating lung-room, and hence a good constitution. The flesh here is also valuable.

LEGS.—Short, clean, flat; should stand well under the animal, and be graceful in their movements; leg bones fine and smooth. Hind legs should be straight as practicable and not in-hocked. The elbows should have free play.

BACK.—Straight; broad from withers to tail attachment.

LOIN.—Broad, and slightly arched.

RUMP.—Full, wide between pin bones, and tail attachment should be even, strong, and on level with line of back.

HIPS.—Full and deep; flesh on thigh should extend well down towards hock.

TWIST.—Full and deep.

FLANK.—Should be let well down—on a level with the lower line of the animal.

QUALITY.—Indicated by a fine head and bone, fine ears and horns, a fine tail; skin of medium thickness covered by fine, soft, silky hair. Quality can also be indicated by the touch. The skin should cover the flesh loosely; and upon pressure by the fingers the flesh on the loin should be firm but elastic. When prime the fat should be evenly distributed over the body, and not be found in protuberances.

Bli Bro Farm.

The accompanying illustration shows a portion of the stock of Messrs. Geary Bros., with the residence and surroundings of Mr. John Geary. The farm is pleasantly situated in

ported mare and another for a colt. The large horse in the cut represents "Lord Warwick," and the large heifer "Favorite of Altyre the Fifth," two years old, weight 1400 pounds.

Winter Feeding.

One of the most important points overlooked by the practical feeder, is temperature. Let us illustrate by taking the results of numerous experiments that have been accurately conducted. It has been estimated that three gallons of water at freezing temperature given to a cow in winter, twice a day, will cut short the milk production over six per cent. in 24 hours. It will be observed that the heat re-

in average temperature being about 15°. All temperature experiments serve to point out the same conclusions, leaving comment unnecessary. Query: Which is the more economical agent in the production of beef, food or shelter?

Another point of economy is convenience. For example, it has been proved that steamed or cooked and cut foods produce better results than raw and uncut, but the profit is not so great as to justify the adoption of these modes of preparation unless he has a large number of head and the greatest conveniences or facilities, and it must be borne in mind that the quality of the beef from cooked food is inferior. In feeding for profit grains should be ground.

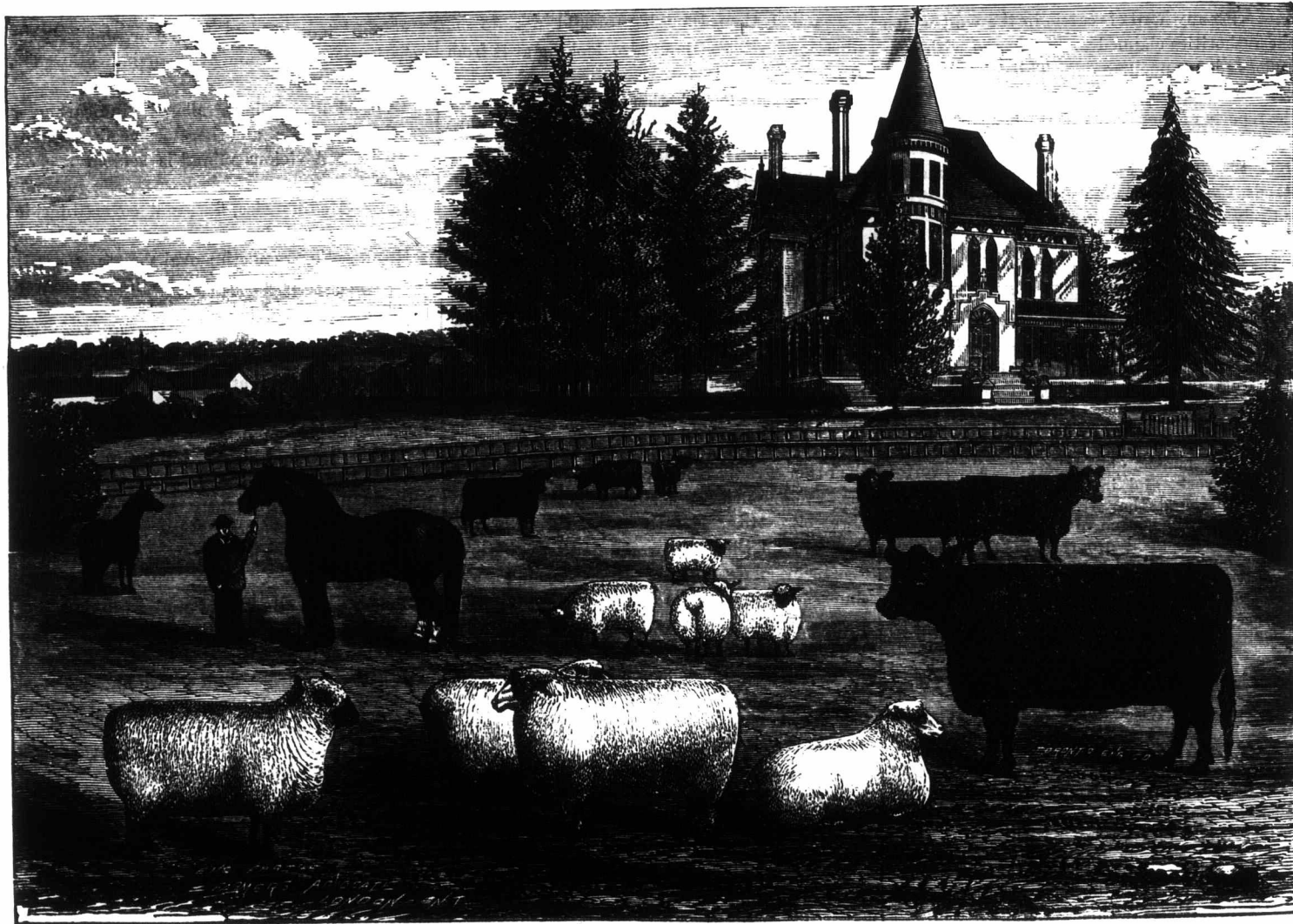

BLI BRO FARM.

THE PROPERTY OF MESSRS. GEARY BROS., LONDON, ONT., WITH RESIDENCE OF MR. JOHN GEARY.

London Township, just beyond the northern suburbs of this city, and embraces 400 acres of excellent land. The stock consists of 40 head of Polled Angus cattle, five Shire horses, 150 Shropshire Down sheep, and 160 Lincolns. Messrs. Geary Bros. swept all the prizes in the Polled Angus class at the Western Fair just held in London, nearly all in the Shropshire breed of sheep, and they were awarded about two-thirds of the prizes in Lincolns. In Shires they took first prize and diploma for a three-year-old stallion, and three prizes for mares and colts. At the Industrial, lately held in Toronto, they took about one half of the prizes in the classes just mentioned, including two firsts for Shire horses— one for an im-

quired to raise this water to the temperature of the body was produced at the expense of food consumed, which would otherwise have aided the flow of milk. Query: Which is the more economical, the heating of drink-water by artificial or by animal heat?

As great a loss would also have occurred in giving freezing water to fattening cattle. At the Ohio Experiment Station a very important experiment was conducted. A quantity of corn, 3,240 lbs., was given to a lot of pigs in a closed pen, and in a given time they gained 350 lbs. in weight. At the same time the same quantity was given to another similar lot in an open pen, and during the same time they gained only 250 lbs. in weight, the difference

Facilities for feeding, without waste or loss of time, and conveniences for the disposition of the manure are also important points of economy. Skill in varying the ration, the oftener the better, is an extremely important qualification. It is well known that an expensive ration may be given, which may be more detrimental to the progress of animal growth than cheaper mixtures.

Punctuality in feeding, watering, and exercising, is also an important requisite. The natural habits of each animal should be studied. Kind treatment and freedom from excitement or fretting are useful considerations in the progress of animal growth. Under all circumstances it should be borne in mind that an inferior animal requires the same stabling and management as a superior animal, and the difference in the breeding is almost invariably a measure of the profits in the business.

Garden and Orchard.

Three Valuable Trees for the Northwest.

BY HORTUS.

These are the silver-leaf poplar, the Norway maple and the ash-leaved maple. This group possesses characteristics required for the successful cultivation of trees in the great unwooded plains of the illimitable Northwest. The chief want of that region is good and useful timber, and the rapid settling and improving of the farms and surroundings will, in a great measure, depend on its prompt supply. To fill this want, were our choice confined to

for planting on bleak hillsides, and places subject to washouts, and in localities where it is desired to re-wood with various trees, such as evergreens, birch, maples, etc. For such places procure stout cuttings of the poplar; they can be made of any size convenient, from pieces a foot long to six feet in length. Push these into the soil firmly, at least a third or half of the whole length. Do this early in the spring; the cuttings may be made in the winter. The wood soon commences to grow, throwing out strong shoots covered with dense foliage, whose shade will encourage the growth of grass and plants on the bare bank. The roots of the poplar in searching for moisture and nourishment, unite firmly the sections of

the simplicity of its cultivation. To grow it in rows for transplanting about the farm or other uses, as fencing, and for building material, plant the cuttings about a foot deep, a foot apart in the rows, and the rows four feet between each. Keep clear of weeds by hoeing the first year and cultivating or plowing the second; they will then be able to take care of themselves. From these rows the third year strong trees may be thinned out for planting in other places, but the balance may be left to grow up into timber. If left growing as when planted, about a foot or twenty inches apart, they would soon present an impenetrable fence and would form a wall almost intact. The writer planted cuttings this distance apart twenty



Three Valuable Trees for Canada, Particularly the Northwest.

one tree alone, we would at once select the silver poplar, *Populus alba* in botany.

This tree, originally introduced from Europe, has spread freely over this western continent, and when fully grown, assumes noble proportions. It is more robust in its nature than our native aspen poplar, with wide spreading branches and roundish, slightly heart-shaped, wavy-toothed or lobed leaves, soon green above and very white cottony beneath. This white part of the foliage gives the tree a very pleasing and striking effect when disturbed by passing breezes. It is particularly easy to propagate, growing freely from suckers (an objection in old settled localities) or cuttings made of the wood. A parent tree would soon produce a thicket around it affording shelter to stock in inclement weather. It is invaluable

earth through which they pass, and gradually but surely a firm breastwork is formed, defying the attacks of storms or changes of the seasons.

Other trees can now be introduced and planted amongst the poplar growth; safely growing by its shelter, they soon become self-supporting. Birds of the air will be heard singing on their branches, and flowers blooming at their base, and so very soon does time pass that what was a bleak and barren hillside or point of land, scarred and seamed by summer storms and winter frosts, will be transformed into a wooded hillside, with glancing lights and embosomed shadows, with swaying branches and tremulous leaves.

But very little labor is required to bring about this pleasant change of aspect, from the ease by which the poplar may be grown, and

years ago, which have grown into trees forty and fifty feet high and trunks fifteen to twenty inches in diameter a foot from the base.

Planting the poplar thickly induces it to grow up evenly and straight. The wood of old trees makes capital firewood, and when sawed and prepared as other lumber for the mechanic, furnishes an exceedingly durable and beautifully marked wood, useful for carving or other artistic furniture use, and susceptible of a high polish. To sum up, the silver poplar cannot be too highly recommended for planting in the Northwest or other places destitute of useful trees.

The silver poplar occupies the position to the left in the illustration, specially drawn from nature and engraved for this article, and in the centre of the cut stands a representation of the

Norway maple (*Acer platanoides*). This noble tree stands almost at the very head of handsome ornamental trees. Of rapid growth, covered with abundant foliage, bright green in color, assuming a massive globular form. When fully grown, it always commands admiration and creates surprise from its beautiful appearance. It is one of the hardiest of maples, never

inches. This trimming back induces the young plant to have fibrous roots, thus allowing its successful transplanting any time in after years.

In Fig. 1 is shown a representation of a leaf and seed catkin of the silver-leaf poplar, and following is a cut showing a leaf and seeds of the Norway maple; and in Fig. 3 a leaflet and

other climbing plants; a clump of trees together would be wreathed and festooned from one to the other with the Spanish moss, creating a festive and romantic appearance. There it is quite a familiar tree to the inhabitants, as we said before, as box-elder. Here in Ontario it is known, where known, as ash-leaved maple, while in Manitoba, where it is also at home and



SILVER-LEAF POPLAR.



NORWAY MAPLE.

known to be winter killed. What more could be desired in a tree for cultivation in the Northwest! The wood possesses the same valuable qualities of usefulness as the native hard or sugar maple, which it resembles very much in appearance, the tree, however, growing more rapid and arriving at maturity earlier than the latter. For single specimens on a lawn or in a field, no tree is so desirable; its dense foliage affording every shade and protection.

The Norway maple ripens its seed in the fall, in the latter part of September, when it should at once be gathered and sown in a sandy loam. Sow the seeds in drills two inches deep, covering the seed evenly and tramping the soil down firmly. Mulch the seed rows or bed with a goodly covering of leaves or litter, where it should remain till the warm weather of the succeeding spring; then examine your seeds, which sprout early, and if showing signs of growing remove your mulch, but not till then. The young plants

may be left growing in the seed rows for two seasons, when they should be taken up and assorted in two sizes, viz., a large and a small. With a sharp knife trim back the roots evenly, but not too short, a proper length of root from collar of stem being six

seeds of the ash-leaved maple, all being about one-third of the natural size.

Last but not least in this important group of trees to the planter of the Northwest, we come to the ash-leaved maple. And here we cannot help mentioning the different names which this tree rejoices under. To the botanist it is known as *Acer negundo*. In the Southern and

indigenous to the soil, we have heard it is known as Manitoba maple.

What a latitude this tree thrives and lives over! From the balmy breeze of the Gulf of Mexico to the nipping frosts of Manitoba, this tree grows and bends its branches alike to cyclone or blizzard. To Southern heat and Northern cold it presents the same leafy front

with impunity. Like the preceding trees, its habits of growth are very rapid and it soon strides from the tiny seedling to the imposing tree. Like the Norway maple, it ripens its seed in the fall, of which it bears great quantities, so that the cultivator who takes the trouble may propagate thousands and tens of thousands. The same method may be followed as recommended for the Norway maple in growing from seed and after transplanting. The wood of the older trees can be used for anything that wood is useful for, but we consider this tree invaluable for forming shelter belts and windbreaks, hedges or shade trees. It does well in all soils, only asking to be planted, and it is bound to grow and will give an ample return for any trouble taken in its behalf.

Science without practice is dead.

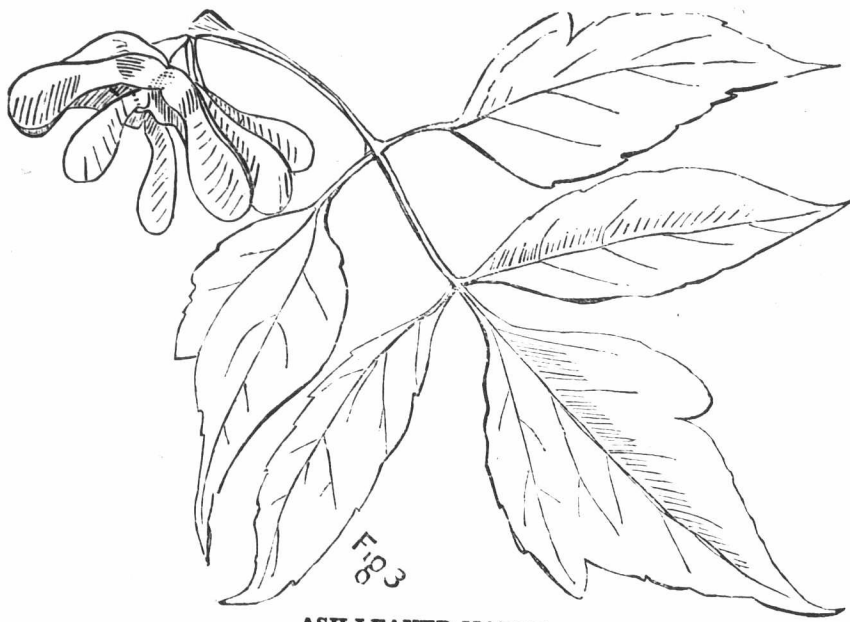

ASH-LEAVED MAPLE.

Western States it is called box-elder. In the moist and humid soils of the river bottoms of the Missouri, Mississippi and Red River valleys, this tree attains a great size, towering up like gigantic basswoods, sometimes completely enveloped with wild grape vines and

The Farm.

Preserving Roots.

One of the greatest obstructions to root-growing is the risk of loss by rotting, and this has induced many farmers to construct expensive root cellars. Quite a number of farmers have not yet got out of the old rut of building high heaps with whisks of straw as ventilators, and often without ventilators at all.

A gently-sloping location is best, and where the benefits of snow drifts may also be obtained. A sudden fall is not so necessary where the land is naturally well drained. If the soil is loose, dry, and has abundant drainage, the pit may be sunk entirely in the ground, or only partially so, if the conditions are not all at their best.

If the bottom of the pit is made about five or six feet wide, the height will be three or four feet, the proper pitch being given, and the length will, of course, depend upon the quantity of roots convenient for the pit.

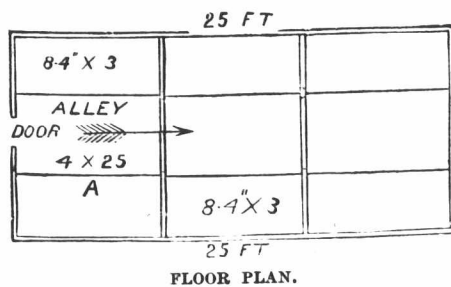

FLOOR PLAN.

with a thin layer over the heap. Five or six inches of straw are then put on, then another layer of earth. This will be sufficient in early autumn; but before the frost arrives, another coating of straw should be put on, with a final layer of earth.

With regard to ventilation, the number of ventilators will depend partly upon the quantity of moisture to be evaporated, and this is again affected by the condition of the roots when gathered.

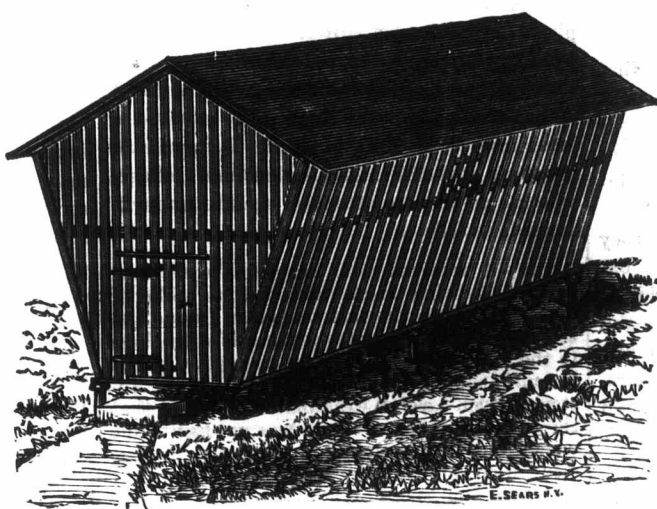

A CORN HOUSE—ELEVATION.

is to sink them no deeper than the covering of soil. Some cover the ventilators in severe weather by fastening a lid tightly on top.

In harvesting and pitting roots it will be well to remember that turnips and carrots are hardier than mangels, and may be left in pits till later in the spring, but mangels are more palatable in the spring than earlier.

The Aftermath.

Many farmers feel annoyed at the sight of their fields growing up green in autumn, thinking that unless they have stock enough to keep them bare the result is a dead loss. This is another relic of superstition.

A Corn House.

This corn house is quite common in Western New York. It has a most pleasant look, is convenient, and the cost is reasonable.

The frame plan shows the manner of framing the bents. An alley four feet wide passes through the centre of the building, with latticed cribs upon each side. A small door should be placed near the floor on the alley side of the crib; when opened the ears will come out in quantities of not more than three bushels at a time.

The cribs may be divided into three apartments each, or left whole, as desired. By removing the section, A, of the crib (see floor plan), a room 7x8 will be obtained, for shelling or other business.

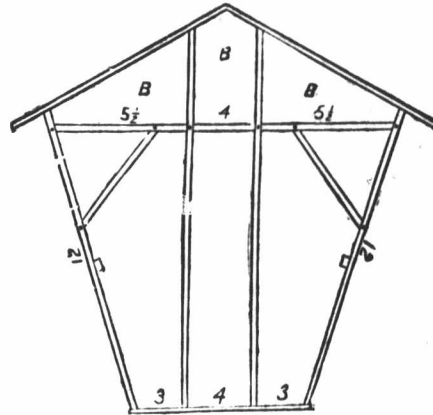

FRAME.

jump three feet high, hence a building, to be secure from their depredations, should have its lower floor three feet from the ground.

The farmer who works to learn, as well as learns to work, gets a practical training an equivalent of which no school or master can instil into his mind.

If you have been so unfortunate as to have left any manure lying in your barnyard all summer, it may now be applied on the pasture, if well decomposed and any substance is left in it.

Should Farmers Wait for Higher Prices.

The crops recently harvested have, on the whole, been excellent, but in some localities they were somewhat injured by the drouth, and in other places by the early frosts. As a natural sequence of good crops everywhere, prices range low, so that many farmers contemplate holding on in anticipation of enhanced prices. It is possible for us to be in error, but it is our firm conviction that they should sell now. The present prospects are that greater breadths of wheat will be sown in Manitoba and India than in any previous year, so that unless next year proves to be a conspicuous failure, wheat will be lower twelve months hence than it is to-day. Farmers should not fail to take into consideration the losses incurred by storage, risks in various forms, interest on capital invested, etc., before they make up their mind to keep their grain; but whether they should sell the raw material or the finished productions—beef, mutton, and pork—will depend upon individual circumstances. It is not probable that the large reduction of the wheat area in England and France will go far towards enhancing next year's prices.

Cow Catechism.

Q. What is a scrub cow?

A. A scrub cow is a domesticated animal which does not get food and shelter enough to make her grow large or put on flesh, and therefore she "must go."

Q. Does she give any milk?

A. Well, yes, plenty of it; but the quality is not good.

Q. Why is the quality not good?

A. Because her food and drink are not good. Being of a kindly disposition she lets down milk instead of making growth and putting on flesh, and being cheap anything is good enough for her; it does not pay to shelter her from the solar rays and the bot flies of summer, nor the blasts and slush of winter; so poor bossy "must go" to give place to *Princess Royal* the fortieth.

Q. What is an improved cow?

A. An improved cow is a domesticated female animal of bovine aristocracy on whose leavings the scrub cow feeds.

Q. Does she get all she needs?

A. Yes; if she didn't she would be a scrub, too. Being costly, she feeds on the delicacies of the season and all sorts of expensive condiments for the purpose of coaxing her to eat more after she has had enough, and nothing is too good for her. Whenever the weather permits, the blanket is taken off her and she is groomed as slick as a mouse; and she has drawing-room comforts all the year round.

Q. Does she give any milk?

A. Well, some; but not enough to raise her calf (if she should chance to have one), the scrub cow making up the deficiency.

Q. But her milk must be of excellent quality, must it not?

A. No; as she looks out for No. 1, the essence of her food runs to bone and flesh, and the refuse to milk.

Q. Well, then, her flesh must be good—not so?

A. No; the muscle is innutritious and immature, and the fat is a mass of diseased obesity, if not of fatty degeneration.

Q. What, then, is the advantage of the improved cow?

A. She costs a pile of money, is stylish, and belongs to a good family.

The Wheat v. Chess Question.

In our correspondence columns will be found communications from prominent farmers in reply to our September editorial on the question, Does wheat turn to chess? One writer made the experiment of sowing chess, and found that it turned to grass. We have also received a letter from W. J. Beal, M. S. Ph. D., professor of botany at the Michigan Agricultural College, who has given close attention to the subject. It reads as follows:

SIR,—I received your magazine with illustration showing chess attached to spike of wheat. During the last ten years I have had sent to me specimens of wheat heads with chess in the head, not at the base of the spike, but at the middle or towards the top. In every instance, upon careful examination, I found that the base of spikelet of chess was not fast to the wheat, but the chess had in some way become wedged or lodged in the spike of wheat. The specimen you speak of is apparently of a like nature, although I could better pass an opinion if I saw it. If you mail me the specimen I shall examine it, and return it with my opinion.

Sept. 18, 1884.

W. J. BEAL.

On receiving this letter we re-examined the head of wheat and submitted it again to the scrutiny of Mr. Saunders, who is satisfied that the spikelet of chess is not lodged in the ear of wheat, but is an actual growth thereon; indeed, it could not have been wedged in or lodged, for it projects from the lowermost portion of the head of wheat, and would have easily fallen off, had it not been firmly attached. Mr. Saunders has forwarded the head, with spikelet attached, to Prof. Beal, who will conduct such experiments as he thinks fit.

The Hampden Agricultural Society of Massachusetts offer premiums of \$15, \$10 and \$5 for the best gardens in the country, of at least one-eighth of an acre each.

How to keep squashes through the winter.—The Hubbards are almost exclusively grown in the west for that purpose. They are gathered before they are at all frosted, and handled very carefully. Place them in some place where they can be kept dry until somewhat ripened. We generally cut the vines say three to six inches from the stems, and leave them on the squashes. Before any freezing weather, put them into a warm, dry place for winter. They should be placed upon shelves not more than two or three deep, and the room should not be allowed to get within ten degrees of the freezing point during the winter. They are very sensitive to cold, but if carefully kept until spring they are nearly equal to the best sweet potatoes. They should be turned over occasionally during winter, and if any specked or decayed ones are found remove them at once, as they have a tendency to dampen the air and cause the decay of those around them.—[J. M. Smith, in N. Y. Tribune.

The Harvest in India.

The agricultural department of the Indian Government recently issued a report of the crops of that country, wherein it is stated that the yield of wheat in the north-western provinces is below the average, while in Punjab, Bombay and the central provinces it is considerably above the average. The total wheat production of India will reach 250,000,000 bushels, of which 50,000,000 may be brought to the English market. There are now nearly 10,500 miles of railways in India which bring the grain cheaply to the markets, and as wheat can be produced very cheaply in that country, land being very cheap, and farm labor costing not over \$2 a month, India will, in the near future, play an important part in the wheat market of the world. This continent will be seriously affected by this result; and we may look out for a speedy reduction in the price of our land, unless India can be converted into a consumer of dairy products. Two crops a year can be produced in India, so that a failure of one will lead to no deplorable results, especially when it is considered that vast tracts of the wheat belt can easily be irrigated.

The wheat belt lies west of a central line drawn through the centre of the country, the eastern half being the rice belt. Add to all these prospects the fertility of the soil, and it is by no means improbable that the time is not far distant when Britain will procure her full wheat supply from India. The introduction of British laws will be potent in the amelioration of the condition of the inhabitants; and as most all the land belongs to the government, the production and trade can easily be regulated to advance its own interests, warding off the competition of other nations whenever it is deemed advisable to do so.

It is asserted by a writer to the *Husbandman* that the odor from strips of paper dipped in coal-tar will drive rats and mice from garret, weevils from granary and lice from hen-house.

We pay altogether too much attention to native maples. Both hard and soft maples make fine shade or ornamental trees, but the timber is of little value except for fuel, until the trees reach a large size. It would be wiser to plant more white ash, elm, basswood, hickory, oak, walnut, pine, etc. Our object should be to combine the useful with the ornamental. Such trees should be planted as will be ornamental during their growth and the timber of which is useful while they are still comparatively small.

The *Poultry World* says that the difference between an egg laid by a plump, healthy hen, fed with good, fresh food daily, and an egg laid by a thin, poorly-fed hen, is as great as the difference between good beef and poor. A fowl fed on garbage and weak slops, with very little grain of any kind, may lay eggs, to be sure, but when these eggs are broken to be used for cakes, pies, etc., they will spread in a weak, watery way over your dish, or look a milky white, instead of having a rich, slightly yellow tinge. A "rich egg" retains its shape, as far as possible, and yields to the beating of a knife or spoon with more resistance, and gives you the conviction that you are really beating something thicker than water or diluted milk.

Hints for Threshermen.

Operators of portable threshing engines should not overlook the importance of keeping their boilers clean. Unless soft water is used the boiler is sure to become incrustated with scales of lime. Some boilers are allowed to scale so thickly that the fire-box has not sufficient capacity to supply the necessary quantity of heat, and the manufacturer of the engine is then almost invariably blamed. The best way to remove incrustations is by putting caustic soda, the liquid form being preferable, into the boiler. Caustic soda does not injure the boiler plate like most of the patent remedies. There is still a cheaper and more practicable plan of keeping the boiler clean. Take about a half a pailful of good lye—that from the ashes of hard wood being best—pour it into a barrel full of water (the barrel or tank used for holding the water for the engine may be conveniently used for the purpose), and in less than an hour, the time varying with the strength and quality of the lye, sediments of lime will be found in the bottom of the barrel. If the lime is allowed to settle before the water is pumped in, little or no scale or sediment can get into the boiler, and it will scarcely ever require cleaning out. The lye should, when possible, be put into the water the evening previous to the day it is used, or it may be put in just after shutting off the pump before the dinner-hour, in both of which cases the lime will have time to settle in the bottom of the barrel or tank, and thus be prevented from being pumped into the boiler.

By attention to these hints and other minor details, the durability of the engine will be amazingly increased, breakages and other causes of delay and annoyance will be prevented and the liability to explosions reduced to a minimum.

Farmers who select their thoroughbred stock by virtue of its pedigree, should insist that the judges in the show ring base their awards on the length of the pedigree; it would save the trouble of examining the prize animals.

The presence of destructive insects has given a phase to crop rotation which was formerly undreamt of. Nothing will draw this plague more effectually than monotony in all tillage operations. The same mode of tillage, the same manure, the same varieties of grains, vegetables and fruits, are sure to create hotbeds of injurious insects; whereas variety in these respects has the effect of checking their dissemination. The same truth holds good in its application to weeds. These facts should wake up the farmers to a sense of the necessity of establishing fairs and clubs directly in the farmer's interests, where they can meet for the exchange of varieties of seeds, &c., and for the interchange of views as to practical methods of operation.

SIR.—I enclose you my ninth subscription to the FARMER'S ADVOCATE. I have obtained more valuable information, hints, and suggestions on farming through it than from all the other papers I have ever read, and I have read a good many. A. R.

MARSHFIELD, EAST RIVER, P. E. I.

The Dairy.**The Cream Element.**

BY JOHN GOULD.

Why does cream rise? is a question very often asked; and the reply is, "Because it does!" Cream is in reality in a fluid state when drawn, *i. e.*, when milk is at the temperature of the animal, or animal heat, the specific gravity of the caseine or cheese and the butter fats are practically equal, and therefore the fats remain in the milk, but, as the milk gets cool, there is a change in the gravities, the serums become slightly the heaviest, and the fats retaining their natural gravity, the cream rises, and the heavier portions fall. The separation of the cream is also influenced to a great extent by the condition of the food that produces the milk. In the summer, when the cows feed upon grass, or have at other seasons of the year succulent food like ensilage or roots, the caseinous part of the milk is less condensed, and so parts with its cream more readily, and we say in such a case, "How nice this butter is;" but when cream is long in coming and yet harder to free from the buttermilk, and by long friction has been beaten out of real resemblance to perfect butter globules, how "sticky and salvy this is," simply because of over-churning, and too great quantities of caseine.

Then when we set milk in the summer, unless we can get a very cool place, we remark, "how thin this cream is." Cream cannot rise unless we have a falling temperature to cause the caseinous element of the milk to grow denser, and as the temperature only falls a few degrees, only the larger globules can obtain gravity enough to separate from the mass. If we could in four or five hours gradually lower the temperature so that the air would take up this surplus heat of the milk until about 53° was reached, we should get a good thick cream.

It is from this very reason that scalding milk in summer is productive of more cream; it simply raises the warmth of the milk so much above the air in the milk room, that it gives a longer time for the cream to rise between the two extremes of heat and existing temperature. Then the heating of the milk, by a slight coagulation of the caseinous matter, prolongs the time of the milk remaining sweet, and affords time for slight changes of temperature in the air, which influence the milk slightly and release more of the fat globules. This explains why milk in the winter will raise more cream if it is taken after twelve hours and warmed up to 100° and then set back again to get more cream. The cream on the pan holds the heat in the milk much longer than without the covering, and the cold penetrating the sides and bottom of the pan, approaches the centre of the milk, and by the regular progress, liberates the exterior butter globules first, and the centre of the pan remaining warm, allows the globules slower to seek the surface.

In the cabinet creameries the same principle exists; a sudden cooling of the outside of the milk cans and the cold finding its way to the centre last, has afforded the globules escape, and thus by sudden chilling of the milk has made a wide difference between the specific gravities of serums and fats, and the latter per force must be driven to the surface.

There are traditions afloat that cold water turned into a pan of milk will assist the cream to rise. Such is a fact. Water has no affinity for butter oils, and cannot absorb them, but water will absorb caseine. So if water is put into the milk, it renders the caseine more fluid in quality, and unites with it, and also by increasing its specific gravity, assists the fats to rise, just as any oil will float upon water.

That it is a good thing to do, is quite another question. That some of the good German wives in Central Ohio do so dilute the milk and get good butter, cannot be denied, but as for the writer, he yet prefers to have the water outside of the milk, the thickness of a sheet of tin separating them.

Salt is also put into milk to give the cream a better start! And whether the person who so does understands the philosophy of the thing, is unknown. But the why of it is that salt, when it comes in contact with the milk, acts much the same as water and unites with the caseine, and causes it to be heavier and tends to promote separation between it and the butter fats. It is also an antiseptic and aids in the keeping of milk, and we should regard it as less harmful to good butter than water in the milk.

Carried a little further, this same salt principle becomes the greatest factor in assisting to free butter from the buttermilk. When the butter is in the granular or fine stage, if brine is added after drawing off the greater part of the buttermilk, the caseine and milk sugar is absorbed by it, and if the butter is floated and allowed to stand in the brine for some time, and then the brine is drawn out from below the butter, so as not to disturb it, it will be seen that the cheesy matter, or caseine, has settled to the bottom very largely, and that the last of the brine to run off will not be nearly as white in color as the first. The water and salt having absorbed the caseine, and increasing its gravity, it sank to its lowest level.

Why does not all cream rise? is best answered by saying that the cream globules vary greatly in size, and their coming to the surface is exactly aided, or retarded, by their size. The largest ones have the most volume, or oily contents, and therefore best overcome resistance, and so on down the scale of size until they become so small that they cannot overcome the resistance by a repelling lighter gravity, and so remain. In using ice, the milk is cooled so rapidly that the serums, in contracting, lose to a certain per cent. their resistance, and there is a greater rise of cream than when the cooling is slower, and fails by several degrees in reaching the low point of the creameries. The centrifuge goes yet farther in nice discrimination, and in the terrible whirl the gravities are forced yet wider apart, and there must be a more perfect separation of fats and their original enveloping fluids. When milk is scalded, a wrinkly cream rises, but it is not cream. Above a certain point the gravities of caseine and butter fats are reversed, and the "scum" upon the top is cheese and not butter, but as the milk cools and the cream comes up, the cream absorbs it, but it yet leaves its "shining" track behind. When milk is scalded, it should be stirred during the operation to avoid this "skin" forming, for it is likely to reappear in the butter as minute white specks.

Can Private Dairies Compete with Creameries?—Winter Dairying.

To the Editor of the Farmer's Advocate:

SIR,—I was much pleased with your editorial on "Private Dairies vs. Creameries," but I must take exception to one or two remarks. Your article would lead the reader to infer that the creameries were tending to close up, and do away with, the first-class private dairies. This, I think, is a mistake, and all those who have a good herd of butter cows and are making first-class butter need have no fear about the creameries driving them to the wall. The creameries may stimulate them to more care in making and taste in putting up and sending their butter to market or to their customers. If these dairies will put in the same appliances that the creameries use in the manufacture of butter, together with the same skill, they need have nothing whatever to fear. It is a well-known fact that no manufacturer can make the same quality of butter from cream of 50 to 150 different patrons that the same individual could make with the same appliances from the cream of 20, 30 or 50 cows all cared for and fed alike. "Competition is the life of trade," and an American paper thus defines the reason why creamery butter as a rule sells higher than dairy. "The secret probably lies here—it is better butter, and one prime reason for its being better is because the man who makes the butter does not own the milk and therefore has to compete with others and stand the criticism of those who furnish the milk. When a man has 50 to 100 persons wondering why he does not get the highest market price for his butter, he is very apt to get it. When the butter maker owns all the milk he is too easily satisfied, and has not the incentive that the man has who has the 50 to 100 people watching him and ready to criticize and perhaps kick him out if he does not get the top price in the market."

Let those who have a nice dairy and are prepared to make choice goods, study the wants of the trade and their customers, and not be afraid of investing a few dollars in neat, tasty packages, give their dairy a name, have some good muslin cloths neatly printed and a brand for the packages. Then let them go about the business determined to make the best butter in the Dominion, and they will succeed. In my opinion there is plenty of room for both creameries and private dairies, and the former are doing a good work. The only trouble is there is not enough of them. There is no reason why there should not be as many creameries as cheese factories. Creamery butter is worth 22 to 23 cents, and at the same time ordinary western and store packed butter is only worth 14 to 15 cents. Let any one sit down and figure for him or herself the difference in value between 15 and 22 cents on 20, 50 or 300 tubs (50 pounds each), and the difference will be surprising. The money that this Dominion loses every year on poor butter is something enormous.

Another very important point for the owners of dairies to take into consideration is winter dairying. Let any one compare the price of butter, summer and winter, for the past ten years and he will find that the price in winter will average 12 to 15 cents

per pound higher than in summer. With good warm stables and the necessary appliances, it cannot cost more than five cents per pound more to manufacture butter in winter than summer. In the States this winter dairying is being entered into very largely and with good results, and Canadian dairymen will do well to take the matter into consideration.

J. SEABURY.

How to Make Skim Cheese.

An Eastern writer claims that a fine palatable article of skim cheese can be made if the precautions are taken in season to retain the butter fats that naturally remain in the skim milk, and by careful manipulation of the curd, "work it" just right until it is in the hoop. The milk should be set at 80 degrees and the best of brine soaked rennet used, so that taint in the curd will be impossible from this cause. Only enough rennet should be used to bring the curd in forty-five minutes, and the milk must not be allowed to cool until perfect coagulation has taken place. The curd, when solid, or firm, should be cut fine, and then gradually raised in temperature to 100 degrees and kept at that point until the curd becomes elastic, but no acidity should be allowed to develop. The whey is then drawn partially, and then the curd should be suddenly cooled by turning on cold water. It is then put in the drainer, separated from its moisture, and salted at the rate of a "small teacupful" to each twenty pounds of curd. After a thorough working and airing, so that all gases are liberated, the curd is pressed and afterward cared for the same as the cheese. The process of making is recommended to be very slow, of gentle character, and no part of the milk or whey should be heated to impart warmth to the rest; but all should be heated and scalded alike, so that the quality of the goods should be even in character.—*Farmer and Dairyman.*

The chief regulator of the market value of butter is flavor, and this may be increased or diminished at the will of the herdsman according to his mode of feeding or managing his herd. Milk or cream may be actually and literally adulterated by a reckless system of dairying, and there is no reason why this should not be a crime as well as other forms of villainy. This would not be so particularly objectionable if the product of every herd were separately classified, for then the slovenly dairymen would soon be forced out of the business. We talk about weeding out our scrub cows, but this will never be accomplished till some of the owners be first weeded out by an improved method of education. Let consumers unite and inscribe "Flavor, Purity, and Uniformity" on their banner, and the desired results will soon follow.

The Maritime Provinces are waking up with regard to the importance of dairy matters, two Dairymen's Associations having been formed since last April, one in Nova Scotia and another in Prince Edward Island, and New Brunswick is likely to follow their example before long. This movement will give all the agricultural interests of the provinces a thorough shaking up.

Editor's Diary.

Cultivate seeing, tasting, and smelling in your dairy operations; the sense of touch is superseded by the thermometer. So there is no more danger in getting your fingers burnt, but your pocket is still exposed to the flame.

English farmers are importing peat moss in large quantities from Germany. They use it for bedding in their stables, and claim that it is very valuable as an absorbent of liquids, that when dry it will take up nine times its own weight of moisture.

Farmers should be on the lookout for seeds and nuts which ripen on our native trees at the end of September or in October. Nature's method is to sow them as soon as they fall off the trees. If at all convenient nature should be imitated, but if that cannot be done, the seeds and nuts may be preserved until spring in a box of dry sand, and kept in a cool, dry place.

Now gather up all the scrap bones you can find, put them in a covered receptacle with about three times their bulk of good unleached ashes, placing the bones and the ashes in alternate layers, keep the mass moist, and stir once a week. In six or eight weeks the bones will become so brittle that they can be crushed to pieces with the slightest blows. Such a fertilizer will contain all the elements of plant food, but will be very deficient in nitrogen, and will be superior to many of the superphosphates sold in the markets.

We have the authority of the Boston *Commercial Bulletin* for stating that the oleomargarine law in New York is a dead letter. It was supposed to have taken effect June 1st. "Oleo must go" was shouted all over the land and great efforts were put forth for the purpose of testing the constitutionality of the law. No less than \$30,000 have been wasted under the bill, and the moral, or rather immoral, effect in creating a disregard for all law or justice cannot be estimated in dollars and cents. When evil-doers have once the upper hand, our legislators should pause before giving effect to statutory laws; but they are paid for doing something, and they must make it appear that they are doing it. There is more than one dead letter law in our own statute books.

It is as natural for vegetation to grow on the fields to protect the soil as it is for hair to grow on the head. Those plants whose value we have not yet discovered, are called weeds. If one class of plants monopolize a certain spot, watch how soon it robs the soil of the food peculiar to it, and how another class will spring up. This is nature's plan of rotation, and every principle of rotation and manuring may be traced back to it. In this way we learn the mistakes which farmers make, not only in false systems of rotation, but also in continually applying the same kind of manure on the same plan of treatment. By varying the modes of treatment, manures can be rotated as well as crops; in fact manures could be rotated to such an extent that there would be little necessity in rotating the crops.

Prof. C. S. Sargent, of Harvard, speaks of the Scotch pine as follows: "It is the most valuable tree farmers can plant for screens and wind breaks about their fields and buildings."

Every farmer should have several of each kind of our indigenous nut bearing trees in his orchard or elsewhere on the farm. Also a few wild cherry trees should be found on every farm. They require little room, but give the boys much pleasure.

Last year 15,000,000 pounds of butterine were sold in New York. This was in reality lard, and as none of the consumers died of trichinosis, the New Yorkers are tolerably sure that their hogs are free from disease, but in order to make assurance doubly sure, they are repeating the experiment this year.

Before the hard weather sets in see that the fowls have a supply of charcoal, gravel, sand or ground oyster shells, etc., where they can help themselves at any time. These may seem rather indigestible food, but the poultry will make good use of them.

One important interest which should be fostered by some of the large exhibitions, has been overlooked. We refer to the encouragement of arboriculture or tree-planting. This might be accomplished by the awarding of prizes for specimens of tree-seeds, samples of the growths of timber or polished wood grown by the exhibitor. This interest might be fostered in many ways, and it is more deserving of encouragement than many other departments to which prizes and awards are given.

Most people know that cheese has double the nutritive value of beef, and that a cheese-carcass contains no bone or offal of any kind; but fashion rules us with tyrant hand. From one point of view it is not surprising that Canadians are not cheese eaters; that is, they send their best cheese abroad, keeping the refuse at home. Europeans find it to their pecuniary and sanitary advantage to eat cheese even under drawback circumstances; they will eat good cheese if they can get it—if not they will eat cheese anyhow. If we could keep our good cheese at home for one season, sending the inferior abroad, cheese-making would suddenly become the most profitable industry on the face of the earth.

Our knowledge of the best methods of destroying injurious insects appears to be yet in its infancy. We were too late in discovering that we were destroying useful birds; and with all our knowledge of beneficial insects, it is not unlikely that we are destroying many that should be cultivated. The question of how to destroy ants has often been asked, and fortunately about as often futilely answered. The Farmer's Review, an ably edited paper published in Chicago, relates cases in which colonies of ants have been planted in different parts of the garden and orchard, and the wars which they have waged with the insect enemies have displayed deeds of commendable heroism. Even giants did not awe them, and their success in taking prisoners was astonishing. But further investigations are required to ascertain the extent of their usefulness.

A woman at Saginaw City was poisoned by eating cabbage on which Paris green had been sprinkled to kill worms.

After all the fuss about the contagiousness of pleuro pneumonia, the new Department of Animal Industry at Washington, under the direction of Commissioner Loring, is about to institute a series of experiments with the view of ascertaining whether the disease is contagious or not. Surely the Department does not intend to create work for the purpose of spending the surplus revenue of the people.

Owing to the late breaking out of pleuro-pneumonia in different parts of the United States, and from the belief that diseased cattle are moving west for breeding purposes, the Government have prohibited the importation of American cattle into Manitoba and the North-western Territory of Canada under heavy restrictions and penalties. It is sincerely to be hoped that the provisions contained in the order will be strictly enforced.

Most farmers and gardeners can discourse intelligently on the influence and value of mulch for different kinds of crops. Nature's mulch is snow, and if it could be distributed evenly over our fields, nature's laws would be obeyed. By the inauguration of wire fences the first right step has been taken, but it is far from being the last. It is not the freezing so much as the thawing that does the mischief. The next step should be the planting of belts of trees in every locality, in situations where they will afford the greatest protection. There is cash in it besides; it will not only enhance the price of the land, but also create the foundation of our future supply of timber, of which the country is fast becoming denuded, and the first farmer that starts will have the advantage of all his neighbors. Let there be but one go-ahead farmer in each township and he will soon put his neighbors on their mettle.

There seems to be no earthly means of preventing fraud in countries where large tracts of land fall into the hands of ranchmen and other grabbing speculators. In the Western States there are myriads of land sharks, corporate and incorporate, who are lords of all they survey over millions upon millions of acres of land which might have been settled by millions of happy and prosperous families. During the last year the commissioner has made investigations in no less than seventeen States and Territories, and his report shows that nearly 4,000 fraudulent entries have been made, and cases are recorded in which honest and peaceful settlers have been driven from their sacred heritage at the muzzle of the rifle. And yet the Union is swarming with railway land bureaus, and other agencies created for the purpose of inducing farmers to "go west" to get into the rapacious maw of these all-devouring desperadoes. Unless some statesman soon takes hold of the helm of state, the people will be burdened with taxes for all time to come, to meet the costs of investigations without an attempt being made to suppress the iniquities. If the farmers knew their might, and had any regard for themselves and for posterity, they would put their iron heel on the huge and hideous monster and summarily dispatch him.

Correspondence.

NOTICE TO CORRESPONDENTS.—1. Please write on one side of the paper only., 2. Give full name, Post-Office and Province, not necessarily for publication, but as guarantee of good faith and to enable us to answer by mail when, for any reason, that course seems desirable. If an answer is specially requested by mail, a stamp must be enclosed. Unless of general interest, no questions will be answered through the ADVOCATE, as our space is very limited. 3. Do not expect anonymous communications to be noticed. 4. Matter for publication should be marked "Printers' MS." on the cover, the ends being open, in which case the postage will only be 1c. per 4 ounces. Non-subscribers should not expect their communications to be noticed.

Voluntary correspondence containing useful and seasonable information solicited, and if need, will be liberally paid for. No notice taken of anonymous correspondence. We do not return rejected communications.

We do not hold ourselves responsible for the views of correspondents.

SIR,—Will you kindly answer the following through the columns of your paper. Can maple trees be transplanted in the fall with success, and if so, when is the proper time? G. L. G.

WENDIGO, ONT. [In a favorable autumn maple and other deciduous trees will thrive as well when transplanted in fall as in spring. Plant as soon as the leaves fall off the trees; pull off any withered leaves that may remain on. If you are planting many trees, plant some this fall and dig holes for others to be planted in spring, scattering the soil from the holes well about, so as to receive the full benefit of the frost and rain. You will then find out for yourself which is the best time for transplanting.]

SIR,—I have a horse that has a dry husky cough mornings while feeding; could you give a cure? 2. I have also another that fills his mouth so full that he slobbers his oats; what will prevent this? F. H.

DAKOTA, U. S. [1. Your horse has a chronic cough. Dress his throat externally with a sharp ammoniacal liniment, and give him the following dose night and morning. Nitrate of potash, 1 dram; sulphur 1 dram; powdered digitalis 1 dram. 2. Mix from one to two quarts of dry bran with his oats every time you feed.]

SIR,—I am well pleased with the Advocate, and I say that it gives more value for a dollar than any money I ever spent. It's what every farmer should have and read. J. S.

PREDLTON, ONT.

SIR,—Great care should be taken in selecting thorough competent and impartial judges at our agricultural fairs especially in the stock departments. It is often the case the prize animals do not get the prizes due them, owing to the incompetent or impartial judges; also no doubt in many cases the judges become careless or have not the time, as their own affairs call their attention. Perhaps by selecting competent judges in due season, and by amply rewarding them for their labor, would give greater satisfaction and justice to all. J. H. S.

LOGAN, IND., U. S.

SIR,—If it will have any effect, I want to protest against the prevailing system, practiced by farmers and others, of exhibiting for prizes goods that are not raised by themselves. The practice is getting so common that some exhibitors make a special business of it. If the directors of exhibitions cannot prevent the evil, the question of abolishing prizes should be discussed at once. R. D.

THAMESVILLE, ONT.

SIR,—In your September number you ask the question, "Does wheat turn into chess?" I have been taking evidence on that question for some years, and although the scientific are against me, I find the weight of evidence in favor of the answer, "Wheat does turn into chess." When I see a piece of new land sown to wheat perfectly free from chess, produce chess, and only chess in the low spots where the wheat met unfavorable conditions, and good wheat on the higher portions of the field, more suitable for that grain, I find it impossible to believe anything else. Is it not easier to believe that chess is degenerate wheat, than that it is a plant that only grows where wheat dies? Wheat seems to be the product of high cultivation, the food of civilized man, not found wild anywhere; it will not grow wild, and requires the continuance of the same high cultivation that produced it, to keep it in existence. "By the sweat of your brow shall you eat bread." Is it not likely that chess was the original wild grain, that under extraordinary favorable conditions it produced wheat, and that like any other highly cultivated thing, it is subject to rapid degeneration under gross neglect? This will happen to our best bred cattle, sheep and hogs, to all our most delicious fruits and vegetables, our most beautiful flowers, even to man himself, if the laws of his being are neglected or broken. We see it too often. S. G.

WOLFE ISLAND ONT.

SIR.—I saw in your September number a head of wheat which had a spikelet of chess growing out on one side of it, which is proof enough for any one that wheat will turn to chess; but there is a class of farmers that don't believe wheat will turn to chess. I have made it my study for a number of years about wheat turning to chess, and I am satisfied that wheat will turn to chess. I have selected the best seed wheat that could be purchased and sown it on a piece of new land which never had a crop on; when I harvested there was plenty of chess in it, especially where it was low and wet, and on the high land there would not be one head of chess to be seen, and all the low wet places it would be all chess. Now I would like to know where the chess came from, for I did not sow it, neither was it in the land. I took a piece of land which was summer fallowed and sowed chess on it and it did not grow chess, it grew a coarse grass. So it is very seldom chess will produce chess, but when wheat is winter killed or water stands on it until the properties of the wheat are gone, but with still enough of life to grow, it grows chess. I have found growing in a stool of wheat one stock of chess in the same stool.

DEXTER.

N. H. R.

SIR.—I purpose purchasing a white boar of some breed. Please describe the Suffolk of the large breed. Is it a desirable kind for general farm use? Or do you prefer the large York, or Chester White, or small Suffolk, or small York? Would you describe the white Lincolnshire? If of value, why? In what respect is there any improvement? Are those named above established breeds, like the Berkshire? Is the Middle York equal to the whites named above?

LANES.

[The improved Suffolk is a neatly formed animal, with compact, long, cylindrical body, short legs, short, small head, fine hair, very fat cheeks, and is a rapid maturer. This breed has of late become very popular. The "Chester White" is large, strong, and hardy; and its chief characteristic is its adaptability to farmers who are not well skilled in the feeding and management of pigs. The Lincolnshire is a very large, long-legged, weak-jointed, coarse animal, and is out of the question for your purpose. The "Middle York" is the most useful and popular of the white breeds, uniting the good qualities of the large and the small York, but it is of modern origin and not yet firmly established. The improved Suffolk and Chester White are also modern breeds. The largest experimenters of the best breeds of pigs declare that they cannot decide which is the best breed, everything depending upon the system of management; and the weak points of any breed are made up by other strong points. If you are not a skilled manager of pigs and are not acquainted with their history and breeding, you had better choose the Chester White; otherwise you may succeed better with the others herein named, or with the Berkshires. There are inferior kinds of Chester Whites; get the best.]

SIR.—Last May I planted one grain of Egyptian spring wheat and it produced sixteen heads; four heads I lost and the remaining twelve I cleaned out and they produced six hundred and ten grains. Seeing that there has been quite a controversy in the ADVOCATE with regard to the yield of fall wheat, I thought this might be of some interest to your readers.

SOUTH MIDDLETON, ONT.

J. F.

SIR.—I have an acre of white hullless barley. If you know there is any demand for it, I think it will take the place of pot barley. It can be grown in this country with success, averaging 35 to 40 bushels per acre. Please answer in your next issue.

SIDNEY.

T. B.

[The best way to find a market for your barley is to write to the best seedsmen. You will find their advertisements in the columns of the ADVOCATE from time to time. A still better plan is to advertise it in some first class agricultural paper, but the quantity you have is probably too small to make advertising pay unless you want to continue growing it for seed. The sample you send is very good.]

SIR.—We have a piece of three year old stubble under summer fallow. How much wheat do you consider necessary to sow to the acre? Yours respectfully,

LINTRATHAN, MANITOBA.

J. B.

[All depends upon the seed, the character of the soil, and the depth you sow. If the seed is fresh and has strong vitality, less will be required than if old seed is used. A rich soil requires less than a poor soil, and more seeds will germinate if they are put in at a uniform depth (as with a drill, or sown broadcast on an evenly plowed field), and not too deep. Taking these circumstances into consideration, you may sow from five to seven pecks per acre.]

SIR.—Would you inform me through your valuable paper how to cure a sore neck of a horse which was sore all summer and part of last winter. It is where the collar rests. I tried a good many cures, but failed.

BRIDGEPORT.

J. E.

[It is a stiffness that is wrong with your horse's shoulder. Move the sore place, with any diseased flesh, removed

with the knife, being careful not to leave any of the diseased part; then treat it as a common wound.]

SIR.—1. I have a weed in one of my fields which is causing me considerable trouble (I send you a root of it). I noticed it when I came here five years ago. I had the field in wheat the first season and about two or three rods by the fence was overrun with it; it wound around the straw so thick that the grain lodged. The next two seasons I mowed the field and did not notice it. Last year I had it in pease and found it was spreading. This year I have it in hoed crop, and have hoed it five or six times, and now it is worse than when I first commenced hoeing and is spreading fast. I dug down about two feet, but could not get to the end of the root. What can I do to kill it? 2. I have some swamp land which I intend underdraining. It is heavy clay subsoil. How many rods apart should the drains be? Should the branch drains be on a level with the main drain or a little higher? 3. I have a heap of barn yard (not stable) manure which I intend to put on a field for the next crop. When will be the best time to spread it, now, and plow it in, or put it out after the land is plowed? If the latter, when is the best time to spread, this fall or next spring?

CONSTANT READER.

[1. The weed you send is called bind weed, the *Polygonum convolvulus* in botany. With regard to the destruction of weeds, read our answer to W. G., September issue. 2. For thorough drainage in clay lands the distance apart varies from 90 to 110 feet, according to the stiffness of the soil and the depth of the drain, the deeper the drain and the more porous the soil, the farther the distances. It is better to dig deep (say 3½ feet) and have wide distances, than to dig shallower, with closer distances. Branch drains should have some fall. 3. If the manure is not well rotted, put it out now and plow it in; otherwise it may be spread on the plowed land this fall, if you intend to plow the field again in the spring. If the manure is well rotted, there will be a loss in keeping it in the yard all winter, even if it is kept under cover. Manure should never be left in heaps. If you put it out this fall, by all means spread it. When the soil is stiff, a coarser manure may be plowed under than when it is porous. In these remarks we go on the presumption that the land is level enough to prevent the substance of the manure from being washed away.]

SIR.—I would like if you or some of your correspondents would give me some reliable information regarding tile drains, through the ADVOCATE. I wish to know: 1. What distance they will work and keep themselves clean, the fall of the land being 1 foot in 50 rods, and the outlet 3 feet deep? Will they work for 200 rods? 2. What size of tile would be required to carry the water that would fall on the land in that distance, there being no head water?

LOGRRAIT, ONT.

S. M.

[1. The distance a drain will work depends upon the size of the tile, a long drain having less carrying capacity, other conditions being equal, than a short one. Two hundred rods is a long stretch, and should at least have three mains. 2. The size of the tile depends upon the area to be drained, the maximum rain-fall, and the quantity of water to be removed. The surplus water depends upon the character of the soil, that is, whether it is stiff or porous. You will therefore see that we can give no arbitrary answer to your question. The standard for the maximum rainfall is considered to be one inch of rain in 24 hours, and it is necessary to provide for the removal of the excess of this quantity before it stagnates sufficiently long to prove injurious to the roots of the crop. Here also the depth of the roots must be considered. On the average of soils and seasons it may be laid down as a general rule that one half of the rainfall will be carried away through the drains. By knowing the average rainfall, the character of the soil, and the depth, fall, and distances of the drains, calculations can be made as to the size of the tiles required. The following calculations have been made, which may be some guide to you: Drains not exceeding 500 feet long will drain five acres with a 2-inch tile; a 3-inch tile will drain five acres, providing the length is not more than 1000 feet. These figures are under average conditions and calculated on the basis that the drains are three feet deep and the fall not less than three inches in one hundred feet. On the same basis a 4-inch tile will drain twelve acres, and a 6-inch forty acres. Your land having very little fall, larger tiles are required than under a greater fall. If your soil is retentive, and the lengths of your drains not too great, a 4-inch tile may do after it has worked a few years, if the tile bed is smooth, but a 5 or 6-inch would be far better. You can make no mistake in putting in too large a tile, except as to expense. If you think these answers too indefinite, please send us more particulars and we shall give you a more definite answer.]

SIR.—I would like if you would give a few hints on feeding cattle for beef. I have quite a quantity of hay

and it is only worth \$6 to \$8 per ton here, so I thought of trying to feed it up. I would have to buy my cattle. I would like a few hints on buying and feeding, as I am young and not experienced. 2. I would also like to see a piece in the ADVOCATE on tile drainage; about laying the tiles, how it is done, and if they will drain water cut of land all along the whole length of drain or just at the head. For instance, how can water get through the tile, say 10 rods from head? I have some low places on my farm where water lies till too late for spring grain, and to make open ditches they will be in the way. What shall I put in hole of head of drain to keep tile from filling with dirt?

W. H. P.

FRANKFORD, ONT.

[For buying steers you will find the information required by reading our article on "Standard Points of Beef Steers" in another column. With regard to feeding, the rules adopted by practical feeders are so varied that no definite guide can be given. If your hay is good and well mixed with clover, you will not require much grain. If your steers are grades from any of the beefing breeds, and are two years old or over, there is more profit in high than in low feeding, while if they are younger and growing rapidly, and especially if they are not well-bred, you should feed moderately. For moderate feeding a good daily ration would be: 1 part grain, 4 parts roots, and all the hay the animal will eat. You may take 9 lbs. of grain as a standard, which will give 36 lbs. of roots, but this quantity may be somewhat more or less according to the size of the steer. For high feeding add to the above ration nearly half as much bran or oil-cake as grain, or, say 3½ or 4 lbs. daily, varied according to the weight of the animal. But the rations should be changed every three or four days. Bran and oil-cake having nearly the same feeding value, one may be substituted for the other; oats may be substituted for barley, but a less quantity of peas must be fed. If you have different kinds of grain, they are better mixed as thoroughly as possible. The grains should be ground, and some of our best feeders cook or steam some of the foods for a change when they have the facilities for doing so. Remember that oil-cake and bran are laxative in their properties, and the quantity must sometimes be regulated according to the state of the bowels. By attending to these general directions and studying the likes and dislikes of the animals, you will succeed. 2. It would be impossible for us to give you full directions here just now; you must either get an experienced drainer to lay the tiles or follow the minute instructions which appeared in a series of articles in different numbers of the ADVOCATE last year. A tile drain will drain the land all along its length to a distance of 50 to 60 feet on each side or from the head on a light soil, and 40 to 50 feet on a heavy soil. The water goes through the tiles as well as through the joints. No filling is required to prevent clogging of head. In soft land the ditches should be left open a year or two in order to let the soil sink firm, else many of the tiles are likely to become displaced.]

SIR.—1. I have grown potatoes on part of my land for five consecutive years without applying any manure, the ground being naturally rich and heavy. I intend to manure it next spring, and plant potatoes again. As the soil is wet (there are lots of springs), though it is well drained, I think the best fertilizer would be lime. Will you have the kindness to inform me, in the next issue of the ADVOCATE, how to apply the lime and the proper quantity wanted per acre. Is it better to apply it in the drills or broadcast and plow it? 2. Can I grow turnips where I have grown parsnips and mangels the year before?

PRIZE ROAD, QUE.

L. L.

[1.—Lime is only used on soils containing an excess of vegetable matter for the purpose of aiding decomposition and neutralizing the organic acids, and on stiff clays for the purpose of liberating the mineral constituents for plant food. In the latter case it should be used in very small quantities, but from your description of your soil, we cannot say whether a small quantity would be beneficial or not. A good deal would depend upon the season, and your soil being wet we are strongly inclined to believe that lime would be more injurious than beneficial. However, you can easily make a small experiment. Thorough tillage has about the same effect on heavy clay as lime has. Lime is not a manure, as a sufficient quantity for plant food is hardly ever lacking in the soil, so that, although it may make large yields for a few years, it expedites the exhaustion of the soil. Lime should never be drilled in; it should be broadcasted, and thoroughly mixed with the soil by harrowing or other light tillage. Rotation of crops is the fertilizer you need. 2.—Turnips being a shallow rooted crop, will thrive after parsnips or any other deep rooted crop; but it is usually advisable to rotate with some kind of grain, unless you manure well or want to get the land thoroughly clean.]

Family Circle.

"SISTER EYES."

A COMPLETE STORY. BY THE AUTHOR OF "SO BLUE: THE STORY OF A GIRTON GIRL," ETC., ETC.

CHAPTER THE FIRST.

There are many girls and women nowadays who will sympathise with Katharine Ackroyd as she sat one afternoon apparently engrossed in an instructive book, but in reality chafing against the monotonous littleness of her existence, and seeking the monotonous littleness of the enigmas offered by her presence in the world.

Katharine was seven-and-twenty now, and had for many years led the tranquil, easy life of the eldest daughter in a well-to-do house. Nothing was required of her more than that she should play her part pleasantly at home and in society; should perform certain household duties, and take an interest in those about her; should go out calling pretty often, and be ready to entertain guests; should sing when she was asked, keep up her drawing, and always look ladylike.

True, there was marriage as an alternative; but Katharine's love-story was a thing of the past, and she had never cared for any man since a certain Godfrey Hale had ceased to visit at her father's house.

But there was one channel of useful activity in which her energies might find full scope—depriving needier sisters of their difficult earnings. A longing, of old standing, to lead the life of a hospital nurse had been asserting its sway of late, and this afternoon Katharine was slowly screwing up her courage to the point of trying to overcome her father's objection to her leaving home.

At last, when dessert was put on the table and the servants left the room, Mr. Ackroyd broke silence. "Katharine," he said with a faint smile, "shall I satisfy their curiosity?"

The girl looked at him beseechingly. "If you will, father, but don't—don't—decide against me."

He laid his hand on hers across the corner of the table and held it while he continued.

"Wife, Katharine wishes to leave home—she cannot be

contented with us. Hush! Say nothing till I have finished" (for Mrs. Ackroyd had started in alarm). "She has given me a very simple, honest account of her present life, and it does not seem to offer much scope for the use and development of her best faculties. I, therefore, consent to her turning hospital nurse."

It was a very brief, abrupt speech, but Katharine knew what it must have cost her father, and a cry of joyful gratitude burst from her.

Up to the moment of their coming in to dinner he had refused to give her any definite answer, and she could not tell from his manner what his intentions might be.

He had yielded, and there was no impediment between her and the achievement of a position in which she might be of real use.

She hardly noticed the wonder and suppressed admiration of her sisters, nor could even Mrs. Ackroyd's tender distress quench her delight in the freedom accorded her.

From this moment she was not merely a young lady; she was a woman with work to do and a purpose in life.

CHAPTER THE SECOND.

I do not propose to enter into any detailed account of Katharine's life during her first three years at St. Nathaniel's Hospital. Suffice it to say that the hard work brought with it health and happiness, and that among the many ladies busy there as probationers and sisters, there was no more general favorite with patients, doctors and nurses.

Her earnestness, energy and ability strengthened her position day by day, and at the end of her three years' training a ward was at once assigned to her. As head nurse of the eye ward, with the new title of "Sister Eyes," and a number of patients under her own immediate charge, she was more completely content than she had ever believed possible.

Her cosy little room adjoining the ward was an additional source of pleasure, for here from time to time she could indulge in long talks about home with her mother and sisters.

In no way had she slipped out of the family circle, for a deep affectionate nature like hers does not drift easily away from its early moorings. Rather she drew her sisters after her; all of them visited at the hospital, knew her patients, and interested themselves in every detail of her work.

Then, unexpectedly, in the midst of Katharine's new-found tranquillity, entered that fertile element of disquiet—love.

It was at the sisters' dining-table one day that the first warning of danger came.

"So hear," remarked Sister Casualty, "that the new oculist has been appointed at last."

It may perhaps be as well to explain that at St. Nathaniel's no sisterhood exists; but the head nurse in each ward is called Sister, and further distinguished by the name of the ward.

"Yes," replied Katharine; "a Mr. Hall. Does any one know anything of him?"

"You have mistaken the name," said Sister President, "It is not Hall, but Hale—Godfrey Hale. He was house-surgeon here when I first came, and always specially devoted to your branch."

One or two of the older sisters joined in and spoke in warm praise of Mr. Hale's character and ability, while Katharine sat by in a maze of alarm and dismay.

Godfrey Hale! How would they meet? As strangers? As mere acquaintances? Or with the memory of something more than acquaintanceship tingling their manner between them? There had never been any explanation of her wrong still make friendliness impossible? Must she still endure the hardly-concealed disdain with which he had last parted from her?

Yet even that would have been more tolerable than what actually occurred. Her patients were hardly put straight next morning before the house-surgeon came in and informed her that Mr. Hale wished to make a preliminary inspection of the ward.

A minute or two later the oculist entered, was introduced to "Sister Eyes," and, without the faintest movement of surprise or recognition proceeded to put to her a few necessary questions about the patients.

If Katharine had remembered that to any one coming in from the light the eye ward seemed at first to be in almost complete darkness, she need not have felt so deeply hurt at being unrecognised; but as it was, she found it very difficult to force down her womanly disappointment and answer quietly and clearly in her purely professional capacity.

For her part, she would have known him anywhere. It was the same slight, wiry figure, the same keen, sensitive face, only the expression was changed; it was that of a man whose interest lay wholly in intellectual things.

"This is your most serious case, Sister," he said presently, laying his hand gently on the head of a poor fellow who had been accidentally shot in the eye. "I should like to alter the treatment a little."

He gave her a series of careful directions, and then quitted the ward, little dreaming what a sore heart he left behind him.

Next day he came again, quite unexpected by Katharine, as it was unusual for the visiting physicians to see the patients two days running.

"I have felt anxious about the case," he said, going straight to the bedside of the man mentioned above. "Did he sleep at all?"

"No," said Sister Eyes; "he was delirious with pain the greater part of the night."

"Ah! I was afraid of that."

He made a second careful examination of the sufferer, and again changed the prescription.

"I hope that will relieve the poor fellow," he said compassionately, "and you will remember about the bandaging, Sister."

"Certainly," Katharine was more self-possessed now, and she raised her grave eyes steadily to his.

manner changed and stiffened: "I beg your pardon, Miss Ackroyd; I forgot the distance of time and circumstance that separates us."

She withdrew her hand with a quiver of silent chagrin. Would he never give her the chance of vindicating herself? Must they meet week after week on the same terms of forced coolness and alienation?

Something of the same sort passed through Hale's mind. Katharine's face, not perhaps so pretty as of old, but more thoughtful, sweet, and womanly than ever, brought up a flood of tender memories and urged him to put out of mind the injury he supposed her to have done him.

"Let us be friends," he said gently, at the end of an embarrassed pause. "This is no place for the remembrance of old wrongs."

"You know, then, now how deeply I was wronged," said Katharine slowly.

"You?" he exclaimed. "I do not understand you."

"Perhaps not," returned Katharine with a shade of bitterness in her low voice; "but that is not my fault."

They were standing together at the door of the ward, and out of ear-shot of the patients, yet Hale could not feel at his ease.

"I must speak to you again," he said hastily; "but not here—not now. Cannot I see you alone somewhere?"

She shook her head.

Hale turned as if to go, then came back. "I cannot wait," he said impatiently; "tell me how it all was."

It did not need many words. They had been separated by the treachery of a mutual friend, a man whom Hale had wholly trusted. The oculist saw it all now, and realized what Katharine must have suffered.

He went away full of troubled thoughts. At the time he had thought it his duty to wrench himself away from her, and by dint of long years of determined persevering to his profession he had schooled himself to forget her—or, at least, to believe that he had forgotten her.

Now his hardly won peace of mind was disturbed as here had been. Disquiet and unrest took possession of them both. Both knew that their old feelings had come to life again, strengthened, not weakened, by the lapse of time; both wondered what this unlooked-for meeting would lead to.

At last one day Hale looked in at an unusual hour to see the patient he was specially interested in, and they found themselves practically alone in the darkened ward and among the sightless patients.

"Doctor," murmured the man whom Hale had done so much for, "you are so good to us poor folks with bad eyes, you ought to have a home of your own for us, with Sister for head nurse."

The oculist flushed up nervously. On a man of his shy, diffident temperament, the perception that this was an opportunity not to be lost had the effect of making speech difficult. There was a moment's awkward silence, and then he drew Sister Eyes aside.

"What do you say, Katharine? Will you accept the post?"

"Does it exist?" she asked wonderingly.

"It shall exist, if you will give me courage to embark on the enterprise. I mean—I mean, Katharine, would you, as my wife, help me in the management of some such home if I could work its institution?"

Would she accept the double happiness of being his wife, and carrying on the labour she had given her whole mind to for so long! Her answer need not be recorded.

Get Your Money's Worth.

In shopping, my dear madam, try to buy things of real value, even if you buy less than you fancy you require. Only rich people can afford to buy bargains. Never buy a cheap or poor material made up as a good one, as it will only last a third or fourth of the time, and never look as well. A cheap material tempts to excessive trimmings to cover its poorness, while a good stuff will be a continual pleasure from its own excellence.

A good dress-material may be worn for years. It may be soiled, turned, dipped, made-over, and at last given away, while a flimsy one is unfit even to give away, after a little wear.

To trimmings the same principle will apply. A woman will often spend in two or three years, on fringes and fancy trimmings, an amount that would purchase real lace sufficient for a lifetime.

The fringes wear out, fade, and are good for nothing in less than a season, while the lace would last out her time and then go down to her descendants.

Yet she says she cannot afford to buy real lace. Fancy-stuffs in dress goods should be looked upon with great suspicion, especially if they present an unusually fine appearance for the price.

It is safer to keep to standard materials of which you have proved the durability, though even those will vary in different years.

If ladies would insist on obtaining durability rather than cheapness, the manufacturers would soon rise to the demand, and would improve the style of their goods as fast as they are deteriorating them at present.

Minnie May's Department.

MY DEAR NIECES.—Once more the much talked of Western Fair has come and gone. Doubtless many of you visited and already know more than I could tell about it, though time and space allowed; but many other nieces live too far away to come for that purpose alone, and for their sakes I should be glad to

others being a cash prize of ten dollars for the best collection of berlin wool work ; a painting valued at fifteen dollars, for the best collection of fancy work of all kinds ; and another ten dollar prize for the best pair of worked slippers; thus offering greater inducements than ever to intending exhibitors. The whole Fair proved most interesting as well as instructive.

Now a few words about the fall and winter fashions, as we suppose many of our girls have dressmaking to be done. Woolen goods are still as fashionable as ever; in fact, a pretty cloth costume is more fashionable for street and church wear at present, than richer goods. The leading colors are plum, prune, dahlia, heliotrope, golden browns and red, the latter playing a conspicuous part, and is seen both in vivid and dull hues.

Velvets remain very popular for dresses, wraps and trimmings. The vest, high collar, cuffs and either borders or panels being the parts of the woolen dress where velvet is most effectively used: choosing, of course, either plain velvet or small figures, as large figures are reserved for outside wraps exclusively, the latter garments being trimmed with a border of fur, feathers or chenille. Velvet ribbons of unusual width are imported for bordering dress skirts, for belts and sashes. Several rows of narrow velvet ribbon will be much used, as also braids of various kinds.

Owing to the heavy fabrics used for winter costumes, the straight draperies are favored. Round waists are popular in all materials, and Jerseys are not to be discarded.

Dame Fashion ordains for the coming season brilliant colored hats and bonnets, the most striking being red, on velvet and plush, with feathers to match. The small bonnets, as also the round hat with high crown and narrow brim, similar in shape to those worn during the past summer, are to continue in favor through the winter; feathers, including the wings and breasts of wild birds, being the most suitable trimmings. The ornamentation, whatever it be, is placed directly on top and in front. Cloth bonnets and capots to match the wool costumes will be much worn, proving an economical fashion to

many, as any deft-fingered girl can, with a little skill, manufacture a becoming head covering, and save the milliner's bill.

FIG. 1.—Shows a neat and stylish walking costume, which has no trimming except tucks, so much seen on woolen dresses; the drapery is simply hemmed and hangs straight at the back.

FIG. 2. A suit for boy from six to ten years

of age. The coat is sacque shape fitting slightly to the figure in the back and cut away in front. FIG. 3.—Child's costume, suitable for child from two to six years of age. A kilted skirt,



FIG. 1.

write of all the wonderful things the rest of us saw there.

The display in the Ladies' Department was very large, but few novelties. Painting on china, silk and velvet, embroidery, bead work, braiding, lace work, berlin wool work, wax work, crocheting, knitting, plain sewing, etc., were all well represented. Besides the regular prizes, there were several extras offered, among



FIG. 2.

the waist cut away in front showing a vest of another color or material.

The prize of a *Silver Napkin Ring* with winner's initials engraved, has been awarded to Miss Lizzie Gibson, of Bloomfield, Ont. We now offer a *fine Meteor Alarm Clock* for the best



FIG. 3.

essay on "Kitchen Economy," and owing to increase in the number, as well as the ability of our competitors, we deem it advisable to allow more time both for your writing and

shape fitting slightly
cut away in front
suitable for child
e. A kilted skirt,



showing a vest of
in Ring with win
been awarded to
mfield, Ont. We
on Clock for the best



" and owing to
as well as the
deem it advisable
our writing and

our decisions; therefore will give until November 15th for the above essay; but all *must* be in by that date. The decision will then be given in the December number instead of November, when we will give another subject for the January number.

MINNIE MAY.

Work Basket.

Embroidery in every style and variety is very popular, that called Japanese being the latest. It consists of squares, each bearing a Japanese figure, or wonderful flowers, birds and insects worked in dazzling, well-shaded colors.

Braiding is again used for dress-trimming as well as for various fancy articles.

Drawn work is a simple and effective style of decoration. It is used for large collars, tidies, napery, the ends of towels, and ordinary bed linen.

Pretty table covers are made of canton flannel, with a pretty stripe of cretonne to form the border. Finish the edge with worsted fringe.

Now is the time for preserving autumn leaves for winter use, which are used for winter decoration. They may be used in bouquets with dried grasses, etc., or formed into pretty graceful sprays and fastened on a light wall. A pretty effect is gained by fastening a piece of thin lace net upon the wall between windows or on the door panel, providing the paint is white or some light color, and then decorate with autumn leaves and ferns by passing the stems through the meshes of the lace. Another way to use the dried leaves is for ornamenting tables, screens, blotting books, boxes, etc. The article to be decorated can be painted black by using Brunswick black to stain the wood or Brunswick black and turpentine mixed for a brown ground. Arrange the leaves tastefully and gum them on, being careful to cut away all the under parts of the leaves which will be hidden by others above, as too many thicknesses will make an uneven surface and give an ugly appearance to the work when finished. After the leaves are all on, varnish the entire surface carefully.

COVER FOR MUSIC STOOL IN CROCHET.—Crochet 6 stitches and unite the chain, and into each stitch put 2 double crochet. You have then 12 stitches; into each put 2 double all round again, making 24 stitches. You now begin the pattern, which is worked throughout in treble stitch, and only one stitch is worked in each loop except when directed.

1ST ROUND.—Work 2 stitches, then 2 chain, 2 more stitches, 2 chain and repeat all round.

2ND ROUND.—2 stitches into the first of the 2 of last round and 1 in the other, 2 chain and repeat all round.

3RD ROUND.—2 stitches, into the first stitch, and one into each of the other two, 2 chain and repeat all round.

You see now that you have a circle in twelve gores, and these gores increase in width each time round. The two chain stitches which separate the gores, must always be directly over each other. This centre can be made as large as desired, and if the two stitches made in the first stitch of each gore do not keep the work flat, then make two in the last stitch of each gore also; finish with a simple border of heavy fringe.

CAP BASKET.—A basket of this description is very useful for elderly ladies who live in the

country and carry their caps when dinnig out, and it is also useful for carrying fancy work, etc. A round is formed of cardboard about eight inches wide, covered with Java canvas, plush or velvet, upon which is worked in embroidery or cross stitch a pretty vine, and then lined; then make a bag of silk or satin and fasten on either side of the round and draw the ends up with a silk cord.



The above cut illustrates a Novelty Rug Machine, which is employed for making rugs, tidies, door mats, mittens, hoods, etc. It is very simple in construction, and is worked with ease and rapidity.

PRIZE ESSAY.

True Politeness.

BY MISS LIZZIE GIBSON, BLOOMFIELD, GALT P. O., ONT.

What is it? Not merely etiquette or conventional good manners. They are artificial, and can be defined, classified, designated, and may cover a cold, ungenerous, unkindly heart.

But "true politeness" has its root in the heart, and springs from an innate regard for the rights and feelings of others, and is to a person what perfume is to a flower, something so sweet and charming which is necessary to make even the beautiful lovely. Its very essence is sympathy.

"To learn to put ourselves instinctively in another's place, is the grand secret of 'true politeness.'"

A true Christian ought not to be anything but polite, though there are too many gruff and uncivil members in our churches; but how can anyone be so who has taken the "Gospel of Christ" into his heart—the very essence of that Gospel being love, and who is under obligation to obey the Divine commands to "be courteous," "be kind one to another," "esteeming others better than ourselves," &c. &c., and which teaches us to be respectful to our superiors, kind and considerate to our inferiors, and brings to us the highest graces of moral and social culture.

"True politeness," which embraces all good manners, is not confined to the rich or poor, to the mansion or cottage, to any one class or sect of people.

Money will not buy it, so all may possess it. Books on politeness are beneficial; graceful and

attractive demeanor well worth our study, anything indeed that will enable us to deport ourselves in an agreeable and pleasing manner, and teach us to be truly polite in spirit.

If we have that "true politeness" we will exercise it at home as well as abroad, in the kitchen as well as the parlor, to parents, brothers, sisters and servants, as well as to friends, relatives, and those we meet in society.

How truly beautiful all our homes would become; what little paradises on earth we would enjoy if father and mother were always truly polite. The children would naturally grow up so, for they pattern after them. The impatient word would be checked and replaced by kind and tender ones. Apologies would be given and accepted. The "golden coin of courtesy" would be always bright from use.

How sweet are the "I thank you," "You are so kind"—thrice sweet from those dearest to us, and all the little attentions which constant association in every day life calls for, and which tells so mightily on the heart and has its strong refining influence on our lives.

The influences of such a home will perpetuate themselves in the lives of the children. The gentle grace of the mother will live in the daughter. The nobility and courtesy of the father will be traced in the son when his place will be filled by him. No matter how lowly that home, if thus garnished with sweet smiles and tender, loving words, the heart will turn longingly towards it from all the troubles and vexations of life. So we say to every man and woman, boy and girl, cultivate the habits of courtesy and "true politeness" at home, and you will not be in danger of betraying a want of them where you would least desire to, for it is a satisfaction to know that that they are not put on, but that they belong to the character and will manifest themselves under all circumstances. It was a wise mother who said, "My boy, treat every one with politeness, even those who are rude to you. For remember you show courtesies to others, not because they are gentlemen, but because you are."

No error in conventional "good manners," mortifying as such errors often are, is nearly so serious as the rudeness which springs from the heart, for the one who would maliciously laugh at the person who would commit that error, is much the less polite of the two.

It was not the least royal act of good Queen Caroline, "when seeing at one of her little tea parties two ladies drinking tea from their saucers, she looked with stern reproof at some of her maids of honor who were laughing behind their fans, and reassured her guests by tranquilly pouring her own tea into her saucer and drinking it."

Good temper and unselfishness are absolutely necessary to "true politeness." Presence of mind is also essential, so that one is not easily taken by surprise, and a quick sense of propriety; and when about to speak, think if your words would wound the feelings of any one present in the slightest degree; if so, leave them unspoken, except when in so doing would sacrifice truth or honesty. But if the truth should be unpleasant, if kindly and pleasantly expressed, will seldom offend.

The want of "true politeness" spoils conversation far more than deficiency of talent, and renders a man or woman wearisome to their

best friends, and almost unendurable to others, while the possession of it will make people easy with whom we converse, and gives conversation its deserving charm, and "whoever makes the fewest people uneasy is the most polite man in company." Some will say all this is so trifling, but life is made up principally of little things, and attention to them the index of the character, and on which the joy of life so much depends, for oftentimes they are unfathomable in their power. And if in "treading on life's rough pathway" we can smoothen the rugged places a little for others, by being courteous and considerate to the stranger, respectful and helpful to the aged, kind and obliging to our friends, and by gentle acts and sweet smiles help to make home the dearest spot on earth, and a foretaste of a purer, holier and better life above, then we can understand practically something of what constitutes the main spring of "true politeness."

Answers to Inquirers.

MABEL.—Is it proper when pouring tea to ask how they take their tea, or pass cream and sugar around the table? **ANS.**—As a rule now-a-days people are allowed to suit themselves, the cream and sugar being passed to each, but some still prefer the old-fashioned easy way of being helped by the hostess, who must then of course ask each as to his or her taste.

HOLLY.—We do not think much of either party in a breach of promise case, and certainly think that of a man who would marry a girl rather than lose his money, and of a girl who would be married in such a way, the less said the better; they surely could not hope for happiness in their union.

H. M. M.—1. Vinegar made from cider should be kept in a room where it will not freeze; place your cask on end without a head, fill one-third full of soft water and the other two-thirds with cider and two quarts of yeast. In a few weeks you will have good vinegar; without the yeast it would be all the season in becoming good. Then put into casks or jars for use, leaving about one-eighth in the open cask, fill up again with water and cider and it will become good much quicker than before. Pure cider may be used, but makes vinegar too strong and requires much longer time in making. You may place a board over the cask to keep out flies and dirt. 2. For chow chow take 1 peck green tomatoes, 4 very small, solid cabbages, 6 white skinned onions, and 6 green bell peppers, all chopped fine and mixed. Sprinkle a cupful of salt over the mixture and let it stand over night. In the morning drain off the juice and add 2 lbs. of brown sugar, 1 cupful of mustard-seed, and 1 gallon of vinegar to the chopped mixture. Boil until clear and tender, then put in jars. 3. Mustard pickles are made as follows: 100 small cucumbers, 2 qts. of small onions, 2 qts. string beans, 2 qts. green tomatoes, 2 heads of cauliflower. The vegetables need to stand in salt and water over night. Drain out in the morning and cover with vinegar. Boil twenty minutes. Mix one quart of mustard and ten cents worth of turmeric powder in one extra quart of vinegar about ten minutes before taking off the fire.

A READER.—1. How can a canary's feet be prevented from getting sore? 2. What kind of gem is the onyx? **ANS.**—1. It is caused by want of cleanliness. Once a week scrape the perches clean, and rub them with a little soap, then dust them with starch. Wash the bird's feet clean and dust them with fine starch; this will cure the soreness. 2. A partly transparent one generally marked alternately with colors of white, black, brown, blue, and green. It is found in the East Indies, Siberia, America, and Germany. The word, in Greek, signifies a nail, on account of its supposed resemblance in color to the whitish crescent at the base of the human nail.

Recipes.

CHICKEN POT PIE.—Cut up one large chicken; grease a deepish pot with lard, roll out enough of "plain crust" to line it, cutting out the bottom; as you put in the pieces of chicken, strew in flour, salt and pepper, a few pieces of the crust rolled thin, and a few potatoes, cover this with water, and put on it a covering of paste, with a slit in the middle; let this cook slowly two hours; have hot water at hand to add in case it be too dry. Veal, lamb, etc., may be made thus; also peach or apple pot pie.

Scalloped potatoes make a nice dish for tea, prepared in this proportion:—Two cups of mashed potatoes, two tablespoonfuls of cream or milk and one of melted butter; salt and pepper to taste. Stir the potatoes, butter and cream together, adding one raw egg. If the potatoes seem too moist, beat in a few fine bread crumbs. Bake in a hot oven for ten minutes, taking care to have the top a rich brown.

TAPIOCA CREAM.—Cover three tablespoonfuls of tapioca with water and let it stand over night, then pour off the water, if any, and put into a quart of milk, over the fire; when it boils stir in the yolks of three eggs, $\frac{1}{2}$ cup sugar and brown in the oven.

GRAHAM BREAD.—In one pint of water dissolve $\frac{1}{2}$ yeast cake, to the above take $\frac{1}{2}$ teaspoon of soda, $\frac{1}{2}$ teaspoon of molasses and $\frac{1}{2}$ teaspoon of sugar; salt. Then add a cup of graham and a cup of white flour and so on until stiff enough. Place by the fire to rise. Just before taking from the rising pan, melt a teaspoon of butter and cut into the dough. Work as little as possible and put in the pans, set to rise, then bake in a moderately hot oven.

COOKIES.—One egg, one teaspoon of cream or milk, three quarters cup butter, one cup of sugar and one teaspoon soda. Excellent.

MAURITIA CREAM.—Take about a soup-plateful of rather firm curds, hang them in a cloth until most of the whey has run off, but not till very dry. Turn into a bowl and beat until quite smooth. Then add two tablespoonfuls of raspberry or strawberry jam and a few drops of essence of lemon, and beat the whole mixture together till it be thoroughly blended; turn them into a glass dish for the table.

PICKLED PEARS.—Six lbs. of pears, three lbs. sugar, one quart cider vinegar. Stick six cloves in each pear; if the vinegar is too strong add a little water. Boil all together till soft.

CHOCOLATE CANDY.—1 cup grated chocolate, 3 of sugar, 1 of molasses, 1 of milk, butter the size of a walnut; boil all together for twenty minutes, stirring all the time or else it will burn.

Magazines, etc., Received.

The "Caterer," a family journal issued monthly, contains excellent information on table and other matters of interest to the home. Published by C. E. Whitton, Philadelphia.

The "Dorcas Magazine," a new monthly of infinite value, giving as it does instructions for various kinds of work, particularly knitting and crochet work. Edited by Laura B. Starr, New York.

The Right Wife.

A physician writes to young men as follows: "My profession has thrown me among women of all classes, and my experience teaches me that the Creator never gave man a greater proof of his love than to place woman here with him. My advice is—Go and propose to the most sensible girl you know. If she accepts you, tell her how much your income is, and from what source derived, and tell her you will divide the last shilling with her, and that you will love her with all your heart in the bargain; and then keep your promise. My word for it, she will live within your income, and to your last hour you will regret that you did not marry sooner. Stop worrying about feminine extravagance and feminine untruth. Just you be true to her—love her sincerely, and a more fond, faithful, foolish slave you will never meet anywhere. You will not deserve her, I know; but she will never know it."

The Ashes Upon the Hearth.

I went to the old time cottage
Where I dwelt in childhood days;
I looked through the dear old window
That seemed to return my gaze;
I sought for some sweet reminder
To bear from my place of birth,
But ah! there remained no token
But the ashes upon the hearth.

The chambers were bare and empty,
And the echoes seemed to say:
"Oh! where is the busy household,
Oh! why do the children stay?"
A branch of the veteran oak tree,
That now was a century old,
Still curtained my little window
That mirrored the sunset's gold.

I wandered to "mother's chamber,"
To the room where father wrote,
No sound broke the mournful stillness
But the chimney swallow's note.
Then again I sought the kitchen,
Once a place of joy and mirth,
And naught brought the past before me
Like the ashes upon the hearth.

How often we merry youngsters,
For our chestnuts sweet and brown,
Made a bed in the hot "wood ashes,"
With the live coals dropping down,
While the girls pulled molasses candy
And tossed it with glee on high,
And the golden pippins roasted
In an earthen pan near by!

Since those happy days of childhood
It is fifty years or more,
And the "boys and girls" have scattered
To many a distant shore,
While some dear hands were folded
And sheltered by Mother Earth,
As they dropped away from the spirit
Like the ashes upon the hearth.

The more we help others to bear their burdens the lighter our own will be.

Uncle Tom's Department.

MY DEAR NEPHEWS AND NIECES—How very clever you are all becoming, to be sure. Your answers to puzzles on the whole last month were splendid; if you are improving in all your other studies as well, in time you may become either a president, governor, judge, member of Parliament or something else. I think the variety of puzzles we receive and publish are limited, so I intend giving some new samples next month. We are having some glorious days for sporting, nutting, etc. How I should like to join all my boys and girls in a day's outing! What a time we should have gathering the lovely autumn leaves and rambling for nuts! I believe I could feel and act as young as the youngest of my large family. I will give a prize of a handsome mouth organ to the child which sends me the three prettiest colored leaves in your next letter. I suppose most of you have visited some show or fair, perhaps taken prizes for poultry or vegetables or flowers; if so, tell me all about them, for I like to know what is going on and how you employ your time. Below I give you a lesson in politeness. UNCLE TOM.

Thirty years ago, there was a noted exhibition of foreign paintings in New York, which, from the name of the owner and exhibitor, was known as Bryan's Gallery. The custodian of gallery, in the absence of Mr. Bryan, was an art-student, a boy who was allowed to copy the pictures on the walls.

One day, while the student was mounted on a step-ladder copying a large picture, an old gentleman entered the gallery. The custodian descended from his lofty perch, took the admission fee, and offered the gentleman a catalogue, which, however, he declined to buy.

The youth again mounted the ladder and resumed his work. The old gentleman began asking questions about the pictures, which, at first, were pleasantly answered by the copyist. At last the questions annoyed him, as they distracted his attention, and he, thinking the old gentleman a little parsimonious, answered,—

"Sir, if you have twenty-five cents, you can purchase a catalogue for that sum, and thereby learn all about the pictures."

"Ah! quite true; thank you!" replied the gentleman, politely, to the rude answer.

"What an excellent copy you are making!" he continued, surveying the young man's work. "You are very far advanced for so young an artist," he added. "Your picture is very promising."

Of course, the youth's vanity was touched by this praise, and descending from the ladder, he accompanied the gentleman around the gallery pointing out the works of famous painters and calling attention to their merits.

While thus engaged, Mr. Bryan, the proprietor, entered, and, taking off his hat, spoke to the gentleman with the most deferential politeness.

"Do you know who that gentleman was?" asked Mr. Bryan, after the visitor had departed.

"No, sir."

"Well, sir, that was Martin Van Buren, ex-President of the United States."

The young man mused, and then said to himself,—

"I've not only been taught a lesson in politeness, but in diplomacy also."

met a (cape off Africa), as we thought, under the influence of (island west of Scotland). He was neatly dressed in a suit of (river in Scotland), and so we went to him and accosted him in a (island in Pacific Ocean) manner. He did not speak, but allowed us to bring him home, where he lay on the floor as one insensible. My comrade and I sat down to play cards, and scarcely had we turned our backs when he rushed at us with a (island east of United States) knife and plunged it into my companion's heart. He was just about to attack me when I wrenched the weapon from him, and throwing him on the floor, already (sea in Asia) with my (sea in Asia) comrade's blood, tied his hands and feet and made my escape.

ADA ARMAND.

6—GEOGRAPHICAL PUZZLE.

Turn to the map of the British Isles and point out the following towns—(1) Part of a berry; (2) an animal and to wade; (3) Part of the body and a small pond; (4) increasing two-fold; (5) a color and a river; (6) a light substance; (7) another light substance; (8) what ought to be taken every day; (9) a musical instrument and firm; (10) an inheritor; (11) a watch and a great monopolist; (12) a bird and a piece of water; (13) a cravat and a gate; (14) tying and a piece of meat.

HARRY A. WOODWORTH.

7—TRANSPOSITION.

Mtpetat eth nie dan venr danst ot bodut; Ginnohit os rahd ubt cheras lwil difn ti utu. ALICE HUME.

8—I am the name of a writer; exchange my first letter, I become a term in geography; exchange again, I am a portion of time; exchange again, I am food; exchange again, I am another portion of time; exchange again, I am what all honest men do. AGNES M. FROOD.

9—CHARADE.

My first is used in every house To keep the floor clean, My second on every garment You'll always find, I ween, My third you'll find at the very top Of almost every house, Now add a letter and you will find A science they will bring to mind. A. J. TAYLOR.

10—TRANSPOSITION.

When whole I'm used by ladies fair To trim their dresses nice with care, Behead me now, curtail me too, A jewel I will bring to view, Transpose me now and you will find A funny laugh I'll bring to mind, Now twice behead and you will see A preposition I will be. A. J. TAYLOR.

11—DIAMOND PUZZLE.

A vowel; an animal; a flower; old; a reptile; courteous; a teacher; a small mark; a consonant. A. J. TAYLOR.

Prizes will be given for the best illustrated mottoes and best puzzle pictures sent in by the 15th of December. 1st, Windsor Castle; 2nd, Chrono of the Marquis of Lorne and Louise; 3rd, Life's Voyage. One set of prizes for the rebuses and one set for the puzzle pictures. They must be of a moral, entertaining or instructive tendency, devoid of religious or partisan illusions.

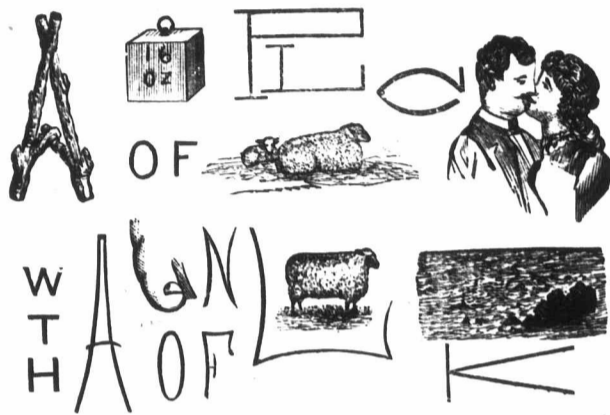

Puzzles.

1—ILLUSTRATED REBUS.

Th-h-r-t h-s t-nd-r-l-s l-k th-v-n- Wh-ch r-r-nd-n-th-rs b-s-m tw-n- -tspr-ng-ng fr-m th-p-r-nt tr-- f-d- pl-pl-nt-d s-m p-th- Wh-s fl-w-rs-r-h-p-ts fr-ts-r-bl-s B-n-f-c-nc-ts h-rv-st-s

CHRISTENA HADCOCK.

3—SQUARE WORD.]

An island in the Mediterranean; a heavy substance; a large package; a city in Africa. W. M. HEAD.

4—ILLUSTRATED REBUS.



We offer three prizes, one of \$4, one of \$2, and one of \$1, for the best deduction drawn from this puzzle. The puzzle can be easily seen. Answer not to exceed half of a column in space. Competition open until 15th of December. The first prize answer will be published in the January issue, with the names of successful competitors.

5—GEOGRAPHICAL PUZZLE.

My brother (Mt. in Australia) was travelling through Africa, and while there met with some hair-breadth adventures, one of which I will relate in his own words:—"One night, the (Mount in Africa) being up, my comrade and I went for a walk. We had not gone far when we

Answers to September Puzzles.

- 1.—All is not gold that glitters.
A rolling stone gathers no moss.
2.
B
C U P
B Y R O N
O N E
S
- 3.—Absence makes the heart grow fonder.
- 4.—There is in every human heart
Some not completely barren part,
Where seeds of love and truth might
grow,
And flowers of generous virtue flow.
- 5.—Cod, shark, bass, perch.
- 6.—Agincourt.
- 7.—(a.) Stray, tray, ray. (b.) Price, rice,
ice.
- 8.—Prelate, relate, elate, late, ate, tea, eat,
at, a.
- 9.—Live with wolves and you will learn to
howl.
- 10.—Hindustan.
- 11.—Satisfactory.

Names of Those Who Have Sent
Correct Answers to September
Puzzles.

Lottie A. Boss, Robt. Kerr, Samuel J. Rutherford, Sarah Wessel, Simeon Ashley, Ada Hagar, Mary McArthur, Ada Manning, Peter Lamb, Ellen O. Tupper, Wm. Carney, Lottie A. Sewell, Willie B. Bell, Carrie Christner, Becca Lowry, Minnie Weldon, Sarah H. Pickett, Alice Hume, Belle McLeod, Sarah E. Miller, Thos. H. Forbes, Thos. Armstrong, Maggie F. Elliott, Harry A. Woodworth, Mary Marshall, Belle Richardson, Addie Davidson, Katie Miller, Alice Dowler, R. J. Risk, Ada Armand, A. J. Taylor, Jas. Paterson, Eva C. Kelly, Tiny Docker, Carrie Amey, Robert Wilson, Christina Haddock, Annie B. S. Scott, Elmon M. Moyer, Henry Reeve, Esther L. Ryan, Ann J. Phoenix, C. Gertie Heck, Chas. H. Foster, Agnes M. Froot, Aggie Willson, W. L. Sissons, Byron G. Bowerman, Stephen J. Smith, Amelia E. Walker, James Watson, Jessie M. Fox, Sarah M. Brett, Will Thirlwall, W. M. Head, Wm. S. Howell, Lena B. Scott, Philip G. Boulton.

The "First He Ever See."

The good old lady who complacently warmed her feet at a fire-proof safe, and remarked on the comfort of "these 'ere new-fashioned stoves," showed how perfectly sure ignorance and imagination can be in drawing conclusions. The Chicago *Inter-Ocean* gives a still later example:

A well-to-do but unsophisticated farmer from one of the border counties of Indiana was in the city lately, attending the stock show, and brought with him his wife and daughters to see the sights and do some shopping. Among other places they visited a new store, and after wandering around the first floor for a while the party came to a stop near the elevators.

One of the daughters was the first to discover the elevators moving silently up and down, receiving and discharging their cargoes of passengers. She pulled her father's coat-sleeve to direct his attention to the phenomenon, and in a tone that was audible to the clerks in the neighborhood, asked,—

"What's that, paw—that thing going up and down, with sofas in it?"

The old man gave the elevator a long, calm, scrutinizing stare, and exclaimed,—

"True as you live, it's a telephone! the first I ever see!"

Little Ones' Column.

"Hare and Hounds."

"What shall we do?" the children said,
By the spirit of frolic and mischief led,
Frank and Lulu and Carrie, three
As full of nonsense as they could be;
Who were never known any fun to stop
Until they were just about ready to drop.

Frank, whose "knowledge-box" surely abounds
With games, spoke up for "Hare and Hounds."
"Down the cellar, or up the stair,
Here and there, and everywhere,
You must follow, for I'm the Hare!"
Lulu and Carrie gave quick consent,
And at cutting their papers and capers went,
For the stairs were steep, and they must not
fail

To have enough for a good long trail.
A way went the Hare
Right up the stair,
And away went the Hounds, a laughing pair;
And Tony, who sat
Near Kitty, the cat,
And was really a dog worth looking at,
With a queer grimace
Soon joined the race,
And followed the game at a lively pace!
Then Puss, who knew
A thing or two,
Prepared to follow the noisy crew,
And never before or since, I ween,
Was ever beheld such a hunting scene!
The Hare was swift; and the papers went
This way and that, to confuse the scent;
But Tony, keeping his nose in air,
In a very few moments betrayed the Hare,
Which the children told him was hardly fair.

I cannot tell you how long they played,
Of the fun they had, or the noise they made;
For the best of things in this world, I think,
Can ne'er be written with pen and ink.
But Bridget, who went on her daily rounds,
Picking up after the "Hare and Hounds,"
Said she didn't mind hearing their lively capers,
But her back was broke with the scraps of
papers.

Carrie, next day, couldn't raise her head;
Frank and Lulu were sick in bed;
The dog and the cat were a used-up pair,
And all of them needed the doctor's care.
The children themselves can hardly fail
To tack a moral upon this trail;
And I guess on rather more level grounds
They'll play their next game of "Hare and
Hounds."

Cheap John.

An Austin Israelite, says the *Texas Siftings*, has his dwelling and place of business in the same house, which is quite a small one. There were several customers in the store when his wife, who is a very affectionate creature, called out from the next room:

"O, Schon, my dear Schon, come to dinner."

A shade of rage passed over his Hebraic features, and going to where she was, he seized her brutally by the arm, and with a voice hoarse with annoyance, said:

"Rebecca, does you vant to ruin me in my pishness? What for you call me dear Shon, ven I vants to be known as sheep Shon? Do you vant to have dot peebles lose confidence?"

Whatever you would have your children become, strive to exhibit in your lives and conversation.

Study yourself: and most of all note well
Wherein kind Nature meant you to excel.

Modern Geography.

"Of what is the surface of the earth composed?"

"Of corner lots, mighty poor roads, railroad tracks, base ball grounds, cricket fields and skating rinks."

"What portion of the globe is water?"

"About three-fourths. Sometimes they add a little gin and nutmeg to it."

"What is a town?"

"A town is a considerable collection of houses and inhabitants, with four or five men who 'run the party,' and lend money at fifteen per cent. interest."

"What is a city?"

"A city is an incorporated town, with a mayor who believes that the whole world shakes when he happens to fall flat on a cross walk."

"What is commerce?"

"Borrowing five dollars for a day or two and dodging the lender for a year or two."

"Name the different races."

"Horse race, boat race, bicycle race, and racing around to find a man to indorse your note."

"Into how many classes is mankind divided?"

"Six, being enlightened, civilized, half-civilized, savage, too utter, not worth a cent, and Indian agents."

"What nations are called enlightened?"

"Those which have had the most wars and the worst laws, and produced the most criminals."

"How many motions has the earth?"

"That's according to how you mix your drinks, and which way you go home."

"What is a map?"

"A map is a drawing to show the jury where Smith stood when Jones gave him a lift under the eye."

"What is a mariner's compass?"

"A jug holding four gallons."

A "Queer" Story.

There is a cheap clothing dealer in Kerny, near California, whose confidence in mankind has received a severe setback. The other day an honest looking countryman walked into his store and said:

"You remember that second-hand overcoat I bought here for eight dollars yesterday?"

"Never dakes pack anytings ven vonce solt, my friendt," said the hand-me-downer.

"Oh! that's all right. I just wanted to say that I found this five hundred dollar bill sewed in the lining. Perhaps the owner will call for it."

"Of gorse he vill—he has call already, my tear friendt," exclaimed the dealer eagerly capturing the money. "You ish von honest man. Here I gif you feefy tollar ash a revard. Dot vill pe all right."

When the honest customer got around the corner he murmured softly, "I guess I'd better take this fifty and skip up to Portland, before that sheeny tumbles to that counterfeit. Its getting mighty hard to shove the 'queer' round these parts, and that's a fact."—*San Francisco Post*.

Simplicity, of all things, is the hardest to be copied, and ease is only to be acquired with the greatest labor.

Home Amusements.

Do not begrudge the family innocent amusement. Life brings abundant sorrows and regrets; let the home be as nearly like Paradise as possible. A blessed oasis is memory. For small children, toys simple ones, or home-made, are the very best. Let boys have some kind of a workshop, and give girls a work basket, round-end scissors, and plenty of material for invention or experiment. Let them have musical instruments if possible, if there is musical taste; pencils, patterns, drawing paper, and paints, if they like art. Give them a boat if you can, if they are near a pond or creek; let them go fishing and picnicing when it is suitable. Croquet, ball, and out-of-door games, with a pole and bar for gymnastics, add much to the likelihood of keeping active children peaceably at home. Puzzles, dissected maps, checkers, chess, the game of authors, fox and geese, and jackstraws all help, with useful and pleasant books, to pass evenings, holidays, and rainy days cheerfully; while they do their part in developing self-sacrifice, courtesy, ingenuity, and quickness of thought. Let the children have an occasional "candy pull," a trial of nut-cracking, corn-popping, and apple-roasting. Life will move more smoothly for the whole family by the help of such occasions of mirth and social pleasure. In winter skates and sleds should not be denied; they are good for both boys and girls. Sleds can be of home manufacture if money is scarce, and children will find means by self-denial and industry to buy their own skates if they are allowed reasonable time to use them. Give them all the fun you can, and it will pay you.

Long Life.

Some one wisely says that he who strives after a long and pleasant term of life must seek to attain continual equanimity, and carefully avoid everything that too violently shakes his feelings. Nothing more quickly consumes the vigor of life than the violence of the emotions of the mind. We know that anxiety and care can destroy the healthiest body; we know that fright and fear, yes, excess of joy, becomes deadly. They who are naturally cool and of a quiet turn of mind, upon whom nothing can make too powerful an impression, who are not wont to be excited either by great sorrow or by great joy, have the best chance of living long and happy lives after their manner. Preserve, therefore, under all circumstances, a composure of mind which no happiness, no misfortune, can too much disturb. Love nothing too violently, hate nothing too passionately, fear nothing too strongly.

To give glass great brilliancy, wash with damp sponge dipped in spirit, then dust with powdered blue or whiting (tied in a muslin bag) and polished with a chamois skin.

A paste made of whiting and benzoin will clean marble, and one made of whiting and chloride of soda, spread and left to dry (in the sun if possible) on the marble, will remove spots.

Fuller's earth, mixed to a stiff paste with water, spread on the carpet and covered with brown paper, will in a day or two remove grease spots. A second application may be necessary.

OUR USEFUL PREMIUMS for 1885.

For One New Subscriber:

YOUR CHOICE OF THE FOLLOWING

Trees especially adapted to the Northwest.

The Ash Leaf Maple.—One packet of seed or six plants of this ornamental and hardy tree. For description and illustration see page 297 of this number.

The Silver Poplar.—One packet of cuttings or six plants. This tree is of very rapid growth and when dry makes good fire wood. See articles on page 297.

The Norway Maple.—One packet of seed or six plants of this beautiful and hardy variety of the maple, a description of which appears on page 297 of this number.

Adapted to Southern Ontario.

The Horse Chestnut is one of the most beautiful and useful trees grown, of very rapid growth, and for shade or ornament cannot be excelled. One packet of seed from a grand tree owned by the proprietor of this journal, and can be seen from the study window, see page 264 of September issue; or six young plants.

The Black Walnut.—Of all timber for making furniture or other useful purposes this is considered the most valuable, and is now very scarce. This excellent timber will pay for cultivation. One package of seed from trees growing on the old homestead of the editor of this paper, or six young trees.

—OR THE—

CHROMOS

Chromo "Life's Voyage."—Or Lithograph "Yes or No." Beautiful pictures, and highly prized by those who have received them.

SEEDS.

A useful collection of **Vegetable Seeds**, ten varieties, and one packet novelties for 1885.

A choice collection of **Flower Seeds**, ten varieties.

STRAWBERRY PLANTS.

Two plants, **Prince of Berries**, said to be the latest and best of the many excellent varieties, and is of the finest flavor lately introduced.

Two plants, **Daniel Boone**.—This plant has grown in favor greatly during the past season, and bids fair to be in great demand, both as to flavor, productiveness and keeping qualities.

Three plants of **James Vick Strawberry**.—In addition to the already favorable opinions expressed about this berry, it has this season averaged fully as large berries as the Wilson, and produced more fruit. One large grower states that he could fill a basket sooner from the James Vick than from any other strawberry.

Two plants of the **Dwarf Juneberry**.—These plants should be in every garden. The plant is very hardy. The fruit ripens early, and in enormous quantities.

Six plants of the **Russian Mulberry**.—The popularity of this plant still continues, and we have decided to give it again for another year.

ROSES.

So very few really good roses are to be found in the country gardens of Canada that we have decided to offer two of the best varieties grown, one a dark crimson and the other a deep yellow. The ordinary price for these roses if bought from florists is 50 cts. to \$1, but we offer your choice of either of the following for one new subscriber:

One plant of the **General Jacqueminot**.—This rose is one of the finest and prettiest; in color it is a rich velvety scarlet, changing to brilliant crimson. The buds of this variety are magnificent, rendering them of especial value for bouquets, and for wearing in the button hole. It is also a good rose for forcing. See issue for April, 1884.

One plant of the **Isabella Sprunt**.—In color it is sulphur yellow. It is a very free bloomer, and is one of the most beautiful of the yellow roses, and of especial value state can scarcely be surpassed. It is of especial value for bouquets, and makes an excellent potting plant.

The **Lady's Manual of Fancy Work**.—Four hundred illustrations, paper cover, containing a great variety of excellent designs for dress or household decorations. It is a book which will please, and should be in the hands of every lady.

For Two New Subscribers:

YOUR CHOICE OF THE FOLLOWING

Large and beautifully finished

CHROMOS

"Windsor Castle," or "Balmoral Castle."—These fine pictures are 30x24 inches, and form a pretty ornament to any home.

Or Lithograph of **Lorne and Louise**. The picture contains a puzzle which few are able to solve.

The **Novelty Rug Machine**.—Makes rugs, tidies, door mats, etc. Is an entirely new invention. Performs its work satisfactorily, is simple of construction, and can be worked by a child. This little machine not only saves much time and labor, but much of the material used by the use of the ordinary mat hooks. For making Turkish rugs it cannot be excelled. Every housekeeper should have one. See page 307 of October issue.

For Three New Subscribers:

YOUR CHOICE OF THE FOLLOWING

The **World's Cyclopedia and Library of Useful Knowledge**.—Giving concise information on nearly every subject. Contains 800 pages, 50,000 references, and 1,200 illustrations, and is an indispensable library of universal knowledge.

The **White Mountain Apple Parer**.—This machine does its work economically and quickly, leaving the fruit ready for drying, &c. This parer is the best and most serviceable one which we know of, and can strongly recommend it to every person. Per express at receiver's charges.

The **White Mountain Potato Parer**—is said to be not only the best one made, but the only one manufactured which will pare a potato better than it can be done by hand, taking off a thinner paring from every shape or kind of potato, but will go into and clean out the eyes. Per express at receiver's charges.

The "Household" Special Premium, the new **American Dictionary**.—Contains 1,000 engravings, and more pages than any similar work. No house should be without one.

OUR RULES.

Each new name must be accompanied with \$1 for the annual subscription.

The premium is for the person who secures the new name, and does not in any way belong to the new subscriber.

All books, plants, seeds, &c., will be sent free by mail except otherwise mentioned.

Send for our Illustrated Premium List, Sample Copies, and commence your canvas at once.

Sample copies sent free on application.

Address.

The FARMER'S ADVOCATE, London, Ont.

Notices.

The fifth annual match of the Sherbrooke Plowmen's Association will be held on Mr. S. Mathewson's farm, near Lennoxville, on Wednesday, 15th Oct. This will be a good opportunity for western plow makers to exhibit their plows, as Lennoxville is situated in the best section of the Eastern Townships. Any information can be had by writing to R. H. Tylee, Sec. Treas., Lennoxville.

To Our Prize Essayists.

Our readers must be aware that when they compete for our prize essays their writings must be original. We peruse all the leading journals and other writings on agricultural matters, whereby we are enabled to detect plagiarists; yet it must be expected that articles occasionally escape our notice. Such has been the case with reference to our prize essay on "How can Farmers Make the Best and Cheapest Cheese for their Own Use", by Miss Maggie Webster, Augustine Cove, P. E. I. Our attention has been drawn to the fact that the same article appeared several months previously in the *Montreal Star* and on writing to Miss Webster she acknowledged she had copied the article from that paper. In all our long experience with prize essayists we never had occasion to complain, but we are surprised that a lady (?) should be the first to demean herself by perpetrating such a fraud. Such a demoralizing practice is not only unjust to ourselves but to the papers in which the articles originate, and frequently also to the writers of the articles. We hope this will be a warning to our readers. Such practices are sure to be discovered, and to recoil upon the perpetrators.

Commercial.

THE FARMER'S ADVOCATE OFFICE,
London, Ont., Oct. 1, 1884.

With the last days of the past month has ended the fine dry weather which has prevailed all through September. The fall seeding has been somewhat impeded by the drouth, but is now well advanced.

WHEAT

Has been very quiet the past month, with a downward tendency, and farmers are not marketing freely; in fact we doubt if they will till the price moves up towards the \$. The farmer who has wheat to sell has his compensations. If he has to sell cheap he can buy equally as cheap. If wheat was never so low neither were sugars, teas, cottons, clothing. These, with above an average crop, should compensate for the low prices now prevailing.

Wheat can now be laid down in Liverpool for less than \$1. An English journal estimates that at \$1 per bushel the British farmer loses 30 per cent. In our opinion the European farmer has much the best grounds for grumbling. H. Kains Jackson, probably the highest authority in England, asserts that English farmers will immediately reduce their wheat crop 1,000,000 acres, and the French farmers 5,000,000 acres. These are important figures, and if carried out, as Mr. Jackson asserts, will make a very important change in the production of wheat in both England and France.

There are indications that the low price of wheat will lead to an enlarged feeding of wheat to stock in England. The *Mark Lane Express* says:

"If a quarter of wheat weighing 63 lbs. to the bushel, comes to be worth no more than 30s—and as it is selling at 32s in London, it cannot be worth much more than 30s on the farm—it will be easy to show that it is by far a cheaper feeding-stuff, relatively to its value, than either maize or cake. At the price and weight named above, a ton of wheat would sell at £6 13s 4d; maize, at 26s per 480 lbs. the lowest price it can be got home for, costs £6 1s 4d a ton; and undecorticated cotton cake costs at least £6 home. Decorticated cotton cake was quoted last week at £7 5s to £7 10s in London; and linseed cake, also in London, at £8 8s to £9 5s."

We question very much if wheat is not the cheapest feed a farmer can buy even in this country. Farmers who may have to buy coarse feed and have wheat to sell, will do well to weigh this matter over before selling their wheat.

PEAS

Are a good crop and free from bugs. We look for a good export demand through the winter.

OATS

Are a good crop and will be in fair demand.

CORN.

This crop is the best in many years, and is an important crop in some sections of Ontario.

LIVE STOCK.

Cable reports of the British Live Stock trade are not of a favorable character, although there has been no striking change in its condition the past week. The *Montreal Gazette* says: "What

change there has been, however, is of an unsatisfactory nature, but not enough to quibably effect values, which are cabled unchanged all round. The most noticeable feature is the spiritless demand for cattle. Special cables from the leading markets report trade for cattle worse, the demand being very weak and uncertain, with buyers holding off in hope of a decline. Prices, however, remain unchanged with the top figure for well finished beasts at 15c. The receipts of Canadian and American cattle at the principal ports since this day week have been fair, which, together with fair supplies of English and Irish cattle, make up a supply large enough to place the trade more in buyers' favor. Sellers, however, refuse to make concessions, and business drags somewhat, a good number being left unsold. At to-day's market at Liverpool transactions were made on the basis of the following prices—prime steers, 15c; fair to choice, 14c; poor to medium, 13c; and inferior and bulles, 10c to 12c. The sheep trade is unchanged, and retains its former characteristics. Supplies continue heavy and in excess of demand, which gives an easy tone to prices, they being barely sustained. To-day best sheep are cabled at 15c; secondary qualities at 13c to 14c; merinos at 12c to 13c; and inferior and rams at 10c to 12c. There has been an advance in dressed beef at Liverpool, the market being cabled 3d higher than a week ago at 5gd.

BUTTER

Has been in fair demand and no special change to note.

CHEESE

Keeps very quiet and very little doing. The fact is, prices are relatively too high in this country for a healthy trade. They are on a purely speculative basis and are quite as likely to recede as advance, and before the buyers can get out without any loss on August cheese at 11c, they will have to sell for 5s to 6s shillings in Liverpool. The *Utica Herald*, speaking of the cheese markets, says:

"Cheese is accumulating rapidly in New York, and it is claimed that the stock is now 79,000 boxes greater than it was a year ago. It is difficult to tell what effect this will have upon the later makes. It may mean that England is willing to take September goods at a fair price, but does not want heated goods at any price. This we believe to be the case, and if it is, the earlier goods that are now in storage will have to be sold at lower prices, no matter how high September may go. This has been the position taken by the *Herald* for several weeks past, and we continue still of the same opinion. There is considerable early cheese still on hand in different parts of this country, and Canada is said to be full of it. A great deal of the cheese that has actually been sold there has not been shipped, but lies in storage, and some of it has not even been moved from the factories. A careful footing of the total shipments from this continent since May 1, 1884, and of the shipments from Montreal alone, show that about 38 per cent. of the whole has gone from Canada. From the accounts that reach us we should judge that there must be fully as much cheese held back in Canada as there is in New York city, say 100,000 boxes in each. Then there is the cheese in the interior of this country, and it all

makes a large quantity to be accumulated at this season of the year."

STEEL NAILS.

A good deal of interest is being manifested in the States over the introduction of steel nails. They can be made much cheaper than iron, and if the trials now going on are a success, this process of nail making will completely revolutionize the whole nail manufacturing interest.

PRICES AT FARMERS' WAGONS, TORONTO.

Wheat, fall, per bushel	\$0 80	to 0 82
Wheat, spring, do.	0 80	0 83
Wheat, goose, do.	0 63	0 65
Barley, do.	0 48	0 70
Oats, do.	0 34	0 35
Peas, do.	0 63	0 65
Rye, do.	0 60	0 60
Beans, do.	0 50	1 50
Dressed hogs, per 100 lbs.	0 45	0 60
Chickens, per pair	0 45	0 60
Ducks, do.	0 65	0 70
Butter, pound rolls	0 23	0 25
Cheese	0 10	0 12
Eggs, fresh, per dozen	0 19	0 20
Potatoes, per bag	0 45	0 50
Apples, per bbl.	0 50	1 75
Cabbage, per dozen	0 25	0 30
Turnips, per bag	0 25	0 30
Carrots, per doz.	0 12	0 15
Beets, per doz.	0 12	0 15
Parsnips, per peck	0 15	0 20
Hay, per ton	10 00	13 00
Straw, do.	4 00	7 00

BRITISH MARKETS BY WIRE.

Cattle Firmer—Sheep Steady.

LIVERPOOL, Sept 25th, 1884.

Trade rather better with an advance of 1d per lb. for good Canadian steers. Store stock, if well bred, in more demand. Prospects rather better.

	Cents	per lb.
Good Canadian steers	(Sinking the offer)	7
Medium Canadian steers	6 1/2	6 1/2
Medium Canadian sheep	7 1/2	7 1/2
Good States cattle	7	7 1/2

LIVE STOCK MARKET.

East Buffalo, N.Y., Oct. 4.

Receipts—Cattle, 1,768; hogs, 3,005; sheep, 1,000. Shipments—Cattle, 2,106. Cattle—About 40 cars were on sale; market dull and slow at market prices; best offerings, \$6 to \$6.30; good shippers, \$5.50 to \$5.90; outlook bad. Sheep and lambs—Offerings moderate; market steady at former prices. Lambs in fair supply; market a shade stronger—all sold. Prospects fair. Canada lambs, \$4.80 to \$4.90; two loads went at \$4.90 to \$5. Hogs—Fairly active; prices somewhat higher. Sales of Yorkers, good to choice, at \$4.30 to \$5.50, a few choice at \$5.50 to \$5.60; good light to fair, \$5 to \$5.25; good to choice mediums, \$5.50 to \$5.65. Pigs, \$4.25 to \$4.60.

CHEESE MARKETS.

LONDON.

Oct. 4.—10,450 boxes were offered. Sales 1,200 boxes August at 11c; 1,000 boxes at 10c; 1,115 boxes at 11c; 100 boxes August and September at 11c; 4,180 boxes balance of season at 12c.

LIVE STOCK AT EXHIBITIONS.—A voice asks why so many of the best herds of cattle were not represented at either of the four leading exhibitions. Another asks the question, Is a first prize or gold medal a guarantee that the exhibit gaining it is the best in Canada? Another asks, Which is to take precedence at our agricultural exhibitions, amusements, partizanship or agriculture? A question is also asked, Would it not be better to have two sets of managers, one to look after the agricultural interest, and one for amusements? Why should the farmers of one locality unite and withhold from exhibiting? Why should the arts be discarded from another?

At the present time the Provincial Board appears to be in jeopardy. The best way in our opinion to restore confidence in it would be for some of its members to expose any defects they may have seen and suggest such improvements they deem best, and allow time for discussion before any changes are made. The deliberation should extend over several months.

See Stock Notes, page 316.

NEW ADVERTISEMENTS.

ADVERTISING RATES.

The regular rate for ordinary advertisements is 25c. per line, or \$3 per inch, nonpariel, and special contracts for definite time and space made on application.

Advertisements unaccompanied by specific instruction inserted until ordered out, and charged at regular rates.

The FARMER'S ADVOCATE is the unrivalled advertising medium to reach the farmers of Canada, exceeding in circulation the combined issues of all the other agricultural publications in the Dominion. Send for advertising circular and an estimate.

SPECIAL NOTICE.

THE FARMER'S ADVOCATE refuses hundreds of dollars offered for advertisements suspected of being of a swindling character. Nevertheless we cannot undertake to relieve our readers from the need of exercising common prudence on their own behalf. They must judge for themselves whether the goods advertised can in the nature of things be furnished for the price asked. They will find it a good rule to be careful about extraordinary bargains, and they can always find safety in doubtful cases by paying for goods only upon their delivery.

4th ANNUAL SALE

OF REGISTERED

Shorthorn Bulls, Cows, Heifers and Calves

High Grade Cows and Heifers, 20 Steers, and Shropshire Down Rams and Ewes.

VANSITTART HOUSE, EASTWOOD

(next G. W. R. Station east of Woodstock),

ON TUESDAY, OCTOBER 14TH, 1884.

Luncheon at 12.30. Sale at 1.

TERMS.—Sums under \$20, cash. Nine months' credit on approved notes over that amount.

For catalogues and pedigrees apply to

Or S. G. BURGESS, Auctioneer, Woodstock. T. C. PATTESON, Postmaster, Toronto.

HERBY CLIMAX HORSE & CATTLE FOOD.

LONDON FEED COMPANY,

Sole manufacturers of the highly celebrated King of Feeds, the Herby Climax, which is

Acknowledged the Best in the World FOR ALL KINDS OF STOCK.

It was first introduced in 1881 and sold entirely on its own merits, and we take pleasure in saying that the sales have doubled every year. It has worked its way on its own merits in spite of the opposition of other foods, and

NOW STANDS AT THE HEAD OF THEM ALL.

To meet the extensive demand for our food, we have made arrangements all over the Dominion so that it can be had in almost every Village in the country.

We pride ourselves in having overcome the objection raised to other kinds of Cattle Foods, which contained injurious ingredients, such as Antimony, Arsenic, Vitriol, Sulphur, Saltpetre, &c., &c., which are right enough in their proper places, but should never be used in stock feeds for regular use. All practical farmers know the result of the continued use of such foods. We are the only Company in Canada that has filed an affirmation that their feeds are free from any of the above ingredients. It contains no mineral of any kind except salt.

We will pay \$1,000 to any one who will find anything of an injurious nature in the food we manufacture. It can be fed any length of time to stock of all ages and conditions, with the best possible result. It is made principally of ground seeds, which possess the greatest nutritive qualities. It is beyond a doubt the BEST FOOD THAT HAS EVER BEEN OFFERED TO CANADIAN FEEDERS.

A fair test will convince the most sceptical. It is equally good for Horses, Cattle, Calves, Sheep, Pigs, &c., &c.

It is exceedingly profitable to feed to milk cows, as it increases the flow and richness of milk and improves the colour of the butter. For circulars containing testimonials, particulars, prices, &c., apply to your local dealers, or address to the

LONDON FEED CO., London, Ont.

THE BOOKS OF THE SEASON!

JUST READY

"ALDRERSYDE,"

A BORDER STORY OF 70 YEARS AGO, BY ANNIE S. SWAN. 12 mo. Cloth extra, with six original illustrations. Price, \$1.25.

"JACK HALLIDAY,"

A Grass Market Herd, or Sketches of Life and Character in an old City Parish. By Robina F. Hardy. 12 mo. Cloth; Illustrated. Price, 65 cents.

WILLIAM BRIGGS,

78 and 80 King St. East, Toronto.

Fire Insurance.

—THE—

GLASGOW & LONDON INSURANCE

Company

OF GREAT BRITAIN,

Issue a special farm policy, covering ordinary contents of dwellings and of outbuildings, give permission (without extra charge, and without notice) for the use of any standard steam thrasher, and where contents of outbuildings are insured, will pay for any live stock killed by lightning anywhere on farm; pay losses liberally and justly at once without discount.

They also issue a lightning policy (not fire) covering all the buildings on any farm, and their contents, and live stock in fields, in one amount, for \$2 for \$1,000 per annum. This policy covers damage done by lightning only, when no fire ensues.

Farmers before insuring elsewhere would do well to see the above two policies, which can be done at any of the Company's Agencies, or at the Head Office, Montreal.

Agents controlling a farm business or desiring to transact such a business, can obtain every information at the Head Office, and with all pushing and energetic agents who can and will control business, liberal arrangement, will be made.

A GREAT OFFER!

We have made an arrangement with the publisher of the FARMER'S ADVOCATE to club with that magazine during the coming year. Our

"WEEKLY WITNESS"

is acknowledged by its readers, which now number 40,000, to be

"THE BEST FAMILY PAPER IN CANADA."

The Montreal Daily Witness and the Farmer's Advocate from now till the end of next year for \$1.75.

JOHN DOUGALL & SON,

WITNESS OFFICE, MONTREAL.

ECONOMY!

The Farmer's Advocate

—AND—

The Catholic Record

MAY BE HAD FOR

\$2.25 PER ANNUM.

The Catholic Record is not identified in any way with party politics, its sole purpose being to supply a reliable organ of Catholic opinion. It is supported and recommended by nearly all the Bishops and Priests of the Dominion. The proprietors of the Catholic Record and the leading agricultural paper of Canada, The Farmer's Advocate, have decided to supply both at the low rate of \$2.25 per annum, in advance. Remittances may be made either to THOS. COFFEY, Catholic Record Office, London, Ont., or to WM. WELD, Farmer's Advocate Office, London, Ont.

WORTMAN & WARD'S



REVOLVING BARREL CHURN.

It was awarded the Silver Medal at the Dominion Exhibition, at Ottawa, 1884; and First Prize over all competitors at the Industrial Exhibition in Toronto, 1884. If agents in your town have not these Churns, for particulars, prices, &c., address,

Wortman & Ward, York St., London, Ont.

"The Standard"---"Champion."

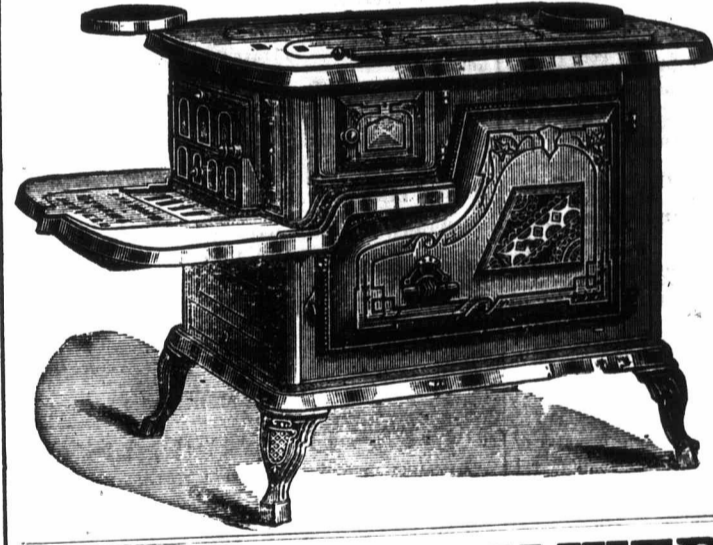

The Cook Stoves for the Farmer.

LARGEST OVEN FOR THE MONEY IN THE MARKET. All perfect cooks on a moderate consumption of fuel.

"THE ARGAND"

A coal-heating Stove, never excelled for freedom from gas and economy in heating.

ASK FOR THESE STOVES. If you don't find them with dealers write to us.

THE OSHAWA STOVE CO.

OSHAWA, ONT.

Holders of Highest Awards for Stoves for Ontario and Quebec.

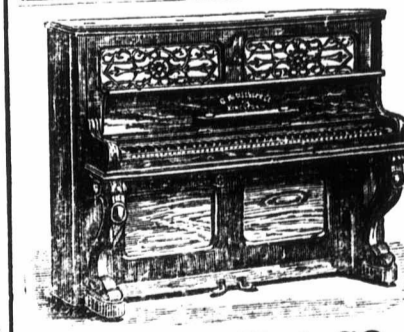

G. M. WEBER & Co.

—MANUFACTURE THE—

BEST PIANO MADE IN THE DOMINION.

Their Pianos are not only THE BEST, but are also THE CHEAPEST.

BE SURE AND SEND FOR CATALOGUE AND REFERENCES BEFORE PURCHASING.

G. M. WEBER & CO., 42 Princess-St., Kingston, Ont.

-AN-
AUCTION SALE
-OF THE-
CELEBRATED HERD OF HEREFORD CATTLE, AND FLOCKS OF SHROPSHIRE AND SOUTHDOWN SHEEP,

And of the various farms belonging to estate of late C. C. Bridges, Shanty Bay, Ont., Canada, will take place at "Manor Farm," near Gowen Station, on Northern Railway of Canada, on 14th and 15th OCTOBER next. Sale subject to reserve bid on each farm and animal. For full particulars of farms and catalogues and pedigrees of cattle, apply to W. C. SCHUBER, Allandale P. O., Ont., Canada. 226-x

SEEDS!

My Annual Descriptive Catalogue for 1885 will be issued early in January next and mailed FREE to all intending purchasers on application. I will offer a choice selection of the best varieties of

FIELD, GARDEN AND FLOWER SEEDS

at lowest prices. Be sure to see this Catalogue before ordering.

226-x **WM. RENNIE, Seedsman, Toronto.**

NIAGARA GRAPE VINES

A. M. Smith, of the Dominion Fruit Gardens, St. Catharines, Ont., is the only propagator of the Niagara Grape Vines for the Niagara Grape Co. in Canada, and he is authorized by the Company to dispose of a limited number of strong, two year old vines, to be delivered in the spring of 1885, for \$2.00 each.

All orders filled in rotation, and each vine will be under the seal of the Company. As the Company have never before sold unreservedly a vine or authorized its sale or propagation, any one offering it in any other way may be set down as a fraud.

Parties desiring to secure this valuable Grape, should apply at once to the undersigned,

A. M. SMITH, St. Catharines, Ont.

N. B.—A large assortment of other Grape Vines, small Fruits of all kinds, also Trees and Plants, for sale at the DOMINION FRUIT GARDENS, St. Catharines, Ont.

Send for Catalogue and Price List. 226-c

STOCK AND GRAIN FARM FOR SALE

Situated on the shore of Lake Erie, near Port Dover; excellent shipping facilities by rail or boat. A grist mill, warehouse, school, church, post office, and telegraph office, within 1/4 mile of the farm; 240 acres, about 150 acres cleared; suitable buildings. Apply to HARRIS, MAGEE & CLARK, Solicitors, &c., London, Ont. 226

C. P. MILLS, St. Catharines, Ont., Manufacturer of Iron and Brass, Lift and Force Pumps, for dug and drilled Wells, Cisterns, Tanks and Fire purposes; Wooden Pumps with porcelain lined iron cylinders; Rubber Bucket Chain Pumps; Corn Shellers, and Self-Sharpening Feed Cutters, which will cut as fast as two men with the most rapid of other kinds. Send for descriptive illustrated catalogue. Responsible agents wanted to whom we will consign our goods to sell on a liberal commission. Our works have been in constant operation since 1824. 226-x

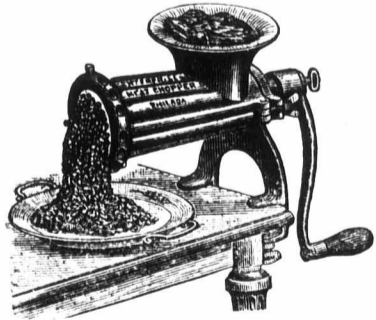

THE NEW MEAT CHOPPER which will **CUT** the New Fruit Press for making Wines, Jellies, Butters, &c., for Sale Wholesale and Retail by **L. J. A. Survoyeur**, Novelty Hardware Store, 1588 Notre Dame Street, MONTREAL. 226-x

Office of D. W. BEADLE'S NURSERIES:

**THE NIAGARA
WHITE GRAPE!**

For Sale without any restriction whatever at

TWO DOLLARS EACH.

AGENTS WANTED. Apply to

D. W. BEADLE,

St. Catharines, Ont.

226

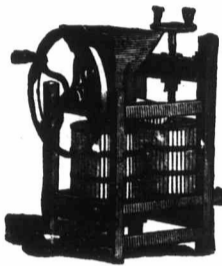

Corn Huskers, Cider and Wine Mills and Presses.

Sell's Patent Friction Clamp.

Something entirely new. For hitching straps, ropes, &c., without tying knots.

AGENTS WANTED.

Address—**H. SELLS & SONS,** 952-4-6 Queen St. West, 226-a TORONTO, ONT.

DICK'S UNIVERSAL MEDICINES FOR

Horses and Cattle

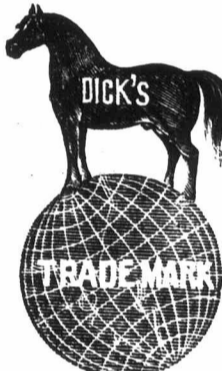

DICK'S BLOOD PURIFIER is no sham made up to sell only, but is prepared from the best material. One package of Dick's Blood Purifier we confidently believe contains more real medicinal strength and virtue than ten times its weight of any other Powder in the market. It tones up the system, imparts new life and vigor, and is adapted for the cure of worms, loss of appetite, roughness of the hair or coat, stoppage of water and bowels, all coughs and colds, inflammation of the lungs and bowels, recent founders, swelling of the glands of the throat, horse distemper, hide bound, botts, scurvy, loss of

cut, horn distemper, black tongue, &c., and also will backen the heaves, and in recent cases effect a cure. In fact, there is no case of disease among Horses and Cattle where Dick's Blood Purifier is not called for, and by its timely administration will save the lives of many valuable animals.

DICK'S BLISTER, for Spavins, Ringbones, Curbs, Swellings, &c.
DICK'S OINTMENT, for Cuts, Burns, Bruises, Saddle Galls, Sores, Flesh Wounds, Scratches, &c.

AND

DICK'S LINIMENT, for Swellings, Scalds, Contusions, Frost Bites, Cracked Heels, Chapped Hands, &c., but above all for Rheumatism.

PRICE LIST.

DICK'S BLOOD PURIFIER, 50c
DICK'S BLISTER, 50c
DICK'S OINTMENT, 25c
DICK'S LINIMENT, 25c

Try DICK'S MEDICINES and be convinced of their merit. For Sale by Druggists and Dealers. Ask for them and take no other.

226-f&x **DICK & CO., Montreal, P O Box 482.**

FOUND AT LAST!

A PERFECT FACTORY AND DOMESTIC KNITTING MACHINE.

-THE-
"ECLIPSE" KNITTING MACHINE

HAS NO EQUAL FOR
SIMPLICITY, RAPIDITY, AND QUALITY OF WORK.

Will knit a pair of socks, with real ribbed tops, in ten minutes. All sizes and kinds of hose and half-hose can be knitted on one machine; also, tuques, sashes, mitts (including thumbs,) fringes, and many other articles. Ribbed work as simple and easy as plain work. Turns out better goods than the imported. No seams, real ribbed tops, cap heel, perfect shape. No shaping on boards. Can be learned in one hour. Do not confound it with any other. It is a new invention.

Sold on the **Installment Plan**, or at a **Liberal Discount for Cash.**

TORONTO KNITTING MACHINE CO., (LIMITED),
116 BAY STREET, TORONTO.

AGENTS WANTED EVERYWHERE. 226-x

THE TUCKER TRUSS

EASE, SECURITY

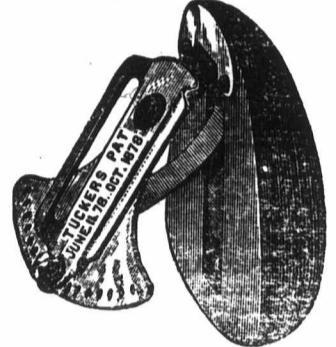

AND DURABILITY.

FOR RUPTURE.

Acknowledged by Physicians, Druggists and Patients everywhere to be the simplest and most efficient Truss. No Iron Spring around the body, as the pressure is conveyed from the Pad in a **natural Inward and Upward** direction. We can confidently recommend this Truss to sufferers from Hernia as the most secure and easiest to wear. For sale by druggists, or sent prepaid by us. Don't suffer longer with your old Iron Truss. Write for pamphlet. Address—**TOMS & CO., Druggists, 123 Church-St., Toronto.** 226-x

**PETHICK & McDONALD,
TAILORS**

AND IMPORTERS OF

CLOTHS AND GENTS' FURNISHINGS

New Scotch Tweeds,

New English Suitings,

New Irish Tweeds & Serges.

New and Large Stock Of Overcoatings.

FIRST-CLASS WORK & LOW PRICES.

Inspection Invited.

PETHICK & McDONALD

NEXT CITY HALL,

Richmond Street.

226-x

"CRASH!"

Until further notice is given,

A. B. POWELL & Co.

will sell the following goods at the prices given below, viz:

Pure Wool Grey Chambray Flannels at 25c. per yard.
Canadian Wool Bed Blankets, all to be sold by the pound, at 45c. per lb.
Canadian Yarn, all colors, at 50c. "
Fingering Wool Yarn, at 75c. "
All \$1.15 Col'd Silks reduced to 75c. per yd.
All \$1.25 Colored Duchess Dress Satins reduced to 95c. "
Dress Plushes, Dress Velvets, Broche Mantle Silks and Velvets, all to be sold at a **small advance on cost.**

N.B.—Send for samples. Goods ordered by mail expressed without delay.

Kid Gloves in every shade and make. Prices from 25c. to \$3.00 per pair.

Don't forget our address. Write for what information you desire in the way of Dry Goods, &c.

A. B. POWELL & Co.

THE GREAT KID GLOVE HOUSE,

134 Dundas Street, LONDON, ONT. 226-cx

CANADA BUSINESS COLLEGE HAMILTON, ONT.,

Affords the best facilities for obtaining a complete business education. Has the best staff of experienced and successful teachers. The most magnificent college rooms in the Dominion. Course of instruction improved and practical. Ladies admitted to all departments. A large 40 page Catalogue, specimens of penmanship and full particulars sent on application to

R. E. GALLAGHER, Principal.

Mention this paper.

Spencerian
BUSINESS COLLEGE,
Detroit, Mich., U.S.A.

"SPENCERIAN" is the acknowledged American standard of Penmanship. One of its authors is associate proprietor of the Detroit College.

YOUNG MEN of Canada desiring a knowledge of the modern methods of doing business in the States, or a start in business there, should attend this College. It is one of the largest and best on the continent, and is thorough and complete in every department.

SHORTHAND, PENMANSHIP and TELEGRAPHY Taught as Specialties. Books, Board and Tuition for a Twelve Weeks Business Course Supplied by the College for \$86; the same for Twenty-four Weeks, \$155.

The actual **Business Practice Course** is unequalled. Five Departments are maintained. The Faculty is composed of nine competent and experienced instructors. Rooms are pleasant and elegantly furnished. College is located in the Board of Trade building, in the business centre of the city. There are no vacations, and students may enter at any time. Write for illustrated circular. Address

Mention *Farmer's Advocate*. 224-c **SPENCER, FELTON & LOOMIS, PROPRIETORS.**

BRITISH AMERICAN BUSINESS COLLEGE TORONTO, CANADA

This is the Leading Commercial College in Canada. Its Location is in the Business and Educational Centre of this Province. The Course of Studies has been specially arranged to give a sound business training. Every Subject in the course is taught by men who make these subjects specialties. Arithmetic, Commercial Law, Book-keeping, Correspondence, Penmanship and Phonography are thoroughly taught. The School will re-open on Monday, September 1st. For Catalogue and other information, address **THE SECRETARY, Arcade Buildings, Yonge Street.**

225-d

"THE GOLDEN BELT"

ALONG THE KANSAS DIVISION U. P. R'WAY.
STOCK RAISING Buffalo Grass Pasture Summer and Winter. Unsurpassed for Climate, Grasses, Water.
CORN and WHEAT 200,000,000 Bus. Corn. 30,000,000 Wheat. The best in the Eastern Market.
FRUIT Pamphlets and Maps free. **B. McALLASTER, Land Commis'r, Kansas City, Mo.**

226-c

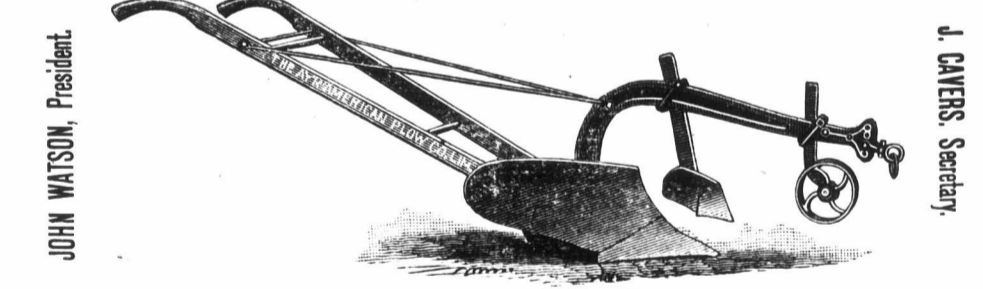

NO. 23 PLOW CHILLED.
THE AYR AMERICAN PLOW COMPANY (Limited)
MANUFACTURERS OF THE
CELEBRATED BUFORD SULKY PLOWS
with Steel or Chilled Iron Bottoms.
SULKY GANG PLOWS and STEEL and CHILLED PLOWS
of all the Latest Patterns.

BETTSCHEN'S CORN and ROOT CULTIVATOR and WHIPPLE'S SPRING HARROW
Our **SULKY PLOWS** are beyond question the best made in Canada, either for the Prairie or the older Provinces. Our No. 23 **CHILLED PLOW** is the neatest, strongest, and best working jointed Plow in the market. The **BETTSCHEN CULTIVATOR** has taken First Prizes wherever shown. We have the sole right for Canada to make the **WHIPPLE SPRING HARROW** either on wheels or on shoes. It is the most effective cultivating implement ever introduced to the Canadian farmers. It will do more and much better work than two old fashioned field cultivators or three gang plows. It is not a spring tooth harrow, but greatly superior to any spring tooth harrow in the market. Address
Send for an illustrated catalogue. 225 h
THE AYR AMERICAN PLOW COMPANY (Limited), AYR, ONT., CANADA.

BULBS!

My Autumn Catalogue of Choice
HOLLAND BULBS
Now Ready. Free to all applicants.
226 f **WM. RENNIE, Seedsman, Toronto.**

WESLEYAN LADIES' COLLEGE HAMILTON, CANADA.

The oldest and the largest Ladies' College in the Dominion. Has over 180 graduates. Faculty, 5 gentlemen and 12 ladies. The building cost \$110,000, and has over 150 rooms. Music and Art specialties. Pupils admitted at any time. Address the Principal.
226-c **A. BURNS, D.D., LL.D.**
MENTION THIS PAPER.

ONTARIO LADIES' COLLEGE Whitby, Ont.,

Affords an advanced collegiate course with the privilege of taking professional or University examinations; a full conservatory course in instrumental and vocal music under the direction of Mr. Edward Fisher, of Toronto; a fine arts course by two specialists from the Ontario Society of Artists; judicious training in home and social life by the lady principal, Miss Adams. Buildings and grounds unrivalled in the Dominion for elegance and completeness.
For calendar apply to
225-f **Rev. J. J. Hare, M.A., Principal.**

Ontario Business College BELLEVILLE, ONT.

Students in attendance from all parts of the continent and the West Indies. Course most thorough. Fees as low as in other first-class colleges.
Board only \$2.75 a Week.
Entrance at any time.
For circulars, &c., address
ROBINSON & JOHNSON,
225-c Belleville, Ont.

BUSINESS EDUCATION!

HAMILTON COMMERCIAL COLLEGE.

Corner King and James Streets.
(Over Federal Bank.)

THIS INSTITUTION offers special terms and advantages to

YOUNG GENTLEMEN AND LADIES

desiring a thorough, practical Business Education. Its course of instruction embraces all the branches necessary to complete commercial training, and is second to none. Its teachers are well qualified for their work, and the number of pupils is limited to what can be properly attended to. Everything connected with the school is the newest and best. No old system has any place in its curriculum.

The location of the College is in the best spot in the city of Hamilton, overlooking the Gore Park. The rooms are large, airy and newly furnished throughout. It will pay to call before applying elsewhere.

Send for circular.

M. L. RATTRAY,
223-f **PRINCIPAL.**
Please Mention this Paper.

SECTIONAL VIEW OF

Miller's "New Model" Vibrating Thresher

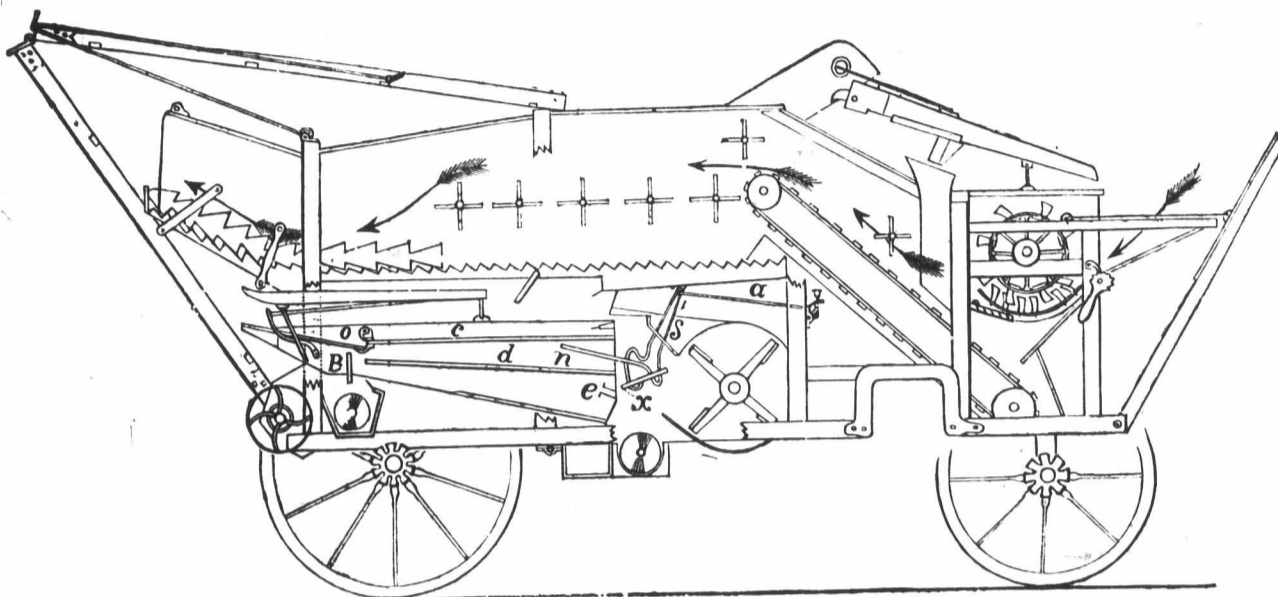

Manufactured by the Joseph Hall Manufacturing Company, Oshawa, Ontario.

THE MOST PERFECT THRESHER, THE MOST PERFECT SEPARATOR, THE MOST PERFECT CLEANER EVER OFFERED TO THE PUBLIC. THE ONLY TRUE GRAIN SAVER

JOHN DRYDEN, M. P. P., on the "NEW MODEL." (From the "Ontario Reformer," December 21st, 1883.)

Our readers are, probably, all aware that John Dryden, M. P. P., President of the Canadian Shorthorn Breeders' Association, occupies one of the finest farms in the Dominion of Canada, and is one of the best farmers. He cultivates something over five hundred acres of land, and there is scarcely an acre but what is in a high state of cultivation, and the whole farm is free from all weeds or plants which are injurious to crops. Not only does he own one of the finest and best tilled farms in the country, but his stock throughout, whether horses, cattle, or sheep, are of the very best breeds, and all of them fine animals. In every department Mr. Dryden looks out for the best whether it is in the line of stock, machinery or seed grains. He and his neighbor, Mr. Samuel Holman, purchased for their own use, this year, a New Model Vibrating Threshing machine of the Hall Company, and Mr. Dryden's opinion we give below. Every one who is acquainted with him knows that he would not put his name to any statement which is not correct in every particular; therefore his opinion of the New Model is of great value to those who desire to purchase a threshing machine:

Brooklin, Ontario County, Dec. 13, 1883.

The Joseph Hall Manufacturing Company, Oshawa.

We are highly delighted with the New Model Vibrator purchased from you this season. It runs smooth and easy; threshes perfectly; separates thoroughly; and the fanning mill does its work so completely that it cannot be excelled. It is just the machine for the farmers to buy because it is easy to control. It is comparatively free from dust, there can be no waste of grain, and it is bound to do good work under every circumstance. We heartily congratulate you on the introduction of so complete a separator, a great boon both to threshers and farmers.

Very truly yours,

JOHN DRYDEN, M. P. P.
SAMUEL HOLMAN,

Stock Notes.

Farmers and breeders favoring us with stock notes of their purchases or sales, may write them something like the style in which they appear in our stock note column. Two advantages will be gained in doing so: 1. One cent stamp will pay the postage if the words "Printers' Copy" are written on the envelope, and the envelope left unsealed. 2. We will be saved the trouble of putting the manuscript in shape for the printer. Every breeder who sends stock notes consults his own interests more than ours, our aim being the encouragement of stock breeding, and the best way for stockmen to encourage it is by extensive advertising. These notes are in reality a free advertisement.

Messrs. Green Bros., of the Glen Stock Farm, Innerkip, Ont., have sold their imported yearling bull, Earl of Roseberry, bred by Mr. W. S. Marr, of Uppermill, Aberdeen, Scotland, to Mr. J. E. Brethour, of Burford, in the County of Brant, Ont. He is by Athabasca (47,359), dam Emma 2nd; she is also the dam of their stock bull, the Earl of Mar (47,815), who took first prize in his class at the Provincial Show, Guelph, 1883. Emma 2nd has bred several heifers who have taken prizes in Scotland at the Highland shows.

Henry Arkell, Farnham Farm, held an auction sale of live stock on the 10th ult. Shorthorns and their grades and Oxford Down sheep brought fairly good figures. Cotswolds sold very low. Berkshire hogs went off fairly well.

Messrs. Geary Bros., London, Ont., have just completed the following sales: W. J. Justin, Streetsville, one shearing Shropshire ram; Jas. Went, Chatham, one Shropshire ram lamb; Mr. Medcroft, Union, one yearling Shropshire lamb; Model Farm, Guelph, one yearling Lincoln ram; Wm. Oliver, St. Marys, one Lincoln ram lamb; E. Parkinson, Guelph, one ram lamb; Geo. Gatecliff, one Lincoln ram lamb. Messrs. Geary Bros. have also just received from England two Shropshire rams to replace Acme, sold a few months since for \$4,500.

The fourth annual sale of stock, consisting of milch cows, heifers, steers, thoroughbred bulls, cows, calves, Shropshire Down rams and ewes, etc., the property of Mr. T. C. Patteson, Eastwood, Ont. (near Woodstock), will take place on Tuesday, Oct. 14th. Upwards of 60 head will be auctioned off.

Stockmen will do well to read the advertisement of the London Feed Co., in this issue. We believe this company to be strictly honorable and reliable.

(Continued on page 318.)

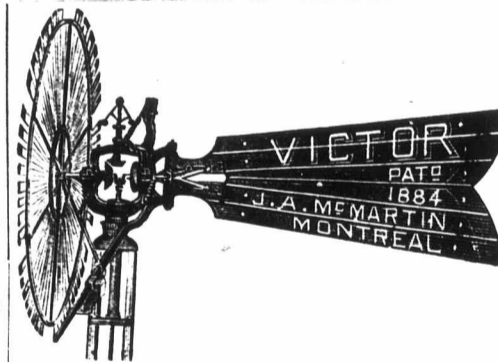

NATIONAL PUMP WORKS, 637 Craig St., Montreal.
J. A. McMARTIN & Co., Manufacturers of Pumps, Windmills, Fire Engines, Hydraulic Rams, etc. Illustrated Catalogues on application. 226-c&x

"The leading denominational paper in Canada."—N. Y. Christian-at-Work.

THE CANADA PRESBYTERIAN,

PUBLISHED EVERY WEDNESDAY BY THE
PRESBYTERIAN PRINTING AND PUBLISHING CO.,
AT 5 JORDAN ST., TORONTO.

Terms—\$2 Per Year, in Advance.

THE PRESBYTERIAN is recommended by the General Assembly as well worthy the hearty support of the membership. For 1885—13th year of publication—new and interesting features will be introduced, while old and valued departments will be continued with increased efficiency.

Advertisers will find THE PRESBYTERIAN a useful medium. Write for rates.

C. BLACKETT ROBINSON, Toronto.

The Farmer's Advocate and The Canada Presbyterian

Are Clubbed at the Low Price of \$2.50,
Balance of the Year Free. 22

THE BAIN WAGON

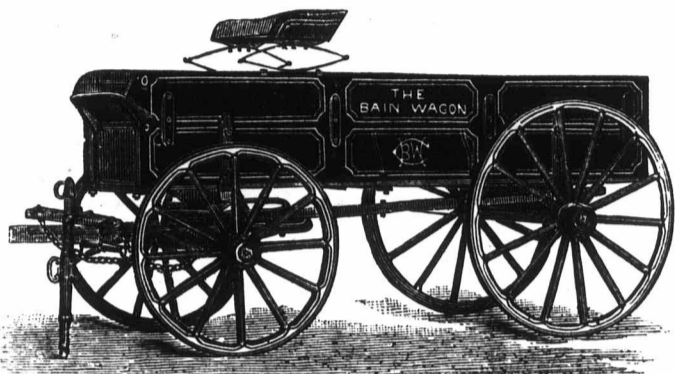

IS THE FARMER'S FAVORITE.

Because it is the lightest running wagon made.
 Because it is made in the most careful manner, from the best selected seasoned timber.
 Because no inferior iron is used, and special attention is paid in ironing it off.
 Because the wheels before the tire is put on are thoroughly saturated in boiling linseed oil, which is a sure preventive of loose tires.
 Because the patent arms made from our own patterns are superior to those made by other makers.
 Because all material used in painting it is of the finest quality, which gives it a superior finish.
 Because every wagon is inspected in all its parts by one of the members of the company before being sent out.
 Because it is just as represented every time.
 Because "the Bain Wagon" is warranted to be well made and of good material, and any breakage occurring with fair usage within one year, by reason of defective material or workmanship, will be made good by any of their agents, upon the purchaser producing the broken or defective parts as evidence.

Agents wanted for every county. Send for descriptive circular and prices to the
BAIN WAGON COMPANY, WOODSTOCK, ONT.
 N. B.—We make a specialty in spring wagons. Prices given on application. 225

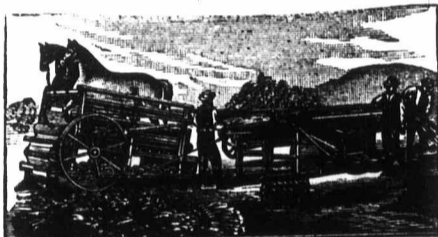

OLDS' PATENT
1, 2 AND 3 HORSE-POWERS AND SEPARATORS
 The leading Threshing Machine in the Dominion. Will do almost double the work of the old style mills.
 Send for Pamphlet to **B. W. OLDS & CO., 174 Mullins St., Point St. Charles, Montreal.**
 Or to **LARMONTH & SONS, General Agents, 33 College St., Montreal.**
 Or to **W. S. CASSON, General Agents for Frost & Wood, Truro, Nova Scotia.**
 Our Powers, formerly made at St. Albans, are used to operate the Laval Cream Separator. 222-f

THE EXTRA IMPROVED UNION CHURN

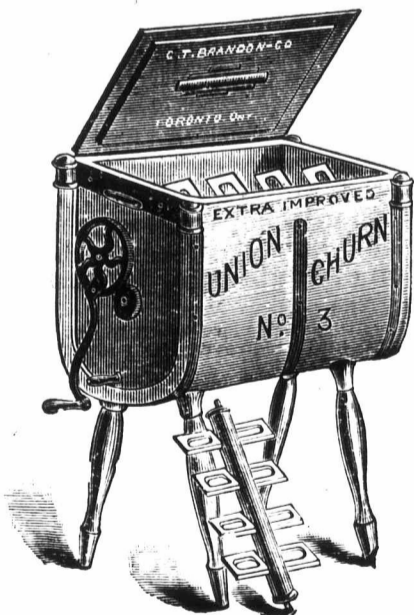

Admitted to be the Best Churn in the World!

Took the following 1st Prizes against all competitors:—

Hamilton	1876 and 1881
London and Quebec	1877
Sydney, New South Wales	1877
Paris, France	1878
Guelph	1883
Toronto	1878, 1879, 1880, 1883

Made in Four Sizes:—

No. 1	\$ 8 00 each
No. 2	8 50 "
No. 3	9 00 "
No. 4	11 00 "

If no dealer in your nearest town keeps our churns in stock, we will forward to your nearest railway station for above prices. Send for circular.

MANUFACTURED ONLY BY
C. T. BRANDON & CO., Toronto.
 Manufacturers all kinds of Wooden Goods. 225-b

FOR FALL PLANTING.
 The largest assortment in the country of the best Old and New Fruit and Ornamental Trees, Shrubs, Paeonies, Hedge Plants, Grape Vines, Small Fruits, etc. Abridged Catalogue mailed free.
ROSES. A Superb Collection. Carefully compiled varieties mailed free. Catalogue describing Best Old and New varieties mailed free.
BULBS. New Illustrated Catalogue, containing lists of the choicest bulbs, at lowest prices, now ready and mailed free.
NEW GOOSEBERRY. We now offer a very valuable new variety. Circular giving full description and price, together with a handsome colored plate, and New Catalogue of Small Fruits, free. Address: **ELLWANGER & BARRY, Mount Hope Nurseries, Rochester, N. Y.** Mention this paper. 225-b

VIENNA BAKING POWDER
S. H. & A. SEWING
 Proprietors & Manufacturers
 57 & 61 ST. JAMES ST.
MONTREAL.
 For Sale by all Grocers. 215-y



THE LINE SELECTED BY THE U. S. GOVT TO CARRY THE FAST MAIL.

Burlington Route.
 CHICAGO BURLINGTON & QUINCY R.R.



GOING WEST.
 ONLY LINE RUNNING TWO THROUGH TRAINS DAILY FROM CHICAGO, PEORIA & ST. LOUIS,
 Through the Heart of the Continent by way of Pacific Junction or Omaha to DENVER,
 or via Kansas City and Atchison to Denver, connecting in Union Depots at Kansas City, Atchison, Omaha and Denver with through trains for **SAN FRANCISCO,** and all points in the Far West. Shortest Line to **KANSAS CITY,** and all points in the South-West.
TOURISTS AND HEALTH-SEEKERS Should not forget the fact that Round Trip tickets at reduced rates can be purchased via this Great Through Line, to all the Health and Pleasure Resorts of the West and South-West, including the Mountains of **COLORADO,** the Valley of the Yosemite, the **CITY OF MEXICO,** and all points in the Mexican Republic.
HOME-SEEKERS Should also remember that this line leads direct to the heart of the Government and Railroad Lands in Nebraska, Kansas, Texas, Colorado and Washington Territory.
 It is known as the great **THROUGH CAR LINE of America,** and is universally admitted to be the **Finest Equipped Railroad in the World for all classes of Travel.**
 Through Tickets via this line for sale at all Railroad Coupon Ticket Offices in the United States and Canada.
T. J. POTTER, Vice-Pres. and Gen. Manager. **PERCEVAL LOWELL,** Gen. Pass. Ag't Chicago.
JNO. Q. A. BEAN, Gen. Eastern Ag't, 317 Broadway, New York, and 308 Washington St., Boston. 222-y

NIAGARA GRAPE VINES No restrictions as to planting. First class two year vines \$2.00 each. Grape vines of all the leading kinds at bottom prices. small Fruit plants, old tried kinds and latest novelties. Russian Mulberry very cheap. Send a list of your wants for quotations, and a free price list. E. D. SMITH Winona, Ont. 226-4f

STOCK NOTES.

(Continued from page 316.)

J. & Nathan Norton, of 1st Con., Westminster, have sold the celebrated stallion, Sunk Island Hero, to Mr. Peter Macrae, of Centreville, P. E. I., for the sum of \$2,000.

During the late pleuro-pneumonia infection amongst Jersey cattle in Illinois, Dr. Smith, Principal of the Ontario Veterinary College, was commissioned by the Dominion to go and ascertain the extent of the outbreak in that State. He believes that not only the infected animals should be slaughtered, but also all those having had any contact with them, the State recompensing the owners for the loss, and thinks that a fund of \$140,000 of compensation money would be required.

This is the "weeding out" season. The expert feeder may have old, but will never have inferior stock, to weed out; but this is not the man to whom we purpose addressing our remarks. The farmer who has a quantity of inferior stock, cows or steers, has a heavy burden to bear during all the winter months. Their usefulness as manure machines may be doubted, to regular buyers or feeders he can not sell them at a margin of profit, and his prospect is confined to making sales to neighboring farmers whose skill in judging live stock is inferior to his own. If there are any old cows in the lot get rid of them at any sacrifice.

The Canada Farm Stock Association, Brantford, Ont., sold Rigdon Huston & Son, Blandinsville, Ill., the 11-months old Shorthorn bull, 2nd Duke of Brant, for \$5,000; Duke of Sharon 14th, 7-months old, to Kellogg & Fitzgerald, Portland, N. J., price \$400; Opheus 16th, calved Nov. 30, 1882, to Dougal Ferguson, Pt. Stanley, Ont., for \$350; Duke of Kirklevington 21st, calved April 2nd, 1884, and Princess Victoria 20th, to B. F. Winn, Graysonville, Mo., for \$1,000 each; Baron Louan 10th, calved April 9th, 1883, to Thos. Ayres, Galveston, Texas, for \$350; Baron Fawsley 8th, calved Dec. 31st, 1882, to Mr. Mann, Bowmanville, Ont.

Before stabling the stock the first duty to be attended to, is to calculate the quantity of feed on hand, and then compare it with the number of animals it has to sustain through the winter. Yet this practice should not be the highest aim of the feeder. If he has business capacity as well as experience in feeding, his object will be to accommodate the feed to the herd, not the herd to the feed. He will not only retain all the good animals he has, but also buy up all the good ones which he can procure at reasonable figures, making up any deficiency in his food supply by purchases. He will also watch the market reports closely, and will sell such food stuffs as will bring more than their intrinsic value, purchasing those which are worth more to him than the market prices.

WATER---Clear, Cold and Pure.



The Radial Centre secures water better than any other point made, as it gives the whole surface under the gauze. Circulars free.

223 a

F. G. BULLOCK, Otterville, Ont.

WASHBOARDS

THE BEST IS THE CHEAPEST.

P
L
A
N
E
T

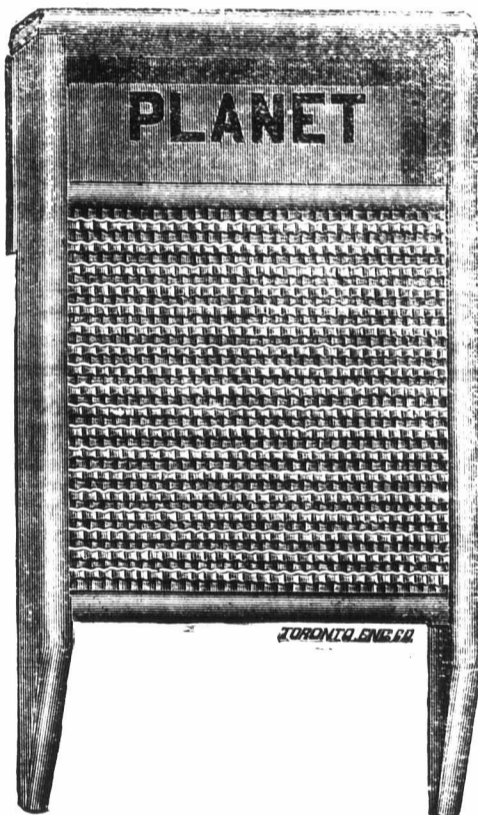

—THE—
PLANET
IS THE BEST.

ASK FOR IT AND TAKE NO OTHER!
SATISFACTION GUARANTEED!

Saves Time, Labor and Soap!

E. B. EDDY,
HULL, P. Q.

Manufacturer of
PAILS, TUBS, WASHBOARDS and MATCHES
All goods manufactured by me bear my name and are guaranteed to be the best in the market.
E. B. EDDY

WHOLESALE AGENTS:

H. A. NELSON & SONS, TORONTO and MONTREAL,

221-y

In consequence of the increased demand for my ENGINES, I have added to my shops and machinery, and shall largely increase the production of engines for 1884.

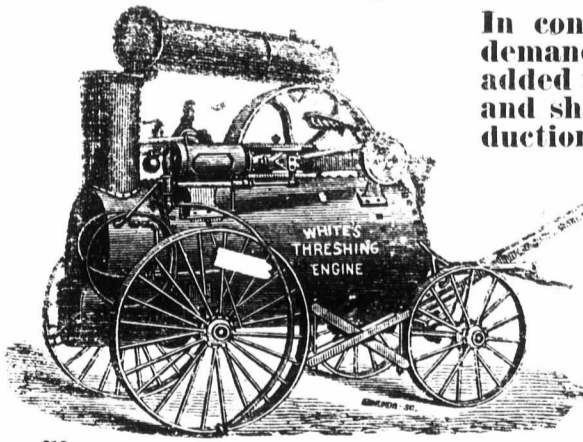

219-y

It is licensed by all Insurance Co.'s and has proved itself to be the most durable.
The Engine for the Northwest is made to burn either coal, wood or straw. Farmers, procure a Genuine White Threshing Engine at the Forest City Machine Works, London, Ont., Can.
GEORGE WHITE, Proprietor and Manager
H. B. WHITE, Supt. of Machinist Dept.
A. W. WHITE, Supt. of Erecting Dept.
HUB. J. WHITE, Secretary-Treasurer.
F. J. WHITE, Assistant-Secretary.
The engines may be seen at Van Tassal's foot bridge warehouse, Belleville.

SMALL FRUITS

Cornelia, Daniel Boone, Prince of Berries, Atlantic, Connecticut Queen, James Vick and other new and old Strawberries.

Marlboro, Beebe's, Golden Prolific, Souhegan, Tylor, Hopkins, Shaffers, Hansell and other leading Raspberries.

Early Cluster Blackberry.

Fay's Prolific Currant.

Gooseberries, Grapes, and other Small Fruits.

FIRST-CLASS PLANTS. LOW PRICES

Send for full Price List, free to all.

W. W. HILBORN & CO.,

225-11 ARKONA, ONT., CANADA.

DERICK'S HAY PRESSES.

are sent anywhere on trial to operate against all other presses. the customer keeping the one that suits best.



Manufactory at 90 College Street, Montreal, P. Q. Address for circular P. K. DEDERICK & CO., Albany, N. Y.

HAVE YOU A FRIEND WHO WANTS TO GET INTO a good paying business, or would you prefer to go in and win yourself. Agents and farmers will find this an easy way to make money. Write for particulars, enclosing 3c. stamp; don't delay. Address, JAMES LAUT, 281 Yonge Street, Toronto, Ont. 219-y



J. N. ANDERSON, M. D. M. C. P. S. Ont.—Eye and Ear Surgeon, 34 James St. Hamilton, Ont. Dr. Anderson gives exclusive attention to the treatment of the various diseases of the EYE and EAR. CROSS EYES STRAIGHTENED.

BUY ONLY THE DOHERTY ORGAN

220-y



The NOVELTY RUG MACHINE

(PAT. MARCH 6th, 1882.)

Makes Rugs, Tildies, Hoods, Mittens, Door Mats, &c.,

with ease and rapidity. Price only one dollar. Single machines, with full directions, sent by mail on receipt of price. Agents wanted. Apply for circulars to R. W. Ross, P. O. Box 541. Sole Manufacturer, Guelph, Ont. Also dealer in Rug Patterns. 225-f

NORTHERN PACIFIC R. R. LANDS

In Minnesota, North Dakota, Montana, Idaho, Washington and Oregon.

The Northern Pacific country is the newest region open for settlement, BUT THE RICHEST IN NATURAL RESOURCES. Its exceptionally fertile soil, well watered surface, fine wheat and farming lands, best of cattle grounds, large bodies of timber, rich mining districts, healthful climate, great navigable waters, and grand commercial opportunities are the chief attractions which invite a large population.

NOTE 10,818,433 acres or MORE THAN HALF of all the Public Lands disposed of in 1883 were in the Northern Pacific country. Send for maps and publications describing the railroad lands and the country. They are sent FREE. Address CHAS. B. LAMBORN, Land Com'r, St. Paul, Minn.

ACME STEAM HEAT EVAPORATOR

—FOR— DRYING FRUITS AND VEGETABLES.

Has twice the capacity for its size of any machine in the market, and is warranted to use less than one-half the fuel used by any other drying machine. Is used for drying Straw Board, Fish, Confectioneries &c. Send for Catalogue and Price List.

J. J. BLACKMORE & CO., 224-c ST. THOMAS, ONT

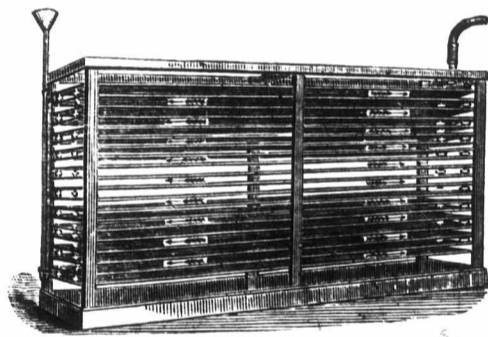

Campbell's Riddle for Extracting Cockle and Wild Peas from Wheat.

6000 OF CAMPBELL'S MILLS NOW IN USE!

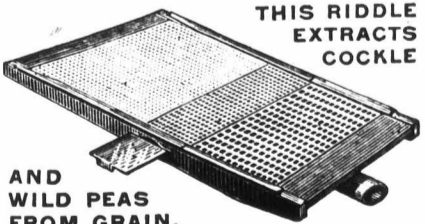
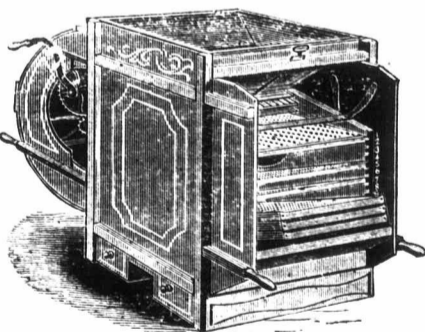

THIS RIDDLE EXTRACTS COCKLE

AND WILD PEAS FROM GRAIN.

The accompanying cuts represent the top view of Campbell's Patented Riddle for extracting cockle and wild peas from grain.

You will notice that there are three different sizes of perforated zinc on the top over which the grain passes. The size of the holes where the grain runs over first, is 1/4 of an inch, and the next size is some larger and by means of a Sheet Iron Slide, you can either close the middle holes or leave them open, according to size of cockle or wild peas you wish to take out.

The holes in the piece furthest out are 1/2 of an inch, and they let the clean grain through, down on the screen, just the same as an ordinary riddle.

This Riddle works grand, and farmers who desire to have clean grain to sell and clean seed to sow, will be well satisfied with it.

It will be in all of my Mills sent out after this date. The Mill is also fitted with Screens and Riddles for cleaning every kind of grain that grows.

The Mill has proved itself to be first-class in every respect, and farmers who favor me with an order will get a Mill that will give them every satisfaction, and it is second to none in the market.

GEARING INSIDE. SCREENS and RIDDLES ADJUSTABLE TO ANY PITCH.

Send for circular and prices to

MANSON CAMPBELL, Box 106, CHATHAM. 222

SWISS SOAP!

Guaranteed Best in the World! Ask Your Grocer For It!

Manufactured only by the HURON SOAP COMPANY, Goderich, Ont. 220-y

FARM FOR SALE.

That fine farm of 200 acres, more or less, in the township of Delaware, known as Green Park, held by the undersigned in trust for the co-heirs of the late Rothwell Garnett, Esq., being lot No. 10 in the 1st concession. Enquire of J. SEANLY, London } Co-trustees } E. MOETIMER, Toronto } Dated 31st March, 1884. 220-1f

INTERCOLONIAL RAILWAY

The Great Canadian Route to and from the Ocean.

For Speed, Comfort and Safety is Unsurpassed.

Pullman Palace, Day and Sleeping Cars on all through Express Trains.

Good Dining Rooms at Convenient Distances.

NO CUSTOM HOUSE EXAMINATION.

Passengers from all points in Canada and the Western States to Great Britain and the Continent should take this route, as hundreds of miles of winter navigation are thereby avoided.

IMPORTERS and EXPORTERS

will find it advantageous to use this route, as it is the quickest in point of time, and the rates are as low as by any other.

Through freight is forwarded by FAST SPECIAL TRAINS, and experience has proved the Intercolonial route to be the quickest for European freight to and from all points in Canada and the Western States.

The Pullman cars which leave Montreal on Monday, Wednesday and Friday, run through to Halifax without change, and those which leave Montreal on Tuesday, Thursday and Saturday run through to St. John, N. B., without change.

Tickets may be obtained, and also information about the route, and about freight and passenger rates from R. B. MOODIE, Western Freight and Passenger Agent, 93 Rosin House Block, York St., Toronto, and E. DE LAHOKE, Ticket Agent, No. 3 Masonic Temple, London.

D. POTTINGER, Chief Superintendent, Moncton, N. B. Railway Office, Moncton, N. B., 10th December, 1883. 217-1f

Agricultural Savings & Loan Company, LONDON, ONTARIO.

President—WM. GLASS, Sheriff Co. Middlesex. Vice-President—ADAM MURRAY, Co. Treasurer

Subscribed Capital, - \$600,000 Paid Up do. - 575,000 Reserve Fund, - 61,000 Total Assets, - 1,339,000

The Company issues debentures for two or more years in sums of \$100 and upwards, bearing interest at highest current rates, payable half yearly by coupons.

Executors and Trustees are authorized by law to invest in debentures of this Company. For information apply to JOHN A. ROE, Manager. 306-1f

THE SUCCESSFUL FIRE-PROOF CHAMPION!



WATEROUS ENGINE WORKS CO., BRANTFORD, CANADA.

OVER 150 SOLD and DELIVERED THIS YEAR

We are still turning out SIX Finished Engines every week and cannot keep up to the demand.

7 Years Test has proved the Champion to be the best engine in every respect for farmers,

The Thresher's Favorite { Always ready. No delays.

The Farmer's Favorite { Uses little wood and water. Perfect safety from fire.

The Only Engine that has stood the test of time and still continues more popular than ever.

ENDLESS THRESHING BELTS { 5, 6 and 7 in. Gandy 100 ft. long. 6 in. 4-ply Rubber 100 ft. long.

225-

ONTARIO PUMP CO., Limited, TORONTO, ONT.,

MANUFACTURERS AND DEALERS IN

Wind Mills, I. X. L. Feed Mills, Hay Carriers, Horse Hay Forks, Tanks, Double and Single Acting Pumps, Wood or Iron. Also Steam Pumps and Water Supplies, Iron Pipe and Pipe Fitting, all kinds.

STATE WHAT YOU WANT AND SEND FOR ILLUSTRATED CATALOGUES.



Halladay's Standard Wind Mills. 17 Sizes.



Pumps—Iron & Wood. Force or lift. Deep Geared Wind Mills, for driving Machinery, Pumping Water, &c. From 1 to 40 horse power.

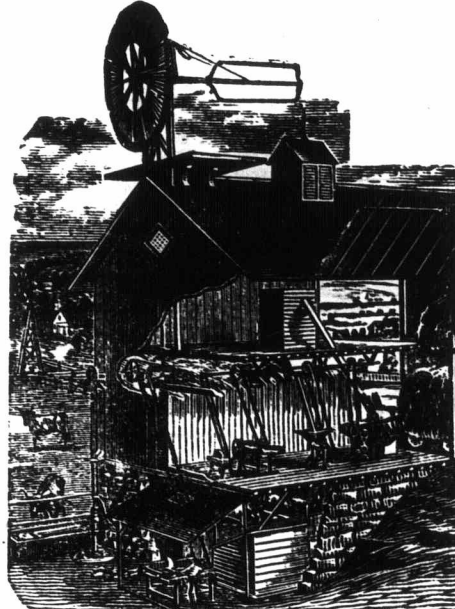

Geared Wind Mills, for driving Machinery, Pumping Water, &c. From 1 to 40 horse power.

March 14, 1884.

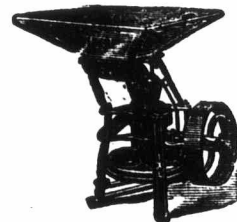

I X L FEED MILLS. The cheapest, most durable and perfect iron feed mill ever invented.

ONTARIO PUMP CO.,

Gentlemen,—In regard to the 16-foot geared Wind Mill I bought of you, I can say it more than fills my expectations in every respect. In a fair to good wind I can saw wood at the rate of four cords of hard wood per hour, cut once in two. In a stiff wind I open the fans just half way and get all the power I require. In regard to your feed mill it is just grand. I have ground peas and oats at the rate of a bushel in three and a half minutes, and ground it as fine as one would wish for. I can grind fine corn-meal, also Graham flour. Have ground, since the 15th of February, 325 bushels of grain for customers, besides doing my own work with it. One man brought a grist of screenings, such as small wheat, mustard, and pussy grass seed, thinking that I could not grind it; but I ground it to powder, looking just like ground pepper. Your 13-foot geared mill, I think, is quite large enough for any farmer to do his own work.

220-tf

Yours truly, EDWIN KEELER, Maitland P. O.

W. & F. P. CURRIE & CO.

100 Grey Nun St., Montreal,

MANUFACTURERS OF

SOFA, CHAIR AND BED SPRINGS.

A LARGE STOCK ALWAYS ON HAND

IMPORTERS OF

Drain Pipes, Vent Linings, Flue Covers, Fire Bricks, Fire Clay, Portland Cement, Roman Cement, Water Lime, Plaster of Paris, Borax, Whiting, China, Clay, etc.

210-y

PROCURE THE BEST.

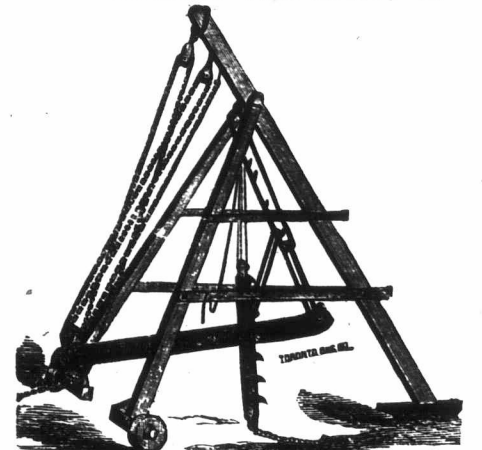

The Whitfield Stump Extractor.

The superiority of this machine consists in the rapidity and ease in which it can take out the largest stumps; the ease with which it is operated by man or beast, and the great strength and durability of this machine. It leaves no holes to fill up, nor any stumps or snags in the ground. Send for circular of testimonials and particulars about it before purchasing an inferior machine.

JOHN WHITFIELD, 202 St. Dominion Chain Works, Front Street, Toronto.

Ontario Veterinary College

TEMPERANCE STREET, TORONTO.

The most successful Veterinary Institution in America. All experienced Teachers. Fees, Fifty Dollars per Session. Session 1882-3 begins Oct 25th. Apply to the Principal, PROF. SMITH, V. S., Edin., TORONTO, CANADA. 201-l

AMBER SUGAR CANE MACHINERY. NEW PARAGON SCHOOL DESKS. M. BEATTY & SONS, WELLAND, ONT. Early Amber Cane Seed imported from the States. Pure and reliable. Send for catalogues and prices. 219-h

DR. W. E. WAUGH—Office, The late Dr. Anderson's, Ridout Street, LONDON ONT. 217-y

FARMS FOR SALE

In Western Ontario a number of choice Farms. Full description list sent on application. Correspondence invited, full information given, and on personal application at my office, plans of the townships shown, enabling strangers to see the position of properties and their proximity to towns, railway stations, &c. Farms with acreage to suit every one. Send to

CHARLES E. BRYDGES,

Real Estate Agent.

Land office, 93 Dundas street west, London, opposite to the City Hotel, for list of farms for sale. 176-s

