

## Technical and Bibliographic Notes / Notes techniques et bibliographiques

The Institute has attempted to obtain the best original copy available for scanning. Features of this copy which may be bibliographically unique, which may alter any of the images in the reproduction, or which may significantly change the usual method of scanning are checked below.

L'Institut a numérisé le meilleur exemplaire qu'il lui a été possible de se procurer. Les détails de cet exemplaire qui sont peut-être uniques du point de vue bibliographique, qui peuvent modifier une image reproduite, ou qui peuvent exiger une modification dans la méthode normale de numérisation sont indiqués ci-dessous.

- Coloured covers /  
Couverture de couleur
- Covers damaged /  
Couverture endommagée
- Covers restored and/or laminated /  
Couverture restaurée et/ou pelliculée
- Cover title missing /  
Le titre de couverture manque
- Coloured maps /  
Cartes géographiques en couleur
- Coloured ink (i.e. other than blue or black) /  
Encre de couleur (i.e. autre que bleue ou noire)
- Coloured plates and/or illustrations /  
Planches et/ou illustrations en couleur
- Bound with other material /  
Relié avec d'autres documents
- Only edition available /  
Seule édition disponible
- Tight binding may cause shadows or distortion  
along interior margin / La reliure serrée peut  
causer de l'ombre ou de la distorsion le long de la  
marge intérieure.

- Coloured pages / Pages de couleur
- Pages damaged / Pages endommagées
- Pages restored and/or laminated /  
Pages restaurées et/ou pelliculées
- Pages discoloured, stained or foxed /  
Pages décolorées, tachetées ou piquées
- Pages detached / Pages détachées
- Showthrough / Transparence
- Quality of print varies /  
Qualité inégale de l'impression
- Includes supplementary materials /  
Comprend du matériel supplémentaire
- Blank leaves added during restorations may  
appear within the text. Whenever possible, these  
have been omitted from scanning / Il se peut que  
certaines pages blanches ajoutées lors d'une  
restauration apparaissent dans le texte, mais,  
lorsque cela était possible, ces pages n'ont pas  
été numérisées.

Additional comments /  
Commentaires supplémentaires:

Various pagings.

In Sessional paper No. 8B, page 124 is incorrectly numbered page 224.

In Sessional paper No. 8C, page 272 is incorrectly numbered page 227.

# SESSIONAL PAPERS

VOLUME 6

FOURTH SESSION OF THE SEVENTH PARLIAMENT

OF THE

DOMINION OF CANADA

SESSION 1894



---

VOLUME XXVII.



See also Numerical List, page 4.

ALPHABETICAL INDEX  
TO THE  
SESSIONAL PAPERS  
OF THE  
PARLIAMENT OF CANADA

FOURTH SESSION, SEVENTH PARLIAMENT, 1894.

NOTE.—In order to find quickly whether a paper has been printed or not, the mark (n.p.) has been inserted when not printed; papers not so marked, it may be understood, are printed. Further information concerning each paper is to be found in the List, commencing on page 4.

A	C
Adulteration of Food..... 7a	Canal Tolls.....(n.p.) 85
Agriculture, Annual Report..... 8	Cattle Inspection..... 90
Archives, Canadian..... 8a	Cattle Rancho, Government.....(n.p.) 66
Atlantic Steamship Line..... 84, 84a, 84b	Certified Captains or Mates.....(n.p.) 88
Auditor General, Annual Report..... 1	Chambly Canal.....(n.p.) 24, 57a
Australia, Mission to..... 5a	Chartered Banks..... 3
Awards, Agricultural Implements at Chicago. 8e	Chevalier, I. B.....(n.p.) 33c
B	Chicago Awards..... 8c
Banks, Chartered..... 3	Chicago Exposition, Prizes at..... 101
Banks, Unclaimed Balances in..... 3a	Civil Service Board of Examiners..... 16b
Baptisms, Marriages and Burials.....(n.p.) 105	Civil Service Insurance.....(n.p.) 51
B. C., Commutation of Sentence in.....(n.p.) 65d	Civil Service List..... 16a
Blue Books.....(n.p.) 39	Civil Service Superannuations.....(n.p.) 25, 25a
Bonds and Securities.....(n.p.) 38	Cockburn Island Wharf.....(n.p.) 75e
Bonus paid for Settlers.....(n.p.) 67	Coffin, Charles.....(n.p.) 63
Boundary, Alaska and British Columbia.(n.p.) 86	Colonial Conference..... 5b
Breweries and Distilleries.....(n.p.) 104	Columbian Exposition, Nova Scotia Employees at.....(n.p.) 55
Bridge at St. Michel d'Yamaska.....(n.p.) 34b	Columbian Exposition, Report on..... 8g
British Canadian Loan & Investment Co.(n.p.) 20	Commission on Liquor Traffic..... 21
British Columbia Penitentiary.....(n.p.) 59c, 59d, 59e	Commissions to Public Officers..... 31
British Columbia Railway Belt.....(n.p.) 45	Commutation of Sentence in B. C.....(n.p.) 65d
Building of Canadian Ships.....(n.p.) 74, 74a	Connolly and McGreevy.....(n.p.) 37
Bureau of Labour Statistics.....(n.p.) 68	Contractors' Securities.....(n.p.) 87
Butter.....(n.p.) 69	Copyright Laws..... 50
Butter and Cheese..... 8h	Cornwall Canal.....(n.p.) 77b, 77c
C	Criminal Statistics..... 8f
Campbell, Samuel.....(n.p.) 33d	Customs Affairs at Woodstock.....(n.p.) 92
Canadian Cattle, Scheduling of..... 8d	D
Canadian Pacific Railway :	Dairy Commissioner..... 8b
Payments to.....(n.p.) 28	Davis, W. H., & Sons.....(n.p.) 77b, 77c
Lands sold by.....(n.p.) 34	Departmental Reports.....(n.p.) 39
Business with Interior Department..(n.p.) 34a	Dividends Unpaid in Banks..... 3a
Schedule of Rates..... 34c	Dominion Lands.....(n.p.) 35, 35a
Western Division.....(n.p.) 34d	Dominion Police Report.....(n.p.) 22
Canadian Ships.....(n.p.) 74, 74a	Dominion Savings Banks.....(n.p.) 71
Canadian Tobacco.....(n.p.) 106	

<b>E</b>		<b>L</b>	
Elgin Voters' List .....	(n.p.) 86	Loans for Seed-grain.....	(n.p.) 102
Ellis, John V. ....	(n.p.) 49	Loebster Fishing .....	(n.p.) 33e
Estimates.....	2	Luther, Sale of Lot in.....	(n.p.) 72, 72a
Exchequer Court Rules.....	(n.p.) 32	<b>M</b>	
Excise.....	7	Manitoba, Homesteads in.....	(n.p.) 70
Expenses, Unforeseen.....	(n.p.) 26	Manitoba Schools.....	40a, 40c
Experimental Farms, Annual Report.....	8c	Manitoba School Laws.....	40d
<b>F</b>		Marine and Fisheries, Annual Report.....	11
Fast Steamship Line.....	84, 84a, 84b	Militia and Defence, Annual Report.....	19
Fisheries in Ontario.....	(n.p.) 33f	Militia, Establishment Lists.....	19a
Fishing Bounties.....	(n.p.) 35b	Mill River.....	(n.p.) 89
Fishing Licenses.....	(n.p.) 33	Mining Machinery.....	(n.p.) 47
Flag Station, Removal of.....	(n.p.) 89	Miscellaneous Unforeseen Expenses....	(n.p.) 26
Food, Adulteration of.....	7a	Mission to Australia.....	5a
French Treaty.....	56, 56a	Montpetit, Julien.....	(n.p.) 33a
<b>G</b>		Montreal Timber Dues.....	(n.p.) 79a
Galops Rapids Channel.....	(n.p.) 60	Mounted Police, Annual Report.....	15
Geological Survey Report.....	13a	<b>Mc</b>	
Gosselin, Michel.....	(n.p.) 41	McGreevy and Connolly.....	(n.p.) 37
Governor General's Warrants.....	(n.p.) 27	McLeod, John.....	(n.p.) 98
Grand Etang.....	(n.p.) 75	McQueen, Timothy.....	(n.p.) 33b
<b>H</b>		<b>N</b>	
Half-breeds' Lands.....	(n.p.) 91	North-west Mounted Police.....	15
Harris Property.....	(n.p.) 44a	North-west School Teachers.....	(n.p.) 40
Herring Fishing.....	(n.p.) 33e	<b>O</b>	
Homesteads in Manitoba.....	(n.p.) 70	Ontario Fisheries.....	(n.p.) 33f
Howlan Road.....	(n.p.) 89	Ontario Junior Judges.....	(n.p.) 83
Hudson Bay, Explorations to.....	(n.p.) 36	Ottawa, Colonial Conference at.....	5b
Hurons of Lorette.....	(n.p.) 78	<b>P</b>	
<b>I</b>		Palmer, Justice.....	(n.p.) 29
Immigration Return-men.....	(n.p.) 93	Prince Edward Island Railway.....	(n.p.) 23
Imports, Various.....	(n.p.) 81, 81a, 81b, 81c	Prince Edward Island School Law.....	40b
Indian Affairs, Annual Report.....	14	Penitentiaries, Deaths in.....	(n.p.) 59
Inland Revenue, Annual Report.....	7	Pickets Pier.....	(n.p.) 76
Insurance, Annual Report.....	4	Pig Iron.....	46
Insurance Companies.....	4a, 4b	Postmaster General, Annual Report.....	12
Intercolonial Railway Freight Rates. (n.p.)	34d, 44	Post Office Savings Banks.....	(n.p.) 71
Interior, Annual Report.....	13	Prizes at Chicago Exposition.....	101
<b>J</b>		Provencher, Rivers in.....	(n.p.) 62
James Bay, Explorations to.....	(n.p.) 36	Public Accounts, Annual Report.....	2
Johnstone, Judge.....	(n.p.) 58	Public Officers' Commissions.....	31
Junior Judges, Ontario.....	(n.p.) 83	Public Printing and Stationery.....	16c
Justice, Annual Report.....	18	Public Works, Annual Report.....	9
Justice Palmer.....	(n.p.) 29	Public Works, Expenditures on.....	(n.p.) 75d
<b>K</b>		<b>Q</b>	
Kingston Penitentiary. (n.p.)	59a, 59b, 59c, 59d, 59e	Quebec Timber Dues.....	(n.p.) 79
<b>L</b>		<b>R</b>	
Lacouture, Joseph.....	(n.p.) 24	Railways and Canals, Annual Report.....	10
Lands allotted to Half-breeds.....	(n.p.) 91	Receipts and Expenditures.....	(n.p.) 52, 52a
Lands, Dominion.....	(n.p.) 35, 35a, 54	Reciprocity with United States.....	(n.p.) 85
Library of Parliament, Annual Report.....	17	Return-men, Immigration.....	(n.p.) 93
Licenses to U. S. Fishing Vessels.....	(n.p.) 33	Revising Officers.....	(n.p.) 43
Liquors, Distilled and Fermented.....	(n.p.) 103	Rocheleau, Joseph Placide.....	(n.p.) 82
Liquor Traffic, Royal Commission.....	21	Royal Commission on Liquor Traffic.....	21

<b>R</b>		<b>T</b>	
Royal Military College.....	48, 48a	Timber Dues, Montreal.....(n.p.)	79a
Rules, Exchequer Court.....	(n.p.) 32	Timber Dues, Quebec.....(n.p.)	79
Rustico Breakwater.....	(n.p.) 75c	Timber Licenses.....	(n.p.) 79c
<b>S</b>		Timber Sold.....	(n.p.) 79b
Sabourin, Théophile.....	(n.p.) 33a	Tobacco, Canadian.....	(n.p.) 106
Sale of Lot in Luther.....	(n.p.) 72, 72a	Trade and Commerce, Annual Report.....	5
Sandford Breakwater.....	(n.p.) 75a	Trade and Navigation, Annual Report.....	6
Saugeen Indians.....	(n.p.) 65b, 65c	Trade Unions.....	(n.p.) 30
Saw-logs.....	(n.p.) 96	Trent Valley Canal.....	(n.p.) 64
Scheduling of Canadian Cattle.....	8d	Tunnel between P. E. I. and Mainland.....	95
School Teachers in North-west.....	(n.p.) 40	<b>U</b>	
Secretary of State, Annual Report.....	16	Unforeseen Expenses.....(n.p.)	26
Securities for Contracts.....	(n.p.) 87	United States, Cattle from.....	90
Seed-grain, Loans for.....	(n.p.) 102	<b>V</b>	
Seigniori of Silley.....	(n.p.) 78	Vankoughnet, L.....	(n.p.) 53
Settlers, Bonus paid for.....	(n.p.) 67	Voters' List, Elgin.....	(n.p.) 80
Sheik's Island Dam.....	(n.p.) 77b, 77c	<b>W</b>	
Six Nation Indians.....	(n.p.) 65, 65a	Warrants, Governor General's.....	(n.p.) 27
Sorel Board of Trade.....	(n.p.) 34b	Weights, Measures and Gas.....	7b
Soulanges Canal.....	(n.p.) 57, 57b, 57c, 57d	West Bay, N.S.....	(n.p.) 97a
St. Andrew's Rapids.....	(n.p.) 99	Whycocomagh, N.S.....	(n.p.) 97
Steamboat Inspection.....	11a	Wood, A. F.....	(n.p.) 73
Steamer "Stanley".....	(n.p.) 94, 94a	Wood Island Breakwater.....	(n.p.) 75b
Steamship Service.....	84, 84a, 84b	Woodstock, Customs Affairs at.....	(n.p.) 92
Superannuations, Civil Service.....	(n.p.) 25, 25a	World's Exposition, Report on.....	8g
Swine, Slaughtering of.....	(n.p.) 100	Wrecking and Towing.....	(n.p.) 85
<b>T</b>		<b>Y</b>	
Tariff Changes.....	(n.p.) 42	Yamaska River Dam.....	(n.p.) 77, 77a
Thousand Islands.....	61		

See also Alphabetical Index, page 1.

## LIST OF SESSIONAL PAPERS

*Arranged in Numerical Order, with their Titles at full length; the Dates when Ordered and when Presented to both Houses of Parliament; the Name of the Member who moved for each Sessional Paper, and whether it is ordered to be Printed or not Printed.*

### CONTENTS OF VOLUME B.

Census of Canada, 1890-91. Second Volume..... *Printed for both distribution and sessional papers.*

### CONTENTS OF VOLUME C.

Census of Canada, 1890-91. Third Volume..... *Printed for both distribution and sessional papers.*

### CONTENTS OF VOLUME 1.

1. Report of the Auditor General on Appropriation Accounts, for the year ended 30th June, 1893. Presented 20th March, 1894, by Hon. G. E. Foster. *Printed for both distribution and sessional papers.*

### CONTENTS OF VOLUME 2.

2. Public Accounts of Canada, for the fiscal year ended 30th June, 1893. Presented 20th March, 1894, by Hon. G. E. Foster. 2a. Estimates for the fiscal year ending 30th June, 1895; presented 20th March, 1894. 2b. Supplementary estimates for the financial year ending 30th June, 1894; presented 20th June, 1894. 2c. Supplementary Estimates for the year ending 30th June, 1895; presented 12th July, 1895..... *Printed for both distribution and sessional papers.*
3. Lists of Shareholders in the Chartered Banks of Canada, as on 31st December, 1893. Presented 20th April, 1894, by Hon. G. E. Foster..... *Printed for both distribution and sessional papers.*
- 3a. Report of dividends remaining unpaid and unclaimed balances in the chartered banks of Canada, for five years and upwards, prior to 31st December, 1893. Presented 11th June, 1894, by Hon. G. E. Foster..... *Printed for both distribution and sessional papers.*

### CONTENTS OF VOLUME 3.

4. Report of the Superintendent of Insurance for the year ending 31st December, 1893. *Printed for both distribution and sessional papers.*
- 4a. Preliminary abstract of the business of Canadian life insurance companies for the year ending 31st December, 1893. Presented 20th March, 1894, by Hon. G. E. Foster. *Printed for both distribution and sessional papers.*
- 4b. Abstract of statements of Insurance Companies in Canada for the year ending 31st December, 1893. Presented 7th May, 1894, by Sir John Thompson *Printed for both distribution and sessional papers.*

---



---

 CONTENTS OF VOLUME 4.

5. Report of the Department of Trade and Commerce, for the year ended 30th June, 1893. Presented 17th May, 1894, by Sir John Thompson.....*Printed for both distribution and sessional papers.*
- 5a. Report of the Mission to Australia, by the Minister of Trade and Commerce. Presented 4th July, 1894, by Sir John Thompson..... *Printed for both distribution and sessional papers.*
- 5b. The Colonial Conference, held at Ottawa, 1894.....*Printed for both distribution and sessional papers.*

## CONTENTS OF VOLUME 5.

6. Tables of the Trade and Navigation of Canada for the fiscal year ended 30th June, 1893. Presented 27th March, 1894, by Hon. N. C. Wallace .....*Printed for both distribution and sessional papers.*
7. Inland Revenues of Canada. Part I., Excise, etc., for the fiscal year ended 30th June, 1893. Presented 20th March, 1894, by Hon. J. F. Wood...*Printed for both distribution and sessional papers.*
- 7a. Inland Revenues of Canada. Part II., Adulteration of Food, 1893. Presented 14th June, 1884, by Hon. J. F. Wood.....*Printed for both distribution and sessional papers.*
- 7b. Inland Revenues of Canada. Part III., Inspection of Weights and Measures and Gas. Presented 6th July, 1894, by Hon. J. F. Wood.. .....*Printed for both distribution and sessional papers.*

## CONTENTS OF VOLUME 6.

8. Report of the Minister of Agriculture for Canada for the calendar year 1893. Presented 12th June, 1894, by Sir John Thompson..... *Printed for both distribution and sessional papers.*
- 8a. Report on Canadian Archives, 1893. Presented 12th June, 1894, by Sir John Thompson.  
*Printed for both distribution and sessional papers.*
- 8b. Third Annual Report of the Dairy Commissioner of Canada for 1892-93. Presented 18th May, 1894, by Hon. T. M. Daly..... *Printed for both distribution and sessional papers.*
- 8c. Report of the Director and Officers of the Experimental Farms for the year 1893. Presented 20th April, 1894, by Hon. G. E. Foster..... *Printed for both distribution and sessional papers.*

## CONTENTS OF VOLUME 7.

- 8d. The Scheduling of Cattle in England—the Canadian Case. Presented 4th May, 1894, by Hon. T. M. Daly.....*Printed for both distribution and sessional papers.*
- 8e. Special Report of the Executive Commissioner on Awards on Agricultural Implements at Chicago, 1893. Presented 7th May, 1894, by Hon. T. M. Daly.  
*Printed for both distribution and sessional papers.*
- 8f. Criminal Statistics for the year 1893..... *Printed for both distribution and sessional papers.*
- 8g. Report of the Executive Commissioner on the World's Columbian Exposition.  
*Printed for both distribution and sessional papers.*
- 8h. Special Report on the production of and markets for Butter and Cheese.  
*Printed for both distribution and sessional papers.*

## CONTENTS OF VOLUME 8.

9. Annual Report of the Minister of Public Works, for the fiscal year ended 30th June, 1893. Presented 16th April, 1894, by Hon. J. A. Ouimet.....*Printed for both distribution and sessional papers.*
10. Annual Report of the Minister of Railways and Canals, for the past fiscal year, from the 1st July, 1892, to the 30th June, 1893. Presented 27th March, 1894, by Hon. J. Haggart.  
*Printed for both distribution and sessional papers.*



---



---

 CONTENTS OF VOLUME 9.

- 11.** Annual Report of the Department of Marine and Fisheries, 1893—Marine. Presented 1st May, 1894, by Sir Charles Hibbert Tupper. . . . . *Printed for both distribution and sessional papers.*
- 11\*.** Annual Report of the Department of Marine and Fisheries, for the fiscal year ended 30th June, 1893—Fisheries. Presented 11th April, 1894, by Sir Charles Hibbert Tupper. . . . .  
*Printed for both distribution and sessional papers.*
- 11a.** Report of the Chairman of the Board of Steamboat Inspection, etc., for calendar year ended 31st December, 1893. . . . . *Printed for both distribution and sessional papers.*

## CONTENTS OF VOLUME 10.

- 12.** Report of the Postmaster General, for the year ended 30th June, 1893. Presented 9th April, 1894, by Sir Adolphe Caron. . . . . *Printed for both distribution and sessional papers.*
- 13.** Annual Report of the Department of the Interior, for the year 1893. Presented 21st March, 1894, by Hon. T. M. Daly . . . . . *Printed for both distribution and sessional papers.*
- 13a.** Summary Report of the Geological Survey Department, for the year 1893. Presented 20th March, 1894, by Hon. T. M. Daly . . . . . *Printed for both distribution and sessional papers.*
- 14.** Annual Report of the Department of Indian Affairs, for the year ended 31st December, 1893. Presented 20th March, 1894, by Hon. T. M. Daly . . . . *Printed for both distribution and sessional papers.*

## CONTENTS OF VOLUME 11.

- 15.** Report of the Commissioner of the North-west Mounted Police Force, 1893. Presented 13th April, 1894, by Hon. W. B. Ives. . . . . *Printed for both distribution and sessional papers.*
- 16.** Report of the Secretary of State of Canada, for the year ended 31st December, 1893. Presented 20th March, 1894, by Hon. J. Costigan. . . . . *Printed for both distribution and sessional papers.*
- 16a.** Civil Service List of Canada, 1893. Presented 20th March, 1894, by Hon. J. Costigan. . . . .  
*Printed for both distribution and sessional papers.*
- 16b.** Report of the Board of Civil Service Examiners, for the year ended 31st December, 1893. Presented 30th March, 1894, by Hon. J. Costigan. . . . . *Printed for both distribution and sessional papers.*
- 16c.** Annual Report of the Department of Public Printing and Stationery of Canada, for the year ending 30th June, 1893, with a partial report for services during six months ending 31st December, 1893. Presented 23rd May, 1894, by Hon. J. Costigan. . . . .  
*Printed for both distribution and sessional papers.*
- 17.** Report of the Joint Librarians of Parliament for the year 1893. Presented 15th March, 1894, by Hon. Mr. Speaker . . . . . *Printed for sessional papers only.*
- 18.** Report of the Minister of Justice as to Penitentiaries in Canada, for the year ended 30th June, 1893. Presented 20th March, 1894, by Sir John Thompson. . . . .  
*Printed for both distribution and sessional papers.*
- 19.** Report of the Department of Militia and Defence of Canada, for the year ended 30th June, 1893. Presented 19th April, 1894, by Hon. J. C. Patterson. . . . .  
*Printed for both distribution and sessional papers.*
- 19a.** Establishment Lists of the Active Militia for the financial year, 1894-95. Presented 20th July, 1894, by Hon. J. C. Patterson . . . . . *Printed for both distribution and sessional papers.*
- 20.** Statement of the affairs of the Canadian Loan and Investment Company, on the 31st December, 1893. Presented 20th July, 1894, by Hon. Mr. Speaker . . . . . *Not printed.*

## CONTENTS OF VOLUME 12.

- 21.** Royal Commission on the Liquor Traffic. Minutes of evidence taken in the provinces of Nova Scotia, New Brunswick and Prince Edward Island. . . . .  
*Printed for both distribution and sessional papers.*

## CONTENTS OF VOLUME 13.

21. Royal Commission on the Liquor Traffic. Minutes of evidence taken in the province of Quebec.  
*Printed for both distribution and sessional papers.*

## CONTENTS OF VOLUME 14.

21. Royal Commission on the Liquor Traffic. Minutes of evidence taken in the provinces of Manitoba, North-west Territories and British Columbia....*Printed for both distribution and sessional papers.*

## CONTENTS OF VOLUME 15.

21. Royal Commission on the Liquor Traffic. Minutes of evidence taken in the province of Ontario.  
*Printed for both distribution and sessional papers.*

## CONTENTS OF VOLUME 16.

21. Royal Commission on the Liquor Traffic. Minutes of evidence taken in the United States.  
*Printed for both distribution and sessional papers.*

## CONTENTS OF VOLUME 17.

22. Report of the Commissioner, Dominion Police, for the year 1893, under Revised Statutes of Canada, chapter 184, section 5. Presented 20th March, 1894, by Sir John Thompson..... *Not printed.*
23. Return to an order of the House of Commons, dated 15th March, 1893, for a return showing the number of employees dismissed from the Prince Edward Island Railway since the 1st day of March, 1892, the name of each employee dismissed, the date of each dismissal, the reasons for such dismissals; also the names of employees reinstated, if any. Presented 20th March, 1894.—*Mr. Perry*..... *Not printed.*
24. Return to an order of the House of Commons, dated 20th March, 1893, for copies of all documents, claims, petitions, correspondence, reports of the superintendent of the Chambly canal, reports of experts and others, plans, agreements, proposals and decisions of the government in relation to the claim of Joseph Lacouture, of the parish of St. Luc, for damages caused to his property by the waters of the Chambly canal. Presented 20th March, 1894.—*Mr. Lavergne*... *Not printed.*
25. Statement of all superannuations and retiring allowances in the civil service, giving the name and rank of each person superannuated or retired, his salary, age and length of service; his allowance and cause of retirement, whether vacancy has been filled by promotion or new appointment, &c., for the year ended 31st December, 1893. Presented 20th March, 1894, by Hon. G. E. Foster.  
*Not printed.*
- 25a. Return to an order of the House of Commons, dated 10th April, 1894, for a return showing the number of permanent civil servants in each department, inside and outside service, who contribute to the superannuation fund, and the gross amount of wages paid. Presented 25th April, 1894.—*Mr. McMullen*..... *Not printed.*
26. Statement of expenditure on account of miscellaneous unforeseen expenses, from 1st July, 1893, to date. Presented 20th March, 1894, by Hon. G. E. Foster..... *Not printed.*
27. Statement of Governor General's Warrants issued since last session of parliament, on account of the fiscal years 1892-93 and 1893-94, in accordance with the Consolidated Revenue and Audit Act, section 32, subsection b. Presented 20th March, 1894, by Hon. G. E. Foster..... *Not printed.*
28. Papers and correspondence relative to the payment to the Canadian Pacific Railway Company of amounts deducted from their subsidy in the year 1883. Presented 20th March, 1894, by Hon. G. E. Foster..... *Not printed.*
29. Return to an address of the House of Commons to his excellency the Governor General, dated 20th March, 1894, for copies of papers and correspondence relating to charges made against Mr. Justice Palmer, or to his resignation and acceptance thereof. Presented 20th March, 1894.—*Mr. Davies*.  
*Not printed.*

VOLUME 17—*Continued.*

- 30.** Return of applications for registration under the provisions of chapter 131, Revised Statutes of Canada, "An Act respecting Trade Unions." Presented 20th March, 1894, by Hon. J. Costigan. *Not printed.*
- 31.** List of public officers to whom commissions have issued under chapter 19 of the Revised Statutes of Canada, during the year 1893. Presented 20th March, 1894, by Hon. J. Costigan. *Printed in No. 16.*
- 32.** Order establishing certain rules in respect of matters therein mentioned, in the Exchequer Court of Canada. Presented 20th March, 1894, by Hon. J. Costigan. *Not printed.*
- 33.** Copy of an order in council of the 17th January, 1894, continuing for the current year the issue of licenses to United States fishing vessels to enter any ports on the Atlantic coast for the purchase of bait, etc. Presented 21st March, 1894, by Sir Charles Hibbert Tupper. *Not printed.*
- 33a.** Return to an address of the House of Commons to his excellency the Governor General, dated 16th April, 1894, for: 1. Copy of order in council appointing Théophile Sabourin fishery overseer for the division of the Lake of Two Mountains and Isle Perrot. 2. Of the order in council appointing Julien Montpetit fishery overseer for the same division. 3. Of all instructions and orders issued by the fisheries department to the said overseers. 4. Of the reports of the two said overseers for the years 1891, 1892. Presented 5th June, 1894.—*Mr. Harwood*. *Not printed.*
- 33b.** Return to an address of the House of Commons to his excellency the Governor General, dated 26th April, 1894, for copies of all telegrams, letters, petitions, orders in council, and all correspondence relating to the dismissal of Timothy McQueen as fishery overseer in the county of Kent, Ontario. Presented 8th May, 1894.—*Mr. Campbell*. *Not printed.*
- 33c.** Return to an address of the House of Commons to his excellency the Governor General, dated 25th April, 1894, for copies of all papers, letters, petitions and reports sent to the minister of marine and fisheries, from 1st October, 1893, to this date, respecting the dismissal of I. B. Chevalier, of Iberville, from the post of fishery overseer; and of any communication sent from the government to the said I. B. Chevalier. Presented 11th May, 1894.—*Mr. Béchard*. *Not printed.*
- 33d.** Return to an address of the House of Commons to his excellency the Governor General, dated 30th March, 1894, for a return of all papers, correspondence, telegrams, reports to and orders in council, together with all departmental orders relating to the discharge from office as superintendent of St. Paul's island and keeper of Ingonish island, of Mr. Samuel Campbell, or relating to his superannuation allowance. Presented 23rd May, 1894.—*Mr. Davies*. *Not printed.*
- 33e.** Return to an order of the House of Commons, dated 14th May, 1894, for copies of all correspondence since 1st January, 1892, to the present time, from fishery officers and others from the western counties of Nova Scotia and the county of Charlotte in New Brunswick, as regards the taking of lobsters and of the limitation of size, and of all recommendations in regard to the same. Also a copy of all correspondence between the minister of marine and fisheries and his officials and all other persons as regards the close season for the herring fishing at Two Island harbour, Grand Manan, and of the weirs at that place. Presented 11th June, 1894.—*Mr. Bowers*. *Not printed.*
- 33f.** Return to an address of the House of Commons to his excellency the Governor General, dated 26th April, 1894, for copies of all orders in council and departmental orders now in force in the province of Ontario, concerning fisheries therein, and of all petitions received by the department with regard to the same. Presented 21st June, 1894.—*Mr. McGregor*. *Not printed.*
- 34.** List of all lands sold by the Canadian Pacific Railway Company from the 1st October, 1892, to the 1st October, 1893. Presented 21st March, 1894, by Hon. T. M. Daly. *Not printed.*
- 34a.** Return under resolution of the 20th February, 1882, in so far as the same is furnished by the department of the interior, respecting the Canadian Pacific Railway Company. Presented 28th March, 1894, by Hon. T. M. Daly. *Not printed.*
- 34b.** Return to an order of the House of Commons, dated 15th March, 1893, for copies of all documents, memorials and correspondence between the government and the Sorel board of trade and others, in relation to the granting of a subsidy to the Canadian Pacific Railway Company, for the rebuilding of a bridge at St. Michel d'Yamaska. Presented 10th April, 1894.—*Mr. Bruneau*. *Not printed.*

VOLUME 17—*Continued.*

- 34c.** Return to an address of the Senate to his excellency the Governor General, dated 5th April, 1894, for a schedule of the passenger and freight rates of the Canadian Pacific Railway Company, including the rates from St. Paul and Minneapolis to the seaboard, now in force. Presented 30th April, 1894.—*Hon. Mr. Boulton* ..... *Not printed.*
- 34d.** Return to an address of the Senate to his excellency the Governor General, dated 17th May, 1894, for a schedule of the passenger and freight rates of the Intercolonial Railway; and the revenue derived by the Canadian Pacific Railway Company on its western division, between Port Arthur and Calgary, for the financial years ending 1892 and 1893. Presented 6th June, 1894.—*Hon. Mr. Boulton.*  
*Not printed.*
- 35.** Return of orders in council, in accordance with subsection (*d.*) of section 38 of the regulations for the survey, administration, disposal and management of Dominion lands within the 40-mile railway belt in the province of British Columbia. Presented 27th March, 1894, by Hon. T. M. Daly.  
*Not printed.*
- 35a.** Return of orders in council of 1893 relating to the department of the interior, in accordance with clause 91 of the Dominion Lands Act, chapter 54, Revised Statutes of Canada. Presented 27th March, 1894, by Hon. T. M. Daly ..... *Not printed.*
- 35b.** Statement in reference to fishing bounty payments for 1892-93, required by chapter 96 of the Revised Statutes of Canada. Presented 28th March, 1894, by Sir Charles Hibbert Tupper.... *Not printed.*
- 36.** Return to an order of the House of Commons, dated 1st March, 1893, for copies of all reports, documents, maps, manuscripts and correspondence in relation to exploring expeditions heretofore made to James Bay and Hudson Bay. Presented 27th March, 1894.—*Mr. Jones* .. *Not printed.*
- 37.** Return to an address of the House of Commons to his excellency the Governor General, dated 20th March, 1894, for a return showing copies of all petitions or communications to the government or to any member thereof, or to his excellency, asking for any interference with the sentence passed by his lordship the Hon. Mr. Justice Rose on Messrs. McGreevy and Connolly, of all replies thereto and all correspondence between any member of the government and any other person on the subject of commutation of such sentence; of all medical reports made in regard to either said McGreevy or Connolly, whilst undergoing such sentence; of all reports or recommendations on the said subject, by any member of the government to his excellency, and of all replies thereto and of all orders in council in anywise bearing upon the subject of the commutation of said sentences. Presented 29th March, 1894.—*Mr. Mulock*..... *Not printed.*
- 38.** Detailed statement of all bonds and securities registered in the department of the secretary of state of Canada, since last return, 1893, submitted to the parliament of Canada under section 23, chapter 19, of the Revised Statutes of Canada. Presented 29th March, 1894, by Hon. J. Costigan.  
*Not printed.*
- 39.** Return to an order of the House of Commons, dated 20th March, 1894, for a return showing the dates in each year since May 5th, 1887, when the Public Accounts, the Appropriation Accounts, and the Trade and Navigation Returns of Canada, for the next preceding fiscal year, have been published and ready for distribution; and when the said accounts and returns have been issued to the senators and members of the House of Commons of Canada in each of the years aforesaid. Presented 30th March, 1894.—*Mr. Charlton*..... *Not printed.*
- 40.** Return to an order of the House of Commons, dated 13th March, 1893, for a return showing the number of school teachers engaged in teaching in the North-west Territories, and the length of time each was engaged during the past year, with the salary received; also the number of pupils attending each school, and all sources of revenue for the maintenance of schools. Presented 2nd April, 1894.—*Mr. Semple*..... *Not printed.*
- 40a.** Supplementary return to an address of the Senate to his excellency the Governor General, dated 3rd February, 1893, for: 1. A copy of the deliberations, resolutions and ordinances of the former council of Assiniboia, relating to educational matters within its jurisdiction as it existed on the banks of the Red river before the creation of the province of Manitoba. 2. A statement of the amounts paid by the said council of Assiniboia for the maintenance of schools, showing the persons to whom such payments were made, the schools for which such amounts were paid, and the religious denomination to which such schools belonged. 3. A statement of the amounts paid by

VOLUME 17—*Continued.*

- the Hudson Bay Company, or by its agents, to the schools then existing in the territories forming to-day the province of Manitoba. 4. A copy of all memoranda and instructions serving as basis for the negotiations as a result of which Manitoba became one of the provinces of the confederation; together with a copy of the minutes of the deliberation of the persons charged on both parts to settle the conditions of the creation of the province of Manitoba and of its entrance into the confederation; and also a copy of all memoranda, returns and orders in council, establishing such conditions of entrance, or serving as a basis for the preparation of "The Manitoba Act."
5. A copy of the despatches and instructions from the imperial government to the government of Canada on the subject of the entrance of the province of Manitoba into the confederation, comprising therein the recommendations of the imperial government concerning the rights and privileges of the population of the Territories, and the guarantees of protection to be accorded to the acquired rights, to the property, to the customs and to the institutions of that population by the government of Canada, in the settlement of the difficulties which marked that period of the history of the Canadian West. 6. A copy of the acts passed by the legislature of Manitoba relating to education in that province and especially of the first act passed on this subject after the entrance of the said province of Manitoba into the confederation, and of the laws existing upon the same subject in the said province immediately before the passing of the acts of 1890, relating to the public schools and relating to the department of education. 7. A copy of all regulations with respect to schools passed by the government of Manitoba or by the advisory board, in virtue of the laws passed in 1890 by the legislature of Manitoba relating to public schools and the department of education. 8. A copy of all correspondence, petitions, memoranda, resolutions, briefs, factums, judgments (as well of first instance as in all stages of appeal), relating to the school laws of the said province of Manitoba, since the 1st June, 1890, or to the claims of catholics on this subject; and also a copy of all reports to the privy council and of all orders in council relating to the same subject since the same date. Presented 21st March, 1894.—*Hon. Mr. Bernier*. . . . . *Printed for both distribution and sessional papers.*
- 40b.** Return to an address of the House of Commons to his excellency the Governor General, dated 30th March, 1894, for copies of all papers, petitions, letters, reports, minutes and orders in council respecting the school law of Prince Edward Island, intitled "The Public Schools Act, 1877." Presented 23rd April, 1894.—*Mr. Leclair*. . . . . *Printed for both distribution and sessional papers.*
- 40c.** Return to an address of the Senate to his excellency the Governor General, dated 9th April, 1894, for copies of all school ordinances, school regulations and amendments thereto, adopted by the legislative assembly, the executive, and any board or council of education, in reference to the establishment, maintenance and administration of schools in the North-west Territories since 1885. Also for copies of all petitions, memorials and correspondence in reference thereto. Also for copies of all orders in council, reports to the governor general in council, and all communications and representations to the authorities in the North-west Territories. Presented 30th April, 1894.—*Hon. Mr. Bernier*. . . . . *Printed for both distribution and sessional papers.*
- 40d.** Return to an address of the House of Commons to his excellency the Governor General, dated 21st March, 1894, for copies of all petitions, memorials and correspondence, in reference to the appeal made in the name of the Roman catholic minority of the province of Manitoba, in reference to the school laws of that province; also copies of reports to and orders in council in reference to the same; also copies of the case submitted to the supreme court of Canada respecting aforesaid appeal, and including factums and all materials in connection therewith, and copies of all judgments rendered and answers given by said court on or to the questions referred to them. Presented 27th June, 1894.—*Mr. LaRivière*. . . . . *Printed for sessional papers only.*
- 41.** Return to an address of the Senate to his excellency the Governor General, dated 20th March, 1893, for a copy of all documents in relation to the demand of Michel Gosselin, Half-breed, living at Roseberry, Manitoba, and claiming indemnity for losses sustained during the troubles in the North-west in 1869 and 1870. Also a copy of all correspondence exchanged between the Dominion government and the said Michel Gosselin in relation to the said claim. Presented 21st March, 1894.—*Hon. Mr. Bellerose*. . . . . *Not printed.*
- 42.** Return to an address of the Senate to his excellency the Governor General, dated 21st February, 1893, for a copy of all the changes that have been made in the tariff since the national policy became law in 1879, giving the name of each article, showing the original duty imposed thereon, the amount of increase or reduction subsequently made, or placed upon the free list, together with the date of all such alterations in the tariff. Presented 2nd April, 1894.—*Hon. Mr. McMillan*. . . . . *Not printed.*

VOLUME 17—*Continued.*

43. Return to an order of the House of Commons, dated 30th March, 1894, for a complete list of the revising officers under the Franchise Act, giving their names, their electoral divisions, and when appointed. Presented 5th April, 1894.—*Sir Hector Langevin*. . . . . *Not printed.*
44. Return to an order of the House of Commons, dated 20th March, 1894, for return of all rates, general or special, charged on the Intercolonial Railway on through freight from Lévis to Halifax; with the dates when such existing general or special rates came into force, and in cases where such rates have been altered, specifying the alteration. Presented 6th April, 1894.—*Mr. Davies*.  
*Not printed.*
- 44a. Return to an address of the House of Commons to his excellency the Governor General, dated 30th March, 1894, for all papers, correspondence, telegrams, reports to, or orders in council, or departmental orders not already brought down to parliament, relative to the purchase of the Harris property in St. John for the Intercolonial Railway, or the payment of the purchase moneys therefor or relative to the uses or purposes to which that property has since been applied. Also for a list of all the claimants to the title of said property or any interest therein, together with the amounts paid to them respectively, and a summary or abstract of all deeds or agreements taken from the claimants respectively. Also for a statement of all moneys since laid out upon such property, and its total cost up to date. Presented 19th June, 1894.—*Mr. Davies*. . . . . *Not printed.*
45. Return to an address of the House of Commons to his excellency the Governor General, dated 20th March, 1893, for copies of all correspondence between the government of British Columbia and the minister of the interior, relating to the boundary of the railway belt in the province of British Columbia. Presented 9th April, 1894.—*Mr. Mara*. . . . . *Not printed.*
46. Return to an order of the House of Commons, dated 30th March, 1894, for a statement showing the various amounts paid by way of bounty on pig iron produced in Canada, the quantities produced, and the parties to whom the bounty was paid, and the province in which their works are situated, since the date of the last return. Presented 10th April, 1894.—*Mr. Edgar*.  
*Printed for sessional papers only.*
47. Return to an order of the House of Commons, dated 30th March, 1894, for a return showing (by provinces) the value of mining machinery admitted free of duty since the year 1890. Presented 10th April, 1894.—*Mr. Mara*. . . . . *Not printed.*
48. Return to an order of the House of Commons, dated 29th March, 1894, for a return of: 1. The number of students who have graduated from the royal military college since its establishment. 2. Number of these graduates who are now in the public service of Canada and number in the service of the imperial government. 3. Amount expended on capital account and on income since the college was established. 4. Number of students graduated in 1893. 5. Number of students now in attendance. 6. Total amount of salaries paid each year, to the different persons employed in connection with the college. 7. Name of the commandant of the college: his salary, perquisites, if any, in the way of free residence, maintenance thereof, supplies, servants, &c. 8. The cost of the residence for use of commandant, if purchased, and the amount expended thereon by the government since the purchase. Presented 12th April, 1894.—*Mr. Mulock*.  
*Printed for sessional papers only.*
- 48a. Supplementary return to no. 48. Presented 11th May, 1894.—*Mr. Mulock*.  
*Printed for sessional papers only.*
49. Return to an order of the House of Commons, dated 30th March, 1894, for a return of the sentence imposed by the supreme court of the province of New Brunswick upon John V. Ellis, editor of the *St. John Globe*, in the past year, for an alleged contempt of court; together with the names of the judges composing the court at the time the sentence was imposed. Presented 12th April, 1894.—*Mr. Davies*. . . . . *Not printed.*
50. Return to an address of the House of Commons to his excellency the Governor General, dated 20th March, 1894, for the production of all correspondence and other papers relating to the copyright question which have not already been brought down. Presented 13th April, 1894.—*Mr. Edgar*.  
*Printed for sessional papers only.*

---



---

VOLUME 17—*Continued.*

- 51.** Return to an order of the House of Commons, dated 30th March, 1894, for a statement showing the working of the civil service insurance, how many civil servants have insured their lives in such insurance, and for what amounts respectively, without giving their names. Presented 13th April, 1894.—*Sir Hector Langevin*. . . . . *Not printed.*
- 52.** Return to an order of the House of Commons, dated 16th April, 1894, for a return of the receipts and expenditures to dates of 10th April, 1894, and 10th April, 1893. Presented 16th April, 1894. *Sir Richard Cartwright*. . . . . *Not printed.*
- 52a.** Return to an order of the House of Commons, dated 7th May, 1894, for a return showing the total amount of receipts and expenditures chargeable to consolidated fund from 1st July, 1893, to 1st May, 1894, and also for same period from 1st July, 1892, to 1st May, 1893. Presented 11th May, 1894.—*Sir Richard Cartwright*. . . . . *Not printed.*
- 53.** Return to an address of the House of Commons to his excellency the Governor General, dated 10th April, 1894, for copies of all correspondence between Mr. L. Vankoughnet and the government, or any member, or department, relating to his superannuation, and of all communications or reports to council or the treasury board or any member of the government, relating to such superannuation, and of any orders in council dealing with the same. Presented 17th April, 1894.—*Mr. Mulock*. . . . . *Not printed.*
- 54.** Return to an order of the House of Commons, dated 1st March, 1893, for a return of any correspondence which may have taken place between the government and any of the railway companies which have received public lands in aid of railway construction, in reference to the prices at which these lands are held and as to the steps taken by these companies to fulfil their trust by securing the early settlement of the lands so granted. Presented 18th April, 1894.—*Mr. Mills, Bothwell*. . . . . *Not printed.*
- 55.** Return to an order of the House of Commons, dated 10th April, 1894, for a return showing the names of officials employed in connection with the Canadian exhibit at the Columbian exposition from the province of Nova Scotia, showing their official position, amount of salaries paid and dates at which such employment ceased. Presented 20th April, 1894.—*Mr. Patterson, Colchester*. . . . . *Not printed.*
- 56.** Return to an order of the House of Commons, dated 10th April, 1894, for a statement in the form of Table C in the blue-book already published on the French treaty, for the years ending 30th June, 1892 and 1893. Presented 20th April, 1894.—*Mr. Laurier*. . . . . *Printed for sessional papers only.*
- 56a.** Supplementary return to an order of the House of Commons, dated 10th April, 1894, containing correspondence and other matter relating to the French treaty. Presented 3rd July, 1894.—*Mr. Laurier*. . . . . *Printed for sessional papers only.*
- 57.** Return to an address of the House of Commons to his excellency the Governor General, dated 30th March, 1894, for copies of all correspondence between the government and George Goodwin in connection with the transfer of his contracts or any of his contracts on the Soulanges canal. Presented 23rd April, 1894.—*Mr. Charlton*. . . . . *Not printed.*
- 57a.** Return to an address of the House of Commons to his excellency the Governor General, dated 25th April, 1894, for copies of all communications in the form of letters, petitions and reports, from 1st April, 1887, to 1st March, 1894, between the government and Mr. J. B. Many, or the municipal council of St. Luc, in the county of St. Jean, in relation to the construction of a swing bridge on the Chambly canal, opposite the south-east end of Ste. Thérèse island, in the Richelieu river. Presented 4th June, 1894.—*Mr. Béchard*. . . . . *Not printed.*
- 57b.** Return to an address of the House of Commons to his excellency the Governor General, dated 28th May, 1894, for : 1. Copies of all the reports of the engineers recommending that certain changes be made in the original contract, both in the materials and the nature of the works entering into the construction of the locks and other masonry on sections 1 and 2 of the Soulanges canal, giving the reasons why such changes should be made and the names of the engineers who recommended such changes. 2. Copies of all the correspondence exchanged between the engineers, the department of railways and canals, the contractor and other persons in connection with those changes, and copies of all orders in council in relation thereto. Presented 6th June, 1894.—*Mr. Tarte*. . . . . *Not printed.*

VOLUME 17—*Continued.*

- 57c.** Return to an order of the House of Commons, dated 16th April, 1894, for copies of all advertisements inviting tenders for the construction of sections 1 and 2 of the Soulanges canal; also copies of specifications connected with said work, copies of extensions of said specifications and tenders with estimated quantities and work to be done according to engineer's estimate; also copies of all tenders, copies of contracts let, of correspondence which took place between the contractors tendering for this work and the contractor to whom the contracts were awarded and the department of railways and canals in this matter, copies of all reports of engineers since the letting of the contract. Presented 14th June, 1894.—*Mr. Tarte* ..... *Not printed.*
- 57d.** Return to an order of the House of Commons, dated 14th May, 1894, for: 1. Copies of all correspondence between the department of railways, the minister of public works and any other persons in relation to sections 12 and 13 of the Soulanges canal. 2. Copies of the call for tenders and of all tenders received. 3. Copies of contracts awarded. Presented 14th July, 1894.—*Mr. Tarte* ..... *Not printed.*
- 58.** Return to an order of the House of Commons, dated 27th July, 1891, for copies of all correspondence relating to application for increase of salary of Judge Johnstone, county court judge for Halifax county, Nova Scotia. Presented 25th April, 1894.—*Mr. Fraser* ..... *Not printed.*
- 59.** Return to an order of the House of Commons, dated 30th March, 1894, for a return showing the names of all prisoners who have died in penitentiaries in Canada during the last ten years, with the cause of death and the length of their last sickness in each case. Presented 25th April, 1894.—*Mr. Martin* ..... *Not printed.*
- 59a.** Return to an address of the House of Commons to his excellency the Governor General of the 10th April, 1894, for a statement showing amount of receipts each month for gate money at Kingston penitentiary between 1st January, 1887, and 1st January, 1894. Statement showing disposition of these moneys, including statement showing the amount of those moneys deposited in any banks, with the names of such banks and particulars as to whose credit such deposits were made. Presented 26th April, 1894.—*Mr. Mulock* ..... *Not printed.*
- 59b.** Return to an address of the House of Commons to his excellency the Governor General, dated 13th March, 1893, for a statement showing: (a.) Amount of money received as visitors' entrance fees at the Kingston penitentiary during each year from 31st January, 1885, to 1st February, 1893. (b.) Payments out of said moneys to the receiver general, and disposition of such funds. (c.) Particulars of goods manufactured and work done at said institution for any of its officers, showing who supplied the material for such goods, what sums were charged to said officers for said goods, and what sums have been actually paid during each of said years for said goods. (d.) Quantities of coal oil and gas supplied such officers, amount paid therefor, and when. (e.) Amount of laundry work done at said institution during said dates, for whom done, amount charged and paid therefor, with dates of such payments and names of persons making such payments. Presented 26th April, 1894.—*Mr. Mulock* ..... *Not printed.*
- 59c.** Return (in part) to an address of the House of Commons to his excellency the Governor General, dated 30th March, 1894, for copies of all charges brought to the attention of the government or any department since 1891 in regard to any matters connected with the Kingston penitentiary, and the British Columbia penitentiary; of all appointment of persons to make investigations into any such charges, including their instructions; of all correspondence between any of such persons and any member of the government or department; of all evidence taken on any such inquiries; of all reports thereon, including any schedules in connection with such reports; and of all other documents and papers relating to any alleged irregularities in connection with the management of said institutions since 1891. Presented 1st May, 1894.—*Mr. Mulock* ..... *Not printed.*
- 59d.** Supplementary return to no. 59c. Presented 15th May, 1894.—*Mr. Mulock* ..... *Not printed.*
- 59e.** Further supplementary return to no. 59c. Presented 15th May, 1894.—*Mr. Mulock* ..... *Not printed.*
- 60.** Return to an order of the House of Commons, dated 1st March, 1893, for a return of the report or reports of plans and surveys of the Galops Rapids channel, made by Mr. Kennedy. Presented 26th April, 1894.—*Mr. Reid* ..... *Not printed.*



VOLUME 17—*Continued.*

- 61.** Return to an address of the House of Commons to his excellency the Governor General, dated 30th March, 1894, for copies of all reports made to the department of the interior or to the superintendent general of Indian affairs as to the value of the Thousand Islands and any offers received for the purchase of the same. Presented 26th April, 1894.—*Mr. Mills (Bothwell)*.  
*Printed for distribution only.*
- 62.** Return to an order of the House of Commons, dated 16th April, 1894, for copies of report of engineer who inspected river Aux-Roseaux, river Aux-Rats and river La-Seine, in the electoral district of Provencher. Presented 1st May, 1894. *Mr. LaRivière*.....*Not printed.*
- 63.** Return to an order of the House of Commons, dated 30th March, 1894, for a return of all papers and correspondence relative to a claim for compensation for railway damages made by one Charles Coffin, of Midgell, Prince Edward Island, in the railway department of the government. Presented 1st May, 1894.—*Mr. Davies*.....*Not printed.*
- 64.** Return to an order of the House of Commons, dated 23rd April, 1894, for the report of the commission appointed to inquire into all matters concerning the Trent Valley canal. Presented 1st May, 1894.—*Mr. Hughes*.....*Not printed.*
- 65.** Return to an order of the House of Commons, dated 25th April, 1894, for a return giving the amount paid out of the Six Nation Indians' fund (by way of gift or loan) to individual members from the year 1886 to date, stating in each case: The name of the person, the fact of whether gift or loan, the date when paid, the amount, the reason for the gift or loan, the authority for such gift or loan, the conditions on which such loan was made, the provision for repayment, the amount repaid.—Presented 2nd May, 1894.—*Mr. Paterson (Brant)*.....*Not printed.*
- 65a.** Return to an order of the House of Commons, dated 16th April, 1894, for a return showing the amount of money that has been paid out of the funds of the Six Nation Indians for the payment of debts incurred by individual members thereof since the year 1886, and giving: 1. The names of the several persons who incurred the debts, with the separate amounts, the date or dates when incurred, and the proportion thereof that has been paid. 2. The names of the creditors to whom the payments were made, the dates when paid, with the total sum paid to each of such creditors; and stating in each case the authority given for incurring the debt, the authority for payment of the same, and whether such amounts have been repaid to the fund in whole or in part out of the annuities of the individuals on whose account the payments were made, and whether such was the condition on which such payments were authorized. Presented 14th May, 1894.—*Mr. Paterson, (Brant)*.....*Not printed.*
- 65b.** Return to an address of the House of Commons to his excellency the Governor General, dated 25th April, 1894, for copies of all petitions from the Indians of the Saugeen reserve claiming the exclusive right of fishing in French bay, lake Huron, of all answers to the same, and of all departmental orders in reference to that subject. Presented 16th May, 1894.—*Mr. Laurier*.....*Not printed.*
- 65c.** Supplementary return to no. 65b. Presented 23rd July, 1894.—*Mr. Laurier*.....*Not printed.*
- 65d.** Return to an address of the Senate to his excellency the Governor General, dated 10th April, 1894, for copies of all petitions or communications to the governor general, or the government, or any member thereof, asking for interference with the death sentence passed by Mr. Justice Harrison upon the two Chehalis Indians, Peter and Jack, in November, 1893, for the murder of the late Albert Edward Pittendrigh, in New Westminster, British Columbia, on the 27th October, 1892; of all replies thereto, and all correspondence between any member of the government and any other person on the subject of commutation of such sentence; of all reports or recommendations on the said subject by any member of the government to his excellency, and of all replies thereto, and of all orders in council in anywise bearing upon the subject of the commutation of said death sentence to imprisonment for life. Presented 14th May, 1894.—*Hon. Mr. MacInnes*.....*Not printed.*
- 66.** Return to an order of the House of Commons, dated 30th March, 1894, for all papers and correspondence in connection with the establishment of a government cattle ranche near Fort Macleod, North-west Territories, including the purchase of cattle for said ranche; the disposal of said cattle, and the management and disposition made of said ranche. Also a statement showing the amount of moneys paid for cattle placed upon said ranche, and for all other expenses incurred in connection with the same, also the total amount of moneys received for the sale of cattle from said ranche, and all other sources in connection with the same; which statement shall show the balance

VOLUME 17—*Continued.*

- to the credit or debit of said ranche on the first day of January last, and shall further give the names of all parties indebted to said ranche account for cattle purchased or for any other property or material, with the amount due from each of said parties, if any. Presented 2nd May, 1894.—*Mr. Charlton*..... *Not printed.*
67. Return to an order of the House of Commons, dated 10th April, 1894, for a return showing the amount paid to railways or steamship companies, as a bonus for bringing settlers to Manitoba or the Territories, in 1891, 1892 and 1893, and a list of settlers so brought, showing their names and locations. Presented 11th May, 1894.—*Mr. Martin*.....*Not printed.*
68. Return to an order of the House of Commons, dated 30th April, 1894, for copies of all communications received by the minister of agriculture in relation to the establishment of the bureau of labour statistics for the Dominion. Presented 14th May, 1894.—*Mr. Lépine*.....*Not printed.*
69. Return to an order of the House of Commons, dated 30th March, 1894, for a return showing the quantity of butter manufactured at the experimental creameries, established at Elgin and Woodstock, in the province of Ontario, from the time they were established up to the 1st of January, 1894; the number of sales made; where sold, and the amounts realized. Copies of all letters, reports, or other correspondence, especially the report of Clement & Son, of Glasgow, relating to the prices realized, and the condition of the goods when put upon the market. The amounts of money spent, and the different purposes for which the money was used. Presented 14th May, 1894.—*Mr. McMillan*.....*Not printed.*
70. Return to an order of the House of Commons, dated 30th March, 1894, for a return showing the number of homesteads taken up in Manitoba during the years 1892 and 1893, and the number of homesteads cancelled in Manitoba during said years, in each case showing the municipalities in which the homesteads were located. Presented 18th May, 1894.—*Mr. Martin*.... *Not printed.*
71. Return to an order of the House of Commons, dated 25th April, 1894, for a return showing: 1. The total number of depositors in the Dominion and post office savings banks. 2. The number of said depositors having deposits of \$1,000 or upwards and the total amount held by them. 3. The number having deposits of \$500 and over, not exceeding \$1,000, and the total amount held by them. 4. The number of depositors having deposits of less than \$500 and the total amount held by them. 5. The number of depositors not residing in Canada and the total amount held by them. Presented 18th May, 1894.—*Sir Richard Cartwright*..... *Not printed.*
72. Return to an address of the House of Commons to his excellency the Governor General, dated 7th May, 1894, for a copy of the order in council authorizing the sale of lot 16, concession 12, township of Luther, in the county of Wellington, for \$800 to John McNab and John Gallagher. Presented 22nd May, 1894.—*Mr. McMullen*.....*Not printed.*
- 72a. Supplementary return to no. 72. Presented 14th June, 1894.—*Mr. McMullen*.....*Not printed.*
73. Return to an order of the House of Commons, dated 30th March, 1894, for a return showing the sums of money paid to Mr. A. F. Wood, government valuator, for services, maintenance and transport during the years 1891-1892-1893, and the particular pieces of land or other property valued during those years. Presented 23rd May, 1894.—*Mr. McMullen*..... *Not printed.*
74. Return to an address of the House of Commons to his excellency the Governor General, dated 16th April, 1894, for copies of all orders in council in force in Canada (provinces of Lower Canada and Upper Canada) in 1858, concerning any drawback or bounty with respect to the building of Canadian ships, barques and other vessels; and also all orders in council amending the same, or concerning the same from 1858 up to the beginning of the confederation. Presented 23rd May, 1894.—*Mr. Amyot*..... *Not printed.*
- 74a. Return to an address of the House of Commons to his excellency the Governor General, dated 10th April, 1894, for copies of all orders in council from the origin of confederation up to the year 1879, inclusive, respecting any drawback or bounty with respect to the building of Canadian ships, barques or other vessels. Presented 30th May, 1894.—*Mr. Amyot*..... *Not printed.*
75. Return to an order of the House of Commons, dated 7th May, 1894, for copies of all calls for tenders, tenders received, contracts made, correspondence, telegrams, letters and papers relative to the public work (wharf or breakwater) at Grand Etang, Cape Breton; together with a statement of all moneys advanced or paid on such contract, with dates of payment. Presented 29th May, 1894.—*Mr. Davies*..... *Not printed.*

VOLUME 17—*Continued.*

- 75a.** Return to an order of the House of Commons, dated 6th February, 1893, for copies of all letters, petitions, surveys and reports in the possession of the government, relating to the threatened destruction of, and claims for, repairs on the breakwater at Sandford, in the county of Yarmouth, N.S. Presented 29th May, 1894.—*Mr. Flint* ..... *Not printed.*
- 75b.** Return to an order of the House of Commons, dated 6th February, 1893, for copy of the report of government surveys on Wood island breakwater, P.E.I. Presented 29th May, 1894.—*Mr. Welsh.* ..... *Not printed.*
- 75c.** Return to an order of the House of Commons, dated 15th March, 1893, for copies of all reports, correspondence or other documents, not already brought down, relating to the state of repair of the breakwater at Rustico, P.E.I. Presented 29th May, 1894.—*Mr. Davics.* ..... *Not printed.*
- 75d.** Return to an order of the House of Commons, dated 1st March, 1893, for a statement showing : 1. What is the total sum spent by the government since confederation in each province of the Dominion on the public works classified as (1) harbours, piers and breakwaters, (2) improvements of rivers, and (3) dredging and dredges. 2. How much of the sum so spent in the province of Quebec was expended on works within the harbour of Montreal. 3. (1) How much money the government has loaned to the harbour commissioners of Quebec towards the construction of the new harbour works in that city ; and (2) what amount of interest, derived from the revenues of the said works, have the harbour commissioners paid to the government in respect of the interest due on the said loans ; and (3) how many years' interest, if any, are in arrears. 4. (1) How much money the government has lent to the harbour commissioners of Montreal towards the construction of harbour works in that city ; and (2) how much interest is due thereon. Presented 12th July, 1894.—*Mr. Lépine* ..... *Not printed.*
- 75e.** Return (in part) to an order of the House of Commons, dated 30th March, 1894, for a return giving the total cost of the Cockburn island wharf and dock (lake Huron) ; the name of the contractor or contractors ; the date of its completion ; the number of sailing vessels that have called ; the quantity of freight imported and exported since its completion ; the number of steamers that made during the season regular calls at the wharf since its completion. Presented 12th July, 1894.—*Mr. McMullen* ..... *Not printed.*
- 76.** Return to an order of the House of Commons, dated 14th May, 1894, for copies of all letters, reports of engineers or other papers in the hands of the government relating to the condition of the Pickets pier and the non-expenditure thereon of the sum voted last year for the purpose of repairing said pier. Presented 29th May, 1894.—*Mr. Borden.* ..... *Not printed.*
- 77.** Return to an order of the House of Commons, dated 18th April, 1894, for a statement of all sums paid by the government for the construction of the river Yamaska dam, under the first contract and subsequently thereto up to this date. Presented 29th May, 1894.—*Mr. Laurier.* ..... *Not printed.*
- 77a.** Return to an order of the House of Commons, dated 2nd May 1892, for copies of report of any inquiry held under the authority of the department of public works with a view to estimate the losses inflicted on proprietors of the commune of Yamaska, by the erection of a dam in the Yamaska river. Presented 4th June, 1894.—*Mr. Laurier.* ..... *Not printed.*
- 77b.** Return to an address of the House of Commons to his excellency the Governor General, dated 30th March, 1894, for copies of all letters, papers and statements in connection with awarding contract to William H. Davis & Sons for constructing a dam at Sheik's island, in connection with the Cornwall canal. Presented 5th June, 1894.—*Mr. Charlton* ..... *Not printed.*
- 77c.** Supplementary return to no. 77b. Presented 15th June, 1894.—*Mr. Charlton.* ..... *Not printed.*
- 78.** Return to an address of the House of Commons to his excellency the Governor General, dated 10th April, 1894, for copies of all petitions, letters, plans, deeds and other documents respecting the claim of the Hurons of Lorette in relation to the seigniori of Sillery. Presented 29th May, 1894.—*Mr. Frémont* ..... *Not printed.*
- 79.** Return to an order of the House of Commons, dated 10th April, 1894, for a return showing the amount of timber dues collected at Quebec for each year for the last ten years. The quantity of timber culled each year, and the wages paid to cullers and staff. Presented 30th May, 1894.—*Mr. McMullen.* ..... *Not printed.*

VOLUME 17—*Continued.*

- 79a.** Return to an order of the House of Commons, dated 10th April, 1894, for a return showing the quantity of timber that passed through the cullers' hands and was culled each year at Montreal, for the last ten years. The amount of fees collected for each year during the same period, and the amount of wages paid to the cullers and staff at Montreal for the same time. Presented 30th May, 1894.—*Mr. McMullen* . . . . . *Not printed.*
- 79b.** Return to an order of the House of Commons, dated 7th May, 1894, for a return showing: 1. How much timber has been disposed of in townships 1, 2, 3 and 4, in ranges 14, 15, 16 and 17, east of the 1st principal meridian, and also on the Whitemouth river. 2. To whom said timber has been disposed of. 3. In what way said timber has been disposed of. 4. Prices realized for same. 5. Copies of all advertisements in connection with same, with names of newspapers in which same appeared and dates of insertion. 6. How much timber still remains undisposed of in said townships. Presented 29th June, 1894.—*Mr. Martin* . . . . . *Not printed.*
- 79c.** Return to an order of the House of Commons, dated 25th April, 1894, for a statement of all timber licenses granted since January 1st, 1887, showing the date of each grant, the location, the area of the same, the name of the grantee, the bonus, if any, paid upon the same, whether disposed of: (a) At public auction duly advertised, where the public were invited to compete. (b) At auction where only applicants for the berth or limit were invited to bid. (c) By private application. (d) If in neither of the ways above mentioned, then stating in what way disposal and grant was made. (e) Length of public notice in each case when limits were sold either at public auction or by other form of public competition. Also a summary statement giving total area granted and total amount of bonuses received. Presented 12th July, 1894.—*Mr. Charlton* . . . . . *Not printed.*
- 80.** Return to an order of the House of Commons, dated 28th May, 1894, for copies of all correspondence between D. J. Hughes, Esq., county judge of Elgin, Ont., and the officials of the government printing office, in regard to the printing of the last revised voters' list for Elgin. Presented 4th June, 1894.—*Mr. Casey* . . . . . *Not printed.*
- 81.** Return to an order of House of the Commons, dated 14th May, 1894, for a return showing the amount and value of crucible steel imported into Canada free of duty in each year since 1885, under the provisions of order in council of 6th November, 1885. Also amount and value of lastings and mohair cloth imported into Canada free of duty in each year since 1885, under the provisions of order in council of 6th November, 1885. Presented 4th June, 1894.—*Mr. Charlton*.  
*Not printed.*
- 81a.** Return to an order of the House of Commons, dated 14th May, 1894, for a return showing the amount and value of hatters' bands, bindings, tips, and sides and linings, both tips and sides, imported into Canada in each year since 1885, under provisions of order in council of 5th July, 1886. Also amount and value of steel strip for buckthorns and plain strip fencing imported into Canada free of duty since 1885, under provisions of order in council of 17th July, 1886. Also amount and value of wire rope imported into Canada free of duty since 1885, under provisions of order in council of 17th July, 1886. Also amount and value of twisted brass and copper wire imported into Canada free of duty since 1885, under provisions of order in council of 20th July, 1886. Also amount and value of yarn spun from the hair of the alpaca or angora goat, imported into Canada free of duty since 1885, under provisions of order in council of 18th November, 1886. Presented 4th June, 1894.—*Mr. Charlton* . . . . . *Not printed.*
- 81b.** Return to an order of the House of Commons, dated 14th May, 1894, for a return showing the quantity and value of felloes of hickory wood imported into Canada in each year free of duty since 1887, under provisions of order in council of 16th November, 1888. Also quantity and value of homo spring steel wire, smaller than no. 9 and not smaller than no. 15, imported into Canada free of duty in each year since 1837, for the use of manufacturers of mattresses, under provisions of order in council of 6th December, 1888. Presented 4th June, 1894.—*Mr. Charlton* . . . . . *Not printed.*
- 81c.** Return to an order of the House of Commons, dated 14th May, 1894, for a return showing the value of sweat leathers imported into Canada free of duty in each year since 1886, under provisions of order in council of 1st July, 1887. Also the value of square reeds, rawhide centres, textile leather or rubber heads, thumbs and tips, and steel, iron or nickel caps for whip ends imported into Canada free of duty in each year since 1886, under provisions of order in council of July 2nd, 1887. Also value of copper rollers for use in calico printing imported into Canada free of duty in each year since 1886, under provisions of order in council of 22nd November, 1887. Also quantity and

VOLUME 17—*Continued.*

- value of steel of no. 12 gauge and down to no. 30 gauge imported into Canada free of duty in each year since 1887, under provisions of order in council of 11th July, 1888. Also quantity and value of yarns, of wool and worsted, imported into Canada free of duty for use of manufacturers in each year since 1887, under provisions of order in council of 11th July, 1888. Also quantity and value of jute yarn, cotton yarn finer than no. 40; and wire of iron or steel, galvanized or tinned, or coppered, or not, of no. 16 gauge or smaller, imported into Canada free of duty in each year since 1887, under provisions of order in council of 11th July, 1888. Presented 4th June, 1894.—*Mr. Charlton*.....*Not printed.*
- 82.** Return to an order of the House of Commons, dated 25th April, 1894, for copies of all complaints made by one Etienne Tremblay, since 1st November, 1893, against Joseph Placide Rocheleau, postmaster of Pauline, in the county of Rouville, P.Q.; and of the report of the post office inspector who inquired into said complaint, or of any other official charged with such inquiry. Presented 5th June, 1894.—*Mr. Fréchette*.....*Not printed.*
- 83.** Return to an order of the House of Commons, dated 2<sup>nd</sup> May, 1894, for a return giving the names of the junior judges in the province of Ontario and dates when appointed, the name and population of the county to which appointed, also the salary and allowance of each of such judges. Presented 5th June, 1894.—*Mr. Lister*.....*Not printed.*
- 84.** Return to an address of the House of Commons to his excellency the Governor General, dated 7th May, 1894, for copies of all letters, proposals, cablegrams and correspondence since the 1st of January, 1890, between the government and any member thereof and any person, firm or company in relation to establishing a fast Atlantic steamship line between Canada and Great Britain, and also a line between Canada and France, and in relation to the subsidies for such services asked for or proposed to be given by the government, and any draft or completed contracts for such steamship service. Presented 6th June, 1894.—*Mr. Mulock*.....*Printed for distribution only.*
- 84a.** Supplementary return to no. 84. Presented 29th June, 1894.—*Mr. Mulock*.  
*Printed for distribution only.*
- 84b.** Further supplementary return to no. 84. Presented 5th July, 1894.—*Mr. Mulock*.  
*Printed for distribution only.*
- 85.** Return to an address of the House of Commons to his excellency the Governor General, dated 6th February, 1893, for copies of all correspondence, papers and documents, not already laid before the house, in reference to negotiations and communications between the government and the United States, in reference to reciprocity, canal tolls and wrecking and towing. Presented 11th June, 1894.—*Mr. Tisdale*.....*Not printed.*
- 86.** Return to an address of the House of Commons to his excellency the Governor General, dated 30th March, 1894, for copies of all correspondence, instructions, orders in council and reports about the boundary line between Alaska and British Columbia not already laid before this house. Presented 11th June, 1894.—*Sir Hector Langevin*.....*Not printed.*
- 87.** Return to an order of the House of Commons, dated 7th May, 1894, for a return showing in detail all sums of money in the hands of the government held as security for the performance of contracts completed, the name of each contractor who deposited the money, date of each such deposit, and amount of interest accrued on each deposit. Presented 11th June, 1894.—*Mr. Lister*.....*Not printed.*
- 88.** Return to an address of the House of Commons to his excellency the Governor General, dated 30th March, 1894, for a return of all correspondence, telegrams, reports to council, orders in council, or departmental orders or instructions relative to the employment of certified captains or mates on steamers plying in the waters or ferries of the Dominion, or to the running of such steamers or ferries without such captains or mates. Presented 19th June, 1894.—*Mr. Davies*.....*Not printed.*
- 89.** Return to an address of the House of Commons to his excellency the Governor General, dated 14th May, 1894, for copies of all correspondence between the minister of railways and the Rev. A. E. Burke and others having reference to the moving of the flag station from Mill river, on the Prince Edward Island Railway, to Howlan road, and all telegrams and documents having reference to the same, as well as all petitions, etc., against the removal of said flag station. Presented 19th June, 1894.—*Mr. Perry*.....*Not printed.*

VOLUME 17—*Continued.*

90. Return to an address of the House of Commons to his excellency the Governor General, dated May, 1894, for copies of all correspondence between J. B. Wright, M.D., V.S., and the government, or any member, department or officer of the government, and of all correspondence between the Grand Trunk Railway and the government, or any member, department or officer of the government, and of all correspondence between Mr. A. Brush and the government, or any member, department or officer of the government, and of all correspondence between the imperial authorities, or any one on their behalf, and the government of Canada, or any member, department or officer thereof, from, and including, the year 1882 until, and including, the year 1891, regarding the inspection of cattle passing through Canada from the United States. Presented 21st June, 1894.—*Mr. Mulock* ..... *Printed for sessional papers only.*
91. Return to an order of the House of Commons, dated 16th April, 1894, for a return showing all lands allotted to Half-breeds in Manitoba for which patents have not been issued, giving along with a description of the land, the name of the allottee and the reasons why the patent has not been issued. Presented 21st June, 1894.—*Mr. Martin* ..... *Not printed.*
92. Return to an order of the House of Commons, dated 21st May, 1894, for a return of the order, minute or direction authorizing the collector of customs at Woodstock, Ont., to admit free of duty certain goods consisting of vestments or other church articles for the use of the Roman catholic church at Woodstock, consigned to the Reverend Father Brady, of Woodstock, in the month of February, 1894. 1. The decision upon which the collector acted in admitting such goods free of duty. 2. All correspondence between the controller of customs or other person in the department of customs relating thereto. 3. Copies of the letters and correspondence which passed between the Rev. J. C. Farthing, of Woodstock, and the controller of customs, with reference to the admission of such goods and the alleged unfairness with which Mr. Farthing had been treated on the importation by him of a similar class of goods for the use of the Anglican church at Woodstock, of which he is rector. 4. And if duty has since been exacted upon the said articles, or any of them, a copy of the entry or minute in respect thereto and the amount of duty paid thereon. Presented 29th June, 1894.—*Mr. McCarthy* ..... *Not printed.*
93. Return to an order of the House of Commons, dated 7th May, 1894, for a return showing the names of all persons appointed to act as what are known as return-men, in connection with immigration work, the period during which each worked, the amount of money paid to each, the names of the settlers brought to Canada by each return-man, and the places in which such settlers were located. Also statement showing what arrangements are made with these return-men. Presented 29th June, 1894.—*Mr. Martin*..... *Not printed.*
94. Return to an order of the House of Commons, dated 28th May, 1894, for a return showing the date on which the steamer "Stanley" commenced running between Charlottetown, P.E.I. and Pictou, N.S.; the date said steamer commenced running between Georgetown, P.E.I. and Pictou; how many trips were made; the date of each trip; how many mail bags were carried each trip; the date at which said steamer stopped carrying mails; the number of passengers and the amount of freight carried to and from Prince Edward Island; the amount of expenses and revenue for the winter 1893-94, in connection with said service. Presented 29th June, 1894.—*Mr. Perry*.  
*Not printed.*
- 94a. Return to an address of the Senate to his excellency the Governor General, dated the 14th June, 1894, for a statement giving in detail the days, during the month of January, February, March and April last, on which the steamer "Stanley" crossed between Prince Edward Island and the mainland, such statement to show separately the days on which the said steamer made single and return trips, and also the ports of departure from either side. Also for a statement covering the same period, giving in detail the days on which the government ice-boats crossed between Cape Traverse and Cape Tormentine, such statement to show separately the days on which single and return trips were made. Also for a statement giving in detail the days during the same period on which no mails were conveyed from the mainland to Prince Edward Island, and from Prince Edward Island to the mainland. Presented 6th July, 1894.—*Hon. Mr. Ferguson (Queen's, P.E.I.)*  
*Not printed.*
95. Return to an address of the Senate to his excellency the Governor General, dated 19th June, 1894, for a copy of the report made on the 5th May, 1891, by Sir Douglas Fox, regarding the proposed tunnel under the Straits of Northumberland, without the plans. Also copies of reports on the same subject by Mr. Francis Bain, dated the 9th and 18th of December, 1890, and the 14th March, 1891. Presented 5th July, 1894.—*Hon. Mr. Ferguson (Queen's, P.E.I.)*  
*Printed for sessional papers only.*

VOLUME 17—*Continued.*

- 96.** Return to an address of the House of Commons to his excellency the Governor General, dated 27th April, 1892, for copies of all correspondence, memorials, departmental orders and orders in council, respecting or in any way relating to the removal of the export duty from saw-logs and other un-manufactured lumber exported from Canada to the United States. Presented 9th July, 1894.—*Mr. Rider*..... *Not printed.*
- 97.** Return to an order of the House of Commons, dated 9th May, 1892, for a copy of the report of the inspector of customs, Nova Scotia, in reference to the establishment of a port of entry at Whycomagh, in the county of Inverness. Presented 9th July, 1894.—*Mr. Cameron*..... *Not printed.*
- 97a.** Return to an order of the House of Commons, dated 9th May, 1892, for a copy of the report of the inspector of customs, Nova Scotia, in reference to the establishment of a port of entry at West Bay, in the county of Inverness. Presented 14th July, 1894.—*Mr. Cameron*..... *Not printed.*
- 98.** Return to an address of the House of Commons to his excellency the Governor General, dated 18th June, 1894, for a return of all charges, complaints, letters, telegrams, correspondence, reports or orders relative to the dismissal or removal of John McLeod as inspector of the repairs of the Broad Cove Marsh pier, Cape Breton. Presented 12th July, 1894.—*Mr. Davies*..... *Not printed.*
- 99.** Return to an address of the House of Commons to his excellency the Governor General, dated 25th April, 1894, for the production of all orders in council, correspondence, instructions to officers of the department of public works, and reports of such officers respecting the improvement of St. Andrew's rapids in the Red river of the North. Presented 12th July, 1894.—*Mr. Martin*..... *Not printed.*
- 100.** Return to an address of the House of Commons to his excellency the Governor General, dated 6th February, 1893, for copies of all orders in council now in force regulating the slaughtering of swine for exportation in bond, passed under authority of an act respecting customs, cap. 32, Revised Statutes, sec. 93; and for a copy of the quarantine regulations governing the importation of such swine into Canada for the purpose of slaughtering in bond. Presented 14th July, 1894.—*Mr. Smith (Ontario)*..... *Not printed.*
- 101.** Return to an order of the House of Commons, dated 28th May, 1894, for a detailed report showing the prizes awarded by the judges or jury at the Chicago Columbian exposition for the work of pupils of primary and special schools of every kind and degree, and also to pupils of secondary educational institutions of each of the provinces of Canada. Presented 14th July, 1894.—*Mr. Lachapelle*..... *Printed for sessional papers only.*
- 102.** Return to an order of the House of Commons, dated 21st May, 1894, for list of persons in Manitoba who have not as yet repaid the loans made to them, in or about the year 1876, for seed-grain, etc., with statement of the amount owing by each person and the interest claimed, up to 1st January, 1894, on each such amount. Also a list, showing the amounts of mortgages received as collateral security for each loan, with description of land mortgaged, with name of proprietor and name of borrower if he be another person. Presented 18th July, 1894.—*Mr. LaRivière*..... *Not printed.*
- 103.** Return to an order of the House of Commons, dated 28th May, 1894, for : 1. A statement showing the quantities of distilled and fermented liquors, under the different names as given in the trade returns, imported into and taken for consumption in Canada, from 1883 to 1893, both years included, computed in imperial gallons; the value of the same, and the duty paid thereon. 2. The quantity of distilled and fermented liquors, under the different names given in the inland revenue returns, manufactured in Canada and taken for consumption therein; the value of the same, and the duty paid thereon for the same years. 3. The amount of materials used in brewing and distilling alcoholic liquors in the several provinces of Canada during the same years. Presented 19th July, 1894.—*Mr. Flint*..... *Not printed.*
- 104.** Return to an order of the House of Commons, dated 28th May, 1894, for a statement showing the number of breweries, distilleries and maltsters' establishments in Canada in the year 1891; the amount of capital invested therein; the value of the output; the amount of wages paid; number of employees, and the revenue derived therefrom. Presented 19th July, 1894.—*Mr. Flint*..... *Not printed.*
- 105.** General statements and returns of baptisms, marriages and burials in the districts of Bellechasse, Chicoutimi, Gaspé, Kamouraska, L'Islet, Montmagny, Ottawa, and Saguenay. Presented 20th July, 1894, by Hon. Mr. Speaker..... *Not printed.*
- 106.** Return to an address of the House of Commons to his excellency the Governor General, dated 4th June, 1894, for copies of all correspondence, petitions and memorials in relation to the reduction or abolition of the duties on Canadian tobacco, or in relation to any possible changes in the inland revenue laws in that behalf. Presented 23rd July, 1894.—*Mr. Brodeur*..... *Not printed.*

57 Victoria.

Sessional Papers (No. 8.)

A. 1894

# REPORT

OF THE

# MINISTER OF AGRICULTURE

FOR THE

DOMINION OF CANADA

FOR THE CALENDAR YEAR

1893

*PRINTED BY ORDER OF PARLIAMENT*



OTTAWA

PRINTED BY S. E. DAWSON, PRINTER TO THE QUEEN'S MOST  
EXCELLENT MAJESTY

1894

[No. 8.—1894.] *Price 15 cents.*





# Department of Agriculture.

## TABLE OF CONTENTS.

---

MINISTER'S REPORT :—

PAGE.

I. General Remarks .....	v
II. Arts and Agriculture, containing :	
Crops .....	v
Cattle Trade .....	vii
do Importation .....	vii
Point Lévis            Cattle Quarantine .....	viii
Ontario                    do .....	viii
Maritime Provinces    do .....	ix
North-west              do .....	ix
British Columbia      do .....	ix
Exportation of Live stock .....	x
Investigation of Animals' Disease .....	xi
Pictou Cattle Disease .....	xi
Tuberculosis .....	xi
Sheep Scab .....	xii
Hog Cholera .....	xii
Glanders .....	xii
Veterinary Congress .....	xiii
Cattle Scheduled in England .....	xiii
Experimental Farms .....	xiv
Bee-keeping and Honey .....	xvi
Dairying .....	xvi
Butter (Exports) .....	xx
Cheese    do .....	xx
Phosphate .....	xxi
Canadian Hops .....	xxii
Canadian Hay in England .....	xxiii
Flax .....	xxiii
Moss Litter .....	xxiii
General Subjects .....	xxiv
Australian Fruit .....	xxiv
Imperial Institute .....	xxiv
Exhibitions .....	xxv
Antwerp Exhibition .....	xxv
World's Columbian Exposition .....	xxv
Agricultural Societies .....	xxviii
Public Archives .....	xxviii

	PAGE
III. Patents.....	xxix-xxxii
IV. Copyrights, &c.....	xxxiii-iv
V. Quarantine.....	xxxiv
Year's Proceedings.....	xxxiv-ix
Summary Reports.....	xxxix-xli
Leprosy.....	xli
VI. Statistics.....	xli-iv
Health Statistics.....	xlili
Criminal Statistics.....	xlili
VII. Census.....	xliv
Year Book- or Statistical Abstract.....	xliv
General Statistics.....	xliv

## APPENDICES :

Reports of Quarantine Officers.	
do	Cattle Quarantine Officers.
do	Miscellaneous Subjects.

Department of Agriculture.

REPORT

OF THE

MINISTER OF AGRICULTURE

1893

---

*To His Excellency the Right Honourable Sir John Campbell Hamilton-Gordon, Earl of Aberdeen; Viscount Formartine, Baron Haddo, Methlic, Tarves and Kellie, in the Peerage of Scotland; Viscount Gordon of Aberdeen, County of Aberdeen, in the Peerage of the United Kingdom; Baronet of Nova Scotia, etc., etc., Governor General of Canada.*

MAY IT PLEASE YOUR EXCELLENCY,—

I have the honour to submit the report of the Department of Agriculture, up to 31st October, 1893.

I.—GENERAL REMARKS.

The legislation affecting this department during last session consisted of chap. 7, 56 Vic., intituled: "An Act respecting the appointment of Commissioners to the World's Columbian Exposition."

Also:—Chap. 34, 56 Vic., intituled: "An Act further to amend the Patent Act."

Also:—Chap. 37, 56 Vic., intituled: "An Act to prevent the manufacture and sale of filled or imitation cheese, and to provide for the branding of dairy products," and known as "The Dairy Products Act."

A synopsis of the operations of the various branches comprised in my department is laid before you under their respective headings, and I am happy to state the work in each branch has been efficiently carried on.

II.—AGRICULTURE.

The unusually low prices which products have commanded during the past two years have had a depressing influence on agriculture generally. This depression has been felt to a considerable extent in various parts of the Dominion, and more particularly in Manitoba and the North-west Territories where grain growing is the chief industry. In those districts where mixed farming is carried on and especially where the dairy interests have been largely developed and associated with the production of cattle and swine, farmers have experienced a fair degree of prosperity.

The hay crop of 1893, was unusually heavy throughout Ontario and Quebec, but dry weather in the early part of the season reduced the yield in the Maritime Provinces below the average. The unusual demand in Great Britain and France owing to a protracted drought there, has led to large shipments of Canadian hay to those countries and the brisk demand has been associated with satisfactory prices. The fall wheat in Ontario was about an average crop, but the drought which prevailed in the western and central portions of that province during the summer lessened the yield of spring grain. The apple crop was light, but small fruits and grapes yielded abundantly and satisfactory returns have been had from plums and peaches.

The ample rainfall experienced in the province of Quebec maintained the pastures in good condition throughout the season, and permitted dairy work, which is rapidly developing there, to be carried on with advantage and profit. The grain crop was also fairly good, although it suffered in some districts from rust, aggravated by wet weather preceding and during harvest.

In the Maritime Provinces the dry weather of the early part of the year was followed by favourable rains and the pastures were well maintained. The grain crop in most localities has given a fair average and the root crop has been unusually good. The dairy industry is making rapid progress in these provinces also.

The yield of the cereal crops in Manitoba and the North-west Territories gave a lower average than was expected in consequence of unusually hot weather which prevailed in August causing the grain to ripen prematurely and reducing the size and weight of the kernel. In some localities the influence was less felt and the crops were very good. The harvest was early and the weather favourable, so that all classes of grain were well saved. The quality of the wheat is generally good; barley weighs on the average lighter than usual, but oats in most districts are well developed and plump, and in some localities have given an abundant yield.

In British Columbia the yield of grain was good in many of the interior districts, but in the coast climate was below the average. The sample however was plump and good. The fruit crop was light. The area under cultivation is extending rapidly especially in fruit, and in some localities the hop industry is claiming especial attention. The hop plantations yielded well and preparations are being made to extend the acreage next season. The reclaiming of some of the low lands in the river valleys near the coast by dyking, is working satisfactorily and at the present rate of progress will in a few years add largely, from this source, to the quantity of arable land in the province immediately available for agricultural purposes.

I made during the autumn, with one of my colleagues, the Minister of Finance, an extended tour in the province of Manitoba, the territories of the North-west, and the province of British Columbia, with the object of examining personally the natural resources of those great areas of the Dominion; and for making myself personally acquainted with the progress made by the settlers, their needs and methods. I found that in Manitoba and the North-west the attention of farmers, generally speaking, had been mainly fixed on the raising of wheat. When no drawbacks happen to prevent the large yields from this grain which may naturally be expected in the virgin fertile soils of the North-west, and when fair prices can be obtained for the product, the production of wheat is lucrative, and there is a strong temptation to farmers to follow it in preference to other branches. But draw-

## Department of Agriculture.

backs sometimes arise even in the favoured regions of the North-west, in the same way as in other countries, and it happened during the year of my visit to South Manitoba, the large promise of the early spring sowing was materially checked by the influence of hot dry winds, above referred to, which occurred during the summer; a drawback which was followed by the unusually low price which prevailed for wheat. This combination of circumstances I found bore more heavily on some localities than others. It constituted as I have stated, a local drawback, but I was glad to find it was not destructive of the hope and courage of the farmers, who well knew the resources of the rich soils they were working. But the circumstances impressed on my mind the importance of what is called mixed farming for Manitoba and the North-west, in the same way as for other parts of the Dominion of Canada and elsewhere. I found in many parts of the North-west, so exclusive was the devotion of the farmers to the production of wheat, that generally speaking, they had not bestowed attention to such details as butter, cheese, eggs, poultry, swine, sheep, &c., for the supply of their own needs. A farmer raising all these things is naturally in a better position and more independent when the accident of a more or less serious drawback arises, than another who has devoted the whole of his attention to one crop, the subject of such accident. Mixed farming would also be more useful for fostering the home industries which play so important a part in older settled farming communities, and which tend so materially to the well-being and comfort of the farmers. I did not for instance see any of the forms of the home manufacture found to be so useful and important in other parts of the Dominion, and which in the aggregate play so important a part of the general wealth. The fact of so exclusive a dependence on the growing of wheat is a proof of the natural richness of the soil, which has not yet been denuded of its productive properties; and the extent to which wheat has been exclusively grown may be taken as a proof of the very great and unexhausted richness of the soil. So much exclusive growing of this grain would be impossible in any of the older parts of the Dominion, or the old settled portions of the United States, or the farming countries of Europe; but with the possession of this great natural wealth in the soil, I should be glad to see the North-western farmers avail themselves of the methods which I have ventured to suggest.

### CATTLE TRADE.

#### IMPORTATION OF LIVE STOCK.

The total importation of cattle into the Dominion during the ten months ending 31st October, was as follows:—1,349 cattle; 35,718 sheep; 177 swine; and 1,883 horses and mules. They were brought in as shown below, viz.:—

#### BY SEA.

	Cattle.	Sheep.	Swine.	Horses and Mules.
Quebec and Point Lévis (breeding).....	12	1,911	17	.....
Halifax do .....	18	.....	.....	.....
St. John do .....	.....	.....	.....	.....
Victoria, B. C. do .....	7	29,274	2	181*

\* 8 of these were mules.

## BY LAND.

	Cattle.	Sheep.	Swine.	Horses and Mules.
Ontario (Point Edward) (breeding).....	52	.....	37	.....
Emerson and Gretna (stock purposes).....	568	398	120	680
Manitou do .....	1	280	1	134
Deloraine do .....	150	.....	.....	43
Fort Macleod do .....	492	3,855	.....	837*
Kootenay, B. C. do .....	49	.....	.....	8
Total .....	1,349	35,718	177	1,883

\* 8 mules.

## POINT LÉVIS QUARANTINE.

The importation of stock for breeding purposes is shown by the following tables which give the total number of animals arriving and their destinations:—

	1892.	1893.
Cattle .....	1	12
Sheep.....	2,828	1,911
Swine.....	10	17
Total. ....	2,848	1,940

The destination were as follow:—

*For Canada.*

	1892.	1893.
Cattle.....	1	12
Sheep .....	969	811
Swine .....	19	15
Making a total for Canada.....	989	838

*For United States.*

Cattle .....	—	—
Sheep.....	1,859	1,100
Swine.....	—	2
Making a total for United States.....	1,859	1,102

No disease was discovered in any of the animals and they were all discharged from quarantine in perfect health, cattle after a detention of 90 days, and sheep after 15 days at the sea-board.

## ONTARIO CATTLE QUARANTINE.

The importations, for breeding purposes only, at Point Edward Cattle Quarantine, Ontario, were 52 cattle valued at \$4,560, and 37 swine valued at \$875. Pre-

## Department of Agriculture.

cautions were taken at this quarantine, for the detention on their return of cattle and swine which had been sent from Canada to the World's Fair at Chicago. The necessity for this precaution was manifested in an outbreak of hog cholera among swine returning from Chicago, within 15 days after their reception at quarantine. The outbreak was limited, prompt isolation of the diseased swine was effected, and by the use of the prompt measures taken, this insidious disease was arrested and its spread prevented.

### MARITIME PROVINCE CATTLE QUARANTINES.

The importations of stock through the respective quarantines of the Maritime Provinces were confined to Halifax, at which port 18 cattle were admitted and discharged after undergoing the regular quarantine detention.

### NORTH-WEST CATTLE QUARANTINES.

The number of cattle imported into Manitoba and the North-west Territories during the season, through the different ports of entry is given in the general table of imports, the returns being made by the veterinary inspectors at the various stations. In my report of last year, allusion was made to the Cattle Quarantine Reserve along the boundary in the North-west Territories, sanctioned by Order in Council of the 17th September, 1892, consisting of a belt of two townships, which was rescinded by that order and special quarantine stations delimited as stated.

Two additional reservations were made in March last, by Order in Council, viz., at Estevan, and south of Wood Mountain. The services of the Mounted Police, acting on behalf of my department and the Department of the Interior, jointly, have been utilized for these stations, and the fact of this service being under the control of a semi-military force, like the Mounted Police, has doubtless tended to create greater confidence in the enforcement of the quarantine west of Lake Superior, than management by any purely civil branch of the public service.

### BRITISH COLUMBIA CATTLE QUARANTINE.

The number of cattle imported, for breeding purposes, into British Columbia was 56, seven of which came in by sea to Victoria and 49 of them were brought over by land at Kootenay. These were brought in by a settler, and the collector of customs, who acts there as veterinary inspector, reported them free from disease, stating at the same time that the stock through that district are free from any contagious disease. Mr. Blanchard, the veterinary inspector at Victoria, B.C., reports all the animals entering there remarkably healthy, and they were above the average. Of the sheep imported, 4 were thoroughbred rams, and the remainder were for consumption. He reports a slight outbreak among calves, but which from the history of the case and the symptoms presented, he considered of an anthracoid nature.

The following table gives comparative figures:—

	1892	1893
At Victoria.		
Cattle (breeding).....	162	7
Sheep.....	29053	29274
Horses.....	80	173
Swine.....		2
Mules.....	12	8
At Kootenay.		
Cattle (stock purposes).....		49
Horses.....		8



Professor McEachran reports that stock also comes into British Columbia at the following points, viz., Blain, which is on the North-west Southern Railway; Huntingdon, on Bellingham Bay and B.C. Railway; Osoyoos, at the foot of the Okanagan Lakes, Kettle River; Fort Sheppard, at the junction of the Pend d'Oreille and Columbia River; Bedlington on the Kootenay River; and at Philips Range, where the Columbia crosses the boundary going south. The custom-house for this point is at Fort Steele, 50 miles north of it.

The reports of the officers of the various quarantine stations contain a considerable amount of general information.

#### EXPORTATION OF LIVE STOCK.

The exportation of live stock, for 1893, to the United Kingdom, from Canadian sea-ports, inspected before sailing, by the veterinary officers of my department, was :

Cattle.....	80,899
Sheep.....	1,781

Of the above cattle, 80,495 were shipped from Montreal, 400 from Halifax, and 4 from St. John, these latter being for the West Indies.

The following table gives comparisons for the last ten calendar years:—

	Cattle.	Sheep.
1883.....	55,625	114,352
1884.....	61,843	67,197
1885.....	69,158	38,534
1886.....	64,555	94,297
1887.....	64,621	35,473
1888.....	60,828	46,167
1889.....	85,053	58,983
1890.....	122,182	43,780
1891.....	108,947	32,157
1892.....	98,755	15,932
*1893.....	80,899	1,781

\*For ten months only.

Professor McEachran reports that the quality is steadily improving a fact well marked in the ranche stock, of which 6,500 were forwarded from Alberta, and 2,000 from Manitoba and the Territories.

He further says that owing mainly to the embargo on Canadian cattle which prevented the shipment of "stockers," and partly to the low prices and heavy losses incurred by shippers, there has been a considerable falling off in the numbers of stock exported during the current season as compared with previous years.

Careful inspection was made of all cattle and a detention of twenty-four hours between the time of their arrival off the cars and subsequent embarkment.

Not a single case of disease or suspicion of disease appeared among any of these cattle. Instructions were given to the inspectors to reject any cows or oxen which showed symptoms of age or which were not in good condition, or which showed any distress or bruises from the railway journey. Any such were rejected, but in most cases after resting a few days and having thoroughly recovered were

## Department of Agriculture.

allowed to proceed on another vessel. The fact of 80,495 head of cattle being collected from different parts of the Dominion, extending from the Atlantic to the Rocky Mountains, without showing symptoms of disease of a contagious nature, ought surely be sufficient proof that no contagious disease exists in Canada.

The total export trade of cattle from the whole Dominion, is shown in the following table, taken from the Trade and Navigation Reports for the fiscal years since 1873:—

Year.	Horses.		Cattle.		Sheep.	
	Number.	Value.	Number.	Value.	Number.	Value.
		\$		\$		\$
1874	5,399	570,544	39,623	951,269	252,081	702,564
1875	4,382	460,672	38,968	823,522	242,438	637,561
1876	4,299	442,338	25,357	601,448	141,187	505,538
1877	8,306	779,222	22,656	715,750	209,899	583,020
1878	14,179	1,273,728	29,915	1,152,334	242,989	699,337
1879	16,629	1,376,794	46,569	2,096,696	308,093	988,045
1880	21,393	1,880,379	54,944	2,764,437	398,746	1,422,830
1881	21,998	2,094,037	63,277	3,461,871	354,155	1,372,127
1882	20,920	2,236,637	62,106	2,256,330	311,669	1,228,957
1883	13,019	1,633,291	66,396	3,898,028	308,474	1,388,056
1884	11,505	1,617,829	89,263	5,681,082	304,403	1,544,005
1885	12,310	1,640,506	144,441	7,508,643	335,207	1,264,811
1886	16,951	2,232,623	92,661	5,916,551	359,488	1,184,106
1887	19,081	2,350,926	116,490	6,521,320	443,628	1,595,350
1888	20,505	2,563,407	100,748	5,012,788	395,320	1,283,537
1889	17,874	2,226,892	102,980	5,714,526	360,939	1,276,918
1890	16,709	2,007,533	81,478	6,952,185	316,013	1,276,999
1891	11,868	1,572,564	117,765	8,744,769	299,587	1,150,865
1892	11,306	1,484,431	107,180	7,749,399	331,278	1,429,067
1893	13,387	1,588,007	107,225	7,745,103	362,455	1,288,540

### INVESTIGATION OF ANIMALS' DISEASE.

With the exception of tuberculosis and Pictou cattle disease, it may be said that no disease of a serious nature exists among Canadian cattle, and a special report appears in the appendices herewith, on the minor diseases reported during the past season.

#### PICTOU CATTLE DISEASE.

Prof. McEachran says the Pictou cattle disease shows a very marked decrease as compared with last year, 125 cases demanding slaughter this year as against 363 in 1892, and a consequent reduction in the indemnity paid under the authority granted in the slaughtering provision of the Animal Contagious Diseases Act. The exciting cause of this disease is yet unsolved. It appears to be predominant during the summer months and to dwindle down with colder weather, to a minimum, almost entirely disappearing during the winter, thus assuming a seasonal character.

#### TUBERCULOSIS.

I have to report that this disease continues to exist. The recent adoption of the tuberculin test, a report on which will be found in the appendices, as an indicator

of the presence or absence of this disease is receiving the attention of the department, and so far, the tests made by it seem to indicate that its adoption will be beneficial. I regret to have to state that during the year this disease manifested itself among the cattle at the Central Experimental Farm where the tuberculin test was applied. The disease was found in 28 animals, one of which died and 27 were slaughtered, their carcasses being buried at a considerable depth, with a liberal application of quicklime.

As this disease is regarded as incurable, slaughter appears to be the only remedy to prevent its spread.

In addition to a report from Dr. Bryce on "Tuberculin injection," with results of experiments conducted therein, I further received through the Secretary of the Ontario Provincial Board of Health, Professor McKenzie's diagnosis of tuberculosis in cattle, which is published as a separate appendix. The method of injecting the tuberculin is described and examples of the results obtained in Europe by its use as a diagnostic agent are given.

#### SHEEP SCAB.

There was a slight outbreak of this disease in Western Ontario, and in Manitoba; whilst in the North-west Territories it assumed such proportions that very stringent quarantine measures had to be enforced for the purpose of eradicating it. In the two former provinces the outbreaks were quickly and successfully dealt with and Dr. McEachran who makes a special report on this disease in the North-west Territories, which will be found in the appendices, states it is now so well under control, that it is hoped early next year all the present existing quarantine restrictions there can be removed.

#### HOG CHOLERA.

From two localities in Ontario, I received intimation of an outbreak of hog cholera which, however, was, by the slaughter of the diseased animals, very quickly extirpated. This disease also manifested itself among some of the swine returning from the World's Fair at Chicago, during their detention in the cattle quarantine at Sarnia, Ont. By prompt measures, it was eradicated and prevented from gaining ingress into the country as it doubtless would have done had not a quarantine of all the animals returning from Chicago been enforced.

#### GLANDERS.

Cases of glanders are occasionally reported, but this disease comes under the jurisdiction of the provincial authorities.

Professor McEachran was authorized, in view of the frequent intimations of this disease in Manitoba, in July last to report respecting its occurrence. He visited a ranche on Maple Creek, amongst the horses of which glanders was reported to be prevalent, and he states that having no authority under the Animal Contagious Diseases Act to deal with the diseases of horses, all he could do in the premises was to advise the territorial veterinarian who accompanied him, and confirm the diagnosis. Prof. McEachran examined a herd of over one thousand horses, among which he found twelve cases of glanders in various stages, and recommended that they should be shot, the entire herd placed in quarantine, and that no movement or sale be allowed. The greatest difficulty is experienced in dealing with

## Department of Agriculture.

an outbreak of this nature in a herd of so many horses requiring very large range; and a source of danger to other herds in the district constantly threatens, unless quarantined, owing to the inability of preventing the animals from straying to other ranges. Professor McEachran dwells strongly on the danger of this disease spreading, not only among horses, but as being communicable to man, and suggests stringent measures being taken to eradicate it by the local legislature of the Territories and the Government of Manitoba.

### VETERINARY CONGRESS.

The first United States Veterinary Congress was held at the World's Fair in Chicago in October last, at which Canada was represented by Professor D. McEachran, who received authority from my department to be present at that meeting. At this congress a distinct declaration was made that it did not believe there was any contagious pleuro-pneumonia in Canada. It was claimed also that that disease had been eradicated from the United States, and Dr. Gadsden, an authority on pleuro-pneumonia, on both sides of the Atlantic, stated in a paper read by him before the congress, that the British veterinary advisers of the Imperial Privy Council had made an error in the Canadian case, a statement which was concurred in by all the other members.

### CATTLE SCHEDULED IN ENGLAND.

Hopes were entertained that the scheduling of Canadian cattle in England, reference to which was made in last year's report, would have been removed and that a resumption of the live stock trade would have been permitted during this year.

The question formed the subject of voluminous correspondence between the High Commissioner, the Imperial Board of Agriculture and the Colonial Office. A report was submitted by me to Council showing the results of the investigations made at the points of origin of all cattle shipped by the SS. "Monkseaton" and "Hurons" in 1892, and the special reports made by the veterinary officers of my department bearing thereon, show in the plainest possible way and with conclusive evidence that no disease exists among the flocks and herds of the Dominion.

The subject of again allowing Canadian cattle to be landed at the ports of the United Kingdom without having to be slaughtered was engaging attention when, on the 2nd of June last, the High Commissioner cabled from London, England, that the lung of an ox landed ex SS. "Winnipeg" from Montreal, on the 21st of May, gave rise to suspicion of pleuro-pneumonia. Inquiries made by me elicited the fact from Dr. M. C. Baker, the veterinary in Montreal, in charge of the above shipment, that there were among the cattle some working oxen none of which were old or feeble but proved when inspected to be strong and healthy. Nothing was discovered on their inspection to lead to the suspicion that lung disease would develop whilst crossing the Atlantic. The ox in question was traced to Pilot Mound, Manitoba, and Veterinary Inspector McFadden personally made careful examination of that district where he found no disease whatever existing. Professor McEachran, who was later in Manitoba, also visited Pilot Mound and declared positively that pleuro-pneumonia does not, and never did exist in the Pilot Mound District nor in any part of Manitoba. His report on this case will be found as an appendix herewith.

There was a further case of alleged pleuro-pneumonia in an ox landed ex "Hurons" at Deptford on October 22nd last. This was one animal of a lot of twenty-one shipped

from Howe Island near Kingston, none of which had been in contact with other animals until sent forward by the "Hurona." Professor McEachran made a thorough personal investigation of all the circumstances connected with the shipment, and reported that no contagious disease of any kind was ever known on the island. This animal alone was found to present symptoms of lung disease on arrival. A pathological examination of a portion of the lungs was subsequently made by Professor McEachran and Professor Adami (of McGill University). The result of the whole examination entirely discredited the assumption that the animal was affected with contagious pleuro-pneumonia. The details of this pathological investigation form an appendix to my report.

#### EXPERIMENTAL FARMS.

The aid and encouragement which the farmers of Canada have received through the information diffused by the experimental farms in all departments of agriculture and horticulture, are giving a considerable impetus to better farming. These farms have also supplied the means and given the opportunity for carrying on much useful work with cattle and swine, covering extensive series of experiments in furtherance of the dairy interest in showing the most economical methods of feeding and fattening cattle and swine. The publication in the reports and bulletins of the experimental farms of the results obtained in feeding swine with coarse grains and low grades of wheat has had an immediate and gratifying influence favourable to this branch of farming industry, manifested in the increased production of pork for home and foreign markets.

The distribution of useful varieties of seed grain to farmers is now carried on at all the experimental farms but more especially at the Central Farm at Ottawa, and the reports which have been received from farmers who have tried these new varieties show a gratifying measure of success. Owing to the great increase in the number of applicants, it has been found necessary to limit the number of samples sent to each individual.

The constantly increasing demand for the reports and bulletins issued from the experimental farm is a pleasing evidence of the usefulness of the work and that it commends itself to intelligent farmers everywhere.

Several of the new varieties of wheat and barley which have been produced by cross-fertilization at the central farm have been tested during the past year and have given promising results as to earliness and yield. Tests have been conducted with all the most promising varieties of cereals, roots, and fodder plants, also with a number of different sorts of fertilizers on a variety of crops. These latter have been under continuous trial for five or six years past and are furnishing useful information on this important topic. Experiments have been continued by the agriculturist in the feeding of swine by testing in comparison pure-bred with cross-bred animals; also with mixed fodder to cattle with the view of cheapening the production of milk and beef.

In the horticultural department many new sorts of fruits and vegetables have been tested, experiments have also been conducted with many varieties of tobacco to determine which are the earliest and most productive in this climate and the best in quality. In the poultry department further trial has been made with different breeds of fowls and in crossing them for the purpose of promoting egg laying and the early maturing of chickens.

## Department of Agriculture.

In the chemical department many analyses have been made of soils, fodder plants, and many other substances, also of well waters for farmers, while the entomologist and botanist has continued his investigation of the insect enemies and parasite fungi, which are injurious to useful crops. In the forestry department a great variety of trees are being tested and information gained as to their relative growth and suitability for this climate.

At the experimental farm for the Maritime Provinces, at Nappan, N.S., the great advantage of underdraining has been demonstrated by a considerable increase in crop and better quality of products. Many sorts of cereals, fodder plants, roots and fruits are being tried there from year to year; and improved breeds of dairy stock kept. This farm has assisted materially in awakening interest in the dairy industry of those provinces.

The experimental farm at Brandon, Manitoba, is making excellent progress. The large area devoted to tests of cereals and other important crops has proved very attractive and instructive to farmers in Manitoba who visit the farm in large numbers to gain information. The experimental farm at Indian Head, N.W.T., is doing similar good work for the territories. Besides tests of field crops, experiments are carried on at both these farms in many different lines with cattle, also with root and fodder crops, native grasses, fruits, vegetables and forest trees.

The experimental farm at Agassiz, in the coast climate of British Columbia, is situated in the valley of the Fraser River, near the western base of the Coast Range of mountains. The large test fruit orchards which have been planted there are making excellent progress. Experiments are also being conducted with promising breeds of dairy cattle, and with swine and poultry. The tests conducted with field crops include all the leading sorts of grain, roots, fodder crops and vegetables. A large area of broken land on the mountain sides is devoted to the planting of hard wood timber, and already a large number of young trees of black walnut, elm, ash, oak, hickory, wild cherry and other useful varieties have been planted.

A number of agricultural and dairy conventions and other meetings of farmers have been attended during the year by the officers of both the central and branch farms. Particulars of much of the work going on at all these farms will be found in the annual report appended, which may be obtained on application to the director.

A large and very varied assortment of cereals, both in straw and cleaned grain, together with samples of roots, potatoes, vegetables and fruits all grown at the experimental farms, were forwarded to Chicago to be exhibited at the recent exposition. A large and attractive trophy was built entirely of the products of the experimental farms in the centre of the space allotted to Canada in the agricultural building, which attracted much attention and was highly commended by visitors for the excellence and variety of the products shown, as well as for the tasteful arrangement of the exhibits. A fine display was also made of fruits throughout the season, in the building devoted to horticulture. The experimental farms received a number of awards in recognition of the excellence of these exhibits.

At a recent meeting of the Lancashire (England) County Council, of which Lord Derby is president, his lordship, speaking of the severe competition to which the British farmers are already subjected, in consequence of agricultural progress in Canada, declared that: "This was mere child's play compared with what they might expect in the course of a few years." He believed a vast amount of this

successful competition "was due to the better technical training which men got and the means they had by experimental farms and other similar establishments of ascertaining what was most suitable for the soil and what were the best methods of cultivation. Information on all these points was collected and circulated by a special department, sometimes by the Dominion, and sometimes by the provinces. Added to this there were now, and would be more by and by, agricultural colleges, for the most part maintained by the provinces, and they were means by which the young men were taught the technical as well as the practical part of farming. It was owing to these things very greatly that agricultural progress had been such a marked characteristic on the other side of the Atlantic."

#### BEE-KEEPING AND HONEY.

From inquiries made of my department during the past season, respecting the trade in honey and apiculture generally, I am led to believe that considerably more attention should be given to this branch of industry than it has hitherto received. The last census returns indicate that about 200,000 hives are kept in the Dominion, of which 146,341 are in Ontario. The statistician calls my attention to the fact that at an average of 50 lbs. to the hive of 5,000 bees, the production in Canada would be about 10,000,000 lbs. of honey. The trade returns show that in 1891 we exported honey to the value of \$264, whilst we imported that article to the value of \$3,558, chiefly from the United States. However, since that year either the home consumption has fallen off or else the production has been larger, for in the last fiscal year the value of the imported article had declined to a little over \$2,000, and the export shows a considerable increase, it having reached \$1,700 in 1892, of which \$1,200 worth went to Great Britain. The United States trade returns show large exportations of honey to Great Britain, the shipments to that country in 1891 being valued at \$36,000. The United Kingdom imports 3,500,000 lbs. of honey, valued at \$250,000. About 1,300,000 lbs. of this come from Chile, or over one-third of the total import, and over 1,000,000 lbs. are imported from Spanish and British West Indies. Great Britain also imports about 28,000 cwt. of beeswax, of which article there appears to be no mention in our returns. Taking the foregoing figures into consideration, I consider that this industry is of such importance that with care it might be made to add considerably to the wealth of the country. I would strongly call attention to this subject, with a view to increasing the stock of bees in the community, and thus materially swelling the annual yield of honey and its exportation.

#### DAIRYING.

The dairying branch of agriculture has continued to yield good returns to the farmers, who are devoting more attention to it from year to year. The enlargement in the quantity of dairy products has been mainly in the article of cheese. The value of Canadian cheese exported during the year ending June 30th, 1893, was an increase of 40 per cent over the value of the cheese exported in the year 1890. The demand in Great Britain for it has been steady; and the general excellence of quality and the total absence of adulteration have gained a continuously improving reputation with the consumers in Great Britain. It is expected that "The Dairy Products Act, 1893," will protect the good name which has been won and conserve it from injury by misrepresentation.

## Department of Agriculture.

Notwithstanding the great increase in the quantity of cheese which has been exported, the price has not fallen as low as the average of the past few years. I am informed that the following figures from *The Montreal Gazette* are correct. They show the quotations by public cable report from Liverpool, and the prices quoted in Montreal:—

PRICE of cheese in shillings and pence per 112 lbs. at Liverpool.

	1893.		1892.		1891.	
	Highest. s. d.	Lowest. s. d.	Highest. s. d.	Lowest. s. d.	Highest. s. d.	Lowest. s. d.
May .....	54 6	50	58	51	59	51
June .....	50	45	53	44 6	49	43 6
July .....	47 6	45	45	43	44	42 6
August .....	47 6	45	47	45	46	44
September .....	49 6	47 6	49	46	46	45 6
October .....	55	49 6	52	49	50	46
November .....	55	54	53	52	55	50 6

PRICE of cheese in cents per pound at Montreal.

	1893.		1892.		1891.	
	Highest. c.	Lowest. c.	Highest. c.	Lowest. c.	Highest. c.	Lowest. c.
May .....	10	9 $\frac{3}{4}$	10 $\frac{1}{2}$	9 $\frac{3}{4}$	10 $\frac{1}{2}$	9 $\frac{1}{2}$
June .....	9 $\frac{3}{4}$	9	10	8 $\frac{3}{4}$	9 $\frac{1}{2}$	8 $\frac{3}{4}$
July .....	9 $\frac{3}{4}$	9 $\frac{1}{4}$	9 $\frac{1}{2}$	8 $\frac{3}{4}$	9	8 $\frac{3}{4}$
August .....	9 $\frac{3}{4}$	9 $\frac{3}{4}$	9 $\frac{3}{4}$	9 $\frac{3}{4}$	9 $\frac{3}{4}$	8 $\frac{3}{4}$
September .....	10 $\frac{1}{2}$	9 $\frac{3}{4}$	10 $\frac{1}{2}$	9 $\frac{3}{4}$	10 $\frac{1}{2}$	9 $\frac{3}{4}$
October .....	11 $\frac{1}{2}$	10 $\frac{3}{4}$	10 $\frac{1}{2}$	10 $\frac{1}{2}$	10 $\frac{1}{2}$	9 $\frac{3}{4}$
November .....	11	10 $\frac{3}{4}$	10 $\frac{3}{4}$	10 $\frac{1}{2}$	11	10 $\frac{1}{2}$

It may be stated that many new cheese factories have been erected in districts where formerly butter only was made. Since the establishment of branch experimental farm stations in 1891, a great push forward has been given to the new departure of manufacturing butter during the winter, on the same premises where cheese-making is carried on during the months of summer. Two winter-dairying stations only were established under the charge of the Dairy Commissioner in 1891; at the present time, seven of these butter-making stations are being conducted by the *Dairying Service* of the department. As a result of the influence of this part of the work, a large number of cheese factories (mostly in Ontario) have been fitted up by the proprietors for the manufacture of butter during the winter. This method of dairying furnishes an additional and valuable source of revenue to farmers.

The use of fodder corn, in the weather-dried condition and in the form of ensilage, is becoming more general. By means of it, as a feed for milch cows, a supply of rich wholesome milk can be obtained during the winter season at a minimum of cost. Many other advantages, besides the direct revenue from sales of butter, result



to the farming interests from winter dairying. Not the least of these is the gain in the number and quality of cattle and swine which can be reared and fattened upon farms, where a liberal supply of skim milk and buttermilk is available for feeding.

A few paragraphs will give an outline of the principal work which is being carried on in the different provinces.

During the year of the Dairy Commissioner's report, ending June 30, 1893, no less than 375 meetings were attended and addressed by the Dairy Commissioner and his assistants. Particular directions and instructions were given from time to time to cheese-makers and butter-makers in nearly all parts of the Dominion by means of bulletins and by personal visits.

In the province of Ontario, winter butter-making is being carried on at Chester-ville, Wellman's Corners, Woodstock, Mount Elgin and London. The farmers are furnishing supplies of milk larger than last year, and this branch of dairying may be considered as fairly well started in Ontario.

In the province of Quebec, the Assistant Dairy Commissioner held meetings throughout the year. During most of the summer he was accompanied by an expert cheese-maker from the Dairy Commissioner's staff.

The combined experimental dairy station and dairy school at St. Hyacinthe, which was erected by the Dairy Association of the province of Quebec, has been continued under the direction of the Dairy Commissioner for the Dominion. The Dairy Association for the province of Quebec contributes a sum of \$1,000 per annum towards its maintenance. During the winter season of 1892-93, 214 students attended the school and took the short course of instruction in cheese-making and butter-making. Applications, to the full capacity of the school, have been received for the season of 1893-94.

In the province of New Brunswick, an experimental dairy station was conducted at Kingsclear for the manufacture of butter during the summer. The cream only was collected from the farmers. The manufacturing of butter during the winter is being continued in the cheese factory premises at Sussex, N.B. The whole milk is received from the farmers, and the skim-milk is returned to them after the cream has been separated by a centrifugal cream separator.

In the province of Nova Scotia, an experimental dairy station has been established on the experimental farm, at Nappan, N.S. The buildings were erected by capital furnished by persons in the neighbourhood, and the Department of Agriculture put in the apparatus for cheese-making and butter-making. Cheese was manufactured during the summer, and butter is being made since the end of October. The most of the cheese was sold for export to Great Britain. The practice of co-operative dairying is extending in the province.

In the province of Prince Edward Island there was only one small cheese factory in operation in 1891. A branch experimental dairy station was established at New Perth in 1892. During the winter of 1892-93 and the spring of 1893, nine new cheese factories were erected and equipped by joint stock companies of farmers. The Dairy Commissioner was authorized to manage these factories for the farmers at a charge of one and a quarter cents per pound of cheese, where the farmers delivered the milk at the factories. Unfortunately one of the factories was burned before it passed under the charge of the Dairy Commissioner. The farmers who owned two

## Department of Agriculture.

of the old cheese factories made application to receive similar terms to those accorded to the patrons of the new factories. This was granted, and eleven factories were in operation during the summer, under the direction of the *Dairying Service* of the department. The net proceeds from the sales of cheese, after deducting the charge for manufacturing, are to be paid to the farmers who supplied milk. At this writing the cheese are not all sold, but over \$45,000 worth have been manufactured during the summer, besides what was purchased by the patrons of the factories. The growth of Indian corn fodder for cattle feeding has now become a general practice in the sections where cheese factories are located. A large number of small fields have been sown with winter rye for feeding in the early summer.

On the whole the dairying movement in the Maritime Provinces has already resulted in yielding an increase of revenue to the farmers and has put new hope into their estimate of what the future of farming has in store for them in that part of Canada.

In the province of Manitoba, an expert cheese-maker from the Dairy Commissioner's staff visited the cheese factories to give instruction in that branch of the work. This was in accordance with a request which was made to my department on behalf of the Dairymen's Association of the province of Manitoba.

In the North-west Territories, an expert butter-maker was placed during part of the summer at Wolseley, to act as instructor in butter-making to all who visited the station. One of the Dairy Commissioner's assistants stayed at Moose Jaw while a local company took the necessary steps for the erection and equipment of a butter factory. Owing to the late date at which the creamery was completed and to the fact that some of the expected patrons were not ready to furnish as much milk as was looked for, the opening of the creamery was postponed for the present season. More attention is being given every year to the methods of mixed and dairy farming, with the result that the farmers have more numerous sources of revenue than formerly.

The province of British Columbia contains many valleys which are admirably adapted for dairy farming; but, owing to the extra labours imposed on the *Dairying Service* in managing the exhibitions of Canadian cheese and butter at the World's Columbian Exposition during the year, it was not practicable to extend help to the dairy interests of that province, except through correspondence and the distribution of bulletins and reports.

The holding of the World's Columbian Exposition afforded an opportunity for putting Canadian cheese and butter on exhibition with similar products from the United States of America and other countries. The record of the success of the Canadian exhibits in winning awards is unparalleled.

In the competition held in June, there were 162 lots of cheese from Canada; of these, 129 were scored high enough to entitle them to an award of a diploma and medal. In the competition of October, 687 lots of cheese were from Canada; and 607 of them were found to be scored at or above the minimum number of points to entitle to a diploma and medal. In the two exhibits (June and October), out of a total number of 849 entries of cheese from Canada, no less than 736 lots were found by the judges to be worthy of medals and diplomas. In the June and October competitions respectively, 31 and 130 exhibits of cheese from Canada were scored

higher than the highest award to the cheese from any other country in the same classes. In the June and October competitions, out of 207 exhibits of butter, 40 lots were scored high enough to entitle them to awards of a diploma and medal.

The magnitude and growth of the export trade of Canada in dairy products, is shown by the following tables (year ending 30th June):—

DOMINION OF CANADA—Exports of Dairy Products—Home Production.

BUTTER.

Year.	Quantity.	Value.	To Great Britain.	To United States.	To France.	To Germany.	Other Foreign Countries.	B.N.A. Provinces.	British Indies.
	Lbs.	\$	\$	\$	\$	\$	\$	\$	\$
1868.....	10,649,733	1,698,042	534,707	1,015,702	.....	1,496	14,870	95,777	26,986
1880.....	18,535,362	3,058,069	2,756,064	111,158	.....	.....	24,710	163,290	2,847
1881.....	17,649,491	5,573,934	3,333,419	58,522	.....	.....	30,574	143,935	6,584
1882.....	15,161,839	2,936,150	2,195,127	529,169	.....	.....	32,052	169,270	10,538
1883.....	8,106,447	1,705,817	1,330,585	206,154	.....	.....	29,446	131,341	8,291
1884.....	8,075,537	1,612,481	1,395,652	46,618	.....	.....	16,455	151,224	2,532
1885.....	7,330,788	1,430,905	1,212,768	16,795	.....	15,172	21,473	161,862	2,835
1886.....	4,668,741	832,355	652,863	17,545	.....	.....	17,577	142,485	1,885
1887.....	5,485,509	979,126	757,261	17,207	.....	.....	23,789	180,238	631
1888.....	4,415,381	798,673	614,214	13,468	.....	.....	5,226	164,329	1,436
1889.....	1,780,765	331,958	174,027	7,879	.....	.....	22,921	124,349	2,782
1890.....	1,951,585	340,131	184,105	5,059	.....	.....	29,342	119,989	1,636
1891.....	3,768,101	602,175	440,060	10,054	.....	20,447	24,021	101,649	5,944
1892.....	5,736,696	1,056,058	877,455	6,038	.....	5,160	27,207	133,770	6,428
1893.....	7,036,013	1,296,814	1,118,614	7,539	.....	1,175	35,042	127,412	7,032

CHEESE.

1868.....	6,141,570	620,543	548,574	68,784	.....	.....	891	1,954	340	
1880.....	40,368,678	3,893,366	3,772,769	114,507	.....	.....	170	5,710	210	
1881.....	49,255,523	5,510,443	5,471,362	28,500	.....	.....	14	10,027	540	
1882.....	50,807,049	5,500,868	5,571,076	18,436	.....	.....	242	8,196	2,318	
1883.....	58,041,387	6,451,870	6,409,859	24,468	.....	.....	202	15,480	1,863	
1884.....	69,755,423	7,251,989	7,207,425	24,866	.....	.....	188	19,248	262	
1885.....	79,655,367	8,265,240	8,178,953	68,978	.....	.....	205	15,899	1,207	
1886.....	78,112,927	6,754,626	6,729,134	15,478	.....	.....	156	9,139	549	
1887.....	73,604,448	7,108,978	7,065,983	30,667	.....	80	90	211	11,982	165
1888.....	84,173,267	8,928,242	8,834,997	83,153	.....	5	.....	828	9,087	172
1889.....	88,534,887	8,915,684	8,871,205	31,473	.....	.....	1,582	11,208	216	
1890.....	94,260,187	9,372,212	9,349,731	6,425	.....	.....	370	2,154	12,777	755
1891.....	106,202,140	9,508,800	9,481,373	13,485	.....	.....	.....	1,954	9,104	2,884
1892.....	118,270,052	11,652,412	11,593,690	39,558	.....	2	.....	2,124	12,942	4,096
1893.....	133,946,365	13,407,470	13,360,237	23,378	.....	.....	.....	2,689	18,669	2,297

*ERRATUM*

At page xx of the Report of the Minister of Agriculture in the table relating to exports of butter, in the value column for 1881, for \$5,573,034, read \$3,573,034.

## Department of Agriculture.

The following table, from the Board of Trade returns of Great Britain for seven years (ended 31st December), shows the total quantities and values of butter and cheese imported into Great Britain:—

BUTTER.			CHEESE.		
Year.	Quantity.	Value.	Year.	Quantity.	Value.
	Cwts.	£		Cwts.	£
1886	1,543,566	8,141,438	1886	1,734,890	3,871,359
1887	1,513,134	8,010,374	1887	1,836,789	4,514,382
1888	1,671,433	8,913,045	1888	1,917,616	4,546,408
1889	1,927,842	10,244,636	1889	1,907,999	4,490,970
1890	2,027,717	10,598,848	1890	2,144,074	4,975,134
1891	2,135,607	11,591,181	1891	2,041,317	4,815,369
1892	2,182,999	11,965,284	1892	2,232,814	5,417,777

### PHOSPHATE.

I am informed that comparatively little or nothing has been done during the past year as regards the phosphate industry of this country, the low prices ruling in the home market and the cheap rate of production which has enabled the Florida supply of the raw material to be laid down in Europe materially tending to injure if not destroy the Canadian trade. In this connection there is a point deserving of much consideration and to which I desire to call marked attention, viz., the amount of phosphoric acid that is taken out of the soil by a cereal crop; the shipment of the greater part of which abroad takes this phosphoric acid with it out of the country instead of returning it to the soil whence it was taken. Professor H. W. Wiley points out the fact that 19 lbs. per acre of phosphoric acid is absorbed by grain, and 12½ lbs. per acre is absorbed annually by the grass crop. This constituent element of the proper plant food, one of the chief essentials to all vegetable and animal life, must be restored to the soil unless the latter is to become entirely exhausted; and the agriculturist should understand that his farm is not a bank on which he can draw at pleasure but a laboratory which will only do its work well when the needed supply of material is forthcoming. Exhaustion of this nature can only be remedied by reintroducing artificially the material that has been abstracted. If a thorough knowledge of the need of phosphate for the soil prevailed, and practical application of such knowledge were more general it would materially help to develop the phosphate industry of this country and would lead to the manufacture of fertilizers on a large scale, whilst an extensive home market tending to a lower price for the manufactured article instead of exportation of the raw material, would be the result. I am informed that the cereals and the grass crop of Canada extract from the soil annually an average of 235 million pounds of phosphoric acid equal to 117,972 tons of 2,000 lbs. each. Supposing one-half only of this to be returned to the soil in the stable manure, there is still left a deficit of 59,000 tons of phosphoric acid. The percentage of phosphoric acid in Canadian apatite is, according to evidence obtained from the leading experts in the trade in England, and given in a report made by Mr. Dyke of Liverpool, in his appendix to the departmental report for 1885, about 33 per cent. Taking this as a fair average, the require-

ment for the production of the needed quantity of phosphoric acid to be restored to the soil would be about 177,000 tons (of 2,000 lbs.) of apatite. During the past six years, the apatite raised averaged 25,500 tons, of which 24,000 tons have been exported; so that we have been supplying ourselves with 500 tons of phosphoric acid against 59,000 tons needed to keep the constituent elements of plant food to the proper standard. What I mainly desire to impress upon the agricultural community is the necessity of bringing up their farms to the normal condition of fertility, and to give at the same time thereby a much needed impetus to the manufacture of fertilizers and the mining of phosphate. To sum up, the whole art of farming consists in supplying the nutritious elements of plants in the form most favourable for absorption and assimilation. As ordinary manure does not always contain the two most important inorganic elements of plant food, phosphoric acid and potash, in sufficient quantity for plant use, the needs of mankind demand the employment of artificial fertilizers along with or as a substitute for farmyard manure. A demand for the materials from which these could be manufactured would at once materially aid the now almost abandoned phosphate mining of this country.

Inquiries were made of my department, early in the year, regarding the question of rendering natural phosphate soluble in an economical manner through calcination. It was stated that in France and Belgium apatite had been treated in the same way as limestone for the manufacture of lime, the crude material being baked in an oven, then powdered and mixed with soil with which it at once became incorporated.

I had the subject at once referred to the chemist at the experimental farm and his report forms an appendix herewith.

The experiments appear to show that the solubility of this valuable natural fertilizer is not materially increased through calcination. The finely ground phosphate is soluble only to a slight degree in water and in the soil the process is extremely slow, but further experiments are now in progress with the hope of obtaining results which will be of practical benefit to the agricultural community.

#### CANADIAN HOPS.

I desire to call attention to an industry which I consider as capable of a considerable degree of extension, that is hop growing. In the year 1892, the United Kingdom imported from all countries twenty-one million pounds of hops, of which Canada only exported to that country 24,000 lbs., whilst the United States sent to Great Britain over twelve million pounds, valued at upwards of two million dollars. In the year 1891, the census figures show that there was a net import into Canada, of 341,312 pounds, which at twenty-five cents per pound, the average price calculated during a period of ten years, is equal to \$85,330 paid out for an imported article. Now it seems to me that the cultivation of hops is an opening for agriculturists in an industry which has hitherto been completely overlooked; for the importation of an article from abroad which can be raised on our own soil, takes out of the country an amount of money which would be far better circulated among our own people.

I have called the attention of the director of the experimental farm to this matter and expressed the desire that a bulletin be issued as soon as possible to supply full information on the subject of hops and hop growing.

## Department of Agriculture.

### CANADIAN HAY IN ENGLAND.

I am informed that recently, Canadian pressed hay has attracted considerable attention in the British markets, and more especially during the past year, in consequence of the drought which prevailed in England and which was so detrimental to the hay crop. Last autumn and winter Canadian hay was contracted for and sold at the port of Bristol for five pounds sterling, per ton. It should be borne in mind that in England the long ton (2,240 lbs.) prevails and not the short ton weight, as here. I would recommend to those who engage in this industry to take measures to have each bale of hay, before shipment, marked "Canadian." Mr. J. W. Down of Bristol, who has paid special attention to the Canadian hay trade, and a letter from whom on that subject forms an appendix of this report, informs me that hundreds of tons of an inferior quality are palmed off as Canadian. This is an important matter for shippers to consider, as otherwise Canadian hay, which now holds a good name in English markets, will rapidly lose its reputation. The question of freight stands somewhat in the way of shipment. Mr. Norman, a gentleman largely interested in Anglo-Canadian trade, has stated in the press that some of the Canadian steamship lines refused to take hay because the very large space it occupied might be more profitably occupied by other and heavier freight. As a matter of fact, he says the bulk of the hay from the Dominion has been shipped *via* New York. Whenever there is a dearth of hay in England and the crop in Canada has been good, it would pay to ship it, provided everything is done by the forwarder to promote despatch and to secure the proper quality for the English market.

### FLAX.

Inquiry having been made during the year respecting flax and flax products in the Dominion, I consider some allusion necessary with respect to this industry. Flax is grown extensively in the Mennonite settlements of Manitoba, and to a lesser extent in some parts of western Ontario. In the early settlement of the former province it was frequently grown on land newly broken, as a first crop, where with very little attention it amply repaid for the seed and labour. It is now cultivated by the Mennonites on land that has been cropped for years and yields a sure return. It is raised by them for seed only, for which there is a ready market, the greater part being used in the mills at Winnipeg, and the surplus shipped to Ontario. The yield of flax in Manitoba this year, reported by the Provincial Department of Agriculture in its bulletin (42) was 116,454 bushels. A large quantity of flax seed is imported into Canada. In 1892 the quantity was over 160,000 bushels.

My department is engaged in collecting information respecting the capabilities of this country for the growth of flax, and the uses to which its various products can be put, the object being to give intelligent guidance to all interested. The census returns showed that in 1891 there were fifty flax mills in operation employing over 1,500 hands and manufacturing over \$700,000 worth of products.

### MOSS LITTER.

Germany and Holland have for some years been exporting to Great Britain and to the United States for use in stables as bedding, and as an absorbent, bog moss, known in England as "Moss Litter," in Germany as "Torfstreu," and generically known as *Sphagnum*. This moss grows abundantly in Canadian swamps and bogs,

xxiii

especially where peat exists, the average thickness of a bed of it being about 4 feet, and it is I am given to understand, equally as good in quality as that of Europe. The value of moss litter in London, England, varies from 20s. to 25s. per ton. The properties upon which its value depends, are its soft yielding spongy nature which makes it suitable for bedding in stables, its capacity for absorbing moisture and retaining ammonia when mixed with the excrement of animals, and its original contents of nitrogen which after such mixture of composting is more readily utilized. Good air dried moss litter is capable of absorbing 10 to 20 times its weight of water and of retaining nearly two per cent of ammonia resulting from the decomposition of urine. It contains also in its original state from one-half to one per cent nitrogen, which is not readily available for plant food. According to Fleischer this nitrogen is readily changed into ammonia and nitric acid if care is taken to mix it with animal manure, and so becomes capable of plant utilization. When the fact becomes known that a company in Rotterdam, Holland, interested in this industry produce 80,000 tons of moss litter annually in their works, an idea may be formed of the demand for what is with us an entirely neglected natural product. Apart from its use for litter, dried moss might be used for packing eggs and fruit for shipment abroad with great success, and prove valuable both as an absorbent of moisture, and from the uses it could be put to after the goods it covered were disposed of.

Great Britain imported in 1892, 73,770 tons weight of this "moss litter," valued at £94,194 sterling. This was a larger amount than in previous years showing that the demand for the article is increasing. The imports of it into Great Britain were entirely from the continent of Europe and not from elsewhere.

#### GENERAL SUBJECTS.

##### AUSTRALIAN FRUIT.

In June last the Queensland Minister of Agriculture forwarded per SS. "Miowera," the first steamer which sailed from Australia for Canada direct, ten cases of fruit, the product of that country, for the purpose of ascertaining whether it would reach here in good condition, and what prospect there might be of a trade therein with this country. The fruit consisted of oranges and pineapples. The several samples of the former were tested and found to be good in quality and flavour, and to have arrived in good condition. The exterior appearance of the pineapples was very fine, but when cut into they were all found to be too much decayed for use. The oranges were undoubtedly suitable for Canada, but freight charges from so long a distance as Australia will stand in the way of a possible profitable trade.

In addition to the fruit, five boxes of Australian arrowroot were received at the same time from Queensland, with the same object in view, which I caused to be distributed among several leading grocery firms for commercial valuation and sale. No report, however, has yet been received on the result.

##### IMPERIAL INSTITUTE.

Towards the close of the summer, a communication was received in my department, from the Imperial Institute, to the effect that a collection of maps was in course of formation by it, which it desired to make with respect to the possessions of the British Empire as complete as possible. It further stated that a room had been specially set aside and fitted up for the reception of this collection, which at



## Department of Agriculture.

present comprises maps transferred to the Institute from the Colonial and Indian Exhibition. In this connection, a request was made for my department to procure and forward all maps possible. I immediately caused application to be made to the various departments of the public service to furnish a complete set of such as they possessed, and a collection which involved considerable time in preparing, is now completed and a case containing nearly five hundred copies of maps, relating to the various provinces of the Dominion, has been forwarded to the Imperial Institute.

### EXHIBITIONS.

#### ANTWERP EXHIBITION.

In July last the subject of representation by Canada at the next International Exhibition to be held at Antwerp during 1894 was brought to my attention. In 1885, Canada was well represented at a similar exhibition in the same city, the year prior to the Colonial and Indian Exhibition in London, England, the exhibits collected for one being also utilized at the other. After mature deliberation it was decided in Council that this country should take part in the Exhibition to commence in May next and the principal exhibits should be selected as far as possible chiefly from those at the World's Fair, Chicago, and should consist mainly of articles in the class of agriculture, horticulture, minerals, fisheries and special articles of manufacture. Antwerp being a port from which considerable European emigration takes place and having in view the making known the resources of Canada for the information of intending European emigrants, an exhibition held at that point I consider of importance.

#### THE WORLD'S COLUMBIAN EXPOSITION, CHICAGO.

The World's Columbian Exposition, which was held in Jackson Park, Chicago, opened on 1st May, and closed October 31st last. Canada was represented in this International Exposition. Mr. J. S. Larke, who was appointed Acting Executive Commissioner on the retirement of Mr. Saunders, through ill-health, was subsequently made Executive Commissioner. Later the Honourable Joseph Tassé, Senator, and Mr. G. R. R. Cockburn, M.P., were appointed Commissioners in accordance with the special Act of last session.

The Pavilion designed as the official building of Canada, was built on one of the most commanding and attractive points within Jackson Park. The total cost was beyond the first estimate, owing to the enormous increase in the rate of workmen's wages which took place during its construction. It proved most valuable in attracting attention to this country, and afforded conveniences which were highly appreciated by those of our people who attended the exposition.

The arrangements with the provincial governments, as reported last year, with the exception of that of Manitoba, which withdrew from them, were carried out with respect to the collection of cereals, fruits, vegetables, minerals, educational exhibits and live stock.

The Dominion central and branch experimental farms, under Mr. Saunders, the director, assisted very materially in the collection and preparation of cereals, vegetables and fruits. The display of the economic minerals, as collected by the provinces, was supplemented by the large, varied and scientific collection of the Geological Department, under the charge of Dr. Selwyn.

Canada had exhibits in all the great departments, and in all the buildings of the exposition, except that of electricity. In several buildings she had more than one court, an arrangement necessitated by the official classification. This very materially increased the cost of installation and supervision, but had its compensation in the frequency with which Canada was brought to the attention of visitors. In all the buildings the Canadian courts had striking positions on the main thoroughfares, a feature of great value in giving prominence to the display from this country.

The fruit, cereal and vegetable exhibits attracted great attention, both for the variety of product and high excellence of quality. They tended to dispel the illusion so common in both the United States and Europe that Canada is a frozen country, "a few acres of snow," with but a narrow habitable strip along its southern boundary. A demand on the part of United States farmers has already arisen for grains from the North-west Territories for seed purposes as a result of the inspection of these exhibits.

A cheese weighing 22,000 pounds was made under the supervision of Mr. Robertson, the Dominion Dairy Commissioner, which proved a valuable advertisement for the dairy interest of the country, as it was one of the two or three "biggest things" in Jackson Park. The quality of this cheese, shown by tests after it had withstood the high temperature prevalent in the agricultural building for the six months of the exhibition, and the marked superiority of the Canadian cheese shown in June and October, cannot but assist in gaining a wider market and better prices for this important product. The butter did not rank relatively as high as did the cheese from this country. The result of the competition in this department warrants the efforts that are being made to effect an improvement in the quality of Canadian butter.

The showing of live stock from this country, while successful and highly creditable to the exhibitors, hardly fulfilled the high expectations of the more sanguine of our people. This is accounted for by the extraordinary preparations of the breeders of the United States for this competition. They are generally companies of men of large capital, and have spared neither pains nor expense in purchasing both in Great Britain and in Canada the finest stock obtainable and in specially fitting them for the prize ring. Canadian exhibitors were sometimes beaten by animals bred by themselves. It was noteworthy that with the younger animals Canada took a higher position than with the older animals, demonstrating that our breeders have neither lost their skill, nor the country its prestige, for healthy, vigorous stock. The sales of live stock to United States buyers were disappointing. This was due mainly to the financial depression prevailing in that country, and the large supply of high grade stock now furnished by United States breeders. Nearly all of the sheep, swine and poultry sold were bought by the Commissioner for Costa Rica, showing that a new market may be opened to Canadian enterprise, as increased attention is now being paid to stock raising in the countries of Central and South America.

The fishery exhibit was made directly under the supervision of the Department of Marine and Fisheries. The display of the stuffed birds, fish-eating birds and animals was pronounced by the jurors to be superior to any other exhibit coming under their cognizance. The display of canned fish and fish products was scarcely equal

## Department of Agriculture.

to what might have been expected. Great difficulty was found in inducing firms engaged in this business to interest themselves in this exhibition, largely owing to the attitude of the United States Government on the sealing and fishery questions.

A like difficulty, and for a somewhat similar reason, was experienced in getting manufacturers of the country to participate. While desirous of upholding the dignity of Canada, they did not feel that the great expense which would be necessary when exhibiting by the side of goods made by concerns of greater age and enormous capital, was warranted by any expectation of profit, nor by the course of the government of the United States. Persistent effort, however, succeeded in bringing together a collection in the departments of manufactures, agriculture, and general machinery, liberal arts, transportation, and food products, which proved not only to be most creditable to the country, but a surprise to skilled visitors. The Canadian Pacific railway train was set down in the official guide book of the Exposition as the most complete and finest train on exhibition.

The largest and most varied display of agricultural machinery was that shown in the Canadian section by the Massey-Harris Company. Demands were made for catalogues and price lists of the Canadian iron and wood working tools from the United States, Great Britain and Europe. One of the first notable sales made in the Machinery Hall was that of a traction engine shown by John Abell, of Toronto, to go to Asiatic Turkey. Professor Thurston, chairman of the jurors on agricultural implements, and consulting mechanical engineer to the exposition, in an address stated that in design, finish and smoothness of operation, the Canadian agricultural and general machinery were the equals of anything of the kind in the exhibition, and as compared with the exhibit made in 1876 at Philadelphia, this manifested that Canada had made greater progress in manufacturing than any other nation taking part in the exposition. Mr. H. Latzko, president of the jurors from Austria, a member of the Imperial Austrian commission, and himself a large manufacturer of high grade cloths in that country, called upon the Executive Commissioner to express his high opinion of the great progress which the textile manufacturers of Canada had made as shown by the goods exhibited. He said he considered the rate of progress had been more rapid in Canada during the last few years than in any other country showing such industrial products.

The position taken by Canada in the sections devoted to education, fine arts, and women's work, was highly honourable and was an evidence that the instruction and cultivation of the people of this country is at least keeping step with the advancement of the world.

A final official list of the awards to Canadian exhibitors has not yet been issued by the exposition authorities, but so far as made known, Canada has taken a large number in every department in which she has had a part. The number of visitors from Europe was not equal to expectation. They, however, embraced distinguished experts sent out by the governments of France, Germany, Austria, Japan and other countries, who were deputed to report upon special features of the exhibition. Many of these gentlemen after visiting the Canadian sections, although their time was limited, resolved to make a visit to this country itself. Already some of the reports of these gentlemen have been published in newspapers or in books, in which prominence is given to the Dominion and its resources. In this respect, as in others, the part taken by Canada in the exposition cannot fail to be of great benefit both in respect to immigration and trade.

The total cost of the Canadian representation at Chicago will be about \$250,000. That of the Colonial and Indian Exhibition, in London, was \$312,076. Both of these expenditures were relatively much less than those of several states of the neighbouring union, at Chicago. The utmost economy was used throughout consistently with efficiency.

The official list of awards to Canadian exhibitors has not yet been received, but the Executive Commissioner has furnished me with an unrevised list, inserted as an appendix herewith, in which it appears that the following awards have been made to Canadian exhibitors:—

Dept. A,	Group	Agriculture.....	1,016
“ B,	“	Horticulture.....	65
“ C,	“	Live Stock.....	1,175
“ D,	“	Fisheries.....	24
“ E,	“	Mines and Mining.....	71
“ F,	“	Machinery.....	23
“ G,	“	Transportation.....	30
“ H,	“	Manufactures.....	124
“ K,	“	Art.....	5
“ L,	“	Liberal Arts . . . . .	183
“ M,	“	Ethnology.....	5
Total awards.....			<u>2,721</u>

This large number of awards is indicative of the magnitude of the Canadian representation at Chicago. It was necessary, in accordance with the rules of the Exposition Commission, to make this representation by departments in the several buildings provided and spread over the large area of Jackson Park, an arrangement which required a larger number of caretakers than would otherwise have been necessary; and these facts, coupled with the abnormally high prices which prevailed in Chicago during the exposition, may be held to be proof of the economy of the management when comparison is made between the figures of cost at Chicago and that at the Colonial and Indian Exhibition in London.

#### AGRICULTURAL SOCIETIES.

The action taken during the past year in the distribution of the grant of Parliament to agricultural societies in the North-west Territories has not differed from that of the previous year. This grant amounting to \$7,000 was distributed amongst thirty-six agricultural societies, the conditions of its distribution being that only societies numbering over fifty subscribers are allowed by the regulations to participate in its allotment. Amongst the societies participating, four represented the grants of 1892, which could not be paid in that year, owing to statements required by law not having been furnished to my department in time for adjustment. Promptness in forwarding these returns is very necessary, and delay frequently occasions considerable trouble.

#### PUBLIC ARCHIVES.

Mr. Douglas Brymner, the Archivist, is still in London (England) continuing his searches in the Colonial papers of the “British Museum” and of the “Record Office” while the copying of documents relating to the early history is continued in Paris, under the direction in Ottawa, of Mr. Joseph Marmette, the Assistant Archivist.

## Department of Agriculture.

The work of calendaring the Colonial Office Records has been carried on and embraces the very interesting period of the War of 1812, which calendar will be published in the Report for the year as a separate appendix.

The work of the branch continues to be actively and carefully conducted and embraces as well as the calendaring and general routine work that of cataloguing and indexing the original manuscripts.

### III.—PATENTS.

By reference to the following comparative statement it will be seen what the different transactions of the Patent Office have been in each year since 1872.

COMPARATIVE STATEMENT of the business of the Patent Office, from the year 1872 to 1892, and 31st October, 1893.

Years.	Applications for Patents.	PATENTS AND CERTIFICATES GRANTED.			Caveats.	Assignments of Patents.	Fees Received, including Designs and Trade Marks.
		Patents.	Certificates.	Totals.			
1872.....	752	671	.....	671	184	327	\$ cts. 19,578 65
1873.....	1,124	1,016	10	1,026	171	547	29,830 14
1874.....	1,376	1,218	27	1,245	200	711	34,301 98
1875.....	1,418	1,266	57	1,323	194	791	34,555 82
1876.....	1,548	1,337	46	1,383	185	761	36,187 63
1877.....	1,445	1,277	75	1,352	168	841	35,388 00
1878.....	1,428	1,172	96	1,268	172	832	33,663 67
1879.....	1,358	1,137	101	1,238	203	728	33,303 60
1880.....	1,601	1,252	156	1,408	227	855	42,141 14
1881.....	1,956	1,510	222	1,732	226	907	52,856 65
1882.....	2,266	1,846	291	2,137	198	955	60,811 19
1883.....	2,641	2,178	291	2,469	242	1,052	73,023 20
1884.....	2,681	2,456	167	2,623	238	1,772	69,530 69
1885.....	2,518	2,233	214	2,447	222	1,075	69,075 21
1886.....	2,776	2,610	250	2,860	187	1,322	73,949 29
1887.....	2,874	2,596	254	2,850	219	1,335	76,132 74
1888.....	2,747	2,257	282	2,539	240	1,159	74,508 37
1889.....	3,279	2,725	356	3,081	221	1,437	97,158 60
1890.....	3,560	2,428	369	2,797	248	1,307	94,027 16
1891.....	3,233	2,343	393	2,736	215	1,231	86,960 59
1892.....	3,176	3,417	415	3,832	242	1,500	86,713 05
*1893.....	2,614	3,153	292	3,445	229	1,345	71,863 52

### DETAILED STATEMENT, Patent Office Fees.

Year..	Patents.	Assignments.	Caveats.	Copies.	Subscription to Patent Record.	Notices to Apply for Patent.	Sundries.	Totals.
	\$ cts.	\$ cts.	\$ cts.	\$ cts.	\$ cts.	\$ cts.	\$ cts.	\$ cts.
1884.....	58,524 33	2,471 07	1,198 60	898 25	.....	.....	165 22	83,257 47
1885.....	57,777 31	2,225 63	1,226 65	895 89	.....	.....	50 75	62,176 23
1886.....	62,263 45	2,692 50	1,054 11	1,047 90	.....	.....	94 91	67,176 23
1887.....	62,924 44	2,715 88	1,169 50	1,044 31	.....	.....	86 08	67,940 21
1888.....	60,436 78	2,562 22	1,257 40	971 98	.....	.....	18 13	65,246 51
1889.....	72,411 30	3,027 90	1,205 47	1,267 60	.....	.....	134 45	78,046 72
1890.....	78,192 61	3,202 00	1,320 15	931 83	.....	.....	504 19	84,150 78
1891.....	72,664 26	2,411 95	1,124 60	782 29	.....	.....	340 53	77,723 63
1892.....	71,840 84	2,794 66	1,270 13	793 32	236 52	89 96	195 33	77,216 76
*1893.....	58,441 91	2,633 71	1,244 70	796 15	285 18	337 81	110 73	63,850 19

\*For 10 months only.

By the Act of the session of 1892, 55-56 Vic., chap. 24, the life of patents issued thereafter is extended from fifteen to eighteen years, with the privilege to the inventor or applicant, by payment of a partial or proportionate fee, to reduce this period to six or twelve years respectively. It is expected by thus extending the life of patents that the number of applications will largely increase. The above Act also provides that models shall be dispensed with, unless specially required, and it is thought by thus relieving inventors or applicants from the necessity of producing models, some of a costly character, that it will operate as an additional incentive to increase the number of applications for patents.

The number of notices filed under authority of section 8 was 169. In the year 1888, 2,257 patents were granted. Of these 67 were granted for the full fifteen years, and 7 for ten years; and the remainder, 2,183, for five years; of these last mentioned, 1,952 were allowed to expire, and the remaining 231, were continued in force for a further quinquennial period by the payment of the required additional fee.

This fact shows that only a small percentage of Canadian patents remains in force beyond the period of five years from their date of issue.

Ten patents were reissued during the first 10 months of the year.

In many instances patentees having represented and shown to the satisfaction of the office, that they were unable to comply with the requirements of section 37 of "The Patent Act," by means beyond their control, an extension of time within which to commence the manufacture of their inventions was granted. An extension of time to import was also accorded to others, where satisfactory reasons were shown to justify the granting of this privilege; 727 extensions to manufacture, and 448 extensions to import, were thus granted.

The attention of applicants for patents should be directed to the necessity for the greatest care in the preparation of their applications, a work which is generally advantageously performed by patent solicitors, not only in Canada, but in other countries where patent laws are in active operation.

The number of applications for patents, examined and reported on by the examiners was 2,914.

The utmost care and diligence have been observed by the Patent Office in thoroughly scrutinizing all applications for patents, and in cases where the alleged invention possessed none of the requisites of a patent, under the provisions of "The Patent Act," the application was not entertained.

Although only 7,355 visitors registered their names in the visitors' book, fully three times the number visited the model museum.

A change has been made in the manner of publishing the *Patent Record*, which is now printed at the Government Printing Bureau, whereby the work is both better and more economically done,—the type, paper and illustrations, being much superior to what they formerly were. A further advantage is that the illustrations instead of being put at the end of the *Record* as formerly, now immediately precede the claims in each and every patent. Subscriptions to this publication are now received by the office, instead of allowing the profit arising therefrom to go to the contractor, as formerly.

## Department of Agriculture.

The Joint Committee of the Library of Parliament last session permitted the removal to the Patent Office, of all works issued by the British and French Patent Offices relating to patents issued therefrom respectively. The removal has already taken place.

These books together with those already in the Patent Office comprise about 3,000 volumes, for which a light and convenient room adjoining the Patent Museum has been provided, to which inventors and the public generally have free access. The special library will not only be an advantage to the public generally, but will also be of material assistance to the examiners and other officers of the Patent Office in the discharge of their respective duties.

The patentees resided in the following countries:—

Countries.	1882.	1883.	1884.	1885.	1886.	1887.	1888.	1889.	1890.	1891.	1892.	1893.
Canada.....	538	612	607	610	687	639	565	609	620	606	671	685
England.....	103	116	94	85	140	153	152	203	116	122	298	206
United States.....	1,452	1,711	1,714	1,408	1,730	1,740	1,425	1,788	1,623	1,519	2,227	2,061
France.....	9	12	9	7	8	11	21	18	10	10	26	24
Germany.....	9	10	11	11	20	29	33	51	23	36	106	88
Other countries.....	26	8	21	22	25	24	61	56	36	50	89	89
Totals.....	2,137	2,469	2,456	2,233	2,610	2,596	2,257	2,725	2,428	2,343	3,417	*3,153

The Canadian patentees were distributed among the provinces of the Dominion as follows:—

Provinces.	1882.	1883.	1884.	1885.	1886.	1887.	1888.	1889.	1890.	1891.	1892.	1893.
Ontario.....	351	385	389	397	462	442	354	383	425	394	464	437
Quebec.....	129	165	151	150	152	131	128	129	125	140	131	151
New Brunswick.....	26	21	26	16	23	18	19	22	20	16	19	23
Nova Scotia.....	25	26	24	33	21	26	35	30	17	22	16	29
Prince Edward Island	2	7	2	7	3	4	2	2	3	1	1	3
Manitoba and North-west Territories.....	4	6	12	13	20	16	18	32	14	28	22	26
British Columbia.....	1	2	5	4	6	2	9	11	16	5	18	16
Totals.....	538	612	607	610	687	639	565	609	620	606	671	*685

\* For ten months only.

The office fees received during the first ten months of the year show a surplus of \$29,227.98 over the working expenses of the office, as per subjoined table:—

Receipts.		Expenditures.	
	\$ cts.		\$ cts.
Cash received.....	63,850 19	Salaries.....	27,617 91
Cash refunded.....	1,505 51	Patent Record.....	8,498 79
		Receipts over expenditures.....	36,116 70
			26,227 98
Net cash.....	62,344 68		62,344 68

Statement of the number of patents issued under the system, in force in Canada since 1869, of granting patents on which the fees are paid for periods of five, ten or fifteen years, at the option of the patentees, and of patents on which certificates of payments of fees were attached after the issue of patents; also for periods of six, twelve and eighteen years granted under the Act of the session of 1892, 55-56 Vic., chap. 24.

Years.	Periods for which the Fees were paid on first issue.			Patents on which Certificates were attached after Issue.	
	5 Years.	10 Years.	15 Years.	5 Years.	10 Years.
1869.....	204				
1870.....	556				
1871 .....	509				
1872.....	624	19	28		
1873.....	873	47	96	4	4
1874.....	1,098	38	87	17	5
1875.....	1,173	33	60	35	21
1876.....	1,261	21	55	28	9
1877.....	1,211	17	49	47	14
1878.....	1,109	20	43	58	19
1879.....	1,042	39	56	73	14
1880.....	1,144	20	88	110	23
1881.....	1,350	23	137	138	32
1882.....	1,633	26	187	175	58
1883.....	1,965	29	184	250	41
1884.....	2,357	15	84	146	21
1885.....	2,116	15	102	193	21
1886.....	2,524	12	74	226	24
1887.....	2,510	7	79	232	22
1888.....	2,183	7	67	254	28
1889.....	2,607	37	81	326	30
1890.....	2,382	9	37	340	29
1881.....	2,343	8	56	369	27
1892 (Six months ending 30th June).....	1,202	10	26	387	25
1893 (Ten months ending 31st October).....				279	10
	6 Years.	12 Years.	18 Years.	6 Years.	12 Years.
1892 (Six months ending 31st December)	2,141	3	35		3
1893 (Ten months ending 31st October).	3,098	9	46		3



## Department of Agriculture.

### IV.—COPYRIGHTS, TRADE MARKS, INDUSTRIAL DESIGNS AND TIMBER MARKS.

The following table shows a comparative statement of the business of this division from 1868 to 31st October, 1893, inclusive:—

Years.	Letters Received.	Letters Sent.	Copyrights Registered.	Certificates of Copy-rights.	Trade Marks Registered.	Certificates of Trade Marks.	Industrial Designs Registered.	Certificates of Industrial Designs.	Timber Marks Registered.	Certificates of Timber Marks.	Assignments Registered.	Fees Received.
1868	110	128	34	34	32	32	6	6				\$ cts.
1869	198	211	62	62	50	50	12	12				183 00
1870	473	463	66	66	72	72	23	23	190	190		418 00
1871	562	562	115	115	106	106	22	22	105	105		877 00
1872	523	523	87	83	103	103	17	17	64	64	11	927 00
1873	418	549	122	38	95	95	30	30	69	69	20	940 50
1874	1,027	1,027	134	55	163	163	30	30	41	41	19	1,339 50
1875	943	986	131	50	149	149	31	31	21	21	15	1,175 00
1876	1,175	1,240	178	57	238	238	47	47	17	17	33	1,758 25
1877	1,190	1,236	138	37	227	227	50	50	18	18	31	1,732 70
1878	1,210	1,285	193	61	223	223	40	40	10	10	14	1,671 25
1879	1,104	1,127	184	69	154	154	41	41	13	13	24	2,434 82
1880	1,145	1,292	185	98	113	113	40	40	19	19	28	3,806 15
1881	1,172	1,307	225	94	156	156	38	38	30	30	22	4,772 70
1882	1,192	1,264	224	87	160	160	45	45	21	21	64	4,956 40
1883	1,178	1,286	253	100	160	160	66	66	24	24	33	5,397 72
1884	1,186	1,186	281	120	196	196	68	68	14	14	49	6,273 22
1885	1,542	1,542	555	125	209	209	48	48	16	16	54	6,898 98
1886	1,544	1,544	574	101	203	203	54	54	17	17	58	6,795 42
1887	1,543	1,543	554	167	245	245	105	105	16	16	56	8,192 53
1888	1,655	1,889	566	167	288	288	71	71	29	29	71	9,262 86
1889	1,721	1,987	616	178	280	280	88	88	26	26	49	9,111 88
1890	1,766	2,169	688	222	293	293	68	68	21	21	104	9,876 38
1891	1,651	2,385	541	174	307	307	129	129	11	11	51	9,236 96
1892	1,773	2,300	536	159	294	294	30	30	27	27	66	9,496 29
1893	1,432	2,070	475	126	257	257	41	41	19	19	55	8,013 33

The total number of registrations of copyrights, trade marks, industrial designs and timber marks was 792 during the ten months ending 31st October, 1893. This consisted of 475 registrations of copyrights, 257 registrations of trade marks, 41 of industrial designs, and 19 of timber marks. There were also issued 126 certificates of copyrights, 32 registrations of interim copyrights, and 15 certificates; 3 registrations of temporary copyrights, and 2 certificates. The total number of assignments of these different rights recorded was 55.

The correspondence of this branch of the department amounted to 1,432 letters received and 2,070 sent.

The fees during the ten months amounted to \$8,013.33.

## COPYRIGHT AND TRADE MARKS DIVISION.

Detailed Statement of all Moneys received from January to 31st October, 1893.

Month.	Trade Marks.	Copy-rights.	Designs.	Timber Marks.	Assignments.	Copies.	Total.
	\$ cts.	\$ cts.	\$ cts.	\$ cts.	\$ cts.	\$ cts.	\$ cts.
January .....	615 00	39 00	25 00	6 00	11 50	3 50	700 00
February. ....	505 00	38 50	25 00	6 00	8 00	2 00	584 50
March .....	1,014 00	64 40	31 00	6 00	7 00	.....	1,122 40
April.....	810 00	47 50	35 00	4 00	9 00	4 50	910 00
May.....	907 00	49 00	33 50	6 75	4 00	50	1,000 75
June .....	604 75	33 50	35 00	.....	4 00	1 00	678 25
July.....	835 00	45 48	30 00	4 00	1 00	.....	915 48
August .....	649 75	37 50	3 50	2 00	2 00	1 00	695 75
September.....	650 00	38 50	29 00	6 00	8 00	2 50	734 00
October.....	545 45	45 75	25 00	2 00	52 00	2 00	672 20
Grand Total.....	7,135 95	439 13	272 00	42 75	106 50	17 00	8,013 33*

\* (The receipts since October to the beginning of December, bring this amount to \$9,586.58. For the whole year the amount will be about \$10,000.)

## V.—QUARANTINE.

When my report last year was in the press, a conference which had been called of representatives from the Provincial Governments on Maritime and Provincial Sanitation, was officially held in my department, the report of which was inserted as the last appendix to my annual report of 1892. The subjects considered thereat were twofold: *First*.—The relation between Dominion and Provincial sanitation. *Second*.—How to devise a method for collecting and publishing health statistics to be common to the Dominion and the provinces. As regards the first of these, a committee of members of the conference prepared and submitted a report containing a variety of suggestions embodying the responsibilities to be assumed respectively by the Dominion and the provinces in the matter of taking precautions against the dealing with any threatened invasion of Asiatic cholera. As regards the second consideration, resolutions were passed in favour of adopting a system of joint action between the Dominion and Provincial Governments. The following regulations were authorized by Order in Council and put in practice:—

1. During the coming season of St. Lawrence navigation, as a precautionary measure for the protection of Canada from contagious disease, the luggage of every immigrant entering Canada, except that of first class passengers, by way of the St. Lawrence in vessels not detained at Grosse Isle, for the reason of having no sickness on board, shall be disinfected at the point or points hereinafter named.

## Department of Agriculture.

2. Such disinfection shall be made by the steam process, by the fumes of sulphur, or by the bichloride drench, to the satisfaction of the Medical Superintendent of the Grosse Isle Quarantine Station.

3. The certificate given by the quarantine officer at Grosse Isle to vessels inspected at that station shall not be valid until such disinfection shall have been certified to be effective.

4. Such disinfection shall take place at :—

(a) The Louise embankment, or

(b) The immigrant landing place at Lévis, in respect to immigrants booked for transport by the Grand Trunk Railway.

5. The whole to be under my direction in virtue of the provisions of chapter 68 of the Revised Statutes, intituled "An Act respecting Quarantine."

Disinfection of the luggage of all immigrants arriving was strictly carried out, and more than 100,000 pieces of luggage, arriving *via* the St. Lawrence, were handled, their contents sterilized by steam, and the whole equipment disinfected. No vessel arriving in Canada can make a customs entry without having first obtained a quarantine clearance. To evade quarantine inspection would necessitate sending back to quarantine, the pilot in charge would make himself liable, and the collector of customs at the port knows that the non-compliance with the quarantine regulations would imperil his position. Moreover, no single piece of immigrant luggage can leave quarantine till it has passed through the disinfecting process, and been so marked. Under such supervision as the above, together with the cordial co-operation of the railroad companies, I am of opinion that the safeguards thus provided by the Government went far to allay public uneasiness respecting the introduction of Asiatic cholera, or other infectious diseases, from abroad. I may here cite, as an evidence of the high opinion how the work of the St. Lawrence quarantine system has this season been carried on, the following resolution adopted at a special meeting of the Michigan State Board of Health, held at Lansing, on the 27th and 28th of October last :—

"*Resolved* :—That the action of the Dominion of Canada in disinfecting the baggage of all immigrants from Europe coming into its territory and the establishment of its admirable appliances for this purpose as described by Dr. Montizambert, at the recent meeting of the American Public Health Association of Chicago, meets our most hearty approval. We commend earnestly this action of Canada to the United States Government, and hope that similar disinfecting plants be established by it at United States Atlantic ports, and that the baggage of all immigrants to this country be disinfected. We ask that this be done not alone that we may be saved from threatened invasions of small-pox and cholera, but also that a vastly greater saving of lives may be effected from measles, diphtheria, scarlet fever, pneumonia, consumption, and other diseases which are of much more serious concern to the people of this country than cholera or small-pox."

This resolution is the more noticeable from the fact that the State Board of Health of Michigan, earlier in the year ignored the certificate of the Medical Superintendent of the St. Lawrence Quarantines as to the efficiency of the disinfection of immigrants' luggage arriving *via* the St. Lawrence and insisted on a second disinfection, under the plea that that of the Canadian service was insufficient.

An outbreak of cholera, which was confined to the Quarantine Station in New York Harbour during the summer, was a proof of the value of extreme vigilance

in preventing that disease gaining a foothold on shore; and the officers of the various quarantine stations under my charge were unremitting in their inspection of incoming vessels with a view to the immediate detention of any suspicious case, should such come under their observation. Our freedom during the season, from the disease, will not relax the watchfulness that will be exercised during the coming year. The *London Times* of September 27th last, says: "Our present relations with the cholera leave us with some ground for confidence and some for apprehension with respect to the future, for, if precedent goes for anything, and hitherto it has proved a sound guide, we have got to look forward to many months of danger from without if not from within. Supposing the cholera within our gates is stamped out, fresh infection will still be brought from abroad and in all probability next year also, and our aim should be to prevent a recurrence of what has happened this year, and the first essential to success is the recognition of danger."..... "Do not let us throw away the popular warning of this year's cholera by pretending there has been none."

The Order in Council prohibiting the importation of rags from any part of Europe other than the United Kingdom has not yet been withdrawn. The Imperial Local Government Board Regulations were announced to me through the High Commissioner as follows :—

Continental rags in bales imported as merchandise, not prohibited; if otherwise they can only be landed for disinfection or destruction," and some doubt apparently having arisen as to the meaning of the word "Merchandise," a further definition in the same regulations of the 13th September last, says :—"The above mentioned words rags "packed" in bales and mentioned as merchandise mean rags compressed by hydraulic pressure transported as wholesale merchandise in bales surrounded by iron bands, and with marks and numbers, showing their origin, and accepted as such by the Commissioner of Her Majesty's Customs."

At Grosse Isle, three steam disinfecting chambers were placed in position during the year and are reported by Dr. Montizambert as having rendered invaluable service. The equipment of the station on that island, although still requiring a few details of minor importance is rapidly nearing completion. A commodious detention building for saloon passengers has been erected, its object being, to offer as far as possible accommodation and comfort equal to that on board ship, should necessity require transfer of passengers from one to the other. Two of the already existing buildings on the island have been fitted up with accommodation for intermediate passengers and a thorough overhauling of the building for steerage passengers has been carried on.

At Lawlor's Island, Halifax, N.S., the necessary work to place that station in a state of efficiency of the first-class was pushed forward as rapidly as possible in the early part of the season. The Halifax Board of Trade, early in April represented to me the necessity of extended vigilance in quarantine arrangements and practice of that city.

As a matter of extra precaution, however, I gave instructions for the disinfection of all immigrants' luggage, including that of passengers from healthy countries in order to avoid any possible error of any mixings from an infected country. Two new detention buildings, one for cabin passengers and the other for intermediate and steerage, have been erected this year. A new pier, or deep water wharf, has also been constructed at the head of Lawlor's Island and a large steam disin-

## Department of Agriculture.

factor has been placed on the pier at the island. Dr. Wickwire in his report states the Halifax Quarantine Station will now be prepared to meet any probable emergency.

Representations were made to me, from St. John, N.B., early in the year, that vigilance was necessary to be observed in inspecting coasting vessels from the United States under the terms of section 6 of the new Quarantine Regulations, in view of the fact of cholera having made its appearance in the states of New York and New Jersey, although it did not become epidemic. It was also represented that coasting schooners might possibly, before sailing, get a man from a boarding house and land him in St. John within a week, just as the disease is on the verge of showing itself: thus necessitating the utmost vigilance as regards inspection.

Instructions were at once given to Dr. Harding, the medical officer in charge of St. John Quarantine, to satisfy himself that there was no infectious disease on board any vessel coming from any port outside of Canada, and that the mode to be taken, especially in times of excitement such as prevailed this year, must be of a nature to satisfy not only himself but the public, that no infectious disease was present. His obligations were indicated as defined in sections 10 and 11 of the new Quarantine Regulations.

The revised regulations, in section 1 subsection (c.) specify both the harbour of St. John and Partridge Island as quarantine stations, while the old regulations ordered all vessels to stop for inspection outside Partridge.

Prior to Confederation, the provincial law provided for medical inspection at the port of St. John, only between 1st May and 1st November, with originally three medical officers to perform this duty, and always within the harbour. This number was subsequently reduced and exclusive right given to one officer, who was to reside on Partridge Island and inspect outside of it during the same period. After Confederation, the inspecting physician who had resided on the island, removed to the main land, and thence inspected as circumstances required, either outside or inside the harbour. This condition of affairs, dated so far back, doubtless gave the impression of some special advantage from inspections exclusively outside the island. Under the present system of inspection and precaution all introduction of infectious diseases is reduced to a minimum.

During seven months of the year, *i. e.*, from the 1st of October to the 1st of May, owing to the prevalence of high winds, it is scarcely safe for large vessels, and not at all for small ones, to anchor outside the harbour. Should they be compelled to do so by quarantine regulations, such detention might last for several days, if, by means of a heavy sea it became difficult for even a tug to get at them. Dr. Harding alleges that no harm can arise from allowing all vessels requiring inspection to enter the harbour, stating that when the pilot in the discharge of duty imposed on him by the quarantine regulations, has received answer from the master that he has not, nor has had, any of the interdicted conditions on board his ship, and shows a clean bill of health, even on being allowed to enter, no one is permitted to go on board or to leave the vessel.

In August last my attention was called to the prevalence of cholera at Smyrna and the consequent danger of the disease being introduced to this country through the method of handling figs and dried fruit for shipment, from that province or port. The United States Consul at Smyrna cabled to Washington that the whole province was quarantined, and immediately the importation of figs from that country

was prohibited by the United States Treasury Department Regulations. Figs and other dried fruits, not being susceptible of being disinfected by the ordinary processes, necessitated urgent measures, and on the 31st August an Order in Council was passed, prohibiting such importation, so long as cholera was epidemic in that province.

As soon as it was officially ascertained that Smyrna was free from disease the prohibitory order was rescinded and the trade was again permitted to import as usual. Some idea of the extent of this trade may be formed from the last fiscal year report—value of importation of dried fruits was \$769,614 on which the duty paid was \$227,565.

An important International Sanitary Conference, having general interest, was held in March last at Dresden, Europe, at which the subject of quarantine was fully discussed in all its phases, and in connection therewith, cholera, and the means to stay its diffusion. This conference was looked forward to by the delegates from other countries represented with the hope that its labour would result in a relaxation of the restrictions to which in many parts of Europe traffic whether of individuals or merchandise had hitherto been exposed. The proceedings were of such interest that the report made by the British delegates attending that conference, to the Imperial authorities, is of sufficient importance to be inserted as an appendix to my report.

Early in the spring of the year the Lieutenant-Governor of British Columbia telegraphed to the Secretary of State the desirability of taking steps to ensure the thorough inspection at the port of departure of passengers and goods coming from Asiatic ports so as to prevent infected passengers and cargoes being received on board vessels destined for Canada. Departmental representations were made to ensure vaccination of all steerage passengers from Asiatic ports before embarkation, and from which it was believed a large measure of protection might be expected. It was, however, found that the inspection of vessels at ports in China or Japan would imply the stationing of Canadian Quarantine Officers at those ports, which was found to be an action that would be accompanied with difficulties.

Early in the year, my attention was called to a case of small-pox discovered among passengers on the westbound train of the Canadian Pacific Railway at Port Arthur, the sufferer being an immigrant then recently landed from the SS. "Vancouver" at Halifax. From inquiry made of the medical superintendent at that port, I ascertained that all the luggage of immigrants had been there disinfected and that there was no sickness on board the "Vancouver" on her voyage. He further reported that when the passengers left Halifax none showed signs of illness, but he stated: "It is not unusual that the eruption of small-pox will appear in a few hours without any marked preliminary symptoms or at least not sufficiently characteristic as to create suspicion." The outbreak of the disease was not discovered till the passengers reached Montreal. It led to considerable correspondence on the subject, and a copy of the report of the secretary of the Provincial Board of Health of Ontario on this subject was forwarded to me, which together with the reply thereto will be found as an appendix herewith. This disease among the immigrants in question having broken out after they had received pratique from the Halifax quarantine officer had ceased to be a quarantine matter within the administration of this department.

I authorized during the year the attendance of Dr. Montizambert at some important sanitary conferences held on this continent, viz. :—First, the International

## Department of Agriculture.

Cholera Conference in New York, held in April last, at which an international health ticket for immigrants was decided upon and the subject of quarantine generally was thoroughly discussed. Next, the Pan-American Medical Congress held at Washington in September last, a report of which forms one of the appendices herewith. Eighteen different countries were represented at this meeting and over one thousand delegates were present. Nine of these were from Canada, and Dr. Montizambert was elected honorary president of the association on Marine, Hygiene, Quarantine and Climatology. An international committee was also appointed to keep up by correspondence between the meetings the main object of this conference. The last meeting was the International Conference of Public Health in conjunction with the annual meeting of the American Public Health Association held at Chicago in October last. Many of the leading sanitary authorities of the day were present at this conference and very important measures dealing with quarantine and public health were freely discussed. A report on the proceedings of this association will be found as an appendix herewith.

### SUMMARY OF REPORTS.

The reports and appendices from the medical superintendents of the various stations, show their operations during the present season and the nature of their work in dealing with contagious diseases and preventing them getting a hold on our shores. Dr. Montizambert, the Medical Superintendent of the St. Lawrence Quarantine Service at Grosse Isle, reports infectious disease found by him on board of eighteen vessels, the diseases being small-pox, yellow fever, scarlet fever, enteric fever, diphtheria, chicken-pox and measles. The admissions to the quarantine hospital at the station numbered 237, and the deaths in hospital were 25. The measures adopted in dealing with the several diseases which were brought to this station effectually prevented their entry into this country, and thus saved much suffering, and probably many lives.

The equipment of the station is now in such complete condition that the superintendent reports it as brought into the first rank of quarantine stations of the first class. The disinfecting sub-stations at Quebec and Point Lévis have proved very effective and the system adopted there of showing by label that disinfection has taken place has proved invaluable in preventing delay in transmitting the immigrants' effects into the interior of the country. The inspection by medical officers of the United States Government of our system of quarantine, to which I consented, has called forth the utmost approval and resulted in the issue of a circular letter from the Treasury Department at Washington to the sanitary inspectors of that country on the Canadian frontier to this effect:—

“The certificate of the Medical Superintendent of the St. Lawrence Quarantine Service or of the Medical officer of the Marine hospital service who has been permitted to witness the disinfection at Quebec will be accepted by all Inspectors on the Canadian border.”

If further evidence were wanting, Surgeon General Banks, in the United States Weekly Abstract of Sanitary Reports, says:—

“The work now being done by the Dominion Government in the most thorough and scientific manner has left no room for criticism.”

Dr. Montizambert proceeds to give details of the four sanitary conferences attended by him during the year.

He reports that inspection of the mail steamers at Rimouski was ably conducted during the season by Dr. P. A. Gauvreau, and that he himself from time to time visited Rimouski for the purpose of coming up on various steamers and thoroughly inspecting them personally, en route.

The sanitary outlook for the next season he considers unfavourable, and that the utmost precautionary measures will be necessary to prevent the introduction of infection into this country, not only by immigrants from Europe but from our nearer relations with Great Britain.

The increased work of the station and the sub-stations necessitated an increase in Dr. Montizambert's staff, all of whom he reports as fulfilling satisfactorily their various duties.

Dr. Wickwire, the Medical Superintendent at Halifax, states that less disease was brought into that port during last season than in any previous corresponding period for many years, and that there was no case requiring quarantine isolation or removal to the quarantine station. Very careful inspection was made by him of all arrivals from across the sea.

Considerable additions to the appliances to that quarantine station have been made during the year, and a suitable deep water wharf has been constructed. When the works now going on are completed, Dr. Wickwire says the station will be ready to meet any probable emergency.

Dr. Harding, the Medical Superintendent at St. John, N.B., dwells upon the system of inspection maintained by him at that port. He states vessels arriving there during the season were found exceptionally free from disease of an infectious nature. He reports the total number of vessels from foreign ports as 2,378, of all of which, requiring it, the most rigid inspection was made. He alludes to the requirements of the station, the completion of which is already arranged for.

Dr. Conroy, the Medical Superintendent at Charlottetown, P.E.I., reports no case of disease in any vessel arriving there during the season, and that he carefully inspected all vessels arriving from foreign ports.

Dr. McLeod, Medical Superintendent at Sydney, N.S., reports no disease requiring quarantine detention during the season. Inspection was carefully carried out by him, and this work has been greatly facilitated by telegraphic notice of approaching vessels sent from the signal station outside the harbour through arrangements to that effect kindly allowed by the Minister of Marine.

Dr. Macpherson, of North Sydney, reports inspecting 112 vessels, only one of which was ordered to quarantine through an irregularity in her papers. This, however, was satisfactorily explained, and the vessel was allowed to proceed.

Dr. P. A. McDonald, Medical Superintendent at Port Hawkesbury, N.S., reports no case of contagious or infectious disease on any of the vessels entering at the different ports on the Strait of Canso.

Dr. J. Macdonald, Medical Superintendent at Chatham, N.B., reports inspecting 105 vessels, three of which coming from infected ports were fumigated before being admitted to pratique. No case of infectious disease was found in any of them.

Dr. J. Pelletier, of Matane, P.Q., reports inspecting fourteen vessels during the season, on board of which were no cases of infectious or contagious disease.



## Department of Agriculture.

Dr. McN. Jones, Superintendent of Quarantines in British Columbia, reports that the new station at William Head is now occupied by him and that it will be, as soon as the furnishing is completed, very perfect. He reports three outbreaks of smallpox—one at the very beginning of the year, another at the end of January, and another in April. The cases, he says, were of a peculiarly malignant nature. In none of these cases did the disease spread beyond the quarantine grounds though several cases broke out among suspects detained in quarantine. The number of vessels inspected by him during the season were:—

Steamers.. .. .	619
Sailing vessels from across the sea.....	128
Coasting vessels.... ..	1,242

—————  
Making a total of inspections.....1,989

Dr. A. C. Smith, the Inspecting Physician at the Tracadie Lazaretto, reports that there are now twenty patients in the institution, eleven of whom are in the first or early stage of the disease, six in the second, and three in the third or final stage. Six deaths took place during the year, and four new cases were admitted. He reports no new cases from Tracadie, where he believes the disease has been overcome, the new admissions being from outside parishes. He reports considerable sickness of an ordinary nature among the inmates during the present season. The necessity for a new building is urged by him, and I may here state that arrangements have been made for the immediate construction and equipment of the same.

### VI.—STATISTICS.

The Statistical Branch of the Department of Agriculture is based upon the Union Act which specifically assigns Census and Statistics to the exclusive authority of the Parliament of Canada.

In accordance with this assignment of duties the Parliament of Canada passed chap. 21, Acts of 42 Vic.

In the Revised Statutes of Canada 1886, this Act forms chapters 58 and 59. Chap. 60 is the authority for the collection of criminal statistics.

By chap. 15, Acts of 1890, the collection and publication of labour statistics are defined to be part of the duties of the Minister of Agriculture, acting under the general authority conferred upon him by chap. 59, R. S. C.

As misapprehension seems to exist leading to indiscriminate and unofficial publication of statistics, sections of the Act chap. 59, R. S. C. are here given:—

The first section provides for the collecting, abstracting, tabulating and publishing vital, agricultural, commercial, criminal and other statistics by the Department of Agriculture.

The fourth section gives the Minister of Agriculture power to arrange with any Lieutenant-Governor in Council or with any provincial organization, for the collection and transmission of information collected under provincial systems.

The fifth section says :

“The Minister of Agriculture may in collecting statistics, in the manner provided by this Act, call upon any and all public officers to furnish copies of papers

and documents and such information as lie respectively in the power of such officers to furnish, with or without compensation for so doing, as is regulated from time to time by the Governor in Council."

The sixth section provides for the publication of an abstract and record of the various departmental or other public reports and documents.

The seventh section gives power to the Governor in Council to authorize the Minister of Agriculture to cause special statistical investigations as regards subjects, localities or otherwise to be made.

The eighth section empowers the Minister of Agriculture to cause all statistical information obtained to be examined, and any omissions, defects or inaccuracies discernible therein, to be supplemented and corrected as far as practicable.

The ninth section is as follows:

"Every one who wilfully gives false information or practises any deception in furnishing information provided for by this Act shall, on summary conviction before two justices of the peace, be liable to a penalty not exceeding one hundred dollars."

By another section in the Act the Governor in Council is empowered to appoint temporary clerks or employees for an indefinite period.

The evident aim and intention of these several Acts is the establishment of a Bureau of Statistics, which shall form part of the Department of Agriculture, and in which shall be consolidated the general statistics of the country, the officers in charge of which shall have every facility necessary to enable them to obtain the needed statistics from the several departments of the Federal Government, of the Provincial Governments, or by special statistical investigations.

A general collection and issue of Dominion Government statistics, by the Statistical Bureau, as directed by the statute, would establish uniformity, coupled with increased accuracy, and large economy in compilation.

The public appear to appreciate the efforts of this division of the Department of Agriculture, the preparation of general statistics in answer to inquiries having been greatly in excess of former years; the aim is to give all inquirers the best information obtainable. The Statistician's office has become a general inquiry office for all parts of the world.

His office has been visited by prominent officials of France, Germany and the United Kingdom, on their way to or from the Chicago fair. They have in all cases been supplied with information which it is believed will prove of benefit to Canada, since it has been supplied in the best way possible, namely by oral communication in answer to questions asked on the spot.

In the course of these interviews the Statistician has been forced to confess the fact that Canada lags behind other countries in many branches of statistics.

In no branch have there been so many inquiries as in that relating to agricultural statistics. These inquiries have necessarily been answered in a most unsatisfactory way, owing to the absence of any system of collecting agricultural statistics coextensive with the Dominion. If a good plan, ensuring accuracy and early publication, could be adopted in Canada, the value to farmers and business men of this information can hardly be over-estimated.

# Department of Agriculture.

## HEALTH STATISTICS.

No steps have been taken as yet to provide a better system of collecting vital statistics than that which was abrogated in 1891.

In the provinces of Ontario, Quebec, New Brunswick, British Columbia, Manitoba and the North-west Territories, the provincial and territorial authorities have placed on the statute-books Acts dealing with the collection of vital statistics. Section 4 of chapter 59, Revised Statutes, already quoted, gives the necessary legislative authority, to enable my department to join the provincial authorities in making arrangements for the better collection of different kinds of statistics, without limiting the power of this department to enter upon provincial fields not worked by provincial organizations.

By a combination of forces, the result would be more satisfactory than by any other system that could be originated by the federal authorities. Instead of clashing statistics, there would be statistics having a joint approval.

This plan could be carried out in respect to agricultural statistics: so that while each province could have its own statistics for publication, the world at large would have those of the Dominion. The very great attention given to crop statistics in the United Kingdom, the United States, France, Germany and Australia, and the large monetary operations based upon them make it almost imperative upon Canada to provide her farmers and business men with these aids to successful efforts.

## CRIMINAL STATISTICS

Chap. 60 of the Revised Statutes of Canada gives the special authority under which criminal statistics are collected. During the past year 281 persons made returns to the Statistical Branch of the Department of Agriculture. By provinces these returns are as under:

Prince Edward Island.....	6
Nova Scotia.....	43
New Brunswick.....	34
Quebec.....	39
Ontario.....	137
Manitoba.....	6
British Columbia.....	10
North-west Territories.....	6
Making a total of.....	281

The compilation which is published as an appendix shows that the number of persons convicted of indictable offences was 4,030 in 1892 as against 3,964 in 1891 or 8.23 per 10,000 inhabitants in 1892 against 8.20 per 10,000 in 1891. If to the number of convictions for indictable offences is added the number of summary convictions the result is a total of 34,997 convictions in 1892 against 37,415 in 1891. The result is that there was one conviction for each group of 140 persons in 1892 and one for each group of 129 in 1891, showing considerable decrease in crime.

During the year the Statistician prepared a monograph on crime in Canada grouping the statistics for the period 1882-92, and presenting the results in a number of tables.

A clerk is engaged in tabulating the reports of the Mounted Police of the North-west so as enable the branch to secure full returns of the Territories in respect to crime, these not having been wholly included in former returns to the department.

In the earlier years of the compilation of the criminal statistics the arrangement differed from that under which the tabulation was carried on since 1884. Returns previous to 1884 having been in this way deprived of their value for purposes of comparison, these are now being compiled over again so as to bring them into unison with the subsequent years.

#### VII.—CENSUS.

The tabulation of the census returns was brought to a close in June last, the work of completion having occupied practically less than two years in the place of the five years taken in the previous census. Several bulletins giving details on specific subjects have been issued in connection with the census. The second volume of the census has been printed and distributed. The printing of the third volume relating to industries will be completed in a few weeks.

#### YEAR BOOK (STATISTICAL ABSTRACT).

The Year Book has been prepared, printed and distributed. A number of alterations were made in it, designed to increase its usefulness. The demand for it is yearly increasing. The greatest care has been exercised in distributing it. Notwithstanding this care, the supply has proved altogether inadequate and the Statistician has been compelled to curtail the orders very considerably. An order for 600 in French for France could not be filled. Another order for a large number for Great Britain had to be cut down. The cause of this was the unfortunate reduction of the edition by 1,000 copies.

The volume in course of preparation will contain several new features calculated to enhance the value of this publication.

This Statistical Abstract and Record is published under authority of chap. 59, section 6, Revised Statutes of Canada.

#### GENERAL STATISTICS.

A large amount of statistical work has been done under authority of section 7, chap. 59, Revised Statutes. A small staff has been engaged in retabulating the census returns in reference to industries, so as to classify them according to value of output. This work has been undertaken in obedience to an address of the Senate transmitted through the Department of State, and enlarged by the Governor in Council.

An examination of the forest wealth of Canada has been begun and a large amount of material bearing upon the subject has been collected.

During the year, the Marquis of Ripon forwarded to His Excellency the Governor General, a letter from the Trade Committee of the Imperial Privy Council, generally known as the Board of Trade, stating that Mr. Bateman, a principal clerk of that Board, would visit Canada for the purpose of procuring information

## Department of Agriculture.

of a statistical character. This letter was referred from the Privy Council to my department, as dealing with statistics, and Mr. Bateman, subsequently, on his arrival here, had a long interview with the Dominion Statistician. The range of Mr. Bateman's mission may be gathered from the following substance of a letter subsequently written by him to that officer: "In regard to the various statistics of the Dominion which we have discussed, including those of Trade and Commerce, the chief points relate to

1. Valuation of imports and exports.
2. Registration of the origin of imports and the disposition of exports.
3. A classification of the articles of imports and exports."

The views and recommendations of the Colonial Office upon these three questions are contained in a report of the committee, copies of which have been communicated to the Dominion Government, together with Mr. Bateman's report to the Imperial Statistical Institute at its biennial session recently held in Chicago, together with a copy of the resolution passed by that body. The latter report gives the latest information as to what is being done in other countries in furtherance of the comparability of Trade Statistics. Mr. Bateman in this letter, expresses the hope that it may be found possible to carry out the suggestions of the Colonial Office Committee in respect to classification and valuation, at any rate by furnishing an abstract supplementary statement of exports and imports. He attaches great importance to obtaining more complete information with regard to the origin of imports and exports and the trade with the United States, and he would be pleased to hear any suggestions in the way of overcoming existing difficulties.

The whole subject is of very great importance and I am now in correspondence departmentally with authorities of other countries with a view to effect arrangements that may produce the requisite information.

The whole respectfully submitted.

A. R. ANGERS,  
*Minister of Agriculture.*

Ottawa, Dec. 30, 1893.



Department of Agriculture.

INDEX TO APPENDICES.

QUARANTINE.

No.		PAGE.
1.	Report on Grosse Isle Quarantine.....F. Montizambert, M.D., F.R.C.S .....	3
2.	do Halifax do ..... W. N. Wickwire, M.D...	11
3.	do St. John, N.B. do .....W. S. Harding, M.D., M.R.C.S. ....	12
4.	do Charlottetown..... P. Conroy, M.D. ....	14
5.	do Sydney..... W. McK. McLeod, M.D.	15
10.	do North Sydney.....H. B. Macpherson, M.D.	20
6.	do Pictou.....J. McMillan, M.D. ....	16
7.	do Port Hawkesbury ..... P. A. Macdonald, M. D.	17
8.	do Chatham N.B.....J. Macdonald, M.D. ....	18
9.	do Matane (sub-station).....J. B. Pelletier, M.D....	19
11.	do Rimouski do ..... P. A. Gauvreau, M.D...	21
31.	do Victoria, B.C..... W. McN. Jones, M.D...	79
12.	do •Tracadie Lazaretto..... A. C. Smith, M. D. ....	23

CATTLE QUARANTINE.

26.	Report on Quebec and the Maritime Provinces..Prof. D. McEachran, F.R.C.V.S.....	68
25.	do Point Lévis (Quebec)..... J. A. Couture, D.V.S...	64
27.	do Halifax..... W. Jakeman, D.V.S. ...	72
29.	do St. John, N.B.....J. H. Frink, D.V.S. ...	74
21.	do Ontario.....Prof. And. Smith, F.R.C. V.S.....	49
22.	do do (Point Edward). ....S. P. Westell, D.V.S ...	50
28.	do Lyn Stock-yarde..... W. Stafford, V. S.....	73
24.	do Manitoba (Emerson).. ....D. H. McFadden, D.V.S.	55
17.	do do (Manitou)..... M. M. Young, D.V.S....	38
18.	do do (Deloraine) ..... Jos. Dann, D.V.S. ....	40
19.	do N. W. Territories (Fort McLeod)....R. Evans, D.V.S.....	29
16.	do do (Maple Creek)....J. L. Poett, D.V.S.....	36
13.	do British Columbia (Victoria) . ....M. G. Blanchard, D.V.S.	25
23.	do do (Kootenay).....C. Clark.....	54
19.	Transit of U. S. Live Stock (St. Thomas).....L. Slater, V.S....	41
20.	do do (Windsor) .. .... Jas. Bowler, V.S.....	47
15.	do do (London).... .. T. A. Allen, D.V.S.....	34
30.	Report Pictou Cattle Disease.....	75
	{ Prof. D. McEachran,	
	F.R.C.V.S.....	75
	G. Townsend.....	77

## MISCELLANEOUS.

		PAGE
No. 32.	Report on Pan American Medical Congress, Washington .....	F. Montizambert, M.D., F.R.C.S. . . . . . 81
33.	do Dresden Sanitary Conference .....	Communicated by the High Commissioner... 83
34.	do Small-pox outbreak on Trains.....	Hon. R. Harcourt..... 90
35.	do National Conference, State Board of Health, New York.....	F. Montizambert, M.D., F.R.C.S. .... . . . . . 97
36.	do American Public Health Association, Chicago... ..	F. Montizambert, M.D., F.R.C.S. .... . . . . . 101
37.	do Haras National. ....	A. Turenne..... 103
35.	do Tuberculin Injection.....	T. H. Bryce, M.D..... 105
39.	do Tuberculosis Diagnosis.....	J. J. Mackenzie, B.A... 107
40.	do Investigation of alleged Pleuro- pneumonia.....	Prof. D. McEachran, F.R.C.V.S..... 112
41.	do Calcination of Apatite (Phosphate)...	F. T. Shutt, M.A., F.I.C 114
42.	do Quarantine Regulations.....	Dept. Agriculture..... 116
43.	do Sheep Scab, and Western Cattle Quarantines.....	Prof. D. McEachran, F.R.C.V.S..... 124
44.	do Canadian Hay in Great Britain.....	J. W. Down..... 129
45.	do Microscopic Examinations, Pleuro- pneumonia .....	{ Prof. McEachran .... 130 " Adami .....
46.	do Apiculture (Bees) and Honey.....	R. F. Holternum ..... 137
47.	Precis of Cattle Quarantine Regulations, 1893.....	138
48.	World's Columbian Exposition Awards.....	139
49.	Reports of Inquiries relating to Health of Animals in the North-west.	142
50.	Report of Investigation of cattle disease at Maple Creek.....	154



Department of Agriculture.

# APPENDICES



## QUARANTINE.

No. 1.

### REPORT ON ST. LAWRENCE QUARANTINE SERVICE.

F. MONTIZAMBERT, M.D., EDIN., F.R.C.S., D.C.L.,  
*Medical Superintendent.*

31st October, 1893.

SIR,—I have the honour to submit this my annual report for 1893, made up to this date as directed.

Infectious disease was reported by or found on board of the following vessels arriving in the St. Lawrence, named in the order of their arrival:—SS. "Pickhuben," "Labrador," "Buenos Ayrean," "Sarnia," "Lake Ontario," "Polaria," "Monte Videau," barque "Gratia," ss. "Lafna," "European," barque "Norma," ss. "Slavonia," "State of Georgia," "Lake Huron," "Lake Winnipeg," "Polaria," "Circasian" and "Rosarian."

The diseases so reported or discovered were small-pox, yellow fever, scarlet fever, enteric fever, diphtheria, measles and chicken pox.

In addition to the above recited list of vessels the ss. "Storm King," "Leny" and "Briscoe" were subjected to disinfection at quarantine by sulphur dioxide fumigation.

The vaccination regulations were reported by the ships' surgeons to have been regularly enforced amongst the steerage passengers.

An exception to this occurred through ignorance of the regulations in the case of the first voyage of the ss. "Olbia," the pioneer vessel of the new direct line of passenger vessels from France. Her passengers were vaccinated at quarantine.

Only one instance occurred of a person refusing vaccination. This was a passenger by the ss. "Mongolian," arriving 19th August. He was landed at the quarantine station for the usual period of observation.

The admissions to the quarantine hospitals to date number two hundred and thirty-seven for this season.

The deaths in hospital to date have been twenty-five, nine from measles and its sequelæ, eight from diphtheria, six from scarlet fever and two from cholera infantum.

Of all the vessels handled at quarantine this season but a few seem to call for special mention.

The ss. "Oregon," Gibson, master, from Liverpool, 19th May, with forty-five saloon, seventy-six intermediate, and five hundred and eighty-seven steerage passengers and ninety-two crew, arrived at quarantine on the 31st May. This vessel had an outbreak of diphtheria and measles amongst the steerage passengers, and had had five deaths in the forty-eight hours previous to arrival. These diseases were so generally spread throughout the steerage as to have defied isolation. I therefore landed all the five hundred and eighty-seven steerage passengers. Other cases occurred among these passengers in quarantine from disease contracted before they left the vessel. The hospital records show the admission of sixty-one sick, eighteen cases of diphtheria and forty-three cases of measles from this ship alone. Of these seventeen proved fatal.

The "Oregon" was thoroughly disinfected here, and has since brought out four shiploads of passengers without any recurrence whatever of disease.

SS. "Monte Videan," Calvert, master, from London, 17th June, with ten cattle-men and a crew of forty-one, arrived at quarantine on the 29th June. One of the crew had the small-pox. The vessel arrived late on Thursday evening. The sick man was landed and the crew vaccinated. During the next two days the vessel underwent the usual process of disinfection employed at the station. On Sunday July 2nd the owners sent down a new crew to take the vessel on, immediately the disinfection was concluded. Prior to their arrival the old crew were taken off and landed at the quarantine station to be kept under observation. The necessity for this was demonstrated by six of them developing during the first few days ashore the small-pox they had contracted on shipboard before the vessel arrived. The new crew were from the ss. "Pomeranian," then loading at Montreal. Part of them subsequently left Montreal on the "Pomeranian," part on the "Monte Videan." No case or symptom of small-pox subsequently occurred on either vessel.

The placing of a fresh lot of men to occupy and live in the necessarily confined quarters of a vessel immediately after the disinfection, constitutes the most practical, and at the same time the most severe test conceivable of the value of the disinfection.

The entirely satisfactory result in this case may fairly be claimed as conclusive proof of the thorough efficiency of our methods.

SS. "Rosarian," Dunlop, master, from London, 1st October, with three cattle-men and a crew of forty, arrived at quarantine, October 14th. The chief steward was ill with small-pox. Here also a new crew was sent to take on the vessel as soon as disinfected, the old crew being landed for quarantine observation during the period of incubation of small-pox. All were of course vaccinated on arrival. On the 24th those whose arms had taken and showed the areola and "zone of safety" were discharged. They proceeded to Montreal, brought down the vessel, and calling for the remainder of the crew as they passed the station outwards bound, on the fifteenth day, the 28th October, took all those who had remained well on board again.

This included all of them except the second steward who had attended to the sick man on board, and had been the most exposed. He became unwell on the 12th day after arrival, and was, of course, immediately isolated. The eruption of small-pox developed the following day.

This case is of interest as an example and as an illustration of the necessity of retaining under isolation and observation during the full average period of incubation of small-pox, fourteen days, those who have been exposed to this disease. Landed from the infected vessel, being under perfect hygienic conditions, and isolated from any fresh source of infection he remained perfectly well until the twelfth day. Then and then only he sickened with the disease, contracted from his brother steward before the vessel reached the station nearly a fortnight previously.

The sailing of the vessel outwards was within the last few days only. But from the history of the crews of the "Monte Videan" and the "Pomeranian," there is every reason to believe that our disinfecting apparatus and disinfecting processes have proved thoroughly efficacious on this occasion also.

Why the shipping companies do not obviate delays and losses from small-pox amongst the crews by making revaccination a condition of engagement seems somewhat difficult to understand.

Two sailing vessels reported having had yellow fever during the voyage. Both were from South America. The barque "Gratia," Jacobsen, master, from Santos, had had one fatal case, and the barque "Norma," from Rio de Janeiro, had lost captain, captain's son and steward from yellow fever. Both vessels arrived in July, and were disinfected at the St. Lawrence quarantine.

The remaining vessels on the list of those on which infectious disease was reported or found did not present anything that seems to call for special remark.

*Equipment.*—The three steam chambers for disinfecting have been placed in position since my last annual report, and have been of invaluable service this season. The needle or rain baths have been completed, and give entire satisfaction. A most comfortable detention building for saloon passengers has been erected. It

## Department of Agriculture.

would hold one hundred and twenty-four passengers, with stewards, cooks, &c. It offers as far as possible the same comfort and accommodation as they have on board ship. Two of the existing buildings have been fitted with staterooms, &c., for intermediate passengers, with accommodation for two hundred. Galvanized iron berths have replaced the wooden ones in some of the steerage buildings. An ample supply of water for all but drinking purposes is provided by two large pumps which draw water from the end of the pier and force it to a 50,000-gallon reservoir from which it is supplied to the detention buildings. For drinking purposes potable water is available from the condensing and aerating appliances connected with the steam boilers. And from the fissures struck in the artesian boring of 1,125 feet, Mr. Savage, of Petrolia, who made the boring, has estimated that at least 200 barrels of pure water may be pumped daily.

The additional appliances and equipment which have been completed this season bring Grosse Isle into the foremost rank of quarantine stations of the first class.

This has been fully acknowledged in the reports which have followed the official inspections by the Provincial Board of Health of Quebec, the officers of the United States Marine Hospital Service, and other sanitary officials who have this season visited the station. And the Government of Canada in this matter has been the subject of laudatory articles in sanitary and scientific journals and magazines.

*Sub-stations at Quebec and Lévis.*—The disinfection of the luggage of all immigrants arriving has been scrupulously carried out since the very first arrival in the St. Lawrence last spring, in accordance with the Order in Council dated the 18th April, and the provisions of section 29 of the Quarantine Regulations of 1893. More than 100,000 pieces of luggage have thus been handled, their contents steam sterilized, and the containers also disinfected. Every piece has received the official tag before being allowed to leave the disinfecting building, or to be checked and forwarded. At first the tag was tied on in the ordinary way. Later the manufacturers of a lead seal and wire attachment supplied the Marine Hospital Service, a similar one was authorized by law for our "service," and has since been exclusively used. It is a safeguard against substitution, and against loss of the tag. Moreover the lead seal itself has "CANADA" and "DISINFECTED" stamped upon it by the process of sealing. So that even if the tag be accidentally torn off in transit, the seal and wire may remain to witness to the disinfection.

Intentional removal of evidence of disinfection we cannot of course guard against. In this connection I may perhaps refer to the remarks made in some of the newspapers last June about a party of eight Poles found at Toronto without their luggage bearing any evidence of disinfection. They had been inspected at quarantine, and their luggage had been steam sterilized and tagged at Quebec. There was the interval from Tuesday morning at seven to the Sunday following, between their leaving Quebec and their being so found at Toronto. During this time they are stated to have undertaken work at Cornwall, and from thence to have been taken on by a "boss" to work in the States. This being so they would naturally remove all possible trace of recent arrival so as to evade the Alien Contract Labour Law at the frontier.

We inspect, we disinfect, we tag, we warn immigrants to preserve their evidences of disinfection, and we provide against accidental loss of these by the use of a stamped seal and almost unbreakable wire attachment. But we cannot prevent the intentional removal of the tags once the luggage has been claimed by its owner from the railway train.

Without the tags it is difficult to prove the disinfection. Dr. Banks, the senior medical officer of the United States Marine Hospital Service, stationed at this port, writing from Quebec on this subject, stated: "Such is the perfection of the work done here that none of it shows evidence of the sterilization."

No vessel from outside Canada can make customs entry without the quarantine clearance. To evade quarantine inspection would therefore involve the immediate sending back of the vessel to quarantine. The pilot in charge would be liable to heavy punishment. The collector of customs could not condone the offence without becoming liable to a fine and imprisonment for six months. These facts are not

hidden away in the statutes, but are familiar to all concerned, as the regulations in question are printed on the face of every quarantine clearance for customs entry.

No piece of immigrant luggage can be checked or forwarded until it has passed through the disinfecting process and received the official tag. In securing this we have, in addition to our own precautions and vigilance, the cordial co-operation of the railway companies. This is moreover in their own interest, for they know well that untagged luggage discovered inland would mean delay to their trains and consequent loss to themselves.

As the people of Canada and the Western States become more generally acquainted with the manner in which work is really done at this port, and also with the safeguards the Government has provided to prevent evasion of quarantine inspection and disinfection, there will be an ever increasing confidence in the quarantine service, and less and less unnecessary uneasiness and fear for themselves.

*Officers United States Marine Hospital Service.*—By your consent the United States Government stationed medical officers of their Marine Hospital Service at this port to watch the St. Lawrence quarantine methods and report upon them. Dr. C. E. Banks, the senior officer so detailed, has carefully watched our system all the season. I have asked him repeatedly for criticisms and suggestions of improvement in our appliances or the methods in which they are worked. But he has expressed himself as perfectly satisfied, and this alike verbally, by reports to his Surgeon General, published in the official "Weekly Abstract of Sanitary Reports," and by the practical proof of the causing the official tag of the United States Government to be added on all pieces of baggage disinfected and tagged by us and destined for the United States.

In a circular letter to the Sanitary Inspectors, United States Marine Hospital Service, on duty on the Canadian border of the United States, dated Treasury Department, Washington, 21st July, it is ordered that: "The certificate of the Medical Superintendent of the St. Lawrence quarantine service, or of the medical officer of the Marine Hospital Service, who has been permitted to witness the disinfection at Quebec, will be accepted by all inspectors on the Canadian border."

In the "Weekly Abstract," 25th August, a report from Dr. Banks is published, in which he wrote from Quebec: "The work now being done by the Dominion Government in a most thorough and scientific manner, has left no room for criticism."

*Sanitary Conferences.*—I have had the honour to attend by appointment as the representative of the Government of the Dominion at four sanitary conferences this year—the first a Conference with the Health Authorities of the various provinces of Canada held at Ottawa in your Department on 31st January and following days; the second an International Cholera Conference in New York, April 5th to 8th; the third the Pan-American Medical Congress at Washington, September 5th to 9th; and the fourth the "World's Congress Auxiliary of the World's Columbian Exposition of the International Congress of Public Health, in conjunction with the annual meeting of the American Public Health Association," at Chicago, October 9th to 14th.

*Sanitary Conference with Provinces, 31st January to 2nd February.*—The resolutions formulated by this conference, with their recommendations of special appliances; of an experienced general superintendent to be in charge of all the Canadian quarantines; of the disinfection of immigrant luggage, etc., have been published in the appendix to your last annual report. I may, however, be permitted to remark that doubtless the understanding then perfected had its share in the production of the satisfactory conditions of this season, which has been entirely free from any recurrence of the local panic or of the supplementary restrictions of last autumn.

*International Cholera Conference, New York, 5th April to 8th April.*—This conference appointed a committee to prepare an international health ticket for immigrants. This ticket designed to show by various punchings the sanitary conditions of immigrants from the time they touch the port of departure until they are settled in their western homes. It also recommended the schedules of immigrants according to destination by provinces and states since adopted in this service by your authority. It further resolved "That during the presence of cholera in Europe the disinfection of the baggage of all immigrants destined for this country should be re-

## Department of Agriculture.

quired, unless disinfected at port of departure, and that certificates therefor showing manner of disinfection shall be placed on the baggage." An amendment was offered that only baggage from infected or suspected ports be disinfected. This amendment was negatived by seventeen to seven, one vote only being allowed to each country, state or province. A committee reported on a uniform system of frontier inspection service, and upon what requirements should be made of transportation companies to prevent the spread of disease. A committee consisting of Dr. Patton, of Louisiana, chairman, Drs. McCormack and Plunket of Tennessee, Luchapelle of Montreal, Probst, of Ohio, and Hon. Mr. Wells, of Michigan, was appointed to report on the New York quarantine. Their report, which was adopted by the conference, was as follows:—

"*Resolved*,—That it be expressed as the sense of this conference, representing the health authorities of the United States, Canada and Mexico, that the importance of having maintained at the port of New York a thoroughly efficient system of quarantine against imported pestilence is so great as to warrant the conference in offering certain urgent recommendations: therefore inasmuch as the state of New York has assumed the responsibility of carrying on the important work upon the equipment and efficacy of which other states must of necessity largely depend, the representatives of those states and communities feel themselves justified in urging that the present plant and appliances for the performance of quarantine at Hoffman Island be so enlarged and improved as to conform with the highest standard of modern improvement.

"The conference recognized the fact that the present quarantine administration has laboured under the disadvantage of having to operate a system, burdened with grave inherited defects, and full credit is accorded for such good work as has been done by the present active quarantine officer. The conference is informed that several important improvements are contemplated, and that as soon as possible these will be instituted. It is intended to increase the area of Hoffman Island, the observation and disinfecting station containing the principal quarantine plant, from two acres to about ten.

"The facilities for the disinfection of baggage and bedding are deemed entirely inadequate. The conference is informed that an extension of the same to about nine times its present capacity is contemplated, but in view of the constant menace from cholera, the conference urgently recommends that these facilities be increased immediately.

"If practicable it is also recommended that a wharf in deep water be built for the better accommodation of vessels under treatment at Hoffman Island.

"The supply of drinking water in cisterns is such as to render the contamination at the station possible, and the necessity for a better arrangement is imperative.

"It appears that no disinfection of immigrants' baggage, other than on vessels has been practised at the port of New York since last October, and this conference formally protests against the continuance of this neglect. The conference also deems it its duty to report that the certificates at present issued by the United States officials as represented by Dr. Wheeler, of that service, have no value whatever in guaranteeing any previous inspection or disinfection of immigrants' baggage, as this station is not designed for quarantine work.

"The hospital at Swinburne Island is well equipped, and the crematory attached to same is one of approved construction."

The Pan-American Medical Congress at Washington, September 5th–9th.—This was very largely attended. Over one thousand delegates were present. They came from all parts of the Americas, some eighteen different countries being represented. I had been appointed an Honorary President of the Section on Marine Hygiene and Quarantine, and also of that on Hygiene, Climatology and Demography. These two sections were consolidated into one. From this joint section several important resolutions were reported and submitted to the whole congress. One was as follows:—

"*Resolved*,—That in the opinion of the Pan-American Medical Congress the interests of the public health in every country should be and must be submitted to a department of the Government, especially charged with their administration, and

that while the precise form of administration may be left to legislation, the indispensable requisites are: that it shall be national; that it shall have parity of voice, and influence in the national councils; that it shall have independent executive authority under the limitations common to the other departments; and that it shall be entrusted to educated and experienced medical men, who alone are competent to assume the responsibilities." This resolution was referred to the International Executive Committee, and adopted by that committee and by the congress.

A resolution for the temporary suspension of immigration from Europe was referred to the International Executive Committee. That committee reported it back with an expression of opinion that it was not expedient that it should be adopted by the congress, and in that opinion the congress concurred.

A resolution was presented on the last day and referred to the International Executive Committee in the following terms:—"Resolved, that it is also the opinion of this section that the habitual and thorough disinfection of all personal effects liable to carry contagion of immigrants to the American hemisphere, and of dunnage of crews of vessels carrying these immigrants from any quarter of the globe, and the exaction of scrupulous cleanliness of all vessels arriving at American ports, should be enforced at all times as the most efficient means of greatly lessening the introduction of the seeds of the various contagious diseases, which are now and have been in the past, almost constantly conveyed by the immigrant classes, and distributed widely among the populations of this hemisphere."

At a meeting of the Canadian delegates called by the General Secretary of the Pan-American Congress, I had the honour to be unanimously elected, by the nine votes then present, as the member of the International Executive Committee to represent Canada. This International Executive Committee holds permanent tenure of office, and is to continue work between the meetings by correspondence; and in addition to an International Committee on the Pharmacopœia, and one on Medical Education and Pedagogics, is to appoint an International Quarantine Committee for the general, united and international study of this very important subject.

I may perhaps be permitted to add that while at Washington for this congress, the diploma of member, *honoris causa*, of the National Academy of Medicine of Mexico, was formally conferred upon me by the officers of that academy then present as delegates, who had brought it from Mexico for that purpose after my election by the senatus of the academy.

International Congress of Public Health in conjunction with the annual meeting of the American Public Health Association, Chicago, October 9th—14th.

The committee on "Sanitary and Medical Service on Immigrant ships," of which committee I was a member, submitted their report. Of this report I trust to receive and to have the honour to forward to you, a copy very shortly.

Many interesting papers were read and discussed at this congress. Amongst those specially dealing with Quarantine and Public Health may be mentioned: "Importance of Civic Public Hygiene to the State," Sir Charles A. Cameron, Chief Medical Officer of Health for Dublin; "Sanitary Organizations, National, State and Municipal from the standpoint of an Executive Officer," Dr. Hewitt of Minnesota; "The Objects of the National Health Society of London," Ernest Hart, Editor British Medical Journal; "Progress of Sanitary Knowledge amongst the Women of England," Lady Priestley; "Sanitation in Japan," Dr. Kagami, Japanese Imperial Commissioner; "Sanitation in Great Britain," Dr. Renwick, Commissioner from New South Wales; "Cholera," Dr. Mason, Health Officer, Hull, England; "Yellow Fever in its Geographical, Medical and Prophylactic Aspects," Dr. Liceaga, President Academy of Medicine, and of the Supreme Board of Health, Mexico; "Difficulties in the practice of Quarantine in some of the Mexican Ports," Dr. Orvananos, Mexico; "The Hygiene of Sleeping Cars," Dr. Zarraga, Mexico; "An experiment in Disinfection," Dr. Jerome Cochran, Alabama; "Scientific and experimental data for the establishment of International Maritime Police," Dr. Liceaga; "The Canadian Quarantine System," Dr. Montizambert; "Quarantine System of Texas," Dr. Swearingen, State Health Officer of Texas; "Quarantine," Dr. Oliphant, President State Board of Health of Louisiana.



## Department of Agriculture.

Of this "World's Congress Auxiliary of the World's Columbian Exposition on an International Public Health Congress," I had the honour of being appointed the honorary president for Canada.

During an *ad interim* meeting of the American Public Health Association as such, the following resolution was adopted: "That the American Public Health Association again urge upon congress the necessity of the appointment of some officer with general sanitary authority in connection with the National Government. That the functions of such an authority are of sufficient importance to demand the exclusive attention of the best instructed sanitarian."

*Rimouski Substation.*—This advance inspection substation for the mail steamers I visited from time to time, coming up on those occasions on the mail steamers and thoroughly inspecting them en route. This substation continued in charge of Dr. P. A. Gauvreau, who has ably filled the office for several years past.

*Quarantine Staff.*—The increased work at the station and its new substations this season led to an increase in the staff. Dr. Joseph V. Côté was appointed by you as second medical assistant at the station; Mr. D. M. Stuart as supervisor of disinfection at the Quebec substation, and Mr. A. F. Belleau as supervisor at the one at Lévis. I have much pleasure in taking this occasion of expressing my sense of the faithfulness with which these officers—as well as the very efficient senior Medical Assistant, Dr. F. W. Church—have fulfilled their various duties. The numbers of the subordinate staff had also, of course, to be increased to meet the large addition to the work.

*Sanitary Outlook.*—This continues to be unfavourable. Asiatic cholera has seeded itself down in very many centres of infection this autumn. From four to six years is the shortest time cholera has ever taken to disappear after effecting an entrance into Europe. The following list of countries now actually infected is indeed a formidable one: Russia, Turkey, Roumania, Austria-Hungary, Italy, Netherlands, Spain, France, Germany, Belgium, Holland and England. In England, Hull, Grimsby, London, Liverpool, Leeds, Manchester, Hurst, Ashton, Mansfield, Derby, Ilkerston, Mitcham, Appleton, Cleethorpe, Rotherham, Low Moor, North Brierly, Ormskirk, Rawmarth, South Mills, Newcastle, Balby, Keighey, Ingrow and Warrington have all had cases of the disease. Judging from past experience it seems probable that during next spring and summer there may be a general recrudescence of Asiatic cholera in some at least of the above countries and places. And that the infection of this country may continue to be gravely threatened not only by immigration from and through Russia, Germany, Belgium, France, etc., but from our nearer relations with Great Britain.

The widespread prevalence of small-pox in so many parts of England, and to so considerable an extent, is also fraught with menace to this country. And this disease, unlike cholera, tends to an increased seasonal prevalence at the time of year we are now approaching. The present indications with regard to this disease also, are thus, not at all reassuring.

*Conclusions.*—I have already referred to the favourable reports upon the St. Lawrence quarantine system made this season by the Board of Health for the Province of Quebec, by the United States Marine Hospital service, and in sanitary and secular journals and magazines as a result of the somewhat numerous visits of inspection that have been made to the station since last spring. I am happy to be able to add that during the discussions on quarantine at the various international congresses at which I have this year had the honour to represent Canada, speaker after speaker most warmly commended the precautions taken by the Government of this Dominion, the St. Lawrence quarantine service, and the work done at its stations and substations. Even as I write this I am in receipt of the following communication from the State Board of Health of Michigan, dated three days ago, the 28th instant: "At the special meeting of the Michigan State Board of Health, held at Lansing, October 27th and 28th, 1893, the following resolution was adopted:"

"Resolved,—That the action of the Dominion of Canada in disinfecting the baggage of all immigrants from Europe coming into its territory and the establishment of its admirable appliances for the purpose as described by Dr. Montizambert at the

recent meeting of the American Public Health Association at Chicago, meets our most hearty approval. We commend most earnestly this action of Canada to the United States Government and hope that similar disinfecting plants be established by it at United States Atlantic ports and that the baggage of all immigrants to this country be disinfected. We ask that this be done not alone that we may be saved from threatened invasions of small-pox and cholera, but also that a vastly greater saving of lives may be effected from measles, diphtheria, scarlet fever, pneumonia, consumption and other diseases which are of much more serious concern to the people of this country than cholera or small-pox."

It is impossible to say to what extent the infection of cholera might have been disseminated through the country had not the immigrant luggage been sterilized before being allowed to enter Canada.

The organization and superintendence of these substations, and the instruction, training and supervision of their new disinfecting staffs proved an arduous addition to my other duties, especially during the earlier months.

What was aimed at was the obtaining efficient disinfection scrupulously carried out, but avoidance of such extreme measures, as do harm to individuals and to commerce, and, because superfluous, bring science into disrepute.

And the satisfaction of being able to report to you that this new development of protection for the country, previously untried anywhere, was brought into working order so promptly in the spring, and was carried out so successfully, and with so little friction, during the whole season, is some return for much careful and anxious forethought, and much continuous and unwearied work.

I have the honour to be, sir,

Your obedient servant,

F. MONTIZAMBERT, M.D. Edin., F.R.C.S., D.C.L.,  
*Medical Superintendent, St. Lawrence Quarantine Station.*

The Honourable  
The Minister of Agriculture,  
Ottawa.

# Department of Agriculture.

No. 2.

## REPORT OF THE HALIFAX (N.S.) QUARANTINE STATION.

(W. N. WICKWIRE, M.D.)

HALIFAX, N.S., 1st November, 1893.

SIR,—I have the honour to submit my report for the year 1893, or rather that part of the year ending 31st October.

I am pleased to be able to state that we have had less disease of any kind brought into this port during the nine months mentioned than in any previous corresponding period for many years, not one contagious or infectious case of disease, requiring quarantine isolation or removal to the quarantine station, has presented itself.

Unusual care in the matter of inspection has been exercised, and although different lines of steamers have brought a large number of immigrants to the port since 1st January last, not one person upon arrival was suffering from any disease or symptom of disease, except of a trifling and non-contagious character. The number of vessels inspected up to 31st October was 117 steamships and 105 sailing vessels, a total of 222.

A considerable sum has been expended at our quarantine station during the year, in placing a large disinfecting chamber and apparatus there, and also in building a suitable deep water wharf as well as additional buildings. When the works, now well advanced, are completed, and the station fully fitted up as contemplated, we will have an excellent quarantine station, and we will be prepared to meet any probable emergency.

I have the honour to be, sir,  
Your obedient servant,

W. N. WICKWIRE, M.D.,  
*Inspecting Physician.*

The Honourable  
The Minister of Agriculture,  
Ottawa.

## No. 3.

## REPORT OF THE ST. JOHN (N. B.) QUARANTINE STATION.

(W. S. HARDING, M.R.C.S., Eng.)

QUARANTINE STATION,

ST. JOHN, N. B., 31st October, 1893.

SIR,—I have the honour to submit my annual report for ten months of the year 1893, ending 31st October.

Notwithstanding the fact that there has been a well founded ground for apprehension regarding cholera, I have to state, that up to the present time, the disease has not presented itself at this port, nor has there been any reason for suspecting any vessel of being infected therewith.

In regard to other sickness, I have to state that vessels arriving during the year have been found exceptionally free from disease of an infectious nature.

Rightly to estimate our good fortune in escaping from cholera, we should glance at the fact of the very extensive diffusion of the disease in countries from which vessels have been continuously coming to this port during the past summer.

An idea of the extent of this diffusion can be formed by looking at the following statement of the "Local Government Board" in England, dated 25th September, 1893, which declared the following ports and countries to be infected with cholera at that date:

"Rotterdam, Antwerp, Amsterdam, Hamburg, Constantinople, all ports in the Black Sea, and the sea of Asof, all Russian ports in the Baltic Sea, and Gulf of Finland, all Italian and southern French ports, and all ports in the north of Spain." I include England in the list, where cholera has occurred in several places. It must be admitted that St. John is very fortunate in having escaped, considering the circumstances of the arrival here of many vessels from the infected countries, and ports, enumerated in the above list, including Rotterdam, Amsterdam, Hamburg, Antwerp, &c.

Our good fortune during the past, however, does not warrant relaxation of vigilance. Vessels coming here from the other side of the Atlantic require to be carefully examined, past exemption notwithstanding.

I shall now refer to the station at Partridge Island:

At the time of your visit to the island—the last of May—in company with the Finance Minister, and other ministers of the Crown, the work in hand for the equipment of the station was not quite completed, although nearly so, in the details which had been arranged; but almost immediately after that date such work was finished, and we have I may say been ready to deal with any sickness or infection should it have been brought here.

In regard to those further details, which with so much care and consideration you planned to meet deficiencies, and for the improvement of the station, I have to say that circumstances have prevented the work up to this time being put in hand. The circumstances I allude to are that after a detailed statement of your plans had been furnished the Department of Public Works at Ottawa, which were sent down here, and a plan and specification sent back, the time has slipped away, so that winter is close at hand. In consequence of this fact, arising from causes stated, I think the work in carrying out your plans will need to be deferred until spring. I hope, however, that action will then be taken in accordance with your suggestions so that the requirements may be supplied, and improvements made, as I have a high opinion of the advantages to arise therefrom.

## Department of Agriculture.

In regard to the much mooted question of water supply, I beg to state that acting on your suggestions about this matter, existing wells were cleared out and enlarged, with the following result:—

Of two wells on south side of island—one old, the other new—examined October 13th:

No. 1.—Old well, has been deepened to 12 feet, is 10 feet square laterally, contains  $8\frac{1}{2}$  feet of water.

No. 2.—Near No. 1, is 10 feet deep, 10 feet square laterally, contains  $6\frac{1}{2}$  feet water.

No. 3.—Is on north side of island, 13 feet deep, round, 9 feet diameter; has 12 feet depth of water.

No. 4.—East of above, near renovated hospital, round, 4 feet diameter, 8 feet deep, 6 feet of water.

No. 5.—Near old gas house, round, 3 feet diameter, 12 feet deep, 9 feet water.

I have to remark, respecting No. 3 and No. 5, they are as two *additional* wells, of important size, as you will observe, and so contribute largely to the supply of water. They had become completely filled up with rubbish, which being removed, and the wells deepened, the result is what I mention.

Yet further, on south side of island, on shore level, below "doctor's house," the spring has been deepened and is now a well, which fills and overflows, and furnishes quite an addition to the general stock of water.

To sum up the question of water supply for requirements of the island: Looking at the additions to supply made by deepening and cleaning out existing wells, and one yet to be made in place suggested by you, or even without this last, I can with confidence assert that the supply will be abundant and ample for all possible requirements of the future.

As to quality, its purity is unquestionable, which analysis made by Government analyst at Ottawa, of samples sent up for the purpose from each well, *proves*.

Looking at *facts*, therefore, I hope no more of those absurd *conjectures* we have had so much of will be thrust forward respecting the water requirements of the station; and what there has been of the kind I trust will be regarded as sufficient reason for my occupying so much space of my report in presenting the facts bearing on the mooted question.

In the list sent up of working stock required, the need of bedsteads was stated, and mention made of a probable means of getting a full supply—by seeking a transfer of a store of them at the Marine Hospital in this city, which are not in use, and as I suppose not required by the Marine Department, since all the patients have been transferred to the General Public Hospital.

The total arrivals of vessels from foreign ports was 2,378, of which all from across the sea were closely inspected.

I have the honour to be, sir,  
Your obedient servant,

W. S. HARDING, M.R.C.S., Eng.,  
*Medical Superintendent.*

The Honourable  
The Minister of Agriculture,  
Ottawa.

## No. 4.

REPORT OF THE CHARLOTTETOWN (P.E.I.) QUARANTINE  
STATION.

(P. CONROY, M.D.)

QUARANTINE STATION,  
CHARLOTTETOWN, P.E.I., 31st October, 1893.

SIR,—I have the honour to submit for your information my annual report on matters relating to quarantine at this station during the term ending 31st October of the current year.

No case of epidemic disease was found on board any vessel arriving at this port during the past season.

The total number of arrivals from foreign ports is as follows :—

From Great Britain.....	7
“ United States.....	11
“ West Indies.....	6
“ Newfoundland.....	12

All these vessels were carefully inspected.

I have the honour to be, sir,  
Your obedient servant,

PETER CONROY, M.D.  
*Inspecting Physician.*

The Honourable  
The Minister of Agriculture,  
Ottawa.

# Department of Agriculture.

No. 5.

## REPORT OF THE SYDNEY (C.B.) QUARANTINE STATION.

(W. McK. McLEOD, M.D.)

SYDNEY, C.B., 31st October, 1893.

SIR,—I have the honour to report as follows on matters in connection with the Sydney, C.B., quarantine station, from 1st January, 1893, to the present date, and to state the gratifying fact that, so far, no disease of a quarantinable nature has appeared.

Inspection of vessels from ports outside of Canada has been carefully carried out. Hitherto one of the greatest obstacles was the lack of means for notifying the inspecting physician of the arrival of vessels requiring inspection. It appeared that this difficulty could be removed by causing telegraphic notice of such approaching vessels, to be sent from the signal station at Low Point lighthouse, at the entrance of this harbour, to the inspecting officer. Instructions to this end were issued by the Department of Marine to their signal officer, and a short experience has demonstrated its usefulness. Some defects have also become apparent, but they are of a remediable kind. The boat service at this station is not abreast of the requirements, inasmuch as the department has to depend on being able to procure such of the harbour boats as happen to be unemployed at the moment. It happens that no boat is to be had in many instances, causing delay in the inspection. The number of arrivals at this port have been 155, which is exclusive of coastwise vessels, numbering in all probability nearly 1,000, but which do not so particularly require attention.

The number of vessels inspected by me during the season were as follow: From across the sea, 25. From United States, 8. Total, 33. All were steamships, no sailing vessels being reported to me.

The station buildings and wharf are in good condition, having received repairs and additions this season. The grounds will claim some further notice and attention, while some other matters of a minor nature remain also to be attended to.

I have the honour to be, sir,

Your obedient servant,

WM. MCKENZIE McLEOD, M.D.,  
*Medical Superintendent.*

The Honourable  
The Minister of Agriculture,  
Ottawa.

## No. 6.

## REPORT OF THE PICTOU (N.S.) QUARANTINE STATION.

(JOHN McMILLAN, M.D.)

QUARANTINE STATION, PICTOU, 31st October, 1893.

SIR,—I beg leave to report that I have inspected twenty-five vessels at this station this season. There was one case of small-pox landed from ss. "Miac" from Middleboro, N.S. This vessel arrived on Saturday, July 22nd, at 4 p.m., flying the yellow flag, and anchored on the quarantine ground. Being a large vessel her captain did not wish to risk anchorage outside the lighthouse, so I permitted him just inside the lighthouse, as being much safer. I found one of the crew suffering from varioloid, which disease the captain diagnosed correctly on the 17th. The patient was on that day removed to a place prepared for him in the hold of the vessel, as far away as possible from the rest of the crew, one only of the latter, who had been vaccinated, taking care of him. These two I removed to the quarantine hospital without any intercourse with any one on board. Although the forecabin had been thoroughly cleansed and fumigated, I had it washed with carbolic acid and chloride of mercury, and the clothes and bedding were taken to the quarantine grounds and burned.

The vessel and crew, after a thorough fumigation, were fully discharged from observation, and the patient recovered from the disease. The disease did not spread, and there was only one case; with this exception, there has not been any sickness at this station this season. The quarantine buildings are in good condition; the building for convalescents has been renovated on the inside and painted outside. There is a plentiful supply of good water in the well which was dry last summer.

As stated in my last year's report, a small wharf is required for landing at the quarantine grounds; it is impossible to land from a boat except at high tide.

During the season I inspected 25 vessels, 14 of which were from across the sea, 8 from United States ports, and the balance from St. Iago. The most rigid and careful inspections were in all cases carried out by me.

I have the honour to be, sir,  
Your obedient servant,

JOHN McMILLAN, M.D.,  
*Inspecting Physician.*

The Honourable  
The Minister of Agriculture,  
Ottawa.



Department of Agriculture.

No. 7.

REPORT OF THE PORT HAWKESBURY (N.S.) QUARANTINE STATION.

(P. A. MACDONALD, M.D.)

PORT HAWKESBURY, 1st November, 1893.

SIR,—I have the honour to forward you my report for the ten months just ended. My monthly reports transmitted regularly to your department, show the number of vessels boarded and inspected in the Strait of Canso, during the part of the season which has elapsed, and which were as follow: Steamships, 28; sailing vessels, 21. The whole number reporting entry was 114 foreign and 160 coasters, besides many others passing through without reporting.

Several vessels arrived here from South America and the West Indies where yellow fever and small-pox prevailed, but after close inspections it was not deemed necessary to quarantine any of them. The schooner "Minnie Bride" arrived from Barbados, W. I., with the captain ill of spinal paralysis from rheumatism. He was placed in the marine hospital where after an illness of several weeks he died.

I am happy to be able to report that no case of a contagious or infectious character was found on any of the vessels entering at the different ports on the Strait of Canso.

All instructions and regulations from your department were faithfully attended to.

I have the honour to be, sir,  
Your obedient servant,

P. A. MACDONALD,  
*Quarantine Officer.*

The Honourable  
The Minister of Agriculture,  
Ottawa.

## No. 8.

## REPORT OF CHATHAM (N.B.) QUARANTINE STATION.

(J. MACDONALD, M.D.)

CHATHAM, N.B., 31st October, 1893.

SIR,—I beg to submit my annual report for 1893.

One hundred and seven vessels were inspected by me during the past season.

Three vessels, two from Marseilles and one from Nantes (France) were ordered on account of the prevalence of Asiatic cholera at the above mentioned ports to place the ballast (sand) under water. They were afterwards thoroughly fumigated and admitted to pratique.

No contagious or infectious disease was found on any of the vessels inspected at this port.

I respectfully recommend the painting of the hospital buildings on Middle Island.

I have the honour to be, sir,  
Your obedient servant.

J. MACDONALD,  
*Quarantine Officer.*

The Honourable  
The Minister of Agriculture,  
Ottawa.

Department of Agriculture.

No. 9.

REPORT OF THE MATANE (UNORGANIZED) STATION.

(J. B. PELLETIER, M.D.)

MATANE, P.Q., 31st October, 1893.

SIR,—I have the honour to submit my annual report for the year 1893.

Fourteen vessels from foreign ports were boarded and inspected this season, ended 31st October, 1893.

Twelve were boarded and inspected at Matane, two others were boarded and inspected, one at Baie des Capucins, a distance of 45 miles; the other one at Ste. Anne des Monts (Ruisseau à Patates), a distance of over 60 miles.

I am grateful to be able to state that there were no cases of infectious or contagious diseases received at this port during the season just ended.

All vessels from outside ports were boarded and inspected immediately on their arrival and were admitted to pratique, except two, which left after two hours.

The acquisition of a small boat placed under the control of the custom officer at Matane is suggested, and would greatly contribute to the efficiency of the service.

Your instructions and regulations were carefully observed.

I have the honour to be, sir,

Your obedient servant,

J. B. PELLETIER,

*Inspecting Physician.*

The Honourable  
The Minister of Agriculture,  
Ottawa.

## No. 10.

## REPORT OF NORTH SYDNEY (C.B.) (UNORGANIZED) STATION.

(H. B. McPHERSON, M.D.)

NORTH SYDNEY, 1st November, 1893.

SIR,—In accordance with your request, I beg leave to report that I inspected 112 vessels, steamships and sailing vessels, for quarantine purposes, from May 1st, 1893, to November 1st, following. Those vessels were all from foreign ports; some of them from ports infected with cholera, and others from ports infected with yellow fever. Quite a number of the vessels were from Alexandria, Hamburg, Antwerp, Amsterdam, Stetin and other European ports. Some of these ports were infected at the time of sailing of the vessels, but on account of the length of time they were necessarily at sea, and no disease having shown itself on board during the voyage, they were admitted to pratique at once. Only one vessel, the ss. "Amur," from New York, was ordered to quarantine. Cholera was in the port of New York at the time of her sailing (August 12th). The vessel's clearance was Sydney, N.S.W., and when she arrived here, two men who were on the articles were not to be found among the crew. It looked at least suspicious. The matter was reported to you, and the vessel was ordered to quarantine. Subsequently the master and the mate of the steamship made affidavit that the two men did not join the vessel in New York, and she was admitted to pratique. It is a fortunate circumstance that disease did not break out in any of the vessels during the voyage, for had such a thing happened they would certainly have carried it into this port. Hence the necessity of careful inspection of every vessel from foreign ports, particularly ports known to be infected. My inspection covered 88 vessels from across the sea, and the remaining 24 were from the West Indies, South America and the United States.

I have the honour to remain,

Your obedient servant,

H. B. McPHERSON, M.D.,

*Inspecting Physician.*

The Honourable  
The Minister of Agriculture,  
Ottawa.

Department of Agriculture.

No. 11.

REPORT OF INSPECTING PHYSICIAN AT RIMOUSKI SUBSTATION.

(P. A. GAUVREAU, M.D.)

RIMOUSKI, P.Q., 30th October, 1893.

SIR,—According to your request, I have the honour to transmit the return of my general proceedings during the season 1893.

I have the honour to be, sir,  
Your obedient servant,

P. A. GAUVREAU, M.D.  
*Inspecting Physician.*

The Honourable  
The Minister of Agriculture,  
Ottawa.

RETURN of Vessels inspected at the Quarantine Station, Rimouski, from the 13th May to the 31st October, 1893.

Number.	Class and Name of Vessel.	Master.	Port whence Sailed.	Date Sailed.	Date Arrived.	Cargo.	Passengers.			Crew.	Born.	Died.	Sick.	Discharged from Quarantine.	Remarks.
							Cabin.	Inter-mediate.	Steerage.						
1 SS.	Parisian	Capt. Ritchie	Liverpool.	May 4	May 13	General.	171	154	810	135				Yes	8 cabin passengers landed at Rimouski.
2 SS	Vancouver	Capt. Williams	do	do 11	do 20	do	100	95	617	129				Yes	do do
3 SS.	Numidian	Capt. McNicol	do	do 18	do 28	do	55	94	858	103			5	No.	do do
4 SS.	Sardinian	Capt. Richardson	do	do 25	June 3	do	56	80	735	109				Yes	do do
5 SS.	Labrador	Capt. McAuley	do	do 1	do 10	do	88	84	673	104		1		No.	do do
6 SS.	Parisian	Capt. Ritchie	do	do 8	do 16	do	117	157	815	148				Yes	do do
7 SS.	Vancouver	Capt. Williams	do	do 15	do 24	do	125	86	635	129				Yes	do do
8 SS.	Numidian	Capt. McNicol	do	do 29	do 1	do	56	70	739	15		1		Yes	do do
9 SS.	Sardinian	Capt. Richardson	do	do 6	do 8	do	68	95	639	15		1		Yes	do do
10 SS.	Labrador	Capt. McAuley	do	do 13	do 14	do	64	76	338	1				Yes	do do
11 SS.	Parisian	Capt. Ritchie	do	do 20	do 21	do	107	165	507	138				Yes	do do
12 SS.	Vancouver	Capt. Williams	do	do 27	do 28	do	116	75	261	112				Yes	do do
13 SS.	Numidian	Capt. McNicol	do	do 3	do 5	do	69	72	266	6				Yes	do do
14 SS.	Sardinian	Capt. Richardson	do	do 10	do 11	do	100	76	266	6				Yes	do do
15 SS.	Labrador	Capt. McAuley	do	do 17	do 18	do	112	273	186	2		1		Yes	do do
16 SS.	Parisian	Capt. Ritchie	do	do 24	do 25	do	201	167	245	153				Yes	do do
17 SS.	Vancouver	Capt. Williams	do	do 31	do 2	do	220	243	295	128				Yes	do do
18 SS.	Numidian	Capt. McNicol	do	do 7	do 9	do	66	89	290	5				Yes	do do
19 SS.	Sardinian	Capt. Richardson	do	do 14	do 16	do	133	84	170	10				Yes	do do
20 SS.	Labrador	Capt. McAuley	do	do 21	do 22	do	106	115	240	4				Yes	do do
21 SS.	Parisian	Capt. Ritchie	do	do 28	do 30	do	113	146	254	138				Yes	do do
22 SS.	Vancouver	Capt. Williams	do	do 5	do 8	do	97	80	169	105				Yes	do do
23 SS.	Numidian	Capt. McNicol	do	do 12	do 14	do	79	69	128	9				Yes	do do
24 SS.	Sardinian	Capt. Richardson	do	do 19	do 21	do	57	42	107	1				Yes	do do
25 SS.	Labrador	Capt. McAuley	do	do 28	do 28	do	60	73	268	2				Yes	do do

P. A. GAUVREAU, M.D.,  
Quarantine Officer.

RIMOUSKI, 31st October, 1893.

# Department of Agriculture.

No. 12.

## REPORT ON THE LEPER HOSPITAL, TRACADIE, N.B.

(A. C. SMITH, M.D.)

TRACADIE, N.B., 31st October, 1893.

SIR,—I beg leave to submit for your consideration the general annual statement of the work and condition of the hospital for lepers at Tracadie, N.B., for the year 1893.

There are on the register to-day twenty patients—eleven males and nine females. Eleven of these are in the first or early stage of the malady; six in the second, and three in the third or final stage. There were six deaths during the year, and four new cases were admitted. Of those admitted two came from Lower Caraquet, one from Shippegan parish, and one from the parish of St. Isidore—all in the county of Gloucester, N.B. I have again to report, as I have reported for several years past, there are none this year from Tracadie. I believe we have seen the last of the disease here. Those entering the hospital during recent years came from the above-mentioned outlying parishes, and from the poorer class of the inhabitants. I find that here, as in other countries, poor sanitary surroundings, defective and bad dietetic conditions, and uncleanness are important factors in the spread of leprosy.

Our lepers are subject to the common ailments of mankind, and I regret to say that there was an unusual amount of sickness in the wards during the year. In addition to some typhoid and rheumatic fever, we had a severe epidemic of erysipelas—thirteen of the inmates having been ill with it, some of them several times in succession. Three of the patients, already worn out with the ravages of leprosy, succumbed. There can be no doubt that the outbreak of erysipelas was due to the wretched sanitary condition of the lazaretto. The need of a new building, on a more elevated and healthy site, is becoming more and more urgent.

The behaviour of the inmates was generally good. It is noticeable that the female patients on entering the institution, although seeming to suffer more keenly at first, become resigned to their sad lot much sooner than do the males. Friends and relatives are allowed to visit the poor unfortunates, but, as a general thing, a leper's relatives look upon him, when immured in the lazaretto, as gone from them for ever, and seldom visit him. In the early stages of the disease there is seldom much suffering beyond pains resembling rheumatism, but near the close of life there is much distress, particularly from ulcerated mouth, tongue and throat.

As stated in a former report, our lepers are not in any sense prisoners. During the past summer the men and boys spent a portion of each day, during fine weather, in boating and fishing on the harbour. The Government having kindly and liberally provided for their maintenance, and the religious ladies in charge devoting their time to their bodily comfort and spiritual welfare, our lepers seem to pass the time happily rather than otherwise.

I have made many excursions through infected districts during the year, and now have two or three cases remaining under supervision, which I do not consider it advisable to bring to the lazaretto *at present*. For reasons given above, overcrowding might end in disaster.

Two of the male patients left the institution during the summer, and went to their former homes. They are now back to the lazaretto, and no further escapes are likely to occur.

The institution is fulfilling the object of its organization—the segregation of leprous persons, who otherwise would insidiously and surely become centres of contagion, or spread the disease through hereditary transmission.

I have the honour to be, sir,  
Your most obedient servant,

A. C. SMITH, M.D.,

*Inspecting Physician and Medical Adviser to the Tracadie Lazaretto, etc.*

The Honourable  
The Minister of Agriculture,  
Ottawa.



Department of Agriculture.

CATTLE QUARANTINE.

No. 13.

REPORT OF VICTORIA (B.C.) CATTLE QUARANTINE STATION.

(M. G. BLANCHARD, V.S.)

VICTORIA, B. C., 1st November, 1893.

SIR,—In accordance with instructions, I have the honour to submit a report of my work as veterinary inspector at this port, for the ten months ending 31st October, 1893.

The class of animals entered here and inspected by me has been above the average and in all cases remarkably healthy, there having been in all 173 horses, 8 mules, 7 cattle, 2 hogs and 29,274 sheep. Of these sheep there were 4 thoroughbred rams, 1 Cotswold, 1 Oxford and 2 Shropshire Downs, the remainder being for mutton. Of the 7 cattle there was one cow and 6 yearling shorthorn heifers. Of the 2 hogs, 1 was a Berkshire and the other an Essex boar, both about 2 months old.

The horses might be classed as follow; 7 thoroughbred stallions and mares, 8 trotters and 4 ponies, the balance being about evenly divided between carriage, buggy, draft and general purpose horses. The mules were for use in the mines at Nanaimo.

On April 7th, 7 cattle arrived from the Sound and having no permanent quarantine, I placed them in a field on Simcoe street, temporarily, and on receiving permission from the department, transferred them to a field at Saanich where they remained for the required 90 days, after which they were discharged, being perfectly healthy.

On August 16th, two small pigs arrived from San Francisco which were quarantined in the pens at the outer dock for the 21 days, being discharged perfectly healthy.

On August 22nd I received instructions from the department to investigate an outbreak of disease among the calves at Matsqui. On proceeding thither I found that there had not been a case for three weeks.

In inquiring into the cases from the various owners, I found such a variety of conflicting statements regarding the symptoms and progress of the disease, that it was impossible to form any definite conclusion in regard to the nature or cause of the outbreak without either seeing a case in progress or at least holding an autopsy.

On my return home I advised the department in accordance with the facts.

On September 3rd I received word of another case, and under instructions I went to Abbotsford hoping to see a live animal; in this I was disappointed, but was able to make an autopsy on a cadaver 8 hours old. I found from the history of the case and the symptoms presented, evidences of an anthracoid nature, but nothing which corresponded to any of the regular anthracoid diseases already known. However, I sent a sample of the blood to Prof. McEachran requesting an examination of it microscopically and otherwise; I am now waiting for his report which I hope will throw some more light on the case. I advised the owners to burn the carcasses and thoroughly disinfect the premises where the affected cattle had been.

Subjoined you will find a detailed report of the inspections performed by me and of the animals quarantined.

I remain, sir,

Your obedient servant,

M. G. BLANCHARD, V.S.,

Veterinary Inspector.

The Honourable  
The Minister of Agriculture,  
Ottawa, Ont.

DETAILED Report of Inspection, from 1st January to 31st October, 1893, at Victoria,  
B.C., by M. G. Blanchard, V.S.

Date inspected.	Name of Importer.	Where from.	Horses.	Mules.	Cattle.	Hogs.	Sheep.
1893.							
January 6.	Uncle Tom Cabin Co . . . . .	U.S.A . . . . .	3				
do 12.	C. Marsden . . . . .	Washington Ter. . . . .	2				
do 13.	J. Parker . . . . .	do . . . . .					178
do 17.	do . . . . .	do . . . . .					180
do 23.	R. Porter & Sons. . . . .	do . . . . .					180
do 24.	J. Parker . . . . .	do . . . . .					356
do 31.	do . . . . .	do . . . . .					327
Feb. 8.	do . . . . .	do . . . . .					350
do 13.	W. J. McAulay . . . . .	Oregon . . . . .	1				
do 15.	J. Parker . . . . .	Washington . . . . .					353
do 18.	G. A. Kirke . . . . .	do . . . . .	2				
do 20.	J. Parker . . . . .	do . . . . .					351
do 21.	R. Porter & Sons . . . . .	do . . . . .					90
do 23.	do . . . . .	do . . . . .					85
do 25.	C. E. Stevenson. . . . .	do . . . . .	1	8			
do 28.	J. Parker . . . . .	do . . . . .					352
do 28.	A. J. Bectel . . . . .	Oregon . . . . .	2				
March 7.	J. Parker . . . . .	Washington . . . . .					365
do 9.	J. C. Cameron . . . . .	do . . . . .	3				
do 10.	J. W. Hollingshead . . . . .	Oregon . . . . .	16				
do 15.	J. Parker . . . . .	Washington . . . . .					289
do 24.	do . . . . .	do . . . . .					369
do 29.	R. Porter & Sons . . . . .	do . . . . .					156
do 30.	A. S. Eglin . . . . .	Oregon . . . . .	14				
do 30.	J. Parker . . . . .	Washington . . . . .					150
do 31.	R. Porter & Sons . . . . .	do . . . . .					143
do 31.	J. Parker . . . . .	Oregon . . . . .	5				
April 1.	do . . . . .	Washington . . . . .					288
do 7.	do . . . . .	do . . . . .					296
do 8.	Cameron & Jones . . . . .	do . . . . .	20				
do 8.	do . . . . .	do . . . . .			7		
do 11.	J. Parker . . . . .	do . . . . .					177
do 12.	R. Porter & Sons . . . . .	do . . . . .					180
do 12.	M. H. Cowan . . . . .	Oregon . . . . .	1				
do 14.	J. Parker . . . . .	Washington . . . . .					285
do 14.	C. T. W. Piper . . . . .	do . . . . .	4				
do 21.	J. Parker . . . . .	do . . . . .					577
do 26.	C. E. Stevenson . . . . .	do . . . . .	31				
do 27.	F. Adams . . . . .	Oregon . . . . .	1				
do 29.	T. S. Lamb . . . . .	do . . . . .	2				
do 29.	J. Parker . . . . .	Washington . . . . .					153
May 2.	R. Porter & Sons . . . . .	do . . . . .					211
do 3.	J. Parker . . . . .	do . . . . .					395
do 7.	R. Porter & Sons . . . . .	do . . . . .					221
do 7.	R. P. Rithett . . . . .	California . . . . .	1				
do 10.	J. Parker . . . . .	Washington . . . . .					421
do 10.	R. Porter & Sons . . . . .	do . . . . .					221
do 11.	J. Parker . . . . .	do . . . . .					429
do 11.	R. Porter & Sons . . . . .	do . . . . .					229
do 14.	D. McIntyre . . . . .	Minnesota . . . . .	15				
do 14.	R. F. Tolmie . . . . .	Washington . . . . .	1				
do 17.	J. Parker . . . . .	do . . . . .					127
do 18.	H. S. Anderson . . . . .	do . . . . .	1				
do 19.	J. Parker . . . . .	do . . . . .					428
do 20.	do . . . . .	do . . . . .					216
do 22.	H. H. Hill . . . . .	Oregon . . . . .	1				
do 23.	R. Porter & Sons . . . . .	Washington . . . . .					442
do 25.	J. Parker . . . . .	do . . . . .					432
do 31.	do . . . . .	do . . . . .					432
June 2.	R. Porter & Sons . . . . .	do . . . . .					400
do 7.	do . . . . .	do . . . . .					146
do 7.	J. Parker . . . . .	Washington Ter. . . . .					630
do 9.	do . . . . .	do . . . . .					142
do 14.	do . . . . .	do . . . . .	2				
do 15.	do . . . . .	do . . . . .					639
do 20.	R. Porter & Sons . . . . .	do . . . . .					420

## Department of Agriculture.

DETAILED Report of Inspection, from 1st January to 31st October, 1893, at Victoria,  
B.C., by M. G. Blanchard, V.S.—Continued.

Date inspected.	Name of Importer.	Where from.	Horses.	Mules.	Cattle.	Hogs.	Sheep.
1893.							
June 21.	J. Parker..	Washington Ter.					654
do 25.	J. G. West	do					185
do 29.	J. Parker	do					431
July 6.	R. Porter & Sons	do					429
do 9.	F. Campbell	British Columbia.	2				
do 12.	J. G. West	Washington					182
do 13.	J. Parker..	do					646
do 18.	R. Porter & Sons	do					850
do 20.	J. Parker	do					423
do 20.	J. Cameron	Oregon	4				
do 22.	J. Parker..	Washington					229
do 25.	J. R. Dalton	do	1				
do 27.	J. Parker	do					416
do 29.	W. S. Chambers	do	1				
Aug. 29.	J. Giovanni	New York..	2				
do 2.	J. Parker.	Washington					431
do 6.	R. Porter & Sons	do					415
do 11.	do	do					198
do 12.	J. Parker.	do					454
do 15.	do	do					222
do 15.	do	do	1				
do 16.	R. P. Rithet & Co.	California				2	
do 17.	J. Parker..	Washington					209
do 18.	R. Porter & Sons	do					413
do 18.	J. Parker.	do					442
do 23.	do	do					676
do 25.	W. T. Racine	Oregon.	2				
do 28.	J. Irving	California	1				
do 30.	J. Parker	Washington					437
do 31.	do	do					195
Sept. 3.	R. Porter & Sons	do					647
do 6.	J. Parker..	do					888
do 13.	J. McLaughlin.	do					6
do 13.	J. Parker	do					652
do 19.	R. Porter & Sons	do					401
do 19.	R. Musgrave.	Wisconsin					4
do 19.	W. H. Smith	Oregon.	2				
do 20.	Geo. Burns.	Australia.	6				
do 20.	J. Parker	Washington					442
do 20.	S. Leiser	do	1				
do 21.	W. J. Alden	do	2				
do 26.	J. Parker.	do					833
do 27.	E. Helsom.	do	9				
do 29.	E. Southern.	do	1				
do 29.	M. Aleck	do	1				
do 29.	John Jock	do	1				
do 30.	R. Porter & Sons	do					633
do 30.	R. Allenquene	do	1				
Oct. 5.	J. Parker	do					660
do 11.	D. Jones	Oregon	3				
do 11.	J. D. Pemberton.	do	2				
do 11.	J. Parker.	Washington					628
do 15.	Jas. Jackson	do					219
do 17.	J. Wright	do					400
do 18.	J. Parker	do					626
do 31.	do	do					602
do 31.	R. Porter & Sons	do					185
	Total..		173	8	7	2	29,274

DETAILED Report of Cattle quarantined at Victoria, B.C., for the year ending 31st October, 1893, by M. G. Blanchard, V.S., Veterinary Inspector.

Importer.	Where from.	Breed.	No.	Where quarantined.	Date entered.	Date released.
Cameron & Jones.....	Oregon.....	Shorthorn..	7	Simcoe Street and Saanich.....	April 8...	July 7

DETAILED Report of Hogs quarantined at Victoria, B.C., for the year ending 31st October, 1893, by M. G. Blanchard, V.S., Veterinary Inspector.

Inspector.	Where from.	Breed.	No.	Where quarantined.	Date entered.	Date released.
Mr. Mulligan.....	Colorado.....	1 Berkshire, 1 Essex...	2	Quarantine pens ..	Aug. 16..	Sept. 7

M. G. BLANCHARD, V. S.

VICTORIA, B.C.,  
1st November, 1893.

# Department of Agriculture.

No. 14.

## REPORT OF FORT MACLEOD CATTLE QUARANTINE STATION.

(ROBERT EVANS, V.S.)

FORT MACLEOD, 31st October, 1893.

SIR,—I have the honour herewith to submit a detailed statement of inspections made by me up to date this year.

There has been quite a decrease in the number of cattle as compared with previous years, although the number of actual settlers is fully as many as formerly.

Early in the season in conjunction with Colonel Herchmer, Commissioner of the North-west Mounted Police, arrangements were made for the rigid enforcement of the quarantine regulations.

All cattle and sheep were inspected before entering Canada at a point where the trail crosses the North Fork of Milk River about three miles south of the international boundary line.

Corrals were built for securing the cattle at night and herders were employed to look after them during the day.

Immediately after inspection cattle were driven on to the quarantine ground and placed in charge of the police, a detachment of which were stationed there.

Daily patrols were kept up between the quarantine camp and the main trail; and the crossing at Milk River being a night camping place for all parties driving cattle, none escape the vigilance of the police.

Their duty of herding and caring for the cattle was well and efficiently performed, and during the early part of the season they did very well, but since the middle of September, owing to repeated snow storms, cold and damp weather and the long nights during which the cattle must be inclosed, some of them have fallen off in condition, particularly young and weak cows with calves, and those which were partially worn out on arrival.

Many of the settlers view the quarantine detention as a very great hardship, owing to the fact that their families are in a measure dependent upon the cows for a portion of their living, which is lost to them entirely, as by the end of 90 days the cows are all dry except those with calves at foot.

All the cattle came from Utah, Idaho and Washington, and were from five to eight weeks on the road and as a matter of course nearly all this time completely isolated from all other stock, and if disease existed among them before starting it would certainly have shown itself plainly before arrival, as none but the most healthy animals could stand a drive of six or seven hundred miles over the most difficult trails and where food is none too plentiful.

For this reason some modification might well be made in the length of time cattle should be kept in quarantine and I am of the opinion that the time might be very materially reduced.

Another cause of complaint among settlers is that newly calved cows and those milking but without calves are in danger of inflammation and destruction of the udder for want of milking and proper attention, which the herders are not expected to attend to.

Only one instance of this occurred under my observation during the season.

Some deaths occurred in quarantine from different causes, but none that could be attributed to negligence on the part of those in charge.

Some of the cattle still remaining in quarantine are in rather poor condition from causes before mentioned, and as the bad weather still continues I have ordered them to be released by the 6th November, a few days before the expiration of the allotted 90 days.

There will still remain thirty-one head, the property of one Bennett, but in the care and at the risk and expense of the owner.

I have the honour to be, sir,  
Your obedient servant,

ROBERT EVANS, V.S.  
*Quarantine Inspector.*

The Honourable  
The Minister of Agriculture,  
Ottawa.

## Department of Agriculture.

Report of Animals inspected at Macleod Quarantine Station, during the Year 1893, up to 1st November.

Date.	Name of Importer.	Whence imported.	Destination.	ANIMALS INSPECTED.			Remarks.
				Horses.	Mules.	Cattle.	
May 2	Wm. W. Gates.	Washington	Wetaskiwin.	15		17	
June 1	A. T. Schneider.	do	do	17		34	
do 1	Carl Schneider.	do	do	15		14	One calf died; injured before arrival.
do 1	Albert Masterman.	do	do	19			
do 1	E. T. Ramser.	do	do	2			
do 1	Carl Wabel.	do	do	5		20	
do 1	Hans Finzen.	Idaho.	do	7		2	
do 1	Martin Embertson.	do	do	12		3	
do 1	G. A. Halverson.	do	do	15		29	
do 1	Wm. Wilson.	do	do	16		20	
do 9	Frank Hyde.	Utah.	Cardston.	2			
do 11	J. A. Newell.	Washington	Wetaskiwin.	12		16	
do 19	C. H. Luttie.	do	Edmonton.	7		6	
do 26	O. F. Hurlburt.	do	Reddeer.	4			
do 26	Jno. Turville.	do	do	6			
do 26	James Chiswell.	Oregon.	Edmonton.	20			
do 26	T. A. Chiswell.	do	do	1			
do 26	Jas. W. Chiswell.	do	do	5			
July 4	J. B. Bibber.	do	do	54			
do 4	R. G. Parker.	Idaho.	do	2			
do 4	Francis Broadbent.	Utah.	do	9			
do 4	C. F. Broadbent.	do	Cardston.	8		7	
do 10	H. C. Glassgow.	do	do	16		3	
do 10	Clara Hausen.	Oregon.	Pincher Creek.	9			
do 10	May Wood.	Utah.	Cardston.	6			
do 10	Susie Wood.	do	do	12			
do 10	Elizabeth Wood.	do	do	5		14	
do 10	Frank Hyde.	do	do	5		13	
do 10	Ernest Hensall.	do	do	3			
do 10	Jos. Biemerhan.	do	do	2			
do 10	Geo. Tippolt.	do	do	4			
do 10	R. M. Leishman.	do	do	2			
do 10	Robt. Leishman.	do	do	4			
do 10	Alex. Leishman.	do	do			16	
do 10	Jos. Leishman.	do	do	13		15	
do 10	Wm. Leishman.	do	do	4		1	
do 10	Geo. Olsen.	do	do	3			
do 10	H. Woodward.	do	do	6			
do 10	W. O. Biglow.	do	do	6		5	
do 10	Emma Biglow.	do	do	8		16	
do 10		do	do			16	

Prospecting. Gone out again

REPORT of Animals inspected at Macleod Quarantine Station, during the Year 1893, up to 1st November—Concluded.

Date.	Name of Importer.	Whence imported.	Destination.	ANIMALS INSPECTED.				Remarks.
				Horses.	Mules.	Cattle.	Sheep.	
July 10	Winfield Scott.	Utah.	Cardston.	1		10		
do 10	Johnathan Hunt.	do	do	5		7		
do 10	Frank Leavitt	do	do	3		9		
do 13	Henry Schoubert.	Montana	Macleod	2				(Gone out again.
do 18	W. F. Tolley	Idaho	Calgary	16				
do 18	Chas. Tolley	do	do	5				
do 19	W. T. Herndon	Washington	Battle River.	6				Prospecting. Gone out again.
do 19	J. N. West.	Idaho	do	3				
do 19	Wm. Kabary.	Montana	Cardston.	4				Visiting. (Gone out again.
do 19	Philip Whitford	do	do	3				
do 20	Hugh Kennedy	do	Edmonton	2				
do 20	A. Carter.	Washington	do	4		5		
do 20	John Morris.	do	do	12	2			
do 24	W. H. Gaunt.	do	do	1				
do 24	Homer Pease.	Idaho	Cardston.	11		57		One died very poor on arrival.
do 25	Dan Allan.	Montana	do	2				
do 25	R. Sherrar.	do	do	2				
do 25	H. Sherrar	do	do	1				
do 25	Joseph Poitier	do	do	2				
do 29	V. B. Martin.	Washington	Calgary	2				
Aug. 1	Jno. McCormack	Idaho	Idnnsfall.	20				
do 4	Al. McNely	do	do	1				
do 4	Emil Fournay	Montana	do	1				
do 4	D. E. Wilcox	Idaho	Cardston	135				
do 5	A. McPhee.	Washington	do	25				
do 7	W. E. Swame.	do	do	21		12		
do 7	John Swane.	do	do	10		16		
do 8	G. C. Pears.	California	do	10				
do 8	Henry Whitford	Montana	do	9			200	
do 10	C. Begin.	do	Lethbridge	9		21		One bull and two calves died.
do 13	Geo. Burrows.	Utah	Cardston.	3		15		One cow died, prolapsus uteri; one heifer, snow storm.
do 13	V. J. Stewart.	do	do	16		16		
do 13	A. G. Burrows	do	do	2		14		
do 13	Job Webb	do	do	2				
do 18	John Sewell	Montana	do	1				
do 18	Robt. Hodnett.	do	do	14				
do 24	J. H. Bremer.	Washington	Reddeer	2				
do 24	Jno. Simpkins	do	do	2				
do 24	B. M. Lemton	do	do	5				
do 24	Geo. O. Bremer.	do	do	7				



# Department of Agriculture.

do	24	Geo. Bremer	do	do	9		
do	24	Jeff Simpkins	do	do	1		
do	25	L. E. Roberts	do	St. Mary's	21		
do	25	M. L. Johnston	do	Cardston	2		
do	28	J. M. Butler	do	Lacombe	16		
do	28	J. T. Butler	do	do	7		
do	28	Chas. Milledge	do	do	5		
Sept.	4	Geo. Porter	do	do	2		Prospecting. Gone out again.
do	4	A. McDonald	do	do	2		do
do	5	Martin McCormick	do	Edmonton	4		
do	5	S. Rice	do	do	9		
do	9	J. Jensen	do	Cardston	2		
do	9	A. Steinmuller	do	Edmonton	2		
do	9	W. A. Asher	do	do	13		
do	9	Isaac Cooper	do	do	1		
do	9	Chas. Clarke	do	do	1		
do	9	W. H. Clarke	do	do	1		
do	22	P. A. Carnell	do	Calgary	4		
do	22	Thos. Nelson	do	do	4		
do	22	Cooper & Cowell	do	do	2		
do	26	F. D. Cooper	do	Macleod		904	Macleod and Lethbridge; for sale.
do	26	R. Powell	do	Calgary		1,533	Calgary; for sale.
do	26	R. R. Vancil	do	Pincher Creek	6		
do	26	R. R. Vancil	do	do	2		
Oct.	14	S. L. Potter	do	do		1,218	
do	16	A. F. Tolbert	do	Cardston	9		
do	16	Geo. Bennett	do	do	3		
do	16	A. J. Bennett	do	do	3	15	
do	21	Antoine Pelan	do	Edmonton		16	
do	21	Jno. B. Barr	do	Calgary	3		
do	21	Enoch Elison	do	Calgary	4		
do	27		do	Cardston	2		
		Total			829	492	3,855

ROBT. EVANS, V. S.,  
Quarantine Inspector.

## No. 15.

## REPORT ON AMERICAN CATTLE IN TRANSIT.

(THOS. A. ALLEN.)

LONDON, 1st November, 1893.

SIR,—I have much pleasure in submitting my second annual report.

The number of animals going through Canada, in transit, during the past year is not so great as in former years; especially on the main line. So far as I can ascertain that falling off is due to scarcity of stock, especially is this the case in swine.

The number of animals entered at Windsor for year ending June 30th, 1893, is as follows, viz.:—Cars, 17,859; swine, 587,948; cattle, 113,022; sheep, 451,452; horses and mules, 2,292. Total number of animals, 1,154,714. During July, August and September of this year there has been 2,772 cars; cattle, 34,457; swine, 45,593; sheep, 44,049; horses, 285. Total number of animals for the three months, 124,384. July, August and September are the slackest months in the year.

The number entered *via* Sarnia for year ending June 30, 1893, main line, cars, 10,398; hogs, 942,392; cattle, 4,929. *Via* Buffalo, cars, 8,462; hogs, 107,259; cattle, 147,616. Total, swine, 1,046,651; cattle, 152,545. Total number of cars, 18,561; animals (allowing 300,000 for horses and sheep, which, I believe, is a fair estimate, I was disappointed in getting the exact number) 1,502,196. Total number of animals entered during year ending June 30th ult., 2,656,910. Cost of inspection per head, about 2½ mills.

*Lyn Stock Yards.*

There were 4,929 head of cattle, besides a number of horses unloaded for feed, water and rest during the year ending June 30th ult.

I have visited the yards frequently during the year, and have always found them in good condition, and properly inclosed.

*Fort Erie.*

All stock not going by Montreal enter the United States *via* Fort Erie.

The Grand Trunk and Canada Southern yards lie side by side, and cover a large space of ground. This is a very important point, and requires very careful looking after. It is necessary that stock cars loaded and unloaded, be detained for a considerable time, and shunted back and forth, in making up trains; as a result there is considerable litter dropped from the cars whilst in the yards. Cattle are allowed to run at large in the vicinity. A close watch is kept on them by a man employed for that purpose by the Grand Trunk Company.

The Canada Southern has lately constructed a fine wire fence on their side of the yards, with necessary turnstiles and cattle guards. The Grand Trunk has, within the last week, commenced to build a wire fence on their side, which, if properly completed, will render the yards completely isolated.

Mr. L. Slater, who has been sent here from St. Thomas, will, no doubt, render good service, by seeing that the regulations are strictly enforced, from day to day.

*Condition of Cars when entering Canada.*

This matter is closely attended to, and as a result, with but few exceptions, they are in good condition. When not in a good state they are detained until properly attended to. Dead or sick animals are not allowed to enter under any circumstances.

## Department of Agriculture.

### *Stock en route.*

All stock from the time they enter Canada until they leave are handled with the utmost despatch; and are not detained by the way any more than is absolutely necessary; with the exception of swine, which are detained at certain stations, during warm weather, for the purpose of slushing them with water.

Stock cars through to Buffalo, go by way of King's Court to St. Thomas, thence direct to Fort Erie. Empty cars are returned by Stratford.

### *Cleaning and Disinfecting Cars.*

The cars are cleaned and disinfected at Black Rock, N.Y., before returning *via* Fort Erie; and at St. Albans before returning *via* St. Armand, Que. The cleaning and disinfecting has been performed in a very satisfactory manner, during the past summer.

### *Conclusion.*

During the yast year I have visited the most important points from two to three times each month, and at other times when circumstances required attention at intermediate points; and have, at all times, been careful to report to your department all matters that come under my notice not in strict accordance with, or a violation of, the Order in Council governing stock in transit.

I believe that the railway companies are fully alive to the fact that it is to their interest that the regulations are properly carried out.

Respectfully submitted,

THOS. A. ALLEN, V.S.,  
*Inspector of Stock in Transit.*

The Honourable  
The Minister of Agriculture,  
Ottawa.

## No. 16.

## REPORT OF DISTRICT VETERINARY AT MAPLE CREEK.

(J. L. POETT, V.S.)

MAPLE CREEK, 31st October, 1893.

SIR,—I have the honour to most respectfully report for your information that an outbreak of *scabies* in sheep occurred almost simultaneously in the Maple Creek and Medicine Hat districts, supposed to have been introduced into this country by a band of sheep from Idaho, United States.

I am of opinion that the late exceptionally hard winter and want of food had much to do in propagating this disease. Also owing to the fact of its being such an unusual occurrence to experience so severe a winter in this part of the North-west Territories, the ranchmen and sheepmen generally did not have sufficient provender put up for such a prolonged and cold winter. As soon as possible in the early spring steps were taken by the authorities to eradicate this disease.

Previous to the wool clipping season antiparasitic ointments in many instances were applied to the sheep most affected with scab. Immediately after clipping the sheep were dipped upon the ranches owned by the following parties, viz.:—Mr. T. Johnson, Bear Creek, Mr. Brown, Maple Creek and Mr. Dixon, Maple Creek. In the Medicine Hat district, where this disease existed in the more acute type, active measures were being taken by Mr. Robinson, and later by Messrs. W. Nichol and Grant with a view to stamping out this disease. Cooper's and McDougall's dips were those principally used by the above named parties. This work was done under the supervision of Mr. Warnock, M.R.C.V.S., who was temporarily ordered to remain in this district by Dr. McEachran, Chief Dominion Inspector of Stock, as at this particular time I was employed upon special duty under the North-west Government.

Towards the end of the latter part of September I was requested by Dr. McEachran to make a very close inspection of Mr. Nichol's sheep. I at once proceeded to Walsh station, on the Canadian Pacific Railway, and drove over to Mr. Nichol's ranche. I there examined 1,020 head of wether lambs, ewe lambs 1,137 head, two bands of aged ewes numbering about 2,340 head, all of which are in good condition and free from any taint of scab. These bands of sheep had been herded separately and had never come in contact with his fat wether herd, numbering about 2,900 head and which were suffering from scab of the dermatodectic type. All of this gentleman's sheep had been dipped twice with McDougall's preparation and his fat wether band have been dipped three times with Cooper's English dip. The infected band of sheep are being herded ten miles south of the ranche among the foot hills of the Cypress Mountains, where there is absolutely no possibility of their coming into contact with other flocks.

Owing to the fact of these sheep having been repeatedly dipped I failed to discover any trace of acute *scabies* in this herd.

I am satisfied from the exertions that Mr. Wilmot is now making, that scab will be eradicated from his band of sheep this fall. I next inspected 1,800 head of sheep owned by Mr. Robinson, Chief Locomotive Engineer of the Medicine Hat Division Canadian Pacific Railway, whose ranche is situated about 13 miles from Medicine Hat in a south-western direction. These sheep suffered from the most acute type of scab and at the time of my inspection the herdsmen in charge of these sheep had already dipped them 7 times and had hand scrubbed each sheep singly and was now preparing to give them a final dip with Cooper's English preparation.

This band I found in excellent condition and in no single instance did I find scab in the acute stage. I would further beg leave respectfully to state that Mr.

## Department of Agriculture.

Robinson deserves the greatest credit for the very persistent measures which he has taken with a view to stamping out this disease and which has only been done with an outlay of some six hundred dollars for sheep dip alone.

I strongly suggested to Dr. McEachran that all corrals, sheep pens, etc., be burnt upon this ranche, as well as burning over the valley in which the sheep have ranged during the summer months, owing to the fact that a species of grass somewhat resembling dwarf bull rush grows luxuriantly in the centre of this valley, and shreds of scabby wool with the scab crusts attached thereto I found adhering to this grass for some miles up the valley. I consider these depositions of shredded wool a potent factor in disseminating scab, should unfortunately other flocks pass over this point of the country.

The sheep belonging to the Little Plume Ranche Co. were next examined, all of which I found in prime condition and free from any taint of scab. These districts having been declared infected, all sheep sold and shipped from either Maple Creek or Medicine Hat are slaughtered upon their arrival at destination on the railway. The officer in command of the North-west Mounted Police at Calgary was notified to this effect by me. I also forwarded by letter to Mr. Thompson, the principal veterinary surgeon of Manitoba, instructions to the same effect.

All sheep, before they are shipped, are seen and examined by me before being put upon the cars. I have no hesitation in saying that the sheep ranches of this and the Medicine Hat District have been fully aroused to the very serious nature of this parasitic disease and are sparing no exertions and expense to stamp it out. I look upon it as a certainty to see scab eradicated from this section of the country before winter sets in. The disease has been well kept under control this summer and everything in connection with dipping of sheep has been done in a proper, efficient and systematic manner on the ranches where the disease exists, and no fears need be apprehended as to its spreading. I would further respectfully suggest as a precautionary measure against the introduction of scab or other parasitic diseases amongst sheep from the United States of America, that it is absolutely necessary for a proper sheep dipping trough of an approved pattern to be put up inside an inclosed corral either at or near the Ten Mile crossing of Battle Creek or at the head of Fish Creek, so that all sheep crossing the international boundary line into Canadian territory be quarantined for at least one month and during their detention in quarantine be dipped twice with McDougall's or Cooper's preparation, this work to be performed by a proper qualified veterinary surgeon. If the authorities should deem it advisable to take action in this matter I am satisfied that the preventive measures taken will meet with the approval of all sheep ranchers in the territories and thus effectually prevent the introduction of scab. In concluding this report I would respectfully observe that Dr. McEachran and Mr. Warnock saw this disease during the early months of the summer in its virulent form, but owing to the more active measures taken later on in the season and as already stated in this report the disease in question has, I trust, been effectually stamped out.

I have the honour to be, sir,  
Your obedient servant,

J. L. POETT, M.R.C.V.S.  
*District Veterinary Surgeon.*

## No. 17.

## REPORT OF MANITOU CATTLE QUARANTINE STATION.

(M. YOUNG, V.S.)

MANITOU, 31st October, 1893.

SIR,—In compliance with your directions, I have the honour to submit this my report of animal inspections for the part of the year 1893 ending October 31st.

By referring to the subjoined statement of inspections you will observe that only one head of cattle has entered this province at any of the points under my supervision. This animal (an ox) was smuggled into the country from the neighbourhood of St. Johns, North Dakota, and seized by the North-west Mounted Police and reported to me for inspection. I quarantined it for ninety days in a stable on section 2, township 1, range 18 west, where it still remains in the care of the North-west Mounted Police. I also at the same time quarantined the whole of the cattle owned by, or found on the premises of, the person who brought the ox into this country, for the period of ninety days from the date of my visit.

The number of persons who have entered at the different points in this district from the United States for the purpose of securing homes in Canada during the part of this year already expired, corresponds exactly with the total entries of 1892, at the same points, and there seems to be every indication that a still greater immigration, especially from South Dakota, may be expected during this fall and the coming spring. I am glad to report that no outbreak of any form of cattle disease has taken place throughout Southern Manitoba (or, as far as I am aware, any part of Manitoba) this year.

I have the honour to be, sir,

Your obedient servant,

M. YOUNG, V.S.,

*Inspector.*

The Honourable  
The Minister of Agriculture,  
Ottawa.

# Department of Agriculture.

DETAILED REPORT of Animals inspected by M. Young, V.S., for the Year 1893, up to October 31st.

Date.	Name of Owner.	Where from.	Destination.	ANIMALS INSPECTED.					Where inspected.	Remarks.	
				Horses.	Mules.	Cattle.	Sheep.	Swine.			
1893.											
July	5 Percy Gadsden.....	Schnyler, Colf's Co., Dak.	Alberta, N. W. T.							Killarney	
do	5 Christoph'r Buckmaster.	do	do							do	
do	5 Wesley Baine.....	do	do					22		do	
do	5 Jno. Gould.....	do	do					22		do	
do	5 Chas. Frye.....	do	do					22		do	
do	5 Jas. Walford.....	do	do					1		do	
do	14 W. G. Williamson.....	Dakota.....	Brandon, Man.	2				2		do	
do	14 T. W. Williamson.....	do	do	2				2		do	
do	31 Jno. Landerkin.....	S. Dakota.....	Baldur	15				15		do	
do	31 J. A. D. Wheelihan.....	do	do	1				1		do	
Aug.	7 F. Hannah.....	Hannah, N. do	Star Mound, Man.	1				1		Manitou.	
do	14 J. E. Evans.....	Antelope Co., Nebraska.	Prince Albert, N. W. T.	2				2		Killarney	Quarantined for 30 days.
do	14 David Evans.....	do	do	2				2		do	
do	18 Geo. Latham.....	N. Dakota.....	Killarney, Man.	2				2		do	
do	28 Clovis Guerin.....	do	Wakopa							do	
do	2 James Cave.....	Cavalier Co., N. Dakota.	Snowflake							do	
Sept.	6 Jno. L. Goudette.....	Willow City	N. W. T.	6				6		1	Wakopa, Sc. 2, 1, 18. Seized by N. W. M. Police, quarantined for 90 days.
do	8 F. Hannah.....	Hannah	Star Mound Man	1				1		Manitou.	
do	8 Roderick Cameron.....	do	Brandon	3				3		do	
do	8 W. G. Smallcombe.....	St. Johns	Killarney	1				1		do	
do	19 Luke McConnell.....	Breckinridge, Minnesota.	Whitemouth	3				3		Manitou.	
do	19 Morris Shea.....	do	do	3				3		do	
do	29 Paul Blondell.....	St. Johns, Dakota.	Killarney	1				1		Killarney	
do	16 Crystostom Ducharme.....	Dunseith	Lake Manitoba, Man.	5				5		Manitou.	
Oct.	16 B. B. Barnes.....	Cavalier Co., Dakota.	Mowbray	2				2		do	
do	20 Malcolm McLarty.....	Crystal	Lake Dauphin	2				2		Clearwater	
do	24 Norman McLeod.....	St. Thomas	do	2				2		Manitou.	
do	25 Jno. McKinnon.....	St. Johns	Edmonton, N. W. T.	3				3		Killarney	
do	25 Angus McKinnon.....	do	do	1				1		do	
do	25 John S. O'Brien.....	do	Killarney, Man.	1				1		do	
do	26 Robt. Robinson.....	Towner Co.	Cartwright, Man.	4				4		Cartwright	Suspicious of glanders, ordered back into the U. S.
do	27 Hugh McFarlane.....	do	Turtle Mountain, Man.	3				3		Killarney	

MANITOU, 31st October, 1893.

M. YOUNG, V. S., Inspector.

## No. 18.

## REPORT OF THE DELORAINE QUARANTINE STATION.

(JOSEPH DANN, V.S.)

DELORAINE, MAN., 31st October, 1893.

SIR,—I have the honour herewith to submit my annual report up to the 31st of October, 1893.

During the year passed, although the number of animals entered here has been less, yet the quality has been superior to last year, and in every instance perfectly healthy.

The health of horses and cattle throughout this district for the year ended has been remarkably good.

I have the honour to be, sir,  
Your obedient servant,

JOSEPH DANN,  
*Veterinary Inspector.*

The Honourable  
The Minister of Agriculture,  
Ottawa.

## INSPECTIONS made by J. Dann, V. S.

*(Detailed Report, 1893.)*

Date of Inspection.	Name of Importer.	Whence imported.	Horses and Mules.	Cattle.	Sheep.	Swine.
1893.						
Jan. 9	Mr. E. White	Dakota	2			
June 3	Wm. McGillis	do	2			
do 17	R. Marr	do	1			
Aug. 14	M. Williams	Nebraska	1	2		
do 14	B. Schmidt	do		9		
do 14	H. Briggs	do		8		
do 14	E. Bane	do		44		
do 14	G. Gadson	do		8		
do 14	A. J. Wright	do		8		
do 14	L. Junebluth	do	3	17		
do 14	A. J. Samis	do	8			
do 14	J. Samis	do		29		
do 14	F. Junebluth	do	4	25		
Sept. 4	Henry Watson	Botineau, U.S.	3			
do 4	Hector McVicon	do	2			
do 7	J. P. Endersley	Dakota	1			
do 28	Wm. Grogan	do	1			
do 29	Corpl. R. S. Knight, N.W.M.P.	do	1			
Oct. 5	E. W. Franklin	Moninghan	7			
do 9	Wm. Hobbs	Dakota	4			
do 19	Chas. DeMontine	do	1			
do 23	John Fonsbois	do	2			
Total						

JOSEPH DANN, V. S.,  
*Inspector.*



# Department of Agriculture.

No. 19.

## REPORT ON TRANSIT OF UNITED STATES LIVE STOCK.

(L. SLATER.)

ST. THOMAS, 31st October, 1893.

SIR,—I beg leave to forward my thirteenth annual report on the transportation of United States live stock in transit and in bond from Windsor to East Buffalo by the Michigan Central, Canada Division, also by the Grand Trunk Loop Line, Southern Division, from Windsor to East Buffalo, and also from Sarnia to Glencoe, via King's Court Branch, and east by the Loop Line to East Buffalo. All trains stop at St. Thomas for the purpose of exchanging engines, and examining rolling stock and taking on fresh crews of trainmen, before proceeding east.

### *Michigan Central, Canada Division.*

The Michigan Central Railway Company have been doing a very good business in the carrying of United States live stock in transit, and in bond by this route from Windsor to East Buffalo during the ten months of this year, and have not had any serious accidents to any of their live stock trains while in transit through Canada by this route. The snow was very heavy during the months of January and February, causing a good deal of delay to live stock trains, and thereby causing the live stock to be a long time in transit; but in the second week in March the weather became fine and the snow was all gone, so that the rail tracks were clear of snow and trains carrying United States live stock were making faster time and moving more regularly than during the two previous months, and the number of trains during ten months was 1,291; all have passed without casualty during that period.

All trains stop at St. Thomas to exchange engines and examine cars, and fresh crews of men take charge before the trains proceed on the journey. The journey from Windsor to East Buffalo takes the average live stock train from ten to twelve hours; the rolling stock or cars used by this company are first-class, all being thoroughly equipped with air brakes and patent couplings, and all the latest improvements; the cars before being loaded and passing eastward, are all well supplied with sawdust and other absorbent for the animals' droppings as they accrue, and empty cars all return by this route well cleaned and disinfected before returning from Buffalo and pass back empty *en route* to the west through St. Thomas in strict accordance with the restrictions of the department, and according to my instructions which are carried out with all due care.

### *J. B. Squire's Hogs or Swine.*

We had 755 cars of J. B. Squire's hogs passing through by this route in January and twenty-five in February, and again in the month of April, we had eighty-four cars, making in all 864 cars, but since that date there have not been any of them passing by this route, but only a few cars of hogs, per month, as the table following the report shows.

### *Sheep.*

United States sheep are passing through by this route in double deckers, and average 160 sheep to the car; we only have a few cars on each train, but during

the first four months of the year there were a good many sheep passing through by this route until the shearing season commenced, when the number of cars fell off to only a few a month.

*Mixed Live Stock.*

Under this head there is quite an item shown on the appended table as live stock mixed; it is made up of hogs, sheep and calves, all in the same car, and is for butchers' supply in the Buffalo and other eastern markets; this kind of live stock is loaded in cars to suit the business.

*Isolation.*

Live stock trains, while detained, in the St. Thomas railway yards, for the purpose of exchanging engines and examining cars, are kept well isolated from all other trains that are not engaged in the transportation of United States live stock; it takes from thirty to forty minutes to examine a train. The total number of cars of cattle passing per month by this route is not quite so large as during the previous year, but all kinds of live stock have passed through by this route without accident. All the railway yards of this company at St. Thomas are kept clean and free from animal droppings that might fall from the cars while stopping at this station for examination and exchange of engine and crews. Such droppings as may fall are carefully gathered up daily and destroyed under my inspection.

*Local Live Stock at Toronto and Montreal.*

There is gathered in at this point on the Michigan Central (Canada division) into the railway yards here at St. Thomas for shipment to Toronto and Montreal, cattle, sheep and hogs, but mostly cattle, from the counties of Essex, Kent, Lambton and West Elgin. A large number of cars of local live stock, viz., cattle, hogs and sheep, for shipment to Toronto and Montreal for export during the shipping season, all of which live stock arrives in St. Thomas during the day on local trains and in local cars used for this local business, is given to the Grand Trunk Railway or the Canadian Pacific for transportation to Montreal and Toronto for export. This local business has been done between the Michigan Central and Grand Trunk Railways until the 1st of March last, when the London and Port Stanley branch passed out of the hands of the Grand Trunk Railway, and since that time the local trains that bring in the live stock from the west on the Michigan Central and its branches hand it over to the Canadian Pacific for transportation to Toronto and Montreal. All of this local live stock business has been carried on with the greatest care, as to isolation from United States live stock while in transit through St. Thomas by this railway company, and in strict observance of the Act to provide against infectious or contagious diseases affecting animals, all of which regulations have been carried out with the utmost economy by the Michigan Central Railway authorities at this point and with constant attendance on my part.

*Grand Trunk Loop Line, Southern Division, United States.*

Live stock by this route in transit and in bond from Windsor to East Buffalo, and from Sarnia to East Buffalo, via Sarnia branch to London and south to St. Thomas, and east on the Loop Line trains, carrying United States live stock from Sarnia, via Sarnia branch to London and south to St. Thomas, continued coming round by London until the 13th day of February last, when the King's Court branch was opened for traffic to Glencoe, and since that date United States live stock in transit from Sarnia to East Buffalo have been carried by the Grand Trunk Railway Company more direct to St. Thomas over the Loop Line.

To admit of the examination of cars all trains stop in the St. Thomas yards on arrival, and the trains from Windsor also exchange engines and trainmen at this

## Department of Agriculture.

point and the cars are examined before proceeding east. The examination of cars and exchange of engines takes about forty to fifty minutes, and the whole journey over this route takes on the average about nine hours with 25 cars of live stock to the train. Empty live stock cars returning by this route through St. Thomas are all well cleaned and disinfected before being returned.

### *Isolation of Live Stock Trains.*

United States live stock trains while standing in the St. Thomas railway yards are isolated from all other business, during the time said trains are detained here for examination of rolling stock. The yards are kept clean of all animal droppings that may drop from the cars while standing here for examination. All droppings are carefully gathered up and destroyed so as to prevent the possibility of contagion therefrom.

### *Accidents to Live Stock in Transit during the year.*

On the 13th day of June, we had a car of cattle in transit from Sarnia to East Buffalo on special train No. 480, Conductor Buchanan, delayed here at St. Thomas four hours and fifty minutes, the cause of the delay was one of the trucks of the car which the cattle were loaded in, got out of repair and had to be repaired at St. Thomas before it could proceed east, and was afterwards put on to train No. 80 and proceeded to its destination.

Accident number two took place at Cortland, July 15th; special train No. 452 was passing the west switch at Cortland Station going east, at a point 28 miles east of St. Thomas, which train had 19 cars of United States cattle and 1 car of hogs in transit from Sarnia to East Buffalo. Car "Lackawanna" live stock express No. 168, ran off the rails and travelled on the ties for some distance but did not upset, the car was crippled and I was called to proceed to Cortland to inspect the cattle, being transferred to Grand Trunk car No. 7464, which was done in a satisfactory manner without the cattle being landed, and the crippled car No. 168, L. L. & St. R. express was brought back to St. Thomas and cleaned out, and the droppings burned and the car repaired and sent back to the Western States.

With the two minor accidents which I have reported in detail as above, the large amount of United States live stock has passed through in transit on trains made up of 20 to 25 cars to the train and all first class equipped cars without accident.

I have free access to the Grand Trunk Telegraph office and am notified of the departure of all United States live stock leaving Windsor and Sarnia in transit through St. Thomas and keep a record of the arrival of all said trains and the conductor in charge.

Thus I am informed of any thing that takes place while such trains are in transit so that the business of my office is conducted here at St. Thomas in the most economical and trustworthy manner and with due regard to all the restrictions of the department all observed and carried out by the several railway companies' servants with the greatest care and satisfaction.

### *Local Live Stock gathered in at this Point of St. Thomas,*

on the Grand Trunk Loop Line, Southern Division, and received here from the Michigan Central Canada Division for shipment to Toronto and Montreal. There has not been so many cars of local stock shipped from St. Thomas (via) London this season as, in former seasons to Toronto and Montreal, owing to the Grand Trunk Railway Co. not having control of the London and Port Stanley branch since the first of March last, but this local stock has been transported from here by different routes on the Grand Trunk system to Toronto and Montreal in local cars and isolated from through trains leaving United States live stock in transit.

*Local Shipments to Buffalo.*

I inclose table showing the number of cars of lambs gathered in at St. Thomas from the Grand Trunk west of St. Thomas, and also from the Michigan Central Canada Division and forwarded to Buffalo from the several counties west of St. Thomas.

*West Bound Live Stock.*

Of west bound live stock passing from the Eastern States to the west, there has been a number of cars of horses in horse palace cars, and a few cars of horses from local points in Canada to the west, and a few cars of sheep passing from eastern Toronto and also from local points to the west, all of which are shown on the annexed table of the west bound live stock.

All of which is respectfully submitted.

I have the the honour to be, sir,  
Your obedient servant.

L. SLATER,  
*Cattle Guardian, St. Thomas.*

The Honourable  
The Minister of Agriculture,  
Ottawa.

## EAST BOUND.

TABLE showing the Number of cars of each kind of Live Stock.

Date.	Company.	Cattle.	Hogs.	Sheep.	Horses.	Live Stock, mixed.	Live Poultry.	Mules.	Calves.	Live Stock & Household Goods.	M.C.R., C. Div.	G.T.R., L.L., S. Div.	Total.
1893.													
Jan. 31	M.C.R., C. Div. ....	690	933	285	9	115					2,032		
do	31 G.T.R., L.L., S. Div. ....	608	73	208	4	145	3					1,041	3,073
Feb. 28	M.C.R., C. Div. ....	735	98	303	26	81	1				1,244		
do	28 G.T.R., L.L., S. Div. ....	620	34	199	5	91	2			1		952	2,196
Mar. 31	M.C.R., C. Div. ....	646	49	351	23	7	2				1,150		
do	31 G.T.R., L.L., S. Div. ....	724	49	218	11	53	3			1		1,059	2,209
April 30	M.C.R., C. Div. ....	711	151	230	24	102	4				1,222		
do	30 G.T.R., L.L., S. Div. ....	734	63	204	11	90						1,102	2,324
May 31	M.C.R., C. Div. ....	720	76	62	21	62	2				943		
do	31 G.T.R., L.L., S. Div. ....	653	43	40	12	59	1					810	1,753
June 30	M.C.R., C. Div. ....	665	32	9	21	36	4		1		768		
do	30 G.T.R., L.L., S. Div. ....	563	29	5	6	65						668	1,436
July 31	M.C.R., C. Div. ....	598	37	7	13	38	6		7		706		
do	31 G.T.R., L.L., S. Div. ....	613	29	20	6	80						748	1,454
Aug. 31	M.C.R., C. Div. ....	551	77	27	18	44	5		1		723		
do	31 G.T.R., L.L., S. Div. ....	614	21	41	9	95	1					781	1,504
Sept. 30	M.C.R., C. Div. ....	554	159	47	22	95	9		1		887		
do	30 G.T.R., L.L., S. Div. ....	601	97	70	15	138	5					926	1,813
Oct. 31	M.C.R., C. Div. ....	453	237	56	16	128	7				897		
do	31 G.T.R., L.L., S. Div. ....	786	100	115	14	230	13	1				1,259	2,156
		12,841	2,387	2,497	276	1,826	68	1	10	2	10,572	9,346	19,918

L. SLATER,  
*Inspector.*

ST. THOMAS, 31st December, 1893.

## Department of Agriculture.

**REPORT** of Miscellaneous Shipments of Local Live Stock from St. Thomas to Montreal and to Toronto by the Grand Trunk Railway, and from Points east and west of St. Thomas on the Grand Trunk Loop Line, Southern Division, and from the Michigan Central, Canada Division, west of St. Thomas, to Montreal and Toronto, *via* the Canadian Pacific Railway, showing the number of cars.

Date.	Company.	Montreal.				Toronto.			M.C.R., C. Div.	G.T.R., L.L., S. Div.	Total.
		Cattle.	Hogs.	Sheep	Horses.	Cattle.	Hogs.	Horses.			
1893.											
Feb. 28	M.C.R., C. Div. ....					1	2		3	3	
May 31	M.C.R., C. Div. ....					1	1		2		
do 31	G.T.R., L.L., S. Div. ....	1	1						2	4	
July 31	M.C.R., C. Div. ....	10				6		1	17		
do 31	G.T.R., L.L., S. Div. ....	10	1			2			13	30	
Aug. 31	M.C.R., C. Div. ....	15			1	20			36		
do 31	G.T.R., L.L., S. Div. ....	7				5			12	48	
Sept. 30	M.C.R., C. Div. ....	10				7		1	18		
do 30	G.T.R., L.L., S. Div. ....				1				1	19	
Oct. 31	M.C.R., R. Div. ....	1	1			9	1		12		
do 31	G.T.R., L.L., S. Div. ....	1				1			2	14	
		55	3		1	53	4	2	88	30	118

### WEST BOUND.

**WEST** Bound Shipments of Live Stock from through points in the Eastern States and from local points in Canada to the Western States by the Michigan Central, Canada Division, and Grand Trunk Loop Line, Southern Division Railroads, showing the number of cars of each kind.

Date.	Company.	Through Horses.	Local Horses.	Jackasses.	Through Sheep.	Local Sheep.	Live Stock and Household goods.	M.C.R., C. Div.	G.T.R., L.L., S. Div.	Total.
Jan. 31	M.C.R., C. Div. ....	2	2					4		4
Feb. 28	do	1						1		1
Mar. 31	do	9	2				2	13		13
April 30	do	11	2				1	14		14
May 31	do	8	2					5		5
June 30	do			4				4		4
July 31	do	4						4		4
Aug. 31	do	10	1		1			12		12
Sept. 30	do	4			4			10		
do 30	G.T.R., L.L., S. Div. ....						1		1	11
Nov. 30	M.C.R., C. Div. ....	2						2		
do 30	G.T.R., L.L., S. Div. ....									2
		46	9	4	5	1	5	69	1	70

## LOCAL TO BUFFALO.

REPORT of the Miscellaneous Shipments of Local Live Stock to Buffalo on the Grand Trunk Loop Line, Southern Division, and on the Michigan Central, Canadian Division, and from the Canadian Pacific Railroad at St. Thomas and *via* Michigan Central to Buffalo, showing the different kinds and the number of cars.

Date.	Company.	To Buffalo.			M.C.R., C. Div.	G.T.R., L.L., S. Div.	Total.
		Lambs.	Hogs.	Horses.			
1893.							
Jan. 31.	M.C.R., C. Div.	19			19		
do 31.	G.T.R., L.L., S. Div.	23				23	42
Feb. 28.	M.C.R., C. Div.	2			2		
do 28.	G.T.R., L.L., S. Div.	1	3			4	6
Mar. 31.	M.C.R., C. Div.						
do 31.	G.T.R., L.L. Div.			1		1	1
April 30.	M.C.R., C. Div.		2		2		2
do 30.	G.T.R., L.L., S. Div.		3			3	3
May 31.	do		3			3	3
June 30.	M.C.R., C. Div.			1	1		
do 30.	G.T.R., L.L., S. Div.		1			1	2
July 31.	do	1				1	1
Aug. 31.	M.C.R., C. Div.	1		1	2		2
Sept. 30.	do	5			5		5
Oct. 31.	do	10			10		
do 31.	G.T.R., L.L., S. Div.	6	1			7	17
		28	13	3	41	43	84

L. SLATER,  
*Cattle Guardian.*

ST. THOMAS, 31st October, 1893.

Department of Agriculture.

No. 20.

REPORT ON INSPECTION OF STOCK IN TRANSIT.

(JAMES BOWLER, V.S.)

WINDSOR, ONT., 1st November, 1893.

SIR.—I have the honour to submit to you my third annual report for the inspection ending 31st October, 1893, of American stock passing through Canada in bond, also imported into Canada (local) crossing at the port of Windsor by Canada Southern, *via* Michigan Central, Grand Trunk and Canadian Pacific railways. There are two railways feeding the Grand Trunk at Detroit: Wabash, and Detroit, Grand Haven and Milwaukee railways. Fewer swine crossed at this port during the past season as compared with the previous year. The stock men report that this is owing to a scarcity.

The stock have been in in an exceedingly clean and healthy condition. I beg leave to say the railway officials at each road in Detroit have a man to clean dirt off the sides of the cars, such being liable to drop off in transit. We get a dead hog and sheep occasionally. We have them taken out before entering Canada. The hogs die, I believe, from being exhausted somewhat in loading, and are smothered with others piling upon them. The dead ones are invariably large fat hogs. Farmers in the county of Essex have suffered from outbreaks of hog cholera; and from its being known that I have had considerable experience in this disease in this county during the past twelve years, I have had a great many interviews with the farmers since I was appointed Inspector. It is some time since I have had a complaint from them, and I am pleased to say the hog cholera is about stamped out in this county.

I shall use every precaution in regard to the inspection of hogs crossing at this port. It is a noticeable fact that the empty stock cars are returned in a clean and disinfected condition, and inspection is so arranged that the stock cannot pass without being inspected. I can say the inspection at this port is carried on in a strict and efficient manner.

I have the honour to be, sir,

Your obedient servant,

JAMES BOWLER, V.S.,  
*Inspector of Stock.*

The Honourable  
The Minister of Agriculture,  
Ottawa.

FOLLOWING is a List of Stock inspected per month by Drs. F. W. Mathews, R. F. Golden and James Bowler.

## STOCK IN TRANSIT AND IN BOND.

1893.	Cars.	Cattle.	Swine.	Sheep.	Calves.	Horses.
January .....	1,971	12,769	85,751	52,452	344	137
February .....	1,528	15,426	13,043	75,730	476	221
March .....	1,347	11,236	12,130	84,258	378	202
April .....	1,474	14,863	20,553	68,161	706	229
May.....	1,117	15,165	11,454	23,272	637	2 mules- 312
June.....	782	11,485	5,394	4,200	499	260
July.....	788	10,809	5,569	5,052	478	75
August.....	903	10,404	12,502	16,027	447	66
September .....	1,081	11,751	27,524	22,970	558	152
October .....	1,091	19,874	34,993	27,129	860	168
Total .....	12,082	133,782	228,913	379,251	5,383	1,822 2 mules.

## LOCAL STOCK FOR CANADA.

1893.	Cars.	Sheep.	Horses.
January.....	1		1
February.....	1		3
March.....	3		9
April.....	7		21
May.....	1		1
June.....	1		13
July.....	2		5
August.....	4		60
September.....	9		83
October.....	10	45	32
Total.....	39	45	228



Department of Agriculture.

No. 21.

REPORT ON ONTARIO CATTLE QUARANTINE.

(PROF. ANDREW SMITH, F.R.C.V.S.)

OFFICE OF GOVERNMENT VETERINARY INSPECTOR, FOR PROVINCE OF ONTARIO.

TORONTO, 31st October, 1893.

SIR,—I beg to inclose report received from Mr. E. P. Westell, Veterinary Surgeon, in charge of quarantine at Point Edward; as to the number of cattle and swine received into quarantine to October 31st.

I have also very great pleasure in reporting that the horses and cattle of this province have been singularly healthy.

There have been a few cases of swine fever, but the outbreaks have been readily controlled.

I again state that contagious pleuro-pneumonia, has never existed in this province.

I have the honour to be, sir,

Your obedient servant,

ANDREW SMITH, F.R.C.V.S.

The Honourable  
The Minister of Agriculture,  
Ottawa.

## No. 22.

## REPORT OF POINT EDWARD (ONT.) CATTLE QUARANTINE.

(E. P. WESTELL, V. S.)

SARNIA, 31st October, 1893.

SIR,—I beg to submit my annual report of cattle and swine received into the Ontario Cattle Quarantine for the year ending 31st October, 1893.

I may state that there has been a slight decrease in the number of cattle imported, and also that they were of an inferior class in comparison to those of former years.

The import of swine was fair, and many of them were of excellent quality and breeding.

In addition to the cattle and swine imported for breeding purposes, we have now in quarantine the Canadian cattle and swine which were returned from the World's Columbian Exposition.

The cattle are in excellent health and condition, but I regret very much to state that in fifteen days after the swine were received into quarantine we had a serious outbreak of hog cholera. However, up to the time of writing, we have only lost ten animals diseased, the balance of the herd remaining healthy as yet, and owing to the prompt isolation of those discovered and also those that were exposed, together with a free use of disinfectants, fumigation, &c., the disease has made no further advance, and I am strongly of the opinion that we will not have much more trouble, although this disease is of an insidious nature and demands the most careful attention for some considerable time.

I may state that there is but little doubt that those pigs came in contact with the disease germ when being shipped from Chicago, as they were driven over a platform subsequent to a herd of American swine which was believed to be affected with cholera—of the presence of which I am satisfied that the owners of the Canadian swine had no conception of at the time.

Believe me to be, sir,

Your obedient servant,

E. P. WESTELL, V. S.,

*Inspector.*

The Honourable  
The Minister of Agriculture,  
Ottawa.

## Department of Agriculture.

### ANNUAL Report of Swine received into the Ontario Cattle Quarantine for the Year ending 31st October, 1893.

Date of Entry.	White Chester.		Poland Chinas.		Duroc Jerseys.		Berkshires.		Victoria.		Removal.	Valuation.	Consignee and Address.
	M.	F.	M.	F.	M.	F.	M.	F.	M.	F.			
1893.											1893.	\$ cts.	
Jan. 12											Feb. 1	80 00	H. Jones, Ingersoll, Ont.
do 12			1	1							do 1	25 00	W. N. Tope, Ridgetown, Ont.
do 26					1	1					do 15	50 00	Peter Lamarsh, Whently, Ont.
Feb. 1			2	1							do 21	75 00	Wm. Rowe, Ingersoll, Ont.
do 2				1							do 22	50 00	do do
do 13					1	1					May 6	35 00	Peter Lamarsh, Whently, Ont.
do 25	1	1									do 16	40 00	H. Harding, Thorndale, Ont.
Mar. 14									1	2	April 4	50 00	Revd. Trappist Fathers, Two Mountains, Que.
do 29								1			do 18	30 00	S. Coxworth, Claremont, Ont.
April 7				1							do 27	35 00	Capt. A. W. Young, Tupperville, Ont.
do 12					1						May 3	20 00	Tope Bros., Ridgetown, Ont.
May 29					1						June 19	40 00	D. McKillop, Dutton, Ont.
do 31				1							do 20	20 00	S. Coxworth, Claremont, Ont.
June 2	1	1									do 22	25 00	Daniel de'Corcy, Mitchell, Ont.
July 1					1	1					July 21	20 00	S. L. Hoover, Stouffville, Ont.
do 6					1	1					do 26	25 00	S. Barefoot, Chatham, Ont.
do 17							1	1			Aug. 7	25 00	C. T. Garbutt, Claremont, Ont.
Aug. 31	1								1		Sept. 20	40 00	Wm. Buttler, ———
Sept. 6											do 26	50 00	Rev. Trappist Fathers, Two Mountains, Que.
do 13				1							Oct. 4	35 00	Capt. A. W. Young, Tupperville, Ont.
Oct. 11					1	1					Nov. 1	40 00	J. E. Small, St. Thomas, Ont.
do 26					1						In quar.	25 00	Wm. S. Burkholder, Hawtry.
do 28	1	1									do	40 00	Robt. Barnes, London, Ont.
Total..	4	3	7	7	6	3	1	2	2	2		875 00	

### REPORT of Canadian Swine returned from World's Columbian Exposition, Chicago.

Date of Entry.	Large Yorkshires.		Suf-folks.		Essex.		Poland China.		Tam-worths.		White Ches-ters.		Consignee and Address.
	M.	F.	M.	F.	M.	F.	M.	F.	M.	F.	M.	F.	
1893.													
Oct. 16	7	12	1		10	4	2	2					Joseph Featherson, Springfield, Ont.
do 16	4	16									1	3	J. E. Beathons, Burford, Ont.
do 16									1	1			John Bell, Amber, Ont.
do 16									1	2			James Calvert, Thedford.
Total..	11	28	1		10	4	2	2	2	3	1	3	

E. P. WESTELL, V.S.,  
Inspector.

ANNUAL Report of Cattle received into the Ontario Cattle Quarantine for the Year ending 31st October, 1893.

Date of Entry.	Holstein.		Durhams.		Jerseys.		Grades.		Valuation.	Removal.	Consignee and Address.
	M.	F.	M.	F.	M.	F.	M.	F.			
1893.									\$ cts.		
Jan. 26					1				40 00	Yet in quar.	Geo. Pugsley, Collingwood, Ont.
Feb. 9					1				25 00	May 9	J. W. Humpridge, London, Ont.
do 28		4							100 00	Yet in quar.	Geo. Pugsley, Collingwood, Ont.
Mar. 2						1			40 00	May 30	Mrs. Kate Sterling, Belt River, O.
do 2	3	25							4,000 00	do 30	McDuffer & Butters, _____, Que.
do 9	1	1							30 00	June 6	W. Ronan, Bearbrook Crossing, O.
April 18	1	2							100 00	Aug. 20	Geo. Pugsley, Collingwood, Ont.
do 18						2			50 00	do 20	do do
do 28			1	1					50 00	July 26	J. A. McGillvary, Q. C., Toronto, O.
do 29							3		75 00	do 27	Mrs. Hamilton Settler, Niagara Falls, Ont.
June 16	1								50 00	Sept. 13	Thos. Lamy, Yamachiche, Que.
July 5					3					Oct. 2	Salmon Club, Metapedia, Que.
Aug. 30	1									Yet in quar.	Louis P. Hubbs, Hillier, Ont.
Total..	7	32	1	1	5	3		3	4,560 00		

E. P. WESTELL,  
Inspector.

SARNIA, 31st October, 1893.

Department of Agriculture.

Report of Canadian Cattle returned from the World's Columbia Exposition, Chicago.

Date of Entry.	Holstein.		Durham.		Polled Angus.		Hereford.		Ayrshire.		Jersey.		Galloway.		Devons.		Guernsey.		Consignee and Address.
	M.	F.	M.	F.	M.	F.	M.	F.	M.	F.	M.	F.	M.	F.	M.	F.	M.	F.	
1893.																			
Sept. 11																			Robt. Robertson, Howich, Que.
do 11										4									Thos. Irvin, Montreal, Que.
do 11										6									D. Drummond, Petitecote, Que.
do 11										3									Thos. Watson, North Georgetown, Que.
do 11										1									Wm. Steward & Son, Menie, Ont.
do 11										4									Thos. Guy, Oshawa, Ont.
do 11										4									Yull & Son, Carleton Place, Ont.
do 11										4									Wm. Smith, Fairfield Plains, Ont.
do 11										4									G. W. Greenfield, Danville, Que.
do 11										6									Dr. Craig, Montreal, Que.
do 11						4													Wm. Kough, Owen Sound, Ont.
do 11																			W. J. Rudd, Eden Mills, Ont.
do 11																			J. C. Snell, Edmond, Ont.
do 11												1							H. D. Smith, Compton, Que.
do 11																			F. A. Fleming, Weston, Ont.
do 11																			J. & W. Russell, Richmond Hill, Ont.
do 11																			John Morgan & Son, Kerwood, Ont.
do 11																			F. Birdsall & Son, Birdsall, Ont.
do 11																			W. C. Edwards, Rockland, Ont.
do 11																			R. & S. Nickleson, Sylvan, Ont.
do 11																			W. Bl Cockburn, Averfoyle, Ont.
do 11																			W. G. Saunders, St. Thomas, Ont.
do 11																			R. Gibson, Ilderton, Ont.
Oct. 1	2	6																	J. G. McNiven, Wenona, Ont.
	2	6	19	37	4	7	7	13	30	44	1		5	5	5	8	2		

E. P. WESTELL, V.S.,  
Inspector.

SABINIA, 31st October, 1893.

## No. 23.

## REPORT ON KOOTENAY (B. C.) CATTLE QUARANTINE.

CUSTOMS, EAST KOOTENAY, B. C.,

FORT STEELE, 31st October, 1893.

SIR,—In reply to your letter of the 4th instant, *re* quarantine of cattle, I have only to report for the season one settler with stock, Mr. Wait Wade from United States. He brought in fifty-seven head of horses and cattle, viz:—20 cows, 10 calves, 19 yearlings, 6 horses, 2 colts. I found the above cattle and horses free from contagious disease, also the prospectors' horses from the United States. Stock throughout this district are free from contagious disease as far as I know.

I have the honour to be, sir,

Your obedient servant,

CHARLES CLARK,

*Sub-Collector.*

The Honourable  
The Minister of Agriculture,  
Ottawa.

# Department of Agriculture.

No. 24.

## REPORT OF EMERSON (MAN.) CATTLE QUARANTINE.

(D. H. McFADDEN, V.S.)

EMERSON, 31st October, 1893.

SIR,—By direction of your department, I have the honour to submit my tenth report which, in this instance, covers a period of ten months only.

Accompanying my report I append the customary tabulated statements showing:—

1. The horses and mules imported, their importers, whence, and their point of destination in each case.
2. The cattle imported and details as above.
3. The sheep table and details.
4. Table of swine and details as in other classes.
5. A comparative table showing the volume of imports under each head.

Turning naturally to this last table, it would appear at first glance to betoken a very serious falling off in stock of all kinds except swine. This impression is, however, deceptive; for, in the first place, these tables cover a period of ten months only, whereas the reports of previous years have embraced the whole term of twelve months. Then, as regards the most important particular, the importation of cattle, there is a very full and satisfactory explanation to be made for the undoubted falling off in numbers. The table under review exhibits a five-fold increase in cattle from 1890 to 1891, as also the maintenance of this satisfactory increase in 1892 and then the very visible drop in 1893, of which the fact that this is only a ten months' report, is not sufficiently explanatory.

In my report for 1890, I had the honour to submit that my certificate of inspection, accompanied by a sworn affidavit of the settler, stating: (1) the locality from which he came; (2) that the cattle had been in his possession for at least 3 months prior to the date of entry into this province, and (3) that said locality was free from contagious disease or suspicion thereof amongst cattle, was sufficient in the cases of all *bona fide* settlers. These, it will be readily understood, brought only such as they had bred themselves; they do not usually have money enough at the time of their immigration to buy more cattle simply for export. Cattle in 1891 and 1892 were admitted into this province and the territories on these terms and without the rigid and literal enforcement of the ninety days' quarantine. This elastic arrangement induced settlers to bring their cattle along with them instead of sacrificing them just on the eve of their immigration (a practice which had previously obtained), and the consequence was as indicated in the comparative table.

In 1893, however, the strictest quarantine of ninety days was insisted upon in all cases and the settler had to leave his cattle at the quarantine and lose the use of them for that period of time. This stringency was not long in getting noised abroad amongst other intending immigrants, who forthwith sold, gave away, exchanged or otherwise disposed of their cattle possessions. Hence the shortened term covered by this report and the literal and strict interpretation of the quarantine regulations are distinctly responsible for the falling off in the number of cattle imported this year.

The falling off in the number of horses imported is strongly indicative of the prosperity of the Canadian North-west; for, whereas, in 1892 there were 38

entries of horses in car lots for sale purposes, in 1893 we find but four such entries. More horses have been required than in any previous year, of course, but Manitoba and the North-west Territories can, and do now raise sufficient horses to supply the home market. Indeed, it is safe to assert that the day is now at hand when these provinces will be exporters, rather than importers of horses.

With respect to sheep and swine, it is in my opinion (and as stated in my report a year ago), to be deplored that settlers do not bring more of this class of stock with them, as no other class of animals gives such quick and profitable returns.

The most notable incident of the past year, however, which I have to chronicle, has relation to improvements at the quarantine at Gretna. On the 28th of March last, in conjunction with Commissioner Herchmer, of the North-west Mounted Police, we leased the race track and grounds of the Gretna Turf Club, which we found inclosed by a close board fence 10 feet high. The inside space was at once divided into separate yards by means of portable fences, in which were erected sheds and feed boxes, as also box stalls for weak cattle or calving cows. All this was done whilst keeping well in view economy in the use of lumber, and the keeping down of expense generally, compatible with the proper care and comfort of the cattle whilst in charge of the quarantine. Much of the lumber was so cut that it can be again used in the erection of other permanent buildings if so desired, or it can be removed to the Emerson quarantine with very little loss.

That the quarantine arrangements were complete and satisfactory the incoming settlers will themselves testify, many regretting they had not been able to bring more cattle along with them, on viewing the preparations made for their care and comfort during their 90 days' detention. In all, there were in quarantine 568 head of cattle, to which account there must be added 36 births, whilst only six deaths have to be recorded: a gratifying fact, and reflecting, I would respectfully submit, to the credit of all concerned in the care of the two quarantine stations. The causes of these deaths were: One cow died from internal hemorrhage after calving; two small and weak yearlings which were admitted to quarantine early in April, and which in spite of the unremitting care and attention bestowed upon them by the attendants, seemed unable to gain strength and condition; the remaining three were young calves born in a weak condition, which died from chronic diarrhoea.

When it is considered that the class of animals quarantined were many of them of the inferior sort, and in wretchedly poor condition when admitted, in some cases having to be carried to quarantine, as they were unable to walk there, and further, that we were establishing a new quarantine, with all its incidental difficulties, it will not, I hope, be considered out of place if I venture to congratulate the department and those associated with me in the management and care of the cattle on the result of their labours.

It is important also to note that no case of sickness of a contagious character made its appearance amongst the cattle during the year.

In pursuance of instructions, the Gretna quarantine was practically closed in September last, it having been used since that time as a temporary place of detention for a couple of days for any cattle that might arrive, pending their transportation along the boundary line to the station at Emerson, where there is a sufficiency of substantial stabling and sheds, together with every facility for the proper care of the cattle during the severe winter months. There are at present 77 head in detention here, all doing well.

In conclusion, it is but fitting to record the invaluable services rendered by Commissioner Herchmer. His men, amongst whom was Staff-Sergeant Joyce, were unremitting in their care and attention to the stock in their charge at all times; that they were painstaking, not to say enthusiastic in the discharge of their duties is indisputably proven by the low death rate amongst the cattle whilst in quarantine. The Canadian customs as well as railway officials are also entitled to my acknowledgments for their courteous assistance to me in my duties as quarantine inspector.



## Department of Agriculture.

And finally, I trust I may be permitted to say that the past has been the most arduous year's work since my first connection with your department ten years ago, but that in performance and effect it has been thorough and conducive to the best interests of the Dominion.

I have the honour to be, sir,  
Your obedient servant,

D. H. McFADDEN, V.S.

*Inspector.*

The Honourable  
The Minister of Agriculture,  
Ottawa.

### DETAILED Report of Horses and Mules inspected at Emerson and Gretna Quarantine Stations.

Date.	Name of Owner.	Where from.	Destination.	Horses and Mules.
1893.				
Jan. 6.	W. Galloway	St. Thomas, N. D.	Innisfail, N.W.T.	1
Feb. 9.	A. Yeandle	Chicago, Ill	Winnipeg, Man.	1
do 9.	C. Wilson	do	Regina, N.W.T.	2
do 25.	J. C. Morison	Bathgate, N. D.	Edmonton, N.W.T.	1
do 27.	do	do	do	2
do 28.	do	do	do	1
March 2.	W. Nelson	Mountain, N. D.	Prince Albert, N.W.T.	6
do 7.	Geo. Bevington	Nebraska	Edmonton, N.W.T.	2
do 7.	A. E. Evans	do	do	2
do 7.	H. Neal	do	do	4
do 15.	R. Grandy	Bathgate, N. D.	do	3
do 17.	R. Hulbert	Crystal, N. D.	do	6
do 22.	F. W. Wall	do	Clearwater, N.W.T.	2
do 26.	J. A. Hanson	Emporia, Neb	Edmonton, N.W.T.	4
do 26.	C. F. Brideen	do	do	8
do 26.	W. Robinson	Brunswick, Neb.	do	5
do 26.	R. Swan	do	do	10
do 26.	Geo. Maynard	Reed City, Neb.	Caron, Man.	2
do 26.	I. J. Willows	Cedar Bluff, Neb.	Edmonton, N.W.T.	6
do 28.	Alf. Myers	Peabody, Kansas	Didsbury (Calgary)	4
do 28.	Absalom Myers	do	do	4
do 30.	J. Morgin	Neche, N. D.	Edmonton, N.W.T.	1
do 31.	W. P. Cornwill	Leigh, Neb	Olds, N.W.T.	4
do 31.	R. D. McKee	do	do	8
do 31.	Ed. Barne	Schuyler, Neb	do	7
do 31.	H. R. Moore	Leigh, Neb	do	4
do 31.	R. Smith	Schuyler, Neb	do	8
do 31.	D. McRae	do	do	5
do 31.	J. McIntosh	do	do	9
do 31.	Nels. Oslen	do	do	2
do 31.	J. H. Lawrence	do	do	4
do 31.	E. Laurence	do	do	8
do 31.	J. Courtney	Rogers, Neb.	do	11
do 31.	A. Lawrence	Schuyler, Neb	do	2
do 31.	W. M. Lawrence	do	do	2
do 31.	A. Hilbert	Rogers, Neb	Alberta, N.W.T.	6
do 31.	L. J. Sarnis	do	do	5
do 31.	J. Sarnis	do	Olds, N.W.T.	3
do 31.	C. McLaughlin	do	do	7
do 31.	A. C. Judd	Nebraska	Winnipeg, Man.	2
do 31.	N. Peterson	do	do	2
do 31.	J. Edmondson	do	do	4
do 31.	J. Sarnis	do	do	5
do 31.	Geo. M. Groat	do	do	3
do 31.	Thos. Preston	do	do	5
April 2.	J. Morgin	Neche, N. D.	Edmonton, N.W.T.	4
do 2.	J. Lambert	Grand Forks, N. D.	Alberta, N.W.T.	6

DETAILED Report of Horses and Mules inspected at Emerson and Gretna Quarantine Stations.—Continued.

Date.	Name of Owner.	Where from.	Destination.	Horses and Mules.
1893.				
April	3. J. McMartin	Hoople, N. D.	Leduc, N. W. T.	6
do	4. R. Bell	Glarston, N. D.	Oxbow, N. W. T.	4
do	4. J. Morgin	Neche, N. D.	Edmonton, N. W. T.	1
do	5. F. Miller	St. Thomas, N. D.	Innisfail, N. W. T.	6
do	5. W. Galloway	do	do	5
do	5. Geo. Gillis	do	do	4
do	5. F. Lambert	Thompson, N. D.	Wetaskewin, N. W. T.	7
do	5. M. Lambert	do	do	3
do	7. Mat. Redmond	Wynona, Minn.	Moosomin, N. W. T.	2
do	8. J. Brundle	Grafton, N. D.	Edmonton, N. W. T.	1
do	10. T. H. Moorhouse	Hazel, S. D.	Lumsden do	4
do	12. J. G. Parker	Oakdale, Neb.	Alberta do	8
do	16. L. E. McMinch	Erving, Neb.	Prince do	5
do	16. F. A. Prumus	do	do do	1
do	16. D. Currie	Grafton, N. D.	Edmonton do	3
do	16. A. McDonald	do	do	1
do	17. W. Schincke	Stanton Co. Neb.	do	2
do	17. L. LaChappella	McIntosh, Minn.	do	3
do	18. M. Cranger	Palmer, Kansas	do	8
do	18. J. B. Charrette	St. Joe, N. E.	Rat River, Man.	1
do	20. J. VanHorn	Chadron, Neb.	Edmonton, N. W. T.	9
do	27. L. Gardner	Emperia, Neb.	do	4
May	5. J. Rae	Mallory, Minn.	Prince Albert, N. W. T.	6
do	R. W. Hunt	Emperia, Neb.	Edmonton, N. W. T.	9
do	5. J. Wade	Aberdeen, S. D.	do	3
do	10. H. J. Carleton	Grand Forks, N. D.	Winnipeg, Man.	1
do	11. G. M. Webb	Alexander, Minn.	do	1
do	18. H. Bush	Luddon, S. D.	Lacombe, N. W. T.	3
do	18. G. T. Campbell	Scotland, S. D.	Edmonton do	2
do	18. J. McNicol	do	do	4
do	21. D. Newfield	Parker, S. D.	Prince Albert, do	3
do	23. J. Watson	Moorhead, Minn.	Calgary do	7
do	26. F. Bear	Demison, Iowa.	Portage la Prairie, Man.	2
do	29. G. Doze	Blimfield, Neb.	Edmonton, N. W. T.	6
do	29. W. Foster	Clerk Co. S. D.	Leduc do	2
do	29. A. Hendrickson	Dickson, Neb.	Edmonton do	1
do	29. J. Cross	Blumfield, Neb.	do	8
June	1. J. B. Charratte	St. Joe, N. D.	St. Mayo, Man.	5
do	5. H. A. Bayley	Coleridge, Neb.	Lacombe, N. W. T.	10
do	6. J. L. Rose	Pembina Co. N. D.	Arden, Man.	6
do	10. J. Prove	Wright Co. Minn.	Edmonton, N. W. T.	5
do	12. W. X. Dixon	Bowdle, S. D.	Elkhorn, Man.	6
do	16. A. Good	Eureka, S. D.	Dunmore, N. W. T.	4
do	22. D. Wright	Hamilton, N. D.	Penhold do	3
do	23. J. A. Greenmond	Pembina, N. D.	Gretna, Man.	2
do	22. T. Rooney	Bathgate, N. D.	do	4
do	22. W. Bride	do	do	2
July	8. W. Watson	Neche, N. D.	Portage la Prairie, Man.	1
do	21. D. W. Marshall	Port Austin, Mich.	Winnipeg, Man.	1
do	22. J. Hudson	Aberdeen, S. D.	Edmonton, N. W. T.	10
Aug.	7. J. J. Witherick	Plato, Minn.	do	3
do	15. B. Schragg	Neche, N. D.	Gretna, Man.	1
do	22. H. Lynn	St. Thomas, N. D.	Carnduff, N. W. T.	8
Sept.	4. J. H. Rudel	Doland, S. D.	Edmonton do	9
do	6. J. F. Sanderson	Warner, S. D.	Carman, Man.	5
do	15. J. Turner	Chicago, Ill.	Winnipeg do	2
do	21. E. J. Penemene	Moorhead, Minn.	Brandon do	1
do	26. J. Fulton	Crystal, N. D.	Lake Dauphin, Man.	2
do	30. H. G. Lincoln	Lebanon, S. D.	Prince Albert, N. W. T.	8
Oct.	5. J. L. Rose	Cavilier, N. D.	Arden, Man.	4
do	5. E. W. Schmidt	Putney, S. D.	Crystal City, Man.	2
do	10. J. Kavanagh	Clay City, Kansas	Edmonton, N. W. T.	2
do	10. M. Cassidy	Kansas	do	2
do	19. M. E. Darough	Bethinghan, Minn.	do	5
do	22. A. Bayley	Coleridge, Neb.	Lacombe, N. W. T.	10

## Department of Agriculture.

### DETAILED Report of Horses and Mules inspected at Emerson and Gretna Quarantine Stations.—*Concluded.*

Date.	Name of Owner.	Where from.	Destination.	Horses and Mules.
1893.				
October 27	C. N. Anderson	Marshall County, S.D.	Edmonton, N.W.T.	4
do 27	W. LaClerc	do do	do do	6
do 30	J. Northwood	Riverdale, N.D.	Lacombe do	4
do 30	J. W. Fossett	Guelph, N.D.	do do	4
do 30	Winder and Yeandle	Chicago, Ill	Moosomin do	2
Jan. 6	R. T. Houston	St. Thomas, N.D.	Edmonton do	6
do 20	Little and D'Orsey	Waterloo, U.S.	Winnipeg, Man.	2
Feb. 14	H. Munroe	Glaston, N.D.	Emerson do	3
do 26	T. McKenzie	Strathroy, Ont.	Wawanesa do	9
March 3	G. R. Morkill	Wales, Ont.	Winnipeg do	16
do 6	J. T. Charleton	Strathroy, Ont.	Portage la Prairie, Man.	19
do 9	R. Frise	Ashland, U.S.	Winnipeg, Man.	2
do 10	Little and D'Orsey	Waterloo, U.S.	do do	1
do 17	R. Hunt	Sembina, N.D.	McGregor do	7
do 18	J. Harrison	Woodstock, N.D.	Winnipeg do	5
do 19	Christie and Fares	Iowa, U.S.	Emerson do	12
do 23	T. A. Craig	Waterville, Kan.	Virden do	3
do 24	J. W. Brown	Tynor, N.D.	Emerson do	1
April 7	A. J. Andrews	United States.	Winnipeg do	1
do 8	J. E. Taylor	Warren, Minn.	Edmonton, N.W.T.	2
do 14	J. Carsner	Stratford, Ont.	Morris, Man.	2
May 22	J. Linsey	United States.	Brunswick, Man.	4
do 23	R. T. Bruce	Creighton, Neb.	Lacombe, N.W.T.	2
June 15	L. Bancroft	Ontario.	Westbourne, Man.	2
do 16	J. Marshall	United States.	Alberta, N.W.T.	8
do 27	G. S. Herdman	Nebraska, N.S.	do do	6
do 27	S. A. Roberts	do do	do do	2
do 29	W. Mills	Blythe, Ont.	Wawanesa, Man.	16
July 13	W. Wilson	Watford, Ont.	Brandon do	17
do 18	D. Dick	Pembina, N.D.	Winnipeg do	2
do 25	W. Yeo	Hallock, U.S.	Douglas do	2
August 22	J. Sanders	Pembina, N. D.	Emerson do	2
do 24	T. A. Thynne	Scotland, U.S.	Portage la Prairie, Man.	5
Sept. 5	J. Carling	Rochester, Minn.	Winnipeg, Man.	1
do 25	J. Gallich	Pembina, N.D.	Emerson do	2
do 27	J. R. Woolley	Park River, U.S.	do do	4
October 8	F. Schooley	Merriton, Ont.	Midina do	4
do 12	J. Bladen	Nebraska, U.S.	Alberta, N.W.T.	4
do 12	G. Bladen	do do	do do	4
do 17	G. Keech	Barboo, Wis.	Brunswick, Man.	5
do 23	M. Anderson	United States.	Manitoba, do	2
do 24	S. V. Stewart	Hamilton, N.D.	Emerson do	2
do 27	E. B. Cooper	Redwood, Minn.	Morden do	2
Total.....				680

D. H. McFADDEN, V.S.  
*Inspector.*

EMERSON, 31st October, 1893.

DETAILED Report of Cattle inspected at Emerson Cattle Quarantine Station, 1893.

Date.	Name of Owner.	Where from.	Destination.	Cows.	Oxen.	Bulls.	Heifers.	Steers.	Calves.	Births in Quarantine.	Deaths.	(Grand total.
Jan. 6.	G. Gillis	St. Thomas, N.D	Imnisfail, N.W.T	1								
do 28.	Paul Froise	Neeche, N.D	Kathwell, Man.	2								
March 26.	Brideen	Emporia, Neb.	Edmonton, N.W.T.	5			21		2	5		
do 26.	Geo. Maynard	Reed City, Neb.	Caron	1								
do 28.	Alf. Myers	Feabody, Kansas	Calgary, N.W.T	1			3			1	1	
do 31.	N. P. Cornwall	Leigh, Neb.	Olds, Alberta, N.W.T.	5			4		1	1		
do 31.	R. D. McKee	do	do	5		3	17		2	6	3	
do 31.	H. P. Moore	do	do	5					1	1		
April 2.	J. Morgan.	Neeche, N.D	Edmonton, N.W.T.	5		5	2		1	4		
do 3.	J. McMarin.	Hoopie, N.D	Leduc, N.W.T.									
do 3.	J. Morgan.	Neeche, N.D	Edmonton, N.W.T.	3			2			1		
do 5.	W. Galloway.	St. Thomas, N.D	Imnisfail, N.W.T	5			1		3	2		
do 5.	Geo. Gillis	do	do	15	2	3	10	4	4	6	1	
do 5.	F. Leambert	Thompson, N.D	Wetaskewin, N.W.T		2							
do 5.	M. Leambert.	do	do		2							
do 10.	J. Hickery	Clark Co., S.D.	Edmonton, N.W.T.	3			10		2	1		
do 12.	J. C. Parker	Oakdale, Neb.	Alberta, N.W.T.									
do 16.	D. Currie	Grafton, N.D	Edmonton, N.W.T.	2	2	1	5	2	1	1		
do 17.	F. Bedow	McIntosh, Min.	do	2	2	1	3		2	2		
do 17.	L. LeChapelle.	do	do	3	6	1	3	1	2	2		
do 17.	M. Junesau	do	do	1			8					
do 17.	A. Leambert.	do	do	4		1	1					
do 27.	R. W. Hunt.	do	do	4			1					
May 5.	J. Wade	Emporia, Neb	do	3			1		2			
do 18.	H. Bush	Aberdeen, S.D.	do	3			1					
do 21.	D. Newfield.	Ludlow, S.D	do	3			1					
do 29.	G. Doze	Parker, S.D	do	2	2							
do 29.	W. Foster	Blinfield, Neb.	do	6			4		2			
June 10.	J. Provo.	Clerk Co., S.D.	Edmonton, N.W.T.	4			5					
do 12.	W. H. Dixon	Wright Co., Min.	Edmonton, N.W.T.	3			5		1	1		
do 16.	A. Good	Bowels, S.D.	Edmonton, N.W.T.	3			5					
do 22.	D. Wright	Eureka, S.D.	Edmonton, N.W.T.	187			3					
do 22.	J. Hudson.	Hamilton, N.D	Edmonton, N.W.T.	3			3					
do 22.	J. Hudson.	Aberdeen, S.D.	Edmonton, N.W.T.	3			3					
July 17.	E. Larson	Moorehead, Min	Edmonton, N.W.T.	2			3					
do 19.	D. McDonough	Bethlehem, Min	Edmonton, N.W.T.	5	2	1	4		3			
do 19.	Christie & Fares.	Iowa, U.S	Edmonton, N.W.T.	3			1		1			
March 23.	J. A. Craig	Waterville, Kansas.	Varden, Man.	2			1		1			
do 23.	J. E. Taylor.	Warren, Min.	Edmonton, N.W.T.	2	5		1		1			



## DETAILED Report of Sheep inspected at Emerson and Gretna Quarantine Stations.

Date.	Name of Owner.	Where from.	Destination.	No. of Sheep.
1893.				
Jan. 6.	G. Gillis .....	St. Thomas, N.D. ....	Innisfail, N.W.T. ....	55
do 6.	W. Galloway .....	do .....	do .....	54
April 4.	R. Bell .....	Glarston, N.D. ....	Oxbow .....	135
do 17.	L. L. Chappella .....	McIntosh, Minn. ....	Edmonton, N.W.T. ....	3
May 21.	D. Newfield .....	Parker, S.D. ....	Prince Albert, N.W.T. ....	4
do 29.	G. Doze .....	Blimfield, Neb .....	Edmonton, N.W.T. ....	137
June 22.	D. Wright .....	Hamilton, N.D. ....	Penhold, N.W.T. ....	7
July 7.	J. Heppner .....	Neche, N.D. ....	Gretna, Man. ....	3
	Total .....	.....	.....	398

D. H. McFADDEN, V.S.,  
Inspector.

EMERSON, 31st October, 1893.

## Department of Agriculture.

### DETAILED Report of Swine inspected at Emerson and Gretna Quarantine Stations.

Date.	Name of Owner.	Where from.	Destination.	No. of Swine.
1893.				
March 17	R. Hulbert	Crystal, N.D.	Edmonton, N.W.T.	2
do 26	C. F. Brideen	Emporia, Neb	do	2
do 26	T. F. Willows	Cedar Bluff, Neb	do	2
do 31	W. P. Cornwill	Leigh, Neb.	Olds, N.W.T.	1
do 31	R. D. McKee	do	do	2
do 31	Ed. Barne	Schuyler, Neb	do	6
do 31	J. McIntosh	do	do	2
do 31	E. Lawrence	do	do	2
do 31	T. Preston	Nebraska	Winnipeg, Man.	2
do 31	H. P. Moore	Leigh, Neb.	Olds, N.W.T.	1
do 31	D. McRae	Schuyler, Neb	do	1
April 2	J. Morgin	Neche, N.D.	Edmonton, N.W.T.	5
do 2	J. McMartin	Hoople, N.D.	Leduc do	3
do 5	F. Miller	St. Thomas, N.D.	Innisfail, N.W.T.	3
do 5	W. Galloway	do	do	1
do 5	Geo. Gillis	do	do	8
do 17	F. Bedow	McIntosh, Minn.	Edmonton, N.W.T.	2
do 17	L. La Chappelle	do	do	3
do 17	M. Juneau	do	do	3
do 17	A. Lambert	do	do	1
do 27	L. Gardner	Emporia, Neb	do	1
do 27	R. W. Hunt	do	do	8
do 5	J. Wade	Aberdeen, S.D.	do	4
do 18	H. Bush	Luddon, S.D.	Lacombe, N.W.T.	2
do 29	W. Foster	Clegg Co., S.D.	Leduc do	12
Oct. 5	E. T. Smith	Putney, S.D.	Crystal City, Man	2
do 10	J. Kavanagh	Kansas.	Edmonton, N.W.T.	2
do 10	M. Cassidy	do	do	3
do 17	E. Larson	Moorehead, Minn.	Wetaskawin	2
do 18	D. McDonough	Bethingham, Minn.	Edmonton, N.W.T.	3
do 19	J. Harrison	Woodstock, N.D.	Winnipeg, Man.	1
do 19	Christie & Fares	Iowa, U.S.	Emerson, Man	10
June 2	W. H. Jones	Philadelphia	Kamloops, B.C.	2
do 2	Jones Bros	do	do	2
do 27	S. A. Roberts	Nebraska, U.S	Alberta, N.W.T.	2
do 27	G. S. Herdman	do	do	2
August 11	W. W. Fraser	United States.	Emerson, Man.	2
Oct. 30	J. Northwood	Riverdale, N.D.	Lacombe, N.W.T.	3
do 30	J. W. Fossett	Guelph, N.D.	do	5
Total				120

D. H. McFADDEN, V.S.,  
*Inspector.*

EMERSON, 31st October, 1893.

### COMPARATIVE Inspection Table, Emerson and Gretna, for the Years 1890-91-92-93.

Year.	Cattle.	Horses.	Sheep.	Swine.
1890.	229	732	137	258
1891.	1,022	1,767	123	275
1892.	1,199	1,375	495	111
1893.	568	680	398	120

D. H. McFADDEN, V.S.,  
*Inspector.*

EMERSON, 31st October, 1893.

## No. 25.

## REPORT OF THE POINT LEVIS CATTLE QUARANTINE.

(J. A. COUTURE, D. V. S.)

QUEBEC, P. Q., 29th October, 1893.

SIR,—I beg to transmit to you my annual report of live stock imported during this season till date.

There have been 917 sheep less than last year; there has also been a decrease of 2 swine compared with last year. Up to date there have been 11 more cattle than last year.

I have the honour to be, sir,

Your obedient servant,

J. A. COUTURE, D.V.S.,

*Assistant Inspector.*

The Honourable  
The Minister of Agriculture,  
Ottawa.

The total number of sheep are divided between the following breeds, viz :

Breeds.	For United States.	For Canada.	Total.
Shropshire .....	862	243	1,105
Oxfords .....	46	169	215
Dorsets .....	27	130	157
Lincolns .....		151	151
Hampshires .....	143		143
Cotswolds .....	64	15	79
Suffolk .....		27	27
South Down .....	3	13	16
Leicesters .....		12	12
Iceland .....		6	6
Total .....	1,145	766	1,911

The number of swine imported were as follow, viz. :

Breeds.	For United States.	For Canada.	Total.
Berkshires .....	2	9	11
Yorkshire .....		4	4
Tanworth .....		2	2
Total .....	2	15	17



Department of Agriculture.

STATEMENT of Cattle imported at Point Lévis Cattle Quarantine, 1893.

Date of Arrival.	Steamer.	Line.	From	No.	Breed.	Sex.	Owner.	Address.	Date of Sailing.	Date of Discharge.
1893.										
May 19	"Dominion"	Dominion	Cardiff	1	Guernsey	Bull	I. J. Greenshields	Danville, Que.	May 6	Aug. 3
July 21	"Mexico"	do	do	5	Ayrshire	Cows	R. G. Steacy	Brockville, Ont.	July 11	Oct. 9
Aug. 20	"Texas"	do	Bristol	5	do	do	do	do	Aug. 10	In quaran-
do 20	do	do	do	1	do	do	Alex. Hume	Burnbrae, Ont.	do 10	time.
			Total	12						

STATEMENT of Swine imported at Point Lévis Cattle Quarantine, 1893.

Date of Arrival.	Steamer.	Line.	From	Berkshires.			Yorkshires.			Tamworths.			Owner.	Address.	Date of Sailing.	Date of Discharge.
				Boars	Sows	Total	Boars	Sows	Total	Boars	Sows	Total				
1893.																
July 12	"Lake Winnipeg"	Beaver	Liverpool				1	2	3				I. J. Greenshields	Danville, Que.	July 1	Aug. 3
do 18	"Lake Superior"	do	do	1	1	2							Metcalf Bros.	Buffalo, N. Y.	do 8	do 2
do 18	do	do	do	1	2	3							J. G. Snell	Edmonton, Ont.	do 8	do 2
do 18	do	do	do					1	1				Jos. Featherstone	Straightville, Ont.	do 8	do 2
do 18	do	do	do		2	2				1	1		A. C. Hallman	New Dundee, Ont.	do 8	do 2
do 18	"Lake Winnipeg"	do	do	1	3	4					2	2	J. C. Snell	Edmonton, Ont.	do 8	do 4
Sept. 19			Total	3	8	11	1	3	4	1	1	2			Sept. 9	Oct. 4

J. A. COUTURE, D.V.S.,  
Assistant Inspector.



## Department of Agriculture.

Point Lévis Cattle Quarantine, 1893.

Suffolks.			South Downs.			Leicester.			Ice-landics.			Grand Total.	Owner.	Address.	Date of Sailing.	Date of Discharge.	
Rams.	Ewes.	Total.	Rams.	Ewes.	Total.	Rams.	Ewes.	Total.	Rams.	Ewes.	Total.						
													43	Robert Miller	Brougham, Ont	April 27	May 26
													117	A. O. Fox	Oregon, Wis	do 27	do 26
													37	Messrs. Reid & Wells	Souris, Man	May 6	June 3
													105	S. W. Hawkshaw	Glanworth, Ont.	do 6	do 3
													2	John Dryden	Brooklin, Ont	do 6	do 3
2	25	27											72	Gbison & Walker	Denfeld, Ont.	do 6	do 3
													27	W. B. Cockburn	Aberfoyle, Ont	do 30	do 24
													10	D. & A. McKenzie	Corwhin, Ont.	do 30	do 24
													10	Jas. P. Phin	Hespeler, Ont.	do 30	do 24
													13	T. W. Hector	Springfield on Credit, O.	June 30	July 27
													114	G. A. McGillvery	Uxbridge, Ont.	do 30	do 27
													39	Wm. Oliver	Avonbank, Ont.	July 1	do 27
													102	Cort Son & Co.	Marshall, Mich	do 1	do 27
			1		1								193	G. E. Breck	Paw Paw, Mich	do 1	do 27
													1	W. H. Cochran	Hillhurst, Que.	do 8	Aug. 2
													35	H. W. Rays	North Hoverhill, N.H.	do 8	do 2
													24	Geo. Allan	Alerton, Ills	do 8	do 2
													3	A. Bates	Irwin, Ohio.	do 8	do 2
													13	F. D. Ward	Byron, N.Y	do 8	do 2
													50	Chs. Best	Mukwonago, Wis	do 8	do 2
													123	A. O. Fox	Oregon, Wis	do 8	do 2
													45	Robt. Miller	Brougham, Ont	do 8	do 2
													11	M. Baily	Lewiston, N.Y	do 8	do 2
													35	T. G. McFee	Lenox, Iowa	do 8	do 2
													12	Geo. McKerrow	Sussex, Wis	do 8	do 2
													34	R. G. Stone	Stoneington, Ills.	do 8	do 2
													1	O. Thorn	Millbrook, N.Y	do 8	do 2
													46	Geo. Harding & Son	Waukesha, Wis	do 8	do 2
													20	John Tolton	Walkerton, Ont	do 8	do 2
													15	Henry Arkell	Arkell, Ont.	do 8	do 2
													6	Peter Arkell	Teeswater, Ont.	do 8	do 2
													20	Smith Evens	Gourock, Ont	do 8	do 2
													7	Jas. Main	Milton, Ont.	do 8	do 2
													8	John Thompson	Uxbridge, Ont.	do 8	do 2
													1	I. J. Williams	Muncie, Ind	do 8	do 2
			1		1								1	J. H. Potts	Jacksonville, Ills.	do 8	do 2
			2	9	11								11	T. C. Douglass	Galt, Ont	do 8	do 2
			2	3	5								5	John Jackson	Abingdon, Ont	do 8	do 2
						1		1					1	John Kelly	Shakesper, Ont	do 8	do 2
													38	Wm. Walker	Ilderton, Ont.	do 8	do 2
			1	4	5	1		1					42	Chs. Richanbach	Apple Creek, Ohio	do 8	do 2
			4	4	8								104	Wright & Phin	Guelph, Ont.	do 20	do 18
													16	T. B. Benington	Grafton, Ohio	do 29	do 24
													45	Wm. Newton	Pontiac, Mich	do 29	do 24
													6	S. Christopherson	Winnepeg, Man.	do 30	Sept. 4
						2	8	10					10	Jos. Thompson	Elora, Ont.	Aug. 17	do 9
													47	T. U. Vail	Lyndon, Vt	Sept. 2	do 26
													103	G. E. Breck	Paw Paw, Mich	do 9	Oct. 4
													100	Robt. Taylor	Abbot, Neb	do 8	do 4
			1		1								2	S. E. Taft	Menton, Mich.	do 8	do 4
													1	Dr. Webb	Shelburn, Vt.	do 12	do 9
2	25	27	12	20	32	4	8	12	2	4	6	1926					

J. A. COUTURE, D.V.S.,  
Assist. Inspector.

## No. 26.

## REPORT OF THE CATTLE QUARANTINES IN QUEBEC AND THE MARITIME PROVINCES.

(PROF. D. McEACHRAN, F.R.C.V.S., D.V.S., V.S. Edin., CHIEF INSPECTOR.)

OFFICE OF THE INSPECTOR OF STOCK,  
MONTREAL, 31st October, 1893.

SIR,—I have the honour to present my annual report on the work under my charge for the season ending 31st October, 1893.

## EXPORTATION OF LIVE STOCK.

Owing partly to the embargo on Canadian cattle having prevented "stockers" from being shipped, and partly to the low prices and heavy losses incurred by shippers, there has been a considerable falling off in the numbers of live stock exported during the current season as compared with preceding years, as will be seen by the following figures:—

## EXPORTATION FOR FIVE YEARS.

	Cattle.	Sheep.
1889.....	85,053	58,983
1890.....	122,182	43,780
1891.....	108,947	32,157
1892.....	98,755	15,932
1893 up to 1st November only.....	*80,895	1,781

Of these about 6,500 were Alberta ranche cattle and 2,000 from Manitoba and the Territories. The quality of the cattle is steadily improving; this is well marked in the ranche stock. The system of inspection was the same as in previous years. All were detained twenty-four hours of daylight for rest and inspection. Dr. M. C. Baker had charge of inspection at the Canadian Pacific Railway yards, Hochelaga, with a foreman and two men for marking the cattle after inspection; Dr. C. McEachran is inspector at the Grand Trunk Railway yards, Point St. Charles, and has also a foreman and two men for marking.

I am happy to be able to report that not a single case of disease or suspicion of disease, was discovered in any of the cattle inspected. Owing to the mistaken diagnoses by the veterinarians of the Department of Agriculture at London, having occurred in old cows or working oxen, orders were given to the inspectors to reject any very old cows or oxen, which were not in good condition, also big-jawed cattle as well as any showing distress or bruises from the railroad journey. These and these only were kept back, many of the latter when rested a few days were allowed to go on another vessel. In no single instance was it considered necessary to slaughter an animal, for in not one single instance was disease of a contagious nature even suspected. Had there been, the animal would have been killed at once to prove the diagnosis.

---

\* Of these 80,495 were shipped from Montreal and 400 from Halifax.

## Department of Agriculture.

The robust health of 80,495 cattle collected from different parts of Canada from the Atlantic to the Rocky Mountains proves beyond doubt that no disease of a contagious nature exists in Canada, notwithstanding the repeated reports of the London experts to the contrary.

I have much pleasure in reporting that the duties of inspectors were most satisfactorily conducted by Professor M. C. Baker, D.V.S., and Professor Charles McEachran, D.V.S., and the men under them.

### REPORTED CONTAGIOUS PLEURO-PNEUMONIA ON SS. "LAKE WINNIPEG."

I beg to report in addition to the testimony already furnished of the freedom from disease of the herd at Pilot Mound, Manitoba, whence the steer was exported which was suspected to be suffering from contagious pleuro-pneumonia, that in accordance with departmental instructions I visited Pilot Mound on the 26th August, went direct to the farm of Mr. E. Cecil Montague, 20 miles from there, from whose herd the steer in question was drafted, and can confirm Mr. McFadden's report in every particular. Mr. Montague bred the steer, kept him for four years and worked him with a mate, he was allowed to be the best working ox in the district, had been at times worked hard but always well cared for, was never known to be sick from any cause. When sold he was fat and of unusual size and weight. The balance of the herd, eight head, were still on the farm and a finer lot of grade Shorthorns would be difficult to find anywhere.

Mr. Montague has been there ten years, and has never known of any contagious disease in Manitoba.

I visited most of the farms in the district, including that of the reeve, Mr. Peter Strong, who had every opportunity of knowing if disease existed; he showed me his own stock, and assured me that no disease had existed in Manitoba during his residence of ten years.

Among other farms which I visited was that of George Mutch, who has a grazing farm on which there had just been collected 170 head belonging to fifteen different owners living in different parts of the district. A healthier lot of cattle it would be difficult to find.

Messrs. Baird Bros. also showed me a lot of about 100 head which their buyer had bought in the following parts of the district, viz.: Clearwater, Silver Lake, Balden, Silver Spring, and south to the boundary line, covering over forty miles square. If disease existed in the district these two collections of cattle would scarcely be free. Yet not one single case of illness nor suspicion of disease existed in either.

### REPORT OF CONTAGIOUS PLEURO-PNEUMONIA ON SS. "HURONA" AT DEPTFORD, NOVEMBER 2ND.

Yet another mistake in diagnosis has been made by the official veterinarians at London, this time the animal has been traced to Howe Island, one of "the Thousand Islands," in the St. Lawrence River, eight miles below Kingston, Ont. The ss. "Hurona" sailed from Montreal on the 7th October last, with the following cattle on board, after complying with the quarantine and shipping regulations, viz.:—

Gordon & Ironsides... ..	429	All Alberta ranche cattle.
Judge, Priddot & Price.....	160	From Moosomin and Moose Mountain.
C. McLauchlin .....	19	Ontario.
P. Paulin.....	21	do
C. Donahue.....	21	do
J. Kenney.....	54	do
D. Murby .....	59	do

The suspected animal was marked D and was one of a lot of 21 shipped by Mr. Donahue, Kingston. I went personally to Kingston on the 4th November and was driven by Mr. Donahue to his farm on Howe Island. He had bought the steers on Toronto market, 16 on the 19th May and 6 on the 16th June, which were placed on the farm within twenty-four hours of purchase. They were shipped on the 5th October to Montreal, one too small for shipment was sold in Montreal; the 21 steers were inspected on the 6th and shipped in perfect health on the 7th. The farm is well fenced with wire, put up only last year, good gates and perfect isolation.

They were the only cattle on the farm, and could have no means of contact with other cattle till they reached the stock yards at Montreal.

Disease of a contagious nature has never been known on the island or district. Being nearly four months on the farm, isolated completely, a sufficient period for the development of the disease had it been latent when purchased. The cattle all thrived well and were fat when shipped and, I have no hesitation in saying, perfectly free from contagious pleuro-pneumonia or any other disease of a contagious nature.

Having spent three months and a half in Alberta and the North-west Territories whence most of the cattle of this shipment came, I know that no disease exists there and repeated inspections and the intimate communications existing with all parts of the province of Ontario enable me to assert most positively that no such disease exists there. Therefore the ox or steer on which suspicion now rests certainly was free from contagious pleuro-pneumonia or any other disease when shipped. Another blunder has therefore been committed, and an unjust aspersion has been cast on the reputation of our healthy Canadian cattle.

#### IMPORTATION OF LIVE STOCK.

##### *Point Lévis Cattle Quarantine—Quebec.*

The following animals were quarantined at this station up to the 31st October:—12 cattle, 1,911 sheep and 17 swine; of these 12 cattle, 811 sheep and 15 swine were for Canada, and 1,100 sheep and 2 swine were for the United States.

Particulars of dates, breeds and owners' names are furnished by report and schedules accompanying the report of Dr. J. A. Couture, D.V.S., inspector in charge of this quarantine.

I am happy to report that no disease was discovered in any of the animals and that they were all discharged in perfect health, the cattle after a detention of ninety days and the sheep and swine fifteen days.

I have pleasure in reporting that the duties of inspector were satisfactorily discharged by Dr. Couture, and of superintendent by Mr. Walsh and the men under him.

##### *Halifax Cattle Quarantine.*

The importations to this quarantine consisted of ten Ayrshire and eight Shorthorns, all for Canada.

The exportations consisted of 400 head of Ontario cattle, in none of which has any disease been discovered. Particulars will be found in the report and schedules appended to Dr. Jakeman's report.

I have pleasure in reporting that the duties of inspector at this port and those of caretaker were satisfactorily conducted by Dr. Wm. Jakeman, D.V.S., and Mr. Frank Hyde respectively.

##### *St. John, New Brunswick, Cattle Quarantine.*

There have been no importations, nor exportations from this port up to date, 31st October. This I believe to be due in a great measure to the want of proper facilities.

## Department of Agriculture.

I beg again to recommend that a proper quarantine station be established here for the encouragement of importation to this important stock raising province.

Inspector Frink reports a total freedom of all classes of live stock in the province of New Brunswick from disease. He also reports a marked improvement in the breeds of sheep and horses throughout the province.

I have the honour to be sir,

Your obedient servant,

D. McEACHRAN, F.R.C.V.S., D.V.S., V.S. Edin.

The Honourable  
The Minister of Agriculture,  
Ottawa.

## No. 27.

## REPORT OF THE HALIFAX, N.S., CATTLE QUARANTINE STATION.

(WM. JAKEMAN, D.V.S.)

HALIFAX, 23rd October, 1893.

SIR,—I have the honour to submit my annual report as Superintendent of Cattle Quarantine at the port of Halifax for the year 1893.

*Cattle Exported.*

April 29th, 1893.—Per SS. "Numidian," Allan Line, for Liverpool, G.B., 400 head of cattle, the property of Messrs. Price & Aitkin.

*Cattle Imported.*

June 3rd.—Per SS. "Siberian," eight head of Ayrshire cattle, for James Johnston, Montreal.

July 14th.—Per SS. "Corean," two head of cattle, Ayrshires, the property of R. Reford, Esq., Montreal.

Sept. 25.—Per SS. "Corean," eight head of Shorthorn cattle, the property of D. D. Wilson, Esq., Seaforth, Ont.

All of which have been discharged except Mr. Wilson's cattle which are now in quarantine.

July 4th.—I received a letter from the Deputy Minister of Agriculture requesting me to visit the farm of Ronald N. McDonald, of East Point, P.E.I., and investigate a disease said to exist in his cattle. This I did, finding it to be tuberculosis, as per my report of July 15, 1893.

I have the honour to be, sir,  
Your obedient servant,

WM. JAKEMAN, D.V.S.

*Inspector.*

The Honourable  
The Minister of Agriculture,  
Ottawa.



Department of Agriculture.

No. 28.

REPORT OF LYN (ONT.), STOCK-YARDS.

(W. STAFFORD.)

LYN STATION, 31st October, 1893.

SIR,—I have the honour to herewith submit to you my report relating to American stock, unloaded in the Lyn yards, for the purpose of feed, water and rest.

Official regulations concerning the transportation of American stock have been strictly carried out.

The yards are kept in first-class state of repair. No Canadian cattle are allowed to come in contact with the yards. All animals dead on arrival have been buried within the isolated yards under my direction. I dealt with 13 cars, 210 head of cattle; 9 cars, 185 horses; and 1 car, 113 sheep. All of which were unloaded, fed, watered and rested.

I have the honour to be, sir,  
Your obedient servant,

W. STAFFORD,  
*Cattle Guardian.*

The Honourable  
The Minister of Agriculture,  
Ottawa.

## No. 29.

## REPORT OF CATTLE QUARANTINE, ST. JOHN, N.B.

(JAMES H. FRINK, V.S.)

ST. JOHN, N.B., 31st October, 1893.

SIR,—I have the honour to submit to you my annual report on the quarantine station here. There has been no disease of a contagious nature in the live stock of the province during the year. I have not heard of a single outbreak even among horses and it is very seldom indeed that a year passes over without some epidemic making its appearance among this class of animals. There has been a marked improvement in the breeds of sheep and horses throughout the province. Great natural facilities are presented here for the sheep industry and the entire absence of disease in the flocks and herds of the province should prove a stimulus, to those who may contemplate the pursuits of agriculture.

There have been no importations of stock from foreign countries.

The exports consist of 4 head of cattle to the British West Indies and 1,300 sheep to the United States. The exports have declined this year in this class of animals on account of dull markets. Large numbers of sheep and lambs pass through here in transit to United States, but I keep no record except of those shipped from this port.

I have the honour to be, sir,

Your obedient servant,

JAMES H. FRINK, V.S.

*Veterinary Inspector.*

The Honourable  
The Minister of Agriculture,  
Ottawa.

# Department of Agriculture.

No. 30.

## REPORT ON PICTOU AND OTHER CATTLE DISEASE.

(By Prof. D. McEachran.)

MONTREAL, 31st October, 1893.

By referring to the detailed schedule in the appendix furnished by Dr. George Townsend, D.V.S., inspector at New Glasgow, N.S., it will be seen that 124 cases of this disease occurred between January 1st and November 1st, viz.: 11 steers and 114 cows and heifers, all of which were slaughtered and indemnity paid amounting to \$1,115.33 which shows a very marked decrease as compared with the previous year when the number slaughtered was 363, and the indemnity paid \$4,429.91.

This peculiar disease is yet a mystery as to its causation. It still presents the same seasonal character, and the same sectional location, spreading but little. During January, 3 cases; February, 2; March, 1; April, 5; May, 5; June, 32; July, 36; August, 15; September, 10; October, 15. The maximum number occur during the midsummer months, June and July, the disease almost entirely disappearing during winter.

I would suggest that the investigations into the pathology and causation of the disease be continued during the coming summer by Professor Adami, for until we know accurately its true nature, its cause and prevention cannot be ascertained.

I have much pleasure in reporting that Inspector George Townsend, D.V.S., and Appraiser W. G. Cunningham, have performed their duties in a most satisfactory manner.

### *Tuberculosis.*

I regret to have to report that this disease continues prevalent, and is probably increasing throughout the Dominion, and calls for the serious consideration of the department, as it is a menace not only to the herds of Canada, but a very serious one to the public health, by means of dairy cattle.

I would suggest that no cattle be allowed to leave quarantine till they have been tested by tuberculin injections, the success of which as an indicator of the presence or absence of this disease can now be relied upon. I trust that the day is not far distant when all dairy stock in Canada, will be so tested under Government supervision from time to time so that the disease may be thoroughly eradicated from our herds.

### *Glanders.*

So far as reports have reached me or my own observations have gone this disease has decreased throughout the Dominion. Occasional cases occur in the large cities, one serious outbreak occurred in a herd of ranche horses in the territories and a few cases occasionally occur in Manitoba.

I beg to suggest that the "Animal Contagious Diseases Act" be amended so as to include horses, and that the department take necessary steps to stamp out this disease, which could be done at a comparatively trifling cost. The use of mallein like tuberculin can be relied on to insure correct diagnosis.

### *Big Jaw—"Actinomykosis."*

This disease continues to exist and to slightly increase, especially on the ranges. The successful treatment of it in domestic cattle by administering iodide of potassium in drachm doses twice daily in the early stages of the disease, has been found to be very efficacious in arresting the disease.

*Scab in Sheep.*

As will be seen by the appendix to this report scab was unfortunately introduced by some sheep from Idaho into a part of Assiniboia and southern Alberta, causing considerable loss and inconvenience to sheep ranchmen in that district. I am happy to be able to report that the quarantine measures employed to eradicate the disease promise to be successful, and I trust to be able to remove all quarantine restriction early next summer. This disease also occurred to a limited extent in Manitoba and western Ontario, which outbreaks have been successfully dealt with by quarantine measures.

*No Contagious Pleuro-pneumonia in Canada.*

As will be seen from the appendix reports hereunto the most diligent search for contagious pleuro-pneumonia from ocean to ocean has failed to discover such a disease or suspicion of such disease.

I am happy to report therefore that no contagious pleuro-pneumonia exists in the Dominion. In further testimony of which I beg to add the following report of a resolution passed unanimously by the first American Veterinary Congress, which was held at Chicago, during the World's Fair at which I had the pleasure of taking part.

*Resolutions on Contagious Pleuro-pneumonia adopted at the First Veterinary Congress of America, Chicago, Ill., 18th October, 1893.*

"Whereas, the most satisfactory evidence and conclusive testimony has been presented to the First Veterinary Congress of America, assembled in Chicago, that our country is entirely free from a single case of contagious pleuro-pneumonia, and has no doubt been so for the past two years, be it

"Resolved, that we ask of Great Britain the entire removal of the quarantine regulations applying to contagious pleuro-pneumonia in the United States, and, be it further

"Resolved, that it having been clearly demonstrated by the Canadian Department of Agriculture that contagious pleuro-pneumonia does not exist in Canada, it is the opinion of the Congress that the quarantine of the United States against Canadian cattle is unnecessary and should be removed, and

"Resolved, that we ask of Canada a similar consideration in regard to the freedom of trade between Canada and the United States."

A. W. CLEMENT,  
W. HORACE HOSKINS.

All of which is respectfully submitted.

I have the honour to be, sir,  
Your obedient servant,

D. McEACHRAN,  
*Chief Inspector.*

# Department of Agriculture.

## QUARANTINE Work on Pictou Cattle Disease during Year 1893.

Date.	Owner's Name.	Address.	Month.	No. Killed.	No. Male.	No. Female.	Amount paid.
							\$ cts.
Jan. 2.	John C. McDonald.	Arisaig.	Jan.	1	1		3 33 $\frac{1}{2}$
do 24.	Alex. McGillivray	McLennan's Brook	do	1		1	8 00
do 27.	Mrs. Ronald McVicar	W. Merigonish	do	1		1	10 00
Feb. 8.	Mrs. Angus McVicar	W. Merigonish	Feb.	1		1	10 00
do 9.	Hugh McGillivray.	Maryvale	do	1		1	10 00
March 3.	Alex. Reid	Little Harbour.	March.	1		1	10 00
April 1.	Ronald McGillivray	Lismore	April	1		1	10 00
do 6.	Angus Camp. all	McLennan's Brook	do	1		1	10 00
do 25.	James McDonald.	Maryvale	do	1		1	10 00
do 25.	A. A. McDonald.	McAra's Brook.	do	1		1	10 00
do 25.	Martin W. McDonald.	Knoydart	do	1		1	10 00
May 4.	Hugh McGillivray	Maryvale	May	1		1	8 09
do 12.	Ronald McDonald	Malignant Cove	do	1		1	7 00
do 17.	James Stewart.	Little Harbor.	do	1		1	10 00
do 28.	Annie Chisholm	Malignant Cove	do	1		1	10 00
do 29.	Alex. H. McDonald.	Arisaig.	do	1		1	7 00
June 1.	Edwards Waters	Granton	June	1		1	10 00
do 2.	Mrs. J. J. Jardine	Westville	do	1		1	10 00
do 9.	James Roy	W. Merigonish	do	1		1	6 00
do 12.	Thos. McPherson	Fisher's Grant	do	1		1	10 00
do 13.	Hugh McDonald.	Pictou	do	1		1	10 00
do 14.	W. G. Johnstone	McLennan's Brook	do	1		1	10 00
do 15.	Alex. McDonald, Sr.	McAra's Brook.	do	1		1	10 00
do 16.	Alex. H. McDonald	Arisaig	do	1		1	10 00
do 17.	Alex. Fraser.	Pictou.	do	1		1	10 00
do 18.	Andrew Wier.	Thorburn	do	2		2	20 00
do 18.	Mrs. J. J. Jardine.	Westville	do	1		1	10 00
do 19.	James Conn	Alma	do	1		1	10 00
do 19.	Danial McBain.	Stewarton	do	1		1	10 00
do 20.	Neil Kell	Antigonish	do	1		1	10 00
do 21.	W. G. Johnstone	McLennan's Brook	do	2		2	20 00
do 21.	Thos. McPherson	Fisher's Grant	do	1		1	10 00
do 22.	Wm. McDonald	Churchville	do	1		1	10 00
do 23.	Angus McGee.	Knoydart	do	1		1	10 00
do 23.	Alexis McDonald.	Drs Brook	do	1		1	5 00
do 24.	Alex. Reid	Little Harbour	do	1		1	10 00
do 24.	Wm. Lothead.	Alma	do	2		2	12 00
do 26.	Wm. A. McGillivray	Bailey's Brook	do	1	1		5 00
do 26.	Mrs. J. McGillivray	Bailey's Brook	do	1	1		7 00
do 26.	J. J. McGillivray	Bailey's Brook	do	1		1	10 00
do 27.	Ronald McDonald.	Malignant Cove.	do	1		1	10 00
do 26.	James R. McMillan	Churchville	do	1		1	10 00
do 28.	Hugh McPherson.	McAra's Brook	do	1		1	10 00
do 29.	Chas. Mitchell	W. Merigonish	do	1		1	10 00
do 31.	Duncan Grant	Bailey's Brook	do	1		1	7 00
July 1.	James K. McDonald.	New Glasgow.	July.	1		1	16 66 $\frac{1}{2}$
do 3.	David Porter.	Granton.	do	1		1	7 00
do 3.	Alex. Pervis.	Westville	do	1		1	10 00
do 4.	John Dryden	do	do	1		1	10 00
do 4.	J. J. McGillivray	Bailey's Brook	do	1	1		3 33 $\frac{1}{2}$
do 4.	Mrs. J. McGillivray	do	do	1	1		5 00
do 4.	Wm. A. McGillivray	do	do	1		1	5 00
do 5.	Colin Ross.	Maryvale.	do	2		2	14 00
do 6.	A. Lamont.	Glensh-e	do	1		1	10 00
do 8.	J. S. Sutherland.	Woodburn	do	1		1	10 00
do 9.	Angus Cook.	Brookville.	do	2		2	25 00
do 10.	W. G. Johnstone	McLennan's Brook.	do	1		1	10 00
do 10.	John J. McDonald.	Ardness.	do	1		1	10 00
do 12.	Dan. Lamont.	W. Merigonishe	do	1		1	10 00
do 12.	Wm. McDonald.	Chestville	do	1		1	10 00
do 13.	James Stewart.	Little Harbour	do	1		1	10 00
do 14.	Peter McIntosh.	Piedmont Valley.	do	1		1	10 00
do 15.	L. Johnstone	Loch Brown.	do	1		1	10 00
do 17.	M. Cashen.	Antigonish	do	2		2	20 00
do 19.	Mrs. Donald McDonald.	Arisaig	do	1		1	10 00
do 19.	Donald J. McKinnon	Knoydart.	do	1		1	10 00
do 21.	Wm. J. Lester.	Fisher Grant.	do	1		1	10 00
do 22.	George Christie	do	do	1		1	10 00
do 22.	Even. McLennan.	New Glasgow.	do	1		1	10 00

## QUARANTINE Work on Pictou Cattle Disease, &amp;c.—Concluded.

Date.	Owners' Name.	Address.	Month.	No. Killed.	No. Male.	No. Female.	Amount paid.
							\$ cts.
July 23.	Angus McVicar.....	W. Merigonishe.....	July...	1		1	5 00
do 24.	Peter McIntosh.....	Piedmont Valley.....	do	1		1	7 00
do 26.	J. R. McLean.....	Thorburn.....	do	1		1	10 00
do 28.	John A. McDonald.....	Arisaig.....	do	1		1	11 00
do 28.	Martin D. McDonald.....	Knoydart.....	do	1		1	3 00
do 30.	John C. Munroe.....	Thorburn.....	do	1		1	15 00
do 30.	John Murray.....	W. Merigonishe.....	do	1		1	10 00
do 31.	Alex. Cameron.....	Thorburn.....	do	1		1	10 00
do 31.	H. J. Townsend.....	New Glasgow.....	do	1		1	10 00
Aug. 4.	Angus McDonald.....	Dinnaglass.....	August.	1	1		3 00
do 5.	Angus McDonald.....	James River.....	do	1		1	10 00
do 6.	Mrs. Alex. Cameron.....	E. French River.....	do	1		1	10 00
do 7.	Richard Smith.....	Granton.....	do	1		1	10 00
do 8.	Dan. J. McDonald.....	Plymouth.....	do	1		1	10 00
do 10.	Wm. McIntosh.....	Montville.....	do	1		1	5 00
do 10.	A. Lamont.....	Glenshee.....	do	1		1	3 33 $\frac{1}{3}$
do 12.	Wm. McLaurin.....	Wentworth Grant.....	do	1		1	7 00
do 13.	James Henderson.....	Granton.....	do	1		1	13 33 $\frac{1}{3}$
do 14.	Wm. Sutherland.....	2nd Div. Cariboo.....	do	1		1	10 00
do 19.	Robt. Turner.....	E. French River.....	do	1		1	10 00
do 22.	Simon Smith.....	Granton.....	do	1		1	12 00
do 22.	John C. McRae.....	do.....	do	1		1	13 33
do 24.	James Robson.....	Piedmont Valley.....	do	1		1	5 00
do 30.	Mrs. Chas. McVicar.....	W. Merigonishe.....	do	1		1	10 00
Sept. 9.	Dan. Campbell.....	Old Gulf Road.....	Sept.	1	1		4 00
do 11.	Chas. E. Tanner.....	Pictou.....	do	1		1	15 00
do 11.	Henry S. Poole.....	Stellarton.....	do	1		1	15 00
do 13.	Rod. W. McGillvray.....	Ardness.....	do	1	1		7 00
do 15.	Alex. Chisholm.....	Malignant Cove.....	do	1		1	5 00
do 18.	M. Cashin.....	Antigonish.....	do	1	1		6 00
do 23.	James Robson.....	Piedmont Valley.....	do	1		1	4 00
do 26.	Dougall McDonald.....	Ardness.....	do	1		1	10 00
do 27.	Alex. Robertson.....	Churchville.....	do	1		1	5 00
do 29.	Angus McIsaac.....	Maryvale.....	do	1		1	10 00
Oct. 2.	John R. Hungly.....	French River.....	Oct	2		2	15 00
do 4.	Nat. Hamilton.....	E. French River.....	do	1		1	10 00
do 7.	Wm. Stevenson.....	Logans Tannery.....	do	1		1	10 00
do 9.	Mrs. John Collingwood.....	Fisher Grant.....	do	1		1	7 00
do 11.	John Weir.....	Pine Tree.....	do	1		1	10 00
do 12.	Dan. Campbell.....	Old Gulph Road.....	do	1		1	5 00
do 16.	Wm. McIntosh.....	Montville.....	do	1		1	12 00
do 18.	M. Cashen.....	Antigonish.....	do	2		2	14 00
do 19.	Donald Sutherland.....	New Glasgow.....	do	1		1	7 00
do 21.	Wm. McIntosh.....	Mortville.....	do	1	1		10 00
do 24.	Dan W. McGillvray.....	Bailey's Brook.....	do	1		1	10 00
do 24.	Angus McDonald.....	Bailey's Brook.....	do	1		1	10 00
do 26.	Peter McIntosh.....	Piedmont Valley.....	do	1		1	10 00

GEO. TOWNSEND, D.V.S.,  
Inspector.

## MISCELLANEOUS REPORTS.

No. 31.

REPORT OF SUPERINTENDENT OF QUARANTINES, B. C.

(W. McNAUGHTON JONES, M.D.)

VICTORIA, 31st October, 1893.

SIR,—In accordance with your instructions, I beg to forward my report ending October 31st. The reports for November and December I shall forward at the close of the year. On December 30th ult., the steamer "Tacoma" came in from China and Japan, with 91 passengers and a case of small-pox on board. On January 27th ult., the "Flintshire" from the same places arrived with two cases of small-pox on board, and 123 passengers. On April 13th the "Empress of Japan" also from China and Japan arrived with 1,154 passengers and three cases of small-pox. All these passengers were with great difficulty conveyed to Albert Head owing to the severity of the weather, heavy south-easterly gales as it happened, prevailing on all three occasions, during two of which the snow lay thickly on the ground. The cases seemed to be of a peculiarly malignant nature, one of the patients dying on being landed, after 24 hours' illness, and another dying on board after a very few hours' illness, both cases apparently of primary fever. There were 7 deaths; but in only 3 of all the cases did the disease reach the secondary stage. All the passengers were vaccinated. As Albert Head was quite inadequate for the accommodation of such numbers I was obliged to put the suspects under canvas in January and April. On neither occasion did the disease spread beyond the quarantine grounds, though several fresh cases broke out among the suspects; these were detained for quarantine of observation for the presumed period of incubation, after the appearance of the last case. One man was landed with mania and died lunatic. I have been informed by the quarantine officer of the Straits Settlements that an extraordinary epidemic outbreak of small-pox started from Singapore about two years ago, and extended over and through the entire east. This would almost coincide with our first case here, last December twelve months, which broke out on a lady who came from Singapore direct. It will be seen that from the end of December ult., to the end of June your quarantine officer was in constant attendance at Albert Head, and the steamer "Earl" kept equally busy. The new buildings at William Head were completed about three weeks ago; they still however require furnishing, and like all large new wooden buildings, have yet some considerable requirements; when these are completed and the furniture in, the quarantine station at William Head will be very complete and perfect. The key of my dwelling was handed to me by Mr. Gamble, chief engineer of lands and works on the 26th of August, and I moved down permanently on the 28th. The three suspect stations, Cabin, Chinese and Japanese, are capable of containing nearly 1,000 people, and the hospital about 80. This also contains several private wards. The water supply is abundant and very perfect. The disinfecting chamber is very good. I would strongly suggest that a telephone be put in the station from town, and the road continued (from the main road to Victoria) to the hospital grounds. At present there is only approach to the city by water, owing to the fact that a small stretch of about one and a half miles on land is impassable. It would cost very little. It is desirable that the furnishing of the buildings be completed as soon as possible; we may have illness at any time.

I append a list of the steamers, ships, coasters, passengers, and crews, inspected by me to the end of October. But I beg to state that this is not a fair indication of the traffic of this port, as since June I have ceased to inspect the daily Sound boats which bring a large number of passengers. I estimate that if these were included, the number of passengers would be more than half as much again.

I have the honour to be, sir,

Your obedient servant,

W. McNAUGHTON JONES, M. D.,

*Superintendent of Quarantines, B.C.*

The Honourable  
The Minister of Agriculture,  
Ottawa.

VESSELS INSPECTED, VICTORIA, B.C., 1893, to 31st October.

British steamships .....	164
Foreign do .....	455
British sailing ships.....	89
Foreign do .....	39
Coasters. ....	<u>1,242</u>

W. McNAUGHTON JONES, M.D.,

*Superintendent of Quarantines.*



# Department of Agriculture.

No. 32.

## REPORT ON PAN-AMERICAN MEDICAL CONGRESS AT WASHINGTON, SEPTEMBER, 1893.

(F. MONTIZAMBERT, M.R.C.S., M.D.)

QUARANTINE STATION, GROSSE ISLE, P.Q., 13th Sept., 1893.

SIR,—I have the honour to submit this my report of the meeting of the first Pan-American Medical Congress held at Washington, D.C., 5th September.

The meeting was attended by over one thousand registered members, from sixteen of the countries of the Americas.

Owing to press of work from the occurrence of cholera at Jersey City and of yellow fever at Brunswick, Surgeon General Wyman, of the United States Marine Hospital Service, President of the section of Marine Hygiene and Quarantine, was unable to attend or to work up his section. At his request therefore it was combined with the section on Hygiene, Climatology and Demography under Medical Director Albert L. Gihon, United States Navy.

This joint section was very largely attended. It was generally remarked that it was in the line of its work that International and Pan-American effort could best be looked for.

From this section several important resolutions were reported and submitted to the whole congress.

1. "Resolved that in the opinion of the Pan-American Medical Congress the interests of the public health, in every country should be and must be intrusted to a department of the government especially charged with their administration; and that while the precise form of administration may be left to legislation, the indispensable requisites are that it shall be national, that it shall have parity of voice and influence in the national councils, that it shall have independent executive authority under the limitations common to other departments, and that it shall be intrusted to educated and experienced medical men, who alone are competent to assume its responsibilities."

This resolution was referred to the International Executive Committee, and accepted by them, and by the congress.

A second resolution was submitted from the section, but was not accepted by the International Executive Committee. It was as follows: "Resolved that it is the sense of this section that in view of the prevalence of Asiatic cholera in Europe at the present time, and the constantly increasing number of *foci* of infection, immigration from European countries in which cholera exists should be temporarily suspended, as this action affords, in our opinion, the only certain means of averting a threatening invasion by the disease of the countries of the American continent." The International Executive Committee thought it best not to pass this resolution at the present time and the congress concurred in laying it on the table.

On the last day at the close of the proceedings the following resolution was presented from the same section:

"Resolved that the thorough disinfection, without discrimination, of every piece of baggage, dunnage or article of personal effects belonging to the immigrant classes, and to the crews of immigrant ships, and the exaction of scrupulous cleanliness of all vessels arriving at American ports, should be rigidly enforced at American ports, supplementing and enhancing the protective value of similar treatment at the ports of departure, especially at times when cholera exists in Europe, is a sanitary measure second only in efficiency and importance to the temporary suspension of immigration."

“Resolved that the habitual and thorough disinfection of all personal effects liable to carry contagions of immigrants to the American hemisphere, and of dunnage of crews of vessels carrying these immigrants from any quarter of the globe, and the exaction of scrupulous cleanliness of all vessels arriving at American ports, should be enforced at all times, as the most efficient means of greatly lessening the introduction into this hemisphere of the seeds of various contagious diseases which are now and have been in the past almost constantly conveyed by the immigrant classes and distributed widely among the populations of this hemisphere.”

This double resolution was referred to the International Executive Committee, which may report upon it later.

The General Secretary called by circular letter a meeting of the Canadian delegates to elect a Canadian representative on the International Executive Committee.

Nine Canadian delegates attended this special meeting, seven in person and two by proxy. It was moved by Professor Macallum, of the University of Toronto, that Dr. Montizambert be elected the Canadian member of the International Executive Committee of the Pan-American Congress. This was seconded by Dr. Blackadder, of Montreal, speaking for himself and as authorized to that purpose by Drs. Roddick and Gardiner. Dr. Blackadder took occasion to express in very flattering terms the complete confidence entertained by McGill University in Dr. Montizambert. No other name being put in nomination, Dr. Montizambert was declared elected.

The next place of meeting is to be at the city of Mexico, either in 1896 or 1897.

I may state that I have received assurances from the most widespread sources of the general approval of the Canadian quarantine regulations and practice; this was again manifest at this Pan-American Congress both in the private and public utterances of delegates, Canadian, United States and Mexican.

I have assurances from representatives from the states of Ohio, Illinois and Minnesota that our tags will be fully recognized in those and other western states.

And I would venture to suggest that if Dr. Baker give any more trouble at the frontier, the cars with immigrants bound for points beyond Michigan be sent through that state as sealed cars “in bond.” And for any immigrants bound for Michigan itself, I would leave Dr. Baker to carry out such supplementary disinfection as he may desire after they have entered the territory of his own state.

The International Executive Committee are to continue work by correspondence during the interim; and in addition to an international committee on the Pharmacopœia, and one on Medical Pedagogics, are to appoint an International Quarantine committee for the general, united and international study of that very important subject.

I have the honour to forward to you, by this mail, a copy of the hand-book of the First Pan-American Medical Congress.

At this congress the Diploma of Member “*honoris causa*” of the National Academy of Medicine of Mexico was formally conferred upon me by the officers of the academy, who were present as delegates to the Pan-American Medical Congress.

I have the honour to be, sir,

Your obedient servant,

F. MONTIZAMBERT, M.D., F.R.C.S., &c., &c., &c.,

*Delegate to the Pan-American Congress.*

# Department of Agriculture.

No. 33.

## REPORT OF THE BRITISH DELEGATES TO THE DRESDEN SANITARY CONFERENCE.

(PRESENTED TO THE IMPERIAL PARLIAMENT, SEPTEMBER, 1893.)

*Communicated by the High Commissioner for Canada.*

DRESDEN, April 18, 1893.

SIR,—We have the honour to report that, in accordance with your lordship's instructions of the 7th March last, we attended the International Sanitary Conference held at Dresden. We were present at all its meetings, and took part in all its deliberations.

The countries represented were: Germany, Austria-Hungary, Belgium, Denmark, Spain, France, Great Britain, Greece, Italy, Luxemburg, Montenegro, the Netherlands, Portugal, Roumania, Russia, Servia, Sweden and Norway, Switzerland and Turkey.

The printed proceedings of the conference are submitted separately.

The first meeting was held on the 11th March, 1893, and this, and the three subsequent meetings were mainly taken up by formal statements by the different delegates, of the laws and regulations in force in their respective countries, and of their application during the epidemic of last year. Some of the statements were coupled with the expression of the hope that the labours of the conference would result in a relaxation of the restrictions to which, in many parts of Europe, traffic, whether of individuals or of merchandise, had hitherto been exposed.

At the fourth sitting we explained the policy which, for many years past, had been carried out in England with regard to the prevention of cholera, we showed the results of our practice, and, after a brief account of the circumstances which attended the importation of cholera into England last year, we pointed out that the disease had in no case extended beyond persons arriving from abroad. And that at the ninth sitting, when the conference had under discussion the regulations for arrivals at sea frontiers, we described in some detail the application of our cholera regulations to English sea ports.

To facilitate the labours of the conference, three committees were appointed to consider the interrogatory submitted by the Austro-Hungarian Government, and to submit conclusions for discussion by the full conference. Such conclusions as were adopted by the conference were subsequently embodied in a convention. We were represented on each of these committees.

The first committee was concerned with the duties imposed on a government when cholera appears in its country. The second committee dealt with the measures which devolved on a government to prevent cholera from spreading into its own territory from abroad, or from one part of its own country to another. These subjects were treated under three headings, namely, measures on land, measures on rivers, and measures by sea. The third committee was concerned with traffic of the Sulina mouth of the Danube.

The first committee held four sittings. It dealt, in the main, with the information as to the existence of cholera which each government should secure for itself and communicate to other countries; with the reciprocal notifications to be made between countries concerning the spread of cholera and the means taken to stay its diffusion; with the conditions under which any area should be regarded as infected (*contaminé*); and, lastly, with the measures to be adopted in order to prevent the restrictions being imposed against an entire country when only a limited portion of it is infected.

A number of conclusions were arrived at by this committee, and, with certain modifications, they were adopted by the full conference at a later sitting. They embody the principle of the notification between countries of cases of cholera, and they aim at preventing certain unreasonable measures of restriction against countries in which cholera has appeared. We assented to them; but as regards a proposal to the effect that "*les cas restés isolés ne feront pas nécessairement l'objet d'une notification*" we expressed the opinion that the limitation of the notification to a so called "*foyer*" would encourage a secrecy with regard to the onset of cholera which might materially affect the value of the notification, and under any circumstances, England would maintain her present practice of making public every occurrence of cholera in her country. The desire to limit the notification between countries to an actual "*foyer*" was, however, very general; the limitation was necessary, as was alleged; to avoid exposure to restrictions unnecessary in the case of isolated attacks of the disease; and, under the circumstances, we did not press our objections to the proposal. No satisfactory definition as to what constitutes a "*foyer*" could be arrived at.

The second committee had to deal with by far the largest number of the subjects of Austro-Hungarian "Interrogatory." Thus their labours included the definition of infected and healthy districts, the application of disinfection, and the restrictions to be imposed on traffic, whether of merchandise or of persons, and whether by land, by river, or by sea, with a view to the prevention of cholera.

No district is to be considered infected, or to be the subject of restriction, until it is held to be the seat or a "*foyer*" of cholera, and all restrictions are to cease, subject to the adoption of certain measures of disinfection, as soon as five days have elapsed since the last occurrence of or death from cholera. But, whilst this is the case, the limitation of these restrictive measures is only to apply to countries the Governments of which take steps to prevent the exportation of articles from the infected district which are deemed to be "*susceptible*," *i. e.*, capable of transmitting cholera. We pointed out that, as yet, Great Britain had never been placed in a position rendering it necessary for her to impose restrictions on any articles exported from her territory for the purpose of preventing extension of cholera abroad; but as the conclusion in question is concerned only with articles coming from an actually infected district, and as it is limited to the few articles which the convention defines as "*susceptible*," we did not insist on our objections.

The term "*susceptible*" has, indeed, under the convention, a very limited application. It relates only to articles of clothing and bedding which have been in use, and to rags as defined by the words "*chiffons*" and "*drills*." But some very important exceptions are made with regard to articles which in our country come under the term "*rags*."

Thus, it was decided that "*rags*" sent in bulk, and under the customary conditions which apply to rags as an article of merchandise, shall not be deemed "*susceptible*," and should therefore be free from all restrictions; the same exemption was made to apply to clean clippings and various similar articles, as also to woollen rags coming under the trade definitions "*Kunstuolle*" and "*shoddy*."

Some considerable discussion took place as to these exemptions, not only in the committee, but in sub-committee, and at more informal gatherings of which there are no records. As regards the interchange of views which took place at these meetings, it will suffice to say that the leading technical delegates present, including Professors Koch, Brouardel, and Proust, were unanimously of opinion that in no case had cholera been traced to "*rags*" in the form in which they are now exempted and that risk of their conveying the infection of cholera was so remote as to justify the exemptions specified.

It was further decided that the transit through a country even of merchandise classified as "*susceptible*" must not be prevented if the goods are so packed that they cannot be handled on the way; that merchandise ought not to be prevented entering a country even if it had passed through an infected district, provided it had been so conveyed as to avoid contact with infected things; that no merchandise should be subject to restrictions if it could be shown that it had been despatched

## Department of Agriculture.

from an infected country not less than five days before the commencement of an epidemic; and that no merchandise ought to be retained in quarantine at land frontiers.

At one stage of our proceedings considerable difficulty arose in regard to disinfection. There was formally submitted to the committee a proposal to the effect that the disinfection of dirty (*i. e.*, unwashed) linen, which formed part of the luggage of passengers, should be obligatory at the frontiers of all countries. The French representatives maintained very strongly that this should be accepted as a definite obligation, whereas a number of delegations, including those of Germany, Austria-Hungary, Italy, Belgium, Switzerland and Great Britain, contended that such a practice was useless, except when the articles were infected. In opposition to the alleged experience of France, that there had been no importation of cholera at her frontiers, where the practice in question had been carried out, we were able to speak to a precisely similar immunity in England, where no such action had been resorted to as regards the vast numbers of persons reaching our shores from infected countries. The matter having been discussed at great length, we submitted an amendment to the effect that such articles should be disinfected, provided the local authorities had reason to regard them as having been contaminated by choleraic discharges, but this was at once met by a demand on the part of the French delegation to the effect that a vote should be taken on the question whether this disinfection was in all cases to be compulsory or permissive. Of eighteen delegations present, thirteen voted that it should be permissive; four, namely, France, Greece, Russia and Turkey, that it should be compulsory. Portugal abstained.

At the opening of the sitting of the committee on the following day the French delegation proposed to render it obligatory to disinfect all dirty linen and other articles, provided they came from a district declared to be infected. Although this proposal was in effect the same as that which, after lengthened consideration, had been rejected in so definite a manner on the preceding day, the majority of the delegations present had come prepared to accept it, the result being that it was adopted on behalf of all the powers represented except Great Britain.

Having regard to the contradictory nature of the proceedings of the committee on this subject, and the overwhelming vote of the previous day, we felt that so sudden a change of front could have no real influence in the direction of imposing on all nations alike this useless proceeding, and, as we shall have occasion to point out under the head of maritime restrictions, we had eventually reason to find that our judgment was correct.

After deciding on a number of conclusions affecting the passage of trains and persons across land frontiers in such a manner as to secure a diminution in the restrictions which have been heretofore so commonly resorted to, it was decided that the regulation of traffic along rivers common to two or more countries should be left in each case to the respective *riverain* states; the committee further recommending for adoption the regulations drawn up by the German Government on the subject, which had in practice been found to give good results during the epidemic of 1892.

The subject of maritime measures and arrivals by sea having been reached, a sub-committee was formed to prepare answers to that portion of the "interrogatory" which related to arrivals at seaports. These having been drawn up, were submitted in the form of provisional propositions at the fifth sitting of the second committee. They prescribed, amongst other things, the treatment to which three classes of vessels, namely, *infectés*, *suspects*, *et indemnes*, were to be subjected.

The first proposal related to the definition of the terms *navire infecté*, *navire suspect*, and *navire indemne*.

It was decided that a vessel should be held to be infected if there was cholera on board or if a case had occurred on board within seven days before arrival in port. As regards such vessels, three regulations were laid down. In the first place, persons actually sick of cholera were to be landed, a condition to which we assented. By the second regulation it was laid down that all other persons on board were also

to be landed, if possible, and then subjected to a process of "observation" for a period not exceeding five days, reckoned from the date of the occurrence of the last case.

Having regard to the fact that in a subsequent regulation dealing with suspected vessels the term *surveillance* and not *observation* was used, it was clear that the intention was to subject healthy passengers landing from an infected vessel to a definite detention in some lazaret or similar institution; in short, to carry out what is known as a *quarantaine d'observation*. We, therefore, felt it our duty to explain that, as the result of a lengthened experience, it had been decided in England that compulsory detention should be limited to those who are actually sick on arrival, and that we trusted to inland sanitary authorities to maintain such sanitary conditions and arrangements as would enable them to prevent the extension of the disease should any case of cholera arise subsequent to landing. And we added that our assent of the regulation in question could only be given on the distinct understanding that the "observation" would in the case of England, be limited to the supervision to which passengers arriving from infected vessels are subjected for a few days in their own homes by the local sanitary authorities. This reserve we repeated at a subsequent sitting of the full conference, and it was inserted in the "*protocole de signature*."

The third regulation is concerned with the disinfection of articles and of certain portions of an infected vessel. This regulation, as first presented to the committee, was so framed as to make it compulsory to disinfect all unwashed linen in the trunks of passengers arriving in a vessel on which a case of cholera had occurred within the previous seven days. In short, it practically repeated the requirement already referred to in connection with the subject of disinfection, and it was strongly insisted on by the French delegation. The extension of this obligation to arrivals by sea was very distasteful to the German delegation, and after an unsuccessful attempt on their part to get the French delegation to modify the proposal, they announced in committee that they could not accept it. We supported them, adding that our experience in England over a long term of years was such as to show that the requirement was unnecessary, and that, under the circumstances, we absolutely declined to be bound by any such obligation merely because another country considered it necessary in her own interests. In the end the obligation as to disinfection stands as limited to such articles as, in the opinion of the local sanitary authority, have been actually contaminated by choleraic matters. In short, the proposal made by the British delegation when the subject was first discussed in connection with disinfection was in substance accepted, and the corresponding conclusion already referred to in dealing with that subject was also altered in like manner. In their present form, both regulations closely correspond with the actual practice adopted in England.

Suspected vessels were next dealt with. They are defined as vessels on which cholera has occurred either at the moment of leaving the port of departure or during the voyage, but on which no fresh case has arisen for seven days. These vessels are subjected to a medical visit, to disinfection of articles actually infected, and to certain precautions concerning bilge and drinking water. A recommendation is appended as to the advisability of maintaining under supervision (*surveillance*) the crew and passengers for a period of five days. As regards this suggestion, which is repeated as to vessels styled *indemnes* we explained that the practice was not likely to be deemed necessary in England, but as it came as a recommendation only, and was held to be of value in other countries, we should raise no objection to it.

A further suggestion in a like recommendatory form relates to some supervision over the movements of the crew.

Vessels styled *indemnes* were next discussed. They were defined as vessels on which there has been no death or attack from cholera. Such vessels are at once to have free pratique, even though they may have come from an infected port; and it is laid down that the regulations to which they can be subjected when coming from

## Department of Agriculture.

an infected port shall, in no circumstances, exceed those concerning suspected vessels. The definitions of the terms *infected*, *suspect*, and *indemne* agree with those in the convention of Venice.

A few other general conclusions were adopted, such as the power to enact special regulations in the case of vessels which carry emigrants, which are overcrowded, or are in a bad sanitary condition.

There follow certain important conclusions as to merchandise. Thus it was decided that goods arriving by sea were to be submitted to no other restrictions, whether prohibitory or relating to such matters as disinfection, than were permissible at land frontiers.

It was also resolved that any ship declining to submit to the regulations affecting the three classes of vessels above referred to should be free to resume her journey without detention, but that any such vessel could land her merchandise under certain conditions, which will not, we trust, be regarded as needlessly irksome; and, further, that any passengers willing to submit to the regulations affecting arrivals at the port should also be free to land.

It was further laid down that every country should provide on each of its coasts at least one port so fitted and adapted as to be able to receive vessels whatever their sanitary condition.

Meanwhile, the third committee was engaged on its labours. The question before it was, in substance, as follows. What sanitary restrictions should be imposed on navigation in the Sulina mouth of the Danube, and how far are the rules of the convention of Venice applicable to this particular case?

At the second meeting of the committee the principal Russian delegate brought forward a set of rules drawn to meet, according to his view, the special requirements of the steamers trading between Odessa and the port of Reni on the Pruth, in the Russian province of Bessarabia, which is reached from the Black Sea by the Sulina branch of the Danube. They also professed to offer adequate security to the Roumanian Government, to whom the maintenance of the local waters in a state of purity is a capital interest, as a portion of the *riverain* populations—more especially the inhabitants of the town of Sulina—derive their drinking water from the stream.

It was the Russian contention that this difficulty would be met by the grant to the Odessa steamers of leave to mount the Danube to Reni "in quarantine," under guarantee of a set of restrictions to be enforced on the Black Sea by Russian medical authority, and during the ascent of the river "in quarantine" by the Roumanian sanitary police.

The Russian delegate's proposals were elaborately drafted so as to give effect to this scheme. We do not quote them in detail, as they were rejected by M. Ghika, the representative of Roumania, in a reply which dealt exhaustively with the points at issue by every available resource of administrative, topographical, statistical, and medical argumentation.

In objections of the last named category lay the onus of M. Ghika's refusal. He maintained, as decisive for his government, that the Russian proposals, failed to provide those absolute safeguards for the maintenance of the purity of the river against contamination by choleraic dejections from passing steamers, which that Government regard as vital for Roumanian interests.

In presence of this apparent deadlock, the committee charged a scientific sub-committee to advise on the points at issue, and as to the conditions, if any, under which the principles adopted by the conference of Venice in the case of the Suez Canal might be susceptible of application to the Sulina channel. The sub-committee included the technical delegates of France, Germany, Italy, Roumania, Turkey, and Great Britain. Diplomatic representatives of Austria-Hungary and Russia were invited to attend its meetings, and supply such information on topographical or other local details as might be required.

In the discussion that ensued, the experience of Germany during the recent cholera epidemic as to the pollution of rivers in resort for domestic water supplies, was carefully considered. The sub-committee decided that between the circumstances of the Suez Canal, with its salt and brackish water and arid shores, and those

of the Sulina channel, with a population drinking the fresh water from the river, no parallel could be drawn as regards the transit "in quarantine" by possibly infected vessels. Thereupon a set of rules resting on an entirely different basis was drawn up, and submitted to the third committee.

The measures in question relate exclusively to vessels arriving from infected ports. They are in substance, as follow:—

All ships of that category reaching the mouth of the Danube to be subjected to daily medical inspection for a period which, in the absence of any occurrence of cholera on board, shall not exceed three days; all infected linen to be disinfected; certain securities to be taken in regard to the ship's drinking water and bilge water. Further, these and other allied precautions are to be carried out, and eventually repeated, according to the state of health on board, at sanitary stations to be established up the river; while all vessels ascending the Danube from Sulina must comply with certain general regulations, such as the avoidance of overcrowding, &c., which aim at the maintenance of a reasonable standard of healthiness on board.

This scheme, being laid before the third committee, and some amendments of small importance having been adopted, was accepted by the delegates of Ruesia and Roumania. Its conclusions were approved by the committee, and recommended to the full Conference, which thereupon passed them by an unanimous vote. Such was the solution of that which at one time promised to be one of the most difficult problems of the "*Interrogatory*;" its attainment was chiefly due to the intervention of the scientific delegates.

We have thus discussed the main conclusions adopted by the conference, and embodied in the convention. Some of them involve restrictions in excess of that which, according to English experience, is necessary, or even desirable, for the prevention of cholera. But as regards land and maritime traffic generally, they approach more closely to our English standard than any rules that have ever before been accepted, or even suggested, at any similar international gathering; they were only adopted by some of the consenting Delegations after repeated argument. Thus it was necessary constantly to point to the baneful influence of restrictions which give a sense of false security and hinder the adoption of an efficient sanitary administration, which constitutes the only true safeguard against cholera. If the new measures are so carried out as neither to trespass beyond the limits of the spirit of the letter in which they are conceived, some substantial advance in the direction of the freedom of traffic both by land and by sea, and of the maintenance of a higher standard of public health in all the countries represented, will, we venture to hope, have been achieved.

We availed ourselves of every opportunity to limit the restrictions which, under the convention, may be imposed on vessels to which some suspicion of cholera attaches. The regulations as to this, as they now stand, may be regarded both as defining a maximum and as permitting a minimum of restrictions. As regards even vessels deemed to be actually infected with cholera, the maximum restriction to which they may be subjected, if they elect to enter a given port, will involve a detention of the hitherto healthy passengers for a period not exceeding five days, as reckoned from the date of the last occurrence of cholera on board. This maximum, which does not necessarily involve the vessel itself, compares most favourably with the length of detention to which both vessels and passengers have hitherto been subjected in many foreign ports. The minimum of restrictions, which is held to be obligatory, in the case of vessels actually infected, complies, with one exception only, namely that relating to that which is in effect a quarantine of "observation" as applied to healthy persons landing from infected ships with the restrictions which it has long been deemed necessary to apply to such vessels arriving in English ports. And it thus happens that, subject to our reserve in the matter named, the adoption by England of the conclusions arrived at will involve no alteration whatever in the cholera regulations under which our ports are at present administered.

It must also be remembered that the number of British ships which, by reason of their having recently had cholera on board, would come within the restrictions



## Department of Agriculture.

applicable under the convention to (1) infected vessels, or to (2) suspected vessels, must be extremely small; whereas vessels held to be (3) "*indemnes*," will, notwithstanding the fact that they may have come from an infected port, immediately receive free pratique.

It will be observed that only three classes of vessels are referred to in the convention, namely, the "*infectes*," "*suspects*," and "*indemnes*," all of which have some relation to cholera either on board or in the ports from which they have sailed. It was not thought necessary by the conference in any way to refer to vessels that were in no way related to any occurrence of cholera, it being assumed that since the conclusions arrived at were concerned with cholera only, no other vessels than those specified could be regarded as in any way coming within any of the restrictions allowed by the convention. This view was assented to, but, notwithstanding, we thought it advisable to make a definite statement, which is included in the proceedings of the last sitting of the conference, to the effect that it must obviously be assumed that no vessels other than those having had cholera on board, or having come from an infected port, would fall under any of the provisions of the convention.

As we have already pointed out, the convention offers advantages as regards the landing of merchandise, which we trust will tend to free our commerce from some of the vexatious restrictions to which it has hitherto been so often subjected. It constitutes a considerable advance towards freedom from unnecessary restrictions. Though the representatives of certain powers felt it their duty to adopt an attitude of opposition to the progress involved, it is noteworthy that they often did so in an apologetic tone; some of them expressing a hope that before long their own governments should find it possible to follow the majority of powers represented at the conference. On no single occasion was any proposal made to maintain quarantine in its more stringent form.

The convention, which we have now the honour to submit to your lordship's consideration, was signed by the delegates of the following countries, acting as plenipotentiaries, namely:—Germany, Austria-Hungary, Belgium, France, Italy, Russia, Switzerland, Luxemburg, Montenegro, and the Netherlands.

We also have the honour to enclose a copy of the "*protocole de signature*," recording the final declarations of the various Delegations in regard to the Convention. In that protocol we renewed the reserve we had already expressed, stating that in the United Kingdom no "observation" of healthy persons leaving infected ships will extend beyond a medical supervision carried out in their homes. No exception was taken to this reservation.

We also made a statement, for insertion in the "*protocole de signature*," that we would submit the convention to the consideration of Her Majesty's Government.

The announcement that the convention was not to be at once signed on behalf of Her Majesty's Government produced a certain feeling of disappointment among our foreign colleagues, the more so as many of its provisions had been specially framed to meet our views; we, therefore, explained that our instructions did not admit of our taking this step, as the final text of the instrument had not been settled in time to allow of our referring it to your lordship. Under the circumstances, however, we felt ourselves justified in expressing our personal satisfaction at the great advance which had been made, and, generally, at the provisions of the convention. Looking to the terms of this instrument, we trust that we have in some measure attained the object which Her Majesty's Government had in view in appointing us to act as their representatives at the Dresden conference.

We have, &c.,

GEORGE STRACHEY.  
R. THORNE THORNE.  
H. FARNALL.

To the EARL OF ROSEBURY,  
London, England.

## No. 34.

## CORRESPONDENCE ON OUTBREAK OF SMALL-POX ON IMMIGRANT TRAINS.

TORONTO, 27th April, 1893.

SIR,—During the past fortnight the Secretary of the Provincial Board of Health has brought to my attention certain difficulties which during past years (notably in 1892) have arisen in dealing with immigrants who have either had contagious disease amongst them or have been suspected by American health authorities as having come from infected centres. Acting on this assumption, the American authorities during 1892, as well as in 1893, have kept up and still maintain a border inspection, with the result that at any moment hundreds of immigrants may be detained at Windsor, Sarnia or Sault Ste. Marie, to the serious endangering of the health of these places and the placing upon them of very considerable expense incident thereto. The influx of immigrants into the Canadian North-west has added another element of difficulty of which you are doubtless aware in the instance of the small-pox cases occurring on the Canadian Pacific Railway train en route to Winnipeg, whereby the towns of Fort William and Port Arthur were much alarmed owing to one case being detained there. This alarm is reasonable when it is remembered that a small-pox patient brought to Port Arthur from the west last year over the Canadian Pacific Railway involved that town in a very serious outbreak and heavy expense.

The Secretary of the Provincial Board has only to-day received another most serious protest from Fort William against the action taken by the Provincial Board of Health of Manitoba, in placing a medical inspector at Fort William to examine all immigrants en route to that country, and if any are suspected of being sick, to prevent them going further west, thus making them a burden upon that municipality.

In view of this route growing yearly in importance in the matter of immigration, some systematic provision should be made for dealing with this class of cases.

Recognizing the interest of municipalities in this province in the matter of local trade and healthfulness, and viewing their interests from a provincial standpoint, it will be evident to you that a trade of direct interest, not to this province, but to the Canadian Pacific Railway, to the province of Manitoba and to the Federal Immigration Department, cannot be allowed to become detrimental to the interests of Ontario. This being the case, the Provincial Board of this province urges strongly that at certain points along this railway route within the province of Ontario, small-pox hospitals be located and properly equipped, as well as "houses of detention" wherein patients and suspects may on occasion be placed. These need not be within town centres, but in some locality contiguous thereto. It will be for the Immigration Department or that of railways to determine whether, as is the case in the United States, the railways shall be required to bear such an expense, or whether the Immigration Department should bear it. Manifestly this province must protect its own towns and people, and in case no such provision as above indicated is made, the Provincial Board will have to determine whether in the public interest, inspection and detention at the eastern boundary of the province are necessary, until the railways have consented to bear the expense of the construction and maintenance of such hospitals and houses of detention under the supervision of the Board, not only along the Canadian Pacific Railway line to the north, but also at the other points indicated.

The Provincial Board of Health of Ontario is wholly in accord with the view held and expressed by resolution of the recent Inter-State Conference at New York, at which the Dominion Government's representative was present, "that inspection

## Department of Agriculture.

should not be defined by state lines ; and it is anxious that there should be great expedition in the transshipment of immigrants westward, as their removal from the cars lessens the danger of disease spreading to the healthy." Hence the board is most anxious that your department will make speedy arrangements at some point in the neighbourhood of Port Arthur, Sudbury and Rat Portage for dealing with the North-west immigration, and at Windsor, Sarnia and Sault Ste. Marie for the United States traffic.

Trusting to receive an early reply,

I am, sir, yours truly,

RICHARD HARCOURT,  
*Provincial Treasurer of Ontario.*

The Honourable  
The Minister of Agriculture,  
Ottawa.

---

### REPORT OF THE SECRETARY OF THE BOARD OF HEALTH, ON OUTBREAK OF SMALL-POX.

TORONTO, 31st May, 1893.

Having learnt of the existence of small-pox at Fort William and Rat Portage in this province, and of a number of cases at Winnipeg, I proceeded on 1st May, to the district, with a view to inform myself as to the facts, and of the measures taken, to prevent the spread of the disease.

I first visited North Bay, a town of some 2,000 population, and found it still with snow hardly disappeared, and the streets, lanes and yards, with the collections of refuse created during the winter. The local Board of Health, although appointed, had not met this year, and the inspector had only notified ratepayers to clean up before the 15th of May.

I had an informal meeting with several members of the board, and indicated the necessity for prompt and extended action, with a view to removing sources of danger to health, and to the end of preparing for the care of any cases of disease, which might be introduced by immigrants passing that point. It is a point of great importance on the through route to the North-west, as it is some twenty hours from Quebec, and is the junction of the Canadian Pacific Railway and northern railways, and has the immigrants trains both *via* the Sault and Port Arthur, passing through. These occasionally are delayed there several hours, and immigrants leave the train and mingle with persons at the station, and also go into the town. There is a public water supply taken from shallow water in Lake Nipissing, which receives, within a mile of the intake pipe, at least one sewer from the railway station. No sewerage system yet exists, but there is a number of open ditches helping to drain away surface wastes.

The next town on the line northward, is Sudbury, the centre of a large mining district with probably a population of 1,500 in the town, and a total of 6,000, in the district. The town is well situated, with a sandy soil, but is rather low in the central portion, and a polluted creek running to the east of the town. It is the centre of a judicial district, there being a provincial lock-up, and a police magistrate. The town is newly incorporated, and its local board has only been organized, but cannot be said to have started work. The council, had, however, last week directed a town contractor to begin carting away refuse, and householders were ordered to begin cleaning up. There is no public water supply, there being however, in addition to several driven wells, a spring on the hillside boxed in, from which water is hauled in barrels, at a cost of twenty cents per barrel. This spring is badly protected, and is suspected of having been polluted last autumn and to have been the cause of a serious outbreak of typhoid. There is some talk of its being improved and a pipe being laid to a tank in the town, supplying, on its way, the lock-up. This is greatly needed, both for lessening the cost of water and for fire purposes. At

this point, the Sault branch meets the main Canadian Pacific Railway, and in view of this fact and the several outbreaks of small-pox, there is alarm lest a similar occurrence may at any time take place there. It is 80 miles north-west of North Bay. From this point the main line runs north-westerly, passing a number of small stations, the principal being Chapleau and Schreiber, where the workshops are. Beyond, there are Port Arthur and Fort William, at the head of Lake Superior, and twenty-four hours run from North Bay. The former of these is a town of 2,500, well situated on the hillside and extending westward meets Fort William, a neat town on the flat-land between three rivers, of which the Kaministiquia is the chief. Neither has a proper public water supply, although Port Arthur is partially supplied by wells, or by being carted in barrels. Some sewers exist in Port Arthur, and both towns have a number of good buildings. They are connected by an electric railroad. Both are in a fair sanitary condition, although cleaning up had hardly begun, owing to the late spring.

Diphtheria has been prevalent more or less in Port Arthur during the last year or so: but few cases exist at present. There are local Boards of Health in both towns fairly active at present, having had to deal with an outbreak of small-pox.

Some twelve hours by railway west of these town are Rat Portage, Norman, and Keewatin, all practically together on the shores of the Lake of the Woods, with drainage into Winnipeg River. Rat Portage is a thriving town of 2,000 or 2,500, situated on a rocky foundation, much scattered, but with good drainage, first into the lake, thence into Winnipeg river. The houses are good, and lumbering is a chief industry. The town, however, had not begun to clean up and it stands in great need of it. Owing to the large lumbering and mining interests, there are probably 5,000 people in the town and district, which make this their headquarters. This, with the floating character of the population, as at Sudbury, make it peculiarly exposed to the introduction of contagious disease, and creates a difficulty in dealing with such outbreaks. There is a local board which with an active mayor and council, have shown much activity in dealing with the outbreak of small-pox.

Typhoid has in past years greatly prevailed, owing to the drainage into the lake from which water has been hauled from along the shore in barrels, at twenty-five cents a barrel. Some scheme, it is hoped, will soon be adopted whereby a pipe will be extended into the deep current of pure water of the lake, and carried to some central high point convenient for domestic use and fire purposes.

I also visited Winnipeg and spent several days there, and found a committee of the newly organized Provincial Board of Health in session taking evidence in an inquiry into the "Smead-Dow" system of ventilating and heating schools.

The province is divided into four health districts and inspectors appointed for each. The inspector of the Winnipeg district was busily engaged in connection with the small-pox camp. A general hospital and splendid isolation hospital exists in the city, and except in the matter of a good and efficient water supply and an extended sewerage system, Winnipeg is well advanced in matters of public sanitation.

The members of this Board have already been made acquainted, through the newspaper press, with the several outbreaks of small-pox in this northern district, the first case being one in the person of a servant engaged in a private house in Winnipeg, who had arrived *via* Halifax in the SS. "Buenos Ayrean" the rest being either passengers on the SS. "Vancouver" to Halifax, or persons exposed on one of the two trains which carried immigrants from this steamer westward.

On 13th April, two trains passed westward to Winnipeg, the first of which had a case of small-pox in a child. The child had apparently been sick twenty-four or more hours; the rash was well developed. The Canadian Pacific Railway physician, Dr. Beck, of Port Arthur, was sent for and diagnosed the case, locked the car and sent it on to Fort William, the divisional terminus of the railway.

The details of the case will be found in the report of the local board, to be submitted.

The second train likewise, had a child sick of small-pox, on board. The trouble created on account of the first case, resulted in the second train being carried past Port Arthur directly to Winnipeg, the sick child, it is said, having died en route.

## Department of Agriculture.

Consternation ensued when the case was reported in Winnipeg and when it was known that the passengers from the same car and the other cars were going about the streets and mingling with the general public. I further learned while I was in that city that most of these immigrants were not intending to stay in the Canadian North-west, but were carried by the Canadian Pacific Railway on tickets to Winnipeg and there were to buy new tickets to Dakota. By a ruse these passengers were mostly got into the train again and were at once taken outside the city and quarantined in the cars. Thence they were subsequently moved into tents temporarily erected, one or two cars likewise being kept for use. Some 300 suspects were in camp at the time of my visit, and nine cases had occurred, two of whom have died. The cost of maintaining this camp, in providing police, physicians, etc., is a most serious one: and the same may be said of the camp at Fort William, there being some 67 suspects quarantined there, and seven cases, with one death, to date. Second cases occurred at both these camps, most of those at Fort William being French Canadians who boarded the train, it is stated, from Ottawa. The Rat Portage case, which has also died, was likewise a French Canadian. He, with several others, had gone west on the train on the 15th, bearing the child to Winnipeg, and went to an hotel boarding-house. On the 26th of April, taking ill, a physician was called and on the 29th the case was declared small-pox, and was removed to a temporary hospital which was hurriedly erected. The hotel was quarantined with some seventeen inmates, and a guard placed upon it. Trouble was with difficulty averted, as the owner complained of loss of business. As several had been exposed, it was feared other cases would occur: but prompt vaccination it is hoped will avert the danger. The future danger from these several camps will be of course when those exposed are set free. The care being taken in delaying the period of detention to twenty-one days, and in disinfecting, will it is hoped, however, avert it.

These several outbreaks bring into prominence a number of points which I desire to bring to the board's attention. Dealing with the outbreak as a whole, it is apparent at the outset, that whatever may be said of the quarantine at other ports, that at Halifax was during the past winter, and is still, as seen in the fact of immigrants by two vessels having within the month of April transmitted small-pox to this province, most defective. That vaccination on the ocean vessels is not practised regularly, is seen in the fact of three cases of infection, at least, being introduced, and that the unvaccinated are allowed entrance at this port, is equally apparent. That no great care, even of inspection of the sick, has been carried out in these cases is learned from the fact that two of the cases had the rash well developed when Port Arthur was reached, one child having even died when the train had reached Winnipeg. Manifestly, therefore, we have the following points made plain: (1) that these immigrants were infected in Europe, there having been, they say, a case of small-pox on the train on the continent on which they travelled; (2) that the ship-surgeons are not obeying the quarantine rules regarding the general vaccination of steerage passengers; (3) that the port examination for evidence of vaccination is neglected or wholly perfunctory; and (4) that the railway company knowingly transported two cases many hundred miles after their sickness was evident to the most casual observer.

Dealing with the matter as it affects the health of this province, it is manifest that when such a state of affairs is possible along the route of immigrant travel, every municipality, but especially those towns at railway junctions and terminal points of divisions are at any moment liable to be exposed to cases of disease thus introduced, since trains are delayed at times several hours and immigrants mingle with persons at the station and visit restaurants and shops, purchasing provisions. What protection then, we may ask, is being afforded to the citizens of these places, and the rest of the province?

The relatively small size of these towns, their recent foundation, and comparatively small wealth, necessarily have made health matters of slow growth, and as has been noticed, the routine health work of these towns is not greatly advanced. As regards hospital arrangements, except in Port Arthur, there is nothing whatever of a permanent character. There is there a well-conducted general hospital: but,

except the temporary huts at present at Fort William and Rat Portage, no structure whatever exists for dealing with cases of contagious disease. A small private hospital exists at Sudbury, mostly of use for surgical cases from the mines.

Recognizing urgency in this matter the following letter was transmitted by your secretary to the minister of the department, who thereupon communicated regarding the matter with the several ministers of the Federal Government. Replies have been received that the matter is receiving consideration.

During my visit of inspection to the various towns, I met with the health authorities in each town and urged the following method of providing against future dissemination of the disease:—

1. That the municipality erect a permanent isolation hospital for use at all times for diphtheria, scarlatina, etc.; and that they have an annex or separate structure for any cases of small-pox or cholera which may arise. Such would be equipped and have caretakers who could do the cooking, heating, etc.

2. That, where perfectly equipped, the authorities might then apply to the Ontario Government for aid, under the Charities' Act, as a per diem allowance according to the number of patients treated during the year.

3. That the Immigration Department be asked to establish, at three points on this route, "houses of detention" for the care of suspects, these being under the supervision of the local board of the town or districts. These points would be, North Bay or Sudbury, Port Arthur or Fort William, and Rat Portage. The method of procedure in these cases as regarding division of cost, which seems equitable, would be as follows:—

1. The local board, or a committee of two or more would control the hospital and house of detention.

2. The charges would be levied by them for all patients, on the patient in the first instance, and if unable to pay, then on the person who is his legal guardian.

3. If a poor person from the municipality, the latter would bear the cost.

4. If from an outside municipality, then according to the small-pox regulations, the first named municipality must take charge of patient and transmit cost of caring for same to this board, which I presume would apply to the municipality or other authority responsible for his care. This procedure would be the same in the case of suspects.

5. If such persons were from outside the province, and had transmitted the disease, it seems reasonable that the provincial board of health of such other province should bear the responsibility of collecting the charges.

6. If an immigrant who had passed quarantine, then whether sick, or a suspect, his charges would be borne by himself or by the immigration department, if a *bona fide* immigrant to Canada.

7. If a through immigrant to the United States, even though ticketed to a Canadian terminus, it seems only proper and just, that the railway carrying him should be responsible for his maintenance and care. This principle should govern immigrants whether by Port Arthur, Sault Ste. Marie, Sarnia or Windsor.

All of which is respectfully submitted.

PETER H. BRYCE,  
*Secretary.*

DEPARTMENT OF AGRICULTURE,  
OTTAWA, May 2, 1893.

SIR,—The Minister of Agriculture desires me to acknowledge your letter of the 27th ult., on the subject of quarantine regulations and practice in relation to points connected with the question of public health.

The minister, who was on the eve of leaving for Chicago when he received your letter, has desired me to make the following explanation in reply:—

As respects the difficulties which have been found on the United States border and particularly in 1892, in dealing with immigrants passing through Canada for

## Department of Agriculture.

entry into the United States, I have to inform you that an agreement has been made with the Supervising Surgeon General of the United States Quarantine Service, in virtue of which United States inspectors will be allowed to watch the quarantine operations at any of the quarantine ports in Canada, for the purpose of satisfying themselves as to the fact of efficiency.

As a result of this arrangement Dr. Banks, United States Quarantine Officer, is now at Grosse Isle, and I understand that other United States Medical Quarantine officers will be stationed at the Princess Louise Embankment or Lévis, with the same object.

The disinfection of all immigrants' luggage, including that coming by healthy ships not detained at Grosse Isle, or not coming from an infected country, will during the whole of the present season of St. Lawrence navigation be practised at the Louise Embankment, Quebec, or at the Grand Trunk wharf, Lévis, in the case of those immigrants booked to go by the Grand Trunk. The disinfection is to be by the process of steam, the dioxide blast, or the bichloride drench.

The department has an understanding to the effect that these processes will be satisfactory to the Supervising Surgeon General at Washington, and also to the health authorities of the several states immediately affected. A card, of which I send you herewith a sample, is to be punched in such way as to show whether the disinfection took place at Grosse Isle, or the Louise Embankment or Lévis, or whether by steam, the dioxide blast, or the bichloride drench.

The disinfection is to take place under the personal supervision of Dr. Montzambert, who will become professionally responsible for its efficiency, and I understand the United States Medical Officer will also certify as to the fact of his satisfaction.

As a consequence of these proceedings it is not believed that any difficulties will arise at the United States frontier ports of the nature indicated in your letter during the present season.

As respects the small-pox cases, to which you refer, occurring on a Canadian Pacific Railway train *en route* for Winnipeg, which created some difficulties at the points of Fort William and Port Arthur in Ontario, the immigrants in question arrived by the steamship "Vancouver" at Halifax, and Dr. Wickwire, the quarantine officer at that port, states that he personally examined all the passengers before landing without finding any small-pox among them.

I also understand that in pursuance of his duty he called on the ship's surgeon to answer specific and minute questions on this head, with the result of not finding the occurrence of any disease of small-pox during the voyage.

The incubation of the disease of small-pox is 14 days, and until it actually breaks out, it cannot be diagnosed. And there is the specific fact reported by one of the attendants of the immigrants in question that the first manifestation of the disease occurred at Montreal, the second or third day after the immigrants had left the "Vancouver." In the circumstances there was no possibility of detecting it at the Halifax Quarantine Station.

The disease among the immigrants in question having broken out after they had received pratique from the Halifax Quarantine Officer, had ceased to be a quarantine matter within the administration of this department.

By the amendment to the Quarantine Act of 1872, those clauses which conferred on this Department administrative functions in matters relating to public health were revoked for the purpose, as was announced at the time in Parliament, of relegating them to the governments of the provinces.

In this position it is not seen how this department could move in the matter of the detention houses or small-pox houses, as mentioned in your letter.

As respects dealing with the disease in question as incidental to the care of immigrants, the statements in your letter in relation to that particular, will be referred to the Minister of the Interior, who is charged with the administration in such matters.

And as respects the suggestion in the last paragraph of your letter that the Provincial Board of Health of Ontario "is most anxious that your—this—depart-

ment should make speedy arrangements at some point in the neighbourhood of Port Arthur, Sudbury and at Rat Portage for dealing with North-west immigration, and at Windsor, Sarnia and Sault Ste. Marie for the United States traffic," I have to state that if this reference has relation to the possible accumulation of passengers at the points named, from difficulty to enter the United States in consequence of their quarantine or public health restrictions, it is not believed that such will further be found, arising from the arrangements above alluded to.

I have the honour to be, sir,

Your obedient servant,

J. LOWE,  
*Deputy Minister of Agriculture.*

Hon. RICHARD HARCOURT,  
Provincial Treasurer,  
Toronto, Ont.



# Department of Agriculture.

## No. 35.

### REPORT ON NATIONAL CONFERENCE OF STATE BOARDS OF HEALTH, HELD IN NEW YORK, 1893.

*(Communicated by Dr. Montizambert, 25th April, 1893.)*

The following reports and resolutions were adopted by the Conference at a meeting held in New York city, 5th, 6th and 7th April, 1893.

*Report of the Committee on Proposition No. 5; Dr. Watson, of New Hampshire, Chairman.*

#### PROPOSITION.

5. (a) What available plan can be agreed upon which will pass a properly certified passenger or immigrant and his baggage and effects from his starting point in the United States, Canada or Mexico, to his destination without unnecessary interference or delay?

(b) Is it necessary and practicable to disinfect the baggage of all immigrants, and require certificates of disinfection?

1. Whereas, Article 14 of the Immigration Regulations of the United States provides that each immigrant or head of a family, prior to or at the time of embarkation, shall be given a ticket on which shall be written his or her name, a number or letter designating a list, and his or her number in said list for convenience of identification on arrival:

*Resolved*, That for the purpose of assisting the quarantine officers and health inspectors of the ports and places through whose jurisdiction said immigrants may pass, in determining the sanitary condition of said immigrants and their baggage, said ticket should also have printed thereon figures, letters or words, as shall be hereafter provided; that the ship's surgeon or agent shall indicate, by punch or otherwise, on said ticket the information hereafter to be specified; that the quarantine officer at the port of arrival, and the inspecting officers at the several inspection stations in the interior states, shall indicate in like manner the same information, said ticket to be carried by the immigrant from the port of embarkation to the point of destination, and there delivered to the proper health authorities. Provided that this provision does not conflict or interfere with the rules and regulations of the Treasury Department as already made.

*Resolved*, That the Secretary of the Conference be directed to forward these resolutions, with the necessary form, to the Secretary of the Treasury.

*Resolved, further*, That the Governments of the Dominion of Canada and the Republic of Mexico be requested to adopt measures similar as may be to the above.

2. *Resolved*, That steamship companies shall be furnished with blank forms, to be filled up by surgeon on voyage, dividing passengers into lists by state or province to which they are destined. Such lists to be handed to quarantine officer, to be by him punched with information derived at quarantine, inclosed in stamped envelope with printed address of the executive officer of each such state or provincial board of health, and at once posted. The state or provincial officer, on receiving it to

notify, by telegraph, if necessary, the local health officer into whose jurisdiction each family or person is going. Some such form as the following is suggested:—

*STEAMSHIP*.....*from*... ..*Date*.....*State of*.....

Place Whence Started.	Name.	Age.	Destination. — Fullest detail.	Disease. Port, Vessel.	Disinfection or quarantine Station.	Isolated Cases.
				Ch. . . . . Ch.	Steam.	
				S. P. . . . . S. P.		Landed
				Ty. . . . . Ty.	Sul. fum.	with
				Th. . . . . Th.	Bichloride drench.	attendants.
				Y. F. . . . . Y. F.		
				S. F. . . . . S. F.		
				M. . . . . M.		
				D. . . . . D.		

3. *Resolved*, That during the presence of cholera in Europe the disinfection of the baggage of all immigrants destined for this country should be required, unless disinfected at port of departure; and that certificates therefor, showing manner of disinfection, shall be pasted on the baggage.

*Report of Committee on Propositions 6 and 8; Dr. Vaughan, of Michigan, Chairman.*

6. In the emergency of an epidemic, would it be practicable to conduct a uniform system of inspection service at the various state lines, as against any given infected district, by means of which co-operation and mutual protection would be secured?

8. In the event of cholera in this country, what requirements should be made of transportation companies to prevent spread of the disease?

In our opinion a uniform system of inspection service may be established and carried out, but we do not believe that this inspection should be defined by state line. In the emergency of an epidemic of cholera at any place, inspection of outgoing trains should be instituted, and no suspect should be allowed to enter a train.

A medical inspector should accompany each outgoing train. He should carry medicines, disinfectants, &c., and should pay special attention to the water-closets, following directions furnished by the State Boards of Health, or the Marine Hospital Service. Rules for the care of water-closets should be posted in each closet.

In the emergency of an epidemic of cholera, it should be required that all passenger coaches should be provided with water-closets specially arranged for the retention and disinfection of all fecal matter, the apparatus and methods to be subject to the approval of the respective State and Provincial Boards of Health.

If any person on the train shows symptoms of the disease, such person should be isolated, so far as possible. One closet should be selected for the exclusive use of such person. The sick should be carried to one of the temporary hospitals provided for below, or the car containing the sick should be side-tracked in an isolated place, and proper accommodations provided in the car. In either case, the names, addresses and destinations of other passengers on that car should be telegraphed to the health authorities at their respective places of destination.

When passengers in a car in which a suspect has been found, have been transferred, another car should, if possible, be provided for their exclusive use.

Railroad companies should be requested to provide at such places in each state, as the State Board of Health may designate, accommodations for those who may be taken sick *en route*. Such accommodations should be subject to the inspection and approval of the State Board of Health.

## Department of Agriculture.

Each train medical inspector should be furnished by the State Board of Health with a list of physicians along the line, any one of whom may be called upon for assistance in case of necessity. The compensation for these auxiliaries should be fixed by the State Boards of Health. A special car or cars must be provided for passengers getting on a train at an infected place.

Ordinary articles of merchandise do not require disinfection. The mails, even from an infected place, ordinarily do not require disinfection. Household goods, personal effects and wearing apparel from an infected place, must not be received for transportation until such articles have been properly disinfected; and when so disinfected, each trunk, box or package must bear a card showing that the article has been disinfected, and the method of disinfection.

In case any car should be contaminated in any way, such car must be removed from the train as soon as practicable, and purified.

A system of rules applicable to river and lake transportation should be formulated in accordance with the above rules.

*Report of Committee on New York Quarantine Station; Dr. Patton, of Louisiana, Chairman.*

*Resolved*, That it be expressed as the sense of this Conference, representing the health authorities of the United States, Canada and Mexico, that the importance of having maintained at the port of New York, a thoroughly efficient system of quarantine against imported pestilence is so great as to warrant the conference in offering certain urgent recommendations.

Inasmuch as the state of New York has assumed the responsibility of carrying on this important work, upon the equipment and efficiency of which other states and communities are necessarily and largely dependent, the representatives of these states and communities feel themselves justified in urging that the present plant and appliances for the performance of quarantine work at Hoffman's Island be so enlarged and improved as to conform to the highest standard of modern requirement.

The conference recognizes the fact that the present quarantine administration has laboured under the disadvantage of having to operate a system burdened with grave inherited defects, and full credit is accorded for such work as has been done by the present quarantine officer. The conference is informed that several important improvements are contemplated, and as soon as practicable these will be instituted. It is intended to increase the area of Hoffman's Island, the observation and disinfection station, containing the principal quarantine plant, from two acres to about ten. The facilities for the disinfection of baggage and bedding are deemed entirely inadequate. The conference is informed that an extension of the same to about nine times its present capacity is contemplated; but in view of the constant menace from cholera, the conference urgently recommends that these facilities be increased immediately. If practicable, it is also recommended that a wharf in deep water be built for the better accommodation of vessels under treatment at Hoffman's Island.

The supply of drinking water in cisterns is such as to render its contamination at the stations possible, and the necessity for a better arrangement is imperative.

It appears that no disinfection of immigrants' baggage other than on vessels has been practised at the port of New York since last October, and this conference formally protests against the continuance of this neglect.\*

---

\*NOTE.—Dr. Jenkins states that in the absence of infectious disease all persons from suspected ports or places, who have not had consular certificates of baggage, have had same opened and disinfected by sulphur-dioxide on board their vessels. Also, that all cargoes on such vessels have been disinfected in like manner. Portions of cargo and baggage brought as freight have had special disinfection when not accompanied by consular certificate, and special customs permit has been granted for discharge of same.

The conference also deems it its duty to report that the certificates at present issued by the United States officials at Ellis Island, as represented by Dr. Wheeler of that service, have no value whatever as guaranteeing any previous inspection or disinfection of immigrants' baggage, as this station is not designed for quarantine work.

The hospital at Swinburne Island is well equipped, and the crematory attached to the same is one of approved construction.

*Resolution of Dr. Baker, of Michigan.*

*Resolved,* That every state maintaining any maritime quarantine should, in the present emergency, unless for special reasons unnecessary, have a complete plant for the thorough disinfection of vessels, cargoes and baggage of passengers.

# Department of Agriculture.

No. 36.

## REPORT ON AMERICAN PUBLIC HEALTH ASSOCIATION MEETING HELD AT CHICAGO, OCTOBER, 1893.

(Communicated by Dr. Montizumbert.)

REPORT of Committee on "Sanitary and Medical Service on board Emigrant Ships," presented by Medical Director Albert L. Gihon, United States Navy; Chairman, at the Session held at the Art Institute, Chicago, Ill., Wednesday, 11th October, 1893.

Your committee beg to report the following concise statement of their views as to the organization of such a sanitary and medical service on board vessels, engaged in bringing immigrant passengers to the United States, as the experience and intelligence of this age make a necessity among civilized and enlightened nations.

They are of opinion and advise:

*First.* As to the location and dimensions of the quarters for emigrant passengers, the number of berths in each, and the provisions for their ventilation and cleansing:

That the preferable location for such quarters is abaft the midship section of the vessel: that single males' quarters shall be distinct from those occupied by women and children, and that if any are forward the midship section, it shall be those for single men.

That there shall never be more than two decks (properly there should be only one) occupied by emigrant passengers' berths, with 16 feet of superficial space for each adult on the upper berth-deck, and 20 feet of such space on the lower berth-deck, with not more than two tiers of berths on each deck, the bottom of the lower tier being not less than 18 inches above the deck, with not less than 30 inches between the two tiers and between the upper tier and the ceiling of the compartment, to allow the occupants of the berths to sit upright.

That no solid partitions or bulkheads shall be placed in any steerage compartment to obstruct light and air.

That the framework of the berths shall be of iron, easily removable that the compartment may be completely emptied and thoroughly cleaned after each passage;

That a steam ventilating apparatus by aspiration shall be introduced into all emigrant vessels; and

That all compartments occupied by passengers and crew shall be lighted by the incandescent electric light by night and day.

*Second.* As to the location and dimensions of hospitals on board such vessels and the number of sick berths for which provision should be made;

That the hospitals or "sick bays" on board emigrant passenger vessels shall be at the extreme after part of the upper deck, thoroughly lighted and ventilated, with 18 feet of superficial space for every 50 passengers, and not less than four sick berths or hospital cots for every hundred passengers.

*Third.* As to the number of medical officers proper for the maximum of emigrant passengers, any vessel should be permitted to carry, being the maximum number able to be berthed with regard to health, cleanliness and comfort;

That there should be one duly qualified medical officer for every 250 passengers.

*Fourth.* As to the professional records which the senior medical officer of every such vessel should be required to keep and his responsibility to the health authorities of the port of arrival for the truthful and professionally accurate statements of such records;

That the senior medical officer of every such vessel shall be required to keep (1) a *List of Sick*, recording in a bound book, in the order of their admission, and on a single line, the name, sex, age, birth-place, date of admission to treatment, date

of death or discharge from treatment, disease, and such remarks as may be necessary to enable the inspecting medical officer at the port of arrival to have a clear and complete understanding of the case, and (2) a Medical Journal, in which each medical officer, when there are more than one, shall record the medical history, including symptoms and treatment of every case, to be approved and signed by the senior medical officer at the close of the day's record; and such List of Sick, and Medical Journal shall be submitted to the health authorities of the port of arrival, and the accuracy of the statements in such records shall be established by oath and penalties for perjury shall be provided.

*Fifth.*—As to the location and capacity of latrines for emigrant passengers:

That the latrines, shallow troughs with a continuous flow of salt water, shall be on the upper deck under shelter with two water-closet seats for every fifty passengers, with a proportionate number for women and children, in a separate locality near their own quarters and inaccessible to men.

*Sixth.*—As to the number of attendants provided for such passengers, and their duties as to polishing and cleansing emigrants' quarters:

That there shall not be less than one berth-deck attendant for every fifty passengers, female attendants in the same proportion being exclusively assigned to the quarters for women and children;

That the berth-decks shall be thoroughly cleansed every morning, by the attendants, never wetted in rainy or damp weather, when they shall be scraped, swept and freshly sanded, and in pleasant weather, washed with hot water and quickly dried, the passengers being sent on deck during the operation;

That the berth-deck attendants shall be on duty night and day in rotation by regular sea-watches, and the attendants on watch required to remove the dejecta of sea-sick passengers without delay; and that benches and mess-tables shall be provided and the passengers' food be distributed by the berth-deck attendants, who shall take away all unused food, and carry the dishes to the pantry.

*Seventh.*—As to additional provisions for the personal health, cleanliness and comfort of emigrant passengers:

That wash-rooms under cover, with basins supplied with running water, shall be provided on the upper deck, those for men to be separate from those intended for women and children:

That fresh water for drinking purposes shall be provided in each compartment:—and

That inexpensive mattresses, pillows (these to be serviceable as life-preservers,) and blankets shall be provided for emigrant passengers, the mattresses to be destroyed after each passage, and the pillows and blankets to be steamed and washed before being again used.

While other suggestions as to sanitary provisions might appropriately be made, your committee feel that those indicated are of such urgent necessity that they should be insisted upon and put into effect without delay.

All which is respectfully submitted.

(Signed) ALBERT L. GIBON, M.D.,

*Medical Director, U. S. Navy., Chairman.*

(Signed) F. MONTIZAMBERT, M.D., F.R.C.S., D.C.L.,  
*Supt. Quarantine Station, Grosse Isle, Quebec.*

(Signed) WALTER WYMAN, M.D.,

*Supervising Surgeon-General, U.S.M.H.S.*

(Signed) S. R. OLLIPHANT, M.D.,

*President State Board of Health of Louisiana.*

(Signed) WILLIAM T. JENKINS, M.D.,

*Health Officer of the Port of New York.*

The report was accepted, referred to the Executive Committee, and reported back with the recommendation that it be adopted by the association, which was done without dissent, and the secretary instructed to cause it to be published and distributed in advance of the annual volume of transactions.

# Department of Agriculture.

No. 37.

## REPORT OF THE "HARAS NATIONAL," 1893.

MONTREAL, 31st October, 1893.

SIR,—I have the honour to report that, on the 31st of March, 1893, Professor Saunders of Ottawa, accompanied by Veterinary Surgeon McCormick, of Huntington, called at Outremont, for the purpose of selecting the stallions of the Haras, for the season of 1893, for the experimental farms of the government.

The Clydesdale "Gallant Model," was selected for the Experimental Farm of Agassiz, the Clydesdale "Barlocco" for the Farm of Indian Head, the Percheron "Clement" for Brandon, the Normand "Marquis of Puisaye" for Nappan, and the Percheron "Boston" and the Normand "Général Protte," for Ottawa.

### CENTRAL FARM (EXPERIMENTAL) OF OTTAWA.

The Percheron "Boston" (29863) 8 1st prize, Brandon, Man., 1891; 1st prize, Montreal, 1893; and the Normand "Général Protte," left Montreal on the 21st of April, for Ottawa and returned here on the 1st of August, 1893. They were sent afterwards to Chicago for exhibition, where "Boston" was classified as the 14th and "Général Protte" as the 12th in their respective classes. "Boston" has given 18 services at Ottawa; the average age of the mares being 9 years and 9 months.

"Général Protte":—the number of his services has been 95, the number of mares being 75. The average age of mares being also 9 years and 9 months.

### EXPERIMENTAL FARM, BRANDON, MAN.

The Percheron "Clement" (32172), 4 1st prize, Brandon, 1892; 3rd prize, Montreal, 1893. Left Montreal on the 20th April and returned on the 7th August. The number of services having been 37. Average age of the mares 8 years and 3 months.

### EXPERIMENTAL FARM, INDIAN HEAD.

The Clydesdale "Barlocco" (7461), 1st prize at Huntington, 1890; 1st prize at Montreal, 1890; 1st prize at Ottawa, 1891. Left Montreal on the 20th April and returned on the 7th of August. Sent afterwards to Chicago where he obtained the ninth prize, being classified the third for the Dominion, the very day after a long trip of 14 days by railway. Served 52 mares (80 services), average age being 6½ years.

### EXPERIMENTAL FARM, AGASSIZ, B.C.

"Gallant Model" (7726), Clydesdale, 1st prize, Kilmalcolm, Scotland, 1889; 1st prize, Huntington, 1889; 1st prize, Ottawa, 1889; 1st prize, Sherbrooke, 1889-90. Left Montreal on the 20th April and returned on the 7th of August, after having served in the valley of Agassiz, viz., 28 services, average age of mares being 6 years and 9 months.

### EXPERIMENTAL FARM OF NAPPAN, N.S.

"Marquis de Puisaye," Normand, left Montreal on the 20th April, and returned on the 4th of August, having given 58 services. Average age of mares 11 years and 9 months.

Total number of mares served, 1891.....	148
do do 1892.. .....	243
do do 1893... .....	246

## PRIZES GRANTED BY THE HARAS NATIONAL, 1893, TO THE BEST OF ITS PRODUCTS.

The "Haras National" as a rule, refunds under the form of prizes, the money received by the farmers for the services of its stallions.

Indian Head,	4 prizes.....	\$25 50
Brandon,	1 do .....	10 00
Aylmer, Ottawa,	6 do .....	32 00
Ottawa,	6 do .....	42 00

A number of American horse dealers were present at these exhibitions in order to purchase the Canadian Normand products.

Average of births among the mares covered by the stallions of the "Haras National," 1892:—

Ottawa, "Bonne Chance," Percheron.....	65·00	per cent.
do "Holopherne," Normand.....	72·88	do
Brandon, "Clement," Percheron.....	82·23	do
Indian Head, "James Arthur," Clydesdale .....	65·50	do
Agassiz, "Barlocco," Clydesdale .....	65·50	do
Nappan, "Général Protte" .....	70·83	do
General average, 1893 .	71·28	do
do 1892.....	73·20	do

These births are scrupulously kept recorded in books with stubs, at the Haras National.

## GENERAL REPORT.

The crisis which affects the horse trade has retarded the advance movement of breeding. This state of things affects specially horses of inferior quality. The "Haras National" received, last year, a prompt welcome from the farmers, and the number of mares served is over that of 1892.

The "Haras National" whose quality of horses is sometimes criticised, replies to such criticisms by the enumeration of prizes received at the great competition in Chicago, with its horses, coming out of season and after long trips, against horses ready and specially prepared for the exhibition during a whole year.

Class of Percherons, "Voltaire".....	4th prize;	1st of Dominion.
Class of Clydesdale.....	9th do	3rd do
Class of Normands.....	11th do	2nd do

I have the honour to be, sir,  
Your obedient servant,

AUZIAS TURENNE,  
*Director, Haras National.*

The Honourable  
The Minister of Agriculture,  
Ottawa.



Department of Agriculture.

No. 38.

REPORT ON TUBERCULIN INJECTION.

(P. H. BRYCE, M.D.)

TORONTO, 23rd December, 1892.

SIR,—I have the honour to bring to your attention a matter which has come under the notice of the Provincial Board of Health of Ontario, and of so much public interest that I am sure you will be thankful for the opportunity of knowing the facts, and of considering what action ought to be taken in the premises under the statutes of Canada.

Some two months ago I was informed by a prominent veterinarian of this city, that a herd of some fourteen thoroughbred Jersey cattle about four miles from Toronto, which professionally he had come to know, was infected to a greater or less degree with tuberculosis. As these cattle were supplying milk to Toronto the matter assumed importance in the interests of the public health which made it desirable that I should know exactly the facts of the case. I instructed my laboratory assistant to proceed to the premises in company with the veterinarian and to make a test on the suspected animals with tuberculin, the substance recently discovered by Professor Koch, and since recognized by scientific men and veterinarians as having positive value in the diagnosis of early cases of tuberculosis both in man and in animal. The results of the tuberculin in eight animals of the herd gave the results given on the accompanying table.

The conclusion was thus promptly arrived at that five out of the eight animals were affected with tuberculosis.

As there are cases of tuberculosis in many parts of Canada, and as we have now a scientific way of diagnosing the disease, I trust that such consideration will be given to the importance of this subject as will result in a commission being appointed by the statute, similar to that which has been appointed in New York States, for investigating this disease in various herds in this country, but especially in those cattle which are devoted to the milk supply of our cities.

Trusting that this matter may receive your favourable consideration.

I have the honour to be, sir,

Your obedient servant,

PETER H. BRYCE, M. D.

*Secretary, Provincial Board of Health of Ontario.*

The Honourable

The Minister of Agriculture,  
Ottawa.

## TUBERCULIN injected at 8.30 a.m., Nov. 5th.

	Temperature before Injection.			3.30 12 N.	7.30 3 P.M.	8.30 4 P.M.	9.30 5 P.M.	10.30 6 P.M.
	Nov. 2.	Nov. 4.	Nov. 5.					
	1. Floss	101.0	101.6					
2. Duchess	101.4	101.2	101.4	101.6	101.4	101.4	101.8	101.4
3. Maid	101.8	101.0	101.6	101.6	101.4	101.4	101.6	101.6
4. Bedford		101.4	101.4	101.0	101.2	101.4	102.2	101.6
5. Neta	101.6	101.0	101.8	102.0	102.0	102.0	102.4	102.2
6. Lily P.	101.6	101.6	101.6	101.2	102.2	102.8	103.4	103.4
7. Maggie		102.8	101.0	101.4	101.6	101.8	103.0	104.4
8. Lily of Cranmore		101.2	100.2	101.0	102.4	103.8	104.6	104.4

## CONTINUATION OF TABLE.

	12.30 8 P.M.	1.30 9 P.M.	3.30 10 P.M.	Amount of Tuberculin In- jected.
1. Floss	102.4	102.2		70 drops.
2. Duchess	101.6	102.0		70 do
3. Maid	101.4	101.4		70 do
4. Bedford	102.6	103.6	104.6	70 do
5. Neta	103.6	105.2	105.8	70 do
6. Lily P.	104.2	105.2	104.8	70 do
7. Maggie	105.0	105.8	105.6	100 do
8. Lily of Cranmore	104.6	104.4	104.0	100 do

NOTE.—The first top line indicates the number of hours after injection that the temperature was taken. The second line shows the hour at which the temperature was taken. As will be seen, Nos. 4, 5, 6, 7 and 8 are the ones affected with tuberculosis, as the temperature increased in these, and did not in the others.

P. H. BRYCE, *M.D.*

DIAGNOSIS OF TUBERCULOSIS IN CATTLE.

BY J. J. MACKENZIE, B. A., ANALYST OF THE PROVINCIAL BOARD OF HEALTH, ONTARIO.

*(Communicated by Secretary of Provincial Board of Health, Ontario.)*

That tuberculosis disease is common in cattle needs no specific proof from me; we may accept it as more than probable that in the ordinary milch cows of the province the percentage of animals affected may reach 6 per cent; that at any rate has been shown to be the case in countries where exact data have been obtained. In the expensive inbred stock such as the Jerseys, the percentage is higher, so high in fact that it is very startling to think of.

It has been unfortunately maintained by some writers that there is comparatively little danger of tuberculosis in man resulting from the use of milk from tubercular cows, but it seems to me that this is an idea which should be combated at every point by sanitarians. One must of course grant that appearances show that the great majority of cases of phthisis are due to infection through the respiratory organs, and as long as phthisical patients ignorantly spread the disease in all directions by allowing their sputum to fall in any locality where it may be converted into dust, such must be the case; but this very carelessness masks the real danger from tubercular cattle and renders it less apparent. The primary tubercular lesions in the adult are undoubtedly commonest in the respiratory organs, but in infants we find the disease often as a miliary tuberculosis, or tuberculosis of the meninges, or of the joints, all conditions which may be taken to point to an infection through the intestinal tract, and it is just this class, viz., infants, which are most exposed to the danger of infection from milk.

The students of the geographical distribution of the disease have brought forward interesting facts in regard to the relationship which exists between its presence or absence in aboriginal races and the use or non-use of cow's milk, but it would be foreign to the purposes of this paper to repeat them here. Aside from all these facts we also have cases on record which point very conclusively to infection from tubercular cows, and at any rate the significance of the alarming frequency of this affection in an animal from which the human race derives so much of its food is very great.

Unfortunately, heretofore, the greatest difficulty has been experienced in diagnosing the disease with any degree of accuracy until it is sufficiently advanced to show itself by the presence of the bacillus in the milk. There are, however, a number of fairly well marked symptoms in connection with its progress which give us points on which to base our diagnosis, and cause us at any rate to look with suspicion on certain animals.

I purpose first, to enumerate these ordinary clinical features and later on to touch on the methods which apparently now enable us to make an exact scientific diagnosis. These features may be divided for the sake of convenience into general and special symptoms. The general symptoms are the condition of the animal, the characters of the skin and hair and the presence or absence of a cough; the special symptoms, the enlarged lymph glands in various parts of the body, but more especially in the udder.

One of the first outward evidences of tuberculosis in an animal is the tendency to lose flesh and become emaciated in spite of hearty feeding. It does not put on flesh but loses it, although apparently possessed of as good an appetite as other animals in the same herd. This of course is a symptom which might escape a health officer making an inspection, and would only be observed by the owner who has his

animals constantly under his eye. Nevertheless it is important, and an animal exhibiting it should be watched. As the disease progresses the skin assumes a dry, harsh appearance, the hair loses its usual lustre and the animal appears decidedly ill. These symptoms, combined sometimes with a cough, are the more general ones noticed in diseased animals, and 84.21 per cent of the tuberculous animals killed by order of the police in Berlin in 1888 and 1889 showed these symptoms. The cough, with shortness of breath, are very commonly present and some veterinarians claim to be able to distinguish between a cough caused by tuberculosis of the lungs and that caused by other diseased conditions. In the former case it is dull, superficial, but yet combined with a heavy shaking of the whole body, so that, as one observer describes it, one sees rather than hears the animal coughing. Where the lungs are still unaffected the cough of course is absent, but when the animal is made to take violent exercise a peculiar shortness of breath may be observed.

One case is on record where the disease has been conclusively diagnosed by driving the suspected animal rapidly up and down an inclosure until a violent fit of coughing ensued, the nostrils being covered with a cloth; as a consequence the cloth became covered with a quantity of mucus in which the bacilli were recognized microscopically. It is likely that this method would answer frequently, and it would be well to give it as wide a trial as possible.

Of the special symptoms, the swelling of the glands are the ones to be particularly noticed. These are to be looked for in the laryngeal region, in the axilla and in the udder. Enlarged glands may be also noticed in the uterus and mesenteries upon rectal examination, but they are difficult to determine. Tubercular lesions in the lungs may be noticed, it is claimed by some authorities, by percussion and auscultation, but it is evident that only the most superficial ones could be so detected, and the peculiar character of a cow's breathing combined with the noises arising in the stomach render the method unsafe.

It will be seen then from this brief outline of the clinical features of the disease, that a diagnosis is hardly possible until the disease is far advanced, and that even then diagnosis may not be considered absolutely safe. But there seems to be no doubt from the evidence published that medical health officers must look with suspicion upon animals which show the sudden falling off in flesh noted above combined with the peculiar character of the coat and shortness of breath or cough. Where such is the case the animal must be carefully examined for enlarged glands, and the method mentioned above used to obtain some of the secretion from the nostrils and lungs, viz., the cow must be driven up and down the yard until a violent fit of coughing is brought on, at the same time the nostrils are covered with a piece of cotton. If any sputum collects, it is an easy matter to decide microscopically whether bacilli are present or not. As this point has not been sufficiently worked out as yet, I would like medical health officers to try it and to send me the sputum collected.

When tuberculosis attacks the udder there is another chance of accurately diagnosing it, viz., by the presence of the bacilli in the milk. At first there is no particular change in the character of the milk. It appears perfectly normal, but as the disease progresses it becomes thinner and thinner, until it finally has the appearance of blood serum and a chemical examination shows that it has approached blood serum in composition. This is no doubt due to the gradual destruction of the gland tissue by the tubercular processes. In the early stages of tuberculosis of the udder it is sometimes extremely difficult, if not impossible, to detect bacilli in the milk microscopically; indeed Dr. Ernst, of Boston, claims that the virus may be present in the milk while yet the closest examination fails to reveal the tuberculosis of the udder; this proof resting on the infection of guinea pigs, a much surer and more delicate though more complicated method of diagnosis than by the microscope.

The usual method of microscopic examination is to allow the milk to sediment for twenty-four hours, and I use for that purpose a large ungraduated burette holding about a litre with a stop-cock at the bottom, so that at the end of that time the sediment may be carefully drawn off without mixing with the supernatant fluid. The milk is prevented from coagulating by the addition of a small quantity of mer-

## Department of Agriculture.

curic chloride. This yields fairly successful results, but is tedious also, and it seems to me might be hastened by centrifugal action. Scheuerlen has shown that bacteria which are incapable of independent motion settle quite rapidly when submitted to centrifugal action, at least they separate from the milk, but a great percentage are carried up with the cream.

The tubercle bacillus is one of those which may be separated in this manner, and we have had constructed a centrifugal machine giving us from 500 to 1,000 revolutions a minute. A large percentage of the bacilli however go up in the cream caught by the ascending fat globules and the presence of the fat also renders the straining more difficult; consequently I found it necessary to add a quantity of ether, thus dissolving out the fat and allowing all the bacilli to settle. As far as I have tested this method it works admirably and promises fairly constant results. Unfortunately however only about forty c. c. of the milk can be treated at a time and where bacilli are few in number the chances of missing them are very much increased. Consequently when an examination of the small quantity which may be subjected to centrifugal action does not show the presence of bacilli, the rest of the milk may be allowed to stand for forty-eight hours and the sediment drawn off. For this purpose forty c. c. may be drawn from the bottom after standing forty-eight hours and then placed in the centrifugal machine, and in this manner the greater part of the bacilli in a quart of milk obtained for investigation. The apparatus for carrying on this investigation of milk has only been in the laboratory of the Provincial Board of Health for a short time, and I invite medical health officers when inspecting the dairies under their jurisdiction to send me samples of milk from cows showing the symptoms mentioned above. About a quart of milk is necessary for investigation, and it is best to have half of it consist of the milk first drawn, the other half from the last of the strippings. From the great prevalence of the disease in cattle, every health officer must have one or more animals in his district which should certainly be watched, and we might thus be able to a certain extent at least to combat the disease.

These then are all the clinical facts at our disposal at present in Ontario and on which we may just now depend for the diagnosis of bovine tuberculosis.

Since 1890, however, a new diagnostic agent has been discovered which apparently is going to yield rich results in the detection of the disease in cattle. I allude to Koch's tuberculin. Since the publication of its discovery it has to a certain extent fallen into disrepute as a remedial agent, but it has been steadily gaining ground as a diagnostic agent in bovine tuberculosis and I think that we in Ontario may make use of it and perhaps by doing so systematically, go far towards stamping out the disease in our cattle.

It will be remembered by those of you who watched the results of the treatment that the most marked feature of its use was the reaction set up in tubercular patients a number of hours after the injection. There was a distinct rise in the temperature. Now veterinarians have thought it possible to take advantage of this reaction in diagnosing the disease in animals. At first only a few isolated cases were tried on account of the expensive character of the reagent and not much could be done. It has now however become much cheaper and is being experimented on all over the world; indeed it may now be considered as past the experimental stage, and if tuberculin never becomes a success as a remedy it certainly will be used to a very large extent as a diagnostic reagent in animals.

As a rule the method of injection is as follows: The temperature of the animal is taken for several days before the injection three times a day then on an average about 0.4 grams (6 grains) of tuberculin mixed with 5 per cent carbolic acid is injected subcutaneously in the region of the shoulder. The temperature is then taken every two hours until nine or ten hours after the injection, and then every hour until twenty-four hours after the injection. The reaction in diseased animals usually sets in between twelve and fifteen hours after the injection and lasts for several hours. As a rule those animals which show a rise of from 0.8 to 1.4° C. should be regarded as suspicious and should be again injected in a month's time, whilst those which show a reaction above 1.4° should be condemned and killed.

The evidence upon which these results depends is now fairly complete, and it is perhaps well to give it. Omitting those cases where only a few animals were treated the following are the most important: Bang, a Danish observer, in April, 1891, injected 53 suspected animals and obtained the reaction in 38 cases. All the animals were killed and the autopsy showed the presence of the disease in 41 of the animals. Only three of the diseased animals had not reacted or reacted feebly, and two of these had received apparently too small a dose. In 93 per cent it had given an exact diagnosis. Bang has also tried it on calves and found it even more certain. He also stated that a number of Danish veterinarians have experimented with it on their own account and have obtained satisfactory results. At the veterinary school in Dresden 40 animals have been sacrificed, and 23 were found to be tubercular on post mortem examination, whilst 21 had given a reaction, that is 90 per cent. Johne and Siedamgrotzki, the observers, conclude that "we must consider tuberculin as a very important means in diagnosis."

Lydtin, chief of the veterinary board of the Grand Duchy of Baden, tried it also; 110 animals were selected, injected and killed for post mortem examination. 70 animals presented no tubercular lesion and gave no reaction, 1 reacted weakly, 39 reacted clearly, of which 37 showed the presence of tuberculosis at the autopsy. These results are the more valuable as in the case of 80 animals, they were selected from slaughter-houses, were designed for slaughter and had passed a severe veterinary examination; of these 18 presented the ordinary reaction, whilst one gave it faintly. At the autopsy 17 showed the disease whilst none of the others showed a trace of it. At Karlsruhe, Lydtin investigated a model dairy, the milk of which was especially used for invalids and children, all the cows being apparently in a very fine condition. There were 19 cows, each of which received 5 grains tuberculin, 9 reacted, and the autopsy showed that they had the disease; 4 months later six of the remaining cows were injected, three reacted and at the autopsy tuberculosis was found. At Karlsruhe, at least, these results have borne fruit, for the authorities have decided that the cattle for the dairies under their surveillance shall undergo the test before being admitted and shall have it repeated every six months.

The Imperial health office at Berlin has carried on similar experiments, the results of which have been published this year. Altogether 133 animals were treated and in over 80 per cent the results were satisfactory.

Nocard in France has injected 71 animals, 22 reacted and 21 were tubercular. Of the 48 which had not reacted 3 were tubercular, but there were animals so badly diseased that they would be condemned by ordinary veterinary examination. He also used this method in examining the cows in an important dairy 18 in number; two reacted, one was returned to the dealer, as he was convinced the other gave no evidence and was killed, when a very limited tubercular centre was found in one of the pulmonary lobes and three of the mediastinal glands were tubercular.

These are a few of the examples of the results obtained in Europe by the use of tuberculin as a diagnostic agent and they speak for themselves. All these experiments and others up to February, 1, 1892, have been tabulated by A. Ebers (*Centralblatt für Bakteriologie*, Vol. 1, 9 and 10), and out of 134 cattle which reacted and were killed 85.82 per cent were tubercular. On the other hand 113 animals gave no reaction and 89.38 were free from tuberculosis. But we must remember that all the conditions of the reaction are not yet completely known to us, and on the other hand the reaction is known to occur most markedly where extremely slight progress has been made by the disease, when it is often difficult to find it at the autopsy, so that the chances are very much in favour of the per cent being much higher.

In the United States tuberculin has been used also and with the same results as in Europe.

It has been used at Cornell University, in New York State, and in Pennsylvania as well as in other places.

A very interesting series of results have been described by Dr. Pearson, of the veterinary department of the University of Pennsylvania in the June number of 'Agricultural Science.' These were in connection with a herd of highly bred Jerseys owned by Mr. J. E. Gillingham, of Villa Nova, near Philadelphia. The herd was

## Department of Agriculture.

founded about 10 years ago from imported animals, and the establishment was in every way a model one. Inbreeding was avoided, animals were selected, everything was done to keep them in good condition. About four year ago, tuberculosis was first observed in the herd, and the infected animals were destroyed and their stalls disinfected. The herd was periodically examined by experts and diseased animals removed. In February of this year Dr. Pearson was called in and found one cow suffering from tuberculosis. It was killed. A careful examination of the whole herd of 79 animals revealed 5 additional cases and all these were destroyed. Mr. Gillingham then decided to have the tuberculin test applied to all his animals, and 33 of them gave the reaction. They were to all external appearances as fine as any on the farm and could have been sold for thousands of dollars, yet with a public spirit of the rarest order Mr. Gillingham turned over the whole 33 to the authorities of the University of Pennsylvania to be killed and examined. The examination fully confirmed the results of the experiment.

I think I have made it clear that we have in the tuberculin a reagent which is of immense value in the diagnosis of the disease. Especially as it is just in those cases in which other clinical evidence is wanting that it is most certain, for the results have all shown that in animals with only few tubercular lesions, so few that the ordinary health is in no way affected, the reaction is most marked. When the disease has gone so far that there is a distinctly feverish condition present, the reaction cannot always be depended upon. But in these cases the diagnosis is possible without its aid.

J. J. MACKENZIE,  
*Analyst.*

## No. 40.

REPORT OF INVESTIGATION RESPECTING ALLEGED DISEASE IN  
CATTLE SHIPPED FROM PILOT MOUND, MANITOBA.

(PROF. D. McEACHRAN, F.R.C.V.S.)

MONTREAL, 29th September, 1893.

On the 26th August, I left Winnipeg for Manitou where I met a number of cattlemen and farmers from whom I could learn of no disease or suspicion of disease.

I drove from Manitou to Pilot Mound, and visited Mr. James Morrow, reeve of the county, who knows of no disease in the district.

He arranged to meet me at Pilot Mound and to render me any assistance in his power, which he did two days afterwards, when he made the following statement:—

“I am reeve for the municipality of Louise, of which Pilot Mound is the centre. We have a by-law in which provision is made for compensation for animals which might be killed for disease, under the authority of the ‘Animals Contagious Diseases Act.’ I have been in the council for eight years, and have never known of such a disease as contagious pleuro-pneumonia or any other contagious disease of cattle. Had such disease existed I must have known of it. During my connection with the council we have never paid one cent nor have we been called on to pay a cent for such disease. I am certain that no contagious disease exists or has existed during my 14 years residence in the district.”

Mr. G. T. Watson, cattle dealer, made the following statement:—

“I travel all over the district buying cattle and if any disease existed I would certainly know of it. I unhesitatingly state that I do not know of the existence of any contagious disease in cattle in this district, nor has contagious pleuro-pneumonia existed in this district for seven years which is the length of time I have been here.”

Mr. Peter Strang, Baldur, says:—

“I am reeve of the municipality of Argyle, and as such, under the ‘Animals Contagious Diseases Act,’ I would be notified of any disease existing in the municipality. I do not know of any disease nor have I known of any disease since I came to the province of Manitoba, except three years ago, when a few sudden deaths occurred from anthrax.”

Mr. Strang’s farm is twenty miles from Pilot Mound. I visited most of his neighbours and farms on the way.

Mr. W. E. Cecil Montague, a neighbour of Mr. Strang, from whose farm the ox suspected of contagious pleuro-pneumonia was sold to Messrs. Ironsides and Gordon, made the following statement:—

“I had eight head which I raised myself. I had the ox in question four years last March, he was always fat, was never known to be ill, was an extra good work ox, much better than his mate. I never knew him to have any form of pneumonia nor to be ill a day in his life.

“I have been here ten years and never lost a horse or cow beast since I came. I have never heard of any lung or other disease in this district except an occasional case of ‘black leg.’”

I examined all his cattle and healthier cattle do not exist; they are well bred grade Shorthorns, nearly all bred by himself and not a single importation for years.

I visited a number of farms in various directions.

On the farm of George Mutch there were being pastured 170 head, belonging to fifteen different owners. Had disease existed in this district this would have been a very likely place to find it. I found, nevertheless, every hoof in perfect health.



## Department of Agriculture.

I had also an opportunity of inspecting about 100 head of butcher's cattle which had been bought, recently, in the district from farmers, were collected at farm of Messrs. Baird Bros., and were now driven in to be shipped.

If disease existed in the district we would expect to find it in such a collection, but every animal I found in perfect health.

The Messrs. Baird Bros. stated as follows:—

“ We are engaged in buying cattle the whole year round, and our buyers travel all over the district and beyond it, and if any disease or suspicion of disease existed, we would be certain to know of it one way or another. We can positively affirm that we know of no disease nor have we known of any disease in southern Manitoba for over ten years. A few years ago some deaths occurred from ‘black leg.’ The cattle you inspected this morning may be taken as samples from all over the district, and as you saw, a healthier lot of cattle cannot be found anywhere.”

I have, therefore, much pleasure in confirming, by personal inspection of the district, previous reports, and in being able to declare positively that pleuro-pneumonia does not exist and has never existed in the Pilot Mound District nor in any part of Manitoba. The health of stock generally in that province is excellent, and I am pleased to report that by more attention to breeding, the quality of the stock is improving very much.

I have the honour to be, sir,

Your obedient servant,

D. McEACHRAN, F.R.C.V.S

The Honourable  
The Minister of Agriculture,  
Ottawa.

## No. 41.

REPORT ON RENDERING AVAILABLE THE PHOSPHORIC ACID  
IN APATITE BY CALCINATION.

(FRANK T. SHUTT, M.A., F. I. C.)

EXPERIMENTAL FARM, OTTAWA, 31st October, 1893.

SIR,—In the early part of the present year several communications were received from the Department of Agriculture, Quebec, through the Honourable the Minister of Agriculture, upon the above subject. In these letters it was stated that a process for rendering available the phosphoric acid of mineral phosphates had been discovered in France and likewise in Belgium—the process consisting simply in the heating or calcination of the phosphate in a lime or plaster kiln.

This statement was accompanied by a request from yourself that we should make such experiments with ground apatite as would prove the correctness or otherwise of the assertion, or rather whether the process is applicable to our Canadian phosphate—since that in France is often of an organic origin and mixed more or less with organic and other matter. An extract from a French journal gives the calcined product the name of Thermo-phosphate, and further affirms its phosphoric acid is in a soluble form.

A series of experiments with finely ground apatite was accordingly instituted. I should, however, state at the outset that favourable results from the calcination of phosphate *per se* were not expected, since heat alone has no action in altering the chemical composition of tricalcic phosphate, of which apatite is chiefly composed. The calcination however might induce a physical change, resulting in a more ready solution of the phosphate in the soil-water—which under ordinary circumstances, due to the presence of carbonic acid, exerts a slightly solvent action on the finely divided, crude phosphate. (According to Warrington 1 part of pure tricalcic phosphate dissolves in 6,788 parts of water saturated with carbonic acid.)

All the experiments, the details of which are now to be given, were made with a finely ground apatite, found on analysis to have the following composition:—

Moisture.....	09
Tricalcic phosphate.....	58.48
Insoluble rock matter.....	17.33
Carbonate of lime, &c.....	24.10
	100.00

Equivalent to 26.79 per cent phosphoric acid ( $P_2O_5$ ).

*Experiment A.*—5 grams of the phosphate were placed in 150 c. c. of water through which carbonic acid was slowly passed for 3 hours. The whole was then filtered and an estimation of the phosphoric acid in the filtrate made. This resulted in showing that phosphoric acid equivalent to .05 per cent of tricalcic phosphate had been made soluble by this treatment.

*Experiment B.*—5 grams of the phosphate were heated in a platinum dish in a gas muffle furnace for three hours to a bright red heat. The cooled mass was treated with 150 c. c. of water through which carbonic acid was passed, as in the previous experiment. The whole was then filtered and an estimation of the phosphoric acid in the filtrate made. The data obtained showed that phosphoric acid equivalent to .45 per cent of tricalcic phosphate had been converted into a soluble form by ignition and the subsequent action of carbonic acid dissolved in water.

*Experiment C.*—In general principles this is a duplicate of Exp. B. 1 gram of the phosphate was heated for five hours, and treated with 500 c. c. of water through which carbonic acid was passed at the rate of two bubbles per second for three hours. The whole was filtered and the phosphoric acid determined in the filtrate. Phosphoric acid equivalent to .18 per cent of tricalcic phosphate had become soluble.

## Department of Agriculture.

*Experiment D.*—1 gram of phosphate was ignited as in Exp. C. After cooling, the mass was thoroughly moistened with ammonium carbonate to reconvert any caustic lime formed by the calcination into carbonate, and gently ignited. The mass was treated with ammonium citrate solution in the usual way. This would bring into solution any "reverted" as well as water-soluble phosphoric acid present. Upon analysis it was found that by this treatment phosphoric acid equivalent to .05 per cent tricalcic phosphate had been converted into a soluble form.

From these experiments the following conclusions may be drawn:—

1. That the finely ground mineral phosphate is soluble only to a very slight degree in water containing carbonic acid—our experiments showing only one five-hundredths of one per cent. In the soil such a solvent action undoubtedly takes place, but our present experience would indicate that the process is an extremely slow one.

2. That previous calcination appears to render the phosphate slightly more soluble in carbonic acid water. As already stated, the ignition of the tricalcic phosphate could bring about no chemical change. This slight increased solubility is therefore due to (1) a physical change induced by the heat, or (2) to the action, at the temperature of calcination, of some impurity present in the phosphate. The conversion, however, is so slight (by our experiments, about one-half of one per cent) that it cannot be considered to have any commercial importance.

3. That it is evident that the calcined phosphate is not soluble to any extent in ammonium citrate solution, showing that very little, if any, phosphate containing "reverted" phosphoric acid is formed by simple ignition.

The experiments now to be detailed give the results of fusing the finely ground phosphate with the sulphates and bisulphates of potash and soda.

*Experiment E.*—0.6 gram of phosphate and 0.8 gram of sulphate of potash were fused together in a platinum crucible for half an hour over the blast blow-pipe. The mass was cooled, treated with water and filtered. The filtrate only gave evidence of traces of soluble phosphoric acid. Sodium sulphate gave similar results.

*Experiment F.*—0.5 gram of phosphate and 5 grams of bisulphate of potash were heated together in a platinum crucible to redness for half an hour. The cooled mass was treated with hot water and the whole filtered. The filtrate contained phosphoric acid equivalent to 4.74 per cent of tricalcic phosphate.

*Experiment G.*—0.3 gram phosphate and 1.5 gram of bisulphate of soda were ignited together for 15 to 20 minutes at a red heat. The resulting fused mass treated with water and filtered. The filtrate contained 17.63 per cent phosphoric acid, equivalent to 38.49 per cent of tricalcic phosphate.

I infer from these results (1) that any soluble phosphoric acid that may be formed during the ignition of the mineral phosphates with the sulphates of soda and potash immediately recombines in the presence of water to form the insoluble tricalcic phosphates, and (2) that the ignition of the mineral phosphates with the bisulphates of soda and potash produces, according to circumstances, more or less soluble phosphoric acid.

This latter conclusion is a very important one, since it is possible that by using the by-product sodium bisulphate an economical method for the treatment of mineral phosphate may be devised. It is scarcely necessary to add that such a process would prove of great value to Canada and Canadian agriculturists. Before an affirmative statement can be made regarding the commercial success of this method for converting and utilizing our phosphate, the cost of the raw materials and of the treatment, as well as the price obtainable for the manufactured article, must be taken into careful consideration.

In conclusion, I would state that further experiments are now in progress on this important subject. The results of these when obtained, will be duly reported.

I have the honour to be, sir,  
Your obedient servant,

FRANK T. SHUTT, M.A.,  
*Chemist, Dom. Experimental Farms.*

The Honourable  
The Minister of Agriculture, Ottawa.

## No. 42.

## CANADIAN QUARANTINE REGULATIONS.

## THE QUARANTINE STATIONS.

The quarantine stations of Canada at the Atlantic maritime ports, are :—

- (a.) Grosse Isle, in the river St. Lawrence, with Rimouski, the Louise Embankment and the Grand Trunk wharf at Lévis, as sub-stations, province of Quebec;
  - (b.) Halifax, the harbour and Lawlor's Island, in the province of Nova Scotia;
  - (c.) St. John, the harbour and Partridge Island, in the province of New Brunswick;
  - (d.) Sydney, Cape Breton, in the province of Nova Scotia;
  - (e.) Pictou, in the province of Nova Scotia;
  - (f.) Hawkesbury, in the province of Nova Scotia;
  - (g.) Chatham, in the province of New Brunswick;
  - (h.) Charlottetown, in the province of Prince Edward Island;
2. On the Pacific coast :—

(a.) Williams Head, including Albert Head, in the strait of Fuca, province of British Columbia, and also including as a sub-station the port of Victoria; and,

3. Every other port, on both oceans, at each of which the collector of customs is the quarantine officer, such port being designated an unorganized quarantine station;

4. And every inland customs port on the Canadian frontier, between the Pacific and Atlantic oceans, each port being designated an unorganized inland quarantine station.

## GENERAL PROVISIONS.

5. Every quarantine officer at a quarantine station in Canada, and every customs collector in his quality of quarantine officer, shall for the purpose of these regulations be a justice of the peace in virtue of the provisions of sec. 5 of the Act respecting Quarantine, chap. 68, Revised Statutes.

6. Within the meaning of these regulations an infected port or country is a port or country where Asiatic cholera or other epidemic disease has been communicated to one or more persons through the medium of an infected person, personal effects or otherwise. A port or country is not considered infected when a single case or a small number of cases has been imported and the disease has not been communicated from such cases.

7. Any of Her Majesty's ships of war or any transport having the Queen's troops on board, accompanied by a medical officer, and in a healthy state, is exempt from quarantine inspection and detention.

8. Every vessel from any port outside of Canada requiring quarantine inspection shall, on arrival at any port in Canada, display a yellow flag at the fore, for a distinctive quarantine signal, in order to inform the quarantine officer that his services are required, and any vessel arriving by night shall display a red light at the fore for such signal.

9. Coasting vessels from Newfoundland and from ports in the United States contiguous to Canada and free from infectious disease may, from time to time, be excepted from these regulations by order of the Minister of Agriculture.

10. Every vessel arriving from any port outside of Canada (liable to quarantine) shall be inspected by a duly appointed quarantine officer and shall not be allowed to make customs entry at any port in Canada until it has received a clean bill of health.

## Department of Agriculture.

11. No person shall be allowed to land from any vessel until such person shall have been declared by a quarantine officer free from infectious disease, and until, in the judgment of such officer, such landing can be effected without danger to the public health.

### QUARANTINE DETENTION.

12. Every quarantine officer shall satisfy himself as to the presence or absence of infectious disease by the personal inspection of those on board or by the sworn statement of the captain or surgeon, in the form hereto annexed, or by both;

(a.) A vessel may be detained at quarantine for disinfection during the time necessary for that purpose;

(b.) The time during which a vessel may be detained for quarantine of observation is the accepted period of the incubation of the disease quarantined against from the ascertained date of last possible exposure.

13. Every vessel with infectious disease on board, or coming from an infected port or country, shall be liable to be detained at a quarantine station for disinfection, together with its passengers, crew and pilot, and passengers' luggage and cargo.

14. Any vessel so detained by order of the quarantine officer shall forthwith be anchored or moored in such position as the quarantine officer shall direct.

15. And whilst such ship is so detained no person shall leave the same, nor shall communication be allowed with such vessel, without permission from the quarantine officer.

16. The quarantine officer detaining any ship as aforesaid shall immediately notify the Minister of Agriculture, stating the cause of such detention.

### HOURS OF INSPECTION—PUTTING BACK—COSTS.

17. Every vessel may be inspected during any hour of the twenty-four;

(a.) With the exception that in times of epidemic the Minister of Agriculture may direct that inspection shall only take place during the hours of daylight.

18. Any vessel shall have the right before breaking bulk to put to sea in preference to being quarantined, as provided by section 9 of the Act intituled "An Act respecting Quarantine," chap. 68, Revised Statutes.

19. All costs incurred in the maintenance of healthy persons who may have been exposed to infection detained for quarantine of observation are to be at the charge of the vessel;

(a.) And the master of a vessel may make arrangements with the quarantine officer for the landing of the necessary provisions and attendants or stewards for serving them;

(b.) Persons actually sick will be treated and taken care of in the quarantine hospitals, at the charge of the Government;

(c.) In the event of a vessel being allowed to proceed and leaving its passengers in quarantine, the subsequent transfer of such passengers from quarantine to the port of destination shall be at the charge of the vessel.

### QUARANTINABLE DISEASES.

20. The graver quarantinable diseases are: Asiatic cholera, small-pox, typhus fever, yellow fever and the plague. The minor: scarlet fever, enteric fever (typhoid), diphtheria, measles and chicken-pox;

(a.) In addition to the above recital, it is the duty of every quarantine officer to satisfy himself as to the presence or absence of any other contagious or infectious disease;

(b.) And with respect to leprosy it is the duty of every quarantine officer, and particularly on the Pacific coast, to satisfy himself as to the fact of the presence or absence of such disease among the passengers, and in the event of any case of such disease being found the person affected shall not be allowed to land, but must be taken back by the vessel to the place whence he or she came.

## PILOTS FURNISH REGULATIONS.

21. It shall be the duty of every pilot to furnish the master of every vessel arriving at any port in Canada with a copy of these regulations under the penalty hereinafter prescribed.

## RELATING TO VACCINATION.

22. Every passenger shall be required to furnish evidence to the satisfaction of a quarantine officer of having been vaccinated, or having had the small-pox.

23. The production of a certificate by a ship's surgeon, called "a protection card," and his testimony under oath verifying the truth of such certificate, may be taken by a quarantine officer as evidence of such vaccination and protection. Such quarantine officer shall, however, from time to time, make personal examination of holders of such certificates to satisfy himself of the manner in which they have been issued.

24. Any person not having shown satisfactory evidence of having been vaccinated, or of having had small-pox, shall be vaccinated by a quarantine officer; or in the event of refusal shall be landed at the quarantine station, subject to detention for observation, and the expense of the maintenance of such person during such detention shall be a charge against the vessel;

(a) A vessel arriving at any quarantine station in Canada will be less liable to detention if the vaccination of all steerage passengers not showing proof of vaccination within seven years is insisted on before embarkation. The ship's surgeon should satisfy himself of such fact in the case of every passenger early during the voyage, or at the time of embarkation if possible, in order to be able to answer the questions put to him by the quarantine officer.

25. In the event of small-pox having occurred on any vessel every person on board not showing satisfactory evidence of having been vaccinated within 7 previous years, or of having had the small-pox within that period, shall be vaccinated by or under the supervision of the quarantine officer; or in the event of refusal, shall be landed at the quarantine station, subject to detention for observation, and the expense of maintenance of such persons during such detention shall be a charge against the vessel.

## EXAMINATION.

26. The quarantine officer shall examine the surgeon or any officer of any vessel, under oath, touching the state of health of such vessel and of every person on board, in the form of the questions appended to these regulations.

## ISOLATION.

27. Every vessel provided with an isolated hospital for men, and another for women, on the upper deck, ventilated from above and not by the door only, shall, in the case of minor quarantinable disease, if the quarantine officer is furnished with satisfactory evidence that such hospital accommodation has been promptly and intelligently made use of, be allowed to proceed after the landing of the sick and the disinfection of such hospital as has been used; any vessel, however, arriving with any infectious disease, without having such special isolated and ventilated hospital accommodation, or if having it, without satisfactory evidence that it has been promptly and intelligently made use of, shall be liable to be detained for disinfection at a quarantine station.

## MAILS AT RIMOUSKI.

28. In the case of a vessel carrying Her Majesty's mails and arriving by the St. Lawrence, clearance certificate shall be from a quarantine officer at Rimouski or Grosse Isle, and in the case of every other vessel from Grosse Isle only;

## Department of Agriculture.

(a.) With the exception that during a time of cholera or other epidemic, the permission to a mail steamer from an infected port or country to land passengers at Rimouski may be suspended by direction of the Minister of Agriculture ;

(b.) And in such conditions the mails only to be landed at Rimouski, the vessel to proceed to Grosse Isle for inspection ;

(c.) In the event of cholera having occurred on board of such vessel during the voyage, the outer bags containing the mail matter to be left on board the steamship for disinfection at Grosse Isle.

### DISINFECTION OF LUGGAGE.

29. During a time of cholera epidemic the luggage of immigrants by every vessel arriving by way of the St. Lawrence, not disinfected at Grosse Isle, whether from an infested or healthy port or country, may by direction of the Minister of Agriculture be disinfected at the Louise Embankment; Quebec, with the exception that the luggage of those immigrants booked by the Grand Trunk Railway may be disinfected at the Grand Trunk wharf at Lévis.

(a.) The clearance granted by the quarantine officer shall be conditional on the landing of immigrants and their luggage for disinfection at the Louise embankment or Lévis.

(b.) The supervising officer of such disinfection to count the immigrants as they land, and if he finds the number tallies with that marked on the clearance of the quarantine officer and has satisfactory evidence their luggage has been landed with them, he shall punch the clearance at the place marked for that purpose, which shall then become valid for custom entry.

### PASSENGERS CERTIFICATES.

30. Every maritime quarantine officer shall punch each immigrant "International passenger certificate" where such are in use, in such manner as to convey to inland health officers the result of the quarantine inspection, as provided by such card or certificate.

(a.) Every maritime quarantine officer shall punch the schedule list of immigrants by destination, province or state (if destined for the United States) where such is in use, which shall be furnished by the ship's surgeon on forms supplied by the government, and shall forward such lists forthwith to the secretary of the board of health in the province or state to which such immigrants are destined.

### UNORGANIZED QUARANTINE STATIONS.

31. At every port at which there is no regular quarantine station the collector of customs at each port shall be the quarantine officer for the purposes of these regulations; and every such port shall be designated an unorganized quarantine station.

32. Every vessel arriving at an unorganized station from an infected port, or on board of which any death from infectious disease or outbreak of infectious disease has occurred during the voyage, shall remain outside until it receives permission to enter from the quarantine officer.

33. All the regulations applicable to regularly organized quarantine stations shall also apply to every unorganized quarantine station in so far as circumstances will admit, and particularly the provisions relating to inspection, anchoring or mooring, disinfecting, customs clearance, putting back to sea before breaking bulk, questions to ship's surgeon or officers, and penalties.

34. In the event of a vessel arriving at an unorganized station with quarantinable sickness on board, the master shall pay a fee of \$4 for each medical inspection ordered by the quarantine officer and such fee or fees must be paid before customs clearance is granted.

(a.) If no sickness is found on board a vessel arriving at an unorganized quarantine station and ordered to be inspected by the quarantine officer, the cost of such inspection shall not be a charge against the vessel, but will be defrayed by the government.

#### STEAM TUGS.

35. Any steam tug or other vessel which shall have towed or otherwise communicated with any vessel of the class of vessels subject to quarantine or quarantine inspection shall thereby be held to the same regulations and requirements as apply to the vessel communicated with;

(a.) If the communication between the vessel and the steam tug is confined to attachment of a rope, afterwards loosed, the quarantine officer may decide to release such tug from quarantine detention.

#### RAGS.

36. Rags coming from a port or country in which infectious disease prevails, shall be prohibited, and the name of any port or country so infected shall, from time to time, be published in the *Canada Gazette*.

(a.) Rags arriving from prohibited ports at a quarantine station shall be liable to be burnt or otherwise treated on the order of the Minister of Agriculture based on a report of the quarantine officer.

#### NEW MERCHANDISE.

37. New merchandise in general may be accepted without question.

#### IN TIMES OF EPIDEMICS.

38. Passengers during a period of epidemic disease should be notified by steamship agents to dispense as far as possible with luggage that may be injured by wetting, in case of having to undergo disinfection—such as fabrics, of which the dyes are likely to run, as the owners will be compelled to assume all risks of injury.

39. Vessels during a period of epidemic disease should dispense as far as possible with woollen hangings, curtains, carpets and upholstering, substituting non-absorbing coverings.

40. Every vessel carrying cargo, and liable to be disinfected, should have provided a plain frame shaft allowing a clear inside space of 12 inches each way, placed in the main hatch, in a sailing vessel; and one in each hatch of a steamship, divided by bulkheads. The frame work in this shaft to be set before loading and to extend from the hatchway to the bottom of the vessel. This simple arrangement would receive the fumigating pipe and avoid shifting cargo.

#### PASSENGERS.

41. Passengers, for the purpose of these regulations, are divided into two classes, cabin and steerage. Steerage passengers are those occupying compartments other than those of first and second cabin.

#### METHODS OF DISINFECTION.

42. The methods of disinfection at the quarantine stations of Canada shall be as follows:—

(a.) Exposure to steam not less than 30 minutes, steam to be of the temperature of not less than 100° Centigrade (212° Fahrenheit) nor greater than 115° Centigrade (239° Fahrenheit);

(b.) Articles that would be destroyed by the above method to be disinfected by thoroughly wetting with a solution of mercuric chloride, of one part to one thousand, or approximately one drachm to one gallon, wine measure, applied by means of a brush, or by drenching, or by immersion;



## Department of Agriculture.

(c.) Where sulphur dioxide is used it is to be provided by burning not less than 3 pounds of rolled sulphur per 1000 cubic feet of space, or if it is used in liquid form in the same proportionate strength, and the period of exposure to be not less than 6 hours.

43. The disinfection of iron vessels shall be as follows, as may be required:—

(a.) *Holds*—After mechanical cleansing, the hold to be thoroughly washed with an acid solution of mercuric chloride, 1 to 800 (mercuric chloride 1 part, hydrochloric acid 2 parts, water 800 parts), applied to all surfaces by means of a hose. If danger is apprehended from the poisonous effects of the mercury deposited on the surfaces, it can be subsequently washed down with clean water;

(b.) *Steerage*—The same treatment should be given the steerage as to the hold, but when there is a steam-pipe provided for each compartment (for the prevention of fire), steam disinfection of the steerage should be practised. The temperature in all parts of each compartment to be not less than 100° C. (212° Fahr.);

(c.) *The forecabin or apartment for crew*—After mechanical cleansing the application of mercuric chloride in the manner hereinbefore prescribed, or sulphurous fumes, or steam disinfection, if facilities are provided for the same;

(d.) *Officers' quarters, cabin, staterooms, etc.*—Each compartment to receive the same treatment, under the same conditions as hereinbefore specified, it being borne in mind that the decorative metal work in cabins, saloons, &c., would be injured by the use of the mercuric chloride solution, and therefore in such cases other forms of disinfection are to be used as determined by the quarantine officer.

44. The disinfection of wooden vessels shall be as follows, as may be required:—

(a.) Fumigation by sulphur dioxide made by burning not less than 3 pounds of rolled sulphur to each 1,000 cubic feet of space; or by the use of liquid sulphur dioxide in the same proportionate strength; and the period of exposure to be not less than 24 hours.

(b.) Washing or flushing with acid solution of mercuric chloride (1 to 800). Cabins, forecabin and other apartments to be thoroughly washed with bichloride solution and all clothing, bedding, curtains, etc., to be subjected to steam for 30 minutes at from 100° C. (212° Fahr.) to 115° C. (239° Fahr.)

45. In all classes of vessels the bilges to be first flushed with sea or river water, pumped out, and then treated with acid solution of mercuric chloride in large quantity, and allowed to remain in long contact.

### UNORGANIZED INLAND QUARANTINE STATIONS.

46. Every inland port on the frontier of Canada between the Atlantic and the Pacific oceans, at which there is a collector or a sub-collector of customs shall, for the purpose of these regulations, be constituted an unorganized inland quarantine station.

47. Every collector or sub-collector of customs at every such inland frontier port shall be the quarantine officer.

48. Any collector or sub-collector of customs in his quality of quarantine officer at any inland unorganized quarantine station in Canada, if he is informed of or has reason to suspect the presence of any of the graver quarantinable diseases recited in section 20 of these regulations shall, in time of cholera or other epidemic disease, order a medical inspection to be made of the car, carriage, vehicle, boat or thing bringing such disease;

(a.) And such quarantine officer is empowered to detain such car, carriage, vehicle, boat or thing, until such medical inspection shall have been made to his satisfaction;

(b.) A medical man making such inspection by order of the quarantine officer, shall, while engaged in such service, be the quarantine medical officer.

49. The fee payable to such quarantine medical officer for each such inspection shall not exceed the sum of \$4, and in the event of any quarantinable disease being found, such fee shall be payable by the company or owner of the car, carriage, vehicle, boat or thing, bringing such disease.

50. The customs collector or sub-collector in his quality of quarantine officer shall, on the report of the medical quarantine officer, in a time of epidemic disease, in the event of any of the graver quarantinable diseases being found, cause the detention of the car, carriage, vehicle, boat or thing, bringing any person ill with such infectious disease until the requirements of these regulations are in his judgment satisfied;

(a.) Any such sick person shall not be allowed to enter Canada until in the opinion of the medical quarantine officer he or she can safely do so;

(b.) Any car, carriage, vehicle, boat or thing, bringing such sick person to the frontier shall have the option of returning as an alternative to quarantine detention; or

(c.) The customs collector or sub-collector in his quality of quarantine officer shall in his discretion, on the report of the quarantine medical officer, cause the removal and isolation of such sick persons in any car or boat, set apart for that purpose, or in any suitable building sufficiently separated from other buildings to prevent contact;

(d.) And such quarantine officer may cause the disinfection of the car, carriage, vehicle, boat or thing bringing such sick person, by means of sulphurous fumes, or any other mode of disinfection prescribed in these regulations adapted to the circumstances of the particular case.

51. In the event of cholera or other epidemic disease prevailing in any part of the United States through which a railway crossing the frontier of Canada runs, the Governor in Council may, on an order published in the *Canada Gazette* or in an extra of the *Canada Gazette*, made on a report of the Minister of Agriculture, and where there may not happen to be at that point of the frontier any adequate quarantine arrangements and apparatus to cope with an inroad of such epidemic disease, direct the complete cessation of passenger traffic at such point, or such restriction thereof, as may, in the circumstances, be deemed advisable.

QUARANTINE OFFICERS GIVE ALL NECESSARY ORDERS—PROHIBITED FROM RECEIVING FEES OR GRATUITIES.

52. Every quarantine officer is empowered to give any necessary order, or do any necessary act, to enforce these regulations, and it is his duty to report any breach of them, or any attempted breach, immediately to the Minister of Agriculture;

(a.) No quarantine officer nor other person employed in the quarantine service of Canada shall directly or indirectly receive or take any fee or private gratuity or reward for any service rendered to any company, or owner, master, or crew, passenger, or other person at or detained in any quarantine, maritime or inland. Every person to whom the knowledge of any breach of these regulations may come should forthwith report the same to the Minister of Agriculture.

PENALTIES FOR CUSTOMS OFFICERS, PILOTS, MASTERS, SURGEONS AND OFFICERS OF VESSELS, &c.

53. Every pilot shall be furnished with printed copies of these regulations, one of which it shall be his duty to hand to the master of every vessel, under a penalty of \$50.

54. Every collector of customs or customs officer shall be liable to a penalty of \$400, and imprisonment for 6 months, for allowing customs entry of any vessel in the absence of production of a quarantine clearance, in accordance with the requirements of these regulations.

55. Every master of a vessel shall be liable to a penalty of \$400 and imprisonment for 6 months, for any contravention of any of the foregoing regulations. The vessel shall be held liable for any pecuniary penalty imposed on the master.

56. Every ship's surgeon or other officer not answering with exact truth any of the questions contained in the form hereunto appended shall be liable to a penalty of \$400, and imprisonment for six months.

57. Every breach of subsection a of section 52 of these regulations shall be held to be a malfeasance of office, an offence punishable with dismissal, fine, or imprisonment.

## Department of Agriculture.

*Questions to be answered under oath to quarantine officers by masters, surgeons or officers of vessels.*

Date

189.

1. What is your vessel's name and your name ?
2. From what port and what date did your vessel sail ?
3. What is your cargo and whence taken on board ?
4. Are there any rags in such cargo ?
5. Has your vessel touched at any place or places on her voyage ?
6. Was such place or places, or any of them, to your knowledge, infected with cholera, small-pox, plague or any pestilential fever or disease ?
7. How many persons were on board when the vessel sailed ?  
Cabin passengers ; intermediate ; steerage ; cattlemen ; crew . Total .
8. State whether any person on board during the voyage has been, or is now, ill with any of the diseases above referred to, and if so how many ?
9. Has any person died on board during the present voyage, and if so, state all particulars ?
10. Has each of the steerage passengers on board been vaccinated or had the small-pox ?
11. Did the vaccination of steerage passengers take place at time or before embarking ?
12. How many have you vaccinated on your present voyage ?
13. (*Question to be asked, in the event of small-pox having occurred during the voyage, of ship's surgeon, if such is on board*).—Have you personally during the present voyage, examined each one of the passengers and crew for proof of vaccination within seven years, or of having had the small-pox in that period ?
14. Did you or any of the crew or passengers, within your knowledge, land at any place or places within Canada during the present voyage ?
15. Is there any person on board lunatic, idiotic, deaf and dumb, blind or infirm, and if so, is such person accompanied by relatives or guardians ?
16. Have you an isolated hospital for men, and another for women, ventilated from above and not from the passage ?
17. Were such hospitals, or one of them, immediately made use of on the occurrence of disease ?
18. Are there any other facts which, in your opinion, should be communicated ?

(Signature)

*Master.*

(Signature)

*Surgeon.*

I,

*Master,*

*Surgeon,*

(*here state whether ship's master, or occupying another position on board*) do solemnly and sincerely swear to the exactness and truth of the answers to the above questions signed by me. So HELP ME GOD.

*Master.*

*Surgeon.*

SWORN before me at

this day

189 .

.....  
*Quarantine Officer and Justice of the Peace, authorized by Order in Council in virtue of chap. 68 Revised Statutes, intituled "An Act respecting Quarantine."*

## No. 43.

## REPORT ON SHEEP SCAB IN MANITOBA AND NORTH-WEST TERRITORIES, AND INSPECTION OF WESTERN CATTLE QUARANTINES.

(PROF. D. McEACHRAN, F.R.C.V.S.)

MONTREAL, 27th September, 1893.

SIR,—I beg to report that in compliance with departmental instructions of 23rd June, covering a copy of an Order in Council of 10th June, 1893, I engaged the services, temporarily, of David Warnock, M.R.C.V.S., to assist me in carrying out quarantine for sheep in the districts of Medicine Hat, Walsh and Maple Creek, and I entered on that duty on the 15th July.

*Sheep Scab.*

By request of Controller White, and accompanied by himself and Commissioner Herchmer, I paid a visit to the Merino sheep ranche at Mitford, where we were shown about 5,000 sheep, which I found entirely free from disease.

My next visit was to the ranche of Mr. P. Robertson, twelve miles from Medicine Hat. He had 1,100 sheep, and in November last bought 200 ewes two years old from Mr. W. L. Nicol, Walsh, who had bought them from one Philbrick who imported them from Idaho, United States.

I found that most of Mr. Robertson's sheep had been affected by scab. He had been dipping them, using McDougall's dip.

I left Mr. Warnock to remain to see them all thoroughly dipped and other necessary precautions against reinfection taken. I could hear of no other infected flocks there.

From Medicine Hat I was conveyed by a police team to the ranche of Mr. Joseph A. Grant, south of Walsh. Mr. Grant had 1,700 sheep, 800 lambs and 31 bucks. Last fall he bought 1,000 Idaho sheep, brought in by Philbrick, and by them scab was introduced into the flock. Three hundred of them died. The flock had been dipped three times, said to have been done most thoroughly, McDougall's dip being used. No sheep had been sold or moved off this range.

I next visited his neighbour, Mr. W. L. Nicol, also south of Walsh. His flock consisted of three bands numbering 2,300 ewes and 2,600 wethers. Last fall he bought 1,500 Idaho sheep; scab appeared in the spring. They had been dipped twice, and some of them three times, with McDougall's dip.

I went to Maple Creek and visited Brown's ranche, where I found 1,700 sheep all badly affected more or less. Quick, Wharton, Hasset and Newson had put their sheep together which had just been dipped and appeared clean.

Leaving Mr. Warnock to follow up and visit all the sheep ranches in the vicinity, I declared the district comprised within the following boundaries infected and quarantined, prohibiting all movement of sheep except under specific instructions, viz., inspections by a duly appointed inspector, a certificate of health,—such sheep to be permitted to be moved for slaughter only at their destination on the railway immediately on arrival, and all cars carrying sheep from the infected district to be disinfected, viz. :—

Townships 1 to 16, inclusive, west 3rd Principal Meridian.

Ranges 23 to 30 " " "

Townships 1 to 16 " 4th "

Ranges 1 to 8 " " "

On the 29th July I visited the sheep range belonging to Messrs. Card and Harkers, south-east of the Mormon settlement, where they have about 5,000 sheep.



I recommended that all of them be shot, and the entire herd placed in quarantine, and no movement or sales be allowed from the herd.

Considering that there are nearly 1,500 head, requiring a wide range, the difficulty of dealing with such an outbreak can be imagined, and the loss and expense of keeping them without being able to sell any of them for revenue is a ruinous matter for the owners as well as a source of danger to other herds in the district, as it is nearly impossible to prevent stray horses from ranches or settlers' farms from mixing with these infected herds.

I have reason to believe that this disease exists to a considerable extent in some other districts in the North-west Territories and more especially in Southern Manitoba.

I would recommend that you make a communication of the above facts to the local government of the territories, and to the government of Manitoba, with a suggestion that they should deal with these cases promptly and efficiently.

#### *The Boundary Line Cattle Quarantine.*

On the 27th of July I drove from Macleod *via* St. Mary's police post, and Lees Creek settlement, reaching the cattle quarantine grounds on the 28th.

The quarantine grounds are situated on the north fork of Milk River within a few miles of the boundary line, bounded by the branches of the Milk River within Townships 1 and 2, Ranges 19, 20, 21 and 22, west of the 4th Principal meridian.

I here found a detachment of North-west Mounted Police under the command of Inspector Col. Morris and four men, whose duty is to patrol the quarantine and trails, to keep settlers' and other cattle off, and generally assist in carrying out the quarantine regulations. Captain Denny is in charge of the Indian herders of whom there are five, besides a man and team hauling material for building corrals.

Three corrals were then built and material was on the ground for two more.

The corrals are a mile and a quarter apart; they are built of posts, rails and wire, are flimsily constructed and while they may retain domestic cattle in small numbers they would be quite useless for holding range cattle. The cattle are all domestic of inferior quality, few of them worth the expense of transport and quarantine.

They are divided according to their dates of entry in the separate quarantines, one herded during the day time and corralled at night.

At the date of my visit there had been from 24th May till 24th July entered for quarantine:—

Bulls.....	5
Cows.....	180
Calves.....	67
Heifers. ....	74
Steers.....	20
	<hr/>
Total.....	346
Born in quarantine.....	11
	<hr/>
	357
Less died in quarantine.....	1
	<hr/>
Total in quarantine.....	356

I suggest that for large numbers of range cattle, or non-pedigree cattle or beef steers that owners be required to furnish their own herders and necessary outfit of men and horses. The government paying only the expenses of the veterinary inspector, and police or quarantine men necessary to enforce the regulations.

## Department of Agriculture.

### *British Columbia Quarantines.*

At Victoria, I find that in 1891 the importations consisted of:—

#### Cattle.

For beef.....	826
Dairy and breeding.....	83
Total .....	909

#### Sheep.

For mutton.....	33,183
For breeding.....	14
Total.....	33,197

#### Swine.

For pork.....	53
For breeding.....	1
Total .....	54

#### In 1892.—Cattle.

For beef.....	119
Dairy and breeding.....	43
Total .....	162

Mutton sheep.....	29,053
Breeding.....	1

Total..... 29,054

Swine..... none.

#### 1893 up till end of July.

Cattle, breeding.....	7
Mutton .....	17,156

### *Boundary Quarantines in British Columbia.*

I find that stock comes in at the following points, viz.:—

Blain, which is on the North-west Southern Railway; Huntingdon, on Bellingham Bay and B. C. Railway; Osoyoos, at the foot of the Okanagon Lakes, Kettle River; Fort Sheppard, at the junction of the Pend d'Oreille and Columbia River; Bedlington, on the Kootenay River; and at Philips Range, where the Columbia crosses the boundary going south. The custom-house for this point is at Fort Steele, 50 miles north of it.

### *Mr. Warnock's Report.*

McLEOD, 12th August, 1893.

SIR,—On the 15th day of July, acting on your instructions I left Fort Macleod for the purpose of visiting the sheep ranches in the Medicine Hat, Walsh and Maple Creek districts.

I reached Medicine Hat on the morning of the 17th July and proceeded to inspect the sheep belonging to Mr. Peter Robertson, whose ranche is about twelve miles south-west of Medicine Hat. Robertson's flock numbers about nineteen hundred

sheep and a considerable percentage of them were found to be affected with scab. Three of those sheep were so badly diseased that I considered it advisable to have them killed and the carcasses burned. We commenced dipping the band on Wednesday the 19th, and finished on Saturday the 22nd.

I left Medicine Hat on Saturday night and arrived at Maple Creek on Sunday, and on Monday proceeded to the Bear Creek, Piapot Creek and Skull Creek districts, thirty miles south-east of Maple Creek. Here I inspected twenty-five hundred sheep, the property of Mr. Thomas Johnston, and found scab prevalent. Mr. Johnston had been trying to eradicate the disease and had already dipped his sheep three times, twice with good results. One ram, that was still suffering severely from a bad form of the disease, I ordered to be slaughtered and the carcass burned. I advised Mr. Johnston to have his sheep dipped again within ten days and to clean and disinfect his corrals and sheds thoroughly.

I next visited the summer grazing grounds of Mr. Gourley's flock of about one thousand sheep. These sheep were free from disease and in excellent condition.

On succeeding days to the 28th of July, I visited the summer camps in the Cypress Hills, of Messrs. Cumberland, Glennie, Bertram, Farr, Olson and Wallace, and found their sheep free from disease. On the 29th I inspected Quick, Martin, Mutrie and Hassett's sheep—numbering two thousand, and found them perfectly healthy. On Monday, 31st July, I visited Mr. Brown's ranche and inspected his and Mr. Dixon's band of two thousand sheep, and found them diseased. I ordered the sheep to be thoroughly dipped and the corrals whitewashed and disinfected.

On 1st August, I went to Mr. Grant's ranche about forty miles south-west of Maple Creek. On inspection I found scab amongst the band of over two thousand sheep, and as Mr. Grant was absent I remained at the ranche and saw the sheep dipped, on the 3rd, 4th and 5th of August.

I then visited Mr. Wm. Nicol's sheep ranche and found one portion of his flock, viz., the wethers and dry ewes, numbering about three thousand, affected with scab, and ordered them to be dipped and the corrals disinfected. This lot of sheep has never been in contact with Mr. Nicol's bands of ewes and lambs, which are free from disease.

The affected herds mentioned in this report had all been contaminated by the sheep brought in from the United States last autumn, and nearly all those imported sheep died from the disease during the winter.

Having seen all the sheep in those districts I left Maple Creek on the morning of the 7th instant, and arrived at Macleod on the 9th.

I am, sir, yours respectfully,

DAVID WARNOCK, *M.R.C. V.S.*

All of which is respectfully submitted.

I have the honour to be, sir,  
Your obedient servant,

D. McEACHRAN, *F.R.C.V.S.*

The Honourable  
The Minister of Agriculture,  
Ottawa.



## Department of Agriculture.

No. 44.

### CANADIAN HAY IN GREAT BRITAIN.

(MR. J. W. DOWN.)

BRISTOL, ENGLAND, 26th October, 1893.

Mr. J. W. Down, one of the Government Immigration Agents in England, has communicated to the Department of Agriculture the following remarks on Canadian pressed hay in the Bristol market :—

“ It is astonishing to see the large quantities of foreign hay about town ; but the Canadian takes the palm. If the Canadian shippers would only be particular in shipping all would be right ; but I am sorry to see this trade drifting into the hands of our brokers. Now, I would urge one thing to be done at once, namely, for every bale to be labelled ‘ Canadian,’ that the consumer may know the article he really is using. As it is, Canadian hay sells best, and hundreds of tons of inferior Irish and South American are palmed off as Canadian, whereas if this trade could be kept from such frauds, I am convinced it will be a growing trade for years, and it will become also a paying trade. I have heard men who keep and feed a large number of horses the year round, say that they would as soon have Canadian hay as the best English. I also heard a horse keeper, one of our largest carriers, who keeps 600 horses, remark that they did better off Canadian hay than any other at a less cost by one shilling sterling per week per horse. This shows that shippers should be particular and keep the name up, and I am of opinion it would keep itself up if the bales are properly labelled. I have got all our British dealers to advertise it as Canadian.”

In a subsequent letter of 30th October last, he says :—

“ I have had one of the busiest weeks I ever experienced in the hay trade. What with letters from merchants in Toronto and Montreal and our hay merchants here, I have been kept busy all the week. Hay appears to be on the upward move again. Our buyers appear to be very anxious to buy, or at least our larger men. Mr. R. F. Webb, of the firm of Webb & Co., has purchased several hundred tons of Canadian hay this week to come on, and he now informs me he has not bought enough to cover his sales.

“ There is no doubt that this hay trade will, in the end, greatly help emigration, and especially more so if Canadian shippers deal honestly and are particular in shipping, label every bale with a distinguishing mark, letter or number, and stamp every bale ‘ Canadian.’ This Canadian hay is now being used considerably by our largest farmers, and I can assure you it opens their eyes. It shows them what the country can produce. I am very pleased to say that I have had no complaint whatever made as to quality of the hay. The only trouble has been the short weight, and this mostly arises owing to not being properly labelled, as the buyer here scarcely ever gets the same bales as are weighed for him in Canada.

Labelling hay now appears to me to be better understood by the principal shippers in Canada, and no doubt this trade will hereafter go on more smoothly. The Canadians will now, with proper management, for many years to come, be able to rule the British hay trade.

Messrs. Waddell & Co., of 75 Yonge Street, Toronto, write me as follows :—

“ Having read with pleasure your several comments *re* the Canadian hay trade, we feel that the suggestions contained therein can be acted upon to the advantage of shippers, &c.” They further say in sending some 400 tons to London, they had one whole lot of good timothy and clover stolen and American prairie grass delivered in its place. This firm will hereafter label every bale and stamp it “ Canadian”.

J. W. DOWN,

*Canadian Government Agent.*

## No. 45.

## REPORT OF MICROSCOPIC EXAMINATIONS IN ALLEGED CASES OF PLEURO-PNEUMONIA.

PROF. D. McEACHRAN, F. R. C. V. S., *Chief Inspector*,  
 PROF. J. G. ADAMI, M. D., *Pathologist*.

MONTREAL, 11th December, 1893.

(Reports of the examinations of portions of lungs and microscopic slides forwarded from the office of the High Commissioner at London, said to be portions of diseased lungs of Canadian cattle, ex ss. "Lake Winnipeg," and ss. "Hurona," pronounced by the Imperial Veterinary Staff of the Board of Agriculture to be affected with contagious pleuro-pneumonia.)

## PROF. McEACHRAN'S REPORT.

SIR,—On the 25th November ultimo, I received in your department a small box containing the following:—

I. A bottle labelled: Portion of lung from Canadian ox, ex ss. "Hurona."—W.H.

II. A bottle labelled Laboratory, R. C. P., London, and R. C. S., England, English Pleuro, 5-6-'93.

III. A bottle similarly labelled and on it written—Canadian cow, ex ss. "Lake Winnipeg," 31-5-'93.

IV. A cardboard box containing three microscopic slides labelled, R. C. P. and R. C. S., England—sent apparently by Dr. Woodhead. Marked as follow:—

(I.) English contagious pleuro-pneumonia diagnosed, 5-6-'93.

(II.) Canadian cow No. 1, Mr. Hunting received, 31-5-'93.

(III.) Canadian cow, diagnosed not contagious pleuro-pneumonia, received, 5-6-'93.

V. A small wooden box, marked—"Klein," containing two microscopic preparations, marked—lung, A., string; lung, B., plain.

Considering the importance of our being afforded an opportunity of examining the lungs or portions of the lungs of Canadian cattle, suspected of being affected by a contagious disease, viz., contagious pleuro-pneumonia, under at least fair if not favourable conditions, it is much to be regretted that more care was not exercised by whoever procured and packed the specimens.

In my letter to the Deputy Minister, of 1st November, I asked him to cable Mr. Colmer, Secretary to the High Commissioner, to "have several pounds of the suspected lung properly put up, and sent to us for examination by Prof. Adami and "myself." Instead of this being done, bottle I., contained a portion of lung, 4 inches long, 1 inch wide, less than  $\frac{1}{2}$  inch thick, weighing  $1\frac{1}{4}$  ounce; the cork of which was tightened by paper, was not sealed, fitted loosely, and as a consequence, the spirit had leaked out or evaporated. Fortunately, however, the morsel was in a sufficient state of preservation to answer the purpose of examination both necroscopic and microscopic, as far as such a specimen could be used for the purpose.

The naked eye examination of the portions of lungs said to be from Canadian animals showed clearly:—

I. (a.) The pleura but slightly, though distinctly thickened.

(b.) The section presents a uniform pale pink colour of the lung tissue.

(c.) There is a total absence of hemorrhagic spots or necrosis so characteristic of contagious pleuro-pneumonia.

(d.) The interlobular lymph deposits which are well marked, are firm and can easily be picked out of the lymph spaces as oval or elongated wax-like bodies, with a smooth convex surface, leaving smooth corresponding cavities in the lymph channels;

## Department of Agriculture.

the very peculiarities which were pointed out to me at Baltimore in 1890, by Prof. Welch, as a non-contagious form of pneumonia which had till then been mistaken by the United States inspectors for the contagious disease. Within a week afterward Dr. Smith, Pathologist of the Bureau of Animal Industries at Washington, pointed out the same condition. In January, 1891, Professor Brown, C.B., Director of the Veterinary Branch of the Board of Agriculture, invited me to meet him at the Royal Veterinary College, London, to examine and compare two sets of lungs, one of contagious pleuro-pneumonia, the other what he called "Canadian lung," a name which this diseased condition still continues to receive, notwithstanding that it is not known in Canada, being seen only in animals carried long railway or ocean journeys.

Transit pneumonia would be a more applicable name by which to distinguish it. Canadian it certainly is not. The examination was confined to a naked eye comparison of the two sets of lungs by which the differences in the gross changes produced by the two diseases were apparent not only to both of us, but also to several other professional gentlemen who were present, and as they are to-day in preserved sections in my possession.

I find in the morsels of lungs, sent for examination, the same peculiarities, and taking them in conjunction with the history of the animals from which they were obtained, as set forth in my reports, September 27th—"Search for pleuro-pneumonia at Pilot Mound," Ox ex ss. "Lake Winnipeg,"—and November 6th—"Report of suspected steer in cargo of ss. 'Hurona.'" I have no hesitation in giving my opinion that the animals in question did not suffer from contagious pleuro-pneumonia.

This opinion, I am happy to say, is supported by no less authority than Professor Brown himself, who says in his report: "The cut surface of the lungs of the Canadian ox differed in some respects from those seen in pleuro-pneumonia in this country. For example, it has been pointed out that the lobules on the diseased part, instead of varying in colour from light pink to dark red or nearly black, were of a uniform vermilion tint, and that the interlobular bands were rather more dense than is generally observed in pleuro-pneumonia and did not exhibit many small cavities (lymph spaces) filled with fluid." It is (he says) "undeniable that these peculiarities did exist.

"No satisfactory explanation of the deviations referred to has been offered, but the history of pleuro-pneumonia on the North American continent proves, beyond doubt, that it is as contagious and fatal as the pleuro-pneumonia of Europe."

In all of which I have no hesitation in concurring, nor have I any difficulty in deducing the opposite conclusion to that arrived at by Professor Brown, viz, that the pathological differences clearly point to a different disease and the non-contagiousness of this disease is illustrated by the case of the "Hurona," on board of which there were 763 susceptible cattle, yet not a single animal was infected by the Howe Island steer. History points to no case of such providential escape, either in England or America, in both of which countries the disease is equally contagious.

I have much pleasure in presenting the thoroughly scientific report of the histological and bacteriological investigations of the specimens above referred to by Professor J. G. Adami, formerly of Cambridge University, now Pathologist of McGill University, by which it will be seen that he has arrived at a similar conclusion, viz. that the Canadian lungs show no conclusive evidence of contagious pleuro-pneumonia and if he does not express himself so positively, it is due to the fact that at the present stage of our knowledge of the microscopic changes and bacteriological facts characteristic of this disease, no such examination can be considered conclusive evidence apart from the history of the animal and accurate clinical reports; besides it must be remembered that the portions of lung received by him, which were not accompanied by any information except what the label conveys, were altogether insufficient for the purposes of such an important examination.

I have the honour to be, sir,

Your obedient servant,

The Hon. Minister of Agriculture,  
Ottawa.

D. McEACHRAN, F.R.C.V.S.,  
Chief Inspector.

## PROF. ADAMI'S REPORT.

SIR,—I have the honour to report that upon Saturday, November 25th, I received from the Chief Inspector Prof. McEachran, a box forwarded from the Dominion offices in London, containing three small bottles, together with five glass slides with specimens of sections of lungs prepared for microscopical examination by Dr. Sims Woodhead (three slides) and Dr. Klein (two slides). The bottles were labelled respectively:—

“English Pleuro, 5-6-93. Laboratories R.C.P. Lond, and R.C.S. Eng.”

“Canadian Cow, 31-5-93, ex ss. Lake Winnipeg, Laboratories R.C.P. Lond., and R.C.S. Eng.”

“Portion of lung from Canadian Ox, ex ss. “Hurona, W. H.”

The cork of the last of these had become loosened in transit and as a consequence most of the spirit had escaped. Fortunately the contained portion of lung had undergone no deterioration.

All the pieces of lung in these bottles were very small, the largest (that from the ox, ex ss. “Hurona”) was not more than 3 cubic inches in size. The bottle labelled “English Pleuro” had two small pieces, evidently taken from different regions.

*Naked-Eye Examination.*

The smallness of the portions of tissue renders it impossible to make a confident diagnosis upon the condition of the whole lung in each case, unless I am to understand that each portion sent to me has been taken from the regions of the affected lungs where the process of disease was most advanced. It is only upon this understanding that I can come to any definite conclusions. In true contagious pleuro-pneumonia the affected lung presents in its different regions every stage of disease, from the earliest inflammatory manifestations (congested vessels, abundant exudations, both cellular and fluid, into the air sacs, and lymphatics distended with fresh lymph) to manifestations of the effects of continued severe inflammation (namely, vessels filled with old thrombi (clotted blood), hemorrhages and death of the lobules supplied by the thrombosed vessels, and enlarged septa between the lobules of the lung, in which simple distension of the lymphatics has been followed by organization, formation of fresh fibrous connective tissue along the septa, and encroachment of this new tissue upon the alveoli and lung tissue proper). It is only when these latter conditions are well marked in some portion or portions of the lung that a positive diagnosis can be made by the naked eye of true contagious, as distinguished from other forms of pleuro-pneumonia.

In connection with the naked eye examination of the three cases in question, I would call attention to the following points:—

1. Of the material conveyed to me not one single portion shows such evidence of advanced disease as can permit me to diagnose positively the existence of *pleuro-pneumonia contagiosa*. The most advanced process is seen in the English lung which is firmer and presents great development of fibrous bands between the lobules: but even in this I can make out no discolourations or areas of necrosed tissue.

2. The thick bands of connective tissue in the English lung present an outline which is not perfectly sharp. This indicates some encroachment of the newly forming tissue of the septa upon the air sacs of the lobules; the process is advancing in, upon, and between the air sacs. On the other hand the septa in both the Canadian lungs while thick and prominent, are not so thick as in the English, and give the general impression, not of a series of bands of fibrous tissue running between the lobules, but of a series of rounded or oval swellings between them. The presence of these white oval and rounded masses immediately arrests the eye. As is shown by more minute investigation they are the coagulated lymph contained in greatly dilated lymph channels.

3. In the Canadian lungs these masses of coagulated lymph can easily be pricked out, leaving rounded hollows with smooth walls (the dilated lymphatics). Somewhat similar white masses can be recognized within the thickened septa of

the English lung, but their outline is not so sharply cut, and attempts to prick out the masses are ineffectual, or at most only little particles break away, leaving irregular holes in the tissue. I believe that Professor Welch, of the Johns Hopkins University, was the first to call attention to this difference in the behaviour of lungs affected by contagious, and by other forms of pneumonia, in cattle. Where the coagulated lymph is easily removable "en masse" there it must be of comparatively recent formation; where it is not easily removable there must have been a more or less complete organization of the lymph with organic fusion to the walls of the lymphatics, or again an exudate of peculiarly adhesive properties.

This difference in behaviour alone is sufficient to separate off sharply the two Canadian lungs from the English. It is a proof that the former present a process of more recent development than the latter, and according to Professor Welch, must prove the Canadian lungs to be unaffected by the contagious disease.

*Microscopical Examination.*

Portions of each separate piece were removed, passed through the various stages of hardening, imbedding in paraffine and cutting by the microtome, and the sections so obtained were stained with several reagents, and examined both from a histological and bacteriological standpoint.

*English Pleuro.*

I. Portion No. 1.—This piece of lung tissue shows the following conditions:—

The interlobular septa are very greatly thickened. Many of them present well formed, new fibrous tissue, and at the edges of the septa the new formation is encroaching upon the air sacs. Other septa present a rather earlier stage of fibrous tissue formation, with dilated capillary loops, small cell infiltration, and all the appearance of "granulation tissue." Within these thickened septa are distended lymphatics, some full of small cells, and passing imperceptibly into the surrounding new tissue, others sharply defined with more recent lymph that has undergone coagulation. These latter present an exquisite network of fibrin.

While close to the septa the *alveoli* or air sacs are compressed, in the more central areas of the lobules they are of the usual diameter, indeed they are somewhat distended. All are filled with a dense vitreous exudate, composed of a fine fibrinous network in whose meshes are relatively few cells. The great majority of these cells are small round *leucocytes*; only a very few larger cells with much protoplasm can be seen. The walls of the air sacs give evidence of compression and malnutrition; they are thin and stain poorly. Although not absolutely necrosed, they are in several regions in a condition very nearly approaching to death.

There are numerous thrombosed vessels, both arteries and veins. Many of the arteries contain recent coagula, a few show coagula of longer duration in which the first stages of organization are manifested. Others show a combination of the two, namely, canalisation of the old thrombus with a recent clot filling the passage. It is noticeable that in spite of this very considerable thrombosis, relatively very little signs of hemorrhage are to be seen. Here and there are small hemorrhagic *foci* but that is all.

II. Portion No. 2.—This portion of lung presents a much less acute and severe condition. The pleura is greatly thickened and from this there run downwards, between the lobules, greatly thickened septa of well formed connective tissue.

The *alveoli* or air-sacs beneath the pleura are greatly compressed, so that many of their cavities are quite obliterated, but throughout the sections the alveolar walls are broad and stain perfectly. Immediately beneath the pleura and in the neighbourhood of the septa there is a considerable amount of new connective tissue infiltration between the *alveoli*.

Compared with the previous sections, there is in these relatively very little exudation into the air sacs; some contain rather shrunken plugs of vitreous exudation, but in very many the contents are very insignificant in amount and almost entirely cellular, composed of large oval cells with nuclei that stain lightly and

much clear protoplasmic cell substance. Examination under a high power disclosed the fact that the shrunken plugs were undergoing organization, the fibrin becoming replaced by spindle cells.

No thrombi can be seen in the vessels, but the walls both of the arteries and of the *bronchi* are thickened and infiltrated. There is *peri-arteries* and *peri-bronchitis* with much small-celled infiltration around the affected vessels.

In fact this specimen shows a totally different condition from that presented by portion No. 1.\* Here we are dealing with a region of the lung that can be seen to have undergone previously some form of fairly acute pleuro-pneumonia; the thickened interstitial septa remain and present the results of this older disturbance. The pneumonic exudation has become for the most part absorbed and otherwise removed; where the absorption has been incomplete the organization has set in (a condition which is observed often in the human lung after acute croupous pneumonia). Superadded to these processes of old acute disease and partial resolution, there is present what some authorities would regard as a mild catarrhal condition, and what other authorities show to be a stage of resorption and resolution. In either case the portion of lung does not present advancing disease, and the sections in consequence are of no value for diagnostic purposes, that is to say, they are far from typical and do not present appearance in any way distinguishing contagious from other forms of pleuro-pneumonia.

*Canadian Cow ex ss. Lake Winnipeg.*

III. In this portion of the lung the *pleura* is moderately thickened, there has been chronic pleurisy of some little duration, but in the place of the thickened fibrous septa which formed so characteristic a feature of the English lung No. 1, there is mainly an enormous distension of the lymphatics. The lymph channels are distended with a vitreous lymph, containing a fair number of *leucocytes*. This lymph does not show the fibrinous net-work seen here and there in specimen No. 1.

Beneath the *pleura* and round the dilated lymphatics there is a very noticeable compression of the *alveoli*. The alveolar walls are thinner than those of No. 2, but stain more deeply than those of No. 1.

The alveolar contents are looser than in No. 1 and vary. In parts they are almost entirely composed of vitreous material showing no contained cells,—that is to say, of a serous fluid that has become coagulated after death. In other regions the contents are almost entirely cellular, formed of small round *leucocytes*. In others again the contents are slight and formed almost entirely of the so-called catarrhal cells.

The smaller *bronchi* exhibit a well marked proliferation of their *epithelium* and many of them contain an exudation of fibrinous material containing numerous small cells. Part of this may have been derived from the exudate into the air sacs, but part would certainly seem to have been given off from the inflamed bronchial walls, affected, as they are, by bronchitis.

Both arteries and bronchi present the condition of thickening of their outer walls; this thickening is fibroid, and not cellular as was the case in No. 2. It is the thickening associated not with acute disease, but (not unfrequently) with advancing age of the individual.

No hemorrhages are visible, but the capillaries below the *pleura* and in the alveolar walls are congested, and the appearance of the sections as a whole is not unlike that of slight pneumonia along with hypostatic (a condition associated with enfeebled heart action) older pleurisy. Nothing in the sections points certainly to typical contagious pleuro-pneumonia.

\* NOTE. The whole appearance of this second portion coincides almost absolutely with Dr. Woodhead's description of the lung of the Canadian cow said not to be affected with pleuro-pneumonia. (See Yellow Book of English Board of Agriculture, Papers and Correspondence on Canadian Cattle, 1893, p. 100). Can this piece have been placed in the bottle by mistake?

## Department of Agriculture.

### *Canadian Ox ex ss. Hurona.*

IV. In this there is singularly little thickening of the *pleura*. The interlobular septa are rather thicker than in the "Lake Winnipeg" case, but the thickening is almost entirely lymphoid, and due to the enormous distention of the lymph channels.

The alveolar walls are richly nucleated and of considerable breadth; they stain well. The air sacs are not distended; on the contrary they appear smaller than normal,—partially compressed. Their contents are very loose and easily fall out, if care be not taken to fix the sections to the slides before removing the paraffine in which they have been imbedded. Many of the alveoli contain little more than two or three loose cells of the large so-called catarrhal variety. The majority in addition to a considerable number of catarrhal cells, and a few *leucocytes* have small shrunken masses of vitreous or fibrinous exudation.

The bronchial *epithelium* is intact; there is no sign of bronchitis. There are no old thrombi in the vessels, at most some of the arteries contain recent post-mortem *coagula*.

The whole appearance of the section is that of a lung that has undergone a recent pneumonic or mild pleuro-pneumonic disturbance which is in the process of clearing up, for the same large "catarrhal" cells and leucocytes can be seen in the looser peripheral areas of the lymph channels, and these would seem to have passed from the air sacs into the lymphatics in the process of absorption and removal of the exudation.

### *Conclusive.*

Nothing in any of the sections of this lung gives any positive evidence of the presence of contagious pleuro-pneumonia.

Summing up the results of the histological examination of these four portions of lung tissue I conclude, that if the pieces sent to me represent the most advanced conditions presented by the several lungs, then:—

I. Portion No. 1 of the English lung might very possibly be taken from a case of contagious pleuro-pneumonia.

II. Portion No. 2 of the English lung only shows conditions that might be present in any case of pleuro-pneumonia, contagious or otherwise, that is undergoing resolution.

III. Neither of the Canadian lungs presents lesions sufficient in themselves to lead to a diagnosis of contagious pleuro-pneumonia.

IV. The lung from the "Hurona" ox shows the stages of resolution and repair following upon a mild attack of some form of pleuro-pneumonia; that from the "Lake Winnipeg" cow shows also the signs of resolution rather than of extension of the process of disease, whatever be its nature.

Adding to these conclusions the fact noted in connection with the naked eye examination, namely, that the Canadian lungs contain *coagula* of lymph which can easily be removed, whereas the English lung does not contain such, I come to the general conclusion that, if I am to form a judgment from the specimens conveyed to me, it is safe to say that the Canadian animals did not suffer from contagious pleuro-pneumonia. At the same time I must call attention to this proviso. It is possible that other portions of the Canadian lungs presented more acute or more advanced disturbances. If this were so, however, I am surprised that the English authorities did not forward them to the High Commissioner for the Dominion of Canada.

### *Bacteriological Examination.*

I have carefully examined sections of the various lungs to determine the presence or absence of bacteria. According to Nocard no bacteria are recognisable by ordinary methods in the lungs of true cases of contagious pleuro-pneumonia, while he and other observers have chronicled the presence of bacteria in other forms. Hence I had hoped that possibly some useful information might have been gleaned by bacteriological study.

Unfortunately upon examination of the English lungs abundant bacteria were found both along the vessels and in the air sacs. These were most abundant upon and close beneath the surface, a sure sign that they were of putrefactive development, and had gained an entry into the tissue in consequence of the lungs being left out of spirit for some little time after death. The most common form was a short stumpy *bacillus* with a decided tendency to form short chains. There were also fine chains of *streptococci*.

In the "Lake Winnipeg" case occasional clusters of very small *bacilli* could be found. In the "Hurona" besides a few rare large putrefaction *bacilli*, there could be made out occasional small rather faintly stained *diplococci*.

It is evident that under the circumstances no satisfactory conclusion can be reached from these bacteriological observations, the tissues not having been obtained in the first place with due regard to future examination of this nature. I would point out, however, that when the histological method of arriving at a diagnosis is so unsatisfactory, the various forms of pneumonia in their earliest stages being so similar, it will in all probability be by a proper bacteriological study of true contagious pleuro-pneumonia and of the other non-contagious forms that we shall in the future be able to state with precision the nature of any given case.

J. GEORGE ADAMI,  
*Professor of Pathology in the University of McGill College,  
Montreal, late Fellow of Jesus College, Cambridge.*

The Honourable  
The Minister of Agriculture,  
Ottawa.



# Department of Agriculture.

No. 46.

## REPORT ON APICULTURE AND HONEY.

BRANTFORD, ONT., 31st October 1893.

SIR,—The bee-keepers of the country feel that something in the way of experimental work should be done for them. At the World's Fair lately, Ontario alone secured more than as many awards as the whole of the United States and more than all other foreign countries, combined. This bears out what I have always said, of Canadian honey. I have been in a good many parts of the United States, and I know the average Canadian honey is better than that of the United States: in short, our honey is the best, and Canada can produce it in large quantities. Quebec and other provinces, even the North-west Territories could have exhibited honey but they did not. The subject has too long been considered of no importance. By better methods in Ontario, in the direction of wintering, &c., larger yields could be secured. By taking honey from the bees at more seasonable times a better quality could be secured: in fact I know a great industry of value to the country could be built up and large quantities exported. In Quebec they are beginning to take more interest in improved methods of bee-keeping, and I have, when showing at Montreal these last two years, met many anxious to learn. The Trappist Fathers, Oka, asked me if I could come or get some one to come and teach them better bee-keeping. They have over one hundred hives now, and are anxious to increase to 1,000; others in the same direction.

In Manitoba and the North-west good results could be secured from bee-keeping, in fact I know very much can be done. In the United States they have several experimental apiaries, one at Lapiere, Michigan. They give a bee-keeper so much per annum and he turns his bee-yard to a large extent into an experimental apiary, and the Government need not go to expense of equipping an apiary or have any responsibility in that direction. They can get the services of a first class bee-keeper for less money, and the method works well. Bee-keeping has a special claim in this direction, viz., honey is a product which takes nothing from the fertility of the soil. Next, a man can grow just as much on his farm every year after he has 100 colonies of bees as before. The bees displace no other crop. Moreover bees assist very much in the fertilization of flowers and assist the fruit and clover seed grower. Bee-keeping increases, therefore, the wealth producing powers of the country. I know one firm having the name of over 10,000 bee-keepers on its books. There is no better time to embark in this than now, when we can make in Europe the most of what we did in Chicago, and when Canadians for the same reason are turning their eyes to bee-keeping.

I have the honour to be, sir,

Your obedient servant,

R. F. HOLTERMAN,

*Secretary, Ontario Agricultural Union.*

The Honourable  
The Minister of Agriculture,  
Ottawa.

## No. 47.

## PRECIS OF ORDERS IN COUNCIL RELATING TO CATTLE QUARANTINE REGULATIONS PASSED IN 1893, AND SUPPLEMENTARY TO APPENDIX No. 32 IN LAST YEAR'S REPORT.

1893.

- Feb. 18.—Rescinding privilege of allowing settlers' cattle to be excepted from 90 days detention; and ordering settlers' and all other cattle entering Canada from the United States west of Ontario, to be subject to 90 days' quarantine.
- March 22.—Establishing Cattle Quarantine Reserve at Estevan and south of Wood Mountain, and authorizing services of the North-west Mounted Police in connection with the same, and arrangements for transport of settlers' cattle from United States.
- Sept. 1.—Extending boundaries of Cattle Quarantine Reserves south of Lethbridge and Fort Macleod.
- Oct. 28.—Prohibiting entry of cattle from eastern boundary of Manitoba to Pacific Coast between 30th September and 31st March, and in the event of grass being burned, the North-west Police may remove cattle and herd them outside of quarantine limits.
- Dec. 13.—Amending Order in Council of 28th October, by excepting Manitoba and British Columbia from its provision.

# Department of Agriculture.

No. 48.

## CANADIAN AWARDS AT THE WORLD'S COLUMBIAN EXPOSITION, CHICAGO, 1893.

(*Furnished by the Executive Commissioner.*)

The following is a list of awards at the Chicago Exposition to Canadian Exhibitors. This list is subject to revision:—

### *Department A.—Agriculture.*

Group.	Awards.	
1 Cereals and grasses .....	145	
2 Biscuits .....	1	
3 Sugars, syrups and confectionery .....	32	
5 Broom corn, field vegetables .....	16	
6 Preserved meats.....	1	
7 Dairy products.. .....	776	
8 Tobacco .. .....	2	
9 Wool and fibres.....	5	
10 Mineral and artificial waters.....	4	
11 Whiskey.....	1	
12 Malt liquors.....	9	
14 Farms and farm buildings.....	2	
16 Farming tools.....	10	
17 Fertilizers.....	2	
19 Fruit productions.....	10	
	1,016	

### *Department B.—Horticulture.*

20 Viticulture .....	6	
21 Pomology .....	45	
22 Floriculture .....	2	
23 Culinary vegetables.. .....	12	
	65	

### *Department C.—Live Stock.*

27 Horses.....	31	
28 Cattle .....	107	
29 Sheep.....	262	
31 Swine.....	65	
34 Poultry.....	710	
	1,175	

### *Department D.—Fisheries.*

37 Fish.....	1	
38 Sea fishing.....	5	
40 Products of fisheries.....	17	
41 Fish culture.....	1	
	24	

*Department E.—Mines and Mining.*

Group.	Awards.	
42 Minerals and ores.....	23	
43 Coal and petroleum. ....	7	
44 Building stones.....	12	
46 Graphite and asbestos.....	15	
47 Limestones, cement. ....	4	
48 Salts.....	5	
51 Copper.....	1	
53 Nickel.....	1	
67 Literature of mining.....	3	
		71

*Department F.—Machinery.*

69 Engines, boilers and water-wheels.....	9	
70 Fire-engines.....	1	
71 Iron working tools.....	3	
72 Textile machinery.....	2	
73 Wood-working machines.....	2	
74 Type setting machinery..	1	
77 Miscellaneous tools.....	3	
79 Machinery for preparation of foods.....	2	
		23

*Department G.—Transportation.*

80 Railways.....	2	
83 Vehicles.....	11	
85 Vessels and boats.....	17	
		30

*Department H.—Manufactures.*

87 Pharmaceutical products.....	3	
88 Paints and colours.....	3	
89 Type, paper, blank books.....	7	
90 Furniture.....	2	
91 Ceramics.....	3	
92 Monuments.....	3	
95 Stained glass.....	2	
96 Carvings.....	1	
98 Jewellery.....	2	
100 Silk fabrics.....	2	
102 Cotton goods.....	3	
103 Woollens.....	6	
104 Clothing.....	7	
105 Furs.....	1	
106 Embroidery, &c.....	57	
107 Hair work.....	2	
111 Leather.....	3	
112 Scales.....	1	
113 Stoves and furnaces.....	6	
116 Metal ware.....	1	
118 Wrought iron work.....	1	
119 Edge tools, &c.....	3	
120 Sanitary ware.....	1	
121 Miscellaneous.....	4	
		124

## Department of Agriculture.

### *Department K.—Art.*

Group.	Awards.
140 Oil paintings.....	5

### *Department L.—Liberal Arts.*

147 Physical development.....	5
148 Instruments of medicine.....	1
149 Education.....	156
151 Photography.....	9
152 Engineering.....	1
153 Government.....	5
154 Commerce... ..	1
155 Institution for increase of knowledge.....	1
158 Musical instruments.....	4
	183

### *Department M.—Ethnology, &c.*

159-176. ....	5
	2,721

Department of Agriculture,  
OTTAWA, December 22nd, 1893.

## No. 49.

REPORTS OF INQUIRIES RELATING TO HEALTH OF ANIMALS IN  
THE NORTH-WEST MADE THROUGH THE LAND COMMISSIONER'S  
BRANCH OF THE DEPARTMENT OF THE INTERIOR.

## STATEMENT OF MR. KOBOULD, BUTCHER, OF WINNIPEG.

1. How long have you been engaged in trade as butcher in Winnipeg?—Thirteen years.
2. Have you bought any cattle from the vicinity of Pilot Mound?—Yes.
3. If so, can you say approximately how many head within the last three or four years?—Within the last four years, over four thousand head.
4. Have you ever discovered signs of pleuro-pneumonia in any of the carcasses you have obtained from there or elsewhere?—No.
5. Have you found diseased lungs in any of the carcasses? If so, what was the nature of the disease?—No.
6. Of your own knowledge are you aware of any cases of pleuro-pneumonia occurring in this country, either Manitoba or the Territories?—No.

(Sgd.) KOBOULD &amp; Co.

WINNIPEG, 28th September, 1893.

## STATEMENT MADE BY MR. JOSEPH COBBE, OF BALDUR, MAN.

1. How long have you been living in the vicinity of Baldur?—About ten years.
2. When did you commence butchering?—March, 1893.
3. Have you ever discovered signs of pleuro-pneumonia in any of the carcasses butchered?—No.
4. If so, how many? and when?—
5. Have you bought beef cattle for the Winnipeg butchers?—Yes.
6. If so, for whom and how many head of stock?—One car for Kobould & Co.
7. Have you ever seen signs of pleuro-pneumonia in any of them or anywhere in the district?—No.
8. Have you ever heard of it existing in the district?—Never.
9. Have you ever seen pleuro-pneumonia in Canada or elsewhere, so that you would recognize it again if you saw it? And if so, where?—No; there has been no sickness or disease in any of the stock in this district.
10. Please mark on accompanying plan the district you visit in buying stock.

(Sgd.) JOSEPH CORBE.

Baldur, 25th September, 1893.

---

CITY OF WINNIPEG, MAN., 3rd October, 1893.

I, Howard Benallack, make solemn declaration and say that I have carried on in the city of Winnipeg a wholesale butchering business continuously from the year 1882 inclusive till present date, numbers of cattle slaughtered and sold yearly varying from one thousand to twenty-five hundred; and I further state that during said years I have purchased the cattle slaughtered principally in the districts contiguous to the C. P. R. railway leading from Winnipeg to Deloraine, said districts including the country around the respective town sites of Morris, Gretna, Morden,

## Department of Agriculture.

Thornhill, Manitou, Pilot Mound, Crystal City, Clearwater, Cartwright and Deloraine, though I have occasionally purchased cattle from districts around Glenboro' on the so-called C. P. R. South-western Railway, and also from district contiguous to the main C. P. R. Railway, said latter mentioned districts including Portage la Prairie, Carberry and Moosomin, and even as far west as Calgary; and I hereby state that amongst all the cattle I have slaughtered and sold during the years intervening between 1882 inclusive and present date, I have not known a single case of pleuro-pneumonia, neither have I ever heard that a single case of it has been discovered by any other butcher or dealer in Manitoba, nor do I personally believe that a case of it has ever been known amongst any of the cattle hitherto raised either in Manitoba or the North-west Territories.

(Sgd.) HOWARD BENALLACK.

---

CITY OF WINNIPEG, 2nd October, 1893.

I, George E. Brown, butcher, make solemn declaration and say that I have been engaged in buying, selling and slaughtering cattle respectively as a wholesale and retail butcher in the city of Winnipeg from the year 1879 inclusive till the present date, and further state I have purchased my supply of cattle from the districts extending as far west from Winnipeg as Moosomin, and including nearer Winnipeg the districts surrounding Morris, Morden, Thornhill, Manitou, Pilot Mound, Crystal City and Deloraine; and further state that in my experience of dealing in cattle during the past fourteen years in Manitoba I have not met a single case of pleuro-pneumonia, neither have I heard from any of the stock-raisers, or from any one dealing in cattle (either butcher or buyer) that any case of the kind has ever been known in any of the said districts, and personally I do not believe that any animal in Manitoba has ever as yet shown symptoms of said disease.

(Sgd.) GEORGE E. BROWN.

---

CITY OF WINNIPEG, MAN., 2nd October, 1893.

We, the undersigned, state we have been personally engaged in buying, selling and slaughtering cattle in the city of Winnipeg, both by wholesale and retail trade the past thirteen years, the numbers killed and sold in years intervening between 1880 inclusive and present date averaging about two thousand yearly, excepting year of the "Rebellion," 1885, when we killed about four thousand.

We further state that in consequence of requiring so many fat cattle we have been obliged to purchase from a large area of the surrounding country, namely, district east of Winnipeg, including municipalities of Springfield, Ste. Anne's and Township of La Broquerie, west including districts around Morden, Thornhill, Manitou, Pilot Mound and Deloraine, also districts around Gladstone, Portage la Prairie, Austin, Carberry and Moosomin; and we respectively make a solemn declaration and say that we have never met with a single case of pleuro-pneumonia amongst all the cattle we have killed during the said term of thirteen years, neither have we ever heard that a single case was ever known to have occurred in any of the districts mentioned, nor in any part of Manitoba outside of said districts, neither do we believe that an individual case ever was found amongst any cattle either in Manitoba or the North-west Territories.

(Sgd.) P. GALLAGHER & SONS.

---

CITY OF WINNIPEG, MAN., 2nd October, 1893.

I, Maxime Rocan, butcher, of the city of Winnipeg, Man., make solemn declaration and say that I have been engaged in buying, selling and slaughtering cattle in said city of Winnipeg from year 1872 inclusive till present date, and during the intervening years have carried on said cattle trade respectively by

wholesale and retail, some years the cattle bought and slaughtered amounting to one thousand, and as I could not obtain cattle of standard quality for the market in any one locality, I was obliged to purchase cattle in outlying districts, including Springfield, Plympton, Ste. Anne on the east of Winnipeg and south in the district around Morris and west in the districts respectively around Morden, Thornhill, Manitou, Pilot Mound, Crystal City, and Deloraine, also districts around Gladstone, Portage la Prairie, Austin, Carberry and Moosomin; and further state that during the period intervening between year 1872 inclusive and present date, I have never met with a single case of pleuro-pneumonia amongst any of the cattle I have sold and slaughtered during the said term of years, neither have I ever heard of a single case of it occurring amongst any of the herds kept in said districts or in any part of Manitoba outside of said mentioned districts, neither do I believe that an individual case ever was found either amongst any cattle in Manitoba or the North-west Territories.

(Sgd.) MAXIME ROCAN.

---

DELORAINÉ, MAN., 12th October, 1893.

SIR,—I have the honour to acknowledge the receipt of your circular on the 5th instant, No. 271326, and in reply to say that I have been employed as a Homestead Inspector five localities, principally in the Deloraine and Coteau districts extending from range 18 west of the first principal meridian in the east, to Estevan (Souris Coal Fields) in the west, a distance of about one hundred and fifty miles, the width of these districts being thirty miles north from the Canadian and United States boundary line. During one winter I was engaged in the same capacity in the Little Saskatchewan district covering a large area farther north.

Although my business has been exclusively with farmers, among other duties constantly inspecting their stock and stables, frequently meeting veterinary surgeons in the towns, I have not once seen or heard anything that would indicate even a suspicion of the existence of such a disease as pleuro-pneumonia among the cattle in the districts I have habitually traversed.

On the contrary, the general absence of disease of all kinds among cattle has been remarkable, and has impressed me with the conviction that both the grass and atmosphere of the prairie are highly promotive of the healthfulness of stock and, consequently through such an important article of diet, to healthfulness of man wherever the beef of the Canadian North-west may find a market.

I have the the honour to be, sir,

Your obedient servant,

(Sgd.) W. H. ALLISON,  
*Homestead Inspector.*

The Commissioner of Dominion Lands,  
Winnipeg, Man.

---

PILOT MOUND, 13th October, 1893.

SIR,—In answer to your circular ref. 271326 of the 5th inst., I would beg to state that I have held the position of Inspector of Dominion Homestead lands and visited nearly the whole of Manitoba and portions of the North-west Territories, since July, 1883, and during that period have been in almost daily contact with farmers and cattle dealers and have never known or heard of a case of pleuro-pneumonia or other lung disease among cattle in this province or the North-west—in fact it is generally considered the most healthy stock-raising country known; and I may further state that had there been any complaint of pleuro-pneumonia or any other cattle disease, I would certainly have heard it. In 1884 and 1885 there was a then supposed disease among cattle in the Mennonite Settlement east of the Red River, called “foot-rot” and “black foot,” but upon investigation, it turned out to be frozen feet caused by neglect and want of proper protection and care. I am



## Department of Agriculture.

fully satisfied that if cattle, after arrival in England are condemned as having pleuro-pneumonia, such cattle must have become diseased from close confinement on shipboard, for there is no such disease known here.

I have the honour to be, sir,

Your obedient servant,

(Sgd.) T. H. AIKMAN,

*Homestead Inspector.*

H. H. SMITH, Esq.,  
Commissioner of Dominion Lands,  
Winnipeg, Man.

---

PRINCE ALBERT, 8th October, 1893.

SIR,—I have the honour to acknowledge the receipt of your letter of the 5th instant, ref. 271326, asking a report from me as to the supposed existence of pleuro-pneumonia among Canadian cattle, &c. In reply, I beg to say that I have been employed as Homestead Inspector in the Prince Albert district during the following periods, viz., April, 1887, to July, 1889; April, 1890, to the present date. From August, 1889, to December of the same year, I travelled over the western country by buckboard, from Moose Jaw to Calgary; January and February, 1890, were spent in the Brandon district, and March was spent in the Birtle district, and in April I drove from Birtle to Prince Albert by way of Qu'Appelle, and during all this period, although constantly mixing and camping with the farming community, I have not known of a single case of pleuro-pneumonia. It certainly cannot exist in this district, else I would know of it. I may also say that from 1880 to 1887, I was travelling about Manitoba and the North-west, was four years with the Land Department of Canadian Pacific Railway, and inspected a large portion of their land grant along the main line and all of the Southern Manitoba grant, also made a lot of crop inspections for them, and if pleuro-pneumonia existed at all among the farmers' cattle I would certainly have heard of it.

The cattle of this district are healthy and in excellent condition.

I have the honour to be, sir,

Your obedient servant,

(Sgd.) R. S. COOK,

*Homestead Inspector.*

H. H. SMITH, Esq.,  
Commissioner of Dominion Lands,  
Winnipeg.

---

BRANDON, Man., 9th October, 1893.

SIR,—In reference to the alleged existence of pleuro-pneumonia among the cattle either in Manitoba or North-west Territories, I beg leave to say that I have been employed as Homestead Inspector from 1st May, 1884. I have travelled in the North-west Territories among settlers almost continuously from that date to 1st June, 1887. I never heard or knew of one single case of pleuro-pneumonia during that time. I have not heard that there existed one single case since. During that time I visited a large extent of territory, the most of West and East Assiniboia, from range 30 west to range 11 and 12 west of the 2nd meridian, and from the American boundary to the northern limit of settlement. I also visited the Prince Albert district as far as township 50 north, in ranges 26, 27 and 28 west, 2nd meridian, including Fort à la Corne, &c., also North and South Manitoba.

Since 1st June, 1887, I have been visiting localities from western limit of Manitoba to range 7 west, also north and south of main lines of the Canadian Pacific Railway and Northern Pacific where it is all well settled, since 1882 and 1884. In all of these localities I never saw or heard of any trace of pleuro-pneumonia. In one instance the only contagious disease I heard of among cattle was that known as

anthrax, or black-leg. One man south of McGregor, in range 10, lost most of his stock, some were saved by proper medical treatment. The disease was confined to his stock.

This is the only case of contagious disease heard of which was supposed to be anthrax.

I have the honour to be, sir,  
Your obedient servant,

(Sgd.) JOHN J. ARSENAULT,  
*Homestead Inspector.*

The Commissioner of Dominion Lands,  
Winnipeg.

MINNEDOSA, 10th October, 1893.

SIR,—In answer to your circular No. 271326, 5th October, 1893, I beg to inform you that I have been employed as Homestead Inspector in the Birtle and Minnedosa district, including Lake Dauphin for three years and nine months, that I have travelled over this country from two to three times every year, and that during that time I have never heard of or seen a single case of pleuro-pneumonia or any other disease. I have met a few cases of swelled jaw, but very few, and nothing else; during the last winter I heard of loss in cattle, but when I went into the matter I found the loss was due to shortness of feed and insufficient protection from the weather during the last very hard winter, and the hay having been burnt by prairie fire. It would be impossible to find a country in which cattle are more healthy or do better than in Manitoba.

Yours obediently,  
(Sgd.) WM. D. DE BALINHARD,  
*Homestead Inspector.*

The Commissioner of Dominion Lands,  
Winnipeg.

CROWN TIMBER OFFICE,  
CALGARY, 16th October, 1893.

SIR,—I have the honour to state, in reply to your letter of the 5th instant, ref. 271326, that I have been in the position of Homestead Inspector and Forest Ranger since the 1st May, 1888, and have during that time visited all the large cattle ranches, and most of the small farmers in Southern Alberta at least once a year, and have not seen or heard of a single case of pleuro-pneumonia among cattle in this vast grazing country which I travel over, viz., from the summit of the Rocky Mountains on the west to Swift Current on the east, and from township 49 on the north to the American boundary on the south. From my experience with cattle, I may say, I find them in a very healthy condition in Alberta.

I have the honour to be, sir,  
Your obedient servant,

(Sgd.) J. R. THOMPSON,  
*Homestead Inspector.*

The Commissioner of Dominion Lands,  
Winnipeg, Man.

CARTWRIGHT, MANITOBA, 20th October, 1893.

SIR,—In response to your questions regarding diseased cattle, I would beg to state that I have resided in Manitoba for the past ten years, eight of which I have lived in this place.

## Department of Agriculture.

That during the whole of said period I have dealt largely in the purchase and sale of cattle both for local dealers and for shipment to Europe, and have never known or heard of a single case of pleuro-pneumonia or other lung disease among them.

I cannot state the number of head I have handled during that period, but it would be many hundreds, and in travelling over the country purchasing stock I have had every opportunity of hearing of diseased cattle, if there were any. There is not now or ever has been pleuro-pneumonia, lung or other disease among the cattle in the province of Manitoba that I have ever heard of.

I have the honour to be, sir,  
Your obedient servant,

(Sgd.) JOHN WALLACE.

Commissioner of Dominion Lands,  
Winnipeg, Man.

---

PILOT MOUND, 17th October, 1893.

DEAR SIR,—In answer to your question I must say I have lived at Pilot Mound seven years, during which time I have been employed as C. P. R. Agent and have also a mixed farm or, as you may term it, a ranche of my own, during which time have never kept less than one hundred head per year. I have never lost a head from any disease nor ever had a disease of any kind existing among my herd.

I have while C. P. R. Agent here shipped thousands of head and never heard of any disease among them. We have shipped to Winnipeg, Montreal and England prior to my coming here. I was agent for C. P. R. at Elkhorn, where I also had a stock farm, and we never heard of such a thing as a disease of any kind existing among cattle there.

Yours respectfully,

(Sgd.) D. C. BURNS,  
*Agent C. P. R., Pilot Mound.*

Or Pembina Ranche,  
Pilot Mound, Man.

---

OFFICE OF THE SUPERINTENDENT OF MINES,  
CALGARY, 21st October, 1893.

SIR,—Replying to your favour of the 13th instant, ref. 271326, with respect to the facilities I have had for observing the state of health of the stock in Manitoba and the North-west Territories at different periods, I will briefly recite where my work has been during the past number of years.

In 1874-76 I was engaged adjusting certain surveys in the settlement belt of the province of Manitoba, and in doing so I probably had the opportunity of seeing at least 50 per cent of the stock then in the settlements of the province. In 1877-78 I was engaged in connection with the acquirement of the right of way for the Canadian Pacific Railway line in the province of Manitoba, and I had during that time also the best facilities for seeing the stock in that province. In 1879-80 and 1881 I was doing block outline surveys chiefly ahead of settlement; but at least twice each season had to pass through the settled portion of the country going to and from work on the survey, and travelling in those days could only be accomplished by means of horse and wagon.

From the year 1882 up to the present time my work, as you are aware, has been almost exclusively confined to the ranching districts and settlements all over the

country, and as a member of the Dominion Land Board, I have had to visit every old settlement, that is, those settled in advance of survey, from Red River on the east to the Rocky Mountains on the west, and from the international boundary on the south to Lac la Biche on the north, this latter point being near the northerly limit of the district of Alberta. The only settlement I have not visited within the above named boundaries, is a small half-breed settlement consisting of some ten or twelve families at Wood Mountain; but I have been in the neighbourhood of even that settlement.

Since 1883, I have at least twice a year and more often four or five times been through by horse and rig, what is usually called the ranching district proper of the North-west Territories, and having from boyhood been used to stock, it has been a great pleasure to me to find out all I could about the same here, as it is a subject I take a great interest in, and I have only to say, that in all my experience as a resident of the North-west and Manitoba, I never knew a case of pleuro-pneumonia.

In I think the latter part of the winter or spring of 1888, I am not certain as to the year, a number of cattle which were being held some 30 miles south-west from Maple Creek Station on the Canadian Pacific Railway, owned by some ex-Mounted Policemen, and in which Mrs. McIlree, the wife of the then Mr. Superintendent McIlree, was also interested, had an outbreak among them. Several of the cattle died suddenly at least it appeared to those in charge that the sickness had lasted but a short time. The Veterinary then attached to the Mounted Police at Regina, I think it was Mr. Creamer, proceeded to Maple Creek to examine the cattle, and reported that it was pleuro-pneumonia; that report naturally alarmed the other stockholders of that locality, and one of them, Mr. D. W. Marsh, of Calgary, who was largely interested in stock at Maple Creek, came to me and read me letters he had received from his associates at Maple Creek which seemed very alarming. On that I telegraphed I think to the Minister of Agriculture, then the Honourable Mr. Carling, and the result was that Dr. McEachran, of Montreal, was despatched forthwith to the scene. His report (Appendix No. 50), however, showed that it was not pneumonia. I did not see his report, but I understood that he had stated that the outbreak was caused probably by too close herding.

I am, sir, your obedient servant,

(Sgd.) WM. PEARCE,  
*Superintendent.*

The Commissioner of Dominion Lands,  
Winnipeg, Man.

---

PILOT MOUNT, MAN., 13th October, 1893.

DEAR SIR,—We have lived here for thirteen years as general merchants and stock dealers.

We have handled about four thousand head, shipped to Winnipeg, Montreal and old country. Never saw any signs of pleuro-pneumonia, nor ever had a sick animal. We have never seen any lungs we at all thought affected.

(Sgd.) BAIRD BROS.

---

WHITEWOOD, 13th October, 1893.

SIR,—I have the honour to acknowledge receipt of your letter (circular), ref. 271326, in reference to the wish of Sir Charles Tupper to obtain information to

## Department of Agriculture.

refute the charge that pleuro-pneumonia exists in Canada, and also your request asking how long I have been employed as homestead inspector in the several districts of Manitoba and the North-west Territories.

In answer to that I have been ten years in the service of the Department of Interior as homestead inspector, five years of which was spent in Manitoba and the balance in the North-west Territories. I may say that I have travelled through every settled part of Manitoba and during all my travel, and during the five years of residence in every land district in Manitoba, I never heard, nor saw, nor came across any case of pleuro-pneumonia. I am sure that if there had been any case or cases in existence, I would have heard of it.

I have now been close on to six years in the North-west Territories. I have travelled through every settled portion, from Moose Jaw eastward to the Manitoba boundary as far north as Prince Albert, south to the boundary between United States and Canada, and as far north as Fort Pelly on the east during these years, and in the many districts travelled, I have never seen nor have I come across any case or cases of pleuro-pneumonia.

I have the honour to be, sir,

Your obedient servant,

(Sgd.) R. S. PARK,

*Hd. Inspector.*

The Commissioner of Dominion Lands,  
Winnipeg.

---

NORTH-WEST MOUNTED POLICE,  
HEADQUARTERS, REGINA, 25th October, 1893.

SIR,—In reply to your letter of inquiry *re* the existence of disease, and particularly pleuro-pneumonia, among cattle in the North-west Territories and Manitoba, I may state that during the last seven years I have been in command of the North-west Mounted Police, my duties have occasioned constant travel over the Territories, and, during the last four years, since the police occupied Southern Manitoba, that section of the country has also been frequently visited by me. That, as I was interested in stock for many years before joining the police, I have, naturally, kept myself posted, not only on the most suitable stock for the country, but in their management and diseases.

During this experience the only diseases I have known among cattle, are, anthrax, big-jaw, and tuberculosis. Anthrax appears occasionally in the different districts, almost invariably among young animals, and is generally attributed to too succulent vegetation; the settlers insert "setons" as a preventive of the disease, apparently with good effect. Big-jaw occurs rarely, and generally in some old bull or cow, which has probably had its jaw injured at some time, or a diseased tooth, and although on the ranges all such cattle are at once killed whenever found, it is doubtful if this disease is generally, although in some cases it may be, contagious, as I have known a cow in Ontario have it for three years, and no other cases to occur in the same farm-yard.

Only on two occasions has tuberculosis been reported during my residence; once in a cow from New Brunswick in 1886, and again during last summer, when a band of cattle on the Little Bow River, belonging to one Finley, a number of which had died in early spring, were reported to be diseased; I at once sent out a veterinary surgeon, who carefully examined the cattle and reported that at the time they were perfectly healthy, but that a considerable number of this man's cattle had died during last winter, they having been very badly sheltered, fed and taken care of generally, and some of them, from the symptoms described, may have developed tuberculosis before dying. (This herd is to be examined again before the winter sets in, by a competent Police Veterinary Surgeon.) In connection with this, I may state that a very great number of cattle died in this country last winter, in nearly every case, domestic cattle or in bands, the property of small ranchers—who had lately come to the country—that were close herded

during an extremely cold winter following a very mild one. Very little hay was put up, although it could be got for the cutting in abundance, and a great deal of that put up was burned by prairie fires, the stacks being insufficiently protected; as the winter commenced very early, it was impossible to get hay in spring and the result was starvation. Naturally, the owners tried to make out that some disease was killing their cattle, but, after a careful investigation, it was found that exposure, and want of food, added in some cases to a want of water (settlers not having taken the trouble to dig wells, and failing to melt sufficient snow for their animals), were invariably the causes of death.

For police purposes, the country is divided into nine districts, in each of which a division, consisting of from 60 to 150 police, under a superintendent and subordinate officers are stationed. In each district a number of small detachments are placed at convenient points, each immediately under a non-commissioned officer or senior constable. These detachments patrol all the time, and carry patrol slips with remark columns, which are signed by all the settlers they call upon, and every week each of these detachments send in their slips, with a report on the state of the country, crops, crime, settlers coming in and stock they bring, disease, if any, among stock, Indians seen, &c., &c., and these reports and slips are all read by myself. In addition to this these detachments are constantly visited by commissioned officers, and the settlers questioned as to the state of the country and work done by the police when patrolling, and, on their return, they also report. In each division there is a veterinary, who, on any disease being reported at once investigates, and the results forwarded to me, and if there is any occasion, I report at once by wire to the Dominion Government through my department, and direct to the Local, when the necessary action is taken by the latter Government on glanders, and by the Dominion in cases of cattle or sheep diseases.

From these explanations I think you will believe that it is practically impossible for pleuro-pneumonia, or any other contagious disease, to exist in the territory under my charge, without the matter being speedily brought to the notice of the Government.

I have the honour to be, sir,  
Your obedient servant,

(Sgd.) L. W. HERCHMER,  
*Commissioner, N. W. M. P.*

H. H. SMITH, Esq.,  
Commissioner of Dominion Lands,  
Winnipeg.

BATTLEFORD, 10th November, 1893.

SIR,—I have the honour to acknowledge the receipt of your letter, dated the 30th ultimo, No. 277365, ref. 271326, desiring me to state whether during my official service under the Government I had ever come across any cases of pleuro-pneumonia within the district travelled over or visited by me.

In reply I have to state that in May, 1883, I was appointed to the position of Intelligence Officer at Moosomin, in the district of Assiniboia, North-west Territories, and served in that capacity until November, 1887, when I was transferred to Battleford in the district of Saskatchewan, and assumed charge of that district as Agent for Dominion Lands and Inspector, making a service under Government of ten years.

During the period in which the position of intelligence officer was held by me, it was one of my duties to be closely in contact with all matters appertaining to the location of new settlers and the general welfare of those who had previously located in the district of Assiniboia, and therefore had necessarily to travel over, at different periods, the eastern portions of that district, and visit settlers on their homesteads to note improvements of all classes.

## Department of Agriculture.

In my present office the district included in this land agency comprises an area of about 31,200 square miles, the settled portion of which is mainly occupied by settlers engaged in mixed farming, and the outlying portions by small stock and cattle ranchers.

My duties bring me into frequent contact with these farmers and ranchers, by personal visitations and inspections of the locations occupied by them, in the course of which the cattle and stock come under my notice.

In the period of my official connection with the Government, and in the several localities visited by me, a case of pleuro-pneumonia amongst cattle has never come, or been brought to my knowledge or attention; neither has a complaint of this character been made before me as a justice of the peace, under the territorial ordinance provided against such cases.

If it may be considered pertinent to this matter, I would further state for your information, that I have resided for thirty-five years in Canada; twenty-two of which residence has been in Manitoba and the North-west Territories, during which term I have been more or less in contact with the farming and stock-raising community of the Dominion of Canada; both as a resident amongst them, and the publisher of one of the first newspapers established in Manitoba; and I cannot call to my recollection, a case of this class of disease amongst cattle coming under my notice or being reported to me.

In fact it has been and still is my impression, that Canada—the western districts especially—is most conspicuously free from disorders and diseases of this nature. That impression is more fully confirmed from the fact that during last winter—one of the severest within my knowledge—the deaths of unsheltered or unhoused cattle in this district was less than one hundred head.

The loss in this instance was caused by some of the settlers having been improvident in stacking the natural fodder available against such a contingency, and not from disease.

I have the honour to be, sir,

Your obedient servant,

(Sgd.) E. BROKOVSKI,  
*Dominion Land Surveyor.*

The Commissioner of Dominion Lands,  
Winnipeg, Man.

---

EDMONTON, ALT., 30th October, 1893.

SIR,—With regard to pleuro-pneumonia amongst cattle in Canada, I beg to report that I have never seen nor heard of any cattle being so affected except through the newspapers, and I have been employed as Homestead Inspector at Edmonton since I received the appointment about May, 1892.

I have resided in Manitoba and the North-west Territories since 1873, and have resided for short periods in nearly every district. I have resided here since the summer of 1877, and have been farming and freighting between Fort Macleod and Athabasca Landing during the last 14 years. I have handled and brought into Northern Alberta, a very large number of cattle for various settlers and the Hudson's Bay Co., during which time I never knew nor heard of any disease amongst them in any way analogous to pleuro-pneumonia.

I have the honour to be, sir,

Your obedient servant,

(Sgd.) JOHN COLEMAN,  
*Forest Ranger and Homestead Inspector.*

Commissioner of Dominion Lands,  
Winnipeg, Man.

REGINA, 1st November, 1893.

SIR,—I have the honour to acknowledge the receipt of your circular of 5th ult., ref. No. 271326, and in reply to say, that I have been engaged in the capacity of Homestead Inspector for over ten years past, during which time I have been over a large portion of Manitoba and the Territories, having been for about four years, through the Winnipeg, Souris, Birtle and Little Saskatchewan district, and since 1887, through the Qu'Appelle, Touchwood and Swift Current district, and have never come across cases of pleuro-pneumonia.

That I have met a great many farmers having cattle, and ranching with large herds of cattle, and have never heard of pleuro-pneumonia among cattle throughout these districts.

Upon receipt of your circular I made inquiries respecting the disease and inclose herewith certificate of a veterinary surgeon, resident at Moose Jaw.

I have the honour to be, sir,

Your obedient servant,

(Sgd.) JOHN ROGERS,  
*Homestead Inspector.*

The Commissioner of Dominion Lands,  
Winnipeg, Man.

*Certificate.*

I, Benjamin Fletcher, of the town of Moose Jaw, in the district of Assiniboia and the North-west Territories of Canada, a veterinary surgeon of the said Territories, do hereby certify as follows:—

That I have been residing and practising my profession at this place for some three years now past.

That I have been and am now well acquainted with the state of the cattle throughout the Moose Jaw district, and during that time there has been no trace observed or heard of by me of any cattle in this part of the said Territories being afflicted with any disease of any kind whatsoever, except one light outbreak about a year ago of "quarter evil", and there has been at no time any disease which in any way resembles pleuro-pneumonia.

And I have much pleasure in giving this certificate as to the state of the cattle throughout the Moose Jaw district, in answer to the inquiries made regarding their condition by Mr. Homestead Inspector Rogers.

Dated at the said town of Moose Jaw the 11th day of October, A.D. 1893.

(Sgd.) BENJ. FLETCHER, V.S.

WINNIPEG, MAN., 2nd October, 1893.

SIR,—I have the honour to inform you that from the month of June, 1886, till the month of June, 1887, I occupied the position of Homestead Inspector in the district lying between the townsite of Cartwright on the east and the present townsite of Estevan on the west, and from June, 1887, till the present time I have acted in the same capacity in the district lying between Cartwright on the west and the city of Winnipeg on the east, in which latter district are located the respective townsites of Deloraine, Boissevain, Killarney, Homefield, Cartwright, Clearwater, Crystal City, Pilot Mound, Manitou, Thornhill, Morden, Gretna and Morris.

Respecting the duties required of a Homestead Inspector, I may be allowed to say that it is imperative on him to make a personal inspection of the buildings, cultivation, and cattle owned by each homesteader, and in addition, to ascertain from reliable sources the term of actual residence performed by each homesteader on his respective homestead, and in the performance of said duties it necessitates him to drive continuously from one homestead to another to obtain all the facts mentioned, said driving only retarded by nightfall, and as the course pursued is to remain



## Department of Agriculture.

wherever night overtakes us in the discharge of duty—it may correctly be said homestead inspectors know as much of the general business in connection with farming as do the settlers themselves.

In my personal intercourse and conversation with them I have repeatedly asked the settlers in different parts of the hereinbefore mentioned widely extended district their opinion, from their own personal experience, as to the adaptability of the country for stock-raising and fattening cattle for export, and the answer invariably has been "The country is all right, if prices were," they further stating that from the character of the climate and the richness of the varied natural grasses on which they graze during the summer season, the cattle grow up very healthy, robust and fat, and when fed on crushed grain a few months prior to sale, are in excellent condition for shipping abroad.

With special reference to the rumour that a case of pleuro-pneumonia had been discovered in an animal shipped from Pilot Mound and slaughtered in England, I can conscientiously say that in the discharge of my official duties which require me to drive over and through each of the numerous localities which comprise the large district under my charge, four times at least yearly, during which journeys I am in constant intercourse with the settlers, staying always at nights in their homes and making friendly inquiries of them as to their general prosperity,—I have never heard from any one the most remote hint that such a disease had ever manifested itself in any of the localities—and as the prosperity of the settler depends largely on the sale of his cattle, should any disease ever have been prevalent amongst their cattle, especially the dreaded one of pleuro-pneumonia, it would have been a matter of public notoriety and could not have been kept hidden, and personally I do not for a moment believe that even a single case of it ever existed in Manitoba or the Northwest. In further connection I beg leave to add that having had some personal experience in shipping cattle to England from Nova Scotia, prior to my coming to Manitoba, I never knew of a case of it occurring amongst Canadian cattle, though it was prevalent amongst American cattle on landing in England and in consequence all American cattle were excluded from the live markets, and obliged to be slaughtered at Deptford on arrival.

I have the honour to be, sir,

Your obedient servant,

(Sgd.) JOHN ALLISON,

*Homestead Inspector.*

The Commissioner of Dominion Lands,  
Winnipeg, Man.

## No. 50.

## REPORT OF INVESTIGATION OF CATTLE DISEASE AT MAPLE CREEK.

MAPLE CREEK, N.W.T., 14th April, 1888.

The Honourable  
The Minister of Agriculture,  
Ottawa.

SIR,—In compliance with your instructions I arrived here on Wednesday 11th, and proceeded next morning to Greyburn, in the Cypress Hills, to the ranche of Messrs. McIlree, Gow & Stothers, accompanied by Mr. Creamer, V.S., who had previously investigated and reported pleuro-pneumonia.

On arriving I met Mr. Stothers, and shortly after Mr. Gow, who had just returned from visiting the herd. Mr. Stothers volunteered the following statement:—

“I am a partner with Mr. Alexander Gow, we have been here since 1886. I brought these cattle direct from Ontario, from around Orangeville, Grey and Wellington, near Mount Forest, and some from counties of York and Vaughan in June, 1886, moving here from Maple Creek in July, 80 head altogether. They are owned jointly by McIlree, Gow and myself. They are the only cattle brought from Ontario here since then. In July of the same year, Conrad's cattle were brought in from Montana. There has been no disease known among them. The first we knew of the disease was the loss of fourteen calves last summer, during July and August. They were rolling fat, they were very sensitive on the quarter over the loin, if pressed on there they would cringe to the ground. Some of them before they died would bleed from the nose and pass blood from their anus. They were out on the range, we found them dead and very much swollen. Some people called it black leg, others said that they were poisoned. We only saw three sick ones alive, the others died without our seeing them. Five or six seemed to die on one day, they were following the cattle and dropped dead. We did not open any, nor did we bury them, we left them lying on the prairie. We thought it was poison and drove the cattle away from the place. The first died on the 5th of February. We know of 30 dead ones. The first that took ill came and died in the yard. We took in all that we saw drooping and tried to feed them, some of them lingered about a week. They looked dull, the eye glassy, they had a far away look, they looked excited as if they would run at you, but would not move. They would feed for a short time then stop and start again. Some, I think all of them passed bloody matter from the nose and eyes, and a bloody fluid would pass from the anus. They became gradually more and more stupid as if in a happy sleep, would turn over on their side and die, and after death the body would swell up very much. Some of them may have coughed a little but it was not a feature in the disease. They all died, we have not known one to recover. We had a heifer in the stable which we thought had the disease, it ran a greenish stuff from the nose. Mr. Creamer killed it for post-mortem examination.”

Mr. Creamer gave the following description of the post mortem:—

“I found the right lung and lower lobes of the left congested, one part was of a deep red colour, the rest more mottled. There was slight adhesion to the ribs and diaphragm.” (As the carcass lay just at the door, I at once went out with him and found that the lungs and diaphragm were gone, but I have never seen a healthier costal pleura).

Returning—Mr. Stothers continued.—“The cattle which died fed all round where the calves died last summer, they fed a good deal around the very place where the dead calves were lying. The grass there was long and good. They were in good condition when they went there but began to die soon after”.

## Department of Agriculture.

We next proceeded to where the dead cattle were lying on the prairie and I obtained the following certificate from Stothers and Creamer.

"We the undersigned do hereby certify that we were present and assisted at post-mortem examination on three cows held by Dr. McEachran, these cows died at the end of February, but being frozen were in a fair state of preservation. In all three carcasses the lungs showed no signs of disease, they were collapsed, small and would float in water. The covering membrane (pleura) was transparent and glistening. There was no fluid in the cavity of the chest in either of them. No signs of disease were visible in any of the other organs. These, however, being frozen and in a more or less decomposed condition were only casually examined.

(Signed) "J. W. CREAMER, V.S.  
"W. STOTHERS."

On the 13th April, accompanied by Mr. Gow, Stothers and Creamer, I went to where the balance of the herd were, some fifteen miles off, and two cows were pointed out as showing the symptoms shown by the others. One cow which Stothers informed me was clinically examined by Mr. Burnett, V.S., Calgary, and suspected by him of pleuro-pneumonia—this one we secured; I found no signs of lung disease on either auscultation or percussion of the chest, she was emaciated, weak and covered by blue lice. The skin denuded of hair in patches, scabs and erythema of the skin. Temperature 101°, pulse 45, membranes palid, no cough or disturbed breathing. I had her killed for post-mortem examination by concussion of the brain. The organs of the cavity of the chest were perfectly healthy but pale and anæmic as were all the other internal organs, but like the lungs free from all pathological changes of structure. The want of internal fat and bleached anæmic condition of the organs and a small quantity of serous fluid clear and transparent in the abdominal cavity were the only change from the normal condition observable.

I obtained the following certificates from Gow and Stothers who assisted at the post-mortem, and from Creamer who was not present, but to whom the lungs were carried immediately after.

"Having been present and assisted at the above post-mortem examination, we hereby certify the above to be correct in every particular.

(Signed) "W. STOTHERS,  
"A. GOW."

"Having seen and examined the lungs of the cow referred to above I consider them free from all disease either of the lungs or pleura, and I consider them to be perfectly healthy.

(Signed) "J. W. CREAMER, V.S."

From a consideration of the above facts I have great difficulty in comprehending how any man of ordinary intelligence, who had ever read or heard of pleuro-pneumonia or lung plague, could make such a mistake. The disease is anthracoid in its character as its history and symptoms prove. But we must not overlook certain circumstances connected with this outbreak which go to show that the persons in charge of the herd are not blameless, in fact their ignorance and negligence combined were important factors in its spreading.

We are informed by themselves that 14 calves died and were left unburied on the prairie where the grass was good and where the cattle congregated. I may here state that the unsanitary condition of their premises when I visited them was simply scandalous. Within twenty-five yards of their shack door were eleven carcasses, five of which were in a shed, the floor of which was simply an accumulation of manure, without a particle of either hay or straw, and these carcasses have lain there since February.

Again, both the dead and the living animals were swarming with blue lice, the irritation of which caused the hair to come off in patches, leaving a red, itchy, scab covered skin, the emaciation being no doubt largely induced by this cause.

When to this we add the fact that while there was an abundance of grass last summer, the autumn was a very wet one and the seeds fell early, and the rain kept the grass green and moist till it was frozen, hence deficient in albumenoids, innutritious and insufficient to support an animal in good condition, consequently when stock had wintered indifferently on such food it is not surprising that they should readily be affected by any form of anthrax.

I regret not having facilities with me for a microscopic investigation to determine beyond question the presence of bacilli, but the outbreak resembles so closely others which have been investigated by me that I have no hesitation in classing it as one of the anthracoid outbreaks seen from time to time the whole world over.

I beg to report that I ordered the cremation of all carcasses on the range, which Gow and Stothers have undertaken to carry out, and Superintendent Antrobus of the North-west Mounted Police has promised that his out-post men at Greyburn, will report as to the thoroughness with which it is done.

I have also written to the owners of the cattle and recommended that they should dress them with a remedy to destroy the vermin, and where necessary to feed the debilitated one with a little oil-cake to supply albumenoids.

I have much pleasure in reporting that it is a local disease in which no one but the owners are interested so far as any danger of its affecting other herds is concerned, and calling for no special quarantine measures by the department, and even in this herd, except one animal, I do not expect any more deaths from this cause. They are removed fifteen miles away and new grass is beginning to grow so that they will soon have a nutritious diet to subsist on.

It is but fair to state that I have doubts as to the correctness of Mr. Stothers' statement that Mr. Burnett pronounced the cow, which I caused to be killed, as affected with pleuro-pneumonia, for I have not been able to learn of any statement of that kind having been made by him; on the contrary, I am informed that he reported the deaths to be due to starvation and over herding.

Respectfully submitting the above report,

I have the honour to be, sir,  
Your obedient servant,

D. McEACHRAN, F.R.C.V.S.,  
*Chief Inspector.*

57 Victoria.

Sessional Papers (No. 8A.)

A. 1894

# REPORT

ON

# CANADIAN ARCHIVES

BY

DOUGLAS BRYMNER, Archivist

## 1893

*(Being an Appendix to Report of the Minister of Agriculture.)*



OTTAWA

PRINTED BY S. E. DAWSON, PRINTER TO THE QUEEN'S MOST  
EXCELLENT MAJESTY

1894

[No. 8a.—1894.] Price 15 cents.



Department of Agriculture—Archives.

CONTENTS.

	PAGE.
ARCHIVIST REPORT.....	v
List of books, &c., presented, with the names of the givers.....	vi
STATE PAPERS, LOWER CANADA, CALENDAR.	
Q. 107. Governor J. H. Craig, 1808.....	1
Q. 108. do and miscellaneous, 1808.....	16
Q. 109. do 1809.....	24
Q. 110. do 1809.....	33
Q. 111. do 1809.....	35
Q. 112. do 1810.....	37
Q. 113. do and miscellaneous, 1810.....	41
Q. 114. Acting Gov. Dunn, and Gov. Sir G. Prevost, 1811 ..	45
Q. 115. Gov. Sir G. Prevost, and miscellaneous, 1811.....	51
Q. 116. Accounts, 1811.....	59
Q. 117-1. Governor Sir G. Prevost, 1812.....	59
Q. 117-2. do 1812.....	62
Q. 118. do 1812.....	66
Q. 119. do and miscellaneous, 1812 .....	76
Q. 120. Miscellaneous, 1812 .....	85
Q. 121. Governor Sir G. Prevost, 1813.. ..	90
Q. 122. do 1813.....	99
Q. 123. do and miscellaneous, 1813.....	107
Q. 124. Miscellaneous, 1813.. ..	114
STATE PAPERS, UPPER CANADA, CALENDAR.	
Q. 311-1. Lieut.-Governor F. Gore and miscellaneous, 1808.....	1
Q. 311-2. do do 1808.....	5
Q. 312-1. do do 1809. ....	9
Q. 312-2. do do 1809.....	13
Q. 313-1. do do 1810.....	15
Q. 313-2. do do 1810.....	19
Q. 314. Acting Governor I. Brock do 1811.....	26
Q. 315. do and Lieut.-Governor R. H. Sheaffe, 1812.....	32
Q. 316. Miscellaneous, 1812.....	38
Q. 317. Lieut.-Governor R. H. Sheaffe, Lieut.-Governor de Rottenburg and miscellaneous, 1813.....	43





# REPORT ON CANADIAN ARCHIVES.

DOUGLAS BRYMNER, LL.D., F.R.S.C., ARCHIVIST.

---

Honourable A. R. ANGERS,  
Minister of Agriculture,  
&c., &c., &c.

SIR,—I have the honour to present the report of the Historical Archives Branch for 1893.

The Archives are growing in extent and importance, and also in the estimation of those interested in historical investigations.

In consequence of the near completion of the copying in London of the documents relating to the province of Quebec, of Lower and Upper Canada, it has been thought desirable to investigate and prepare for copying the documents relating to all the other provinces. Very satisfactory progress has been made, but as the investigation covers a period of about two centuries and a half, the work is not so far advanced as to admit of a thoroughly complete report of it being now prepared.

The report for this year, therefore, comprises only the continuation of the calendar of the State Papers of Lower and Upper Canada, which has been prepared as usual in the Archives Branch.

The whole respectfully submitted.

DOUGLAS BRYMNER,

*Archivist.*

LONDON, November, 1893.

## LIST of BOOKS, &amp;c., presented with the Names of the Givers.

Agriculture, Department of.....	Toronto .....	Reports.
Boston, Institute of Technology...	Boston .....	Catalogue.
Buffalo Public Library.....	Buffalo.....	Report.
Cayuga County Historical Society.	Auburn, N. Y.....	Manuel, Collections No. 10.
Civil Engineers, Society of.....	Montreal.....	Publications.
Cruikshank, Ernest.....	Fort Erie.....	A Century of Municipal History.
Geological Museum .....	Ottawa.....	Publications.
Gosselin, (l'abbé A.) .....	St. Charles, P.Q..	Jean Nicolet Pamphlet.
Griffin, J. A.....	Hamilton .....	Pamphlet.
Harbour Commissioners.....	Montreal .....	Report.
Kelton, Capt. Dwight H.....	Quincy, Mich.....	Annals of Fort Mackinac.
Laval University.....	Quebec .....	Reports 1883 to '93.
Macalester College .....	St. Paul, Minn...	Contributions.
Manitoba Historical Society.....	Winnipeg.....	Reports.
Master of the Rolls.....	London, Eng.....	Domestic 1643-1647 and 1643-1660 part IV. Henry VIII., 1538, Vol. 13, part I. Colonial East Indies and Persia.
Matheson, David.....	Ottawa.....	Pamphlet.
Moore, Charles.....	Washington .....	Pamphlet.
Oblat Fathers.....	Paris, France.....	Missions de la Congrégation des Missionnaires Oblats, 1862 to 1893.
Prince Edward Island, Secretary of	Charlottetown .....	Official Publications.
Raymond, Revd. W. O.....	St. John, N. B....	Pamphlet.
Record Commissioners.....	Providence, R. I..	Early Records of the Town of Providence, 2 vols.
Remington, Cyrus K.....	Buffalo, N. Y.....	Pamphlet.
Rochester Historical Society.....	Rochester, N. Y..	Publications.
Shewen, E. T. P .....	Sackville, N. B ..	Pamphlet.
Smithsonian Institute.....	Washington .....	Report.
Toronto Public Library.....	Toronto .....	Pamphlet.
Ward, J. W. W. ....	Ottawa .....	Pamphlet.
Wentworth Historical Society.....	Hamilton .....	Journal and Transactions.
Windsor, Justin.....	Cambridge, Mass..	Pamphlets.
Wisconsin State Historical Society	Madison.....	Proceedings.
Yale University.....	New Haven.....	Reports.

STATE PAPERS—LOWER CANADA.

GOVERNOR J. H. CRAIG, 1808.

Q.—107.

1807.  
November 16, Quebec. Ryland to Sir John Johnson. Encloses copy of complaint delivered to him by three Indians. His Excellency desires the fullest information. Page 348  
(In Craig's No. 34 of 22nd October.)
- November 24, Quebec. Return of ammunition (No.1) required to complete the proportion for this garrison. Signed by George Glasgow, Col. commanding Royal Artillery. 10
- December 1. Gore to Craig. (Extract.) As a means of defence the Indians may prove useful; the apprehension of the Americans at Detroit on this head has caused them to issue a proclamation threatening retaliation on the wives and children of those joining the British Standard. Their resolution shaken. He should not trust too much to Indian assistance. 221
- December 1, York. Queries by Gore respecting the Indians, and answers by Craig. 220
- December 2, Quebec. Demand for ordnance stores (No. 2) wanted from England, signed by J. Danford. 13
- December 6, Quebec. Craig to Gore. Owing to severe illness has been unable to communicate with him sooner. Hoped to have received information before now by which he might have been enabled at least to conjecture as to the probable issue of the pending controversy. A sufficient time has not elapsed for the means he (Craig) has employed to take effect. Has had no communication as yet from the British Minister in the United States; he therefore knows little except the slender information which can be gleaned from the papers and the temper of the President's speech at the opening of Congress. A state of defence necessary. His Majesty's instructions, as well as his own views, on the subject, seem to point to the preservation of Quebec as the first consideration; it is the only post, defective as it is, that can be considered tenable for a moment. If America decides to attack us, powerful assistance will be needed from home. Is ignorant of the state of the Militia in the Upper Province, but is sure that he (Gore) knows the value of the co-operation and concentration of the forces, but leaves all that in his hands, as he knows the upper country. If the Americans should turn their attention to the Lower Province, which is most probable, operations must terminate in a siege; the artillery, &c., for this purpose will surely exhaust all their means and occupy all their attention, and so prevent any attack being made on the Upper Province at the same time. Has no hope that the forces here can accomplish anything more in case of attack than the checking the enemy for a short time; will eventually be compelled to take refuge in this place (Quebec); when collecting all the forces possible from both provinces we must endeavour to get as far as possible to the rear of the besiegers and cut off convoys and communications. In this way time at least can be gained. The destruction of the magazines would be very distressing to them. The American Militia are little to be feared. The command of the lakes is of great importance. If the Indians are not employed with us, they will certainly be employed against us. Caution necessary in dealing with them; the loss of the valuable Indian trade if they

1807.

are not kept on our side. Governor Hull restricts himself to advising the Indians to remain neutral. The policy to be pursued by them. Desires information as to the history of the Indian called the Prophet. Wants communications on the subject of his (Gore's) resources. Understands that not one of his forts is in a state for making any resistance; thinks it fortunate that there is no temptation to risk garrisons in them.

Page 209

- December 15, Quebec. Requisition. (No. 3.) Gunpowder required for the garrison of Quebec for field service, &c., signed by George Glasgow. 15
- December 18, Raleigh, River Thames. J. Baby to Gore. Asks for instructions as to his future conduct. He and his brother called on the commanding officer at Amherstburg to consult as to calling out the detachments they had been ordered to prepare and placing them at that post, to ward danger from the reinforcements expected by our neighbours in addition to which they have just raised two hundred extra men for duty at Detroit. His answer was that he had no orders to receive men, and the state of his provisions would not allow of it; recommended applying to him (Gore). Asks that he point out what course is to be followed. In the event of the arrival of an extraordinary force, what is to be done about calling out the militia? Must hostilities first take place? How are the militia to be provisioned? Has come to this river to review them. The County of Kent very loyal; one fourth of the whole ready for service. Essex also appears loyal. 447  
(Enclosed in Gore's of 5th January, 1808.)
- December 22, Montreal. Speech made by Sir John Johnson to the Indians. 351  
(In Craig's No. 34 of 22nd October.)
- December 23. Proceedings of a council held with the Iroquois and Caughnawagas by Sir John Johnson. 356
- December 28, Montreal. Johnson to Ryland. Transmits the results of the meeting held with the Iroquois of the Lake of Two Mountains and the Caughnawagas. The reception of the three young Indians who went to England to present their complaint, has made them insolent. On his refusing further issues till instructions were received these young men threatened to go to Quebec. Something must be done to check them, or they will become unmanageable. 349  
(In Craig's No. 34 of 22nd October.)
- December 29, York. Gore to Baby. The loyalty of the men of Kent. Should further reinforcements be made to the garrison of Detroit, one-fourth of the militia should be called out; will direct Lt.-Col. Grant to receive them into the garrison of Amherstburg. To wait for hostilities might render defence ineffectual. Arms and ammunition to be issued as necessary. If one-fourth of the militia does not seem sufficient, more may be called out, even if necessary, the whole body. At this distance particular instructions are impossible. Beef to be furnished for the militia. Has all confidence in his (Baby's) zeal and discretion. 250  
(In Craig's No. 25 of 15th July.)
- December 29, York. Gore to Lt.-Col. Grant. Encloses copy of his letter to Baby, Lieutenant of the County of Kent. The defence of the country can only be directed by persons on the spot. If the garrison of Amherstburg appears weak he should receive the militia. Arms to be given out as necessary. Rations to be issued the same as to regulars. 253  
(In Craig's No. 25 of 15th July.)
1808.  
January 5, York. Same to Craig. Has been much honoured with the secret despatch of 6th December, brought by Ensign Shawe. The unfavourable reports of his (Craig's) health prevented his communicating sooner. Is in a similar state for want of intelligence. Only one communication received from Erskine and that just after the Chesapeake affair. Does not agree with him that in such a state of uncertainty, we should be prepared for hostility. The extent and slender population of this province afford but

Department of Agriculture—Archives.

1808.

too good grounds for the plan specified in His Majesty's instructions. Beyond defending it from a partial or sudden incursion, little could be done; this fact must be kept from the knowledge of the people. Sends return of the militia. The inhabitants from Kingston to the Lower Province are to be depended on; those about Niagara and Long Point are doubtful; except those at Glengarry, the rest of the inhabitants are chiefly emigrants from the United States and retain their prejudicial ideas of equality, &c. The militia must be placed so as to repel sudden attacks. Agrees with him (Craig) as to the advisability of harrassing the enemy in case of an attempt on Quebec; shall never lose sight of that fortress. Our superiority on the lakes; asks whether the brig the "Duke of Kent" should be repaired and seamen engaged. Encloses Baby's letter and his (Gore's) answer, also one on the same subject to Lt.-Col. Grant. Importance of appearing to defend Amherstburg to inspire confidence; St. Joseph should be reinforced with a few regulars. Considers that could we destroy the American posts of Detroit and Michillimackinac many Indians would declare for us. Agrees that if not for us they will be against us. Thinks two or three thousand of them the utmost to be counted upon; importance of fit persons to manage them; recommends Elliott for charge of the post of Amherstburgh. The inefficiency of the Indians without regular troops. Necessity of having the Indian presents stored here instead of at Lachine. The Prophet seems to be disposed to favour our cause; he is believed to have an influence over about a thousand of his brethren; will try and find out more about him from Elliott. Has had a confidential correspondence with Chief Justice Alcock on the political transactions since his arrival. Page 236

(Enclosures calendared at their respective dates.)

January 5,  
York.

Annual return of the militia of His Majesty's Province of Upper Canada. 246

(Enclosed in Gore's of 5th July, 1808.)

January 5,  
Quebec.

Craig to Castlereagh. (No. 8.) Finding the originals of the enclosed returns have been despatched by this communication, he does not scruple, notwithstanding what he has said in No. 7, to forward this by same means. He has discovered that demands for stores from the Ordnance must be forwarded through His Lordship's office; hopes therefore such steps will be taken as will secure these necessary supplies. Found almost all the bayonets here without scabbards. He has had them made here, which incurred greater expense than getting them from home. 8

January 8.

Gore to Craig. (Extract.) Has little to remark on Sir John Johnson's letter, except his total lack of information on the subject of McKee's influence over the Indians. Understands from other quarters that influence entirely lost. Intemperate habits of McKee. Advises the employment of Elliott. 224

Enclosed. McKee to Prideau Selby. By the enclosed newspapers it appears that the Americans spare nothing to gain the Indians. They leave us daily. Has been obliged to purchase ammunition at his own expense. The dead Indians now amount to 41, and more deaths every day. 225

January 11,  
Quebec.

Craig to Castlereagh. (No. 7.) His arrival in Quebec. Has assumed the charge with which His Majesty has honoured him, since which little of importance has occurred. State of his health improving. Upon enquiry, finds communication with Halifax not safe enough to warrant writing on subjects where caution is needed. Hopes His Lordship will approve of his abstaining from entering upon any military subjects. Everything in pretty much the same state as when he last wrote. "The utmost good appears to prevail in every part of the province," and though he has not thought necessary to embody the militia, every arrangement is made for calling out and arming a fifth of them at the shortest notice. Camp equipage to be added to the requisition already made. Since last

1808.

letter he has written to Lt.-Gov. Gore and sent an officer to him with his letters in which the subject of the co-operation that might be necessary between the provinces in the event of war with the United States is freely discussed. The Lt.-Governor has despatched Col. Shawe with letters so there will be a complete understanding. Has delayed calling together the Provincial Parliament till the 29th inst. From the present disposition of the public mind he expects cordial co-operation in measures for the public benefit. Jails for districts of Quebec and Montreal to be erected. Fears the £9,000 allotted for each will not be sufficient. The position of auditor of the public accounts vacant by the removal of Mr. Coffin to Europe, being important, has after consideration, appointed Mr. Hale, D.P.M.G. of the Forces. Page 1-

January 12,  
Quebec.

Naval officers' returns of vessels entered inwards at Quebec between 10th October and 3rd December; and outwards between 13th October and 27th November. 16

January 12,  
Quebec.

Craig to Castlereagh. (No. 10.) Enclosing copy of the proceedings of the Executive Council concerning matters of State between 26th September and 16th October last, inclusive. 17

January 13,  
Quebec.

Same to same. (No. 11.) Enclosing copy of the rates of exchange and current prices at Quebec for the month of December last. 18  
*Enclosed.* Prices current. 19

January 22,  
Downing St.

— to Craig. (Draft.) Recent intelligence has rendered it expedient in the judgment of His Majesty's ministers that the defences of British possessions in America should be strengthened. With this view, a regiment of 3,000 rank and file will sail for Halifax under the command of Sir G. Prevost. Further reinforcements to be governed by circumstances; although measures will be taken to support with regular troops His Majesty's North American subjects, yet much of the exertion must be made by the people themselves. The number of militia considered necessary to be raised and armed, and the method in which it is to be done. Respecting the rank officers of the militia will take. Not less than 16,000 stand of arms will be immediately forwarded and uniforms, to be issued to the militia, only in case of actual service. Two companies of artillery will be immediately sent to Halifax and two additional companies held in readiness to proceed to Quebec upon any intelligence which may indicate an approaching rupture. Camp equipage for 10,000 men will also be sent. In order to liquidate the extraordinary expenses a supply of specie will be forwarded. His Majesty relies on the Legislatures of the respective provinces for making every exertion for the general defence, with their internal resources. The residue His Majesty will recommend Parliament to provide. No time to be lost in establishing communication with Sir G. Prevost, so that in case of attack the forces may be moved to the proper quarter. A copy of this will be communicated to Major General Prevost before his departure in order that he may take corresponding steps in Nova Scotia and New Brunswick. 22

January 23,  
Quebec.

Ryland to Attorney General Sewell, enclosing despatch from the Secretary of State and other papers relative to the claims brought forward by a deputation of Indians who went to England last year. Against the Governor's express orders, they are come down to Quebec. He refused them an audience, but told them to lay before him (Sewell) such particulars as they may wish. 365

(In Craig's No. 34 of 22nd October.)

February 4,  
Downing St.

Draft of a letter to Sir J. H. Craig. Enclosing copy of a letter from Mr. Harrison, stating that £100,000 will be soon forwarded to Quebec, and that £102,664 are now at Portsmouth for shipment to Nova Scotia. The Lords of the Treasury desire that general orders be published stating that the dollars be issued to the army at 4s. 8d. sterling each. 73

## Department of Agriculture—Archives.

1808. February 6, Downing St.	Draft of a letter to Sir J. H. Craig. (No. 7.) Transmitting duplicate of letter written to Sir G. Prevost with copy of an additional instruction upon the publication of which if it shall appear to him advisable after his arrival, the civil and military command of the province of New Brunswick will be united under the officer commanding His Majesty's forces in the Province.	Page 74
February 6, Montreal.	Petition of Eleanor Birnie, widow of Arthur Davidson, for an allowance from Government.	78
	<i>Enclosed.</i> Recapitulation from the inventory of the estate of the late Mr. Justice Davidson.	80
February 8, Quebec.	Craig to Castlereagh. (No. 12.) Enclosing printed copies of his speech to the two houses and their addresses. Has great satisfaction in stating that the utmost cordiality and loyalty mark their proceedings.	29
	<i>Enclosed.</i> Speech by Sir J. H. Craig to the Provincial Legislature, English.	30
	do do do French	36
	Address by the Legislative Council to Craig, English.	42
	do do French.	50
	Address by the Legislative Assembly to Craig, English.	59
	do do French.	66
February 8, Quebec.	Craig to Castlereagh. (No. 13.) Enclosing petition of Marguerite LeMay on behalf of her husband Guillaume Martin, confined as a prisoner of war on the prison ship at Chatham. Recommends the petition.	75
February 10, Quebec.	Craig to Gore. (Extract.) Encloses an extract of Mr. Erskine's letter, and a paragraph cut from a newspaper, both relative to the disposition of the Indians. Advises abstaining as far as possible from irritating the public mind in the United States, though preserving the attachment of the Indians. The Council to be held at Amherstburg will simply be laid hold of by the violent party in America. Regrets his (Gore's) doubts of Mr. McKee's influence. Though willing to dismiss McKee, he doubts the propriety of reappointing Elliott. As in the event of employing the Indians, other officers besides in the Indian Department will be required, desires he will be on the lookout for proper persons.	221
	<i>Enclosed.</i> Extract of a letter from Erskine.	223
	Paragraph from the <i>National Intelligence</i> .	223
February 12, Quebec.	Craig to Castlereagh. (No. 14.) Enclosing petition from the widow of Arthur Davidson, late puisne judge for the District of Montreal. Recommends the petition.	77
February 24, Quebec.	Same to Edward Cooke. Is anxious to apprise him as soon as possible, for the information of Lord Castlereagh, of the death of the Chief Justice. Forwards this letter by New York; avoids pursuing this subject further at present in case the letters may be intercepted.	89
February 24, Quebec.	Same to Castlereagh. Reporting the death of Chief Justice Alcock. Recommends Mr. Jonathan Sewell as his successor.	87
March 2, Swanton, Vt.	John Henry to Ryland. The inhabitants of the northern part of Vermont are much excited by the law passed by Congress prohibiting the transport of American produce into Canada. The clamour is so great that there is danger of an engagement between the officers of Government and the people, on the first effort to stop the introduction of the vast quantity of lumber and produce for the Montreal market. If Jefferson intended only to preserve the commerce of the country from falling into the hands of the belligerent powers, he has already done everything towards that object; but, as that policy does not include the suspension of intercourse with Canada, we may look for the origin of this paltry attempt to deprive our navy of a few masts and spars, in the inveterate hostility of the American Executive and the desire to abet the designs of Buonaparte	113

1808.

March 6,  
Windsor, Vt.

John Henry to Ryland. As the mail leaves for Montreal to-morrow, he will send a summary of what he has learned of the state of the public mind in the northern part of Vermont. The prevalent opinion of well-informed men is that war with England is inevitable. He should have ascribed this to their fears, but the representatives from the several districts in Vermont write to their friends that the majority of Congress are determined, *if forced from their neutrality*, to take part with France, unless Great Britain surrenders the right of search. As this will not be done, they say that if there is a time when concessions can be extorted from Great Britain, it is now. The bold talk publicly of an organized resistance; the timid, who foresee individual distress, would consent to an "armed truce along the borders," or even a union with Great Britain. An alliance with Buonaparte is dreaded, and they seem to value the advantages derived from a state of amity with Great Britain. The general conviction is that the interests of the Northern States are not now regarded and will never again predominate in the Councils of the Nation. General distress prevails. The collector at the frontier has not yet received instructions as to the intercourse with Canada. It is not yet certain that the bill has gone through; but he has not found a man who would tamely submit. Is happy to find that men now speak more rationally of the conquest of Canada and ask where are the arms, ammunition, officers, &c., and think it only a project hatched under the influence of a French Minister. They see their own weakness, and infer from the appointment of our Governor General that Great Britain is determined to preserve the Colony. He goes to see what he can save from the bankruptcy of his agent; he has partly overcome his distress by reflecting that it comes from no fault of his own. Page 115

March 8,  
Quebec.

Craig to Castlereagh. (No. 15.) Enclosing copy of an address presented to him by the House of Assembly for the purpose of obtaining a repeal of the Act of 28th of His present Majesty, Chapter 39, stated to be prejudicial to the Provincial Revenue without equivalent advantage to Canada or the Sugar Colonies. The annual difference to the revenue through the operation of this Act, on an average of five years, has been upwards of £2,000. Concurs with the House in recommending a repeal of the Act in question. 90

*Enclosed.* The Address. 91March 10,  
Boston.

John Henry to Ryland. Sends a paper containing an account of the failure of Mr. Rose's mission, and his intention of immediately quitting the States. Also a letter from Mr. Pickering, formerly Secretary of State, to the Governor of Massachusetts, on the danger of a war with England. The principal men of Boston express their determination not to be at war with Great Britain so strongly as to indicate resistance. The mob appears to be on their side. Despair is felt both by those who lost everything and by those who have everything to lose, and every secret exertion is being made to rouse the people from the lethargy which must end in their subjection to the modern Attila. Fears the mass of the people will awake in the chains of the Corsican. 111

March 10,  
Quebec.

Craig to Gore. (Extract.) Has consulted Sir John Johnson as to a proper person to succeed McKee. He points out no one but Elliott, and Mr. Johnson, who, under present circumstances, it is impossible to appoint. 226

March 18,  
Boston.

John Henry to Ryland. Has received from England a copy of the King's Speech. His Majesty refuses to concede any point to the American Government in connection with the "Chesapeake." It now remains with Great Britain whether or not there will be a war, as the American Government has pushed coercive measures as far as possible. It only remains for England to commit such an act of violence as will deprive



## Department of Agriculture—Archives.

1808.

- the Americans of every excuse for resistance to the measures of that Government. Until this happens, Jefferson will continue his present irritating system. Thinks that in a few months the New England States will be ready to withdraw from the Confederacy, establish a separate Government and adopt a policy congenial to their interests. The men of property and of talent are not ready, until sure of an efficient remedy. The Commander of the "Chesapeake" is acquitted; he justified himself by orders "not to resist." The conclusion is inevitable. The captain of a ship in from a French port states that two American vessels were condemned on the charge of being boarded by a British ship of war; they were confiscated. His pecuniary losses. Page 121
- March 25, Amherstburg. Shawenese. Proceedings of a private meeting held between Col. Claus and the Shawenese. 255
- (In Craig's No. 25 of 15th July.)
- April 2. Gore to Craig. (Extract.) Feels difficulty in conducting the Indian Department. The general idea is that Mr. Elliott is the only man capable of calling forth the energies of the Indians. Col. Claus is decidedly of this opinion. Has ordered the Deputy Superintendent General of Indian Affairs to reside at Amherstburg till further orders. The late arrival of stores at St. Joseph's necessitated the Indians leaving for their wintering grounds without their usual presents, which can be avoided in future by having a second year's supply in store. 227
- April 5, Quebec. Craig to Castlereagh. (No. 16.) Enclosing memorial from Henry Reid (Read) convicted of having enticed a soldier to desert; he was fined £40. As this man has been in jail twelve months through inability to pay, he has ordered his release, and the suspension of the fine till His Majesty's pleasure be known. Recommends the memorial. 98
- Enclosed.* The memorial. 100
- Sentence passed on Henry Reid or Read. 102
- April 6, Quebec. Same to same. (No. 17.) Accounts received from Washington of the failure of Mr. Rose's mission, have induced him to accede to the offer of the inhabitants of Glengarry to raise a corps of Fencibles of 500 rank and file. Cannot enclose any details yet, except that they can be disembodied at any time and are to be clothed every year while embodied. They claim the privilege of wearing the Highland dress. Proposes to appoint Lt.-Col. Æneas Shaw as Lt.-Colonel commandant. 104
- April 6, Quebec. Same to same. (No. 18.) For reasons stated before, declines entering into particular details of our situation. Everything perfectly quiet. The Deputy Commissary General has received information that the Treasury intends to send \$100,000. However acceptable, it is quite inadequate in case of hostilities. State of the money market. Proposes closing the Provincial Parliament in a few days. The proceedings have been very temperate. Among the Acts passed is one for raising £7,000 for repairing Chateau St. Louis, which is much needed, as he is now living in a private house, the Chateau being uninhabitable. 105
- April 8, York. Gore to Craig. Encloses copy of proceedings of a private meeting held at Amherstburg with the Shawenese. This nation is said to have great influence. Col. Elliott is to send them a message when their services are required; their attachment to Elliott. 228
- April 10, Quebec. Craig to Castlereagh. (Private.) Enclosing four letters which may convey useful information on the subject of the disposition of the Eastern States of America. Hazards the packet by the Halifax mail. The communication with Vermont continues, in spite of the act prohibiting it. Mr. Henry is a gentleman of ability; he resided for some time in the States and is well acquainted with some of the leading people in Boston. At present he lives in Montreal, and has not the most distant idea that his correspondence is being made use of. 111

1808.  
April 14.  
Montreal.

John Henry to Ryland. Has returned from the States and is possessed of information not to be obtained from newspapers. In the present state of affairs every man should furnish all the information and aid in his power. Beginning with Boston, only men of large fortunes can subsist there. Personal exertion has ceased to bring its reward, and the commercial cities present a dreadful spectacle of distress, despair and that abandonment of principle which grows out of poverty. Measures to remedy this have not been resorted to, as only within the last few weeks could the co-operation of the mob be counted on. However, as the feeling is now unanimous, spirited measures will soon be taken. Measures discussed at a private meeting in Boston. The general feeling against war. Believes in that case the Northern district would negotiate with the Governor of Lower Canada and claim his protection. From everything heard, he infers border states would detach themselves from the Union and each consult its own safety. To accomplish this important object, Great Britain must use and address conciliation towards the friendly states. Conversation with Capt. Dunham, commanding Michillimackinac, who spent the winter at Washington, and on his return has been instructed to expect war. He (Dunham) says that when the Kings address reached Washington all agreed that war was inevitable, and that the delay was in waiting for the India ships, and that the majority of Congress will risk everything to protect American citizens in public and private vessels. Report that Mr. Rosc has sailed and a vessel been sent to England for Mr. Pinkey. The report not yet confirmed. Page 150

April 20,  
Amherstburg.

Wm. Claus to Gore. (Extract.) Assures him of his zeal in the service. As his opinion has been asked on the prospect of Indian assistance states that from the best information he can collect, the fighting men on the borders of the Miamis, east borders of Lake Michigan and the interior between these waters do not exceed 1,500, and in the present state of this post, without any garrison to back them, they will be very backward. If there was an adequate force here, a sufficient number might be brought together to keep our ground till the Indians on the Mississippi could be brought forward. Messages sent to the Nations west of Lake Michigan last October. Constant reports of their being on their way have prevented his sending again, but he shall now lose no time in despatching a confidential person. Suggests that a message would reach St. Joseph's much sooner from York by Matchedash. Cannot sufficiently thank Mr. Elliott for his voluntary services. 233

April 25,  
Quebec.

Louis Foy to Ryland. Was appointed in 1806, deputy agent for the distribution of hemp seed to those willing to engage in its cultivation, to pay for the experiments, ship the hemp addressed to him, and to take charge of the store at Quebec. Desires compensation for the experiments made on his own land. Offers himself as cultivator for the district of Quebec; if it is incompatible with his present situation he will relinquish it for the new office. His object is to raise good seed. 162

April 25,  
Montreal.

John Henry to same. Omitted to mention in his last that individuals are selected in the several towns on the seaboard and throughout the country to correspond and act in concert with the committee at Boston to avert a French alliance. Benefits of an organized plan over individual efforts. This confederacy will soon be strong enough to apply for England's friendship. No laws in the United States to prevent this as "constructive treason" is unknown in their criminal code. The paper from Burlington, which he (Henry) led him to expect by his last letter, is received. He is disappointed in not finding it more determined in tone; still, it is a sign of the union of those who before disagreed in everything political, and an assurance of co-operation with Canada in case of war. The accession of the Northern part of Vermont and the command of Lake Champlain would be a barrier to any inroad by the usual

Department of Agriculture—Archives.

1808.

route. Vermont is well fortified by nature and can easily be defended by militia against the United States army. The road from Burlington to Connecticut River is over mountains and through defiles. Sends latest Boston Repertory. The election of a governor in Massachusetts is unfavourable to the Federals. Page 154

*Enclosed.* Recapitulation of the United States troops and their distribution. 157

May 3,  
Quebec.

Craig to Castlereagh. (No. 19.) Transmits *Quebec Gazette* containing speech made on closing the session, also a list of Acts presented for the Royal assent, one only of which—that relating to jails in Gaspé—is reserved till His Majesty's pleasure be known. Recommends the bill. He dissolved the Legislature soon after the session closed. Has issued writs for the election of a new House of Assembly. Exemplifications preparing; when he transmits them he will submit remarks on any that require particular attention, and also when completed he will forward printed copies of the whole, together with the journals of both Houses. 123

*Enclosed.* Acts. English. 125  
French. 137

May 5,  
Quebec.

Same to same. (Private.) Though Mr. Rose will have furnished all particulars on the state of the country, yet encloses two more letters written by Mr. Henry after his return to Montreal. His (Henry's) account of the disposition of the people of Vermont verified in so far as relates to the embargo. Rafts have actually arrived at St. Johns in defiance of a vessel placed under the direction of the customs officers. A struggle was feared, but avoided, on the raftsmen declaring their determination to go on, and the boatmen declining to interfere. Although stationed close to the line he has avoided taking any notice of it, to prevent any event which might occur being ascribed to interference on our part. If any affray takes place, he will immediately advance a post to our side of the line with instructions not to interfere beyond the boundary, but to give protection to either party on our side and at least to preserve his Majesty's territory from violation. Will take care to have this post under a reliable officer. 148

May 6,  
Quebec.

Same to same. (No. 20.) Enclosing letter from Mr. Foy, of the Storekeeper General's Department, which explains itself. Did not feel authorized to give any answer. Refers it to him (Castlereagh), but had induced Foy to proceed in the business—the culture of hemp. Is assured of the importance of this object; hitherto it has not received proper encouragement, and has been confined to a few. Has been urged to increase the price, but does not feel warranted without further instructions. Mr. Greece, stationed near Montreal, seems industrious, but Mr. Campbell, in Three Rivers, is too fond of speculation, he has not fulfilled his engagements in this cultivation, though frequently applying for funds. He claims £500 which he claims was promised by the Government in England. 159

May 7.

Draft of letter to Craig. (Secret and confidential.) Acquaints him that a communication has been made to His Majesty's Minister for Foreign Affairs by Mr. Pinckney, stating that he has received information from Paris that the demand made by the United States that France should revoke or soften her decree of blockade against Great Britain had been refused by Buonaparte; in consequence thereof he had nothing to communicate to the Court of London. This information diminishes the probability of a rupture with the American States though it does not avoid the necessity of precaution and preparation. 165

May 11.

Craig to Gore. (Extract.) The irritation between the Indians and the Americans gives good grounds to expect that they could not easily be persuaded to take part against us. Attention on our part would easily secure them. Probability of the appearance of the French in some part

1808.

of the province likely to be either in Orleans or Florida. In the event of their appearance we must use our strongest measures to attach the Indians to us by ties sufficiently strong to resist this persevering foe. After serious consideration withdraws his objection to Elliott succeeding McKee; the latter must be removed from Amherstburg; he might be ordered down to York. Recommends the continuance of his present pay. Has engaged a Mr. Cadotte with the view of replacing the interpreter at St. Joseph's. Col. Claus and Mr. Elliott are to be informed of the importance of securing the Indians. Recommends that their attachment be secured without any allusion to possible hostilities. Page 229

May 12,  
Quebec

Craig to Castlereagh. (No. 22.) Has stated in his despatch No. 7, his reasons for not entering before into any detail of the military situation of the province. The first safe opportunity now offers by H. M. frigate "Nemesis." As a fortress Quebec is very deficient in almost every point of view; gives details of the deficiencies. Account of the works which he is carrying on to remedy some of the defects without which he does not consider the work tenable for four days. What works he considers necessary. 176

May 12.

*Enclosed.* Lt.-Col. Bruyere's report and estimate of the expense needed to improve and increase the works of fortification, and to build additional barracks, magazines and storehouses at Quebec. 189

Gore to Craig. (Extract.) Encloses extract of letter from the Deputy Superintendent at Amherstburg. 223

May 13,  
Quebec.

(Enclosure calendared at its proper date.)

Craig to Hon. D. M. Erskine. His two letters, forwarded by Mr. Gillespie, received. That gentleman's success at Washington has relieved the apprehensions of the North-west Company. The failure of Mr. Rose's mission to be regretted. Has no doubt but that the good sense of the Americans must prevail, and the *sort of hostile array* in which the two countries have been set against each other end in closer ties of connection than have existed since the separation. Will use every endeavour to avoid irritating our neighbours. Irregularity in the Indian Department. Any change there will excite suspicion. The condition of affairs both in this country and Europe seems to point to the appearance of the French on this theatre. Buonaparte never loses sight of an object on which he has once fixed his attention. This colony should in sound policy be the object of his first attempt. He would find a healthy climate, plenty of provisions, a not unfriendly people, who would at least furnish him in the future with great resources of men and a good stand from which to coerce the Americans. The imminent risk of the loss of the naval force he (Buonaparte) would have to employ, and the proximity of the Spanish settlements lead me rather to expect their first appearance to the southward, either New Orleans or the Floridas. From that moment we must expect every effort the ingenuity of man can devise to detach the Indians from their allegiance to us and induce them to fall upon our defenceless frontier of Upper Canada. With the view of binding the Indians more closely, he has given directions that the officers of the Department be particularly attentive in all points and has also recommended that intercourse be opened with the most distant nations, with whom little communication has lately been had. Has added two officers to that Department. The instructions given particularly point out his desire that all means pursued should be such as are of general conciliation and attachment, without allusion to possible hostilities. Is well aware that suspicion will be awakened, but adopts these measures to prevent the Indians from reporting that he was trying to instigate them against the States. Complaints on this head probable. Disposition of the people of Vermont and Northern New York to resist the embargo, particularly respecting the supply to our merchants here

## Department of Agriculture—Archives.

1808.

of timber and lumber. Believes though some are actuated by views of future profit, the greater number wish to discharge by the only method open to them, their obligations to our merchants, from whom they had received large advances in money before the law passed. Some rafts have arrived; both Canadians and Americans were conducting them. Some of the former were put in jail; they will receive no protection from this Government. Mr. Woolsey, Collector of Champlain District, wrote to the judges of Montreal on this subject. Page 261

May 31,  
Quebec.

(In Craig's No. 25 of 15 July.)

Craig to Castlereagh. (No. 21.) Has investigated the subject of the raising of the Glengarry Fencibles and finds that their zeal exceeds their ability; finds it impossible to raise nearly the number proposed in a reasonable time; therefore, he recalled the letter of service issued to them. Lt.-Col. Shawe is exempt from any little blame; as, though so generally recommended, yet he had not been communicated with and was ignorant of the proposed appointment and, in short, wished to decline it. 166

May 3,  
Quebec.

Same to Edward Cooke. Major Armstrong arrived about three weeks ago. He had been detained by illness between New York and Albany. He (Craig) has had several unimportant letters from him. He represents that the money advanced was not sufficient for his journey; recommends that he be reimbursed what he has borrowed (\$200), but does not recommend the repayment of £80 drawn for without directions. Asks for a speedy answer. 168

May 3,  
Downing St.

Draft of letter to Craig. Transmits an Order in Council confirming an Act authorizing the formation of the Quebec Benevolent Society. The sixteen following Acts have been considered, and do not seem liable to objection:—

- 1st. Respecting the regulation of trade.
  - 2nd. The better preservation of His Majesty's Government.
  - 3rd. The more effectual regulation of police.
  - 4th. Empowering the Justices of the Peace to make regulations for the government of apprentices and others.
  - 5th. Regulating provincial post houses.
  - 6th. Repealing certain laws respecting the terms of the Court of King's Bench in Three Rivers.
  - 7th. For building a new market house in Montreal.
  - 8th. For completing the market house in Quebec.
  - 9th. For preventing the desertion of seamen.
  - 10th. For the better regulation of pilots and shipping in the ports of Quebec and Montreal and improving the navigation of the St. Lawrence.
  - 11th. Respecting aliens and certain of His Majesty's subjects who have resided in France.
  - 12th. For the recovery of small debts.
  - 13th. For the nomination and appointment of inspectors and constables.
  - 14th. For the better regulation of the fisheries in Gaspé.
  - 15th. For granting to Jean-Baptiste Bedard the exclusive right of erecting bridges in the Province.
  - 16th. For the providing of returning officers for the election of knights, citizens and burgesses to serve in the House of Assembly. 170
- Enclosed.* The Act respecting the Quebec Benevolent Society. 174

June 3,  
Downing St.

Draft of letter to Sir J. H. Craig. (No. 9.) Despatches received. Although no definite settlement with the States has yet taken place, yet as hostilities appear improbable, he has not ordered the additional camp equipage for 2,500 men to be sent out to him, nor the canteens, &c., required in his letter No. 7, but a large proportion of the ordnance stores required in No. 8 have been forwarded. In case of rupture he will take

1808.

- care to have other articles required forwarded. Has considered the memorials of Mrs. LeMaistre and Mrs. Davidson. Disapproves of pensions, but His Majesty approves of grants of land to the petitioners. Mrs. Martin's case transmitted to the Admiralty. Respecting the lease of the forges at St. Maurice. Page 84
- June 8. Gore to Craig. (Extract.) Thinks it would contribute to the interests of His Majesty's service if he (Craig) should meet the Indians himself at Amherstburg. They appear to expect it. He is to be very guarded in his speech so as not to give offence to the Americans. 234
- June 14, Quebec. Ryland to Joseph Plante. Dismissing him from his office on account of his share in the publication of a seditious paper. 313
- June 14, Quebec. (In Craig's No. 29 of 5th August.) Same to Panet, Taschereau, Bedard, Borgia and Blanchet, dismissing them from their positions in the militia. 316
- June 14, Quebec. (In Craig's No. 29 of 5th August.) Same to Hon. G. E. Taschereau. Desiring that his son, J. T. Taschereau be no longer employed as his (Taschereau's) deputy. 314
- June 22, Quebec. (In Craig's No. 29 of 5th August.) Attorney General Sewell's report on the claims of the Indians of the Lake of Two Mountains. 366
- June 22, Quebec. (In Craig's No. 34 of 22nd October.) Attorney General Sewell's report on the claims of the Indians of the village of Caughnawaga. 368
- July 7, Downing St. (In Craig's No. 34 of 22nd October.) Draft of letter to Sir J. H. Craig. (No. 10.) Despatches Nos. 17 and 18 received. Information gives reasonable ground to believe that hostilities will be avoided. Trusts therefore that the specie remitted will meet all demands. If affairs should take another turn he will provide the supply necessary. Directions given to Sir G. Prevost to keep his force in readiness. The secret intelligence transmitted by him (Craig) appears to come from a person of good information and discretion and he deserves encouragement. Under existing circumstances, the failure to raise the Glengarry Fencibles is less to be regretted. The reduction of the fine imposed upon Reid will be approved, also the jail bill for Gaspé, and the extending of the encouragement proposed to Mr. Foy. Letter on the contract price for hemp has been transmitted to the Admiralty and he will forward their Lordships' sentiments upon the subject as soon as possible. The questions submitted as to the repeal of the 28th of His Present Majesty C. 29 has been referred to the Committee of Trade and Plantations. 109
- July 15, Quebec. Craig to Castlereagh. (No. 23.) Encloses exemplifications of the several Acts passed in the last session of the Provincial Legislature. Also copy of an Act respecting the erection of two jails in the District of Gaspé. Recommends their erection. Assents to the Act for applying a further sum towards the completing a jail in the District of Quebec. Owing to some irregularity a similar bill respecting the jail at Montreal did not pass. The only remaining acts of last session requiring attention are: "An Act to declare in whom is vested the power of granting *Lettres de Terrier* in this province;" and the "Act to continue for a limited time the Act of the 43rd of His Majesty respecting the militia." Discusses these Acts. The grant for the repair of Government House to be levied on the country and not on trade. Returns having been made to the several writs for members of the House of Assembly, there will be no obstacle to the meeting when found necessary. 195
- July 15, Quebec. Schedule of the Acts. 200
- July 15, Quebec. Same to same. (No. 24.) Enclosing copy of proceedings of the Executive Council on matters of State between 16th October, 1807, and 13th June, 1808. 201

## Department of Agriculture—Archives.

1808.

Craig to Castlereagh (No. 25.) The Indian Department has claimed much of his attention. The improbability of its ever becoming useful again had led the Government to use the utmost economy in its management, which caused many of the Indians to turn towards America, where fortunately the system of gratifying these people is not much in vogue; though of little use as friends we must prevent them becoming enemies. In the event of hostilities they will be surely one or the other. Has endeavoured to secure them to the interests of Great Britain. Encloses the correspondence with Lt.-Gov. Gore on the subject. Has readmitted Mr. Elliott into the service as the first means for conciliating the Indians; his influence over them. The general opinion is that the charge on which he was dismissed was groundless. Dismissal of McKee; recommends his receiving a pension. Perfect harmony exists between himself and Lt.-Gov. Gore. Suggests that the Indian Department be again placed under military command. His reasons. Page 202

July 15,  
Quebec.

(Enclosures calendared at their respective dates.)

Craig to Castlereagh. (Private.) Acknowledges two letters by Lt.-Col. French and Mr. Caldwell; shall have great pleasure in obeying his commands by showing them every attention. The impossibility of keeping Col. French at Quebec. Has sent him to Montreal, as good a station as Quebec in the opinion of many. His (French's) difficulty in procuring a house there. 267

July 15  
Quebec.

Same to Cooke. (Private.) Sends to Lord Castlereagh by the same opportunity a long letter relative to the works undertaken here, also the estimates and a plan. The importance of holding this spot. The French will be here sooner or later; they will perhaps begin to the southward, but will certainly reach here. Had begun another long letter on the subject of the militia, must defer it till next vessel. Has unwavering faith in the attention of *Jonathan* to his own interests, which means peace. Jefferson, who certainly meant war, lost his opportunity. Believes he laid a trap for Berkley, but wanted spirit to pursue the point; he is naturally timid. Now the insolence of Buonaparte is fighting the battle for us, the scale is already turned. Our intercourse by the lakes so far suffers little from the embargo. Has applied to Greenwood for the £600 allowed to all governors under the name of picture money, without success; thinks himself entitled to it. State of his health. 268

July 16,  
Quebec.

Same to Castlereagh. (No. 26.) Transmits certified copy of the rates of exchange of current prices here for the last six months.. 271

August 4,  
Quebec.

*Enclosed.* Monthly current prices in Quebec from January to June, inclusive. 272 to 289

August 4,  
Quebec.

Same to same. (No. 26.) Transmits certified copy of the rates of exchange and current prices here for July. 290

*Enclosed.* Current prices in Quebec for the month of July. 291.

August 4,  
Quebec.

Same to same. (No. 27.) Enclosing naval officers' returns of vessels cleared outwards and inwards at the port of Quebec between 5th January and 5th July, 1808. 294

Same to same. (No. 28.) The "Amelia," with her convoy arrived, but none of the store ships, nor any of the articles promised in the despatch of 22nd January, for the use of the militia, which the same despatch instructed him to embody. Without these articles it is impossible to assemble them even for exercise. No buildings in the country capable of housing them, and camping is too expensive. The militia have been hitherto only contemplated in theory, except in the town of Quebec. Lord Dorchester could not assemble any in 1775, and in the following year he (Craig) commanded the largest body ever brought together, but was then in pursuit of a flying enemy. Since then no attempt to assemble them has been made. The Canadians of to-day not warlike; they like to make a boast of the militia service, but all dis-

1808.

like the subordination and constraint. If the seigneurs possessed their old influence it might be different; lawyers and notaries appear now to have sprung into notice, and with them insubordination. The members returned to the new House consist of fifteen lawyers, fourteen farmers and only seven seigneurs. The lawyers form a very powerful party in the House, always together, and they think by opposing the views of Government to force themselves into office. The militia is their *stalking horse*, and the preserving the people from the degradation of being soldiers their theme of merit. Danger and difficulty of attempting to enforce the militia system. In the event of having to contend with a French force, no help is to be expected from this province; on the contrary, arms in their hands would be dangerous. They are French at heart yet; though not denying the advantages they enjoy, still there would not be fifty dissentient voices if the proposition was made of their reannexation to France. The general opinion here among the English is that they would even join the Americans if that force was commanded by a French officer. Is persuaded the trouble and expense just now would be useless. By our law those trained now would not be those he could call on in case of attack. In the event of hostilities apprehension might make them more tractable. By the present law he is empowered to keep the militia together for not more than twelve months, and in the present situation of America it would require more than half that period to complete the preparations necessary for attacking us. In that time we could discipline our force and be sure they would be brought into use. Embarrassment on the score of rank; there are twenty-seven colonels and more lieutenant-colonels and majors all tenacious of their rank. In the Upper Province there are Lord Lieutenants of counties who are empowered of themselves to call out the militia without recourse to the authority of the Governor. Their proximity to the American frontier might furnish them with motives for so doing. Has only confirmed the rank given to Lieut.-Colonels in Upper Canada. Page 295

August 5,  
Quebec.

Craig to Castlereagh. (No. 29.) In his letter on the militia, has alluded to the strong party at present in the House. They try by an idle clamour to intimidate the Government, and believe they will be put into office for the purpose of silencing them. A newspaper, *Le Canadien*, has been publishing articles calculated to create dissatisfaction among His Majesty's subjects. During the late elections it was more excusable, but upon enquiry, he finds the persons who were leaders of the party alluded to, bore characters which warranted the attributing to them the worst intentions. Great pains have been taken to circulate the paper in all parts of the province gratis. Its increasing malignity led him to intimate to those concerned in its publication that they would certainly fail in their design of intimidating Government into compliance with their views of personal interest. Two of the supporters of this paper, viz., Mr. Plante and Mr. J. T. Tachereau, held positions under government; he has dismissed them by letters, copies of which are enclosed. On Mr. Plante's stating that he had all along disapproved of the paper, has reinstated him. Mr. Panet, a lawyer, is the ostensible head of the party; suspects him to be the tool of others. Mr. Blanchet is a doctor; his character. Mr. Bedard and Mr. Borgia are lawyers, the former said to be the principal contributor and the most dangerous of the set. Has dismissed those with commissions from the militia. Copy of dismissal enclosed. The influence of the Canadian party strong in the House; would not be surprised if some resolution was adopted which would necessitate his dissolving it. 306

(Enclosures calendared at their respective dates.)

August 6,  
Downing St.

Draft of a letter to Craig. Letters received and laid before the King. Encloses letter from Sir Stephen Cottrell in answer to No. 20, on the cultivation of hemp. Also one enclosed from the Treasury with par-



## Department of Agriculture—Archives.

1808.

- August 15, Quebec. Particulars of articles shipped for Quebec, which His Majesty has been pleased to order for the use of the Metropolitan Church. Page 164
- August 15, Quebec. Craig to Castlereagh. (Separate.) Deficiency in the number of members composing the Legislative Council; it should consist of fifteen, but at present there are only twelve. Their names. The first vacancy caused by the death of Chief Justice Alcock. Takes it for granted his successor, when appointed, will fill it. For the other vacancies recommends John Richardson and Charles de St. Ours. In order to avoid such inconvenience in future, proposes that two additional members be appointed; recommends John Hale, Deputy Paymaster General, and Antoine J. Duschesnay. Early attention to this subject necessary. Mr. Craigie superseded as Deputy Commissary General, causes a vacancy in the Executive Council. Recommends Monsr. Louis de Salaberry. Requests that Mr. James Irvine be also appointed. 318
- August 25, Quebec. Craig to Edward Cooke. Letter of 4th June received, also warrants necessary for appointing Sewell as Chief Justice. Has delayed sending them that he (Sewell) may continue for a short time in his present office, till he can be replaced. Two persons, Mr. Greece and Mr. Campbell, have been sent here to instruct the people in the culture of hemp. The former is industrious, doing his best; the latter idle. Apprehension of hostilities subsiding. Private accounts all concur in saying that so far a war depends upon the effort of Mr. Jefferson. A letter this morning from a private gentleman intimates that even the suspicion of a rupture has vanished and no exertion on the part of Jefferson could now bring on hostilities. The embargo still a source of distress. He and the Bishop are in a sad state for want of houses. Anxiety about the accounts from Spain. 322
- September 2, Quebec. Same to Castlereagh. (No. 30.) Transmits copy of the rates of exchange and current prices for the month of August. 326
- Enclosed.* Prices current at Quebec for the month of August. 327
- September 2, Quebec. Same to Edward Cooke. Letter by Mr. Young received. Does not quite approve of Mr. Young receiving the salary as Master of the Trinity House. His treatment of his creditors &c., much talked of here. As a member of the Executive Council, he is entitled to a grant of land. 332
- September 14, Quebec. Same to Castlereagh. (No. 31.) Enclosing list of such half-pay officers on the Army Establishment in this province as have returned their names during the last twelve months, together with a list of magistrates specially appointed to administer the oaths to officers of this description. 334
- Enclosed.* List of officers. 335
- List of Magistrates. 336
- September 22, Quebec. Craig to Castlereagh. (No. 32.) Mr. Sewell took the necessary oaths as Chief Justice and a member of the Executive Council. The office of Attorney General is thus left vacant; it is a very difficult place to fill at this crisis. After much deliberation recommends Mr. Sewell, brother to the Chief Justice, or Mr. Bowen, as best fitted for the post. Has given the latter a commission while waiting His Majesty's pleasure, as it was not expedient to allow the office to remain vacant. Has named Mr. Oliver Perault as His Majesty's advocate, which position was left vacant also by Mr. Sewell's appointment; it is almost a sinecure. 337
- October 14, Bishop's Palace. Report of a committee of the whole Council on the claims of the Indians of Caughnawaga and of the Lake of Two Mountains. 371
- (In Craig's No. 34 of 22nd October.)
- October 19, Quebec. Craig to Castlereagh. (No. 33.) Enclosing certified copy of the rates of exchange and current prices at Quebec for the month of September last. 342
- Enclosed.* Current prices at Quebec for September. 341

1808.  
October 22,  
Quebec. Craig to Castlereagh. (No. 34.) Has caused an investigation to be made into the complaints of the Indians. Encloses correspondence on the subject, viz. :—
1. Ryland to Johnson, 16th November 1807.
  2. Johnson to Ryland, 28th December, 1807.
  3. Speech by Johnson to the Indians, 22nd December, 1808.
  4. Proceedings in Council with the Indians, 23rd December, 1807.
  5. Letter of reference to the Attorney General, 23rd January, 1808.
  6. Attorney General's report on the Indian claims of the Indians of the Lake of Two Mountains.
  6. Ditto of the Indians of Caughnawaga.
  8. Report of a committee of the whole Council on the above. Page 345 (Enclosures calendared at their respective dates.)
- October 24,  
Quebec. Same to Castlereagh. (No. 35.) Despatches received. The only particular answers required are to No. 9, relative to the Forges of St. Maurice and Nos. 10 and 12 relative to the culture of hemp. Has hitherto declined signing the lease of the Forges to Monroe and Bell, who however, retain them; it appears advisable to see if they will not accept the lease on more reasonable terms for the province. In consequence of the detailed statement sent he awaited instructions thereon. Has not assembled the Council for some time owing to the vacancy in the office of Chief Justice and the absence of several members. These objections now removed. The unsatisfactory reports of the hemp culture. 372
- October 26,  
Quebec. Same to Castlereagh. (No. 36.) Enclosing printed copies of the Journal of the House of Assembly of Lower Canada during the last sitting. 375
- November 23,  
Downing St. ——— to Craig. Despatches Nos. 26 to 30 inclusive, and one of 15th September, marked separate, laid before the King. The decreasing probability of hostilities, and the necessity of supporting the Spaniards prevented the militia supplies being sent out. His (Craig's) letters on the subject of the militia are clear and satisfactory. His Majesty approves of the persons concerned in the publications of seditious newspapers being removed from office. 330
- December 28,  
Quebec. Craig to Gore. (Extract.) In letter of 6th December he has entered pretty fully into his ideas on the subject of the Indians. Nothing since has altered his opinions. Repeats that they must be either for or against us. By a letter from Mr. Baby, it appears there are greater difficulties than at first supposed in the way of obtaining their co-operation. Thinks our power to withdraw all supplies should act powerfully on them. The Indian Department must be active and vigilant and keep these topics before them. 219

## GOVERNOR CRAIG AND MISCELLANEOUS—1808.

## Q. 108.

1805.  
January 3,  
Downing St. Earl Camden to the Bishop of Quebec. Will recommend to his Majesty that he be granted leave of absence to return to England. Shall then be ready to converse with him upon the topics touched on in his letter. Gives no encouragement that he will recommend that he be allowed to divest himself of his diocese. 148
1806.  
January 15,  
Quebec. Wm. Lane to Lt.-Col. Green. Transmitting remarks on the Indian Store accounts to be laid before Col. Bowes. 188
- Enclosed. Extract from the instructions to Sir John Johnson respecting the store keeper's accounts. 189

## Department of Agriculture—Archives.

1806.  
September 7. A paper on the Church establishment in the Canadas. (Extract from minutes of Council respecting parishes.) Page 150  
*Enclosed.* Observations on the same. 157  
Memoir, on the Bishop of Quebec's papers. 168, 173, 174
- December 24,  
Quebec. Wm. Lane to Col. Brock. Enclosing copy of letter to the military secretary with copies of his remarks on the Indian Store accounts, particularly on those of the Island of St. Joseph. 187
1807.  
June 13,  
Quebec. Same to same. The remarks on the Indian Store accounts which he had submitted to Col. Bowes have been returned. Submits some observations on them. 191
- June 25,  
Quebec. Same to George Harrison. Transmitting copy of his report to Col. Bowes, also copies of two others made to Col. Brock on the Indian Store accounts. 186
1808.  
January 7,  
Treasury  
Chambers. George Harrison to Edward Cooke. Transmitting letter from Craig with a requisition for stationery for the use of the Indian Department in Lower Canada. 92
- January 7,  
Treasury  
Chambers. Same to same. Transmitting letter from Craig with a requisition for Indian Stores with presents for the Indians in Lower Canada, for the year 1809. 93
- January 7,  
Treasury  
Chambers. Same to same. Transmitting letter from Craig with proposed establishment for the Indian Department in Upper Canada and list of persons holding temporary appointments and pensions for the year 1808. 94
- January 7,  
Treasury  
Chambers. Same to same. Transmitting letter from Craig with report of a board of survey held at Lachine on Indian Stores imported in the bark "Industry." 95
- January 20. Sir Robert S. Milnes to same. (Private.) Stating that Sir James Craig has "clipped off a part of the savings" allowed him by Lord Castlereagh. Asking that the money still be given him. 96
- January 21. John Black to same. Learns that probably the Secretary of State has been informed that he has received a very large portion of the waste lands of the Crown in Canada. Encloses memorial to Lord Castlereagh and states that he has only been granted 1,200 acres in common with other associates in Dorset. 97  
*Enclosed.* Memorial, asking that the Forges at St. Maurice be leased to him for twenty years at £1,000 per annum. 99
- February 20,  
Clifton. Bishop of Quebec (Anglican) to ———. By reference to his letter of 24 October, 1804, he will see that the change in salary made the maintenance of his position then in the Province an impossibility, and it is much more so now the necessity for augmenting the ministers' salaries being so urgent. All the clergy are deeply interested in the decision of the Ministers, respecting the Establishment of the Church of England and the restrictions placed upon the present system of Roman Church Government. The Canadian Catholics have long expected the first and can raise no particular objection. Is confident no real difficulty has ever existed to prevent this establishment. The dislike of the Canadian Catholics to the Bostonois (as they call the Americans) and dread of a union with the States would prevent them from withdrawing in the least from English rule, therefore the second part of the question would cause no trouble. After the encouragement held out to him in Lord Camden's letter (extract enclosed) and after what has since passed, he did not expect to have to return without having found relief for his people, clergy and himself, a bishop without jurisdiction to a church without establishment. Begs to have the matter of this letter conveyed to Lord Castlereagh and requests to be informed whether the intimation to return to Canada is imperative. 103
- February 24. John Black to Edward Cooke. Had submitted on the 18th inst., copy of letter of credit for £1,200 to enable him to carry on the hoped for lease

1808. of the Forges of St. Maurice. If not adequate, a note from him (Cooke) will be immediately attended to. Page 110
- March 8, Craig to Erskine. Encloses memorial from the merchants of Montreal. Understands one on the same subject was forwarded by Mr. President Dunn last April. The effect of the non-importation and embargo Acts on this trade. As this despatch will be delivered by Mr. Gillespie, who is fully informed and a trader himself, everything necessary can be learned from him. 16
- (In Craig's No. 37 of 29th October.)
- March 15. Alexander Lennox to Edward Cooke. Had the honour to write on the 24th ult., requesting he would move Lord Castlereagh in behalf of the widow of Colonel La Corne St. Luc, who spent most of his fortune in the service of Government. She is now in great distress. Mr. Stuart has the memorial copy of Col. St. Luc's commission, to which reference can be made. 111
- March 18, George Harrison to same. Has laid before the Treasury a letter from Mr. Taylor, requesting to be furnished with the reports or minutes of the Executive Council on the accounts of Henry Caldwell as Receiver General of Lower Canada, from 11th October, 1799, to 11th October, 1805. Is therefore commanded by their Lordships to move Lord Castlereagh to give directions that the said reports be transmitted to this Board to be communicated to the Commissioners of Audit. 112
- March 27. John Young to same. Requesting that the enclosed memorial be presented to Lord Castlereagh. Hopes his Lordship will take up his case. 114
- Enclosed.* Memorial to Lord Castlereagh asking for lands and a salary as master of the Trinity House of Quebec. 115
- Copy of a memorial to Sir Robert Shore Milnes, dated 31st July, 1805, on the same subject. 117
- March 29, W. Fawkener to ——— The Lords of the Committee of Council for Whitehall. Trade and Foreign Plantations, having had under consideration several acts passed by the Legislature for Lower Canada, have reported to His Majesty that the Act (No. 163) for the incorporation of an association under the name of the Quebec Benevolent Society is proper for His Majesty's Royal confirmation. As it does not appear necessary to submit the other Acts, returns them. 211
- March 29. Bishop (Anglican) of Quebec to ———. Offers his assistance in any measures for the benefit of the Protestant Church in Canada. Thinks some augmentation of the salaries of the ministers of York, Kingston, Quebec, Montreal, and William Henry is necessary. The clergy living in the country have many advantages over those in towns, as rent and the expenses of living are much lighter. Wishes it to be considered that the present practice of issuing marriage licenses by a lay surrogate is productive of ill consequences; objections are, however, made to the power being vested in the Bishop. As the Catholic Bishop exercises the power it does not seem equitable to withhold it from the Anglican. The whole annual profit does not exceed £40 or £50. Wishes to change the title of his commissaries, thinks archdeacon a better title, as there are so many military commissaries in his diocese. 123
- March 30, W. Huskisson to Cooke. Is commanded by His Majesty's Treasury Chambers. request he will move Lord Castlereagh to have transmitted an account of all pensions chargeable upon the Civil Establishment and the grounds upon which they are granted. 126
- April 2. John Black to same. Trusts his petition is on the eve of being decided upon. Asks that he be appointed agent for the Seigniorship of Sorel. 127
- April 14. Bishop (Anglican) of Quebec to ——— As the convoy sails for Quebec on the 25th inst., he will understand it is important he should carry back the final determination of Government upon all points to which there appeared no objection. 128

## Department of Agriculture—Archives.

1808. April 14.	John Black to Cooke. Asks that while his petition is being considered he be granted some situation.	Page 129
April 23.	J. Nicholl to Lord Castlereagh. Transmits copy of the patent appointing the Bishop of Quebec, also set of queries respecting the powers of said patent.	130
	<i>Enclosed.</i> Patent.	131
	Queries.	142
April 28.	Bishop (Anglican) of Quebec to ——— Asking for £4,000 to complete the building of a church at Quebec.	176
April 29.	Same to ——— Grateful thanks for the extra allowances which His Majesty has granted to certain clergymen and to himself in lieu of a see house. Will report on any houses which appear proper as a bishop's residence on his return to Quebec.	178
April 29.	Same to ——— Lord Castlereagh's letter received; notices no mention is made of the erection of parishes. Presumes that is settled in the Instructions to the Governor; hopes the subject of marriage licenses will be mentioned there also. Will be much disappointed if he does not receive a grant of waste land. Observes that the addition of £50 to the salary of the Minister of William Henry is said to raise it to £200. He only has £100 now.	179
May 2.	W. Scott to Lord Castlereagh. It appears that the bishop's power is limited to a superintendance and coercive authority in matters of discipline over the clergy. This appears too feeble, he should have a court with the necessary officers and power of enforcing process, but confined to Church discipline over the clergy and church officers so far as the latter are answerable to ecclesiastical rule.	181
May 19.	John Black to same. Praying that his petition be speedily decided on.	182
May 30, Treasury Chambers.	George Harrison to Edward Cooke. Having laid before the Lords Commissioners a report of the Comptrollers of Army accounts, dated the 17th inst., on a letter from Mr. Lane, Assistant Commissary of Accounts, relative to the Indian store accounts for Upper Canada, he has been instructed to transmit copy of Mr. Lane's letter and its enclosure to him (Cooke) in order that they may be thoroughly examined.	84
	(Enclosures calendared at their respective dates.)	
May 31.	John Black to ——— Asking again for some position under Government.	194
June 1, Ordnance Office.	R. H. Crew to Edward Cooke. Enclosing abstracted return of small arms, ammunition and stores which the Board of Ordnance have ordered to be sent to Quebec since the beginning of the present year; also abstract of the same sent to Halifax in the month of March last.	195
	<i>Enclosed.</i> Ordnance stores sent to Quebec.	196
	Ditto to Halifax.	197
June 2, Quebec.	Craig to Erskine. The only chance of alleviating the loss sustained by the merchants trading to the Indian country, through the seizure of their goods at Niagara by the United States Customs, lies in their immediate restitution, that they may be sent to their destination before the season closes. Consider the seizure a mistake resulting from the over zeal of the customs officer. Considers it an outrage; armed boats had no right to pursue citizens in free waters. The American government should put a stop to such violence.	18
	(In Craig's No. 37 of 29th October.)	
June 3, Whitehall.	W. Fawkener to Cooke. Has laid before the Council for Trade and Foreign Plantations his (Cooke's) letter, enclosing one from Craig with copy of an address of the House of Assembly of Lower Canada, respecting the repeal of the Act of 28th of His Majesty, chap. 39. The Lords of the committee will take the same into consideration particularly that part relating to the valuation of staves and headings.	199

1808.  
June 3, Admiralty Office. John Barron to same. Has laid before the Admiralty the letters respecting Guillaume Martin, a prisoner of war at Chatham. Directions given for his release. Page 198
- June 23, Audit Office. Wm. Walter, secretary, to same. Respecting the papers necessary to elucidate the accounts of Henry Caldwell, Receiver General of Lower Canada. 200
- July 4, Treasury Chambers. Wm. Mitford to the Lords Commissioners of the Treasury. Enclosing particulars of articles presented to the Metropolitan Church at Quebec from His Majesty. 203  
*Enclosed.* Particulars of communion plate, &c., bought of Rundell, Bridge and Rundell. 204  
List of altar cloths bought of Charles Smith, upholsterer. 206  
List of books bought from Mr. Payne. 207
- July 18, Treasury Chambers. George Harrison to Edward Cooke. Having laid before the Lords Commissioners of the Treasury a letter from Mr. Mitford transmitting particulars of the articles to be sent as a present from His Majesty to the Metropolitan Church at Quebec, he is commanded to transmit said paper to him (Cooke) in order to have a communication made to the Lieut.-Governor at Quebec. 202  
(Enclosures calendared at their respective dates.)
- July 21. John Black to same. Requesting that his application for the Forges of St. Maurice be looked into as soon as possible, to enable him to proceed to Quebec. Asks to be appointed to the position of superintendent of the King's ship and batteaux yards, inspector of all the timber expended in the military departments and by the civil governments, and agent for the Seigniory of Sorel. If these cannot be granted, asks that he be provided for upon the Canada establishment. 208
- July 23, Whitehall. Stephen Cottrell to ———. The committee of the Council for Trade and Foreign Plantations having considered the letter from Sir J. H. Craig relative to the culture of hemp, desire he (Craig) should be authorized to give all encouragement to that industry. Whatever measures shall be adopted by him will meet with the sanction of this Council. Lord Castlereagh to be informed that their Lordships see no good reason for increasing the indemnity to growers of hemp, though the value has risen to an unforeseen height, yet the expense of raising is not greater than when the price was fixed at £43 per ton on delivery at Quebec, Montreal or Niagara. They may, if they see fit, dispose of it in any other way or ship it to England, where they will receive the market price when received into His Majesty's stores, unless that price be under £50 per ton, which is the least price to be paid for Canadian hemp for the period of two years. 211
- July 29, St. Rochs. Bishop (Anglican) of Quebec to Sir J. H. Craig. Thinks the house belonging to the widow of Chief Justice Elmsley the most eligible for a see house. 217
- July 30, Quebec. Craig to Bishop of Quebec. Though the house belonging to Mrs. Elmsley is not all that can be desired, yet considers it would be better to purchase it than to attempt to build. 218
- August 1, Quebec. J. Hale to same. The price fixed for her house by Mrs. Elmsley before leaving the country was £4,000; he has since been authorized to make such arrangements as will expedite the sale, therefore would accept £3,500, reserving to Mrs. Elmsley the power to revoke before the transfer is completed. 219
- August 2, St. Rochs. Bishop (Anglican) of Quebec to Craig. Is anxious to obtain the best information as to the value of Mrs. Elmsley's house and the amount required to put it in a fit state. Thinks Col. Bruyeres or some other person should examine the building to ascertain these two points. 220
- August 3, Quebec. R. H. Bruyeres, Lt.-Col., R. E., to Lt.-Col. Thornton, Military Secretary. In obedience to the order of the Commander of the Forces has

## Department of Agriculture—Archives.

1808.

- examined Mrs. Elmsley's house. Is of opinion that it is in the most eligible situation and fully worth the price asked. Considers £2,500 would finish the interior and make the necessary alterations. A new house could not be erected at the same cost.
- August 4, Aoust 4, Qu bec. Thornton to the Bishop of Quebec. Enclosing Lt.-Col. Bruyeres' report on the state and value of Mrs. Elmsley's house. Page 223
- August 4. Forsyth, Richardson and Co. to Inglis, Ellice and Co. (Extract.) The boats which had escaped seizure by the American Custom House Officers all arrived at Michillimackinac. By orders from the United States Government the officer at Niagara is to give up the goods upon security to abide the issue of a trial in their courts, &c. This is considered as a trick to protect their officers, and as it is now too late to make use of the goods, they will remain at Niagara. Our plea when the trial comes on, will be that the goods were seized in waters out of the jurisdiction of the American Courts. 213
- August 8, Quebec. Bishop (Anglican) of Quebec to Castlereagh. In obedience to his Lordship's instructions he has made all enquiries respecting a house which might be purchased for the use of the Bishop. Encloses copies of letters on the subject. Importance to Mrs. Elmsley of a speedy decision. Thanks for the favourable attention to his application for waste lands. 215
- (Enclosures calendared at their respective dates.)
- September 5, Quebec. Same to same. Asks that Sir James Craig be notified of the increase to the salaries of the ministers established in the towns as they were disappointed on the 1st of May, no orders having been received to that effect. Is in the same situation himself as regards the allowance made him in lieu of a see house. His increase dates from his return to Canada. Is the date to be the time of sailing, 2nd May, last, or the date of landing, 10th July? Has not yet heard anything from Lieut.-Governor Gore on the subject of the waste lands he, the Bishop, had asked for. 224
- September 12 Treasury Chambers. George Harrison to Edward Cooke. Transmitting a letter from Craig, enclosing the account current of the Receiver General together with the report of a committee of the Executive Council on the public accounts commencing 11th April 1807. Requests Lord Castlereagh's opinion thereon. 227
- September 18, Eltham. Captain Hallowell to Castlereagh. Enclosing substance of Mrs. Elmsley's memorial, as neither the original nor a copy are to be found. A short time before Mr. Windham went out of office she memorialized him for some relief, and stated that if the three houses she owns could be purchased for government she would be helped in the easiest way; since then she had hoped to be able to find tenants for them or sell one as a Bishop's residence; she has been disappointed on both points. He thinks she might have a pension on account of her husband's services. 228
- Enclosed.* Memorial. 230
- September 22, Tedworth, near Andover. Lady Milnes to same. Reminds him of the Duke of Portland's promise of a grant of a township in Lower Canada to Sir Robert. 233
- September 26, Eltham. Captain Hallowell to (Castlereagh?) Begs to know what will be done for Mrs. Elmsley. 234
- October 6, Lachine. Requisition for goods to complete the supply of His Majesty's Indian stores with presents for the Indians in Lower Canada, for the year 1810. 22a
- (In Craig's No. 38 of the 29th October.)
- October 6, Lachine. Requisition for stationery for the use of the Storekeeper General's Department for the year 1809. 26
- (In Craig's No. 38 of 29th October.)
- October 20, Montreal. Memorial of the merchants of Montreal carrying on trade to Michillimackinac and the Indian country, within the territory of the United

1808.

States. Signed by Forsyth Richardson and Co., McTavish McGillivray and Co., James and Andrew McGill and Co., Parker Gerrard Ogilvy and Co. Page 3

Enclosed estimate of the loading of eight batteaux belonging to the company seized on Lake Ontario by John Lees, the American Collector of Customs at Niagara. 15

October 23,  
Lachine.

George Hawdon, Storekeeper general, to Ryland, explaining the reason for the larger requisition for Indian presents this year than last. 23

(In Craig's No. 37 of 29th October.)

October 29,  
Quebec.

Craig to Castlereagh. (No. 37.) Enclosing copy of a memorial from the merchants of Montreal concerned in the Indian trade in the territory of the United States. Also two letters to Mr. Erskine, His Majesty's minister at Washington, on the same subject. 2

(Enclosures calendared at their respective dates.)

October 29.

Same to same. (No. 38.) Enclosing a requisition for Indian presents. As it is £360 in excess of last year, sends letter from the Storekeeper General, explaining the reasons for the increase. Also encloses a requisition for stationery for the Storekeeper General's office and the proposed establishment of the Indian Department for the ensuing year. Serious inconvenience caused by the Indian presents not arriving at Quebec till the Autumn. 21

(Enclosures calendared at their respective dates.)

October 29.

Same to same. (No. 39.) Enclosing memorial of Mr. Dunn; strongly recommends it. 27

*Enclosed.* Memorial of Thomas Dunn. 29

October 31  
London.

Memorial of Margret Le Maistre to Lord Castlereagh. Asking for relief in the form of a pension. 235

November 9,  
Treasury  
Chambers.

George Harrison to Edward Cooke. Asking, for the information of the Treasury, when Sir Robert Shore Milne's salary as Lieutenant-Governor of Lower Canada ceased. 237

November 10,  
Quebec.

Craig to Castlereagh. (No. 40.) By the despatch of 7th July, he was prepared for the removal of Sir George Prevost and his force from Halifax to a distant station, and able to replace his force with a regiment from this province. Had received a despatch from Prevost stating he had fresh instructions making his departure depend upon a contingency. Should he now be obliged to sail, it would at this season be very difficult to send troops. Impossibility of procuring ships for transports. Had previously directed Prevost to recall the 101st from New Brunswick in the event of his (Prevost's) departure. The loss of H. M. ship "Banterer" near Port Neuf; the crew saved; the provision made for them. 32

November 13,  
Quebec.

Same to same. (No. 41.) Wishes to correct the delays in granting the waste lands, which discourage settlers. One difficulty was the offering for sale of parts still ungranted of the surveyed and subdivided townships; the interest of the money to be used to defray the public expenses. The sale was a complete failure; they were put up a second time, but no bidders offered. Ever since then the council has not considered it right to grant any of these lands. Thinks that after the failure of the experiment the land should be granted as before. Benefit to the province through settling complete townships, instead of scattered settlements. Encloses copy of a report of the whole council on the subject. 36

*Enclosed.* Report of the whole committee. 40 to 45

November 15,  
Quebec.

Same to same. (No. 42.) Transmitting certified copy of the rates of exchange and current prices at Quebec for October. 46

*Enclosed.* Prices current at Quebec for October. 47



## Department of Agriculture—Archives.

1808. November 15, Quebec.	Same to same. (No. 43.) Enclosing memorial of the North-west Company, and also a paper forwarded with it, referring to the bill to be brought before the Parliament of Great Britain for prohibiting the use of spirituous liquors among the Indians.	Page 50 51 53
	<i>Enclosed.</i> Memorial. Paper respecting the bill.	
November 15, Quebec.	Craig to Castlereagh. (No. 44.) Enclosing memorial from the widow of Mr. de la Bruère and letter on the same subject from Col. Bruyères. Recommends the petition, which asks that her husband's pension be continued to her.	69 70 71
	<i>Enclosed.</i> Letter from Col. Bruyères recommending the memorial. Memorial, in French.	
November 16.	Order in Council appointing M. de Salaberry an honorary member of the Executive Council of Lower Canada.	238
November 16.	Order in Council appointing Mr. James Irvine an honorary member of the Executive Council of Lower Canada.	239
November 20.	Sir Robert S. Milnes to — (Confidential.) Has not yet received any satisfactory information either on the subject of his retiring allowance or the grant of a township in Lower Canada.	240 243
	<i>Enclosed.</i> Extract on the subject of the grant.	
November 20, Quebec.	Bishop (Anglican) of Quebec to Ed. Cooke. (Private.) Enclosing letter from Dr. Stewart on the state of the Church in Canada, and extracts from a despatch from the Duke of Portland to Governor Milnes on the subject of rectories.	244 248 254
	<i>Enclosed.</i> Letter from Dr. Stuart. Extracts.	
November 21, Bridge Fields, Wandsworth.	The Chevalier de Thomin to ——. Asking that his pension be commuted and that he be allowed to settle in Canada.	256
	<i>Enclosed.</i> Letters from the Treasury allowing him to commute his pension.	257
November 22, Quebec.	Craig to Castlereagh. (No. 45.) Enclosing requisition for stationery for the Civil Department of Lower Canada, for 1809.	73 74
	<i>Enclosed.</i> Requisition.	
November. Quebec.	Same to same. (No. 46.) Enclosing naval officers' returns of the vessels entered inwards and cleared outwards at the Port of Quebec between 5th July, 1808, and 10th October, 1809.	76
December 6, Treasury Chambers.	George Harrison to Ed. Cooke. Transmitting a requisition for Indian stores for the year 1810, and one for stationery for the office of the storekeeper.	259 258
	<i>Enclosed.</i> General requisition for Indian stores.	
December 6, Treasury Chambers.	Same to same. Transmitting account current of Receiver General dated 10th April last, and report of a committee of the whole Executive Council on the public accounts for the six months commencing 11th October.	260
December 27, Quebec.	Craig to Castlereagh. (No. 47.) Enclosing certified copy of the rates of exchange and current prices at Quebec for the month of November last.	77 78
	<i>Enclosed.</i> Prices current at Quebec for November.	
December 28, Quebec.	Same to same. (No. 48.) Enclosing a report made by the Attorney General on the suit between the Crown and Mr. Sanguinet, proprietor of the Seigniori of La Salle, which is now in appeal; also a statement of the case. A copy of the proceedings in the Provincial Courts shall be sent by the next mail, to enable His Majesty's law officers to meet the case.	81 83 84a 85
	<i>Enclosed.</i> Report of the Attorney General. Plan of the Seigniori of La Salle. Statement of the case.	

1808.  
December 31, Draft of a letter to Craig. (No. 14.) Authorizing the granting of land  
Downing St. in Lower Canada, equal in quantity to a township, to Sir Robert Shore  
Milnes. Page 90
- No date. Proposed establishment for the Indian Department, Lower Canada for  
the year 1809. 26a  
(In Craig's No. 38 of 29th October.)

## GOVERNOR CRAIG, 1809.

## Q. 109.

1808.  
November 5, Ryland to Mouro and Bell. Asking, if they are willing to make a  
Quebec. better offer for the St. Maurice Forges. 31  
(Enclosed in Craig's No. 50 of 21st February, 1809.)
- December 31, Monro and Bell to Ryland. In answer to his letter of the 5th ult.,  
Quebec. relative to the lease of the Forges of St. Maurice, give a full statement  
of the case. 32  
(Enclosed in Craig's No. 50 of 21st February, 1809.)
1809.  
January 5, Draft of a letter to Sir J. H. Craig. Transmitting extract of a letter  
Downing St. to the Bishop of Quebec, authorizing increases to the salaries of certain  
clergymen, also an allowance of £400 a year to the Bishop (Anglican)  
of Quebec, till a see house shall be purchased or erected. 1
- January 25, Craig to (Castlereagh ?) (No. 49.) Transmitting copy of record of  
Quebec. the proceedings had in the principal courts of Lower Canada in the  
cause between the Crown and Mr. Christopher Sanguinet, proprietor of  
the Seigniorship of La Salle, now in appeal to His Majesty in the Privy  
Council. Thinks it proper to mention that Mr. Sanguinet has not as  
yet taken out the transcript prepared for him of the proceedings; should  
he fail to prosecute his appeal within 15 calendar months the judgment  
of the Provincial Court of Appeals may be carried into effect. 3
- January 25, Same to same. (No. 50.) Enclosing certified copy of rates of exchange  
Quebec. and current prices at Quebec for the month of December. 5  
*Enclosed.*—Quebec prices current for December. 6
- January 31, Draft of letter to Sir J. H. Craig. The customary oaths to be dis-  
Downing St. pensed with in the case of Sir Robert Shore Milnes, to whom His Majesty  
has been pleased to order a grant of land in Lower Canada. 9
- February 6, Craig to John Henry. (Most secret and confidential.) Instructions to  
Quebec. proceed to Boston on a secret mission. He is to endeavour to obtain the  
most accurate information of the true state of affairs in that part of the  
Union; from the wealth and intelligence of some of the leading men it  
must naturally possess a very considerable influence over the other  
Eastern States. His own judgment and the connections he has in the town  
must be his guide as to how this information is to be obtained. Warns him  
against the sanguineness of the Federalists. He (Henry) is to send the  
earliest intelligence if this party should contemplate a separation from  
the Union. If such a thing appears likely and they manifest a desire for  
assistance from us he is authorized, if he can form an intimacy with any  
of the leading party, to insinuate that he will forward communications.  
Encloses credential in case such should be required. He is to obtain all  
possible information while passing through Vermont; to write frequen-  
tly. How his letters are to be addressed for safety. 254
- February 12, Martin Chittenden (a member of Congress) to ———. The feeling at  
Washington. Washington. Four days spent in debate over a resolution for repealing  
the embargo laws on first of June next, and granting letters of marque and  
reprisal. Britain appears ready for an amicable settlement of the exist-  
ing difficulties and seems to want to avoid war if it can consistently be  
done. The expected strength of the parties in the Congress to meet on  
22nd May next. 88

## Department of Agriculture—Archives.

1809.  
February 13.

Craig to Castlereagh. (No 50 Duplicate.) The information from His Majesty's minister at Washington gives him every reason to expect war as the probable issue of the discussion pending. Thinks it will take place at no very long period after the next meeting of Congress. Considers it right to draw his Lordship's attention to the state and defences of these colonies. The security of Quebec is unquestionably of the first importance; while we retain possession of that place we have always a door open by which to recover the province, although it affords no security against the loss of it. Some little assistance may be expected from the militia, should we retain the province; should we lose and attempt to regain it, a much larger force would naturally be required in the latter than in the former case. The province has been neglected, the posts not kept up, and the works on the Isle aux Noix and the Fort at St. Johns are no longer in existence, while the projected post at William Henry has never even been begun; our frontier is thus entirely open. He has never attempted to re-establish these posts, first: as all available means are required for the fortress of Quebec, and second; as garrisons would then be required to keep them up. The two last named forts necessary to help to make the province secure. Thinks the conquest of this province must still be effected by the old route of Lake Champlain. Upper Canada is also destitute of forts by which the advance of the enemy could be delayed two days, such forts as do exist are only calculated to cause the loss of the men put in them; at present we have the superiority on the Lakes. The enemy is building a vessel of considerable size; he has directed a vessel of superior dimensions to be built at Kingston. Thinks the entry to this province would be across the strait between Lakes Erie and Ontario; as the strait is only thirty-five miles long and nine miles of that distance impassable on account of the Niagara Falls, is of opinion we might guard the remainder. Another entry could be had by crossing the St. Lawrence at Oswegatchie and from thence up to Kingston. The difficulties in the way. The most probable route by Lake Champlain is quite unguarded by vessels as we have not one on that Lake, and no possibility of building. No ordnance whatever at any post except Quebec. Sees no probability of success without at least 12,000 men. The militia show a good disposition, but must have troops to help them. In addition to the force mentioned, would require a reinforcement of at least three companies and some artillery. A frigate and three or four smaller vessels are indispensable. The supplies required. 10

February 14,  
Burlington.

A. B. (John Henry) to——. The state of public feeling in Vermont. Great indignation felt on the subject of the embargo laws. Page 82

*Enclosed.* Long paper, undated and unsigned, answering thirty-six questions on the state of feeling in Vermont, especially regarding the embargo laws, political feeling in the United States and measures likely to be taken in case of war. 58 to 81

February 15,  
Burlington.

A. B. (John Henry) to——. Encloses letter from a member of Congress (Martin Chittenden) to an active Federalist in Vermont. According to his statement, the relative strength of the two parties in the new Congress is:—Federalists, 45, Democrats, 82. The state of feeling. 86

February 18,  
Windsor, Vt.

Same to——. His last two letters were written from Burlington, the principal town in the Northern section of Vermont. Is now at Windsor, the principal town in the Eastern section, where Democracy (to use local phraseology) predominates over Federalism. Distrusts the over sanguine calculations of the Federalists. They declare "that the state will negotiate separately for itself in case of war with England; and maintain its neutrality even by an armed force if no other state should unite with it." The Democrats on the contrary assert: "If war would not unite the people the equality of power would at least paralyze

1809.

the efforts of both parties." Difficulty of deciding; thinks it safer to rely on the latter opinion in the present state of things. The Governor of Vermont is a prudent, industrious man, but has not the great abilities required to inspire confidence; he has at least pledged himself to co-operate with Massachusetts. Finds it necessary to correct by means of the public papers the erroneous idea that 5,000 men are equal to the conquest of Canada. Page 261

(In Craig's (separate) of 9th June.)

February 21,  
Quebec.

Craig to Castlereagh. (No. 51.) Had observed in his (Craig's) despatch No. 35, that he considered it advisable before taking further steps in the business of the St. Maurice Forges, to ascertain whether Messrs Monro and Bell were disposed to take the lease on more favourable terms to the Province than the rent at which they had purchased at auction. Encloses a letter to those gentlemen from Ryland and their answer, which contains a detailed and candid account of the whole transaction. Considers it to have been a fair sale, and recommends that he be empowered to sign the lease. 24

(Enclosures calendared at their respective dates.)

February 21,  
Quebec.

Same to same. (No. 52.) Enclosing petition from James Monk, Chief Justice, for a grant of lands. 45  
*Enclosed.* Memorial. 47

February 21,  
Quebec.

Same to same. (No. 53.) Transmitting copy of proceedings of the Executive Council concerning Waste Lands between 26th September, 1807, and 28th January, 1809, also concerning Matters of State between 14th June and 28th January, 1808. In the proceedings concerning the Waste Lands is given a full report on the claims of Mr. Cuyler. Under the circumstances could not decline issuing a patent to the family of the late Mr. Allsopp for sundry lots of land in Farnham, which had been prayed for by Mr. Cuyler; but after the suit between the Crown and Mr. Delorme, who lays claim to a portion of land of Farnham, there will still remain upwards of 2,000; he can recommend both Mr. Cuyler and Sir John Johnson for grants. It does not appear necessary to bring to his especial notice any of the proceedings of the Executive Council in Matters of State except the report from the Inspector General of the King's Domain and a letter from the Receiver General. The measures adopted in consequence are now in operation and he thinks they will tend to augment considerably the Provincial revenue by forcing a regular payment of the mutation fines due to the Crown. 49

February 21,  
Quebec.

Same to same. (No. 54.) Transmits proceedings in the Executive Council on petitions for leases of the Crown and Clergy reserves in this province between 14th June and 28th January, 1808. Applications increasing rapidly. The rates charged. The rising value of these reserves. Has given a commission to Edward Burke as Auditor of land patents for Lower Canada; recommends that a salary be granted by the Crown for these duties. 51

February 23,  
Amherst,  
N. H.

A. B. (John Henry) to———. Hopes the caution he has observed in sending letters will be approved of. It is believed that war will not be declared during the present session of Congress. It is thought an "armed commerce" will be permitted. The policy he hears Mr. Jefferson intends to pursue. 264

(In Craig's (separate) of 9th June.)

February 23,  
Quebec.

Craig to Castlereagh. (No. 55.) Enclosing certified copy of rates of exchange and current prices at Quebec for the month of January, 1809. 53

*Enclosed.* Quebec prices current. 54

February 23,  
Quebec.

Same to same. Enclosing copies of the two letters and an enclosure contained in one from a gentleman (J. Henry) whose correspondence in

## Department of Agriculture—Archives.

1809.

the months of March and April last he had transmitted. Cannot be more explicit as he sends this by way of Halifax. Page 57

(Enclosures calendared at their respective dates.)

February 26,  
Boston.

A. B. (John Henry) to———. Has carefully collected and sent by safe private conveyances all the information worthy of credit that he could obtain as to the policy of the two parties in the United States. The public post offices are not safe in these times. Has not yet had time to judge to what lengths the Federal party will go; will wait till after the election of the Governors of Massachusetts, New Hampshire, and Rhode Island, which will indicate the comparative strength of the parties and the measures which the "Junto" in Boston may safely pursue. The best informed men here do not expect immediate war, but think means will be fallen upon to provoke Great Britain to commence hostilities, or at least furnish the American Government with a more plausible excuse for a rupture during the next session of Congress. However, it is confidently believed England will perceive the snare and throw all responsibilities upon the American Government. The effect of Mr. Canning's dignified civility will be to humble while it will irritate the French faction. 267

(In Craig's (separate) of 9th June.)

March 5,  
Boston.

Same to ———. A gentleman going direct to Montreal enables him to send this packet to Mr. Richardson, and does away with the necessity of writing in cypher. How he gets the confidence necessary to his mission. The apprehension of an immediate war has subsided. The probable effect of the non-intercourse law. Mr. Madison will probably bring about hostilities without appearing to be the blamable party; how this might be done. Should war be declared in spite of the Eastern States, thinks Massachusetts would call a congress to be composed of delegates from the Federal states and erect for the time being a separate government. In such an event he can only conjecture what would be the result; relations would probably be established with Great Britain. Does not know what permanent benefit would grow out of this, but it is generally understood that a secession of the Northern States would be followed by an alliance with England. The project of withdrawing the Eastern States from the Union is abandoned for the present, as the common people are disinclined for it. The meeting of Congress in May will decide what situation public affairs are to remain in. Believes in the *integrity of intention* of the leading characters but cannot forget that they derive all their power from a giddy multitude. 269

(In Graig's (separate) of the 9th June.)

March 9,  
Boston.

Same to ———. In his letter of the 5th inst., had expressed his opinion on the non-intercourse law, and how Great Britain may defeat its object. More observations on the same subject. 274

(In Craig's (separate) of 9th June.)

March 15,  
Boston.

Same to ———. He will have seen by the public papers that the Federalists of Massachusetts have prevented war with Great Britain by convincing the Government of the United States that it would be more than the resources, &c., the country could stand. The session has passed without any part of the plans of the administration being carried into effect, except an interdiction of commerce with Great Britain and France. Even this will cease in June, unless renewed, which the Federalists will try to prevent. The circumstances under which the new Congress will meet depend on the state elections. The policy to be observed by Great Britain. Regard must in the meantime be had to the election, which will soon take place. Laments that the non-intercourse law has superceded the embargo, as it is calculated to check the progress of revolution lowering in the horizon, and giving promise of a tempest which would overturn Democratical institutions and deter the world from making

1809.

another experiment in this sort of Government. "While the high road of history is strewn with the wrecks or whitened with the monuments of republics this alone remains to encourage innovation or render the popular theories even plausible." Page 277

(In Craig's (separate) of 9th June.)

March 20,  
Quebec.

Craig to Castlereagh. (No. 56.) Enclosing certified copy of rates of exchange and current prices at Quebec for the month of February, 1809. 91

*Enclosed.* Quebec prices current for February. 92

April 6,  
Boston.

A. B. (John Henry) to ———. Nothing of any moment has occurred since his last communication. The election of governor, on which peace or war depends, was made on the 3rd inst. The returns from the distant states not yet received, but the success of the Federal candidate seems certain. This success, however, to produce the desired effect, ought to be more complete. Wonders that Democracy has still so many adherents. Reasons why Mr. Gore had not a larger majority of Federal votes. In his letter of 5th ultimo, had briefly stated the plans which he believed the "Junto" in Boston would act upon in case of war. The first step would be an application to the Governor General of British America for aid, especially that which would protect the small sea ports from the naval force of the General Government. There must be some one in Canada prepared to decide on this and other matters of similar importance, whenever it shall be necessary to apply to him. His own opinion is that the general government will travel round all intrigues before declaring war. In his next will submit his reasons for thinking so. 280

(In Craig's (separate) of 9th June.)

April 8,  
Downing St.

Draft of letter to Craig. (No. 18.) Despatches Nos. 31 to 46 inclusive received. On the subject of No. 32, he (Craig) has long since received His Majesty's pleasure for appointing Mr. Sewell, late Attorney General, to be Chief Justice, and for appointing Mr. Uniacke who is now proceeding to Canada to succeed him. In No. 34, the explanation respecting the complaints of the Indians who claim certain rights in the Seigniorship of Two Mountains appears satisfactory. By No. 35, he is glad to find that he (Craig) has not confirmed the lease of the St. Maurice Forges recommended by Mr. Dunn, and that he has hopes of amicably setting aside the sale and making an arrangement more advantageous to Government. Is sorry the culture of hemp is not proving more satisfactory; efforts should not to be discontinued. His Majesty has taken No. 39 into consideration and when his successor is appointed, Mr. Dunn will be permitted to retire from the position of puisne judge, with a pension of £500. No. 41, respecting the ungranted residues of townships. If any bill should come before Parliament for prohibiting the use of spirits among the Indians of North America he will take care that the considerations in No. 42 shall be attended to. Regrets Mrs. Bruyère's application for the pension granted to her late husband cannot be entertained. 95

April 8,  
Downing St.

Same. (No. 19.) Has sent a separate despatch recommending him (Craig) to investigate the circumstances of the Indians in Canada. Entirely concurs that in present relations with the United States, the Indians must be conciliated on the principle that if not for us they will be against us. No immediate necessity for altering the system of paying the expenses of the Indian Department. His Majesty approves of the appointment of Mr. Elliott to succeed Mr. McKee, allowing the latter his allowance till further orders. 99

April 8,  
Downing St.

Same. (Private.) The existing state of affairs, though presenting a hope that hostilities may be avoided, yet prevents our desisting from cautionary measures. Therefore recommends him (Craig) to persevere in the strengthening Quebec, and making the militia force available.

## Department of Agriculture—Archives.

1809.

April 12,  
Boston.

Care to be taken that these measures be not misconstrued and made the ground for misunderstanding or retaliation. Page 101

A. B. (John Henry) to——. As he is anxious to transmit with the utmost speed all the facts and the public opinion on important matters, his correspondence must of necessity be rather desultory, but flatters himself he is perfectly acquainted with the state of affairs here. Mr. Gore is elected by a majority of 3,000, thus raising an insuperable barrier to prevent war. The New England States side against the Administration. Reasons why the Federalists are not stronger. By the aid of a small sum of money the Federal "junto" obtained copies of despatches of the American minister at Paris, from which were selected the letters published under the title of "Suppressed Documents," a copy of which he (A. B.) sent to Mr. R——d. The notes were written by the author of "The Analysis," which so largely helped to allay the feeling against Great Britain. Thinks if war should be declared under the existing state of affairs the New England states would not be a party to it. Reasons for thinking the General Government would try every expedient before declaring war. Will forward a statement of the number of Democrats and Federalists in the Northern states when he has accurately ascertained it. 283

(In Craig's (separate) of 9th June.)

April 26,  
Boston.

Same to——. Has little to communicate on local politics since the 12th inst. Has not yet accurately ascertained the number of the respective parties in the New England states. New Hampshire, Connecticut and Rhode Island are decidedly federal. Elections in Massachusetts take place next week; he does not doubt the result will be favourable. The elections for Congress in the Southern States indicate a change. Thinks the minority will be more numerous than Mr. Chittenden's letter stated. The New England Federalists are well satisfied with the proclamation restoring the intercourse between the two countries; the Democrats affect to be pleased with it also. The chief benefit to be drawn from the settlement of existing difficulties is that Buonaparte, baffled in his attempt to involve England and the United States, may think it to his advantage to declare war against America; great advantage might result for Great Britain from this step, as party feeling would be forgotten in a common cause. The present state of affairs not favourable to the Democrats. On beginning this letter, had intended to make some observations on the treaty talked of, especially that part relating to the boundary line. The American Government will certainly try to arrange this matter so as to obtain a portion of the fur trade. This subject is amply discussed in a memorial of the North-west Company to the Governor General. 289

(In Craig's (separate) of 9th June.)

May 6,  
Boston.

Same to——. As there seems a great probability of an accommodation between the two countries he will now have more leisure for writing on general politics. In the more critical period, passing events took up all his time. Has nothing to say on local topics. Thinks the parade made in the Government paper of the sincere disposition on Mr. Madison's part to be on friendly terms with Great Britain should awaken vigilance and distrust rather than confidence and hope. Analyses his (Madison's) motives. 293

(In Craig's (separate) of 9th June.)

May 15,  
Quebec.

Craig to Castlereagh. (No. 56.) Enclosing memorial from Mr. Justice Crawford, provincial judge of the District of Gaspé, whose claims for an augmentation of salary were reported on by the Executive Council in April, 1807, and afterwards transmitted for his (Castlereagh's) consideration, to which no answer has been received. His reasons for recommending Mr. Crawford's petition. 102

*Enclosed.* Memorial. 104

1809.

Extract on the subject from the proceedings of the Executive Council. Page 107

May 15,  
Boston.

A. B. (John Henry) to——. Nothing new or interesting has occurred since his last. Mr. Madison's prompt acceptance of the friendly offers of Great Britain has caused a temporary lull in the party strife; neither party believes him to be sincere, and both distrust him. The growing strength of the Federalists should decide the President to abandon the policy of his predecessor. Should Buonaparte attempt any act of hostility these states would soon be indissolubly bound to Great Britain. The federal party would then support Mr. Madison; they have already promised to do so, provided he conclude an honourable treaty with Britain and resent the insults of France. Whatever may be Mr. Madison's motives for appearing to abandon the system of hostility against Britain, his acts so far seem to prove his sincerity. Has ordered the militia to be disbanded and the crews of the gun-boats in this harbour discharged. Has also partially withdrawn his support from the "National Intelligencer" on account of some remarks ascribing the recent accommodations to other reasons than his sincere desire to do equal justice to Britain and France. 298

(In Craig's (separate) of 9th June.)

May 22,  
Boston.

Same to —— . As soon as the result of the election in this state is ascertained will be to correctly state the relative strength of the parties in all the Northern States, including New York, which has joined "the league." Is now confident that a war with Great Britain originating in present causes is scarcely possible. Whatever Mr. Madison's real designs, he must adopt a friendly policy towards Britain. The tide of public opinion blows in her favour. Two months ago the State of New York was not counted an ally of Massachusetts. The elections for the Lower House are going on in this State; curiosity felt as to the result. Means taken to defeat Mr. Gore. 301

A P.S. states he has at that moment received Mr. R——'s letter and will be at Montreal in the first week of June.

(In Craig's (separate) of 9th June.)

May 22,  
Quebec.

Craig to Castlereagh. (No. 57.) Enclosing petition (in French) from the nuns of the Hotel Dieu at Montreal, for authority to enable them to acquire, by means pointed out, two separate funds limited to the annual sum of £500, one for the support of the hospital, the other for the support of the nuns themselves. The utility of the institution. Recommends the petition. 108

*Enclosed.* Memorial.

May 24,  
Quebec.

Same to same. Enclosing certified copies of the rates of exchange and current prices at Quebec for the months of March and April, 1809. 116

*Enclosed.* Quebec prices current for March. 117

do do April. 120

May 29,  
Quebec.

Craig to Castlereagh. Transmitting naval officers' returns of vessels entered inwards and cleared outwards at Quebec between 10th October, 1808, and 5th April, 1809, inclusive.

May 30,  
Quebec.

Same to same. (No. 58.) Despatches received. Transmits account of the exports from this province to the West Indies for 1807 and 1808. The report of the Executive Council on the provincial accounts for half-year ending 10th October last, will be forwarded without delay. Is not aware of any property or revenue here, that comes under the description pointed out in Mr. Harrison's letter enclosed in his (Castlereagh's) of 6th March, except it be the Jesuit Estates, which never having been as yet granted by His Majesty or appropriated to any particular purpose may possibly be viewed in that light. Is at a loss what steps to take respecting this property. The value, etc., of these estates. Will do his



Department of Agriculture—Archives.

1809.

	best to prevent encroachments on the wood lands or timber reserved for the use of the Royal Navy. Intends to proceed up the country on a six months' tour.	Page 124
	<i>Enclosed.</i> Statement of exports from Lower Canada to the West Indies.	127a
June 1, Quebec.	Craig to Castlereagh. Regrets that he has found it indispensably necessary to dismiss Mr. Stuart from his office of Solicitor General. His reasons for so doing. Has not as yet filled up the vacancy on account of the prevailing report that His Majesty has appointed Mr. Uniacke Attorney-General; in which case he shall offer the post to Mr. Bowen who at present does duty in that office. Some observations on the qualifications necessary for that position. If Mr. Uniacke does not possess these qualifications, recommends that he succeed to the office of Chief Justice of New Brunswick, vacant by the death of Mr. Ludlow. His entire satisfaction with the appointment of Mr. Sewell to the Chief Justiceship.	128
June 5, Quebec.	Same to same. (No. 59.) Encloses speeches on the opening and closing of the Provincial Parliament. Reasons for the complexion which he (Castlereagh) will notice they bear. The party of which he gave an account in despatch No. 29, had an alarming number of adherents in the House, and the general behaviour of the Parliament was such that he judged it expedient to dismiss it and call a new one in the hope that none of the objectionable members would be again elected. Satisfaction with the measure.	134
	<i>Enclosed.</i> Speech on the opening of the Provincial Parliament.	134
	French.	144
	English.	153
	Answer to the above, English 159, French 180.	159, 180
	<i>Quebec Gazette</i> , 16th May, 1809, with speech on the prorogation of Parliament. English 202, French 209.	202, 209
June 6, Quebec.	Craig to Castlereagh. (No. 60.) Transmits exemplifications of the several Acts passed in the last session of the Provincial Legislature of Lower Canada, also printed copies of the same and manuscript copies of the Journals of the Council and Assembly; the latter could not be printed as the Houses were prorogued so suddenly there was no time to pass the necessary vote.	223
	<i>Enclosed.</i> Schedule of the Acts passed.	224
June 7, Quebec.	Same to same. (No. 61.) Enclosing memorial from the widow of John Coffin, Inspector of Police at Quebec, and Surveyor General of Woods in Lower Canada. Recommends the petition.	225
	<i>Enclosed.</i> The memorial.	228
	Letters accompanying the memorial.	229 to 235
June 8, Quebec.	Craig to Castlereagh. (No. 62.) Enclosing memorials with accompanying document from a committee of trade on behalf of the merchants of Lower Canada. Will add no arguments as they speak for themselves.	236
	<i>Enclosed.</i> Memorial to Craig.	238
	Ditto to Castlereagh.	239
	List of exports from the port of Quebec enclosed with the memorials.	248a
June 9, Quebec.	Craig to Castlereagh. Enclosing certified copy of the rates of exchange and current prices at Quebec for May, 1809.	249
	<i>Enclosed.</i> Quebec prices current.	250
June 9, Quebec.	Same to same. (Separate.) Had mentioned some time ago in a private letter to Mr. Cooke that he had been induced by the state of affairs in the United States to send Mr. Henry on a confidential mission to Boston. Encloses instructions which he (Craig) gave to Mr. Henry and the original letters received from him between 14th February and 22nd May last, at which time he received instructions to return.	253

1809.

(Enclosures calendared at their respective dates.)

- June 10,  
Downing St. Draft of a letter to Craig. Transmitting copy of letter from the Treasury to Mr Cooke, dated 30th March last, with respect to a memorial from the widow of Colonel St. Luc. Page 304
- June 10,  
Downing St. Same. Transmitting letter from the Treasury, dated 17th ult., relative to the settlement of the Indian Store accounts in Upper Canada, together with a copy of Lt.-Gov. Gore's despatch of 19th October last, therein referred to. 305
- June 16,  
Quebec. Craig to Castlereagh. (No. 63.) Mr. Forbes, Lieut.-Governor of Gaspé has arrived at Quebec, and will go down to that district in the course of the summer. His Majesty's assent to the Gaspé Jail Bill not yet received, though he (Castlereagh) mentioned in his despatch No. 10, of 7th July last, that it would be approved. The bill was presented for Royal assent on 14th April, 1808, it will be necessary to introduce it afresh unless regularly notified of its approval within two years from that time. 306
- September 7,  
Downing St. Draft of letter to Craig. (No. 21.) Has laid before the King his (Craig's) letter of 5th June detailing the reasons for dissolving the Parliament. Has no doubt he (Craig) was influenced solely by a desire for the King's interest, and as he represents that the English part of the community and the sensible part of the Canadians approve, trusts it will not be attended with any prejudicial effect. Hopes in future if any unfortunate difference should arise between him (Craig) and the Legislative Assembly, in dissolving them, he will take care to use such temperate ends and chosen language as may not leave it in the power of the Assembly, afterwards chosen, to question the propriety of his statements. His Majesty approves of Mr. Stuart's removal, and Mr. Bowen's appointment in his place as Solicitor General. 217
- September 7,  
Downing St. Same. (Private.) Having written officially on the subject of the dissolution of the Legislative Council, thinks it right to express his private sentiments. Difficulty of managing a Provincial Assembly constituted like that of Lower Canada; all the privileges of the British House of Commons are exercised where there exist little means of influencing and inducing the members to coalesce with the Government. The example of the American states and the nature of a popular assembly afford great opportunities for turbulent minds to raise themselves into imaginary or real importance by opposing the Administration. The great difficulty lies in the fact that there are no means of punishing an Assembly but by dissolution, and if they are popular it is sure to fail of success. Caution must be used in taking these extreme measures. The two grounds of complaint against the Assembly which he specifies are: "their proceedings for preventing judges sitting in the assembly and for endeavouring to expel a member on the allegation of his being a Jew, "although he had taken the regular qualification oaths on the Gospels." Considers neither of these objects illegitimate to pursue, therefore does not doubt the Assembly acted in the spirit he represents. Great care should be exercised in the wording of his speech on dissolution, as the new Parliament would be very liable to object to it on the ground of its interfering with their freedom, &c. Judges might be admitted to seats in the Legislature if he (Craig) should at any time see fit to acquiesce. 219
- September 8,  
Downing St. Same. (No. 23.) Has laid before the King his despatches from No. 50 to 63. Since receiving his letter on the subject of the Forges of St. Maurice, thinks it advisable to accept at once the offer of Munro and Bell of £500 a year. Cannot transmit a final decision as to the grant of land asked for by Chief Justice Monk; wishes to be informed whether he at present has any grants of land and to what extent, also what grants are usually made to persons of his rank. Is glad to find by his despatch

## Department of Agriculture—Archives.

1809.

No. 54 that the reserved lands are likely to become very productive. Approves highly of letting these lands. Also thinks well of the arrangements adopted upon the claims of Mr. Cuyler and Mr. Allsop; if the 20,000 acres in Farnham become disposable, empowers him to carry out his intentions respecting Mr. Cuyler and Sir John Johnson, the reserves should be on no account alienated. Approves of the measures adopted respecting the registry of the sales of any part of the King's domains and the recovery of arrears due thereon. Is not at present enabled to give any decision respecting the application of the nuns of the Hotel Dieu. Cannot authorize a pension to Mrs. Coffin. Representation of the Merchants respecting the trade of the provinces has been transmitted to the Committee for trade and plantations. Authorizes an increase to the emoluments of the Judge of Gaspé. Acknowledges his (Craig's) confidential communication of 9th June. Page 307

### GOVERNOR CRAIG—1809.

#### Q. 110.

1808.  
July,  
Downing St.

Draft of a letter to Craig. Authorizing the allowance of £200 per annum to the widow of Chief Justice Elmsley. 1

1809.  
August 7,  
Quebec.

Craig to Castlereagh. (No. 66.) Despatches received. Has transmitted copy of despatch dated 8th April, to Lieut. Governor Gore; will collect such particulars as to the state of the Indians as will enable His Majesty's Ministers to settle the points mentioned. Mr. Dunn's wish to resign on hearing he had been granted a pension; he will have no hesitation in accepting his (Dunn's) resignation. Has given the commission to James Ker. Mr. Bowen having declined the situation of Solicitor General left vacant by the dismissal of Mr. Stuart, he has therefore appointed Mr. Sewell, brother of the Chief Justice, to the office. 2

September 8,  
Downing St.

Draft of letter to Craig. (No. 22.) The acts 164 to 197 inclusive have been submitted to the Privy Council and approved. That respecting the erection of common jails in Gaspé is under consideration. 4

September 8,  
Downing St.

Same. (No. 24.) The Bishop of Quebec on his arrival in England had laid before the Government a representation of the ecclesiastical state of Lower Canada, which was referred to the Advocate General, who, before giving a final opinion, required the report of the Law Officers in that Province. Had supposed the Bishop would have brought the subject before the Council on his return; finds that, however, he waits until it is officially recommended to him (Craig) who must converse with the Bishop as to the best mode of bringing the subject before Council. 5

September 8,  
Quebec.

Same. (Separate.) The uncertainty of affairs between Great Britain and the United States prevents his giving him distinct instructions upon the subject of his (Craig's) letters of 13th February, preceding. Has received a letter from the Treasury upon the subject of the very great increase of expense in Canada from which he thinks it right to call for account of the sums drawn by the Governor and Lieut.-Governors of Canada. Transmits statements which show that the expenditure for Canada alone for the last year and a half amounts to £372,219 which exceeds that of former years so greatly as to necessitate asking for a detailed explanation, not with the object of censuring but with a view of knowing the full effect of his measures; trusts no additional expense will be required except in case of hostilities. Advises economy. 7

September 8,  
Quebec.

Craig to Castlereagh. (No. 67.) Enclosing memorial of the puisne judges of Quebec and Montreal, and of the Provincial judge of Three Rivers, stating that owing to the price of the necessities of life their present salaries are insufficient for their support. 9

	1809.	<i>Enclosed.</i> The memorial.	Page 10
September 8,	Quebec.	Craig to Castlereagh. (No. 68.) Enclosing petition to His Majesty from the minister (Jehosaphat Mountain) and other members of the Protestant Episcopal congregation of Christ Church, Montreal, asking for money to help to finish their church, the shell only of which is put up, and for want of funds to complete it is falling into ruin.	12
		<i>Enclosed.</i> The petition.	14
September 11,	Quebec.	Same to same. (No. 69.) Enclosing certified copy of the rates of exchange and current prices at Quebec for the months of July and August last.	17
		<i>Enclosed.</i> Quebec prices current for July.	18
		Ditto for August.	21
September 12,	Quebec.	Craig to Castlereagh. (No. 70.) A Mr. Black arrived here and delivered his Lordship's despatch, No. 11. He proposes to give £1,000 a year for the lease of the Forges of St. Maurice, and states he has already lodged security with him (Castlereagh). Asks for further advice. Should he not close with Messrs. Monro and Bell, they might refuse to relinquish their right. Some time must elapse before it could be settled; only then could negotiations be opened with Mr. Black. As he considers him a person of no capital nor credit, he will not come to any agreement with him unless he can really give that security required by the Council for renting and working the Forges. Black also asks to be made superintendent of the King's ships and bateaux, they are under the charge of the Quarter Master General's Department, no single man could discharge the duties which are at present satisfactorily managed. As to his application for a further grant of land, Mr. Black has already had a complete township, which he sold. If he must be provided for, he considers a grant of land the most suitable way. Does not recommend him for any office.	24
September 18,	Quebec.	Same to same. (No. 71.) Is under the apprehension that some accident must have happened to delay the communion plate ordered by His Majesty for the Metropolitan Church at Quebec.	28
October 10,	Quebec.	Same to same. (No. 72.) Transmitting copy of the proceedings of the Executive Council on matters of State between 28th January and 22nd August last inclusive.	29
October 26,	Quebec.	Same to same. (No. 73.) Enclosing a requisition for Indian stores and presents for Lower Canada, a requisition for stationery, and the proposed establishment of the Indian Department for 1810.	30
		<i>Enclosed.</i> Requisition for Indian stores.	31
		Ditto for stationery.	32
		Proposed establishment of the Indian Department for 1810.	33
October 27,	Quebec.	Craig to Castlereagh. (No. 74.) Enclosing a requisition for stationery for the Civil Department of Lower Canada for 1810; requests it may be sent out as early as possible in the spring.	34
		<i>Enclosed.</i> Requisition.	35
November 4,	Quebec.	Same to same. (No. 75.) Enclosing certified copy of rates of exchange and current prices at Quebec for the months of September and October last.	37
		<i>Enclosed.</i> Quebec prices current for September.	38
		do do for October.	41
December 14,	Quebec.	Craig to Castlereagh. (No. 77.) In conformity with the instructions in his despatch of 21st June last, has written to the persons holding Civil appointments in this province, asking them to transmit an account of the duties and emoluments of their several offices. Encloses the returns sent accompanied by a general abstract, also list of persons from whom no replies have yet been received, but which will be forwarded as soon as they come in.	44
		<i>Enclosed.</i> Returns.	46 to 93

# Department of Agriculture—Archives.

GOVERNOR CRAIG, 1809.

## Q. 111.

	Continuation of the returns enclosed in Craig's No. 77 of 14th November, 1809.	Pages 1 to 140
1808. August 10, Grand River.	John Norton to ———. The intention of attempting to civilize the British Indians as also the probability of a rupture with America leads him to make some observations on the state of the Indians and their lands.	170
September 1, Grand River.	Same to Hon. Wm. Wilberforce. Respecting the Indian lands.	179
1809. January 11,	Robert Prescott to ———. Enclosing a memorial to be laid before the King.	149
	<i>Enclosed.</i> The memorial.	151
February 1, Montreal.	J. Monk to Rashleigh and Co. Transmits copy of a memorial to Lord Castlereagh. States the grounds on which he bases his petition.	185
	(In Rashleigh, Son and Lee's letter of 5th May.)	
February 18, Westminster.	Memorial of Col. Lauchlan McLean for lands.	151
February 28, London.	Idle and Co. to Edward Cooke. Complaining of the infringements of their rights for cutting masts and other naval timber in Canada.	155
March 5, London.	Alexander Mackenzie and Thomas Forsyth to Castlereagh. Applying for the aid which the Bishop of Quebec assured them would be given to finish the Protestant Church at Montreal.	157
March 10, London.	Memorial of the merchants of London trading to Canada to the Privy Council, respecting the duties on furs.	158
	<i>Enclosed.</i> Schedules of duties.	160, 161
March 30, Treasury.	George Harrison to Edward Cooke. The Lords of the Treasury on considering the memorial of the widow of La Corne St. Luc think she has a strong claim to an allowance. If Lord Castlereagh concurs in their opinion he is to direct Sir James Craig to pay her such annual pension as is proper.	162
April 8.	Unsigned paper on the subject of the Mohawk lands.	163
April 27, Dundee.	List of fifty persons who sailed for Quebec on board the "Albion."	192
	(In Harrison's of 20th May.)	
May 5, Hatton Garden.	Rashleigh, Son and Lee to George Cooke. Having received from their client Chief Justice Monk, a petition for lands which had been forwarded to Lord Castlereagh, they are desirous of knowing whether it has been received and whether any steps have been taken upon it. Also enclose copy of a letter received at the same time from Mr. Monk to be laid before Lord Castlereagh when the petition is under consideration.	184
	(The enclosure calendared at its proper date.)	
May 9, Edinburgh.	Morris West, secretary to the Board of Customs, to George Harrison. Encloses a list of 60 persons who sailed for Quebec on board the "Albion" to be laid before the Lords of the Treasury.	191
	(In Harrison's of 20th May.)	
May 20, Treasury Chambers.	George Harrison to J. Beckett. Having laid before the Lords Commissioners a letter (enclosed) from the secretary to the Board of Customs in Scotland with a list of 60 persons who sailed in the "Albion" for Quebec, transmits the same for the information of the Earl of Liverpool.	190
	(Enclosures calendared at their respective dates.)	
June 2, Adelphi.	Sir Alex. Mackenzie to Ed. Cooke. Thinks it unnecessary to recall the claims of the Chevalier de la Garde as they have been sufficiently explained; confines himself to giving his opinion as to the best mode of procuring the means of subsistence for Mr. de la Garde and his family.	194

1809.  
June 9,  
Quebec. Sarah Taylor, widow of Nathaniel Taylor, to Lord Castlereagh. Memorial asking for an addition to her present allowance. Page 197
- July 7,  
Rosemount. Bishop (Anglican) of Quebec to Ed. Cooke. Thinks from the tone of his (Cooke's) answer to the application made by Sir Alex. Mackenzie for assistance for building the Protestant Church at Montreal, that he (Mackenzie) must have conveyed the idea that he had received a "particular assurance" from Government of the aid requested. In case it might be thought he assumed much more than should have been done, he explains the transaction in question. 199
- August 1,  
Quebec. Wm. Smith, Master in Chancery, to Lord Castlereagh. Memorial for salary. 209
- September 8,  
Downing St. Draft of a letter to the Anglican Bishop of Quebec. His letter to the Archbishop of Canterbury expressing disappointment at receiving no official communication on the subject of the grant for finishing the Church at Montreal has been transmitted to this office. Though hopes were held out to him (the Bishop) it was expected that on his return to Quebec a memorial would have been sent to the King. The Chancellor of the Exchequer will be ready to move the House at the next session, but a detailed memorial is necessary. Reasons for the delay is settling other matters respecting ecclesiastical rights in Canada. 206
- September 11,  
Whitehall. Stephen Cottrell to ——. The Lords of the Committee of Privy Council for Trade have taken the joint memorial of the merchants of Lower Canada into consideration and are glad to find that they have been anticipated in several instances by certain bills which have since received the sanction of the Legislature. An account of these Acts. The Lords of the Committee will be ready to attend to any further representations on the subject. 211
- September 22,  
Whitehall. Same to Ed. Cooke. The "Act" for erecting common jails, with Court Halls in the Inferior District of Gaspé, has been laid before the Committee of the Privy Council for Trade and their Lordships observing that Mr. Baldwin has not given his opinion thereon, he requests that it be forwarded. 214
- November 11  
Treasury Chambers. George Harrison to Hon. Cecil Jenkinson. Having laid before the Lords Commissioners a letter from Craig, transmitting the Receiver General's accounts for the half year ending 10th October, 1808, and report of the Council on the public accounts for the same period, is commanded to transmit the same for Lord Liverpool's observations thereon. 215
- November 23,  
Quebec. Craig to Castlereagh. (No. 79.) A report that H. M. Ship "Foxhound" has been lost occasioned him to refer to the letter book to see what letters had been sent by her. Sends a copy of one, of which no duplicate appears to have been transmitted. 143
- December 20,  
Treasury Chambers. George Harrison to Hon. Cecil Jenkinson. Having laid before the Lords Commissioners Craig's letter enclosing a list of astronomical instruments required for the Surveyor General's office in Canada, is commanded to transmit the same for Lord Liverpool's opinion thereon. 216
- Enclosed.* Craig's letter dated 3rd November. 217
- List of astronomical instruments. 218
- December 22,  
Downing St. Draft of a letter to Craig. (No. 1.) Five Acts passed by the Legislature of Lower Canada in May last have been approved of. 144
- December 22,  
Downing St. Same (No. 2.) Transmitting Order in Council authorizing the giving due effect to the Bill passed by the Legislature of Lower Canada for erecting jails in the District of Gaspé. 146
1810.  
January,  
Downing St. Same. (No. 3.) Despatches received and laid before the King. Cannot recommend the application of the puisne judges for an increase of salary, as the ground of the memorial, the advanced price of the necessaries of life, might be put forward by every other public officer in the

## Department of Agriculture—Archives.

1810.

country. Application will be made to Parliament for a sum not exceeding £4,000 to complete the Protestant church at Montreal. The instructions he (Craig) has already received to close with the offer of Monro and Bell for the lease of the Forges of St. Maurice, render it necessary to enter further into the subject of Mr. Black's proposal. The requisitions for Indian stores and stationery for 1810 and 1811 have been forwarded to the Treasury. Transmits copy of memorial from the widow of David Lynd, praying for an extension of the lease of certain lands. If he sees no objection, necessary directions are to be given. /Page 141

### GOVERNOR CRAIG, 1810.

#### Q. 112.

1810. January 14, Quebec.	Craig to Castlereagh. (No. 79.) Enclosing certified copy of the rates of exchange and current prices at Quebec for the months of November and December last. <span style="float: right;">Page 2</span>
	<i>Enclosed.</i> Quebec prices current for November. <span style="float: right;">3</span>
	Ditto for December. <span style="float: right;">6</span>
January 15, Quebec.	Same to same. (No. 80.) Enclosing copy of the answer of Chief Justice Monk to a communication on his application for a grant of a township. Hitherto it has not been usual to give grants for services under the Civil Government. One quarter of a township was granted to each of six Executive Councillors constant in their attendance to the land business, under authority of a despatch dated 6th June, 1801; which also empowered the governors to decide what proportion should be given to members who had only attended occasionally. Three grants were made, 7,000 acres each, to the Bishop of Quebec and Mr. Baby, and 11,000 to the representatives of Mr. Finlay. Encloses an extract showing that the largest quantity intended to be granted to a single individual was 12,000 acres. Mr. Monk does not appear to prefer any claim on the plea of having given his time to the land business. <span style="float: right;">9</span>
	<i>Enclosed.</i> Letter from Monk, 23rd December, 1809. <span style="float: right;">11</span>
	Extract of a despatch on the subject of grants of land. <span style="float: right;">13</span>
February 21, Quebec.	Craig to Castlereagh. (No. 81.) The Legislature of Lower Canada met on the 2nd inst. Encloses printed copy of the speech on the occasion. <span style="float: right;">15</span>
	<i>Enclosed.</i> Speech, English. <span style="float: right;">16</span>
	Ditto French. <span style="float: right;">23</span>
February 21, Quebec.	Craig to Castlereagh. (No. 82.) Enclosing addresses from the Legislative Council and Assembly on the event of His Majesty entering into the fiftieth year of his reign, to be laid before the king. <span style="float: right;">30</span>
	<i>Enclosed.</i> Address, English. <span style="float: right;">31</span>
	Ditto French. <span style="float: right;">33</span>
February 21, Quebec.	Same to same. (No. 83.) Enclosing certified copy of rates of exchange and current prices at Quebec for January last. <span style="float: right;">35</span>
	<i>Enclosed.</i> Quebec prices current. <span style="float: right;">36</span>
February 21, Quebec.	Same to Lieut.-Col. Bunbury. (Private.) Congratulates him on his appointment in the Secretary of State's office. Gives a lengthy account of how he is situated with the Parliament, as he thinks Lord Liverpool will be glad to know the peculiar circumstances under which he dissolved his last one. <span style="float: right;">39</span>
	<i>Enclosed.</i> List of the members, with their circumstances and professions or trades. <span style="float: right;">53</span>
March 24, Quebec.	Craig to—— (No. 5.) Though pressed by business, sends a report of the Democratic party here, lest an exaggerated account should reach England. This party has long been engaged in sowing the seeds of their pernicious principles, among the ignorant. It now becomes necessary

1810.

	to take decisive steps to quell the dissatisfaction. Has seized the press in the service of this party and arrested the leaders, Messrs. Bédard, Blanchet and Taschereau, together with the printer, on a charge of treasonable practices. Encloses copy of a proclamation issued on the occasion. It has produced a considerable effect among the wavering; he has not had time to hear of the full effect yet. Believes the people at large will be brought to a sense of the folly of their allowing themselves to be led astray.	Page 55
	<i>Enclosed.</i> Address to the Canadians (French).	59
	Speech on the dissolution of Parliament.	77
	Proclamation by Craig: English, 81; French, 89.	81, 89
March 30, Quebec.	Craig to the Earl of Liverpool (No. 6, duplicate). Enters into his reasons for dissolving Parliament, for the information of His Majesty.	98
April 27, Quebec.	Same to same. (No. 6.) Encloses certified copy of rates of exchange and current prices at Quebec for the months of February and March last.	114
	<i>Enclosed.</i> Quebec prices current for February.	115
	Ditto for March.	118
May 1, Quebec.	Craig to Liverpool. (No. 7.) Conceives it to be his particular duty to forward a report on the state of this province. A lengthy report on the general affairs and political situation.	121 to 157
	<i>Enclosed.</i> Letter dated 27th July, 1805, from Milnes to Earl Camden. Sending memorial of Monseigneur Pierre Denault to be acknowledged bishop of the Roman Catholic Church.	158
	<i>Enclosed.</i> Memorial.	160
May 10, Quebec.	Craig to Liverpool. (No. 8.) An Act was passed in the year 1805 for laying duties on the importation of certain articles therein mentioned, and on sales by auction, to provide a fund for the erection of jails in the districts of Quebec and Montreal, which was to expire on 25th March last. This measure has been so much more productive than was expected that by the expiration of the year the fund will amount to about £72,000. The charges will be £13,000 for Quebec jail, the same for Montreal, and £2,000 for Gaspé, which will leave a large surplus on the subject of which he wishes for instructions. The operation of this Act was very unfavourably looked upon by the merchants. Remarks on the civil expenditure of the province.	163
	<i>Enclosed.</i> Statement of cash received under the Jail Act.	169
May 12, Downing St.	Draft of a letter to Craig. (No. 4.) He is to collect a military report from each colony or station within his command, with a detailed description and necessary plans with remarks on the inhabitants, their political character, &c., to be kept to form a collection for the information of His Majesty's Government whenever they may require to refer to them.	170
May 12, Quebec.	Craig to Liverpool. (No. 9.) Recommending the Hon. Pierre Amable De Bonne to be a member of the Legislative Council.	172
May 17, Quebec.	Ryland to the Chief Justices and Puisne Judges of the Courts of King's Bench, Quebec and Montreal. Asking for a report as to Attorney General Uniacke's fitness for the position.	229
May 17, Quebec.	Craig to Liverpool. (No. 10.) The state of the police both in Quebec and Montreal has been a cause of complaint ever since he (Craig) arrived. Encloses two presentments of different grand juries. Difficulty of inducing gentlemen to act as magistrates. The Quarter Sessions often adjourn for want of a sufficient number of Justices. Has appointed a barrister, Mr. Cuthbert, to be chairman of the Quarter Sessions, with a salary of £400 a year, with £100 additional as Inspector of Police. At Montreal, has appointed two Justices as Police Magistrates at £250 a year each. The advantage of these appointments. Trusts the measures will be approved.	173
	<i>Enclosed.</i> Presentments.	177, 180



## Department of Agriculture—Archives.

- 1810.
- Report of the Committee of the whole Council on the defective state of the police in Quebec and Montreal. Page 183
- May 18, Quebec. Craig to Liverpool. (No. 11.) Enclosing such returns relative to the revenue and expenditure of the Colony as appear calculated to bring the important subject under one view for his Lordship's information. Explanation of these returns. 184
- May 21, Montreal. *Enclosed.* The returns. 188a, 188b, 188c, 188d  
 Sewell, Williams, De Bonne, and Kerr to Craig. Reporting that they consider the Attorney General's knowledge of criminal law very superficial. His knowledge of civil law often defective and he possesses little acquaintance with the French language, therefore they do not consider him qualified for the office. 234
- May 21, Montreal. James Reid to Ryland. Having been absent from the province during the sitting of the only court where Mr. Uniacke had any business to manage, he is unable to report on his efficiency. 233
- May 21, Quebec. Monk, Panet, and Ogden to ———. Reporting that they have hardly had a chance to judge of Uniacke's efficiency but do not think he quite comes up to what the Attorney General should be. 231
- May 22, Quebec. Craig to Liverpool. (No. 12.) Transmitting copies of the only two Acts passed by the Legislature last session, also printed copies of the Journal of the House of Assembly for 1809 and 1810, and a transcript of the Journal of the Legislative Council for 1810. 189
- May 29, Quebec. Same to same. (No. 13.) Transmitting copy of the proceedings of the Executive Council, Lower Canada, on Matters of State, between 22nd August, 1809, and 19th March, 1810, inclusive. 190
- May 31, Quebec. Same to same. (No. 14.) Referring to correspondence which has already taken place on the subject of granting the waste lands. Thinks there was some misunderstanding respecting his despatch No. 41, where he enquired as to the residues of townships, as the answer, No. 23, seemed to refer to Crown and Clergy Reserves. Requests an explanation as matters are at a standstill. 191
- May 31, Quebec. Minute of a communication made to the Attorney General by order of the Governor suspending him (the Attorney General) from his office. 236
- June 1, Quebec. Craig to Liverpool. (No. 15.) Enclosing, in order to complete the report on the state of the province, two papers, the first a copy of Chief Justice Sewell's letter to him (Craig) respecting the politics, waste lands, &c., of the province, and discussing the subject of uniting Upper and Lower Canada, on which he is well able to write; the second, an extract of notes by a gentleman, also on the subject of the union. 193
- Enclosed.* Sewell's letter. 196  
 Extract of notes. 210
- June 1, Quebec. Craig to Liverpool. Encloses an abstract of disbursements on account of the extraordinary services of the army in Canada, and of moneys paid on warrants to supply the deficiencies of the Civil Revenues of Upper and Lower Canada between 25th December, 1803, and 24th June, 1809, also a detailed explanation of the particulars by which the increase of expense within the last three years has been incurred. Observations on these expenses. 213
- Enclosed.* Remarks in explanation of the increased expenditure. 215  
 Abstract of disbursements. 223a
- June 3, Quebec. Craig to Liverpool. (No. 16.) In June last Mr. Uniacke was appointed Attorney General in the place of Mr. Sewell, made Chief Justice. That gentleman's total ignorance either of the French law or language, knowledge of both of which is absolutely necessary in Canada, has brought matters to such a standstill that he decided to suspend Uniacke; however, to avoid unpleasantness he desired him to ask for leave of absence to go to England, which he (Craig) granted. Asks that he be removed from office. Has appointed Mr. Ed. Bowen to act in the meantime,

	1810.	and recommends that he be appointed. Encloses some correspondence on the subject.	Page 224
		(Enclosures calendared at their respective dates).	
June 4, Quebec.		Craig to Liverpool. (No. 17.) Enclosing Addresses from the Legislative Council and House of Assembly on the event of His Majesty having entered on the fiftieth year of his reign.	238
		<i>Enclosed.</i> Address from the Legislative Council	239
		Ditto from House of Assembly.	241
June 4, Quebec.		Craig to Liverpool. (No. 18.) Enclosing address from the House of Assembly to the King relative to the payment of the civil expenditure of the Government of this Province. Similar Addresses were voted by them at the same time to the House of Lords and the Commons in England, stating that the House of Assembly is enabled to engage to pay the civil expenditure of the Government. Encloses copies of these Addresses.	244
		Address to the King, English.	246
		French.	248
		Ditto to the House of Lords.	250
		Ditto to the House of Commons.	252
June 6, Quebec.		Craig to Liverpool. (No. 19.) Mr. Caldwell, Receiver General, died a few days ago. Has appointed his son John to fill the position till His Majesty's pleasure be known. Recommends him for the situation.	254
June 6, Quebec.		Same to same. (No. 20.) Despatches received. Has directed a lease of the Forges of St. Maurice to be made out in favour of Monro and Bell, at an annual rental of £500. Mrs. Lynd has applied for an extension of her lease of the Jesuits' Farm, adjoining the suburbs of Quebec, for a term of ninety-nine years. Does not recommend its being granted. Reasons for thinking a short lease should be sold to the highest bidder.	255
June 8, Quebec.		Same to same. (No. 21.) Three Bills have been passed annually here, the first respecting aliens and certain subjects of His Majesty who have resided in France coming into the Province, or residing therein, the second for the better preservation of His Majesty's Government, and the third for making a temporary provision for the regulation of trade between this Province and the United States. The first Bill is of much importance here; several persons belonging to the Province have gone to France, certainly with no good intention, and it would be dangerous to allow them to return. These Acts are not now in existence, not having been passed last Session. Is convinced the Parliament will not pass the first two again. Begg that they should be supplied by Acts of the Imperial Parliament, the first to continue only during the war, but the third, relating only to trade, might be made perpetual.	258
June 10, Quebec.		Same to —. Circumstances have occurred which make him (Craig) desirous that the seat in the Executive Council be withheld from Mr. de Salaberry.	262
June 10, Quebec.		Craig to Liverpool. (No. 22.) Enclosing certified copy of the rates of exchange and current prices at Quebec for the months of April and May last.	263
		<i>Enclosed.</i> Quebec prices current for May.	264
		Ditto for April.	267
June 10, Quebec.		Craig to Liverpool. (No. 23.) Transmitting naval officers' returns of vessels entered inwards and cleared outwards at Quebec between 10th October, 1809, and 5th January, 1810.	270
July 10, Quebec.		Same to same. (No. 24.) Reasons for his delay in furnishing the information respecting the Indians, required by Lord Castlereagh in his despatch of 8th April, 1809. Encloses the information asked for in the form of questions and answers by officers of the Indian Department.	271

## Department of Agriculture—Archives.

1810.	<i>Enclosed.</i> Questions answered by J. M. Lamothe (in French). Page	273
	Ditto by Charles de Lorimier (in French).	283
	Ditto by Lt.-Col. F. D'Eschambault.	294
	Ditto by Louis de Salaberry.	302
	Ditto by Louvigny de Montigny.	306
September 12, Downing St.	Draft of letter to Craig. Despatches laid before the King. Will re-serve for separate consideration the state of the ecclesiastical establish-ments, both Catholic and Protestant. Some observations are necessary on the subject of the application of the surplus fund raised for the erec-tion of jails. Under any circumstances, the offer made in the House to provide for the future charge of the civil establishment of the Pro-vince would have required scrutiny, but in the present temper of the Assembly there can be no doubt that the object is to increase the powers of that body by assuming the control of the public supplies. Can hardly suppose a case in which it would be proper to agree to any inno-vation of this kind without a previous reference Home and the formal sanction of the Crown. The arrangements for the better management of the police of Quebec and Montreal are approved. Has ordered a copy of the despatch respecting the disbursements on account of the extraordinary service of the forces in Canada to be transmitted to the Treasury. Under the circumstances, Mr. Uniacke's leave of absence and Mr. Bowen's appointment <i>ad interim</i> is approved. The recommenda-tion of Mr. Justice de Bonne for a seat in the Legislative Council will be submitted to His Majesty.	311

### GOVERNOR CRAIG AND MISCELLANEOUS, 1810.

#### Q. 113.

1809. December 18, Admiralty Office.	John Barrow to Harrison. Capt. Henniper of H.M.S. "Mermaid" has notified the Lords of the Admiralty that the plate, &c., for the Metropolitan Church at Quebec, had been delivered to the Bishop through the Governor in Chief. (In Harrison's of 13th January 1810.)	104
1810. January 8, London.	John Black to Adam Gordon. Transmitting copies of sundry docu-ments on the subject of the Forges of St. Maurice, the originals of which he has shown to the Duke of Kent, who has promised to use his influence with the Earl of Liverpool to further his cause. Also transmits copy of a patent for the Township of Dorset, issued in his (Black's) favour with forty-three associates. Sends this patent to do away with the idea that he had received a larger grant than is usual.	99
January 13, Treasury Chambers.	Harrison to Lt.-Col. Bunbury. In answer to letter from Craig stating that the plate for the Metropolitan Church had not been received, encls-ose copy of a letter from Mr. Barrow on the subject. (Enclosure calendared at its proper date.)	103
January 20, Quebec.	Ryland to the Attorney General. Enclosing extract of minutes of Council. Desires he will prepare draft of a lease to Monro and Bell of the Forges of St. Maurice as therein ordered. Encloses also copy of the terms and conditions of the lease as specified in the advertisement in <i>Quebec Gazette</i> .	188
	Enclosed conditions of the lease.	189
	Letter from Ryland to the Attorney General directing that a new draft of the lease be prepared as the Committee altogether disapprove of that submitted.	192
	Extract from report of a committee of the whole Council.	193
	Opinion of the Attorney General of Nova Scotia, Mr. Uniacke, upon the draft of the lease.	198

1810.  
January 27, Quebec. Norman Fitzgerald Uniacke, Attorney General, to the Governor General. Respecting the propriety, under existing circumstances, of a controlling power over the trade at present carried on between Canada and the States. Page 253
- January 27, Whitehall. The Lords of the Council direct that Mr. Grece wait on them while meeting on the subject of Danish and Swedish vessels. 247
- February 7, Quebec. Attorney General Uniacke's opinion as to the effect of not passing the temporary Act regulating the trade with the United States. 255
- February 14, Treasury Chambers. Harrison to the Hon. Cecil Jenkinson. Transmits the accounts of the Receiver General of Canada from 11th October, 1808, to 10th April, 1809, with report on the public accounts for the same period for Lord Liverpool's observations thereon. 105
- February 18, Maidenhead. Lady Dorchester to ———. Asking that he (——) use his influence to obtain her son a staff appointment. 106
- March 10, Treasury Chambers. Harrison to Cecil Jenkinson. Transmitting the requisition for Indian presents for Lower Canada, for 1811, together with the proposed establishment of the Indian Department, for Lord Liverpool's opinion thereon. 107
- March 25, Whitehall. Stephen Cottrell to John Wm. Grece. Informs him that Russian, Swedish, and Danish vessels bringing cargoes belonging to these nations or any other not at war with Great Britain, to any of her ports shall be protected while so employed. Instructions have been given and passes will be granted. 248
- April 14, Treasury Chambers. Harrison to Cecil Jenkinson. Transmitting for Lord Liverpool's opinion thereon an application from Mr. Claus, Deputy Superintendent General of Indian Affairs, for an increase to his salary. 108
- June 7, Quebec. Bishop (Anglican) of Quebec to ———. Encloses a representation which he (the Bishop) lately made to Craig, respecting the ecclesiastical affairs of this province. Takes this opportunity of submitting the result of an application made by him for lands. The documents relating to the application are enclosed and comprise four papers marked C to F. 109
- Enclosed.* Representation on the state of ecclesiastical affairs. 112
- Two documents accompanying the above, both extracts from the Council Minutes. 134, 136
- Papers respecting his application for lands marked C to F. 139, 141, 142, 143
- June 8. John Black to Cecil Jenkinson. With his memorial for lands and the accompanying documents. 144
- Enclosed.* The memorial. 145
- Accompanying documents. 148, 150, 152, 153, 156
- July 16. William Parker to Robert Peel. Enclosing a memorial from William Crawford asking to be appointed to the vacancy in the Court of King's Bench. 173
- Enclosed.* The memorial. 174
- July 21, St. Johns, Nfd. Isaac Coffin, Vice Admiral, to Liverpool. Requesting his (Liverpool's) favourable consideration of the memorial in behalf of the widow of his uncle, the late John Coffin. 176
- July 31, Plymouth Dock. Ryland to same. Has arrived in port with despatches to be delivered in person, but finding it impossible to proceed till next day, sends them by mail, and will wait on him as soon as possible. At the time of his leaving Quebec the measures pursued by Craig had placed the province in a state of tranquility, and no immediate danger of disturbance was apprehended. 178
- August 1, Halifax. Richard John Uniacke to ———. Asks that his son, Norman Fitzgerald, be returned to his office. 179

## Department of Agriculture—Archives.

1810. August 5, Quebec.	Craig to Liverpool. Respecting a suit for wages instituted by three seamen against their captain.	Page 3
	<i>Enclosed.</i> Documents relating to the proceedings.	4 to 42
August 10, Quebec.	Same to same. (No. 25.) Enclosing certified copy of the rates of exchange and current prices at Quebec for June and July last.	43
	<i>Enclosed.</i> Quebec prices current for June.	44
	<i>Enclosed.</i> Quebec prices current for July.	47
August 11.	John Black to R. Peel. Enclosing copy of his petition for lands, to be laid before Lord Liverpool.	203
	<i>Enclosed.</i> Memorial.	145
August 22.	Paper signed V. Gibbs and endorsed "C. Answers to the Queries in papers marked B and A."	204
August 23, Covent Garden.	John Black to ——— Wilmot, private secretary to Lord Liverpool. Asking for his good offices in procuring him a situation.	207
August 30, Covent Garden.	Same to Adam Gordon, Secretary of State's Office. Asks for his good offices in procuring him a situation.	209
September 5, London.	Norman F. Uniacke, Attorney General, Lower Canada, to Col. Bunsbury. For an audience with Lord Liverpool.	212
September 5, Westminster.	Nat. Atcheson to R. Peel. Enclosing memorial from the merchants interested in the trade and fisheries of the British North American Colonies, for Lord Liverpool's consideration.	213
	<i>Enclosed.</i> The memorial.	214
September 8, Quebec.	Craig to Liverpool. (No. 26.) Transmitting naval officers' returns of vessels entered inwards and cleared outwards at Quebec between 5th April and 5th July last.	50
September 12, Downing St.	Draft of a letter to Craig. (Confidential.) On matters relating to the constitution of Lower Canada.	51
October 2, Cockglade.	Ryland to Gordon. Requests he will have the goodness to forward the letters sent, with the despatches leaving for Halifax in October.	218
October 6, Quebec.	Craig to Liverpool. (No. 27.) Some account of the works being carried on at Quebec.	67
October 18, Stirling.	Memorial of Jane and Sarah Lees.	219
October 27, Quebec.	Craig to Liverpool. (No. 26.) Enclosing certified copy of rates of exchange and current prices at Quebec for August and September last.	60
	<i>Enclosed.</i> Quebec prices current for August.	61
	Ditto for September.	64
November 6, Quebec.	Craig to Liverpool. (No. 28.) Since the departure of Mr. Ryland the province has been in a state of perfect tranquillity. An effort was made to obtain the implements of the printing office in order to resume the seditious publications; he (Craig) prevented these designs by buying in the press, &c., at auction, though the bidding was high; intends to dispose of it again to different printers. Attributes the quiet in a great measure to the discontinuance of the paper. The expiration of the Alien Act has allowed some known characters to return from France. The harvest bad this year. Arrangements for procuring meat, &c. Has received applications from some Highland families for lands.	73
November 6, Quebec.	Same to same. (Private.) Has received his (Liverpool's) commands by Mr. Percival, to whom he will show all civility.	82
November 6, Quebec.	Same to same. (No. 29.) Enclosing requisition for stationery for the Civil Department, Lower Canada, for 1811. Requests that the same may be sent out as early as possible.	79
	<i>Enclosed.</i> Requisition.	80
November 6,	Same to same. (No. 30.) Enclosing requisitions, and proposed establishment of the Indian Department.	83

1810. *Enclosed.* Requisition for Indian presents, Lower Canada, for 1811. Page 84
1811. Ditto for stationery for the Indian Department, Lower Canada, 86
1811. Proposed establishment of the Indian Department, Lower Canada, for 1811. 87a
- November 10. Simon McGillivray, of the firm of McTavish, Fraser & Co., to Liverpool. Enclosing copies of documents transmitted to the Marquis of Wellesley from the committee of British merchants interested in the trade and fisheries of His Majesty's North American Colonies. Remarks. 221
- November 14, *Enclosed.* Documents. 224, 228, 231, 243, 244.  
Quebec. Craig to Liverpool. (No. 30.) Transmitting copy of the proceedings of the Executive Council of Lower Canada on Matters of State between 19th March and 7th August, 1810. 88  
(Letter dated 6th November, is also numbered 30.)
- November 19 Same to same. (No. 31.) Despatches received. The subject of the post Quebec. office here has long been open to great complaint. Had hoped a surveyor would have been sent out; but the Postmaster General here was ordered to make a report instead; his ideas about bridges, roads, &c., were good, but he quite overlooked the state of the country, which in many cases prevents any improvements; he also dwells upon the difficulty of managing the postmasters, the control of whom seems to belong to the Director of Posts, which situation is at present vacant. Difficulties in arranging the Halifax mails. 89
- November 19, Same to same. (No. 32.) Had enclosed a demand for Ordnance stores in Quebec. January, 1808, was informed that they had been loaded, but affairs in Spain taking a sudden turn had been sent there instead. Asks that the requisition be filled as soon as possible. 94
- November 23, Same to same. (No. 33.) A communication from Mr. Morier, at Wash- Quebec. ington, and an attentive consideration of affairs has strongly impressed him with the idea that war is probable. Under this conviction thinks it right to resign his command, as he has not recovered his health sufficiently to undertake the extra exertion which hostilities would call for. Will cheerfully sacrifice his wish for retirement if it is considered he can be of use. 95
- December 23, John William Grece to Liverpool. Memorial asking for a grant of Reigate. land. 249
- December 26, Earl of Harrowby to Peel. Recommends Mr. Grece for an allotment Grosvenor Square. of land. 246
1811.  
January, Draft of a letter to Craig. (No. 8.) Letter of the 23rd November re- Downing St. ceived. Regrets that indisposition will prevent him (Craig) from under- taking the extra responsibilities caused by the unsettled state of the country, owing to His Majesty's illness is unable to give any instructions, but hopes he will not be inconvenienced by holding the appointment till arrangements can be made. 97
- No date. Memorial of Jane Lynd, asking for a renewal of her lease of a farm called Belle Ville near Quebec. 101
- No date. Attorney General Uniacke's draft of a proclamation of general pardon in honour of His Majesty's jubilee to all prisoners except those detained for treason or murder. 257
- No date. Attorney General Uniacke's opinion upon John Mure's lease of part Quebec. of the King's wharf. 259
- No date. Attorney General Uniacke's opinion as to the resolution to be made upon *lods et ventes*. 261
- No date. Attorney General Uniacke's opinion to the Trinity House respecting

## Department of Agriculture—Archives.

1811. No date.	the power within its jurisdiction to make a table of fees for the affairs of the corporation.	Page 264
No date.	Attorney General Uniacke's opinion on the case of a lunatic, the wife of Sergeant Richards, R.A.	267
No date.	Attorney General Uniacke's opinion to Col. Kempt, Adjutant General, respecting the wages of seamen.	269
	Attorney General Uniacke's draft of a lease of the Forges of St. Maurice to Munro and Bell.	271

GOVERNOR CRAIG, ACTING GOVERNOR DUNN, GOVERNOR SIR G.  
PREVOST, 1811.

### Q. 114.

1810.  
July 9,  
Amherstburg. M. Elliott to William Claus. Indians to the number of 125 arrived here. They are unanimous in saying they will wait the King's commands either for peace or war. Advised them to be peaceable towards all nations and each other, and supplied them liberally with presents.

66

(In Craig's of 29th March.)

October 16,  
Amherstburg. Same to same. Enclosing heads of what passed at the Council at Brown's Town, except the answer of the Hurons, who accused the Six Nations of perfidy on almost every occasion, telling them they should keep their speeches concealed and not circulate them among their brother Nations. Red Jacket's mission appears to have failed. The Indians ripe for war, they consider they have been trampled upon by the Americans. Dreads they may commence hostilities themselves, and our government be blamed for encouraging them. Red Jacket and others have proceeded to Detroit where Governor Hull furnished them with a boat to carry them home. Had treated his party with coolness. Wants directions as to those who left the Grand River.

68

*Enclosed.* Substance of speeches at the Council at Big Rock.  
(In Craig's of 29th March, 1811.)

70

November 16,  
Amherstburg. Same to same. Enclosing speech of the Shawanese Prophet, which fully convinces him our neighbours are on the eve of an Indian war. In answer to their demand for supplies has told them their speech will be laid before their great father. Requests instructions as to how the Prophet and his adherents are to be treated. Has already served 6,000 with their annual presents and the provisions expended to 24th ult. has amounted to 70,770 rations. Reasons for the extra outlay. Asks for flags. 18th Nov. Since writing the foregoing has had a private conference with the Prophet's brother who said that at first they intended to keep their plans secret but as Governor Harrison has pushed them to avow their intentions they have decided now to disclose them. Frederick Fisher died on the 12th inst.

74

*Enclosed.* Speech of the Prophet's brother.  
(In Craig's of 29th March, 1811.)

77

December 29,  
York. Gore to Craig. Enclosing letters from Capt. Elliott, Superintendent of Indian Affairs at Amherstburg, and speeches from Red Jacket and the Prophet's brother. Asks for instructions.

65

(In Craig's of 29th March, 1811.)

1811.  
January 9,  
Quebec. Craig to Liverpool. (No. 33.) Enclosing certified copy of rates of exchange and current prices at Quebec for October and November last.

2

*Enclosed.* Quebec prices current for October.

3

do

November.

6

February 2,  
Quebec. Craig to Gore. His letter of the 29th December did not reach here till the 30th ult. Thinks upon consideration that our policy is to prevent a rupture between the Indians and the United States. A war so near

1811.

our frontiers would be very inconvenient in every way, and would expose us to suspicion on the part of the Americans, which would sooner or later involve ourselves. The bad effects inevitably attending such a war. The Indians must be advised that to avoid hostility is for their own good. They must be carefully managed. Wishes Capt. Elliott's letters were a little more explicit as he neither knows to what tribe Red Jacket belongs nor in what mission he failed of success. Page 80

(In Craig's of 29th March, 1811.)

February 26,  
York. Gore to Claus. He (Claus) is to instruct Elliott to be more than usually circumspect in his communications with the Indians so as to leave no possible suspicion of favouring their projected hostilities against the United States. He is to impress upon the Indians the certainty of misfortune to themselves in any attack upon the Whites, and that it is their father's regard for them which induces him to advise them to maintain peace. They must be delicately managed. 108

(In Craig's of 21st May.)

February 27,  
Quebec. Craig to Liverpool. (No. 34.) His failing health will compel him to give up the Governorship and leave Canada at the first opportunity. 9

March 2,  
York. Gore to Craig. Letter of the 3rd February received. Had lost no time in directing the Deputy Supt. General of Indian Affairs to caution and restrain the Indians from committing any act of hostility on the white inhabitants in the neighbourhood. Encloses copy of his letter to Col. Claus. Red Jacket is a Seneca residing on the American side, his late visit to the Westward was for the purpose of drawing away the Indians from the British to the American interest. The Canadian Indians were indignant and Red Jacket had to fly to save his life. 106

(In Craig's of 21st May.)

March 28,  
Quebec. Craig to Liverpool. (No. 35.) Enclosing copies of speeches on the opening and closing of Provincial Parliament. The session just closed much quieter than he had reason to expect. Gives a general idea of the temper of the House. 12

*Enclosed.* Speech delivered by Craig on the opening of the Parliament: English, 23; French, 26. 23, 26

Answer from the Legislative Council English 30, French 34. 30, 34

Answer from the Legislative Assembly: English, 38; French, 44. 38, 44

Speech on closing: English, 52; French, 56. 52, 56

March 29,  
Quebec. Craig to Liverpool. (No. 37.) Enclosing letter with enclosures from Lt.-Gov. Gore on the subject of the Indians, together with his answer to Gore, in which he details his reasons for wishing to discourage hostilities on the part of the Indians towards the Americans. They appear to have made up their minds as long ago as last November to have recourse to arms. By way of avoiding the horrors of an Indian war, had communicated with Mr. Morier, giving him permission to verbally inform the American Government, which he did. Reinforcements necessary in Upper Canada should hostilities take place. 63

(Enclosures calendared at their respective dates.)

March 29,  
Quebec. Same to same. (No. 36.) Notwithstanding the observation in his (Liverpool's) despatch, No. 7, of 12th September, 1810, he has been induced to give His Majesty's assent to an Act for continuing the duties imposed by that of the 45th of His Majesty. The fund arising therefrom is to be appropriated to erecting a proper building for the meeting of the Legislature. The general favour with which this Act is looked upon has compelled him to assent to it. 61

Same to same. Enclosing certified copy of rates of exchange and current prices at Quebec for February and March last. 83

*Enclosed.* Quebec prices current for February. 84

Ditto for March. 87

April 3,  
Quebec.



## Department of Agriculture—Archives.

1811. April 18, Quebec.	Craig to Liverpool. (No. 38.) Hazards enclosed triplicate of a document by an insecure conveyance as he is afraid neither the original nor the duplicate which he sent to Mr. Barclay at New York have arrived. His health unimproved. <span style="float: right;">Page 90</span> (No enclosure.)
May 5, Quebec.	Same to same. In reference to his despatch of 6th November last, No. 27, describing the states of the barracks and hospitals in Quebec, reports that he contemplates erecting a building to accommodate some of the officers as the townspeople charge them most exorbitant rents for their lodgings. A hospital is also a necessity. Has looked for a site, but the grants here have been so numerous as not to leave a single lot to Government, within the walls, eligible for the latter object. Has therefore considered the house and lot belonging to Mrs. Elmsley, and now for sale, and appointed a board of officers to report. £4,000 the price demanded. Encloses report, which was so favourable that he ordered the purchase to be made. The officers' quarters are nearly completed, and the foundation dug for the hospital. <span style="float: right;">91</span> <i>Enclosed.</i> Report of a board of officers. <span style="float: right;">94</span> Order to call the board of officers. <span style="float: right;">99</span> Report of W. Somerville, Deputy Inspector of Hospitals, on the necessity of a new hospital building. <span style="float: right;">101</span> Plan of the late Chief Justice Elmsley's house. <span style="float: right;">103</span> Statement as to value of the late Chief Justice Elmsley's house. <span style="float: right;">103</span>
May 21, Quebec.	Craig to Liverpool. (No. 39.) In despatch No. 36, he thought it right to warn him (Liverpool) of the hostile intentions of the Indians of the Upper Country towards the Americans and of the steps taken in the matter. Encloses two letters from Lt.-Gov. Gore and also copy of his (Gore's) instructions to the Deputy Supt. of Indian Affairs. <span style="float: right;">105</span> (Enclosures calendared at their respective dates).
May 31, Downing St.	Draft of a letter to Craig. From the circumstances stated in letter of 23rd November, it is thought advisable to authorize him (Craig) to deliver over to Sir George Prevost the authority with which he is vested, who has been instructed to hold himself in readiness to proceed to Canada upon the first intimation he may receive of his (Craig's) intention to relinquish the government. Transmits an additional instruction to be used if necessary for placing the officer in command of His Majesty's Forces in Canada for the time being next in rank to the Lieut.-Governor in the list of the Council; a successor under any contingency, would thus be provided. His continuance in the Government left to his own discretion. <span style="float: right;">111</span>
June 18, Quebec.	Craig to Liverpool. (No. 38.) Transmitting copy of proceedings of the Executive Council concerning matters of State between 8th August, 1810, and the 11th March, last, also concerning the Waste Lands of the Crown between 29th January, 1809, and 11th March last, together with a copy of the proceedings in the Executive Council relative to petitions for leases of the Crown and Clergy Reserves between 29th January, 1809, and 11th March last. <span style="float: right;">113</span>
June 18, Quebec.	Same to same. Transmitting naval officers' returns of vessels entered inwards and cleared outwards at Quebec between 5th January, 1810, and 5th January last. <span style="float: right;">114</span>
June 18, Quebec.	Same to same. (No. 39.) Transmitting copy of the Journal of the Legislative Council together with the exemplifications, agreeably to the enclosed schedule of the several Acts passed in the last session of the Provincial Legislature; also some printed copies of the same and of the Journals of the House of Assembly. Copy of an Act for erecting a jail in the District of Three Rivers and for providing the means for defraying the expense thereof is also transmitted for his Majesty's approbation. Recommends this as jail as indispensably necessary. <span style="float: right;">115</span> <i>Enclosed.</i> Schedule of Acts passed. <span style="float: right;">116</span>

1811.				
June 18, Quebec.	Same to same. (No. 41.)	Enclosing certified copy of the rates of exchange and current prices at Quebec for April and May last. Page	121	
	<i>Enclosed.</i>	Quebec prices current for April.	122	
		Ditto for May.	125	
June 20, Quebec.	Thomas Dunn to Liverpool. (No. 1.)	Craig sailed for England on the 19th inst., therefore the government has devolved on him as oldest Protestant member of the Executive Council. Craig's unremitting attention to civil matters has left little to be done just now.	128	
July 5, Downing St.		Draft of a letter to the officer administering the Government. Six months additional leave has been granted to Attorney General Uniacke.	130	
July 13, Downing St.		Draft of a letter to Craig. (No. 13.)	Lieut.-Governor Gore having requested leave to return to England on his private concerns, the Civil Administration is to be placed in the hands of the senior military officer during his absence. Transmits an instrument authorizing this arrangement. The selection of a proper officer left to his (Craig's) selection.	131
July 28, Downing St.		Draft of a letter to the officer administering the Government in Lower Canada. The Prince Regent entirely approves of Craig's management of the Indians hostile to the United States, and desires that the same methods be persevered in.	110	
July 29, London.		Craig to Liverpool. He landed in London on the 28th inst. Had embarked at Quebec on the 19th June, leaving the Government in the hands of Mr. Dunn. Reasons for selecting that gentleman. Only the very infirm state of his health could have induced him to give up his charge. His malady will not at present allow him to pay his respects to him (Liverpool.)	132	
July 31, Downing St.		Draft of a letter to Craig. (No. 15.)	His despatch of the 29th inst. has been submitted to the Prince Regent, who considers him in the state of his health to have been perfectly justified in acting as he did, and regrets the cause which compelled him to solicit the appointment of a successor.	134
August 2, Quebec.	Dunn to the Chief Justice.	Having received a memorial in behalf of John Stephenson, respecting 201 chests of tea refused entry at the post of St. Johns, and a letter from the collector of that post, corroborating his statement, he takes this opportunity of desiring that the opinion of the whole Council be asked as to the propriety of adopting the enclosed or some other form of proclamation making public the prohibition of the statute 7th Geo. I., sec. 9, which would probably have the effect of checking the import of prohibited goods and saving much trouble to the Custom House officers. If the Committee do not consider a proclamation advisable, asks to be informed what course is to be pursued.	157	
	<i>Enclosed.</i>	Memorial of John Stephenson.	159	
		The proclamation (not adopted).	161	
August 10, Quebec.	Dunn to Liverpool. (No. 2.)	The important despatch of the 6th April relative to the enforcing of the statute of the 7th George 1st, received on the 13th July. Had submitted it with its enclosures to a committee of the whole Council. Encloses copy of the minutes on the same. Encloses also a quarterly statement showing the amount of East India produce imported from the United States by way of St. Johns. The vicinity of this post to the frontier affords daily opportunities for importation. Has ordered that no seizure be made of East India goods until after the 24th inst., when the instructions will be carried into effect. Encloses proclamation and Order in Council on the subject.	135	
	<i>Enclosed.</i>	Copy of minutes of Council.	137	
		Statement of imports and exports at the Port of St. Johns.	144	
		Proclamation: English, 147; French, 149.	147, 149	
		Order in Council: English, 151; French, 154.	151, 154	
August 21, Downing St.		Draft of a letter to the Officer commanding in Lower Canada. Transmitting copy of memorial from Jane and Sarah Lees for a grant of land		

Department of Agriculture—Archives.

1811.

- to which their brother, John Lees, had a right as a member of the Executive Council. The propriety of laying an attachment upon the property will be determined by the progress made towards the final settlement of Mr. Lees's accounts and by ascertaining whether he is actually indebted to the province. Page 163
- August 26, 1811. Dunn to Liverpool. (No. 3.) Despatch of 23rd April received and laid before a committee of the whole Executive Council for their opinion and advice. Encloses copy of the minute of the proceedings thereon. The proclamation he recommended was issued on the 12th inst. Minute of proceedings of the Council relative to the prohibition of gunpowder, arms, etc., being exported without license. 165
- September 23, 1811. Enclosed. Draft of the proclamation. 167
- September 23, 1811. Sir George Prevost to same. (No. 1.) Arrived in Quebec on the 13th inst. Assumed the Civil Administration and command of the forces. Will proceed immediately to Montreal and the military posts in the neighbourhood to acquire a necessary insight into the military resources of the country. Will, on his return, represent some necessary objects for the commands of His Majesty. 170
- September 24, 1811. Same to same. (No. 2.) Despatch No. 9 received. Will make a full communication on the subject mentioned therein when he returns from the interior of the country. In the meantime has ordered two officers to proceed from Halifax to Quebec by land, and from their report he will be furnished with matter of observation upon the statement of Mr. Heriot, D.P.M.G., forwarded to him. Despatches Nos. 10, 12 and 13 received. Shall issue to Mr. Ryland the amount of his expenses contained in despatch No. 12. That addressed to Lieut.-Gov. Gore enclosed in No. 13, has been forwarded. Has selected Major General Brock as the fittest person to undertake the Civil Administration of Upper Canada upon the departure of Gore, and he has consequently been ordered to proceed immediately to Upper Canada. Wm. Thomson, Deputy Commissary General, has received leave of absence as clerk of the Crown and prothonotary in Nova Scotia, and is to proceed to Quebec to audit the accounts. 172
- October 3, 1811. Draft of letter to Prevost. Robert Gilmour has been promoted to be Deputy Assistant Commissary General to the Forces. 175
- October 3, 1811. Return of camp equipage remaining in store at Quebec. 181
- October 4, 1811. A. H. Pye, Deputy Quartermaster General. Enclosing a return of the camp equipage in Quebec. 180
- October 10, 1811. Prevost to Liverpool. (No. 3.) Reporting the death of Mr. de Lanaudière, a member of the Legislative Council and Grand Voyer of Lower Canada. Has appointed Mr. Baby, Adjutant General of Militia, Grand Voyer, on his resigning the military position. He was becoming too infirm and efficient officers are absolutely necessary at this critical time. Has promoted the Deputy Adjutant General and appointed a brother of Mr. de Lanaudière to be deputy. Hopes these appointments will be approved. 176
- October 11, 1811. Same to same. (No. 4.) Asks to be allowed to issue an allowance in lieu of forage for the horses of the Adjutant General and Quartermaster General of the Militia in Lower Canada. 178
- October 13, 1811. Same to same. (No. 5.) Encloses a report of the quantity and state of the camp equipage in His Majesty's magazines in this garrison. Suggests that in the present state of relations with the United States a supply of camp equipage of the new pattern complete for 5,000 men be sent out as early next season as possible. 179
- (Enclosures calendared at their respective dates.)
- October, 21 1811. Sewell to Prevost. The death of Mr. de Lanaudière makes it necessary to draw attention to the present state of the Legislative Council, as he fears the business next session will be delayed for want of a quorum

1811. if some new members are not appointed. Transmits list of the Council stating the present residence of each member. Page 187
- October 21, Same to same. On the state of the police at Three Rivers; and recommends Mr. Coffin to be chairman of the sessions. 189  
Quebec.
- October 22, Prevost to Liverpool. (No. 6.) Chief Justice Sewell, as Speaker of the Legislative Council, has represented that owing to the great age and serious infirmities of several members, inconvenience has been caused; recommends that John Richardson, Jean Baptiste Hertel de Rouville, John Caldwell, Ignace Aubert de Gaspé, James Cuthbert, Charles Gaspard de Lanaudière, Jacques Perrault and Charles William Grant be appointed members. Encloses descriptive return of the Legislative Council, also Sewell's letter. 182  
Quebec. *Enclosed.* List of members. 184  
(Sewell's letter calendared at its proper date.)
- October 24, Same to same. (No. 7.) Enclosing representation from the Chief Justice on the state of the police at Three Rivers. Has appointed Thomas Coffin to be Chairman of the Quarter Sessions there with a salary of £200 a year. Hopes it will be approved. 188  
Quebec. (Enclosure calendared at its proper date.)
- October 28, Same to same. (No. 8.) Enclosing return of small arms in the Ordnance store at Quebec. Arms and accoutrements sufficient for 10,000 men necessary next Spring. Has recommended Lieut.-Colonel Deschambault for the brevet of Colonel and to be substituted for one of the absent Inspecting Field Officers belonging to the Canadian Staff. Concluding he was to finish all works begun by Craig, he has given orders to that effect. Asks for authority to put up additional quarters in this garrison. 191  
Quebec. *Enclosed.* Return of small arms, &c. 193
- October 31, Extract of a letter from Lieut.-Colonel Bruyères, Royal Engineers, to the Military Secretary. Respecting the works being carried on by the Royal Engineer Department. 203  
Quebec.
- November 7, Prevost to Liverpool. (No. 9.) Enclosing memorial of John Caldwell, Receiver General of Lower Canada. Recommends it. 195  
Quebec. *Enclosed.* The memorial. 196
- November 7, Same to same. (No. 10.) On the 22nd October he had sent a statement of the Legislative Council, now encloses one of the Executive Council; an increase in the number of members is necessary. Recommends Antoine Louis Juchereau Duchesnay, James Kerr, Ross Cuthbert, Michael Henry Percival, John Muir, Oliver Perrault, and Wm. Batchelor Coltman. 199  
Quebec. *Enclosed.* Descriptive list of the Executive Council. 200
- November 7, Same to same. (No. 11.) Enclosing extract from the Commanding Engineer's report, showing that besides the works begun, barracks are necessary at Quebec. Has applied for a detachment of Royal Military artificers to assist the Engineer Department. Hopes the application will have his support. 202  
Quebec. (Enclosure calendared at its proper date)
- November 9, Same to same. (No. 12.) Transmitting Naval officers' returns of vessels entered inwards and cleared outwards at Quebec to 5th July. 220  
Quebec.
- November 9, Same to same. (No. 13.) Enclosing requisition for stationery for the Civil Department of Lower Canada for 1812. 222  
Quebec. *Enclosed.* Requisition.
- November 9, Same to same. (No. 11 B.) Enclosing the following requisitions, &c. 210  
Quebec. *Enclosed.* Requisition for goods to complete the Indian presents in Lower Canada for 1812. 211  
The same for Upper Canada. 211  
Requisition for stationery for Indian Department, Lower Canada, for 1812. 213

## Department of Agriculture—Archives.

1811.	Proposed establishment of the Indian Department, Lower Canada for	Page 215
	1812. Ditto for Upper Canada.	216
	Requisition for provisions and rum for the Indians in Upper Canada for .812.	217
	List of persons holding pensions in the Indian Department of Upper Canada.	218
December 31 Downing St.	Draft of letter to Prevost. (No. 1.) Despatches received. The necessary instruments are preparing for the appointment of the persons recommended to be members of the Executive and Legislative Councils, and will be forwarded as soon as completed. The appointments spoken of in despatch No. 3 are approved of. He is to issue an allowance in lieu of forage for the horses of the Adjutant and Quartermaster General of Militia. The appointment of a chairman to the Quarter Sessions at Three Rivers approved.	224
December 31, Downing St.	Same. (No. 2.) Approves of Mr. Thomson's proceeding to Quebec to audit the army accounts.	174
1812. February 5, Downing St.	Same. (No. 4.) Despatches respecting the fortifications received. Approves of such works as are in hand being carried on. Urges economy. No estimate of the expense of the barracks received. Asks that it be sent as soon as possible.	207
February 13, Downing St.	Same. (No. 7.) Orders have been given that the requisitions sent are to be filled and sent to Quebec on the first opportunity. Is anxious for a report on all matters relating to the military defence of the province. Any observations on the measures to be adopted in case of attack, the fortifications, militia, &c., would be received with great interest.	219

### GOVERNOR SIR GEORGE PREVOST AND MISCELLANEOUS.

#### Q. 115.

1790. July 17.	Inventory of real and movable property and debts belonging to the estate of the late Henry Taylor in the possession of Johnston and Purss.	236
1794. January 9, Quebec.	Report of the auditors on the accounts rendered by Johnston and Purss regarding their management of the estate of the late Henry Taylor.	226
March 13.	Report of the plaintiff to the judges of the Court of Common Pleas on the accounts of Johnston and Purss, and report of the auditors made to the Court last January.	239
	<i>Enclosed.</i> Accounts due Johnston and Purss by the estate of the late Henry Taylor.	246, 249, 250
1810. May 31.	——— to Liverpool. Memo. of despatches from Craig concerning waste lands of the Crown.	140
June 11, Montreal.	P. Langan to Gore. On the subject of his claim to some islands near Kingston.	161
	<i>Enclosed.</i> 1st, Report of the Committee for examining applications made for lands. Extracts concerning Grande Isle and adjacent islands, dated 12 Dec., 1788.	165
	2nd, Report of the Fund Committee.	170
	Extract of the minutes of Council respecting Grande Isle, dated 9th November, 1789.	172
	Report of a Committee appointed in 1789, to examine report of the Land Committee on the claim to Grand Isle.	173
1811. January 8.	Extract from the will of the late James McGill concerning the legacy for founding a university in Lower Canada.	17

1811.  
January 9,  
Treasury  
Chambers. George Harrison to Robert Peel. Transmitting accounts of the late Receiver General of Lower Canada from 10th October, 1809, to 28th May last, for Lord Liverpool's observations thereon. Page 24
- January 24,  
Treasury. Same to same. Transmitting a requisition for Indian presents, together with the proposed establishment of the Indian Department for 1811, received from Craig, for Lord Liverpool's opinion thereon. 25
- February 2,  
Whitehall. W. Fawkener to ———. The Committee of Council for Trade and Foreign Plantations having had under consideration a memorial from the merchants interested in the Trade and Fisheries in the British North American Colonies, stating that the Act of the 28th of His present Majesty, Ch. 39, passed to encourage trade between Canada and the West Indies, has not produced the effect intended as stated in an address of the Assembly to the Governor, 27th February, and the report of the said Assembly of the 2nd March, asking that the said Act be repealed, have directed him to enquire whether the Governor transmitted these proceedings to the Secretary of State and whether he expressed any opinion thereon. 26
- Enclosed.* The memorial. 28
- February 7,  
Whitehall. Extract from the proceedings of the House of Assembly. 29
- Same to R. Peel. The Lords of the Committee of Council for Trade after considering the memorial of the British merchants, praying that East Indian and other foreign goods be prohibited from entering Canada through the United States, have decided that the provisions of the Act of 7th Geo. I., Stat. 1, Ch. 21, Sec. 9, are sufficient to prevent all foreign goods except those from Great Britain from entering the country. 38
- Enclosed.* The memorial. 40
- Extract of a letter from James Irvine, Chairman of the Committee of Trade at Quebec, and John Richardson, Chairman at Montreal, dated 1st May, 1810, to Nathaniel Atcheson, respecting trade. 44
- Nathaniel Atcheson to Thomas Lack, enclosing a letter from Wm. Goodall to be sent in with the memorial. 48
- The letter from Mr. Goodall. 49
- February 11,  
London. Ryland to Peel. Brings to his recollection some points relative to the Colonial politics of Lower Canada upon which a final decision would be of the highest importance to the interests of the Crown in that province. Encloses a paper on the subject. 51
- Enclosed.* The paper. 53
- February 12. F. Freeling to same. Has had a correspondence with the Postmaster General of Canada on the subject of a memorial from the merchants praying for a better regulation of the posts in Upper Canada. Has transmitted the official points to the Board of Trade through which the memorial was presented. Encloses parts of the correspondence, not considered as official, as a confidential communication to Lord Liverpool. 59
- Enclosed.* Extract of letter from George Heriot, D.P.M.G. 60
- February 19,  
London. Ryland to same. Transmits copy of a paper received by him from the Lord Bishop of Quebec, Mr. Joseph Octave Plessis, which he considers a gross violation of the prerogatives of the Crown. 62
- Quebec, 25th October, 1810. Mandate of the Lord Bishop of Quebec, referred to in the above letter, ordering that public prayers be said in Roman Catholic Churches after parochial mass for the delivery of the Pope who is kept a prisoner in the fortress of Savona in Italy. 64
- Ryland to Liverpool. As the time approaches for his return to Canada, gives an account of the extraordinary expenses attending his mission to England. Encloses memorial and statement. Refers to the points on which he wrote on the 11th and 19th of February. If steps are not speedily taken for strengthening the executive power, and giving the Crown due influence over the Roman Catholic clergy, trouble may result. Difficulty of combining the English and French inhabitants against a

## Department of Agriculture—Archives.

1811.  
common enemy. He is only actuated by a sincere desire for the good of Canada in any observations he may make. Page 70  
*Enclosed.* The memorial of Ryland. 73  
Statement of expenses. 75
- March 21.  
Ryland to Peel. (Private.) Will be out of town for a few days but will return if required on business. Letters to be addressed to Northampton. Is satisfied with the determination to refer his memorial to Craig. 76
- March 21,  
Quebec  
J. Kerr, Judge of the Court of Vice Admiralty, to Craig. Encloses an exposition of facts with some observations on the subject of the jurisdiction of the Court over the River St. Lawrence, which may render the decision more easy for the King's advocate and attorney. Since his interview a judgment has been rendered by the Court of King's Bench which still more unsettles the question, and may occasion confusion at a future time. 77  
*Enclosed.* The exposition. 78
- April 4,  
Quebec.  
Thornton to Ryland. (Extract.) Sir James Craig desires him to say that all despatches have been received. He is unable to write himself, and finds his health absolutely requires that he should leave the country as early as possible. 150  
(Enclosed in Ryland's of 15th June.)
- April 22,  
London.  
Ryland to Peel. Enclosing papers relating to the powers that are assumed by the Roman Catholic Bishop of Quebec. 92  
*Enclosed.* (A.) Quebec, 22nd February, 1805. Copy of a report made by Lieut.-Governor Milnes of a cause between Mr. Bertrand, curate of St. Antoine, and one of his parishioners, named Lavergne, who had refused to furnish *pain bénit* to the new church of St. Léon. 96  
(B.) Quebec, January, 1805. Statement of the pleadings in the said cause before the Court of Appeal previous to the Attorney General's being ordered to be a party to the suit. 99  
(C.) Quebec, 11th November, 1806. Copy of the reasons of intervention on the part of the Crown which the Attorney General afterwards filed in the Court of Appeals. 105  
(D.) Quebec, 10th September, 1810. Extract of a letter received from the Governor in Chief in the month of October, 1810, containing one instance among many of the difficulties arising from illegal erection of parishes by the titular Roman Catholic Bishop of Quebec. 110
- April 23,  
Whitehall.  
W. Fawkener to Peel. Encloses by direction of the Lords of the Committee of Privy Council for Trade, copy of a report from Mr. Heriot, the Deputy Postmaster General, on the subject of a memorial from certain British merchants respecting the interior communications in British North America. The report is to be transmitted to the Governor General for any observations he may deem proper. Encloses copy of the memorial. 112  
*Enclosed.* Report dated 8th October, 1810, from George Heriot to F. Freeling, giving an account of the mode of communication and the expense attending it, hitherto adopted in the province. 113  
Copy of the memorial. 121
- May 1,  
Montreal.  
P. Langan to Lt.-Col. Bunbury, stating his circumstances, and enclosing a memorial to Lord Liverpool, asking that he be confirmed in his appointment as Paymaster of Contingencies. 126  
*Enclosed.* Copy of the general order appointing him paymaster. 129  
The memorial. 130
- May 9,  
London.  
Ryland to Peel. Stating some particulars concerning the Jesuit Estates in Lower Canada, which call for the attention of His Majesty's government. Proposing that the revenue arising from these estates be applied to educational ends. 133

1811.  
May 10,  
London. Ryland to Peel. Respecting the money required to complete the Metropolitan Church at Montreal. Page 136
- May 14. Same to ———. (Most private and confidential.) Was taken by surprise by the communication in Prevost's despatch of 13th inst. Encloses two letters as an additional motive for interesting himself in the matter. If he (Ryland) were to lose the secretaryship he would be badly off. 137
- May 21. Memorandum on the annual establishment of the Indian Department in Upper and Lower Canada, including pensions, for the last 12 years. 139
- May 29,  
Office of  
Ordnance. R. H. Crewe to Lt.-Col. Bunbury. The articles mentioned in the requisition for ordnance stores, dated 2nd December, 1807, have been ordered to be forwarded to Quebec. 141
- May 31,  
Tottenham. John Wilmot to George Harrison. Returns letter from Peel enclosing an application from Major Coffin to be compensated for services rendered by his family at Quebec. Thinks they must have been referred to him by mistake, as he has no means of knowing anything about Major Coffin's pretensions. 148
- (Enclosed in Harrison's of 13th June.)  
June 4,  
London. Uniacke to Liverpool. For an extension of his leave of absence. 142
- June 4,  
London. Ryland to Prevost. Hopes he will excuse the liberty he takes in writing. Craig's reasons for sending him to England have probably been made known to him; therefore thinks it right to lay before him (Prevost) his correspondence with the Secretary of State. Transmits copies of nine letters. A correct idea of the matter relative to the Government of Lower Canada now under the consideration of His Majesty's ministers may be drawn from them. The points of the greatest importance are the St. Sulpician or Seminary Estates at Montreal, and the assumption of the patronage of the Romish Church. If the business is got through in time will sail in the July packet. 182
- June 7,  
London. Same to Peel. Cannot find among his papers the documents which would enable him to state the annual expense of the Indian Department, however, it can be easily ascertained. Encloses a rough calculation of the saving which might be made by substituting an allowance in cash to the Indians instead of presents of goods. An exact account should be obtained of the value of the annual presents given to each tribe before any offer be made to the Indians. Thinks about two-thirds of the actual value of the presents in cash would satisfy them. Hopes his suggestions may prove of some use. A P.S. states that Lord Castlereagh's despatch to Craig (No. 21, of 10th June, 1809), will show the great difficulty of obtaining a settlement of the Indian Storekeeper's accounts in Upper Canada. 143
- Enclosed.* Calculation of the saving to Government by giving money instead of presents. 146
- June 13,  
Treasury  
Chambers. Harrison to Peel. Encloses letter from Wilmot of 31st ulto. The Lords Commissioners find that Major Coffin's family have no claim upon the fund for the relief of American Loyalists and do not know of any other source from which relief might be granted. 147
- June 15. Ryland to same. (Private.) Encloses an extract of a letter from Lt.-Col. Thornton, Military Secretary, to Sir James Craig, as it contains some particulars respecting the General which he (Ryland) may be desirous of knowing. 149
- (Enclosure calendared at its proper date.)  
June 15,  
Reigate. John Wm. Grece to same. Asks that a day be appointed for an interview. 152
- June 26,  
London. Thomas Daniel Cowdell to Liverpool. Asking a passage to British America for himself and his two sons. 153



## Department of Agriculture—Archives.

1811.  
June 27,  
London.
- Ryland to Peel. (Private.) Has at length had the good fortune to procure a copy of Sir J. Marriott's report of a code of laws for the province of Quebec, which he sends for perusal. Agrees with Marriott in all he has said concerning the province of Quebec. The importance of the Canadas both politically and commercially, increasing every day. Is glad to find that the Advocate and Attorney General are already provided with copies of this report. By pages 210 and 211 of that work he will see that so far back as 1773, the St. Sulpician estates at Montreal yielded a revenue of £8,000 sterling a year, in 1805 the produce is said to be only £3,750. If this is really the case, there can be no pretense for complaint should the Crown take upon itself the management of the property in question. Asks if any steps have been taken with respect to his memorial of 13th March. Page 155
- July 3,  
Doctors  
Commons.
- Report of the law officers of the Crown on the assumption of the patronage of the Roman Catholic Church of Quebec, that is to say:—1st. Whether the right of presentation to vacant Roman Catholic livings in the Province of Lower Canada be vested in the Crown? 2nd. Whether the vested Crown has not the right of property in the estates of St. Sulpicians, commonly called the Seminary estates of Montreal. 176
- July 5,  
Montreal.
- P. Langan to Liverpool. Memorial for himself and for the Baroness of Longueuil, relict of the late David Alexander Grant. Respecting the title to Grand Isle, near Kingston. 158
- July 5,  
Montreal.
- P. Langan (Duplicate.) Letter accompanying his memorial to Lord Liverpool on the subject of his claim to certain islands. 197
- July 8,  
Quebec.
- Edward Couch, Deputy Commissary General, to Gordon. (No. 50.) Transmitting estimates of provisions required for Canada which General Drummond declined signing, owing to the uncertain state of affairs here. His statement in despatch No. 46, of 19th June, that all provisions except rice, could be procured here, was only meant to apply in times of peace. Should hostilities commence, the supplies, especially fresh meat and salt pork, would be very precarious, and a supply of the latter should be sent from England immediately on the declaration of war. Flour and meat have been procured from the States. 262
- July 11.
- Ryland to Peel. (Private.) Asks that the accompanying letter be returned, with alterations and observations, if he appears to have taken too much upon himself. His object has always been to put the voluminous despatches into as compact a form as possible, for the consideration of His Majesty's Ministers. 181
- July 13,
- Same to ———. Enclosing letter of thanks to Lord Liverpool. 186  
*Enclosed.* The letter. 187
- July 19  
Quebec.
- Drummond to Harrison. Enclosing general estimate and statement of provisions required to victual His Majesty's troops and others in Canada, from 25th December to 1st October, 1813. Rice to be sent as early as possible. Respecting the contract for beef. Should hostilities be apprehended, it would be policy to lay in a further supply of provisions of every description. 255  
*Enclosed.* Estimate. 257  
Statement. 258
- July 20,  
Transport  
Office.
- Alex. McLeay to Peel. A passage to Canada will be provided for J. H. Smith, Loyalist. 188
- July 31  
Woolwich.
- Robert Pilkington, Lieut.-Col. Royal Engineers, to Right Hon. S. Percival. Enclosing his proposal to raise a corps of Highland emigrants for the service of Canada. 189  
*Enclosed.* The proposal. 190
- August 3,  
Treasury  
Chambers.
- Richard Wharton to Peel. Is commanded by the Lords Commissioners of the Treasury to transmit letters from Craig, dated Quebec, 18th June last, enclosing account current of the Receiver General, 189

1811.	together with a report of the committee of the whole Council on public accounts for the six months commencing the 11th April, 1810, for Lord Liverpool's observations thereon.	Page 192
August 5 Montreal.	P. Langan to Peel. Further respecting his claim to Grande Isle and adjacent islands.	193
August 8, London.	Craig to same. Returns Mr. Langan's memorial with the accompanying papers. Considers his expectations most unreasonable.	201
August 8, Woodhall, near Edinburgh.	Richardson to Gordon (?) Enclosing a memorial from the Misses Lees.	203
August 10, London.	<i>Enclosed.</i> The memorial. William Halden to Harrison. The Indian stores ordered by his (Harrison's) letter of 9th April, were shipped at Portsmouth on the 3rd and 7th instant.	204 212
August 19.	Craig to Peel. Some observations on the memorial of the Misses Lees.	206
August 21.	Major General Charles Grant, Viscount de Vaux, to Lord Liverpool. Memorial for a grant of land in the Isle of France instead of Canada.	208
August 22, Treasury Chambers.	Harrison to Peel. Enclosing copy of a letter from Storekeeper General, dated 10th inst., reporting the shipment of the supply of Indian stores, for the information of the Earl of Liverpool. (Enclosure calendared at its proper date.)	211
August 25, Saxmundam.	T. S. Gooch to ———. Requests that Mr. James Jackson, who has a situation in the Army Paymaster's Department, in Canada, be given an order to the Governor for a grant of land.	213
August 26, Ordnance Office.	Crew to Peel. Encloses an extract of letter dated 24th inst., from the Transport Board, relative to the tonnage required by the Board for the Ordnance stores to be transported to Canada. Does the Earl of Liverpool think it advisable to hire a transport or to detain them till next spring?	214
September 4, Admiralty Office.	<i>Enclosed.</i> The extract. Barrow to Lieut.-Col. Bunbury. The "Manilla" now ready to sail from Halifax to Portsmouth. What tonnage is required for the military stores for Quebec?	215 216
September 6, Whitehall.	The Prince Regent in Council has approved of the drafts of three commissions for Prevost, and Lord Liverpool is ordered to have the documents prepared for signature.	217
September 11, London.	Ryland to ———. Sir George Prevost has signified his intention of continuing him in his position as secretary. Mr. Brenton is to fill the office till his return to Canada, which will be either in the winter or early next spring. After Prevost's appointment took the liberty of transmitting to him all particulars of his mission to England. Can he be of any service to His Majesty's interests in Canada?	218
September 14,	Promotion of Robert Gilmor to be Deputy Assistant Commissary General.	220
September 19, Montreal.	(In Harrison's of 28 September.) Commissioners for building a Protestant church at Montreal to Craig. Stating that the £4,000 voted for building the Protestant church at Montreal is still unappropriated, owing to a mistake in the wording of the grant when Montreal is described as being in Upper Canada. The money is in the hands of William Dacre Adams, agent for the upper province. Asks that measures be taken to secure the money. (In Craig's of 22nd November.)	283
October 5, Chelsea College.	Lt.-Col. Mathews to Gordon. Takes the liberty of referring him to a copy of a memorial received from the Misses Lees, of Stirling, with their request that he would make enquiry at the Earl of Liverpool's office respecting the success of the original. He was acquainted with Mr. Lees, brother of the memorialists, who was a most useful officer. Mr.	

Department of Agriculture—Archives.

1811.

John Black of Halifax has written to find out the success of Sir George Prevost's recommendation that he (Black) have a seat in His Majesty's Council of Nova Scotia. Lt.-Col. Bird has also written to enquire what has been done in consequence of his memorial respecting his father's claim for indemnification for his grant of land and buildings thereon at the mouth of the Detroit, taken possession of by government. In consequence of Lt.-Col. Bird's first memorial, this property was greatly undervalued at \$1,200. Should Lt.-Col. Bird be disposed to accept, to save further trouble, desires to be informed if application may be made for payment thereof and in what quarter. He (Mathews) will wait upon him in a few days for information on these points. Page 221

- October 7, London. J. C. Harries to Harrison. Enclosing copy of a letter addressed to Col. Gordon by Deputy Commissary General Couch, dated Quebec, 8th July, transmitting the annual estimates of provisions required for the troops, which owing to the uncertain state of affairs with the States, Major General Drummond declined signing. A great part of the provisions are drawn from the States; in the event of hostilities, Mr. Cronch suggests a supply of salt pork should be forwarded from England immediately on war being declared. 261
- October 23, Quebec. Thomas Charles Heslop Scott, late Chaplain to the 34th to———. Asking for assistance. 223
- October 24, Horse Guards. J. W. Gordon to Lt.-Col. Bunbury. Enclosing a memorandum from Col. Kempt, Q. M. G., in Canada, from which it appears that Capt. Gray has obtained for the Secretary of State's use at great expense and labour, certain plans, &c., of the topography of Canada. Asks that he be remunerated. 251  
Memo. From Kempt. 252
- October 29, Comptroller's Office. J. King and J. Drinkwater to the Lords of the Treasury. Respecting the supply of provisions for the troops in Canada during the ensuing year. 260
- November, Treasury Chambers. Harrison to Bunbury. Encloses copy of letter from Major General Drummond, dated Quebec, 19th July, enclosing a general return and estimate of provisions issued and wanted to victual the troops, &c., in the Canadas, to the number of 5,250 exclusive of Indians, to 1st October, 1813. The whole of the supplies required, except rice, can be provided in the province if peace continues; 100,000 lbs. of rice to be forwarded to Quebec. 254  
(Enclosures calendared at its proper date.)
- November 8, Whitehall. Order in Council that the instructions to Sir George Prevost as Governor of Canada be prepared for signature. 253
- November 11, Quebec. Prevost to Liverpool. (No. 14.) Enclosing memorial of Isaac Winslow. Clarke recommends the petition. 2  
Memorial. 3
- November 12, Treasury Chambers. George Harrison to Lt.-Col. Bunbury. Transmitting copies of the report of the Comptrollers of Army accounts of 29th ult., and one from Deputy Commissary General Couche, at Quebec, relative to provisions required for the use of the troops in Canada, for the consideration of the Earl of Liverpool. 259  
(Enclosures calendared at their respective dates.)
- November 15, Westminster. Ryland to Liverpool. Asking that he be given a seat in the Legislative Council. 264.
- November 18, H. M. S. of "Arethusia" Spithead. Memorial of Francis Holmes Coffin, R. N., on behalf of his mother, widow of the late John Coffin. 267
- November 22, Rochampton. Craig to C. Arbuthnot. Enclosing letter from the Commissioners for building the Protestant church at Montreal, respecting a mistake in the wording of the grant of £4,000. 285  
(Enclosure calendared at its proper date.)

1811.  
November 24, Ryland to Peel. Does the right of presentation to Church livings (as  
London. well as the right of erecting parishes) belong to the Crown? Page 268
- December 3, Prevost to Liverpool. (No. 15.) Has sent Capt. Macdonell to endeavour  
Quebec. to raise a Fencible corps from the Glengarry emigrants. Motives in  
choosing this gentleman. As soon as 300 men are enlisted asks to be  
authorized to appoint Major Battersby, Lt.-Col. Commandant. Such  
other officers as are required shall be selected and their names submitted  
for approval. 5  
*Enclosed.* Conditions for raising a corps of Glengarry Light Infantry  
Fencibles. 7
- December 5, Rowd-Wimburn to Peel. Respecting the memorial of the Count de  
Chancery Puisaye. 272  
Lane.
- December 10, Craig to Liverpool. Recommending that Mr. Ryland be advanced to  
a seat in the Legislative Council. 273
- December 10, Prevost to same. (No. 16.) Respecting the uniforms for the pro-  
Quebec. posed Glengarry Fencibles. 14
- December 10, Craig to Peel. Letter of the 14th received, acquainting him that Lord  
Liverpool's sole reason for hesitating in submitting Mr. Ryland's name  
for a seat in the Legislative Council is a doubt whether that gentleman's  
situation as clerk of the Executive Council is quite compatible with it ;  
asking his opinion on the subject. He (Craig) considers Ryland quite  
eligible and does not see how the duties can conflict. 275
- December 17, Harrison to same. Having laid before the Lords Commissioners of  
Treasury the Treasury Sir George Prevost's letter dated 9th ult., enclosing a  
Chambers. requisition for stationery for the Civil Department, Lower Canada, for  
1812, he is commanded to transmit the same for Lord Liverpool's opinion  
thereon. 276
- December 17, Same to same. Having laid before the Lords Commissioners of the  
Treasury a letter from Sir George Prevost, dated Quebec, 9th ult.,  
Chambers. enclosing requisitions for completing the supply of Indian stores for  
Upper and Lower Canada, for 1812, he is commanded to transmit the same  
for Lord Liverpool's opinion thereof. 277
- December 18, Order in Council that the Governor of Lower Canada be instructed to  
give his assent to the Bill intituled " An Act for erecting a common jail  
" with its dependencies in the District of Three Rivers, and to provide  
" the means for defraying the expenses thereof." The Governor's atten-  
tion to be called to Mr. Secretary Windham's letter of the 5th June, 1806,  
to Mr. President Dunn, and to recommend to him to promote some  
measure for the application of the surplus money which may be raised  
under the Act which provides for the erecting of two jails and also for  
raising money to defray the expenses thereof. 279
- December 20, Harrison to Peel. The sum of £4,000 voted for building the Protes-  
Treasury tant Church at Montreal, described by mistake as Montreal, Upper  
Chambers. Canada, consequently remains unappropriated. Asks that the Governor  
of Lower Canada be directed to draw upon Mr. Adams, the agent for Upper  
Canada, for the above mentioned sum as it may be required from time  
to time. 281
- December 23, Ryland to Peel. (Private.) Has had some conversation with Gore  
London. concerning Indian affairs. Asks for the loan of the proposed establish-  
ment of the Indian Department in both Canadas and the requisitions for  
presents for the ensuing year, that he may make a better estimate of the  
advantages which would arise from granting money instead of presents.  
Also asks for the loan of the establishment and requisitions sent home in  
1795. 286
1812.  
March 30, Draft of a letter to Prevost. He is to suspend the measures for raising  
Downing St. a regiment of Glengarry Fencibles. Reasons. 11
- No date. List of the Executive Council of Lower Canada with the names of  
additional members proposed. 266

# Department of Agriculture—Archives.

ACCOUNTS, 1811.

## Q. 116.

This volume consists of the accounts of the Receiver General (John Caldwell) from 11th April to 10th October, 1811. Pages 1 to 32.

GOVERNOR SIR G. PREVOST, 1812.

## Q. 117.—1.

- |                                    |                                                                                                                                                                                                                                                                                                                                                                                                                                                                                                                                          |
|------------------------------------|------------------------------------------------------------------------------------------------------------------------------------------------------------------------------------------------------------------------------------------------------------------------------------------------------------------------------------------------------------------------------------------------------------------------------------------------------------------------------------------------------------------------------------------|
| 1812.<br>January 1,<br>Downing St. | Draft of letter to Prevost. (No. 3.) The £4,000 voted for building the Protestant Church at Montreal is in the hands of Mr. Adams, and he (Prevost) is to draw upon him for the amount as required for the above mentioned purpose. <span style="float: right;">Page 2</span>                                                                                                                                                                                                                                                            |
| January 2,<br>Quebec.              | Prevost to Liverpool. (No. 17.) Requesting that 200 cavalry sabres and belts with saddles, bridles and equipments complete for that number of Light Dragoons, be sent as early as possible to equip the yeomanry who have offered to form themselves into corps of cavalry for the defence of their threatened country. <span style="float: right;">4</span>                                                                                                                                                                             |
| January 6,<br>Quebec.              | Same to same. In 1810, Geneviève Piché was convicted of murder at Montreal and sentenced to death, which sentence was afterwards respited by Craig till His Majesty's pleasure should be known. Asks that the Prince Regent's pleasure be ascertained. Recommends clemency. <span style="float: right;">5</span>                                                                                                                                                                                                                         |
| January 6,<br>Quebec.              | Same to same. (No. 19.) Has received the despatch dated 22nd June last, communicating the Prince Regent's pleasure that an annual allowance of £100 be granted to every future missionary leaving this colony after a residence of ten years. Encloses an extract of letter from the Bishop of Quebec to whom a copy of the despatch was transmitted. The great importance of there being no misconception on the subject leads him to ask for a communication which will leave no room for doubts. <span style="float: right;">6</span> |
|                                    | <i>Enclosed.</i> Extract of letter from Bishop of Quebec to Prevost, dated 27th November, 1811. If the bounty of £100 to missionaries is to be limited strictly to the letter of the instructions, which state that "a grant of a hundred pounds per annum will be proposed for every future missionary sent from this country, who upon removing, &c.," a great many worthy men now labouring in Canada will miss this advantage. <span style="float: right;">7</span>                                                                  |
| January 6,<br>Quebec.              | Prevost to Liverpool. (No. 20.) No intimation was given to the Governor of this province that £4,000 had been voted for building the church at Montreal. It was only discovered by accident. Has drawn bills upon Mr. Adams for the sums required. <span style="float: right;">10</span>                                                                                                                                                                                                                                                 |
| January 22,<br>Quebec.             | Same to same. (No. 22.) An attempt having been made at Washington to misrepresent and vilify the British Government as a promoter of the hostilities on the Wabash, he has thought it right to refute this charge by transmitting evidence to Washington and publishing and circulating throughout the United States the enclosed letter from an able pen and signed "Philalethes." Is making all possible preparations to meet the threats of America. <span style="float: right;">15</span>                                            |
|                                    | <i>Enclosed.</i> Copy of letter signed "Philalethes" from the <i>Quebec Mercury</i> , and dated 18th January, 1812. <span style="float: right;">17</span>                                                                                                                                                                                                                                                                                                                                                                                |
| February 3,<br>Quebec.             | Same to same. (No. 23.) Transmitting copies of the proceedings of the Executive Council on matters of State between 11th March and 22nd August, 1811, and on land matters between 11th March and 13th June. <span style="float: right;">24</span>                                                                                                                                                                                                                                                                                        |

1812.  
February 7,  
Quebec.      Prevost to Liverpool. (No. 24.) Enclosing memorial from Edward Bowen, late acting Attorney General, asking that he be appointed Attorney General for Lower Canada and suggesting that Mr. Uniacke be appointed for Upper Canada. Page 25  
*Enclosed.* The memorial. 26
- February 8,  
Downing St.      Draft of letter to Prevost. (No. 5.) Transmitting copy of minute on the bill for the erection of a jail in the District of Three Rivers, to which his Royal Highness the Prince Regent assents. Regarding the appropriation of the surplus money. 32
- February 10,  
Downing St.      Same. (No. 6.) List of 16 Acts passed by the Legislature of Lower Canada in March, 1811, which have been approved by the Privy Council. 34  
Same. (No. 7.) The requisitions have been forwarded to the proper Department with directions that the articles required are to be forwarded by the first opportunity. The existing state of affairs make a report on the military defence of the provinces necessary. Any suggestions as to measures to be taken in case of attack will be received with interest. 39
- March 3,  
Quebec.      Prevost to Liverpool. (No. 25.) He opened the Provincial Parliament on the 21st February. Encloses the speech on opening and the addresses in reply from the Council and Assembly. Thinks there are some dangerously disaffected persons amongst the Canadians as agents of France and America. Believes the latter country would consider war against Great Britain premature and is at present endeavouring to corrupt the minds of the Canadians to render their designs easier at a more distant period. His efforts to arouse the inhabitants of Canada from their lethargy receive considerable assistance from the arrogant declarations made in Congress respecting the easy conquest of their country; thinks their pride will help him in his plans for a militia force. Will seek the aid of the Catholic clergy in influencing the people. The Canadians' indifference to militia service arises from a disuse and consequent aversion to arms. Arms, accoutrements, and clothing are required. Major General Brock has every reason to expect he will receive from the Legislature of Upper Canada all that is necessary for defending that province. Is anxiously expecting the necessary means of adding to the number of members of the Legislature to prevent embarrassment in case of the death of any of the present members, an event by no means improbable from the infirm health of two or three. 41  
*Enclosed.* Speech on the opening of Parliament: English, 47; French, 53.  
Address in reply from the Legislative Council. 59  
Ditto from the House of Assembly. 65
- March 3,  
Quebec.      Prevost to Liverpool. (No. 26.) Enclosing statement of the exports and imports of the province for 1811. 76  
Enclosed exports and imports. 76a to 78a
- March 3,  
Quebec.      Same to same. (No. 27.) States that York, the seat of Government in Upper Canada, is a position well adapted for a citadel and depot of military stores; at present it is quite unfortified. Encloses report by the commanding engineer on the strengthening the King's reserve there; will inspect the post himself in the summer and report. Has authorized some repairs to be made in the several ports in Upper Canada in case of sudden attack. 79  
*Enclosed.* Report of Capt. Vigoureux, R.E., on the project for fortifying the ground at York, whereon the Government House is situated. 81
- March 4,  
Quebec.      Same to same. (No. 28.) From the state of affairs here he has considered it expedient, without waiting for His Majesty's commands, to issue a warrant for the raising of the Light Infantry from the settlers of Glengarry. Asks for permission to allot a proportion of land to such as enlist. Colonel Baynes nominated to conduct the levy; recommends

## Department of Agriculture—Archives.

1812.	that he be made colonel. Has prohibited the enlisting of Canadians or Americans recently come from the United States. <span style="float: right;">Page 85</span>
March 13, Quebec.	Prevost to Liverpool. (No. 29.) Endorsing Mr. Heriot's recommendation for an increase of salary to John Howe, postmaster at Halifax, and Daniel Sutherland, postmaster at Montreal. <span style="float: right;">87</span>
March 16, Quebec.	Prevost to Liverpool. (No. 30.) The representation of the British North American merchants, respecting the interior communication, engaged immediate attention. The measures to be followed to improve the mail service. <span style="float: right;">88</span>
March 17, Quebec.	Same to same. (No. 31.) Enclosing report from the Trinity House, Quebec, respecting an establishment formed by Sir James Craig upon the Island of Anticosti. The importance of keeping up this establishment. <span style="float: right;">94</span>
	<i>Enclosed.</i> Report of the Trinity Board. <span style="float: right;">96</span>
March 17, Quebec.	Same to same. (No. 32.) Enclosing memorials of Charles F. Grece and James Campbell for further remuneration for their endeavours to encourage the culture of hemp in this province. Refers him to the last reports of the Executive Council upon this subject (enclosed) from which he may be able to judge how far it may be expedient to encourage the industry in future. <span style="float: right;">102</span>
	<i>Enclosed.</i> Memorial of Grece. <span style="float: right;">104</span>
	Ditto of Campbell. <span style="float: right;">110</span>
	With the memorials are sent the two following documents :
	1st. Transactions on Becancour Farm, 1807. <span style="float: right;">128</span>
	2nd. Losses sustained by James Campbell from the commencement of the "hemp business." <span style="float: right;">138</span>
	Report of a Committee of the whole Council. <span style="float: right;">141</span>
March 31, Downing St.	Draft of a letter to Prevost. (No. 9.) Mr. John Blackwood having been recommended as a proper person for a seat in the Legislative Council for Lower Canada, he would submit his name to the Prince Regent in case he (Prevost) should think fit to propose him. <span style="float: right;">147</span>
April 1, Quebec.	Prevost to Liverpool. (No. 33.) Enclosing letter from Col. Baynes, reporting the progress made in the levy of the Glengarry Light Infantry Fencibles. <span style="float: right;">148</span>
	<i>Enclosed.</i> The letter from Col. Baynes. <span style="float: right;">149</span>
April 2, Quebec.	Same to same. (No. 34.) Acknowledging letter enclosing the memorial of Misses Jane and Sarah Lees. Has delayed answering till it could be ascertained whether their father John Lees was indebted to the public. The accounts have not yet been delivered to the office of the Commissary of Accounts, but as they are making up he will soon be able to announce the result. <span style="float: right;">150</span>
April 2, Quebec.	Same to same. (No. 35.) Enclosing rates of exchange and current prices from September to March last, inclusive. <span style="float: right;">151</span>
	<i>Enclosed.</i> Quebec prices current for September. <span style="float: right;">152</span>
	Ditto for October. <span style="float: right;">155</span>
	Ditto for November. <span style="float: right;">158</span>
	Ditto for December. <span style="float: right;">161</span>
	Ditto for January, 1812. <span style="float: right;">164</span>
	Ditto for February. <span style="float: right;">167</span>
	Ditto for March. <span style="float: right;">170</span>
April 2, Downing St.	Draft of a letter to Prevost. (No. 10.) Troops (mentioned) to be sent to Canada. Hopes he will be able on the arrival of these troops to allow the 41st and 49th to return to Europe. If he apprehends an immediate rupture before reinforcements could arrive, these regiments may be kept in Canada. <span style="float: right;">173</span>
April 2, Downing St.	Same. (No. 11.) Transmitting commissions appointing him Captain General and Governor in Chief over the Province of Lower Canada, together with the usual instructions. The commissions and instructions

1812.  
for New Brunswick and Nova Scotia have been forwarded to the officers administering the Government but transmits copies for his (Prevost's) information. Page 176
- April 3,  
Quebec. Prevost to Liverpool. (No. 36.) Transmitting, to be laid before the Prince Regent, the memorial of Mrs. de Lanaudière. 177  
(The memorial is in Q. 117, part 2, page 178.)
- April 21,  
Downing St. Draft of a letter to Prevost. (No. 16.) In answer to the letter enclosing the memorial from Bowen, states that the appointment of Attorney General for Upper Canada has been filled. If any opportunity for compensating Mr. Bowen should arise, he will remember his memorial. 31
- May 13,  
Quebec. Prevost to Liverpool. (No. 21.) Despatch of 28th July received, on the subject of the hostile intentions manifested by the Indians against the Americans, copy of which he immediately forwarded to Major General Brock. Encloses extract of letter since received from Brock, by which it will be seen that previous to the hostilities which have taken place on the American Frontier, he (Brock) had fully anticipated his (Liverpool's) directions on that head, by his judicious measures in assuming the government. Has deemed this extract of sufficient importance immediately to transmit it to Mr. Foster at Washington, to enable him to repel any attempts to charge His Majesty's Government with encouraging the hostilities actually commenced in the Wabash. In consequence of the threatening language of the American Government and the apparently warlike measures which they are pursuing he has sent his aide-de-camp, Capt. Coore, to Washington for the purpose of receiving any information Mr. Foster may wish to send by this the only safe mode of conveyance. 12
- Enclosed.* Extract of letter from Brock to Prevost, dated 3rd Dec., 1811. 14
- August 5,  
Downing St. Draft of a letter to Prevost. (No. 4.) Having transmitted the memorials and other papers on the subject of the claims of Messrs. Grece and Campbell to the Lords of Trade, encloses copy of the answer by which he (Prevost) is to shape his conduct. 146

## GOVERNOR SIR GEORGE PREVOST—1812.

## Q. 117.—2.

1802.  
January 9,  
Montreal. Memorial of Sarah Morris to Sir Robert S. Milnes for a grant of land. 211
- Enclosed.* Extract from a report of the Land Committee on the above. 210
- Ditto from a report of a committee of the whole Council on the same. 213
1812.  
March 3,  
Quebec. Memorial of Elizabeth de la Corne, widow of Charles de Lanaudière, (in French.) 178
- April 3,  
Quebec. Prevost to Liverpool. (No. 37.) By this time he (Liverpool) is probably in possession of the circumstances relative to Henry's treachery. The papers left by his predecessor leave no information of any consequence other than what has already appeared in the public prints. Henry's thorough acquaintance with the Canadian character, religion and language, and above all his deep resentment against the British, might induce Buonaparte to give him a favourable reception in France. Expects Mr. Madison's next move will be to cause a declaration of war to be laid on the Tables of Congress. Has therefore directed the Commanding officers in the Provinces to be especially prudent and cautious in their intercourse with the United States. Encloses extract of his letter to Major General Brock, that to Sir John Sherbrooke contains the same except as respects the Fort of Detroit. 181
- Enclosed.* Extract of letter to Brock. 183



## Department of Agriculture—Archives.

1812.  
April 3,  
Downing St. Draft of a letter to Prevost. (No. 12.) Directions have been given for complying with the requisition in despatch No. 17, for cavalry equipments, which will reach Canada early in the summer. Page 191
- April 13,  
Downing St. Same. (No. 13.) The measures to be taken respecting the representations from the Committee of Merchants interested in the trade of the British North American Colonies. 192
- April 14,  
Quebec. Prevost to Liverpool. (No. 38.) Considers a naval force properly constructed for the lakes, the most efficient and cheapest mode of defence. The arrangements to be made for improving that force. Thinks it advisable that the naval establishment, stores, etc., should gradually be removed to York. His reasons. 194
- April 14,  
Downing St. Draft of a letter to Prevost. (No. 14.) Transmitting memorial of Jane Lynd. Some enquiry upon the subject has already taken place and probably a decision has been postponed till a final determination shall be taken as to the disposal of the Jesuit Estates. Directs an enquiry to be made as to the expediency of granting the prayer of the memorialist. 197
- April 20,  
Quebec. Prevost to Liverpool. (No. 39.) Enclosing a memorial from Messrs. Samuel Sansum and Robert Allsop upon the subject of their claims in behalf of their children, to lands in Lower Canada. 198  
*Enclosed.* The memorial. 199
- April 20,  
Quebec. Same to same. (No. 40.) The temper of the Parliament is not quite as satisfactory as he had thought when sending his despatch No. 25. Has obtained a Bill amending the Militia Act, by which a proportion of the Sedentary Militia are converted into a permanent force. Some remarks on the militia. The measures lately taken by the Americans have induced him to accept the services of 500 Canadians to be formed into a corps of Voltigeurs, to serve during the war, or apprehension of war; the conditions under which they are to be raised. Hopes the measures he is taking for the preservation of Canada will be represented to the Prince Regent. As soon as militia matters will allow he intends visiting Upper Canada to concert with General Brock a plan of defensive and offensive operations, in the event of the Democratic spirit of the United States having put the dispute beyond the bounds of accommodation. 214
- April 20,  
Downing St. Draft of a letter to Prevost. (No. 15.) The arrangements proposed for the distribution of the troops. 220
- April 21,  
Quebec. Prevost to Liverpool. (No. 41.) Enclosing copy of the conditions he (Prevost) has approved of for conducting the levy of the Canadian Voltigeurs. Has selected Major De Salaberry to superintend this service; asks that he be confirmed in his rank. 222  
*Enclosed.* The conditions for raising the corps. 224
- April 21,  
Quebec. Same to same. (No. 42.) Enclosing memorial from John Young, Executive Councillor and master of the Trinity House at Quebec, for an adequate salary for the duties of the latter appointment. 230  
*Enclosed.* The memorial. 231  
Document accompanying the memorial giving the state of the establishment of the Trinity House. 237
- May 15,  
Downing St. Draft of a letter to Prevost. (No. 17.) By this time he (Prevost) must surely know of the treachery of Henry, he having disclosed to the American Government the documents relative to his employment by Craig in 1809, on a secret service. Trusts no hostilities will be shown by the American Government until an explanation can be given. Transmits copy of a despatch from Lord Castlereagh to Foster signifying the Prince Regent's pleasure respecting the language to be used in negotiating with the United States. Hopes he (Prevost), will not think that when forwarding Mr. Henry's memorial in the letter of 16th September he admitted Mr. Henry's account of his services to be a correct one; it

1812.  
was only done in conformity with official usage. Will not discuss Craig's part in the transaction. Hopes that in making arrangements for the defence of the Provinces, even under the menace of hostility, no measures will be resorted to which could be cited as a want of faith in a power not at war with Great Britain. Page 239
- May 15,  
Downing St. Draft of a letter to Prevost. (No. 18.) Notwithstanding the irritation produced by Mr. Henry's disclosures and other existing causes, His Majesty's government apprehends no immediate rupture with America. In the event of hostilities he (Prevost) is to consider himself vested with the same general discretion in taking measures for the defence of the Provinces which was given to Craig. Trusts the expenses already incurred for strengthening Lower Canada, will be adequate without any further demand on the Treasury. Repeats that he is to avoid any act which can irritate the people of the United States. 243
- May 16,  
Quebec. Prevost to Liverpool. (No. 43.) Enclosing a memorial from Mr. Justice Williams, a member of both Councils, whose long services render him worthy of His Majesty's consideration for a suitable provision. Recommends that he be allowed to retire on a pension of £500 sterling. Mr. Justice De Bonne has handed in his resignation; recommends him to consideration. Has filled up the vacancies by appointing Oliver Perrault and Edward Bowen. 246
- Enclosed.* The memorial of Jenkin Williams. 250
- May 16,  
Quebec. Short account of the various Civil appointments held by Williams. 252
- Prevost to Liverpool. (No. 44.) Respecting the requisitions for rum and provisions to the Indians. Encloses a code of instructions for the good government of the Indian Department for his (Liverpool's) consideration, by which the management of Indian affairs would be under the military control. 255
- Enclosed.* The code of instructions. 258
- May 17,  
Quebec. Schedule of allowances for officers, &c., of the Indian Department. 281
- Same to same. (No. 45.) Despatch of 5th February relative to the fortifications and barracks at Quebec received; has directed that the works approved by Craig be proceeded with. Encloses an estimate for erecting a barrack on Cape Diamond and also copy of an estimate for a commissariat store. Has approved these estimates and ordered work to be commenced. Encloses plan and estimate for building proposed barracks on the vacant space adjoining the Jesuit Barracks. 282
- Enclosed.* Estimate for a barrack on Cape Diamond. 284
- Ditto for Commissariat store house. 286
- Plan of Jesuit barracks and adjoining ground. 288a
- Estimate for barracks adjoining the Jesuit barracks. 288
- May 18,  
Quebec. Prevost to Liverpool. (No. 46.) A lengthy report upon the military position of His Majesty's North American provinces and the means of defending them. 292
- May 23,  
Downing St. Draft of a letter to Prevost. (No. 19.) Transmitting copy of a notification of the promotions in the Commissariat Department in Canada. 307
- May 26,  
Quebec. Prevost to Liverpool. (No. 47.) The Glengarry regiment complete; Three Rivers the headquarters, where about 400 fine young men are assembled under Major Battersby. The promise of a grant of land has been a great incentive to the men. 308
- May 27,  
Quebec. Same to same. (No. 48.) Enclosing extract of a communication in cypher which has just reached him from Mr. Barclay, Consul General at New York. Assures him (Liverpool) that every prudent precaution as far as the resources of the country will permit has been taken. 310
- Enclosed.* Extract of letter from Mr. Barclay stating that "war is inevitable." 311
- May 29,  
Quebec. Same to same. (No. 49.) Enclosing extracts from Brock's report on the state of affairs in Upper Canada. Has given strict directions to the

## Department of Agriculture—Archives.

1812.	<p>officers commanding posts, to observe perfect civility towards the States and to prevent as far as possible any circumstance calculated to cause irritation. <span style="float: right;">Page 312</span></p> <p style="text-align: right;"><i>Enclosed.</i> Extracts from Brock's reports. <span style="float: right;">313, 315</span></p>
June 1, Quebec.	<p>Prevost to Liverpool. Transmitting naval officers' returns of vessels entered inwards and cleared outwards at Quebec between 5th July, 1811, and 5th April, 1812. <span style="float: right;">318</span></p>
June 8, Quebec.	<p>Same to same. (No. 50.) Enclosing speech on the closing of the session of the Legislature which has terminated in a more satisfactory manner than he had expected; also the speech made by the Speaker of the Assembly upon delivering the Bills of Supply. Respecting the three temporary Bills. <span style="float: right;">319</span></p> <p style="text-align: right;"><i>Enclosed.</i> Speech on closing the session. <span style="float: right;">326</span></p> <p style="text-align: right;">Speech from the Speaker of the Assembly. <span style="float: right;">329</span></p>
June 8, Quebec.	<p>Prevost to Liverpool. (No. 51.) Enclosing rates of exchange and current prices at Quebec for April and May. <span style="float: right;">332</span></p> <p style="text-align: right;"><i>Enclosed.</i> Quebec prices current for April. <span style="float: right;">333</span></p> <p style="text-align: right;">Ditto for May. <span style="float: right;">336</span></p>
June 9, Quebec.	<p>Prevost to Liverpool. (No. 52.) Arrangements for disposing of the troops. Has just received the following secret communication from the Consul General at New York, dated 30th May, 1812. "His Majesty's minister at Washington writes me on the 27 instant, that notwithstanding the clear proofs of the continuance of the French Decrees, it seems war will be proposed on Monday, and it is said will be carried in the House of Representatives." Notwithstanding this information the troops asked to be sent home in despatch No. 10 will be embarked, substituting the 1st Batt. of the 8th for the 41st, unless hostilities shall have actually commenced. It is reported that the Americans are reinforcing their posts in Upper Canada, which circumstance seems to require the 41st to remain in its present position till the spring. <span style="float: right;">339</span></p>
June 11, Quebec.	<p>Same to same. (No. 52.) Despatches received. In reply to the circular of 21st March last, respecting the communication between this colony and those parts of the continent under the control of France, states that the Alien Act effectually provides against the introduction of foreigners into the province without the permission of the Governor. Believes the Act is strictly enforced. Mr. Ryland arrived yesterday, but brought neither his (Prevost's) commission nor the <i>mandamus</i> for the Legislative Councillors. <span style="float: right;">343</span></p>
June 14, Prescott.	<p>Extract of letter stating that the "Lord Nelson," a trading vessel, had been taken by the Americans. <span style="float: right;">349</span></p> <p style="text-align: right;">(In Prevost's No. 53 of 22nd June.)</p>
June 15, Prescott.	<p>Extract of a letter stating that the "Ontario," an American vessel with a British cargo on board, had been detained by the United States. <span style="float: right;">351</span></p> <p style="text-align: right;">(In Prevost's No. 53 of 22nd June.)</p>
June 16, Downing St.	<p>Draft of a letter to Prevost. (No. 1.) Transmits copy of letter from the Secretary to the Postmaster General in answer to his (Prevost's) No. 30, recommending an increase to the salary of the postmasters at Halifax and Montreal. <span style="float: right;">345</span></p>
June 22, Quebec.	<p>Prevost to Liverpool. (No. 53.) Takes advantage of a ship for Liverpool to transmit copy of a despatch which he (Prevost) addressed to His Majesty's minister at Washington in consequence of statements from British subjects of acts of violence shown to their merchant vessels on Lake Ontario, while lawfully trading, by the armed force of the United States. <span style="float: right;">346</span></p> <p style="text-align: right;">(Enclosures calendared at their respective dates.)</p>
June 22, Quebec.	<p>Same to Augustus Foster, Minister Plenipotentiary at Washington. Encloses extracts from letters received stating that violence has lately been shown to merchant vessels trading on Lake Ontario. Has no reason</p>

1812.

to doubt the correctness of these accounts though not yet officially communicated to him. Transmits them that redress may be had. Page 347  
(In Prevost's No. 53, of 22nd June.)

June 22.

Draft of a letter to Prevost. Enclosing copy of a letter from Mr. Beckett with a pardon for Geneviève Piché. 352

July 4,

Downing St.

Draft of a letter to Prevost. (No. 2.) Despatches received and laid before the Prince Regent, who is happy to hear of the willingness of the Assembly and people of Lower Canada to second his (Prevost's) exertions. It is desirable to acquaint the Legislature and Assembly that the addresses on opening the Parliament have been laid before the Prince Regent, who hopes he will not be compelled to call upon his Canadian subjects for the sacrifices they would willingly make, but that his declaration of 23rd June will secure peace. Trusts he will be enabled safely to suspend all extraordinary preparations for defence. Hopes all arrangements for raising the Glengarry Regiment have been abandoned in consequence of Lord Liverpool's letter of 30th March. The appointments mentioned in letters No. 10 and 25 approved. In answer to his despatch No. 27, has to state that no idea of the expense of fortifying York can be gathered from the report. Despatch No. 29, relative to the interior communication has been transmitted to the Postmaster General. The establishment on Anticosti to be continued for the present. The Prince Regent regrets there are no funds at the disposal of the Crown from which to assist Madame DeLanaudière. The claims of Messrs. Grece and Campbell are under consideration. The instructions given to Brock and Sherbrooke approved of. 185

## GOVERNOR SIR GEORGE PREVOST, 1812.

## Q. 118.

1812.

June 18, War  
Department.

W. Eustis to Brigadier General Hull. Letters received. Arrangements for provisioning the troops approved. Circumstances have recently occurred which render it necessary he (Hull) should march to Detroit with all possible expedition. 75

(Enclosed in Prevost's No. 59 of 30th July.)

June 24, Camp  
Necessity.

Hull to Eustis. Heavy rains impede his progress. Expects to arrive at the Foot of the Rapids by the 1st July. Five strong block houses are now established on this road. Soldiers in good health. General Brock arrived at Malden on the 14th inst., with 100 British troops, on the 17th he sailed for Fort Erie and it is said will return with reinforcements. Large numbers of Indians are collecting at Amherstburg. Feels convinced in case of hostilities his army will be superior to any which can oppose it. 76

(In Prevost's No. 59, of 30th July.)

June 25,  
Quebec.

Prevost to Liverpool. (No. 54.) Enclosing intelligence just received, which comes from so good a source that, though not official, he transmits it by a vessel just sailing for Cork. The writers, being the principals of the North-west and South-west Companies, have taken extraordinary means to obtain the earliest information. Asks for money. The arms and accoutrements shipped for Canada last autumn have not yet arrived. 2

Enclosed. Letter from Forsyth Richardson and Co., and McTavish, McGillivray and Co., dated 24th June, 1812, to H. W. Ryland, asking that he inform the Governor that war is declared against Great Britain. 4

June 26,  
Camp at Fort  
Findlay.

Hull to Eustis. Constant rains have rendered progress slow. Strong block houses are erected to preserve the communication. Has garrisoned them and left the sick there with all necessary comforts. Suggests relieving the troops stationed in the block houses, by the militia of the

## Department of Agriculture—Archives.

1812.

Ohio. In case of war, this communication is very necessary. The Indians appear friendly. Expects to be at the Foot of the Rapids in three days. Mr. Arthur's block house is on the Scioto, intends building another about half way between this and the Foot of the Rapids. The friendly Indians will carry some baggage in their canoes. Page 79

(In Prevost's No. 59 of 30th July.)

June 29,  
Quebec.

Prevost to Liverpool. (No. 55). Encloses the Act of Congress by which war is declared against Great Britain and which has just reached him through the public prints. Has received no official communication from Mr. Foster yet, but the fact cannot be doubted. Understands by a ship from Portsmouth that the troops for Quebec have sailed. Refers him to the resolutions of the town meeting of Boston contained in the *New England Palladium* of 16th June (enclosed). 5

Enclosed. Extracts from the *Montreal Herald* of 27th June, 1812, taken from the *New York Evening Post*. 6

Extract from the *Palladium*, Boston, Tuesday, 16th June. 20

June.

Monthly return of the garrison of Michillimackinac, commanded by Lieut. Porter Hanks, for the month of June. 156

(In Prevost's No. 65 of 14th August.)

July 6,  
Montreal.

Prevost to Liverpool. (No. 56.) Has removed to this town to be nearer the scene of operations. Trouble with the militia in some of the neighbouring parishes. Is quite satisfied with the loyalty of the embodied militia. 35

July 15,  
Quebec.

Same to same. (No. 57.) Despatches received. Had given permission, from the strong indications of war, to raise the strength of the Glengarry levy to 600. Recourse was had to all the Provinces, and he does not consider a sufficient number had been raised in Glengarry to entitle the regiment to that name. Had limited the Canadian Voltigeurs to 300, as the state of the military chest would not allow him to carry on both recruiting services at the same time. The 103rd has been safely landed at Quebec. It has become necessary to establish a cordon of troops upon the frontier between the St. Lawrence and Richelieu Rivers, to prevent incursions of the enemy and protect Montreal. This precautionary measure will prevent his parting with the 100th Regiment for service in Nova Scotia. If the lateness of the season should prevent the 1st Battalion of the Royal Scots from reaching Quebec, they will winter in Halifax. The American General Officer commanding the Niagara District had planned the surprise of Fort George, but fortunately the report of hostilities had brought General Brock to the Fort, which induced them to relinquish their attempt. Brock had considered himself justified in offensive operations, but upon the reflection that Detroit and St. Joseph's were weak and that the reduction of Fort Niagara was the utmost he could do at present, and that that could be done as well at any future time, he decided to confine himself to defensive measures. Has repeatedly recommended this policy to Brock and the officers in command of the other districts of British America. In the present state of politics in the United States he considers it prudent to avoid every measure with the least tendency to unite the people of America. Brock has called out the flank companies of the militia, about 800 men. The Americans very active on the opposite side of the Niagara River. So far General Brock considers himself safe. About 100 Indians from the Grand River have come in answer to his (Brock's) summons. A report that the Americans have taken Carleton Island. We still possess superiority of vessels of war on Lakes Erie and Ontario. Embarrassment from the scarcity of arms for the use of the militia: has sent to Halifax for half the arms in the store there. It is necessary now to establish a paper medium, and he is about to get the aid of Parliament to give it value, upon which measure he will report more fully.

1812. Brock, on the declaration of war, had to resort to a paper currency. General officers badly needed. Page 39
- July 16, Head Quarters of the North-western Army of the United States, Sandwich. Hull to Lt.-Col. St. George, commanding, Amherstburg. Asks for the papers taken on board the boat captured while under the command of Capt. Chapin, as they can be of no service to the British. The bearer, Brown, to receive them. Wishes to know his determination relative to the private apparel and baggage taken. He has it in his power to retaliate and avenge any delay in the restitution of the property. 192  
(In Prevost's No. 3 of 17th August.)
- July 16, Amherstburg. Lt.-Col. St. George to Hull. Upon examination, the papers prove to be almost all public documents; to select the private ones from among them would be too much labour. As to private property, he (St. George) must wait the determination of his Government on the subject. Regrets the use in his (Hull's) letter of the words retaliation and avenge, and hopes he (St. George) will not be obliged to use the means for either which he also possesses. 194  
(In Prevost's No. 3, of 17th August.)
- July 17, Height above Fort Michillimackinac. Articles agreed on between Captain Roberts, commanding His Majesty's Forces and Lieut. Hanks for the capitulation of Fort Michillimackinac. 154  
(In Prevost's No. 65, of the 14th August.)
- July 17, Fort Michillimackinac. Charles Roberts to the Adjutant General. Michillimackinac has capitulated. 151  
(In Prevost's No. 65, of the 14th August.)
- July 18. Return of ordnance, ammunition, stores, &c., taken possession of in Michillimackinac garrison by Capt. Roberts. 157  
(In Prevost's No. 65, of 14th August.)
- July 18, Quebec. Prevost to Liverpool. (No. 58.) Enclosing Speech which he (Prevost) delivered to the Provincial Parliament on the 16th inst., to which satisfactory answers have been made. Has called their attention to the necessity for a modification of martial law and a paper money. Believes these measures will meet their approval. Reasons which have induced him to ask for this currency. Has received official notice from Mr. Foster, of the declaration of war. Encloses proclamation continuing the embargo till the 5th August, with permission to such vessels to depart as were ready to take advantage of the convoy of H.M.S. "Savage." Has received instructions and commission and was sworn in as Governor on the 15th inst. 49  
*Enclosed.* Proclamation. 53  
Speech. English, 60; French, 63. 60, 63
- July 25, Downing St. Draft of a letter to Prevost. (No. 3.) Transmitting copy of a notification of a promotion in the Commissariat Department. 67
- July 30, Quebec. Prevost to Liverpool. (No 59.) Has received despatches from Brock that an American army of 2,000 men under General Hull has made its appearance at Detroit and that a detachment crossed to the Canadian side and is now occupying Sandwich, causing the militia and troops to retreat from thence to Fort Amherstburg. Immediately after taking this village, General Hull ordered a proclamation (enclosed) to be issued which has already done harm. Lt.-Col. St. George is at present secure in Fort Amherstburg, should he be forced to retire, it will be necessary for him to embark for Fort Erie. State of the ordnance at Amherstburg. Brock has sent copies of some documents found on board a schooner captured from the Americans which are enclosed. 68  
*Enclosed.* Hull's Proclamation. 71  
(Three letters taken from the Americans calendared at their respective dates.)
- July 30, Quebec. Same to same. (No. 60.) The exhausted state of the military chest exposes the service to serious difficulties which will not be altogether 68

## Department of Agriculture—Archives.

1812.

removed by the operation of the Army Bill Law, which has passed the Assembly and is now before the Council. It will bring relief, but the Canadians have a deep rooted prejudice against paper money. Enclosed letter from the Commissary General stating his difficulties from the want of specie. Page 82

(Enclosure calendared at its proper date.)

July 30, Quebec. W. H. Robinson, Commissary General, to Prevost. His embarrassment from the want of money. 84

July 30, Quebec. Same to Liverpool. (No. 61.) The death of Mr. De Lanaudière and the resignation of Mr. Richardson. Recommends John Blackwood and Pierre D. Debartzch for the vacancies. 87

August 2, Montreal. Same to Baker. Enclosing copy of a letter sent this day to the Commander of the U. S. Forces. 127

(In Prevost's No. 63, of 5th August.)

August 2, Montreal. Same to Major General Dearborn. Has received from Mr. Foster a communication stating that he has received despatches from England the contents of which may possibly induce the Government of the United States to agree to a suspension of hostilities as a preliminary to negotiations for peace. Has forwarded these despatches with a flag of truce to New York to be communicated to the Government. Hopes no further movements may be made by the United States troops; as soon as he (Prevost) hears that such orders have been issued he will see that the forces under his command desist from all hostilities likewise. Col. Baynes who is sent with the flag will bring back an answer. He is also the bearer of a despatch to Mr. Baker communicating the proposal made. 123

(In Prevost's No. 63, of 5th August.)

August 3, Quebec. Same to Liverpool. (No. 62.) Encloses his speech on closing the Legislature. The only Act passed was one to facilitate the circulation of Army Bills, a copy of which is enclosed, together with the report of the Executive Council thereon. The great advantages to be derived from the passing of this Bill. A public notification agreeably to the copy enclosed will be made. Trusts the Prince Regent will sanction the measure. The insufficiency of the troops now in Canada. Has not as yet heard the result of Hull's attempt. Major General Sheaffe and such troops as he can spare are now on their way to reinforce Brock. 89

*Enclosed.* Speech. 95

Notification. 97

Report of the Board on the subject of Army Bills. 100

Report of a Committee of the whole Council on the same subject. 109

Copy of an Army Bill. 119

August 4, Sandwich. Hull to Wm. Eustis, Secretary Department of War. At the time his army took possession of this part of Upper Canada everything appeared favourable. Circumstances have since occurred which seem materially to change the future prospect. The unexpected surrender of Michillimackinac and the tardy operations of the army at Niagara are the circumstances to which he alludes. Expects shortly a large body of Indians to attack against this army; they are under the influence of the fur companies whose trade depends on opening the Detroit River this summer. The consequences following on the delay at Niagara. The preparations he is making. Promises his best and most faithful exertions to promote the honour of the army. 203

(In Prevost's No. 4 of 24th August.)

August 5, Quebec. Prevost to Liverpool. (No. 63.) In consequence of a despatch from Mr. Foster at Halifax, communicating the contents of one from Lord Castlereagh, he sent Col. Baynes, Adjutant General, with a flag of truce to Major General Dearborn, or the officer commanding the forces of the United States on the frontiers. Encloses copy of letter sent with the

1812.

flag and also copy of one forwarded to Mr. Baker. Is glad to find his policy at least has not widened the breach between the two countries, and unless the safety of the province requires it he will resort to no measure likely to cause bad feeling. Page 120

(Enclosures calendared at their respective dates.)

August 6,  
Quebec. Prevost to Liverpool. (No. 64.) Enclosing rates of exchange and current prices at Quebec for June and July. 128  
*Enclosed.* Quebec prices current for June. 129  
Ditto for July. 132

August 8,  
Green Bush. H. Dearborn to Col. Baynes, assuring him of his disposition to meet the views of Sir George Prevost, but regrets it is out of his power. However, he will give orders to the commanders of the frontier posts to take defensive measures only, also write to Hull to suspend all offensive operations. Will write to the Executive of the United States and state the measures he has taken. 169

(In Prevost's No. 2, of 17th August.)

August 8,  
Green Bush. Same to Prevost. Has this day communicated his answer to the proposition brought by Col. Baynes. The measures to be as promptly carried into effect as circumstances will permit. 171

(In Prevost's No. 2, of 17th August.)

August 10,  
Downing St. Draft of a letter to Prevost. (No. 5.) Despatches received. Since his letter of 4th July, the Prince Regent has received intelligence that war is declared. His Royal Highness anxiously hopes that when his intentions respecting the repeal of the orders in council are known in America tranquillity may be restored. Owing to the extended warfare in which Britain is engaged, the means for defending Canada must be limited, but trusts to the known valour of the troops and their commander should Canada be invaded. Great satisfaction felt at the way in which Canadians have shown their anxiety to protect their country. The Prince Regent feels perfect confidence in confiding to him (Prevost) the command of the Canadas. 32

August 10,  
Downing St. Draft to Prevost. (No. 6.) The Prince Regent has given his sanction to the levy of a corps from the Glengarry emigrants; clothing to be forwarded. The establishment is to be limited to 800, and land is to be allotted to each man when the regiment shall be disbanded. The 103rd must by this time have landed in Quebec. Trusts he (Prevost) has despatched the 100th to Halifax. Has received a letter from Sir George Beckwith from which it appears that the 4th Battalion of the 60th arrived at the Barbados, and that the Royals had been embarked on the same transport for Quebec. It is left to his own discretion whether or not the 41st be kept in Canada; the 95th Regiment is on its way to reinforce the troops under Sherbrooke, who found it impossible to dispense with the 98th, therefore sends the 102nd to strengthen Bermuda. Brigadier General Horsford is to exercise both civil and military duties to allow Sir James Cockburn to return to England. Holds out no hope that the requisitions for specie can be filled. Is aware of the awkwardness caused by the want of it, but necessity prevents. Heard with regret that the transport which sailed last autumn for Canada has not arrived. At the time he received the communication, two transports were just sailing for the Mediterranean with arms, etc., thinking that the service might admit of some delay he had obtained the Prince Regent's consent to change the destination of one of them, the "Lady Shore," with arms, &c., for 10,000 men. It is now under orders to sail for Quebec. On the declaration of war had directed the Commissary in Chief to fill requisitions for provisions. Trusts he (Prevost) will believe that the utmost has been done to reinforce the troops in Canada. The method of employing the Indians. Estimates for barracks to be considered immediately. Should



## Department of Agriculture—Archives.

1812.

- have known sooner of the wish of Mr. Justice Williams and Mr. De Bonne to retire. Doubts if pensions can be granted. Page 135
- August 10, Downing St. Same to Prevost. (No. 7.) Transmitting letter to Mr. Desbarres, notifying the appointment of Col. C. Douglas Smith to be Lieut.-Governor of Prince Edward Island. 146
- August 11, Downing St. R. Peel to Prevost. Respecting the clothing for the Glengarry and 95th Regiments. 147
- August 12, Montreal. Edward Baynes to same. Had delivered his (Prevost's) despatches to Major General Dearborn on the 8th instant, who received him politely, but stated that he could not take upon himself to conclude an armistice, but would have no hesitation in giving positive orders to the commanding officers at the frontier posts to confine themselves to defensive measures till further orders. The same to be communicated to the Executive Government, and if disapproved of when countermanding the order for defensive measures, a period of four days would be allowed to elapse before hostilities could commence. Had consented to this arrangement. Dearborn stated that he had no direct control over Hull, but would write him and recommend a similar line of conduct. Has furnished Dearborn with orders for the commanders of the Canadian frontier posts to be on the defensive only. General Dearborn strongly deprecated the employment of Indians in the contest. He also objected to the agreement being drawn up in writing and copies exchanged. 163  
(In Prevost's No. 2. of 17th August.)
- August 14, Montreal. Prevost to Liverpool. (No. 65.) Enclosing papers relating to the capitulation of Michillimackinac. His despatch (No. 59) will have acquainted him that a large detachment of the United States army had taken possession of Sandwich on the 12th instant. Hull commenced his operations against Amherstburg a few days after. The 41st behaved with great gallantry in repelling these attempts against the fort by the River Canard. These successes may be favourable to the security of Upper Canada. 150  
(Enclosures calendared at their respective dates.)
- August 16, Camp at Detroit. Capitulation for the surrender of Port Detroit entered into between Major General Brock and Major General Hull. 237  
(In Prevost's No. 7, of 1st September.)
- August 16. Return of ordnance taken in the fort and batteries at that fort. 241  
(In Prevost's No. 7 of 1st September.)
- August 16, Detroit. Return of Ordnance and ordnance stores taken at Detroit. 242  
(In Prevost's No. 7, of 1st September.)
- August 16, Fort Detroit. Copy of Proclamation issued by Brock on the taking of Detroit. 245  
(In Prevost's No. 7, of 1st September.)
- August 16, Detroit. Brock to Prevost. This post surrendered to-day with 2,500 prisoners of war and 25 pieces of ordnance, and without the sacrifice of a drop of British blood. Had only about 700 troops and 600 Indians with which to accomplish this service. Was admirably supported by Col. Procter and the whole staff and every individual under his command. 218  
(In Prevost's No. 5 of 26th August.)
- August 17, Montreal. Prevost to Earl Bathurst. (No. 1.) Congratulations on his succeeding the Earl of Liverpool. 158
- August 17, Montreal. Same to same. (No. 2.) Enclosing papers relating to the mission of Col. Baynes to the Headquarters of the American Army. 160
- August 17, Montreal. Same to same. (No. 3.) An invasion of Upper Canada took place on the 12th July last. The enemy crossed the River Detroit with about 2,300 under Hull and took post at Sandwich. The Canadian militia being unable to oppose them retreated to Amherstburg. Several skirmishes took place, the 41st distinguishing themselves. Encloses Hull's Proclamation. Brock's measures respecting the Militia. Encloses copies of two letters between Hull and Lieut.-Col. St. George at Amherstburg.

1812.

General Brock, fully aware of the importance of that post, had previously strengthened it in every way in his power and on the news of the invasion made all preparations for marching to its relief. Part of the 49th proceeded from Montreal to Kingston to be followed soon by other troops. Has given Major General Sheaffe a temporary employment upon the Staff in Upper Canada. Our Naval supremacy has helped to ward off the fall of Amherstburg and will no doubt enable reinforcements to reach it safely while the surrender of Fort Michillimackinac will give Brock great advantages. The present safety of the Upper Province is to be ascribed to the energy of that officer. Is enabled now to relieve him somewhat since the Army Bill Act has passed. The frontier line from Montreal to Kingston appears secure at present. Arrangements for disposing of the troops. Hopes the measures he has adopted will meet His Royal Highness's approbation. Page 177

*Enclosed.* General Hull's proclamation. 71

Proceedings of the Executive Council, York, 3rd August, 1812, respecting the Militia. 187

(Letters between Hull and St. George calendared at their respective dates.)

August 17,  
Detroit.

Brock to Provost. The enemy crossed the Detroit on the 12th ultimo, occupied Sandwich and ravaged the country as far as the Moravian town. Particulars of the surrender of Detroit; encloses copy of the capitulation. The force giving themselves up cannot be estimated at less than 2,500 men. The Indians under Elliott and McKee took an active part and their conduct was highly satisfactory. Has appointed Col. Myers to the command at Niagara; Capt. Glegg his aide-de-camp, will deliver this, he is charged with the colours taken at Detroit and with those of the 4th U. S. Regiment. Encloses copy of a proclamation which he issued immediately on taking possession of this country. Capture of the "Adams," a fine vessel. 228

(In Prevost's No. 7, of 1st September.)

August 24,  
Montreal.

Prevost to Bathurst. (No. 4.) Since his despatch of the 17th respecting the surrender of Michillimackinac, Hull has made three attempts to approach Fort Amherstburg, in all of which he was repulsed and forced to return to Sandwich. No movement of importance against Upper Canada has taken place. It is now evident that Hull remains inactive from want of reinforcements and supplies, which he is daily expecting. Our forces on the contrary have been able to detach a body across the Detroit River into the United States. The mode of acting upon the enemy's line of communication and supply has been attended with considerable success. A mail from Detroit was taken on the 5th inst., and another on its way there. It will be seen by Hull's intercepted letter how much that officer's hopes of conquering Upper Canada are diminished. As General Dearborn had not the power of including that part of the army under Hull, in the arrangement for a cessation of hostilities he has not thought it necessary to restrain Brock. Has therefore used all possible means to forward him supplies of men, money and stores. Has reason to think Brock reached Amherstburg on the 12th with reinforcements, which, with those from other quarters ought to be sufficient to compel Hull to give up his ideas of conquering Upper Canada. Has received no further word from the United States since Col. Bayne's return. The objects gained by a cessation of hostilities on part of the frontier. The Army Bill expedient has surpassed his most sanguine expectations. Hopes the measures he has pursued will be approved. 196

(Enclosure calendared at its proper date.)

August 26,  
Montreal.

Same to same. (No. 5.) Encloses with great satisfaction a letter from Brock announcing the surrender of Fort Detroit on the 16th. In despatches Nos. 3 and 4, had detailed the operations which had taken place

## Department of Agriculture—Archives.

1812.

in Upper Canada in consequence of General Hull's invasion. Additional particulars; cannot withhold from General Brock the tribute of applause so justly due to him. His (Prevost's) aide-de-camp, Capt. Coore, will deliver this despatch. He is well qualified to give all information respecting the military resources of this command and also the state of politics in the United States, having lately been employed on a mission to Washington. Page 217

(Enclosure calendared at its proper date.)

August 26,  
Green Bush.

Dearborn to Prevost. The President has received no official information from the British Government to warrant a continuance of the provisional measure, temporarily agreed on between Col. Baynes and himself. Therefore informs him that at the end of four days from the time this communication reaches Montreal, and copies to the same effect reach the frontiers, he will consider the arrangement no longer obligatory on either party. Has sent copies to the commanding officers of the U. S. troops. 224

(In Prevost's No. 6 of 31st August.)

August 31,  
Montreal.

Prevost to Bathurst. (No. 6.) The accompanying letter from the Commander in Chief of the U. S. Army will show the disposition manifested by the President on the measure temporarily agreed upon between the two countries. The conduct of the American Government in directing the invasion of Upper Canada will fully justify Brock's offensive measures against an assailing army. Regrets having to send Capt. Coore off before the particulars of the Detroit affair reach here, but will forward them as soon as possible. 222

(Enclosure calendared at the proper date.)

September 1,  
Montreal.

Same to same. (No. 7.) Enclosing despatches from Brock containing the particulars of the termination of Hull's invasion of Upper Canada. 227

September 12,  
Montreal.

Same to same. (No. 8.) The despatches which he has sent home since the declaration of war, will show that he could not consistently suspend the preparations for defence. The convincing proof given by the British Government in their declaration of 23rd June, of their desire to conciliate the United States, is not deemed sufficient by the President to restore tranquillity. All preparations are making by the Americans for the subjugation of the Canadas. Notwithstanding their defeat on the western frontiers, they are assembling in great numbers on the Niagara frontiers, and seem to meditate an immediate attack. Brock asks for reinforcements, which cannot be spared from Lower Canada, owing to the preparations of the enemy near Montreal, therefore, he asks for more troops for both provinces. The people are to be depended upon while we are successful, but doubts them in time of adversity. Stores and accoutrements not yet arrived. The want of clothing for the Glengarry Regiment is a serious inconvenience. Hopes the precautionary measures he has taken will be approved. 247

September 22,  
Montreal.

Same to same. (No. 9.) In his despatch, No. 7, had transmitted particulars of the surrender of Fort Detroit. Has now the honour to report that Brigadier General Hull, with the first division of the prisoners, 22 officers and 343 men, have arrived at this place, the remainder, about 140 men, to be forwarded as soon as possible. Hull has been allowed to go to Boston on parole, accompanied by his aide-de-camp, for the purpose of justifying his conduct to his Government. Has allowed the officers with families to go home on parole. The loyal and brave spirit shown by the militia leads him to hope for a satisfactory result should the country be invaded. The importance of the works he is completing on Isle aux Noix. About 150 Indians have been embodied and placed on this frontier. 251

1812.  
September 24,  
Montreal.      Prevost to Bathurst. (No. 10.) The satisfactory operation of the plan for raising money by Army Bills. Indian presents not yet arrived, the importance of keeping the Nations in good humour. Page 256
- September 30,  
Downing St.      Draft of a letter to Prevost. (No. 9.) Transmitting copy of a letter from Mr. Jack, dated 20th August last, enclosing at the desire of the Lords of the Council for Trade, the draft of a Bill to amend, at the suggestion of the merchants trading to Canada, the schedule of the Act Geo. 3rd, chap. 39, which is to be laid before Parliament next session. Asks for his (Prevost's) observations thereon. 264
- October 16,  
Downing St.      Same. (No. 10.) Despatches No. 59, 3 and 4, laid before the Prince Regent. Brock's prompt measures in dissolving the Assembly of Upper Canada, and his determination to enforce Martial Law, are proofs of his judgment and decision which have not escaped observation. The Prince Regent desires that his approbation be conveyed to him. 207
- October 1.  
Downing St.      Same. (No. 11.) Despatches received. His Royal Highness approves of his having removed to Montreal. Reasons why His Majesty's Government are unable to comply with the requisitions for specie and provisions, Directions will be sent for the establishment of the Newfoundland Regiment to 1,000 men. The Prince Regent has also been pleased to approve of the proposal for raising a corps in New Brunswick. Is glad the Act lately passed for giving circulation to Army Bills has been of such assistance. As his (Prevost's) desire to avoid hostilities is quite in accordance with the wishes of His Majesty's Government, therefore the correspondence with General Dearborn is sure to meet with approval. Col. Bayne's conduct is satisfactory. 172
- October 5,  
Montreal.      Prevost to Bathurst. (No. 11.) Suggestions respecting the Indians of the western frontier. 265
- A P.S. states that he has transmitted a copy of the despatch to Sir John B. Warren, as the public prints say he has been appointed to negotiate a peace with America.
- October 5,  
Montreal.      Prevost to Rt. Hon. Sir John B. Warren. Encloses copy of his letter to Bathurst respecting the Indians on the western frontiers, together with the extract of letters from Brock on the same subject. Hopes from what is enclosed, the advisability of consulting their interests in any negotiations for peace will be obvious to him (Warren). 271
- (In Prevost's No. 11, of 5th October.)
- October 10,  
Downing St.      Draft of a letter to Prevost. Despatch of the 26th August received and laid before the Prince Regent, who most highly approves of the judicious and decisive conduct of Brock, the zeal of Proctor and the intrepidity of the troops. By the exertions of this little army Upper Canada has been secured. His Royal Highness has been pleased to appoint Brock a Knight of the Bath. While giving due credit to Brock the Prince Regent wishes to remark how much his (Prevost's) exertions have contributed to this fortunate conclusion in Upper Canada. 219
- October 13,  
Fort George.      Major General Sheaffe to Prevost. Giving an account of the Battle of Queenston Heights and death of Brock. 281
- (In Prevost's No. 13, of 21st of October.)
- October 17,  
Montreal.      Prevost to Bathurst. (No. 12.) The troops of this neighbourhood have moved into winter quarters. Last accounts of the American Army state General Dearborn to be at Green Bush, near Albany, with about 3,000 men; Brigadier General Bloomfield to be at Plattsburg with 6,000. A force has moved towards Chateauguay and the Americans are making great exertions from St. Régis as far as Sackett's Harbour to interrupt our intercourse. Latest intelligence represents all quiet about Detroit. On the Niagara frontier both parties are acting on the defensive. The Americans are making great exertions to obtain a superior force on the lakes. The advantage of keeping up our Navy. War was declared on the 18th of June and hostilities quickly followed, while he (Prevost)

## Department of Agriculture—Archives.

1812.

struggled to overcome the difficulties arising from the want of specie and the lukewarmness of the Canadians. These obstacles now overcome. Great want of stores. The introduction of Army Bills has had the best effect. Page 273

October 21,  
Montreal.

General orders issued after the Battle of Queenston Heights. 288  
(In Prevost's No. 13, of 21st October.)

October 21,  
Montreal.

Prevost to Bathurst. (No. 13.) Reports with satisfaction that the Militia and Indians stationed on the Niagara frontier have completely repelled a second attempt of the enemy to invade Upper Canada, and that a victory has been gained which has left in our possession 900 of the American Army with their Commander, Brigadier General Wadsworth, who surrendered to Major General Sheaffe. We have to deplore the loss of an able and most gallant officer, Major General Brock, who fell early in the battle. Refers him (Bathurst) for further particulars to Sheaffe's report herewith transmitted. Also encloses copy of a general order he has just issued to the British forces. Will send by the next opportunity a return of killed and wounded and of the stores captured, also the colours taken. Capt. Fulton, his aide-de-camp, will deliver this; he is able to give all information respecting the provinces. 278

(Enclosures calendared at their respective dates.)

October 22,  
Montreal.

Same to same. (No. 14.) All American prisoners are to be sent on parole to Boston to be exchanged as soon as possible, in accordance with the President's desire, that the calamities of war be lessened as far as possible. Arms, accoutrements, and clothing for the militia needed. 296

November 16,  
Downing St.

Draft of a letter to Prevost. (No. 13.) Despatches Nos. 8, 9 and 10 received. The preparations he has made for defence approved by His Royal Highness, who confidently expects that the attacks made upon the Canadas will terminate like the late attack upon the North-western Frontier, in defeat and disgrace. Every exertion to be made to keep the naval superiority on the lakes. Can give no hope of reinforcements at present, but will send troops as soon as they can safely be withdrawn from other quarters. It has not been thought expedient to sanction the measure proposed by General Des Barre, commanding Prince Edward Island, to raise a corps of 500 men, but he (Prevost) might use the resources of the Island for completing the Newfoundland regiment. Is surprised to find that clothing is expected for the Glengary regiment, as Col. Baynes had stated that all but great coats had been provided at Quebec. Indian presents, arms and accoutrements have been sent to Halifax. The paroles granted to Hull and his aide-de-camp to return to the United States are approved. At the same time it is but just that a like indulgence should be granted to any British subjects who may become prisoners in America. The works at Isle aux Noix appear well calculated to impede the advance of the enemy in that quarter. 259

December 8,  
Downing St.

Same. (No. 14.) Despatch No. 13 received. His Royal Highness requests that Sheaffe be notified of his entire approbation of his conduct, and that the title of Baronet has been conferred on him. The regret of His Royal Highness at the great loss the country has sustained in the fall of Brock. The death of Attorney General McDonnell a loss to the province. 294

December 9,  
Downing St.

Same. (No. 15.) Despatches Nos. 11 to 14 received. The necessity of the co-operation of the Indian tribes during the present hostilities; how that co-operation is to be secured. The arrangements for putting the troops into cantonments approved. The 13th, 98th and the 2nd Batt. of the 41st have been withdrawn from other services and will be sent at once to Bermuda, to enter the St. Lawrence as soon as the season will permit. The naval means of defending the province to be increased by 200 sailors and a proportion of officers, to be sent to Quebec as early as possible in the spring. Reasons why the arms, &c., asked for by the re-

1812.

quisitions have not reached Canada. The utmost will be done to place such means at his disposal as will lessen the difficulties of the situation and secure the province. Page 298

*Enclosed.* Memorandum of stores sent to North America or ordered to be shipped to that destination. 305

December 9,  
Downing St.

Draft of a letter to Prevost. (No. 16.) Acknowledges receipt of despatch No. 14. Apprehends that the indiscriminate release of all prisoners of war on parole may increase the difficulties of the situation without a corresponding advantage, however, he (Prevost) being on the spot is best able to judge, as he can ascertain whether the American army does not derive strength from these prisoners, who have only undertaken not to join General Dearborn's force, but yet may join that of another Commander. At all events, objects to the prisoners being sent to Boston, as it is such a short distance from the headquarters of the American army. 307

## GOVERNOR SIR G. PREVOST AND MISCELLANEOUS—1812.

## Q. 119.

1812.  
January 6.

Order in Council appointing William Batchelor Coltman, Lewis Duchereau Duchesnay, Oliver Perrault, Michael Henry Percival, James Kerr, Ross Culbert and John Muir, honorary members of the Executive Council of Lower Canada. 149

January 14,  
Lisbon.

Joseph Cheniquy, the British Ambassador's chief secretary, to ——. Informing him that prints of French victories are to be smuggled into Canada. 256

(In Stuart's of 25th April.)

January 22.

W. Grant to Liverpool. John Blackwood is desirous of being appointed a member of the Legislative Council, or of that and the Executive together. 151

January 31,  
Treasury  
Chambers.

R. Wharton to Peel. Transmitting papers relating to the memorial of Capt. Steele requesting to be allowed to retire on his pay. 152

January.

General statement of the expense attending the Indian Department in the two Provinces. 153

February 1,  
Oxford.

Ryland to Peel. Will as he desires, wait on him in a day or two to discuss the surplus moneys arising from the duties collected under the Jail Acts of Lower Canada. Remarks on the subject. 155

February 3,  
Lisbon.

Joseph Cheniquy, the British Ambassador's chief secretary, to ——. Asking for a passage in a transport going to England. 258

(In Stuart's of 25th April.)

February 7,  
Horse Guards.

J. Torrens to Col. Bunbury. Has the Commander in Chief's commands that the Earl of Liverpool be notified that the establishment of the Canadian Fencibles has been raised to 800, therefore it would be expedient to appoint a second major. 163

February 24,  
Poet's Corner.

Ryland to Peel. Respecting the requisitions for rum and provisions for completing the Indian stores in Upper and Lower Canada. 164

February 27,  
Horse Guards.

The Duke of York to Liverpool. The opening of the season for communicating with North America renders it necessary that a decision be come to as to what troops are to be sent out to Canada. Proposes that a foreign regiment and a regiment of the line be embarked for Quebec; that the 41st and 49th be brought to Europe if affairs will allow, and that the 104th be brought home from New Brunswick. 168

March 2,  
Poet's Corner.

Ryland to Peel. Concerning an order from the Lords of the Treasury directing Mr. Caldwell to pay into the Military Chest at Quebec, the moneys arising from the Jesuits' Estates. Should these revenues in

## Department of Agriculture—Archives.

- 1812.
- future be entirely appropriated to military purposes there is a fear of dissatisfaction and irritation arising in the province. Was in hopes that he would, before this, have been favoured with Prevost's sentiments respecting the subject of his correspondence with the Colonial Department prior to August last. Is just now in an embarrassing situation, left without any directions from the present governor to guide him. Page 170
- A P.S. states that his passage for Quebec is engaged in a vessel to sail with the first convoy.
- March 12, William Walter to Lt.-Col. Bunbury. Asks to be furnished with the  
Audit Office. rate of pay fixed for the second battalion of the Royal Canadian Volunteers in 1796, and whether it was altered between that time and 176
- March 12, Joseph Cheniquy to Castlereagh. As he now has not the least hope  
Portsmouth. of being employed by the British Government, asks that he be allowed to solicit the French Government to restore his brother (Louis) the only support of his parents, taken prisoner in the "Humber," and permit him (Joseph) to take his place until an exchange of prisoners can be arranged. 260
- March 13, Ryland to Peel. As his passage is taken in a vessel expected to sail  
Poet's Corner. next month, he submits for the Earl of Liverpool's consideration, the circumstances which have induced him to prolong his stay in England a year beyond the time calculated upon. Asks to be reimbursed the amount of his expenses. 177
- March 15. Same to same. Acknowledges letter in answer to his of the 13th  
inst. Would not have asked to be reimbursed unless he considered there was fair ground for doing so. Will acquiesce in Liverpool's determination. 180
- March 16, Same to Stuart. Has no document by him which will give informa-  
Poet's Corner. tion about the rate of pay originally fixed for the 2nd Batt. Royal Canadian Volunteers. Has no recollection of the rate being altered. States where he thinks the information may be found. 181
- March 18. Memorial of Captain Alexander Macdonell to the Earl of Liverpool. 193
- March 24. John Inglis to Liverpool. Enclosing copy of a communication on the  
Mark Lane. military state of Canada made to the Committee of Merchants interested in the Trade and Fisheries of the British North American Colonies by several highly respectable inhabitants of Canada, now in London. Asks attention to this communication. Refers him for further information either to Gore or Ryland. 184
- The enclosure dated 18th March, 1812, states that Canada would not be able to resist an invasion. 185
- March 25, Sir Henry Torrens to Peel. The Commander-in-Chief requests that  
Horse Guards. tonnage be prepared for the conveyance of certain troops to Canada. 189
- March 25, Harrison to same. Having laid before the Lords Commissioners of  
Treasury the Treasury a letter from Mr. Caldwell relative to paying into the Chambers. Military Chest at Quebec the moneys arising from the estates of the late order of Jesuits in Lower Canada, transmits the same for Lord Liverpool's opinion thereon. 190
- March 27, Torrens to same. How the 104th Regiment is stationed. This corps  
Horse Guards. is under great difficulties for want of efficient officers. His Royal Highness recommends that a company be added to this regiment for the purpose of recruiting. 192
- April 3, Augustin Boiton to Liverpool. Memorial. 209  
London.
- April 4, Torrens to Peel. Enclosing return of detachments for which passages  
Horse Guards. to Canada are required. 197

1812. *Enclosed.* The return. Page 198
- April 6, Ryland to Peel. Transmits letters relating to a Canadian named  
Poet's Corner. Cherrique suspected of being employed by the enemy as a spy. Thinks  
from his knowledge of him that it is more than probable. 199
- April 6. Jane Lynd to Liverpool. Her memorial of which a copy is enclosed,  
was sent in about eighteen months before. As no answer has been re-  
ceived, renews her application. 201
- Enclosed.* Copy of the memorial asking for a renewal of the lease of  
a farm called Belleville near Quebec, which formerly belonged to the  
Jesuits. 202
- April 6, George Harrison to Robert Peel. Instructions to be sent to the  
Treasury Chambers. officers commanding foreign stations (except Canada from whence re-  
turns are received) to have strict returns made at the beginning of each  
year, of the persons proposed to be employed in the public departments,  
with salary, pay allowances, &c., with a comparative statement of the  
amount of the estimate for each separate department and that of the  
current year. 205
- April 9, ——— to Liverpool. (In French.) Enclosing petition from Augustin  
London. Boiton. 207
- (Enclosure calendared at its proper date.)
- April 9, Chetwynd to Peel. Respecting a Bill to be submitted to Parliament  
Whitehall. to provide that no goods or commodities whatever, except such as are  
of the growth, produce or manufacture of the territories of the United  
States shall be brought from those territories by inland navigation or  
land carriage into the provinces. 211
- April 10, Ryland to same. Is extremely sorry that owing to his papers being  
Poet's Corner. on board the vessel he is unable to give information asked for. Will  
wait on him (Peel) to-morrow. Asks to be allowed to carry the despatches  
to Prevost, as he sails for Canada in a day or two. 214
- April 11. Same to same. Since being at his (Peel's) office it has occurred to  
him that Sir James Craig did not particularly mention the Jesuit  
Estates in any one of his despatches to Liverpool. Has by him a copy  
of the written instructions which were given him on his departure for  
England. Encloses an extract respecting the Estates. 215
- Enclosed.* The extract. 216
- April 17, Duke of York to Liverpool. Recommends an exchange between the  
Horse Guards. 1st Batt. Royal Scots stationed eleven years in the West Indies, and the  
4th Batt. of the 60th. 217
- April 18, Sir Henry Torrens to Peel. Stating where the 1st Batt. of the Royal  
Horse Guards. Scots is stationed. 219
- April (?) 21, Joseph Cheniquy to same. Acknowledging answer to his letter of the  
London. 15th instant. Finds his endeavours to serve Government disappointed.  
As Lord Liverpool's answer is conclusive thinks himself at liberty to  
offer his services to some other government in amity with Great  
Britain. 220
- April 21, Ad- John Barrow to same. To know when the troops will be ready for  
miralty Office. transport. 222
- April 21, Augustus J. Foster to Castlereagh. Despatch No. 1, containing the  
Washington. Prince Regent's command that he should make diligent enquiries into  
the actual military establishments of the United States received. Has  
taken measures to procure the most accurate information and expects to  
be able to forward a complete statement by the May packet. Some re-  
marks on the United States army officers and the political aspect of that  
country. 265
- Enclosed.* Debate on the Navy Bill, taken from the *National Intel-*  
*ligencer*, of 14th April, 1812. 273
- An Act in addition to that entitled "An Act to raise an additional  
military force." 284



## Department of Agriculture—Archives.

1812.

“An Act to authorize a detachment from the militia of the United States,” taken from the *National Intelligencer*, April 21st, 1812. Page 286

- April 23, Transport Office. Alexander McLeay to Peel. Concerning the time when the troops will be ready to embark. 223
- April 23, Horse Guards. Sir Henry Torrens to same. The troops mentioned now ready for transport. 224
- April 24, Horse Guards. Same to same. Stating the strength of the detachments of the 98th and 100th Regiments. 225
- April 25, Admiralty Office. John Croker to Peel. H.M.S. “Minerva” is to give protection to the transports carrying the 60th to the West Indies, and asks to be informed of the several places to which they are successively to proceed, that distinct instructions may be given for the performance of this duty. 226
- April 25, Lisbon. Charles Stuart to ——. In answer to letter of 10th April, respecting the suspicions entertained of a native of Canada, Joseph Cheniquy, states what he knows of him while in Lisbon. Encloses two letters from Cheniquy. 255  
(In W. Hamilton’s of 21st May.)
- April 27, Admiralty Office. J. W. Croker to Peel. H. M. S. “Minerva” is to give protection to the transports to Barbados and Rear Admiral Sir Francis Laforey is to give protection to the various other destinations. 227
- April 27, Horse Guards. Torrens to same. The Commander-in-Chief proposes that the 41st Regiment should return to England on the arrival of the 4th Battalion of the 60th at Quebec. 229
- April 27, Admiralty. Croker to same. Requests an immediate answer to his letter of the 25th inst. 230
- April 28, Transport Office. Alexander McLeay to same. The strength of the Battalion 60th Regiment is increased to 1,077 rank and file. 233
- May 2. Mr. Bond to same. Transmitting two pamphlets which plainly indicate the condition of the State of Massachusetts, as well as the general grounds of apprehension of war with Great Britain which prevailed in the United States at the period alluded to in his (Peel’s) conversation yesterday. 234
- May 3, Washington. Foster to Castlereagh. (Extract.) Enclosing copy of a circular letter sent by the Secretary of War to the Governors of the different States calling upon them for their quotas of 100,000 militia voted this winter. General Harry Lee has accepted the office of Adjutant General, Colonel Talmage had refused both that situation and the Quarter Master Generalship. Mr. Lewis, the future Quarter Master General, has assured him that the returns of recruits amount already to 3,000 men. Doubts the statement. A Bill is pending laying such rigid restrictions on the Quarter Master and Commissary Generals as to prevent any respectable men from taking the offices. The part of the Bill relating to the appointment of additional officers in the U. S. Army struck out. A report is published of an armed British and Indian force being about to enter the United States, probably intended to irritate and to influence the New York elections. 290
- Enclosed. Copy of a circular letter from the *National Intelligencer* 25th April, 1812. 292
- May 4. Memo. for Col. Bunbury. Mr. Destemauville, Deputy-Supt. of Military Roads in Lower Canada, wishes to sail in some transport bound for Quebec. 235
- May 6, Treasury Chambers. Harrison to Peel. Transmitting all the papers concerning the appeal of Christopher Sanguinet relative to the boundary line between the Seigniory of La Salle and the adjoining lands of the Crown. The Commissioners of the Treasury wish to be informed if any communication has been received from Canada upon the subject. 236

1812.  
May 7, Foreign Office. Castlereagh to Foster. Despatches received. The intelligence of the disclosure made by Henry and communicated in No. 13, has reached this country through the American press. The Prince Regent desires that immediately upon receipt of this he (Foster) deliver to Mr. Munro an official note, disclaiming on the part of the British Government any knowledge of the nature of the mission upon which Mr. Henry was sent by Craig until several months after the whole was terminated and after Mr. Henry was specially recalled from the United States, and that no authority or instructions were ever given by this Government to Craig to send any mission of that description into the United States. He is also to state to the American Government that when this Government was first notified of Henry's mission they understood that he was sent for the purpose of procuring information at a time when military preparations were actually making for the invasion of Canada. He is also to intimate that the Prince Regent was both surprised and concerned that the U. S. Government did not at once on receiving the information require an explanation through him (Foster) and not resort to the extraordinary measure of bringing forward a charge against the British Government. The Prince Regent hopes the explanation will be received in the same spirit in which it is made. Page 239
- May 14, Admiralty Office. John Barrow to Col. Bunbury. Mr. John Black has applied for a passage to Quebec. Asks Lord Liverpool's opinion on the application. 237
- May 14, Foreign Office. W. Hamilton to same. Enclosing, for Lord Liverpool's information, copy of a despatch from Lord Castlereagh to His Majesty's Envoy in the United States on the subject of the disclosure to the American Government of Henry's correspondence. 238  
(Enclosure calendared at its proper date.)
- May 16, London. Joseph Cheniquy to Peel. States that while in Lisbon he fell in with an Italian who closely questioned him about affairs in Canada and pointed out the great advantage to be derived by that country if it could separate from Great Britain and that if the Canadians showed a desire the French would be ready to help. He wanted some prints of French victories to be sent to Canada, which he (Cheniquy) undertook to send out; being suspicious, informed the British Ambassador who caused the pictures to be seized and brought back to Lisbon. Asks for some situation as he is in great poverty. 245
- May 18, Treasury Chambers. George Harrison to Lieut.-Col. Bunbury. Enclosing list of promotions in the Commissariat Department. 250  
*Enclosed.* The list. 251
- May 21. Greenwood Cox and Co. to ———. Asking to be informed if Sir George Prevost's proposal for raising the Glengarry Light Infantry has been acceded to. 252
- May 21, Foreign Office. W. Hamilton to Peel. Transmits, to be laid before Lord Liverpool, copies of a despatch and its enclosures from Mr. Stuart at Lisbon, relative to Joseph Cheniquy, together with a letter from Cheniquy to Castlereagh. 153  
(Enclosures calendared at their respective dates.)
- June 9, Office of Ordnance. R. H. Crewe to Peel. The "Cambo," with the ordnance stores for Quebec sailed for Portsmouth on the 19th October, and, after wintering at Bermuda, sailed for Quebec on the 20th April. The 7,000 stand of arms forwarded in her completed the supply for 10,000 men, the number mentioned in Liverpool's letter. 263
- June 10, Foreign Office. W. Hamilton to Col. Bunbury. Enclosing, for the information of the Earl of Liverpool, extracts of two despatches from His Majesty's Envoy at Washington. 264  
(Enclosures calendared at their respective dates.)

## Department of Agriculture—Archives.

1812. June 13.	F. Preeling to Peel. Acknowledging letter respecting the inadequate salaries of the postmasters at Quebec and Halifax. The matter will be considered.	Page 295
June 18, Whitehall.	J. Beckett to same. Enclosing a pardon for Geneviève Piché. <i>Enclosed.</i> The pardon.	296 297
June 23, Treasury Chambers.	Harrison to same. Transmitting memorial from sundry merchants of London, praying for compensation for loss sustained by the Michillimackinac Company through the seizure of their bateaux by the Americans in 1808, for Lord Bathurst's opinion thereon.	298
June 24.	Sir Watkin (?) to Bathurst, sending letters from Canada which may be interesting to Government.	299
October 15, Fort George.	Return of killed, wounded and missing of the army under the command of Major General Isaac Brock, in an action at Queenston (sic), Niagara, on the 13th of October. (In Prevost's No. 16, of 5th November.)	14
October 15, Fort George.	Return of killed, wounded and prisoners of war, in the action at Queenston (sic.), Niagara, on the 13th October. (In Prevost's No. 16, of 5th November.)	16
October 15, Fort George.	Return of ordnance, stores, &c., captured at Queenston, Niagara, on the 13th October. (In Prevost's No. 16, of 5th November.)	17
October 26, Montreal.	Prevost to Bathurst. Recommends his brother, a post captain in the Royal Navy, to be appointed for the purpose of organizing such a marine establishment as His Majesty's Government may deem sufficient for the Canadas.	2
October 27, Montreal.	Same to same. (No. 15.) The vacancies in the Legislative Council caused by the deaths of Messrs. Perrault and Boucherville, the advanced age and infirmities of some members and the absence of others, render it necessary that the number should be increased. Submits the names of James McGill, Jean-Antoine Panet and William McGillivray. Would have recommended McGill before, but thought he would object to attending at Quebec; on finding he does not, asks that the <i>mandamus</i> be antedated to give him precedence.	3
November 5, Montreal.	Same to same. (No. 16.) Despatches Nos. 3 to 7, inclusive, received. The several communications which he has had the honour of addressing to him (Bathurst) must have long ago shown that the conduct of the President has not corresponded with the just expectation of His Majesty's Government, and that the repeal of the Orders in Council which was made the ostensible object of the war on the part of America has not tended in the smallest degree to check its progress or to interrupt the designs for the invasion of the Canadas. Under these circumstances, it would certainly be regretted should the reliance placed by His Majesty's Government upon the good faith of America have induced it to withhold any part of the help so indispensably necessary for the defence of the Canadas. The contest could not long continue, as the foe can so easily augment his forces to almost any extent. Is led to make these observations as all hope of reinforcements before spring is gone. His despatch, No. 6, came too late for him (Prevost) to make any use of the regiments sent to Halifax and Bermuda. Nova Scotia does not need at present a regiment for its defence. New Brunswick stands little in need of help. Bermuda is well protected by the shoals and rocks, so that these regiments should have been sent to strengthen the sorely menaced Provinces. The small force he has must ultimately give in. Is satisfied that whenever the pressing exigencies in other	

1812.

parts of the world will permit, the Prince Regent will consider how limited the means for the defence of British North America are. Encloses returns of killed and wounded at Queenston and also returns of arms, &c., taken on that day. The colours have been committed to the charge of Capt. King to be laid at the feet of the Prince Regent. Last news from Sheaffe report no further attack on Fort George. Great preparations making by the enemy to obtain the superiority of the lakes; many ships building in their harbours on Erie and Ontario. Naval officers and seamen needed for the Canadian vessels. The disadvantages from want of specie are effectually removed. Transports with arms and ammunition received. Is glad that his (Prevost's) idea as to the employment of the Indians is so entirely in accord with his (Bathurst's). Will observe the greatest economy in every branch of the service. Page 5  
(Enclosures calendared at their respective dates.)

- November 5, Montreal. Prevost to Bathurst. (No. 17.) Despatch No. 6, received. As the acceptance of the resignations of Williams and DeBonne and the appointment of successors was quite unavoidable, hopes the appointments will be confirmed. 18
- November 7, Montreal. Same to same. (No. 18.) Enclosing prices current at Quebec for August, September and October. 20  
*Enclosed.* Quebec prices current for August. 21  
Ditto for September. 24  
Ditto for October. 27
- November 7, Montreal. Prevost to Bathurst. (No. 19.) Transmitting naval officers' returns of vessels entered inwards and cleared outwards from Quebec for the quarter ending 5th July last. 30
- November 7, Montreal. Same to same. (No. 20.) Transmitting a deal box containing exemplifications of the Act passed in the two last sessions of the Provincial Legislature, of which he encloses a schedule. 31  
*Enclosed.* The schedule. 32
- November 10, Camp near Buffalo. Smyth's proclamation to the men of the State of New York. 134  
Answer of the men of New York inhabiting the western district. 136  
Smyth's proclamation to the soldiers of the Army of the Centre, dated 17th November. 139  
(In Prevost's No. 30, of 17th December.)
- November 18, Montreal. Prevost to Bathurst. (No. 21.) In his despatch No. 50, of 8th June last, had the honour of submitting a statement of the debt due by Government to the Provinces of Lower Canada and of the manner in which the same had been incurred, at the same time stating that the amount of the debt might soon be called for. As the increased expenditure owing to the war has exhausted the Civil Chest, he has been under the necessity not only of repaying the sum of £25,000 due from the Government to the province, but of advancing the further sum of £15,000. Encloses a list of the salaries not provided for by the Legislature and for which he has directed the sum of £5,103 sterling to be issued to the Receiver General from the Military Chest. Draws attention to the inadequacy of the salary allowed to the bishop of the Catholic Church in this country. Has always received from Bishop DuPlessis the most cordial and ready assistance in forwarding the views of His Majesty's Government. Attributes the ready obedience of the militia and the facility with which the army bills were circulated in a great measure to the influence of the Catholic clergy. Transmits representation from Committees of Trade at Montreal and Quebec. 33  
*Enclosed.* List of payments made by the Receiver General of Lower Canada and not laid before the Legislature. 38
- November 18, Montreal. Prevost to Bathurst. (No. 21 duplicate.) Enclosing a return of men declaring themselves to be British born subjects, selected from among

## Department of Agriculture—Archives.

1812.

the prisoners recently taken at Queenston in the service of the United States. They have sailed for England to be disposed of as the Prince Regent may direct. Page 39

*Enclosed.* The return. 40

November 18, Downing St. Draft of a letter to Prevost. (Private and confidential.) As the United States have appointed Mr. Mitchell to act as agent for prisoners of war at Halifax, and as Sir John Sherbrooke thinks he is also commissioned to communicate to his Government such information as he may from time to time collect, he proposes that an intelligent person be employed in a similar capacity in the United States. He (Prevost) is to consult with Sir John Sherbrooke on this subject. Should the United States refuse to receive an agent a similar line of conduct is to be adopted regarding Mr. Mitchel. 41

November 21, Chambly. Prevost to Bathurst. (No. 22.) The enemy frustrated in their designs for taking Kingston. Great necessity for keeping the Naval superiority on the lakes. Vessels building. Recommends that the marine on the lakes be a naval establishment under the control of the Navy Board, and that proper officers be appointed by that board; till this is done the forces under his command will not be as efficient as they might be. The enemy's force encamped at Plattsburg is advancing to the village of Champlain with the avowed purpose of penetrating into the frontier. He has sent troops under Col. Baynes to the support of Major General DeRotenburg. The enemy has made several reconnaissances beyond the lines into the province, their army, though not large may be reinforced and therefore he is obliged to collect all his disposable troops near this frontier. The lateness of the season, &c., leads him to think that if not immediately reinforced they must in a few days retire. 43

November 21, Chambly. Same to same. (No. 23.) The clothing, &c., wanted for the Embodied Militia and Voltigeurs. 50

November 28, La Prairie. Same to same. (No. 24.) Since his last report from Chambly the vigor of the enemy's operations against Lower Canada has gradually declined and terminated on the 22nd in a complete retreat upon Plattsburg, Burlington and Albany, where he is informed they intend to take up their winter quarters. Encloses copies of the general orders he has issued to the Militia of Lower Canada upon this occasion. The improvement in character and disposition of the Canadian peasantry is caused by their being called on to protect their own country. A small body of militia called Voyageurs, stationed at St. Regis, were taken prisoners by the Americans; he had thought proper to direct as a measure of retaliation that an attempt should be made to carry off an American party stationed in the Block House at Salmon River, which service has been most effectually performed; for the particulars encloses copy of general order issued on the occasion. The President's Message to Congress contains such strong evidence of the hostile intentions of that Government that he feels confident reinforcements, &c., will be afforded him (Prevost) to successfully terminate the war. 52

*Enclosed.* General orders dated 26th November. English, 56; French, 57. 56, 57

Ditto dated 27th November. English, 60; French, 61. 60, 61

Ditto dated 27th November, upon the attack on Salmon River. English, 64; French, 65. 64, 65

November 28. Return of the killed, wounded, and missing in the affair with the enemy on the Niagara Frontier. 128  
(In Prevost's No. 30 of 17th December.)

November 30, Montreal. W. H. Robinson, Commissary General, to Prevost. Respecting the provisions required. 70

(In Prevost's No. 25 of 1st December.)

1812.  
November 30, Same to same. Difficulty of provisioning the troops. Has not a  
Montreal. proper supply of clerks, storekeepers, &c., men should be sent out from  
England. Some remarks on the officers of the department. Page 73  
(In Prevost's No. 25 of 1st December.)
- November 30, Major General Sheaffe to Prevost. An attack was made on our batteries  
Chippawa. opposite Black Rock on the 28th instant. The enemy repulsed. A short  
account of the engagement. 114  
(In Prevost's No. 30 of 17th December.)
- December 1, Prevost to Bathurst. (No. 25.) Enclosing copies of two letters from  
Montreal. the Commissary General of British America and addressed to him  
(Prevost). The subject of them is important. 68  
(Enclosures calendared at their respective dates.)
- December 1, Same to same. Enclosing schedule of the Acts passed in the last two  
Montreal. sessions of the Provincial Parliament which should have accompanied  
his despatch, No. 19. 82  
*Enclosed.* Schedule. 83
- December 1, Lt.-Col. Cecil Bisshopp to Sheaffe. An account of the action at Black  
Frenchman's Creek. Rock on the 28th ult. 120  
(In Prevost's No. 30 of 17th December.)
- December 4, Sheaffe to Prevost. Enclosing Col. Bisshopp's report of the engage-  
Fort George. ment of the 28th ult. A return of the killed, wounded and missing,  
also sundry other documents, among them a proclamation by Brig.  
General Smyth. The character of the latter is such as to reflect great  
discredit on those connected in its publication. He (Prevost) will see  
by some of the accompanying papers that a want of confidence existed  
between the General and his troops. 118  
(In Prevost's No. 30 of 17th December.)
- December 7, Prevost to Bathurst. (No. 26.) Enclosing prices current and rates  
Quebec. of exchange at Quebec for November last. 90  
*Enclosed.* Quebec price current for November. 91
- December 7, Same to same. (No. 27.) Enclosing, in answer to despatch No. 8, a judg-  
Quebec. ment delivered in the Court of King's Bench, the answer of the Chief  
Justice of that Court to the memorial of the Judge of the Vice-Admiralty  
Court, alluded to in his (Bathurst's) despatch. 94  
*Enclosed.* Judgment signed by J. Sewell on the memorial of the  
Judge of the Vice-Admiralty Court. 96
- December 10, Prevost to Bathurst. (No. 28.) Enclosing copy of a treaty entered into  
Quebec. between Major General Dearborn and himself for the release of prisoners  
on parole and for their eventual exchange. 104  
*Enclosed.* The treaty. 105
- December 15, Draft of a letter to Prevost. (No. 17.) His Royal Highness approves of  
Downing St. the appointment of Mr. Edward Bowen as Attorney General of Upper  
Canada. 147
- December 16, Prevost to Bathurst. (No. 29.) Clothing for the Militia wanted. Hopes  
Quebec. upon the next meeting of Parliament to be empowered to embody a  
considerable number in addition to those already employed. In the  
event of the continuation of hostilities he would require cavalry appoint-  
ments for 400, and 500 pistols. Also recommends that 10,000 stand of  
arms be shipped for Quebec. 109
- December 17, Same to same. (No. 30.) Enclosing despatches from Major General  
Quebec. Sheaffe, containing an account of an attack made by the enemy on the  
28th ult., which was repulsed with trifling loss. The enemy suffered  
considerably in killed and wounded, with one Captain (King) and 38  
men taken prisoners. The particulars are given in Sheaffe's despatches.  
Lieuts. King, R. A., and Lamont, 49th., were severely wounded. Encloses  
also copy of the general order which he issued on the occasion. 112  
(Enclosures calendared at their respective dates.)

## Department of Agriculture—Archives.

1812. December 17, Quebec.	General orders issued on receipt from Sheaffe of the news of the engagement of the 23th ult. (In Prevost's No. 30 of 17th December.)	Page 130
December 18, Quebec.	Prevost to Bathurst. (No. 31.) Enclosing a requisition for stationery for the Civil Department, Lower Canada, for 1813. <i>Enclosed.</i> The requisition.	143 144
December 18, Quebec.	Prevost to Bathurst. (No. 32.) Transmitting copy of the proceedings of the Executive Council on Matters of State, between 7th June, 1812, and 21st July following.	146
No date.	Memo. for Peel. Received from Sir R. George respecting the destination of the transports.	231

### MISCELLANEOUS 1812.—Continued.

#### Q. 120.

February 8, Quebec.	General order announcing another brilliant victory achieved by the army under Procter at Detroit. English, 189; French, 192.	
March 24.	J. Inglis to Liverpool. Is requested by the Committee of merchants interested in the trade and fisheries of the British North American Colonies to transmit the enclosed copy of a communication made to them by several highly respectable inhabitants of Upper and Lower Canada now in London, on the Military state of those colonies. Asks his (Liverpool's) attention to the same and for further information refers him to Sir Francis Gore. <i>Enclosed.</i> The communication dated 18th March, 1812, calls attention to the danger threatening these colonies in the event of war.	21 22
May 20.	———, to Lt.-Col. Thornton. (Extract.) The success is greater than expected. The bounty offered is so small that many of the officers have had to draw from their own funds for expenses. Has purchased green cloth for uniforms. Sir George Prevost expresses himself highly satisfied with our labours. Has incurred many debts and if not made Colonel will be half ruined.	32
July 3, London.	J. Barker, Deputy Storekeeper General, to Harrison. The 200 cavalry sabres ordered were shipped on the 27th ult. (In Harrison's of 13th July.)	4
July 11, Washington.	Baker to Castlereagh. (Extract.) Enclosing copy of an act of Congress making provision for the more perfect organisation of the Army of the United States. <i>Enclosed.</i> The Act. Abstract referred to. (In Hamilton's of 24th August.)	57 58 60
July 13, Treasury Chambers.	Harrison to Peel. Enclosing letter from the Storekeeper General, reporting the shipment of 260 cavalry sabres. (Enclosure calendared at its proper date).	3
July 14, Horse Guards.	Torrens to same. The Commander-in-Chief requests that tonnage may be provided for troops to North America.	5
July 17, Treasury Chambers.	Harrison to same. £2,000 has been advanced to the Receiver General of Upper Canada, in aid of the Civil expenditure of that province, by Commissary General Robinson.	6
July 21, Halifax.	Vice-Admiral Sawyer to Croker. Relating to the naval arrangements.	46
July 22, Whitehall.	Chetwynd to Peel. The Lords of Trade have considered the papers relating to the claims of Messrs. Campbell and Grece, and are of opinion that Mr. Campbell has no claim beyond his salary to November, 1811, and that Mr. Grece should be granted a lease of the farm now occupied by him on reasonable conditions for a term of seven years.	7
July 22, Lincoln.	A. Sutherland to William Merry, Deputy Secretary at War. Suggests that it would be well to enquire about the men of the Highland Fencible	

1812. Regiment who emigrated to Canada on the disbanding of that regiment in 1799. Page 12  
(In Lukin's of 29th July.)
- July 28. F. Freeling to Peel. Relating to the mails between Quebec and Halifax, and to the winter mails from Quebec, which may be forwarded from Quebec and Halifax instead of being taken on to New York. 9
- July 29, War Office. Robert Lukin to Lt.-Col. Bunbury. Enclosing letter from Mr. Sutherland, late Lieutenant 17th Regiment. 11  
(Enclosure calendared at its proper date.)
- August 1, Westminster. Enclosing a memorial of the committee of merchants interested in the trade and fisheries of the British North American Colonies, for Lord Bathurst's consideration. 15  
*Enclosed.* The memorial. 16
- August 1, Washington. Baker to Castlereagh. General Hull entered Canada on the 11th ult., and issued a proclamation from Sandwich, his headquarters. Accounts state that it was his intention to march without loss of time against Fort Malden, the British Force being concentrated about that place. He does not appear to have been joined by any Canadians, though, in consequence of his proclamation, some of the Militia have returned to their homes. 63  
(In Hamilton's of 10th September.)
- August 5, Transport Office. W. George to Peel. The "Cambo," with Ordnance stores for Quebec, sailed from Bermuda the 20th April. There can be no doubt of her arrival at Quebec, as if any accident had happened it would have been heard of. 62
- August 8, Treasury Chambers. R. Wharton to same. States for the information of Lord Bathurst, that a copy of his (Peel's) letter of the 6th ult., respecting the provisions acquired for Canada, has been transmitted to the Commissioners of Victualling. 27
- August 8. Commissioners of Victualling to R. Wharton. Supplies asked for, to be sent without loss of time. 41
- August 10. Charles Bicknell to J. W. Croker. Asks for a copy of the answer of the Chief Justice of the Provincial Court of King's Bench at Quebec, to the memorial of the Judge of the Vice-Admiralty Court, on the subject of a claim, set up by the former court, of exclusive jurisdiction over the whole of the River St. Lawrence. 29
- August 11, Admiralty Office. John Croker to same. Enclosing copy of a letter from Charles Bicknell. 28  
(Enclosure calendared at its proper date.)
- August 11, Mr. Herries to same. In reply to his note of this date states that not any part of the clothing ordered for Canada, except the great coats, need now be shipped. Will take immediate measures to prevent the forwarding of the other articles ordered. 31
- August 12, London. Memorial of the Merchants interested in the North American trade, to Bathurst. 35
- August 12, Treasury Chambers. W. Wharton to Peel. Enclosing copy of a letter from the Commissioners of Victualling. 40  
(Enclosure calendared at its proper date.)
- August 12, Edinburgh. Ronald MacDonell, late Captain, Glengarry Fencibles, to Bathurst. Asks to be allowed to raise a company either in the Highlands or in North America for the regiment now being enlisted. 42
- August 12, Commissary in Chief's Office. J. C. Herries to Peel. Immediately on the receipt of his note he took steps to prevent the shipment of clothing for the Glengarry regiment, except the great coats to be sent soon. 43
- August 15, Admiralty Office. W. Croker to same. As a copy of the answer of the Chief Justice to the memorial of the Judge of the Vice-Admiralty Court on the subject of a claim set up by the former Court of exclusive jurisdiction over the whole River St. Lawrence has not been transmitted by Prevost, requests that a copy may be sent to this office. 44



## Department of Agriculture—Archives.

1812. August 18, Montreal.	Agents of the North-west Company to McTavish, Fraser and Co., Inglis, Ellice and Co., and Sir Alexander McKenzie. Respecting a proposed voyage. <span style="float: right;">Page 89</span>	89
August 20, Admiralty Office.	J. W. Croker to Peel. Enclosing letter from Vice-Admiral Sawyer at Halifax relative to American affairs. <span style="float: right;">45</span> (Enclosure calendared at its proper date.)	45
August 20, Whitehall.	Thomas Lack to Colonel Bunbury. Enclosing copy of draft of a bill intended to be submitted at the next session of Parliament, in consequence of a memorial presented by the merchants trading to Canada, to the Lords of Trade. <span style="float: right;">52</span> <i>Enclosed.</i> Draft of a Bill intituled "An Act to allow the importation of rum or other spirits from His Majesty's colonies or plantation in the West Indies into the Province of Quebec without payment of duty under certain conditions and restrictions." <span style="float: right;">53</span> Schedule referred to in the Bill. <span style="float: right;">55</span>	52
August 24, Foreign Office.	William Hamilton to Col. Bunbury. Enclosing extract of a despatch from Mr. Baker at Washington with copy of an Act of Congress. <span style="float: right;">56</span> (Enclosures calendared at their respective dates.)	56
August 25, London.	William Riggs to Liverpool. He was the bearer of despatches from Canada, which on his landing were forwarded by mail. Asks for a passage back again and any help possible in forwarding the application made by Prevost to procure him the situation of lighthouse-keeper on Bic Island. <span style="float: right;">61</span>	61
August 29, Montreal.	Prevost to Harrison. Has issued his warrant for £10,000 in aid of the Civil expenditure of Lower Canada. <span style="float: right;">98</span>	98
September 10, Foreign Office.	W. Hamilton to Henry Goulburn. Enclosing copy of a despatch from Mr. Baker, dated Washington, 1st August. <span style="float: right;">62</span> (Enclosure calendared at its proper date.)	62
September 14, Fort Augustus	Alex McDonell, Capt. 2nd Inverness Local Militia, to Bathurst. Submitting a memorial which he (McDonell) had addressed to Lord Liverpool, with his answer. Repeats his application to raise a regiment from the Glengarry emigrants. <span style="float: right;">65</span> <i>Enclosed</i> The memorial. <span style="float: right;">66</span> The answer, dated 3rd April, Downing St., stating that the measures for raising a regiment are suspended. <span style="float: right;">68</span>	65
September 17, Commissary in Chief's Office.	J. C. Herries to Goulburn. Respecting the great coats for the Glengarry Regiment. Encloses return of articles intended to be sent before the order was countermanded. <span style="float: right;">69</span> <i>Enclosed.</i> The return. <span style="float: right;">71</span>	69
September 21 Chelsea.	Thomas Tackle to Bathurst. Acknowledging letter of 15th instant, requesting, in writing, information as to the policy of the United States with respect to their Indian neighbours. Feels himself quite unable to give information, except verbally and with a map at hand. Will be glad to wait upon him (Bathurst) or any one he may appoint. <span style="float: right;">72</span>	72
September 24, Office of Ordnance.	Return of ordnance consigned to R. Fleming, Ordnance Store-keeper at Quebec. <span style="float: right;">246 to 262</span>	246 to 262
September 25, Transport Office.	Memorandum of a particular service under orders for Nova Scotia. <span style="float: right;">74</span>	74
September 25, Westminster.	Nat. Atcheson to Castlereagh. Transmitting memorial from the North-west Company and papers annexed. Asks for early attention. <span style="float: right;">76</span>	76
September 26, Foreign Office.	E. Cooke to Goulburn. Enclosing letter and memorial from the agent and company of North-west Merchants. <span style="float: right;">75</span> (Enclosures calendared at their respective dates.)	75
September 27, Philadelphia.	Baker to Castlereagh. Transmitting to the Secretary of War printed copies of Hull's letters of 7th and 13th ult., giving an account of affairs at River Raisin. Since the capture of Detroit the Indians have been	

1812.

active on the Western Frontier. Accounts state that the garrison of Chicago, owing to its exposed situation, received orders to retire to Fort Wayne, but were massacred on the way by the Indians. Apprehensions for the forts on the borders of the Ohio. A large body of troops are assembling under Brigadier General Harrison, U. S. Army. The force under Major General Von Rensselaer at Lewiston with about two or three thousand men. Niagara in a most defenceless state. Major General Bloomfield was at Plattsburg on the 9th inst., with about 2,000 men. Five sloops have been purchased for the use of the U.S., to be added to the two gun boats to form a flotilla capable of commanding Lake Champlain. The headquarters of the American Army are still at Albany, although the troops are moving to Plattsburg. The naval force is all in port at present. Page 150

- September 29, W. H. Harrison, Commissary General, to J. C. Herries. The Commander of the Forces has issued his warrant upon him to pay to the Receiver General of Lower Canada £10,000 and stated his intention of immediately issuing another warrant for a further sum of £15,000; as Brock has represented to Prevost that the Civil Chest of Upper Canada is exhausted, his Excellency also intends to issue a warrant for £5,000 to be paid to the Receiver General of that province. 220  
Quebec.
- October 1, Petition of Messrs. McTavish, Fraser and Co., Inglis, Ellice and Co., and Sir Alex McKenzie on behalf of themselves and the agents and other persons constituting the North-west Company of Canada, for a charter. 93  
London.
- October 9, Nat. Atcheson to Bathurst. Enclosing two papers relating to the North-west Company and asking for an interview on the subject of the Company's application to His Majesty's Government for a charter. 88  
Westminster.
- October 12, General Tupper to General Harrison. Report as to the causes of the failure of the expedition of mounted men under his command to reach the Rapids of the Miamis. 231  
Urbana.
- October 13, Harrison to Goulbourn. Enclosing letter from Prevost stating that he has issued a warrant for £10,000 in aid of the Civil expenditure and asking for Bathurst's opinion thereon. 97  
Treasury Chambers.
- October 13, Order in Council authorizing the instructions (enclosed) for guidance in the capture of all ships, vessels, and goods belonging to the United States. 99  
Enclosed. The instructions. 100, 106
- October 14, Standing interrogations to be administered to all persons found on board ships taken as prizes from the United States. 120  
Horse Guards.
- Torrens to Goulburn. Enclosing for Lord Bathurst's information, copy of the Commander-in-Chief's instructions to Prevost on the subject of the New Brunswick Fencibles, and also copy of one relative to the augmentation of the Newfoundland Regiment. 140  
Enclosed. The instructions dated 12th October, 1812. 141  
The letter concerning the Newfoundland Regiment, dated 9th October. 143
- October 14, H. Donaldson and Co., to Col. Bunbury. Asking on behalf of Major Coore Prevost's aide-de-camp, a gratuity of £500, in consideration of his having brought home the despatches giving the account of the surrender of Fort Detroit by the American General Hull. 144a  
Whitehall.
- October 24, George Herriot to F. Feeling. (Extract.) The Americans have made repeated efforts to conquer Canada, without success as yet. Reports say that an army of 15,000 men is within forty miles of Montreal. All idea of an amicable settlement with our neighbours is at an end. 5,000 or 6,000 men and ten sail of the line in addition to our permanent force is

Department of Agriculture—Archives.

1812.	the only way to put an end to the war. All their principal towns, accessible by water ought to be attacked at once.	Page 167
	(In Freeling's of 28th November.)	
October 31, Liverpool.	John Bridgman, Collector of His Majesty's Customs, at St. Lucia, to Bathurst. Being captured and held prisoner in the United States for several weeks, he had a good opportunity for studying the sentiments of the people respecting the war. Would make an appointment for an interview. Sends with this communication a few American newspapers and a pamphlet.	145
October 31, Foreign Department.	W. Hamilton to Goulburn. Transmitting for Lord Bathurst's information the copy of a despatch from Mr. Baker.	149
October 31, Washington.	Baker to Castlereagh. (Extract.) Giving some idea of the views of the United States on the Spanish possessions in North America.	213
	(In Hamilton's of 25th December.)	
October.	C. Stuarton to Liverpool. (Private.) Enclosing an article on Canadian Finances.	77
	<i>Enclosed.</i> The article.	80
November 2, Westminster.	Nat. Atcheson to Goulburn. Asks that the North-west Company's application for a charter be attended to	153
November 3, Washington.	Baker to Castlereagh. (Extract.) Giving an account of the disposition of the American troops on the frontiers of Canada.	209
	(In Hamilton's of 25th December.)	
November 10, Commissary in Chief's Office.	J. C. Herries to Harrison. Transmitting copy of a letter from Commissary General Robinson, stating the sums which have already been issued in aid of the Civil Chests in Canada.	219
November 11, Washington.	Baker to Castlereagh. (Extract.) The failure of an attempt made by a detachment of the United States troops to proceed to the Mismis Rapids below Fort Defiance. Encloses copy of report, from the officer commanding that detachment.	224
	(In Hamilton's of 30th December.)	
November 18, Admiralty Office.	J. W. Croker to Admiral Sir J. B. Warren. Instructions for his guidance.	170
November 19.	Nat. Atcheson to Goulburn. Enclosing memorial for Lord Bathurst's consideration.	154
	<i>Enclosed.</i> Memorial of the North-west Company.	155
November 23, Admiralty Office.	The Lords Commissioners to Bathurst. Respecting the orders to be given to Admiral Sir John Warren.	163
November 26.	Nat. Atcheson to Goulburn. Asking that the North-west Company be favoured with an interview at an early date.	165
November 28.	F. Freeling to W. Hamilton. Enclosing extracts of letters from George Heriot at Quebec.	166
	(Enclosure calendared at its proper date.)	
November 30, Admiralty Office.	J. W. Croker to Goulburn. Sending copy of his letter of the 18th inst., to Admiral Warren.	169
December 2.	John Trotter to Harrison. Acknowledges letter of 30th ult., directing that 10,000 suits of clothing be forwarded to Quebec with the same number of sets of accoutrements and the presents for the Indians. Encloses return of the articles which he considered to be required by the letter and asking if it is correct.	186
	<i>Enclosed.</i> The return.	187
December 3, Comptroller's Office.	The Comptrollers of Army accounts to the Lords of the Treasury. Report on a letter from Commissary General Robinson respecting the payment of £10,000 to the Receiver General of Quebec in aid of the Civil Chest.	217
December 11, Treasury Chambers.	Harrison to Bunbury. Transmitting letter from the Store-keeper General.	185

1812. December 18, Quebec.	E. B. Brenton to Adam Gordon. Transmitting list of warrants.	Page 188
December 18, Admiralty Office.	John Barrow to Goulburn. Respecting transport for the troops.	195
December 20, High Wycombe.	Howard Douglas to Bathurst. Observations on the extraordinary measures necessary to defeat the attempts shortly to be made by the American Government to gain a naval superiority on the Lakes of Upper Canada.	197
December 21.	Charlotte de la Garde (née de Behm) to ———. Asking for compensation in lieu of a grant.	200
	<i>Enclosed.</i> Papers relating to the claim.	202, 205, 206
December 25, Foreign Office.	W. Hamilton to Goulburn. Enclosing extract of a despatch from Mr. Baker to be laid before Earl Bathurst.	208
	(Enclosure calendared at its proper date.)	
December 25, Foreign Office.	Same to same. Enclosing extract of a despatch from Baker to be laid before Lord Bathurst.	212
	(Enclosure calendared at its proper date.)	
December 26, Treasury Chambers.	Harrison to same. Transmitting report from the Comptrollers of Army accounts respecting the payment of £10,000 to the Receiver General of Quebec, for Lord Bathurst's consideration.	216
December 29, London.	Simon McGillivray to same. When the persons representing the North-west Company were admitted to an interview with Lord Bathurst, he promised to use his influence to procure a convoy to their ship fitting out for the Columbia River and also arrange with the Russian Ambassador some way in which our traders and the Russian settlers and traders might meet on a footing of friendship. Asks what has been done in the matter.	221
December 30, Foreign Office.	Hamilton to Col. Bunbury. Enclosing extract of a despatch from Baker, dated 11th November.	223
	(Enclosure calendared at its proper date.)	
December 30, Ordnance Office.	R. H. Crewe to Goulburn. Transmitting for Lord Bathurst's information lists of the Ordnance stores embarked for Canada on board the "Cambo" and "Lady Johnstone," transports.	245
No date.	J. Searle to Castlereagh. Enclosing copy of letter from John Blackwood of Montreal.	176
	<i>Enclosed.</i> The letter dated 17th October, 1812, gives advice as to the best mode of making war with the United States.	177
No date.	"British Official Account of the Battle at Queenston," from the Plattsburg <i>Republican</i> , copied from the Montreal <i>Herald</i> extra of 21st October.	225
	(In Hamilton's of 30th December.)	

## GOVERNOR SIR G. PREVOST, 1813.

## Q. 121.

1813.  
January 15,  
Quebec.

Prevost to Bathurst. (No. 33.) Had opened the Provincial Legislature on the 29th ultimo. Encloses speeches on the occasion. Nothing particular has occurred on the frontiers since the enemy went into winter quarters: he has been principally employed lately in reinforcing the Upper Province and forwarding supplies for building vessels there. The different requisitions sent to England should be complied with as speedily as possible. Has been obliged to supply the embodied militia in both provinces with clothing till further supplies arrive. 2

*Enclosed.* Speech on opening the Legislature. English. 4  
French. 11

## Department of Agriculture—Archives.

1813. January 15, Quebec.	Prevost to Bathurst. (No. 34.) Transmitting copies of the proceedings of the Executive Council on Land matters between 12th November, 1811, and 26th December, 1812. <span style="float: right;">Page 18</span>
January 16, Quebec.	Same to same. (No. 35.) The enemy having shown a disposition to carry on a winter campaign, has thought it wise to reinforce Upper Canada and strengthen the line of communication between Montreal and Kingston. Has given Sir John Sherbrooke, commanding in Nova Scotia, conditional instructions respecting troops under his command. Hopes these arrangements will be approved. <span style="float: right;">19</span>
January 22, Quebec.	Same to same. (No. 37.) Mr. Justice Panet, a judge of the Court of King's Bench for the District of Montreal and a member of the Executive Council, died on the 2nd ultimo. Has appointed Mr. Justice Foucher, Provincial Court Judge for Three Rivers, to the situation left vacant by the death of Panet and Mr. Pierre Bédard to Foucher's place. <span style="float: right;">49</span>
January 22, Quebec.	Same to same. (No. 38.) Enclosing letter from the Judge of the Provincial Court of Vice-Admiralty, for consideration. <span style="float: right;">51</span> <i>Enclosed.</i> J. Kerr, Judge of the Court of Vice-Admiralty, to Prevost dated 4th August, 1812, urging the necessity of having a prize court established at Quebec. <span style="float: right;">52</span>
January 22.	Return of killed and wounded in the action at River au Raisin. <span style="float: right;">75</span> (In Prevost's No. 43 of 8th February.)
January 22.	Return of prisoners taken after the action at River au Raisin. <span style="float: right;">77</span>
January 22, Prescott.	G. Macdonell, Major Glengarry Light Infantry and Lt.-Col. Commanding the Eastern District of Upper Canada, to the Adjutant General of the Forces. Account of the action at and near Ogdensburg on the 22nd February, when after about an hour's action his position was taken. <span style="float: right;">110</span> (In Prevost's No. 46 of 27th February.)
January 25, Sandwich.	Col. Henry Procter to Major General Sheaffe. Details of the victory over the forces under Brigadier General Winchester, at River au Raisin. <span style="float: right;">71</span> (In Prevost's No. 43 of 8th February.)
January 25, Amherstburg.	Return of the arms, ammunition, &c., taken from the enemy at River au Raisin. <span style="float: right;">76</span> (In Prevost's No. 43 of 8th February.)
January 26, Quebec.	Prevost to Bathurst. (No. 36.) Encloses copy of a memorial from Robert Dickson, with a statement of expenses incurred by order of Major General Brock for articles supplied to the Indians; also proceedings of a board which he (Prevost) called to consider the same. From the report of this board has been induced to order Mr. Dickson to be reimbursed and also given £300 for his services in bringing forward the Indians to aid in the capture of Michillimackinac and General Hull at Detroit. Has drawn for the money under the head of <i>secret service</i> . Has appointed Mr. Dickson to the Indian Department as his knowledge of and influence with the Indians will be invaluable. <span style="float: right;">21</span> <i>Enclosed.</i> Statement of Dickson. <span style="float: right;">26</span> Proceedings and report of the board. <span style="float: right;">29</span> List of articles to be sent to Michillimackinac on the opening of navigation, to be distributed to the Indians. <span style="float: right;">45</span> Ditto to be sent to Chicago, for a similar purpose. <span style="float: right;">47</span>
February 6, Quebec.	Prevost to Bathurst. (No. 39.) His anxiety about the Naval force to be employed on Lake Ontario in the spring, has decided him to visit the dock yards at Kingston and York, he will also visit Prescott and Fort George. <span style="float: right;">56</span>
February 7, Quebec.	Same to same. (No. 40.) Will give immediate orders for the levying of a corps of Fencible Infantry under Lieut. General Coffin in New Brunswick and Nova Scotia, according to the Prince Regent's desire. Since the Glengarry levy has been approved he has raised the bounty money for that corps from six to eight guineas for each recruit to put it on the same footing with the other Fencible Regiments. Has also augmented

1813.

the bounty to the Canadian Voltigeurs from £4 to £5. Hopes these measures will be approved. Asks to be allowed to extend the same indulgence in bounty and promise of land to the New Brunswick Fencibles as is granted to the Glengarry Light Infantry. Page 57

February 8,  
Quebec.

Same to same. (No. 41.) Despatches 10, 11, and 12 received. The Prince Regent's entire approbation of Major General Brock's conduct and his appointment to be an extra Knight of the Bath would have been very gratifying to him had he not unfortunately fallen in action. According to the desire of the Prince Regent he has taken the first opportunity to signify to the Army in British North America his approbation of the judicious conduct of Major General Brock, the zeal shown by Colonel Procter and other officers, the bravery of the troops and the steadiness of the Indians under Col. Elliott and Capt. McKee and the humanity with which they treated their prisoners. This praise will have a stimulating effect. The satisfactory conduct of the Militia. As about 900 of the select Embodied Militia will be entitled to their discharges next June, he has ordered a draft from the Sedentary Militia of 2,200 men to replace them. The five battalions of select Militia will then number 4,000 men exclusive of Voltigeurs and Volunteer cavalry. Clothing is to be issued to them in April. Notwithstanding the season, four companies of the King's Regiment have marched from Montreal to Kingston. The new ship building there is rapidly being completed. The keel of a new vessel has been laid at Ambersburg. Seamen are needed. Eighty guns with their stores are on the way from Quebec to strengthen the posts at Prescott, Kingston and York. Lieut.-Col. Bruyères has been ordered to visit the principal posts in Upper Canada to give the necessary orders for strengthening them. As this is the only season when it would be possible to leave Quebec he intends to spend a few weeks visiting the Upper Canadian posts in order to form from personal observation an idea of their resources. Hopes to close the Legislature before leaving, after obtaining from them the liberal supply of money required for the Militia and the necessary Acts for carrying into effect certain measures. In obedience to orders, will direct Major General de Rottenburg to assume the Civil Administration of the Government. 59

February 8,  
Quebec.

Same to same. (No. 42.) Circular of 12th September, stating the directions which have been given for applying the specie found on captured American vessels and deposited in the Courts of Vice Admiralty, received. The issue of Army Bills has to a great degree relieved the embarrassment caused to the public service from the want of specie. The additional Army Bill Act passed this session will be a great help. 66.

February 8,  
Quebec.

Same to same. (No. 43.) Brigadier General Winchester, with upwards of 1,000 men, being the right wing of Harrison's Army, marching to attack Detroit, was completely defeated by Col. Procter, with a force not exceeding 500 Regulars and militia and 600 Indians. The result of this victory is the surrender of the General with about 500 officers and privates with nearly a like number killed and wounded. Encloses letter from Procter to Sheaffe with details. Encloses also lists of killed and wounded on our side and of the arms ammunition and prisoners taken from the enemy, the latter of which exceeds the whole of the Regulars and militia force opposing them. Major General Harrison, with the main body of his army, consisting of about 2,000 men, was reported about five days march from Winchester's division, advancing in the direction of Detroit. On hearing of the disaster he may retreat, if not, all reliance is to be placed on Col. Procter and his troops. Small reinforcements have been sent to Detroit. 68

(Enclosures calendared at their respective dates.)

February 9,  
Quebec.

Same to same. (No. 43.) Enclosing prices current and rates of exchange at Quebec for December and January. 78

*Enclosed.* Quebec prices current for December, 1812. 79

## Department of Agriculture—Archives.

1813. Quebec prices current for January. Page 82
- February 16, Quebec. Prevost to Bathurst. (No. 44.) He closed the Provincial Parliament on the 15th. Encloses copies of speeches on the occasion. The Army Bill Act has met his wishes exactly. Regrets that the Bill for amending the Militia Laws did not pass. Transmits exemplification of a Bill "for granting certain duties to His Majesty towards supplying the wants of the Province during the present war with the United States of America and for other purposes." Has reserved it for His Majesty's pleasure; recommends it to favourable consideration. His journey to Upper Canada has been delayed, but hopes to set out on the 17th. 85
- Enclosed speeches. 89 to 103
- February 16, Quebec. Same to same. (No. 45.) Respecting the Bill for amending the Acts of the 28th, Geo. 3rd, C. 39. 104
- February 22. Return of killed and wounded in the action of this date. 116  
(In Prevost's No. 46 of 27th February.)
- February 22. Return of prisoners, liquor, clothing, &c., captured from the American army at Ogdensburg on this date. 117  
(In Prevost's No. 46 of 27th February.)
- February 23, Kingston. General orders. Announcing the success of Lt.-Col. McDonell at Ogdensburg. 119  
(In Prevost's No. 46 of 27th February.)
- February 27, Niagara. Prevost to Bathurst. (No. 46.) Left Quebec to visit the military posts in Upper Canada on the 17th inst., arrived in Prescott on the 21st and found the enemy were posted at Ogdensburg, taking advantage of the frozen state of the St. Lawrence to make repeated nocturnal raids. Judging it safer to dislodge the enemy, he ordered Major McDonell of the Glengarry Light Infantry to make the attempt. Encloses his report on the occasion. Speaks highly of the bravery of Capt. Jenkins and Lieut. Impey. Recommends them for consideration, both being wounded. Two stand of colours have been taken which will be forwarded to be laid at the Prince Regent's feet. 106  
(Enclosures calendared at their respective dates.)
- February 27, Niagara. Same to same. (No. 47.) On returning from his tour in Upper Canada he was met by an officer carrying despatches from Detroit. Col. Procter, in command there, states that General Harrison with his forces had precipitately retreated on hearing of the annihilation of Brigadier General Winchester's army. By last accounts Harrison was about eighty miles from Detroit but as the road is almost impassable in places, Procter did not pursue him. The Indian chiefs Tecumseh, Roundhead and Norton with their warriors and a chosen band from the 41st Detroit Militia are employed in interrupting the communication with Harrison's army and intercepting his supplies and reinforcements. Hopes this movement will so work upon the American Army as to render it an easy prey to the Indian force coming from the Southward under Mr. Dickson. Hopes these measures will meet with approbation. 122
- March 1, Montreal. Return of ordnance ammunition and stores taken at the attack on the enemy's post at Ogdensburg on this date. 118  
(In Prevost's No. 46 of 27th February.)
- March 17, Quebec. Prevost to Bathurst. (No. 49.) Reporting the arrival of the 104th Regiment at Quebec, from New Brunswick. 138
- March 18, Quebec. Same to same. (No. 48.) Despatch No. 16 of 19th December received. Regrets to find that the arrangements entered into with regard to the release of the American prisoners of war on their parole appear in any way objectionable. He (Bathurst) was perhaps not aware of the embarrassment which the large number of prisoners would have caused to the officer commanding in Upper Canada with his very limited means of guarding and provisioning them. Does not believe any of the prisoners have violated their engagements. The port of Boston, to which parti-

1813.

	cular objection was taken, was chosen for the purpose of shortening the voyage. Encloses General Order by which it will be seen that an attempt was made by the American Government to consider General Hull and other officers as exchanged, notwithstanding his (Prevost's) assent had not been obtained. A letter of explanation, also enclosed, was immediately sent to General Dearborn. No answer received as yet. The General Order found its way into the American papers and the Court marshal on General Hull has been suspended. Page 126	126
	<i>Enclosed.</i> General Orders.	130
	Letter in explanation dated Quebec, 8th February, 1813.	136
March 18, Quebec.	Return of ordnance, ammunition and stores captured from the enemy since the commencement of hostilities :	156
	At Michillimackinac, 17th July, 1812.	156
	At Detroit, 16th August, 1812.	159
	At Queenston, 13th October, 1812.	164
	At River au Raisin, 22nd January, 1813.	165
	At the attack on Ogdensburg, 22nd February, 1813.	166
	Descriptive return of ordnance captured at the above place.	167
March 19, Quebec.	Prevost to Bathurst. (No. 50.) Despatches received. Is gratified that the measures he has taken for the defence of Canada have been approved. Encloses copy of a report on the British Naval force on the Lakes, accompanied by a comparative statement of the British and American Marine upon these waters. Has conveyed to Major General Sheaffe and the troops under him the entire approbation of the Prince Regent, of their courage displayed at Queenston on the 13th October last, and his regret at the loss of the Attorney General McDonell. Has assured the Indians that they will not be forgotten. Is glad to hear that the 13th, 98th and 41st (2nd Batt.) are to be withdrawn from Bermuda and sent to Canada. The exportation of this reinforcement has enabled him to strengthen the posts in Upper Canada. Is looking forward to the arrival of arms, clothing and stores in the spring. Has much satisfaction in stating that the "cabal" in Upper Canada operating against the person administering the Government has been extinguished.	140
	<i>Enclosed.</i> The report dated Montreal, 12th March.	147
	Comparative statement of the British and American forces on the Lakes.	152
March 20, Quebec.	Prevost to Bathurst. (No. 51a.) Transmitting return of ordnance, ammunition and stores captured since the commencement of hostilities. Asks that the customary valuation be made in order that a distribution can be made to the parties concerned in the capture.	155
March 27, Quebec.	Same to Sheaffe. (Confidential.) Instructions for the defence of Upper Canada.	169
	(In Prevost's No. 51b. of 2nd April.)	
April 2, Quebec.	Same to Bathurst. (No. 51b., should be 52.) Enclosing copy of his letter of instructions for the defence of Upper Canada, to Sheaffe. Enclosure calendared at its proper date.)	168
April 8, Quebec.	Memorial of Herman W. Ryland, clerk of the Executive Council of Lower Canada, asking for an increase of salary.	186
April 9, Quebec.	Prevost to Bathurst. (No. 53.) Enclosing prices current and rates of exchange at Quebec for February and March.	175
	<i>Enclosed.</i> Quebec prices current for February.	176
	Ditto for March.	179
April 20, Quebec.	Prevost to Bathurst. (No. 54.) Submitting the arrangements he has made in the establishments of the offices of Register ( <i>sic.</i> ) and Clerk of the Executive Council and Civil Secretary of the Province.	182
April 21, Quebec.	Same to same. (No. 56.) Despatches 18, 19 and 20 received. Hopes the extraordinary efforts made by the enemy to obtain the ascendancy on Lake Ontario will justify his measures. Is glad to hear of the approach	



## Department of Agriculture—Archives.

1813. by land of several naval officers sent from Halifax, their assistance will be most opportune as the loss of the ascendancy on Lake Ontario would immediately expose Upper Canada to devastation. To shield that province he has marched some troops from the lower, their place to be filled by augmenting the militia. Encloses a return of the Lower Canadian militia that the Prince Regent may be enabled to judge of the assistance afforded by the Canadians. The difficulties of forming efficient corps in Upper Canada are greater. The legislature there has increased the bounty to \$8 and Sheaffe proposes a further augmentation to afford the recruit a reasonable outfit. Is pleased to hear that the number of British seamen ordered to Canada has been increased to 300. The observations in despatch No. 20 not all applicable in the present state of the country. After the battle of Queenston, Sheaffe lost a glorious opportunity of crossing the river and destroying Fort Niagara. He (Prevost) has hitherto carefully avoided any offensive movement upon the American territory except as a just retaliation; when the reinforcements from the Baltic arrive, he will be enabled to convert his defensive into offensive operations. Page 194
- Enclosed.* Return of militia in Lower Canada. 199
- April 22, Quebec. Prevost to Bathurst. Reporting that he has accepted an offer made to him by Mr. Coleman, a merchant of Montreal, to raise at his own expense a troop of light cavalry consisting of fifty men. Asks for clothing, &c., for the same. 200
- April 23, Quebec. Same to same. (No. 58.) Has authorized two companies of Provincial Drivers and one company of Provincial Artificers, to be raised. 202
- April 28, Quebec. Same to same. (No. 55.) Enclosing memorial from the commissioners for rebuilding the church (Protestant Episcopal) at Montreal, to the Prince Regent. 190
- Enclosed.* The memorial. 191
- April 28, Quebec. Same to same. (No. 59.) Enclosing schedule of the Acts passed in the last session of the Legislature of Lower Canada, also printed copies of the Journals of the House of Assembly for the two preceding sessions and a manuscript copy of the Journals of the Legislative Council for last session. 205
- Enclosed.* The schedule. 206
- May 2, York. W. Allan, Major 3rd York Militia, to Sheaffe. In obedience to orders, he, Lt.-Col. Chewett, and Rev. Dr. Strachan entered into terms of capitulation with the commander of the enemy's forces on the 27th ulto. (Encloses copy.) The terms were not ratified till next afternoon, during which interval the inhabitants were exposed to every sort of depredation and insult. After the ratification, his (Sheaffe's) baggage and all public stores were carried off, the public buildings burnt and the troops are now embarking, though every one seems ignorant of their destination. Few houses in the town escaped search and some were badly pillaged. Forty wounded men were left here without medical assistance. 217
- Enclosed.* Terms of capitulation. 219
- List of killed, wounded and prisoners. 222a.
- May 5, Kingston. Sheaffe to Prevost. Details of the capture of York on the 27th ultimo. 212
- (In Prevost's No. 60 of 28th May.)
- May 18, Kingston. Prevost to Bathurst. (No. 60.) Transmitting copy of a despatch from Sheaffe containing the particulars of a successful attack made by the enemy on York, on the 27th ult. The small Regular force at his (Prevost's) disposal and the decided superiority gained by the Americans on Lake Ontario in the last six months will show the gallant efforts made by the handful of troops at that post. The enemy left York on the 8th inst., and proceeded to Niagara, where they landed on the American side for the purpose of strengthening their army on that line, and probably with a view to a further attack upon Fort Erie or Fort George. The flotilla afterwards returned to Sackett's Harbour. The force there con-

1813. sists of about 5,000 men; they are making preparations for another expedition, the object of which cannot be ascertained. Page 209  
(Enclosures calendared at their respective dates.)
- May 18, Kingston. Prevost to Bathurst. (No. 61.) Reporting the arrival at Quebec on the 5th inst., of Commodore Sir James Yeo with the officers and seamen under his command. The first and second divisions of officers and seamen have arrived at this post in bateaux from Montreal. List of the ships in which they will serve. In order that the instructions of His Majesty's government respecting the ascendancy on Lake Ontario may be carried out, he has accompanied Sir James Yeo to this post so as to afford him every facility for the accomplishment of that object. 223
- May 18, Kingston. Same to same. (No. 62.) Despatches 18 to 25, with enclosures, have been delivered to him by Major Coore. Is duly sensible of the efforts being made by His Majesty's Government to supply him with the troops so necessary for the successful resisting of the great efforts the enemy are making to conquer the provinces, particularly the Upper. The prospect of the speedy arrival of reinforcements from Spain and Ireland has induced him to send some troops from Lower to Upper Canada. The late systematic movement of the enemy on York, indicates a strong disposition to make a still more decisive attempt upon the province. Hopes to be able to successfully resist them with the help of the promised reinforcements and the seamen now on their way. 225
- May 26, Kingston. Same to same. (No. 63.) Reporting the arrival at Quebec of troops, about 400 men of the 41st, and part of the 19th Dragoons, to be sent on at once to Upper Canada. The growing discontent of the mass of the people in this Province with the militia laws, and the considerable emigration to the United States have called for the best and reserved soldiers to support the positions on the Niagara and Detroit frontiers. Praises the bravery of Colonels Vincent and Procter. The enemy left Sackett's Harbour on the 20th inst., and have appeared off Fort George with sixteen vessels laden with troops which they disembarked the following day in rear of their Fort at Niagara. In case of immediate attack he has advised Sir James Yeo to sail with the vessels ready for service and reconnoitre the enemy's flotilla that he may form an opinion on the practicability of taking reinforcements to Fort George. Will accompany this reinforcement of 300 men and then return to Lower Canada, leaving the Civil and Military command of the Province to Major Generals de Rottenburg and Sheaffe. 227
- May 27, Fort George. Return of killed, wounded and missing, in the action with the enemy. 260
- May 28, Forty Mile Creek. (In Prevost's No. 65 of 3rd June.)  
John Vincent, Brigadier General to Prevost. Details of the action at Fort George. 251  
(In Prevost's No. 65 of 3rd June.)
- May 29. Return of the killed, wounded and missing in the attack on Sackett's Harbour. 245  
(In Prevost's No. 64 of 1st June.)
- May 30, Kingston. Edward Baynes, Col. Glengarry Light Infantry, to Prevost. Account of the attack on Sackett's Harbour. 237  
(In Prevost's No. 64 of 1st June.)
- May 30. Return of the troops at the Forty Mile Creek. 268  
(In Prevost's No. 66 of 6th June.)
- May 31, Fort George. H. Dearborn, Major General commanding the U. S. forces on the Frontiers, to Prevost. Has been informed by R. G. Beasley, U. S. Commissary of Prisoners in London, that twenty-three soldiers of the 1st, 6th and 13th U. S. Regiments made prisoners and sent to England are held in close confinement as British subjects. Is instructed by his Government to put into close confinement a like number of British

Department of Agriculture—Archives.

1813.

soldiers as hostages. Notifies him that he now has put twenty-three soldiers into close confinement as ordered. Page 269

(In Prevost's No. 66 of 6th June.)

June 1,  
Burlington  
Bay.

John Norton to same. Assuring him of his loyalty and regretting the late affair was not as successful as might have been wished; this does not destroy his confidence, however. Wishes to increase and reward his followers. 271

(In Prevost's No. 66 of 6th June.)

June 1,  
Kingston.

Prevost to Bathurst. (No. 64.) The despatch of 26th ult., was scarcely closed when news arrived of the enemy's flotilla being off Niagara with a second reinforcement of at least 8,000 Regulars, besides volunteers and militia. Colonel Vincent has only about 2,000 men to oppose this formidable force. When last accounts left Fort George it had sustained a cannonade of twenty-four hours duration which deprived our troops of every building near the work, except the powder magazine and the splinter proof barracks. The critical situation of Upper Canada decided him (Prevost) to embark the principal part of the garrison of this place for Sackett's Harbour, where they arrived under Col. Baynes on the 27th ult. Arrangements were being made for an attack at dawn the following morning, which, as will be seen by the report of Col. Baynes (enclosed), was not a complete success. The gallant conduct of the troops on the occasion. A short account of the engagement. Though the enemy is constantly receiving reinforcements, none have as yet arrived to protect Upper Canada, of which a part may be lost unless help speedily arrives. 232

(Enclosures calendared at their respective dates.)

June 2,  
Bazyley's  
Head of the  
Lake.

Vincent to Prevost. Enclosing a letter from Major General Dearborn and stating that permission is granted to the wives and families of the officers left behind at Fort George to embark for Kingston or York. Has reported his arrival here to the Adjutant General and his intention to take up a position till either reinforcements or instructions arrive. The troops are in great spirits, waiting an order to return to Fort George. Finds that the enemy has followed him with the advanced guard to the Fifteen Mile Creek; he received this information from a deserter, who states that the fleet sailed for Sackett's Harbour and that 2,000 men embarked on board in a great hurry. Is afraid Procter will be in pressing need of provisions. Is sending some cattle under charge of a detachment of Militia. As bills would not answer for this service, Col. Clerk of the Militia has sent him 500 guineas. He has already mentioned his wants to Col. Baynes. 265

(In Prevost's No. 66 of 6th June.)

June 3,  
Kingston.

Prevost to Bathurst. (No 65.) On the 27th ult., the enemy effected a landing about two miles from Fort George. Their superior force, notwithstanding spirited resistance, obliged Col. Vincent to retire to the head of Lake Ontario with his whole force. Encloses Col. Vincent's report. The British loss small. Considering that the appearance of the fleet might give additional courage to troops under him he has despatched Sir James Yeo with his ships. The enemy's fleet were reported yesterday to be returning to Sackett's Harbour. Learns that all their fleet is now in that port and that the whole of the naval stores there were burnt on the day of the attack. Regrets that he cannot report the arrival of any of the troops on their way from Cadiz, Malta and the West Indies. 248

(Enclosures calendared at their respective dates.)

June 3,  
Isle aux Noix.

George Taylor, Major 100th Regiment, to Major General Stovin, commanding at Chambly. Particulars of the taking of the "Eagle" and "Growler." 281

(In Prevost's No. 68 of 12th June.)

1813.  
June 6,  
Kingston.

Prevost to Bathurst. (No. 66.) Since last writing has received the enclosed intelligence from Col. Vincent relating to the British subjects taken in arms at Queenston in October last and sent to England. Has taken measures to reinforce the army at the head of the lake, with part of the 104th and Glengarry regiments, which is all that can be done at present. The Americans are pressing forward in very superior numbers for the conquest of Upper Canada. He is afraid his promised reinforcements will not afford the means for making one grand effort. Encloses letter from the Indian Chief Norton, addressed to him (Prevost) after the late unequal contest at Niagara, that the importance of his friendship may be seen. The British flotilla is on Lake Ontario with stores and reinforcements for Col. Vincent. Cannot learn that the American fleet has ventured out to contend for the ascendancy on the lake. Specie urgently needed as paper money cannot now command the hidden resources of the country. Page 262

(Enclosures calendared at their respective dates.)

June 7,  
Kingston.

Same to same. (No. 67.) Reporting an action with the enemy near Isle aux Noix which terminated in the capture of the "Eagle" and "Growler" from the enemy. The capture was made under the direction of Major Taylor. Captain Gordon, R.A., Lieut. Williams, Ensigns Dawson, Gibbon and Humphries, of the 100th, and Lt. Lowe, of the Marine, particularly distinguished themselves. In the contest, which lasted three hours, and a half, we had three men wounded and the enemy had eight wounded and one killed. 278

June 12,  
Kingston.

Same to same. (No. 68.) Enclosing particulars of the affair at Isle aux Noix, mentioned in his despatch No. 67, as detailed in Major Taylor's letter to Major General Stovin. 280

(Enclosures calendared at their respective dates.)

August 12,  
Downing St.

Draft of a letter to Prevost. Despatch No. 66, enclosing a letter from Dearborn stating that twenty-three British prisoners have been put in close confinement as hostages for those confined by Britain, received. States that these latter were British born subjects taken while serving in the American Army, and that they now await a legal trial. He (Prevost) is to inform Dearborn that he has transmitted home a copy of his letter and in answer thereto has been commanded to put into close confinement forty-six officers and non-commissioned officers as hostages for the twenty-three British subjects imprisoned in the United States. Also that if on trial any of the soldiers be found guilty and sentenced to death and any of the hostages held by the United States be executed in consequence, double the number of the officers and non-commissioned officers confined here shall immediately be put to death. The war will be carried on with unmitigated severity, if after this notification the American Government should unhappily put to death any British soldiers who are now or may hereafter be kept as hostages for the purposes stated. 274

No date.

Return of ordnance, ammunition and stores taken on board the United States armed vessels "Eagle" and "Growler" on the morning of the 3rd June, 1813. 285

(In Prevost's No. 68 of 12th June.)

# Department of Agriculture—Archives.

GOVERNOR SIR G. PREVOST, 1813.

## Q. 122.

1813 April 23, Am- herstburgh.	Embarkation return of the Western Army commanded by Brigadier General Procter on an expedition to the Miamis. (In Prevost's No. 69 of 14th June.)	Page 18
May 5.	Return of officers, non-commissioned officers and privates taken prisoners from the enemy at the battle fought at the Miamis. (In Prevost's No. 69 of 14th June.)	15
May 5.	Return of killed, wounded, missing and prisoners from the army under Brigadier General Procter, at the battle fought at the Miamis. (In Prevost's No. 69 of 14th June.)	19
May 6, CampMiamis.	Officers of the Kent Militia to Lt.-Col. Waberton, Inspecting Field Officer of Militia. Stating that it is necessary, to prevent famine, that the militia be allowed to go home to attend to their crops. (In Prevosts No. 69 of 14th June.)	20
May 7, CampMiamis.	Agreement for the exchange of prisoners made between Brigadier General Procter and Major General Harrison. (In Prevost's No. 69 of 14th June.)	13
May 7.	Procter to Harrison. Offering to exchange Indian prisoners for an equal number of Kentucky militia. (In Prevost's No. 69 of 14th June.)	16
May 7.	Harrison to Procter. Will refer his (Procter's) proposal for an exchange of Indians to his Government. (In Prevost's No. 69 of 14th June.)	17
May 14, Sandwich.	Report of Col. Henry Procter of the operations in and present state of his district. (In Prevost's No. 69 of 14th June.)	4
June 6, Bur- lington Heights.	John Vincent, Brigadier General, to Prevost. Particulars of the engagement at Stoney Creek. (In Prevost's of 14th June.)	25
June 6.	Return of killed, wounded and missing in the action. (In Prevosts No. 70 of 14th June.)	32
June 6.	Return of ordnance, &c., &c., captured from the Americans at the head of Lake Ontario. (In Prevost's No. 70 of 14th June.)	34
June 7, Bur- lington Heights.	Return of the prisoners of war taken from the enemy near Stoney Creek. (In Prevost's No. 70 of 14th June.)	33
June 14, Kingston.	Prevost to Bathurst. (No. 69.) Enclosing report from Colonel Procter. Congratulations upon the discipline and valour of the troops on the Detroit frontier. By last accounts Procter is still at Sandwich awaiting reinforcements, which he (Prevost) believes are now on their way; when they arrive Procter will be able to march against Major General Harrison at Fort Meigs. (Enclosures calendared at their respective dates.)	2
June 14, Kingston.	Same to same. (No. 70.) Transmitting particulars of the battle of Stoney Creek. Great praise due to Lt.-Col. Harvey. The Commodore has taken several American vessels. Commodore Chauncey has not again ventured out. Captain McDonall will deliver this despatch. He is an officer of great merit. He will also deliver the colours taken at Ogdensburgh to be laid at the feet of the Prince Regent. (Enclosures calendared at their respective dates.)	22
June 14, Kingston.	Same to Dearborn. Advising the American Government to withdraw the officers serving in their army in direct violation of the parole entered into by these officers. (In Prevost's No. 71 of 24th July.)	39

1813.  
June 24,  
Kingston.      Prevost to Bathurst. (No. 71.) Enclosing copy of a letter which he deemed it his duty to write to Major General Dearborn in consequence of the information received that certain officers taken prisoners by the British, and allowed to proceed to the United States on parole, were serving in the army now invading this province. The American Government had declared General Hull and other officers exchanged and free to serve again before the agreement was ratified. Encloses general orders which he had published by way of protest. Particulars of the affair. Page 35
- (The general orders are to be found in Q. 121, dated Quebec, 8th February, 1813; the other enclosure is calendared at its proper date.)
- June 24,  
Kingston.      Same to same. (No. 72.) Transmitting copy of a public declaration given out by the American commandant of Fort Erie, after the enemy had taken possession of that post, and a proclamation which he (Prevost) had issued in consequence. Finding that Major General Sheaffe had quite lost the confidence of the Province, he has removed that officer to Montreal, and substituted Major General de Rottenburg. 41
- Enclosed.* The declaration signed by James P. Preston, offering protection to life and property to those Canadians who come forward and enroll their names with him and threatening those who hold out. 43
- Answer to the above. 44
- June 24,  
Beaver Dam.      Cecil Bishopp to Vincent. Has the satisfaction to report the taking prisoners a detachment of the United State Army under Lieut.-Col. Boerstler. The Indians under Capt. Kerr were the only force engaged. The surrender may be attributed to the address of Lieut. FitzGibbon. Major DeHaren also deserving of praise. Encloses capitulation entered into between Col. Boerstler and himself, with a return of prisoners taken. Lieut. Barnard who carries this intelligence is a promising young officer. 57
- (In Prevost's No. 73 of 3rd July.)
- June 24,  
Township of  
Louth.      J. FitzGibbon, Lt. 49th, to Major DeHaren. Report of the affair on this day. 59
- (In Prevost's No. 73 of 3rd July.)
- June 24.      Particulars of the capitulation of a detachment of the United States Army under Lt.-Col. Boertsler. 61
- (In Prevost's No. 73 of 3rd July.)
- June 24.      Return of the American prisoners taken. 62
- (In Prevost's No. 73 of 3rd July.)
- June 25,  
40 Mile Creek.      Vincent to Prevost. Enclosing report from Col. Bishopp giving an account of the engagement with the enemy on the 24th inst. Lieut. FitzGibbon, 49th, is deserving of great praise. 56
- (In Prevost's No. 73 of 3rd July.)
- July 3,  
Kingston.      Prevost to Bathurst. (No. 73.) Enclosing letters and papers containing the gratifying intelligence of the capture of a body of the enemy's troops on the 24th ult. Remarks upon the affair. 52
- (Enclosures calendared at their respective dates.)
- July 4,  
Kingston.      Same to same. (No. 74.) Asking permission to take into the service the two vessels captured from the enemy in the River Richelieu as reported in despatch No. 68, and a small vessel lately captured, also for paying their captors their appraised value. In the absence of instructions to guide him he had appointed a board of officers to give an opinion on the measures to be adopted on such occasions. 63
- Enclosed.* Extract from the proceedings of the Board. 65
- July 6,  
Kingston.      Same to same. (No. 75.) Transmitting a paper from the Chief Justice and judges of the Court of King's Bench for the District of Montreal. 67
- Enclosed.* The paper dated 1st June, 1813. 68
- Extracts from an Act referred to in the foregoing. 74

## Department of Agriculture—Archives.

1813. July 11.	Return of stores, &c., captured at and brought from Black Rock.	Page 108
July 12.	Thomas Clark, Lt.-Col. 2nd Lincoln Militia, to Lt.-Col. Harvey. Account of the action at Black Rock.	101
July 12.	Return of ordnance destroyed and captured from the enemy at Black Rock.	107
July 13, Kingston.	Return of killed, wounded and missing at Black Rock.	106
July 15, Kingston.	Additional General Order after the engagement at Black Rock.	104
July 18, Kingston.	<p>Prevost to Bathurst. (No. 76.) Since last writing the enemy has withdrawn into Fort George and its immediate vicinity where he is hemmed in by the Indian warriors. Does not consider an attack on the posts or the Niagara Frontier advisable while the enemy has the largest naval force. The naval ascendancy is the first point to be gained. The enemy seem ready for action. Last reports from Col. Procter are dated Sandwich. Reinforcements have been sent him, he hopes to be able to advance nearer the enemy's position at Fort Meigs. Reports of General Harrison's movements. Has entrusted Lt. Pring, R. N., with the command of the force on the Richelieu River. The good conduct of the troops.</p>	79
July 18, Kingston.	<p>Same to same. (No. 77.) Enclosing copy of a mandement issued by Bishop Plessis, of Quebec, on the subject of the prayer directed to be used for the Prince Regent. Thinks it will be gratifying as an additional proof of the zeal and loyalty of that bishop.</p>	85
	<i>Enclosed.</i> The mandement (in French).	86
July 20, Kingston.	<p>Same to same. (No. 78.) Enclosing extract of a letter from Captain Barclay, senior naval officer on Lake Erie, with a statement accompanying it. What he requires to enable him to man and equip his squadron. Remarks on the naval requirements. Thinks the report Capt. Barclay has received of the American force is an exaggerated one.</p>	92
	<i>Enclosed.</i> The extract.	95
	Statement of the American naval force as last reconnoitred.	97
	Statement of His Majesty's squadron on Lake Erie.	98
July 20, Kingston.	<p>Prevost to Bathurst. (No. 79.) Enclosing report from Lt.-Col. Clark, of the Militia forces, of the result of the attack on Black Rock by a detachment under Lt.-Col. Bisshopp. At the moment when the British force had accomplished its object a hidden enemy threw upon them a very destructive fire. Col. Bisshopp severely wounded and several valuable men killed.</p>	99
	(Enclosure calendared at its proper date.)	
July 23, Kingston.	<p>Same to same. (No. 80.) Enclosing copy of a general order respecting the placing of the naval yard at this place on a better footing.</p>	109
	<i>Enclosed.</i> General order.	111
August 1, Kingston.	<p>Same to same. (No. 81.) The enemy continues to occupy Fort George and its vicinity. Major General de Rottenburg is at St. David's, about seven miles distant. The enemy's fleet left Sackett's Harbour on the 23rd ult. The British squadron has left Kingston Harbour in search of it. Remarks on the naval matters. The arrival of Mr. Dickson with 2,000 Indian warriors will enable General Procter to carry on offensive measures. Difficulty of supplying Amherstburgh and Michillmackinac. In spite of Mr. Madison's boast, H. M.'s flag still waves on Lakes Erie and Ontario and Champlain.</p>	116
	<i>Enclosed.</i> Statement of the force of H. M.'s squadron and that of the enemy employed on Lake Erie, dated 24th July.	122
	Comparative ditto of same date.	123
	Ditto in the Richelieu and Lake Champlain.	124

1813.  
August 1,  
Kingston.

Prevost to Bathurst. (No. 82.) The large number of prisoners of war has made it expedient to send a proportion of them to Nova Scotia. About thirty officers and five hundred men are to be embarked. Any British subjects found among them are to be sent to England to await the pleasure of His Majesty's Government. A ship is to be detained at Quebec to transport the remainder of the prisoners to England, if it is thought advisable. Encloses copy of a letter addressed to M. General Dearborn, apprising him of his intention respecting the prisoners and the want of attention to his (Prevost's) former communications. Page 125

*Enclosed.* Letter to Dearborn, of same date. 128

August 3,  
Isle aux Noix.

J. Murray, Lt.-Col., to Sheaffe. The land forces sent on an expedition to Lake Champlain have returned after executing every order. The public buildings at Plattsburg and the barracks at Saranac have been destroyed, public stores brought off, the barracks and several bateaux at Swanton burned and a detachment sent to destroy those at Champlain town. Every assistance was given by Captains Everard and Pring, R. N. Lt.-Col. Williams, 13th, was also of great assistance. The highest praise is due to all the troops. General Hampton has concentrated his force, about 4,500 regulars, and a large body of militia, at Burlington. The militia force at Plattsburg disbanded on the appearance of the armament. Capt. Loring, the bearer, can give any further information wanted. 138

August 3, H.  
M.S. "Burke",  
Lake Champlain.

Thomas Everard, Commander of H. M. S. "Wasp," to Prevost. The object of Col. Murray's expedition having been fully accomplished, and there being no public buildings on the West side of the lake beyond Plattsburg, he stood over to Burlington with the "Shannon" and one gunboat to allow the enemy an opportunity of deciding the superiority on the Lake. Finding it impossible to induce him to quit his position where it was difficult to attack him, he (Everard) captured and destroyed four vessels and is now returning. 142

August 4,  
Isle aux Noix.

J. Murray, Lt.-Col., to Sheaffe. Enclosing report from Capt. Eliot, D. A. Quarter master General, stating that he has completed the service he was detached upon. 140

(Enclosure calendared at its its proper date.)

August 4,  
Isle aux Noix.

G. A. Eliot, D. A. Quartermaster General, to Lt.-Col. Murray. Had proceeded according to orders to Champlain town and burnt the block house and destroyed the Commissary's store. This service was performed without opposition. 141

(In Murray's of same date.)

August 5,  
Montreal.

Sheaffe to Prevost. Transmitting reports of the Naval and Military commanders employed on Lake Champlain. The object has been effected in a most satisfactory manner. 137

August 8,  
Kingston.

Prevost to Bathurst. (No. 83.) The enemy took possession of York on the 31st ult., liberated the prisoners confined in the jail, seized all the property and stores they could carry off and set fire to buildings on Gibraltar Point. The loss to the government is small as the public stores had been removed. The invading troops consisted of about 250 men under Commodore Chauncey and Lt.-Col. Scott, an exchanged prisoner of war. The town was in an almost defenceless state when the enemy landed. About 500 men had previously been disembarked near Brant's house with the intention of storming Burlington Heights, but finding Major Maule prepared for them had re-embarked. Last reports from de Rottenburg are up to the 3rd inst., when the enemy's fleet had anchored off Niagara. Has received no tidings of the British squadron since the 31st, when they sailed from this place. 131

August 8,  
Kingston.

Same to same. (No. 84.) Transmitting copy of letter from Sheaffe with the official report of Lt.-Col. Murray detailing the operations of the 29th July, also report from Capt. Everard, R. N. The object of this



## Department of Agriculture—Archives.

1813. service to draw the enemy's attention to their own settlements on Lake Champlain, has been accomplished by the total destruction of all their arsenals, block houses, &c., at Plattsburg, Swanton, and Champlain town with the extensive barracks at Saranac. Page 135  
 (Enclosures calendared at their respective dates.)
- August 8, Previst to Bathurst. (No. 85.) The Legislative Council of Lower Canada being deficient in effective members, recommends Pierre De Boucherville, as a fit person to be created a Councillor. Remarks. 144  
 Kingston.
- August 10, Draft of a letter to Previst. (No. 38.) Despatches have been received and laid before the Prince Regent. His (Prevost's) conduct has met with entire approbation. Major General Procter and Brigadier General Vincent are to be informed of the Prince Regent's approval of their conduct. The officers and troops engaged in the attack at Sackett's Harbour are also to be complimented. 48  
 Downing St.
- August 11, Same. (No. 39.) Despatch No. 73, enclosing declaration given out by the American commandant at Fort Erie, received. Hopes none of His Majesty's subjects in Upper Canada have accepted the terms offered. A law should be passed in Upper Canada banishing such subjects and confiscating their lands and property, to be applied to the indemnification of those who have lost by the war. 50  
 Downing St.
- August 12, Previst to Bathurst. (No. 86.) Reports the capture of the May and June packets from Falmouth, which were sunk. Some remarks on the subject of the mails. 145  
 Kingston.
- August 12, Same to same. (No. 87.) Respecting his share in the prizes taken. 149  
 Kingston.
- August 13, Draft of a letter to Previst. (No. 41.) Troops are to be sent out. 152  
 Downing St.
- August 14, Draft of a letter to Previst. (No. 42 Secret.) The seamen under Commodore Yeo are to be reinforced. Respecting the naval arrangements. 155  
 Downing St.
- August 14, Draft of a letter to Previst. (No. 43.) Despatch No. 40 will give instructions as to the conduct to be pursued and the communications to be made to Dearborn. Sir J. B. Warren is to be notified of the further proceedings with regard to this important subject. 157  
 Downing St.
- August 25, Previst to Bathurst. (No. 88.) The danger to which the Detroit frontier was exposed in consequence of the enemy's superiority on Lake Erie decided him to move forward to the centre division under de Rottenburg, to be able to second Procter's movements which he undertakes under such great difficulties. Some account of matters on the Niagara frontier. Yeo is making every effort to bring the enemy's squadron to a decisive action but in vain. He, however, was fortunate enough to capture two of their schooners on the 10th inst. On the preceding night two others overset and sunk in carrying sail to escape the British. About 100 persons perished. Yeo has gone into Kingston, to refit and has seen nothing further of the enemy's fleet. He understands they are in Sackett's Harbour. The Americans seem determined to put off the decision of the Naval superiority. The safe arrival of Indian presents. The concentration of a large part of the enemy's force at Sackett's Harbour renders it necessary that he (Prevost) should immediately proceed to Kingston. 158  
 St. David's,  
 Niagara  
 Frontier.
- September 5, Robert Gilmor, D.A.C.G., to Edward Couche, D.C.G. The alarming situation of this post for want of provisions. Capt. Chambers, who carries this, will be able to give fuller information. 175  
 Amherst-  
 burgh.
- September 5, (In Prevost's No. 89 of 15th September.)  
 Procter to Prevost. Announcing and giving particulars of the loss of the fleet on Lake Erie. 183  
 Sandwich.
- September 14, (In Prevost's No. 90 of 22nd September.)  
 Previst to Yeo. Reports from the centre and right divisions in Upper Canada confirm his apprehensions of the critical situation of 183  
 Kingston.

1813.

both commands from the temporary naval ascendancy of the enemy on Lakes Erie and Ontario. The enemy's policy is evidently to prevent supplies, &c., being forwarded. Encloses extract of a letter from Amherstburg, showing the distress existing there. As the evacuation of that post would inevitably lead to the loss of the fleet on Lake Erie, he desires some bold attempt may be made by Capt. Barclay for the supremacy on that Lake to make an outlet for the supplies at Long Point. A large proportion of the officers and seamen of the "Dover" to be sent to his assistance. He (Yeo) is the best judge as to where Capt. Drury's services will be most useful. Page 173

(In Prevost's No. 8 of 15th September.)

September 15,  
Kingston.

Prevost to Bathurst. (No. 89.) Since the commencement of the second campaign he has faithfully reported all occurrences, not hiding the difficulties under which he labours. The time is fast approaching when a suspension of hostilities must take place. He (Prevost) has received no instructions since the commencement of the campaign as to how it was to be conducted. Encloses letter to Yeo, which clearly shows his (Prevost's) embarrassments. Has impressed on Yeo the necessity of deciding the supremacy on the Lakes as soon as possible. The captain and crew of the "Dover" serve on Lake Erie. Has collected £5,000 in specie for the centre and right divisions of the army. The movements of the enemy's squadron. Regrets there has been no decisive action as yet. 168

(Enclosures calendared at their respective dates.)

September 16,  
Kingston.

Edward Baynes, Adjutant General, to de Rottenburg. Instruction for the guidance of his conduct. 188

(In Prevost's No. 90 of 22nd September.)

September 21,  
Sandwich.

Procter to Prevost. The enemy have been reconnoitred by an officer of the Indian Department. We must expect an attack soon. The sick, women, children and stores are on the Thames, the ordnance, except that for use on the field have been sent off. The enemy having command of the waters, he has decided to fall back on the Thames. Expects great help from the Indians; goods required for them. The enemy is advancing. Provisions urgently needed. Encloses extract of a letter from Lt.-Col. Murray making him (Procter) responsible for the loss of the fleet on Lake Erie. Proposes to pay as militia those accompanying the army as was done during the American rebellion. Hopes the measures will be approved. 265

(In Prevost's No. 100 of 30th October.)

September 22,  
Kingston.

Prevost to Bathurst. (No. 90.) States again as in despatch of 15th inst., the embarrassment caused by the supremacy of the enemy on Lake Erie, and his disappointment that the British squadron has returned with nothing decided on this lake (Ontario). Transmits with deep regret a letter from a letter from M. General Procter announcing our loss under Captain Barclay. Some particulars not given in that letter. How affairs stand in Upper Canada. Enclosing copy of letter sent to M. General de Rottenburg by the Adjutant General previous to the arrival of this disastrous intelligence. 177

(Enclosures calendared at their respective dates.)

October 8,  
Montreal.

Same to same. (No. 91.) The reports that the enemy were assembling on the Montreal frontier induced him to repair to this place, where he learned that Major General Hampton with about 5,000 regulars, after overpowering one of our small piquets near Odel Town, had moved to the Westward and was encamped near the Chateauguay River. Sheaffe has taken precautions to resist the enemy's advance. Remarks on the Militia. The force assembled for the purpose of invading the province is greater than at any other period. Their numbers and disposition. The reinforcements in British seamen for Lakes Ontario and Champlain

## Department of Agriculture—Archives.

1813.

have arrived. Had they been available a few weeks earlier the Lake Erie disaster might have been avoided. Transmits Commodore Perry's official account of the loss of the squadron. Has required of Procter his reasons for allowing Captain Barclay to attempt such an action without waiting for the seamen on their way to assist him. It is a satisfaction to find that victory was at one time on our side before the loss of the services of Captain Barclay and other officers. By last accounts from Procter, he is still at Sandwich. Yeo sailed with his squadron from Kingston on the 19th ultimo, taking stores, provisions, &c., to the centre division of the army. He attempted an action with Chauncey but was obliged to make for an anchorage off Burlington Heights where the enemy did not follow them. Our fleet has refitted and gone in search of the Americans. Hopes by this time some decisive action has taken place. Has ordered a ship of 28 guns and a brig of 20 to be built at Kingston. Page 199

October 22, Montreal.	Prevost to Bathurst. (No. 92.) Remarks on the present system of public accounts. <span style="float: right;">209</span>
October 25, Montreal.	Same to same. (No. 93.) Encloses prices current and rates of exchange at Quebec from April to September last inclusive. <span style="float: right;">214</span> <i>Enclosed.</i>
	Quebec prices current for April. <span style="float: right;">215</span>
	Ditto for May. <span style="float: right;">218</span>
	Ditto for June. <span style="float: right;">221</span>
	Ditto for July. <span style="float: right;">224</span>
	Ditto for August. <span style="float: right;">227</span>
	Ditto for September. <span style="float: right;">230</span>
October 25, Montreal.	Prevost to Bathurst. (No. 94.) Transmitting copies of the proceedings of the Executive Council on matters of State between 26th January and 24th April, 1813. <span style="float: right;">233</span>
October 25, Montreal.	Same to same. (No. 96.) Enclosing requisition for stationery for the Civil Department of Lower Canada for 1814. <span style="float: right;">234</span> <i>Enclosed.</i> The requisition. <span style="float: right;">235</span>
October 25, Montreal.	Same to same. (No. 97.) Enclosing statement of the exports and imports for the year 1812. <span style="float: right;">237</span> <i>Enclosed.</i> The statement. <span style="float: right;">238</span>
October 27, Montreal.	Same to Thomas Barclay, British agent for prisoners of war, stating that he has placed forty six American officers and non-commissioned officers in close confinement. Encloses copy of despatch from Bathurst with the instructions for doing so; also a list of the prisoners still remaining at Quebec. Apprises him of this that he may be prepared for the negotiations sure to take place. Colonel Gardner has been received as American agent of prisoners. The complaints of Dr. McKeehan, Mr. Dickson and other unoffending inhabitants of Niagara, taken prisoners, shall be attended to. Had hoped some arrangement for a general exchange would have been made before now. Respecting the exchange of Hull and the other officers. <span style="float: right;">271</span> (In Prevost's No. 101 of 30th October.)
October 27, Montreal.	General orders respecting the prisoners put into close confinement. English. <span style="float: right;">280</span> French. <span style="float: right;">285</span> (In Prevost's No. 101 of 30th October.)
October 28, Montreal.	Prevost to Bathurst. (No. 98.) Mr. Bowen has declined accepting the appointment of Attorney General of Upper Canada for reasons stated in his letter to Mr. Brenton, an extract of which is enclosed. Bowen is continued in his situation on the Bench in Lower Canada. Asks for some further explanations respecting the pensions proposed to be granted to Messrs. Williams and De Bonne upon their retirement from the Bench. The deficiency of the provincial revenue has been caused

1813.

by the war; and after that is over the pensions of these gentlemen will be paid by the Province, as are those of about twenty other persons. Enclosing copy of letter from Major General de Rottenburg, with copies of two letters therein referred to on the subject of the appointment of an Attorney General in that province. From his (Prevost's) knowledge of Mr. Robinson, he strongly seconds the Major General's recommendation, in his favour.

Page 243

*Enclosed.* Extract referred to.

249

Letter from de Rottenburg, dated 27th September, 1813, enclosing letters from Chief Justice Scott and Justice Powell, recommending Mr. Robinson to be Attorney General of Upper Canada.

251

Chief Justice Scott to de Rottenburg.

253

Justice Powell to the same.

254

October 30,  
Montreal.

Prevost to Bathurst. (No. 99.) Major General Hampton with his forces on the 21st instant, crossed the line, surprised a small number of Indian warriors, drove in some sedentary militia posted at the junction of the Outward and Chateauguay Rivers, encamped there, and is bringing forward artillery. On the 25th he commenced operations against the British advanced posts. An account of the action. The wise measures taken by de Watteville, the bravery of Lt.-Col. de Salaberry and the officers and men engaged. Reports say the American force was about seven thousand, while the British was only about three hundred. Enclosing a list of killed and wounded. Asking for five pairs of colours for the 1st, 2nd, 3rd, 4th, and 5th Battalions Canadian Militia.

255

*Enclosed.* Return of the killed, wounded and missing.

261

October 30,  
Montreal.

Same to same. (No. 100.) Encloses the only despatch received from Procter since the 22nd ult. Has been informed that he commenced his retreat from Sandwich on the 24th of September, after dismantling the posts of Amherstburg and Detroit and destroying all public stores, &c. About five miles from the Moravian village he was attacked by an overwhelming force under General Harrison. He (Procter) was obliged to retreat with the remnant of his army and reached Burlington Heights, the Headquarters of General Vincent. Tecumseh and the Prophet with their bands of warriors were of great service. He is as yet ignorant of the British loss. Procter has sent a flag of truce to learn the fate of the missing officers and men. Hears that the enemy instead of following up their advantage have retreated to Sandwich, followed by Tecumseh and his warriors. Five or six hundred Indians from the Right Division are reported to have joined the Centre. Regrets to say he is still without an official report of Capt. Barclay's action on Lake Erie, which has been the cause of our relinquishing the Michigan territory and abandoning the posts in Upper Canada beyond the Grand River. Fears Capt. Barclay has died of his wounds.

262

(Enclosure calendared at its proper date.)

October 30,  
Montreal.

Same to same. (No. 101.) Has lost no time in carrying out the commands conveyed in despatch No. 40, namely, the putting into close confinement of forty-six American officers and non-commissioned officers to be held as hostages for the twenty-three men held by the Americans and informing Major General Wilkinson of the same. Encloses letters on the subject. He will do all in his power to obtain the evidence necessary for the conviction of the British subjects taken in arms and now in confinement in England. In compliance with the instructions in No. 43, he has communicated these proceedings to Sir J. B. Warren.

268

(Enclosures calendared at their respective dates.)

October 30,  
Montreal.

Same to same. (No. 102.) Despatches Nos. 25 to 46 inclusive, received.

290

October 30,  
Montreal.

Same to same. (No. 103.) The disposition of the forces in Canada.

291

## Department of Agriculture—Archives.

1813.  
October 31,  
Montreal.
- Prevost to Bathurst. (No. 104.) In consequence of his (Prevost's) representation to Sir J. B. Warren of the danger to which the Right Division of the army in Upper Canada was exposed through the loss of the fleet on Lake Erie, he (Warren) has sent ships and marines. By last accounts from de Rottenburg, dated Kingston, 28th instant, the enemy, though still threatening that post, have made no attacks as yet. The American fleet were within eighteen miles of that place. The state of the weather prevented Major General Hampton's attack on Lower Canada and Major General Wilkinson's on Kingston being simultaneous as was intended. Hopes the attack there will end as did that on Lower Canada. Page 293
- No date.
- List of American officers and non-commissioned officers in close confinement at Quebec, also the officers on parole. 277  
(In Prevost's No. 101 of 30th October.)

### GOVERNOR SIR G. PREVOST, AND MISCELLANEOUS, 1813.

#### Q. 123.

1813.  
September 10,  
H.M. late ship  
"Detroit."
- George Inglis to Barclay. An account of the termination of the action on Lake Erie. 63  
(In Prevost's No. 111 of 25th Nov.)
- September 10.
- List of killed, and wounded in the action on Lake Erie. 66  
(In Prevost's No. 111 of 25th Nov.)
- September 12,  
H.M. late ship  
"Detroit,"  
Put-in-Bay,  
Lake Erie.
- Capt. Barclay to Yeo. Detailed account of the disastrous action on Lake Erie. 55  
(In Prevost's No. 111 of 25th Nov.)
- October 22,  
Washington.
- Same to Prevost. Has this day concluded an agreement for the exchange of prisoners of war. Conditions of the exchange. 34
- October 23,  
Ancaster.
- Procter to de Rottenburg. Statement of his movements. 80  
(In Prevost's No. 113 of 30th Nov.)
- November 1,  
Montreal.
- Prevost to Bathurst. (No. 105.) Enclosing a memorial from Major General Sheaffe, asking for compensation for the loss of his baggage which fell into the enemy's hands at York. Recommends the memorial to consideration. 2  
*Enclosed.* The memorial. 3
- November 4,  
Montreal.
- Same to same. (No. 106.) His representation to Sir J. B. Warren, at Halifax, of the state of the provinces, has brought him reinforcements. The disposition he intends to make of them. The movements of the enemy's fleet. General Hampton's army has quitted the Province and is returning to its original encampment at the Four Corners. He (Prevost) intends to concentrate the remains of the Right Division with the Centre, and place the whole under Major General Riall. The sickness amongst the troops is diminishing. The Newfoundland Regiment being so much weakened, he proposes that the remainder be sent to Newfoundland in the spring, to recruit there. Has just received Procter's official report of his retreat from Sandwich on the 26th September, and the disastrous affair of the 5th October. The account is so confused that he has asked de Rottenburg to call upon him for a clearer and more detailed statement, that it may be brought before His Majesty's Government, for their decision upon Procter's conduct. 5
- November 6,  
Quebec.
- Charles McGregor, Major 70th Regt., to Prevost. Respecting his regiment. 25  
(In Prevost's No. 107 of 15th Nov.)
- November 10,  
Hamilton,  
N. Y.
- Agreement to deliver property and stores. 23  
(In Prevost's No. 107 of 15th Nov.)

1813.  
November 11, Williamsburg. J. W. Morrison, Lt.-Col. 89th, to de Rottenburg. Enclosing copy of an agreement with two of the principal inhabitants of Hamilton, State of New York, for the delivery of public property and stores; also copy of General Wilkinson's proclamation. Page 22  
(In Prevost's No. 107 of 15th Nov.)
- November 12, Chrysler's, Williamsburg. Same to same. Reporting the victory at Chrysler's Farm. 17  
(In Prevost's No. 107 of 15th Nov.)
- November 13, Montreal. Prevost to Barclay. Acknowledges letters. Encloses letter to Major Melville or the officer commanding at Burlington, by which it will be seen that the American prisoners at Quebec had sailed for Halifax a few days previous to the receipt of the agreement. Even had they not sailed he does not think he would have been justified in giving up these prisoners, while the retaliating system is being carried on. In case the agreement be carried out, hopes assurances will be given by the American Government that those taken on Lake Erie and under Procter should not be subjected to any retaliation whatever, but be returned in the spring. Has allowed Lt.-Col. Boerstler and Lt. Deacon, to proceed on parole to the United States in return for the indulgence shown to Lt.-Col. Myers and Capt. Gordon. It would be advisable to make an exchange of these officers. The removal of the prisoners to Halifax, was a matter of necessity. He has just learned that instead of proceeding to Halifax, they have, against his orders, been sent with the convoy to England. This must have happened through a misunderstanding. Hopes the American Government will be convinced of this. Drs. Wood and Scott will be permitted to return to the United States as soon as Mr. Dickson and other peaceful citizens made prisoners of war, are allowed to return to Canada. 39  
*Enclosed.* Letter to Melville. 48
- November 15, Lachine. Same to Bathurst. (No. 107.) The enemy's attempts to reach Montreal ended in an action at Chrysler's Farm. Encloses Lt.-Col. Morrison's account of that signal victory. The enemy's movements. Encloses copy of another letter and enclosures from Col. Morrison. The zeal which all classes have shown in their endeavours to oppose the threatened invasion. Encloses also report of the 70th Regiment. States for the information of His Majesty's Government that "the very great exertions made for the preservation of the Canadas by its population in conjunction with the small force under my command, may eventually degenerate into indifference for the result of the present contest, unless the support from the Mother Country is equal to the magnitude of the stake." 11  
(Enclosures calendared at their respective dates.)
- November 15, Lachine. Same to Bathurst. (No. 108.) Asking for authority to make the allotment of land promised to those enlisting in the Glengarry Regiment (100 acres) and to the Voltigeurs (50 acres) in the Township of Sherrington, as he thinks that would prove an inducement. 26
- November 15, H.M.S., "Wolfe," Kingston. Yeo to Prevost. Encloses Capt. Barclay's account of the action on Lake Erie. The British squadron was deficient both in seamen and guns, but the greatest misfortune was the loss of every officer, particularly Capt. Finnis, who, if spared, would probably have saved the squadron. 54  
(In Prevost's No. 111 of 25th June.)
- November 20, Quebec. Major General Glasgow to Noah Freer. Explaining how the prisoners intended to be kept at Halifax were sent on to England. 51
- November 24, Montreal. Prevost to Bathurst. (No. 109.) Enclosing memorial of the agents of the North-west Company, and recommending it to favourable consideration. 27  
*Enclosed.* The memorial. 28

## Department of Agriculture—Archives.

1813.  
November 24, General order, issued in consequence of the state of affairs in this dis-  
Montreal. trict and the defeat on Lake Erie. Page 67  
*Enclosed.* Return of the Right Division of the army in Upper  
Canada. 75  
(In Prevost's No. 111 of 25th November.)
- November 25, Prevost to Bathurst. (No. 110). Transmitting copies of three letters  
Montreal. respecting the exchange of prisoners, also one from M. Genl. Glasgow,  
in explanation of the sending on to England the American prisoners  
whom he (Prevost) intended to remain at Halifax. Asks that they may  
be returned at once by cartel to the United States in order to remove all  
grounds of complaint. 32
- November 25, Same to same. (No. 111.) Enclosing letter from Yeo, Capt. Barclay's  
Montreal. official account of the action on Lake Erie, and general order issued in  
consequence of recent events in this command. Capt. Barclay is re-  
covering. 53  
(Enclosures calendared at their respective dates.)
- November 29, Same to same. (No. 112.) As no answer has been received to the  
Montreal. memorial of Isaac Winslow Clarke, transmitted in his (Prevost's) des-  
patch of 11th November, 1811, he encloses a duplicate and recommends it  
to consideration. 76  
*Enclosed.* The memorial. 77
- November 30, Same to same. (No. 113.) By despatch No. 106 it will be seen that  
Montreal. Procter's account of his retreat was not satisfactory enough. He had  
been called on for a more comprehensive statement; as that has not been  
received, he transmits his first account. 79  
(The enclosure dated Ancaster, 23rd October, calendared at its proper  
date.)
- December 11, Same to same. (No. 114.) Enclosing copy of a letter from Major  
Montreal. General Wilkinson, on the subject of the prisoners held as hostages, with  
his (Prevost's) reply to it. Has also transmitted copies to Sir John  
Warren, at Halifax, asking him as there are only fifteen officers prisoners  
at Quebec, to put into close confinement thirty-one officers prisoners at  
that place. Is afraid proof to convict the twenty-three prisoners in Eng-  
land will be difficult to get. Suggests they be brought to trial immedi-  
ately, and if acquitted, they might be restored to the condition of ordinary  
prisoners of war, in this way the difficulty might be settled. 88  
*Enclosed.* The letter to Wilkinson, dated Malone, 3rd December. 91  
The answer to the above. 95
- December 12, Same to same. (No. 115.) The signal defeat of the Americans at the  
Montreal. Chateauguay River and Chrysler's Farm has relieved both Provinces of  
the invading forces under Generals Hampton and Wilkinson; the latter  
has given up his avowed project of passing the winter at Montreal. A  
detachment of troops on board some gunboats which he (Prevost) had  
ordered to Lake Champlain, burned a large building at Plattsburg and  
brought away some bateaux and stores. The severity of the weather  
compelled them to return. The lateness of the season has frustrated an  
attack on Burlington. Is assured that the two boats building at Kings-  
ton will be ready by the opening of navigation. 100
- December 12, Col. J. Murray to Vincent. Hearing that the enemy were carrying  
Fort George. off the loyal inhabitants and were bent on gaining possession of the  
country between Fort George and the advance, he had marched forward,  
notwithstanding the inclemency of the weather, frustrated their designs  
and compelled the enemy to evacuate this post; on hearing of our approach  
they laid the town of Newark in ashes and sent the stores, &c.,  
across the river. Hopes this movement will save the district from a  
merciless enemy. 107  
(In Prevost's No. 116 of 22nd December.)

1813. December 22, Quebec.	Prevost to Bathurst. Enclosing report to Vincent from Col. Murray of his having taken possession of Fort George, at Niagara, on the 12th instant without opposition. This expedition has sent the enemy back to his own side of the river. The wanton burning of the town of Newark has stained the character of the American nation. Praise due to Col. Murray for the manner in which he rescued the Niagara district from further plunder, &c.	Page 105
	(Enclosure calendared at its proper date.)	
December 22, Quebec.	Glasgow to Prevost. The great need of artillery men and drivers. The necessity for a civil establishment of the Ordnance Department being formed at Kingston and an armourers' establishment at that place and also at Montreal.	110
	(In Prevost's No. 117 of 24th December.)	
December 24, Quebec.	Prevost to Bathurst. (No. 117.) Enclosing and recommending to favourable consideration a letter from Major General Glasgow, asking for gunners, ordnance and arms.	109
	(Enclosure calendared at its proper date.)	
December 27, Quebec.	Same to same. (No. 118.) Correcting the statement in despatch No. 116, that the enemy had passed all his stores and cannon over the river, as several guns and some ammunition have been found in a ditch, and camp equipage for fifteen hundred men has fallen into our hands. The new barracks at Fort George and Chippawa, owing to the hasty flight of the enemy escaped being burned.	114
December 30, Quebec.	Same to same. (No. 119.) Enclosing returns of the ordnance and stores captured from the enemy since the beginning of the war, that the ordnance department may make a valuation for the benefit of the captors.	116
	<i>Enclosed.</i> Return of the ordnance and stores taken at Michillimackinac, 17th July, 1812.	118
	Ditto at Detroit, 16th August, 1812.	121
	Descriptive list of brass and iron ordnance at Detroit on the same date.	127
	Return of ordnance and stores taken at Queenston, 13th October, 1812.	131
	Ditto of small arms taken at the River Raisin, 22nd January, 1813.	133
	Ditto of ordnance and stores taken at Ogdensburgh, 22nd February, 1813.	134
	Extracts of letters relating to the stores.	137 to 141
No date.	Proclamation of Major General Wilkinson. (In Prevost's No. 107 of 15th November.)	24
No date.	Statement of the British and American squadrons on Lake Erie. (In Prevost's No. 111 of 25th November.)	65

## MISCELLANEOUS PAPERS.

1813. January 2, London.	Simon McGillivray to Goulburn. Respecting the application of the North-west Company to the Admiralty for protection to their intended expedition.	143
January 3, "Royal William", Spit-head.	Admiral Sir Richard Bickerton to J. W. Croker. Enclosing to be laid before the Lords of the Admiralty a list of the British born soldiers taken prisoners from the American army, with an extract of a letter from the Adjutant General at Montreal concerning them.	150
	<i>Enclosed.</i> The list.	151
	The extract.	152
January 4, Ordnance Office.	R. H. Crewe to Col. Bunbury. That a copy of the letter from Prevost, dated 5th November, 1812, be laid before Lord Bathurst, that the accou-	



## Department of Agriculture—Archives.

1813.	trements asked for may be sent from the Storekeeper General's Department.	Page 147
	<i>Enclosed.</i> The letter from Prevost.	148
January 4, Admiralty Office.	John Barrow to Col. Bunbury. Transmitting papers relating to the British born subjects found serving in the American Army.	149
January 5, Commissary in Chief's Office.	J. C. Herries to Goulburn. Enclosing copy of a letter from Harrison, asking for a particular information as to the complaints made by the Indian tribes of Canada on the quality of some of the articles sent out.	153
	<i>Enclosed.</i> The letter dated 30th December, 1812.	154
January 5, Treasury Chambers.	Harrison to Goulburn. Enclosing copies of letters from Prevost stating that he has issued warrants for the amount of £5,000 and £15,000 in aid of the Civil expenditure of Lower Canada.	155
	<i>Enclosed.</i> The letters dated 30th September and 3rd October, 1812.	156-157
January 14, Cork.	David Deane Roche to Bathurst. There are many inhabitants of the Northern and Eastern states who would only be too glad to renounce their allegiance to the United States if some help was afforded them by the expedition about to sail. Offers personal services.	158
January 15, London.	Simon McGillivray to A. Gordon. Respecting the application of the North-west Company for protection to their ship.	161
January 18, Treasury Chambers.	Harrison to Goulburn. Enclosing copy of a letter from the Commissioners of transports stating that they have appointed an Agent for prisoners of war in the United States.	165
	<i>Enclosed.</i> The letter dated 7th January, stating that Thomas Barclay has been appointed.	166
January 19, London.	Lord Selkirk to Lord Sidmouth. Unfolding his plan for the formation of a body of Canadian Fencibles.	167
January 22, Admiralty Office.	John Barrow to Bunbury. Enclosing for consideration a copy of a letter from Capt. Dowers, asking to be remunerated for his expenses in conveying Major General Wallis and suite from St. Vincents to Halifax.	170
	<i>Enclosed.</i> The letter.	171
January 22, Admiralty Office.	Same to same. Asks what is to be done with the British subjects taken prisoners in the American Army as they have arrived at Sheerness.	172
January 27, Admiralty Office.	J. W. Croker to Goulburn. (Most secret and confidential.) Giving the time of sailing of the convoys for Lord Bathurst's information.	173
February 8, Doctor's Com- mons.	The opinion of the Advocate, Attorney and Solicitor General as to whether the British subjects taken prisoners from the American army can be legally tried.	176
February 9, Treasury Chambers.	Harrison to Bunbury. Enclosing for Lord Bathurst's consideration, copy of a letter from the Paymaster General relative to the reduction made in the remuneration granted to Captain Gray for preparing plans in Canada.	179
	<i>Enclosed.</i> The letter.	180
February 10, Treasury Chambers.	Same to Goulburn. Transmitting letter from Prevost with requisitions for Indian goods for 1813 and 1814, with the report of the Comptrollers of Army accounts thereon, for Lord Bathurst's opinion.	181
February (?) Castle St. Louis.	E. B. Brenton, enclosing general order for Lord Bathurst's information.	182
	(The order is in Vol. 121, enclosed in Prevost's No. 48 of 18 March.)	
February 11, Treasury Chambers	Harrison to Goulburn. Enclosing report from the Comptroller of Army accounts on two letters from Prevost and one from Col. Bunbury relative to the public expenditure in Lower Canada.	183
February 15 Treasury Chambers.	Selkirk to Bathurst. Enclosing heads of a proposal for raising a regiment in Canada.	184
	<i>Enclosed.</i> The proposal.	186

1813. February 16, London.	Rev. Thaddeus Osgood to Goulburn. Enclosing papers relating to "the case of the destitute poor of his Britannic Majesty's Dominions in Canada," for criticism before it is put in print.	Page 188 189 to 193.
February 17, Horse Guards.	Torrens to same. Enclosing return of the detachments to be sent to North America, for which tonnage will be required.	184 195
February 19, Horse Guards.	W. Wynyard to Torrens. (Private.) Had some months before presented a project, in writing, of Colonel Turner, relative to raising a Fencible Corps in Scotland for service in America. Asks if the Duke's decision has been given.	196 197
February 23.	John Trotter to Hugh Stuart. Respecting the Indian presents.	200
February 25, Admiralty Office.	John Barrow to Col. Bunbury. Enclosing copy of a letter from Captain Austin, stating the destitute situation in which the British subjects, taken in arms in the United States Army, are for want of clothing.	201 202
February 26, Treasury Chambers.	Harrison to Goulburn. Transmitting copy of a letter for the Commissary-in-Chief respecting the supply of Indian presents.	203 204
February 27, Horse Guards.	Torrens to same. Asks that the necessary steps be taken to provide a passage to Canada for Major General Stovin and Brigadier General Darroch with their staffs.	205
February 27, Horse Guards.	Duke of York to Bathurst. Returning Lord Selkirk's proposal to raise a regiment of fencible infantry with his (York's) remarks.	206 207
March 2, Ad- miralty Office.	Barrow to Goulburn. Directions have been given to ship the twenty carronades and ammunition to Canada.	212
March 2.	T. Tackle to Bathurst. As the Indians bordering on the United States will soon be quitting their hunting grounds, no time is to be lost if His Majesty's Government desires to forward any additional directions on the subject. Transmits observations made during his tour in the States.	213
March 2, Ad- miralty Office.	Barrow to Goulburn. Orders have been given for passages to Canada for Majors Goore and Fulton on board the "Woolwich."	216
March 3, Ad- miralty Office.	Same to Bunbury. Major General Stovin and Brigadier General Darroch are to be provided with passages to Quebec on board the "Woolwich."	217
March 3, Com- missary in Chief's Office.	J. C. Herries to Harrison. Respecting the Indian presents now preparing to be sent out for Upper and Lower Canada.	264
March 4, Ad- miralty Office.	Barrow to Goulburn. Respecting the stores for the naval establish-ment in Canada.	218
March 4, Ad- miralty Office.	Barrow to Goulburn. The commander of the "Woolwich" has been directed to receive on board the military stores for Quebec.	219
March 5, Transport Office.	Alex. McLeay to ——. Will let him know when the stores to be shipped on the "Woolwich" will be ready.	220
March 5, Ord- nance Office.	Lt.-Col. Chapman to Goulburn. Orders have been given for the shipping of thirty-six 32 pounder ship carronades to Quebec instead of eighteen as originally intended.	221
March 5, Ord- nance Office.	P. A. Ouvry to same. (Immediate.) Asking for what service the 36 carronades are intended in order to decide the proportion of ammunition necessary.	222

## Department of Agriculture—Archives.

1813.  
March Admiralty Office. Barrow to Goulburn. The "Woolwich" is now ready to receive the naval stores for Canada but it is unable to take the barrack stores. Page 223
- March 5, Ordnance Office. P. A. Ouvry to Croker. Asks whether the orders have been given for equipping the vessels now building in Canada for naval purposes. 268
- March 6, Admiralty Office. J. W. Croker to Goulburn. The difficulty of supplying the requisite naval stores for Canada without a more particular knowledge of what is necessary. A number of officers and 400 seamen to be sent out. The naval officer to be employed on the lakes will be ordered to report on the state of the vessels and stores. 224
- March 8, Transport Office. McLeay to Bunbury. With what department is it necessary to communicate, respecting the provision of tonnage for the conveyance of 150 horses to Quebec? 226
- March 8, Storekeeper General's Office. Barker to Goulburn. In reply to his note to Mr. Trotter, states the Transport Board have been requested to furnish tonnage to Canada. 227
- March 9, Albany House. Wm. Osgsode to same. (Private.) States that the nomination of the Roman Catholic Bishop of Quebec rests entirely in His Majesty's Government. How Bishop Plessis was appointed. 228
- March 9, Horse Guards. Torrens to same. Asks that a passage to Quebec in the transports from Cork be furnished to Brigadier General Darroch, if he has not already left Ireland. 231
- March 9, Admiralty Office. Croker to same. (Secret.) Respecting naval affairs in Canada. 232
- March 9. Selkirk to Bathurst. Explaining the points in his (Selkirk's) proposal for raising a regiment which the Commander-in-Chief had objected to. 236
- March 10, Admiralty Office. Croker to Goulburn. Asks where the stores not already embarked on the "Woolwich" are to be put on board. It is of importance that no delay should occur. 249
- March 10, Transport Office. List of troop and cavalry transports appropriated to embark 1,204 men at Portsmouth, and 550 men and 150 horses at Cork, for Quebec. 250
- March 11, Admiralty Office. Croker to Goulburn. Respecting the stores to be put on board the "Woolwich." 251
- March 11, Ordnance Office. P. A. Ouvry to Bunbury. Transmitting copies of three demands for ordnance and ordnance stores for the vessels to be built in Canada, for the pleasure of His Royal Highness thereon. 252
- March 11, Transport Office. Alex. McLeay to Goulburn. Measures have been taken for shipping the stores for Canada in the "Woolwich" with the utmost despatch. 253
- March 12. J. C. Herries to same. Respecting the additional articles to be sent out as a reserve stock to Canada. 254
- March 12, Admiralty Office. Croker to same. Is commanded by the Admiralty to state that the "Woolwich" having left the Nore, the guns, sails and articles specified in the enclosed list will be put on board at Portsmouth. 256  
*Enclosed. List.* 257
- March 12, Admiralty Office. Barrow to same. (Immediate.) The "Woolwich" passed the Downs and is gone to Spithead. 261
- March 12, Horse Guards. Torrens to same. Is directed by the Commander-in-Chief to apply for a passage for Major Ogilvie, 8th Regiment, on board the "Woolwich." 262
- March 12, Treasury Chambers. Harrison to same. Transmitting copy of a letter from the Commissary-in-Chief respecting the Indian presents for Canada for 1813 and 1814. 263
- March 12, Ordnance Office. Lt.-Col. Chapman to same. Transmitting copy of a letter on the subject of the carronades under orders for Quebec. 265

1813. March 12, Ord- nance Office.	P. A. Ouvry to Lt.-Col. Chapman. Respecting the carronades to be sent to Quebec.	Page 266
March 12, Ord- nance Office.	Lt.-Col. Chapman to Goulburn. The carronades for Quebec will be embarked as soon as the name of the transport is signified.	267
March 12, Transport Office.	Alex. McLeay to same. Respecting the convoy of the transports carrying the 41st Regiment to Canada.	269
March 13, War Office.	W. Merry to same. Transmitting requisition for purveyor's stores for Canada. Requests that after it is laid before the Secretary of State he be informed for Lord Palmerston's information whether they be considered necessary.	270
March 13, Portsmouth.	James F. Fulton to same. A passage will be provided for Major Ogilvy on board the "Woolwich."	271

## MISCELLANEOUS, 1813.

## Q. 124.

1813. March 9, Bermuda.	Sir J. B. Warren to Croker. Enclosing letter from the Chevalier de Ouie and states that he has sent the "Colibri" and "Morgiana" to cruise off the coast of the Floridas and to use all efforts to assist the Spaniards in their defence; not having any troops it was impossible to afford the allied cause further aid.	Page 83
	<i>Enclosed.</i> Letter from the Chevalier de Ouie, dated Philadelphia, 2nd March, with news that General Pinkney is to command an expedition of 2,000 men against the Floridas.	84
March 11, Halifax.	Wm. Miller to the Commissioners for conducting H. M. Transport Service. Respecting a difficulty which has occurred in the exchange of prisoners of war in North America.	159
March 16, Treasury Chambers.	Harrison to Goulburn. Enclosing letter from Prevost, dated Quebec, 18th December last, with account current of the Receiver General of Lower Canada, and a report of the committee of the Executive Council on the public accounts between 11th April and 10th October, 1811, for Lord Bathurst's observations thereon.	2
	<i>Enclosed.</i> Letter from Prevost.	3
	Report of a committee of the Executive Council.	4 to 42
March 16, Ad- miralty Office.	Barrow to Goulburn. As many as possible of the carronades for Canada are to be shipped on board the "Woolwich."	43
March 17, Ad- miralty Office.	Croker to same. (Secret.) The two battalions of the Royal Marines will embark for Canada in a few days. The transports to be employed. The "Mariner" has on board an assortment of Congreves Rockets, with a lieutenant, two subalterns and fifty men, who have been exercised in the use of these rockets. Asks that Lord Bathurst state his views as to the instructions to be given to Admiral Warren, commanding in Canada, for the employment of his force.	44
March 19, Ad- miralty Office.	Croker to same. Enclosing copy of instructions given to Sir James Yeo, who is to sail for Canada on the "Woolwich", for Lord Bathurst's information.	47
	<i>Enclosed.</i> Copy of instructions.	48 to 59
March 19, Ad- miralty Office.	List of officers and seamen to be employed on a particular service on the Lakes of Canada.	60
March 19, Whitehall.	J. Beckett to Goulburn. Is directed by Lord Sidmouth to request that Lord Bathurst give the necessary directions for having the British subjects found serving in the Army of the United States placed on board the tender off the Tower in order to undergo examination.	61
March 20, Treasury Chambers.	Harrison to Bunbury. Transmitting letter from the Commissary-in-Chief, dated 17th instant, respecting clothing for troops in Canada.	62

## Department of Agriculture—Archives.

1813.  
March 20, Portsmouth. Colonel Archibald Stewart to the Duke of Kent. Asks that an Admiralty order be given for passages to Canada for himself and Captain Smyth, as on their arrival they found the fleet had sailed. Page 73
- March 22, Whitehall. J. N. Addington to Goulburn. In answer to Lord Bathurst's suggestions for endeavouring to raise reinforcements for Canada from the Scottish Militia. 63
- March 22, Hanover Square. Count de Sieven to Bathurst. (In French.) Enclosing memorial of the Abbé de la Trappe. Recommends the memorial to favourable consideration. 64
- March 22, Admiralty Office. *Enclosed.* The memorial. 65
- March 22, Admiralty Office. Barrow to Goulburn. The necessary directions have been given for having the British subjects taken in the American Army put on board the tender off the Tower. 68
- March 25, Admiralty Office. Croker to same. Captain Richbell. Regulating Officer on Tower Hill, is to report to him (Bathurst) the arrival of the prisoners on the tender. 69
- March 26, Horse Guards. H. Calvert, Adjutant General, to Torrens. Enclosing letter from the Duke of Kent, requesting that application be made to the Lords Commissioners of the Admiralty for passages to Canada for Colonel Stuart and Captain Smyth, Royal Scots. 71
- March 27, Horse Guards. *Enclosed.* Letter from the Duke of Kent, dated 23rd March. 72
- March 27, Tower Hill. Torrens to Goulburn. Transmitting copies of two letters asking for passages to Canada for Colonel Stuart and Captain Smyth. 70
- March 27, Tower Hill. T. Richbell to same. Stating that twenty-two British subjects found serving in the American Army have arrived and are now on board the tender. 74
- March 27, Treasury Chambers. C. Arbuthnot to same. Lord Bathurst is to be assured that he (Arbuthnot) will have great pleasure in giving him a clerkship in Canada for Mr. Tackle. 75
- March 29, War Office. W. Merry to same. States, for Lord Bathurst's information, that the necessary directions have been given for supplying the Purveyor's stores required for Canada. 76
- March 30, Lincoln's Inn. H. Hobhouse to same. For the names and residences of the witnesses against the twenty-two soldiers now awaiting their trial. 77
- March 31, Plymouth. Col. Sidney Beckwith to same. Expects the Marine battalions will be on board their respective ships this afternoon; is not so sanguine about the company from the Isle of Wight, as the officers seem to know nothing of their men. The "Success" has not made her appearance from Guernsey. Sir Robert Calder is to telegraph whether she is to be waited for or not. 78
- April 6, Plymouth. Same to same. The "Success" having arrived, the ships are all ready for sea. Hopes to set sail next morning. 80
- April 6, Admiralty Office. Barrow to same. Henry Kelley, having arrived at the Tower, asks that directions be given respecting the twenty three men taken in the American Army. 81
- April 7, Admiralty Office. Same to Bunbury. Transmitting letter and enclosure from Sir John Warren, representing that he had sent two vessels to cruise off the coast of the Floridas. 82
- April 8, Transport Office. List of transports under orders for North America exclusive of those collecting at Cork. 86
- April 9, Transport Office. Alex McLeay to Goulburn. Enclosing copy of an extract of a letter from the agent of this department at Deptford, Capt. Young, respecting the loading of the transports with ordnance and Storekeeper General's stores for Quebec and Halifax. 88
- April 10, Transport Office. *Enclosed.* Extract of the letter. 89
- April 10, Transport Office. Same to same. Enclosing for Lord Bathurst's information, a list of transports from Portsmouth to North America, together with copy of a

1813.	letter from the agent at Deptford relative to the ships in the river preparing for that destination.	Page 90
	<i>Enclosed.</i> The list.	91
	Copy of the letter.	93
April 10.	J. C. Herries to ———. Finds that the delay in the departure of the Storekeeper General's stores rests with the Transport Board.	94
April 12, Transport Office.	McLeay to Bunbury. Enclosing a memorandum to correct an error in the return of the 9th inst.	95
	<i>Enclosed.</i> The memorandum.	96
April 12.	Respecting the number of militia in Canada.	97
April 12, Transport Office.	Alex McLeay to ———. Acknowledging letter of the 3rd inst., with enclosure from Messrs Idle, Coates and Co., requesting permission to load with naval timber any transports which may be returning to this country empty, upon paying freight for the same. The disposable tonnage in these transports has been transferred to the Commissioners of the Navy, which is considered preferable to giving it to private individuals.	98
April 14, Transport Office.	Same to Goulburn. Enclosing extract of a letter from Captain Young, agent for Transports at Deptford, which will show that no avoidable delay has taken place on the part of this department in the appropriation of tonnage for the stores to be shipped to the Storekeeper General in North America.	100
	<i>Enclosed.</i> The extract, dated 14th April.	102
April 14, Whitehall.	J. Beckett to same. Encloses the opinion of the Attorney and Solicitor General on the case of the British subjects taken while serving in the American Army. Submits to Lord Bathurst whether it might not be advisable to employ these men in some naval or military service in this country, as although there is evidence enough to detain them, yet there is not sufficient legal evidence in this country to support the charge before a magistrate.	107
	<i>Enclosed.</i> Report of the Attorney and Solicitor General.	109
April 15, Horse Guards.	Torrens to same. Asking that Lord Bathurst give directions that tonnage be provided for conveying a detachment of the 13th Regiment to Canada.	110
April 15, Transport Office.	McLeay to same. Enclosing, for Lord Bathurst's information, a copy of a statement from the Transport agent at Deptford, showing the progress making in loading the store transports for North America.	111
	<i>Enclosed.</i> The statement.	112
April 15, Ad- miralty Office.	Barrow to same. Enclosing copy of a letter from Captain Richbell with enclosure from Dr. Downey, stating that the American prisoners can no longer be kept on board the Tender without inconvenience and asking that they be removed.	114
	<i>Enclosed.</i> Letter from Captain Richbell, 14th April, 1813.	115
	Ditto from Dr. Downey.	116
April 16, Lat. 44.10, Long. 22.26.	Sidney Beckwith to Goulburn. Acquainting him that he is thus far on his voyage. The troops in the best health.	117
April 16, Storekeeper General's Office.	J. Barker, Deputy Storekeeper General, to ———. Acknowledging letter and enclosures of the 15th inst., relative to the vessels now loading for Canada and desiring that the clothing for the Canadian Militia may be put on board the first transports. States, in reply, that the clothing has been already sent down to be loaded. Names of the vessels. Enclosing return of the articles of clothing required for this service and the report of Captain Young, Transport agent, on the state of the ships now loading.	118
	<i>Enclosed.</i> Report.	121
	<i>Enclosed.</i> Return.	122

## Department of Agriculture—Archives.

1813.  
April 16,  
Transport  
Office. Alex. McLeay to Goulburn. Enclosing extract from the report of the  
Transport agent at Deptford. Page 123  
*Enclosed.* Extract. 124
- April 17,  
Mark Lane. John Inglis to Bathurst. Transmitting a printed letter cut out of a  
book of reports on shipping and navigation, published by the Society of  
Ship Owners, in 1807. The author, Lt.-Col. Alex. Fraser, of the 34th, is  
well known. Thinks that circumstances may arise during the war which  
may make the suggestions in this letter useful. Advising an expedition  
to New Orleans. Advantages which might be derived from such an  
expedition. A. P.S. acknowledges letter from him (Bathurst) giving  
permission to use a sum of money for charitable objects. 125
- April 17,  
War Office. W. Merry to Goulburn. Respecting the requisition for purveyor's  
stores for the use of the troops in Canada. 129
- April 19,  
Transport  
Office. Alex. McLeay to same. Enclosing copy of an extract of a letter from  
the agent for transports at Cowes, by which it will be seen that the  
detachment of the 89th was embarked for Canada on board the "Lord  
Cathcart." 130  
*Enclosed.* The extract. 131
- April 19,  
Horse Guards. Torrens to same. In reply to his letter of the 15th inst., with its en-  
closures relative to the British subjects taken in arms, he states for Lord  
Bathurst's information, that His Royal Highness is of opinion that these  
men should have the alternative of returning to the station to be tried  
or of entering the army for general service. They are to be given the  
option immediately. 132
- April 20,  
Storekeeper  
General's  
Office. J. Barker to same. Enclosing a detailed invoice of clothing, necessa-  
ries and accoutrements shipped on board the "Bellfield," "Sarah Ann"  
and "Northumberland," as part of the supply ordered for the use of the  
troops in Canada. 133  
*Enclosed.* The invoice. 134 to 146
- April 22,  
Transport  
Office. List of transports sailing under convoy from Cork for Quebec, on the  
17th inst. 147
- April 22,  
Transport  
Office. List of transports sailing from the Downs for North America, on the  
20th and 21st inst. 148
- April 24,  
Horse Guards. Torrens to Goulburn. The alternative suggested has been offered to  
twenty-two soldiers, who have unanimously rejected the proposal of  
entering the British Army and prefer being ordered to America to stand  
their trial. 149
- April 24,  
Storekeeper  
General's  
Office. J. Barker to Harrison. Enclosing a return of sundry cases of sta-  
tionery shipped for Canada. 162  
*Enclosed.* The return. 163
- April 27,  
London. Thos. Leach, Attorney to Samuel Sansum and John Allsopp, Attorney to  
Robert Allsopp, to Goulburn. Begging that steps may be taken respecting  
the petition of Samuel Sansum and Robert Allsopp, asking for lands in  
Canada on behalf of their children. 150
- April 27,  
Kingston  
Palace. Edward, Duke of Kent, to Bathurst. Enclosing the memorial of the  
widow of the late David Lynd, prothonotary of the Court of King's  
Bench for the District of Quebec. A former memorial appears to have  
miscarried. Recommends the prayer of the memorialist. 151  
*Enclosed.* The memorial asking for a renewal of the lease of the farm  
near Quebec, called Bellville. 153
- April 27,  
Audit Office. Wm. Walter to Goulburn. The commissioners for auditing the account  
of the late Henry Caldwell as Receiver General of the Province of Lower  
Canada, having no further occasion for certain letters and documents  
transmitted in Cooke's letter of 27th June, 1808, return them. 157

1813. April 27, Transport Office.	Alex. McLeay to Goulburn. Transmitting copy of a letter from Lieut. Wm. Miller, agent for prisoners of war at Halifax.	Page 158
May 2, Horse Guards.	The Commander-in-Chief to Lord Sidmouth. Respecting the proposition for augmenting the forces in Canada by procuring volunteers from the militia of Scotland.	165
May 4, Whitehall.	J. H. Addington to Goulburn. The proposition for augmenting the force in Canada contained in his (Addington's) letters of 17th March and 27th April, having been referred to the Commander-in-Chief, he now transmits his reply and begs that Lord Bathurst favour Lord Sidmouth with his sentiments thereon.	164
May 9, Horse Guards.	The Commander-in-Chief to Bathurst. Further respecting the plan for augmenting the forces in Canada.	167
May 10, Hudson's Bay House.	"Petition of the Governor and Company of Adventurers of England trading into Hudson's Bay for and on behalf of the Right Honourable the Earl of Selkirk."	169
May 15, Trans- port Office.	Alex. McLeay to Goulburn. Enclosing a list of transports under orders for North America, and stating that the "Earl of Moira" will receive the 170 men of the 22nd Regiment under orders for the Mauritius.	171
	<i>Enclosed.</i> The list.	172
May 19, Storekeeper General's Office.	J. Barker to Harrison. Enclosing a return of stores for Canada shipped on board the "Northumberland," "Prince of Wales" and "Prospect." Bills of lading have been forwarded to Prevost.	211
	<i>Enclosed.</i> The return.	212
May 25, Treas- ury Chambers.	Harrison to Bunbury. Transmitting letter from the Secretary at War relative to sending out great coats to Canada for the use of the troops for Lord Bathurst's opinion thereon.	175
May 28, Treas- ury Chambers.	Same to Goulburn. Transmitting for Lord Bathurst's information a copy of a letter from Prevost, respecting the civil expenditure in the Canadas.	173
	<i>Enclosed.</i> Letter from Prevost, dated 28th January.	174
May 31, Storekeeper General's Office.	J. Barker to Hugh Stuart. Encloses, agreeable to his request, a return of the stores provided in the present year for the use of the troops in Canada, with the Indian presents furnished; also a return of the stores shipped for Halifax in December last, with a statement of what have been ordered for the present year.	176
June 3, Bermuda.	Beckwith to Bathurst. Arrived here after a passage of forty-six days. The troops generally healthy. Encloses returns showing how he has divided his troops. Has detained D. A. C. G. Osborne, as there is no officer of that department with him. Has obtained the services of Lieut. Robertson, R. A., who knows the coast of America, as he (Beckwith) had no officer with him having the requisite knowledge. Remarks on the troops. The error which has occurred in the Ordnance Department respecting the rockets sent out. Cannot close without acknowledging obligations to General Horsford.	177
	<i>Enclosed.</i> Account of rockets on board the "Mariner."	182
	"General embarkation return and field equipments in possession and wanting to complete the 1st Brigade under Lieut.-Col. C. Napier."	183
	Ditto under Lt.-Col. Williams.	185
	General embarkation return of the force under Colonel Sir Sidney Beckwith.	184
	Extract from the bill of lading of the "Mariner."	186
June 3, Quebec.	Bishop (Anglican) of Quebec to Bathurst. A long paper on ecclesiastical affairs in Canada.	187 to 203
June 3, Carle- ton House.	Proceedings in Council on a Bill intituled "An Act to grant certain duties to His Majesty towards supplying the wants of the Province of Lower Canada during the present war with the United States of America and for other purposes."	204



## Department of Agriculture—Archives.

1813. June 3, Treasury Chambers.	Harrison to Goulburn. Enclosing copy of a letter from the Storekeeper General's Department reporting the shipment of presents for the Indians in Upper and Lower Canada. <span style="float: right;">Page 208</span>	209
June 5, Whitehall.	<i>Enclosed.</i> The letter.	
June 8, Admiralty Office.	J. Beckett to same. Transmitting, by direction of Lord Sidmouth, a communication from the Adjutant General, requesting some explanation as to the terms on which the Scotch Militia will be allowed to enlist into the 49th, for Lord Bathurst's opinion thereon. <span style="float: right;">210</span>	212
June 8, Whitehall.	Barrow to Bunbury. Asks for a description of the sloop of war on Lake Ontario, for which cordage is required. <span style="float: right;">212</span>	213
June 8, Whitehall.	Jos. Buller to Goulburn. Enclosing copy of a report from the Committee for Trade and Foreign Plantations on the Bill for granting certain duties to His Majesty to help to defray the expenses of the present war. <span style="float: right;">213</span>	215
June 8, Horse Guards.	<i>Enclosed.</i> Proceedings.	
June 14, Ordnance Office.	Torrens to same. Is ordered by the Commander-in-Chief to represent the expediency of appointing a second major for the Glengarry Light Infantry. <span style="float: right;">218</span>	219
No date.	R. H. Crewe to Bunbury. The ordnance, small arms and ammunition required by the Adventurers of England trading to Hudson's Bay having been supplied, he asks that the value of these goods, £2,563-4-4 be paid by the Treasury to the Treasurer of this department. <span style="float: right;">219</span>	156
No date.	A memo. stating what had been done respecting Mrs. Lynd's first memorial. <span style="float: right;">156</span>	

# Department of Agriculture—Archives.

## STATE PAPERS—UPPER CANADA.

LIEUT.-GOVERNOR F. GORE AND MISCELLANEOUS—1808.

### Q. 311—I.

1808.  
January 14,  
York.

Francis Gore to Edward Cooke. (Private.) Has never seen the King's instructions to Craig, nor received those mentioned for the guidance of his own conduct, but has fortunately anticipated them. Hopes war will not take place; if it does, is afraid of the consequences. Thorpe's conduct; his object seemed to be to govern the province. Will say nothing about Mr. Wyatt, but will be glad if he can justify himself. Did not approve of the prosecution of Thorpe for libel and ordered the business to be stopped. There is no country in the world where grievances are so little known as in Canada, and for that reason the people are proud and impatient of control. Two classes think they have reason to complain; the soldiers that belonged to the Queen's Rangers, reduced in 1805, who consider it hard they did not receive lands under the King's instructions of 1783, and the troops reduced in Nova Scotia and New Brunswick and other Loyalists settled in those provinces, who also expect land free from expense. An idea prevails, which has been industriously spread by Mr. Thorpe and his partisans, that the revenues collected on goods imported from America have not been accounted for. Such a calumny is easily contradicted. A great cause of dissatisfaction is the want of roads. After the bounty lavished on this country by England, it is hardly to be expected she is now to build roads, concede this point and she will soon be accused of unjustice for not having built their houses. Thanks for the friendly hints on his conduct. Respects to Lord Camden. Wishes for a favourable answer to his letter, No. 26, respecting Lt.-Col. Shaw. Page 2

February 13,

Gore to Castlereagh. (No. 9, duplicate.) Enclosing two requisitions. 18  
*Enclosed.* Requisition for Indian presents required in Upper Canada 20

Requisition for an extra quantity of Indian presents required for Upper Canada in the event of war. 24

February 29,  
York.

Gore to Castlereagh. (No. 10.) By reason of the advanced age of Messrs. Grant and Russell and the retirement of Lt.-Col. Shawe, the Executive Council of this province is at present so circumstanced that the public business is often suspended. Will not bring Mr. Justice Powell to his further notice, but recommends Prideaux Selby as a fit person to be appointed an honorary member. 29

March 20,  
York.

Same to same. (No. 11.) The Legislature met on the 20th of January for the despatch of business. Encloses copy of his speech to the two Houses and their addresses with his answer. Encloses also copy of his speech on prorogation which took place on the 16th inst., also copy of an address from the Assembly and answer. The Militia law is much improved by a Bill last Session, a clause of which provides that in the event of the war the person administering the government is empowered to march the Militia forces not only into Lower Canada, but even into the United States. Six members have been added to the House of Assembly. £16,000 has been appropriated for encouraging the growth of hemp. The ferment excited in the public minds by Thorpe's party appears to be gradually subsiding. 32

1808. *Enclosed.* Speech to the two Houses. Page 35  
 Their addresses and his answer. 37 to 42  
 Speech on prorogation. 43  
 Address from House of Assembly, with answer. 47
- March 21, York. Gore to Castlereagh. (No. 12.) In the existing state of affairs had thought it prudent to employ a confidential agent to obtain information as to the designs of the American Government. Has paid to this person £150 currency, but hearing that others under a higher authority are at present employed has recalled him. 51
- March 26, York. Thomas Scott to Gore. (Private.) Has received this day the news of the death of Chief Justice Allcock. On his (Scott's) appointment to the Attorney Generalship of this province, he was led to expect the Chief Justiceship first of Upper and then that of Lower Canada as vacancies should occur. Has no wish to fill the latter post but only desires to be Chief Justice of Upper Canada. 57  
 (In Gore's of 28th March.)
- March 28, York. Gore to Cooke. (Private.) As the death of Mr. Allcock may occasion some alteration in the arrangements for filling the vacancies on the Bench of the Canadas, encloses copy of a letter from the Chief Justice. He considers himself entirely under the control of Sir James Craig; therefore transmits all reports, &c., respecting the Indian Department to him instead of troubling Lord Castlereagh. States, however, that there is no truth in the assertion made by the newspapers, of the American influence over the Indians. He (Cooke) is not to be alarmed at the clause of the Militia Act empowering the Lieut.-Governor to march the militia into America, he does not propose to conquer the States with the Upper Canadian forces, but in case of war that clause might afford the means of destroying the enemy's depots in our neighbourhood. Our revolutionary press continues its operations. The printer imprisoned for seditious libel. The House of Assembly wished to pass a law to license the press, but as he (Gore) did not know if such a strong measure would be approved he put a stop to it. If he is mistaken the next Assembly will probably enact the law. Is puzzled what steps to take in order to refute the statements made in Mr. Wyatt's reply. Transmits report of the Executive Council for perusal; hopes it will exonerate him from the imputation of fabricating a calumny with the design of injuring Mr. Wyatt. All our information here regarding peace or war is derived from the American press. They appear to be as much in the dark as ourselves. Respects to Lord and Lady Camden. Has not heard from Commissioner Watson for many months. Has received Stewart's letter introducing Colonel Chabot; hopes to show him the lions of Upper Canada. 53  
 (Enclosure calendared at its proper date.)
- April 2, William Firth, Attorney General for Upper Canada, to Gore. It is his intention to apply to the Secretary of State for War, requesting that he be recommended to His Majesty for the position of Chief Justice. Asks for a letter of introduction to Lord Castlereagh. 134  
 (In Gore's No. 13 of 4th April.)
- April 3, York. Gore to Cooke. (Private.) Encloses copy of a report of the Executive Council mentioned in a former letter on the charge made against Mr. Wyatt of having fraudulently erased the name of a person from a plan in his office and inserted his own. As Mr. Wyatt has publicly stated in his reply to that charge, that he (Gore) fabricated the story, writes at length on this subject. 60  
*Enclosed.* Report of the Executive Council, dated 19th March, 1808, with the papers relating to the affair. 68 to 131
- April 4, York. Gore to Castlereagh. (No. 13.) Enclosing letter from Mr. Firth respecting the Chief Justiceship now vacant. Page 133  
 (Enclosure calendared at its proper date.)

## Department of Agriculture—Archives.

1808.  
April 5,  
York.

Same to same. (No. 14.) Calling attention to the enclosed address of the House of Assembly on the subject of the growth and culture of hemp in the province. As the soil and climate of Canada appear well suited for the raising of that article and the reports from the English manufacturers are very favourable as to its quality, recommends every encouragement to the industry. It will be seen by the address that the House has given all the assistance in its power, which is very inadequate.

Page 136

*Enclosed.* The Address.

139

April 18,  
York.

Same to same. (No. 15.) Enclosing abstract from Auditor's Docket Books of grants of land.

142

**ABSTRACT from the Auditor's Docket Books of Grants of Land in Upper Canada which have passed the Great Seal of the Province between the 1st of January and 31st December, 1807.**

Counties.	Number of Grants.	Districts.	Number of Acres.	Total Number of Grants.	Total No. of Acres Granted.
York . . . . .	229	Home . . . . .	83,039 $\frac{1}{10}$	229	83,039 $\frac{1}{10}$
Durham . . . . .	12	} Newcastle . . . . .	2,850	} 36	} 8,601
Northumberland . . . . .	24		2,751		
Lincoln . . . . .	41	Niagara . . . . .	40,072	41	40,072
Glengarry . . . . .	40	} Eastern . . . . .	8,929	} 230	} 51,417
Dundas . . . . .	37		9,141		
Prescott . . . . .	8		2,834		
Russell . . . . .	56		11,712		
Stormont . . . . .	89		18,801		
Grenville . . . . .	32	} Johnstown . . . . .	5,329	} 115	} 26,059
Carleton . . . . .	2		400		
Leeds . . . . .	81		20,330		
Essex . . . . .	26	} Western . . . . .	4,207	} 35	} 8,055
Kent . . . . .	9		3,848		
Middlesex . . . . .	5	} London . . . . .	3,900	} 38	} 12,300
Norfolk . . . . .	21		5,950		
Oxford . . . . .	12		2,450		
Frontenac . . . . .	35	} Midland . . . . .	4,703 $\frac{1}{2}$	} 81	} 14,578 $\frac{1}{2}$
Hastings . . . . .	12		2,900		
Lennox and Addington . . . . .	18		4,161		
Prince Edward . . . . .	16		2,814		
Total . . . . .	805		244,122 $\frac{7}{10}$	805	244,122 $\frac{7}{10}$

Errors excepted.

**PETER RUSSELL,**  
*Auditor General.*

1808.			
April 19, York.	Gore to Castlereagh. (No. 16.)	Asks for approval of a warrant to pay for the fuel and candles consumed in Government House.	Page 145
April 20, York.	Gore to Castlereagh. (No. 17.)	Enclosing petition of Richard Cartwright, a member of the Legislative Council in this province. Recommends the petition.	147
	<i>Enclosed.</i>	The petition asking for a grant of land over and above the 3,000 acres given to him as a Councillor.	150
April 28, York.	Same to same. (No. 18.)	Enclosing letter from George Harrison, conveying instructions from the Treasury requiring Mr. McGill to relinquish two out of the three appointments held by him in this province; copy of his (Gore's) reply to same. Hopes his retaining Mr. McGill to perform the duties of Inspector General of Provincial Accounts until further instructions are received will be approved. It is a measure of necessity as Mr. McGill is the only person in the Civil Departments on whom he can depend for information as to the accounts; should he be removed from the office of the Inspector General great confusion would be the result. Thinks that the salary of 10 shillings a day is not adequate pay for the labour required. The most lucrative of McGill's appointments, agent for purchases, is now withdrawn. The salary of Commissary does not exceed £150 a year. Thinks the salary attached to the office of Inspector General in this Province should be the same as in the Lower, viz., 20 shillings per day.	152
	<i>Enclosed.</i>	Letter from the Treasury to Gore, dated 7th November, 1807, that McGill is to give up two out of the three situations held by him.	157
	Answer to the above.		160
	James Green, Military Secretary, to McGill.	Purchases will in future be made at Quebec, therefore the appointment of Agent for purchases will be withdrawn.	174
	Green to McGill on the same subject.		176
	Statement of the duties of the Inspector General of Public Provincial Accounts.		178
	<i>Public Notice</i> , signed John McGill, agent for purchases.		194
	Letter from the Treasury to Simcoe, dated 2nd April, 1794, respecting the purchasing for the posts.		196
	Simcoe to the Treasury, 5th August, 1794, on the same subject.		199
	Treasury to Simcoe on the subject of purchases and the salary to be given to the agent.		202
	P. Hunter to McGill, dated Quebec, 23rd February, 1801, highly approves of his transactions as agent of purchases.		205
May 31, Downing St.	Draft of a letter to Gore.	Measures to be taken for having a grant of 1,200 acres made to Mr. William Bond in order to enable him to carry on the culture of hemp. This industry is of the greatest importance and every assistance possible is to be afforded him.	207
June 4, Downing St.	Same. (No. 6.)	Despatches Nos. 1 to 10 inclusive, received and laid before the King. His Majesty is pleased to approve of Mr. McGill to succeed Lt.-Col. Shawe as an ordinary member, and of Mr. Powell and Mr. Selby to be honorary members of the Executive Council.	31
June 8, York.	Gore to Castlereagh.	Transmitting copies of sixteen Acts assented to at the close of the fourth Session of the Fourth Provincial Parliament, with a schedule and also copies of the Journals of the Council and Assembly for the same Session.	210
June 30, Downing St.	Draft of a letter from Castlereagh to Gore. (No. 5.)	That he (Gore) is to have the Indian Store accounts of Upper Canada examined and a report sent to the Treasury.	209
July 29, York.	Gore to Castlereagh. (No. 19.)	Despatches received.	211

## Department of Agriculture—Archives.

1808. July 29, York.	Gore to Cooke. Letter of the 16th October, 1807, enclosing estimate of the Civil establishment of Upper Canada for 1807 received. Page 212	
July 30, York.	Same to same. (No. 20.) Papers relating to the claims of the Barons of Longueuil and Patrick Langan to Grande Isle and the adjacent Islands opposite the town of Kingston.	213
	To the end of the volume.	
No date.	Proclamation (in French) by John Graves Simcoe, to those persons desiring to settle on Crown Lands in Upper Canada.	11
No date.	Salary and emoluments of the Attorney General for 1807.	132

### LIEUT.-GOVERNOR F. GORE AND MISCELLANEOUS—1808.

#### Q. 311—II.

	Continuation of the papers relative to Grande Isle and adjacent Islands.	Pages 256 to 238.
	Report of the Attorney General of Lower Canada on the claims made to Grande Isle.	339
	Opinion of the Solicitor General of England on the same.	344
	John McGill to Christie and Shaw. Requesting them to find out what occasions the delaying in forwarding the <i>mandamus</i> appointing him an honorary member of the Executive Council.	437
1807. December 6, Montreal.	John Henry to Edward Ellice. Asks for his influence in procuring him the position of Puisne Judge, vacant through the dismissal of Thorpe.	421
1808. January 2, Treasury.	H. Wellesley to Cooke. Transmitting abstract of warrants issued by Governor Gore, on the Receiver General of Upper Canada, for Lord Castlereagh's observations thereon.	382
January 7, Treasury.	Harrison to same. Transmitting letter from Gore, dated 15th October last, enclosing requisitions for stationery for Lord Castlereagh's opinion thereon.	384
January 8.	Robert Thorpe to Castlereagh. Had received on the 26th October, a private letter from Cooke stating that he was to be suspended from his judicial appointment, and not to remain in Canada through the winter; set off the next day for England. Judges from this that the charges preferred against him are serious. Asks for a speedy investigation as he is in bad health. Flatters himself nothing can be proved against him except poverty.	387
January 19, Colchester.	Wm. Johnson, Lt.-Col. 28th Regiment, to Castlereagh. Wishes to be appointed assistant in the Indian Department under his father.	388
January 23, Treasury.	Harrison to Cook. Transmitting the account of Civil expenditure for Upper Canada, from 1st January, to 30th June, 1807, for Lord Castlereagh's observations thereon.	390
January 28, Foley Place.	James Wyatt to Castlereagh. (Private.) Has suffered great anxiety since hearing of his son's suspension from the office of Surveyor General of Crown Lands in Upper Canada. Is now much relieved to hear that his explanation appears to have exculpated him, and that though it is not considered wise to restore him to his former position yet he is to be recommended to the Treasury for some other equivalent appointment. Asks for particulars as to the charges, &c.	391
February 3, Colchester.	Wm. Johnson to Cooke. Does not wish to conceal the fact that he applied for the situation of Assistant Superintendent of the Indian Department with the hope of succeeding his father. Sir William Johnson, his grandfather, considered that this appointment was to remain in the family. Asks for a final decision.	395
February 5, Chelsea College.	Lt.-Col. R. Matthews to Cooke. Enclosing memorial from Mrs. Bird, widow of the late Lt.-Col. Henry Bird.	406

1808.

The memorial states that no compensation has ever been made for the land at the mouth of the Detroit River, belonging to her late husband, which was taken possession of by the Government for the purpose of building a fort, &c. Page 408

February 6, York. Sketch and memorandum accompanying the memorial. 410a, 411, 413  
Wm. Firth, Attorney General, to same. Soliciting the unappropriated salary of the Attorney General of Upper Canada, from the time of the appointment of Mr. Scott the late Attorney General, to the Chief Justice-ship, up to the date of his appointment. 414

February 10, London. A P.S. states that the House of Assembly are bringing in a bill to establish a Court of Common Pleas in every district, which he thinks will have a very injurious tendency. Considers this the first step towards declaring the independency of the Province, as the offices held by the Judges appointed by the King will become mere sinecures, and Judges will be selected from the few "unlearned native barristers." 416

Edward Ellice to Wm. Ellice. Transmitting letter from Mr. Henry, soliciting the appointment of Puisne Judge in Upper Canada, vacant through Mr. Thorpe's removal. Also several letters recommending the appointment. 418

February — Downing St. Castlereagh to ——. Mr. Wyatt, the Surveyor General of Upper Canada, having been suspended from his office on account of his conduct towards His Majesty's Government, he, Castlereagh, suggests that measures be taken for filling the position. Considers the suspension perfectly just. Hopes Mr. Wyatt may be employed in the public service in some other of His Majesty's colonies, where he may avoid such indiscretion for the future. 470

March 19. Inglis, Ellice & Co., McTavish, Fraser & Co., Brickwood, Daniell & Co., to Castlereagh. Seconding the application made in behalf of John Henry, of Montreal, for the appointment of Puisne Judge in Upper Canada. 425

April 4, York. Wm. Firth to Castlereagh. Asking to be appointed to the Chief Justice-ship of Lower Canada, vacant by the death of Alcock. 428

April 28. W. D. Adams to Cooke. Asks for the appointments, or certified copies thereof, made to John Small, John Powell and Thomas Scott. 435

May 23. Chrystie and Shaw to same. Asks when the *mandamus* appointing Mr. McGill to a seat in the Council will be received, as he cannot draw the salary until it is, although performing the duties. 436

June 1, Treasury Chambers. Harrison to same. Transmitting requisition for stationery for the Indian Department, Upper Canada, for the year 1809, and asking for Lord Castlereagh's opinion thereon. 440

July 3, Chelsea College. R. Mathews to same. Had transmitted on the 5th of February last, a letter on behalf of the widow of Lt.-Col. Bird, accompanied by her memorial, to which no answer has as yet been received. Asks that they be submitted for Lord Castlereagh's consideration. 443

July 19, London. Robert North to same. Respecting his salary. 445

July 29, York. Gore to Harrison. Transmitting public accounts and vouchers for the half years ending 31st December, 1807. Also sends vouchers in support of the accounts for the half years ending 31st December, 1806, and 30th June, 1807. 459

August 15, York. Same to Castlereagh. Transmitting copy of the proceedings of the Executive Council on land matters from 9th September, 1806, to 29th December, 1807, and on State matters from 13th October, 1807, to 25th June, 1808. 347

August 19, York. Same to same. (No. 21.) A number of troops after serving in the American war, were reduced and had grants of land made to them in Nova Scotia and New Brunswick, where they settled, but many of them,

## Department of Agriculture—Archives.

1808.

- finding after repeated exertions that the land was not productive, have come to Upper Canada and ask for grants free of expense. Asks for instructions. Page 348
- September 14. Order in Council appointing Wm. Dummer Powell and Prideaux Selby, honorary members of the Executive Council of Upper Canada. 447
- September 14. Order in Council appointing John McGill an honorary member of the Executive Council of Upper Canada. 449
- September 16, York. Gore to Cooke. (Private.) Has been informed that Lt.-Col. Johnson of the 28th Regiment has quitted the Army or is about to do so, that he may return to Canada, hoping to succeed his father, Sir John Johnson, as Superintendent General of Indian Affairs, who wishes to resign in favour of his son. Personal influence and a thorough knowledge of the character and customs of the nations are of the greatest importance in filling this responsible position. As Lt.-Col. Johnson is a total stranger to the Indians, he does not consider him a fit person for the appointment. Colonel Claus, the Deputy Superintendent General is the proper person to succeed Sir John. Recommends him in the strongest terms. Encloses some letters which Thorpe may thank him for not having transmitted officially. Hopes he is done with that gentleman. Hears that some of the merchants of Montreal have memorialled Lord Castlereagh to appoint a Mr. Henry in Thorpe's place. Can scarcely believe in it, as Henry is an Irish adventurer, not even called to the Bar, and also a citizen of the United States. 351
- September 23. *Enclosed.* Letters respecting Thorpe's debts. 356 to 364  
C. B. Wyatt to ———. Asking if anything had been done on his behalf. 451
- September 26, York. Wm. Dummer Powell to Cooke. (Private.) Enclosing extract of a letter from his son Jeremiah, now at Curacoa. His knowledge of French and Spanish and acquaintance with the trade of the West Indies, should qualify him (Jeremiah) for some situation. Hopes he will be remembered if such an opening occur. 453
- September 28, Whitehall. *Enclosed.* The extract. 455  
W. Fawkener to same. The Lords of the Committee of Council for Trade have considered Mr. Wm. Bond's representation respecting the culture of hemp. Recommend that 1,200 acres of land be granted to him. 476
- October 7, York. Gore to Castlereagh. (No. 22.) Reporting the death of Peter Russell, an Executive Councillor, and Receiver General of this Province. Has appointed Prideaux Selby to act as Receiver General till His Majesty's pleasure be known. Recommends Mr. Justice Powell to be a member of the Council in the room of the late Mr. Russell. 364
- October 9, York. Same to same. (No. 23.) Despatches received. Mr. Powell and Mr. Selby have been sworn in as honorary members of the Executive Council. 365
- October 12, York. Same to same. (Separate.) Asks that his appointment of Mr. Selby as Receiver General be confirmed. 369
- October 14, Treasury Chambers. Harrison to Cooke. Transmitting letter from Lt.-Governor Gore dated York, 29th July, together with the public accounts and vouchers for Upper Canada. Asks for Lord Castlereagh's observations thereon. 458
- October 16, Quebec. Capt. Wm. Armstrong to Cooke. Enclosing a letter to his friend Williamson, about whom he is uneasy, not having heard of him for some-time. Asks that the letter be forwarded. In his last letter had stated his intention of asking his (Cooke's) help, in procuring him one of the consulships now vacant in the United States, but yesterday had received news of the death of Peter Russell, Receiver General, of Upper Canada; To succeed to this position would be the summit of his wishes. Hears that the 3rd Regiment at Halifax is under orders to embark, and the 98th is to take its place. The vessels under the convoy of the "Iphigenia" have



1808.

- arrived. She sails again at the end of the month. The "Centurion" has arrived, but none of her convoy. Page 461
- October 19, Gore to Castlereagh. (No. 24.) In reply to despatch No. 5, states that he has written to the Governor-in-Chief on the subject of the Indian Store accounts, and encloses copy of letter to him. Had some time ago submitted to Sir James Craig the propriety of appointing a Board of Accounts in this province; his motive was to have all the accounts, some of which are of many years' standing, finally adjusted. Craig approved of his proposition, and requested the names of suitable officers, which were sent in June last, but no further instructions have been received. Asks that he be allowed to nominate a Board. 370
- Enclosed. Same to Craig, 18th October, 1808, respecting the store accounts. 374
- October 20, Same to Cooke. (Private.) Is sorry to trouble him with another private communication, but the death of the Receiver General calls for information respecting that office. In Lower Canada the duties are easily executed, but here the Land Granting Department is so extensive that the duties are arduous. The small salary will surely not tempt any one at Home, and as Mr. Selby is in every way competent, hopes he will be appointed. 366
- November 25. Robert Thorpe to same. Respecting his quarter's salary. 464
- November 30, Harrison to same. Transmitting the public accounts of Upper Canada for the half year ending 30th June, 1808, and requesting Lord Castlereagh's observations thereon. 466
- December 6, Harrison to Cooke Transmitting abstracts of warrants issued by Treasury Gore on the Receiver General for Lord Castlereagh's observations thereon. 467
- December 15, Gore to Castlereagh. (No. 25.) Enclosing memorial of D'Arcy Boulton, Solicitor General of Upper Canada; recommends his petition. 377
- The memorial asks for the unappropriated salary for the time he executed the duties of Attorney General. 378
- December 23, Harrison to Cooke. Transmitting three requisitions for stationery Treasury sent by Gore, and requesting Lord Castlereagh's opinion thereon. 468
- December 23. Memo. of a letter to the Treasury unsigned. Though he thinks it advisable that Mr. Wyatt should not be allowed to return to his office in Canada, yet does not by any means wish that he be excluded entirely from the public service. 469
- April 8, Draft of a letter to Gore. (No. 8.) Despatches received. Will transmit by the next packet the opinion of His Majesty's law servants upon Downing St. the case of Grande Isle. Mr. Justice Powell's appointment as a councillor approved. Will recommend the Treasury to direct the agent of the province to pay to Mr. Boulton the portion of the salary attached to the office of Attorney General remaining unappropriated. 380
- No date. Thorpe to Cooke. Asking that Mr. Adams be authorized to pay his London. salary for the last half year. 442
- No date. Memorial of William Bond to the Hon. George Canning, Secretary of State. Asks to be employed in Upper Canada upon the same terms as Messrs. Campbell and Grece are in Lower. Also for money to reimburse him for that expended in studying the agriculture of the colony, and to enable him to purchase utensils, &c., to carry on the culture of hemp. 472
- Enclosed. Memorandum accompanying the memorial. 474
- No date. Observations on the culture of hemp, propagation of the warren rabbit, &c., by a member of the Upper Canada Agricultural and Commercial Society. 478
1823. Memorial of Lt.-Col. Henry Bird, 16th Regiment, asking for compensation for land granted to his father at the mouth of the Detroit River, London. which was afterwards taken possession of by Government, together with the houses erected thereon by his father. 398

Department of Agriculture—Archives.

LIEUT.-GOVERNOR F. GORE AND MISCELLANEOUS.—1809.

Q. 312—I.

1809.  
January 5,  
York.

Gore to Castlereagh. (No. 26.) Has directed Colonel Claus to draw on Messrs. Coutts for £250 on account of the dividends due to the Six Nation Indians. Page 2

January 27,  
York.

Same to same. (No. 27.) His anxiety to promote the culture of hemp must be his excuse for requesting attention to his letter of 5th April last, accompanied by an address of the House of Assembly and his answer. Fears they may not have been received, therefore transmits copies. The money voted by the Legislature falls far short of what is required. An agent in each district authorized to purchase all hemp, the produce of Upper Canada, would be the most direct way of bringing this article into general cultivation. Mills in each district for breaking and scutching would save much manual labour. At first there would be many difficulties to contend with, but he is confident that after a few years the result would be such that a considerable supply might be sent to the British market. 4

Enclosed. Letter, dated 5th April, 1808, same to same. Respecting the cultivation of hemp and transmitting address from the Assembly with his (Gore's) answer. 8

The address. 11

Answer. 13

January 28,  
York.

Gore to Castlereagh. Enclosing abstract from the Auditor's docket book of grants of land from 1st January to 31st December, 1808. 15

ABSTRACT from the Auditor's Docket Book of Grants of Land in Upper Canada which have passed the Great Seal of this Province, between the 1st of January and 31st December, 1808.

Counties.	Number of Grants.	District.	Number of Acres.	Total Number of Grants.	Total No. of acres Granted.
York.....	229	Home.	49,816½	229	49,816½
Durham.....	12	Newcastle.	2,500	44	8,580
Northumberland.....	32		6,080		
Lincoln.....	30	Niagara.	8,325	30	8,325
Glengarry.....	16	Eastern.	3,438	91	18,292
Dundas.....	22		6,216		
Prescott.....	8		1,550		
Russell.....	13		2,600		
Stormont.....	32		4,488		
Grenville.....	79	Johnstown.	16,210	171	34,245
Carleton.....	20		4,000		
Leeds.....	72		14,035		
Essex.....	57	Western.	7,904	80	13,434
Kent.....	23		5,530		
Middle.....	4	London.	1,900	32	8,600
Norfolk.....	14		3,300		
Oxford.....	14		3,400		
Frontenac.....	68	Midland.	13,757½	180	38,494½
Hastings.....	23		4,410		
Lennox and Addington.....	71		15,215		
Prince Edward.....	18		5,112		
Total Grants.....				857	179,786½

Errors excepted.

P. SELBY,  
Auditor General.

1809.  
March 1,  
York. Gore to Castlereagh. (No. 28.) Captain Joseph Brant, principal chief of the Mohawks, died on the 27th November, 1807, leaving a widow and children unprovided for. He had been in receipt of a captain's half pay and a pension of 5s. a day. Encloses letter from E. B. Littlehales and hopes Mrs. Brant's case will be considered. She has much influence over the Five Nations who would be much gratified by any liberality shown to her. Page 18
- Enclosed. Littlehales, Simcoe's Secretary, to Brant, (private) dated 2nd January, 1796, giving the following extract from a letter of Dorchester's to Simcoe: "Should any accident happen to Capt. Brant, I have no doubt of his wife getting a handsome pension, at least I can answer for it as far as may depend on my influence and exertions." 20
- March 14,  
York. Same to same. (No. 29.) The Legislature of this province met on the 2nd of February. Encloses copies of speeches. 21
- Enclosed. Speech delivered by Gore to the two Houses on the opening of the Legislature. 22
- Address in answer from the Council. 25
- Ditto from the Assembly. 28
- Speech delivered by Gore on the prorogation which took place on the 9th March. 31
- March 20,  
York. Gore to Castlereagh. (No. 30.) When he came to the province the Legislative Council consisted of nine members, since then two have died, one vacated his seat, and a fourth is too old and infirm to attend. The Council has often the unpopular task of resisting inexpedient measures brought forward by the Assembly and forms a useful counterpoise to the rashness of the latter body. Recommends Wm. Dummer Powell, Thomas Talbot and William Claus to fill the vacancies. 34
- March 21,  
York. Same to same. (No. 31.) Asks permission to increase the pay of James Givins, Agent for Indians at this place, to 10s. a day. His reasons. 37
- March 31,  
London. Lord Selkirk to Gore. Asking for some explanations of the report of the Executive Council on his (Selkirk's) memorial. 90
- (In Gore's No. 33 of 19th July.)
- April 20,  
York. Gore to Cooke. (Private.) Respecting the public accounts. Does not doubt but that the difficulty with the Americans will be amicably settled. When that happens, hopes that the mode of granting land in Upper Canada may be changed. 40
- Enclosed. List of the only authorities under which public moneys in Upper Canada are paid. 45
- May 2. Wm. P. Bennett, Captain 6th U.S. Infantry, to Henry Arnold. Stating that Capt. Holmes is in no way implicated in the shooting of the deserter, Underhill. The sergeant was under his (Bennett's) orders, and is proud they were executed with so much spirit. The man was not a subject of Great Britain, and he does not understand why he should be protected. If Capt. Holmes's case is considered calmly, is quite sure his men will be discharged. 57
- (No. 1 in Gore's No. 32 of 1st July.)
- May 2. Capt. Bennett to Jesse Purdy. As he fears the affair of yesterday may injure Capt. Holmes in his opinion, states that he (Holmes) was ignorant of the attempt to take Underhill. Considers he was quite justified in trying to get possession of the deserter, but gave his sergeant orders not to injure any inhabitant. 62
- (No. 3 in Gore's No. 32 of 1st July.)
- May 3,  
Elizabeth-  
town. Henry Arnold to Capt. Bennett. His letter of the 2nd inst. received, the style of which would have been astonishing had he not previously been informed that it was under his (Bennett's) orders that the atrocious crime was committed. Whether Underhill was a subject of His Majesty or not is quite out of the question, he was within the province,

## Department of Agriculture—Archives.

1809.

and therefore under the protection of the law. If he (Capt. Bennett) or his petty officer can be taken in the province, adequate punishment will certainly be inflicted, notwithstanding his pretended military authority. Page 60

- (No. 2 in Gore's No. 32 of 1st July.)  
 May 3, Elizabethtown. Corner's inquest on the body on Isaac D. Underhill. 80  
 (No. 9 in Gore's No. 32 of 1st July.)  
 May 6, Elizabethtown. Elizabethtown. Daniel Jones, J.P., Thomas Sherwood, J.P., and Henry Arnold, J.P., to the magistrates of the County of St. Lawrence and State of New York. Isaac D. Underhill was murdered here on the 1st inst.; the persons accused are Sergt. John Graves and two privates, acting under orders given by their Captain, Wm. P. Bennett. As they have violated the laws of Canada, ask that the accused, namely, Capt. Bennett, Sergeant Graves, and the two privates be given up. Will give no particulars of the outrage, as they are probably known. 74  
 (No. 7 in Gore's No. 32 of 1st July.)  
 May 9, York. Gore to Castlereagh. Transmitting a continuation of the minutes of the Executive Council of Upper Canada on State matters, from the 12th July to 10th December, 1808, and on land matters, from the 5th January to 27th December, 1808. 54  
 May 10, Ogdensburgh. Nathan Ford and Louis Hasbrouck, magistrates of the County of St. Lawrence to the magistrates of Elizabethtown. In answer to letter of 6th inst., state that those accused of the murder of Underhill are now at their station at Sackett's Harbour, and consequently out of their jurisdiction. Regret the occurrence and hope it may not disturb the good understanding existing between the two countries. Redress can only be had by applying to the Government. 77  
 (No. 8 in Gore's No. 32 of 1st July.)  
 May 16. Memorial of the magistrates of the District of Johnstown, assembled in Quarter Sessions, to Lt.-Gov. Gore. Consider it their duty to lay the case of Underhill before him, and ask that steps be taken to bring the accused to justice. 84  
 (No. 10 in Gore's No. 32 of 1st July.)  
 June 17, York. Gore to the Hon. David Montague Erskine. By the enclosed documents, Nos. 1 to 10, it will be seen that some American soldiers seized one of their own deserters while residing near Cornwall, without any authority from the civil power, and that while carrying him away he attempted to escape, and was fired upon and killed. Asks that the persons accused of the murder be delivered up. It would be an advantage to both countries if some arrangement could be adopted for the mutual giving up of deserters. 86  
 (No. 11 in Gore's No. 32 of 1st July.)  
 July 1, York. Same to Castlereagh. Transmitting memorial of the magistrates of the District of Johnstown, accompanied by several documents relative to the murder of Isaac D. Underhill, by a sergeant and two privates of the American army. Has forwarded copies of the enclosed papers to His Majesty's Minister at Washington. Also encloses copy of his letter to Mr. Erskine. 55  
 (Enclosures calendared at their respective dates.)  
 July 18, York. Same to Selkirk. Letter of the 31st March received. Regrets extremely that anything contained in the report of the Executive Council should have created any prejudice against him (Selkirk). 97  
 July 19, York. Same to Castlereagh. (No. 33.) Enclosing copy of letter from Lord Selkirk with his (Gore's) answer thereto. 89  
 (Enclosures calendared at their respective dates.)  
 July 20, York. Same to same. (No. 34.) Had recommended in despatch No. 30 that Wm. Dummer Powell, Thomas Talbot, and William Claus be appointed

1809.

- to the Legislative Council. Urging the necessity of filling the vacancies before the meeting of the Legislature early in February next. Page 100
- August 10, Wm. Dummer Powell to Gore. A second season being about to close with no prospect of Thorpe's situation being filled, asks that he be allowed half the salary of the vacant judgeship as he has an undue amount of labour and responsibility. 118  
(In Gore's No 36 of 1st September.)
- August 23, Gore to Castlereagh. (No. 35.) Enclosing petition from Mr. Jarvis, Secretary of this province, and the report of the Executive Council thereon. Recommends that consideration be given to the memorial. 101  
*Enclosed.* The memorial, dated York, 25th May, 1809, states that he is out of pocket through his appointment, and asking for relief. 104  
Report of the Executive Council on the memorial, dated 7th August, 1809. 107
- September 1, Gore to Castlereagh. (No. 36.) Enclosing an application from Mr. Justice Powell for half Mr. Thorpe's salary for the year ending 1st July last. Has received great assistance from Powell. 117  
(Enclosure calendared at its proper date.)
- September 2, Same to same. (No. 37.) Enclosing memorial of Thomas Ridout, joint acting Surveyor General of this province. Recommends the petition being granted. 120  
*Enclosed.* Memorial of Thomas Ridout, stating that he had been put to much expense through the seat of Government being moved from Niagara to York, and asking for a grant of land. 121
- September 4, Gore to Castlereagh. (No. 38.) Governor Craig transmitted a copy of his (Castlereagh's) despatch of 8th April last, with copies of some correspondence from Upper Canada, principally from Mr. Norton, upon the desire of the Five Nation Indians for alteration in the tenure of the lands set apart by General Haldimand for their use, and that of their posterity, and stating that an opinion prevails in England that they might be civilized; to that end it is proposed that they be allowed to lease or alienate their lands, and that Mr. Norton be employed in carrying into effect any measures proposed for improving these Indians. Enters at length into the different points. 128  
*Enclosed.* Papers relating to the subject. 137, 145, 148.
- September 8, Draft of a letter to Gore. (No. 10.) Despatches numbered from 26 to 31 received and laid before the King. Messrs. Couatts have been authorized to accept Col. Claus's bills to the extent of the interest on the sum vested in the funds for the benefit of the Indians. His (Gore's) representation concerning the culture of hemp is before the Committee of Council for Trade and Plantations. His Majesty approves of the pension enjoyed by the late Joseph Brant being continued to his widow. The proper warrants will be prepared appointing Messrs. Powell, Talbot and Claus to the Council. No increase at present to be allowed Mr. Givens. 38
- September 8, Draft of a letter to Gore. (No. 9.) The sixteen Acts, No. 156 to No. 171 inclusive, which passed the Provincial Legislature of Upper Canada in February, 1808, have been submitted to the consideration of the Privy Council and do not appear liable to any objection. 150
- September 26, Gore to Castlereagh. (No. 39.) Has been much surprised to learn by the English newspapers that notice has been given in the House of Commons by a Mr. P. Moore of an intended motion to be made by him relative to his (Gore's) conduct as Lieutenant-Governor of Upper Canada, and stating in his notice that discontent had prevailed in this province owing to his misconduct and oppression. It is true that Thorpe, Wyatt, and others attempted with some success to create discontent in Upper Canada. Refers him to the letters specified in the enclosure marked A which show the opposition offered to Government by these persons. Since Mr. Thorpe's departure things have become perfectly tranquil once

## Department of Agriculture—Archives.

1809.

more. If credit is to be given to the addresses of the House of Assembly in 1808 (enclosure B) and in 1809 (enclosure C) as well as to the testimony of the Chief Justice, who has just returned from visiting five out of the eight districts (enclosure D) the inhabitants are in general contented with the Government under which they live. Is unable to transmit Justice Powell's report, as he has not yet returned from the other three districts. In case he may be accused of not having sufficiently attended to the interests of the Loyalists refers him to his proclamation respecting them (enclosure E). If perhaps the attack against him may be caused by the recent removal of Thorpe, Wyatt, Willcocks and Rogers from office, gives a short account of the reasons for such removals. Page 151

September 26, York.	Enclosures: papers marked. A 155, B 156, C 159, D 162, E 164. Gore to Castlereagh. (Separate.) In case Mr. Moore's intended motion in the House of Commons should have reference to Mr. Wyatt, transmits another copy of the report of the Executive Council with several documents on the complaint of Ralph Clinch, agent to the late Sergeant Young. Sends this letter by Mr. Thomas Ridout, joint acting Surveyor General, on leave, who will be able to give all information relative to land grants.	168
	<i>Enclosed.</i> Report of the Executive Council on the complaint against Wyatt.	170
	Complaint of Ralph Clinch, dated 7th November, 1807, against Wyatt.	186
	Papers relating to the charge.	193 to 231
October 3, York.	Wm. Dummer Powell to Gore. Observations made during his late circuit, on the actual state of the colony.	234
October 4, York.	Gore to Castlereagh. (No. 40.) Transmitting a report from Mr. Justice Thorpe, Judge of the Assize, just returned from circuit.	233
No date.	Examination of Francis Davis in the case of the murder of Isaac D. Underhill.	64
	Ditto of Robert Hugenson.	66
	Ditto of Rebecca Elliott.	70
	Ditto of Jonathan Fulford.	71
	(Numbers 4, 5 and 6 in Gore's No. 32 of 1st July.)	

### LIEUT.-GOVERNOR F. GORE AND MISCELLANEOUS—1809.

#### Q. 312--II.

1809. March 27, Downing St.	Draft of a letter to Gore. (No. 1.) The papers enclosed in letter of 6th October last, relating to the decision of the Court of Upper Canada in the case of Rogers, having been referred to the consideration of His Majesty's Attorney and Solicitor General, he transmits copy of their report, dated 15th inst.	Page 282
1809. January 3, York.	William Dummer Powell to Adam Gordon. Enclosing memorial addressed to Lord Castlereagh, asking that as he has been acting as sole puisne judge, and his duties have been considerably increased since the removal of Thorpe, he may be allowed half the salary of the vacant office.	357
	<i>Enclosed.</i> The memorial.	358
January 11.	Thomas Coutts & Co. to Edward Cooke. Asking if they may accept a bill for £92 10s., drawn upon them by Col. Claus, on account of interest arising from the Six Nation money funded in the 3 per cents.	360
March 5, London.	Thomas Forsyth (Messrs. McKenzie & Forsyth) to Castlereagh. Is requested by some friends of his in Canada to represent him (Castlereagh) that they had some time ago presented a memorial to Governor Gore, concerning their claim to some lands acquired by purchase	

1809.

- in Upper Canada, which memorial was transmitted for His Majesty's decision, not yet received. Asks that instructions be sent to the Governor of Upper Canada to enable him to give a decision. Page 361
- April 21. Order in Council appointing Wm. Dummer Powell an ordinary member of the Executive Council of Upper Canada. 363
- May 9, R. Ward to Cooke. Enclosing a memorial from Michel Alphonse Admiralty. Baliol. 365
- Enclosed.* The memorial. (French.) 366
- May 17, Harrison to Cooke. Respecting the Indian store accounts Upper Treasury. Canada. 368
- July 21, Charles Arbuthnot to same. Transmitting the public accounts for Treasury. Upper Canada and vouchers in support of the same, for the half year ending 31st December, 1808, for Lord Castlereagh's observations thereon. 370
- August 10, Wm. Dummer Powell to Adam Gordon. Asking that he use his York. influence to further his (Powell's) claim to half the salary of the non-efficient judge. 372
- August 17, Charles Arbuthnot to Cook. Transmitting letters from Mr. C. B. Treasury. Wyatt on the subject of the losses sustained by him in consequence of his suspension from office as Surveyor General of Upper Canada. 371
- September 4, Charlotte de la Garde (née Von Behm) to same. Asking that a Camdon favourable answer be given to the memorial presented by her husband Town. some time ago. 374
- September 11, Wm. Jarvis to John Brickwood. As Secretary to the province, it has York. fallen to his share to perfect the patents for lands to the Loyalists, and has in that service incurred heavy liabilities (about £1,500 in ten years) for the parchment, wax, stationery, &c., asks that he (Brickwood) use his influence to have him reimbursed. 376
- October 6, Gore to Castlereagh. (No. 41.) The opinions of the law officers of the York. Crown and the judges of the Court of King's Bench in this province are often so much at variance that he does not know on whose opinion to rely. Transmits documents relating to the case of the King vs. David McGrogan Rogers as an instance, and asks for the opinion of the Attorney and Solicitor General in England on this case. 240
- Enclosed.* Documents relating thereto. 242 to 281
- October 14, Same to Edward Cooke. (Private.) Respecting the motion to be York. made by Mr. Peter Moore at the ensuing session, with the view of censuring his conduct as Lieutenant-Governor of Upper Canada. 283
- October 21, Same to Castlereagh. (No. 42.) Despatch of 21st June received. The York. statement called for of the tenure duties and emoluments of the several officers in Upper Canada is herewith transmitted. Also transmits (as far as they have been received) the several statements signed by the respective officers of their salaries and emoluments. Despatches sent to Canada by way of Halifax and Quebec, are generally from four to seven, and sometimes eight months on their passage, while those by way of New York reach this place usually in about two. 291
- Enclosed.* Statements. 293 to 325
- November 1, Rev. John Stuart to Major Halton, Secretary to Lieut.-Gov. Gore. Kingston. Enclosing statement of the tenure duties and emoluments of his office. He receives half pay as a reduced chaplain, and is also a missionary of the Society for the Propagation of the Gospel, for which he receives £50 a year; as he does not consider these allowances absolutely connected with his office as parochial clergyman at Kingston, he has not included them in his statement. 326
- Enclosed* statement. 328
- November 3, Wm. Bond to the Solicitor General, giving particulars of the pro- York. ceedings of certain "dangerous persons" (Thorpe, Wyatt, and Jos.

## Department of Agriculture—Archives.

1809.

- Willcocks) who are endeavouring to sow the seeds of sedition and rebellion in Canada. Page 333  
 (In Gore's No. 43 of 14th November.)
- November 14, Gore to Castlereagh. (No. 43.) Enclosing a letter to the Solicitor  
 York. General from Mr. Bond, of so extraordinary a nature that he should consider himself wanting in duty did he withhold it. 332  
 (Enclosure calendared at its proper date.)
- November 15, Same to same. (No. 44.) Has been applied to by Wm. Claus in behalf  
 York. of the Five Nation Indians, whose property amounting to upwards of £8,000 was sent home some years ago to the banking house of Messrs. Coutts to be invested in the 3 per cents. He (Claus) had only drawn for £277-15-6½ last year, and this for £400. Asks that such orders be given that the bankers in future may state explicitly what sum may annually be drawn for. 344
- December 21, Same to same. (No. 45.) Sending duplicates of the statements of  
 York. the tenures, duties and emoluments of the several officers in Upper Canada. Encloses also five returns received since his despatch of 21st October. 326  
 (The returns are all enclosed with the originals from page 293 to 325.)
- December 23, Same to same. (No. 46.) Transmits a report of the Executive  
 York. Council respecting an intended road in the Western District. The great necessity of opening up roads in a country so thinly populated as Upper Canada, has induced the Legislature from time to time to grant sums of money for the purpose out of its slender revenue; but as these means fell far short of what was required other measures were adopted. Two great roads, Young and Dundas streets, have been opened by granting lots on each side of these roads on condition that the grantees should make and maintain the portion opposite their respective settlements. A similar plan is recommended for the Western District by the Executive Council, and nothing prevents the plan being brought into operation at once, but the Crown and Clergy Reserves, which, must be removed from the proposed lines of communication. Should His Majesty give directions for the proposed change, as per diagram transmitted, he (Gore) will next turn his attention to the disposing of the tract set apart for public schools in the way best calculated to fulfil His Majesty's intentions. 347
- December 24, *Enclosed.* Report of the Executive Council. 351  
 Kensington Col. J. A. Vesey, Deputy Barrackmaster in Canada, to Lt.-Col. Bun-  
 Palace. bury, Under Secretary of State. In the year 1805, a grant of 5,000 acres was issued in his favour, but the expense has hitherto prevented his taking out the patents. Asks that the said grant may be issued to him free of fee. 380
- December 28, *Enclosed.* Letter dated 22nd June, 1805, from Lord Camden to Lt.-  
 Treasury. General Hunter, respecting the grant to Col. Vesey. 382  
 Harrison to the Hon. Cecil Jenkinson. Transmitting letter from Gore enclosing requisitions for stationery for the year 1810, for Lord Liverpool's opinion thereon. 384
- December 28, Same to same. Transmitting letter from Gore enclosing abstracts of  
 Treasury. warrants issued by him on the late Receiver General of Upper Canada. 385

LIEUT.-GOVERNOR F. GORE AND MISCELLANEOUS—1810.

### Q. 313—I.

1810. Gore to Castlereagh. (No. 47.) Acknowledging circular letters of  
 January 9, 12th May and 21st and 26th June, 1809. Page 2  
 York.



1810.  
February 1,  
York.

Same to same. (Duplicate.) The notice by Mr. Peter Moore of an intended motion in the House of Commons to enquire into abuses in the administration of the Government in Upper Canada, appearing to be founded on a libel published in the name of Mr. Jackson and entitled "A view of the political situation of the Province of Upper Canada in 1808," it seems incumbent upon him (Gore) to furnish evidence to give a direct contradiction to the motion. Hopes the enclosed will be sufficient to do so. Refers him to former despatches respecting Thorpe and Wyatt. Remarks on the case of these gentlemen. Page 3

*Enclosed.* Brief notices of a "View of the Political situation of Upper Canada in 1808," with reference to documents to show the misrepresentations of the author. 9 to 47

February 6,  
York.

*Enclosed.* Papers referred to in the foregoing. 48 to 198  
Gore to Castlereagh. (No. 48.) Enclosing the annual establishment of the Indian Department and requisitions for Indian presents and stationery for the year 1810. Also a requisition to be substituted for the ordinary requisition for presents in case of war. Great need of a surgeon at Amherstburg to attend the sick Indians; the garrison mate might be given 5 shillings a day to attend all cases. Attention to their sick has as great an effect on their minds as the presents given. Asks that permission may be given to place Wm. J. Chew, storekeeper and clerk of the Indian Department at Fort George, on the pension list, as his mind has given way, principally through family misfortunes. 199

*Enclosed.* Proposed establishment of the Indian Department for 1810. 202

List of temporary appointments and pensions in the Indian Department for 1810. 203

Requisition for Indian presents for Upper Canada. 204

Ditto for an extra quantity required in case of war. 208

Requisitions for stationery for Upper Canada. 212, 214, 216, 218, 220

February 7,  
York.

Gore to Castlereagh. (No. 49.) The Legislature met on the 1st inst. for the despatch of business. Encloses speeches on the occasion. 222

*Enclosed.* Speech by Gore to both Houses, on the opening of Parliament. 223

Address from the House of Assembly in answer to the above. 225

Ditto from the Legislative Council. 228

March 1,  
York.

Gore to Castlereagh. (No. 50.) Since the half pay of reduced officers of the Provincial forces, settled in this province, has been paid by the Deputy Postmaster General, a regulation has been acted upon by which no person holding any provincial office is allowed to draw half pay. This has a very bad effect on the Colony from the transfer of the offices of district judges, sheriffs, coroners, clerks of the peace, registrars, &c., from tried and faithful subjects to new settlers. These emoluments are less than the half pay of many of these officers who will be compelled to resign and will thereby be greatly distressed. 230

March 10,  
York.

Same to same. (No. 51.) Enclosing unanimous addresses of the two Houses on the occasion of the King entering the fiftieth year of his reign. Also the proclamation of the Governor of Lower Canada announcing a general pardon; as this seemed to call for a similar one from him (Gore) and having doubts of the propriety as well as the legality of so full a pardon, he called upon the Executive Council for their advice, who unanimously agreed that it would be more respectful to wait His Majesty's commands. 233

*Enclosed.* Addresses. 235, 238

Proclamation. 240

Proceedings of the Executive Council. 243

March 11,  
York.

Gore to Castlereagh. Mr. Jackson's pamphlet carried with it such evident condemnation that he would have allowed it to pass unnoticed

## Department of Agriculture—Archives.

1810.

had not the motion of Mr. P. Moore in the House induced him (Castlereagh) to express a wish to be furnished with the means of refuting its misrepresentations, documents for which purpose were forwarded without delay. With this despatch transmits copy of the unanimous vote of the House of Assembly as follows:—"Resolving that the pamphlet entitled 'A View of the Province of Upper Canada,' signed John Miles Jackson, contains a false, scandalous and seditious libel, comprising expressions of the most unexampled insolence and contumely towards His Majesty's Government of the Province, the grossest aspersions upon the House of Assembly, the Courts of Justice therein, and the officers of the Civil Establishment of the said Government, and most manifestly tending to alienate the affections of the people from His Majesty's Government of this Province, to withdraw them from their obedience to the laws of the country, and to excite them to insurrection." Page 245  
*Enclosed.* The vote of the House. 247

March 12.

Same to same. (No. 53.) Has this day prorogued the Legislature. 248  
*Encloses copies of the speeches on the occasion.* 248

*Enclosed.* Speech on prorogation. 249

Speech from the House of Assembly. 252

March 31,  
 York.

Gore to Castlereagh. Enclosing abstract from the Auditor's Docket Books of grants of land between 1st January and 31st December, 1809. 255

**ABSTRACT from the Auditor's Docket Books of Grants of Land in Upper Canada which have passed the Great Seal of the Province between the 1st January and 31st December, 1809.**

Counties.	Number of Grants.	District.	Number of Acres.	Total Number of Grants.	Total No. of Acres Granted.
York.....	98	Home.....	21,532	98	21,532
Durham.....	6	} Newcastle.	2,309	} 34	9,257
Northumberland.....	28		6,948		
Lincoln.....	46	Niagara.....	9,272½	46	9,272½
Glengarry.....	18	} Eastern.	2,130	} 79	16,250
Dundas.....	4		2,810		
Prescott.....	4		2,050		
Russell.....	29		5,800		
Stormont.....	24		2,460		
Grenville.....	15	} Johnstown.	1,948	} 118	22,878
Carleton.....	45		9,100		
Leeds.....	58		11,830		
Essex.....	13	} Western.	2,405	} 26	4,811
Kent.....	3		2,406		
Middlesex.....	9	} London.	2,700	} 26	6,976
Norfolk.....	8		1,626		
Oxford.....	9		2,650		
Frontenac.....	46	} Midland.	8,182½	} 79	14,648 ½
Hastings.....	16		3,960		
Lennox and Addington.....	9		1,258		
Prince Edward.....	8		1,218		
			Total... ..		

P. SELBY,  
*Auditor General.*

1810.  
April 21,  
York.

Gore to Liverpool. (No. 1.) Having been directed by Lord Castlereagh to grant Mr. Wm. Bond 12,000 acres of land, and to afford that gentleman every assistance in his power to bring to perfection the culture of hemp in this province, he states that after a search of many months Mr. Bond was unable to find land fitted for his purpose without purchasing, but lest the season for sowing should pass without anything being done, has issued a warrant on the Receiver General for £200 to assist Mr. Bond in some experiments he intends to make on some waste lands in the Western District. Page 258

April 23,  
York.

Same to same. (No. 2.) Transmitting a representation from the magistrates of the District of Niagara, in favour of a Mr. Warren. Although His Majesty has been pleased to remove Mr. Justice Thorpe from the province, Mr. Warren's case calls no less for the intervention of the Crown, more particularly as his zeal was exerted to protect foreign property wrecked on our shores. Mr. Justice Powell has stated that when he discharged Hawn for the irregularity of the commitment, the law compelled him to do an injustice, as he merited a capital punishment instead of imprisonment. Asks that the representation of the magistrates be favourably considered, and that he be authorized to pay the damages and expenses incurred by Mr. Warren on the case referred to. 260

(The enclosure "A Report of the Magistrates of the District of Niagara respecting the wreck of an American vessel," given to Governor Gore in original the 12th April, 1810.)

May 4,  
York.

Gore to Liverpool. (No. 3.) Enclosing report of a Committee of the Executive Council as a board of audit for accounts on certain changes in the account of the Attorney General of this Province. The articles suspended by that Board are: 1st. Certain warrants of returning officers for elections, and 2nd, Certain commissions which have passed the great seal of this Province (not for places of emolument or profit) viz.: Commissioners of Assize, *nisi prius* Oyer and Terminer and General Jail Delivery, and also proclamations. Previous to the year 1802, the Auditor General of Upper Canada was authorized to receive like fees to those received by the Auditor General of the Lower Province, according to the table enclosed. Even after the Order in Council of 1802, the Attorney General continued to receive his fees, as well as the Lieut.-Governor and Secretary of the Province, and he (Gore) considers that order did not extend further than regulating the Attorney's fees in criminal and civil suits. Encloses table adopted by Governor Simcoe, in 1793, but mentioned by the Board of Audit as being of doubtful authority. Usage, however, has sanctioned its adoption. Has directed that his (Gore's) own account should be withdrawn, as he considers it due to his situation that he should receive no fees about which a shadow of doubt can arise. Advises that such fees as are sanctioned by usage be made lawful until a complete table shall be made out. The unpleasant situation of the Lt.-Governors respecting fees. Asks for commands relative to the allowance of the fees now for the first time suspended by the Board of Audit, as the Attorney General considers himself aggrieved by such suspension. 263

Enclosed. Report. 269 to 275

Items suspended in former accounts. 276

Attorney General's account for the half year ending December 31st, 1809. 280

Copy of the proceedings in Council on 30th Dec., 1802, respecting the Attorney General's fees. 287

Extract from the proceedings of Lieut.-Gov. Simcoe in Council on 19th July, 1793, with a copy of the Nova Scotia fee tables. 292

## Department of Agriculture—Archives.

1810.  
June 11,  
York. Gore to Liverpool. Transmitting copies of thirteen Acts to which he gave the Royal assent at the close of the second session of the Fifth Provincial Parliament, with schedule. Also copies of Journals of the Legislative Council and House of Assembly for the same session. Page 297
- June 11,  
Montreal. P. Langan to Gore. Respecting his claim to Grande Isle. 299  
(In Gore's No. 4 of 28th July.)
- July 28,  
York. Gore to Liverpool. (No. 4.) Having been notified by Lord Castle-reagh in answer to his despatch, No. 18, that the opinion of the Attorney and Solicitor General should be transmitted to him (Gore) on the claim of the Baroness of Longneuil and Patrick Langan to the Grand Isle, he asks that the opinion be forwarded as soon as possible. Encloses letter lately received from Langan. 298  
(Enclosures calendared at their respective dates.)

### LIEUT.-GOVERNOR F. GORE AND MISCELLANEOUS—1810.

#### Q. 313—II.

1806.  
November 26,  
Utica. N. Le Favre, late of Dublin, lottery office keeper, to Mr. Justice Thorpe. Had written him at Niagara and previously handed \$250 to Mr. Clinch to be given to him (Thorpe.) Has no doubt, but both have been delivered. Asks from what part of England Governor Gore comes and his connections, that he may know to whom to apply for a letter to him. Asks that his son-in-law's name (Wm. Donohue) be put in his place for receiving lands. Owes more to the candour of Col. Claus than to all the parties he had previously communicated with. Asks for the continuance of his (Thorpe's) confidence. Page 489  
(In Gore's of 9th August.)
- December 24,  
Niagara. Samuel Thompson to Justice Thorpe. Is laid up from the effect of the journey from York. Thinks he is being made too much the butt of the party and after the election Mr. Willcocks must get some one else in his place. Mr. Addison afraid of the risk. Is astonished to hear Mr. Gough is taking such an active part in the electioneering, but the freeholders must know his choice cannot be good, as he expended \$200 last election in opposing their candidate. Thinks, instead of keeping the taverns open, something to eat and drink might be kept in some convenient place. Has too good an opinion of the freeholders of the country to think they would sell their votes for a glass of grog. Capt. Brant, Mr. Jones, and several others from the head of the lake will be at York. Hopes for the good of the country that he (Thorpe) will be elected. 442  
*Endorsed.* "An intimate connection between the writer, the Reverend Robert Addison, Mr. Justice Thorpe, the Indian Brant and the future Editor of the *Guardian* newspaper recommending economy at the election."  
(In Gore's of 9th August.)
1807.  
May 19,  
Dublin Castle. C. B. Wyatt to Robert Thorpe. Projecting a charge against the administration of Government in Upper Canada, of exercising arbitrary power, sacrificing the beneficent promises of the Sovereign, misapplying grants of land and stores, abuses in the Indian Department, dissatisfaction of the Five Nations, infringement upon the freedom of election, &c. 428  
(In Gore's of 9th August.)
- July 1,  
Niagara. Rev. Robert Addison to Mrs. Thorpe. Promising to assist the undertaking of Mr. Joseph Willcocks. 325  
(In Gore's of 9th August.)

1807.  
July 1,  
Niagara.

Samuel Thompson to Robert Thorpe. Accident met with by Robert ———, who fell and broke a small bone in his arm. Capt. Brant tells him the Dutchmen are gone up the lake with the money, he (Brant) expects them soon with Mr. Jones, and hopes he (Thorpe) will get assistance then in the money way. Mr. Justice Powell gone to Madrid. Hears John Powell is to have an appointment here. Sends papers and letters. Sees by an Albany paper that the Parliament is dissolved, but it will not appear in any other. Page 436

This letter is endorsed as follows: "A money negotiation was then subsisting between Thompson and Mr. Thorpe and the Indian Brant, agent of the Five Nations and so accounting for the warmth of the party to get rid of the controlling authority of the Deputy Superintendent General of Indian Affairs (Col. Claus)."

(In Gore's of 9th August.)

July 24,  
Niagara.

Joseph Willcocks to Messrs. J. and D. Cozens, New York. Announcing the first number of his paper. Expressing his sentiments on the recent affair of the Chesapeake, connecting that affair with the circulation of his paper (the *Upper Canada Guardian* or *Freeman's Journal*) and betraying his predilection for the Government of the United States and enmity to this Government. 328

(In Gore's of 9th August.)

*Enclosed.* Copy of a file of Upper Canada Guardians. 331 to 426

(In Gore's of 9th August.)

1809.  
July 9.

C. B. Wyatt to Rev. Robert Addison. Has been informed that the chaplaincy of Niagara is at last settled in his (Addison's) favour. As to his own affairs, considers himself badly used, as the Treasury Board has appointed some one else to his situation and he is to get an equivalent somewhere else. Does not complain of the Treasury, but of the Colonial Office where Gore's friends are. Believes every one in Upper Canada is alarmed; great anxiety felt on this side the water to hear how things go on there, particularly to know what was done by the new Provincial Government. Sees that there is a serious schism in Lower Canada between the Government and the Legislature and a notice has been given in the British House of Commons of a motion to investigate the affairs of the Canadas in consequence of Mr. Jackson's pamphlet. Mr. Wardle has also touched on the subject; therefore supposes an investigation is likely to take place and trusts punishment will fall on those who deserve it. Remembrances to all his friends. 456

*Endorsed.* "Complaining of injustice at the Colonial Office and of want of intelligence from Upper Canada, attributing the general silence to fear. Adverting to the dissensions in Lower Canada and connecting all with Mr. Jackson's pamphlet, Mr. Peter Moore's motion and Mr. Wardle's pursuit of investigation."

(In Gore's of 9th August.)

July 19,  
Southampton.

John Mills Jackson to Joseph Willcocks. Hopes his two last letters and some pamphlets have been received. In case they have miscarried repeats what he said before, viz.: That he prepared a statement of the political situation of Upper Canada, printed last January, many circulated, some were sent to the Lords, and one to Mr. Percival, when a notice was given of a motion to be brought before the Commons at the next session relative to the situation of Upper Canada, and the abuses of the British Constitution in that Colony, which from what he can learn are daily increasing. Has exerted himself to procure an investigation and has so far succeeded as to have induced a member of Parliament to take up the cause of the Canadians in the upper country, and hopes that in the end the Ministry may be induced to change the Lieut.-Governor, as well as the majority of the Executive Council. Asks for a true copy of the proceedings of that body, also letters from some principal inhabi-

## Department of Agriculture—Archives.

1809.

tants giving an impartial view of the present state of the Colony, and their opinion of what must be the result of the present system. Has already many documents and letters including the correspondence of Brant and Norton with Mr. Wilberforce. Mr. Owen and Sir Evan Nepean and some Indian speeches. If Mr. Moore succeeds in his endeavour to effect a change in Upper Canada by his application to the Imperial Parliament, he will deserve our gratitude, as the people should have much better treatment than they have experienced from the late and present Lieut.-Governors. Shall write to Capt. Dumont; had written on first arriving in the province, but supposes the letter miscarried. Is sorry not to have heard from him, as he would have given a faithful account of the state of the province. Understands the House is to meet in November, therefore any communications from Upper Canada must be received before that time and be sent by a trusty hand. Hopes to see him next summer, when he apprehends changes will have taken place. Has received a letter from his old friend Cheniquy, who wishes to resume his former situation and seems much to regret his having left his (Jackson's) service; he says: "McGill gave him handfulls of cash and promised him a great deal more if he would go on and persist in his evidence." According to Mr. Addison, it was his (Cheniquy's) evidence which put him (Willcocks) out of office. Asks to be informed in time for the investigation, of all the circumstances connected with the election in which Thorpe was a candidate. Wishes to know what goods it will be advisable to bring out, he intends to erect stills and a brewery at Springfield, and will take him (Willcocks) into a partnership. Page 460  
*Endorsed.* "Soliciting grievances for Mr. Peter Moore. This letter directed to the care of the Rev. Robert Addison." Endorsed and forwarded by Mr. Wyatt.

(In Gore's of 9th August.)

September 2,  
York.

Gore to Castlereagh. Transmitting memorial of Thomas Ridout. Recommends the prayer. 525

*Enclosed.* Extract of despatch from Lieut.-Governor Hunter to Lord Hobart, dated York, Upper Canada, 5th January, 1803, ordering an increase to the salary of Thomas Ridout. 526

1810.  
January 16,  
Paternoster  
Row.

Thomas Ridout, joint acting Surveyor General of Upper Canada, to Hon. C. Jenkinson, Under Secretary of State. Respecting lands which he wishes to obtain in Upper Canada. 507

*Enclosed.* Extract from the minutes, dated York, 11th July, 1799, on the petition of Thomas Ridout. 510

February 8,  
Woolwich.

Thorpe to Joseph Cheniquy. Will be in town soon and will call for breakfast on Sunday. Asks that he (Cheniquy) have as much information there for him as possible. Hopes Mr. C. Wyatt's conversation with Mr. Ridout has been useful. Has any news about Canada come? 445

*Endorsed.* "Soliciting information from Upper Canada, and calling for notes from Bingle (on Mr. Jackson's pamphlet) who had been a confidential clerk in Lieut.-Governor Gore's office and now engaged by Messrs. Jackson, Wyatt and Thorpe to betray his trust."  
 (In Gore's of 9th August.)

February 8.

Memorial of Sarah Margaret Clarke, daughter of the late John Clarke, Capt. 59th Regiment, to the Earl of Liverpool. For an increased pension. 511

*Enclosed.* Recommendation of the above from the Duke of Kent. 514

February 14.

Thorpe to Cheniquy. Thanks for the friendly communication. If he (Cheniquy) wishes to serve Mr. Dickson, he ought to advise him to avoid Mr. Henry Weekes, who is in Exeter. Has received a letter from Mr. Jackson, he is going to Canada immediately. Encloses two notes to be delivered in the hope of getting the Governor's commission without

1810.

troubling Mr. Wyatt. Asks for Mr. Bingle's and his own notes on Mr. Jackson's pamphlet and that he calls on Sunday as he (Thorpe) has promised to finish the petition for Mr. Jackson by next week which he cannot do so without assistance. Hopes Mr. Wyatt is getting on well. Page 449

*Endorsed.* "The authors and promoters of J. M. Jackson's pamphlet and petition and Mr. P. Moore's motion in the House of Assembly."

"Messrs. Wyatt and Thorpe and Mr. Justice Thorpe framing the petition for Mr. Jackson to be presented to Parliament."

February 22. F. Bingle to Cheniquy. Had called on Mr. Wyatt for the purpose of giving him (Cheniquy) a letter for Mr. Jackson, but not finding him in, requests to know when he can be seen, as he wishes to call on Mr. Thorpe but does not know his residence. 446

*Endorsed.* "To introduce him to Mr. Thorpe having been at Mr. Wyatt's with a letter for Mr. Jackson."

(In Gore's of 9th August.)

February 26. Cheniquy to Justice Thorpe. Acknowledging note of Sunday last. Though he promised to give his remarks on the pamphlet entitled "View of Upper Canada," now declines to do so, as he cannot approve of the whole work, and is conscious that his remarks would not be approved if he stated the true cause of the dissensions in Upper Canada. 452

(In Gore's of 9th August.)

February 27. Robert Thorpe to Cheniquy. Asks for the return of the pamphlet lent and if any remarks are to be made, that they be sent next day. Begs that in future he make no appointment unless he intends to keep it. 455

*Endorsed.* "Reproaching Cheniquy for withholding his remarks."

(In Gore's of 9th August.)

February 28. Cheniquy to Mr. Justice Thorpe. Has received his (Thorpe's) note of yesterday and will for the future take care not to enter into any engagement with him. Will correspond direct with Mr. Jackson, and observes that he will be neither forced nor bullied by reason of present circumstances into any measure he does not approve. Having promised to give information of Mr. William Dixon's movements, states that he arrived in London yesterday afternoon. 453

*Endorsed.* "Resenting a supposed attempt to take advantage of his distress to induce him (Cheniquy) to their measures."

(In Gore's of 9th August.)

February 28, York. Memorial of Richard Cartwright to Gore. Asks that a patent for the lands located for the late Captain Thomas Gummersal be issued to him in trust, as he is administrator of the estate, which is not sufficient to satisfy all just debts without disposing of part of these lands. 485

March 15, London. Memorial of Thomas Ridout, to the Right Honourable Spencer Percival. For further leave of absence. 516

*Enclosed.* Copy of leave. 517

March 15, Lincoln's Inn. The Attorney and Solicitor General to Liverpool. In reply to the letter from Gore transmitting papers for an opinion on a case, state that they consider that the Court acted legally in refusing a peremptory *mandamus* to Mr. Rogers to deliver up the Register books and papers in question to Mr. Ward. They consider that Mr. Roger's appointment was for life and cannot conceive that the Court ought by a *mandamus* to have directed the documents to be delivered up to an officer not appointed in the manner prescribed by law. 518

March 16, Kensington Palace. J. A. Vesey to Hon. Cecil Jenkinson. Asking that his grant of land be transferred from Upper to Lower Canada, on account of the immense fees upon all grants in the former. 520

March 22, Whitehall. W. D. Adams to ——— Willimot. Recommending the case of Miss Sarah Margaret Clarke. 522

## Department of Agriculture—Archives.

1810.  
March.

Joseph Cheniquy to Wm. Dixon. Mr. Moore and his friends have at last concluded to bring on the Upper Canada enquiry the moment the Walcheren business is disposed of, but cannot say when that will be. Yesterday Wyatt received a letter of the utmost importance to Jackson's cause from Mr. Addison, dated 11th January, it was communicated in confidence, therefore he cannot repeat it. A spirited answer to Lord Castlereagh's letter has been printed in the Upper Canada *Guardian*. If Gore is really guilty as accused, he should certainly be removed from office and punished. The report that he (Cheniquy) was going to England to assist the party formed to remove Mr. Gore is without foundation, as Mr. Gore must in common justice acknowledge. Mr. Wyatt wishes newspapers sent him. Asks for an advance of a few pounds. Thorpe has not "shown his face to the Sun for the twenty days past." Page 474

*Endorsed.* "Stating that the Cabal had settled, that Mr. P. Moore's motion should be brought forward the moment the Walcheren business was disposed of. Noticing the receipt by Mr. Wyatt, the preceding, of a letter from the Rev. Robt. Addison of the utmost import to Mr. Jackson's cause, the matter of which he could not put to paper, but intimates that it related to an answer to the letter to Lord Castlereagh in the Upper Canada *Guardian*, and accusations against Governor Gore, which it true, ought to insure his immediate removal and punishment."  
(In Gore's of 9th August.)

April 4,  
Treasury.

Arbuthnot to Hon. C. Jenkinson. For information on the enclosed memorial. Page 524

(No memorial enclosed.)

April 7,  
Southampton.

John Mills Jackson to Joseph Cheniquy. Apprehends that the time draws near, that the united efforts of those friends to Upper Canada will prove beneficial to the inhabitants. Asks when his (Jackson's) brother intends to sail. Requests that he tell Bingle that he would be glad to hear from him and wishes to know his address. Is Mr. Dixon in London? 447

*Endorsed.* "To find out Bingle's new residence and to obtain the residue of his remarks."

April 10,  
York.

Wm. Firth, Attorney General of Upper Canada, to Liverpool. (Private.) Respecting several items in his contingent account suspended by the Board of Audit. 527

*Enclosed.* Papers relating to the above. 551, 555

April 13.

Joseph Cheniquy to Wm. Dixon. Has communicated to Mr. Wyatt the result of last evening's conversation. Assisted by his intimate friends, Wyatt has written a letter to him (Dixon) which he hopes will be the base of a happy arrangement. Hopes the fact of his (Wyatt's) having abjured Mr. Thorpe as he did, will be mentioned to his Excellency. Thinks the best plan would be for Gore to appoint some friend in London to receive an apology from Wyatt. Any attempt Jackson may succeed in persuading Mr. Moore to make in Parliament will be opposed with success. Asks to have the amount for which he may draw on him specified. 472

*Endorsed.* "Explaining Mr. Wyatt's letter to Mr. Dickson to have been composed with great attention by advice of Sir Richard Harding, Major Palmer and his father-in-law, Mr. Rogers. That Mr. Wyatt's abjuration of Mr. Thorpe, in presence of Mr. Dickson, should be favourable to Lt.-Governor Gore."  
(In Gore's of 9th August.)

April 14.

C. B. Wyatt to Wm. Dickson, Capt. Patton's agent for Transports, Portsmouth. Thanking him for his liberal conduct in offering to speak to Governor Gore on his behalf. Conveying his thanks to Gore for his honourable mention. Considers that an understanding might be come to without loss of dignity on either side and in future the respective



1810. departments might co-operate with advantage. Asking for a line from him (Dixon) giving his opinion on the conciliatory measures alluded to, founded on his knowledge of the amicable sentiments of Mr. Gore towards him. Page 469
- Endorsed.* "Expressing his thanks to Lt.-Gov. Gore for his honourable mention of him. Offering oblivion of the past and promising co-operation in future, and inviting Mr. Dixon to declare his knowledge that Gov. Gore's opinion of Mr. Wyatt was favourable."  
(In Gore's of 9th August.)
- April 19, C. B. Wyatt to Liverpool. Having been informed that some persons Foley Place. from Upper Canada have been circulating a printed anonymous letter addressed to Lord Castlereagh, in which his name is most calumniously mentioned, takes this opportunity of saying a few words in his own defence. 562  
(In his letter of 19th April, addressed to Lord Liverpool.)
- April 19, Same to Hon. Cecil Jenkinson. Enclosing letter of 19th April and Foley Place. asking his kind offices in having it laid before Lord Liverpool. 565
- May 1. Same to Rev. Robert Addison. Since writing, has been doing all in his power to obtain for him the Brigade Chaplaincy at Niagara, and has great hopes of success. Is sure many stories will be fabricated to mislead his friends in Upper Canada as to what is doing at home respecting the provincial politics. Hopes no one will fancy him (Wyatt) changed, but wait till he is heard before the Privy Council when things will appear in their true light. Does not know what either Dixon or Ridout are about. Has every confidence in his own innocence and in the justice of the Council. Asks him to let Willcocks know that the papers sent by Dixon have never arrived. 478
- Endorsed.* "Cautioning his friends against giving any credit to reports which they might hear of a change in his sentiments (referring probably to his and Cheniquy's letters to Mr. Dixon) and pledging himself to act with the party, notwithstanding appearances to the contrary."  
(In Gore's of 9th August.)
- June 11, Memorial of Patrick Langan and Marie Charles Joseph Lemoine, Montreal. Baroness of Longueuil, widow of David Alexander Grant, to Gore, asking that their claim to Grande Isle be considered. 304  
(In Gore's No. 4 of 28th July.)
- August 9, Gore to Liverpool. The publication of the libellous pamphlet by Mr. York. Jackson, entitled "A view of the political situation of Upper Canada," has induced him to notice it, from the fact that it was connected with Mr. Moore's motion in the House of Commons. His remarks on the subject were transmitted to Lord Castlereagh in his despatch of 1st February, 1810, wherein he stated that he was convinced the libel proceeded from the pen of Mr. Thorpe, and that there then existed in the province, an organization of disaffected persons with Thorpe and Wyatt at the head. His conviction was based on certain documents in his possession, and since then incontrovertible evidence has come into his hands. The object of this "cabal" will doubtless be declared by them only to be the removal of the Lieut.-Governor, the judges and the obnoxious members of the Executive Council. Transmits the evidence alluded to, as he would consider himself wanting in discretion did he withhold it. 316
- Descriptive schedule of certain original papers connecting the motion of Mr. Peter Moore with the organization of disaffected persons in the Province, headed by Thorpe and Wyatt. 318
- August 16. Report of the Committee of the Executive Council refusing the petition of Honourable Richard Cartwright, as administrator of Capt. Thomas Gummersal's intestate estate. 488

## Department of Agriculture—Archives.

1810.  
August 16,  
Treasury  
Chambers. Harrison to Peel. Transmitting letter from Gore, dated 11th June,  
last, enclosing the public accounts of Upper Canada for the half  
year ending 31st December, 1809, for Lord Liverpool's observations  
thereon. Page 566
- August 23,  
York. Gore to Liverpool. Transmitting report from the Executive Council  
for the opinion of His Majesty's law servants. Having been misled on  
an important point by the Attorney and Solicitor General of the Pro-  
vince, has no longer confidence in their opinion in a matter of such  
weight. 483
- August 28,  
York. Same to same Has authorized Col. Claus, Deputy Superintendent  
General of Indian Affairs, to draw on Messrs. Coutts & Co., for £561 ls. 7d.  
being the amount of the dividends due to the Six Nations. If this sum  
should not prove correct, asks that directions be given Messrs. Coutts  
not to protest the bills. 492
- September 1. Wm. Dummer Powell to Adam Gordon. The evil arising from the  
appointment of judges and law officers not sufficiently well known in  
Downing Street will justify this communication. Mr. Boulton has been  
given leave of absence to go to England, it is apprehended with the  
object of soliciting the vacant seat on the Bench, the appointment of this  
gentleman would not meet with approbation, as it was understood when  
the court was first organized that the judges should be barristers of  
Westminster Hall, until our own Bar could furnish fit subjects, and  
hitherto there has been no exception to this rule. Asks that we have  
the goodness to second Gore's representation on this subject, so impor-  
tant to the Colony. 567
- September 10,  
York. Gore to Liverpool. Enclosing a memorial to the Treasury on the sub-  
ject of fees and asking his (Liverpool's) support. 493  
*Enclosed.* Memorial of Francis Gore. 496  
Abstract of Lieut.-Governor Hunter's fees. 497a  
Ditto of Lieut.-Governor Gore's. 497b
- September 10,  
Delaware. Wm. Bond to John Small, Clerk of the Crown in Chancery. Enclos-  
ing a letter to Lord Bathurst and a certificate from the farmers in the  
neighbourhood and asking for a few words in his favour when next writ-  
ing to Bathurst. 569  
*Enclosed.* Bond to Bathurst, Delaware Township, London District,  
10th September, 1810. His experiments in the culture of hemp will  
bring him ruin without some assistance from Government. He has been  
obliged to rent a farm, as the land he was sent to make use of was not  
fit for tillage and encloses some of his memorials on the subject. 571  
Certificate from the principal farmers in the Township of Delaware,  
stating that Mr. Bond is a judicious farmer, and well able to carry on the  
culture of hemp. 578  
Memorial, dated 19th February, 1810, from Wm. Bond, on the subject  
of a grant to be made him in the London District. 583  
Another from the same, dated York, 30th July, 1810. 585
- September 25,  
York. Gore to Liverpool. The Solicitor General of this Province, Mr. Boul-  
ton, has obtained his leave to visit England. Has learned by experience  
that too much caution cannot be used in selecting proper subjects for the  
King's Bench, for which appointment Mr. Boulton is not properly qual-  
ified. Is convinced of the advantage of augmenting the Puisne Judges'  
salary to £1,000 a year. 498
- October 12,  
York. Same to same. Transmitting a continuation of the minutes of the  
Executive Council of this Province on State matters from 1st January,  
1809, to 30th June, 1810, and on Land matters for the same period. 501
- October 12,  
York. Same to same. In his letter of 1st August, 1809, had asked for leave  
of absence to visit England on private affairs, stating that should leave  
be granted he would appoint the Chief Justice to administer the Govern-  
ment, and soliciting that the vacant office of Puisne Judge might be

1810.

filled up. The reasons which persuaded him to ask for that leave are now very much stronger, and he again applies for that indulgence. The advantage of sending out a gentleman of ability to fill the vacant judgeship. Page 502

- November 20, Lincoln's Inn. The Attorney and Solicitor General to same. In answer to letter of 10th November, transmitting a despatch from Lieut.-Governor Gore, submitting for the opinion of His Majesty's law servants the case of the grant of land to the late Captain Thomas Gummersal, state that they consider it proper to comply with the petition of the administrator. 589
- December 26, York. Gore to same. Understanding that Mr. Small, Clerk of the Crown, has sent his son to England to solicit the appointment to that office on his resignation, thinks it his duty to state that that appointment would not meet with approbation here. 505
- December 28, Treasury Chambers. Harrison to Peel. Transmitting abstract of warrants issued on the Receiver General of Upper Canada for Lord Liverpool's observations thereon. 591

## ACTING GOVERNOR I. BROCK AND MISCELLANEOUS.—1811.

## Q. 314.

1810.

- July 9, Amherstburg. Matthew Elliott to Wm. Claus. The Sackies and Foxes to the number of 125 had arrived some days before and demanded a council. After asking for provisions, guns, ammunition, &c., they requested that the King should be assured of their attachment. Page 39  
(In Gore's No. 12 of 1st March.)
- October 7, Amherstburg. Substance of speeches of the Indians at the Council at the Big Rock. 45  
(In Gore's No. 12 of 1st March.)
- October 16, Amherstburg. Matthew Elliot to Wm. Claus. Transmitting heads of what passed at the Council at Brown's Town, excepting the answer of the Huron's. Red Jacket's mission seems to have proved abortive in every point of view. Believes that the Indians are more ripe than ever for war. Dreads they may of themselves soon commence hostilities and our Government be blamed for encouraging them. Some Indians from Buffalo Creek had gone to Detroit where Hull furnished them with a boat to carry them home. Shall attend to his instructions respecting those left at the Grand River. 42  
(In Gore's No. 12 of 1st March.)
- November 5, Montreal. Memorial of the North-west Company relative to a new route in Upper Canada. 142  
(In Brock's of 23rd November.)
- November 15, Amherstburg. Speech of the Shawenese Prophet's brother. 54  
(In Gore's No. 12 of 1st March.)
- November 16, Amherstburg. Matthew Elliott to Wm. Claus. Transmitting speech of the Shawenese Prophet's brother, which fully convinces him that the Americans are on the eve of an Indian war. In answer to the demand of the Indians for supplies, can only tell them that no time will be lost in laying their speech before the King. Asks for directions as to the future treatment of the Prophet and his adherents. The reason for the unusually large issue of presents and provisions. 18th November, called the Prophet's brother to a private conference respecting the intentions of the Indians. 50  
(In Gore's No. 12 of 1st March.)
- November 29, Lt.-Governor's office. Wm. Halton, secretary, to Wm. McGillivray. Answer to the memorial of the North-west Company in Upper Canada. 148  
(In Brock's of 23rd November.)

## Department of Agriculture—Archives.

1811. January 2, York.	Gore to Liverpool. Enclosing report from the Executive Council on the petition of M. de Farey, one of the French Royalist emigrants, and asking for His Majesty's further commands on the subject. Asks how far it may be advisable to grant special charters to enable the French Loyalists to obtain the promised grants. <span style="float: right;">Page 2</span>	5
	<i>Enclosed.</i> Report of the Executive Council on the petition of Captain de Farey, dated 13th December, 1810.	5
	Copy of a letter from the Attorney and Solicitor General to Lord Hobart, dated 5th January, 1802, giving an opinion on the subject of grants of Land to aliens.	11
	List of French Loyalists proposed to be given a special charter of denization, to enable them to obtain land grants.	14
January 7, York.	Gore to Liverpool. (No. 9.) Enclosing a letter and memorial from Mr. St. George, late a major in Royalist Army. Recommends the memorial.	16
	<i>Enclosed.</i> Memorial in French from Quetton St. George to Liverpool, dated 5th January, 1811.	18
	Another of the same date, in English, also to Liverpool.	20
January 7, York.	Certificate signed by Gore, stating during what period Thomas Ridout has been filling the position of Surveyor General.	193
	(In Harrison's of 28th April.)	
January 11, York.	Gore to Liverpool. (No. 10.) Transmitting the annual establishment and annual requisitions.	24
	<i>Enclosed.</i> Proposed establishment of the Indian Department in Upper Canada, for 1811.	24a
	List of persons holding temporary appointments in the Indian Department Upper Canada.	24b
	Requisition for Indian stores for 1811.	25
	Ditto for stationery for the Indian Department for 1811.	30
January 24, York.	Gore to Liverpool. Enclosing memorial from Thomas Ridout and Wm. Chewett for the emoluments of office since the suspension of Mr. Wyatt. Recommends that the petition be granted.	32
	<i>Enclosed.</i> The memorial.	34
January 26, York.	Bill of exchange drawn on W. H. Adams by Thomas Ridout, for salary as Surveyor General of Upper Canada.	192
	(In Harrison's of 28th April.)	
February 19, London.	Statement signed H. W. R. (H. W. Ryland) concerning Bishop Plessis who had issued a <i>mandement</i> in which he had assumed titles and authority to which he was not legally entitled. Is he not liable to criminal prosecution? Under what statute an action might be brought. To what penalty might he be subject if prosecuted?	180
	(In Ryland's of 19th February to Mr. Secretary Peel.)	
February 26, York.	Gore to Wm. Claus, Deputy Superintendent of Indian Affairs. He is to instruct Elliott to be more than usually circumspect in his communications with the Indians so as to give no suspicion of favouring their hostile designs against the United States. They are to be impressed with the certainty of misfortune if they attack the Whites, and convinced that the Americans are now becoming so strong that it would be impossible to prevail against them. They are also to be assured that this advice is given from a sincere regard for their welfare.	37
	(In Gore's No. 12 of 1st March.)	
March 1, York.	Same to Liverpool. (No. 12.) Enclosing copies of three letters with their enclosures from Mr. Elliott, the Superintendent of Indian Affairs at Amherstburg to the Deputy Superintendent General. These letters being communicated to Sir James Craig, he (Gore) in conformity to his opinion, has instructed the D. S. G. of Indian Affairs to restrain the Indians from committing any act of hostility on the subjects of the United States.	36
	(Enclosures calendared at their respective dates.)	

1811.  
March 4, Treasury. Harrison to Peel. Transmitting public accounts for Upper Canada for the half year ending 30th June, 1810, with vouchers, &c., for Lord Liverpool's observations thereon. Page 185

March 5. J. Watkins (for M. Winter) to Messrs. Coutts & Co. Respecting the duty on the 3 per cent consolidated annuities belonging to the Six Nation Indians. 206

March 7, Attorney General's office. Wm. Firth, Attorney General, to Wm. Halton, claiming a fee. (In Gore's No. 14 of 9th April.) 74

March 8, Attorney General's office. Same to same. Respecting his claim for a fee. (In Gore's No. 14 of 9th April.) 77

March 8, Treasury. Harrison to Peel. Transmitting letter from Governor Gore with requisitions for stationery for Lord Liverpool's opinion thereon. 187

March 18, York. Gore to Liverpool. Enclosing abstract from Auditor's Docket Books. 58

ABSTRACT from the Auditor's Docket Books of Grants of Land in Upper Canada, which have passed the Great Seal of this Province, between the 1st of January and 31st December, 1810.

Counties.	No. of Grants.	Districts.	No. of Acres.	Total No. of Grants.	Total No. of Acres Granted.
York.....	99	Home.....	20,692	99	20,692
Durham.....	7	} Newcastle.	1,738	} 25	5,588
Northumberland.....	18		3,850		
Lincoln.....	24	Niagara.....	3,604½	24	3,604½
Glengarry.....	28	} Eastern.	4,347	} 69	10,962
Dundas.....	5		62		
Prescott.....	2		620		
Russell.....	16		3,714		
Stormont.....	18		1,661		
Grenville.....	12	} Johnstown.	2,300	} 118	25,210
Carleton.....	53		11,810		
Leeds.....	53		11,100		
Essex.....	17	} Western.	2,985	} 30	6,385
Kent.....	13		3,400		
Middlesex.....	3	} London.	800	} 20	3,729
Norfolk.....	12		2,79		
Oxford.....	5		850		
Frontenac.....	62	} Midland.	9,212½	} 155	28,367½
Hastings.....	51		11,220		
Lennox and Addington.....	22		4,368		
Prince Edward.....	20		3,567		
			Total...		

Errors excepted.

P. SELBY, Auditor General.

## Department of Agriculture—Archives.

1811. March 19, Lt. Govern- nor's office.	William Halton to John Small, Clerk of the Executive Council. Transmitting copy of a letter from Wm. Firth for the opinion of the Executive Council.	Page 80
	(In Gore's No. 14 of 9th April.)	
March 21, York.	Gore to Liverpool. The Legislature met on the 1st of February last. Encloses speeches.	61
	<i>Enclosed.</i> The Lieut.-Governor's speech on the opening of the Legislature of Upper Canada.	62
	Speech from the Council in answer to the above.	65
	Speech from the Assembly.	67
April 2.	The Lieutenant-Governor's speech on proroguing the Legislature. Harrison to ——— Concerning his application in favour of Mr. Campbell for the situation of Assistant Judge of Upper Canada. His reasons for recommending the appointment.	70 208
April 4.	Copy of a report of a committee of the Executive Council on the Attorney General's letter of the 8th March, 1811, respecting his claims concerning the great seal.	81
	<i>Enclosed.</i> Extract from the proceedings in Council of 13th July, 1799.	85
	<i>Enclosed.</i> Extract from the proceedings in Council of 5th November, 1799.	86
	(In Gore's No. 14 of 9th April.)	
April 9, York.	Gore to Liverpool. (No. 14.) Enclosing letters respecting a fee for the Great Seal claimed by the Attorney General.	72
	(Enclosures calendared at their respective dates.)	
April 15, St. James' Palace.	W. D. Adams to Harrison. Enclosing copies of a bill of exchange and accompanying certificate drawn on him by Mr. Thomas Ridout for the directions of the Lords of the Treasury. Reason why he does not feel justified in paying it.	189
	(In Harrison's of 28th April.)	
April 28, Treasury.	Harrison to Peel. Enclosing letter from W. D. Adams with copy of Bill of Exchange drawn upon him by Thomas Ridout for Lord Liverpool's opinion whether the bill is to be paid.	188
	(Enclosures calendared at their respective dates.)	
May 1, Montreal.	P. Langan to Colonel Bunbury respecting his title to some property, and enclosing memorial, &c.	194
	<i>Enclosed.</i> Memorial.	198
	Appointment of P. Langan to be Assistant Paymaster of Contingencies at Montreal.	202
May 6, London.	Wm. Campbell to Peel. Respecting his case and his application for the vacant situation of Assistant Justice in Upper Canada.	203
June 1,	Same to same. Mr. Harrison having informed him of his appointment to the situation of Assistant Judge in Upper Canada, he is anxious to have the <i>mandamus</i> and other necessary papers made out as soon as possible that he may return home by the June packet.	211
June 3, York.	Gore to Liverpool. Transmitting Schedule of Bills passed in the third session of the Fifth Provincial Parliament; also copies of the Journals of the two Houses during the same session.	87
	<i>Enclosed.</i> Schedule.	88
June 8.	Provisional agreement with the Chippewa Indians for a tract of land.	154
	(In Brock's of 23rd November.)	
June 8, Gwillenbury.	Proceedings of a meeting with the Chippewas.	157
	(In Brock's of 23rd November.)	
June 11, Downing St.	Peel to Harrison. Asking that Lord Liverpool be furnished with an account of the total cost of the Indian Department for the years 1806, '7, '8, '9, '10, to enable him to judge of the propriety of adopting a plan	

1811.  
 proposed for giving a cash allowance to the Indians on the borders of Upper Canada, in lieu of presents. Page 247
- June 13,  
 Strand. Thomas Coutts & Co., to James Chapman and Adam Gordon. After much correspondence with the Tax Commissioners they say that unless it can be declared that the Indian Nations are not subjects of His Britannic Majesty, they cannot comply with the request for the return of the Property Tax collected on the Consolidated 3 per cent stock belonging to the Six Nation Indians in Upper Canada. 212
- July 5,  
 Montreal. P. Langan to Peel. Enclosing a memorial addressed to Lord Liverpool on behalf of himself and the Baroness of Longueuil, widow of the late David Alexander Grant. 214  
*Enclosed.* The Memorial. 219
- July 11. Harrison to Liverpool. In consequence of Mr. Peel's request for a certificate as to Mr. Campbell's character and fitness for the situation of Assistant Judge, has no hesitation in recommending him. 230
- July 11. Ryland to Peel. Concerning the rights of the Crown with regard to the St. Sulpician estates and properties of the Church of Rome, in general, in Lower Canada. 223
- July 13,  
 Downing St. Draft of a letter to Gore. (No. 5.) His request for leave of absence has been approved by the Prince Regent. The Civil Administration of the Colony is to be committed to the Officer Commanding the Forces. 92
- July 18,  
 York. Gore to Liverpool. (No. 15.) In his despatch No. 14, had transmitted papers relating to Mr. Firth's claim respecting the Great Seal, he has now to transmit a letter from that gentleman, claiming the right to conduct all the criminal prosecutions on the circuit at the charge of the Crown. Encloses nine papers relating to Mr. Firth's pretensions. 94  
*Enclosed.* The papers. 98 to 115
- July 24. Provisional agreement with the Mississaguas for land in Thurlow. (In Brock's of 23rd November.) 164
- July 24,  
 Smith's Creek. Proceedings of a meeting with the Mississagua Indians of the River Moira. 166  
 (In Brock's of 23rd November.)
- July 29,  
 York. Gore to Liverpool. (No. 16.) Before an opportunity offered to despatch his letter, No. 15, had received a request from Mr. Firth for leave to go to England, not to return. His reasons for refusing to consent. He has been informed that Mr. Firth is determined to embark without permission. 116  
*Enclosed.* Four letters on the subject. 119, 121, 123, 126
- August 9,  
 London. John Black to Peel. Enclosing his memorial addressed to Lord Liverpool. 232  
*Enclosed.* The memorial. 235
- August 9,  
 Lincoln's Inn. Opinion of the Attorney and Solicitor General addressed to Liverpool on the case referred to them, whether all instruments under the Great Seal should pass through the office of Attorney General of the Province. 238
- August 10,  
 York. Gore to Liverpool. Has directed Col. Claus to draw on Messrs. Coutts and Co. for the sum of £496 2s. 6d., accruing to the Six Nation Indians from the money invested in the funds. 127
- August 15,  
 Downing St. Draft of a letter to the Officer Administering the Government of Upper Canada. Transmitting copy of the opinion of the Law Officers of the Crown on the claim of the Attorney General that all Instruments under the Great Seal should pass through his office and receive his fiat. 128
- August 15,  
 York. Gore to Liverpool. Recommending Mr. Cartwright for a grant of 3,000 acres of waste lands without fees. 130

## Department of Agriculture—Archives.

1811. August 31, Treasury.	Harrison to Peel. Enclosing copy of the report of the Commissioners of Taxes relative to the deduction of the Property Duty from the dividends belonging to the Six Nation Indians, for Lord Liverpool's information.	Page 241
	<i>Enclosed.</i> The report.	242
August 31, Treasury.	Same to same. Enclosing copy of the report of the Commissioners for auditing the Public Accounts, on the expenses of the Indian Department in Upper Canada, for Lord Liverpool's information.	243
	<i>Enclosed.</i> The report, dated 16th August.	244
September 6, York.	Plans of a tract of land intended to be purchased from the Mississagua Indians in the Township of Thurlow. (In Brock's of 23rd November.)	150
September 15, Cornwall.	Wm. Firth, Attorney General, to Liverpool. As the Lieutenant-Governor has refused him leave of absence, asks his (Liverpool's) permission to return home to make some disclosures.	249
September 28, York.	Gore to same. Respecting the claim of Mr. Jarvis, secretary of the province, for the expense incurred by him in perfecting 1,040 patents of land.	133
September 30, York.	Same to same. Apprising him of the unprecedented conduct of Mr. Firth, who has left the province to embark at Quebec. Has, with the advice of the Executive Council, named John McDonnell to perform the duties of Attorney General till His Majesty's pleasure be known. Too much care cannot be exercised in choosing a successor to Mr. Firth.	135
	<i>Enclosed.</i> Extract from the proceedings of the Executive Council.	137
September 30, Treasury.	Harrison to Peel. In answer to letter of 11th June, on the subject of commuting the Indian presents, and requesting to be furnished with an account of the total cost of the Indian Department, for some years past, is commanded to transmit copies of the Indian accounts.	252
	<i>Enclosed.</i> Extract of a report of the Comptrollers of Army accounts, dated September 23rd, 1811.	254
	An account of expenses paid by the Indian Department for presents for the years 1807, 1808, 1809, 1810 and 1811.	257
	Account of provisions issued to the Indians for the years 1806 and 1807.	258
October 8, York.	Gore to Liverpool. Acknowledging receipt of letter conveying to him (Gore) leave of absence for twelve months on private business. Major General Isaac Brock, on whom the administration of the Government devolves, has been sworn in as a member of the Council.	138
October 8, Treasury.	Harrison to Peel. Enclosing letter from Mr. Adams, asking instructions relative to the acceptance of a bill drawn by Mr. Thomas Ridout for his salary, for Lord Liverpool's opinion thereon.	259
	<i>Enclosed.</i> The letter, dated 3rd October.	260
October 9, York.	Major General Isaac Brock to Liverpool. States that the usual oaths were this day administered in Council to enable him to preside over the Civil Government of the Province.	139
November 4, Treasury.	Harrison to Peel. Transmitting letter from Gore with a memorial from Capt. Claus, praying for an increase of salary, for Lord Liverpool's opinion thereon.	262
November 5, Treasury.	Same to same. Transmitting report of the Comptrollers of Army accounts of 24th ult., on a letter from Gore enclosing the accounts of Upper Canada, that Lord Liverpool may make any observations he wishes prior to their being sent to the Audit Office.	264
November 19, Treasury.	Harrison to ———. Respecting the public accounts of Upper Canada.	265
	<i>Enclosed.</i> Extract of report of Comptrollers of Army accounts, dated 1st October, 1807.	267



1811.	Extract of report of Comptrollers of Army accounts, dated 24th October, 1811.	Page 268
November 19, Treasury.	Harrison to Peel. The Commissioners approve of an increase being made to the salary of Captain Claus.	269
November 20, Fort George.	Requisition for goods intended as payment for a tract of land purchased from the Chippewa Indians. (In Brock's of 23rd November.)	151
November 20, Fort George.	Requisition for goods intended as payment for land purchased from the Mississaguas. (In Brock's of 23rd November.)	171
November 23, York.	Brock to Liverpool. Enclosing memorial and accompanying papers from the North-west Company. (Enclosures calendared at their respective dates.)	140
November 25, Downing St.	Draft of a letter to Gore. (No. 6.) Queries on several points connected with the annual estimate for defraying the charge of the Civil Establishment of Upper Canada.	173
December 3, Downing St.	Same. (No. 7.) Transmitting copy of a letter from the Treasury with its enclosures relative to the impropriety of including military expenses in the accounts of the Province of Upper Canada.	175
December 3, York.	Brock to Liverpool. Acknowledging letter, stating that an annual grant of £100 for every future missionary sent to this colony had been sanctioned. The great need of more workers. Reports the arrival of Mr. Justice Campbell.	176
December 3, Admiralty office.	Croker to Peel. Having laid before the Commissioners of the Admiralty a letter transmitting an extract of one from Mr. Boulton, Solicitor General of Upper Canada, who was captured on board the "Minerva" on his passage from Quebec, suggesting how an application for his release might be made, is commanded by the Commissioners to state, for Lord Liverpool's information, that the French Government will be applied to for his release.	271
	<i>Enclosed.</i> Extract of letter, dated Verdun, 1st October, 1811.	272
December 5, Downing St.	Draft of a letter to Gore or the Officer administering the Government of Upper Canada. (No. 8.) The Commissioners of the Treasury approve of an increase to the salary of Col. Claus.	178
December 20, Treasury.	Harrison to Peel. Transmitting letter from Brock containing requisitions for stationery for 1812, for Lord Liverpool's opinion thereon.	270

ACTING GOVERNOR I. BROCK, LIEUT.-GOVERNOR R. H. SHEAFFE—1812.

### Q. 315.

1812. February 7, Downing St.	Draft of a letter to Gore or Officer administering the Government of Upper Canada. (No. 9.) Transmitting an application made by Lord Amherst in favour of Mr. Hale, Deputy Paymaster General at Quebec, who solicits a grant of land. Recommends the application.	Page 2
March 12, Downing St.	Draft of a letter to Brock or Officer administering the Government of Upper Canada. (No. 1.) Transmitting copy of a letter from Gore recommending an additional grant to Mr. Cartwright of 3,000 acres. The Prince Regent approves of the grant.	3
March 23, York.	Brock to Liverpool. The Legislature met on the 3rd ult. Enclosed speeches will give an idea of the temper with which the session commenced. The first bill passed was one to give an additional reward of £5 for every deserter from His Majesty's service. From the number of aliens in Canada had judged an oath of abjuration advisable, but failed in passing the measure. Had also attempted to pass in the Legislative Council a bill for the suspension of the <i>Habeas Corpus Act</i> but failed in	

## Department of Agriculture—Archives.

1812.

	that also. The sum of £5,000 has been appropriated to the use of the Militia, on which he will draw if the aspect of public affairs should call for active measures. Perfect reliance can be placed on the loyalty of the original inhabitants and their descendants. The proceedings in Congress have induced several Americans to withdraw from this Province and many more are preparing to follow. Transmits schedule of Bills which passed the Legislature. Also papers on different subjects. The instructions of Sir James Craig have been well enforced by the officers of the Indian Department to prevent the commencement of hostilities; and though about 300 have had recourse to arms yet the neutrality held by numerous tribes has saved the Western country from destruction. Page 4	
	<i>Enclosed.</i> Speeches on the opening of the Legislature.	14 to 27
	Schedule of Bills passed.	28
	Address from the House of Assembly to Prince Regent respecting a number of Loyalists, &c., who have not received grants of land.	31
	Report of the Executive Council on the above.	36
	Report from the House of Assembly to the Prince Regent; praying for redress from the decision of Chief Justice Scott who had liberated Robert Nichol's from prison.	39
	Papers on the subject of Robert Nichol's commitment.	41 to 69
	Speeches on prorogation.	70, 71
	Observations on the actual state of the Province signed by Brock, and dated 3rd December, 1811.	73
April 2, Downing St.	Draft of a letter to Brock. (No. 2.) Sir George Prevost has been appointed Lieut.-Governor.	85
April 10, Downing St.	Same. (No. 3.) Respecting duties on goods imported from the United States.	86
April 14, Downing St.	Same. (No. 4.) Informing them that requisition for goods required to pay for lands to be purchased from the Chippawas and Mississaguas will be forwarded to Canada.	88
April 14, Downing St.	Draft of a letter to Gore. The Prince Regent has confirmed the appointment of Alexander McDonell to be Attorney General of Upper Canada.	89
April 16, York.	Brock to Liverpool. Transmitting continuation of the minutes of the Executive Council on State matters from 3rd August, 1810, to 5th October, 1811, and on Land matters from 1st July, 1810, to 5th October, 1811.	90
April 18, York.	Brock to Liverpool. Enclosing abstract from the Auditor's Docket Books.	91

1812.

ABSTRACT from the Auditor's Docket Books of Grants of Land in Upper Canada which have passed the Great Seal of this Province between the 1st January and 31st December, 1811, inclusive.

Counties.	Number of Grants.	Districts.	Number of Acres.	Total Number of Grants.	Total No. of Acres Granted.
York.....	238	Home.	46,379 <sup>1</sup> / <sub>10</sub>	238	46,379 <sup>1</sup> / <sub>10</sub>
Durham .....	4	} Newcastle.	950	} 24	5,190
Northumberland .....	20		4,240		
Lincoln.....	41	Niagara.	8,569	41	8,569
Glengarry.....	8	} Eastern.	1,595	} 70	15,194 <sup>3</sup> / <sub>10</sub>
Dundas.....	5		1,050		
Prescott.....	2		600		
Russell.....	49		11,800		
Stormont.....	6		149 <sup>5</sup> / <sub>10</sub>		
Grenville.....	28	} Johnstown.	2,224	} 61	8,924
Carleton.....	1		300		
Leeds.....	32		6,400		
Essex.....	15	} Western.	2,751	} 23	4,906
Kent.....	8		2,155		
Middlesex.....	3	} London.	2,018	} 43	14,024
Norfolk.....	29		9,306		
Oxford.....	11		2,700		
Frontenac.....	27	} Midland.	2,604 <sup>3</sup> / <sub>10</sub>	} 83	12,400 <sup>3</sup> / <sub>10</sub>
Hastings.....	12		2,485		
Lennox and Addington.....	19		3,307		
Prince Edward.....	25		4,004		
			Total... 583		115,586 <sup>1</sup> / <sub>10</sub>

Errors excepted.

P. SELBY,

*Auditor General.*

Page 92

April 20,  
York.

Brock to Liverpool. Transmitting copies of the laws of the Fourth Session of the Fifth Provincial Parliament, also copies of the Journal of the two Houses during the same session. 94

May 11,  
York.

Same to same. Acknowledging receipt of letter of 3rd December addressed to Gore, with its enclosures relating to the impropriety of including Military expenses in the accounts of Upper Canada. Every attention will be given to the instructions. 95

## Department of Agriculture—Archives.

1812. May 11, York.	Same to Peel. Acknowledging circular letters of 5th and 17th December together with the London Gazette's extraordinary, detailing the brilliant achievements of the British Army under Lieut. Generals Hill and Achmutz. <span style="float: right;">Page 97</span>	114
May 19.	Extract from the proceedings in Council approving of the measure proposed by Brock. <span style="float: right;">114</span> <i>Enclosed.</i> General Brock's proposal that at the present juncture the Prince Regent should be moved to give permission to place the family of every soldier, regular and militia, also of every mariner on the Lakes, who may be killed in the coming contest, upon the U. E. list and to extend this advantage to every mariner and militia man who may be maimed or disabled upon actual service. <span style="float: right;">115</span>	114
May 23, Downing St.	Draft of a letter to Gore or Officer administering the Government in Upper Canada. Transmitting letter from the Treasury containing the decision upon the application of the Baroness De Longueuil and Mr. Langan. <span style="float: right;">98</span>	98
May 23, Downing St.	Same. (No. 6.) Transmitting decision of the Treasury on the memorial of Messrs. Ridout and Chewett. <span style="float: right;">99</span>	99
May 23, Downing St.	Same. (No. 7.) Transmitting copy of letter from the Treasury stating that the goods asked for to pay for certain tracts of land purchased from the Indians will be shipped to Canada. <span style="float: right;">100</span>	100
May 23, Downing St.	Draft of a letter to Brock or Officer administering the Government. Transmitting memorial of Mr. Firth, late Attorney General of Upper Canada. Observations on the memorial. <span style="float: right;">101</span>	101
May 25, York.	General order. Application has been made to the Prince Regent asking that lands be allotted to the wives and children of such soldiers and marines as may be killed in the present contest, and relief afforded to those who may be wounded and for whom no other provision is made. <span style="float: right;">110</span>	110
June 3, Downing St.	Draft of a letter to Brock or Officer administering the Government. (No. 8.) The nine Acts passed by the Legislature of Upper Canada in March, 1811, have been submitted to the Privy Council and do not appear liable to any objection. List of the Acts. <span style="float: right;">104</span>	104
July 4, Downing St.	Draft of a letter to Brock (No. 1.) Transmitting extract of a letter written to Mr. Firth by Lord Liverpool's direction, on the subject of his accounts. <span style="float: right;">108</span>	108
July 12, Sandwich.	Proclamation of General Hull to the inhabitants of Canada. (In Brock's of 29th August.) <span style="float: right;">147</span>	147
July 22, Fort George.	Proclamation issued by General Brock in answer to Hull's. (In Brock's of 29th August.) <span style="float: right;">152</span>	152
July 28.	Speeches on the opening of the Legislature of Upper Canada. <span style="float: right;">131 to 142</span> (In Brock's of 29th August.)	131 to 142
July 30, Downing St.	Draft of a letter to Brock (No. 2.) Transmitting letter from the Treasury, enclosing copy of a report from the commissioners of taxes respecting the salaries of Civil Officers in Upper Canada. <span style="float: right;">110</span>	110
July 31, Downing St.	Same. (No. 3.) Transmitting copy of a memorial from Mr. Davenport Phelps praying for lands. <span style="float: right;">111</span>	111
August 3, York.	Proceedings in Council deciding that Martial Law may be proclaimed and exercised. (In Brock's of 29th August.) <span style="float: right;">126</span>	126
August 5.	Speeches on the closing of the Legislature of Upper Canada. (In Brock's of 29th August.) <span style="float: right;">143</span>	143
August 10, Downing St.	Draft of a letter to Brock (No. 4.) Despatches received and laid before the Prince Regent who approves of the measures already taken and is confident that his zeal and activity have increased in proportion to the hostility shown by the United States. Is convinced support may be	

1812. had if required from Sir George Prevost. The liberal appropriations made by both provinces and the loyal spirit of the inhabitants leaves little apprehension of the ultimate result of any action. Page 112
- August 10. Proclamation by Major General Brock to the people of the Michigan Territory. 172  
(In Brock's of 29th August.)
- August 16, Detroit. Capitulation for the surrender of Fort Detroit entered into between Major General Brock and Major General Hull. 168  
(In Brock's of 29th August.)
- August 17, Detroit. Brock to Prevost. The enemy crossed the Detroit River on the 12th ult., without opposition, established himself at Sandwich and ravaged the country as far as the Moravian town. Some skirmishes took place between the enemy and the troops under Lt.-Col. St. George. An account of the surrender of Detroit and the capitulation of Hull and his army on the 16th August. 157  
(In Brock's of 29th August.)
- August 29, York. Same to Liverpool. The invasion by General Hull having produced such an effect that the Norfolk Militia refused to march, he thought it his duty to lay the enclosed representation before the Executive Council. The Legislature prorogued after passing the money bills. Transmits speeches on the opening and closing of both Houses. Is much troubled by the disposition shown by the people of the Western district to submit tamely and of the Six Nations at the Grand River to remain neutral. Encloses copy of Hull's proclamation on taking possession of Sandwich and the counter proclamation which he (Brock) had issued with good effect. Refers him (Liverpool) to his official despatch for his subsequent proceedings. Some account of Tecumseh and the Indians in general. The reinforcements lately arrived place this country beyond the likelihood of an attack. 118  
(Enclosures calendared at their respective dates.)
- August 30, York. Same to Liverpool. Before the despatch respecting the duties to be imposed on American manufactures was received, war had been declared by the United States. When tranquility is restored the commands will be obeyed. 174
- August 31, York. Same to same. Despatches received. Encloses answers to questions contained in that of 25th November, 1811. 176  
*Enclosed.* Questions. 178
- August 31, York. Same to same. Recommending that John McDonnell be confirmed in his appointment as Attorney General of Upper Canada. 185
- September 1, York. Same to same. Acknowledging despatch respecting foreigners arriving in the Province from the parts of Europe that are under the control of the French Government. 187
- September 14, Fort George. Same to Bathurst. (No. 1.) Despatch stating that the seals of the Colonial and War Department had been entrusted to him (Bathurst) received. 192
- September 14, Fort George. Same to same. (No. 2.) Despatch enclosing memorial of the late Attorney General Firth received. The explanations asked for cannot be transmitted by this opportunity. Encloses copy of the general order respecting Mr. Lees, of the 100th Regiment, of which Mr. Firth complains. 193  
*Enclosed.* The General order. 195
- September 26, York. Same to same. (No. 3.) Respecting Mr. Firth's accounts. Despatches received. 197
- September 28, York. Same to George Harrison. Transmitting for the information of the Lords of the Treasury, a report of the Executive Council as to whether Messrs. Campbell and Grece have complied with the conditions required by their bonds to encourage the culture of hemp. 198  
*Enclosed.* The report. 199

## Department of Agriculture—Archives.

1812.

Draft of a letter to Brock. (No. 5.) Transmitting copy of a letter respecting the shipment of stationery for the Indian Department, Upper Canada. Page 204

October 20,  
York.

Major General R. H. Sheaffe to Bathurst. (No. 1.) In consequence of the death of Major General Brock, has taken the oaths as President to administer the Civil Government. Encloses extract of his (Sheaffe's) despatch on the subject of the public loss. No word from Proctor at Detroit lately. The last stated that troops were on the march against him. The enemy has been reinforced on the Niagara Frontier since the 13th inst., and expect more help. They seem determined to repeat the attacks and by the aid of numbers and perseverance they may eventually succeed in gaining possession of a small part of the Province unless reinforcements speedily arrive. At present an armistice exists between himself and Brigadier General Smyth, thirty hours' notice to be given of intended rupture. Lt.-Col. McDonnell, Provincial Aide-de-camp to Brock, and Attorney General of this Province, died on the 14th inst., of wounds received in the action at Queenston. Shall appoint some one to act in his place till His Majesty's pleasure be known. 205

*Enclosed.* Extract, dated 13th Oct., 1812, and addressed to Sir George Prevost. 208

November 16,  
Downing St.

Draft of a letter to Brock. (No. 6.) Despatches received and laid before the Prince Regent, who approves of his (Brock's) conduct. As the success in Upper Canada has secured peace there for some time, he trusts that due preparations will be made to meet future invasions. Mr. McDonnell's appointment has been confirmed. The conduct of many of the Indian tribes gives them a fair claim to protection and reward. 189

December 14,  
Downing St.

Draft of a letter to the Officer administering the Government of Upper Canada. (No. 1.) Giving authority to increase the salary of Mr. Givens, Superintendent of Indians. Grant of land to be made to Mr. Selby, Receiver General of Upper Canada. 211

December 15,  
Downing St.

Same (No. 2.) Edward Bowen has been appointed Attorney General of Upper Canada. 213

December 15,  
Downing St.

Same. (No. 3.) Transmitting memorial of Mr. McGillivray and papers relating thereto. The subject to be put before the Council. 214

December 31,  
Fort George.

Sheaffe to Bathurst. (No. 1.) Being constantly in the presence of the enemy, has prevented him from writing frequently. Respecting the Militia and the Provincial Marine. Proposes going to York, where he will consult the Executive Council as to the expediency of assembling the Legislature before the close of the winter. 219

December 31,  
Fort George.

Same to same. (No. 2.) John Beverly Robinson was sworn in on the 3rd inst. to act as Attorney General of the Province. 216

December 31,  
Fort George.

Same to same. (No. 2.) Enclosing requisition for an extra quantity of Indian presents for 1813, in the event of war continuing. 223

*Enclosed.* The requisition. 224

December 31,  
Fort George.

Same to same. (No. 3.) Acknowledging despatches. The Executive Council has not yet prepared a report on the memorial of Mr. Davenport Phelps. 218

Quebec.

Plan of Fort at Detroit. 173a.

Schedule of the Acts passed in the first (extra) session of the 6th Provincial Parliament of Upper Canada. 145

(In Brock's of 29th August.)

## MISCELLANEOUS.—1812.

## Q. 316

1808. July 30, York.	Gore to Castlereagh. Enclosing papers respecting Mr. Langan's claim to Grand Isle, opposite Kingston, and asking directions on the subject. <span style="float: right;">Page 289</span>
	<i>Enclosed.</i> Petition of Baroness de Longueuil and Patrick Langan, stating that they are the lawful proprietors of Grande Isle and the three small adjacent islands, Garden, Forest and Nut, and asking that they be left in possession. Opinion of the Solicitor General of England respecting His Majesty's title to Grand Isle, dated 28th January, 1796. <span style="float: right;">304</span>
	The report of Attorney General Powell, of Lower Canada, respecting Grand Isle. <span style="float: right;">306</span>
1812. January 1.	Certificate that D'Arcy Boulton, Solicitor General for Upper Canada, is held prisoner at Verdun, France. <span style="float: right;">3</span>
January 1, Montreal.	Amherst to Liverpool. Soliciting a grant of 5,000 acres in Upper Canada for his brother-in-law, Mr. Hale, Deputy Paymaster General. <span style="float: right;">4</span>
January 7, London.	Alex. McDonnell to Gore. Asking that he, as sole executor for the late Solicitor General Gray, drowned on the "Speedy" on Lake Ontario, be given an order for for the salary due him. <span style="float: right;">272</span>
	<i>Enclosed.</i> Copy of letter of administration certified by Joseph Cheniquy. <span style="float: right;">274</span>
	Certificate, that Joseph Cheniquy is a duly commissioned Notary Public. <span style="float: right;">277</span>
	Certificate that Robert Isaac DeyGray fulfilled his duties as Solicitor General of Upper Canada from 13th June to 8th October, when he embarked on the "Speedy" which is supposed to have foundered. <span style="float: right;">278</span>
January 13, Riegate.	John Wm. McGrue to Liverpool. Asking for 40,000 acres of land. <span style="float: right;">6</span>
	<i>Enclosed.</i> Some reflections, in addition to the memorial presented to Liverpool, by John McGrue. <span style="float: right;">9</span>
January 18, Norwich.	Wm. Firth, Attorney General of Upper Canada, to Liverpool. Recapitulation of his complaints against the Governor and Executive Council of Upper Canada. <span style="float: right;">13</span>
February 19, Treasury Chambers.	Harrison to Peel. Respecting the provisions for the Indian Department and the pensions for officers of the same. <span style="float: right;">28</span>
February 19, Treasury Chambers.	Same to same. Asking from what fund the pension of Captain Steele, of the Provincial Marine, is to be paid. <span style="float: right;">30</span>
February 24.	Gore to same. Respecting the provisions and rum for the Indians and also the pensions of the department. <span style="float: right;">31</span>
February 24.	Same to same. Captain Steele's pension is paid out of the Military chest at Quebec. <span style="float: right;">33</span>
February 29, Treasury Chambers.	R. Wharton to same. Transmitting abstracts of warrants issued by Gore on the Receiver General of Upper Canada, from 1st October, 1810, to 7th Oct., 1811, for Lord Liverpool's observations thereon. <span style="float: right;">34</span>
March 5, Treasury Chambers.	Harrison to same. Transmitting letter from Brock, enclosing two requisitions for goods required to pay for lands to be purchased, from the Chippawa and Mississagua Indians in Upper Canada, for Lord Liverpool's opinion thereon. <span style="float: right;">35</span>
March 9, London.	Wm. Smith to ——. Transmitting a memorial from Mr. Firth, Attorney General of Upper Canada. <span style="float: right;">36</span>
March 10.	Gore to Peel. His reasons for entering into a provisional agreement with the Indians of Matchedash and Lake Simcoe for the purchase of about 250,000 acres of land. <span style="float: right;">38</span>
March 11.	Same to same. Observations on Mr. Firth's memorial. <span style="float: right;">42</span>

## Department of Agriculture—Archives.

1812.  
March 12. Wyatt to same. Asking again for copies of certain official letters written by Lord Castlereagh, relative to his suspension from office, the first copies having been mislaid. Page 66
- March 13,  
Washington. Foster, His Majesty's Envoy, to ———. Believes the information he has received of the defenceless state of Detroit to be correct, has written to Prevost to put him on his guard against surprising it even should a declaration of war be proposed in Congress. After war has actually commenced is time enough to take offensive measures. 174  
(In Hamilton's of 5th May.)
- March 21. Wyatt to Peel. Thanks for the copies of the letters asked for. Gives the following extract of a letter from Castlereagh. "What might be deemed charges against Mr. Wyatt, I considered he had satisfactorily explained when I recommended to the Treasury to employ Mr. Wyatt elsewhere." 68
- March 21,  
Riegate. John Wm. Grue (or McGrue?) to same. Thanks for his note stating that the Governor of Upper Canada will make out a grant of such proportion of land as he considers proper. Asks for some official letter to present on arriving in Canada. 69
- March 21. W. D. Adams to Harrison. Stating that a moiety of Mr. Wyatt's salary has been paid to Messrs. Chewett and Ridout. 139  
(In Harrison's of 14th April.)
- March 31,  
Treasury Chambers. R. Wharton to Peel. The Lords Commissioners see no objection to Mr. Gore's suggestions respecting the proposed road in the Western District. 70
- April 6,  
Treasury Chambers. Harrison to same. Respecting the salary of Mr. Justice Powell. 71
- April 9,  
Downing St. Peel to Gore. In reference to letter of 11th ultimo, states that Lord Liverpool has selected such extracts from the letters addressed to him by Mr. Firth as appear to comprehend the specific grounds of Mr. Firth's complaint. 44  
*Enclosed.* The extracts. 45 to 65
- April 10. Wyatt to Liverpool. Asking to be furnished with such parts of Mr. Gore's letters as constitute charges against him (Wyatt). 72
- April 11. Gore to ——— (Private). Has made a few notes for his (Gore's) information on the conduct of Mr. Firth while in Canada. 73
- April 11. Same to Peel. Letter of 9th instant, transmitting extracts from letters of Mr. Firth received. Encloses explanations upon some of the circumstances referred to in the extracts which come within his own personal knowledge and suggests that such passages as relate to the Executive Council, Bench, &c., in Canada be forwarded to them. 74  
*Enclosed.* The explanations. 75 to 87
- April 11. Gore's reply to an extract of a letter from Wm. Firth, dated York, 10th April, 1810. 88  
*Enclosed.* Documents relating to the same. 93 to 126
- April 13,  
Downing St. Draft of a letter to Gore. The letters on the subject of Firth's accounts and his conduct in quitting the Province without leave have been laid before the Prince Regent, who upholds his (Gore's) conduct. 136
- April 14,  
Treasury Chambers. Harrison to Peel. Transmitting letter from Mr. Adams upon the memorial of Messrs. Ridout and Chewett, praying for a moiety of Mr. Wyatt's salary during his suspension while they performed his duties, for Lord Liverpool's opinion on the application. 138  
(Enclosure calendared at its proper date.)
- April 14. Adams to same. Enclosing certificate that Mr. McDonell has discharged the duties of the Attorney General from 28th September to 31st December, 1811, with an order to pay the salary due to Mr. Wm. Allan. Asks for directions. 141  
*Enclosed.* The certificate. 143



1812. April 21.	Memorial of Wm. McGillivray. Asking that the St. Regis Indians be permitted to give him a perpetual lease of their lands opposite the village of St. Regis.	144
	<i>Enclosed.</i> Petition of the Iroquois Indians of St. Regis to Gore, with the same request.	150
	Gore's answer to the above refusing the request.	152
April 24, Treasury Chambers.	Harrison to Peel. The goods asked for by Brock to pay for certain lands in Upper Canada purchased from the Indians are to be forwarded to Canada.	154
April 24, Norwich.	Firth to same. Observations on his letter of 13th instant.	155
April 27.	Gore to Liverpool. Expressing his satisfaction that Mr. McDonell has been confirmed in his appointment of Attorney General.	161
April 29, Treasury Chambers.	Harrison to Peel. Transmitting letter from Brock, inclosing requisitions for stationery for the Indian Department for Lord Liverpool's opinion thereon.	162
April 30.	Smith, Payne and Smith. Stating in connection with the memorial of Wm. McGillivray that they have known him for many years and believe him to be of high character.	163
May 2.	Gore to Liverpool. Respecting the fees which form part of the emolument of the Lieutenant-Governor of Upper Canada.	164
	<i>Enclosed.</i> Statement.	167
May 2.	Thomas Scott to Gore. An account of his dispute with the House of Assembly.	281
May 5.	Adams to Peel. Respecting the salary of Major General Brock.	171
May 5.	John Honeyman, agent for Wm. Campbell to same. Respecting Campbell's salary as Judge of the King's Bench in Upper Canada.	172
May 5, Foreign Office.	Wm. Hamilton to same. Transmitting extract from a despatch from His Majesty's Envoy at Washington, dated 13th March.	173
	(Enclosure calendared at its proper date.)	
May 9.	Gore to same. Returns communication from the Treasury of 29th April. The arrears of stationery for the Indian Department should be ordered out to this country.	175
May 18, Treasury Chambers.	Harrison to same. Directions as to the salary of Mr. Wyatt during his suspension.	176
May 19.	Wyatt to same. Asking for copies of the charges preferred against him.	178
May 20, Whitehall.	Chetwynd to same. Returning Acts passed by the Legislature of Upper Canada which do not appear to require confirmation but may be left to their own operation.	180
May 25, Horse Guards.	Torrens to same. Having laid before the Commander-in-Chief his letter of 23rd instant, with enclosure, states that no such general order as therein alluded to is reported to have been issued. The subject will be referred to Prevost.	181
May 26.	Gore to same. (Private.) Is much pleased with the decision on the claim of the Baroness de Longueuil and Mr. Langan. Asks for a copy of Mr. Harrison's letter on the subject,	182
May 27, Downing St.	John Wm. Grue (or McGrue) to same. Asking for such a letter to the Governor of Upper Canada as will entitle him to attention.	183
May.	Memorial of Margaret Vesey to the Earl of Liverpool, for a grant of land.	185
June 1.	Gore to Peel. Conditions under which he thinks the land reserved for the St. Regis Indians might be granted to Mr. McGillivray.	187
June 6.	Same to same. Asking whether he thinks it probable Lord Liverpool would find any difficulty in granting him a tract of land.	189
June 6.	Copy of the proceedings of Council relative to the memorial of Mr. Secretary Jarvis, asking for compensation for the stationery, &c., used for deeds in the land granting office.	279

## Department of Agriculture—Archives.

1812. June 8.	Wm. Jarvis, Secretary of Upper Canada, to Gore. Assuring him that he (Jarvis) had never authorized Mr. Firth to use his name, and denies being aggrieved by his (Gore's) conduct. <span style="float: right;">Page 132</span>	193
June 30, Whitehall Palace.	Adams to Peel. Respecting Mr. D'Arcy Boulton's salary as Solicitor General of Upper Canada. <span style="float: right;">191</span>	191
July 9, Treasury Chambers.	Harrison to same. Transmitting a memorial from Dr. Ridout, praying for the payment of salary due his brother, Thomas Ridout. <span style="float: right;">193</span>	193
July 14.	Gore to Bathurst. Enclosing memorial of Prideaux Selby, Receiver-General of Upper Canada. <span style="float: right;">194</span>	194
	<i>Enclosed.</i> The memorial. <span style="float: right;">195</span>	195
July 15.	Wyatt to Bathurst. Repeating his request for a copy of the charges preferred against him. <span style="float: right;">197</span>	197
July 21.	E. W. Phelps to Peel. Enclosing a memorial from Davenport Phelps asking for a grant of land. <span style="float: right;">200</span>	200
	<i>Enclosed.</i> The memorial. <span style="float: right;">201</span>	201
July 23.	Gore to same. Recommending that the memorial of Davenport Phelps be referred to the Council of Upper Canada. <span style="float: right;">204</span>	204
August 5, London.	J. Barker, Deputy Storekeeper General, to Harrison. Reporting the shipment of the stationery for the use of the Indian Department in Upper Canada. <span style="float: right;">212</span>	212
August 8, London.	Same to same. Reporting the shipment of the Indian stores to pay for the land purchased from the Chippawa and Mississagua Indians. <span style="float: right;">214</span>	214
August 13.	Wyatt to Bathurst. Asking for an answer to his letter of the 15th ult. <span style="float: right;">206</span>	206
August 14.	Gore to Peel. Calling his attention to the following points which should be settled before he (Peel) leaves the office, viz.: Mr. Given's salary to be increased; grant of land to be made to Mr. Selby; approval of certain sums for secret services expended by him (Gore) to be forwarded to Canada; attention to be given to the House of Assembly who have petitioned the Prince Regent to remove the Chief Justice. Has received a private note from Harrison stating that Liverpool had acceded to the arrangements for increasing the salary of the Lieut.-Governor of Upper Canada. <span style="float: right;">207</span>	207
August 20, Treasury Chambers.	Wharton to same. Enclosing a copy of a letter from the Deputy Storekeeper General reporting the shipment of stationery for the Indian Department. <span style="float: right;">211</span>	211
	(The enclosure calendared at its proper date.)	
August 20, Plimpton.	Memorial of Count Joseph de Puisaye to Liverpool. Asking that Commissioners be appointed to enquire into his own claims and those of the Royalists he had brought out from France. <span style="float: right;">217</span>	217
	(In Wharton's of 9th September.)	
August 22, Treasury Chambers.	R. Wharton to Colonel Bunbury. Enclosing copy of a letter from the Deputy Storekeeper General, reporting the shipment of Indian stores. <span style="float: right;">213</span>	213
	(Enclosure calendared at its proper date.)	
September 1, Treasury Chambers.	Same to same. The four items in Gore's account mentioned in Peel's letter of 18th March last, have been allowed for. <span style="float: right;">215</span>	215
September 9, Treasury Chambers.	Same to Henry Goulburn. Enclosing letter, &c., from Count de Puisaye, respecting the investigation of his claims, for Lord Bathurst's observations thereon. <span style="float: right;">216</span>	216
	(Enclosure calendared at its proper date.)	
September 16, Treasury Chambers.	Harrison to same. In reply to Gore's suggestion that a fixed salary be given the Governors in lieu of fees, the Commissioners of the Treasury have directed that all the fees in future be paid to the Receiver General and £1,000 be given to the Lieut.-Governors in their stead.	

1812. September 30.	John Francklin to same. Enclosing a certificate from Verdun that D'Arcy Boulton, Solicitor General for Upper Canada held prisoner there, is still alive, and asking for an order from Lord Bathurst for his half year's salary.	Page 225
	<i>Enclosed.</i> The certificate.	226
October 22, Quebec.	Extract of letter from Mrs. — to Mrs. —. The news of the taking of Detroit has been followed by the news of another dear bought victory, owing to the death of Major General Brock. He is universally regretted, and had much influence over the Canadians and Indians. Gives copy of a speech made to him by Tecumseh.	245
October 24, Downing St.	Mr. Gordon to Mr. Acheson, acting for Wm. McGillivray. The papers on the subject of McGillivray's petition have been sent to the Treasury, with a request that if the decision is favourable, instructions shall be sent to the Colony to carry the arrangements into effect.	229
October 29, London.	Simon McGillivray to Sir James Shaw, M.P. Asking that he use his influence to further the application of his brother, Wm. McGillivray, who wishes to secure an order from Government permitting him to purchase a tract of land opposite St. Regis from the Indians.	227
November 16, Treasury Chambers.	Wharton to Goulburn. The Commissioners of the Treasury, having considered Wm. McGillivray's memorial, think that he might be allowed to acquire at least a part of the land under certain restrictions.	230
November 28.	John Savery Brock to Bathurst. In compliance with his request, encloses an account of the near relations of his brother, the late Major General Brock, who had determined that all should profit from his pay and emoluments.	234
	<i>Enclosed.</i> The account.	236
	Extracts of letters from Brock to his brothers.	241
December 4.	J. Doyle, L. G., to Goulburn. Enclosing copies of three letters from Brock to his family, which, as they portray his character, should be shown to Bathurst.	247
	<i>Enclosed.</i> Extract of letters from Brock to his brothers in England.	248
December 8.	Edward Begg to Bathurst. Urging the claims of the relatives of Brock.	253
December 18.	Gore to same. Asking for an extension of his leave.	256
December 18, Stamford Hill.	Wm. Brock to ——. Thanking His Majesty's Ministers for their sympathy and their benevolent intention of recommending an allowance to each of Brock's relatives standing in need of it. Asks for some position to enable him to support his family.	257
December 31, Treasury Chambers.	Harrison to Goulburn. In order to prevent any future dissatisfaction among the Indian tribes respecting their stores, asks that the Treasury be furnished with particulars of the complaints.	260
No date.	Notice to His Excellency on the want of King's Council to reside in the several districts.	127
No date.	P. Selby, Receiver General. Certificate as to the date of the payment of the circuit expenses.	135
No date.	Memorandum, unsigned, respecting the fees and Mr. Firth's conduct, and asking that the unofficial document before presented to the Lieutenant-Governor should be entered in the Council books as an official document and an answer to Mr. Firth's reproach on the Board of Audit.	262

## Department of Agriculture—Archives.

LIEUT.-GOVERNOR R. H. SHEAFFE, LIEUT.-GOVERNOR. F. DE ROTTENBURG  
AND MISCELLANEOUS—1813.

### Q. 317.

- |                                                         |                                                                                                                                                                                                                                                                                                                                                                                                                                                                                                                                                                                                                                                                                                                                                                                                                                                                                                |           |
|---------------------------------------------------------|------------------------------------------------------------------------------------------------------------------------------------------------------------------------------------------------------------------------------------------------------------------------------------------------------------------------------------------------------------------------------------------------------------------------------------------------------------------------------------------------------------------------------------------------------------------------------------------------------------------------------------------------------------------------------------------------------------------------------------------------------------------------------------------------------------------------------------------------------------------------------------------------|-----------|
| 1811.<br>October 24,<br>York.                           | Address from some inhabitants of Upper Canada, stating their satisfaction at the removal of Gore.                                                                                                                                                                                                                                                                                                                                                                                                                                                                                                                                                                                                                                                                                                                                                                                              | Page 177. |
| 1812.<br>November 23,<br>Fort George.                   | Sheaffe to Prevost. Fire was commenced on Fort Niagara on the 21st inst. Enclosing a report of the events of the day. The advantage, though not so great as might have been expected, is on our side. Captain Fry, an old half pay officer, was killed while collecting shot, as he said to send back to the enemy. A private in the 49th was also killed. The enemy's expenditure of ammunition was very great. Has observed two of the enemy's camps, one at Schlosser and the other at Black Rock. The greatest number of troops are said to be near Buffalo. Has sent Indians to watch their movements. Colonel Bisshopp commands that flank instead of Major General Shaw, who returns to his duty as Adjutant General of Militia. The number of Militia in the field has considerably increased since the notice of the termination of the armistice.                                    | 3         |
| November 23,<br>Chippawa.                               | <i>Enclosed.</i> Report of Christopher Myers, Lieut.-Col. acting, Quartermaster General, and commanding Fort George.                                                                                                                                                                                                                                                                                                                                                                                                                                                                                                                                                                                                                                                                                                                                                                           | 7         |
| December 1,<br>Frenchman's<br>Creek, near<br>Fort Erie. | Sheaffe to Prevost. Early in the morning of the 28th inst., an attack was made by the enemy on our batteries opposite Black Rock. At first their superior numbers overcame us, but reinforcements arriving they were forced to retire. He (Sheaffe) went up on receiving notice of the action and found the enemy in great force and making a display of it, evidently to give effect to the summons sent to Col. Bisshopp to surrender Fort Erie. Is now at this post, as it is a central situation for receiving news. Captain Fitzgerald, 49th Regiment, was employed to carry Lieut.-Col. Bisshopp's answer to Black Rock, where he saw Brig. General Smyth, who showed him the large force there. Has not yet received the official report and returns from Lieut.-Col. Bisshopp. He and his officers deserve high commendation. Lieuts. King and Lamont of the 49th were early disabled. | 11        |
| 1813.<br>January 1,<br>Stamford<br>Hill.                | Cecil Bisshopp, Lieut.-Colonel commanding, to Sheaffe. Report of the affair with the enemy on the 28th November near Fort Erie.                                                                                                                                                                                                                                                                                                                                                                                                                                                                                                                                                                                                                                                                                                                                                                | 14        |
| January 14,<br>London.                                  | <i>Enclosed.</i> Return of the killed, wounded and missing.                                                                                                                                                                                                                                                                                                                                                                                                                                                                                                                                                                                                                                                                                                                                                                                                                                    | 22        |
| January 15,<br>Fort George.                             | Wm. Brock to Goulburn. Thanks for the liberal manner in which he and his brothers have been treated.                                                                                                                                                                                                                                                                                                                                                                                                                                                                                                                                                                                                                                                                                                                                                                                           | 175       |
| January 25,<br>Sandwich.                                | John Mills Jackson to Bathurst. Having been entrusted with an address to the Prince Regent from the inhabitants of Upper Canada, forwards the same and requests it may be laid before the Prince.                                                                                                                                                                                                                                                                                                                                                                                                                                                                                                                                                                                                                                                                                              | 176       |
|                                                         | Sheaffe to same. Transmitting duplicates of his despatches to Prevost of 23rd and 30th November.                                                                                                                                                                                                                                                                                                                                                                                                                                                                                                                                                                                                                                                                                                                                                                                               | 2         |
|                                                         | Henry Procter, Colonel commanding, to Sheaffe. Account of the engagement at French Town.                                                                                                                                                                                                                                                                                                                                                                                                                                                                                                                                                                                                                                                                                                                                                                                                       | 25        |
|                                                         | <i>Enclosed.</i> Return of the whole of the troops, Regulars, Militia, Marine and Indian Department engaged in the action at French Town, with number of killed and wounded.                                                                                                                                                                                                                                                                                                                                                                                                                                                                                                                                                                                                                                                                                                                   | 31        |
|                                                         | List of the officers in the action.                                                                                                                                                                                                                                                                                                                                                                                                                                                                                                                                                                                                                                                                                                                                                                                                                                                            | 32        |
|                                                         | Return of arms, ammunition, &c., taken from the enemy.                                                                                                                                                                                                                                                                                                                                                                                                                                                                                                                                                                                                                                                                                                                                                                                                                                         | 34        |
|                                                         | Return of the prisoners of war taken.                                                                                                                                                                                                                                                                                                                                                                                                                                                                                                                                                                                                                                                                                                                                                                                                                                                          | 36        |

1813. February 14, Fort George.	Sheaffe to Bathurst. (No. 2.) Transmitting copy of a despatch from Colonel Procter, commanding at Detroit, reporting his defeat of the Americans under Brigadier General Winchester, at French Town, on the River Raisin. The gallant conduct of Procter and his little corps entitle them to the highest commendation. The enemy quiet in this vicinity. The Legislature to meet on the 25th inst.	Page 23
February 17.	John Franklin to Goulburn. Respecting the salary of Mr. D'Arcy Boulton.	186
February 18, Stamford Hill.	Wm. Brock to Castlereagh. Enclosing two letters from Sir Isaac's Aide-de-camp, one from an inhabitant of Montreal, and the address of the Executive Council to his (Major General Brock's) successor, all of which go to show the general opinion entertained of the late gallant officer.	202
	<i>Enclosed.</i> Extracts of letters from Major Glegg to Wm. Brock, the first dated 14th October, 1812, and the second the 25th of the same month.	203, 204
	Letters from Isaac Todd, Montreal, to Wm. Brock.	209
	Address of the Executive Council. (In Castlereagh's of 3rd March.)	211
February 22, London.	Eliazar W. Phelps to Bathurst. Urging that attention be given to the memorial of the Rev. Davenport Phelps.	187
March 1.	C. B. Wyatt to same. Enclosing memorial, and asking that his hard case be considered.	189
	<i>Enclosed.</i> The memorial addressed to the Prince Regent and asking that inasmuch as he was suspended from office without any just cause, he be reinstated and paid arrears of salary or such other compensation as may be considered proper.	193
March 1, London.	Col. Fitzgerald to Castlereagh. Transmits accompanying papers from Wm. Brock and urging that he be given some active employment, for which he would willingly resign his pension.	201
	(In Castlereagh's of 3rd March.)	
March 3.	Castlereagh to Bathurst. Enclosing note from Col. FitzGerald, M.P. for the County of Clare, with the accompanying papers from Wm. Brock, eldest brother of Sir Isaac, and recommending them to Lord Bathurst's favourable consideration.	200
	(Enclosures calendared at their respective dates.)	
March 8.	H. J. Boulton to — (Bathurst?) Asking for the situation left vacant by the decease of the Attorney General of Upper Canada.	214
March 13, York.	Sheaffe to Prevost. The Legislature will close this day. Some of the amendments to the Militia Act promise some benefit, others are doubtful. Has directed a copy of the titles of the Bills passed to be transmitted with this letter. An Incorporated Militia is to be formed with a bounty of eight dollars. Asks for an addition as that sum is not sufficient.	95
March 15, York.	Same to Bathurst. (No. 3.) The Legislature assembled on the 25th of February, and prorogued on the 13th inst., being the second Session of the Sixth Parliament. Encloses speeches, &c.	37
	<i>Enclosed.</i> Speech by Sheaffe on the opening of Parliament.	39
	Answer by House of Assembly.	43
	Answer by Sheaffe.	48
	Address of the Legislative Council in answer to the President's speech.	49
	Answer by Sheaffe.	53
	Address from the House of Assembly to the President (Sheaffe) on his accession to the Government of the Province and on his success in repelling the attempts of the enemy.	54
	Answer by Sheaffe.	58

## Department of Agriculture—Archives.

1813.	Speech by Sheaffe on prorogation.	Page 60
	Schedule of the laws passed.	63
	Explanatory remarks on certain Acts passed.	66
March 15, York.	Sheaffe to Bathurst. (No. 4.) In compliance with a request from the House of Assembly expressed, in the enclosed speech, encloses an address from that body to the Prince Regent, asking that he would grant some of the waste lands in Upper Canada to the family of the late Major General Brock, to keep the name alive in the Province.	70
	<i>Enclosed.</i> Speech.	72
	Address to the Prince Regent.	74
March 16.	L'Abbé de la Trappe to Liverpool. (In French.) Asking for lands, provisions, and a free passage into Upper Canada for himself and his followers, if that is not possible, a passport to go to the borders of the Mississippi.	216
	<i>Enclosed.</i> The memorial.	218
March 16, York.	Sheaffe to Bathurst. (No. 5.) Enclosing a memorial and accompanying papers from Thomas Ridout. Recommends the petition.	78
	<i>Enclosed.</i> Memorial of Thomas Ridout, Surveyor General of Upper Canada, for the suspended moiety of his salary from 30th May to 24th December, 1810, with the accompanying documents.	80 to 85
March 17, York.	Sheaffe to Bathurst. (No. 6.) Transmitting abstract from the Docket Books of the Auditor General, of grants of lands in Upper Canada.	87

1813.

ABSTRACT from the Auditor's Docket Books of Grants of Land in Upper Canada, which have passed the Great Seal of this Province, between the 1st January and 31st December, 1812.

Counties.	Number of Grants.	District.	Number of Acres.	Total Number of Grants.	Total No. of Acres Granted.	
York.....	89	Home.	18,456½	89	18,456½	
Durham .....	10	} Newcastle.	2,000	} 23	5,950	
Northumberland.....	13		3,950			
Lincoln.....	29	Niagara.	6,800	29	6,800	
Glengarry.....	5	} Eastern.	1,030	} 36	(Sic.) 6,436	
Dundas.....	1		200			
Prescott .....	2		600			
Russell.....	16		3,200			
Stormont.....	12		6,406			
Grenville.....	39	} Johnstown.	7,180	} 84	16,708	
Carleton.....	—		} 45			9,528
Leeds.....	45					
Essex .....	6	} Western.	1,102	} 9	4,022	
Kent.....	3		2,920			
Middlesex.....	12	} London.	7,594	} 30	13,954	
Norfolk .....	8		} 10			1,800
Oxford.....	10					4,200
Frontenac.....	12	} Midland.	1,210½	} 40	9,284½	
Hastings.....	8		1,600			
Lennox and Addington.....	7		824			
Prince Edward.....	13		5,650			
			Total...	340	81,611½ (Sic.)	

Errors excepted.

(Signed) P. SELBY,  
Auditor General.

Page 88

March 18,  
York.

Sheaffe to Bathurst. With grateful acknowledgements of the honour conferred on him by the Prince Regent, who has created him a baronet. 90

March 18,  
York.

Same to Prevost. Has offered an addition of ten dollars to the bounty granted by the Legislature of Upper Canada to volunteers for the Incorporated Militia. Thinks the state of the Province will justify his having done so without waiting for an answer to his application. 97

March 18,  
Fort Erie.

Cecil Bisshopp, Lieut.-Colonel, to Vincent. An account of a cannonade commenced by the enemy against the Fort on the morning of the 17th

## Department of Agriculture—Archives.

1813.  
inst. Our loss is only one killed and seven wounded. All behaved gallantly. Page 102
- Enclosed.* Return of the killed and wounded. 105
- March 20,  
York. Sheaffe to Bathurst. The various documents connected with the late session which are preparing for transmission will no doubt be very satisfactory as showing the spirit of unanimity and patriotism which has governed that body. The means at their disposal being so small they could only vote eight dollars as a bounty to each volunteer for the Incorporated Militia. The sum being much too small, he transmits copies of letters to Prevost asking for further aid. Intends to recommend the Incorporated Militia for grants of land. 92
- March 21,  
Fort George. John Vincent, Brigadier General, to Sheaffe. Enclosing letter from Lieut.-Colonel Bishopp, commanding at Fort Erie, with an account of a cannonade on that Fort and a list of killed and wounded. Has since been at the Fort and found all quiet. 100  
(Enclosures calendared at their respective dates.)
- March 25,  
York. Sheaffe to Bathurst. Transmitting copies of despatches which have been forwarded to his Excellency, reporting a cannonade on the right of our line on the Niagara Frontier, on the 17th instant. Brigadier General Vincent is of opinion that it was a mere St. Patrick's day frolic. 99
- March 28,  
York. Same to same. (No. 7.) Letter authorizing an increase of salary to Mr. Givens and a grant of land to Mr. Selby, received. 106
- March 28,  
York. Same to same. (No. 8.) Letter notifying the appointment of Edwin Bowen to be Attorney General of the Province, received. 107
- March 29,  
York. Same to same. (No. 9.) Enclosing report of the Executive Council on the memorial of Mr. Davenport Phelps. The opinion is unfavourable. 108
- Enclosed.* The report. 109
- April 3,  
Lynpstone,  
near Exeter. Gore to Goulburn. States in reply to letter of 30th March, that two hundred acres of land in Upper Canada is the quantity usually granted to persons of the description of those whose names are subscribed to the papers accompanying the letter, the fees to be paid by the public. The practice of giving provisions has been discontinued for some years. The emigrants with the Count de Puisaye were the last to receive this indulgence. The liberal grants of land to Loyalists, disbanded soldiers, &c., caused jealousy. Should the petitioners be allowed free passages and provisions for a time after their landing it would lessen the favour shown to the original Loyalists, &c. 221
- April 5,  
York. Sheaffe to Bathurst. Hopes to return to Fort George in a few days. Wishes before leaving this place to see it put in a better state to resist the attacks of the enemy which are expected in the spring. The American flotilla at present locked up in the ice at Sackett's Harbour. To destroy the ship building here would be a great object with them. Last intelligence of Procter was dated 21st March; at that time, General Harrison, with about 2,000 men were entrenched at the foot of the rapids of the Miamis. Part of the 41st have been sent to Procter since his defeat of Winchester. Has reports of Captain Roberts, commanding Michillimackinac, to the 19th March, he had received information of the advance of 4,000 Americans under General Clarke up the Mississippi, with the design of gaining Lake Michigan. The Sioux and other tribes have declared their intention of vigorously opposing them. Mr. Robert Dickson, whose influence with them is great, has probably joined them. 114
- April 7,  
York. Same to same. (No. 10.) Letter enclosing one from Mr. Wharton with another from the Deputy Storekeeper General, reporting the shipment of stationery for the Indian Department received. 117



1813.  
April 7,  
York. Same to same. (No. 11.) Letter of 16th November received. Measures have been taken to communicate both to the Loyal inhabitants and to the faithful Indians the gracious approbation it conveys. Page 118
- April 7,  
York. Same to same. (No. 12.) Acknowledging circular letter of 16th November, containing instructions concerning the disposal of coin or bullion found on American vessels. The letter referred to of 12th September not received. 119
- April 7,  
York. Same to same. (No. 13.) Acknowledging letter of 24th November, with copy of one of same date from Harrison, together with copies of the enclosures therein referred to, respecting the returns of American property taken on foreign stations. 120
- April 10. Wyatt to same. Asking that some steps be taken in respect to his letter of 1st ultimo. 228
- April 10,  
Verdun. John R. Small to same. Mr. Boulton's liberation gives him a safe opportunity for forwarding a letter from Mr. Bond, hoping even at this late period he (Bond) will get the redress he prays for, if he appears unworthy it is from no fault of his own, but from the shameful neglect with which His Majesty's orders were treated by Mr. Gore, then Governor of Upper Canada. Refrains from saying more or entering into the details of the oppression and cruelty with which he had treated some individuals. Sees no brightening of the prospects of his release, and is quite in the dark as to his father's affairs, therefore forwards a statement of the grievances he was groaning under when he left Canada to endeavour to obtain justice for his father, but was taken prisoner on the way across. Asks for all assistance in his endeavours to relieve him, an old man of 70, and his wife and child, from whom he is separated while-wasting his life in a useless captivity. 229
- May 3,  
Kingston. Sheaffe to Prevost. Detailing the circumstances relating to the surrender of York on the 27th ultimo. 133  
*Enclosed.* Terms of the capitulation entered into. 137  
List of killed, wounded, prisoners, and missing. 140a  
Extracts from letters addressed to Prevost by Sheaffe, dated 29th March and 5th May, 1813, explaining his detention at York. 144
- May 5,  
Kingston. Same to same. Detailed account of the capture of York. 150
- May 10,  
London. Memorial of Eleazar W. Phelps, asking for a township in Upper Canada, on condition that he settle the said township and on any other conditions it may be thought proper to impose. 233
- May 12,  
Kingston. Sheaffe to Bathurst. Acknowledging letter of 15th December, covering one from Wharton, with its enclosure respecting grant of land to Mr. McGillivray. The instructions will be complied with as early as possible. 121
- May 13,  
Kingston. Same to same. Regrets to have to state that the money in the Provincial Treasury fell into the enemy's hands when he obtained possession of York. The amount was about £2,000. Mr. Selby was insensible at the time from the illness to which he soon afterwards succumbed. 122
- May 13,  
Kingston. Same to same. Hopes there may be no difficulty about the payment for the house in York bought for public offices from the representatives of the late Chief Justice Elmsley. The Government House, that in which the Legislature assembled, and two block houses were destroyed by the enemy. 123
- May 16,  
Kingston. Same to same. Explanation of the causes of the extraordinary increase in the expenditure of the Province. 126
- May 17,  
Kingston. Same to same. Enclosing copy of a letter which he had addressed to the Treasury on Mr. Selby's decease and Mr. McGill's appointment. 128  
(Enclosure calendared at its proper date.)

## Department of Agriculture—Archives.

1813.  
May 17,  
Kingston. Same to the Treasury. Mr. Selby, the Receiver General of this Province having died on the 9th inst., he has appointed Mr. John McGill to fill the position till further instructions. Recommends that he be chosen to fill the post. Page 129
- May 18,  
Kingston. Same to Bathurst. Transmitting copies of a letter with its enclosures relating to the affair at York on the 27th ult., together with extracts of letter explaining his detention at that place. 131
- June 3,  
War Office. Lord Palmerston to Goulburn. The Prince Regent approves of the proposition of granting £200 a year to each of the four surviving brothers of Sir Isaac Brock. 236
- June 11,  
Stanford Hill. Wm. Brock to Liverpool. Bringing to his mind his (Liverpool's) intimation in the House of Lords that an address would be proposed as a monument to his late brother. Does so in case it might slip from his memory. 237
- June 15,  
Kingston. Letter from the resident members of the Executive Council of Upper Canada to Sheaffe, congratulating him on the way he has fulfilled the duties of his position. 159
- June 16,  
Kingston. *Enclosed.* Sheaffe's answer. 161
- June 16,  
Kingston. Sheaffe to Bathurst. Recommending Samuel Smith, to fill the vacancy caused by the death of the Hon. Alexander Grant. 147
- June 17,  
Kingston. Same to same. Transmitting copy of his report to Prevost relating the capture of York by the enemy. Major General de Rottenburg being ordered up to this province and being senior to him will take command. He (Sheaffe) will assume the command of the Montreal District as directed. Transmits also copies of a letter addressed to him by the resident members of the Executive Council and his answer thereto. 148
- June 17,  
Turnham Green. (Enclosures calendared at their respective dates.)  
June 19,  
Kingston. Memorial of Sarah Margaret Clarke, daughter of the late Captain John Clarke, of the 59th Regt., to Bathurst. For an increase of income. 239
- June 19,  
Kingston. Francis De Rottenburg to same. Has assumed command of the forces and the administration of the Civil Government. Encloses copy of a proclamation issued on his taking the oaths of office. 163
- June 19,  
Kingston. *Enclosed.* The proclamation. 164
- June 22,  
London. De Rottenburg to Richard Wharton. Has this day assumed the administration of the Civil Government of the Province. 251
- June 29. E. W. Phelps to Goulburn. Having been informed that a report from the Executive Council of Upper Canada on the memorial of Rev. Davenport Phelps has been received, asks for a copy with a statement of the fees for the same. 241
- July 10, Head Quarters, 12, Mile Creek, near Fort George. Robert Eyre to same. Asking for information on the subject of the returns from Upper Canada respecting grants of land promised to himself and several relations. 242
- July 10, Head Quarters, 12, Mile Creek, near Fort George. De Rottenburg to Bathurst. Acknowledging the following letters: 1st. Dated 2nd February, respecting certain alterations in the Order in Council concerning the sale of ships taken from enemies or neutrals. 2nd. Dated 26th March, announcing the death of the Duchess of Brunswick. 3rd. Dated 26th March, with a form of prayer for the Prince Regent. 4th. Dated 5th February, signifying approval of the Acts passed by the Legislature in March, 1812. 166
- July 10, Head Quarters, 12, Mile Creek, near Fort George. Same to Goulburn. Acknowledging letters addressed to Sheaffe, accompanied by a copy of an estimate upon which the House of Commons has voted the sum of £8,441 for the Civil Establishment of the Province for the present year. 168
- August 2,  
Transport Office. Board of Transport to Harrison. Indian stores and cordage for the naval service will be shipped without loss of time. 246
- August 3,  
Treasury Chambers. Harrison to Goulburn. Having laid before the Commissioners of the Treasury his letter of 9th June last, disputing the payment

1813.	of the Surveyor General of Upper Canada's salary, is commanded to state that the letter and enclosures have been forwarded to the agent of Upper Canada with orders to divide the unappropriated moiety of the salary in question between Messrs. Chewett and Ridout. Page 244	244
August 3, Treasury Chambers.	Same to same. Transmitting letter from the Transport Office relative to the conveyance of Indian stores to Upper Canada.	245
August 26, Storekeeper General's Office.	J. Barker, Deputy Storekeeper General, to Harrison. Clothing and appointments for use of the troops in Upper Canada have been shipped.	247
August 30, London.	D'Arcy Boulton to Goulburn. For an extension of leave.	248
September 15, Treasury Chambers.	Arbuthnot to same. Transmitting letter from Major General de Rottenburg stating, that in the absence of the Lieut.-Governor of Upper Canada the Civil Government has devolved on him.	250
October 3, Camp, Four Mile Creek, near Fort George.	De Rottenburg to Bathurst. Acknowledging despatches addressed to Sheaffe, to which due attention shall be paid.	169
October 3, Camp, Four Mile Creek.	Same to Goulburn. Acknowledging letter addressed to Sheaffe with a Gazette extraordinary, containing an account of a glorious victory near Vittoria, obtained over the French armies in Spain by the forces under Wellington. The news cannot fail to please this colony.	170
October 11, Treasury Chambers.	Harrison to same. Transmitting report of the Comptroller of Army Accounts on a letter from Sheaffe, with the public accounts of Upper Canada for the half year ending 30th June, for Lord Bathurst's opinion thereon.	252
October 25, Kingston.	De Rottenburg to Bathurst. Acknowledging letter of 9th August. The list of titles of all the Acts passed by the Legislature of the province and also a complete collection of all the laws will be forwarded as soon as possible. These documents will not probably be ready till after the close of navigation. Causes of the delay.	171
November 18, Hampden.	Memorial of Sarah Margaret Clarke to Bathurst. Praying for an increase to her allowance.	253
No date.	Memorandum on sale of lands.	223
No date.	Memorandum on the Militia of Upper Canada.	225

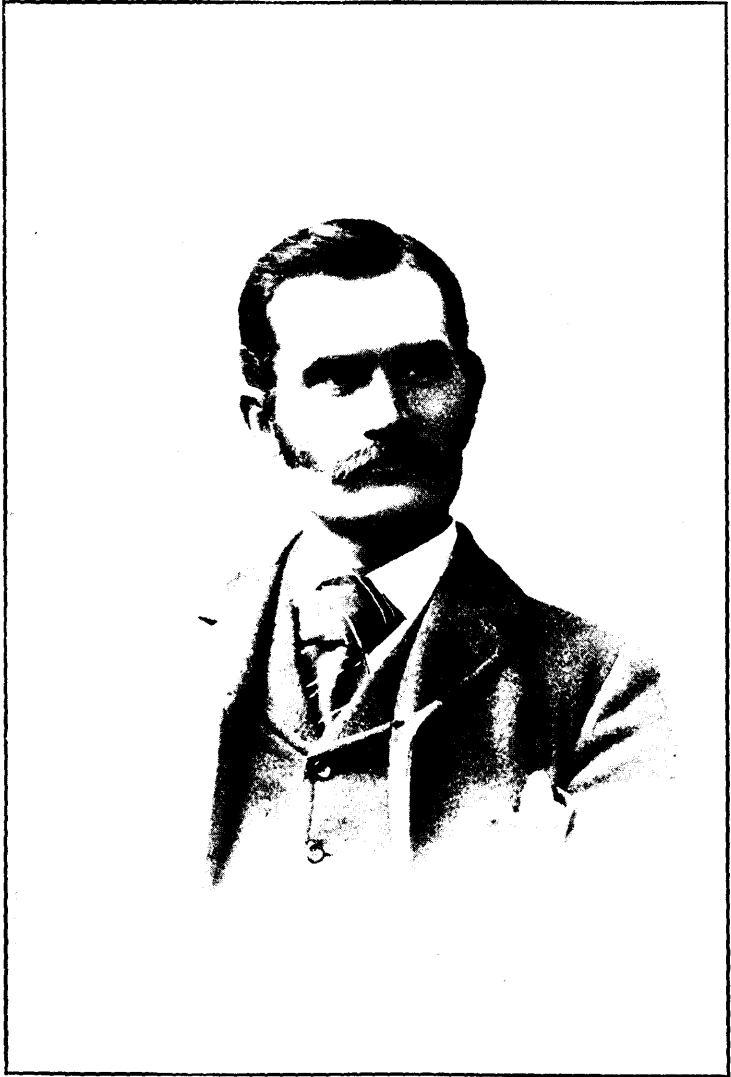

JAS. W. ROBERTSON, DAIRY COMMISSIONER.

57 Victoria.

Sessional Papers (No. 8B.)

A. 1894

APPENDIX TO THE REPORT OF THE MINISTER OF AGRICULTURE

---

THIRD ANNUAL REPORT

OF THE

DAIRY COMMISSIONER

FOR THE

DOMINION OF CANADA

FOR

1892-93

*PRINTED BY ORDER OF PARLIAMENT*



OTTAWA

PRINTED BY S. E. DAWSON, PRINTER TO THE QUEEN'S MOST  
EXCELLENT MAJESTY

1894

[No. 8B—1894.]



# Report of the Dairy Commissioner.

## APPENDIX

TO THE

# REPORT OF THE MINISTER OF AGRICULTURE

BEING

## REPORT OF THE DAIRY COMMISSIONER.

OTTAWA, 30th June, 1893.

The Honourable  
The Minister of Agriculture.

SIR,—I have the honour to submit my third annual report as Dairy Commissioner for the Dominion of Canada.

There is no abatement of the interest and satisfaction with which the *Dairying Service* has been received by the farming community since the date of my last report.

The movement in favour of the manufacturing of butter during winter, in factories where cheese-making has been carried on during the months of summer, received a strong push forward by the establishment of the winter-dairying stations at Mount Elgin and Woodstock, Ont., in 1891. During the winter of 1892-93, four butter-making stations were under my charge in the Province of Ontario. These were at Mount Elgin, Woodstock, Wellman's Corners and London. At all of them the patrons delivered the whole milk and carried home the skim milk in the same milk cans. The delay necessary to obtain it seldom exceeded 15 or 30 minutes. At the desire of the patrons it was decided to discontinue the home-setting of the milk and the cream-gathering plan at Woodstock, and to run the factory on the centrifugal separator plan. At Mount Elgin and Woodstock, the patrons furnished supplies of milk in much larger quantities than during the previous winter. This branch of dairying may be considered as fairly well started and established in Ontario. A summary of the business at all the Experimental Dairy Stations is given in Part IX.

The World's Columbian Exposition at Chicago afforded an excellent opportunity for exhibiting the dairy products of Canada in such a way as (1) to advertise the suitability of Canada as a field for successful dairy farming, (2) to illustrate the progress which has been made by Canadian dairymen in the arts of manufacturing cheese and butter, (3) to win a higher reputation at home and abroad for their fine quality, and (4) to stimulate our dairymen to strive for further improvements in their methods and products. The success which attended our efforts in this connection is abundantly satisfactory. Although the official report from the World's Columbian Commission has not yet reached my hand, I have ventured to open this re-

port and to insert here (under date Dec. 1, 1893,) a statement which may be taken as substantially in accord with the recommendations of the judges of these exhibits.

In the competition in the month of June, 162 exhibits of cheese were sent from Canada; and 129 lots were recommended by the judges for awards of diplomas and medals. Thirty-one of these lots received a higher number of points on the score cards, than the highest number of points awarded to any exhibit from any other country in the same classes. At the June competition there were 43 exhibits of butter from Canada; and 13 lots were recommended for medals.

In the competition in October, 687 exhibits of cheese were entered from Canada and 607 of them were scored high enough to entitle them to be recommended for medals. In this competition ten exhibits of cheese received awards of 99½ points out of a possible of 100 points for perfection; and altogether one hundred and twenty-seven lots of Canadian cheese received a higher number of points on the score cards than the highest score to an exhibit from the United States in the same classes. There were 167 exhibits of Canadian butter, of which 27 lots were scored high enough to entitle to awards. A more extended report of Canadian dairy products at the World's Fair has been inserted in Part X.

In November, 1892, I received permission to visit Great Britain, in order to look after the sale of some of the cheese and butter from the Experimental Dairy Stations in the markets there, and at the same time to call attention to the food producing resources of Canada, the purity and wholesome excellence of Canadian dairy products, and the nature and scope of some of the educational work which is being done by the Government in connection with dairy farming. It was also my intention to make investigation, into the preferences of the British markets in the matter of food products and to make such inquiries into and observations of the condition, systems and methods of agriculture which were prevailing in Great Britain, as the limited time at my disposal would permit. I was fortunate in being the bearer of a few letters of introduction from His Excellency the Governor General, Lord Stanley of Preston, to gentlemen in England who are distinguished for their leadership in agricultural matters there. To the thoughtful kindness and magnanimous courtesy extended by His Excellency, I ascribe no small share of the success which attended the other parts of my mission. Critical and appreciative articles on the progress and possibilities of Canadian agriculture appeared in many of the leading journals of Great Britain. I believe some of these have more than a passing interest and capability of usefulness for the farming community of Canada. In consequence, I have devoted a chapter in this report to that mission and have inserted several of the articles from different newspapers of world-wide reputation, as well as reports of addresses which I had the honour to deliver in Liverpool and London.

#### SUMMARY OF THE WORK IN THE PROVINCE OF ONTARIO.

In Ontario, Branch Experimental Dairy Stations were conducted during the winter of 1891-92 at Woodstock and Mount Elgin, to introduce the practice of manufacturing butter during the winter months in factories where cheese-making had been carried on during the summer. These were entirely successful and satisfactory to the farmers who furnished milk. Particulars of the cost of equipment and extent of the business, and the opinions of some of the leading patrons, are given in my last annual report from pages 4 to 13.



## Report of the Dairy Commissioner.

When the final payments were made to the patrons on account of the business of the season 1891-92, the following circular of explanation was sent:—

OTTAWA, July 27th, 1892.

DEAR SIR,—The advance sheets of part of my Annual Report, which are inclosed herewith, give particulars of the winter dairying at Mount Elgin and Woodstock Dominion Dairy Stations up to April 30th, 1892. There was some delay in obtaining the final account sales of the shipments of butter which were sent to Great Britain. Some of the butter was held in warehouse at Liverpool and elsewhere, longer than it should have been held by the consignees if my directions had been followed. In consequence, it came into competition with the grass made butter of England, and failed to realize a price which was quite satisfactory. Besides there were complaints concerning the quality of a few lots of it, from the development of a flavour which seemed to come from the feeding of roots, which had been kept badly during the winter.

I had the honour to recommend to the Minister of Agriculture, that the patrons of the Mount Elgin Dairy Station be paid for the butter which was manufactured to the end of February, at 24 cents per pound, and for the butter manufactured during March and April, at 21 cents per pound, and that the patrons of the Woodstock Dairy Station be paid for the butter which was manufactured to the end of February, at 22 cents per pound, and for the butter manufactured during March and April, at 21 cents per pound. The difference in the price between the Mount Elgin and Woodstock makes of butter is explained at page 12 of the report. It is my opinion that the butter could have been sold to realize these prices for the patrons, had it been sold without any regard to advertising the growing importance and possibility of developing a large trade in winter-made butter with Great Britain in the near future. These prices should be satisfactory to the patrons, as the result of the first experiment in this direction, and I am confident that in coming years, with market prices equal to those which prevailed during the winter of 1891-92, our winter-made butter from creameries would command a relatively higher price. The experience of the one season has brought to light a few facts which I take the liberty of emphasizing here for the benefit of those farmers and factorymen who intend to continue or to commence this branch of dairying.

I. An abundant supply of succulent feed should be provided for the cows for fall, winter and spring. Corn ensilage is cheapest and best; corn fodder comes next in point of economy and suitability; carrots, mangels, or sugar beets, with hay, straw and bran or meal, make excellent rations, but they cost too dear for profit. At pages 26 to 44, 78 to 84, and 99 to 109 of my Annual Report (of 1891-92) detailed information on the combinations of rations will be found.

II. Where these feeds have not been provided by the patrons, to alter a cheese factory and equip it for winter butter-making would only invite failure and create dissatisfaction.

III. As far as practicable, milking cows should be kept in stables where the temperature is comfortable,—never below 45° and never above 60° Fahr.

IV. The milk from a few fresh calved cows imparts such a quality to the flavour of the whole quantity of butter, which may be made in a creamery from November to March, as will increase its value in the British market by from 1 to 4 cents per pound.

V. To supplement the general directions which are contained in my Annual Report, I will furnish specific information, to those who apply by letter, giving the plans of buildings and other particulars on the details of effecting the alterations in cheese factories, on the most suitable packages in which to put the butter, on the engagement of competent butter-makers, and on the shipment of butter to the British market from those factories whose managers desire to dispose of the product in that way.

VI. It will be better policy to delay for one year the altering of a cheese factory and its equipment for butter-making during the winter, than to begin this new business before the manufacturer and patrons are both quite ready to conduct it with success.

I have the honour to be,  
Your obedient servant,

JAS. W. ROBERTSON,  
*Dairy Commissioner.*

---

From June to September, 1892, experiments were conducted at Perth, in Lanark County. One main object of these experiments was to determine the relation which the percentage of fat found in milk of different qualities, sustained to the quantity and quality of cheese which could be made therefrom. The details of this work, with a summary of the conclusions arrived at, will be found in the report of Mr. J. A. Ruddick, in this volume. The Mammoth Cheese which was manufactured for the Canadian dairy pyramid at the World's Columbian Exposition, was made at this station. It was intended as an advertising device, to attract the attention of the public everywhere to the magnitude of the dairy industry in Canada, and through that, to the opportunities which the country offers for successful dairy farming. It may be considered as one of the best advertising hits of the whole Exposition. Further details concerning it are given in the report on Canadian dairy products at the World's Columbian Exposition.

During the winter of 1892-93, I took charge of four butter-making stations, respectively, at Mount Elgin, Woodstock, Wellman's Corners and London.

The agreements with the proprietors of the cheese factories, and the patrons who supplied the milk, were substantially the same as during the previous year at Mount Elgin and Woodstock. The substance of these was as follows:—

1. The company owning the premises are to put the boiler-room into a frost-proof condition, and to put double windows and double doors where they are required, in order to make the making-room tenable during the winter.

2. The Dairy Commissioner agrees to pay \$100 as rent for the use of the premises and such of the apparatus in them as he may desire to use.

3. The Dairy Commissioner agrees to put into the factory the additional apparatus and equipment necessary for the manufacture of butter.

4. That apparatus and equipment may become the property of the company when the butter-making season is ended, by mutual agreement as to price, or the Dairy Commissioner may remove the same.

5. The company shall keep the buildings fully insured, as usual, for their own benefit.

6. The Dairy Commissioner agrees to remove the butter-making apparatus and utensils, and to leave the building in at least as good a state for cheese-making as when he took possession of it for butter-making, at any time when notified to do so, after the middle of April.

7. At Mount Elgin and Woodstock, in conformity with a promise which was made to the effect that the terms of the original agreement would be good for two years, at the option of the proprietors and patrons of the factory, the Dairy Commissioner agrees to manufacture butter from the milk furnished at the factory, at the rate of 3 cents per pound of butter. That rate includes all charges for labour, tubs, fuel, salt and other furnishings. (At Wellman's Corners and London the charge for manufacturing was put at 3½ cents per pound of butter. The specially low rate of 3 cents per pound was made at first, to induce the farmers to go into

## Report of the Dairy Commissioner.

this new departure in dairying. Now that it is recognized as profitable to them, the charge for manufacturing is put at or near what the actual cost will be to the patrons when the business is large and is run by them on their own behalf.)

8. The Dairy Commissioner agrees to sell the butter to the best of his ability, and to pay to the patrons who supply milk, the net proceeds from all sales of products (after deducting the charge for manufacturing), in proportion to the quantity of butter which is obtained from the milk furnished by each patron, as determined by the Babcock milk tester.

9. The Dairy Commissioner agrees to pay an advance of 15 cents per pound of butter to the patrons after the end of every month.

10. The patrons will receive at the factory about 80 pounds of skim milk, and 10 pounds of buttermilk per 100 pounds of milk furnished; and in case the buttermilk be sold, it will be accounted for to the patrons, and the proceeds distributed to them.

The additional apparatus required for the factory at Wellman's Corners for the manufacture of butter upon the centrifugal cream separator plan, were as follows:—

1 Centrifugal cream separator (capacity 3,000 pounds per hour).....	\$ 350 00
1 10 horse-power engine, 2nd hand, complete.....	120 00
1 Revolving churn (300 gallon capacity).....	45 00
1 Power butter-worker.....	57 50
1 Hand butter-worker .....	12 00
1 Pair butter scales.....	10 00
1 Strainer for cream; 1 hair sieve.....	4 00
1 Butter printer (lettered).....	5 00
1 Large dipper, 40 cts.; 3 dairy pails, \$2.40.....	2 80
2 Perfection gates with couplings (for cream vat).....	8 00
2 Butter ladles; 1 butter spade; 1 butter packer.....	2 50
1 No. 20 Hancock ejector (for elevating skim milk)...	9 75
1 Coal stove .....	12 00
Carpenter work, shafting, pulleys, belting, stanchions, pipes, fittings and teaming.....	277 00
	\$916 05

A summary of the business at each station is given in Part IX.

### *Mr. J. A. Ruddick's Report (Ontario).*

1. Mr. Ruddick reports upon experiments conducted in cheese-making at Perth Experimental Dairy Station under the three headings of:—(1) Experimental investigations to determine the quantity and quality of cheese made from milk containing different percentages of fat; (2) The effect of high *versus* low cooking temperature on the curd and cheese; and (3) The effect of setting the milk at different conditions as to degree of ripeness.

2. He reports the main features of the work at the winter butter-making station at Woodstock, Ont., of which he had charge.

3. He attended and gave addresses at thirty meetings held in the interests of dairying, being present at the annual meetings of many of the cheese factory companies.

4. He reports on some miscellaneous work, including the working dairy at the Sherbrooke Exhibition, assistance in preparing the Mammoth Cheese, and attendance, at Chicago in connection with the exhibit of Canadian dairy products there.

*Mr. J. B. MacEwan's Report (Ontario.)*

1. Mr. MacEwan reports on the work of testing milk by the Babcock tester at the dairy on the Central Experimental Farm.

2. He was released from his engagement as one of my assistants for five months of the summer, in order to act as dairy instructor for the Dairymen's Association of Eastern Ontario. He visited 184 cheese factories, met 244 cheese-makers, and held 20 meetings.

3. He reports on certain faults which he found prevalent in connection with cheese factories and cheese-making. He states that he observed the effects of very much carelessness as to condition and appearance of the buildings, and that he found a tendency on the part of cheese-makers to over-ripen the milk before adding the rennet.

4. He reports on the work at the butter-making station at Wellman's Corners, Ont., of which he was put in charge after he returned from his leave of absence. The Dairy Station was used in some measure as a school of instruction during the winter. Twenty-three cheese-makers visited it during the winter, to learn something of the art of making butter. He attended 12 meetings.

Reference to the work which they severally did in Ontario during part of the season, will be found also in the reports of Messrs. T. J. Dillon (P.E.I.), C. C. Macdonald (Quebec), and R. Cornett (Manitoba).

SUMMARY OF THE WORK IN THE PROVINCE OF QUEBEC.

A combined Dairy Station and Dairy School, was erected at St. Hyacinthe, Que., by the Dairy Association of the Province of Quebec. It was placed under the directorship of the Dairy Commissioner in accordance with the following agreement which was made with the Dairy Association:—

**MEMORANDUM of Agreement between the Dairy Association of the Province of Quebec and the Dairy Commissioner for the Dominion, re the proposed Experimental Dairy Station and Dairy School for the Province of Quebec.**

1. It is agreed that the Dairy School shall be located at St. Hyacinthe, Que.
2. On behalf of the Dairy Association of the Province of Quebec, it is agreed that the Association will provide a building and premises suitably equipped for the manufacture of butter and cheese, and for the giving of practical illustrations and instructions to pupils in these branches of dairying.
3. The building and premises (equipped as stated in paragraph 2), are to be put under the charge of the Dairy Commissioner for the Dominion, free of rent or charge for the use of the same.
  - (a.) Rent, interest, payments on capital account and any other charge or claim on the premises on behalf of those persons who advance money for the erection and equipment of the building, or any other persons whatsoever, are not to be considered as claims upon the Dairy Commissioner or the Department of Agriculture.
4. The Dairy Association of the Province of Quebec hereby agrees to pay to the Dairy Commissioner, the sum of one thousand dollars (\$1,000) per annum, to be

## Report of the Dairy Commissioner.

applied towards the maintenance of the school; payable in two equal sums on 2nd of January and 2nd day of July of each year, while the agreement continues.

5. In consideration of the foregoing, the Dairy Commissioner agrees to provide for giving thorough practical instruction in cheese-making and butter-making to all pupils or others who are entitled to receive such by the certificate of the Dairy Association of the Province of Quebec. The instructions are to be given in the French and English languages.

6. The Dairy Commissioner agrees to meet all the expenses of working the Dairy Station and School, including wages, fuel and furnishings.

7. The Dairy Commissioner agrees to carry on such experimental investigations in the manufacture of butter and cheese as may be called for by the Association, when such work is practicable in conjunction with the experiments of the Dairy Station.

8. All receipts from the charges which may be made for manufacturing the cheese or butter, are to accrue to the Dairy Commissioner, to be administered as the funds of his Department; and all receipts from the sales of products obtained from milk which has been purchased by the Dairy Commissioner, shall accrue to his Department.

9. Such persons as the Dairy Association of the province may designate, will be received as pupils free of charge at the Dairy School.

10. The Secretary of the Dairy Association of the province of Quebec will be paid by the Association. He shall keep the books of the Dairy Station as between the patrons who furnish milk or cream and the Dairy Commissioner; he shall be afforded every reasonable opportunity for obtaining and disseminating information on the results of the experiments at the Station; he shall be under the authority of the Superintendent of the Dairy Station in that part of his work which is directly connected with the management of the Dairy School and Station.

11. This agreement is to continue in force for one year and until it is terminated by either of the parties to it giving a notice in writing to the other party of an intention to withdraw from the agreement. Six months after such notice is given and received by either party, the agreement shall be considered at an end.

For the Dairy Association of the Province of Quebec.

J. DE L. TACHÉ,  
*Secretary.*

T. MONTMAGNY, *Ptre.,*  
*President.*

P. S. The date of the instalments to be paid to the Dairy Commissioner is left as originally written; but for the first payment, the Association may have to ask that it should be made only on the 2nd of July, 1893, as the payments of the yearly subsidy is only made in July each year.

J. DE L. TACHÉ,  
*Sec.-Treasurer.*

T. MONTMAGNY, *Ptre.,*  
*President.*

Sept. 26th, 1892.

During the first winter, although the preparations for giving efficient instruction were rather inadequate, 214 pupils attended the short course of instruction; 163 took lessons in cheese-making, and 51 in butter-making. Particulars concerning the work at the school are given in the report of Mr. J. D. Leclair, Superintendent there.

A full and interesting summary of the work in the province by Mr. J. C. Chapais, Assistant Dairy Commissioner, sets forth what was undertaken in the way of giving instructions to farmers, cheese-makers and butter-makers at many different points.

Considerable attention has been attracted during the season to the improved reputation of "French cheese" and of cheese from the province of Quebec. In Part VIII., I have gathered together some extracts from reports in regard to this

matter. Very great improvements have been effected in the quality of cheese during the past three years ; and the finest cheese of the highest reputation from other parts of Canada are no longer injured by the quality or reputation of cheese from the province of Quebec, as such. Some of the cheese made in all the provinces are still far from being as fine as they should be and would be, if all the patrons of factories and cheese-makers would carry out their respective duties intelligently and faithfully. A spirit of friendly and wholesome rivalry between the dairymen of the different provinces for a foremost place, cannot but prove beneficial to the whole country.

*Report of Mr. J. C. Chapais, Assistant Dairy Commissioner.*

1. Mr. Chapais gives a statement of the number of meetings which he attended. He visited 4 provinces, 32 counties, 104 localities, and delivered 122 lectures. In the course of these missions he travelled 16,364 miles. Over 17,000 people are estimated to have attended the meetings which he addressed ; 29 of his lectures were delivered in Manitoba, 10 in New Brunswick, 4 in Ontario and 79 in Quebec.

2. He discusses how the method of mixed farming, and particularly of dairying, could be extended in Manitoba.

3. He speaks of his ten lectures in the province of New Brunswick, which were mainly concerned with giving information to communities whose men were engaged partly in fishing and partly in farming.

4. He reports upon his labours in the province of Quebec and advocates the extension of dairy farming through the opening of larger numbers of butter and cheese factories and the formation of syndicates.

5. He urges upon the patrons the adoption of the plan of paying for milk according to the percentage of butter-fat which it contains.

6. He states that the Department of Agriculture for the province of Quebec have offered a premium on milk which is furnished to any factory for the manufacture of butter during the winter, to the amount of 5 cents per 100 lbs. of milk in November, 10 cents per 100 lbs. of milk in December, and 15 cents per 100 lbs. of milk in January.

7. He gives a report of one of his lectures on "The Production of Milk in Winter," and of another lecture on "The Possibilities of the Dairy Industry."

8. He makes mention of the holding of an Agricultural Congress at Quebec, and refers to the miscellaneous work he has done, in the way of translating reports and conducting correspondence.

*Mr. C. C. Macdonald's Report (Quebec).*

1. Mr. Macdonald reports on tests with the Babcock milk-tester at the Dairy on the Central Experimental Farm.

2. He outlines the programme which he followed in the province of Quebec during the time when he accompanied the Assistant Dairy Commissioner. He visited 34 cheese factories, 12 butter factories, and gave instruction to 96 cheese-makers and 21 butter-makers. In most cases he spent two days in each factory ; one

## Report of the Dairy Commissioner.

day for work in the factory with the cheese-maker or butter-maker, and one day for meeting with the farmers, to discuss the preparation and care of milk, etc.

3. He speaks of the common use of the rennet cup test in cheese factories, for discovering the condition of the milk as to its ripeness.

4. He found an apparent improvement in the condition of the factories, and in the quality of the cheese and butter which were manufactured, particularly where dairy instructors had been employed, and in those cases in which the factories were members of the syndicates.

5. He assisted in managing the Working Dairy at the Exhibition at Sherbrooke, Que., and afterwards spent some time in the county of Compton, giving instruction in butter-making and attending meetings of farmers.

6. In October, 1892, he took charge of the Experimental Dairy Station at London, Ont. He furnishes a statement of the business which was done there.

7. After May, 1893, he proceeded to Manitoba and the North-west Territories, where his work for the summer lay.

### *Mr. J. D. Leclair's Report (Quebec).*

1. Mr. Leclair speaks of the interest taken by the farmers in the Experimental Dairy Station and Dairy School at St. Hyacinthe. It was opened on the 10th January, 1892; 268 applications for admission were received, and of these 214 were accepted. One hundred and sixty-three of the pupils received instruction in the cheese-making branch, and 51 in the butter-making branch.

2. He outlines the programme of the daily work at the school.

3. He points out that the supply of milk during the winter should be largely increased by the farmers in the neighbourhood, and mentions in that connection the bonus which is offered by the Government of the Province of Quebec, for milk which is furnished to butter factories during the months of November, December and January.

### *Mr. H. A. Livingston's Report (Quebec).*

1. Mr. Livingston commenced his labours at the Dairy School at St. Hyacinthe, on the 27th March, 1892.

2. He indicates the particular duties with which he was occupied at the Dairy School, and discusses the different theories which obtain among the cheese-makers of Quebec, concerning the best methods of carrying on their business.

3. He makes some suggestions concerning the way in which the composite samples of milk for the Babcock tester should be handled, so as to ensure accuracy and reliability in the results.

4. He attributes the absence of flavour in cheese, which were made during the winter, to the poor condition of the cows.

## SUMMARY OF THE WORK IN THE PROVINCE OF NEW BRUNSWICK.

An Experimental Dairy Station was opened at Kingsclear. The following sets forth the agreement which was made with the company owning the premises and the patrons who furnished the cream:—

DAIRY COMMISSIONER'S OFFICE,  
OTTAWA, 14th June, 1892.

CHARLES MURRAY, Esq.,  
President New Brunswick Dairying Company,  
Lower French Village, N.B.

MY DEAR SIR,—Since my return from New Brunswick, after the conference which I had with yourself, Mr. Whitehead and Mr. Hubbard, representing the New Brunswick Dairying Company, I desire to present the following record of our agreement for approval:—

I agree to pay to the New Brunswick Dairying Company, the sum of \$215 per year, as rent for the premises and the use of the plant in the Kingsclear creamery. The building and plant are to be insured by the company for their own benefit, and I am to accept no responsibility in that connection.

I further agree to accept the obligations incurred by the New Brunswick Dairying Company in their promise to pay the patrons of the creamery at least 15 cents per pound for the butter which may be made from the cream which they respectively supply.

I have also agreed with the patrons of the creamery to pay to them the net proceeds from the feeding or the selling of the buttermilk.

I further agree to pay to the company the cost of storing the ice which is used during the present season.

I agree also to keep the premises and machinery in a good state of repair.

The company are to provide suitable accommodation and buildings for the carrying on of butter-making and also of cheese-making during the season of 1893—in case an extension of this agreement should be made with the company after the present year.

The company are to provide a yard and adequate accommodation for the feeding of swine from the by-products of the Dairy Station.

I am, yours very truly,

JAS. W. ROBERTSON,  
*Dairy Commissioner.*

The cream was collected from the farmers of the surrounding country, and the largest part of the butter was shipped to Great Britain. Some of it was sold during my stay in England in December. The butter market during the latter part of that month and early in January was rather dull, owing to the Christmas and New Year's holiday season. Expecting that the market would recover tone, I consented to have some of the butter held until on in January. The financial panic in Australia caused the banks which held the bills of lading for the small quantities of butter which reached England from that country to be hurried on the market in a panicky and timid manner. That was one of the factors which caused a very great drop in the butter market. That came before all the butter from the Kingsclear creamery was sold. As will be seen in the summary of the business there, a portion of it was sold for a low price; and (without admitting any neglect to do all that could be done to obtain the highest price for the butter), I added the sum of \$84 to the net amount received from the last sales in order to make the returns to the patrons as satisfactory as possible under the unfortunate circumstances.



## Report of the Dairy Commissioner.

The butter-making at Kingsclear is being continued during the season of 1893, with the prospect of a considerably higher return to the patrons per pound of butter manufactured.

A winter butter-making station was commenced at Sussex, N.B., where the cheese factory premises had been fitted up with the necessary butter-making apparatus and conveniences. Details of this business will be found in the summary in Part IX., and in the report of Mr. J. W. Hart.

A programme of work for the diffusion of information upon butter-making at private dairies, upon the further extension of co-operative dairying at cheese factories and creameries, and upon the growth of Indian corn for cured fodder and ensilage, was undertaken under the joint management of the Provincial Department of Agriculture and the Dairy Commissioner for the Dominion. During part of the time, five different experts were employed. The expenses of these were met by the Provincial Government, and the official reports of their work have been sent to the Secretary of Agriculture for New Brunswick. The work was conducted in the main satisfactorily and successfully during the year, with evident advantage to the farmers in those branches of their business which are connected with cattle and dairying.

### *Report of Mr. J. W. Hart (New Brunswick).*

1. Mr. Hart reports upon the work at Kingsclear creamery, which was opened on the 15th of June, 1892. A summary of the business will be found in Part IX.
2. On November 22nd he took charge of the winter butter-making station at Sussex, N.B.
3. He delivered an address before the Convention of the Farmers and Dairy-men's Association, at Fredericton, in January. He has presented a report of the address on "The Essentials to Success in Co-operative Dairying."
4. He gives a report of the business at Sussex, N.B., of which a statistical summary will be found in Part IX.

I regret that Mr. Hart gave up his situation in our *Dairying Service* to accept one in connection with an Experimental Station and Agricultural College in the United States. During his short stay in New Brunswick, he gained the confidence of the farmers and did excellent work in promoting the dairy interests of the province.

### *Mr. W. W. Hubbard's Report (New Brunswick).*

Mr. Hubbard succeeded Mr. Hart in charge of the Kingsclear Dairying Station. He had been employed during the previous summer as one of the travelling dairy instructors, by the Provincial Government.

## SUMMARY OF WORK IN THE PROVINCE OF NOVA SCOTIA.

Co-operative dairying is being gradually but slowly extended. Most of the cheese factories are located in the County of Antigonish and in Cape Breton. A few have been established in other parts of the province.

One of the cheese-making experts of my staff, Mr. J. E. Hopkins, acted as travelling instructor in dairying during the summer. He attended and addressed 27 meetings and made 54 visits of instruction and inspection to 18 cheese factories.

A Branch Experimental Dairy Station was established on a site at the Dominion Experimental Farm at Nappan, N. S. The buildings were erected by capital furnished by a few persons in the neighbourhood, our Department put in the apparatus for cheese-making, and will put in the apparatus for butter-making in the autumn of the present year. The following are sketches of the ground plan of the building which has been erected, with the several parts of the machinery in place, as shown on them:—

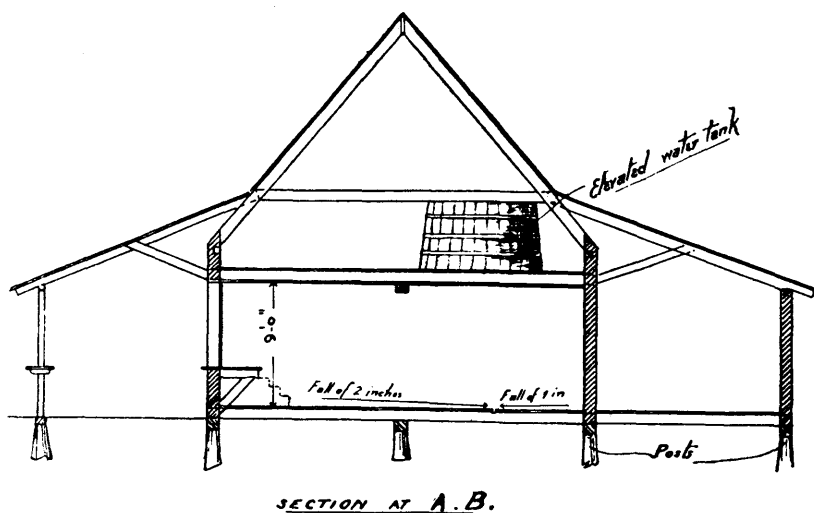

FIGURE I.—Showing a section of Figure II. at A, B, across the covered roadway, the working room and the boiler and engine room.

# Report of the Dairy Commissioner.

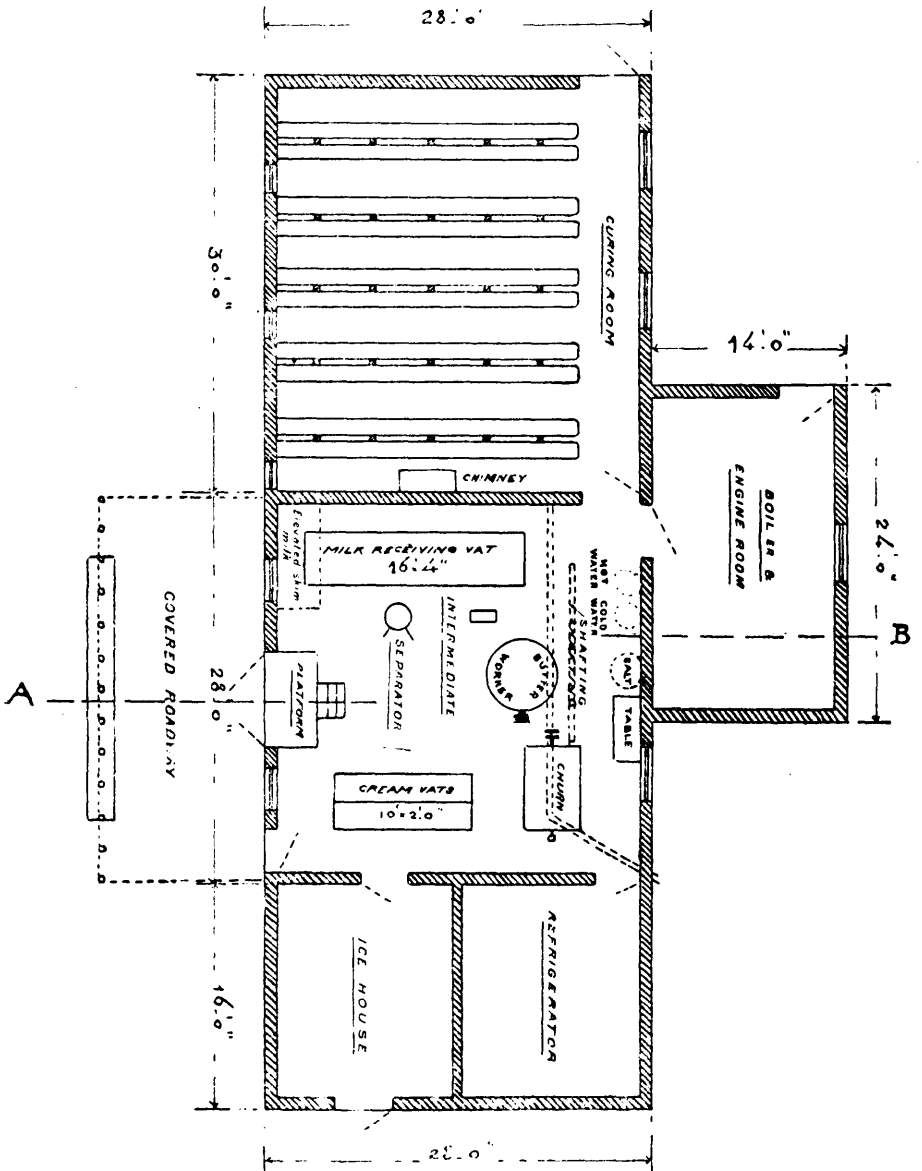

FIGURE II.—Showing the ground plan with the apparatus for making butter in place.

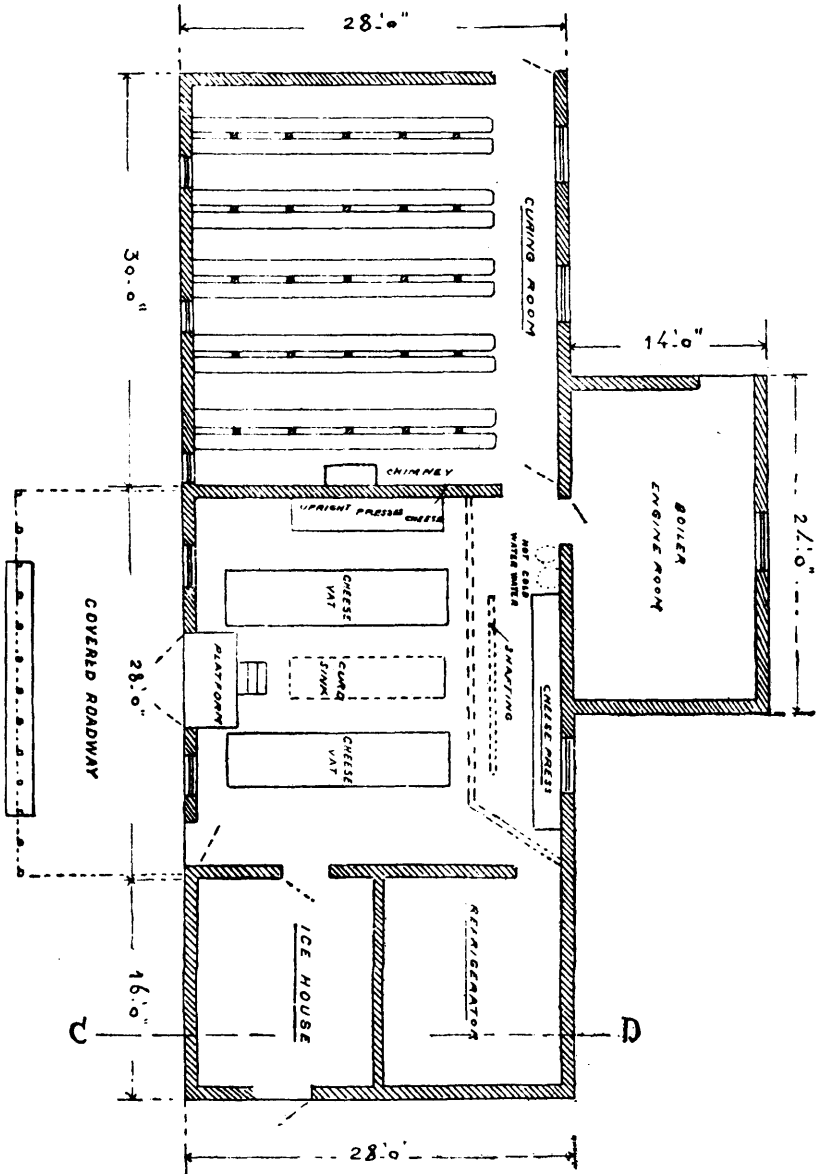
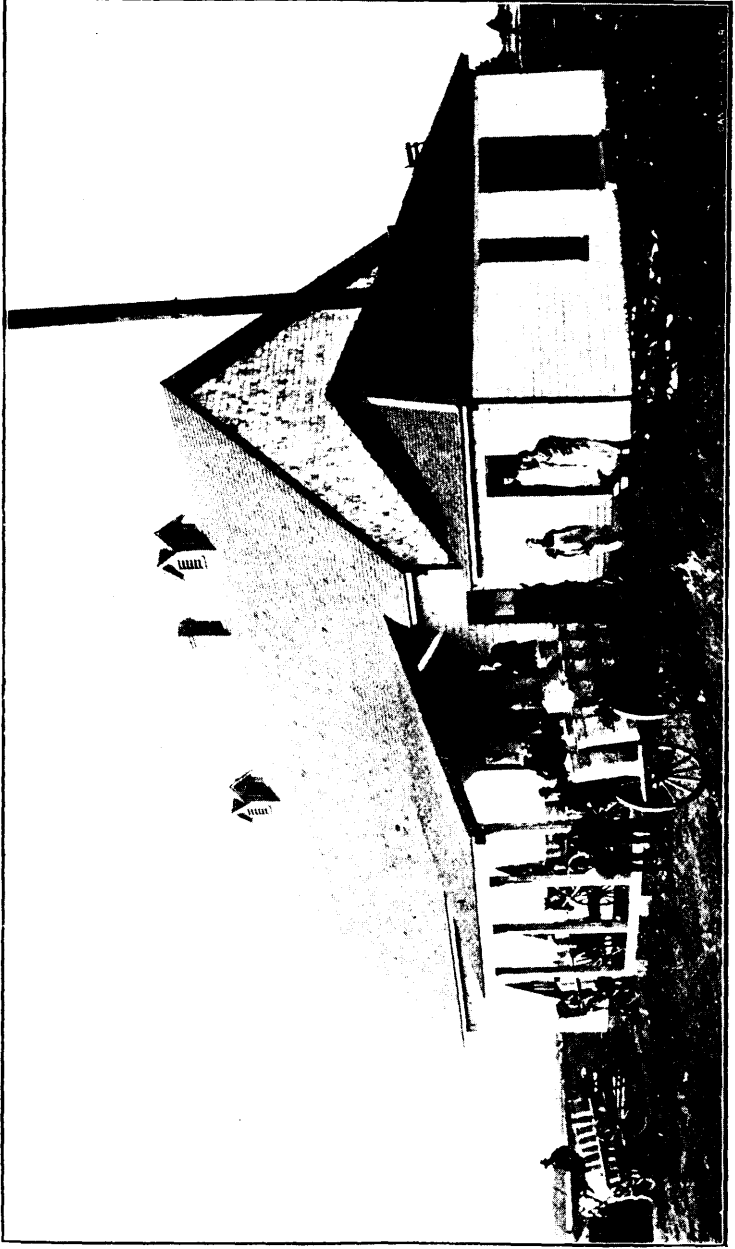

FIGURE III.—Showing the ground plan with the apparatus for making cheese in place.



CHEESE FACTORY AT VERNON, RIVER BRIDGE, P.E.I.

Report of the Dairy Commissioner.

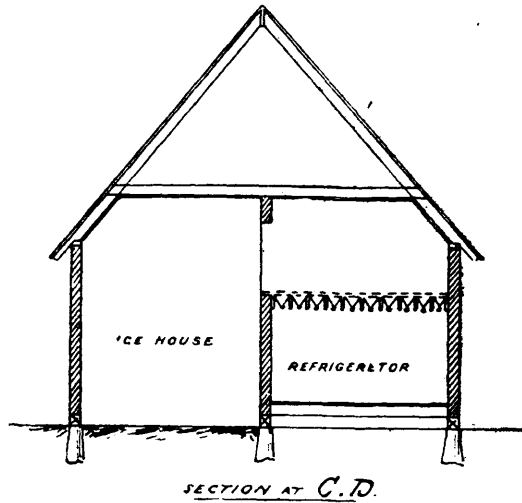

FIGURE IV.—Showing a section of Figure III. at C, D, across the ice house and refrigerator.

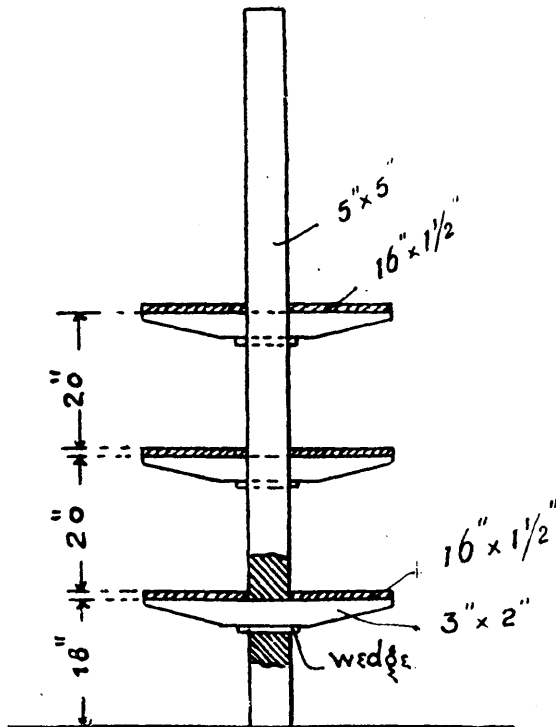

FIGURE V.—Showing the post, arms and ends of shelves for cheese in curing room.

Cheese-making was commenced in June, 1893, and there is every prospect that this station will become a centre of influence and education in dairy matters for the province, which is admirably adapted for the production of large quantities of fine butter, cheese and condensed milk.

*Report of Mr. J. E. Hopkins (Nova Scotia).*

Mr. Hopkins arrived in Nova Scotia on the 30th of May, 1892. His object was to visit the cheese factories and give the makers and patrons practical information to aid them in carrying on their business.

2. He points out that the absence of succulent feed for milch cows during the winter is a serious drawback to successful dairying in both summer and winter.

3. He mentions that a favourable inclination on the part of the farmers is increasing.

4. He found 19 cheese factories in operation. He attended 27 meetings, which were attended by from 30 to 100 farmers each.

During the summer of 1893, Mr. Hopkins is in charge of the Experimental Dairy Station at Nappan, from which he will make occasional excursions into different parts of the province to visit cheese factories.

#### SUMMARY OF WORK IN PROVINCE OF PRINCE EDWARD ISLAND.

During the course of my meetings in Prince Edward Island in 1891, I had intimated that, if the farmers would erect a suitable building for a Dairy Station, our Department would place the necessary machinery in it and run it as an Experimental Dairy Station. In 1891, there was no co-operative dairying on the Island, with the exception of one small cheese factory. The farmers in the vicinity of New Perth formed themselves into a joint stock company and agreed to erect a suitable building for cheese-making on a site which was selected on the farm of Mr. John Hamilton. At first the farmers were reluctant to supply milk, fearing that the venture would not prove successful. However, when the factory was opened, most of the farmers in the vicinity gave it hearty support. Particulars concerning the running of the business are given in the report of Mr. T. J. Dillon, and in the summary of the business in Part IX.

A portion of the cheese was shipped to Great Britain and was sold there at the same prices as were being realized for finest cheese from other parts of Canada at the same time. It was estimated that no less than 1,000 farmers visited the Dairy Station during the summer. In consequence, the farmers in many other districts decided to form joint stock companies, erect suitable buildings, and put in the necessary machinery and apparatus at their own expense, providing the Dairy Commissioner would undertake to manage the manufacturing business for them until they acquired sufficient knowledge and experience to carry it on successfully and satisfactorily themselves.

During the winter of 1892-93 and the spring of 1893, nine new cheese factories were erected and equipped by joint stock companies of farmers. I was authorized to manage these cheese factories upon terms somewhat similar to those which were

## Report of the Dairy Commissioner.

extended to the patrons of the Experimental Dairy Station at New Perth. Unfortunately one new factory was burned before it passed under our care. The companies of farmers who owned two of the old cheese factories on the island made application to receive similar terms to those which were accorded to the owners and patrons of the new factories. This was granted, and 11 cheese factories are in operation during the summer of 1893 under my direction. Seeing that it would be quite impracticable to manage the milk drawing at so many factories from a central office in a manner satisfactory to the patrons, to the milk-drawers or to myself, it was decided to put the manufacturing charge at  $1\frac{1}{4}$  cents per pound of cheese, leaving the patrons to engage such milk-drawers as were required.

Parliament had provided a sum of money to enable me to make advances at the end of every month up to two-thirds of the estimated value of the milk delivered. I was also permitted to make advances on account to the milk-drawers, until such time as the cheese are sold, when all such advances are to be fully refunded to the credit of the Receiver General.

The following is the form of the agreement which has been entered into between the several companies and myself:—

### *Agreement with the Companies and Patrons.*

MEMORANDUM of agreement between James W. Robertson, Dairy Commissioner for the Dominion, and ..... in the matter of manufacturing cheese at ..... during the season of 1893.

1. On behalf of the..... (hereinafter called the company), it is agreed that the company shall provide convenient premises and a cheese factory, suitably equipped with all necessary apparatus and utensils for the manufacture of cheese.

2. On behalf of the company it is agreed that the cheese factory building and premises (equipped as stated in paragraph 1), shall be put under the control and direction of the Dairy Commissioner for the Dominion.

(a.) Any charge or claim on the premises or building on behalf of those persons who advance money for the erection and equipment of the building, or any other persons whatsoever, are not to be considered as claims upon the Dairy Commissioner or the Department of Agriculture.

3. On behalf of the directors and shareholders of the company, it is agreed that they shall use all reasonable means to promote the interests of the factory, and to secure patrons who will furnish a supply of milk.

4. On behalf of the company, it is agreed that the company, or the patrons of the factory, shall deliver the milk at the factory.

(a.) The whey is to be disposed of for the benefit of the patrons in such a way as may be agreed upon between the company and the patrons of the factory.

5. In consideration of the foregoing, the Dairy Commissioner agrees to manufacture from the milk which is received, a first-class quality of cheese at the manufacturing rate or charge of one and a quarter cents ( $1\frac{1}{4}$ ) per pound of cheese manufactured.

(a.) The right to reject any milk which he considers unfit for use in making first-class cheese, is reserved to the cheese-maker.

6. The Dairy Commissioner agrees to provide the fuel, cheese boxes and all other dairy furnishings which are necessary, and to care for the cheese until they are cured and fit for market.



7. The Dairy Commissioner agrees to market the cheese to the best of his judgment and ability, and to pay to the several patrons, the net proceeds realized from all sales of cheese, after deducting the manufacturing charge of one and a quarter cents (1¼) per pound of cheese, and such a further charge as the company require for payment of the drawing of the milk from the milk-stands of the several patrons to the factory.

8. The Dairy Commissioner agrees to advance to the patrons, after the end of every month, such a sum on account as he may estimate to be about two-thirds of the net value of the milk.

9. The Dairy Commissioner agrees to insure the cheese against loss by fire, as trustee for and on behalf of the patrons, to the amount of two-thirds of their market value; but the factory buildings and the apparatus and utensils therein are to be insured by the company on their own behalf, and the Dairy Commissioner is to accept no responsibility in that connection.

10. The Dairy Commissioner agrees to keep the premises and machinery in a good state of repair, from ordinary wear and tear.

11. The Dairy Commissioner agrees to pay to the company a rent of....., (equal to ten per cent on the cost of the buildings and equipment), for the use of the factory and premises for the season of 1893.

Signed at.....this .....day of.....1893.

The following is the form of the agreement which I furnished in blank to the several companies for use in concluding the contracts with the several milk-drawers:—

*Agreement for the Drawing of Milk.*

This agreement made the            day of            one thousand eight hundred and ninety,            , between            of the first part (hereinafter called the            ); and            of the            , in the County of            and Province of Prince Edward Island, of the second part:

Witnesseth that the said party of the second part, in consideration of the covenants on the part of the party of the first part, doth covenant to and with the said party of the first part, that he will draw and deliver at the            factory, according to the rules and regulations of the said            , now made and provided, or which may hereafter be made and provided for, all the milk placed on the milk-stands during the season of            on the milk route known as number            commencing at            milk-stand on the            line, township of            and following the said route            to the said factory, and will handle and deliver the said milk at the time named in the said rules and regulations and will take all necessary care of and protect from injury all milk cans and return them to the milk-stands each day according to the said rules and regulations, and will be responsible for all damages caused by neglect of duties, improper care of milk and cans in the performance of the said work.

And it is further agreed between both parties to this agreement that the rate of remuneration for the said work for the current year shall be the sum of            and that            per cent of the said remuneration shall be retained by the said            until the whole of the said work has been completed in accordance with the said regulations as security for the faithful performance of the said work; and in case of any default, neglect or want of care the whole or a sufficient part of the said            per cent of remuneration retained may be forfeited in payment of any damages caused by such default, neglect or want of care, and it is further agreed that the

## Report of the Dairy Commissioner.

balance of remuneration after it has been earned shall be paid to the party of the second part, by the party of the first part at any time or times during the season, as may be agreed upon between the parties to this agreement.

And it is further agreed that the party of the second part shall commence to draw milk on the \_\_\_\_\_ day of \_\_\_\_\_ and shall draw milk every week day, or the days that the manager for the said \_\_\_\_\_ may appoint, up to the \_\_\_\_\_, when the said season shall close.

In witness whereof we have hereunto set our hands and seals this the \_\_\_\_\_ day of \_\_\_\_\_, one thousand eight hundred and ninety-\_\_\_\_\_.

In the presence of }

SEAL.

SEAL.

Mr. T. J. Dillon was the member of my staff who went to New Perth when the Dairy Station there was established in 1892. He managed the business well.

In the spring of 1893 he was charged with the duty of overseeing the work at the eleven cheese factories which were under our control. His headquarters were at Charlottetown, P.E.I. The management of business upon this comparatively large scale (amounting to between \$40,000 and \$50,000 during the four months of the summer in a district where it is new to most of the patrons), will require unceasing care; but when these factories have been successfully established (as I have no doubt they will be from the very commencement), they will give to the farmers of Prince Edward Island new opportunities for turning their farming resources to good account, with the advantage of beginning co-operative dairying at about the place to which the farmers of Ontario and Quebec have attained after twenty years of experience.

The following copy of a letter, which I sent to the several cheese-makers at the different factories, sets forth the spirit which it was desired should animate the efforts of all who were connected with this movement.

### *Letter to Cheese-makers.*

MY DEAR SIR,—Your engagement as one of our cheese-makers identifies you with the introduction of co-operative dairying into Prince Edward Island at this time. In a large measure it is a new business there. Its immediate and permanent success will depend mainly upon:—

1. The profits to the farmers;
2. The development of the good feeling which already exists on the part of the farmers towards our Department and this business;
3. The hearty co-operation of the patrons of the factory of which you have charge.

With all of these you have more or less to do; and I am trusting you to shoulder the responsibility which belongs to the work at your factory with an untiring and unswerving determination to do the best you can.

As you know, the immediate direction and supervision of the factories in Prince Edward Island have been entrusted to Mr. Thos. J. Dillon, Dairy Superintendent for Prince Edward Island. I have full confidence in his ability; and I desire you to obey his instructions promptly and cheerfully.

For your guidance and to bring out into use the best business capacity and power for work and management which you possess, I invite you to read the following suggestions on the three headings already mentioned, until you know them—not as commands or instructions—but as matters which you practise daily by your own choice and preference.

*Profits to the Farmers.*

1. The profits come from the difference between the cost of production and the price obtained for the product. Therefore, encourage every patron to keep the best of cows in the best way, at the lowest cost for feed. Lose no chance of learning and then pointing out to others the benefits from growing Indian corn for fodder. Indian corn, horse beans and sunflowers are a means for delivering dairy farmers from the yoke of hard times. Preach that gospel in season and out of season.

2. A good price for the cheese—the higher the better—will increase the profits. You cannot push the market price up or pull it down. The finest quality of cheese always fetches a higher price than goods of a common or poor quality. Let the cheese from your factory be faultlessly fine. Let your standard not be—“good enough to pass Mr. Dillon’s or Prof. Robertson’s inspection,” but let it be—“as fine as they can be made.”

3. To attain this will require painstaking care in every detail of the work. From the intrinsic quality and appearance of the cheese, to the condition of the factory floor and surroundings, let your aim be—“As well as it can be.”

4. I will endeavour to get the highest price that can be got for the cheese. Give me no excuse for selling for a fraction of a cent less than the top market price, by turning out goods of fancy quality.

*The development of the good feeling which already exists on the part of the farmers towards our work and this business.*

1. In a measure you are the custodian of my reputation in the district and at the factory.

2. If the words or actions of some well-meaning but quick-tempered person should irritate you, keep control of your temper and preserve your courtesy of manner with a frank, firm civility, in order that you may act creditably for the department. If you want to get mad or feel a need of doing so, go to the woods and attend to it all alone after business hours.

3. I expect you to do all of your work and to attend to every part of your business so well, that as a cheese-maker and a business man you will merit the respect of every patron. When they respect you fully, our Department will be content with what runs over.

*The hearty co-operation of the patrons of the factory of which you have charge.*

1. Confidence is the basis of durable, desirable co-operation. Confidence in the business as a good one is contagious. Try to inoculate everybody with enthusiasm. Confidence in the fairness of the business is essential. Strict honesty of administration, fairplay to all alike, and the fact that the business is theirs—ours only for them—will foster co-operation.

I have not gone into the details of the work. Our monthly notes for cheese-makers and Mr. Dillon’s directions from time to time will do that. The success of this business is of far-reaching importance to the province and to yourself. I have observed young men closely, and have some knowledge of the qualities which enable them to do the best with themselves and for themselves. Integrity, cheerfulness and

## Report of the Dairy Commissioner.

diligence are a trio which I commend to you for bosom friends. The middle one is seldom valued as highly as it should be. If the outlook is dull after you have done your duty faithfully, try to get your liver in better order, take large doses of fresh air, and the world will lose its gloominess.

I attach a statement of the regulations which are to govern the competition for the gold medal and the silver medals which I offer—as a personal matter—to the patrons who furnish the largest supply of milk per cow.

I am, yours very truly,

JAS. W. ROBERTSON,  
*Dairy Commissioner.*

### REGULATIONS FOR MEDALS.

1. The total number of milking cows kept on the farm from which the milk is supplied are to be counted.
2. The total quantity of milk received at the factory from every patron, from the time when the factory opens, with the regular milk-drawers collecting the milk, until the close of the cheese-making season, is to be reckoned.
3. The one patron who supplies the largest quantity of milk per cow (as per clauses 1 and 2), taking in all the factories which are managed by the Dairy Commissioner in Prince Edward Island, will be entitled to a gold medal.
4. Every one of the patrons who severally furnish the largest quantity of milk per cow (as per clauses 1 and 2), to one of the other factories, will be entitled to receive a silver medal.

---

Personally and officially, I am indebted to the officers of the several Dairying Companies, and particularly the President, Secretary and other officers of the New Perth Dairying Company, for the assistance which they have rendered in connection with our work in Prince Edward Island.

### *Mr. T. J. Dillon's Report (P.E.I.).*

2. During the winter of 1891-92, Mr. Dillon had charge of the Experimental Dairy Station at Mount Elgin, Ont. While there he attended meetings of farmers, and gave information on winter dairying, and other aspects of profitable farming.
2. In April, 1892, he started for Prince Edward Island. He first attended meetings in the school-houses in the district of New Perth, and secured the names of 34 farmers who agreed to become patrons of the new Dairy Station. Largely through his energetic efforts (this is not in his report), the numbers of patrons were quickly increased until over 100 farmers were supplying milk.
3. He reports on some of the work in connection with the cheese-making at New Perth, and explains the disposal of the whey.
4. After the cheese-making was finished, he attended meetings of farmers, advising the growing of larger areas of Indian corn, and the sowing of fall rye for feed during the summer. In Part XII. is a cut of a bunch of rye, which was grown on the Island during the summer of 1892.

5. On November 5th, he left for Mount Elgin, Ont., to take charge of the winter butter-making station there. He reports upon that business, and mentions a number of persons who learned butter-making under his supervision.

6. He attended eleven annual meetings of the companies and patrons of cheese factories, after which he left for Prince Edward Island, to take charge of the eleven cheese factories to be run there during the summer.

#### SUMMARY OF THE WORK IN THE PROVINCE OF MANITOBA AND THE NORTH-WEST TERRITORIES.

In 1892, Mr. Robert Cornett, from my staff, visited different districts, addressed meetings of farmers upon dairy topics, and gave practical illustrations of butter-making. He also visited the cheese factories.

I was able to attend several meetings in the province of Manitoba. A report of an address which I delivered before the annual meeting of the Central Farmers' Institute of Manitoba, at Portage la Prairie, will be found in Part VI.

A Dairymen's Association for the North-west Territories was organized at Regina. The question of establishing a co-operative creamery upon a large scale, with branch separating stations at different points, from which cream could be collected to the central manufacturing premises, was brought forward at the meeting, and pressed upon the attention of the public afterwards. An effort was made to have a company formed to engage in this enterprise, with headquarters at Moose Jaw. Considerable correspondence ensued between several of the promoters and myself in reference to this matter. I did not consider it prudent to encourage the scheme as presented by its promoters, as, in my opinion, the country is not yet ready to support successfully such a venture. The following letters which I wrote to the President of the Dairymen's Association of the North-west Territories, and to Mr. Wm. Watson, set forth the attitude which I maintained towards that movement, and also my opinion as to the plan according to which co-operative dairying can be promoted most advantageously in the North-west.

OTTAWA, 3rd February, 1893.

A. C. THORBURN, Esq.,  
President, N. W. T. Dairymen's Association,  
Broadview, N.W.T.

MY DEAR SIR,—Your letter of the 5th December has been here awaiting my return. I have read the address which Mr. Watson delivered before the Convention at Regina with a good deal of interest. I fear that settlement in the North-west is not yet dense enough, nor the railway facilities sufficiently regular with low rates of freight, to make his project likely to succeed at present. In old settlements where cows are several times more plentiful than they are yet in the North-west, that central factory scheme has been a doubtful success. The difficulty of getting the cream to the central factory at regular times, the difficulty of returning the empty milk or cream cans, and the cost connected therewith, and the difficulty of satisfying the farmers who are many miles distant from the creamery and who never come in contact with the manager or the butter-maker, are probably greater than any saving that would be effected in the actual outlay required for the labour of manufacturing the butter. It occurs to me also that there is another difficulty to overcome in the

## Report of the Dairy Commissioner.

neighbourhood of Moose Jaw and Regina; that is, the scarcity of cold, pure water, which is essential to the raising of cream at home, so as to secure the largest quantity in good condition.

I have given the needs of your district of Canada a good deal of consideration recently, and I submit the following for your consideration. Would it not be the better plan for the farmers of the North-west, for half a dozen or ten farmers, who could keep from ten to twenty cows each, to join together, provide a small creamery building, fit it up with a centrifugal cream separator, deliver their own milk at the factory every morning, and take the skim milk home with them? This would do away with the expense of hauling the milk or cream long distances, and would provide the skim milk in the best condition for the raising of calves or the feeding of swine. I know there are not many men yet in the North-west who keep as many as fifteen or twenty milking cows; but a method, such as I have suggested, might be the best means of encouraging them to increase their herds, when they can see an economical way of manufacturing butter and disposing of it. I hope to give effect to a scheme somewhat like this at some point in the North-west during the coming summer, in addition to the work of travelling instruction, which we we expect also to continue.

I am, yours very truly,

JAS. W. ROBERTSON.

OTTAWA, 16th March, 1893.

WM. WATSON, Esq., Moose Jaw, N.W.T.

MY DEAR SIR,—I have received your letter of the 25th ult., and also a copy of *The Times* of Moose Jaw, N. W. T., containing the open letter which you have addressed to me and the people of Assiniboia through its columns. Absence from home at conventions in Ontario and Quebec has prevented me from answering you sooner.

You express some misgivings about how I may view your action in publishing my letter addressed to the President of the North-west Dairymen's Association. I assure you that I have not any objection to the course which you took, and I believe it was taken for the purpose of promoting the welfare of the farmers. However, I may be permitted to suggest that you read the letter itself, as I do not find in it any of the plans, theories or statements which you have discovered there, and have demolished with such evident satisfaction.

The gist of the whole matter—when divested of the unnecessary, and therefore unbecoming controversial quality with which you raiment it in print—appears to me to be :—

I propose that the farmers of the North-west Territories should begin co-operative dairying, mainly in butter-making and the rearing of stock, in such an inexpensive and economical way as they can best afford under the conditions of the sparse settlement which exist. The means and methods of co-operation which may be adopted must be adapted to the peculiar needs and conditions of the country in relation to water supply, temperature, cattle population, &c., &c.

In a country of recent settlement it seems to me desirable to permit each farmer to do as much of the work as is practicable and economical, in order that he may earn for himself what would otherwise go to pay some one else. For that reason it occurs to me that the task of delivering milk from six, or ten, or even twenty farms, to a creamery, and carrying the skim milk home, would not be unremunerative labour for some helper on the farms. If one of half a dozen neighbours undertook to draw the milk for all the others one day a week by turns, the co-operative element would have larger application.

One of the young men or young women from one of the farm homes might soon learn to make gilt-edged creamery butter; (and we have it in view to provide

an opportunity in Assiniboia where they can do so during the coming summer). No such wages as \$75 per month need be reckoned on at the beginning of the business upon a small scale; and I may remind you that nearly all the great and good conveniences which exist for and minister to the prosperity of the people came from small beginnings.

I agree with you that the sooner the farmers of the North-west Territories turn their attention to the mixed farming on the well-watered areas, the better will it be with them in every sense; and I am desirous and ambitious to render them such aid as our Department can give towards attaining success in that direction. Do you not think that most of the closed creameries and idle cheese factories in the western part of the Dominion, owe their failure to the fact that they were full-sized as to expenditure from the beginning, from being started on a scale too large for the cattle population of the localities which they were intended to serve?

It is not difficult to perpetrate an alluring prospectus of a concern gigantic enough to own and operate the whole earth as an adjunct of Heaven,—or of Moose Jaw or Regina; but it might be not so easy to run the business so as to realize on the expectations and money which might be invested in it. On the other hand, if the people of Moose Jaw and its vicinity will go in for establishing and equipping a small creamery adapted to the needs of their locality, I believe it will pay the promoters and will be a means of great benefit to the farmers who furnish milk or cream. I do not see any advantage from burdening the scheme for a creamery at Moose Jaw, by proposals to establish branch cream separating stations in the surrounding territory, until after the central creamery is a workable and working success. If I can help you to reach that first goal, I shall gladly do so.

I am, yours very truly,

JAS. W. ROBERTSON.

Afterwards it was decided to erect a creamery at Moose Jaw, by way of making a beginning in the co-operative business. One of my assistants was sent to Moose Jaw to give information and to personally supervise for a time the placing of the machinery and apparatus. Owing to the late date at which the creamery was completed and owing to the fact that some of the prospective patrons were not ready to furnish as much milk as was looked for, the opening of the creamery has to be postponed for the present season.

An expert butter-maker was placed during part of the summer at Wolseley, to act as instructor in butter-making to all who should visit the station.

It appears to me that if a dozen or more farmers in the North-west Territories would convey the milk from their herds to one central farm, where a small dairy building could be erected, they would find it both economical and profitable to have the butter made at one central place by an expert butter-maker. A centrifugal cream separator would separate the cream and leave the skim milk ready to be carried home in the same cans with a detention of not more than a quarter or half an hour. It was with the object of calling attention to the feasibility and suitability of this method of dairying to North-west conditions, that one of my assistants was sent to Wolseley for the present summer of 1893.

During the winter of 1892-93, a request was made to the Department on behalf of the Dairymen's Association of the Province of Manitoba, that an expert from the Dairy Commissioner's staff be sent to give instruction to the cheese-makers of the province at the different factories. It was represented to me by the President of

## Report of the Dairy Commissioner.

the Dairymen's Association of the Province of Manitoba, that other provision would be made for giving assistance to the butter-makers of the province in that branch of the business. It has been arranged that Mr. C. C. Macdonald visit the cheese factories in Manitoba.

### *Mr. Robert Cornett's Report (Manitoba).*

1. Mr. Cornett gives a statement of his work in general terms and mentions the number and nature of the meetings which he attended and of the cheese factories which he visited.

2. He reports his opinions and impressions concerning the cows, pasture, water, cheese factories and creameries of Manitoba.

3. He visited cheese factories in the province of Ontario, to give to intending exhibitors information concerning the arrangement and plans which had been made for receiving cheese for the exhibition at the World's Fair.

### MEETINGS AND LECTURES.

The Order in Council by which I was appointed Dairy Commissioner, intimates that one main object and sphere of my work is to give practical information to farmers and others by means of bulletins, conferences and lectures. Executive work which has arisen from the establishment and management of the Branch Experimental Dairy Stations—(there have been 19 different dairy stations under my control during the year)—has absorbed a large share of my time; the management of the exhibition of Canadian dairy products at the World's Fair, claimed no few hours of it; my trip to Great Britain appropriated nearly two months; the planning and supervising of work at the dairy on the Central Experimental Farm and investigations into the feeding and management of cattle and swine in my capacity as Agriculturist, received but a scanty portion, considering their importance; and meetings of farmers, correspondence, etc., etc., had to go sparingly served by what was left of it. I have alluded to these matters to account for the smaller number of meetings which I have found it possible to attend than in former years. Since January 1st, 1892, I have been able to deliver addresses at 53 conventions or meetings of farmers and dairymen. These were held in the provinces of Ontario, Quebec, New Brunswick, Nova Scotia, Prince Edward Island and Manitoba. My assistants also gave addresses upon 322 occasions. The nature of the proceedings at these meetings is referred to in their several reports in this volume. I attach much importance to the holding of meetings of and with the farmers. For my own benefit, it affords me sincere pleasure to take part in them. The occupation of farming is one which tends to make those who follow it, take a rather gloomy and despondent view of the outlook for the future of their business. The intensity of new competitions and difficulties become appalling to men who labour most of the time in isolation; and most men retain enough of the herding proclivities of the race to find a renewal of courage in joining a number of their fellows in any effort for the amelioration of their condition. Public meetings of farmers help to imbue them with a spirit of mental activity, which leads in well-balanced men to hopefulness, courage, intelligence and thoroughness in work. For the sake of the subtle, strong and wholesome influence on themselves (and on their products and profits) which comes from frequent meetings to discuss with sincerity and unselfishness, the affairs of



their own calling—threefold trade, business and profession—I cherish the hope that farmers will not forsake the assembling of themselves together, but will rather multiply their meetings and make them continually more helpful and enjoyable. As the subject matter of some of the addresses which I had the honour to deliver during the year, may be useful to many farmers whom the voice of one speaker cannot hope to reach, I have introduced the reports of those which I gave before the Central Farmers' Institute of Manitoba at Portage la Prairie, before the Central Farmers' Institute of Ontario at Toronto, before the Ensilage and Economic Stock-feeding Association at Montreal, and before the Agricultural Congress at Quebec. Under the heading of my mission to Great Britain, I have put the reports of addresses delivered in Liverpool and London, England.

The dairy bulletins which were issued during the year, were mainly for the guidance of cheese-makers. The experimental investigations at the dairy of the Central Experimental Farm have been chiefly for the benefit of butter-makers. The bulletins and reports are in this volume.

The particulars of the investigations which were carried on at the Central Experimental Farm in my capacity as Agriculturist, were reported upon in the annual report of the Experimental Farms. These bear directly upon dairy work, and as the report has been stereotyped, it can be transferred into this volume with little expense and some advantage to dairymen.

The volume of trade from Canada in the exports of butter and cheese is shown by the following tables (years ended 30th June):—

DOMINION OF CANADA—Exports of Dairy Products—Home Production.

BUTTER.

Year.	Quantity.	Value.	To Great Britain.	To United States.	To France.	To Germany.	Other Foreign Countries.	B.N.A. Provinces.	British Indies.
	Lbs.	\$	\$	\$	\$	\$	\$	\$	\$
1868....	10,649,733	1,698,042	544,707	1,015,702	.....	1,496	14,870	95,777	26,986
1880....	18,535,362	3,058,069	2,756,064	111,158	.....	.....	24,710	163,290	2,847
1881....	17,649,491	3,573,034	3,333,419	58,522	.....	.....	30,574	143,935	6,584
1882....	15,161,839	2,936,150	2,195,127	529,169	.....	.....	32,052	169,270	10,538
1883....	8,106,447	1,705,817	1,330,585	206,154	.....	.....	29,446	131,341	8,291
1884....	8,075,537	1,612,481	1,395,652	46,618	.....	.....	16,455	151,224	2,532
1885....	7,330,788	1,430,905	1,212,768	16,795	.....	15,172	21,473	161,862	2,835
1886....	4,668,741	832,355	652,863	17,545	.....	.....	17,577	142,485	1,885
1887....	5,485,509	979,126	757,261	17,207	.....	.....	23,789	180,238	631
1888....	4,415,381	798,673	614,214	13,468	.....	.....	5,226	164,329	1,436
1889....	1,780,765	331,958	174,027	7,879	.....	.....	22,921	124,349	2,782
1890....	1,951,585	340,131	184,105	5,059	.....	.....	29,342	119,989	1,636
1891....	3,768,101	602,175	440,060	10,054	.....	20,447	24,021	101,649	5,944
1892....	5,786,696	1,056,058	877,455	6,038	.....	5,160	27,207	133,770	6,428
1893....	7,036,013	1,296,814	1,118,614	7,539	.....	1,175	35,042	127,412	7,032

## Report of the Dairy Commissioner.

DOMINION OF CANADA—Exports of Dairy Products—Home Production—*Continued.*

### CHEESE.

Year.	Quantity.	Value.	To Great Britain.	To United States.	To France.	To Germany.	Other Foreign Countries.	B. N. A. Provinces.	British Indies.
	Lbs.	\$	\$	\$	\$	\$	\$	\$	\$
1868....	6,141,570	620,543	548,574	68,784			891	1,954	340
1880....	40,368,678	3,893,366	3,772,769	114,507			170	5,710	210
1881....	49,255,523	5,510,443	5,471,362	28,500			14	10,027	540
1882....	50,807,049	5,500,868	5,471,676	18,436			242	8,196	2,318
1883....	58,041,387	6,451,870	6,409,859	24,468			202	15,480	1,863
1884....	69,755,423	7,251,989	7,207,425	24,866			188	19,248	262
1885....	79,655,367	8,265,240	8,178,953	68,978			205	15,899	1,207
1886....	78,112,927	6,754,626	6,729,134	15,478	80	90	156	9,139	549
1887....	73,604,448	7,108,978	7,065,983	30,667			211	11,982	165
1888....	84,173,267	8,928,242	8,834,997	83,153	5		828	9,087	172
1889....	88,534,887	8,915,684	8,871,205	31,473			1,582	11,208	216
1890....	94,260,187	9,372,212	9,349,731	6,425		370	2,154	12,777	755
1891....	106,202,140	9,508,800	9,481,373	13,485			1,954	9,104	2,884
1892....	118,270,052	11,652,412	11,593,690	39,558	2			12,942	4,096
1893....	133,946,365	13,407,470	13,360,237	24,578				18,669	2,297

The following table, from the Board of Trade returns of Great Britain for seven years (ended 31st December), shows the total quantities and values of butter and cheese imported into Great Britain, and illustrates the possible extension of our exports, particularly in fresh-made butter during the winter season :—

BUTTER.			CHEESE.		
Year.	Quantity.	Value.	Year.	Quantity.	Value.
	Cwts.	£		Cwts.	£
1886 .....	1,543,566	8,141,438	1886 .....	1,734,890	3,871,359
1887 .....	1,513,134	8,010,374	1887 .....	1,836,789	4,514,382
1888 .....	1,671,433	8,913,045	1888 .....	1,917,616	4,546,408
1889 .....	1,927,842	10,244,636	1889 .....	1,907,999	4,490,970
1890 .....	2,027,717	10,598,848	1890 .....	2,144,074	4,975,134
1891 .....	2,135,607	11,591,181	1891 .....	2,041,317	4,815,369
1892 .....	2,183,009	11,965,190	1892 .....	2,232,817	5,416,784

In order to make the information which it contains as easily available as possible to those who may consult its pages, the remainder of this report is arranged into parts under the following headings:—

- Part I.—The Feeding of Steers.  
 “ II.—The Fattening of Swine.  
 “ III.—Experimental Dairy Work.  
 “ IV.—Forty-Acre Lot.  
 “ V.—Dairy Bulletins.  
 “ VI.—Lectures and Addresses.  
 “ VII.—Mission to Great Britain.  
 “ VIII.—Miscellaneous Matters.  
 “ IX.—Summary of Business at the Experimental Dairy Stations.  
 “ X.—Canadian Dairy Products at the World's Columbian Exposition.  
 “ XI.—Report of the Assistant Dairy Commissioner.  
 “ XII.—Reports of Superintendents of Experimental Dairying.

#### ACKNOWLEDGMENTS.

The newspapers of Canada have been our invaluable co-workers in the effort to lay before the farmers such information and suggestions as might prove helpful to them in their work and lives. I may be permitted to overlook the impersonal character of the press and to mention that my thanks are due to the many journalists in all parts of Canada, whose brightness, breadth, clearness and catholicity of thought, in the matter of what is good for the people, have led them to include many items of news on dairy topics in the columns, which are becoming more and more every year the foremost and most forceful of educational agencies touching the material, social and intellectual well-being of the community.

Yearly I find myself under a deeper sense of gratitude, to the officers and members of the Farmers' and Dairymen's Associations and of Farmers' Institutes, and to the many hundreds of whole-souled, warm-hearted men and women on the farms of Canada, for the kindnesses which they have loaded upon me in a personal and official capacity.

The ultimate issue, as to real usefulness, of much of the work which is undertaken by the *Dairying Service*, depends in a large measure upon the diligence, integrity and efficiency of my assistants. Particularly taxing and difficult tasks have been entrusted during the year to Messrs. J. A. Ruddick, Thos. J. Dillon and J. W. Ellerby; and I take this opportunity of commending their untiring devotion to their duties and the uncommon quality and value of the services which they have rendered.

I have the honour to be, sir,

Your obedient servant,

JAS. W. ROBERTSON,

*Dairy Commissioner.*

# Report of the Dairy Commissioner.

## PART I.—THE FEEDING OF STEERS.

Experiments in the fattening of steers were begun at the Central Experimental Farm in December, 1890. The main object of the first experiments, was to obtain information upon the relative cost of fattening steers, (1) upon a ration of which the bulky-fodder portion was mainly corn ensilage, hay and roots, (2) upon a ration of which the bulky-fodder portion was mainly hay and roots, and (3) upon a ration of which the bulky-fodder portion was mainly corn ensilage.

Six 2-year-old steers were purchased and were sorted into three lots, as nearly even in quality and size as possible. They were apparently all Shorthorn grades. On 1st December the average weight per head was 1,135 lbs. During the test (which lasted from 1st December to 18th May), they were weighed once every week and the feed they consumed was weighed every day. They had free access to water in a trough in front of the stalls, and a supply of salt was provided at the side of each manger. The preparatory period of feeding lasted from 1st December to 29th December, and during it all the animals were fed upon the same ration.

The three experimental rations were composed as shown in the following Table:—

TABLE I.

Ration No. 1.	Lbs.	Ration No. 2.	Lbs.	Ration No. 3.	Lbs.
Corn ensilage.....	20			Corn ensilage.....	50
Hay (cut).....	10	Hay (cut) ..	20		
Roots.....	20	Roots.....	40		
Straw (cut).....	5	Straw (cut).....	5	Straw (cut)..	5
Oil-cake.....	1	Oil-cake.....	1	Oil-cake.....	1
Cotton-seed meal.....	1	Cotton-seed meal.....	1	Cotton-seed meal.....	1
Pease (ground).....	2	Pease (ground).....	2	Pease (ground).....	2
Barley (ground).....	2	Barley (ground).....	2	Barley (ground).....	2
	61		71		61

For a period of five weeks from the 17th March to the 20th April, an additional 1 lb. each of oil-cake and cotton-seed meal were put into each ration.

For the purpose of obtaining some data which would be understood easily and remembered readily by the farmers, and which would afford means for making a comparison between the cost of feeding the steers on the three different rations, a cash value was estimated for the component fodders in each. The hay was valued at \$8 per ton; roots (turnips and mangels) at \$4 per ton; straw at \$4 per ton; oil-cake and cotton-seed meal at \$30 per ton; pease and barley at \$20 per ton; and corn ensilage at \$1.40 per ton. The corn ensilage was placed at the actual cost, as per statement in Bulletin No. 12, and the other fodders at an estimated valuation, which may be high or low, according to ever fluctuating circumstances of seasons and markets.

Table II shows, (1) the increase in weight of each steer after 20 weeks, (2) the average quantity of feed consumed per day per head, and (3) the average cost per head per day for feed consumed.

TABLE II.

RATIONS.	Increase in weight.	Feed consumed.	Cost per head per day
	lbs.	lbs.	cents.
No. 1. { Hay, roots, corn ensilage and meal.....	128	52·8	15·58
do { do .....	182		
No. 2. { Hay, roots and meal.....	188	55·5	19·23
do { do .....	179		
No. 3. { Corn ensilage and meal.....	221	60·	11·90
do { do .....	212		

*Conclusions.* From these tests it appears that:—

(1.) During the feeding period of 20 weeks, the steers which were fed upon ration No. 3, (corn ensilage and meal), gained in weight, on the average, 33 lbs. per head more, and cost 7·33 cents per head less, per day for feed consumed, than the steers which were fed upon ration No. 2, (hay, roots and meal);

(2.) During the feeding period of 20 weeks, the steers which were fed upon ration No. 3, (corn ensilage and meal), gained in weight, on the average, 61½ lbs. per head more, and cost 3·68 cents per head less, per day for feed consumed, than the steers which were fed upon ration No. 1, (hay, roots, corn ensilage and meal);

(3.) When the experiment was ended, the steers which were fed upon ration No. 2, (corn ensilage and meal) were in the most attractive condition of the three lots for handling and selling;

(4.) A ration of which the bulky-fodder portion was mainly corn ensilage, was more profitable for the fattening of steers, than a ration of which the bulky-fodder portion was mainly or wholly hay and roots.

#### EXPERIMENTS IN 1891-92.

The experiments in the feeding of steers during the winter of 1891-92, were planned,—

(1.) To obtain further information upon the relative cost of fattening steers upon a ration of which the bulky-fodder portion was mainly, (a) in the one case, corn ensilage, hay and roots, (b) in another case, hay and roots, and (c) in the third case, corn ensilage,—

(2.) To discover the comparative values of feed consumed, per 100 lbs. of increase in live weight, by 3-year-old steers, 2-year-old steers, 1-year-old steers and calf-steers respectively.

#### THE FATTENING OF TWO-YEAR-OLD STEERS.

Eight 2-year-old steers were purchased and were sorted into four lots as nearly even in quality and size as possible. They were apparently all Shorthorn grades.

The preparatory feeding period lasted from October 29 to December 1, and during it the animals were all fed upon the following ration:—

Corn ensilage.....	Lbs. 25
Roots .....	50
Straw (cut).....	15
Pease (ground).....	3
Barley (ground).....	3
	—
	<u>96</u>

## Report of the Dairy Commissioner.

They were each allowed as much of the mixture as they would eat.

On October 29 the average weight per head was 1,079 lbs., and on December 1 it was 1,155 lbs., showing a gain of 76 lbs. per head.

Three rations were composed as in Table III.

TABLE III.

Ration No. 1.	Lbs.	Ration No. 2.	Lbs.	Ration No. 3.	Lbs.
Corn ensilage .....	20			Corn ensilage .....	50
Hay (cut) .....	10	Hay (cut) .....	20		
Roots .....	20	Roots .....	40		
Straw (cut) .....	5	Straw (cut) .....	5	Straw (cut) .....	5
Oil-cake .....	2	Oil-cake .....	2	Oil-cake .....	2
Pease (ground) .....	2	Pease (ground) .....	2	Pease (ground) .....	2
Barley (ground) .....	2	Barley (ground) .....	2	Barley (ground) .....	2
	61		71		61

For the purpose of making a comparison of the relative cost of fattening steers upon the three different rations, a cash value was estimated for the component fodders in each. The hay was valued at \$8 per ton; roots at \$4 per ton; straw at \$4 per ton; oil-cake at \$30 per ton; pease and barley at \$20 per ton; and corn ensilage at \$2 per ton. The corn ensilage was valued at a higher figure than in the former experiment (in 1890-91) for the reason that the corn was wilted to a greater extent before it was put into the silos, and because it cost more in 1891 than in 1890 owing to the crop being damaged by a hail storm in August. The prices at which the several fodders are valued for the purposes of this comparison are higher than the cost of production to the ordinary farmer, and may be higher or lower than the prices which could be realized from their sale as fodders.

The following Table shows, (1) the increase in weight of each steer in 18 weeks' (2) the total quantity of feed consumed on the average per head per day, (3) the average quantity of the meal mixture (included in the former) consumed per head per day, and (4) the average cost per head per day, for feed consumed.

TABLE IV.

RATIONS.	Increase in weight.	Feed consumed per head.	Meal in feed per day.	Cost per head per day.
	lbs.	lbs.	lbs.	cents.
No. 1. { Hay, roots, corn ensilage and meal	152	61·96	6·09	18·28
do do do	265			
No. 2. { Hay, roots and meal .....	165	53·92	4·55	18·22
do .....	213			
No. 3. { Corn ensilage and meal .....	260	67·92	6·68	14·47
do .....	229			

## THE FATTENING OF STEERS ON CORN ENSILAGE AND FROZEN WHEAT.

From December 1 until January 5, the other two steers were fed upon a ration composed of—

	Lbs.
Corn ensilage .....	50
Straw (cut).....	5
	<u>55</u>

During that period, they gained in weight an average of 11 lbs. per head, and consumed on the average 61·9 lbs. of feed per head per day, at a cost of 6·75 cents per head per day.

From January 5 until April 5, these two steers were fed upon a ration composed of,

	Lbs.
Corn ensilage .....	50
Straw (cut) .....	5
Frozen wheat (ground).....	6
	<u>61</u>

During that period of 13 weeks, they gained in weight an average of 159 lbs. per head, and consumed on the average 59·88 lbs. of feed per head per day, at a cost of 9·32 cents per head per day. The frozen wheat was valued at 35 cents per bushel.

Table V shows, (1) the average increase in weight per head per day, (2) the average cost per head per day for feed consumed, and (3) the average cost of feed consumed per 100 lbs. of increase in live weight.

TABLE V.

RATIONS.	Increase in weight per day.	Cost per head per day.	Cost per 100 lbs. increase in weight.
	lbs.	cents.	\$
No. 1. Hay, roots, corn ensilage and meal .....	1·65	18·28	11 05
No. 2. Hay, roots and meal .....	1·50	18·22	12 14
No. 3. Corn ensilage and meal.....	1·94	14·47	7 45
No. 4. Corn ensilage and frozen wheat.....	1·74	9·32	5 33

*Conclusions.* From these tests it appears that:—

(1.) During the feeding period of 18 weeks, the steers which were fed upon ration No. 3 (corn ensilage and meal), gained in weight on the average 55½ lbs. per head more, and cost 3·75 cents per head less, per day for feed consumed, than the steers which were fed upon ration No. 2 (hay, roots and meal);

(2.) During the feeding period of 18 weeks, the steers which were fed upon ration No. 3 (corn ensilage and meal), gained in weight on the average 36 lbs. per head more, and cost 3·81 cents per head less, per day for feed consumed, than the steers which were fed upon ration No. 1 (hay, roots, corn ensilage and meal);

(3.) The cost for feed consumed per 100 lbs. of increase in live weight, was 62·95 per cent greater on ration No. 2 (hay, roots and meal), and 48·32 per cent greater on ration No. 1 (hay, roots, corn ensilage and meal) than it was on ration No. 3 (corn ensilage and meal);

## Report of the Dairy Commissioner.

(4.) On ration No. 2 (hay, roots and meal) the quantity of meal consumed per head per day, was 4.55 lbs. as against 6.68 lbs. per head per day on ration No. 3 (corn ensilage and meal);

(5.) The quality of the beef, from the steers fed upon corn ensilage and frozen wheat, was pronounced to be particularly excellent by the butchers, and by the members of eight different households who examined it critically when served as roast beef.

NOTE.—To furnish further data for a comparison between the bulky-fodder portions of rations Nos. 1, 2 and 3, an equal quantity of meal per head per day, will be fed to the several animals in our next series of experiments, instead of equal quantities of meal being added to the different rations.

### THE FEEDING OF THREE-YEAR-OLD STEERS.

Four 3-year-old steers were purchased and were sorted into two lots of apparently even quality. On December 3, the operation of dehorning was performed on them. The wounds on the heads of three of the animals appeared to be acutely painful for about a week, and during that time they all lost from 40 to 100 lbs. each. The other animal did not seem to suffer much, after the operation of sawing off the horns was ended. After the wounds were healed, the animals were fed loose in a cold shed with only one thickness of lumber between them and the outside air.

The preparatory feeding period lasted from October 29 to December 1, and during it the animals were all fed upon the following ration:—

Corn ensilage.....	Lbs. 25
Roots.....	50
Straw (cut).....	15
Pease (ground).....	3
Barley (ground).....	3
	96
	96

They were each allowed as much of the mixture as they would eat.

On October 29, the average weight per head was 1,182 lbs.; and on December 1, it was 1,251 lbs.,—showing a gain of 69 lbs. per head.

Two rations were composed as in Table VI.

, TABLE VI.

Ration No. 3.	Lbs.	Ration No. 5.	Lbs.
Corn ensilage.....	50	Corn ensilage.....	50
Straw (cut).....	5	Straw (cut).....	5
Oil-cake .....	2		
Pease (ground).....	2		
Barley (ground).....	2		
	61		55

For the purpose of making a comparison, a cash value was estimated for each of the component fodders in each ration as mentioned after Table III, page 33.



The following Table shows, (1) the increase in weight of each steer in 18 weeks, (2) the quantity of feed consumed on the average per head per day, (3) the quantity of the meal mixture (included in the former) consumed per head per day, and (4) the average cost per head per day, for feed consumed.

TABLE VII.

RATIONS.		Increase in weight.	Feed consumed.	Meal in feed per day.	Cost per head per day.
		lbs.	lbs.	lbs.	lbs.
No. 3.	{ Corn ensilage and meal.....	102	65·96	6·48	14·05
	{ do do .....	155			
No. 5.	{ Corn ensilage.....	50	54·65	0	5·96
	{ do .....	7			

THE FEEDING OF ONE-YEAR-OLD STEERS.

Four 1-year-old steers were purchased and were sorted into two lots of apparently even quality.

The preparatory feeding period lasted from 29th October, to 1st December, and during it, the animals were all fed upon the following ration:—

	Lbs.
Corn ensilage.....	25
Roots .....	50
Straw (cut).....	15
Pease (ground) .....	5
Barley (ground).....	3
	—
	96
	==

They were each allowed as much of the mixture as they would eat.

On 29th October, the average weight per head was 751 lbs.; and on 1st December, it was 805 lbs.; showing a gain of 54 lbs, per head.

From 1st December until 5th April, both lots were fed upon ration No. 3:—

	Lbs.
Corn ensilage.....	50
Straw (cut).....	5
Oil-cake.....	2
Pease (ground).....	2
Barley (ground).....	2
	—
	61
	==

The two steers of one lot, were fed loose in a cold shed with only one thickness of lumber between them and the outside air; and the two steers of the other lot, were fed tied in stalls in the cattle stable. The average temperature of the stable would be about 50° Fahr.

The following Table shows, (1) the increase in weight of each steer in 18 weeks, (2) the quantity of feed consumed on the average, per head per day, (3) the quantity of the meal mixture (included in the former) consumed per head per day, and (4) the average cost per head per day, for feed consumed.

# Report of the Dairy Commissioner.

## TABLE VIII.

RATIONS.	How fed.	Increase in weight.	Feed consumed per head.	Meal in feed per head.	Cost per head per day.
		lbs.	lbs.	lbs.	cents.
Corn ensilage and meal.....	In stable.	173	45.25	4.45	9.64
do .....	do ..	163			
do .....	In shed..	172	43.94	4.32	9.36
do .....	do ..	129			

*Conclusion.* From this single test, it is not evident that there was an appreciable difference in the increase in the weight of the steers, or in the quantity of feed consumed, which was due to the place or manner of feeding,—stable *v.* shed, and tied *v.* loose.

### THE FEEDING OF CALF-STEERS.

Four calf-steers were put under test on rations Nos. 2 and 3. Each lot contained one steer, out of a grade Shorthorn cow by a Shorthorn bull, and one steer out of a "Quebec Jersey" or "French Canadian" cow. The breeding of the sire of the Quebec steers was not known to us.

The preparatory feeding period lasted from October 29 to December 1, and during it the animals were all fed upon the following ration:—

Corn ensilage.....	Lbs. 25
Roots.....	50
Straw (cut).....	15
Pease (ground).....	3
Barley (ground).....	3
	96

They were each allowed as much of the mixture as they would eat.

On October 29, the average weight per head was 465 lbs.; and on December 1, it was 526 lbs., showing a gain of 61 lbs. per head.

The two rations were composed as in Table IX.

## TABLE IX.

Ration No. 2.	Lbs.	Ration No. 3.	Lbs.
Hay (cut).....	20	Corn ensilage.....	50
Roots.....	40	Straw (cut).....	5
Straw (cut).....	5	Oil-cake.....	2
Oil-cake.....	2	Pease (ground).....	2
Pease (ground).....	2	Barley (ground).....	2
Barley (ground).....	2		
	71		61

For the purpose of making a comparison, a cash value was estimated for each of the component fodders in each ration, as mentioned after Table III, page 33.

The following Table shows, (1) the increase in weight of each steer in 18 weeks, (2) the quantity of feed consumed on the average per head per day, (3) the quantity of the meal mixture (included in the former) consumed per head per day, and (4) the average cost per head per day, for feed consumed.

TABLE X.

RATIONS.		Breed.	Increase in weight.	Feed consumed per head.	Meal in feed per head.	Cost per head per day.
			lbs.	lbs.	lbs.	cents.
No. 2	Hay, roots and meal. ....	Shorthorn.....	255	30·71	2·59	10·38
	do	Quebec. ....	164			
No. 3	Corn ensilage and meal. ....	Shorthorn.....	212	35·25	3·46	
	do	Quebec.....	175			

The following Tables have been arranged to show, (1) the relative rates of increase in weight, (2) the relative cost per head per day, and (3) the relative cost of feed consumed per 100 lbs. of increase in live weight, of the steers of Shorthorn and Quebec blood respectively.

TABLE XI.

—		Breed.	Weight Dec. 1.	Weight April 5.	Increase.
			Lbs.	Lbs.	Lbs.
Steer No.	174	Shorthorn.....	595	850	255
do	173	Quebec.....	480	644	164
do	172	Shorthorn.....	600	812	212
do	171	Quebec.....	430	605	175

TABLE XII.

RATIONS.		Breed.	Increase in weight per day.	Feed consumed per day.	Cost per head per day.	Cost per 100 lbs. of increase in weight.
			lbs.	lbs.	cents.	\$
No. 2	Hay, roots and meal. ....	Shorthorn.....	2·02	35·85	12·11	5·99
	do	Quebec.....	1·30	25·65	8·67	6·66
No. 3	Corn ensilage and meal. ....	Shorthorn.....	1·68	39·00	8·31	4·94
	do	Quebec.....	1·38	31·50	6·71	4·83

*Conclusions.* From these tests with calf steers it appears that:—

(1.) During the feeding period of 18 weeks, the steers which were fed upon ration No. 3 (corn ensilage and meal) GAINED in weight on the average 16 lbs. per head LESS, and cost 2.87 cents per head LESS per day for feed consumed, than the steers which were fed upon ration No. 2 (hay, roots and meal);

(2.) The cost of feed consumed per 100 lbs. of increase in live weight, was 27.6 per cent greater, on ration No. 2 (hay, roots and meal), than it was on ration No. 3 (corn ensilage and meal);

(3.) The cost of feed consumed per 100 lbs. of increase in weight was lowest in the case of a calf steer of "French Canadian" or "Quebec Jersey" breed, fed upon ration No. 3 (corn ensilage and meal).

# Report of the Dairy Commissioner.

## COMPARISONS IN THE FEEDING OF STEERS OF DIFFERENT AGES.

In the foregoing Tables some information has been given showing the comparative quantities of feed consumed and the cost per 100 lbs. of increase in live weight, by 3-year-old steers, 2-year-old steers, 1-year-old steers and calf-steers respectively, when fed upon the same ration.

The following additional Tables have been arranged to present a comparison of the results in convenient form. The lots which are compared were fed from Dec. 1 to April 5, upon ration No. 3, viz.:-

Corn ensilage .....	Lbs. 50
Straw (cut) .....	5
Oil-cake.....	2
Pease (ground).....	2
Barley (ground).....	2
	61

TABLE XIII.

Steers.	Increase in weight.	Increase in weight per day per head.	Feed consumed per day per head.	Meal in feed per day per head.	Cost per head per day.	Cost per 100 lbs. of increase in weight.
	lbs.	lbs.	lbs.	lbs.	cents.	\$
3-year-old, No. 189.....	102	1.02	65.96	6.48	14.05	13.77
do No. 188.....	155					
2-year-old, No. 183.....	260	1.94	67.92	6.68	14.47	7.45
do No. 182.....	229					
1-year-old, No. 178.....	173	1.33	45.25	4.45	9.64	7.23
do No. 177.....	163					
Calf steer, No. 172.....	212	1.53	35.25	3.46	7.51	4.89
do No. 171.....	175					

*Conclusions.* From this one series of experiments, it appears that:—

- (1.) The cost for feed consumed per 100 lbs. of increase in live weight was lowest in the case of calf-steers, viz.: \$4.89 per 100 lbs.;
- (2.) The cost for feed consumed per 100 lbs. of increase in live weight was 84.83 per cent greater by the 3-year-old steers than by the 2-year-old steers;
- (3.) The original weight of the 2-year-old steers was enhanced in value per lb., quite as much by the feeding for 18 weeks, as was the original weight of the 3-year-old steers;
- (4.) The original weight of the 1-year-old steers and calf-steers was not enhanced in value per lb. to any appreciable extent by the feeding for 18 weeks.

NOTES.—The 1-year-old steers and calf-steers have been carried over to be fed during the winter of 1892-93.

The corn ensilage, which was used in these experiments, was made from several varieties of Indian corn, most of which had not reached the early milk stage of growth. By the planting of varieties of corn which ripen early (mainly Longfellow and Pearce's Prolific) a quality of ensilage which appears to be much superior, has been provided for the feeding experiments of 1892-93.

## PART II.—THE FATTENING OF SWINE.

Experiments in the feeding of swine were commenced at the Central Experimental Farm in December, 1890. Particulars of the different sorts of feed, of the quantities of feed consumed, and of the increase in the live weight of the animals under the tests, were given in the Annual Report for 1891.

The objects of these first investigations were,—(1) to discover the difference, if any, in the quantity of grain required to produce every pound of increase in the live weight of the swine, when it was fed steamed and warm, and when it was fed raw

and cold, (2) to obtain a record of the comparative quantities of grain required to produce every pound of increase in the live weight of swine during different stages of the fattening period.

The mixture of grain used in the tests was one composed of equal parts of pease, barley and rye, which had been ground. It was saturated with water and fed wet in all cases.

Cold water was given to drink, and a mixture of salt and wood ashes was put in a box on the floor of every pen, where the pigs had access to it at will.

The quantities of feed consumed were weighed every day, and the swine were weighed once every week.

The following Table shows the quantities of feed consumed per pound of increase in live weight, during six feeding periods in four pens.

TABLE I.

	PEN 1.		PEN 2.		PEN 5.		PEN 6.	
	4 Swine, fed steamed and warm.		4 Swine, fed raw and cold.		4 Swine, fed steamed and warm, plus Sugar Beets.		4 Swine, fed raw and cold, plus Sugar Beets.	
	Grain.		Grain.		Grain	Sugar Beets	Grain	Sugar Beets
	Lbs.	Lbs.	Lbs.	Lbs.	Lbs.	Lbs.	Lbs.	Lbs.
December 9 to January 5.....	3 31	3 30	4 69	0 61	3 17	0 84		
January 5 to February 2.....	3 07	3 07	2 46	2 00	2 76	2 23		
February 2 to March 2.....	3 79	4 43	3 46	2 00	3 81	2 32		
March 2 to March 30.....	5 00	7 07	5 40	3 63	3 15	2 13		
March 30 to April 27.....	7 06	5 68	4 88	4 08	9 51	8 25		
April 27 to May 18.....	8 53	5 71	4 17	3 31	6 58	6 00		
Average.....	4 16	4 25	3 86	+2 46	3 89	+2 73		

*Conclusions.* These two sets of experiments indicate that:—

(1.) There is no appreciable difference in the number of pounds of grain required to produce a pound of increase in the live weight of swine, when it is fed steamed and warm, as compared with it when fed raw and cold;

(2.) On the average there is a gradual and great increase in the quantity of grain consumed for every pound of increase in the live weight of swine, after the second month of the fattening period, and after the average live weight exceeds 100 lbs.;

(3.) It is economical to market swine to be slaughtered when they weigh from 180 to 200 lbs., live weight;

(4.) The consumption of feed per day is *greatest* at or near the period of their fattening, when the quantity of feed consumed per pound of increase in weight, is *smallest*.

It may be added that to produce an increase of 3,231½ lbs. in the live weight of 24 swine, 4-14 lbs. of a mixture of equal parts of ground pease, barley and rye were required for every pound of increase in the live weight.

## Report of the Dairy Commissioner.

### EXPERIMENTS IN FEEDING GRAIN, UNGROUND, GROUND AND WITH SKIM-MILK.

During the winter of 1891-2 experiments were begun to discover the effect of feeding swine upon a ration of grain only (unground and ground) as compared with a ration composed of grain and skim-milk. For the purpose, four pens of pigs were selected and sorted into lots as nearly alike as they could be obtained. In each of the four pens were put two pigs out of a Poland-China sow by an improved Large Yorkshire boar. With them were put three grade pigs in each of the three first pens; and in the fourth pen two pigs out of a Berkshire sow by an Improved Large Yorkshire boar, were put with the two cross-bred Poland-China-by-Yorkshire pigs.

The 9 grade pigs which were put in the first three pens with the 6 cross-bred Poland-China-by-Yorkshire pigs, were purchased outside. Their breeding was not known, but they appeared to be grades of Chester White, or Yorkshire blood. The pigs in the several pens, considered as lots, were as nearly as practicable equal as to breeding, quality, age and size.

The experiment began on January 4th and ended on May 2nd. The feed consumed was weighed every day, and the swine were weighed once every week. The following Tables have been arranged to show the average results at four different times in the fattening period.

TABLE II.

Pen 1 contained 5 swine, as described above—3 grades and 2 cross bred Poland-China-by-Yorkshire. They were fed upon a mixture of equal parts of pease, barley and rye, *not ground*, and soaked in cold water for 48 hours.

—	Jan. 1.	Feb. 1.	Feb. 29.	Mar. 28.	May 2.	Totals.
	Lbs.	Lbs.	Lbs.	Lbs.	Lbs.	Lbs.
Live weight.....	346	386	502	646	780	.....
Increase in weight.....		40	116	144	134	434
Feed consumed.....		378	490	544	538	1,930
do per lb. of increase in live weight.....		9.49	4.13	3.77	4.01	4.45

TABLE III.

Pen 2 contained 5 swine similar to those in Pen 1. They were fed upon a mixture of equal parts of pease, barley and rye, *ground* and soaked in cold water for 12 hours.

—	Jan. 4.	Feb. 1.	Feb. 29.	Mar. 28.	May 2.	Totals.
	Lbs.	Lbs.	Lbs.	Lbs.	Lbs.	Lbs.
Live weight.....	346	430	580	741	865	.....
Increase in weight.....		84	150	161	124	519
Feed consumed.....		461	572	657	576	2,206
do per lb. of increase in live weight.....		5.48	3.81	4.08	4.64	4.36

TABLE IV.

Pen 3 contained 5 swine similar to those in Pens 1 and 2. They were fed upon an allowance of the same mixture as those in Pen 2 (viz.: equal parts of pease, barley and rye, *ground* and soaked in cold water for 12 hours), plus all the skim-milk they would drink.

	Jan. 4.	Feb. 1.	Feb. 29.	Mar. 28.	May 2.	Totals.
	Lbs.	Lbs.	Lbs.	Lbs.	Lbs.	Lbs.
Live weight .....	346	434	590	768	1,017	.....
Increase in weight .....		88	156	178	249	671
Feed consumed. { Meal .....		230	286	432	704	1,652
+ Milk.....		1,081	2,078	2,649	3,537	9,345
do per lb. of increase in live weight. { Meal .....		2·61	1·83	2·42	2·82	2·46
+ Milk.....		12·28	13·32	14·88	14·20	13·92

TABLE V.

Pen 4 contained 4 swine, 2 crossbred Poland-China-by-Yorkshire, and 2 crossbred Berkshire-by-Yorkshire. They were fed upon an allowance of the same mixture as those in Pens 2 and 3, (viz., equal parts of pease, barley and rye, *ground* and soaked for 12 hours), plus all the skim-milk they would drink.

	Jan. 4.	Feb. 1.	Feb. 29.	Mar. 28.	May 2.	Totals.
	Lbs.	Lbs.	Lbs.	Lbs.	Lbs.	Lbs.
Live weight .....	306	395	520	675	842	.....
Increase in weight .....		89	125	155	167	536
Feed consumed. { Meal .....		332	385	514	626	1,857
+ Milk.....		610	481	551	938	2,580
do per lb. of increase in live weight. { Meal .....		3·73	3·07	3·31	3·74	3·46
+ Milk.....		6·85	3·84	3·54	5·61	4·81

*Conclusions.* From these tests which continued 17 weeks, it appears that:—

(1.) 4·45 lbs. of grain were consumed per lb. of increase in live weight, when it was fed *unground* and soaked for 48 hours;

(2.) 4·36 lbs. of grain were consumed per lb. of increase in live weight, when it was fed *ground* and soaked for 12 hours;

(3.) 1 lb. of grain was the equivalent of 6·65 lbs. of skim-milk in increasing the live weight;

(4.) The swine, which were fed upon a ration containing skim-milk, were lustier and more robust in appearance, than those which were fed upon grain only.

#### EXPERIMENTS IN FEEDING FROZEN WHEAT.

The first test in this series was undertaken to discover, (1) what results could be obtained from the fattening of large-sized swine upon a ration of frozen wheat, and, (2) how frozen wheat compared with a mixture of equal parts by weight of pease, barley and wheat for increasing the live weight of the animals.

## Report of the Dairy Commissioner.

Twelve grade swine were purchased; their age and breeding were not known. The average weight at the commencement of the test was 186 lbs. each. They were sorted into three lots, which were nearly even as to weight, quality and appearance.

The frozen wheat was procured from the branch Experimental Farms at Brandon, Man., and Indian Head, N.W.T. It was graded "No. 2 frozen," "No. 3 frozen," and "unmarketable."

TABLE VI.

Pen 1 contained 4 swine. They were fed upon frozen wheat *ground* and soaked in cold water for 12 hours.

—	Dec. 28.	Jan. 25.	Feb. 22.	Mar. 14.	Totals.
	Lbs.	Lbs.	Lbs.	Lbs.	Lbs.
Live weight .....	739	847	969	1,100	.....
Increase in weight .....		108	122	131	361
Feed consumed .....		701	650	565	1,916
do per lb. of increase in live weight .....		6.49	5.33	4.28	5.30

TABLE VII.

Pen 2 contained 4 swine. They were fed upon frozen wheat, *unground* and soaked for an average of 42 hours. (During the first 2 weeks of the test, the wheat was soaked for only 12 hours; that may account for the unusually large quantity consumed per lb. of increase in weight).

—	Dec. 28.	Jan. 25.	Feb. 22.	Mar. 14.	Totals.
	Lbs.	Lbs.	Lbs.	Lbs.	Lbs.
Live weight .....	745	784	958	1,091	.....
Increase in weight .....		39	174	133	346
Feed consumed .....		697	945	640	2,282
do per lb. increase in live weight .....		17.87	5.42	4.81	6.59

TABLE VIII.

Pen 3 contained 4 swine. They were fed upon a mixture of equal parts by weight of wheat, barley and pease, *unground* and soaked for an average of 42 hours.

—	Dec. 28.	Jan. 25.	Feb. 22.	Mar. 14.	Totals.
	Lbs.	Lbs.	Lbs.	Lbs.	Lbs.
Live weight .....	747	816	963	1,114	.....
Increase in weight .....		69	147	151	367
Feed consumed .....		673	935	620	2,228
do per lb. of increase in live weight .....		9.75	6.36	4.10	6.07



*Conclusions.* From these tests with heavy swine, it appears that:—

(1.) when the frozen wheat was fed, *ground* and soaked for 12 hours, 11·3 lbs. of increase in the live weight were obtained per bushel of wheat;

(2.) When the frozen wheat was fed *unground* and soaked for 12 and 42 hours, 9·1 lbs. of increase in the live weight were obtained per bushel of wheat;

(3.) When the frozen wheat is to be fed *unground*, it should be soaked for at least 42 hours;

(4.) Leaving out of the reckoning, the weeks during which the frozen wheat *unground*, and the mixture of wheat, barley and pease *unground*, were soaked for only 12 hours, 5·24 lbs. of frozen wheat were consumed per lb. increase, and 5·22 lbs. of the mixture of wheat, barley and pease were consumed per lb. of increase in the live weight.

The second test in this series was made with younger and smaller swine to discover, (1) the quantity of frozen wheat consumed per lb. of increase in live weight, and (2) the quantity of skim-milk which would be the equivalent of a pound of frozen wheat in increasing the live weight of the swine.

TABLE IX.

Pen V contained 5 swine bred at the Experimental Farm; they were out of a Poland-China sow by an Improved Large Yorkshire boar. They were fed upon frozen wheat *ground* and soaked for 12 hours. During the last 3 weeks of the test, they were fed upon the lowest quality of frozen wheat only, which has been graded "unmarketable."

	Feb. 1.	Feb. 29.	Mar. 28.	May 2.	May 30.	Totals.
	Lbs.	lbs.	Lbs.	Lbs.	Lbs.	Lbs.
Live weight.....	306	470	595	724	827	.....
Increase in weight.....		164	125	129	103	521
Feed consumed.....		565	508	551	580	2,204
do per lb. of increase in live weight.....		3·44	4·06	4·27	5·63	4·23

TABLE X.

Pen VI contained 4 swine bred at the Experimental Farm; they were out of a grade Berkshire sow by an Improved Large Yorkshire boar. They were fed upon an allowance of frozen wheat, *ground* and soaked for 12 hours, plus as much skim-milk as they would drink.

	May 2.	May 31.	June 27.	Totals.
	Lbs.	Lbs.	Lbs.	Lbs.
Live weight.....	415	519	*577	.....
Increase in weight.....		104	141	245
Feed consumed {				
Wheat.....		327	322	649
+ Milk.....		1,601	1,465	3,066
do per lb. of increase in live weight {				
Wheat.....		3·14	2·28	2·65
+ Milk.....		15·39	10·39	12·51

\* 3 swine only.

## Report of the Dairy Commissioner.

*Conclusions.* From these tests with swine weighing an average of 61 lbs. each in the one pen, and an average of 104 lbs. each in the other pen, it appears that:—

(1.) When the frozen wheat was fed *ground* and soaked for 12 hours, 14·18 lbs. of increase in the live weight were obtained, per bushel of wheat;

(2.) In the feeding of swine from an average weight of 61 lbs. each, until they reached an average weight of 145 lbs. each, 15·46 lbs. of increase in the live weight were obtained, per bushel of wheat;

(3.) 1 lb. of frozen wheat was the equivalent of 7·91 lbs. of skim-milk in increasing the live weight;

(4.) The swine which were fed upon a ration containing skim-milk were lustier and more robust in appearance, than those which were fed upon grain only.

---

The swine from Pens V and VI were slaughtered; and the hams, sides and shoulders were cured in pickle by an Ottawa pork-dealer and ham-curer. The bacon and hams were pronounced excellent in quality, by many who examined them and afterwards purchased them for their own tables.

The parts of one side, from a pig of the lot which were fattened upon frozen wheat exclusively, were sent for opinion to Wm. Davies, Esq., of the Wm. Davies Co., Limited, Toronto, who have one of the largest and best known establishments for the curing of swine products in Canada. The following is the sum of the verdict of Mr. Davies upon its quality:—

"It is excellent, rather too salt, but very rich and luscious. I consider it superior to hogs fed on peas alone. The complaint regarding pea-fed bacon in England, is that the lean is hard, and this is the case to some extent with the fat also. It would be well if farmers in Canada would mix the grain and grind it, then give it to the hogs with whey, butter-milk or skim-milk."

### GENERAL REMARKS.

In those parts of Canada, where a less or greater quantity of wheat may be injured by frost or other climatic conditions, the farmers should fortify their positions by providing means whereby to market, in the best way, this product which cannot be sold at paying prices in the form of grain. From 9·1 lbs. to 15·46 lbs. of increase in the live weight of swine have been obtained per bushel of frozen wheat consumed.

When swine are fetching 5 cents per lb. live weight, with an allowance of five per cent deducted for shrinkage, the frozen wheat fed under the least favourable of ordinary conditions, may realize 43½ cents per bushel. At the same price for swine, the frozen wheat, fed under favourable conditions in the quality and age of the swine and the preparation of the feed, may realize 73·45 cents per bushel.

The conditions required for the profitable feeding of swine are (1) clean, dry, warm quarters protected from wind and draughts, (2) as much wholesome feed— if grain preferably *ground* fine—as they will eat clean, three times a day, and (3) free access to a mixture of salt and ashes, to sods, or to soil.

To meet the requirements of foreign markets, swine with lean meat are wanted; larger numbers of them should be fed and fattened during the summer months; and they should be sold alive by the farmer or feeder in order that they may be slaughtered at packing houses, where the carcasses can be cut and cured in a uniformly satisfactory manner, suited to the preferences of different buyers.

PART III.—EXPERIMENTAL DAIRY WORK.

In the Experimental Dairy, the experiments which have been carried on far enough to be reported upon are:—

I. Experiments in the creaming of milk during every month of the year (1) by a centrifugal cream separator; (2) by the gravity or setting method in the use of deep setting pails in ice water; and (3) by the gravity or setting method in the use of shallow milk-pans;

II. Experiments in the creaming of milk and the making of butter from the milk of cows (1) which had been milking for periods exceeding 6½ months each, and (2) which had been milking for periods of less than 6½ months each;

III. Experiments in churning sweet cream at different temperatures;

IV. Experiments in the churning of cream after the addition to it of different percentages of water.

I—Experiments in the Creaming of Milk.

A series of experiments was undertaken to obtain information upon the relative efficiency of three different methods of creaming milk, for every month of the year. The methods used were (1) an Alexandra centrifugal cream separator; (2) deep-setting shot-gun milk pails set in ice water, and (3) shallow milk-pans set on a table in a room of which the temperature was recorded. The milking cows in our herd comprised Shorthorns, Ayrshires, Holsteins, Jerseys, Devons, Quebec Jerseys, and Shorthorn grade cows. Fresh-calved cows came in from time to time during the year. Mixed milk from the herd was used in the tests; and the testing by each of the three methods lasted for a period of one week of every month.

The following Table shows the results which were obtained by the use of a No. 4 Alexandra cream separator, No. 8 size, during one week of every month.

TABLE I.

—	Jan.	Feb.	Mar.	April.	May.	June.	July.	Aug.	Sept.	Oct.	Nov.	Dec.
Temperature of milk.. Fahr.	98°	98°	98°	98°	95°	95°	98°	98°	98°	98°	98°	98°
Speed of separator.... per minute	7,000	7,200	7,200	7,200	7,200	7,200	7,200	7,200	7,200	7,500	7,500	7,200
Milk per hour.... lbs.	500	400	400	450	500	500	550	500	500	450	500	425
Fat in milk...per cent.	3·93	3·88	3·66	3·73	3·70	3·76	3·50	3·40	3·50	3·52	3·55	3·90
Fat in skim-milk..... per cent.	0·30	0·08	0·10	0·04	0·08	0·08	0·04	0·04	0·03	0·08	0·05	0·04
Fat in butter-milk.... per cent.	0·15	0·10	0·40	0·20	0·25	0·15	0·20	0·15	0·10	0·13	0·07	0·30
Milk per lb. of butter.. lbs.	23·89	22·78	24·45	23·44	23·31	23·09	25·48	25·46	25·46	24·94	24·40	22·06
Butter per 100 lbs. of milk..... lbs.	4·19	4·39	4·09	4·27	4·29	4·33	3·92	3·93	3·93	4·01	4·10	4·55
Butter per 100 lbs. of fat in milk..... lbs.	106·60	113·02	111·75	114·37	115·93	115·18	112·13	115·54	112·20	113·88	115·43	116·22
Fat in butter...per cent.	87·53	86·76	86·31	86·19	85·63	84·99	87·85	85·33	88·20	85·80	85·42	84·61
Fat not recovered..... per cent.	6·69	1·94	3·55	1·43	2·50	2·11	1·50	1·41	1·04	2·29	1·40	1·66

The following Table shows the results which were obtained by setting the milk during one week of every month in shot-gun milk-pails in a tank of ice water. The pails were of the ordinary cylindrical shape and size, viz., 20 ins. by 8½ ins. The skimming was effected by the use of a cone-shaped skimmer; and enough of the skim milk was removed with the cream to ensure a complete recovery of the butter fat which had risen to the top. The milk in every case was set immediately after it was received from the stable and it was left for 22 hours in the ice water.

# Report of the Dairy Commissioner.

## TABLE II.

—	Jan.	Feb.	Mar.	April.	May.	June.	July.	Aug.	Sept.	Oct.	Nov.	Dec.
Temperature of milk, when set . . . Fahr.	83°	86°	89°	90°	93°	95°	95°	96°	84°	84°	82°	80°
Temperature of water. . . Fahr.	38°	38°	38°	38°	38°	38°	38°	38°	36°	35°	36°	37°
Temperature of milk, when skimmed. Fahr.	38°	38°	38°	38°	38°	38°	38°	38°	36°	35°	36°	37°
Fat in milk. . . per cent.	3·95	3·81	3·68	3·72	3·70	3·76	3·50	3·40	3·50	3·52	3·55	3·90
Fat in skim-milk . . . per cent.	0·92	0·69	0·51	0·41	0·35	0·45	0·23	0·23	0·35	0·39	0·80	0·87
Fat in butter-milk . . . per cent.	0·20	0·35	0·39	0·20	0·20	0·15	0·20	0·30	0·20	0·30	0·20	0·25
Milk per lb. of butter. . . lbs.	26·51	25·98	26·17	25·77	24·85	25·30	26·49	26·41	25·77	25·94	28·46	25·64
Butter per 100 lbs. of milk. . . . . lbs.	3·77	3·85	3·82	3·88	4·02	3·95	3·77	3·79	3·88	3·85	3·51	3·90
Butter per 100 lbs. of fat in milk. . . . lbs.	95·48	101·01	103·83	104·35	108·75	105·11	107·84	111·39	110·86	109·57	99·03	100·00
Fat in butter. . per cent.	84·42	83·27	83·90	86·41	84·14	85·42	87·01	83·73	82·28	81·99	82·35	81·79
Fat not recovered. . . . . per cent.	19·39	15·88	12·34	9·76	8·49	10·22	5·16	6·74	8·79	10·16	18·44	18·20

The following Table shows the results which were obtained by setting the milk, during one week of every month, in shallow milk-pans. The pans were twelve inches in diameter and the milk was set in them to a depth of three inches. In every case, the milk was set immediately after it was received from the stable; and it was left for 22 hours before it was skimmed.

## TABLE III.

—	Jan.	Feb.	Mar.	April.	May.	June.	July.	Aug.	Sept.	Oct.	Nov.	Dec.
Temperature of milk, when set. . . . . Fahr.	88°	86°	89°	90°	93°	95°	95°	96°	84°	84°	82°	80°
Temperature of room. . . Fahr.	60°	60°	58°	55°	60°	70°	72°	65°	45°	45°	48°	50°
Temperature of milk, when skimmed. Fahr.	60°	60°	60°	56°	60°	70°	73°	66°	45°	45°	48°	50°
Fat in milk. . . per cent.	3·98	3·81	3·68	3·72	3·70	3·76	3·50	3·40	3·50	3·52	3·55	3·90
Fat in skim-milk . . . per cent.	0·72	0·53	0·40	0·58	0·48	0·41	0·32	0·40	0·45	0·47	0·50	0·55
Fat in butter-milk . . . per cent.	0·30	0·35	0·35	0·20	0·15	0·15	0·20	0·15	0·20	0·30	0·15	0·20
Milk per lb. of butter. . . lbs.	25·00	25·05	25·00	27·05	25·46	25·00	25·69	26·53	27·38	27·16	26·92	24·39
Butter per 100 lbs. of milk. . . . . lbs.	4·00	3·99	4·00	3·70	3·93	4·00	3·89	3·77	3·65	3·68	3·71	4·1
Butter per 100 lbs. of fat in milk . . . . . lbs.	100·50	104·76	108·70	99·35	106·17	106·40	111·28	110·86	104·36	104·71	104·67	105·13
Fat in butter. . per cent.	83·75	83·30	82·50	86·82	83·50	84·82	82·31	80·76	85·24	84·04	84·15	83·61
Fat not recovered. . . . . per cent.	15·70	12·73	10·33	13·74	11·35	9·74	8·41	10·46	11·04	12·00	11·92	12·10

The percentages of butter-fat in the mixed herd milk were practically the same for the three several weeks of every month; the greatest difference being in January, when it was .05 of one per cent of fat.

The following charts have been prepared to show at a glance, the comparative results which were obtained from the three different methods.

CHART I.

NUMBER of pounds of Butter obtained per 100 pounds of Milk, from the three different methods of creaming, as per Tables I., II. and III.

Centrifugal cream separator, ————  
 Deep-setting milk-pails, ————  
 Shallow milk-pans, .....

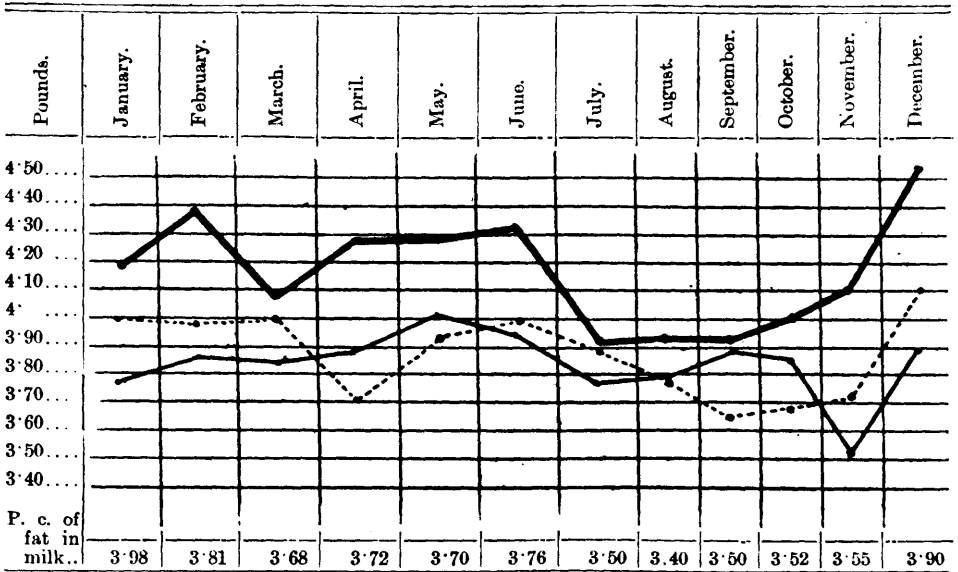
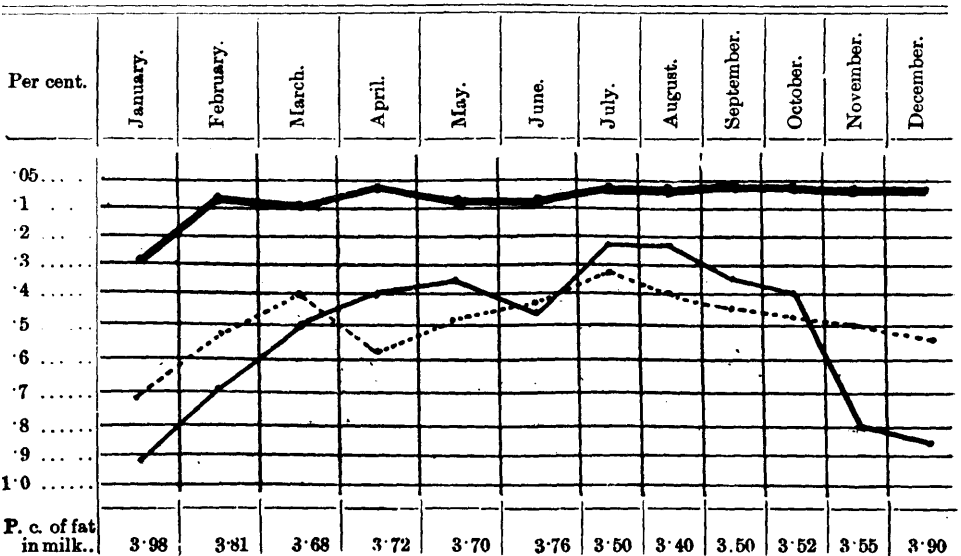

CHART II.

PERCENTAGE of Fat in Skim-milk, from the three different methods of creaming, as per Tables I., II. and III.

Centrifugal cream separator, ————  
 Deep-setting milk-pails, ————  
 Shallow milk-pans, .....



# Report of the Dairy Commissioner.

## CHART III.

NUMBER of pounds of marketable Butter, obtained per 100 pounds of Butter fat in milk, from the three different methods of creaming, as per Tables I., II. and III.

Centrifugal cream separator,   
 Deep-setting milk-pails,   
 Shallow milk-pans,

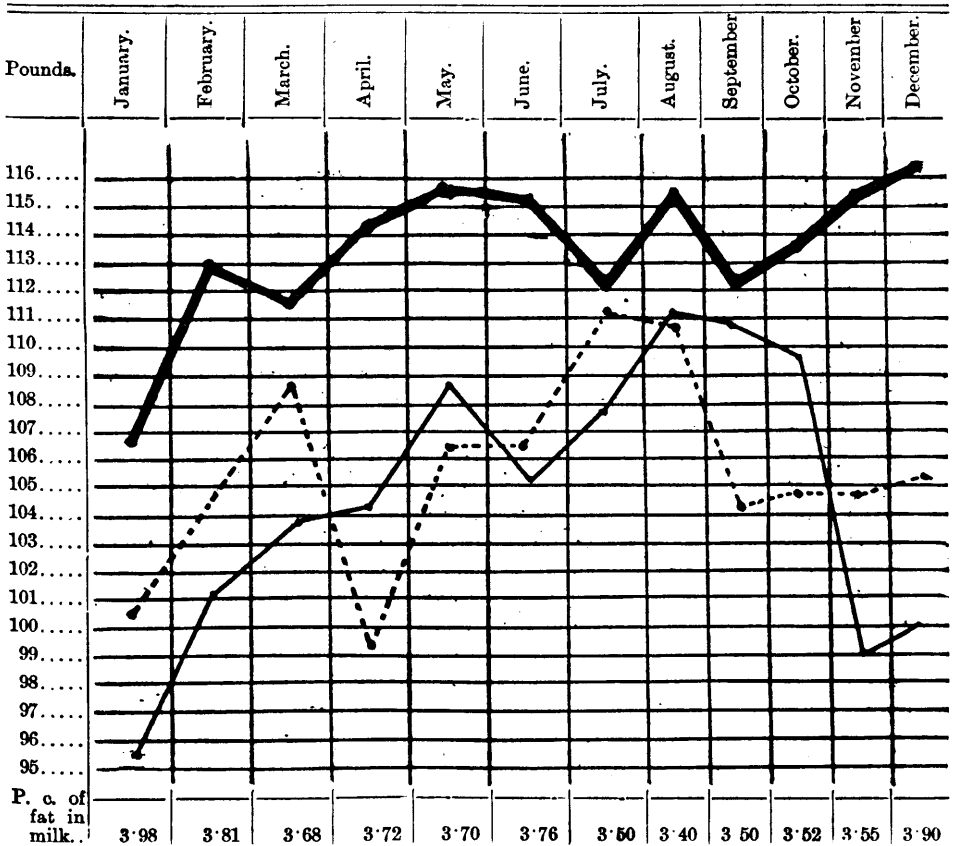

(II) *Experiments in the creaming of Milk and the making of Butter from the Milk of Cows, (1) which had been milking for periods exceeding 6½ months each, and (2) which had been milking for periods of less than 6½ months each.*

The following Table shows the results on the average, from 4 tests in each case, when the creaming was effected by the centrifugal cream separator.

### TABLE IV.

	From Cows milking more than 6½ months each.	From Cows milking less than 6½ months each.
Temperature of milk, .....	98°	98°
Speed of separator .....	7,400	7,400
Milk per hour .....	450	500
Fat in milk .....	3.68	3.18
Fat in skim-milk .....	.20	.02
Fat in butter-milk .....	.05	.06
Butter per 100 lbs. of fat in milk .....	115.06	120.48
Fat not recovered .....	4.23	.72
Butter score for flavour out of possible 40 points. ....	37	30
	(at 1 week)	(at 1 week)
	28	35
	(at 14 weeks)	(at 14 weeks)

*Conclusions.* The results from these 4 tests indicate that:—

(1.) From the milk of cows, which had been milking for periods exceeding 6½ months each, 3·51 per cent more of the butter-fat was not recovered, even when the rate of inflow of the milk into the centrifugal cream separator was 10 per cent less than in the case of the milk from cows which had been milking for periods of less than 6½ months each;

(2.) The butter from the milk of the cows which had been milking for the longer periods, was not as good in the flavour and did not keep so well as the butter from the milk of the cows which had been milking for the shorter periods.

The following Table shows the results, on the average from 7 tests in each case, when the creaming was effected by the deep-setting milk-pails, set in ice water for a period of 22 hours.

TABLE V.

	From Cows milking more than 6½ months each.	From Cows milking less than 6½ months each.
Temperature of milk when set..... Fahr.	85°	86°
Temperature of water..... "	38°	38°
Temperature of milk when skimmed..... "	38°	38°
Fat in milk..... per cent.	3·67	3·56
Fat in skim-milk..... "	1·43	·21
Fat in butter-milk..... "	·40	·35
Butter per 100 lbs of fat in milk..... lbs.	80·91	114·85
Fat not recovered..... per cent.	32·55	6·34
Butter score for flavour out of possible 40 points..... at 4 weeks	33	35

*Conclusions.* The results from these tests indicate that:—

(1.) From the milk of cows which had been milking for periods exceeding 6½ months each, 26·21 per cent more of the butter-fat was not recovered, than from the milk of cows which had been milking for periods of less than 6½ months each;

(2.) The butter from the cows which had been milking for the longer periods was not as good in the flavour as the butter from the milk of the cows which had been milking for the shorter periods.

The following Table shows the results, on the average from 8 tests in each case, when the milk of one fresh-calved cow was mixed with the milk of the cows which had been milking for periods exceeding 6½ months each, and when the creaming was effected by the deep-setting milk-pails, set in ice water for a period of 22 hours.

TABLE VI.

	From Cows milking more than 6½ months each	From Cows milking less than 6½ months each
Temperature of milk when set..... Fahr.	85°	85°
Temperature of water..... "	38°	38°
Temperature of milk when skimmed..... "	38°	38°
Fat in milk..... per cent.	3·58	3·54
Fat in skim-milk..... "	·55	·23
Fat in butter-milk..... "	·40	·32
Butter per 100 lbs. of fat in milk..... lbs.	103·29	114·94
Fat not recovered..... per cent.	14·00	6·71
Butter score of flavour out of possible 40 points..... at 5 weeks	36	38

## Report of the Dairy Commissioner.

*Conclusions.* The results from these 8 tests indicate that:—

(1.) When the milk of one fresh-calved cow was added to the milk from eight cows, which had been milking for periods exceeding  $6\frac{1}{2}$  months each, 7.29 per cent more of the butter-fat was not recovered, than from the milk of cows which had been milking for periods of less than  $6\frac{1}{2}$  months each;

(2.) The addition of the milk of one fresh-calved cow to the milk from eight cows which had been milking for periods exceeding  $6\frac{1}{2}$  months each, resulted in the recovery of 18.55 per cent more of the butter-fat, than from the milk of the same cows when set in deep-setting milk-pails, without the addition of the milk from a fresh-calved cow.

### (III.) Experiments in churning Sweet Cream at different Temperatures.

During the month of March a number of tests were conducted to ascertain the temperature at which the churning of sweet cream would give the most efficient recovery of the butter-fat. In a No. 5 Daisy revolving barrel churn, of a capacity of fourteen gallons, 16 tests were made as shown in Table VII.

TABLE VII.

Number of Tests made.	2	6	6	1	1
Quantity of cream..... lbs.	42	36	38.5	40	23
Temperature when churning was started..... Fahr.	41°	46°	45°	48°	55°
do do finished..... " "	58°	58°	59°·5	58°	58°
Increase in temperature..... " "	17°	12°	14°·5	10°	3°
Period of churning..... min.	90	75	85	40	10
Speed of churn..... rev. per min.	70	70	68	72	74
Fat in butter-milk..... per cent.	0·10	0·20	0·25	0·25	0·60

In a No. 2 Daisy revolving barrel churn of a capacity of three gallons, 26 tests were made as shown in Table VIII.

TABLE VIII.

Number of Tests made.	9	12	2	1	1	1
Quantity of cream..... lbs.	20	12	25·5	19	30	15
Temperature when churning was started..... Fahr.	42°	44°	50°	52°	57°	58°
do do finished..... " "	60°	57°	59°	58°	61°	62°
Increase in temperature..... " "	18°	13°	9°	6°	4°	4°
Period of churning..... min.	113	95	90	50	70	50
Speed of churn..... rev. per min.	68	68	71	65	68	70
Fat in butter-milk..... per cent.	0·15	0·20	0·15	0·30	0·50	0·40

*Conclusions.* The results from these 42 tests indicate that:—

(1.) When the churning of sweet cream is started at a temperature of 50° Fahr., or under, the quantity of butter-fat remaining in the butter-milk need not exceed 0.25 of 1 per cent;

(2.) For the efficient recovery of the butter-fat by the churning of sweet cream, the temperature of the cream should not be above 50° Fahr., when the churning is started; and the churn (if a revolving one) should not be filled to more than one quarter of its actual holding capacity.



(IV.) *Experiments in the churning of Cream after the addition to it of different percentages of Water.*

Four series of tests were made to compare the results from the churning of cream with and without the addition of different percentages of water to the cream, before it was ripened. These tests were conducted at intervals from May 6th to October 1st. The cream was obtained from mixed herd milk (containing on the average 3·45 per cent of butter-fat) by means of a centrifugal cream separator, which separated 14 per cent of the whole milk as cream. The cream, in each test of the four series, was divided into two equal portions. The one portion was ripened to the usual degree of sourness or was kept sweet, and was churned as normal cream; a percentage of water (from 10 to 30 per cent) was added to the other portion in each test, after which it was churned in the same manner as the normal cream.

The following Table shows the results which were obtained, on the average, from the tests of the different series.

TABLE IX.

Number of tests made.	Series 1.		Series 2.		Series 3.		Series 4.	
	5		4		4		5	
	Normal Cream.	10 per cent of water added.	Normal Cream.	20 per cent of water added.	Normal Cream.	25 per cent of water added.	Normal Cream.	30 per cent of water added.
Milk per lb. of butter..... lbs.	25·77	26·11	24·83	25·20	25·17	25·45	25·14	25·74
Butter per 100 lbs. of milk. "	3·88	3·83	4·03	3·97	3·97	3·93	3·98	3·88
Butter per 100 lbs. of fat in milk..... "	115·23	113·76	116·58	114·84	113·50	112·27	115·03	112·34
Fat not recovered..... per cent.	2·32	2·37	1·83	1·83	2·41	2·61	3·20	3·12

The following Table shows the results, on the average from the 18 tests, with normal cream and the results, on the average from the 18 tests, with cream to which water had been added—from 10 to 30 per cent as per Table IX).

TABLE X.

	Normal Cream.	Watered Cream.
Milk per lb. of butter..... lbs.	25·22	25·62
Butter per 100 lbs. of milk..... "	3·96	3·90
Butter per 100 lbs. of fat in milk..... "	115·08	113·30
Fat not recovered..... per cent.	2·44	2·48

An examination was made of the quality of the butter obtained. The butter from the watered cream was not so solid or firm in the grain as the butter from the normal cream; there was no appreciable difference in the flavour.

The churning period in every case was longer with the watered cream than with the normal cream. The additional time which was required for churning the watered cream bore no definite ratio to the percentage of water which had been added to the cream. The extra time was from 1 minute to 30 minutes.

*Conclusions.* When water was added to the cream in these 18 tests from May to October, the results indicate that:—

- (1.) The churning was slightly less efficient in the recovery of the butter fat;

## Report of the Dairy Commissioner.

- (2.) The quantity of marketable butter obtained per 100 lbs. of milk was slightly less (.06 lb.);
- (3.) The butter was not so firm or solid in the grain;
- (4.) The churning period, at an equal temperature, was longer by from 1 minute to 30 minutes.

### PART IV.—FORTY-ACRE LOT.

In the spring of 1891, a portion of the farm, measuring about forty acres, was set apart for the particular purpose of growing forage crops for cattle, in order to ascertain and illustrate how many cattle might be fed for the whole year upon the products of that area. It was not intended to adopt a method of cultivation which would require the employment of hand labour to any unusual extent. The main object was to direct the attention of farmers to the easy practicability of keeping cattle in larger numbers, than has been their custom, on the moderate and small sized farms of Canada.

The soil in that part of the farm devoted to this experiment is of a clay and sand loam; about five acres of it are of a light sandy loam; and about three acres of it are of a peaty loam. A dressing of barnyard manure was given to twenty-nine acres of the area in the spring of 1891, at the rate of from 18 to 20 tons per acre.

It was mentioned in my report of last year that the yield of crops in 1891, did not come up to our expectations. A hailstorm on 13th of August, 1891, injured the crops on it, and was estimated to have lessened the returns and the feeding value of them by 25 per cent. The following is a summary of the crops harvested in 1891:—

#### TOTAL YIELD OF CROPS FROM 40-ACRE LOT IN 1891.

##### *Ripened Crops.*

	Lbs. of Straw.	Lbs. of Grain.
8 acres, Mixed Cereal crop .....	26,454	13,245
3 acres { Golden Vine Pease .....		903
{ Goose Wheat.....	1,003	437
{ Beardless Barley .....	3,102	1,373
{ Banner Oats .....	2,790	2,060
3 acres, Mixed Cereal crop.....	10,442	4,345
14	Totals .....	43,791
		22,365

##### *Root Crops.*

	Lbs.
1 acre, Carrots.....	26,785
1 acre, Mangels and Turnips { Mangels.....	8,110
{ Turnips .....	9,655
1 acre, Turnips.....	29,584
3	Total .....
	74,134
½ acre, Cabbage and Kohl Rabi .....	15,296

*Cured Fodder Crops.*

	Lbs.
2 acres, Spring Rye.....	14,080
Mixed Cereal crop (second cutting) .....	1,825
1 acre, Indian Corn, stooked and cured .....	11,940
11½ acres, Indian Corn, put into silos.....	130 tons+

---

14½

---

1½ acres, Indian Corn, fed green to cattle from 7th of August.  
 3½ acres, Mixed Cereal crop, fed green to cattle.  
 4½ acres, pastured.

The total cost for labour in the growing of these crops of 1891, and in the delivering of them at the barn, silos or stable, threshed or cut and ready to feed, was as follows;—

Hauling and spreading of manure .....	\$109 62
Ploughing, harrowing, sowing and planting.....	114 00
Hand cultivating and weeding .....	85 62
Cultivating by horse.....	23 65
Reaping, teaming, threshing, cutting, grinding, &c.....	223 70
Other labour.....	9 15
	<hr/>
	\$565 74
Permanent improvements, draining and fencing.....	33 50

The time of a team and man was charged at the rate \$2.50 per day and the time of a man at \$1.25 per day.

---

TOTAL YIELD OF CROPS FROM 40-ACRE LOT IN 1892.

*Cereal Crops.*

	Lbs. of Straw.	Lbs. of Grain.
8.75 acres, Mixed Cereal crop, as in Table I....	25,039	13,317
		Lbs., cured Fodder.
5 acres, Mixed Cereal crop, as in Table II.....		32,605
		Lbs. green Fodder.
1.75 acres, Mixed Cereal crop (fed green).....		22,801
3.25 acres, Fall Rye .....		26,155
1.9 acres, Spring Rye. ....		15,910
second cutting of do. (partly cured).....		4,040

*Root Crops.*

	Lbs.
2 acres, Carrots, as per Table III.....	51,015
2 acres, Mangels do .....	57,128
1 acre, Greystone Turnips (catch crop after crop of mixed cereals) .....	20,305

# Report of the Dairy Commissioner.

## Indian Corn Crops.

	Tons.	Lbs.
9 acres, Indian Corn, as per notes, plots Nos. 1 to 6....	156	352
3 acres, Indian Corn, do do 7 to 9....	39	1065
3 acres, Indian Corn, do do 10 .....	38	860
·46 acre, Indian Corn and Sunflowers.....	4	1720
·46 acre, Sunflower heads .....	3	710
·41 + acre, Horse Beans.....	2	1760
2·43 acres, pastured.....		

### NOTES ON THE CEREAL CROPS.

8 acres of *Mixed Cereal Crops*.—The soil on which these were grown was a sandy loam, rather uneven in character; part of it was of a peaty nature with interruptions of clay and sandy soil of a whitish colour. Most of the land had formed part of a wet swamp five years before; and portions of the surface soil had been burned during the clearing of it. In the spring of 1891 it received a dressing of barn yard manure at the rate of about 18 tons per acre. A crop of fodder corn was taken off 7 acres of it during that season; the other acre was cropped in 1891 with mixed cereals.

A different mixture, of *Campbell's White Chaff Wheat*, *Peerless White Barley*, *Banner Oats* and *Golden Vine Pease*, was sown on each plot. By reason of the uneven character of the soil, the yields per acre from the different mixtures did not give results which can be relied upon as evidence of the best combinations of these grains for fodder crops.

TABLE I.

Number of Plot.	No. 1.	No. 2.	No. 3.	No. 4.	No. 5.	No. 6.	No. 7.	No. 8.
Mixture sown—								
Wheat.....Bush.	$\frac{1}{2}$	1	1	.....	1	1½	.....	.....
Barley.....do	.....	1	.....	1	1	.....	1½	.....
Oats.....do	1	.....	1	1	1	.....	.....	1½
Pease.....do	$\frac{1}{2}$	1	1	1	.....	1½	1½	1½
Flax.....Lbs.	3	3	3	3	3	3	3	3
<b>Total, Bush. and Lbs....</b>	<b>3 3</b>	<b>3 3</b>	<b>3 3</b>	<b>3 3</b>	<b>3 3</b>	<b>3 3</b>	<b>3 3</b>	<b>3 3</b>
Yield of straw and grain ....Lbs.	4,742	4,002	4,632	4,222	4,312	4,342	3,542	4,572
Grain from thresher.....do	1,598	1,361	1,516	1,522	1,337	1,490	1,479	1,600

These mixtures were all sown on May 4, and came up from May 14 to 15. They were ripe from August 13 to 17 and were cut between August 15 and 17. The different grains ripened together, with the exception of the oats, which ripened one or two days before the other sorts. The one mixture which did not contain pease (plot No. 5) gave the smallest yield of grain per acre.

The  $\frac{3}{4}$  acre of *Mixed Cereal crop* was grown on an odd strip of land, which had been manured in the spring of 1891. A crop of Indian corn was taken off, and it received a light dressing of barnyard manure in the spring of 1892. The mixture sown was *White Connell Wheat*, *Oderbruch Oats* and *Mummy Pease*, at the rate of one bushel of each per acre. It was sown on May 4, and it came up and was cut at the same dates as plots Nos. 1 to 8. The total yield was,—straw and grain, 3,990 lbs.; grain from the thresher, 1,414 lbs.

5 acres of *Mixed Cereal crop*.—Five plots of one acre each were sown with different mixtures of *Goose Wheat*, *Kinver Barley*, *Banner Oats*, *Multiplier Pease* and 3 lbs. of Flax per acre. The soil of plots Nos. 1 and 2 was a mellow loose sandy loam. It had been cropped in 1891 by rye, which was cut green, followed during the same season by Hungarian grass. A dressing of manure at the rate of 10 or 12 tons per

acre was applied in the spring of 1892. Plots Nos. 3, 4 and 5 were on land which had been manured in 1891 and had been cropped during that season with roots. No manure was applied to them in 1892.

TABLE II.

Number of Plot.	No. 1.	No. 2.	No. 3.	No. 4.	No. 5.
Mixture sown—					
Wheat..... Bush.	$\frac{1}{4}$	1	1	.....	1
Barley..... do	.....	1	.....	1	1
Oats..... do	1	.....	1	1	1
Pease..... do	$\frac{1}{2}$	1	1	1	.....
Flax..... Lbs.	3	3	3	3	3
Total... Bush. and Lbs.	3 3	3 3	3 3	3 3	3 3
Yield of cured fodder... Lbs.	7,991	5,556	5,376	6,606	7,076

These mixtures were all sown on April 30, and came up May 13 and 14. They were cut for cured fodder on August 6 and 8. On account of the wet weather which prevailed, the crops from the different plots did not reach a uniform state of dryness; the weight which is recorded for plot No. 1 was obtained from weighing part of the crop when it was comparatively wet.

1.75 acres *Mixed Cereal crop*.—The soil was clay loam; it received a light dressing of manure in the spring of 1892 at the rate of about 10 tons per acre. The crop was cut and fed green to the cattle from day to day. The total yield of green fodder was 22,801 lbs.

#### COST OF LABOUR FOR GROWING MIXED CEREAL CROPS.

The following statement of the cost of labour for growing 13 $\frac{3}{4}$  acres of mixed cereal crops, may afford useful information for the making of comparisons between the cost of this and other kinds of fodder.

Rent of land, at \$3 per acre.....	\$ 41 25
Ploughing, at \$2 per acre.....	27 50
Harrowing twice, rolling once at 20 cents per acre each.	8 25
Seed, 3 bushels per acre.....	24 75
Sowing 1 $\frac{1}{10}$ days at \$2.50 per day.....	4 00
Cutting with mower, 3 $\frac{1}{10}$ days, at \$2.50 per day.....	9 50
Labour, turning and cocking, 9 days at \$1.25 per day....	11 25
Drawing in, 3 days at \$2.50 per day. ....	7 50
Labour, loading and unloading, 11 days at \$1.25 per day.	13 75
Horse-rake and horse-fork, 1 $\frac{1}{10}$ days at \$1.50.....	2 10
Threshing (8 $\frac{3}{4}$ acres), 10 days at \$1.25 per day.....	12 50
Man at engine.....	1 50
Proportion of time of farm foreman.....	27 50
	<u>\$ 191 35</u>

These figures do not include any allowance for the use of farm machinery, nor do they include any amount as an equivalent for the exhaustion of the soil. The cost for labour, without threshing, is \$12.90 per acre. The average yield of the cured fodder crops from 5 acres was 3 tons 521 lbs. per acre, which gives an average cost of \$3.95 per ton for labour of growing, including cost of seed and rent of land.

#### CROPS OF RYE FOR FODDER.

3.25 acres of *Fall Rye*.—Fall rye of the variety *Reading Giant* was sown in September, 1891, on light sandy loam. It followed a crop of fodder corn which had been taken off in 1891. Part of the rye crop was f. d green, the remainder of it was

## Report of the Dairy Commissioner.

cut on 15th June and put into a silo. It was run through a straw cutter. The total yield was 13 tons 155 lbs.

1.9 acres of *Spring Rye*.—This was sown on a light clay loam soil, lying adjacent to the pasture plot, for the purpose of seeding it down. It yielded 7 tons 1,910 lbs.

### COST OF LABOUR FOR GROWING CROP OF RYE FOR FODDER.

The following is a statement of the cost of labour for growing 5.15 acres of rye and putting the crop in the stable and the silo.

Rent of land, at \$3 per acre .....	\$ 15 45
Ploughing, at \$2 per acre.....	10 30
Harrowing twice, rolling once, at 20 cents per acre each..	3 09
Seed, 7½ bushels at \$1 per bushel.....	7 50
Sowing 1 <sup>5</sup> / <sub>10</sub> day at \$2.50 per day.....	1 25
Cutting with binder and mower, 1 <sup>2</sup> / <sub>10</sub> days at \$2.50 per day	3 00
Drawing in, 1 day at \$2.50 .....	2 50
Labour, loading and cutting, 5 days at \$1.25 per day.....	6 25
Man at engine .....	1 50
Binding twine, 16 lbs. at 11 cents per lb.....	1 76
Stablemen's time, taking in the part fed green.....	2 25
Proportion of time of farm foreman.....	10 30
	\$ 65 15

These figures do not include any allowance for the use of farm machinery, nor do they include any amount as an equivalent for the exhaustion of soil. The cost for labour was \$12.65 per acre. The average yield of the rye fodder, weighed green, was 4 tons 64 lbs. per acre, which gives an average cost of \$3.13 per ton, for labour of growing, including cost of seed and rent of land.

### ROOT CROPS.

4 acres of *Root Crops*.—The soil was a sandy loam with a distinctly peaty character. It received a dressing of barnyard manure at the rate of about 18 tons per acre in the spring of 1891. In that season a crop of mixed cereals was taken off. No manure was applied in 1892. Carrots and mangels were put in rows 2 feet 3 inches apart. They were sown from May 10 to 13. The mangels came up from May 23 to 24; and the carrots came up from May 24 to 30. All of the 8 plots of ½ acre each were cultivated with a small hand cultivator on June 4, and with a horse cultivator on June 7 and June 23. They were thinned from June 28 to July 5. They were pulled October 22. The yields are given in the following Table.

TABLE III.

Plot No.	Varieties of Carrots.	Yields per ½ Acre.
1	Steele's Improved Short White .....	7 tons 260 lbs.
2	Rennie's New Mammoth Intermediate.....	7 " 1,330 "
3	Pearce's Orange Giant.....	5 " 285 "
4	Steele's Guerande or Ox Heart.....	5 " 1,140 "
<i>Varieties of Mangels.</i>		
5	Rennie's Selected Mammoth Long Red.....	8 " 525 "
6	Pearce's Canadian Giant.....	8 " 750 "
7	Steele's New Giant Yellow Intermediate.....	5 " 1,818 "
8	Rennie's Giant Yellow Globe.....	6 " 37 "
Total from 4 acres.....		54 tons 143 lbs.

## COST OF LABOUR FOR GROWING ROOTS.

The following is a statement of the cost of labour for growing 4 acres of roots (carrots and mangels) and putting the crop in the root-house.

Rent of land, at \$3 per acre.....	\$ 12 00
Ploughing, at \$2 per acre.....	8 00
Harrowing twice, rolling once, at 20 cts. per acre each....	2 40
Seed, carrots, 10 lbs., at 50 cts. per lb. ....	5 00
Seed, mangels, 10 lbs., at 20 cts. per lb. ....	2 00
Sowing, $1\frac{5}{10}$ days, at \$1.25 per day.....	1 88
Cultivating by hand, 3 days, at \$1.25 per day.....	3 75
Cultivating with single horse, $5\frac{7}{10}$ days, at \$1.50 per day...	8 55
Labour, thinning, $11\frac{5}{10}$ days, at \$1.25 per day.....	14 38
Labour, hoeing, 21 days, at \$1.25 per day.....	26 25
Labour, pulling, 25 days, at \$1.25 per day.....	31 25
Drawing in, $3\frac{2}{10}$ days, at \$2.50 per day.....	8 00
Proportion of time of farm foreman.....	12 00
Total.....	<u>\$135 46</u>

These figures do not include any allowance for the use of farm machinery, nor do they include any amount as an equivalent for the exhaustion of soil. The cost for labour was \$33.86 per acre. The average yield of the roots was 13 tons 1,035 lbs. per acre, which gives an average cost of \$2.50 per ton, for labour of growing, including cost of seed and rent of land.

## INDIAN CORN CROPS.

9 acres of *Indian Corn*.—The soil for the six plots of corn in this division, was a clay loam which had been cropped with mixed cereals in 1891. It had not been manured for at least six years. In the spring of 1892, it received a dressing of barnyard manure at the rate of about ten tons per acre.

*Plot No. 1* contained 2 acres. It was planted by the use of a hand corn planter on 18th of May, with *Thoroughbred White Flint* corn, in hills 3 feet apart both ways, with from 4 to 5 grains per hill. Some of it came up 1st and 2nd of June, but more than one-half of the kernels rotted in the ground, apparently by reason of the cold and wet weather which prevailed. It was harrowed on the 4th of June, and the blank hills were replanted on 10th June.

On 29th June, two or three grains of *Asparagus Pole Beans* were dibbled in beside every hill of corn in two rows; the next two rows of corn were left without beans; beans were planted at every hill in the next two rows, and in every alternate two rows across the whole plot. The beans came up 9th and 10th July. They gave a rather spindling growth of vines and bore fairly long pods which were filled but not ripened.

The ears on the corn reached the early milk stage; but on the whole, the crop was not sufficiently advanced in growth to make the best quality of ensilage. The leaves were dried and withered to a considerable extent as the result of frost on 9th September. It was cut 26th to 27th September. The total yield from the two acres was 43 tons 1,830 lbs., weighed without being wilted.

*Plot No. 2* contained 2 acres. It was planted with *Longfellow* corn, at the same time and in the same way as plot No. 1. It came up on the 2nd of June and was harrowed 4th of June.

On the 29th of June, *Butter Pole Beans* were planted at every hill in every two alternate rows as in plot No. 1. These beans rotted in the ground at nine hills out

## Report of the Dairy Commissioner.

of ten. The few which grew were not vigorous, and did not have any appreciable value in the crop.

The corn reached the glazing stage of growth, before it was caught by a frost on the 9th of September, which caused the leaves to become dry and withered. The total yield from the 2 acres was 36 tons 733 lbs., weighed without being wilted.

*Plot No. 3*, contained 2 acres. It was planted with *Pearce's Prolific* corn, at the same time and in the same way as plots Nos. 1 and 2. It came up on 2nd of June and was harrowed on the 4th of June.

On 29th of June, *Dutch Case Knife Pole Beans* were planted at every hill on every two alternate rows, as in plots Nos. 1 and 2. These beans came up 9th and 10th July, and reached the stage of growth when the pods were fit for cooking as a table vegetable.

The corn reached the glazing stage of growth. The leaves were dried and withered in consequence of frost before it was cut. The total yield from the 2 acres was 29 tons 539 lbs., weighed without being wilted.

*Plot No. 4* contained 1 acre. It was planted on May 25th with *Pearce's Prolific* corn in hills 3 feet apart both ways, with from 4 to 5 grains per hill. It came up June 3 and was harrowed June 4. Part of this plot was cut green from August 31 for feeding the cattle daily. When the remainder of it was cut for the silo on September 13 it had reached the glazing stage of growth. The total yield from the one acre was 16 tons 950 lbs., weighed without being wilted.

*Plot No. 5* contained 1 acre. It was planted with *Longfellow* corn, at the same time and in the same way as plot No. 4. It also came up and was harrowed at the same time. The crop on this plot was cut from August 12, and was fed to the cattle daily until August 31. The total yield from the one acre was 15 tons 1,045 lbs.

*Plot No. 6* contained 1 acre. It was planted with *Thoroughbred White Flint* corn, at the same time and in the same way as plots Nos. 4 and 5. It also came up and was harrowed at the same time. The crop on this plot reached the early milk stage of growth, and was not near enough to maturity to yield the best quality of ensilage. The total yield from the one acre was 20 tons 1,125 lbs., weighed without being wilted.

*3 acres of Indian Corn.*—The soil was a sandy loam, which had received a dressing of barnyard manure in 1891, had been cropped by Indian corn, and had received a dressing of barnyard manure in the spring of 1892 at the rate of about 10 tons per acre.

*Plot No. 7* contained 1 acre. It was planted on May 25, with *Longfellow* corn, in hills 3 feet apart both ways, with from 4 to 5 grains per hill. It was harrowed on June 2 and came up June 3. It had reached the glazing stage of growth before it was caught by a frost on September 9, which caused the leaves to become dry and withered. It was cut and put in a silo on September 21 and 22. The total yield from the acre was 10 tons 1,895 lbs., weighed without being wilted.

*Plot No. 8* contained 1 acre. It was planted at the same time as plot No. 7, with *Longfellow* corn; but in this case the corn was grown in rows 3 feet apart, with from 3 to 4 grains per lineal foot in the rows. The total yield from the acre was 11 tons 1,525 lbs., weighed without being wilted.



*Plot No. 9* contained 1 acre. It was planted on May 26 with a mixture of equal parts of *Longfellow* corn and *Horse Beans*, in rows 3 feet apart, at the rate of 24 lbs. of the mixture per acre. The beans grew in the rows with the corn to a height of from 3 feet to 3½ feet, and carried pods which in a few instances contained ripened beans. The bean stalks in most cases were green and succulent when the crop was cut. The corn had reached the glazing stage of growth. The whole crop was put into a silo on September 21. The total yield from the acre was 16 tons 1,645 lbs., weighed without being wilted.

*3 acres of Indian Corn and Horse Beans.*—The soil of this plot was a mellow sandy loam. A crop of fall rye had been grown upon it, and had been cut on 15th June. A dressing of barnyard manure at the rate of 8 to 10 tons per acre was applied. On 18th June it was planted with a mixture of *Smut Nose Flint* corn and horse beans, in rows 3 feet apart, at the rate of 12 lbs. of each per acre. The corn was entirely eaten off by crows. It was replanted on 29th June, and suffered a like fate from the crows, in spite of scarecrows and corn soaked in a mixture of Paris green, &c. It was planted the third time on 6th July, with the mixture of *Smut Nose Flint* corn and *Horse Beans*. It came up 12th July. The corn attained a height of about 6 feet and reached the stage of growth when ears were beginning to appear. The bean stalks were from 3 feet to 3½ feet in height, but pods were not formed on them. On 15th September the crop was cut and put into a silo without being wilted. The leaves of the corn were dry and withered from a frost which came on 9th September. The total yield from the 3 acres was 38 tons 860 lbs.

#### COST OF LABOUR FOR GROWING INDIAN CORN FOR FODDER.

The following is a statement of the cost of labour for growing 15 acres of Indian corn and putting the crop into silos or the stable for feeding cattle.

Rent of land, at \$3 per acre.....	\$ 45 00
Ploughing, at \$2 per acre.....	30 00
Harrowing 3 and 4 times, 20 cents per acre per time.....	10 80
Marking hills, 1½ days, at \$1.50 per day.....	1 80
Marking hills, 1 day at \$1.25 per day.....	1 25
Seed.....	7 50
Sowing, 1 day at \$2.50.....	2 50
Planting by hand, 7 days at \$1.25 per day.....	8 75
Cultivating with single horse, 3½ days, at \$1.50 per day.	5 40
Cultivating with team, 7½ days, at \$2.50 per day.....	18 00
Hoeing, 16 days at \$1.25 per day.....	20 00
Cutting in field and at silo, 67 days at \$1.25 per day.....	83 75
Drawing in, 13 days at \$2.50 per day.....	32 50
Man at engine, 7 days at \$1.50 per day.....	10 50
Use of engine and fuel, 6½ days at \$5 per day.....	32 50
Proportion of time of farm foreman.....	30 00

\$340 25

These figures do not include any allowance for the use of farm machinery (except the engine), nor do they include any amount as an equivalent for the exhaustion of soil. The cost for labour was \$22.68 per acre. The average yield of the corn was 15 tons 1,218 lbs. per acre, which gives an average cost of \$1.45 per ton, for labour of growing, including cost of seed and rent of land.

# Report of the Dairy Commissioner.

## PART V.—DAIRY BULLETINS.

### MILK FOR CHEESE FACTORIES.

#### FEED.

The grass of early summer is too watery and weak in feeding substance, to be fed alone to cows to the greatest advantage. A judicious allowance of bran, pease, oats, other grain, oil-cake or cotton-seed meal, will increase the supply of milk, and fortify the cow's system for the production of a larger quantity of it during mid-summer, fall and winter. A soiling crop of some sort should be grown, to furnish plenty of succulent fodder at the time when pasture may be bare or dry from prolonged drought. Indian corn,—when grown to the glazing stage, in rows or hills 3 feet or  $3\frac{1}{2}$  feet apart with from 2 or 3 seeds per foot in the row,—yields a fodder by the use of which cows are enabled to produce a large amount of milk, butter or cheese per acre of land. Fodder corn is not a complete ration, and when it is supplemented by grass, grain, bran, oil-cake, or similar feeds, better returns may be realized for the feed consumed than when it is fed alone.

#### WATER.

An abundant supply of pure water should be easily accessible. Cows which are denied access to plenty of water, will not give as much milk, or milk of as good quality, as when plenty of it is provided with wholesome nutritious feed.

#### SALT.

Dairy cattle should have access to salt every day, and it should be added to their stable feed daily.

From Quebec westward as far as the Rocky Mountains, cows will consume an average of 4 ounces of salt per day, while they are milking during the summer.

#### SHELTER.

Comfortable quarters are indispensable to the health and well-being of cows. During the winter, stables should be kept at a temperature within the range of from 40° to 55° Fahr. In summer some shade should exist or be provided in the pasture fields, or adjoining them, to protect the cattle against the exhausting influence of July and August suns.

#### MILKING.

When practicable, the milking of each cow should be done by the same person, and with regularity as to time. He only who hath clean hands should be allowed to milk a cow. It is no more difficult to milk with the hands dry than with them wet. It is certainly more cleanly, and leaves the milk in a more desirable condition for table use or manufacture. A pure atmosphere in the stables is necessary to prevent contamination from that source. The immediate straining of the milk will remove impurities from it which otherwise might be dissolved to the permanent injury of the whole product.

#### AERATION.

After it is strained the milk should be aerated. Too often it is poured into one large can and left undisturbed. That neglect implies three things which are injurious to it for cheese-making:—

(1.) The peculiar odour which the cow imparts to the milk will be left in it, until it becomes fixed in its flavour;

(2.) The germs of decomposition, that come in the milk and into it from the air, have the best conditions for growth and action when the milk is left undisturbed;

(3.) The milk will become in a degree less fit for perfect coagulation by rennet. Hence it is needful and advantageous to aerate it for three reasons:—

(1.) By pouring, stirring, dipping or trickling it over an exposed surface, any objectionable volatile element that may be in the milk will be eliminated from it by evaporation;

(2.) Neglect of aeration will increase the quantity of milk required to make a pound of fine cheese;

(3.) It has been found impracticable to make strictly first-class Cheddar cheese from milk that has not been aerated.

#### COOLING.

The cooling of the milk should not precede the aeration. A temperature of from 60° to 70° Fahr. will be found cold enough for the keeping of milk over night, when it has been aired previously.

#### PROTECTION.

Milk is a liquid of absorbent proclivities. It should be protected against such injury as would result from exposure to impure air. A general purpose milk-stand is a device specially adapted for the spoiling of milk. Such a contrivance serves as a combined milk-stand and carriage stand, both of which are legitimate uses. Sometimes it is occupied also as a bivouac for swine, with the end of the whey-trough furnishing one step for the stand. Both of these latter extensions of its uses and hospitalities are wrong.

#### HONEST MILK.

The employment of inspectors, the use of the "Babcock Milk Tester," and particularly the payment of milk according to the percentage of solids in it, promise to improve the quality of the milk furnished by some patrons. The adulteration of milk by the addition of water, the removal of any portion of the cream, and the keeping back of any part of the strippings, are forbidden by the Dominion statutes. The inspectors appointed by the Dairymen's Associations have been equipped with suitable and competent testing instruments, and have been instructed to render every assistance to cheese-makers in the prevention of adulteration and the conviction and punishment of those who may be found guilty of the practice.

#### MATTERS MOST NEEDFUL OF CARE.

Helpful advice on the matters most needful of care are put in the following paragraphs.

1. Only the milk from cows in good health and apparent contentment, should be used.
2. Until after the eighth milking, it should not be offered to a cheese factory.
3. An abundant supply of cheap, succulent, easily digestible, wholesome, nutritious feed should be provided.
4. Pure cold water should be allowed in quantities limited only by the cow's capacity and desire to drink.
5. A box or trough containing salt to which the cows have access every day, is necessary for the keeping of cows profitably.
6. Cows should be prohibited from drinking stagnant, impure water. The responsibility for giving effect to that beneficial prohibition, rests wholly with the individual farmer.
7. Cows should be treated with invariable kindness and they should not be driven fast.
8. All the vessels used in the handling of milk should be cleaned thoroughly immediately after their use. A washing in tepid or cold water to which has been added a little soda, and a subsequent scalding with boiling water, will prepare them for *airing*, that they may remain perfectly sweet.

## Report of the Dairy Commissioner.

9. Cows should be milked *with dry hands*, and only after the udders have been washed or brushed clean.
10. Tin pails only should be used.
11. All milk should be strained *immediately* after it is drawn.
12. Milking should be done and milk should be kept only in a place where the surrounding air is pure. Otherwise the presence of the tainting odours will injure the milk.
13. All milk should be *aired* immediately after it has been strained. The treatment is equally beneficial to the evening and morning messes of the milk.
14. In warm weather all milk should be cooled to the temperature of the atmosphere after it has been aired, but not before.
15. Milk is better for being kept over night in small quantities rather than in a large quantity in one vessel.
16. Milk-stands should be constructed to shade the cans or vessels containing milk, as well as to shelter them from rain. Swine should not be fed near the milk-stand.
17. Only pure, clean, honest milk should be offered; and it should be paid for according to its quality and quantity.

### NOTES FOR CHEESEMAKERS FOR MAY.

#### FACTORIES AND THEIR SURROUNDINGS.

1. *The present*, not next week, will be the best time to see that all the drainage facilities of the factory are adequate and in good running order.
2. Whey runs, spouts and tanks should be put into such shape that leaking will not occur.
3. If there be a leakage from floors, spouts or tanks, which is not immediately preventable, provision should be made at once for the removal of the waste, if only by shallow open trenches. A liberal supply of lime and gypsum should be spread around such places. Do not fail to secure a barrel or two of each, *some time this month*, for use during the hot weather.
4. If the factory buildings are not painted and will not be painted, get them whitewashed this month. If you cannot get that done by the proprietors or managers, get permission and do the rest yourself. A curing-room of imperfect construction, whitewashed on the outside, can be kept 10 degrees cooler in summer than one of a dark colour. If the cheese become injured, through excess of heat, neither the buyers nor the patrons will excuse you, whether the blame belongs to you or not.
5. Make the surroundings of the factory neat and tidy.
6. While keeping the outside of the premises creditable to your taste and neat habits, make the inside to reflect your aversion to everything untidy and dirty. Give every part of the factory a thorough cleaning and keep it in a sweet state all summer.
7. Before the curing-room contains any cheese, fumigate it by burning in it sulphur mixed in alcohol, and spray or wash every part of the inside of the factory with a solution of 1 part of bichloride of mercury in 2,000 parts of water. That will help to prevent the growth of mould on the outside of the cheese, and may lessen the occurrence of floating curds in summer.
8. The leisure hours of May, before the large flow of milk is received, should be improved by putting all the apparatus, appliances, utensils and machinery into the best of working order.
9. Be sure that the making-room floor is so constructed and supported that it will not shake or vibrate *during* the coagulation of the milk.

## MILK AND MAKING.

1. Procure a copy of "Milk for Cheese Factories" for each of your patrons by applying to the Dairy Commissioner, Central Experimental Farm, Ottawa, stating the number required and the address to which they are to be sent. They will be furnished free in French and English.
2. Look out for "leaky" flavours in the milk. Do not put such milk into the vat with that of the other patrons. If you have time, make it up by itself, and send the cheese from it to the patron for his private use.
3. Make provision for keeping a record of the work of every day.
4. Milk seldom requires to be ripened for setting, during this month.
5. Use enough rennet to coagulate the curd into a state fit for cutting, in from 17 to 20 minutes, at from 82° to 88° Fahr.
6. Cut it slowly and very carefully.
7. Use the horizontal knife first.
8. Afterwards allow the curd to settle until the whey comes over nearly the whole surface of it.
9. Then begin to cut it with the perpendicular knife.
10. Immediately after the cutting is completed, begin to stir the mass slowly and continuously until the curd is "cooked" or firm.
11. Heat should not be applied until ten minutes after the stirring is begun.
12. The heating should be effected gradually, at the rate of 1 degree every 4 or 5 minutes, until 98° Fahr. is reached.
13. Draw most of the whey early, and so guard against being caught unprepared by the rapid development of acid.
14. Do not dip the curd until the presence of acid is discernible by the hot iron test. "Sweetly flavours" result from removing the whey too soon.
15. After dipping the curd, or removing the whey, stir the curd gently and keep it at a temperature above 94° Fahr.
16. Do not attempt close matting, high piling or packing of the curd this month. Let it be kept loose until the whey has been drained out of it.
17. When it begins to feel "slippy" and smells like fresh-made butter, it should be put through the curd cutter or grinder.
18. Acid develops rapidly, and care must be taken to make the curd dry or firm in advance of the development of acid.
19. After grinding or cutting, stir for 10 or 15 minutes before salting.
20. Apply salt at a rate of about 1½ lbs., early in the month, to 2 lbs. per 1,000 lbs. of milk during the last ten days, varying the quantity according to the wet or dry condition of the curd.
21. Begin to put the curd in the hoops within 20 minutes after the salt is stirred in.
22. Use only pure water in bandaging.
23. Guard against the formation of edges or shoulders on the cheese from the hoop-followers being too small. Apply the pressure gradually until the whole power through the long lever is used, after four hours.
24. Leave the press-cloths on, and turn the cheese in the hoops every morning. Let no cheese leave the press-room until the shape is symmetrical and the finish neat.
25. If and when the press-cloths are removed, use hot clean whey-oil or butter, into which has been dissolved a teaspoonful of soda per cupful of oil.
26. Try to keep the temperature of the press-room above 60° Fahr.
27. The curing-room should be kept at a temperature continuously between 65° and 70° Fahr.
28. Provide strong, smooth boxes of the exact size.
29. Stencil the weight of the cheese in neat figures on the side of every box.

# Report of the Dairy Commissioner.

## BRANDING.

I advise every cheesemaker, who manufactures cheese of first class-quality, to brand or stamp the word "Canadian" on the side of every cheese, and also on the side of every box which contains the same. In order to secure neatness in design and a measure of uniformity, the following figures are presented as suitable forms for the brand or stamp. The letters may be  $\frac{1}{2}$ -inch or  $\frac{3}{4}$ -inch size.



**An Act to prevent the manufacture and sale of filled or imitation cheese, and to provide for the branding of dairy products.**

Her Majesty, by and with the advice and consent of the Senate and House of Commons of Canada, enacts as follows:—

### SHORT TITLE.

1. This Act may be cited as "*The Dairy Products Act, 1893.*"

### IMITATION CHEESE PROHIBITED.

2. No person shall manufacture, or shall knowingly buy, sell, offer, expose or have in his possession for sale, any cheese manufactured from or by the use of skimmed milk, to which there has been added any fat which is foreign to such milk.

### PENALTY.

- (2.) Every person who, by himself or by any other person to his knowledge, violates the provisions of this section, shall, for each offence, upon conviction thereof before any justice or justices of the peace, be liable to a fine not exceeding five hundred dollars and not less than twenty-five dollars, together with the costs of pro-

secution, and in default of payment of such fine and costs shall be liable to imprisonment, with or without hard labour, for a term not exceeding six months, unless such fine and the costs of enforcing it are sooner paid.

**SKIM-MILK CHEESE TO BE MARKED.**

3. No person shall sell, offer, expose, or have in his possession for sale, any cheese manufactured from or by the use of milk commonly known as "skimmed milk," or milk from which cream has been removed, or milk to which skimmed milk has been added, unless the words "skim-milk cheese" are branded, marked or stamped in a legible manner upon the side of every cheese, and also upon the outside of every box or package which contains the same, in letters not less than three-quarters of an inch high and three-quarters of an inch wide.

**MARK NOT TO BE REMOVED.**

(2.) No person, with intent to misrepresent or to defraud, shall remove, or in any way efface, obliterate or alter the words "skim-milk cheese" on such cheese, or on any box or package which contains the same.

**PENALTY.**

(3.) Every person who, by himself or by any other person to his knowledge, violates any of the provisions of this section, shall, for each offence, upon conviction thereof before any justice or justices of the peace, be liable to a fine not exceeding five dollars and not less than two dollars for every such cheese, or box, or package which is sold, offered, exposed or had in his possession for sale, together with the costs of prosecution, and in default of payment of such fine and costs shall be liable to imprisonment, with or without hard labour, for a term not exceeding three months, unless such fine and the costs of enforcing it are sooner paid.

**"CANADIAN" AS A BRAND.**

4. No person shall apply any brand, stamp or mark of the word "Canadian," "Canadien" or "Canada" as a descriptive term, mark or brand, upon any cheese or upon any box or package which contains cheese or butter, unless such cheese and butter have been produced in Canada.

**SALE OF CHEESE SO BRANDED FALSELY.**

(2.) No person shall knowingly sell, offer, expose or have in his possession for sale, any cheese or butter upon which, or upon any box or package which contains the same, the word "Canadian," "Canadien," or "Canada" is applied as a descriptive term, mark or brand, unless such cheese and butter have been produced in Canada.

**PENALTY.**

(3.) Every person who, by himself or by any other person to his knowledge, violates any of the provisions of this section, shall, for each offence, upon conviction thereof before any justice or justices of the peace, be liable to a fine not exceeding twenty dollars and not less than five dollars for every such cheese or box or package, which is sold, offered, exposed or had in his possession for sale, together with the costs of prosecution, and in default of payment of such fine and costs shall be liable to imprisonment, with or without hard labour, for a term not exceeding three months, unless such fine and the costs of enforcing it are sooner paid.

**NAME OF COUNTRY WHERE PRODUCED TO BE MARKED.**

5. No person shall sell, offer, expose or have in his possession for sale, any cheese or butter which is produced in any foreign country, unless the name of the country

## Report of the Dairy Commissioner.

where such cheese or butter was produced, is branded, stamped or marked in a legible manner on the outside of every box or package which contains the same, in letters not less than three-eighths of an inch high and one-quarter of an inch wide.

### PENALTY.

(2.) Every person who, by himself or by any other person to his knowledge, violates the provisions of this section, shall, for each offence, upon conviction thereof before any justice or justices of the peace, be liable to a fine not exceeding five dollars and not less than two dollars for every such cheese, or box, or package of butter, which is sold, offered, exposed or had in his possession for sale, together with the costs of prosecution, and in default of payment of such fine and costs shall be liable to imprisonment, with or without hard labour, for a term not exceeding three months, unless such fine and the costs of enforcing it are sooner paid.

### WHO SHALL BE LIABLE.

6. The person on whose behalf any cheese or butter is manufactured, sold, offered, exposed or had in possession for sale, contrary to the provisions of the foregoing sections of this Act, shall be *prima facie* liable for the violation of any of the provisions of this Act.

### PROCEDURE.

7. In any complaint, information or conviction under this Act, the matter complained of may be declared, and shall be held to have arisen, within the meaning of "The Summary Convictions Act," at the place where the cheese or butter complained of was manufactured, sold, offered, exposed or had in possession for sale.

### APPEAL.

8. No appeal shall lie from any conviction under this Act except to a superior, county, circuit or district court, or the court of the sessions of the peace, having jurisdiction where the conviction was had; and such appeal shall be brought, notice of appeal in writing given, recognizance entered into or deposit made within ten days after the date of conviction; and such appeal shall be heard, tried, adjudicated upon and decided, without the intervention of a jury, at such time and place as the court or judge hearing the same appoints, within thirty days from the date of conviction, unless the said court or judge extends the time for hearing and decision beyond such thirty days; and in all other respects not provided for in this Act the procedure under "The Summary Convictions Act," so far as applicable shall apply.

### RIGHT TO MAKE EXAMINATION OF CHEESE OR BUTTER.

9. It shall be lawful for any person who may be charged with the enforcement of this Act to enter upon the premises of any person suspected of violating the provision of this Act, and make an examination of cheese or butter; and any such suspected person, who obstructs or refuses to permit the making of any such examination, shall upon conviction thereof, be liable to a penalty not exceeding five hundred dollars and not less than twenty-five dollars, together with the costs of prosecution, and in default of payment of such penalty and costs, shall be liable to imprisonment, with or without hard labour, for a term not exceeding six months, unless the said penalty and the costs of enforcing the same are sooner paid.

### APPLICATION OF PENALTIES.

10. Any pecuniary penalty imposed under this Act shall, when recovered, be payable, one-half to the informant or complainant, and the other half to Her Majesty.



## GOVERNOR IN COUNCIL MAY MAKE REGULATIONS.

11. The Governor in Council may make such regulations as he considers necessary in order to secure the efficient operation of this Act; and the regulations so made, shall be in force from the date of their publication in the *Canada Gazette*, or from such other date as is specified in the proclamation in that behalf.

## NOTES FOR CHEESE-MAKERS FOR JUNE.

Years ago our June cheese won a reputation as the finest of the summer. A considerable proportion of the cheese manufactured in June is still faulty. Wrong practice in the handling of the curd in some factories has resulted in cheese which are "open and weak in the body;" in other instances the fear of erring in that direction had caused cheese-makers to turn out goods which are "too dry," "too firm" or "too hard." The qualities that are wanted in June cheese, for both the foreign and home markets, are:—

1. A flavour which is full, rich, clean and creamy;
2. A body and texture which are solid, buttery and uniformly fine in the grain;
3. A bright uniform colour;
4. A clean, neat and symmetrical appearance.

The following particular directions are given to assist cheese-makers in manufacturing the finest quality of Canadian cheddar cheese during this month.

Every cheese-maker of prudent ambition should write to the DAIRY COMMISSIONER, CENTRAL EXPERIMENTAL FARM, OTTAWA, asking for entry forms and address labels for cheese for the World's Columbian Exposition at Chicago. They will be furnished free, and it will not cause the individual cheese-maker any loss to make an exhibit.

*Factories and their Surroundings.*

1. The beginning of this month will be a good time to see that all the drainage facilities of the factory are adequate and in good running order.

2. Whey-runs, spouts and tanks should be kept in such order that leaking will be prevented.

3. If there be a leakage anywhere from floors, spouts or tanks, which is not immediately and wholly preventible, some provision should be made at once for the drainage of the waste,—if only by means of shallow open trenches.

4. The surroundings of the factory should be kept neat and tidy; and when at all convenient, the appearance of the place may be improved by the planting of a few flowers.

5. While the outside of the premises should be kept as creditable to your taste and habits of neatness as possible, the inside should be made to reflect still more your intolerable aversion to everything untidy and dirty. The factory should be thoroughly cleaned in every part at least once a week, and thus be kept in a sweet state all summer.

6. The outside of the milk vats, cheese presses, curd sinks, and larger utensils, should get a thorough cleaning once every week.

7. Make sure that the floor of the making room is so well supported that it will not shake or vibrate during the coagulation of the milk in the vats.

8. Particular care should be taken to keep the curd-cutter or grinder, the curd-whisk or brush, and the curd-cloths *perfectly clean*; otherwise they will become prolific distributors of ferments which produce bad flavours.

*Details of the Process.*

1. Encourage each patron to take a personal interest in the care of the milk which is furnished in his name. Procure a number of copies of Bulletin No. 1, "Milk for Cheese Factories" for your patrons, by applying to the Dairy Commis-

## Report of the Dairy Commissioner.

sioner, Central Experimental Farm, Ottawa, stating the number wanted, the name of the factory, and the address to which they are to be sent. They will be furnished free in English and French.

2. Keep a careful look-out for all tainted milk ; if any patron persists in sending such milk to the factory after his attention has been called to it repeatedly, try to make it up by itself ; then send the cheese from it to the patron for his private use.

3. Keep a short record of every day's work, and of the quality of the cured cheese from any vat to which unusual treatment has been given.

4. Sufficient rennet should be used to coagulate the milk into a state fit for cutting in from 30 to 40 minutes at from 88° to 84° Fahr. When an extra quantity of rennet is added to the milk, a corresponding increase in the weight of salt, should be added to the curd.

5. A thorough distribution of the rennet in the milk should be effected, by diluting the rennet extract to a volume of at least one gallon of liquid for every vat, and by vigorous stirring.

6. The contents of the vat should be perfectly still when coagulation becomes visible. Any vibration of the floor and of the vat during the thickening of the milk, causes waste.

7. The horizontal knife should be used first, and the cutting should be lengthwise of the vat ; the curd may afterwards be allowed to settle until the whey comes over nearly the whole surface ; then the perpendicular knife may be used.

8. Immediately after the cutting is completed, the stirring of the mass slowly and continuously should be commenced ; active stirring by the use of a rake should not be commenced until the cubes of curd become slightly healed or skinned on the surface.

9. Heat should not be applied until 10 minutes after the stirring is commenced ; and the temperature should be raised gradually to 96° or 98° Fahr. at the rate of about one degree for every four or five minutes.

10. Stirring should be continued until the curd particles are "cooked" so "dry," that when a handful has been pressed for a few moments, they will fall apart again as the result of any slight disturbance.

11. The whey should not be removed until the presence of acid is discernible by the hot iron test ; and after that stage the curd should be ripened for the application of salt and hooping, in a period of time about equal to that which elapsed between the addition of the rennet and the removal of the whey.

12. Hand stirring *until the curd is firm* will improve the quality.

13. The stirring at first should be performed very gently and the temperature should be maintained above 94° Fahr.

14. The curd should be allowed to mat into one mass, but not until it has been stirred "dry." It is a better practice to stir the curd in the whey, until the development of acid is perceptibly advanced, (that is, until the hot iron test will show thread-like filaments about  $\frac{1}{4}$  of an inch long), than to remove the whey earlier and then permit the curd to mat while it is in a wet state.

15. Close matting and packing of the curd are beneficial *only when the curd is sufficiently "dry,"* and when aëration is provided for.

16. The matted curd should be turned so frequently that the whey will not collect or stand in small pools in or on it.

17. If it becomes gassy or shows too much moisture, or if the acid develops too slowly, it should be aired, (if need be by grinding, cutting and stirring) and afterwards be kept at a temperature above 94° Fahr.

18. The gas of gassy curds hinders the development of lactic acid ; and the presence of lactic acid prevents the formation of the gas which makes the curd porous. The treatment should provide for the escape of the gas by aëration and the maintenance of the temperature above 94° Fahr. in the curd, by the application of hot water to it, or of hot water or steam to the vat or sink in which it is contained.

19. When the curd begins to feel slippery, smells like fresh-made butter, has a texture somewhat fibrous or stringy in its nature and exudes tiny globules of yellow butter fat when squeezed in the hand, it should be put through the curd-cutter or grinder.

20. After the grinding or cutting, aeration and cooling should be effected by the stirring of the curd for 15 minutes or more before the application of salt.

21. Salt should be added at the rate of  $2\frac{1}{2}$  to  $2\frac{3}{4}$  lbs. per thousand pounds of milk, according to the dry or wet condition of the curd. A variation in the quantity of salt should be made, in order to allow for the portion of it which may be carried off in the whey from a wet curd.

22. The hooping should begin when the harsh surface, which is produced on each piece of curd by the action of the salt, begins to give place to a slippery mellow quality, or in about twenty minutes after the salt is stirred in. Sometimes the flavour is injured and closeness of body prevented by a delay at this stage.

23. Pure water only should be used in the bandaging of the cheese.

24. Shoulders or projecting edges on cheese are unsightly evidences of careless workmanship, and reduce their value from two to three shillings per cwt. in the British markets. Careful pressing and bandaging, and the turning of the cheese in the hoops in the morning will prevent their formation. The pressure should be applied gradually, and through the long lever about four hours after the curd has been hooped.

25. The cheese should be turned in the hoops every morning. No cheese should leave the press-room until the shape is symmetrical and the finish neat; and the press-cloths should be left on the ends of them.

26. If the press-cloths are removed from the ends of the cheese, clean whey-oil or butter (into which has been dissolved a teaspoonful of soda to a cupful of oil), should be applied hot.

27. The temperature of the curing-room should be kept continuously as near  $65^{\circ}$  Fahr. as is practicable.

28. Cheese boxes should not be stored in the curing-room, as the odour of the elm wood penetrates the cheese and affects their flavour. They should be strong, smooth, neat, and of the exact size of the cheese. A badly-boxed lot of cheese, or a lot of cheese arriving in England with boxes in a broken condition, realize from two to four shillings per cwt. less in consequence.

29. The weight of the cheese should be stencilled in neat figures on the side of every box.

30. The word "CANADIAN" should be branded on the side of every fine cheese and also on the box. The following cuts give illustrations of neat and suitable brands.

The letters may be  $\frac{1}{2}$ -inch or  $\frac{3}{4}$ -inch size.





NOTES FOR CHEESE-MAKERS FOR JULY.

July cheese, like July butter, has a reputation for being the poorest of the summer. This year it should be exceptionally fine. The abundance of grass in June, with a too plentiful rainfall, will leave the pastures with richer herbage than usual. Suitable conditions for the production, preparation and preservation of the milk in a fit state for the manufacture of fine cheese can be continued by the patrons giving effect to these simple requirements:—

1. Cows need the owner's providential care in the following matters, viz.:—

- (a) An abundant allowance of succulent or other feed;
- (b) Opportunity to drink pure water at least twice a day;
- (c) Access to salt every day;
- (d) Shade in the pasture fields from the weakening influence of July suns;
- (e) Regularity in milking;
- (f) Management and handling with continuous kindness, and an eye to profits.

2. Cows should be prevented from drinking impure water, and should be protected against the attentions of all dogs.

3. (a) Milk should be strained immediately after it is drawn from the cow;

(b) It should be aired by the use of an aerator, or by dipping, pouring or stirring;

(c) It should be cooled to the temperature of the atmosphere;

(d) It should be protected from contamination by the foulness of impure air.

It will be of quick and durable advantage to direct the attention of all patrons to these matters by sending to each a concise, clear and courteous reminder of duty in connection therewith.

When the yield of milk by the cows begins to shrink, the temptation to make up the quantity in some other way is increased. The Act passed by the Dominion Parliament to provide against frauds in the supplying of milk to cheese, butter and condensed milk manufactories is a piece of wholesome legislation.

It forbids the sending to any such factory (1) milk diluted with water, or (2) milk in any way adulterated, or (3) milk from which the cream has been taken, or (4) milk commonly known as skimmed milk, or (5) milk from which any portion of that part of the milk known as strippings has been kept back, or (6) any milk that is tainted or partly sour. The penalty for each offence against the provisions of the Act, upon conviction thereof before any justice or justices of the peace, is a fine not exceeding fifty dollars, and not less than five dollars, together with the costs of prosecution.

The fine when recovered shall be payable, one-half to the informant or complainant, and the other half to the representative of the factory to which the milk was sent, to be distributed among the patrons in proportion to their respective interests in the product thereof.

Let every cheese-maker get a copy of this Bulletin published in the local newspaper, and further, let him see that every patron is furnished with a copy of that issue.

Some of the qualities that are expected and desirable in the cheese of July are:—

1. Rich, clean, creamy flavour;
2. Solid, firm, buttery body;
3. Fine, silky, flaky texture;
4. Bright, uniform colour;
5. Attractive, neat, symmetrical, stylish appearance.

In order that cheese having just these qualities may be manufactured regularly, I make the following notes for guidance:—

1. Thorough distribution of the rennet in the milk must be effected by diluting the rennet extract and by vigorous stirring.

2. Sufficient rennet to coagulate the curd into a stato fit for cutting in from 35 to 40 minutes at from 86° to 90° should be used. When an extra quantity of rennet is used, a corresponding increase in the weight of salt should be added to the curd.

3. The contents of the vat should be perfectly still when coagulation commences. Vibration of the floor and of the vat during the thickening of the milk causes waste.

4. The horizontal knife should be used first in cutting; and active stirring should not commence until the cubes of curd become slightly heated.

5. The temperature should be raised gradually to 96° or 98° Fahr.

6. The stirring should be continued until the curd particles are so well "cooked" or "dried" that when a handful has been pressed for a few moments they will fall apart again as the result of any slight disturbance.

7. As soon as the presence of the acid is discernible by the hot iron test, the whey should be removed. In the case of gassy curds, a further development of acid before the drawing of the whey will be beneficial.

8. Hand stirring will be of advantage *until the curd is firm*.

9. The temperature should be maintained at or above 94°.

10. The curd should be allowed to mat into one mass.

11. It should be turned so frequently that whey will not collect or stand in small pools in or on it.

12. If it becomes gassy it should be aired (if need be by grinding and stirring) and afterwards kept at a temperature above 94°.

13. The gas formed in gassy curds hinders the development of acid; and the presence of acid prevents the formation of gas. The treatment should provide for the removal of the gas by aeration and the maintenance of temperature by the application of hot water to the curd or steam to the vat or sink in which it is.

14. Close matting and packing of the curd are beneficial only after the curd is sufficiently dry and when aeration is provided for.

15. When the texture of the curd becomes stringy in its nature, it should be put through the cutter or grinder.

16. Aeration should be effected by the stirring of the curd before the addition of salt. Usually 15 minutes of such treatment will suffice.

17. Salt should be added at the rate of from 2½ to 2¾ lbs. per 1,000 lbs. of milk, according to the dry or wet condition of the curd. A judicious variation in the quantity of salt should be made in proportion to the moist or dry state.

18. The "hooping" of the curd should begin when the harsh surface, produced on each piece of curd by the salt, commences to give place to a slippy, mellow quality.

19. Shoulders or projecting edges on cheese are unsightly evidences of careless workmanship, and lessen their value from 2 to 3 shillings per cwt. in the English markets. Careful pressing and bandaging and the turning of the cheese in the hoops in the morning will prevent their formation. The pressure should be continued for at least 20 hours. In that way cheese can be finished having an attractive, neat, symmetrical and stylish appearance.

## Report of the Dairy Commissioner.

20. The sprinkling of cold water in the curing-rooms in the morning and just after noon will reduce the temperature.
21. The curing-room should be thoroughly ventilated and should be kept clean.

### NOTES FOR CHEESE MAKERS FOR AUGUST.

A cheese factory's reputation is largely determined by the quality of its August, September and October output. The beginning of August is a fit time for every cheese-maker who has had only partial success during the hot weather to redeem or improve his reputation and that of his factory. A comparison of the prices realized for the summer cheese of Ontario with the figures reported from the United States market shows that Canadian cheese are in demand at higher rates than American cheese will sell for. That we have gained in reputation and in market favour with British importers and consumers, is evident. That this advance and advantage are the result of the applied skill of not more than half of our cheese-makers, is well known to those who visit the factories and handle their products. To reach and to help speedily those who work in cheese factories without any ambition or aspiration for improvement is well nigh impracticable.

However, we desire to make helpful information not only attainable but unavoidable to such.

In a short time there will be numerous cable orders from England calling for "cool August cheese." That brief description implies a mild, rich flavour that may be preserved for the winter trade, a firm, solid body "full of meatiness," a fine outside finish, with clean, bright rinds, free from cracks, and bandages fresh-looking and not likely to appear mouldy.

To help the cheese-makers in manufacturing a class of goods that may be satisfactorily shipped on such orders, I call attention to some things both outside and inside of the factories which need their immediate and special personal care.

*Around the Premises.*—Insufficient or inefficient drainage facilities, unless enlarged or remedied, will show their worst effects during this month. At the cost of only a few hours of labour and a few dollars of expense, the immediate vicinity of every factory can be kept free from the noxious odours that arise from stagnant slop pools. The frequency and foulness of these about some factories are not only a menace to the permanent prosperity of our cheese manufacturing industry, but a disgrace to the men in charge of the factories.

At factories from which whey is drawn back to the patrons' farms in wagons, the leaking and spilling near the whey tank too often leave its vicinity in an almost impassable condition. A few loads of gravel will abate the nuisance and leave the place fit for approach during the succeeding months when the roads become bad.

The shrinkage in the milk supply will leave a shortage in the whey tank. In order that the whey may have more feeding value, the tank should be thoroughly cleaned and washed at least once a week.

At factories where hogs are fed, salt and ashes or common soil with the sod on it, should be fed liberally during this month.

*In the Making-room.*—This month seems the one when flies become most numerous and troublesome. Some afternoon after the cheese are in the hoops, it will be a good plan to close up the making-room windows and doors, and to burn a small quantity of sulphur for the purpose of fumigating the place. If a tablespoonful of alcohol be mixed with the sulphur, it will burn more freely. Care must be taken to prevent the fumes from getting into the curing-room. The tins of the milk vats and the insides of the sinks should also be washed afterwards before they are used. All vats, presses and utensils should get a thorough quarterly cleaning-up early this month.

Every cheese-maker should persistently fight untidiness and filth in every form; and he ought to have a woman's passion for cleanliness and a similar antagonism for dirt.

*In the Curing-room.*—There will be difficulty in curing the cheese made during July at a sufficiently low temperature. Ventilation of the room during the early

mornings, as well as during the evenings and nights, will be of benefit. Floors should be sprinkled with cold water, morning, noon and evening. While the cheese are being turned on the shelves there should be an abundant admission of light. August is the month when the "skippers" are apt to do damage. A plentiful shaking of fly powder in the room before it is shut up for the day will make it possible to destroy the cheese flies by sweeping them up.

Cheese-boxes should not be stored in the curing-room. The odour from the elm wood penetrates the cheese and affects their flavour.

*Patrons.*—Since the milk is richer and less in quantity, there will be an increased temptation to "even up" by the addition of water, or to "even down" by the removal of cream. You will be doing the community moral service, as well as the cheese trade some good, by reminding the patrons that the Dominion Act on adulteration of milk is in force and will be enforced against all discovered delinquents.

Patrons are more likely during this month than at any other time to forget to provide salt for their cows, and to neglect to supply an abundance of pure cold water. Cool evenings are no excuse for the neglect of aeration of the milk. It should be most thoroughly aired immediately after it is strained.

The making of cheese for exhibitions is usually undertaken during the first two weeks of this month. Send a circular to every patron, making mention of those matters which are referred to in this bulletin, and inviting their co-operation, in order to aid you in the manufacture of cheese fine enough for exhibition and prize-taking. If some patrons pay no heed, and no improvement results, don't get discouraged. Keep right on insisting on a better state of things in their practice.

*Making the Cheese.*—When the evenings are cool and the milk needs ripening, don't fail to leave it in the vat until it reaches the proper state of maturity, before the rennet is added. Use enough rennet to coagulate mature milk to a state fit for cutting in forty minutes when set at 88° Fabr. Dilute the rennet extract to the extent of one pailful of water for every vatful of milk, and then mix it thoroughly by vigorous, rapid stirring.

When you are troubled with gassy curds, allow a development of acid, such as will be indicated by threads from the hot iron test a quarter of an inch long, before the removal of the whey. It is a good plan to run most of the whey off at an earlier stage, and to leave only enough whey on the curd to permit a free stirring of it. After the whey is drawn, air the curd thoroughly and make provision for keeping it warm. Let the temperature be kept above 94°. Frequent turning and aeration will facilitate the development of acid, providing the temperature is maintained. After the curd-cutter has been used, the curd should be stirred and aired for fifteen or twenty minutes before the application of salt. From 2½ to 2¾ pounds of salt per thousand pounds of milk should be added to curds which are fairly well dried by previous stirring. They should be put in the hoops within twenty minutes after the salt has been mixed in.

Pressure in the hoops should be applied very gradually. The cheese should be bandaged neatly when they are turned in the hoops, within two hours after they are put in the presses. They should again be turned in the hoops some time in the following morning. Cheese should be pressed for at least twenty hours.

Endeavour to get every one who sends milk to your factory, or who is concerned in its management, to try to bring it to the very front in point of reputation for the excellent quality of its product. Work conscientiously for that end, then talk up your factory wherever you go, and get your patrons to do likewise. In short, think and work to make your factory and its product worthy of a higher reputation, especially for August cheese.

#### NOTES FOR CHEESE-MAKERS FOR SEPTEMBER.

1. Invite your patrons to co-operate with you in the effort to bring the September cheese from your factory to the very front at the World's Columbian Exposition in 1893.

## Report of the Dairy Commissioner.

2. Urge them to see that the cows have an abundant supply of succulent, wholesome, nutritious feed, and access to pure water. When salt is not provided where the cows can reach it every day, they will drink foul and stagnant water if they can get it. Plenty of salt and prohibition from impure water will effect a double cure.

3. All the vessels used in the handling of milk should be cleaned thoroughly immediately after their use. A washing in tepid or cold water, to which has been added a little soda, and a subsequent scalding with boiling water, will prepare them for *airing*, when they may remain perfectly sweet.

4. Cows should be milked *with dry hands*, and only after the udders have been washed clean.

5. Tin pails only should be used.

6. All milk should be strained *immediately* after it is drawn.

7. Milking should be done, and milk should be kept only in a place where the surrounding air is pure. Otherwise the presence of the tainting odours will injure the milk.

8. All milk should be *aired* immediately after it has been strained. The treatment is equally beneficial to the evening and morning messes of the milk.

9. Some of the qualities that are expected and desirable in the cheese of September make are—

(1) Rich, clean, creamy flavour ;

(2) Solid, firm, buttery body ;

(3) Fine, silky, flaky texture ;

(4) Bright, uniform colour ;

(5) Attractive, neat, symmetrical appearance.

10. Use from 3 to 3½ lbs. of salt per 1,000 lbs. of milk.

11. Put two bandages on each cheese, and finish them on the ends in such a manner that the outside one may be stripped off before the cheeses are put on exhibition.

12. In other respects follow the Bulletin of *Notes for Cheese-makers for August*, from which I take the following extracts :—

Patrons are more likely during this month than at any other time to forget to provide salt for their cows, and to neglect to supply an abundance of pure cold water. Cool evenings are no excuse for the neglect of the aeration of the milk. It should be most thoroughly aired immediately after it is strained.

The making of cheese for exhibitions is usually undertaken during the two first weeks of this month. Send a circular to every patron, making mention of those matters which are referred to in this Bulletin, and inviting their co-operation that they may aid you in the manufacture of cheese fine enough for exhibition and prize-taking.

*Making the Cheese.*—When the evenings are cool and the milk needs ripening, don't fail to leave it in the vat until it reaches the proper state of maturity before rennet is added.

Use enough rennet to coagulate mature milk to a state fit for cutting in forty minutes when set at 88° Fahr. Dilute the rennet extract to the extent of one pailful of water for every vatful of milk, and then mix it thoroughly by vigorous, rapid stirring.

After the whey is drawn, air the curd thoroughly and make provision for keeping it warm. Let the temperature be kept above 94°. Frequent turning and aeration will facilitate the development of acid, providing the temperature is maintained.

After the curd-cutter has been used, the curd should be stirred and aired for fifteen or twenty minutes before the application of salt. The curd should be put in the hoops within twenty minutes after the salt has been mixed in.

Pressure in the hoops should be applied very gradually. The cheese should be bandaged neatly when they are turned in the hoops, within two hours after they are put in the presses. They should again be turned in the hoops some time in the following morning.

Endeavour to get every one who sends milk to your factory, or who is concerned in its management, to try to bring it to the very front in point of reputation for the excellent quality of its product.



## NOTES FOR CHEESE-MAKERS FOR OCTOBER.

A few years ago "October cheese" of Canadian make were deservedly in bad repute in the English markets. Their soft, porous body made them liable to go off in flavour quickly; they did not possess the keeping qualities, combined with that richness of body and flavour, which are so much desired by English merchants and consumers. During the last two or three years a decided improvement in the quality has been effected, and with the finer quality has come a better reputation in the markets. By the exercise of due care on the part of the cheese-makers throughout the remainder of this season, the reputation of our "October cheese" may be so well established that hereafter they will be counted equal to "September's." Cheese can be made as *firm* and *fine* during October as at any other time of the year. Suitable conveniences for controlling the temperature of the curd from the milk vat until the cheese is ripe are required.

## MILK.

The milk delivered at factories during October has a higher per cent of fat and other solids than during the summer months. Its flavour will be equally rich and nice, when the cows are stabled during the cold nights and fed liberally on fodder corn or any other suitable succulent nutritious feed. Turnip tops and rape should not be fed to cows whose milk is furnished to a cheese factory. After the milk is drawn it should be strained immediately and forthwith aired as thoroughly as during the hot weather of July. The aeration will improve its flavour and prepare it for the manufacture of a finer quality of cheese than it will be possible to obtain if that treatment is neglected. The milk should not be cooled below 60° Fahr. A milk-house or the farm kitchen will be a more suitable place for keeping it over night than the open milk-stand when the temperature of the outside air goes below 50°.

## CHEESE-MAKING.

The construction and equipment of the making-rooms of some factories are still defective. At the cost of a little labour and building paper, almost any room can be made so close in its walls that the inside temperature may be regulated at will by the use of a stove or steampipes. Thorough ventilation once every day should be secured. The following paragraphs will be of service in refreshing the experienced cheese-maker's memory and in instructing the others in the best practices.

1. Let the milk be ripened by the application of heat before the rennet is put into it. The ripening should be allowed to proceed to such a degree that not more than three hours will be required between the addition of the rennet and the development of acid perceptible to the taste or discernible by the hot iron test.

2. The use of sour whey to hasten the ripening should not be resorted to. Old milk which has become nearly sour to the taste may be added, but loppered or thick milk should never be used.

3. Rennet should be added in quantities sufficient to coagulate the curd into a state firm enough for cutting in from 45 to 35 minutes at temperature of 86° or 88° Fahr. It should be diluted with water to the volume of at least one gallon of liquid for every vat.

4. After coagulation is perfect the curd should be cut finer than during the summer. The application of heat should be delayed for 15 minutes after stirring is commenced; and the temperature should be raised to 98° and maintained at that point until the whey is drawn off. After the middle of the month a temperature of 100° will be preferable.

5. Care should be taken to so apply the heat and perform the stirring that the curd particles will be so dry, before the development of acid is perceptible, that after a handful has been pressed into a lump they will separate readily.

6. The curd should be stirred before and after the removal of the whey until the whey is so well separated out of combination with its particles that they produce a squeaky sound when bruised between the teeth or otherwise,

## Report of the Dairy Commissioner.

7. After the whey is drawn off the curd should be kept at a temperature above 94°. If it becomes colder than 94° the development of acid will be hindered and excessive moisture will be retained in it during the souring process. The presence of such extra moisture in the curd at this stage will leave the cheese with a weak "pasty" or "tallowy" body, according to the degree of acid development permitted.

8. A cover over the vat of a curd sink with steam pipes seems a simple and effective provision for keeping the curd warm. Where no rack is used, the putting of a few pails of hot water in the lowered end of the vat will maintain the temperature.

9. Just after the removal of the whey, the curd should be hand-stirred until after the whey that will run has been drained off. *After the curd is dry and firm* it may be allowed to mat into one mass, *but not before that condition is reached*. All stirring should be performed so as to avoid wasteful bruising of the grain of the curd.

10. It may then be frequently turned and packed close, till the layers of curd are four or five deep. Whey should never be allowed to collect in small pools on it at this stage. The close packing in layers four or five deep, with frequent turning, prevents the outside of the matted pieces from becoming chilled or more deeply coloured by the action of the air than the rest of the curd.

11. The hot iron test is almost indispensable for determining with certainty, from day to day, the exact stage of acid development at which the whey should be drawn off. The filaments—thread-like processes—should be about one-quarter of an inch long. The proper degree of change for the cutting and salting of the curd has taken place when it feels mellow, velvety and "slippy," and shows a texture passing from the flaky or leafy into the stringy and fibrous. If it be too moist or soft, it should be cut or ground at a rather earlier stage and hand-stirred until dry enough, before the addition of salt. The most of the hand-stirring should precede the salting.

12. Not less than 3 lbs. of salt per 1,000 lbs. of milk should be used, and when the curd is on the soft or moist side, 3½ lbs. per 1,000 lbs. of milk should be added; the 3½ lbs. rate is also preferable during the latter part of the month when cold weather prevails.

13. Immediately after the application of salt the pieces of curd become harsh and gritty on the surface; then in from 15 to 25 minutes the harshness gives place to a mellow condition. At the second stage—and the temperature should not be under 88°—the curd should be hooped and pressure applied. Delay at this point or coldness of the curd destroys the desirable rosy flavour, and imparts to the cheese the bitter taste of the salty white whey.

14. Particular care should be taken to use only *pure* warm water when turning the cheese for bandaging, before the rinds are fully formed.

15. Especially in a cold press-room, pains should be taken to apply heavy pressure to the cheese before they are left for the night.

16. All cheese should be finished in symmetrical shape and kept in the hoops until the rinds are smooth and the edges free from any projecting "shoulders."

### CURING THE CHEESE.

The temperature of the curing-room should be kept as nearly regular at 65 degrees as possible. Where the September cheese are kept in the same room with those of October make, the latter should be kept on the warmer shelves. A slight chilling, after a cheese has been curing at 65° for two weeks, does little damage; but a steady temperature and constant curing give the best results. Bitter-flavoured cheese are usually the result of chilling in either the making-room, press-room or curing-room. If the cause be prevented, the consequence will be unknown.

### TO FACTORY MANAGERS.

As this is the last Bulletin of NOTES FOR CHEESE-MAKERS for this season, I desire to counsel the managers of factories to guard against tendencies that appear to menace the permanent success of our cheese industry, viz. :—

1. The employment of inexperienced, incompetent men to manage the inside work of the factories.

2. The conscienceless cutting down of the remuneration of the makers, until the able men are leaving the occupation.

3. The inevitably penny-wise and pound-foolish policy of using factory furnishings of poor quality, simply because they happen to be a little lower in price.

So much additional trouble, loss, worry and disappointment result from the putting of men without aptitude or experience in charge of large factories that I strongly urge the proprietors to exercise the utmost care and caution, and invariably to inform themselves as to the fitness of an applicant by inquiry from a reliable expert or cheese buyer. No factory should incur needless risk of a loss of reputation, of patronage, of prestige, of price or profit.

### THE BABCOCK TEST.

*By Frank T. Shutt, M. A., Chief Chemist, Dominion Experimental Farms.*

In former publications\* the accuracy of this test as a method for estimating the fat in the milk of creameries and cheese factories has been established. The principle involved by its use, viz., the payment for milk according to its percentage of butter-fat has also been shown to be a sound and correct one. As a natural result of the wide dissemination of these truths, every year marks the more extensive use of the Babcock test in paying for milk for butter and cheese-making. It is, therefore, the intention of this Bulletin simply to give directions to assist in the rapid and accurate working of the test.

The apparatus, consisting of centrifugal machine, test bottles, pipettes and acid measurers or burettes, should be purchased from a reliable firm, since it is absolutely essential to correct results that all should be well made and the glassware should be accurately graduated.

### THE MACHINE.

The capacity of the machine may be from eight to twenty-five or fifty bottles, according to the requirements of the factory. If driven by a handle or pulley, it should be geared by cog-wheels, and preferably of such construction as to hold the bottles, when not in motion, in an upright position. Where steam power is available, the whirler may be driven by a belt, or a jet of steam may be used as a motive power by playing it against tin cups  $\frac{3}{4}$  inch in diameter soldered to the undersides of the disc of the whirler. In the latter case, the steam at the same time serves to supply the necessary heat to the bottles while the test is being made.

### THE GRADUATED GLASS APPARATUS.

The test bottles should be numbered by stamped brass or copper bands which encircle the necks. It will be found to greatly assist in reading the percentages of fat, if occasionally the graduations are made legible by rubbing in a mixture of lamp black and oil. The use of a pair of calipers or compasses facilitates the rapidity of reading the results, but the column of fat so measured should always be read from the same bottle in which the test has been made.

The pipette (17.6 c.c.) should be of a good length above the containing mark. This will conduce to ease and rapidity of measuring.

\*The annual reports of the Dominion Experimental Farms for 1891, 1892; Dairy Bulletin No. 12; The proceedings of Ontario Creameries Association for 1891, 1892, etc.

# Report of the Dairy Commissioner.

## THE ACID MEASURER.

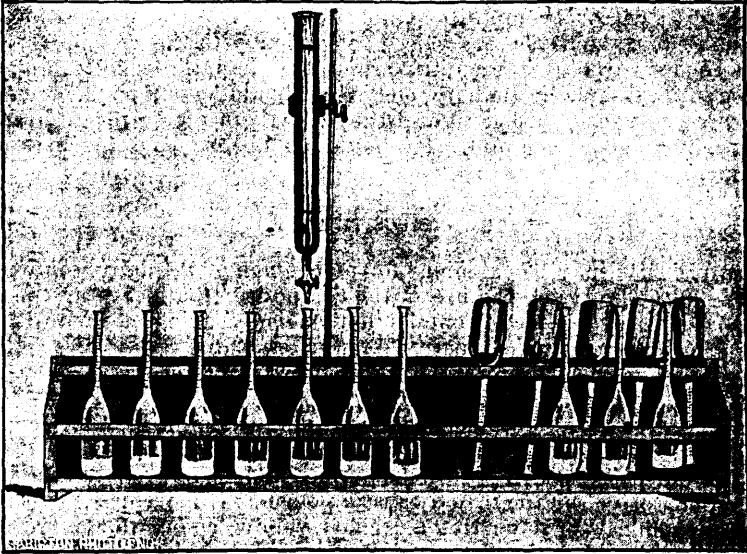

For factory purposes a burette, furnished with a glass stop-cock and holding 12 or more measures, each 17.5 c. c. of acid, will be found to economize time. Such a burette is marked at each 17.5 c.c. and is held by a support of firm and substantial make. (See illustration.)

A can holding 1 quart or so of hot water for filling up the bottles should be conveniently placed and furnished with a rubber tube possessing a pinch cock and terminating in a small piece of glass tubing drawn out to an opening about  $\frac{1}{8}$  inch in diameter.

## THE ACID.

The sulphuric acid (oil of vitriol) should be purchased of the strength of Sp. Gr. 1.82 or 1.83. If stronger than this, somewhat less than the standard quantity should be used and the acid allowed to remain in the test bottle containing the milk, ten minutes or so before shaking. Dilution of the acid is not recommended. If the acid is weaker than the strength above stated, more of it than the standard measure will be required. To economize in the expense of testing, the acid should be purchased by the carboy. A word of caution may here be added. Sulphuric acid is extremely corrosive. If by accident any gets on the skin, it should at once be wiped off with a clean cloth and the part bathed immediately with a large quantity of cold water. A bottle containing carbonate of soda or ammonia should be kept in a convenient place to neutralize any acid that may be spilled upon the clothes or table.

An additional and indispensable piece of apparatus is a wooden rack to hold, say, 12 bottles. (See illustration). By its means the acid and milk may be thoroughly mixed in a large number of test bottles at once, by a motion easily learnt by practice.

## SAMPLING THE MILK.

It is important to obtain a thoroughly representative sample. This may be procured in various ways.

When the test is completed daily, the 17.6 c.c. may be measured directly into the test bottle and the number of the latter recorded against the patron's name.

For semi-weekly or 3-days' test, a pipette measuring 5.90 c.c. is used, and as in the above, its contents should be run at once into the test bottle.

For composite tests of one week, a small dipper, holding about 35 c.c., on a long handle, may be used to stir the milk and take the sample from the weigh-can.\* The milk being poured into the weigh-can, and consequently well mixed, the small dipper full is put into the patron's composite sample bottle. The whole operation occupies but a few moments if the bottles are placed conveniently to the weigh-can.

This method secures a representative sample of the milk as daily supplied.

The composite sample bottle here referred to should have a wide mouth, and be furnished with a stopper or other tight-fitting contrivance to prevent evaporation. Its capacity may be about one pint. It should be labelled conspicuously with the patron's name.

#### THE COMPOSITE TEST.

The patrons' milk may be examined for percentage of fat daily, semi-weekly or weekly. The latter involving the use of the composite test is by far the cheapest and most economical plan, since it entails but one measuring of the milk and one measure of acid per week for each patron; fewer graduated test bottles are required and, as far as our experience shows, the results are fully as accurate as by the more frequent testing.

The preservative here recommended for keeping the milk in a fluid condition is potassium bichromate, a yellowish red crystalline substance. The material although poisonous does not possess such highly dangerous and corrosive qualities as do the preservatives, corrosive sublimate and caustic potash. It moreover has the advantage over these chemicals of imparting a decided yellow colour to the treated milk, whereby error in mistaking the preserved sample for one of normal milk is guarded against. The potassium bichromate should be purchased in a powdered condition and costs retail about 25 cents per pound—a quantity sufficient for 1,000 to 1,500 composite tests. A small amount of the powdered bichromate is put in each sample bottle. The exact quantity is of no moment; from three to seven grains is enough, and this can be measured on the point of a knife or in a small spoon with sufficient accuracy.

The milk from the small dipper is now run into the patron's composite sample bottle every day. It at once dissolves the bichromate and assumes a strong yellow tint. Before adding successive samples, the bottle should be gently shaken with a rotatory motion, so that the risen cream may again become thoroughly incorporated. This is essential if an average sample is to be obtained. These bottles should be kept in a cool place, though not necessarily on ice. After the addition of the milk on the sixth day, the 17.6 c.c. pipette full for the test bottle may be withdrawn.

#### THE USE OF THE PIPETTE.

For a daily as well as a composite test, the 17.6 c.c. pipette is used. The pipette is filled by suction and the level of the milk in the stem carefully lowered to the containing mark by gradually releasing the pressure of the finger which closes the upper end. The milk is then allowed to run into the test bottle.

#### THE TEST.

The bottles being placed in the rack, before mentioned, each receives from the pipette the standard quantity (17.6 c.c.) of the well sampled or composite milk, and

---

\* An alternate method for sampling for composite work, is as follows:—The milk is taken from the weigh-can by means of a tin tube, open at both ends, and of such a diameter that it can be conveniently closed with the finger, about 5-16 inch. Its length should be about equal to the depth of the weigh-can. At two inches from one end a gradual constriction is made—similar to that of a pipette—until the orifice is about 3-16 inch in diameter. This will be the lower end of the tube, the constriction preventing the milk from running out before the finger is removed. The tube is inserted and allowed to touch the bottom of the weigh-can; the finger closes the upper end and the tube is withdrawn. The contained milk flows into the composite sample bottle by simply releasing the finger. The sample so obtained is in direct proportion to the amount daily furnished, thus ensuring greater accuracy in the final result than when an equal quantity is daily taken.

## Report of the Dairy Commissioner.

the number of the bottles is recorded against the patron's name on the printed form, now to be obtained for that purpose. The acid is then run in from the burette. The milk and the acid in the twelve bottles are now to be thoroughly mixed by shaking the rack in the manner before stated. This is repeated until enough bottles to fill the whirler have been filled and treated. The bottles are now placed in the centrifugal machine, and whirled for four minutes. If any delay has occurred before the whirling, hot water should be placed in the machine, unless a steam jet is used as motive power. After the first whirling, hot water is added carefully to the contents of each bottle, till the column of fat is within the graduated portion of the neck, when they are again whirled for 1½ minutes. During the final whirling the temperature in the bottles should not be allowed to fall.

The column of fat should be at once noted, and its percentage recorded. If it is not found convenient to read the fats immediately, the bottles should be immersed in hot water above the level of the fat in the necks for several minutes previous to measuring the fat. The readings will be found quite as clear and free from curd in the bichromate composites as in the fresh milk test; indeed, as a rule we have found less trouble in obtaining clear readings in the former than in the untreated milk.

A time-saving method for emptying the test bottles (which should be done as soon as possible after the percentage of fat is recorded) is to invert them over a sink or pail by putting the necks through holes in a board, the diameter of the holes being such as to easily admit the neck only. A little pearline or soap in the rinsing water will free the necks from any film of fat and leave them bright and clear for future tests.

### THE CALCULATION OF RESULTS.

To obtain the number of pounds of fat furnished in any given time by a patron, multiply the pounds of milk supplied by the percentage of fat and divide by 100.

For creameries and cheese factories, the method of calculating the amount due to each patron may be as follows:—

Deduct the cost or charge for manufacturing from the amount realized from the sales of the butter or cheese, then divide the result by the total number of pounds of butter-fat supplied to the creamery or factory during that period, and the price of one pound of butter-fat is obtained. Multiply the number of pounds of fat furnished by the patron, by this price, and the result is the amount due him.

#### EXAMPLE.

Total weight of milk received.....	6,525 lbs.
"    cheese manufactured and sold.....	621·4 "
Proceeds—at 10 cts. per lb.....	\$62.14
Amount to be deducted for manufacturing (2¼ cts. per lb.).....	\$13.98
	<u>          </u>
Amount to be distributed.....	\$48.16

Milk supplied by the patrons A, B and C, as follows:—

	Lbs.	Per ct. fat.	Lbs. of fat.
A. 1st week.....	500	3·0	15·00
2nd " .....	550	3·3	18·15
3rd " .....	525	3·1	16·27
4th " .....	600	3·5	21·00

Total lbs. of fat supplied by A. .... 70·42

	Lbs.	Per ct. fat.	Lbs. of fat.
B. 1st week.....	500	3·7	18·50
2nd " .....	550	3·9	21·45
3rd " .....	525	3·5	18·37
4th " .....	600	4·0	24·00

Total lbs. of fat supplied by B. .... 82·32

	Lbs.	Per ct. fat.	Lbs. of fat.
C. 1st week.....	500	3·8	19·00
2nd " .....	550	3·3	18·15
3rd " .....	525	3·5	18·37
4th " .....	600	3·7	22·20
Total lbs. of fat supplied by C.....			77·72
Total lbs. of fat supplied by A,B,C.....			230·46
48·16			
<hr/>			
= 20·897 cents price of butter fat per lb.			
230·46			

$$A. 70·42 \times 20·897 = \$ 14 72$$

$$B. 82·32 \times 20 897 = 17 20$$

$$C. 77·72 \times 20·897 = 16 24$$

$$\underline{\underline{\$ 48 16}}$$

## PART VI.—LECTURES AND ADDRESSES.

### (1.) A FEW ECONOMIES IN FARMING.

*(Report of an Address delivered before the Central Farmers' Institute of Manitoba at Portage la Prairie, June, 1892.)*

MR. MAYOR, LADIES AND GENTLEMEN,—It may seem to you a very steep tumble to come from the "Ideal Farmer" down to talk upon economy; but the ideal farmer is an economical man, else he is not a wise man. Many men think that because the ideal is high, it is not worth striving after; and one of the main calamities of middle life is when a man lets go the ideals of his boyhood and is both willing and anxious to lower them in deference to some one's flattery or hostility, be he a friend or a foe. I would call on all the young men here, and those who will hear me through the reporter's pen, never to lower their ideals of manhood, but to try and realize them to the full. If they come short of the mark, they will at least have gone higher than if they had no ideal at all.

Coming to the town of Portage la Prairie by crossing those beautiful plains, I find myself in rather an embarrassing position when I begin to speak upon the subject of economical farming to the people who dwell here. I will explain, perhaps, later on, whence the embarrassment comes; but the people of Manitoba have such an excellent opinion of themselves as a whole, that these most excellent people of Manitoba whom I address to-night may already be exalted in their views of their own merits. I was speaking to an audience yesterday in Virden, Man., a grand audience, such a one as warms the heart of a man who wants to tell the people something they want to hear. They were a people full of interested enthusiasm (and I believe if the people are wisely enthusiastic about their own work the good Lord will make the sun to shine enough to ripen the grain before the frosts come). But to-day I feel like a certain clergyman who had come from a long distance to preach the gospel to a fashionable congregation in Ottawa, who seemed to be very devout. As he looked around the church he thought that things even in Ottawa are not always as they seem, and so he said that he felt it most embarrassing to endeavour to preach the old gospel of repentance to such a congregation, as they looked so eminently respectable, probably they had too high an opinion of themselves already. He would not call it self-righteousness, and you can interpret the meaning and apply it to other questions if you like. I think it might apply to some of the self-satisfied farmers who farm the beautiful plains of Manitoba. I am very glad to reciprocate all you, Mr. Mayor, have said in your words of welcome to the farmers to this town hall. If the people who live in the towns would recognize

## Report of the Dairy Commissioner.

more fully the identity of interests between farmers and themselves, they would help themselves by forwarding the interests of agriculture. The farmers in turn would help them to make more money, and both would obtain more pleasure out of life than they have now. The prevalent opinion is that their interests if not hostile are at least not harmonious. The interests of the town and the country are almost identical. The townsman has goods to sell to men who have to pay for them out of the wealth of their crops; and just as farmers are trained and taught to produce more wealth so will the townsmen have a better chance to share in the possession of it. When the people of the towns neglect the people of the country, they neglect their best friends and interests. They should take more interest in the success of the farmers. Farmers themselves should rub together oftener and have their minds sharpened in that way as to the best means of attaining success in their calling. I think my mission is to harrow up your minds, and if I can, to say something that will stir you up to kill the mental and other weeds, and make better crops come hereafter as the result of your good thinking.

Economic farming is a subject that is especially apt to Manitoba, because agriculture is all important here; you have nothing else to depend upon. In Ontario they have lumbering interests, mining interests, manufacturing interests, shipping interests and many other interests, so that if farming should fail for one year, they can fall back on other sources of revenue and wealth; but when the farming fails here, it is calamitous failure indeed because you have no other resource. This being so, every man who wishes his province well should give some thought to its needs and how they can be met. I would like to see more of our boys who have splendid minds and who go to study law, stay on or come to the farm, not to wear the skin off their hands, but to wear down their brains in thinking for the best interests of the farmers. These would be the nobility of this people. A shop-keeper in Manitoba has little chance of escaping failure should the crops around his town or village fail; the machinery manufacturer or seller has small chance of meeting his obligations unless the crops meet the farmer's expectations. For the prosperity of the country as a whole, you will see that it is most important for the farmers to learn to carry on their work economically.

Farming here and elsewhere is largely concerned in the production of wealth. I have handled in one mouth, thousands, and thousands of dollars worth of farm products in business, but in handling them I never created a dollar's worth of wealth. You may handle wheat, butter and cheese, and the oftener you handle the product the more you increase the cost to the consumer, but the real worth, the life sustaining value has not been augmented. The man who is not in close contact with the sources of wealth, may be acquiring a great deal of wealth, but he is sometimes a man who does not create any wealth. One of the embarrassing things in a man's experience will be to account, by and by, for owning a great deal, when he has made nothing—to account for possessing a great deal, having produced nothing. I would not like to undergo St. Peter's examination in that way, and worth a million, unless I had created it or earned it by the work of my brain or my hands. It is better to give largely to the world even if you have not much left, than to get largely from the world and give nothing back. Life is not always what it seems, and for true noble mindedness, give me the man who creates or makes or produces; such a one as goes through the world serving it and leaving it better than when he found it.

The object of farming is to create wealth for food and clothing. The farmers are entitled to a fair share of it for their own comfort. They provide the wool, cotton, silk, and leather from farms, and in this way furnish the raw material with which to clothe the world as well as feed it. You cannot find more than a few names, and I cannot think of any at the present moment, of men who stand out, glistening from the large beneficial service which they have rendered during the past ages who did not come from some country or humble home. Think back over the list and find out where the boys came from. You can get good crops only from good seed. It will always be so in farming and in life.

As to furnishing food and maintaining fertility, a great many farmers fail in their calling in this respect. They furnish lots of food for a time, but when they



abstract the fertility from the soil, by and by only a portion of their farm will give a fair return for their honest toil. A farmer must fully understand the nature and needs of his business to be enabled to create more wealth, live honestly and leave his farm better than he found it. In following farming along that line a man must follow it economically. I wish to emphasize that word "economy" because the very munificence of your inheritance in this western province has given you large ideas and has made you men who contemn small things. The enterprising and self-reliant of our people have come west; you have had the flower of the population of Ontario come to Manitoba and the North-west Territories, and because you are such you are men of large ideas, sturdy and indomitable. If you had not been such, many of you would have left Manitoba during some of your bad years. And because you are such, you think that economy does not become a people like you. But economy is not meanness, and a man who is not economical will be compelled sometimes to be mean against his will. A wise administration of all that a man can control is economy. Meanness is trying to hold on to two cents so tight and so long that the hands become too numb to do any good work in the world afterwards. Economy means exercising control, but very often a farmer looks down upon himself as a nonentity that is controlled by every ebb and flow of circumstances, and not as a man who should control circumstances and rule over the things that are put under his power. Go back to the very beginning of farming, take the sacred story or the scientific supposition as you choose, you will find that man was given or acquired dominion over the earth that he might rule over it; and the man who farms wisely, says to his plant, grow, and it grows beneficently, if he is a big enough man in his mind to make it grow thus. If he is a mean man, it will be a mean looking plant like himself. When a man says to a plant, grow, and it grows, the plant lives, moves and has its being in that man's thought; and if he does not think well enough and far enough to have a good seed-bed and have a seed adapted to the climate and soil, it will not do well. But if it lives, moves and has its being in his thoughts, and his thoughts furnish a suitable and adequate environment, then it will respond. A farmer can never feel quite so much a man in every fibre of his being, as when he tries to control life. It is not so hard to take a dead block of marble and chip it into a thing that looks like something that once had life; but when a man tries to make a horse take form after the ideal of his thoughts, he is doing a higher and nobler kind of work, requiring more mind if less muscle. If you go back and find the best "No. 1 hard" wheat, the best steer, the best cow or horse in your stables, you will find behind all the excellencies of all these products and their anterior processes, some one's clear thinking. You can see how important it is to a man to think well of what he is striving to do, to have a high ideal, and to devote himself ardently and arduously to its attainment.

In Manitoba, men have good minds. If you discuss provincial politics with a Manitoban, he will display a mind that is sharpened down to a razor edge to cut through any argument opposed to his party; if you discuss Dominion politics, the same man's mind is like a razor that has been sharpened so much that the edge has been turned until it does not cut so well; and if you chance to discuss farming with him, his mind will be like the knife used by the harness makers, keen and sharp at one end for politics, but at the other end for farm topics, dull as a hoe.

Now if men would come to a meeting like this and listen and take part in such a discussion as that which took place this afternoon, you would find that the friction of mind on mind would sharpen up their thinking and ideas. The farmer should not believe everything he hears, and the object of the Farmers' Institute is not so much to load a man with information as to rub his mind up on matters pertaining to his own business. Farmers should meet with their fellow farmers to discuss their common business and its interests.

I will give you an illustration; I went down to Nova Scotia once on a mission in connection with agriculture, and I went to a place where they were making the steel parts of agricultural implements; I saw a vast furnace filled with molten steel bubbling and spluttering like lard in a frying pan. The men who were managing the steel works could lead that steel through the prepared ducts into certain moulds

## Report of the Fairly Commissioner.

and the steel took shape according to the thinking of the men. I have seen men in all occupations of life whacking cold steel with their knuckles and having sore hands for their pains while the steel did not budge. They should have whacked and worked it with their minds first, and then it could be led where and how they listed. In Manitoba men must not only break the land with their ploughs; they must also break it with their minds. Money is made in farming first in the man's head and then in the man's fields and then in his stables. The man who neglects to use his head as well as his hands cannot hope to be successful.

In economical farming a man should economically administer his time. I have known men so busy that they would never *waste* half a day in going to a farmers' meeting; so busy cutting firewood that they never *wasted* half an hour in sharpening the axe, and in consequence have hard tired muscles and badly cut firewood. If you would come together in Manitoba once a week and talk agriculture, you would find the practice of the whole province responding to clear thinking. I could not give you any advice that would help Manitobans more than to come together once a week and discuss the merits of the different methods of farming, and thus settle for yourselves things that have not been explained as yet. I was staying at a nice home the other day and talking to a farmer's wife, a large-hearted, clear-minded woman, and she said, "We get along pretty well up here, but we have nothing at all in the way of social intercourse, except at the church and the prayer meeting," a pretty one-sided social life even if the sermons were good and the prayer meeting service devotional. A farmers' meeting once a week would give a new stimulus to things around the farmhouse, and furnish material for the conversation of the family at the meal table. Too often now life is so dull for the lack of interesting diversity that if I had to live in such a house where there were no new subjects for conversation and everything had a monotonous nature, I would attain to dyspepsia in three days and want to die and thus realize upon the hope of going to heaven inside of a week. I am telling you the truth, the sober truth when I say that the people of Manitoba have been in such eager haste to get rich by getting big crops of wheat, that they have seldom a bright, helpful idea for the home breakfast table unless company be present. Did you ever see a woman sit down in a chair and cry, saying, "We have been here six years and have been hoping ever since"? Well, hope deferred maketh the heart sick, and many a good woman has wished herself well back in Ontario because the farmer was bound to have a large crop of wheat that did not always come, and because he did not fortify himself by having something else to depend upon. I have seen such a sight in Manitoba, and though I did not go down to Ontario and advertise it, still I have seen it, and the farmers here should awaken to an economical management of their business, and have other resources besides wheat and thus brighten up their homes so that the families will be really happy as well as well-off.

It is economical to try and bring about good times. They come between the income and the outlay. If a man's income is very much more than his outlay he is very well-off. But if his outlay creeps up to and is more than his income, times are very bad with him financially. If a man can reduce his outlay with economy then he helps to bring about good times. It is economical to try and reduce the outlay in farming.

One thing that strikes a stranger coming into this country (although I am not an entire stranger here) is the way you allow your machinery to be exposed to the weather during all seasons. The impression is at once formed that you have too many farm machines. Many machines by being exposed to the weather for a whole season will lose twenty-five per cent of their value. I have seen them standing out in all weathers where there was lots of straw lying around which could have been utilized as a shelter for them. It is a plain truth, and one I should like the people of Manitoba to bear in mind, that the atmosphere here is bad for the machinery thus exposed. The result is that in a short time you have to trade your machine off for a new one, losing a great deal in the bargain. I have no spite against the machinery manufacturers; I think they are the benefactors of the country; but still you should protect your own interests by protecting your machinery.

You can be economical by trying to increase your income. Manitoba wheat was quoted yesterday from eighteen to fifty-seven cents per bushel. I do not know but that there may be some means whereby you could get more than fifty-seven cents a bushel if the railway rates were lower; but this I do know, that any man, if he is man enough for his business, and I do not say that every man is equal to that, but if he is man enough he can lift himself up from being the eighteen-cents-a-bushel man to being a fifty-seven-cents-a-bushel man by controlling the quality of his product.

Some men use their soil after the manner of a boy in Ontario who set a hen on twenty eggs. His father said, "Johnny, do you think she will hatch them all?" He answered, "No, papa, I simply wanted to give the old hen a chance to spread herself." I have known men here get more land than they could properly attend to, that they might have more than their neighbours. It is not a wise administration of the soil for a man to put in more crop than he can handle. It will even pay better to have eighty acres of grain crop with three tons of manure to the acre than to have one hundred and sixty acres of crop without any manure at all, and a third of the crop no good. Three tons of manure will put back into the soil as much strength or fertility as one ton of wheat takes off.

It is economical to remember that cultivation of the soil is for two purposes, and because a man fails to discriminate between the two and bear them in mind he gets into a quandary as to whether he should plough in the fall or the spring and cultivate deep or shallow. Cultivation is primarily to prepare a seed bed, and the seed bed is most perfect when the soil is very compact except the top two inches,—that is for wheat. At the same time a farmer should remember that the cultivation of soil is to kill weeds, and by bearing these two objects in mind, he can do both, kill the weeds and have an excellent seed bed.

A man should exercise economy in the selection of seed grain. I would like to draw this distinction, for fear that it has not been made clear to the minds of the people of Manitoba, that good seed is quite a distinct commodity from good wheat, although they may some times appear to be identical. The millers have been running the seed question in Manitoba rather too much. The miller wants wheat to make flour and the farmer wants seed to get a good crop that will ripen in his locality. Sometimes through want of thought he sells the wheat that would, if sown, bring forth an excellent crop, and sows the wheat that would have made excellent flour. Last year over sixteen thousand sample bags of grain were sent out from Ottawa under the direction of Prof. Saunders, for the purpose of inducing the farmers to examine for themselves the merits of the different varieties for seed in the several localities.

It will pay a man to grow the crops he can sell best; and a man can sell frozen grain all right if he administers his materials to the best advantage. He need not try to grow frozen wheat; he should try to grow the crops he can sell to advantage, and he should make provision for selling every kind of crop which grows in Manitoba.

You have not the same sad history here that some districts have, by being injured to some extent by the frost three years out of five. However, a little economical farming here will help the farmers to market to advantage even a crop of inferior grain damaged by the weather. There was some frozen wheat in Manitoba last year, as you know, though I believe you were wonderfully exempt in this district. We had some of it sent to Ontario. I said once in the innocence of my moss-back condition (that is what I was called when I first came to Manitoba, and I have not recovered from the ailment since; further west I was called a "tenderfoot" and I still think it is nice to be tender in one's feelings in some respects) but because I said, in the frankness of uninitiated candour, that I had seen some frozen wheat once in Manitoba, some one sent to Ottawa for Professor Robertson's benefit, a request that he be asked, officially, to give a contradiction of his previous statement. They forgot that Professor Robertson was a Scotchman, and like most of that nationality, "lived only to tell the truth and set a good example." We had some frozen wheat taken to Ottawa last year, and I will tell you what it was sold for net, after deducting the shrinkage. It was sold for eighty-two cents a bushel, and no one was duped. It would not fetch here now more than eighteen or twenty cents a bushel. Every bushel of that wheat

## Report of the Dairy Commissioner.

could be turned into from nine to fifteen pounds of pork, live weight, and that could be sold for five and a quarter cents per pound, less a shrinkage of five per cent. That makes it practicable to realize seventy-five cents a bushel for frozen wheat.

The farmer by properly administering his crops, by preparing to market them, not always in bags, but sometimes in beasts, can get a good price for an otherwise unsaleable article. Then we had some excellent beef from feeding steers on corn ensilage and frozen wheat. I had a dozen roasts sent to my friends and they pronounced the meat as excellent as any they had ever tasted. The steers fed on corn ensilage and frozen wheat cost the least per day of any we fattened, and they gained one and three quarter pounds each, per day. We found frozen wheat for the fattening of cattle to be quite equal, pound for pound, with any other grain. As a further precautionary measure in the districts subject to fall frosts, by the growing of more barley and less wheat, farmers would derive a good income from their bacon, butter and beef, and would have more number one hard wheat to sell.

It will pay the farmers of Manitoba to conserve the fertility of the soil. If a man with a bank account keeps chequing out without making deposits to his credit, in a short time the balance will disappear. In like manner if you go on continuously sowing and selling wheat, your fields will become broken hearted and exhausted, and make you like themselves. The following table shows the quantities of the three essential elements of fertility which are removed in one ton each of different farm products.

Nitrogen, phosphoric acid and potash in one ton each :—

	Nitrogen.	Phosphoric Acid.	Potash.
Wheat.....	41·6 lbs.	15·8 lbs.	10·4 lbs.
Barley.....	32·	15·4	9·
Oats.....	38·4	12·4	8·8
Pease.....	70·6	17·2	19·6
Beans.....	81·6	23·8	26·2
Indian corn.....	32·	11·8	7·4
Hay.....	31·	8·2	26·4
Clover.....	39·4	11·2	36·8
Potatoes.....	6·8	3·2	11·4
Fat cattle, alive.....	50·	31·2	2·8
Fat sheep, alive.....	44·	22·6	2·8
Fat swine, alive.....	34·8	14·6	2·
Cheese.....	90·	23·	5·
Milk.....	10·2	3·4	3·
Fine butter.....	5	0	0

It takes more than one hundred tons of butter at \$400 a ton to carry as much from your country as one ton of wheat. One hundred tons of butter will carry less out of Manitoba, away from the province than one ton of wheat that brings back \$20; therefore why not try to conserve the fertility of your soil and sell what takes least out of the land and brings back the most to your own pockets? It will pay you to reduce the percentage of value absorbed by transportation. The ethics of corporations is not, "as ye would that others should do unto you," but, "just as much as the traffic will stand." It does not necessarily cost any more to carry a tub of butter to Montreal or to Britain than to carry a bushel of wheat. The butter may fetch you \$12 against 60 cents from the wheat.

Then there is economy in the care of cattle. I need not explain to people living in the natural home of the buffalo that you have a soil admirably adapted to the animal health. In one district a man came to me and said there were three hundred cows and calves dying this spring, not from disease, but from the impoverished condition of the animals. They were so tired out trying to live on a scanty supply of dry food that they laid them down and died. That reminds me of a story told by an American who in speaking of the poor condition of the cattle in his state, said their hides were so dry that they had to hire a boy at \$10 a month to oil their joints

to keep them from creaking while going to water, and in the spring all the men in the neighbourhood sold cow hides for a living. Succulent feed of some sort through the winter is a panacea for the ill condition expressed by the term "hide-bound." Where roots grow so well a supply of them or corn ensilage should be provided.

Then in the economical production of butter, it will always pay a farmer to remember that butter is merely a kind of food whereby a man obtains energy for work. If I move my arm I rub off some of the material of my muscles—the friction has worn some off. I need something in my food to repair the waste of tissues in my body; besides, I need a supply of energy that will make it possible for me to originate and continue motions and perform the functions of living. There is nothing in fuel that will repair the waste of the cylinder of an engine, but without the fuel you could not get the motion. What does that mean? You get all energy in all food and fuel from the old sun. He streams his rays down on the earth and on and into the plants, which the soil carries. He rolls his strength up into plants, as I might wind my strength into the spring of my watch. A plant may then become food and fuel. It is economical practice on the part of the farmer, to elect for his fields, the plants which can serve him best in that capacity. The sun can store more of his energy during a single season's growth into the corn plant than into any other plant that grows easily in Canada. A corn stalk furnishes to the cows more energy than any other plant. Then you get this energy transmuted into butter, and you have "materialized sunshine," energy to supply force for your work. There is economy in that method of getting the sun to serve you by means of cornstalks, cows and butter. For this reason I think that every man who helps to make a farmer have increased faith in the value of cornstalks, does a service to his country. The wealth of the western states has come practically from two sources—from the sun and from the minerals—from the sun through the cornstalks, which in various forms of derivative diet has furnished the energy to dig up the minerals. You need not try to "bamboozle" yourselves into thinking that wealth comes into existence without somebody's effort.

Then in the production of excellent butter, the farmer needs to have good cows. I have a great deal of respect for a good cow. I have a good deal more respect for some of the cows in my stable than I have for some men. If you treat a cow properly she will give back an equivalent for what she gets. She is, therefore, honest and will pay her way through life. I will hunt with a microscope in the careers of some men to see what they have given to the world of valuable service and I cannot find it. A cow sometimes does get more than she gives. I would not spare that cow. Put her on the block; get your money out of her in that way. You think of cows as boarders, kept for the profit of the man who keeps the boarding-house. Did you ever think of a man keeping a boarding-house, running on the general satisfaction plan, saying that if he does not get enough from one boarder to pay for his keep, he will get it from the others? No; he expects to make a profit on each one of them. The farmer should act in that way towards the cows. There is advantage from watching the cows and selecting the best of them. It is not so very hard to do and most cows are capable of paying for their board in full, if they are given a fair chance. But if they are brought up the wrong way, they are sure to go astray—just like boys.

Some people have a preference for a large cow. To my mind if I wanted a cow to consume more food than she would give a return for, I would like an immense animal. If I wanted her to pay for her board, I would just as soon have a small one. I believe I would rather have a small cow than a large one, if she will give the same quantity and value in her milk. Then there is a notion that the bigger the cow, the better the quality of her milk. This is not so. I have faith in the quality of goods done up in small packages.

It is possible for a farmer, by judicious selection and feeding, to enlarge the capacity of the cows in his herd. Mr. George Allan, who lives near Ottawa, is an excellent farmer. He had four cows in 1888, which gave only seventy-eight pounds of butter each. He began to grow cornstalks, and feed these with a little bran, and in 1889 they gave 131 pounds each, and in 1890 his cows gave him 204½ pounds of

## Report of the Dairy Commissioner.

butter each. See the enlargement of capacity, and therefore an economical production. It is possible to enlarge the capacity of the cow and thus reduce the cost of production. That belongs to economy, and the wise man is economical always, because to be otherwise is waste; and waste is worse than folly.

Economy in the production of butter involves doing something during the long winter season. I know very few men who get all they want to get, by working five months in the year. Most of us have to work twelve months in the year. I would have my cow work as long as I have to work myself. If you make a heifer with her first calf milk ten months, you create the tendency in her to keep that up, and in a short time you will have established a habit which will be transmitted to the progeny. I will find you herds of cows where they do not go dry at all. You may take these few facts away with you, that if the cow begins the milking season in the fall of the year instead of the spring, she will soon give thirty per cent more milk within the twelve months; she will give you milk during the winter, when it is worth on an average, fifty per cent more money; (and by the closest kind of calculation, it does not require more than twenty-five per cent more food to keep her milking than dry, if kept in proper condition in both cases); it will make it possible to keep a large number of cows on the same farms. Cows milking during the winter will provide a great deal of skim milk, for the raising of better calves, which means richer fields and more prosperity all around.

I have a great deal of faith in the capabilities of winter dairying in creameries to furnish means wherewith to banish almost every economical evil of which the farmers complain. I have no faith in this practice, or any other practice, to bring economic salvation, except by the action of the farmers themselves. I have no faith in their industry being propped up. I have faith in their building it up, together with the prosperity of this country, and thus working out their own betterment of circumstances.

Sometimes people say to me, "if everybody went into this industry of winter dairying, where would the profit come from?" Well a great many people, who do not want to do what is right, excuse themselves by thinking that they would strive to enter by "the straight gate" and walk in "the narrow way,"—but they are afraid of making a crowd and keeping somebody out. You will never find any way to real success but the narrow way. The best way is always the narrow way, I do not care what line you are trying to follow up; and because it is narrow, it will never be crowded,—not because of the lack of room at the gate to get in, but because of lack of heart and courage, and continuity of purpose and effort. Then, in the economical production of butter, it will always be advantageous to produce only the best.

I have spoken quite long enough on the economical production of butter from the farmer's standpoint, without saying a single word about the manufacturing process. However I will say a few words about that now. It is never economical to produce poor butter. A pound of butter which will not fetch more than 11 cents, has cost somebody just as much as a pound of butter which will sell for 25 cents. It is always economical to help the cow to produce a large quantity of butter-fat in her milk, because five-sixths of the butter is fat, and one-sixth water and curd. Now you will not forget that the elaboration of milk by the cow is a most mysterious and exhausting process. It means exhaustion of the nervous force. If you have a cow that is abused, kept out in the cold, ill-fed and uncomfortable, she will give you less butter-fat invariably than one that gets better attention. In butter-making it pays always to be a gentleman. Our folk in Canada are getting to "size a man up" by the clothes he wears. That is a poor plan to discover a man's gentleness or greatness. I believe in the meaning of the word in dairying and elsewhere—a man who is gentle and tender and strong. Now, if you will be harsh and cruel with the cows, you are no gentleman; and you will get only a rough man's pay from them.

Then, after the milk is made by the cow it is always economical to have the best process provided to get the butter-fat out of the milk. After the milk is set, if left at rest, its globules of fat which are held in suspension, easily rise to the top. Stillness and coolness are two conditions required.

Because many of the patrons of cheese factories use the cheese factory cans for setting milk in, after the factory closes, so as to get a large share of the cream for

butter-making, I have had some tests made to discover their suitability for that purpose. I have found the loss from deep setting in common factory milk cans to be six per cent greater than when the milk was set in ordinary shot-gun cans.

Then I set the milk at temperatures from 98 degrees down to 78 degrees, putting the cans in ice water, and found no appreciable difference when milk was set immediately after milking.

I have set the milk immediately after milking, and one hour later, and have not been able to avoid losing 11 per cent additional of the butter-fat, by the delay of one hour in setting. The slowness of a man is contagious—it affects the fat globules in his milk.

Then we have set the milk for periods of 11 and 22 hours respectively; and in the 11 hours' setting there was an additional loss of eight per cent by the shorter period of setting.

We have added water at different temperatures, from 160 degrees down to 60 degrees. I found no appreciable difference from putting water in the milk in deep setting pails.

Then in setting tests with cows at different periods of lactation, averaging 9, 6 and 2 months, we found by the use of the deep setting pails, we recovered only about two-thirds of the butter-fat from the milk of cows which had been milking from five to twelve months. For four days we set the milk pails in water at 38 degrees with the milk when set at a temperature of 78 degrees; and the loss from milk of cows that had calved nine months was 28 per cent; and from that of cows that had calved six months, 21 per cent; and from those which had calved two months, 13 per cent of the butter-fat unrecovered.

For four days the milk was re-heated to 98 degrees and set in water at 38 degrees; the loss from the milk of cows which had calved nine months being 34 per cent; from the milk of those which had calved six months 24 per cent; and from that of cows which had calved two months 12 per cent of unrecovered butter-fat.

In shallow pans we obtained better results from the milk of cows calved more than six months, than by any other method of setting.

Many farmers say that by the whirling process of a centrifugal machine you cannot get all the butter out. If a cow has calved more than six months, by the use of the centrifugal cream separator you will get over 20 per cent more butter from the milk than by the ordinary deep setting method. If she had not calved over two or three months, you will get about 10 or 12 per cent more butter.

Then, we have been trying the effect of heating milk, to remove that offensive odour, which is caused by the feeding of turnips. When we heated the new milk to 150 degrees, we have not been able to quite eliminate the odour.

Then we have heated the cream from other milk to 150 degrees. A few years ago it was thought, that if you heated the cream above 90 degrees, you would burst the globules of fat, and spoil the butter. That is not the case, and by heating the sweet cream to 150 degrees, we have quite eliminated all the odour of turnips. The butter seems to keep better, and we got one pound of butter from one pound less of milk, than we got by not heating the cream.

A common complaint that comes to us by mail, is that "the butter won't come." Well, the butter will come, if the cream be churned at a proper temperature. I have put the limit of time for churning at 35 to 40 minutes. I heat the cream just high enough to make the butter come after about 35 minutes of agitation.

I find some people complain that there are specks in the butter. If you allow the vessel containing the cream, to be exposed to the action of the atmosphere, a part of its moisture will evaporate, and a scum or skin will be formed on the top of the cream. That will be broken up by the churning, and you will have merely small portions of thickened, dried cream in your butter. Prevention is better than an attempt at cure. Let the cream vessel be covered, or by frequent stirring prevent the formation of the skin of dried cream. The straining of the cream into the churn is also a good measure for keeping specks of thickened cream or curd from finding their way into the butter.

## Report of the Dairy Commissioner.

Occasionally, butter-makers find the butter full of streaks. That condition may come from the retention of portions of the butter-milk in the mass of the butter. The addition of a quart of water for every two gallons of cream, after the granules of butter begin to appear, and before the churning is completed, will help to bring about a speedy and full separation of the butter-milk. When the butter-milk has been removed, the granular butter should be washed with cold water. In summer the temperature of the water should be about 55 degrees, and in winter about 60 degrees. For the washing, the churn should be revolved a half faster than for the churning. Care should be taken to prevent the granular butter from settling on any sediment of curdy substance which may be left on the sides or bottom of the churn after the butter-washing water has been withdrawn.

A streaky condition of the butter, sometimes results from an imperfect mixture of the salt with the butter. Re-working, after the salt is dissolved, will correct that. Fine grained salt only should be used. The presence of salt should be perceptible to the taste, but not to the sense of touch.

It is economical to make only the best quality of butter, and that is why one of my assistants has been left in Manitoba this year to give illustrations in butter making. I hope the people will attend those meetings whenever possible in order to see how butter can be made economically to obtain the best quality with the least amount of work or waste. Far back in Manitoba where the men do all the butter making, one of my assistants wrote me last year that the butter was so bad that the shopkeeper could not sell it at all; he said he gave it to the Indians, and there have been strained relations between him and the Indians ever since. So it is economical to learn how to make good butter to get the highest price and to promote good feelings between those who make the butter and those who buy and eat it. I will not tell you now anything further about the process of making butter, but I will be very glad to send to the people of Manitoba and elsewhere in these north-western parts bulletins and reports giving full instructions and particulars on butter-making, so that they can always count on getting the largest quantity of the best butter from the milk they handle.

It is economical to have swine on the farms of Manitoba to consume some of the inferior and spoiled grain. Of course I know there is an objection to having pigs on the farms in Manitoba, but still I think the people miss a great chance for extending their business by not doing so. Portage la Prairie, Winnipeg and Brandon might be great centres for pork and beef packing, and this province instead of paying so much for canned meats and cured bacon brought from other places, could produce these goods and thus reduce the outlay. The poor despised hog has a poor chance to do for his owner all he is capable and willing to do. Here, in Manitoba, the people seem to have regarded the hog as the cause of the prodigal son's aberrations. But I will venture a suggestion: that very good-hearted, but very uneconomical boy, kept on getting down from bad to worse financially until he commenced to feed hogs, and then his salvation began. You can draw any inference you like for Manitobans.

It is economical for a man to wisely administer his money. I know of men whose main ambition in life is to get a bare living, two ounces of tobacco and four cigars a week. I want to tell you that it is not economical to spend money on tobacco. When a man smokes he does so much less thinking about his business. I will not say that a man that does not smoke is a better thinker than the man who does smoke, but a man who does smoke in a climate like ours, does not do so much thinking as he would do if he did not smoke; and therefore our young men are getting into the lamentable habit of soothing themselves into the pleasant condition of not wanting to think.

It is a good thing for a man to buy books and papers for himself and family with the money he has to spare for luxuries. The farm, the farm life, the farm receipts, the farm home will all respond to such investments. It is a pity that so much of the trifles that are available and adequate for the elevation of the family should end only in a smoke.



It is wise for a man to administer his manhood on the farm and off the farm so that he will be the best man he can be, and then he will be the best farmer he can be. By doing that you will find that economic farming will result in making this one of the pleasantest and best places in Canada in which a man may follow farming for a living and for everything the heart of man can honourably and honestly seek.

(2.) ADDRESS TO THE CENTRAL FARMERS' INSTITUTE OF ONTARIO.

*(Delivered at Toronto, Ont., February, 1893.)*

Mr. President and Gentlemen,—I am glad that my other engagements and duties permit me to attend this yearly gathering of the representatives of the Farmers' Institutes of Ontario. Most of us who come here have more expectation of being helped in our own calling and business than of giving what may become helpful to those whom we meet. However, in this as in other matters, the action and reaction are inseparable, and probably those who give the most help to the members of the Central Farmers' Institute will derive most benefit from its sessions.

BENEFITS OF FARMERS' INSTITUTES.

The ordinary labour of the farmer is apt to be of a monotonous and dreary character. Frequent gatherings such as this, help to lift up our occupation into more pleasant experiences as well as more profitable practices. Capacity for good management comes through knowledge, and ability to cope with difficulties is strengthened by conventions like the present. This meeting will fail to fulfil its best functions, if it shall result only in the presentation and dissemination of information—no matter how good or apt that may be. To my mind, its best quality of usefulness lies in the opportunity and power which it possesses of affecting the courage, the attitude, and the spirit of the common people of Ontario. In rural communities good times put people in good spirits. I put the converse to you to-day and say that good spirits will almost, if not altogether, bring good times.

Let me mention, in passing, how pleased I am to recognize the vitality and growth of this institute. It is commonly spoken of as "The Farmers' Organization of Ontario." It is to the credit of its officers and executive committee that the organization is alive and is continually adapting itself to the new needs of those whom it is designed to serve. Organization really implies the happy and best adjustment of certain means to attain a desired end. If all the organs in any organization do not work harmoniously, the sum total of achievement will be very much lessened. The apathy of some of the more distant organs of this institute (I refer to some local institutes in some Sleepy Hollows in the province) may cause such a condition of sluggishness in the spirit of the farmers in their district, that the most that can be said in their praise will be that they have attained unto a deathlike respectability.

The good clear thought of this central institute should be sent throbbing throughout every part of the agricultural community to the utmost ends of Ontario. On the other hand, the delegates from the several institutes should bring to this central gathering every year contributions of curiosity (and that is a quality in which our farmers are all too deficient), information, enthusiasm and hopefulness. By doing this for the central institute every farmer will give something to all the others without making himself any the poorer thereby. At the same time he will acquire from contact with the others, a large measure of these qualities of spirit and heart in his work which can be concreted in his own practice and realized upon in dollars and cents during the following years.

I do not desire to leave an impression upon your minds that the most possible outcome of this institute can be stated in dollars and cents, or can be wholly concerned with the getting of them; but the little part I propose to take in its proceedings will have in view as the primary object the helping of you to realize more money from farming.

## Report of the Dairy Commissioner.

### AN AGRICULTURAL REVIVAL.

An agricultural revival would not be a bad feature of our progress in the present day. I mean a real old-fashioned revival, such as when people met often in a spirit of most earnest and serious concern to discuss problems which were thrusting themselves upon their attention with irresistible intensity. To be a preacher in that revival, with the gift of stirring men's hearts in order to move them to right action, would indeed be a splendid opportunity for helping to call out the good and the God that is in all men. I use that phrase in a spirit of utmost reverence, because in all the manifestations of the God-head in nature, we see a constant endeavour to put and keep all things in their correct relationship with each other. When a farmer acts in that same way he is manifesting and justifying the possession of his noblest birth-right as a man. The application of this principle is not limited to putting soil and seed in their proper relationships to each other through the best methods of cultivation; to putting animals and food in the correct relationship to each other as to quantity, quality and quarters; it should extend also to adjusting the relationship of the finished products which the farmer has to dispose of to the needs and demands of the markets which he can reach. It also implies the correct adjustment of himself to his business as a master and manager and not as a disheartened imitator.

When threatened with hard times, and much more so when they are at the door, it becomes men to be economical. By economy I have no reference to what is generally called "stinginess" or "meanness." The two are as wide apart as the poles. Economy is simply the wise administration of all the agencies and agents which a man can control. It implies the taking into his service of new agents if new work must be undertaken for which the old agents are inadequate. It implies the frequent examination of surrounding conditions, in order that the right agents and the best agencies may be selected. The conditions which surround farmers in Ontario have become greatly changed within the last few years. It is commonly reported that these changes have been for the worse and not for the better, and in this, as in many other cases, frequent repetitions of half-truths sometimes give them, to the minds of the credulous hearers, all the validity of sound reality. These changes of conditions have not come by the will or doings of a few people. They are the outcome and achievement of all those forces which have been at work in the progress and consolidation of our English speaking civilization. Among these I might mention railways, telegraphs, telephones, newspapers, schoolhouses, etc. They have brought markets so close together that direct competition now exists between all the producers of any one class of products in all parts of the civilized world.

The general diffusion of knowledge, and the new wants which that knowledge has brought in its train, require food-products different from those which were formerly the staple diet of the people. World-wide competition and a demand for a better class of food on the part of all people should be reckoned as new conditions which the farmer must meet by an agriculture suited to them. It will no longer pay to keep selling the crude, bulky and primitive products of agriculture which average only meagre returns in money, and which tend to deplete the soil of the substances which are required to enable it to carry to profitable crops. The production of the food products of concentrated quality and value, such as butter, cheese, pork, beef, mutton, poultry and fruits, affords scope for the exercise of intelligent labour, with profit, and at the same time protects the land against exhaustion. It is a fortunate encouragement to those who are extending their operations in dairying, that the prices for dairy products have been maintained at fairly satisfactory figures during the year. The demand in Great Britain for Canadian cheese has been active and more favourably preferential towards Canadian products than ever. The notable increases in the value of the shipments of cheese and butter (under which the prices and the demand have been sustained) indicate a trade which may be much further enlarged with advantage.

## CANADIAN FARM PRODUCTS IN THE BRITISH MARKETS.

A brief statement of some of the matters which came under my observation during my recent trip to Great Britain may have value in this connection towards helping the farmers to adapt their farm practices to the requirements of that market for food products.

I went over to investigate the newer preferences of the markets for butter and cheese; and do these I added beef, bacon, poultry and eggs. As producers we must strive to meet the exact requirements of the consumers who are able and willing to pay the highest prices for our goods. We have no time to educate the tastes of the British public up to liking and buying the things which in our judgment they ought to prefer. Unless one happens to have a century or two of leisure it would not be worth while attempting the task of educating the tastes of the great consuming public. It is more expedient and profitable to cater for those tastes as they at present exist. The working classes in Great Britain, who are the large consumers of our Canadian food products, are both able and willing to pay for the exquisites and the delicacies in the foods which they buy. A while ago they had to content themselves with foods which sufficed only for the bare sustenance of life. Now they are fastidious in regard to both flavour and appearance in the foods which they select. They are also very conservative in regard to names, and have a strong British sentiment which leads them to pay 20, 25 and 50 per cent more for the very same goods under the name of "Best English," than they are willing to pay, or are required to pay under the name of "Best Canadian." I could find but very few butcher shops where Canadian beef under its own name could be purchased. As one butcher said to me, "We keep only the 'Best English;' Canadian and American beef can be found only in the rough shops where the cuts are cheap." I learned of one instance where a retail butcher was reported to have made a profit of a million dollars in five years from selling prime Canadian and American beef as the "Best English." Of course his customers were not wronged, because they got as good value in every pound which they purchased as could be got in a pound of beef, but a very flagrant and very great injustice was inflicted upon the English and Canadian farmers.

In very many cases the crafty shopkeeper gets far too large a share of the price which the ultimate consumer pays for our own food products. We must devise a way of getting some of our Canadian products more directly before the consumers under their own name. I know what can be said in the matter of the enterprise of commerce, and the rest of it, being equal to the needs of economical distribution. But just here comes in the call for the exercise of that quality of which I have spoken—that of putting things in their correct relationship to each other. Here it is the putting of the Canadian producers right in their relationship to the ultimate consumers without the intervention of somebody who by some means gets more than a fair share of the consumers' money for the service which he renders.

When I spoke before this Institute last year I had occasion to remark that a considerable portion of Canadian cheese was ultimately sold under the name of "Best English." I have to repeat at this Institute what I said then, with the added emphasis that a larger proportion of our cheese and other products than I then thought were sold as "Best English," are now being disposed of in that very way.

I think we will be able to use the mammoth cheese which we made at Perth, in Lanark County, to overcome part of the disadvantage under which we now lie. As some of you know, the mammoth cheese was made at one of our Experimental Dairy Stations for the purpose of forming the centre of our pyramid of Canadian dairy products at the World's Columbian Exposition at Chicago. I have arranged for it afterwards to go to England, where it will be taken in hand by Mr. Thomas J. Lipton, the greatest of all retail provision merchants in the world. He has ever so many shops in London alone, some 200 altogether in Great Britain, and sells over 225 tons of tea per week. He will exhibit our mammoth Canadian cheese in every large city of commercial importance in Great Britain and Ireland. This will bring

## Report of the Dairy Commissioner.

to the mind and attention of the public something new in reference to Canadian cheese, which may lead them to inquire from their grocer or provision merchant for a supply of it under its own name.

Others more competent than myself will doubtless treat of and deal with the question of the scheduling of our cattle by both Great Britain and the United States. It is useless to belittle the injurious aspect of this to the Canadian cattle trade. It is more foolish to magnify the effect into the form of a national calamity. Everybody knows that our cattle in Canada enjoy the most superb health. The dreaded disease of pleuro-pneumonia has not been and is not now to be found anywhere within our borders. In the meantime we must put up with the temporary loss, which comes from the misunderstanding and consequent unfair regulations of the authorities in these two countries. At the same time this may be looked upon as an ill that is not all ill in its effects, if it induces the Canadian farmers to turn their attention towards feeding the cattle to a finish of fatness before they are sold or shipped from our own country. The compulsory aspect of this is the most distasteful to a high minded and independent people like our farmers. However, if it have the result to which I have just alluded, while it is an injury and an ill, it will not be without a measure of benefit in its train.

### MORE ECONOMICAL FEEDING OF LIVE STOCK.

There are some matters in the home practice of the farmers which need more serious attention than the restrictions which these two governments have seen fit to impose upon our cattle. Let me ask the attention of the farmers of Ontario to the bulletin which I had the honour to issue on the feeding of steers last November. I shall be glad to mail a copy to every applicant who sends his name and address to the Central Experimental Farm, Ottawa. Farmers of Ontario should study economical methods of feeding in order that they may produce cattle at the least possible cost, because wasteful feeding will so increase the cost of production that no market within reach, under the most favourable circumstances, can leave a profit to the feeder. In conjunction with well-cured corn ensilage, 5 lbs. per head per day of meal seems the maximum limit for the economical fattening of steers; and very little above that seems the maximum limit of meal per day for the economical feeding of milch cows. We carried on a very comprehensive test during the last two years at the Central Experimental Farm to discover if there were any constant relation between the quality of the food which was given (in its content of meal or grain), and the quality of the milk which was yielded, in its richness or percentage of solids. We found that the addition of meal to the ration of cows after it reached from 5 to 7 lbs. per head per day was not economical in point of either the quality or the quantity of the milk which they gave in return. We made something like 20,000 separate tests of the milk in order to have such a measure of data as would enable us as to draw conclusions which would certainly not be erroneous or misleading.

From 5 to 7 lbs. of meal per day seems a small allowance for a milking cow or a fattening steer, but if that amount can be saved to the farmers it would mean many millions of money per year to the cattlemen of Canada.

### THE ROBERTSON MIXTURE FOR ENSILAGE.

For some years I have been seeking to discover some substitute for the expensive and rich meals which have been fed with corn ensilage in order to make it a complete ration for fattening steers or feeding milking cows. At last I venture to think that I have been successful in discovering a substitute which is within easy reach of every farmer in Ontario, and almost every farmer in the Dominion who keeps cattle. I have here samples of ensilage made from Indian corn and horse-beans which have been grown together in the same rows as sunflowers. The sunflowers and horse-beans supply the albuminoids and fat in which the corn is deficient.

The method of growing is as follows:  $\frac{1}{2}$  bushel of horse-beans are mixed with  $\frac{1}{2}$  bushel of Indian corn; these are sown or planted in rows 3 or  $3\frac{1}{2}$  feet apart on one acre. When the crop is grown the product from two acres of that mixture is put

with the heads from  $\frac{1}{2}$  acre of sunflowers (the Mammoth Russian sort). The albuminoids from the beans and sunflowers, thus provided in the ensilage, will be equal to  $4\frac{1}{2}$  lbs. of mixed cereals added to every feed of 50 lbs. of ordinary corn ensilage. Besides, the albuminoids in the green and succulent state of these plants are likely to be more digestible than in the ripened grains.

The value of this to the farmers and cattle-keepers in Ontario is not quite evident at first sight. The advantages are as great as though a farmer could get nearly 40 bushels of mixed cereals per acre, in addition to his Indian corn crop, without the expenditure of any more labour or money than in the growing of the corn alone. The extra cost of growing  $\frac{1}{2}$  an acre of sunflowers, and providing the seed for the horse-beans grown on the two acres in the rows with the corn, is equal to \$15. Against that extra outlay the farmer gets from the  $2\frac{1}{2}$  acres enough additional feed to be equal to 115 bushels of mixed wheat, barley and oats. That is equal to a clear gain in cash (valuing the mixed grain at one cent per pound) of almost \$14 per acre more than from the growing of Indian corn alone, and the growing of ripened grains to feed with it in order to make it a complete or well-balanced ration.

If a patron of a cheese factory or creamery in Ontario would grow three acres of this "Robertson Mixture" for the feeding of cattle, it would be equal to a saving or gain to him, (as good as cash in the first year) of \$41. Multiply that by the 50,000 patrons of cheese factories and creameries in Ontario, and you have a sum of \$2,050,000.

That is not the only gain which would come to the hard working farmers of Ontario from this new discovery. There would be a clear gain to the fertility of the soil equal to about 30 pounds of nitrogen per acre. When it is remembered that a ton of wheat takes from the soil annually about 40 lbs. of nitrogen per acre, it will be apparent that the more the farmers grow beans with their corn and feed this combination, the better will they be able to grow all other grains without permanent exhaustion of the soil. I do not desire to press this aspect of the question very far at present, but this may be said by way of increasing your interest in this new crop for feeding. In all those commercial fertilizers of which nitrogen is a constituent part, the nitrogen is valued at at least 15 cents per pound. The clear gain in the nitrogen from the growth of the bean crop may be quite equal to \$4.50 per acre. If this sum be multiplied by three acres for every patron of all the cheese factories and creameries in Ontario, and that be added to the direct cash gain from the growth and feeding of this crop, the sum will come to \$2,725,000 per annum or more than \$50 per patron annually.

The farmers of Ontario well know that no one who has been honoured as their teacher in matters pertaining to their own practice is less visionary or more cautious in making statements for their guidance than myself; and I ask them to accept the information upon the new mixture for ensilage, which I am able to offer them, with the assurance that it will more than justify all that I have predicted or claimed for it. In order that it may become speedily, widely, and correctly known to the farmers of the province I want the names of 100 reliable and careful farmers who have silos, and who will grow a crop of this "Robertson Mixture for Ensilage" during the coming year, under directions which I am willing to supply. The seed will be furnished at cost price; and of course there is no such thing a personal proprietary right in the mixture. It is given to the farmers free, with the very best of good wishes that it may do for them more than I have ventured to state.

#### THE FATTENING OF SWINE.

On this subject I shall detain the institute but a moment. Canadian fed and Canadian cured swine products are in very active and favourable demand in Great Britain. It will pay our farmers to rear and fatten more of this class of stock. According to the breed of the animals and the care which they receive, from 4 to 5 lbs. of the coarse grains will yield 1 lb. of increase in the live weight of the swine. Canadian bacon and hams are almost equal in reputation to the Danish and Irish

## Report of the Dairy Commissioner.

products. In view of the increased demand for live hogs in Canada, I hope our farmers will give this branch of their business a wide and rapid extension. As a rule it will pay them much better to sell their hogs alive than to butcher them at home and to sell them dressed. When sold alive they can reach the packing-houses in such a condition as to be capable of being dressed, cured and sent to England in a uniform and satisfactory condition. Great Britain imports about \$20,000,000 worth of swine products annually. A much larger share of them should hereafter go from Canada.

### POULTRY AND EGGS.

In the matter of poultry and eggs Canadian farmers need as much awakening as they do in the matter of cows, butter, cheese and beef. Great Britain imports of these two articles of food to the value of \$20,000,000 a year. I know there are difficulties in the way of reaching England with perishable products such as these, but they are not insuperable. I have information with regard to the egg trade which I think will be helpful in promoting it during the year, but I will not detain the institute at present. Let me cite one instance of the capabilities of the trade in poultry. When in Liverpool in company with Mr. John Dyke, I examined a shipment of Canadian turkeys which had just arrived. There was a very active demand for them at 9 pence or 18 cents per pound. The birds arrived in splendid condition with the feathers on, and it was mentioned to me (and I hope it was true) that the shippers would net about \$3,000 of profit on the venture. Between 18 cents per pound and the price which the Canadian farmer has been getting for his turkeys, there is sufficient margin to leave a good profit for somebody; and if the farmers would give their attention to this branch of their business, they would get a very much larger share of the ultimate price than 10 or 12 cents per pound here. If some one could wave the magician's wand over the country, and multiply its wealth, I think he would do it through the cows and hens which have been thought the least valuable of our wealth creating agencies. If this meeting should result in the farmers giving clear thinking and energetic acting to these two branches of their business, it would result in the real acquisition of the wealth which the dreamer might suppose a magician only could create.

### BUTTER-MAKING.

As the subject of winter dairying is on the programme for discussion, I need not make but casual reference to it here.

The four winter butter-making stations in Ontario, which are being managed by the Dominion Dairy Commissioner this year, are being most heartily supported by the farmers in their vicinity. The supply of milk at them has been quite three times as much as that of last year; besides over a dozen of winter butter-making stations were started in different parts of the province, as a direct outcome of the successful illustration of this business which was given by the Government last year.

The English butter merchant judges our butter as public men often estimate each other. He tastes the top and tastes at the sides of the package when *he buys* the butter; that is, he judges it at its very worst points. When he offers *to sell* the butter, he bores down the centre of the package and shows it at its very best, to his expected customer. In order that the butter may be at its very best in all parts of the package, creamery men should use the best quality of grease-proof paper on the inside of the package. There is a very favourable attitude in the English markets towards our winter-made butter. The dealers and consumers do not suspect us of any counterfeits or imitations. In that regard—as it should in all others—the name of “Canadian” stands for honesty and excellence. Of course a good many people who are faithless and unbelieving are continually saying,—“But if everybody goes into the business will it not soon play out?” Such logic is like that of a man who might say, “Straight is the gate and narrow is the way, and don't you think if I tried to get in I might crowd everybody else out?” In all these matters it takes intelli-

gence and care to get money out of any branch of farming, but with those who exercise these and follow farming as a business, there is as much profit-making as in any other honourable calling.

I am glad to have had an opportunity of offering these few observations to this representative gathering of farmers, because I believe some of the information and thoughts will help on the emancipation of the men and women of Ontario into happier lives. The immediate good will not be the only good which will result from the putting of these new and better plans into practice. The further and better result will be the lifting up the farmer's life to a higher plane of activity, wherein he will find scope for the exercise of every manly faculty and power. The first gain to be realized may be the amelioration of his hardships in making money. The best and ultimate gain will be the lifting of his life intellectually, morally and spiritually through doing right, and putting things around him in their correct relationship to each other.

### (3.) ON THE PRODUCTION OF MILK.

*(Report of an Address delivered before the Convention of the Ensilage and Economic Cattle Feeding Association of Central Canada at Montreal, February, 1893.)*

Mr. President and Gentlemen:—

You must not expect a formal speech. I am to open a discussion upon the production of milk, and I shall only try to sprinkle a few thoughts over the audience that you may discuss them and fertilize them into fruitfulness.

Milk is a complete food; therefore the people of our cities and towns are drinking more of it. Common sense is becoming more prevalent where people are civilized and in consequence they are drinking more milk. How to get it of the best quality at the lowest cost, is a very important subject to the producers and consumers.

From his standpoint, the farmer should consider how he can produce milk of such purity, of such flavour, such colour and keeping qualities as will please his customers, without costing too much. It is comparatively easy to tell how the best quality of any product can be made; it is not so easy to make it without costing more than you can get for it. We need a discussion on the question of how to get the best quality of milk at the least possible cost.

There is one way of getting it, by feeding the cow on a cheap food that will make her give the best quality of milk, and the largest quantity at that which she can give.

From the consumer's point of view, milk must first of all be pure. The permanent vigour and health of our people depend on the supply of pure, wholesome milk for the children. This is an important and far-reaching question which touches the vitality of the people. It should not only be pure with regard to its wholesomeness, but clean in its condition. Milk is more often rendered impure by being left exposed in a foul atmosphere than from the cow eating anything that is offensive. The cow is a wonderful organization, and will generally prevent any thing impure that she may eat from damaging her milk. Milk is seldom unwholesome from what the cow eats; but it may be dangerous from what she drinks. Above all things in the dairies and milk houses, let the atmosphere be as pure as possible, free from bad odours and taints. The cows must have an abundant supply of pure water. It is desirable that the milk should be of a most pleasant flavour. I need only give you one illustration: Few people like the flavour of turnips in milk; nobody likes a sour flavour in milk although that may come from ensilage. If the milk be left exposed to the smell of ensilage, you will get the flavour and odour of vinegar. It should be protected by removing it from exposure to that. I will make only this further observation on that point, if milk be suspected of being unwholesome or impure in the least degree, let it be heated to 160° or 170° before it is consumed.

It would pay the farmer to bear in mind two matters in feeding milking cows; first of all, to give them the juiciest kind of feed he can provide. Let him take June grass as his model feed; it is succulent, and nice flavoured. The question is how to

## Report of the Dairy Commissioner.

get feed for the stable and winter as near as possible equal to what the cow gets in the pastures in June. There are two ways. It can be obtained by saving grass (in the form of hay) and preparing it in such a way that it can be given to the cow succulent and juicy. You cannot bring the original juiciness of the grass back to hay by a simple soaking, but you can help it a good deal in that way. If hay be fed with roots and the whole mass be left mixed for twenty-four hours before it is fed, you will get about twenty per cent more milk out of your hay; it will be brought back as near as possible to its natural state. Another way is by providing ensilage, but as I am going to speak on that subject to-morrow, I barely mention it now.

The common grasses in this country are a complete food for cows. Indian corn is not a complete food. It is a grass, but the constituents of corn are not so proportioned as to support life, like the constituents of June grass or Timothy. I do not recommend Indian corn fodder as being the best grass, unless something else, which contains the constituents which the corn lacks, is put with it.

The point needing attention in the food for cows, is to have it palatable and even stimulating in its flavour. I do not know that all stimulants are bad for either man or beast. We have a new kind of ensilage at the Experimental Farm from the heads of sunflowers with Indian corn. The stimulant in ensilage from the oil of sun-flowers makes the cattle greedily fond of it. Any kind of hay well cured and well preserved will have this property; but if it be left loose and exposed for a day or two, or if it be taken off the mow and tossed and trampled under foot for twenty-four hours the appetising, stimulating fragrance and flavour will have gone and the cattle will not like it.

Some people suppose that the giving of salt to cows is a trick of the trade to make them drink more. If a cow can be fed in any way so that she will give the largest possible flow of milk and still be in good health, that milk will be the best of milk from that particular cow. The more work you make a man do, if he keep well, the better work will he do. Let a man work at half speed and capacity and the work will not be half so well done as if he were working hard but not over-worked. Let the cow give the largest flow of milk possible, and the quality of the milk will be good for that cow.

The animals should be kept comfortable. If cows have lice on them you cannot get more than seventy-five per cent of the amount of milk you can get from cows thoroughly clean. A treatment of kerosene emulsion (coal oil and soap) rubbed in will kill the vermin. If the cattle be not turned out so that they can lick themselves, they will be uncomfortable unless they are brushed occasionally. Another point I might throw out for your consideration is, that it is profitable to select cows from those we have, so that a less number of animals will give more milk on less feed. Some cows do not deserve stable room.

I know of no infallible method of judging the merits of a cow except by weighing her milk and watching how she is fed. It will pay to keep cows milking as long as ten months a year. That prolonged season has a decided influence on the milking of the cows the following year. We have been urging farmers in Ontario to produce milk in winter as well as in summer. Let me instance the case of the president of one of the cheese factories where butter has been made during two winters. Mr. L. A. Price had some thirty cows a year ago last summer; he did not keep them milking the previous winter, but he did during the winter of 1891-92, partly to encourage his neighbours to support the winter creamery. He bought extra feed to go with fodder corn; the result was that the skim-milk paid for the extra feed; and he had all the butter money as clear gain above the income of former years. He told me, when the milk went to the cheese factory the following May, that he had twenty-five per cent more milk from the same cows than the year before. The fact of their giving milk all winter caused an increase of twenty-five per cent in their milk the following year.

It will pay farmers to make the most of the by-products of milk; what is done with them is intimately connected with the profits of the man who makes the milk. Small pigs can be reared on skim-milk and butter-milk and there may be swine products to sell with the direct products of the cows.



Mr. Price has not a large farm, he keeps his cows fairly well, and sells on an average (hogs were dear last year), but in an average year, he sells about seven hundred dollars worth of hogs,—not thoroughbreds, but swine for slaughter. Because he feeds the by-products of the milk to the pigs and gets them well started, he gets a direct income from his cows equal to fifty dollars a head and a revenue from his swine of some seven hundred dollars a year. There is money in it.

I conclude by these suggestions: Get the milk pure and wholesome, because on this depends the increasing demand and the health of the people; give the cows a chance to make it like that by feeding them good succulent feed, in warm stables, with all the salt and water they want; see that the milk is handled afterwards so that no impurity comes to it, and you will find the production of milk to be one of the most profitable branches of farming. Progressing from that you can sell milk, butter, cheese, bacon and beef. That is the kind of agriculture which pays best in Canada.

MR. BROWN:—Has milk a different taste when fed on corn ensilage rather than when on roots and meal?

PROF. ROBERTSON:—Not less palatable and not less wholesome.

MR. BROWN:—When fed on corn ensilage is it as rich?

MR. GRINDLEY:—Can you increase the quality of milk by feeding?

PROF. ROBERTSON:—The question resolves itself into two parts; first the quality of the milk in its flavour and appearance, and second, the quality as to its composition. The taste, the smell and the appearance of the milk can be modified by the quality of the feed and the flavour of the feed. Turnips will impart a turnip flavour from the essential oils; corn meal contains oil, oatmeal has oil, wheat has oil, and every cereal has oil. I do not remember the percentages, some have a large percentage and others small, but the oils are there. You may affect the colour of the milk by the nature of the food, but you sometimes have very poor looking milk which will show by analysis that it is a good deal richer than some yellow milk. The appearance of the milk is no indication of its richness; I mean the yellowness or the whiteness of the milk is no indication of its richness. The yellowest milk I have been offered for a long time I got in a fashionable hotel in Montreal; evidently it was made of skim-milk, corn starch and dye.

If the cow is getting a food which is insufficient for nourishing her body, her body will find for itself first, and use the surplus for the production of milk. The cow is not constituted so that she can transfer wholly to another what she needs for herself, although even cow motherhood can go a long way in that direction.

Corn ensilage and hay are both an incomplete ration for milking cows. They will live on it, but will not be thoroughly nourished in all parts, and the milk from such food is not milk of normal strength. If you add wheat bran or cotton seed meal or oil cake to the corn ensilage you can get as perfect and well flavoured milk as any person can desire. The improvement is not by leaving the ensilage out but adding something to it to make it a complete ration.

The effect of the feed of the cow on the composition of the milk is not so direct as though the cow were merely some mechanical device or chemical contrivance. The cow is a living organisation, and the organs of a cow will work in a definite way from force of habit. The composition of the milk will not be altered, unless the working of the milk-secreting organs be changed or affected.

If the feeding of ensilage made bad milk, the milk from three thousand silos in the country would be bad. The fact that unsatisfactory milk from ensilage-fed cows is the exception, proves that the ensilage is not the cause. If you change the food of a cow quickly, you interfere with the action of the organs that make the milk; but it does not necessarily follow that by changing the composition of the cow's feed, you make the milk richer or poorer. We have cows which by actual test have given milk testing three per cent of fat at one time, and within twenty-four hours have given milk testing four and three quarters per cent of fat. By some means the action of the organs which make the milk has been affected. I will give an illustration of that: We put twenty-five cows into three rows as nearly equal as possible as to breed, time of calving and weight. All got the same bulky-fodder rations. We

## Report of the Dairy Commissioner.

gave the cows of one row four pounds of mixed meal per head, per day. The cows in the next row got the same bulky-fodder ration and seven pounds of meal per head per day. If the richer feed made a permanent difference in the quality of the milk, the milk from these latter cows should be richer. The third group of cows received the same bulky-fodder ration and four pounds of meal per head, per day, for a fortnight, five pounds of meal per day for the next fortnight, six the next, seven the next, eight the next, nine the next, ten the next, eleven the next, and twelve the next—or an increase of one pound of meal per head per day, every two weeks. In this latter case you would expect the milk to be richer because the quality of the feed was progressively richer. As a matter of fact, if we judge by one week's test, the milk may be richer from the increase of meal, but taking the results for five months, the milk of these cows which received the progressively richer ration was not richer than the milk of the other cows. It increased in quantity, but the composition had not been changed appreciably in five months by the richer feed. We took up the test the next year, and after making some twenty thousand tests of milk, I came to this conclusion, that the composition of the feed as to richness in meal does not alter the percentage of the constituents of the milk. If a cow does not receive enough feed to keep her in good health, she will drop off in the yield of milk; but the quality of the milk depends upon the nature of the animal and the quantity of milk upon how she is fed. To get the largest supply of milk at the lowest cost to himself, a farmer cannot afford to feed more than six or seven pounds of meal per head, per day with a bulky-fodder ration.

**MR. MACPHERSON:**—Is it not a fact there is another profit which you did not mention, and it is an important one, that is the fertilizer the animal made during that time?

**PROF. ROBERTSON:**—I would not like to say a single word that would prevent the farmer believing in the exceeding great value to him of buying feeding stuffs, if he can make a direct profit out of feeding them; but how much the manurial value is, I do not know. The manure is worth exactly what the man's skill can make out of it; one man makes nothing out of it, and another man makes a great deal.

**MR. GRINDLEY:**—You have decided the question pretty well as to what effect the food ration has on the richness of the milk. Is it not so that by the use of a stick or dog you affect the milk more as regards quantity than quality?

**PROF. ROBERTSON:**—As a matter of fact anything that makes the cow uncomfortable lessens the quantity of milk and the percentage of fat in it. I do not know how that is effected; but I suppose that nearly all the secretions of the body result largely from the action of nerves. Milk is a secretion by certain glands; and these are governed by nerves. Anything that disturbs the nerve centres keeps the cow from doing her work normally and properly.

**A VOICE:**—What do you think is the best method of producing the best and cheapest food ration for a cow supplying milk for the city?

**PROF. ROBERTSON:**—That depends on how a dairyman gets the feed, whether he buys it or grows it?

**A VOICE:**—I am speaking from a farmer's standpoint.

**PROF. ROBERTSON:**—About thirty pounds of the best corn ensilage, about five pounds of straw, five pounds of good hay, twenty pounds of good roots (mangels, carrots or beets) and five or six pounds of grain per day,—that would cost thirteen or fifteen cents per day, according to the size of the cow. That I find better than giving eight or ten pounds of grain per head, per day.

### (4.) THE FOOD-PRODUCING RESOURCES OF CANADA.

*(Report of an Address delivered before the Convention of the Ensilage and Economic Cattle-feeding Association of Central Canada at Montreal, February, 1893.)*

**Mr. President, Ladies and Gentlemen:**—When I come to address farmers, I seldom prepare beforehand the precise words in which to clothe my thoughts, and

to-night instead of giving you a cut and dried lecture on "The Food-Producing Resources of Canada," I want to say something about how the food products from the farm of Canada can be increased in your own district.

In two respects Canada has a primacy of position among the nations,—in mineral resources and food-producing resources our country is not surpassed. I think Canadians know less of their own country than people who live elsewhere. Strangers who come amongst us recognize the great advantages we have in these regards more than our own people do.

It is the pleasure of many public speakers to dilate upon the vast resources of Canada, and it is my privilege to point out how they can be developed.

Upon the welfare of those who produce the food of Canadians and develop Canadian resources, depends the prosperity of the people as a whole. The growth of our cities and towns depends on, or arises from the need of handling the food products, distributing them, and manufacturing what the farming community wants. The growth of the cities and towns of Canada waits upon the intelligence and activity of those who produce the foods.

The food-producing resources of Canada are capable of rendering service and profit to every man who applies himself to their development, diligently and with skill.

The city of Montreal, the trading metropolis of Canada, owes nearly all its commercial importance to the fact that it handles the products of the farm; it ships out grain, cattle, butter and cheese, and these in turn pay for shipments of dry goods, groceries and hardware which come into Montreal to be spread through rural districts.

Look at the commodious warehouses and the splendid wharfs which, during the shipping season, are crowded with the food products of Canada in transit to Europe. Look at the fine shops and magnificent buildings; the large factories and the imposing railway stations, all of which have been called into existence for the purpose of facilitating the distribution of farm products and carrying the necessaries and luxuries of life back to the homes of those who till the fields.

I want you to see that if the quality and quantity of the food products can be increased, every man in business will have a chance to get a larger share of wealth for himself. If the farmer produces more wheat, butter, cheese and cattle, the men who handle these products have a better chance to increase the volume of their business and make more money.

In financial circles, in this money metropolis of Canada, there is a very clear conception of the value of remittances from the country. If the bankers in small towns report that the payments from their customers are slow, then the bankers in the large centres are very slow to let their capital out. Financial stringency follows close on the heels of slow remittances from the country, and slow remittances are consequent on scarcity of money to pay debts in rural localities.

If the farmer can pay off his obligations for groceries, machinery, etc., promptly, the country merchant is in a better business shape, and he in turn can pay his debts to the wholesale men. The importance of agriculture to the commercial enterprises of our country is easily seen by observing how sensitive they all are to the condition of the farmers, the food producers. When hard times prevail in rural districts, depression follows in every centre of manufacturing and commercial endeavour.

Why is it that bankers and other men are so anxious about the condition of the crops? It is because if hard times prevail in the country, hard times follow everywhere else.

Farmers create wealth. I want you to believe that. I do not want you to believe that they all acquire wealth. I will drop an illustration in passing. In this country of ours the farm products amount to about five hundred millions of dollars annually, and the total value of the manufactures of Canada is about four hundred and seventy-five millions of dollars. But there is a difference; wheat is an agricultural product; flour is a manufactured product, and you value flour at its full value and add it to the value of bread which is also a manufactured product. Thus the figures for manufactures include the cost of the raw material several times over;

## Report of the Dairy Commissioner.

that makes a big difference between the sum total of manufactures and the value which has been added to them by labour, or the wealth which has been created in them. About two-thirds of the total value of agricultural products is a gain of real wealth created by the farmers out of the food-producing resources of the country.

As the farmers are able to exchange more of their products (which really are the embodiment of newly created wealth) the money, which facilitates the exchange of these things, will ebb and flow more regularly, and in so much larger volume, that it will float and bear all legitimate enterprises connected with the development of the country's resources to most successful issues.

The interests of the city and country, if not quite identical in our Dominion, should be always harmonious. It is the object of all farming to create wealth by the production of food and the raw material for clothing. With the single exception of fish the articles of food which sustain our lives wholly come from farms. In a study of the relation which the production of food sustains to the condition of human society which we call highly civilized life, it must be remembered that the farms furnish most of these things which outwardly distinguish and differentiate the civilized and cultured citizen from the rude barbarian.

As the farms of a country furnish supplies of food of superior quality in flavour and nutritive properties, so will the energy, ability and capacity of the people to *bring things to pass*, be improved. Good living is promoted by the farmers in this grosser sense, and from it comes also good living in most other senses. When an abundance of nourishing and palatable food, at a low cost of production, comes well within the reach of all the people, when a community is well fed, even to its poorest members, it is strong for the activities, claims and aspirations of our modern life.

No country in the world has more favourable conditions naturally in soil, sunshine, water and atmosphere for the production of fine food products than Canada, it also has vast areas of the best arable and pasture lands waiting to be awakened into fruitful service by the hands of skilled farmers. From the atmosphere and water come more than ninety-five per cent of the constituents of all our food products. Our climatic conditions are such as to permit the growing of such plants and crops as to enable our farmers to obtain these at the lowest possible cost to themselves.

One object of the Experimental Farm system of Canada is to furnish the farmers information how to make the most of these natural conditions. The range of the Experimental Farm work reaches from experiments in the cultivation of the soil to experiments in the handling of the finished products which are intended for the tables of our own people or for export to foreign markets. The whole of Europe is only about one-twelfth larger in area than the Dominion of Canada, which has a land surface twenty-nine times as large as that of the United Kingdom of Great Britain and Ireland. As yet, there are only some twenty-five millions of acres under cultivation, and of these, sixteen and one half millions of acres are under crop every year.

In the one article of wheat, which may be taken as typical of our ordinary cereal crops, Canada has a yield of almost five bushels per acre larger than that of the United States, although she still has a yield on the average of some fourteen bushels per acre less than Great Britain. The resources of Canada, and the natural adaptations of the country and climate, are not less well adapted for large crops than are most parts of Great Britain. When Canadian farmers enrich their fields with as much systematic skill and good management as do the English farmers, there is no reason why the average yield of wheat in this country, per acre, should not exceed in quantity, as it now excels in quality, that of any other place.

In the present and still more in the coming years, it will become less profitable to export the primitive, crude and bulky products of agriculture but the finished and concentrated food products from the farm can be obtained to the most economic advantage only by the growth of crops having a large yield per acre at the lowest possible price of labour.

The result of one series of experiments at the Central Experimental Farm Ottawa, to illustrate this has been as follows:—Experiments have been carried on

to discover the relative results per acre by sowing the same variety of grain in the same soil, during the same season, at different rates. The results for the season of 1891, show the following facts:—Spring wheat sown April 21st, yielded at the rate of 47 bushels 50 lb. per acre, against 19 bushels, 10 lb. when sown on May 26th; oats yielded at the rate of 59 bushels, 24 lb., when sown April 21st, 84 bushels 4 lb. sown April 29th, and 40 bushels per acre, when sown May 26th; barley yielded at the rate of 65 bushels 10 lb. sown April 21st, and 37 bushels 14 lb., sown May 26th. In many other parts of farm work, improvements may be made in the production of cereals.

Experimental work in the feeding of cattle has also a very important bearing upon the prosperity of the country and the relative position of Canada as a producer of food for her own and other people.

At the present time, there are kept in Canada only some four full-grown cattle and four young cattle upon the average farm. By the growth of Indian corn fodder and the making of ensilage, every farm is capable of carrying on an average at least twice as many cattle, with increased profit to the farmers. Besides, farmers should be discouraged from marketing the primitive products, which, in the form of plants, take from the soil large stores of its fertility. They should be encouraged everywhere to sell animals and their products, which enable them to realize large incomes without the exhaustion of the soil.

At the present time at the Central Experimental Farm at Ottawa, experiments are being conducted in the feeding of steers on corn ensilage as the main part of the fodder ration. For the first two months they have been costing at the rate of less than nine cents per head, per day, and have gained nearly two pounds per day.

Great Britain imports cattle and beef annually to the value of some \$65,000,000. Of that sum Canada has sent cattle to the value of \$7,500,000. By the cheaper method of feeding cattle, it is possible for Canadian farmers to send to Great Britain in the not very distant future, at least one-half of the cattle or beef that she buys from outside countries.

Canadian farmers have exceptional advantages in providing cheap fodders for the production of beef. The new "Robertson Mixture for Ensilage" will be explained fully at the convention to-morrow.

In the growth of this excellent feed for cattle, Indian corn, horse beans, and sunflowers, Canada is better adapted than any other country, except a small portion of Central Europe, whose people will not be our keen competitors in the markets which we supply.

In the production of cheese, Canada has made great advance during recent years. The value of the exports for the year to June 30th, 1892, (wholly the product of Canada), was \$11,611,399. The business is being rapidly extended in all the eastern provinces of Canada. Great Britain imports on an average \$25,000,000 worth annually. "Bread and cheese" for a long time was a synonym for a perfect and complete food for the people. Canada can furnish both in increasingly large quantities. During the last financial year, Canada exported twice as much value in butter as during the year previous. Through the extension of the dairying movement in Canada, still larger quantities of this valuable food product can be provided and sent to Great Britain and other countries. No food product, of which the farmers can dispose, takes less from the soil and leaves them a larger amount of profit for their labours. In 1891, the Dominion Government established two winter dairying stations in Ontario, and during the past winter, six of these stations in Canada have been operated under the management of the Dairy Commissioner.

As a direct result of their influence, at not less than eighteen cheese factories in Ontario the managers commenced to manufacture butter during the winter. Thus the existing conveniences can be used to facilitate the increase in the food products of Canada, by the manufacturing of cheese during the summer and the manufacturing of butter during the winter.

Great Britain imports of butter annually to the amount of fifty-six millions of dollars. Of swine products the farms of Canada still furnish only a tithe of what they are capable of supplying.

## Report of the Dairy Commissioner.

At the Experimental Farm at Ottawa, we have been carrying on experiments in the fattening of swine upon the coarse grains, and also upon frozen wheat. The results from the feeding of frozen wheat, have been very gratifying and promise to furnish exceptional help to those districts in Canada where wheat is in danger of being damaged from unfavourable weather.

Large numbers of swine have been fed exclusively upon frozen wheat, ground and soaked. The gain per bushel of wheat has varied a great deal, according to the kind of swine to which it was fed. The increase of live weight per bushel of wheat, has varied from nine pounds to over fifteen pounds per bushel of grain. The average, for over fifty swine, will show more than eleven pounds of increase in the live weight of swine per bushel of wheat fed. The quality of Canadian fed and Canadian cured bacon is being so highly appreciated in Great Britain, that it stands now almost as high in reputation and price as the products from Ireland and Denmark.

The poultry interests of Canada have been a neglected branch of our food producing resources. When the farmers give their thoughtful attention to this matter, the hens of Canada will do their part in increasing the food supply of the people. Great Britain imports poultry and eggs to the value of some \$20,000,000 annually. The peasant farmers of France have amassed their competence which in the aggregate forms the basis of national wealth, largely from their poultry and eggs. In this, which has been called a minor interest, Canada has great capabilities of service for increasing the wealth of her people through furnishing articles of food—eggs and poultry—which are coming into increasing favour everywhere.

I will give you another instance, and this is with regard to poultry. When I was in Liverpool, I found one shipment of turkeys from Canada sent in common wooden boxes,—they had their feathers on and the birds were not even drawn,—selling like hot cakes at eighteen cents a pound. Canadian farmers seem quite content to sell their turkeys for ten and eleven cents a pound, and if they were sure of getting these higher prices,—and the market extends there even to the end of April, with higher prices than in February,—our farmers might go into the business of shipping poultry to England and make large profits.

Of the five farm products to which I have made reference, Great Britain imports annually to the value of some \$216,000,000. Canada is the natural home for cattle. With her fertile soil and bracing climate she gives vigorous health to the domestic animals and freedom from all diseases of a serious nature. It has been reported that pleuro-pneumonia was found in some cattle which arrived in Great Britain from this country. If, by some supernatural or subnatural interference, the dreaded disease was found in cattle which arrived from our shores, it is quite certain that it was acquired after the animals landed and not while they were in this country, as it is not known, and has not been known to exist among the herds of our Dominion. Our customers in other countries everywhere may depend upon the healthful, wholesome and nutritious character of the food-produce which we supply.

(References were made to the trade in apples and other food products which attain their highest quality of excellence under the influence of our temperate and bracing climate,).....The quality of the food-products upon the people themselves can hardly be over-estimated, and in coming years, when the competitions incident to improved conditions of society make the struggle among nations for supremacy the greatest, the odds will always be on the side of those people who are well fed, well clothed, and who enjoy the comforts of life through the excellent food-products which they consume. In the one quality which gives food-products super-excellent value, the resources of Canada are being rapidly developed.

I refer to the quality of skill in agriculture which imparts to products the flavour the finish and attractive appearance which gives them their highest value both in cash to the producer and serviceability to the consumer.

With regard to the cattle exported to the old country. The exporters of cattle nearly all live in Montreal, and I do not think they are getting wealthy. I will tell you one thing I think they ought to do: they ought to try to get Canadian cattle to the English consumer as Canadian cattle, and Canadian beef to the English consumer as Canadian beef and if they do not, they will continue to get a less price in Liverpool, London and Glasgow.

I went into a butcher shop in England on one occasion—a beautifully kept place. I went in and spoke about mutton. I said: "You have some capital mutton; where does it come from?" etc., etc. Then I asked, "Do you sell American or Canadian beef?" He answered: "You can get those only in rough shops where the cuts are cheap." His beef was eleven pence and a shilling, or twenty-two to twenty-four cents a pound.

I got a man who lived opposite to drive me into the country a few miles; he was a chatty man, and talked about the butcher shop. He said it was a fine clean shop. I said: "Yes, first rate. I suppose he gets all the cattle he wants right here." He answered: "No, he gets half a carload every week done up in canvas." He was getting American and Canadian beef and selling it as the best English. I could hardly find a shop where Canadian or American beef was selling under its own name. The ultimate consumer who bought the beef was not cheated, he got as good value, but by selling it as English, the retailer got too much profit. We ought to get more of the money over here which the English consumers pay.

I think the exporters ought to put their heads together and get Canadian beef sold as Canadian beef. When the consumer knows that it is as good as English beef, it will be sold for the same price, or nearly the same price.

I heard of one butcher, near Liverpool, who made £200,000 in five years by selling American beef and Canadian beef as the best English. By getting our beef at a low price, it being good beef, and selling it under another name, he retarded the development of the resources of Canada.

Let me revert to one thing more in that connection before I leave the cattle business. It is possible to develop the resources of this country of ours by getting feed for our cattle which is adapted to the conditions that prevail in this country.

This is not specially a pasturing country; very few cattle can be pastured for more than four and a half months in the year, so we have to provide food for cattle during the time they are not in pasture.

Corn stalks have been our best servant in this regard. But corn stalks are not a complete food and we have been buying cotton seed meal from away down in the Southern States to supplement them. What is the cotton seed meal? Something the sun got from the earth, air and water through the cotton plant away down South without the aid of very much human skill. I want you to drink in exactly what I am saying. That 'something' is carried a great many hundred miles on the railway. American railways never think of believing in and obeying the injunction, "As ye would that others should do unto you, so do ye unto them." You must add the transportation charges to the original cost and then put that 'something' with the corn stalks. I have nothing to say against cotton seed meal, but could not the sun do the same thing up here for us? I think he ought to. We could not get it through the cotton plant, but it is for us to find out some plant through which the sun will act.

The bean stalk is just the kind of plant that will enable the sun to act on it so as to get the constituents for feeding that cotton seed contains; and we can get that at home and put that with the corn stalks.

What further we need is 'something' containing more oil than the bean stalk, and you will find that 'something' in the head of the sunflowers. With these, we have a combination furnishing a complete food for cattle.

There are no railway charges on the corn stalk and bean stalk and sunflower heads. I have nothing against the railways. I think they are capital agents and agencies for developing the resources of the country, but I would rather let them make their profit out of carrying concentrated finished products.

I have talked in an informal way on the food-producing resources of Canada. In all the provinces we are co-operating with the provincial authorities for the improvement of the lot and position of the farmers. And I would be pleased to see the business men and professional men of our cities, the men who work in factories and labour in shops, as well as those who are employed in warehouses, do what they can do to help the men and women who live on farms to apply skill, intelligence,

## Report of the Dairy Commissioner.

hopefulness and courage to their tasks that they might furnish better products, get better prices, and thus help on the prosperity of the country through the development of its food-producing resources.

### (5.) ADDRESS BEFORE THE FIRST CONGRESS OF FARMERS OF THE PROVINCE OF QUEBEC.

QUEBEC, 24th January, 1893.

*Your Honour, Mr. President, Ladies and Gentlemen,*

Imitation is the most sincere sort of flattery; and I will imitate those who have spoken before me by speaking in my own mother tongue. It is with great pleasure that I recognize the splendid tribute that this meeting is paying to the importance of agriculture in the province of Quebec. I congratulate the farmers of Quebec on this manifestation of interest, on the part of all classes, in their occupation. It is full of promise for the people of this province that the foremost men of the country have come to honour this gathering with their presence, and to show their appreciation of the importance of the interests of agriculture in this province. I am very glad that this meeting is held under the auspices of your most distinguished citizen, the Lieutenant-Governor of Quebec, and that so much enthusiasm is evident.

Let me say one word on the importance of agriculture. I do not wear any article of clothing that does not come from some farm; I do not eat anything, excepting fish, that does not come from some farm; and, so, the outlook for our bodily comfort depends very materially upon the class of men who follow agriculture. The men who farm in the province of Quebec create much of its wealth, and the men who follow other callings acquire and possess its wealth until too often the farmer is left with too small a share of that which he has called into existence. The object of this meeting is that farmers may learn to create more, and that they may learn to acquire and retain a larger share of it for their own benefit. I congratulate you upon the character of the men attending this meeting, because they are a body of intelligent men. The more intelligence a man puts into his work, the better the work will be. Before and behind the excellence of all the products of the farm some one's mind must operate. I go to my field to harrow up the surface and sow the seed, in order that I may reap in harvest time: likewise to get a good crop of thought I must first have my mind harrowed, my consciousness sprinkled with good ideas. I must have intelligent purpose controlling my work and guiding my hands in it before I shall succeed in having good products. This congress will help the farmers to acquire that knowledge which will enable them to toil with more advantage to themselves, and to be something more than farmers who glory only in having hard hands. I honour a man who does his work well, and I honour a man for brawn and muscle and untiring strength and energy: but I honour still more the man who puts his mind above his muscle and makes of his brain the governing agent in all his work. The good Lord put man's head on the top that it should rule, yet I find men who misunderstand the meaning of life in all its aspects, and who work twice as hard with their hands as with their heads, because they seem to suppose that, since God gave them two hands and only one head, they are required to work twice as hard with their hands as with their head. That is a mistaken notion, and farmers must recognize that mind must go before muscle.

I desire to-night to do some thinking for you, to stir up your minds, that you may go home with quickened aspirations and invigorated mental powers. The better we farm, the better shall we succeed in all our personal and national aspirations and ambitions. Down in the province of Nova Scotia, I once watched men making some of the steel parts of agricultural implements—parts of reapers, hay-rakes and so on. I saw a great cauldron filled with molten steel spluttering and boiling like lard in a frying-pan; and I saw that steel afterwards take the shape of some man's thought. I bethought me that I had seen men in other tasks in life trying to make things take shape by hand labour alone, without any head work. If a man will try to beat steel into shape with the hands alone, he will have sore



knuckles and no other success; and if a man will try to beat profits into his pocket through cattle and horses and sheep and wheat with his hands and ploughs and other implements alone, without the use of his head, he cannot succeed. Let us learn to make things take the shape of our thoughts, and then we shall have better butter, better cheese, better cattle, and better farms, and be better men. All these benefits should come from a Congress like the present.

The importance of agriculture is sometimes belittled by men who say that manufacturing industries only are what should be looked after by the Government. Farming is the mainstay of the prosperity of Canada. Canada has an area of land to the extent of twenty-nine times that of Great Britain and Ireland put together. Our country is twenty nine times as big, and we now farm only a very small portion of it, and farm it so badly that we have not the quantity or quality of the crops we should have, and do not get for our products the prices we should realize. I have seen butter selling in the markets of the city of Quebec for twelve cents a pound, and I have seen butter, with no more fat per pound in it, selling in Liverpool for thirty cents a pound. It takes less than two cents a pound to carry it thither. If the price obtained here was low, it was not because the markets were wrong: it was because somebody's thinking and practice were wrong.

The Governments of this country should recognize that the best way of helping the people of this country is by helping the farmers to reduce the cost of production through the application of more intelligence and skill in their work. The profit on products lies between the cost of production and the price obtained in selling; and, if a man can reduce the cost of production, he has profit at the safe end of his business. Permit me to mention one instance of this sort of thing. A farmer in the province of Quebec will give one cow three acres of land to roam over during the summer, then he will cut the crop from two acres more to feed the cow during the winter. He will get from that cow about 150 pounds of butter during the year, or thirty pounds per acre. Now, with a little thinking, aided by the helpful suggestions of my esteemed colleagues at the Experimental Farm at Ottawa, we grew Indian corn, English horse beans and sun-flowers—became quite *dilettanti*—Oscar Wilde sort of people, you know. We grew sun-flowers and English horse-beans to cheapen the cost of making butter. We obtained at the rate of 729 pounds of oil per acre from the sun-flowers. The beans were put into our silos with Indian corn, to be given to our cattle. I venture to think that from this new "Robertson Mixture for Ensilage" we can get about three hundred pounds of butter per acre against thirty pounds in the old fashioned way. Our efforts are to show how to lessen the cost and leave more profit. If we can induce many farmers to become, as far as it is possible for them, experimental investigators, in different parts of the country, it will be mightily beneficial to the Dominion of Canada.

At the Experimental Farm at Ottawa, we have been conducting experiments (not for the purpose of trying to do things in such a way as to glorify somebody for his achievements); we have been modestly trying to render some help to every farmer in Canada, that he may be able to do his work better and to make a better living for himself and his family. We have now an Experimental Dairy-Station established at St. Hyacinthe, in the province of Quebec, and I may be allowed to say this,—that much as the Honourable Louis Beaubien may do for the province, in his capacity as Commissioner of Agriculture, he will not be able to do anything which will be more fruitful of good results than this Dairy Station which he has promoted. I hope his life may be spared for many years, to render good service to the farmers of this province; but I venture to repeat that whatever he may do and with whatever his name may be identified it will not be identified with the founding of any institution which will render a greater amount of service to the common people than the Experimental Dairy School and Dairy Station at St. Hyacinthe.

You may have heard that some people in England have objected to the quality and name of some food products from the province of Quebec. Lately, while I was in Great Britain, the Honourable M. Angers, the Minister of Agriculture for the Dominion, sent me a cablegram asking me to shed a little light that might dispel the prejudices about Quebec or *French cheese*, which were blamed for being inferior,

## Report of the Dairy Commissioner.

when in many cases they were certainly most excellent. A committee of the Bristol Provision Trade had recommended the association to adopt a resolution which practically classified all cheese from the French-speaking district of Quebec as being of a lower grade than "Finest Canadian" cheese. That action, or proposed action, furnished an opportunity for calling the attention of the merchants of Great Britain and Canada to the superior excellence of much of the cheese made in the province of Quebec during the past season. Throughout the Eastern Townships, and in the district of St. Hyacinthe, many of the cheese-factories turn out a product which pleases the merchants in some markets in Great Britain quite as well, if not better, than cheese from Ontario. If all the cheese manufactured in the province were brought to a similar or even higher standard of excellence, they might go with the name of "Finest Canadian" upon them, and bring additional credit to that brand. I know the people of Quebec are enterprising enough, courageous enough, and willing enough, to make an effort to manufacture and to send to England cheese of such quality as will win them a better name than they have hitherto enjoyed and fetch them a higher price relatively than they have heretofore received.

I must not make a long speech. I am admonished this moment that I have spoken long enough. I may, however, make a remark in excuse of the length of my address. I took some little pains, when addressing public meetings in Great Britain, to let the people there know what this province of Quebec was like. I did what little I could to bring before the people of that wealthy and spending country, that large food-buying country, a knowledge of the wonderful resources of this province, and of the people of this province, whose real patriotism, whose hopefulness, whose courage, whose aspirations, and whose enterprise, I appreciate very highly. I took some care to bring these things before public meetings in England; and the newspapers in England and Scotland were good enough to report some of the things I said. On my way home, I took some time on board the steamer to figure out the length of the reports of my speeches in England. By taking single columns of the papers which first reported what I had said, and by multiplying the length of reports by the number of copies of each issue of the papers, I found that I had a report of speeches about Canada and Quebec of the length of no less than five hundred and fifty miles. The public seemed to be willing to endure that; and I thought Canadians would be quite willing to have that knowledge of the country spread abroad, without a single cent being paid for advertising.

Competition in the markets is of a three-fold nature. There is the competition among buyers which helps to raise prices; there is the competition among sellers which helps to bring down prices; and there is competition between articles for preference in the markets. If a seller has a poor article of which he must get rid, he becomes timid, loses his courage, and is compelled to take less and less; so the market tumbles down, because somebody has cheese, or butter, or other product, which is not fine and for which he cannot successfully ask a good price. Often, you find the price of cheese or butter coming down because some one, or a great many some ones, has cheese or butter which is not what it should be in quality. In England, I had some butter which I thought should bring a high price. I saw one man who said to me, "I have just been selling Canadian butter for 90s. a cwt."—which was a low price. I said to him: "Was it good?" He said, "It was Canadian butter." "But," said I, "was it good?" He said "it was Canadian butter." "But," I said "was it good?" Still he said, "it was Canadian butter." I said: "It may have been Canadian butter, but it was not finest, it was not like this." It was Canadian butter, and that was enough for him in his effort to get the price down. He was bound to try and bring the general price down, because he had come across Canadian butter which was not up to the mark. If we could manage to prevent the production of any coarse bacon, strong butter, and ill-flavoured cheese, we should get twice the price for those who produce commodities of exquisite quality. I must tell you, too, that it is a mistake for the people of this province to go on shipping hay or the crude, bulky, or primitive products of agriculture, instead of butter, cheese, beef, bacon and poultry. Every ton of hay which you ship robs the land, and makes

Quebec poor. You take from the land eighty-seven times more by raising hay and shipping it, than if you disposed of butter only. For the hay you may get \$10 per ton, and for the butter—how much? \$400 per ton. Four hundred dollars for the butter which takes off the farm about one eighty-seventh part as much of the elements of fertility as one ton of hay!

With reference to the cattle of this province, I may say that we have healthy cattle. I heard on the other side of the ocean of cattle which had come from Canada, and which were reported to be affected by a serious contagious disease. I said in Great Britain, and I repeat it here:—If these cattle were from Canada and were suffering from pleuro-pneumonia, they contracted it in Great Britain and not in Canada, as the disease does not exist there. Our food products are all healthy, wholesome, and honest to the core. A tub of butter from Canada is butter, and a tub of butter from some other places is sometimes cotton-seed oil, sometimes tallow, sometimes lard, and sometimes a mixture of the three. It is worth a good deal in England and elsewhere to have a merited name for honesty; and I hope Canadians will ever maintain their reputation for honesty, and an entire absence of counterfeits and imitations in their products.

England imported last year sixty-five millions of dollars worth of cattle and beef. We did not send very much from Quebec. I will tell you what we are doing at Ottawa. We are feeding some of these despised, half-bred Quebec cattle that are said to be ill-adapted for making beef. Last winter we fed twenty steers, and though the Quebec steers did not gain in weight as much or as fast as the Short-horns, they ate much less per head, and, consequently, gave as good returns for the quantity of feed consumed. If the farmers of Quebec would follow a wise course, they would learn to fatten and kill cattle here and send dressed beef to England. The beef from our dairy cattle is of superior quality, and would be sought after on the English markets. You can do that with profit and advantage to yourselves, and give the poor English workman a chance to obtain good beef at reasonable prices. Moreover, Great Britain buys fifty-six millions of dollars worth of butter annually, and we ought to send more of it from this country. By doing so we should not impoverish our soil, but we should enrich our pockets and make our dairy business more prosperous and profitable.

You can also feed swine here the whole year round, and should do so and ship the swine products to England. England imports fifty millions of dollars' worth annually, and is willing to pay the highest price for Canadian swine products, because of their excellence.

The poor neglected hen—as treated in Canada—has done well for France; and England buys from outside countries no less than twenty million dollars worth of poultry and eggs. We are only beginning to appreciate the value of this undeveloped industry to ourselves. I will give you one instance which will go to show the possibility for a large and profitable business in the shipping of poultry. In Liverpool, I saw a large lot of Canadian turkeys which arrived a few days before Christmas. They were packed in plain wooden boxes, with the feathers on, and without being drawn. They were being sold, like hot cakes, at 18 cts. a pound, and must have realized a handsome profit to the shipper. This is only an indication of what may be done in poultry.

At our Experimental Dairy Stations, which have been established by the Dominion Government, we have the very agreeable assurance and consciousness that we are working in the fullest harmony with the Provincial Governments. And I may state of the province of Quebec, that I know of no part of the Dominion which is capable of having its natural resources more quickly, easily and successfully developed than this province. You have splendid pastures, plenty of pure, clear water, rich, fertile soil, cattle of robust constitutions, and people of enterprise with clear heads and good hearts. You have, however, one bad habit in your dairying business which militates against you. You may take the best of care of the milk and make good butter and fine cheese, but after making them you often buy miserable tubs and shabby, frail boxes in which to put them. You buy the inferior box, because it costs two cents less than a good box; and you send the cheese to England in them.

## Report of the Dairy Commissioner.

I can tell you that the wretched looking cheese boxes, of a worse fit than a tramp's picked-up shoes, and the unsightly butter tubs of the Province of Quebec, have done great injury to the dairy farmers. The people of France have the reputation of putting up things in the most attractive and elegant packages. I suppose that is why the leaders of fashion look to France for their styles. In France, you find articles done up for sale in the prettiest and most pleasing manner possible. Now, you should put your butter into the best sort of neat tub, and your cheese in the best sort of strong, close-fitting box. You will then be better satisfied with your returns, because English people will pay higher prices for goods packed in that way than if packed in poor boxes or untidy-looking tubs.

I hope the people of Quebec will do themselves justice and vindicate my predictions about them in England. I have promised a great deal for you in the way of better performance; and if you go back on me, I will—I will learn to speak French in public, and come down the next opportunity I have, and scold you most unmercifully.

I hope also that you will send a creditable exhibit to the World's Columbian Exposition at Chicago—an exhibit of the products of this province of such excellence that you will secure for yourselves a good name; and, having done this, you will have the exquisite satisfaction of seeing your products sought after eagerly and yourselves immensely benefited. In Ontario, we have made a cheese for the Chicago Fair of 22,000 pounds weight! The purchaser guarantees to exhibit that cheese free to the public in every large city of Great Britain and Ireland after we shall have done it at Chicago; all of which will call attention to Canadian food products. Now if you want to make a bigger cheese in Quebec than that made in Ontario, when the next World's Exhibition is to come off, apply to the Dairy Commissioner, and Quebec may be chosen for that feat.

I wish you every success in all branches of your farming operations and shall ever count it a joy to do all that lies in my power to advance the best interests of the people of Quebec.

### PART VII.—MISSION TO GREAT BRITAIN.

In November, 1892, I received permission to visit Great Britain. A brief report on the objects and results of my mission was made before the Select Standing Committee on Agriculture and Colonization, of the House of Commons in March, 1893; and as the plates of the printed report have been stereotyped, part of that report is transferred here, to save the expense of setting up the same matter which would appear in only slightly different language if entirely written out anew.

#### THE PURPOSES OF A VISIT TO THE BRITISH MARKETS IN 1892.

I went to sell the cheese and butter from our Experimental Dairy Stations; to make such arrangements as might seem desirable for marketing subsequent shipments from the same sources; to look into the newer preferences and needs of the British markets in regard to our food products, such as butter, cheese, beef, bacon, eggs and poultry. Butter and cheese were the commodities in which I was mainly interested, but as opportunity offered and time permitted, I made inquiries in reference to these other articles. Besides, I had it in view to use the butter and cheese which had been sent from our Experimental Dairy Stations, to advertise the excellent quality of Canadian products, to make known as far as I could the food-producing resources of Canada, and to present information upon the educational and experimental work which the government is carrying on for the benefit of the farmers. I had these matters in view, as well as selling the products from the experimental stations. I had it also in mind to discuss with the merchants of Liverpool, London, Manchester and Glasgow, questions of trade concerning such matters as qualities, packages, branding, weighing methods, and the most convenient routes and means of shipping, in order that Canadian goods might arrive there in the most satisfactory condition. I was furnished with a large programme of work; and

when I got to the end of my time of absence from home, I think I was able to accomplish most of what I had set out to do. Let me give a review of the different objects and a very short statement of what I was able to overtake.

#### PRICES REALIZED FOR BUTTER AND CHEESE.

In selling the cheese and butter, I got top market prices at the time, for all that was sold, with the exception of a small quantity of butter from New Brunswick, which we could not sell at the prices I wanted on account of the dullness of the markets. Some of it did not fetch satisfactory prices. A most demoralized condition prevailed in the butter market in Great Britain through January and February, from large shipments of cheap butters from Germany as well as oleomargarine. I was also able to sell the mammoth cheese which we made at the dairy station at Perth, in Lanark County; and I would like for a moment to vindicate my own course in connection with that. A good many farmers and others have said to me: "Wherefore the need, or wherein is the advantage or wisdom, of spending so large a sum as \$3,000 or \$4,000 on a mammoth cheese?"

I was able to sell the cheese for the full amount it cost, including the cost of the labours, the press, the hoop and the truck that carries it, with this additional advantage to the country, that the merchant who purchased it will spend \$15,000 in advertising it through the papers in Great Britain, and exhibit it in every large city of commercial importance in Great Britain and Ireland, at his own expense, as Canadian cheese. It will thus advertise Canadian cheese and call the attention of the great consuming public to the magnitude of our dairy business, and the resources of our country. After all, the investment of a few thousand dollars for a few months has not been a foolish move on the part of the department. I may state that Mr. Van Horne, President of the Canadian Pacific Railway, has been good enough to promise that he will arrange to send this cheese through to Chicago by special train and will have the facts advertised as to the date and the time of arrival at all stations on the road, so that the farmers and others, who may want to see the largest cheese in the world, may see it as it passes to the World's Columbian Exposition.

I made arrangements for the sale of future shipments in the four large distributing centres of Great Britain, viz., Liverpool, London, Manchester, and Glasgow.

I venture to believe I was successful in awakening a spirit of interest and curiosity on the part of the retail merchants about our Canadian food-products. There is an amazing ignorance on the parts of the retailers of the sources of the food which they handle. The wholesale merchants know well the exact localities whence they come, but the retailers and consumer are densely ignorant regarding the countries and districts from which the articles come which they sell and buy from day to day.

The way in which their attention can be attracted is through the newspapers and public meetings. There is commercial virtue in the making of something concerning our country or its products, so unique and interesting as to graft them into the every-day life of the people as topics of common conversation. A traveller who tried only to sell Canadian cheese would meet with little success in advertising Canada; but any one who can make the newspapers discuss the politics and philosophies of Canadian goods and foods, and can make them themes of conversation at the breakfast tables, can strengthen the demand for, and the consumption of our products, and thus help to increase the prices.

#### CANADIAN PRODUCTS IN RELATION TO ENGLISH PREFERENCES.

Another object of my mission was to investigate the needs and newer preferences of the markets. It is necessary that we in Canada, who live so far distant in miles from those who consume a large proportion of our more concentrated food-products, should know their preferences. I have met a great many merchants as well as producers in this country, who say: "Well, let us send what *we* like, and let them take that or go without." The Englishman is not going to be bulldozed into unwill-

## Report of the Dairy Commissioner.

ing obedience in regard to what he shall eat, no matter what he submits to in other respects. If he does not get exactly what he wants, put up as he likes it, in butter, cheese, bacon or beef, he will leave those foods and take to some other class of food. In Canada, we have been successful with our cheese trade, because our merchants have met the exact preferences of the consumers. Those countries which have not done so have been left out of the race. Let me give you an instance. In some parts of Canada it has been customary to produce a class of cheese which is not preferred by the consumers in London. It is of the colour that is not to their liking and the body is too soft to their taste. That class of cheese used to sell for a much lower price by the pound than cheese adapted for the London consumers. Recently discriminating selection on the part of our merchants has sent that class of cheese to Manchester, where it pleases very well. While our cheese from Quebec has been improved in reputation and quality, some of the advantage has resulted from directing that class of cheese to the markets best adapted for it.

In that regard my visit to Great Britain will help the Canadian producer by furnishing information which he might get from the merchant, and which, perhaps, has been tendered to him in the past, but which he had not heeded because of the feeling or suspicion that the merchant in giving advice might be influenced by selfish motives. Some cheese-makers and butter-makers have declined to act on the recommendations frequently given them by merchants. We have no time to educate the taste of the consuming public in Great Britain. One would need a few centuries of leisure to do that. Over there, one cannot but be struck with the prominent and peculiar aspects of the life of the people. I took many opportunities of studying other aspects of life, than merely the consumption of butter and cheese. If you map out into six sections, the time and thought that an Englishman gives to all subjects, food, clothing, house, family, religion, amusements, politics, philosophy and literature, you will find that five-sixths of his conversation is taken up in discussing the one subject of what he eats, has eaten, or is going to eat. As a result, he is a discriminating judge of what he should eat, and in selecting what he wants for his own palate. We who eat simply and innocently what is put before us, do not pay much attention to these matters, but an Englishman will go to a restaurant and select the particular chop or steak which he wants to have cooked for himself, and woe betide the cook if he does not prepare that particular one to his liking. When such a custom pervades nearly the whole community, it will pay us to learn what the people want, and to provide what they want and will pay the highest price for. The whole consuming public of Great Britain has a strong aversion to strong flavours in food-products. The average Englishman dislikes strong cheese, and I have known many cases in which strong-flavoured cheese sells at 4d. a pound less than mild cheese. They prefer mild-flavoured food of all kinds, and for that reason our Canadian dairy butter has gone out of consumption. The people who used to buy strong butter to spread on their bread, now prefer mild margarine. It is sold to them bright, clean-looking and sweet, and is displacing the use of pure butter on the tables of many of the people of Great Britain. If we make mild flavoured cheese and butter, and put them up in neat, attractive packages, I do not think that any imitation can compete successfully against the pure article. I can remember that within the last twenty years, the great masses of the working people in the large industrial centres in Great Britain found it difficult to get enough wholesome food to keep body and soul together. Now they are able and willing to pay for exquisites and delicacies for their tables. Shop-keepers have told me that the wives of workingmen in England are most fastidious in their choice of foods, and that they select the finer flavoured kinds, even if they cost high per pound. It therefore devolves upon us to do our utmost to please that class of consumers, and we can meet their requirements and preferences from the advantage which we possess in the matter of climate.

### IMPORTANCE OF BRIGHT, NEAT PACKAGES.

The English people are critical also as to appearances of packages, and the merchant thinks nothing of knocking 2 cents a pound off his bid for a tub of butter,

if the tub itself looks shabby. A shop-keeper wants three profits off any article which he introduces. For instance, the reputation of Canadian winter-made butter has still to be made. For the present there is a prejudice against it. On the Danish butter, which is no better than ours, the shop-keeper is satisfied with a smaller profit. One of them told me that with a new article like Canadian winter-made butter, he had to push it. "In order to make it go at the beginning," he said, "I want a large profit." The shop-keeper wants to buy cheap, because it costs him more trouble in pushing it on the market.

#### BRITISH PREFERENCES FOR NAMES.

The English people are conservative as to names. For "Best English" they will pay 20, 25 or 50 per cent more, under that name, than for the same article otherwise labelled. Sentiment has a great influence with them in that respect. There is a large share of sentiment combined with business in the ordinary consumer when he buys food. In some shops I found English cheese which was being sold at 22 cents a pound. Cheese of as good and in some cases of better quality than that (the best Canadian make) was selling at 14 cents per pound. There was a difference of 8 cents a pound due to the name. In some cases, I found that the cheaper priced goods were superior both in nourishing properties and flavour to those designated "Best English." Although "Best English" was fashionable as a label, the product was of only commonplace quality. We lose something in this respect, by not having our own goods known under their proper distinctive name. In many instances I found that the finest Canadian cheese was being sold as "Best English." If our cheese were somehow indelibly branded as "Best Canadian," people, *in time*, would begin to look for it under its own name; they would ask for it as such, and eventually we would get a relatively higher price for it. The same observations apply with regard to beef. I found that the best Canadian beef was being sold in many places as the "Best English." A pound of the best Canadian beef would not command as high a price under its own name as if it were sold as English. One service I was able to render the Canadian producers in that regard was by calling attention through the ordinary channels of communication—the newspapers—that our Canadian products were excellent and wholesome; and I endeavoured to induce people to ask for them at the provision shops under their own name. I found also that some importers on the other side had rather deficient information concerning both names and qualities of Canadian dairy products. The Provision Trade Association of Bristol—one of the large importing centres—had under consideration a resolution stating that they would not accept cheese from "the French section of Canada," as they call it, as finest Canadian cheese, because they had the opinion that several years ago cheese from that district was not fine. I was able to answer that objection, and offered to supply them with cheese from the province of Quebec, which is now selling for as high a price as cheese from any other part of Canada. We want to impress upon the British consumer that he should buy by quality and not by name; that he should judge an article, not by what it is called, but by its intrinsic worth.

If we can make our own name, the name "Canadian," the synonym for excellence and honesty in our products we will soon find the advantage. I found a difference in the qualities of cheese which are preferred in the different markets. Manchester wants a different style of cheese from Liverpool or London. I think I will be able to recommend certain districts to make cheese adapted to the preferences of these different markets. The faults that were complained of most in our goods were the shapes, sizes, and packages. In general appearance they are not nearly so attractive as those of the English-made cheese.

The style, as shown by the workmanship in finishing the article, is often quite objectionable. These little things to which our people have not given attention, are magnified into great defects and cause a discrimination against us in regard to prices. We also find that our butter packages and cheese boxes have been telling against us. The cheese-makers have been in the habit of buying boxes for one or two cents less

## Report of the Dairy Commissioner.

than the price at which they can be made and nailed up sufficiently strong to carry their contents uninjured. Cheese arriving in broken boxes will sell for one-half cent a pound less than if the boxes were neat and undamaged. The good box costs 12 cents altogether, and it holds 60 or 70 pounds of cheese. There may be a loss of 30 or 35 cents for a saving of two cents in the price of the box. I had some boxes made in accordance with my own ideas as to strength, fit and finish; and there were six boxes a little bit broken out of a hundred, while in other shipments which I saw there were not more than six boxes whole in the hundred. That is a matter in which it will pay farmers to insist upon the cheese-makers paying enough to get substantial and nice-looking boxes. Our boxes from Ontario are better than those from the other districts in Canada and those from the United States. Yet there is much room for improvement.

The French people are the greatest sinners in this respect, as they send the most wretched looking of all the boxes I saw in the English markets. That is contrary to the traditions and practice of the French race in other affairs. In France, the people have the happy faculty of putting up what they manufacture in the most pleasing and attractive manner; but in the province of Quebec the people have been neglecting the appearances of packages.

### IMPORTANCE OF BRANDING TO PREVENT FRAUD.

In the matter of branding, I think it would be advantageous to have the cheese made in Canada, branded "Canadian," on the cheese as well as on the box. The making of this compulsory might be a little distasteful to some of the cheese-makers at the beginning, but if it were made permissive for the first year, I think most of the cheese-makers would avail themselves of it. The members of the Produce Exchange of London made very strong representations to me on this matter, saying that Canadian cheese should be branded "Canadian" on the cheese as well as on the box, because they had good reason to believe that very frequently cheese were tendered to them on contract under the name of Canadian cheese, which was not produced in Canada. One way to guard against this misrepresentation would be to have the name "Canadian" branded on the cheese when made and on the boxes afterwards. I think we might do this with advantage. We should insist on having the name of the country where the cheese and the butter are produced, branded upon the outside of every box and package which is shipped from any Canadian port to any foreign port. I would not like to see any regulations made which would be harassing, and which would tend to restrict the trade which has grown to considerable magnitude in handling cheese from the United States through our country to Great Britain. This came up in the course of my investigation. I found that a large quantity of cheese from the United States, northern New York State and the Western States of the Union, went through our country in bond, and was bought in Great Britain as cheese from the United States. The bulk of the business is carried on honestly and honourably, in my opinion. There is very little misrepresentation. The business is done mainly by Canadian merchants, and it has grown up for the reason that Canadian merchants are the better judges of the quality of the goods their customers in Great Britain want. The men in this trade in Canada have grown up having a practical knowledge of the trade in all its branches.

The trade in New York and Chicago is largely managed by men who are in a sense speculative business men; instead of being men who are personally practically acquainted with the qualities of the goods they handle. Therefore, our people are able to handle them with better results. Besides, ours is a cooler route than the other routes to the Atlantic seaboard. It is because we have these two advantages that I would not like to see any restriction imposed which would make the trade difficult to be extended or any regulations harassing to those who carry it on. I think if it were enacted that the brand "Product of the United States" should be upon the outside of every box or package before it left a Canadian port for a foreign port, it would not interfere with carrying on the trade in a pleasant and satisfactory way. If the cheese should come to Montreal without bearing this brand



the proper customs officer or any other official appointed to do so, could see that the brand was put on, making a charge of two cents a box. The transportation company should be required to pay the amount with power to charge it against the consignee as necessary expense incurred to comply with government regulations. That would be a simple way of doing it without any offensive regulations or irritating restrictions. I think also that some one in Montreal should be given charge of looking out for shipments of cheese and butter, when they go through in bond and go direct from the railway cars or local steamer into the ocean steamer, in order to see that the cheese and butter which are not warehoused or stored in bond, carry the brand that designates their origin. There is quite enough room and work for an inspector there to look after Canadian interests. I make this mention in this regard, because I was favourable to a movement like this last year. The matter was discussed in western Ontario and from the published reports I received of those meetings, I found that the farmers were expressing hostility towards the departure, because it had been supposed that the inspector would be there to brand the cheese, grade it, and make himself disagreeable generally.

One buyer objected to an inspector at Montreal, apparently because the inspector could prevent any cheese going through from Chicago from being put on the steamer without bearing a designating brand of the country of production. The hostility was on the part of those who have been reported as shipping cheese from Chicago and other western points quite largely through Montreal without any brand at all being on the boxes which designated where they were made. That was reported to me in Liverpool, London and also in Montreal.

I think we should brand on all cheese made from skimmed-milk the words "Skim-milk;" and on cheese made from whole milk the word "Canadian." I would leave the word "Canadian" off skim-milk cheese. We are not anxious to advertise it as from this country. We should have a regulation prohibiting the making of any filled or imitation cheese. There is none made in Canada now; but during the last winter a large joint stock company was reported as proposing to start this business, they were restrained from it by the statement that the government would certainly prohibit the making of filled-cheese as in the case of oleomargarine.

*By Mr. McMillan (Huron)*

Q. There was a Bill before the House last session to make it imperative to have a butter and cheese inspector at Montreal, and to have sales subject to that inspection?—A. I think that would be quite impracticable. Any food product which is perishable in its nature cannot be branded or graded like flour. Butter may be graded No. 1 to-day, and if exposed to hot weather in transit, it would be No. 3 to-morrow. In that way a government brand upon butter would be subjected to ridicule on the other side.

BRITISH IMPORTS OF CHEESE, BY COUNTRIES,—VALUES.

The imports of cheese into Great Britain in 1891 were as follows:—

Holland.....	£ 761,387
United States... ..	1,779,260
Canada .....	1,991,597
New Zealand.....	74,257
	<hr/>
	£4,606,501
All other countries.....	206,903
	<hr/>
	£4,813,404
	<hr/>

I believe there is a preference among the wholesale dealers over there for Canadian cheese over that sold under any other name; and if we maintain the fine quality we shall continue to retain a large share in the cheese trade with Great Britain.

## Report of the Dairy Commissioner.

### BRITISH IMPORTS OF BUTTER, BY COUNTRIES,—VALUES.

The imports of butter into Great Britain in 1891 reached a total of £11,591,183, made up as follows:—

Sweden.....	£1,269,187
Denmark .....	4,865,842
France.....	3,038,063
Canada .....	187,398
Australasia .....	270,880
All other countries.....	1,959,813
	£11,591,183

It will be seen from the foregoing figures that Great Britain imports butter to the extent of two and a half times the value of the cheese. Her imports of margarine, in 1891, amounted to £3,558,203. It will, therefore, be readily observed what a capital chance there is for the extension of our trade in butter to the mother country. Considerable butter might be sent from Canada with advantage to ourselves, reaching there in October, November and December. Those who have any influence with the large transportation companies should endeavour to impress on them—the steamship companies especially—the need for providing refrigerator accommodation for our shipments of butter in the fall and early winter before the cold weather prevails.

### THE QUALITY OF BUTTER WANTED IN ENGLAND AND HOW TO PUT IT UP.

The qualities of butter which the English people want are a fresh-made flavour, without any evidence of staleness. They also want a very mild butter—that is, not heavily salted. Further, they want it pale in colour. In our attempts to secure the market, much depends on the manner in which the butter is put up. Let me show this tub to the committee, for a moment. The British importer is a great stickler for requiring a nice-looking package. The tub which I now show to the members of the committee, I brought, in order that the gentlemen might, in their own districts, advise the shop-keepers to try and introduce a package like it. It is different from the tubs which are generally in use, and I will point out a few of those differences. In the packing of butter, where tubs have been finished with iron hoops in the past, these hoops have not been painted, and the rust from the hoops stained the wood and made the tub look nasty on the outside. The farmers and shop-keepers assert that paint on the outside of the tub will affect the flavour of the butter, but that is a mistake. The paint on the outside will never affect the quality of the butter inside. Butter might be kept in this tub for six months, and it will look as well as the first day it was filled. The English purchaser, if he finds the butter inside to be of good quality, will pay a good price for it. The ordinary butter package of to-day is made with a band on the cover, which extends over the side. In handling, it is often broken and the cover falls to pieces. This has a cover of double thickness, made with a shoulder which fits into the tub. The extra cost of the cover, the lining of paraffine and the painting outside, is about 12 cents per tub, or less than a quarter of a cent per pound of butter. The butter will bring, say from 1 to 1½ cents per pound more. We have also branded on the top of the cover, the words, "Dominion of Canada." The Australian and New Zealand butter-boxes are lined with paraffine paper. The result is that the butter, on arriving at Great Britain, has a sparkling appearance on the surface, and looks for all the world like fresh-made butter. Let me give an instance of how an Englishman chooses butter. It shows what may be gained by our people by paying attention to little matters. The British retailer goes to buy butter from the merchant in his warehouse. He will use a shilling or the end of a knife or a key to take a very little off the very surface of the butter. If he uses the butter trier he will run it

down close to the side of the tub. In each case, the butter is judged at its very worst points. Then, having tried the butter and fixed the standard in his own mind, he will endeavour to purchase the whole quantity he wants on the verdict of that examination. On the other hand, the man who wants you to buy butter and invites you to examine it, will bore down the middle of the tub and ask you to judge the whole from that point. In commerce, the man who wants to buy, tries to reduce the standard of quality to as low a point as possible, while the man who wants to sell desires to make the standard as high as possible. Now, if we pay attention to these little points, it will be money in our pockets. We want a nice, clean looking tub, with good cover and proper lining. When we use these it will be to our material advantage. Excepting one shipment, (one lot of cheese made at Perth, Ontario), the butter and cheese we handled were handled for the farmers who furnished the milk, and they are to get the prices which were realized net. Whatever is handled by us is handled as trustees for the patrons, and not as government property. There has been one exception to the rule. A portion of the butter made at Mount Elgin, during the winter of 1891-92, was sent to Liverpool and held there by the consignee contrary to my instructions, and against all the advice I could send. It was sold at the end of May, against grass-made butter, having been kept in his warehouse two and a half months there. That butter sold at a low price, and the fault was not that of the farmers, and not mine, except in so far as I sent it to a man who did not carry out my instructions. I recommended to the Minister of Agriculture that that butter be paid for at the same price as the other butter which was sold promptly on arrival. The loss to the department from the whole transaction was about \$250. The farmers were not paid any fictitious values, as a statement of the facts was made in the circular which was issued to them at the time.

#### CANADIAN SWINE PRODUCTS IN GREAT BRITAIN.

In the matter of swine products I have only a few observations to make. I found an active demand in London and Liverpool for Canadian fed and Canadian cured bacon; it stands next to the Irish and Danish swine products which have the highest reputation and fetch the highest prices. I have nothing to say that would look like a complaint of the conduct of the men running the packing-houses in Canada; still it is my duty to say this: That Canadian-cured and Canadian-fed bacon was selling in London and Liverpool for within five or six shillings as much per 112 pounds as Danish-fed and Danish-cured bacon; whereas the Danish farmers last summer are reported to have realized from 2 to 3½ cents per pound more, live weight, than the Canadian farmers, and the freight rates from Denmark are not much lower than the freight rates from Canada. The packing-house men and the farmers can draw their own deductions. As our Canadian name gets better known our products will be sought after at such enhanced prices that the men who cure them and handle them will be able to pay higher prices to the farmers and still make a good profit. In fairness I must state that at the Danish packing-houses, a larger revenue is realized upon the offal and by-products; and the wages of the workmen are lower than in Canada. For several years they have been going in for a breed of swine like the Chester White or Improved Large Yorkshire crossed with the Berkshire. My information is that these are the breeds most used in Denmark now; I have heard of some Tamworths also being there.

#### BRITISH IMPORTS OF SWINE PRODUCTS, IN 1891.

The imports into Great Britain of swine products in 1891 amounted to £11,760,469 stg. We can increase our output of swine products very much by turning our coarse grains that way. We might double the output in one year.

#### CANADIAN BEEF IN THE MARKETS OF GREAT BRITAIN.

Now in the matter of the beef trade. To discuss the live stock trade satisfactorily would absorb the whole of my time this morning, and I must be content to

## Report of the Dairy Commissioner.

present only one or two aspects of it. At the large agricultural conference which I attended while in London, it was stated from the platform by a Member of Parliament who said he could furnish the data required to prove his statement, that one retail butcher in the Midland counties of England had accumulated a fortune in five years of £200,000 by selling the best American and Canadian beef as the "Best English." The gentleman who was speaking was addressing the conference as an English farmer, interested in getting the best prices for the British home products; but it struck me that if a man could acquire a million of dollars in five years, by handling our beef under a wrong name that Canadians ought to get a larger share of the ultimate retail price. A rightful share of the profits would come here if we got the purchaser to know that when he is buying so-called "Best English" beef he is really purchasing the "Best Canadian." Let me give you an instance of how this works. I went in to an average butcher shop in a country town where I was visiting. I praised his shop and asked the butcher about his trade. Then I put the question to him, "Do you sell American or Canadian beef?" to which the reply was: "You can find American and Canadian beef only in the rough shops where the cuts are cheap." Beef was being sold in his shop at 10d. to 1s. 1d. a pound, or from 20 to 26 cents per pound. A little later, a livery man of the same town drove me a few miles into the country. He was not averse to talking; in fact he was very communicative and wanted to talk. Presently I brought the subject round to the trade of the village butcher, whom I had interrogated a little while before. I asked the livery man if the butcher received any dressed beef in canvas from Liverpool. "Oh, yes," he replied, "half a railway truck full every week." I pursued my line of investigation until I was convinced that the man who only sold the "Best English," according to his own statement, was really selling three-quarters of the best American or Canadian-fed beef and selling the whole under the name of "Best English." Now, I think the English farmer has good reason to complain; and we have a right to complain also that we do not get the excellence of our beef brought fairly before the English public.

A good many articles and letters have appeared in the newspapers over there, on the part of Scottish farmers especially, in which an ardent desire is expressed that our trade in stockers should be resumed in the summer. They are not at all pleased with the action of the Imperial Government in putting restrictions on the shipment of our cattle after they are landed in Great Britain. The Scottish farmers have been making a good deal of money by fattening our lean cattle. As one instance of this, let me mention it as illustrating the folly of sending lean cattle to Great Britain. I use those words advisedly. A good many farmers have not, as yet, facilities for fattening cattle; and it will be a hardship to them if the stocker trade is discontinued. But if our farmers could fatten cattle to a finish they would make more money. I met one man in Aberdeen County who had just returned from the city. He had just bought a quantity of Canadian hay at £7 per ton with which he was going to feed the lean steers which he had got from Canada awhile ago. He had bought Canadian steers, intended to feed them on Canadian hay and will make money out of them.

### THE SELECTION AND PACKING OF EGGS FOR THE BRITISH MARKET.

The next matter I have to mention is the trade in eggs. I found, particularly in Manchester, that Canadian eggs bore an excellent reputation in the trade. In London also, the reputation stood well. The only circumstances that I heard mentioned against them was the fear that some of them might be stale and rotten. When a feeling of timidity like that spreads through the trade, it takes a long time to eradicate it. If we want to get our eggs to that market, it will pay our farmers to get them to the local merchants and packing-houses regularly and quickly.

The eggs should be collected once or twice a week and put at once into refrigerating compartments. Gathering them in that way we will have a large and a steady demand for our products. The wholesale merchants told me that if half a dozen or fewer eggs in a case were spoiled, it destroyed the retailers' confidence

in them and they would not buy them at all under any name. It was not the percentage of spoiled eggs; it was the fact of their being there at all that destroyed confidence and brought prices down.

#### DEMAND FOR CANADIAN POULTRY IN GREAT BRITAIN.

I think in the matter of poultry, Canadians may develop a large trade with Great Britain. That market seems a long way off to be reached with fresh poultry. In Liverpool I examined a shipment of turkeys shortly after they arrived. The feathers had been left on the birds, and they were not even drawn. They were shipped in rough boxes, and these turkeys arrived in most excellent condition. I plucked the feathers from the breasts of some of them, and the flesh was as firm, fresh and sweet as the day they were killed. They were being sold like hot cakes at 9d. per pound. It was reported that the shipper made £600 sterling out of that small shipment. I found on inquiry that instead of there being an active demand only before and after Christmas, there would be a capital demand for Canadian turkeys up to March. I think we might develop a trade in this with great advantage, because Canadian farmers can grow turkeys quite as exquisite in flavour, as tender in meat and as cheap as they can be grown in any country. The men who buy turkeys now, properly fattened and prepared for market, can handle a larger quantity with profit.

#### RECEPTION IN GREAT BRITAIN.

There are only a few matters more to mention in connection with my English trip, because, as I said in opening, I must not detain you with details. One of the objects of my mission was to reach the public ear and eye with an intimation which would be remembered, of the excellence of the qualities of the Canadian products; to announce to British farmers what the government was doing in the way of agricultural education through the Experimental Farms and Dairy Commissioner's office, and to give some information on the food-producing resources of Canada. I might mention to the committee that I had a unique privilege and advantage in reaching England, being the bearer of letters from His Excellency, Lord Stanley of Preston. I mention this because in half a dozen ways and on many more occasions, His Excellency has done very much to promote the interests of agriculture in Canada—(Hear, hear)—for which he has not received, so far as I know, full credit in public. While I was able to get a large amount of space in the English and Scottish journals for Canadian affairs in connection with agriculture, a considerable share of that came from the advantage I had in carrying letters from His Excellency. While I have been congratulated on all hands for the success of my mission, it is my duty to say, that in this case the power upon the throne deserves most of the praise.

I need not speak of the meetings beyond the fact that both in Liverpool and in London I was given most enthusiastic receptions from the merchants there. Time did not permit me to accept further invitations which were extended to me from Bristol, Manchester and Glasgow. The Liverpool merchants had arranged to have the proceedings of the meetings thoroughly reported, and let me say that although some have supposed that the articles which appeared in the British press must have been paid for to a pretty loud tune, there was not a single cent of money spent in that way. It was all done by the editors and reporters as a matter of courtesy, and in the interest of their own readers. This aspect also may be worthy of notice, seeing that the committee have to do with colonization. While the reports of my addresses in Great Britain were quite full, these reports were also copied largely in the continental papers of Europe.

I have received recently papers from Sweden and Denmark giving a translation in full of a report of one of my addresses in Great Britain published for the benefit of the farmers in Sweden and Denmark. I think that will have a decided influence in the direction of getting the best class of emigrants from these countries to come to Canada, in view of what is being done here to enable the farmers to better their circumstances and follow their business in the most successful way. The reports of

## Report of the Dairy Commissioner.

the meetings themselves were quite lengthy. I have twenty sheets here of clippings of original reports in the best papers in Great Britain. The whole multiplied by the number of copies issued foots up some 550 miles in single column length.

There are a great many matters which I must leave out to-day. I attended the great national conference which met in London to discuss agricultural depression. I have been twitted since I came home of either ascending or descending into the arena of political party discussions by expressing opinions upon protection in Great Britain. Some of the newspapers have honoured or abused me by basing editorial articles on my references to that unprotected subject. I discussed protection in this sense in England. I attended a large conference in London, where every reference favourable to protection—(a protection against Canadian butter, cheese, beef, wheat and other products)—was received with uproarious applause. Every kind of food-product we send from here was to be taxed for the benefit of the British farmer and land owner; and in the intensity of my desire to serve Canada, I objected to that kind of protection. Besides, most men will find on going to Great Britain, that if they desire to secure any public attention to the work they are trying to do, they must introduce into whatever they write or say, something relating to the burning questions of the hour, there. If I could introduce something intimating the excellence of Canadian cheese, butter and beef to a larger and more interested number of listeners or readers, I would talk on any lawful subject. This was all I had done. I had used this work and subject, which have been vilified and defied in political discussions, as I thought best to serve the interest of the Canadian farmer.

(1.) From "*The Canadian Gazette*," London, England 15th Dec., 1892.

### CANADA AND THE AGRICULTURAL CRISIS.

BY THE DOMINION DAIRY COMMISSIONER.

At the present juncture in the experience of British farmers—and I use that term in the widest sense to include the Greater Britain which lies beyond these island shores—it becomes the particular duty of every one who can contribute a mite of information and thought to the discussion of the causes and remedies for agricultural depression, to do so with all modesty and sincerity.

#### CHANGED CONDITIONS.

One of the chief drawbacks to the progress of agriculture and the profits that should be reaped by those who follow it as an occupation has arisen from the fact that farmers forget how much they can help each other by discussing their common interests. Somebody's careful and clear thinking must precede and underlie every measure which makes for the improvement of the conditions of those who create the world's wealth—whether it be by tilling fields, making roads, erecting houses, or providing the many snug conveniences which modern life demands in the country in as full measure as in the cities.

In Canada, as in England with its denser population, the interests of the manufacturing and agricultural classes are not quite identical in every way, but they are always harmonious. The interests of the commercial classes, whose occupation arises from the means of distribution, are sometimes not only directly competitive, but actually antagonistic to those of the producers of food, clothes, and other material conveniences which have become the common necessities of life.

The enlargement and improvement of transportation facilities have brought about changes in the conditions of marketing the products of a farm, to the extent that the producer who lives on the other side of the globe has become a next-door neighbour in market competition. These changes have not been wrought by the will or enterprise of any one man or one class of men. They are the common achievement of all those forces which have been at work in the progress and consolidation of our English-speaking civilization.

## ISOLATION AND FALSE HOPES.

What has the farmer been doing while these great changes have been altering his surroundings? The British farmer, like the farmer in Canada and elsewhere, has, in too many instances, allowed his seclusive and exclusive disposition to stand in his own light. The producers of other articles of common consumption have adjusted their methods to the new and changed conditions. The farmer in England and Canada has, in too many instances, stuck to the style of farming which was adapted to the conditions of market and life of forty years ago. He has farmed as a more or less isolated unit, and as his forefathers did, and the inevitable outcome is financial embarrassment, if not utter loss of capital and of heart. Some experts have tried to lull him into a sense of satisfaction by pointing to a bright future when the American and Australian continents will be peopled so densely that those who are now exporters of food will consume all they produce, but that is idle talk. The power of production of these new continents will undergo indefinite expansion as population increases, and to indulge in such imaginings of a bright future is worse than half-doctoring a symptom to cure a constitutional illness. It is administering a sleeping powder to an exhausted patient in need of food. The inevitable outcome of this isolation and this reliance on false hopes has been in very many cases financial embarrassment, if not utter loss of capital and heart, and the agriculture of Great Britain and her Colonies has been brought face to face with a calamity which has only been half-perceived by the men who generally mould the opinions of the nation by the announcement of their own. The condition of the farmers, in more senses than one, threatens the honour and the stability of the nation. How has Canada sought to meet the danger?

## EXPERIMENTAL AND EDUCATIONAL WORK.

In Canada the Government has been endeavouring to improve the condition of farmers along certain lines, which promises great benefits to those who till the soil there, and furnish the food of the people. The work undertaken has been mainly of an experimental nature, that it might be educational in its influence upon the ordinary farmer of the country. A few years ago an Experimental Farm system was established, with headquarters at Ottawa and Professor Wm. Saunders as director. Ontario had its Experimental Farm sixteen years ago. Branch Experimental Farms have now been established and equipped in the widely separated provinces, in order to discover the varieties of grain, breeds of cattle, and varieties of fruit which are best adapted to the different conditions of soil and climate. Provision has also been made for the distribution to the farmers of small sample bags of new and promising varieties of grain. These were sent out last year to the number of over 15,000. The farmer who receives these samples of grain receives a variety of seed of the very best quality without expense to himself, and can speedily suit his seed to his land. From the sample bag, which is sent by mail, as much as two bushels are frequently obtained from the first crop. From watching the growth of these new sorts of grain with particular and quickened interest and care, the farmer becomes a more observant and capable agriculturist.

## THE COMPETITION THAT KILLS.

The Canadian Government is also making strenuous efforts to further improve the quality, enhance the reputation, and increase the active demand for Canadian butter and cheese. English farmers have small cause to fear the competition of Canada in this regard. The kinds of cheese which lower the price most effectively are those which are of inferior quality, from being made where the surroundings are filthy, the people themselves untidy, and the climate, cattle, and fodder unsuitable. A fancy cheese from Canada (which, pound for pound, is equal in nourishing qualities, rich flavour, and mellow body to the finest English Cheddar) tends to create a more general and active demand for this excellent class of food. In creamery butters the Canadian Government is also promoting the development and extension

## Report of the Dairy Commissioner.

of the manufacture of butter during the winter months. Six of these Experimental Dairy Stations are now controlled by the Government in the different Provinces, and the butter from them will find its way into the British market during the winter months. Here, again, the superficial observer is apt to imagine that the competition from this cause is detrimental to the English dairy farmer. As a matter of fact, in his own markets the English farmer has least to fear those wholesome and honest products and producers who send only the best quality of food commodities to meet demands of the consuming classes.

In all markets a three-fold competition exists—a competition between buyers which tends to raise prices, a competition between sellers which tends to lower prices, and a third competition, which is too often forgotten, between products for preference in the markets. It should not be hard for an excellent quality of anything to displace a poor quality of the same kind of goods; but the producer in Canada has to meet in the markets of England with a most unfair competition which has wrought also the greatest injury to the live-stock interests of Great Britain. The English, the Irish, the Scottish, and the Canadian farmer have all had to meet the unfair competition of counterfeits, in substance and in name which by their low price per pound have turned the consumption from more wholesome, more nourishing, and, on the whole, cheaper, honest animal products.

### PROHIBIT IMITATIONS.

Many instances might be given. The most familiar are perhaps, the subterfuges by which tallow, lard, and cotton-seed oil are sold in enormous quantities in England in the place of English, Irish, Canadian, or Australian butter. Of course, the imitation is sold wholesale, and probably sold retail, under a distinctive name; but the distinction extends only to the label of the package, the shop-window ticket, or the wrapper of the piece of coloured fat. Neither the Imperial nor the Colonial Parliaments can, by their fiats, legislate good times; but it seems to me that both can and should legislate in the direction of good times by prohibiting further competition with imitations and counterfeits which prevent the remuneration of honest British toil, applied to the production of honest British products, for the nourishment of honest British men. A simple remedy for this might be indicated, and it points to a method which may be applied with advantage to several other lines of farm products. Let the colouring of any fatty substance into an imitation of butter be prohibited.

Experiments conducted at the Government Experiment Stations in the United States of America have shown that the bones from swine which are fed upon corn, exclusively or mainly, will break with the application of less than half of the pressure which is required to break the bones of animals of similar breeding which have been fed upon grains or dairy by-products. The vital organs of these corn-fed animals are also much smaller and their health less robust. Can the flesh from their carcasses be as nutritious or wholesome? Would it not be a wise measure, in the interests of the health of the toiling masses of Great Britain, to insist upon a clear and unmistakable means of designating to the ultimate consumer the source whence all the animal products which are offered for sale have originally come?

### A NEW PROTECTION.

Any legislation looking towards the regulation of diet is called offensive to the English-speaking people; but that class of legislation which would protect the poor man from buying a pound of lardy bacon, a pound of oleomargarine, or a pound of "filled cheese," under the supposition that he was getting in these things real value and food which was adequate for the nourishment of his muscles, nerves, and bones, would be a boon to him, which he would not long suspect or complain of as being arbitrary. The effect of the quality of the foods which are produced in these Northern climes upon the constitution, vitality and vigour of the race is one which should not be ignored in any fiscal policy which has in it the elements of directing modifying, or regulating the source of a nation's supply of food. The difference



between a Scotchmen—the finished product in a material sense of oatmeal and the shorter Catechism—and a hundred Chinamen—the embodiment of rice and the Confucius' confusion—is, as I have said before, evident to all students of the material sources of race energy.

The compulsory specific labelling of animal products with the name of the country and place of the original production and shipment will look to some like the entering of the thin edge of the wedge of Protection, and will seem to stir up a warm tumult of confused ideas and sentiments of hostility from those who use the word and apply its spirit in every other relation of life with beneficence. Protection in the sense of taxation of the consumer to increase the price to the producer can be no permanent remedy for the present depression among farmers; but some protection of the interests of the farmers in Great Britain and the Greater Britain must needs be evolved, which will ensure them fair play and fair pay.

#### THE LANDLORD'S PART.

In the Dominion of Canada, the landlord question is one of no appreciable moment, but the problems which face the Canadian farmer for profitable solution are almost identical with those which have to be met by his brother on the English side of the Atlantic. A new life seems to have been put into the agriculture of the Dominion by the movement in favour of information and education about their own business which is sweeping over Canada like a great wave of an agricultural revival. His Excellency the Governor General, Lord Stanley of Preston, from his practical acquaintance with the difficulties of farmers' work as well as its needs and opportunities, has lent invaluable help to this forward movement, which has its first fruits in the mitigation of the financial conditions of the farming communities, giving, especially in Ontario, larger and better crops and higher prices, and in the advancement of their moral, intellectual, and spiritual well-being. Are not these directions in which the British landlord may help the farmer? A long sustained effort to give the farmers in the whole of the whole of the British Dominions a better knowledge and more thorough and comprehensive acquaintance with the principles which underlie the different practices in their own occupation, and to inspire them with well-founded hope and confidence in its capabilities to afford them a good living, a leisure, and a competence, should not be the least of the benefits flowing from the present discussion of agricultural depression.

For my part I am inclined to be sanguine. The present agitation will not, I hope, die down and leave the farmers more dispirited than they have been before any prospect of deliverance had been mooted to them from a measure of fair play in their own markets for their own products. An organization of farmers does not create any energy, but it makes it possible to control the energy of its members with intelligent purpose, and to direct it to the attainment of desirable ends. I have faith that the good sound sense which has characterized the British people, and which has wrought their deliverance in the past from many impending dangers, with plucky disregard of fine-spun theories from those who have not come into contact with the struggling lives of the common people of the nation, will again enable them to work out their economic salvation, and bring British farming back to that condition of honest profit-making which it ought to enjoy.

JAS. W. ROBERTSON.

(2.) *From "The North British Daily Mail," Glasgow, Dec. 17th, 1892.*

#### REMEDIES FOR AGRICULTURAL DEPRESSION.

There is a lesson which the British farmers may take from Canada. Canadian farmers have also had to fight against depression, low prices, and an adverse tariff. The crisis is being met by measures which already seem to have put new life into the agriculture of the Dominion. How is this done? Not by protection or bi-metallism. The secret lies in finding out improved methods of work, and stimulating

## Report of the Dairy Commissioner.

self-help, increased energy and resource on the part of the farming community. The Dominion Government a few years ago established a system of Experimental Farms. We have before us in the shape of official "bulletins" the details of some of the experiments which have been carried out at the Central Farm during the last two years. An examination of these reports is enough to show that such experiments are bound to be of very great practical utility to farmers. One document, for example, shows the comparative value, ascertained by careful tests, of different feeding-stuffs for the fattening of steers: another bulletin gives the results of experiments in the fattening of swine: and from either the one or the other the farmer may ascertain the best and most economical method. The annual report of the Dairy Commissioner, issued in Blue-book form, and a reprint of the evidence given by Professor Robertson before the Select Standing Committee of the Dominion House of Commons on Agriculture and Colonization, give a striking impression of the extent and the value of the educational work which is being carried on amongst Canadian farmers through official agencies. On the Experimental Farms trials are made of the sorts and varieties of grain which are best adapted to different soils, climates, and methods of cultivation; different breeds of cattle are kept and experiments made to find out the effect of different fodders upon the quantity and the quality of the meat or milk produced. An individual farmer could scarcely afford to make these experiments for himself. Here, then, is a legitimate opportunity for the Government to step in to his assistance. The same thing might be done in this country, but there is a difference between the circumstances of the Canadian farmer and those of his British brother. We have a landlord system, which Canada has not.

There is great truth in a remark passed by Professor Robertson that "a landlord who is a real leader of men is underpaid by a rent-roll; a landlord who is only identified with his estate in the collection of rents is a misfortune indeed." The landlord community might do for their tenants what the Canadian Government are doing for their cultivators. Some landlords do undoubtedly recognize their duty in this respect and endeavour to fulfil it. But until not "some" but all landlords do the same—until it is recognized, as it ought to be, that landlordism can only justify its existence by the degree in which it contributes to the promotion of agriculture—the British land system will never be in a satisfactory or permanently stable condition. If landlords are to exist at all, they must not remain an unproductive class. A large landowner concentrates the surplus resources of a whole community. It is a good thing for those profits to be so concentrated if they are employed in effecting measures for the common good which would be beyond the means of any individual farmer to accomplish. By making himself the centre and agent of co-operation amongst his tenants a landlord becomes no longer an unproductive member of the community and a mere burden cumbering the soil. He may be the most valuable man on his estate, and, as a "real leader," to use Professor Robertson's words, he will not be underpaid out of his rent-roll. How many landlords realize any such ideal to any adequate extent? There is still too much truth left in the old assertion which Professor Robertson once more repeats that, while the producers of other articles of common consumption have adjusted their methods to new and changed conditions, the farmers in Britain, and Canada as well, have in too many instances stuck to the old style of farming, which was adapted to the conditions of market and life forty years ago, the inevitable outcome being financial embarrassment if not utter loss of capital and heart. It must, of course, be admitted that the ordinary conditions of agricultural work are not favourable to hasty changes. If new and better methods are to be found, here is the landlord's opportunity for leading the way. Professor Robertson makes a strong point as to the advisability of so extending our legislation as to insist upon a clear and unmistakeable means of designating to the ultimate consumer the source whence all the animal products offered for sale have originally come. He urges that the English, the Irish, the Scotch, and the Canadian farmer have all had to meet the unfair competition of counterfeits, in substance and in name, which, by their low price per pound, have turned the consumption from more wholesome, nourishing, and, on the whole, cheaper honest

products. It is the competition of these "counterfeits" which, in his view, is most to be feared by the British farmer. The law has already done something to ensure that the consumer shall know, for instance, whether it is butter or margarine that he is buying; but Professor Robertson would have us go further still in this direction, and he suggests that the colouring of any fatty substance into an imitation of butter should be prohibited. Whether such prohibition would be considered justifiable is, perhaps, a debatable question, but there should be no objection to the clear designation of every article sold, whether foreign meat, butter, cheese, or any other food-product. Professor Robertson draws attention to the effect of the quality of the foods produced in these northern climes on the constitution, vitality, and vigour of the race. He evinces some of the patriotic partiality and the dry humour of his nationality—for he is a true Scot—in the observation that "the difference between a Scotchman—the finished product, in a material sense, of oatmeal and the Shorter Catechism—and a hundred Chinamen, the embodiment of rice and the Confucius confusion, is evident to all students of the material sources of race energy." Professor Robertson apparently believes that the whole race, as well as the agricultural interest, might be benefited by an extension and thorough application of the Merchandise Marks Act.

(3.) From "*The Daily Post*" Liverpool, December 21st, 1892.

## THE FOOD-PRODUCING RESOURCES OF CANADA.

HOW THEY CAN BE DEVELOPED.

*Address by Professor J. W. Robertson in Liverpool.*

Yesterday, at the Liverpool Produce Exchange, Victoria Street, Professor J. W. Robertson, Dairy Commissioner of the Dominion of Canada, and Agriculturist of the Government Experimental Farms, addressed a meeting of the Liverpool Provision Trade Association on "The food-producing resources of Canada, and how they can be developed to the mutual advantage of the Liverpool merchants and the Canadian producers." The attendance was numerous.

Mr. John Marquis presided, and, in introducing Professor Robertson, said there were two special reasons for the development of Canadian resources. In the first place, Canada was one of our own colonies (hear, hear, and applause), and since this country must import a large proportion of its food supplies, it was preferable that the money should go to subjects of the Queen. In the next place, trade development would add to the attractiveness of Canada as a settlement, and the Association, in hearing Professor Robertson, was pursuing a course at once profitable and patriotic.

Professor Robertson in his address said:—I am glad to have this opportunity of meeting in conference with the leading and representative men of the provision trade of this great city. My mission to England is perhaps more to learn than to teach. Still, I am willing and desirous to communicate information to such bodies as your own concerning the vast resources of our young colony, and how they can be developed to furnish food for the teeming millions of your industrial centres. You will recognize that there is an intimate interdependence of interests between the producers of food and those who are engaged in its distribution to the ultimate consumers. Perhaps some of the wealthy men to whom Liverpool owes much of its commercial prosperity, fail or forget to remember the sources from which that prosperity is drawn. The vast warehouses which line your business streets, the extensive docks which present such scenes of bustling activity, owe their existence largely to the handling of large quantities of farm products.

### THE CAPABILITIES OF CANADA.

The object of all farming is to create wealth, in food and clothing. Wheat, cheese, bacon, butter, and cotton are all products of some farmer's toil and skill.

## Report of the Dairy Commissioner.

If these can be multiplied in quantity and increased in value, every handler of the same, every business man, will have a better chance to enlarge his transactions and to increase his profits. Canada has vast areas of arable and pasture lands which are not yet occupied. It contains some three and a half millions of square miles—in fact, the whole of Europe is less than one-twelfth larger than the Dominion of Canada. It has a land surface nearly twenty-nine times larger than the combined areas of Great Britain and Ireland. As yet there are only some twenty-five millions of acres under cultivation, and about sixteen and a-half millions of these bear a cultivated crop every year. Indeed, no five millions of people on the face of the globe in a national capacity are possessed of natural resources and sources of wealth in an equal degree with the people of Canada.

### THE CANADIAN GOVERNMENT AND AGRICULTURE.

The Government of the Dominion of Canada has recognized that it can help the farmers with the highest efficiency by assisting them to reduce the cost of production and to improve the quality of their products. A few years ago they established a system of Experimental Farms with headquarters at Ottawa. In the widely separated provinces, from Nova Scotia on the Atlantic coast to British Columbia on the slopes of the Pacific Ocean, Experimental Farms have been located and equipped. The primary object of these farms is to investigate the varieties of grain which are best adapted to different soils, climatic conditions, and methods of cultivation. When information has been obtained from experiments, bulletins and reports are distributed widely for the guidance of the individual farmers in their own practice. The work of these Experimental Farms is intended also to stimulate farmers to a more careful study of the principles which underlie successful management of their own business. Already they shed the kindly light of reliable and helpful information into the homes of the poorest, as well as into the lives of their wealthier and more favoured brethren. The official and authoritative nature of the information which is given makes it so much more acceptable and available for use by the average farmer. As an instance of the far-reaching influence of this work, it might be mentioned that last year over 15,000 sample bags of new and promising varieties of grain were distributed free. From the sowing of the contents of these sample bags upon well-prepared soil many farmers were able to obtain from the first crop as much as two bushels of a new and valuable variety of grain, at no cost to themselves. The quickened interest with which the growth of these varieties was watched has had a most wholesome and stimulating influence towards improved methods of grain cultivation. A farmer observes the growing of these new varieties with such thoughtful care that generally he becomes a man practically educated in the best way of cultivating soil and growing cereals. In Canada, more than in any other part of the world to-day, the farmer has a splendid opportunity of governing the quality of the products of his lands and hands, according to the direction of his mind.

### CANADIAN DAIRY PRODUCTS.

Besides the work on the Experimental Farms proper, Experimental Dairy Stations have been established in each of the provinces which lie east of Manitoba. These are becoming centres of exact and authoritative information on the best methods of manufacturing cheese and butter. The products from them are shipped to these markets, mainly through Liverpool, to gain information from close market contact how to meet the preference and prejudices of British merchants and consumers. Through these we are trying to help farmers by showing them how to seek the market, how to suit it, and how to keep it for their own goods. The British farmers have least cause to fear the competition of Canadian food products. A fancy Canadian cheese, which pound for pound is equal to the finest English Cheddar, tends to create a more general and active demand for good cheese. You yourselves know that it is the inferior quality of the perishable food products which tends to glut and depress the market, as well as to bring prices to a ruinously low point. In Canada we are

also conducting experiments to discover how we may obtain food products of animal origin of the most wholesome and toothsome quality at the lowest possible cost. It is a delusion to suppose that the crude, bulky, and primitive products of agriculture in the form of grains or hay crops can be exported indefinitely, or that the trade in these can be made profitable to the country which exports them. They take too much out of the soil. Canada is the natural home of cattle. With its fertile soil and bracing climate, it gives vigorous health to domestic animals and freedom from all serious diseases of an infectious or contagious nature. If by some undefinable, supernatural, or subnatural agency the dreaded disease of pleuro-pneumonia was found in cattle which came from Canada during the present year, it was quite certain that it was acquired after they reached these shores, because the disease is wholly unknown in Canadian herds.

#### THE CATTLE AND HOG TRADES.

We have conducted extensive experiments in the fattening of steers, and have been able to show the Canadian farmers that by the growth of Indian corn fodder and the making of ensilage from the same they are able to produce beef of the most excellent and luscious flavour and quality at a reduced cost to themselves. The cost of feed consumed in the case of calf-steers was rather less than 2½d. per pound of increase in live weight; while the cost of feed consumed in the case of two year old steers was rather less than 3¾d. per lb. increase. Of the £13,000,000 worth of cattle and beef which are imported into England from outside countries, Canada expects to send a much larger share in coming years, and when consumers acquire the habit of asking for Canadian beef and seeing that they get it, trade may be more profitable to producers, importers, and butchers alike. It may be of interest also to you to learn a few facts that have been discovered from our experiments in the fattening of swine. England imports bacon, hams, and pork to the value of over £10,000,000 annually. Canada has come into this market also to increase her output, and to please the British public with the quality of her bacon and hams. Feeding experiments, in which pigs of similar breeding and age were in one case fattened exclusively upon Indian corn, and in another case upon mixed grains and by-products from the dairies, have demonstrated the great superiority of the bacon from the feeding of mixed grains and skim milk, buttermilk, or whey. That is how the pigs in Canada are mainly fed. Our experiments have also brought to light the fact that 15lbs. of increase in the live weight of swine can be obtained per bushel of inferior wheat which has been fed. At this juncture, when there is a great outcry in England about the low prices of wheat, it occurs to me that the English farmer, with the best of wheat at 26s. to 28s. per quarter, might turn it into fresh pork with advantage to himself and the consumers, who would thus obtain a quality of lean and nutritious flesh much superior to the lardy bacons which come from foreign countries, where Indian corn is the staple and almost only food. On the Experimental Farm at Ottawa we have an extensive poultry department. Our trade with England in the exportation of eggs and poultry is a growing one, and it should be capable of great extensions, as I find that you imported of these two items to the value of £3,962,501 last year. Let me offer you a few brief remarks open the food-producing resources of Canada by provinces.

#### CO-OPERATIVE CHEESE AND BUTTER FACTORIES.

Prince Edward Island has a size of about 2,000 square miles. Its population is comparatively dense for Canada, although it reaches only 54.5 persons, per square mile. It is now beginning an export trade with Great Britain in cheese and eggs, and this will doubtless be followed in a few years with butter and bacon. It is a most beautiful and fertile province, and bears the well-deserved title of the Garden of the Gulf of St. Lawrence. There is a very small percentage of waste or unreclaimable land in it. The Dominion Government have established an Experimental Dairy Station at New Perth, and the product from that station is expected at this

## Report of the Dairy Commissioner.

port sometime during the present week. The Island is capable of supporting at least fifty large co-operative cheese and butter factories, the product of which will ultimately find its way into this market. The comparatively cool climate in summer gives the farmers very exceptional advantages in manufacturing the finest quality of both. Nova Scotia, like old Scotia, has a most diversified surface aspect. You can see there the majestic beauty of rugged mountains joined in happy union to fertile valleys. The Annapolis Valley is really a stretch of over fifty miles of orchards whence come the high flavoured and brilliantly coloured apples which are so much appreciated in this country. I am informed on this side that the apple trade with Canada is a satisfactory one, inasmuch as, unlike the manner of carrying it on in other countries, the small ones are found on the top of the barrels. There is a branch Experimental Farm at Nappan in Nova Scotia, where similar work is carried on to that which is conducted at the Central Experimental Farm at Ottawa.

### CONDENSED MILK.

In this province there are condensed milk factories. From these we hope to send quantities of this wholesome food, for which the demand seems to be increasing. In the Antigonish Valley, the county of the present Premier, Sir John Thompson, there are numbers of cheese-factories, which are being enlarged and increased in number every year. Products from these provinces will soon find their way here in larger quantities. The province of New Brunswick is best known in England as a lumber-producing district. However, it has large stretches of arable and fertile soil. Dairying, the cattle industry, and fruit growing are being extended on all sides. The Dominion Government have established an Experimental Dairy Station, and the butter from it has gone to London, where it has met with a favourable reception. The provincial government of New Brunswick last year made a grant of £2,000 to promote the extension of the dairy industry, and to support travelling dairies, which have gone to all sections, giving illustrations and instruction on the best methods of making butter. We have found the farmers in these Maritime Provinces most susceptible to educational and instructive influences. Some of them may be ashamed to be ignorant of the best farming methods, but they are no longer hostile to the educational opportunities which the government has afforded them. The silver medal and second prize for the finest cheese at the Royal Liverpool, Manchester, and Lancashire Exhibition during the present season went to a New Brunswick factory.

### COLONIAL OPTIMISM.

Quebec is a province whose inhabitants are people full of hope, courage, and optimism. They are by far the greatest optimists on a continent where pessimism is an unthrifty exotic, which the brilliancy of Canadian skies and the exhilarating dryness of Canadian air relegates to the crypts of whisky livers, tobacco hearts, disgruntled professors, or disappointed politicians (laughter). The people are becoming most wisely enthusiastic about their own work. Educational agencies for the benefit of the farmers and the development of the food-producing resources of the province are being promoted by both the Federal and Provincial Governments. Very great improvements in the quality of the cheese from these provinces have been effected during the past few years. Many cheese factories and butter factories now turn out a quality of product quite as good as the best from those in Ontario. I have been surprised to observe that a committee of the Bristol Provision Trade Association have accepted a resolution which reflects upon the quality of the cheese from a particular district in Quebec. Cheeses from the French district of Quebec are now made in large quantities, in syndicates of cheese factories which are under the supervision of competent instructors and inspectors. They are not at all what they were a few years ago. The sweet grasses, pure spring water, cool nights, cattle of excellent breed, and people of enterprise, all promise a very rapid extension of the trade between Quebec and Liverpool in a high class of food-products.

I have already referred at considerable length to the work of the Dominion Experimental Farm which is situated in Ontario. There is another experimental farm at Guelph, Ontario, maintained by the Provincial Government. It also is doing admirable work in the interests of the farmers of the province. We have a Dominion Experimental Dairy Station at Perth, in the county of Lanark, where we made during the month of September the mammoth cheese of the world, which is to be exhibited at the Great Columbian Exposition at Chicago next year. It weighs over 22,000 pounds net, and will doubtless find its way to or through Liverpool before it is cut up and consumed. (Laughter and applause.) It is most excellent in flavour and solid in body throughout. We put no wooden hearts in our cheeses. (Laughter.) In Ontario there are now over 800 co-operative cheese factories, and the products from these are sometimes known at this market as "Brockvilles," "Bellevilles," "Napanees," and "Ingersolls." As a matter of fact, the method of making Cheddar cheese throughout Ontario is now almost uniform in all the districts, and while "Ingersolls" are widely known and deservedly held in high repute, they no longer have to struggle against the influence of inferior cheese from other districts.

"MATERIALIZED SUNSHINE" *versus* MARGARINE.

Winter dairying for the manufacturing of fancy creamery butter has now been well commenced. During last winter two Experimental Dairy Stations were established and controlled by the Government. From their influence, and in the information which they were able to disseminate, eighteen co-operative creameries in Ontario and fifty in Quebec are now in operation where none were last year. We have designed an attractive, strong, neat package, to be known as the "Canadian tub," and in it buyers may depend upon receiving only uniformly fine butter, free from all suspicion of adulteration. There is not much difference in appearance between butter and margarine, but there is a tremendous difference upon those who have delicate organs of digestion. In butter is contained energy which is most easily transformed into vital force. More than any other food it merits the name of "materialized sunshine." By furnishing large supplies of this excellent food the cows are becoming most profitable citizens in our country. The purity of flavour and substance of the dairy products of Canada is due to the cleanly habits of the people. Right over the continent a Canadian woman's abhorrence of dirt is proverbial. If the great mass of consumers in England but knew the real difference between pure and fine butter and the conglomeration of fat labelled "Margarine" which looks pretty in your shop windows, they would have no hesitation in deciding which to buy. In these days, when the microbes of disease are fearfully insidious and destructive, it becomes the people to choose for eating only food which is prepared in countries where the home habits of the people are scrupulously clean. Mixed farming mainly is followed in Ontario, and with the many sources of revenue which it provides, the people there have every chance to do well. Our effort is directed towards inducing the farmers to increase their output of those food-products which are concentrated in quality and in value. It pays thus to reduce the percentage of value which is absorbed by transportation charges.

MANITOBA AND THE NORTH-WEST TERRITORIES.

Wheat has been the main product which has been exported as yet from that part of Canada. The great area there which was the native home of the buffalo, whose bones are found in great quantities and made into charcoal, shall yet be the home of the ox, for the furnishing of beef to the dense population of England. The fattening of swine is also becoming more general in that part of Canada, and packing houses will doubtless arise on the banks of the Red River and the Assiniboine, on a smaller scale, but of a similar nature to those which have made Chicago a city almost twice the size of Liverpool in less than half a century. At the Experimental Farm an effort is being made by the crossing of different varieties of wheat and other grains to introduce the early ripening qualities of some sorts which have been

## Report of the Dairy Commissioner.

obtained from Northern Russia and India, into the productive and hardy qualities of other varieties which have been originated or have to be acclimatized in Canada. By these means farming will be rendered more profitable, and by the growth of trees which have been distributed free, to the number of several hundreds of thousands, the conditions of life of these vast plains will be ameliorated and rendered more pleasurable to farmers and their families.

### THE WESTERN PROVINCE.

On the other side of the Rocky Mountains we have a branch Experimental Farm at Agassiz. There we are paying particular attention to the investigation of the varieties of fruits which are best adapted for culture in that climate. The temperate climate of the Western Province and the fertile soil of its valleys make it a perfect paradise for the growth of most sorts of trees which are useful for fruit or valuable for their timber. To put it in the form of the American habit of grotesquely humorous descriptions, some of the trees there are so tall that it takes two men to see to the top of one of them. Without either humour or exaggeration, I may mention that I have seen crops of hay taken from the meadows on the Fraser river valley which yielded four tons to the acre, and crops of oats which produced 120 bushels per acre. Of course these are most exceptional cases, but still they give evidence of the food-producing capacities of that part of Canada. Besides the fruits, grains, and roots which can be grown there, there is an almost inexhaustible supply of food in the salmon fisheries. The same is true of the coasts on the Atlantic side of Canada.

### AGRICULTURAL ORGANIZATION.

From what I have said, it will be evident to your minds that the plan which the Government of Canada has adopted for helping the farmer is one which gives him aid chiefly at the home end of his business, where the profits in most enterprises are mainly made. Upon all the experiments which are conducted reports are made from time to time when they have been carried to a sufficient degree of completion to afford safe guidance for the farmers in their home practice. Then Farmers' Institutes have been organized in all the provinces, which provide for systematic and regular meetings of their members to discuss matters of common interest to all relating to their own business. These conferences of meetings help to clear away mists which gather round men's judgments when their information is imperfect or incorrect, and lead to the adoption of the best practices. Co-operation of the heartiest and best sort is induced, whereby the farmers are enabled to reduce the cost to themselves of carrying on their business.

In this educational work on behalf of the farmers we are deeply indebted to the newspapers of Canada, to the editors of which much credit is due for the public-spirited assistance which they have given in attracting the attention of farmers to the possible benefits which would accrue to themselves and all other industrial, commercial, and professional interests from the adoption of the best methods of farming. Those highest in station in the whole land have given invaluable aid to this forward educational movement. By his active and frequently manifested interest in the welfare of the farmers, the Governor General, His Excellency, Lord Stanley of Preston, is recognized as a statesman whom the farmers of Canada have learned to look upon with great respect and admiration. It was their happiness not to have a nobleman who plays the fiddle of social or political jugglery to amaze and amuse the common people, but a worthy representative of Her Majesty—the leading farmer in Great Britain—who lost no opportunity in cheering the hearts of the sturdy self-reliant yeomen of Canada with words of sound advice and good counsel. (Applause.) Through all these agents and agencies to which I have alluded, it may be seen that Canada is a most valuable part of Greater Britain, possessing enormous resources for the products of the best food for the millions of the industrial centres of Great Britain. Of the opportunities for a larger development of trade in these commodities to which I have referred—cattle, beef, pork, bacon, hams, cheese, and butter



—I have but to instance the fact that Great Britain at present imports about £40,000,000 annually. Canada should, and could send them a much larger share of these than she has done in time past. (Applause.) I am confident that the English market is able and willing to give such prices for excellent produce as to leave a living profit, leisure for workers, and enough of a balance to make Canadians the most prosperous and contented farmers in the world. (Applause.)

Mr. S. G. Sinclair proposed a vote of thanks to Professor Robertson, who had given them a great deal of information and afforded them a great deal of pleasure. They all knew that Canada was a large country, and was steadily growing, and they would feel not only that they now knew more about the Dominion, but also that now they thought it a greater country than they did before. Professor Robertson appeared to be under the impression that the rich merchants of Liverpool had been making tremendous profits out of the poor Canadian farmer. The fact of the matter was that they had been working very hard to help the Canadian farmer, and getting next to nothing for doing it. He hoped that in the future they would be able to do better for the farmer and for themselves. (Applause.)

Mr. J. V. Hodgson seconded.

Mr. W. Marples observed that while the import of Canadian cheese into the United Kingdom was during the last twelve months 300,000 boxes larger than in the twelve months preceding, the import into Liverpool had decreased. The reason was that Canadian cheese was hard, well salted, and close pressed, whilst the markets which Liverpool served required a white, soft, mealy cheese, such as came from Quebec. A large trade was now done, but the trade might be much larger were more of the Canadian cheese like that produced in Quebec. As regarded butter, whilst some years ago Liverpool firms received large quantities of butter from Canada, of recent years they had received practically nothing. He suggested that Canadian fresh butter should be packed in air-tight whitewood firkins of about 100 pounds and that tubs, which were a poor package and liable to be broken, should be disused. Packages from America might with advantage be bagged, in order to present a bright, clean appearance. A parcel of Canadian butter packed as he suggested had during the week sold for 120s. the highest price made for some time.

Mr. B. McGranahan said that they had heard a great deal of what they should do for Canada, but he would suggest that they might ask what Canada was doing for them. If the Canadian Government was able to allow British products to go into Canada duty free, then they might in this country be able to guarantee the formation of a league to sell nothing but Canadian produce. (Laughter and applause.) They certainly in Canada did not institute a McKinley tariff as in the United States.

The vote of thanks having been passed, Professor Robertson, in reply said he thought that they in Canada would be able to meet the demands of the English consumers, retailers, and wholesale importers in the kind of cheese they wanted. They would also try to meet their views in the way of packing butter.

A vote of thanks to the chairman was passed at the close of the meeting.

(4.) *From "The Scotsman," Edinburgh, 21st December, 1892.*

The agricultural problem may not unfairly lay claim to be the question of the day. It may be hoped that when it has had its day of concentrated public attention, a practical solution of some of its perplexities may have been devised. Some of the heroic remedies of which much was heard in the recent Agricultural Conference are rapidly drifting out of the public regard. Their advocates may be expected for some time to occasionally distract attention from more useful proposals, by pressing them on the notice of the agricultural community. But that is all. As an aid to the thoughtful study of the situation that is going on throughout the country, attention is directed in another column to some facts, of which many may not be aware, relating to the progress of agricultural science in Canada. The circumstances of the Dominion are not in all respects comparable with those which rule in Great Britain. Canada, too, however, has had its agricultural problem, for a fall in the prices of produce such as has been experienced could not fail to disturb

## Report of the Dairy Commissioner.

economic conditions. The cultivation of the soil, the rearing of fruit crops, and the raising of farm stock is the national industry of Canada in a sense which does not apply in Great Britain; and on this account the Dominion Government has taken the agricultural interest under its special care and protection. Its task has been to instruct it in the science of taking care of and protecting itself. It is little over two years since the matter was taken in hand on a scale of any magnitude; but the scheme has been attended with a degree of success that, to say the least, is phenomenal, and its results cannot fail to materially affect the prosperity of the whole country. Under the administration of the Minister of Agriculture a Central Experimental Farm has been established in Ottawa. It has been placed under the management of skilful men, capable not only of collating the results of valuable experiments in all departments of farm work, but of presenting them in the form of popularly written reports, and, what is of equal value, instructive lectures to farmers throughout the Dominion. Branch farms in other parts of the country have also been established in order that the experiments might be carried on under diverse conditions as to soil and climate.

The distribution of small sample bags of grain or seed to all farmers who may apply for them is one of the most valuable features of the work at these farms. A large part of their area is set apart for the growing of crops of the most suitable kind, with a view to discovering those which are best adapted to particular soils. Of very great importance, also, is the series of experiments made in the feeding of cattle and swine. There are probably few farmers anywhere to whom the knowledge acquired from these experiments would not be of instruction and value. The first place, however, in the great educational scheme of the Canadian Minister of Agriculture is the work carried on by the Dairy Commissioner, Professor J. W. Robertson, to whose second annual report attention is directed. The exhaustive experiments conducted at the Central Farm are really of secondary importance to the work that he and his staff of assistants have overtaken. They have, it may be said, been over the length and breadth of the land, delivering popular lectures and giving demonstrations in the work of cheese and butter making. They have temporarily taken over for their department a large number of cheese factories for the winter, fitted them with the necessary apparatus and turned them into working creameries, in order to demonstrate the commercial soundness of a scheme that must have been regarded with considerable misgiving. On such a scale has this work been carried on, that it may be accepted as literally true that there are few cheese or butter makers in the entire Dominion who have not witnessed or come into direct acquaintance with the most approved methods known in their industry. The best systems of cattle feeding, swine feeding, the preservation of fodder in silos have been brought under the notice of every farmer in the country, either by means of a lecture or through the medium of the bulletins issued from time to time from the Experimental Farms and Agricultural Colleges. In its several departments this great educative scheme has manifestly made an impression on the people for whose benefit it has been planned. A distinct step in advance has been made, and it need hardly be added that those who fail to keep pace with that advance will fall behind in the race for wealth and the struggle for subsistence.

It must be left for those whom it directly concerns to consider how the facts thus briefly noticed are likely to affect British agricultural interests, and also whether they have or have not an instructive aspect. Our imports of agricultural, dairy, and farmyard produce show no signs of diminution. It has occurred to many observers that the heavy arrivals of butter, cheese, and eggs from abroad that find a place on our produce markets are an unnecessarily severe inroad upon the domain of British farmers. Various and apparently satisfactory reasons have been given for not altering the economy of the farm to combat this foreign competition. So far as Canada is concerned, that competition is likely to become keener. The standard of quality is distinctly raised, and that may be held to mean the shouldering aside of inferior produce, from whatever quarter it may come. These matters enforce their own lesson, but it is desirable that it should be learned at as little expense as possible. It may be that the time has arrived when a readjustment of farming industry has

become expedient; for competition in cereals has reduced the returns in that department to a very narrow limit. Competition, however, is to be confronted in every branch of farming, and it goes without saying that the prize is to the skilful and economical administrator of the materials and means that he has to employ. If there be any lesson to be learned from what is going on in Canada, it assuredly lies on the surface. It is for farmers themselves to decide whether any portion of it is worthy of being put in practice. They also are the best judges of the method by which any scheme of the kind to which attention is drawn may be set in operation. Whether it be necessary, desirable, or practicable in this country, differently circumstanced in many respects as compared with Canada, is a matter for thoughtful consideration; but it will not be denied that it relates to one aspect of the agricultural problem which it would be the depth of unwisdom to disregard.

(5) From "The Grocers' Gazette," London, England, December 24, 1892.

### FOOD PRODUCTION IN CANADA.

#### PROFESSOR ROBERTSON AT THE HOME AND FOREIGN PRODUCE EXCHANGE.

An unusually large gathering assembled on Wednesday afternoon at the Home and Foreign Produce Exchange, Hibernia-chambers, London Bridge, S.E., to hear an address by Professor J. W. ROBERTSON, Dairy Commissioner of the Dominion of Canada, on "The Food Producing Resources of Canada." Mr. J. D. COPEMAN (Chairman of the Exchange), presided.

The CHAIRMAN, in introducing Professor Robertson, said he felt quite sure, from what he heard that gentleman had done in other parts of the country, that they would have a most interesting lecture. It was a happy idea of them to welcome any gentleman representing such a large interest as that which in Canada was connected with their particular business, and it was a very happy thing that they should show the right hand of fellowship to all connected with the provision trade in the great Dominion, which was one of the largest appendages, if they might so call it, of the British Crown. (Hear, hear.) After Professor Robertson had made his remarks, he would be very glad to have any suggestions from them as to what would be beneficial in regard to the mode of shipping goods, or any important facts they might be able to bring to his notice. He thought Professor Robertson would be able to give them a great deal of information, and hoped in return they would give him some to take home with him for the mutual benefit of Canadians and themselves. (Applause.)

Professor ROBERTSON then rose to deliver his lecture, which he illustrated from time to time by reference to a large map of Canada hung on the wall behind him. He said he was very glad to have the chance of speaking to the members of that Exchange as to the food-producing resources of Canada. He came to this country far more to learn than to try to teach them, but he was glad to have the chance of communicating to them something about what was being done in Canada to help to make better and more palatable food for this country. They had in Canada to-day the duty of producing much of the wealth of the world, so far as food and clothing were concerned, whilst the merchants of London and other great commercial centres had to distribute their products and thus the interests of the two parties were identical, and they were dependent on each other for much of their success. (Hear, hear.) The men who produced the world's wealth, he was sorry to say, had very little chance of retaining it, whilst his hearers, who distributed it, had a very large share—(laughter)—and he hoped the rich merchants to whom he was speaking would give the poor Canadians an idea how to retain more for themselves, even if they became rather poorer in consequence. (Laughter.) The object of all farming was to produce wealth in food or clothing. Wheat, and cheese, and butter, and pork, and cotton, and wool, and silk—all those goods from which the greatness of London arose—were in one way or another the produce of the farm. In every part of its business the great city in which he stood was dependent on the land; even

## Report of the Dairy Commissioner.

the silk necktie he wore came from a plant, being raised from the caterpillar on the mulberry leaf. Their business in Canada was to create wealth, the business of the London merchant to acquire it. Canada had a very large area of undeveloped land and therefore vast resources. The whole of Europe, including this island, was just one-twelfth larger than Canada, which contained  $3\frac{1}{2}$  million square miles, and comprised enough land to make 29 countries as big as Great Britain and Ireland. By-and-by, when England sent more of her good men to them, they would fill up the great expanse of fertile soil shown on the map before them, and send food over in vastly greater quantities, receiving clothing and other goods in return. (Hear, hear.) They occupied 25 million acres at present, of which  $16\frac{1}{2}$  millions bore a cultivated crop every year. There were no five million people in the world who in a national capacity owned so much of what produced wealth—in soil, and water, and sunshine, and minerals, and the intelligent labour of the people. Well, the aim of all farming was

### TO MAKE MONEY—TO MAKE PROFIT.

He was aware that in London they had a few people who had no such aim, and who came from a very little part of the island called Scotland. (Laughter.) Those people had no such aim as money making, so far as he could learn, but lived simply to give good advice and benefit their fellowmen, and they had been giving some very good advice to the Government of Canada. That advice was that instead of bamboozling the people with politics the Government should teach them to produce cheaper and better food, and so to send more out of the country and get more in return. (Hear, hear.) So the object of the Canadian Government was to help the common farmer to improve his produce, and so to increase his profit. They had a system of experimental farming extending all over the country, and having its headquarters at Ottawa, and farms extending from Nova Scotia to the Pacific. This system had a far-reaching influence on the butter and cheese and other products that were sent over to this country. Its primary object was to improve the corn growing of the people, and so to improve also the produce raised from corn. Last year 15,000 sample bags of the most promising varieties of grain were distributed to farmers in different parts of the Dominion. Each of these sample bags, sown in a suitable soil, would bring in return to the farmer two bushels of a new variety of grain better adapted to his land than that previously used. The farmer had in many cases fallen into ruts and was unwilling to adapt himself to new conditions. But when he had a present made him of this sample bag of grain he planted it carefully and watched over it and talked about it day after day until in one season he learned more about grain cultivation than he could have acquired in ten years from books. Thus he became practically educated in the cultivation of cereals, and economical production of grain lay at the root of production of all other foods. Whilst they were trying to help the farmer to reduce the cost of what he sold, they did not want the price he received to be reduced. (Laughter.) If he could reduce the cost of his productions, and at the same time make them more excellent, he did not require to reduce the price. (Hear, hear.) If he reduced the cost he got a profit at the safe end of his business, and if the price went up he got another profit on the top of that. No country could produce food so cheaply as Canada. They had been growing Indian corn for ensilage, and it cost them less than 6s. 6d. a ton in the silo, ready for feeding the cattle. They wanted to produce better, and at the same time to get more profit for themselves. To show the range and extent of the work of the Government farming system, he might say that last year they tested 420 varieties of grain, 135 of potatoes, 53 of field roots, and 624 of large fruits. They tried to

### GET BETTER APPLES—APPLES THAT WOULD KEEP

better and have a better flavour and appearance than those sent over hitherto, and he was glad to find that the Canadian apple trade was very satisfactory. One Manchester man said to him—and he could see that he meant what he said—that the Canadians always put the small apples at the top of the barrel. (Laughter.) Of

the smaller fruits 423 varieties had been tested, and of vegetables 293. This shower the scope of their work, showed how they were trying to touch the life of the farmer at every point, and to enable him to produce more at less cost to himself. Besides this, they had Experimental Dairy Stations, which touched the trade of those to whom he was speaking perhaps somewhat more closely than some of the work he had described. They sent dairy produce over to London, and also to Liverpool and Glasgow. Some Canadian produce was received in London the other day, and he would hardly like to tell them the price it was sold at, for it was a little more than the very top quotation at that Exchange. They hoped in Canada to make all the various articles of their produce better than the best that came over at present. Not only were they helping the farmer to produce, but they helped him in seeking the market he could serve best, and helped him to serve that market by suiting it. Once when he was very young he was foolish enough to believe he could educate the English eater to like something which he ought to like, but he had quitted thinking that for a long time, and now he simply wanted to know what the eater liked, leaving the education of his tastes to some one with a century or two of leisure. (Laughter.) He wanted to know what the English liked, so as to go home and tell his people. In the Dominion people were very teachable and wide-awake, and eager to hear from all quarters. They had not "book" farmers in Canada, but men who were anxious to acquire information, and to put it into practice. He had been in Liverpool during the week, trying to get them to give higher prices for Canadian produce than London. That was the sort of competition he liked, the competition to get the produce, but the competition that affected them most was that of the products themselves. He found he could not get Liverpool men

TO GIVE ANY BETTER PRICES THAN LONDON,

not that there was any ring—he did not think such a thing for a moment, but simply that neither town would pay for an article more than it was worth. But they were all most willing to pay for better quality, and quick in appreciating it, and that suited Canada. He would like the prices for inferior goods to go right away down to zero, and those for the best to go up. It did not cost any more to produce good stuff than bad, and Canadian farmers should be taught to feel the loss of producing bad. The farmer in England had less to fear from Canada than from anywhere else. They knew that wherever they had a fine cheese people eat more of it, and the same with fine butter. So Canada by sending the finest produce could help the English farmer, but the poor stuff that was imported from different parts had the effect, by its inferior quality, of reducing the consumption and so depressing the price. Canada wanted to help the English farmer by improving produce, and so increasing the consumption and raising prices. They had been trying experiments as to the best way of raising animal products from corn, because no country could continue long to ship away primitive products like corn and hay and to make it pay. It took the very heart out of the soil, and they could not get it back, but if they fed cattle and kept the manure they kept the fertility of the land. They would send these products only by-and-by, and not the crude materials in the form of corn. Canada was naturally perfectly adapted for keeping cattle healthy. They had no disease among their cattle that was serious or dangerous. It was said some steers from Canada had pleuro-pneumonia when sold here, but if by any supernatural or sub-natural agency these animals got that disease it was after they came, because there was no disease like it over the whole of Canada, and never had been. They could depend on Canadian beef, and bacon, and cheese and butter being wholesome right through, because the animals were healthy and had no disease that they need dread. Canada was ambitious to have a good name in this respect. They were not an old people. Was there ever a boy of twenty (men they were called now)—(laughter)—who had not pretty high ideals and would keep trying every Monday morning to act up to them, but by the time he was 40 he would be quite willing to relinquish his ideals in deference to other people, and to do things he would have scorned to do when young. So Canada, which was still young, had its ideals like the young man, and the Government had prohibited the making of

## Report of the Dairy Commissioner.

### ANYTHING THAT WAS ADULTERATED,

or that was in any way an imitation of some genuine article. (Applause.) Laws to that effect were on the Dominion statute-book to-day. (Hear, hear.) By the use of suitable foods beef could be produced at wonderfully low prices in Canada, the cost of food being only from 2½d. to 3¼d. per pound increase in weight in the animals. But they had no intention of selling those pounds if they could help it for less than 6½d. each. (Laughter.) They tried to reduce the cost to the producer, but to make the quality better, and then there was a margin of profit to be divided between him and the distributor in this country. A sum of £13,000,000 was annually expended by England for imported cattle, and of this Canada expected to get a much larger share in the future. The Canadian Government had been carrying out a number of experiments with regard to the fattening of swine. England purchased ham, bacon and pork to the value of £10,000,000 a year; and some London firms were establishing curing-houses in Canada. Thus Canada was increasing her output of this product, and intended by the quality of her goods to secure a large share of English custom. Some people had an idea that the feeding of swine was hardly as respectable as other occupations. (Laughter.) He did not quite know how this idea originated. Perhaps the scriptures had something to do with it. (Laughter.) At times, when he had referred to the subject, persons had laughed and said something about the prodigal boy. But that boy, who was very uneconomical and hot-headed, never began to re-establish his financial or social position till he had taken to feeding swine. (Laughter.) To show the growth of the Canadian bacon industry, the speaker said that one of the largest packers in that country had assured him that last year he was only able to pack 40,000 swine in twelve months, but this year in six months he had packed 60,000. (Hear, hear.) The business was, in fact, growing rapidly, and the production of swine was capable of being indefinitely expanded by the farmers of the Dominion. He would give one more instance, which might be useful to farmers and other business men. London was a great corn centre—here, he noticed, they called all cereals corn. They had been making experiments in the feeding of swine with grain, and it had been found that, even with inferior wheat, every bushel used would give 15 pound increase in the live weight of the animal. He did not see why in England they should let good wheat go at 26s. or 28s. a qr., when it could be turned into pork in this way. He would never think of selling wheat at less than 40s. a qr. when they could get such high prices for pork. Not only that, but the pork fed in this way was of a far better quality. It was far more luscious and lean than any other bacon. In the West, before very long, Canada would be feeding large quantities of swine and cattle, and

### SENDING MUCH BETTER BACON HERE

than that which had in the past been forwarded from Chicago. Before leaving the subject he would like to give just one more instance, with regard to the sale of poultry. The English people were full of good living—one could see it in their faces, and hear it at every hotel. (Laughter.) For a people of so much intellectual ability he never knew so much time taken up in discussing what they had to eat. He saw some fine turkeys the day before in Liverpool, as fresh and sweet and nice as possible. They came from Canada, and the man who bought them paid what he thought they were worth, but on a very small lot he made £600 profit. He wanted 9d. a pound for them, but he had only given 5d. Really, half the profit would be enough to recompense the capital and risk involved, and then there would be a better return for the producer. Proceeding to deal more particularly with Canada itself, the speaker first referred to Prince Edward Island, which had 2,000 square miles of land. London had got practically nothing from the Island in the past, but there was a shipment of cheese coming that should fetch 57s. in the market this week. It was as fine as any cheese he had ever shipped from Ontario, the cheese from which province were like the finest Scotch cheddars, but with more butter in them. (Laughter.) Farmers there had now commenced to grow Indian corn as

fodder. They used to laugh at him when he advised them to do this, and tell him it would not grow. He said, "I will give you a little bag—just enough to plant a quarter of an acre, for nothing—at the Government expense." Now to get something for nothing always tickled a man. (Laughter.) Last year he again visited the district, and there were 2,000 acres of the corn growing, which would feed as cheaply as hay at 15s. a ton. The year before only ten acres were grown. A great quantity of cheese was being sent out of the Island already. It would be worth the while of some London dealers to get an agent out there to buy produce on the spot. That little island was capable of keeping fifty large co-operative factories going in the manufacture of cheese and butter. They would find in New Brunswick the grandest of mountain scenery, joined to a very productive soil and climate. In the Annapolis Valley they had fifty miles of apples with bright, well-coloured skins and good flesh, and that would keep well into the following spring. In Nova Scotia they have a manufactory of condensed milk. They had a splendid clear atmosphere that kept the milk pure during the manufacture. It would not be possible to make condensed milk so well here, owing to the air. Not that he had anything to say against London air—why, it was full of things. (Laughter.) In the Antigonish Valley, the county of the Premier of Canada, Sir J. G. D. Thompson, there were a number of large cheese factories. New Brunswick was best known here as a lumber-producing country, but the people were beginning to develop cattle-raising and

#### BUTTER AND CHEESE-MAKING.

They exported the products in distinctive Canadian packages. They had examined and tested the packages of all parts of the world, and had made one combining the best points of each. This would be the best of the lot, and would have a distinctive Canadian shape. He warranted that no Danish butter could be found which would be better. Certainly they would get none anywhere where the people had more cleanly habits in their homes. It was worth a lot to know that their butter was made by people of clean and respectable habits like those in their own homes. He would not eat butter from some places—they could not tell where the milk had been set. (Laughter.) New Brunswick had voted £2,000 for the maintenance of travelling dairies to go all over the province, and show the best methods of making butter. That was in addition to the money provided for similar purposes by the Dominion Government. The two co-operated together. The cheese made in the province was excellent. They sent some to the great show at Liverpool, and though they were at disadvantage owing to the time of year at which they were produced, they secured a high position. There would be some excellent cheese from the province in the future; the clear, cool evenings gave the people there a special chance of making the firm body and sweet flavour, which was what London merchants seemed to want. In Quebec there was a French district whose people were perhaps not well understood in other parts, but he was surprised that in Bristol, where they should know more about Canada, being nearer than London—(laughter)—they had passed a resolution proscribing the cheese from a certain district. Did they ever hear of a tailor proscribing cloth from a certain district? No; of course he would proscribe the make and not the place. There were cheeses in Quebec as fine as anywhere, but the people in Bristol wanted to prevent cheeses coming from that part as "finest Canadian cheese." Let them demand a cheese perfect in flavour, solid in body, without crack in the rind, perfect in shape, before they call it finest Canadian cheese. If it came from Quebec it made no difference. Let their standard be in quality, not in place. The educational establishments in Quebec, as in New Brunswick, were sustained both by the Provincial and Federal Governments. The people here were the firmest optimists in a country full of optimists. If they had skies like that of London they would be the most pessimistic people in the world. But their splendid air made them hopeful, and they relegated pessimism to people with whisky livers or tobacco hearts, or to disappointed politicians. (Laughter.) In Ontario there was a splendid farm supported by the Provincial Government.

## Report of the Dairy Commissioner.

### THE LARGEST CHEESE IN THE WORLD,

had been made at one of the Dominion Branch Experimental Dairy Stations, at Perth, in Lanark County, Ontario.

It was not made to give occasion to brag about the cheese, but to advertise the magnitude of the industry. It weighed 22,000 pounds, and was going to the World's Fair at Chicago. By and by it would come to London—he had pretty well negotiated it—and this would get Canadian cheese talked about and the more it was talked about the more they would ask for it in the grocers' shops. (Laughter.) They might smile at this, but people would ask for anything that was sufficiently talked about. One day the *Daily Telegraph*, by mistake, spoke of some butter at an exhibition in London as covered with "suet," instead of "salt." The next day fully a dozen people came and asked him for some of the "butter covered with suet," as they wanted to try it. (Laughter.) In Ontario there were over 800 cheese factories, with an annual output of five million dollars' worth. The cheeses known as "Ingersolls" were better known in this country than the "Brockvilles," "Bellevilles," and many other makes, but efforts had been made to establish a uniform system of manufacture, and the methods employed were now so nearly alike that "Ingersolls" were equalled by cheeses from many other parts. They were trying to get the railway companies to give them better facilities for sending cheese safe and entire. He would like the members of that Exchange to put through the stiffest resolution they could asking cheese makers to put better boxes on their cheeses. He had some boxes which cost three cents over the regular price, and they had been brought here and to Liverpool, and not one in fifteen was broken. If the cheesemongers had a stiff resolution here saying that cheeses in undamaged boxes were worth more they would see it paid to get better boxes even at two or three cents more a piece. Their railway companies were like those in England—very good, but not yet trained to act on the principle of doing as they would that others should do unto them. (Laughter.) It was "just as much as the traffic will stand," that was their motto there and here. (Laughter.) In this province this year there were now 18 co-operative factories making butter on after October, with 50 in Quebec, a total of 68 against only two last year. In Quebec, the provincial Government gave a fairly large bounty on milk supplied to creameries for the manufacture of butter from November to March. He would have spoken of Manitoba and the North-west but that they were not of particular interest to his hearers at present. From Manitoba they had in the past sent merely wheat. Hereafter they

### WOULD SEND BACON, BUTTER AND CHEESE,

and would use the grain mainly as food for live stock of some kind. On the other side of the Rocky Mountains they had a fruit farm, and the district was a paradise for tree growing. The trees grew so fast that he had never seen any like them. He would not say they were as tall as the Americans had them. An American told him it took two men to see to the top of some of their trees, they were so tall. (Laughter.) They had fertile valleys in the British Columbia district, where he had seen four tons of hay to the acre, and 126 bushels of oats to the acre. He did not say those were typical cases, but they showed the food-producing capabilities of the region. They tried to give their people protection against all kinds of imitations and frauds in business. They had been helped wonderfully by the newspapers of Canada in making information for the whole people from the highest to the poorest. From all they had hearty co-operation in making the farmers understand their business better, and the Governor General, Lord Stanley, took an active interest in all that concerned the farmers. At a meeting which the speaker attended, Lord Stanley gave one of the best addresses he ever listened to on the marketing of farm produce. He did not talk a fiddle-playing jugglery to amaze and amuse the people, but good sound sense, giving the farmers a correct opinion about their own business. Canada was a part of this great Empire, and he wanted to see a fashion of using Canadian produce. Fashion had a good deal to do with it. They, the merchants, moulded the sentiment of the people, and sentiment grew. He would not buy of some men



if he could make £500 a year by it, he had an aversion to them; and there were other people he did like and was always ready to buy from especially if they gave better value. (Laughter.) They were trying in Canada to give better quality, to give the very best, and his hearers should try to foster a sentiment which would encourage them. They wanted no favours, just a fair price for their goods. They wanted the good wishes of England, and a little higher prices for next year's cheese. (Laughter.) He hoped members of the Exchange would do him the kindness to make any suggestions they could to him. Anything addressed to "Dairy Commissioner, Ottawa," or even simply "Dairy Commissioner, Canada," would reach him. He would like them to make suggestions in regard to any questions that occurred to them. They would thus be helping their own business by helping Canada to meet their wishes. He thanked them for listening so kindly to him, and hoped that conferences in coming years would be for the advantage of both countries. He concluded by conveying to them the best wishes of the Canadian farmers whom he represented. (Cheers.)

Mr. J. WHEELER BENNETT said that having been connected with Canada for many years, and, as representing the largest packers there, he would like to ask Professor Robertson one thing. They suffered considerably from want of continuity of supply in hogs. At times the supply gave out entirely, because the farmers killed at home. If the lecturer could suggest to the farmers to keep up a regular supply, it would do the curing interest a great service.

Professor ROBERTSON said the Minister of Agriculture had recently sent round a special circular on this very subject.

Mr. BROWNE WEBB said whilst in Canada he had an opportunity of seeing this system of experimental farming, and met the Minister of Agriculture and Mr. Robertson, who received him most courteously. He went pretty far west and could bear witness to the truth of Mr. Robertson's statements. He did not think that gentleman had overstated any of the facts, and he considered Canada to be one of the future food-producing countries of the world. (Hear, hear.)

Mr. J. R. WEBB said that they must allow him to propose, on behalf of the members of that Exchange, a vote of thanks to Mr. Robertson for his exceedingly bright, happy and pleasing address. There was a good deal of appropriateness in making the address there and to that audience. Professor Robertson came there to interest them in this country of Canada, which had already taken a prominent place in food production for the supply of England, and was capable of taking a much larger place; and he was addressing a number of gentlemen whose whole efforts were constantly given to a very difficult and delicate problem—that was, to the supply of the food of the population of London and the immediate neighbourhood. He thought they were so accustomed to let the matter pass on day by day in its ordinary course that they hardly realized what it really meant. Here was a population of something like 5,000,000, for whom they, or some of them, had to find food day by day—neither too much nor too little, neither too cheap nor too dear. But all this was done in the most quiet and unobtrusive manner, through the energy, enterprise and intelligence of persons engaged in the trade, whether as merchants or as dealers in their various branches. They should remember that owing to the size and conditions of London, which were very different from those of most other towns, this food had to be taken day after day to the very breakfast tables and dinner tables of the people. The machinery for this vast distribution had to be kept at work from day to day, and every year the population kept flowing about, generally more and more out into the suburbs, and had to be followed, so that there were constant changes in the arrangement of that machinery. It went on in this easy and quiet way, and they were all much interested in hearing and knowing what was being done to help them in the distant countries where the food was produced. They, all of them, so far as that Exchange was concerned, took considerable interest in endeavouring to improve and assist the trade in various directions, and especially in the improvement of quality. They did so for this reason, that London was not only such a large and important market, but was the market of the world where fine goods and fine quality

## Report of the Dairy Commissioner.

were always sure of meeting with due appreciation. (Applause.) They had of course perhaps not a wholly disinterested feeling in this matter, but he would just like, in passing, to ask Mr. Robertson if he could only bring them the proofs of the enormous fortunes that they were said to be making. (Laughter.) His experience was that no business in England was done on a smaller percentage of return to the people who gave their time and expenditure to it. That, however, had nothing to do with the point. The better the goods were in quality, the more easily they could sell them, and whether the profit was much or little, it was easier to do business, and the business itself was more satisfactory, so that their interest was the same. He had been reading with great interest the reports that had come over of Mr. Robertson's work on the other side. It struck him they were doing a very good and beneficial work there, and there was great scope for it. The lecturer had well pointed out that the raw material of dairy products—milk—was always the same—whether they were well or ill made, so that it did not cost any more to make good butter or cheese than bad. (Hear, hear.) There was no extra expenditure in producing the finished article to make it finer, so that there was an indefinite scope with the farmer for the improvement of his products. The lecturer had been speaking about the great interest taken in England in politics, and he felt considerable sympathy with the strictures passed by Mr. Robertson on the subject. It was not creditable to the press that so little interest was taken in the ordinary matters of country life in regard to agriculture and gardening. (Hear, hear.) He himself felt that it was a noble ambition to raise the condition of agriculture, and the man who did anything to improve and raise the quality and purity of the food of the people was doing a good service in his day and generation. (Cheers.)

Mr. A. J. Rowson seconded the vote of thanks, and said it would be greatly to the interest of the trade to get their goods of the right quality, provided they were not of too high a price. He was sorry to say he did not know any one who was making a fortune out of Canadian cheese, or even making much profit out of it. (Hear, hear.) But they could make a little more out of it than out of cheese from the United States, and he took it that that was a feather in the cap of Canada. (Hear, hear.) As to what Mr. Robertson had said about the amount of attention devoted by Englishmen to their diet, he thought that with such an atmosphere as had been described, full of disease germs, they were bound to pay some attention to their stomachs. ("Hear, hear," and laughter.) They must at least have food that was palatable. He hoped next year they might be able to tell Professor Robertson they had done better with the cheese of 1893 than with that of 1892, and that they had not taken all the cream in Canada. (Laughter and cheers.)

The CHAIRMAN, in putting the resolution, said that Mr. Robertson must not forget that they wanted Canada to take English manufactured goods in return for the food imported. In that simple interchange lay the true wealth of nations.

The vote of thanks was carried with applause.

Professor ROBERTSON, in responding, also proposed a resolution of thanks to the Chairman for presiding. He was able to bear testimony to the business reputation for commercial integrity of English merchants among those who dealt with them on the other side of the Atlantic. That reputation had had the happy effect of making Canadian merchants strive to follow their good example. If any of the gentlemen present would call on him at Ottawa at any time, he would endeavour to extend to them the same courtesy as had been extended to him during his stay here. (Applause.)

(6.) *From the "Free Press," Aberdeen, 14th January, 1893.*

### CANADIAN V. ABERDEENSHIRE AGRICULTURE.

In another column we give in brief summary form an account of the recent visit to this country of Professor J. W. Robertson, of the Central Experimental Farm at Ottawa, who holds also the appointment of Dairy Commissioner and Agriculturist under the Dominion Government. Mr. Robertson has twice reported officially on the subject of dairying, and carefully-tabulated results of experiments in feeding

cattle on different foods have been published for the information and guidance of Canadian farmers. As concerns dairying, very considerable progress has been made, with satisfactory results, in the establishment of cheese factories, in Ontario more especially. The quality of the cheese produced has been distinctly improved, and its character in the market established. Mr. Robertson does not claim that the same progress has been made in the production of butter on a systematic scale, and of a quality to take the British market, but he states that he has induced the Government to take steps for starting creameries in connection with the cheese factories. As regards the whole question of dairying, the system pursued in Canada of bringing the milk to a centre for wholesale manufacture into cheese or butter, the separate deliveries of milk being recorded and the particulars marked on being sent in, and the product divided amongst the individual owners in the same proportion, has not readily "caught on" in this country. And without guarantee as to the uniform quality of the milk brought in, there is undoubtedly a drawback to the system not easily got over. A more important point, if not as regards Canada, certainly as regards the agriculture of Aberdeenshire and the surrounding districts, is, however, raised in the question—How far is achievement of the best dairying results compatible with achievement of the best results in the rearing of cattle of a class fit to take the best place in the great London meat market? That is a point to which, as matters stand, the attention of the Canadian Parliament and its active and intelligent Dairy Commissioner and Agriculturist may without offence be directed. The production of excellent butter and cheese on the old domestic lines is not a thing at all unknown in Scotland. It has long gone on in Ayrshire, and does so at the present time; but then the mass of the Ayrshire farmers live by dairying, and have cows noted as milkers, but by no means noted as beef-producers. And in Aberdeenshire practically the reverse of this has obtained during the past forty or forty-five years. Beef has been produced of the first quality with a success not equalled elsewhere, but dairying has had to go into the background in consequence.

That Professor Robertson and his collaborateurs at the Ottawa Experimental Farm have done valuable work in spreading abroad information as to the exact results arrived at in feeding stock on different varieties of foods, as well as in the growing of special crops on fixed areas, is evident. But the question may, without offence, be asked—What about the general standard of the stock reared as regards their beef-producing qualities? That is undoubtedly the question that most deeply interests people in this north-eastern district of Scotland, which may fairly claim to have a pretty intimate connection with the Dominion from the fact, in the first place, that so large a proportion of the early settlers in Ontario went from these regions; and, in the second place, because within the last few years a considerable trade in the importation of Canadian store stock has been established at Aberdeen. The figures, exclusive of young calves and sheep, show that within the past four years the number of Canadian "store" cattle landed at Aberdeen has been 48,360, or an average of over 12,000 a year. And to meet the local demand amongst farmers prepared to "feed off" for the London market, probably almost double that number would find purchasers; we discount, of course, the recent scheduling of Canada, a step which the Minister of Agriculture had perforce to take, rightly or wrongly, after the report by the veterinary experts of the Department that pleuro had been discovered amongst cattle from Canada. It is not to be believed that the embargo will be permanent. But, as the shrewdest and most long-sighted of our agriculturists have for long held, it is of vital consequence for our home farmers to maintain the character gained for cattle in Aberdeenshire by noted breeders of both Short-horns and Polls more than thirty years ago, and in virtue of which as "prime Scots" they were so long able, without challenge, always to command the highest prices in the London market. We are sorry to believe that during recent years of depression this character has not been fully sustained even by a not inconsiderable proportion of cattle of home rearing. And there need be no hesitation in saying that the shiploads of Canadian "stores" received year by year have contained by far too great a proportion of scraggy, ill-bred, unshapely brutes to do anything else than accentuate the evil, which of course means ultimate selling in the London

## Report of the Dairy Commissioner.

market at probably a third less price than could be got for well-bred beasts, which are easier to keep from birth, and can always be more readily fattened. If, then, the Canadians want to continue and extend the trade in store cattle to the North of Scotland, the question of having them bred of uniform good character and quality cannot be too early or too closely looked at. It will be a real service to the home farmer, while benefiting themselves. And we can only regret that Mr. Robertson's brief visit to Aberdeen did not allow him time to meet a gathering of leading Aberdeenshire farmers for the discussion of such points as we have touched upon. We have not the least doubt that, although his special commission does not embrace stock-rearing, it would have been to mutual advantage to have had a frank interchange of opinions on the subject.

(7.) From "*Bell's Weekly Messenger*," London, England, March 20, 1893.

### THE AGRICULTURAL INTEREST IN CANADA.

There are many interesting and useful lessons which we could learn from our colonies and foreign countries, but none could be made more clear than that it pays well for the Government to foster and encourage, in a practical manner, the home agricultural interest. During the past few months the Canadian Government has shown clearly that practical help *can* be given in this matter, and that, too, without any very great expense. There is in the Dominion a very efficient staff of agriculturists, with Experimental Farms in each of the provinces, as well as a Government department, also with a practical staff. Among the latter none are more efficient or more earnest on behalf of the agriculturists of our nearest colony than Professor J. W. Robertson, the Government Dairy Commissioner, who recently paid a visit to this country. The object of his visit was a very practical one, being to study the markets, tastes, and requirements of the United Kingdom, in order to bring these under the notice of the agriculturists of Canada. He came primarily to investigate the newer preferences of the British consumers of dairy products. It was realized that it does not pay to send to market a food product, unless it be of the sort, quality, and appearance which the expected customers will want. The Canadian farmer cannot afford to lose money while he is trying to educate the British consumers up or down to the standard of what he thinks would be the best sort of food for them. The Government inquiries were intended to guide the farmers into meeting the preferences or prejudices of markets, and to suggest to business men how they can follow up opportunities with enterprise and profit. The information disseminated on Professor Robertson's return, if not always apt to local circumstances, must be suggestive and stimulating. Then, again, Professor Robertson addressed meetings of the merchants in Liverpool and London, who import food products from Canada, upon the products themselves, and the value of Canadian trade. It is expected that these gatherings will become annual hereafter, in five or six of the large cities of Great Britain. It was believed that the business interests of both countries—agricultural and commercial—must be promoted by a better acquaintance of the methods of producing commodities on the one continent, and the means of distributing them to the ultimate users on the other. Professor Robertson also laid before the public, through the press and other agencies, something of the experimental and educational work which the Canadian Government are carrying on for the benefit of the farmers.

On the Experimental Farms and Experimental Dairy Stations in Canada are carried on original investigations into the growth of cereals, the growth of forage crops, the feeding of cattle, the fattening of swine, the rearing of poultry, the cultivation of fruits, etc., etc., the main endeavour being to bridge over the gap which has existed between the attainments of agricultural science and the practice of the ordinary farmers. They are meeting with fair success, and what formerly was exclusively the knowledge of the few is becoming the common property of the many.

In the course of his investigations and journeys into different parts of England and Scotland, some aspects of the harmony of interests between the British and Canadian farmers became more evident, and on several points the following notes were obtained from him.

"I am convinced that of the two millions of pounds' worth (£2,000,000) of cheese which are imported into Great Britain from Canada annually, not more than two-thirds of the quantity are sold to the consuming purchasers as Canadian products."

"The retail butchers in different places informed me that 'only the rough shops with cheap cuts' sold Canadian or American beef. The fact is that English eaters are daily purchasing and consuming fancy Canadian cheese and prime Canadian-fed beef under the guise and name of 'the best English.' That is a manifest and gross injustice to the British farmers, and is of no benefit or gain to the Canadian farmers.

"Of course it would be difficult to frame and administer legislative enactments which would remedy the evil; but most things for the benefit of the public or the individual, which are best worth doing, are hard to do well. Parliaments elsewhere have sunk themselves to the level of a finance or finding committee for any interest powerful enough to enrich the representatives of the people at the expense of the public. Nobody expects the British Parliament to act in that way towards agriculture or any other interest; but it seems the clear duty of Parliament to legislate in such a way as to secure fair play to every one in every plane of his activities as a citizen, and particularly to prevent fraud or unfairness through misrepresentation. The middleman may defraud the customer to whom he sells, by misrepresentation of goods, or he may defraud the producer of the same by a misrepresentation to the ultimate purchaser. Have the British farmers no proprietary rights, calling for legal protection, in the names of 'English beef,' 'Scotch beef,' 'English cheddars,' 'Scotch cheddars,' etc.? It seems not.

"Since the proclivities of the established mediums for distributing fresh beef in England and Scotland to the householders tend to widen the prices which are paid to the producers and are paid by the consumers respectively, to an extent which is out of all reasonable proportion to the service which is rendered, Professor Robertson is hopeful that the Canadian authorities will take steps to remedy that deplorable state of affairs in the interests of our farmers.

"The climatic and soil conditions of England and Canada are different in respects which are seldom recognized or pointed out. The cold and continuous frost of the long winters in the Dominion permit the retention in the soil of those nitrates which would otherwise be drained out. By competent authorities in England it has been estimated that the drainage from November to March carries off a quantity of nitrates per acre sufficient for an average crop of wheat.

"The warmth of summer in Canada brings forage crops to a robust perfection of growth, which makes the feeding of cattle for beef or milk a source of profit during the winter. The country which was the native home of millions of buffaloes is the natural home for neat cattle, which it maintains in the bloom of vigorous health.

"The scheduling of Canadian steers, because of a rumoured instance of pleuropneumonia, will not be an unmixed ill or much of an injury to Canadian farmers if it compels them to fatten their beasts to a finish before they are shipped from the country.

"The compulsory aspect of it is distasteful, but on many occasions the economic salvation of individuals and nations has arisen from some occurrence which compelled them to reconsider and examine their circumstances and practices with the energy born of self-preservation.

"The abilities of intelligent farmers in both countries will find plenty of scope for profitable employment, mainly in producing the finer and more concentrated qualities of food, such as butter, cheese, milk, beef, pork, mutton, poultry, fruits, &c. The common people are now well enough off to be able and willing to pay for the exquisites in flavour and appearance in their food, which is no longer purchased merely to meet the necessities of hunger. In the west and south-west of Scotland, where dairying is the mainstay of the farmers, I found only a hearsay, a newspaper or an academic acquaintance with the subject of agricultural depression. Throughout those districts Canadian instructors in cheese-making have been employed for five

## Report of the Dairy Commissioner.

or six years. It does not follow that profitable farming has been maintained wholly or mainly by that help; but it is an acknowledged fact that the intrinsic quality of the cheeses and the relative price which they will fetch have been improved to a point indicated by from 20 to 25 per cent.

"The wisecracks of England may continue to pooh-pooh the lessons which may be drawn from the ventures and enterprises of a young country like Canada; but those who are seeking to provide remedies for the distress which is reported to have fallen upon agriculture in many districts of Great Britain will be not less competent for that task by a careful study of what the Canadian government are doing.

"Somebody must own—or at any rate somebody will own—the land for many years to come. The owners must have a return for the capital invested, unless capital loses its value for use otherwise and elsewhere. The least considerate of all landlords is *less merciless* than a corporate mortgagor who insists upon getting the whole of his 5 to 7 per cent net, with no return or disbursement for the erection or maintenance of buildings. The tax collector is not in the habit of making rebates in bad seasons or any seasons."

Such were a few of the objects and results of Professor Robertson's visit to this country, and it cannot be doubted but that in sending him the Canadian government have done good service for the Canadian farmers. In fact, we have waited a week or two before noticing the subject in order to see what good would come of it. A large merchant in foreign produce now informs us that it is evident that the visit will be "brimful of good to the Canadian trade, inasmuch as the products are already being selected with greater care than in the past," while "in the future what will come will be just what the markets want."

When, we would ask, will the British government take as much care to inform the British farmer on the requirements of the markets of even his own country? Canada should teach us a lesson on this point.

### PART VIII.—MISCELLANEOUS MATTERS.

#### (1) RELATING TO CHEESE FROM THE PROVINCE OF QUEBEC.

Considerable attention has been attracted during the year to the improved and improving reputation of cheese from the province of Quebec. Acting on instructions received from you when I was in England in December, 1892, I communicated with the Honorary Secretary of the Bristol Provision Trade Association in reference to a resolution proposed for adoption by that association which appeared to discriminate against "French Cheese." I submit copies of the correspondence.

BRISTOL PROVISION TRADE ASSOCIATION, 55, VICTORIA ST.,  
BRISTOL, 17th December, 1892.

To J. W. ROBERTSON, Esq.,  
Adelphi Hotel, Liverpool.

DEAR SIR,—Inclosed herewith I beg to hand you copies of the resolution you wired for.

You will notice that the rule will require confirmation at our next general meeting, which will be held early in the new year. Should you have any remarks or suggestions to make, I shall be pleased to bring them before the meeting.

By the word on the telegram "Commissioner" I presume you are acting for the Canadian Government, or Board of Trade.

I am yours truly,

W. T. PARKER,  
*Hon. Secretary*

*Bristol Provision Trade Association.*

The following resolution was adopted as an addition to the rules of the Bristol Provision Trade Association, at a committee meeting held 15th November, 1892, and will be submitted for confirmation at the next general meeting:

“Cheese made in the French section of Canada may not be tendered in fulfilment of a contract for ‘finest Canadian cheese.’ The seller is entitled to deliver “cheese made in any part of Canada other than the French section.”

It was further resolved “that copies of this resolution be furnished to each “member of the association.”

W. T. PARKER,  
*Hon. Secretary.*

LIVERPOOL, 19th December, 1892.

W. T. PARKER, Esq.,  
Honorary Secretary,  
Bristol Provision Trade Association.

DEAR SIR,—I have received your favour of the 17th instant, with which you inclose copies of a resolution adopted by a committee of the Bristol Provision Trade Association regarding “cheese made in the French section of Canada.” And as you do me the honour of inviting me to offer remarks or suggestions on the substance of the resolution, I desire to submit the following facts for the consideration of your association:—

1. I think I am warranted in believing that the sole object of the resolution is to protect purchasers from being compelled to receive “in fulfilment of a contract for finest Canadian cheese” any cheese of inferior quality as to the cheese, the finish, the boxes, or the condition.

2. I submit that a description of the quality of the cheese and not the proscribing of cheese from any section of Canada, would meet the needs of the case with more satisfaction and benefit, alike to the British merchants, the Canadian merchants and the Canadian producers.

3. I respectfully suggest that a resolution of the following import would be adequate and useful: “Only cheese which have a clean, sweet flavour; a sound, solid and rich body; uniform colour, which is not mottled; rinds free from cracks; neat, workmanlike finish; and good close-fitting boxes, may be tendered in fulfilment of a contract for finest Canadian cheese.”

4. In my opinion the adoption by the Bristol Provision Trade Association of the resolution which has been accepted by the committee, would be detrimental to the cheese trade between Canada and Bristol, and to the producers of cheese in large districts in Canada, where finest cheese are now being made.

5. As a matter of fact, Canadian cheese on the markets in Great Britain and in Canada, are sold mainly upon the merits of their intrinsic quality; and I am aware by personal examination of the goods, that, in some of the “French sections” in Canada, cheese are now manufactured which are as fancy in quality as any from any section in the Dominion.

6. In some sections of Quebec, the cheese are not yet as fine as they might be or as they will be; very great improvements are being effected every year through the work of travelling instructors, and the formation of syndicates of factories, under the care of competent inspectors and the issuing from my office of bulletins of particular directions for every month of the season. In the province of Quebec, during last summer, about 300 factories partook of the benefits of the visits of these travelling instructors and inspectors.

7. If the want of full information concerning the progress of the cheese trade in Canada and the geographical areas where fancy cheese are now being made, permits the Bristol Provision Trade Association to proscribe a certain quality of cheese, this

## Report of the Dairy Commissioner.

season, the same spirit may include the provinces of New Brunswick, Nova Scotia and Prince Edward Island, in the list of areas to be scheduled next year, particularly to the injury of the Bristol importers.

8. No other Provision Trade Association or Exchange on this side has proposed such an inadequate and misleading enactment.

9. Last year I made a shipment of cheese from the province of Quebec to Liverpool; they were branded as such in large letters; they were sold at the very top market price on their merits and under their own provincial name.

10. I have made similar shipments from New Brunswick and Nova Scotia; they were branded as such in large letters; they were also sold at the very top market price, on their merits and under their own provincial name.

11. This year I have shipments here and in London from Ontario. Some of them have been sold for 1s. 6d. above the highest price quoted in the public reports.

12. I have shipments on the way from Prince Edward Island, which I expect will please as well and sell as well as the best cheese from Ontario.

13. If you will be good enough to designate a firm in Bristol, or to receive the same yourself, I shall be glad to send a 10, 20 or 50 box lot of these Prince Edward Island cheese for the inspection of the members of your association.

14. I have no cheese here at present from the "French section of Canada;" but when I return to Canada, I shall be glad to send a few hundred boxes of cheese from the French section to any firm in Bristol which your association may designate, for sale, in order to show the quality of some of the cheese to the members of your association, and to obtain their opinions as to how they can be improved further to meet the views and preferences of your trade.

15. I am anxious to learn what is wanted in quality and in package to meet the wants of English merchants and consumers; and if your association will give me an opportunity, I shall be glad to meet its members in conference and to learn from them how our department in Canada can serve the interests of the dairy industry there by giving effect to any recommendation your association may make.

16. I have sent you a few copies of my annual report for last year, in order that you and the members of your association may learn the nature and scope of our work.

Letters addressed to me, in care of office of High Commissioner for Canada, 17, Victoria Street, London, S.W., will be forwarded to me.

I have the honour to be, sir,  
Your obedient servant,

JAS. W. ROBERTSON,  
*Dairy Commissioner.*

I have observed with pleasure and satisfaction the progress which has been made in dairying in all parts of the Dominion during the past few years. It has been my unswerving aim to render, as far as practicable, equal assistance to dairymen in all the provinces alike, according to my opinion of their need. In Ontario I have given most prominence, most time, thought and labour to the forwarding of the winter dairying movement. In Quebec, I have striven more zealously to help in the work of getting the cheese up to a standard in quality and reputation which will make them creditable to the brand "Finest Canadian." In the Maritime Provinces my endeavour has been mostly in the direction of furthering co-operative dairying and disseminating information on the growing of Indian corn and other forage crops for the cheap feeding of cattle. Much other work of a general character has been carried on with an equal degree of earnestness in all the provinces—except British Columbia which has been rather neglected.

The success of these particular aspects and branches of effort in the different provinces will be for the common benefit of all. In order to illustrate the consistent continuity of effort along these lines, I have collected extracts from reports of addresses delivered by me at different times bearing upon improvement in the quality of cheese from the province of Quebec.



*Extract from Report of Dairy Commissioner for 1891-92, page 15.*

"Partial superintendence and assistance were given at the Dominion Dairy Show, held at Sherbrooke, Quebec, on 1st to 5th September, 1891. At this exhibition there were gathered in competition cheese from Quebec, Ontario, British Columbia and Nova Scotia. I was assisted in the judging of the cheese by Andrew Clement, Esq., Glasgow, Scotland, one of the largest and most experienced importers of cheese into the Scottish markets, and D. M. Macpherson, Esq., of Lancaster, Ont. The quality of the cheese was generally excellent. In my opinion, which was concurred in by the two gentlemen whom I have named, the quality of the cheese on the whole was the finest ever examined at any exhibition held in Canada. The display of butter included packages from British Columbia. The creamery butter from the province of Quebec was exceptionally fine. The exhibition brought to light in a more prominent way than could otherwise be done the great advancement made in dairy practices and in the improvement of dairy products in Quebec during recent years. The friendly rivalry which exists between the sister provinces for holding the first place in the Dominion in the reputation of their products will tend to the advantage of dairymen in them all."

*Extract from Report of Address at the 15th Annual Convention of the Dairymen's Association of Eastern Ontario, held at Cobourg, 7th and 8th January, 1892.*

"In the province of Quebec every county was visited by our travelling instructors; and the quality of the cheese from that part of Canada has been very greatly improved during the last two years. Some work of experimental investigation was carried on at the cheese factory at Dunham, Quebec. The milk in the Eastern Townships and in other parts of Quebec seems to be richer in fat constituents and also in flavour than that in the more level portions of the Dominion. At the Dominion Dairy Show, which was held at Sherbrooke, Que., cheese made in the province of Quebec came into competition with the product of some of the best factories in Ontario. The Quebec cheese carried off the Dominion sweepstakes. On the whole, the display of cheese on that occasion at Sherbrooke was the best in quality which I have ever examined."

*Extract from Report of Address at Quebec, 31st May, 1892.*

"After referring for a moment to our cheese and butter trade, let me say this: that during last year at the large Provincial Exhibition held in the city of Sherbrooke, we had, I think, one of the finest and largest collections of cheese which I have ever seen in this country or in England, or Scotland. In the judging of these cheese at Sherbrooke, one of the most eminent and extensive importers of cheese into Scotland and England was associated with me. His verdict was that, on the whole, these cheese were the finest that he had ever judged; and in that competition, cheese from the province of Quebec carried off the first prize with the Dominion Sweepstakes and Gold Medal. I can recollect that a few years ago, cheese from the province of Quebec sold from half a cent to one and a half cents per pound lower than those from the province of Ontario; whereas in some cases now, cheese from the province of Quebec are bringing almost equal prices. You can make just as fine cheese in the province of Quebec as are made anywhere in the Dominion; and through the enterprise of some of your public men, the work of instruction and of giving information to cheese-makers has been so successful that Quebec recognizes that she may be able to take first place.

The holding of the Dominion Dairy Show was largely due to the efforts of Mr. Rufus Pope, M. P., and Mr. H. S. Foster. Both took a very great interest in its establishment and management; and every public movement like that which is conducted to a successful issue brings credit to the province.

On sending these cheese to England afterwards, I received the most creditable reports of their quality; and the additional attention which has been called to the quality of cheese from Quebec has caused more inquiry for cheese from Quebec than heretofore."

## Report of the Dairy Commissioner.

*Extract from Report of an Address at St. Hyacinthe, Que., 29th October, 1892.*

“Quebec has long enjoyed a good reputation for the excellent quality of its butter. The more I see of the province, its people, its pastures, its streams, its forage crops and its cattle, the more I am assured that it is admirably adapted for successful dairy farming. Until last year the cheese from the province of Quebec did not reflect much credit on the manufacturers. Very great improvement, however, had been made within three years. A gratifying illustration of this was given at the Dominion Dairy Show at Sherbrooke in 1891, when a British judge, who could not be partial to any district in Canada, stated that the cheese from Quebec were among the finest he had ever examined at any exhibition on this continent or in Great Britain. The honours won at Sherbrooke in 1891 were more than maintained by the cheese on exhibition there again during the present year, 1892. Sample cheese from some 20 different factories were selected at Sherbrooke, at the close of the exhibition, by me, and were forwarded to the great Industrial Exhibition at Toronto, to be compared there with the cheese of Western Canada, by some of the leading buyers of cheese in Ontario. No expense in this connection was borne by the Government. The following report from the Toronto newspapers shows what a capital impression the cheese from Quebec made on those who examined them :

“TORONTO, ONT., 14th September, 1892.

“To the President and Directors of the Industrial Exhibition :—

“GENTLEMEN,—On carefully examining a lot of 29 cheese from 18 different cheese factories in the district of Bedford, Quebec, we find them to be well made cheese, of uniform and excellent quality—on the whole superior to the cheese on exhibition here from any other part of the Dominion, and we strongly recommend that a gold medal be awarded to the President of the Dairymen's Association of the District of Bedford, Que., for an exhibit of such superior quality. We desire to record our high appreciation of the improvement and fine quality of the cheese which have come to the exhibition from a district where the cheese-making industry is comparatively new.

“All of which is respectfully submitted.

“E. CASSWELL,  
“JOHN PODMORE,  
“A. F. MACLAREN,  
“JAS. W. ROBERTSON.”

“The fact that the market price for cheese in many of the districts of Quebec has been quite equal to the price realized by the leading factories of Ontario further attests the progress which the dairymen of this province have made. I am glad to know and to assure you of the fact that in all Ontario there are not two men who grudge the people of Quebec their success in these matters; and for myself I shall be glad to know when the time comes, that Quebec has made so much advancement, and has made dairy products of such excellent quality that they will rank among the foremost at the World's Fair, as well as at Sherbrooke and Toronto.”

*Extract from Report of Address at Liverpool, England. From the “Liverpool Daily Post,” of December 21st, 1892.*

“Quebec is a province whose inhabitants are people full of hope, courage, and optimism. They are by far the greatest optimists on a continent where pessimism is an unthrifty exotic, which the brilliancy of Canadian skies and the exhilarating dryness of Canadian air relegates to the crypts of whisky livers, tobacco hearts, disgruntled professors, or disappointed politicians (laughter). The people are becoming most wisely enthusiastic about their own work. Educational agencies for the benefit of the farmer and the development of the food-producing resources of the province are being promoted by both the Federal and Provincial Governments. Very

great improvements in the quality of the cheese from these provinces have been effected during the past few years. Many cheese factories and butter factories now turn out a quality of product quite as good as the best from those in Ontario. I have been surprised to observe that a committee of the Bristol Provision Trade Association has accepted a resolution which reflects upon the quality of the cheese from a particular district in Quebec. Cheeses from the French district of Quebec are now made in large quantities, in syndicates of cheese factories which are under the supervision of competent instructors and inspectors. They are not at all what they were a few years ago. The sweet grasses, pure spring water, cool nights, cattle of excellent breed, and people of enterprise, all promise a very rapid extension of the trade between Quebec and Liverpool in a high class of food products."

*Extract from an Interview published in "The Montreal Star," of January 21st, 1893.*

"Many complaints were made to me of the poor quality of the boxes in which cheese has been sent, particularly from the province of Quebec. The cheese which were sent over from the Experimental Dairy Station at Perth, in Lanark County, Ont., had less than 6 per cent of the boxes broken to any extent, when they reached the London and Liverpool warehouses. Good sound boxes give an additional value to the cheese of from 1s. to 2s. per cwt.; and the extra cost of those strong boxes was only 3 cents each. I hope the cheese-makers, patrons, salesmen and buyers together, will insist upon the use of only strong, close-fitting boxes, quite dry before they are put on the cheeses.

"I found Canadian cheese still growing in favour with wholesale dealers and retailers. In the Manchester district the fat cheeses from Quebec have not met with particular favour. The irregularity in shape and size, the unworkmanlike finish, and the wretchedly bad boxes were the worst features of some cheese from that province. These defects could all be remedied in one season by a little more care and taste. The French race have the reputation of putting up goods of all sorts in the daintiest and most attractive form. The French-speaking dairymen of Quebec should try to maintain the good name of their people in that regard. The fact that it would pay them handsomely to do so, should not be a deterrent."

*Extract from Report of a Speech at the Agricultural Congress, held at Quebec, 24th January, 1893.*

"You may have heard that some people in England have objections to the quality and name of some food products from the province of Quebec. Lately, while I was in Great Britain, the Honourable Mr. Angers, the Minister of Agriculture for the Dominion, sent me a cablegram, asking me to shed a little light that might dispel the prejudices about Quebec or French cheese, which were blamed for being inferior, when in many cases, they were certainly most excellent. A committee of the Bristol Provision Trade Association had recommended the Association to adopt a resolution which practically classified all cheese from the French-speaking district of Quebec as being of a lower grade than finest Canadian cheese. That action or proposed action furnished an opportunity for calling the attention of the merchants in Great Britain and Canada to the superior excellence of much of the cheese made in the province of Quebec, during the past season. Throughout the Eastern Townships and in the district of St. Hyacinthe, as well as in other parts of the province, many of the cheese factories turn out a product which pleases the merchants in some markets in Great Britain quite as well as, if not better than, cheese from Ontario. If all the cheese manufactured in the province were brought to a similar or even higher standard of excellence, they might go with the name of "Finest Canadian" upon them and bring additional credit to that brand. I know the people of Quebec are enterprising enough, courageous enough, and willing enough to make an effort to manufacture and to send to England, cheese of such quality as will win them a better name than they have hitherto enjoyed, and fetch them a relatively higher price than they have hitherto received."

## Report of the Dairy Commissioner.

### (2.)—DIRECTIONS FOR RAISING FODDER CORN. &c.

The experience of the season points to the following conclusions in regard to the growth of corn, the construction of silos, and the filling of the same:—

**SOIL.**—If a field with a loose, warm, loamy soil be convenient to the silo, and can be used, it should be selected in preference to heavy clay, or cold soils. Sod may be ploughed under, shortly before the crop is planted, with the probability of good results from the method of preparation. In all cases, the land should receive a liberal dressing of barnyard manure, be ploughed in the spring, and be harrowed to a state of fine tilth before the corn is planted.

**SEED.**—The vitality and vigour of growth of the variety of corn which has been selected should be tested. The putting of a few grains in a flower pot in a warm place in the house will enable any farmer to verify for himself these qualities in his seed grain. Frequent disappointment results from neglect in testing the vitality of corn before planting it. As a general rule the variety which will yield the largest weight per acre, and reach the 'glazing' stage of maturity before the frosts come, is the one to select for any district. The 'glazing' stage may be otherwise described as the stage when the corn is just past its best condition for boiling in the ear for table use. It is better to err on the side of selecting a variety of a habit of small growth, which certainly will reach the glazing stage, than a variety of large growing habits, which may not come to the desired stage of maturity.

The maximum quantity of seed per acre may be put at 25 pounds; excellent results have been obtained from the planting of 18 to 20 pounds per acre.

**MANNER OF PLANTING.**—Planting in hills, 3 feet apart, both ways, appears to afford the corn a better chance for maturing early, and for producing a large number of ears. A hand corn-planter may be used to dibble in the corn. From 4 to 6 grains per hill should be planted. Corn may also be planted by the use of a hoe, and covered to a depth of at least 2 inches. In that case the foot should be pressed on the soil over the corn. For small areas, furrows 3 inches deep may be ploughed 3 feet apart. A marker (which may be constructed by driving wooden pins or harrow-teeth through a plank at distances of three feet from each other), may be drawn across the furrows. From 4 to 6 grains may be dropped at the points of intersection. They can be covered quickly and well by the planter's foot. For large areas, a single or double horse corn-planter may be used with advantage. The planting of corn in hills affords an opportunity for the effective cleaning of land from weeds, without much hand labour, by permitting cultivation in both directions.

If planted in rows, the rows should be from 3 to 3½ feet apart, and the grains may be put in at rates of 2 to 3 grains per lineal foot. For small plots, a convenient method is to open a furrow with a plough; the seed may be dropped in at the rate already mentioned, when it may be covered. For large areas, a single or double corn-planter will be found a serviceable implement.

**DEPTH.**—Corn seed should be planted to a depth of from 2 to 3 inches.

**CULTIVATION.**—In cases where a crust forms on the land before or immediately after the corn comes through, a light harrowing will prove very helpful to the vigour and growth of the crop. Harrowing of the corn until it is six inches high will increase the rapidity of growth and the yield per acre. The cultivation between the rows, when the plants are small, should be close to them, and deep. When the plants have grown to a height of more than 3 feet the cultivation should be more distant and shallow, in order to avoid injuring the side roots of the plants.

**SILOS.**—The main features that are required in a silo are strength to resist the outward pressure of its contents, exclusion of air by the construction of the sides, and a fair depth of holding capacity, in order to permit the ensilage to settle into a compact mass. Sufficient strength of sides can be obtained in most silos by the use of 2 x 10-inch or 2 x 12-inch studs, placed from 18 inches to 2 feet apart. A clay or earthen floor is most economical, and as good as any that can be put in. The inside of the walls of the silo may be finished by a single lining of lumber, nailed to the studs horizontally. The lumber should be tongued and grooved and dressed on the inside. If each alternate board be allowed to extend at the corners, so as to make

a lock-joint, that will give additional strength to the structure. The corners of the silo, on the inside, should be filled by the use of a board or plank 10 inches wide, set on end. The triangular space behind it should be filled with sand or saw-dust, I consider that studs 2 x 10-inch or 2 x 12-inch, with one ply of sound tongued and grooved lumber, nailed horizontally on the inside, are sufficient for an efficient preservation of the ensilage. Additions to that method of construction may be advantageous, in a few cases, for convenience. If a portion of the ensilage around the sides becomes frozen, that is more an inconvenience than a loss. It should be mixed with the warm ensilage, from the middle of the silo, before it is offered or fed to the cattle.

**CUTTING THE CORN.**—The cutting of fodder corn by hand has been found the most economical of the methods which we have tried. If the crop be allowed to wilt in the fields, until it loses from 15 to 20 per cent of its moisture, a pleasant aromatic odour will be developed, which leaves the ensilage with a more agreeable smel. From an examination which was conducted with two tons of corn, left to wilt in the fields, in small heaps of about twenty-five or thirty stalks each, it was found that, with two days' exposure during bright sunshiny weather, the corn lost 20.5 per cent of its weight; with four days' exposure, 36.8 per cent. After twenty-eight days standing in 'stooks' it had lost 52 per cent; and after five months it had lost 58.8 per cent of its original green weight.

**CURING THE CORN.**—The crop should be cut in the autumn before there is any risk of frost, which would damage it to some extent, if it came before the cutting was completed. The corn may be cut with a sickle, a reaping-hook or corn-knife. It may be put up in large stooks or stacks in the field or yard. After it is partly dried, it may be stored loosely, with the stalks standing on end in a shed, barn or loft. The stalks should never be laid on their sides in large bulk or they will heat and mould. If the corn be left in the field tied securely at the tops by hay rope, straw rope, or binding twine, it will keep with little waste until later in the fall, when it can be taken to the barnyard, where a contrivance can be made almost as serviceable for a small lot of corn as a silo. It is not a new plan for those who live in western Ontario, but it is new to many of the people in many parts of Canada. It consists in taking a number of forked stakes and driving them into the ground. By laying poles in the forks one can make a simple corn trestle. By laying down a few old rails, like the base for a stack, the corn can be placed on end, leaning against that trestle to the thickness of 2 or 3 feet on both sides. Then ordinary rails or poles can be placed on the outside of the corn, on both sides, lengthwise, the whole being tied near the top of the corn by hay or straw ropes. Then, if a few boards be put on the top and on both sides—allowing them to overlap—they will shed all the rain. The corn stalks can be fed from the end, with very little more waste than when the crop is put in a silo, and the outlay required for stooking or stacking it in that way is simply *nil*. Any man can make a contrivance of that kind in a few hours. I have found that method to be quite successful in past years, and the only risk incurred is, that if one put straw on the rails for a foundation it will become a great harbour for mice; but barring that difficulty, the corn saves well, and most of the waste is a little weathering on the outside stalks.

**FILLING THE SILO.**—It is advantageous to cut into the silo, those varieties of corn which have thick stalks, in lengths of from  $\frac{1}{2}$  to  $\frac{3}{4}$  of an inch. Cut into such lengths there is no waste, and the stalks and cobs are all eaten up clean by the animals. Provision should be made for a fairly even distribution of the corn in the silo, while it is being filled, and for tramping the sides and corners most thoroughly. The weighting of the corn does not appear to be necessary or advantageous. After the silo is filled the surface should be levelled and thoroughly tramped if the corn-stalks and leaves be dry from frost, from ripening or wilting in the field, 30 or 40 gallons of water may be sprinkled on the top of the silo with advantage; and after the lapse of *not more than one day* it should be covered to a depth of 6 inches with cut straw. If a foot of straw be put on the top of that a few days later, probably no loss at all from waste ensilage will be found on the opening of the silo for feeding. The feeding should be effected from the top of the ensilage, and a quantity of the exposed ensilage should be raked from the top daily.

## Report of the Dairy Commissioner.

### (3.)—THE ROBERTSON MIXTURE FOR ENSILAGE.

This new mixture is composed of Indian corn, horse beans and the heads of sunflowers. It appears to be a perfect combination which will give cattle a food containing all the nourishment required.

Ensilage has come to mean any kind of fodder which is cured and preserved in a succulent state for the feeding of domestic animals. The silo has no power to add any nutrient to the fodder which is put into it for preservation. Its contents may become more digestible and palatable by the changes which proceed slowly under the action of ferments, or they may become less pleasant and wholesome if fermentation goes too far. Fodder, which is deficient in nutrients before it is put into a silo, will experience no regeneration there. Degeneration into offensive material is the only and constant tendency, and that can be arrested.

Indian corn—the great sun-plant of the continent—is undoubtedly the most serviceable crop which has been used for ensilage; but although it be ever so well preserved as to succulence, odour, flavour and colour it is an incomplete food for cattle. With a marvellous proclivity for storing up starch, gum and sugar out of the elements of the air, the corn-plant becomes a veritable accumulator of sun-strength and energy. Its carbo-hydrates or “heat-producing parts” are largely in excess of its albuminoids or “flesh-forming parts.” These latter are present in no mean quantities in fodder corn per acre; but, for a wholesome, economical, complete food, they are out of correct proportion to the other constituents.

A main function of intelligent men on earth seems to be to put and keep things in their right relationships to each other, and therefore the intelligent farmer has been putting carbo-hydrates and albuminoids, in the rations for his cattle, in the right relationships and proportions to each other—even at the expense of his purse. That has been done commonly by adding ripened grain, such as oats, barley, wheat and pease, to the bulky-fodder part of rations, or by buying for that purpose oil-cake, cotton-seed meal, or some other feeding commodity which is rich in albuminoids.

For a few years, I have been seeking to find and put into the silo, with Indian corn, some other plant or plants which would furnish the necessary quantity of albuminoids in a form which would cost very much less than ripened cereals, or concentrated by-products. Clovers and pease have been tried with indifferent success, and the climbing or pole beans have been grown, with cornstalks for trellis, without appreciable advantage.

The horse bean or small field bean (*Faba vulgaris*, var. *equina*) seems to meet the needs of the case. This plant grows with a stiff, erect stem of quadrangular shape. It attains here a height of from three to four feet; and it grows in England and Scotland to a height of from three to six feet. It bears pods from within six or eight inches from the base of the stalk to near its top. The ripened beans are of a grayish-brown colour, and of an oblong, round-shape, about  $\frac{1}{2}$  inch long diameter and about  $\frac{3}{8}$  inch in short diameter.

With us the plants have carried ripened beans in the lower pods, while the topmost ones on the same stalks were hardly out of bloom. By growing the horse beans as a fodder crop, in rows 3 feet apart, with 3 or 4 plants per foot in each row, we obtained an average yield of 6 tons 1,610 pounds per acre of green fodder. Representative samples of the crop were analysed by Mr. Frank T. Shutt, Chief Chemist of the Dominion Experimental Farms, and from his analyses it is established that the horse beans contained 370 pounds of albuminoids and 94 pounds of fat per acre. They were preserved in a silo in a layer by themselves, and also in mixture with Indian corn plants. They were grown also in alternate rows with Indian corn—and moreover, were grown in the same rows with Indian corn—the beans and corn being mixed before they were put into the planter.

Although albuminoids and carbo-hydrates (in the form of starch, gum, sugar and fibre) may be contained in an Indian corn and horse bean mixture in nearly correct proportions, it is still an incomplete food, from deficiency in fat. The sunflower (*Helianthus annuus*) grows luxuriantly over the whole of the temperate zone

of this continent, and the seeds contain a large percentage of fat. The variety known as the "Mammoth Russian" was grown in rows 3 feet apart, with the plants from 3 to 18 inches distant in the rows. There did not appear to be any appreciable difference in the weight of the crop per acre, where the plants were grown close or more distant in the rows. They yielded at the rate of  $7\frac{1}{2}$  tons of sunflower heads per acre. From the analyses made by Mr. Shutt, it was established that they contained 352 pounds of albuminoids and 729 pounds of fat per acre.

The following table shows the quantities of the nutrients which are contained in a crop of the "mixture" from three and a half acres, at estimated yields per acre which are within what have been actually obtained.

		Albuminoids.	Carbo-hydrates and fibre.	Fat.
		Lbs.	Lbs.	Lbs.
Indian corn,	2 acres, say 30 tons	1,092	10,302	324
Horse beans,	1 " " 8 "	435	1,210	111
Sunflower heads,	$\frac{1}{2}$ " " $3\frac{3}{4}$ "	176	1,186	364
Total	$3\frac{1}{2}$ acres, say $41\frac{1}{4}$ tons	1,703	12,698	799

The cattle relished the Indian corn and horse beans ensilage.

A group of milking cows are being fed on a ration, of which the ensilage part is made from mixing the heads of sunflowers from half an acre with Indian corn fodder from two acres. The cows of another similar group are being fed upon a like ration, of which the ensilage part is from Indian corn alone, with 2 lbs. of grain per head per day more than is allowed the cows of the former or sunflower group. The milk from the two groups, is set in deep-setting pails in ice water under the same conditions; and the following results are apparent from an average of nine tests:—

	From ration with sunflower ensilage.	From ration with ordinary Indian corn ensilage.
Percentage of fat in skim-milk	0.35	0.51
Churning period, minutes	30	20
Percentage of fat in butter-milk	0.25	0.40

The butter from the cows, which are fed on the ration with sunflower ensilage, has a richer flavour and slightly higher colour than that from the other lot.

The sunflower ensilage has developed a most agreeable odour, and the cattle are greedily fond of it.

Besides the points which have been mentioned, it should not be overlooked that horse beans belong to the family of plants which have the faculty of appropriating free nitrogen from the atmosphere for the formation of the albuminoids which they contain. It is possible to increase the fertility of soil rapidly and to a remarkable degree, by growing the crop and feeding it to dairy or fattening stock. Protection to the land and profit to the pockets of the farmers are the two fruits to be expected. These form a capital combination for Canadian farmers, and no personal propriety right restricts the use of it.

# Report of the Dairy Commissioner.

## CIRCULAR OF DIRECTIONS.

### SOIL.

If a field with a drained, warm, loamy soil be convenient to the silo, and can be used, it should be selected in preference to a heavy clay or wet soil for Indian corn. The horse beans do well on clay soils. In all cases, the land will be the better for receiving a liberal dressing of manure. It should be ploughed in the spring, and be harrowed to a state of fine tilth before the seeds are planted.

### TIME TO PLANT.

The time at which Indian corn for fodder may be planted with the best results, is during the last ten days of May, or late enough in the season to escape frosts at night, and early enough to give the plants the advantage of as long a season for growing as is practicable. The horse beans and sunflowers are less liable to injury from frost than Indian corn.

Throughout the province of Ontario and the western portion of the province of Quebec, the horse beans may be planted with advantage from two to three weeks later than the Indian corn. Throughout the Maritime Provinces, they may be planted at or about the same time as the corn.

The sunflowers should be planted as early in the spring as is practicable,—otherwise, the heads may not ripen in time to be put into the silo.

### PROPORTION.

The mixture should contain about 10 tons of Indian corn fodder, to about 3 tons of horse beans, and about 1 ton to 1½ tons of sunflower heads. To obtain it in these proportions, it should be grown at the rate of one-quarter of an acre of sunflowers, and half an acre of horse beans, to every acre of Indian corn.

### HOW TO PLANT.

Throughout the Maritime Provinces and in the eastern part of the province of Quebec, the Indian corn and horse beans may be mixed together and planted in rows 3 feet apart, with from 2 to 4 grains per lineal foot in every row. Elsewhere, a larger crop of bean plants, not too ripe and dry for the silo, may be ensured by planting them separate from the Indian corn.

The Indian corn may be planted in rows 3 feet apart, with from 2 to 3 grains per lineal foot in every row. A horse-power corn-planter or seed drill may be used for that purpose. Or it may be planted in hills 3 feet apart both ways, with from 4 to 6 grains in every hill. A horse-power or hand corn-planter may be used. If neither of these implements and no other suitable planter be available, furrows 3 inches deep may be ploughed 3 feet apart. The seeds may be put in them and covered, after which the field should be rolled.

The horse beans may be sown in rows 3 feet apart, with from 3 to 6 grains per lineal foot in every row. The same machinery or method may be used as for the sowing or planting of the Indian corn.

The sunflower seeds are to be planted by themselves, in rows 3 feet apart. Not more than one plant per lineal foot in the rows should be left to grow. If they come up thicker, they should be thinned out to one plant for every twelve or eighteen inches in the rows.

### PUTTING INTO THE SILO.

To prevent deterioration and decay is the function of the silo; and to that end it should be constructed to exclude the atmosphere. To do so requires the use of building material of adequate strength. The fastening of its parts at the foundation



and at the corners of the silo should be secure. I have found one ply of sound one-inch lumber, tongued and grooved, nailed horizontally on the inside of studs two inches by ten inches, or two inches by twelve inches, to be sufficient.

When the Indian corn has reached the "glazing" stage of growth, the crop is to be put into the silo without wilting or drying; but if and when it has not reached the "glazing" stage before frost comes, it is to be cut and left to wilt or dry in the field for about one day.

The corn and beans are to be cut in lengths of from  $\frac{1}{2}$  inch to 1 inch and put into the silo; and the heads only of sunflowers are to be cut with them. They may be fed through the cutting-box on and with the corn and beans.

A fairly even distribution of the mixture should be made in the silo, while it is being filled. If the leaves and lighter parts are permitted to flutter into one place, and the stalks, ears and heavier portions are allowed to settle by themselves, the ensilage will not keep well.

The mixture is to be tramped thoroughly around the sides and in the corners of the silo.

A thin layer of uncut cornstalks should be put between the "Robertson mixture" and the other contents (if any) of the silo, in order to mark the exact place in the ensilage.

After the silo is filled, the surface should be levelled and thoroughly tramped; and after the lapse of not more than one day, it should be covered to a depth of six inches with cut straw or cheap fodder. If this be tramped occasionally, and a foot of cut straw be put on top of that a few days later, probably no waste ensilage will be found on the opening of the silo for feeding.

#### FEEDING THE ENSILAGE.

The "Robertson mixture" is to be fed with 4 pounds less meal or grain per 50 pounds of ensilage, than has been required with ordinary Indian corn ensilage, to make an economical ration for feeding milking cows and fattening cattle.

#### (4.)—ON THE CARE OF CHEESE WHEN BEING RETAILED.

When the cut surface of a cheese (not protected by the rind), is exposed to the air, evaporation goes on rapidly, and it soon becomes dry and loses much of its exquisite flavour.

When cheese is being retailed in a shop where one cheese will last the trade for a week or more, a simple, cheap and easy way to prevent loss from that cause, is to lay one-half of the cheese, with its cut surface, on a piece of grease-proof or parchment paper which has been covered with butter of good flavour. One half of the cheese may be left in that position while the other half is being cut up. The cut surface of the cheese should be kept covered as far as possible with grease-proof paper, upon which a thin layer of butter has been spread.

To protect the cheese against the attacks of "skippers" or maggots, it should be placed where flies cannot reach it. That can be done by keeping the cheese in a specially constructed case, with at least two sides of glass and a sliding or hinged door on the inward side of the counter.

If the cheese be handled in the way suggested, less loss of weight will be entailed upon the shop-keeper, the customers will be better pleased with it as a food, and the demand for its consumption will be increased.

## Report of the Dairy Commissioner.

### PART IX.—SUMMARY OF BUSINESS AT THE EXPERIMENTAL DAIRY STATIONS.

*Summary of the Business for the Season 1892, at the Dominion Experimental Dairy Station, New Perth, P.E.I.*

The factory was in operation 127 days. Milk was furnished by 143 patrons. The quantity of milk received at the factory was 669,168 lbs. The quantity of cheese manufactured was 63,018 lbs. The average price realized for cheese was 10·12 + cents per lb. The quantity of milk required to make a pound of cheese was 10·61 + lbs. The net value of milk to the patrons was 71·82 + cents per 100 lbs.

	Lbs.	\$ cts.
Proceeds from sales of cheese:—		
Shipped for Exhibition at Liverpool.....	186	18 60
do do Chicago.....	1,145	117 36
Sold to patrons as per Statement No. 1.....	1,927½	204 70
do Milk drawers.....	52¾	5 64
do New Perth Dairy Company for St. John Relief Fund.....	64	6 40
do Sundry persons per T. J. Dillon as per Statement No. 2.....	27,072¼	2,726 69
Shipped to Great Britain per J. W. Robertson, as per Statement No. 3.....	32,571	3,302 59
	63,018½	\$6,381 98
Charge for drawing milk and manufacturing cheese—63,018 lbs. at 2½ cents.....		1,575 46
Divided among patrons for milk as per Statement No. 1—		
Cash.....	\$4,138 39	
Charge for manufacturing, etc., after October 15th.....	23 24	
Milk-can account paid for patrons.....	459 25	
Cheese supplied to patrons.....	204 70	
	4,825 58	
LESS—Balances due by patrons.....	19 77	4,805 81
Fractions of cents.....		0 71
		\$6,381 98

STATEMENT No. 1, showing the totals of accounts at the Dominion Experimental Dairy Station, New Perth, P.E.I.

	Total.
Milk supplied..... lbs.	699,168
Value.....	\$4,805 81
Cheese to patrons..... lbs.	1,927½
Value.....	\$204 70
Milk cans.....	\$459 25
Charge for manufacturing after Oct. 15, seed, &c.....	\$23 24
Net cash to patrons.....	\$4,138 39
Balance due by patrons.....	\$19 77

STATEMENT No. 2, showing the Quantities and Value of Cheese sold to sundry persons by T. J. Dillon.

Name.	Cheese.	Amount.	Name.	Cheese.	Amount.
	Lbs.	\$ cts.		Lbs.	\$ cts.
			Brought forward.....	7,928½	793 00
Benj. Aitken.....	26	2 60	N. B. & M. Rattenbury.....	385	38 50
Angus McLean.....	62	6 20	Edwin Chay.....	77½	7 75
McDonald Bros.....	64	6 40	James Bourke.....	39	4 68
Brace & McKay.....	611	61 10	Benj. Aitken.....	47	5 64
McDonald & Westaway.....	63	6 30	N. B. & M. Rattenbury.....	5,268	526 80
W. A. Poole & Co.....	62	6 20	McDonald & Westaway.....	260	28 60
John G. Graham.....	28½	3 00	Mrs. Conners.....	36	4 32
James McDonald.....	54	5 40	James McDonald.....	252	27 42
Montague Stevens.....	67	6 70	Mrs. Johnston.....	64	7 68
Angus McLaurin.....	62	6 20	James Clow.....	65	7 80
Wm. Easton.....	41	4 30	C. McNeill.....	65	7 80
D. McKay.....	62	6 20	N. B. & M. Rattenbury.....	6,381	638 10
Mrs. Johnston.....	62	6 00	Mrs. Johnston.....	229	22 90
Neill Nicholson.....	190	19 00	Retailed in small amounts.....	5,975½	605 70
N. B. & M. Rattenbury.....	6,474	647 40			
Carried forward.....	7,928½	793 00	Total.....	27,072½	2,726 69

STATEMENT No. 3, showing the proceeds from 506 boxes of Cheese shipped to Great Britain per James W. Robertson, and sold by A. J. Rowson, Esq., 35 Tooley Street, London, S.E., England.

	Cwt.	Qrs.	Lbs.	s.	£	s.	d.
103 boxes cheese.....	59	1	10 @	52/6	155	10	8
115 do.....	65	1	18 @	53/6	174	19	6
212 do.....	120	2	5 @	55/6	334	10	3
76 do.....	42	0	9 @	56/	117	16	6
506	287	1	4		782	16	11
					£	s.	d.
2 months' discount at 5 per cent.....					6	10	6
Survey fee on damaged cheese.....					1	1	0
Sea water damage—Cheese cut and pilfered.....					1	5	0
					8	16	6
					774	0	5
					£	s.	d.
Charges.							
Ocean freight.....					35	4	0
Railway freight.....					20	4	9
Receiving, weighing, coopering, delivery, rent, fire insurance, &c.....					6	6	6
Commission and guarantee, 4 per cent.....					31	6	3
					93	1	6
Total net proceeds.....					£ 680	18	11

Exchange at \$4.85 = \$3,302.59

## Report of the Dairy Commissioner.

### *Summary of Business for the Season 1892-93, at the Mount Elgin Winter Dairy Station.*

The Station was in operation from November 25th to April 1st.  
 Milk was furnished by 95 patrons.  
 The quantity of milk received at the Station was 497,274 lbs.  
 The quantity of butter manufactured was 23,798 lbs.  
 The quantity of milk required to make a pound of butter was 20·89 lbs.  
 The average net price realized for butter was 22·84 cents per lb.  
 The net value to the patrons was 94·96 cents per 100 lbs. milk.

#### *Proceeds from Sale of Butter.*

	lbs.	\$ cts.
Sold to sundry persons as per T. J. Dillon.....	5,200	1,220 82
do do per Jas. W. Robertson.....	100	24 00
Shipped to Montreal per Thos. Shaw, as per statement No. 1.	3,050	663 21
do Great Britain per Jas. W. Robertson as per State- ment No. 2.....	2,808	547 56
Sold to Fitzgerald, Scandrett & Co.....	8,492	2,038 58
do Patrons.....	4,148	947 56
Butter milk.....		2 00
	23,798	\$ 5,443 73
Charge for manufacturing butter..... 23,798 lbs. @ 3c. per lb.		\$ 713 94
Divided among patrons, in butter.....		917 56
do do in cash.....		3,825 43
		5,486 93
Balances due by patrons.....		43 20
		\$ 5,443 73

STATEMENT No. 1, showing the Account Sales of 51 Tubs Butter sold by Thomas Shaw, Esq., Montreal, Que.

1893.	Tubs.		\$	cts.	\$	cts.
April 26....	2	98 lbs. at 24c.....	23	52		
	12	588 do 23½c.....	139	65		
	11	539 do 23½c.....	126	67		
	1	49 do 23½c.....	11	39		
	4	196 do 23c.....	45	08		
	30	1,470	346	31		
		<i>Charges.</i>				
		Freight.....	\$ 10	31		
		Commission, 4 per cent.....	13	85	24	16
						322 15
May 2....	21	599 lbs. at 24c.....	143	76		
	2	100 do 23½c.....	23	75		
	12	600 do 23½c.....	141	00		
	5	250 do 23c.....	57	50		
	31	1,549	366	01		
		<i>Charges.</i>				
		Freight.....	\$ 10	31		
		Commission, 4 per cent.....	14	64	24	95
						341 06
						\$ 663 21

STATEMENT, No. 2 showing the proceeds from 162 tubs of butter shipped to Great Britain and sold by Messrs. Andrew Clement & Son, Glasgow, and by John T. Warrington, jr., Esq., Belleville, Ont.

The following note was sent to the patrons of the Dairy Stations at Mount Elgin, Woodstock and Wellman's Corners at the time when the final payments for the season were made to them under date May 4th, 1893.

NOTES.—Full account sales of the butter shipped to Great Britain have not been received. Sales have been reported at 102s. per cwt. The Dairy Commissioner will be absent on official business in the Maritime Provinces until near the end of May; and rather than delay the settlement with the patrons, the accounts have been made up on that basis, leaving the adjustment of any small balances to be arranged, after the full account of sales have been received.

The account sales referred to are as follows:—

Account Sales of 54 Tubs of Butter sold by Messrs. Andrew Clement & Son, Glasgow, Scotland.

1893.		Cwt.	Qrs.	Lbs.	£	s.	d.	£	s.	d.	
April 29..	29 tubs of butter.....	12	3	21	at 98s.	63	7	10			
	17 do.....	7	2	10	at 96s.	36	8	6			
	8 do.....	3	2	8	at 92s.	16	8	6			
	54	24	0	11				116	4	10	
	<i>Charges.</i>										
	Freight and charges.....					3	10	7			
	Carriages and cartages.....					2	8	10			
	Discounts.....					1	18	8			
	Commission and guarantee, 3 per cent.....					3	9	8			
									11	7	9
									104	17	1

## Report of the Dairy Commissioner.

The information upon which I based the statement made in the note to the patrons that "sales have been reported at 102 shillings per cwt." was contained in a letter from A. Clement, Esq., under date of 19th April, 1893. It says, "your last shipment of butter arrived all right; as Manchester was a better market than ours we sent it there and have advice that they sold half of it when it arrived, and will likely clear it out this week. Butter market has been very bad but they expect to make 102 shillings for it."

ACCOUNT SALES OF 108 TUBS OF BUTTER SHIPPED BY T. J. WARRINGTON, JUN., ESQ., BELLEVILLE, ONT., AND SOLD ON ACCOUNT OF JAS. W. ROBERTSON IN GREAT BRITAIN.

1893.		Cwt. Qrs. Lbs.	£ s. d.	£ s. d.
May 31..	10 tubs of butter .....	4 2 16 at 90s..	20 17 10	
	5 do .....	2 1 4 at 90s..	10 5 8	
	6 do .....	2 3 2 at 88s..	12 3 7	
	6 do .....	2 3 2 at 88s..	12 3 7	
		12 1 24		55 10 8
	27 do .....	12 0 17 at 85s..	51 12 11	51 12 11
	27 do .....	12 1 5 at 85s..	52 5 0	52 5 0
	5 do .....	2 1 6 at 78s..	8 19 8	
	1 do .....	0 2 0 at 84s..	2 2 0	
	15 do .....	6 3 9 at 82s..	28 0 1	
	6 do .....	2 2 26 at 78s..	10 13 1	
	108			49 14 10
	<i>Charges.</i>			209 3 5
	Dock and town dues .....		0 10 5	
	Freight and master portorage .....		6 16 3	
	Carriage to Manchester .....		1 7 1	
	Bank Commission, &c. ....		2 3 7	
	Commission and guarantee, 5 per cent. ....		10 9 2	21 6 6
	By 32 days' interest .....			187 16 11
				0 16 6
				188 13 5
	Net proceeds from 54 tubs per A. Clement & Son. ....		104 17 1	8 cts. 497 98
	Net proceeds from 108 tubs per John T. Warrington, jun. ....		£188 13 5	911 90
	Contributed by Jas. W. Robertson .....			207 76
				\$1,617 64
	Paid to patrons at Mt. Elgin .....			547 56
	do Woodstock .....			547 56
	do Wellman's Corners .....			547 56
	Overpaid the patrons .....			1,642 68
				25 04
				\$1,617 64

### SUMMARY OF BUSINESS FOR THE SEASON 1892-93, AT THE WOODSTOCK WINTER DAIRY STATION.

The Station was in operation from November 16th to March 31st.

Milk was furnished by 57 patrons.

The quantity of milk received at the Station was 345,226 lbs.

The quantity of butter manufactured was 15,120 lbs.

The quantity of milk required to make a pound of butter was 22.83 + lbs.

The average net price realized for butter was 22.75 + cents per lb.

The net value to the patrons was 86.53 + cents per 100 lbs. of milk.

*Proceeds from Sales of Butter.*

	lbs.	\$ cts.
Sold to sundry persons per J. A. Ruddick.....	3,223	777 53
do do per J. W. Robertson.....	30	7 20
do Fitzgerald, Scandrett & Co.....	4,612	1,106 88
Shipped to Montreal per Thos. Shaw as per statement No. 1...	2,500	560 64
do Great Britain per Jas. W. Robertson. as per State- ment No. 2 (Mount Elgin).....	2,808	547 56
Sold to patrons .....	1,947	443 07
	15,120	3,440 88
Charge for manufacturing butter.. .....	15,120 lbs @ 3cts per lb.	\$ 453 60
Divided among patrons, in butter.....		443 07
do in cash.....		2,550 92
		3,447 59
Balances due by patrons.....		6 71
		\$3,440 88

STATEMENT NO. 1, showing the Account Sales of 50 Tubs of Butter sold by Thomas Shaw, Esq., Montreal, Que.

1893.		Lbs.	\$ cts.	\$ cts.
April 26..	6 tubs of butter.....	300 at 25c.....	75 00	
	5 do .....	250 at 24½c.....	61 25	
	7 do .....	350 at 24c.....	84 00	
	5 do .....	250 at 23½c.....	58 75	
	2 do .....	100 at 23c.....	23 00	
	25	1,250	302 00	
	<i>Charges.</i>			
	Freight .....	\$ 8 19		
	Commission, 4 per cent.....	12 08		
			20 27	
				284 73
	2 tubs of butter.....	100 at 25c.....	25 00	
	5 do .....	250 at 24½c.....	61 25	
	9 do .....	450 at 24c.....	108 00	
	5 do .....	250 at 23½c.....	58 75	
	4 do .....	200 at 23.....	46 00	
	25	1,250	299 00	
	<i>Charges.</i>			
	Freight .....	\$ 8 13		
	Commission, 4 per cent.....	11 96		
			20 09	
				278 91
				\$560 64

SUMMARY OF BUSINESS FOR THE SEASON 1892-93, AT THE WELLMAN'S CORNER WINTER DAIRY STATION.

The Station was in operation from November 23rd to March 31st.

Milk was furnished by 62 patrons.

The quantity of milk received at the Station was 302,728 lbs.

The quantity of butter manufactured was 14,037 lbs.

The quantity of milk required to make a pound of butter was 21·70 lbs.

The average net price realized for butter was 22·89 cents per lb.

The net value to the patrons was 89·91 + cents per 100 lbs. milk.

## Report of the Dairy Commissioner.

### Proceeds from Sales of Butter.

	lbs.	\$ cts.
Sold to sundry persons, as per J. B. McEwan .....	2,365	569 50
do Fitzgerald, Scandrett & Co. ....	5,616	1,347 84
Shipped to Montreal, per Thos. Shaw, as per Statement No. 1.	1,612	374 00
do Great Britain, per Jas. W. Robertson, as per Statement No. 2 (Mount Elgin) .....	2,808	547 56
Sold to patrons .....	1,636	374 51
Butter-milk sold .....	.....	23 82
	14,037	3,237 23
Charge for manufacturing butter..... 14,037 lbs. @ 3½c. per lb.		\$ 491 29
Divided among patrons in butter .....		374 51
do in cash.....		2,385 48
		3,251 28
Balances due by patrons. ....		14 05
		\$3,237 23

### STATEMENT No. 1, showing the Account Sales of 31 Tubs of Butter sold by Thomas Shaw, Esq., Montreal, Que.

		\$ cts.	\$ cts.
1893.			
March 25...	5 tubs, 260 lbs., at 25½c .....	66 30	
	12 " 624 " at 25c .....	156 00	
	3 " 156 " at 23½c .....	36 66	
	20 " 1040 " .....	258 96	
	<i>Charges.</i>		
	Freight.....	\$5 43	
	Commission, 4 per cent .....	10 36	
		15 79	243 17
April 13 ...	3 tubs, 156 lbs., at 24½c .....	38 22	
	7 " 364 " at 24½c .....	88 27	
	1 " 52 " at 24c .....	12 48	
	11 " 572 " .....	138 97	
	<i>Charges.</i>		
	Freight.....	\$2 58	
	Commission, 4 per cent .....	5 56	
		8 14	130 83
			374 00



SUMMARY OF BUSINESS FOR THE SEASON 1892-93, AT THE LONDON, ONT., WINTER  
DAIRY STATION.

The Station was in operation from November to April.

Milk was furnished by 22 patrons.

The quantity of milk received at the Station was 122,370 lbs.

The quantity of butter manufactured was 5,563 lbs.

The quantity of milk required to make a pound of butter was 21.99 lbs.

The average net price realized for butter was 23.95 + cents per lb.

The net value to the patrons was 93. + cents per 100 lbs of milk.

*Proceeds from Sales of Butter.*

	lbs.	\$ cts.
Sold to sundry persons per C. C. Macdonald.....	4,870	1,180 97
Loss by reprinting.....	60	.....
Sold to patrons.....	633	151 92
	<hr/> 5,563	<hr/> \$1,332 89
Charge for manufacturing butter 5,563 lbs @ 3½c. per lb.....		\$194 70
Divided among patrons, in butter.....		151 92
do in cash.....		997 58
		<hr/> \$1,344 20
Balance due by patrons.....		11 31
		<hr/> <hr/> \$1,332 89

SUMMARY OF BUSINESS FOR 1892, AT THE DOMINION EXPERIMENTAL DAIRY STATION,  
KINGSCLEAR, N.B.

The Station was in operation from June 14th to Oct. 31st.

Cream was furnished by 64 patrons.

The quantity of cream received at the Station was 28,756.9 inches.

The quantity of butter manufactured was 23,691.7 pounds.

The quantity of cream required to make one pound of butter was 1.22 + inches.

The average net price realised for butter was 19.594 cents per pound.

Proceeds from sales of 399 tubs butter shipped to Great Britain and sold per,—

A. Clement & Son, as per Statement No. 1.....	4,550	pounds	\$ 760 10
A. J. Rowson, " 2.....	9,255	"	1,684 76
Hodgson Bros., " 3.....	4,200	"	900 36
Jas. W. Robertson, " 4.....	1,950	"	369 52
Some freight charges, etc., in Great Britain paid by Department of Agriculture.....			67 10
	<hr/> 19,955		<hr/> \$ 3,781 84
Liverpool Exhibition.....	50	"	9 37
Sundry persons at 22½ cents per pound.....	2,472	"	556 20
do at 25 " ".....	216	"	54 00
Patrons at 16.09 + per pound, plus 3½ cents per pound for manufacturing.....	899	"	176 15
Shrinkage on butter repacked.....	99.7	"	.....
Proceeds from buttermilk.....		"	64 63
	<hr/> 23,691.7	"	<hr/> \$ 4,642 19

## Report of the Dairy Commissioner.

Divided among patrons; Cash.....	\$ 3,418 23
Butter.....	144 69
Manufacturing charge, 899 lbs. at 3½ cents.	31 46
"                    22,792·7 lbs. at 4½ cents.	1,025 67
Balance due patrons.....	22 14
	\$ 4,642 19

### STATEMENT No. 1, showing proceeds from sales of 91 tubs of butter.

*By A. Clement & Sons, Glasgow and Manchester.*

							£	s.	d.
4 tubs butter.....	1 cwt.	3 qr.	4 lbs.	@ 116s.	per cwt.....	10	7	2	
5 ".....	2	0	22	@ 112	".....	12	6	0	
3 ".....	1	1	10	@ 109	".....	7	6	1	
2 ".....	0	3	16	@ 104	".....	4	12	10	
12 ".....	5	1	12	@ 100	".....	26	15	8	
1 ".....	0	1	21	@ 98	".....	2	2	10	
4 ".....	1	3	4	@ 90	".....	8	0	8	
10 ".....	4	1	9	@ 88	".....	19	1	0	
10 ".....	4	1	16	@ 86	".....	18	17	9	
4 ".....	1	3	4	@ 75	".....	6	13	11	
36 ".....	16	0	8	@ 70	".....	56	5	0	
91							£172	8	11

#### Charges:—

Carriage—London to Manchester.....	3	1	10
London to Glasgow.....	2	2	9
Bristol to Manchester.....	0	16	6
	£6	1	1
Discounts.....	2	17	4
Commission and guarantee 3 per cent.....	5	3	5
	14	1	10
£158 7s. 1d. = \$760.10			
	£158 7 1		

### STATEMENT No. 2, showing proceeds from sales of 185 tubs of Butter.

*By A. J. Rowson, 35 Tooley St., London, S.E., England.*

						£	s.	d.
44 tubs butter.....	19cwt.	0qr.	9lbs.	@ 94s.	per cwt.....	89	13	7
28 ".....	12	0	22	@ 100	".....	60	19	7
1 ".....	0	1	21½	@ 116	".....	2	11	3
1 ".....	0	1	20½	@ 108	".....	2	6	9
5 ".....	2	0	21	@ 103	".....	11	5	4
30 ".....	13	0	14	@ 106	".....	69	11	3
28 ".....	12	1	19	@ 102	".....	63	6	10
1 ".....	0	1	12	@ 112	".....	2	10	0
35 ".....	15	2	2	@ 105	".....	81	9	4
12 ".....	5	1	12	@ 112	".....	30	0	0
185						£413	13	11
2 months' discount, 5 per cent.....						3	8	10
Carried forward.....						£410	5	1

		£	s.	d.	
	Brought forward. ....	410	5	1	
<i>Charges:—</i>					
		£	s.	d.	
*	{	Ocean freight, &c .....	17	12	0
		Dock dues, landing, &c.....	6	15	2
		Receiving, weighing, coopering, &c.....	4	19	9
		Special storage, 4 weeks @ £2 2s.....	8	8	0
		Commission and guarantee, 4 p.c.....	16	10	4
	Loss of commission on 214 tubs .....	5	0	0	
		59 5 3			
	£350 19s. 10d. = \$1,684.76.	£350 19 10			

Exchange was calculated at \$4.80 to the £; actual exchange when remittance was received and placed to credit of Receiver General was \$4.86 +, netting \$1,706.21.

STATEMENT No. 3, showing proceeds from sales of 84 tubs of Butter.

By *Hodgson Bros., Liverpool, England.*

					£	s.	d.			
10	tubs butter.....	4cwt.	1qr.	16lbs.	@	113s.	6d. per cwt.....	24	18	7
15	" .....	6	2	18	@			37	16	0
15	" .....	6	2	8	@	108	" .....	35	9	9
10	" .....	4	1	21	@	102	" .....	22	12	8
5	" .....	2	0	22	@	113	" .....	12	8	2
10	" .....	4	1	16	@	112	" .....	24	12	0
10	" .....	4	1	17	@	106	" .....	23	6	7
9	" .....	3	3	22	@	100	" .....	19	14	8
								£200 18 5		
84							Discount.....	1	17	8
								£199 0 9		

*Charges:—*

		£	s.	d.
	Carriage, warehouse, &c. . . . .	2	0	0
	Commission and guarantee, 4 p.c.....	8	0	9
	Brokerage.....	0	4	4
	Carriage from London. ....	2	18	6
		13 3 7		
	£185 17s. 2d. = \$900.36	£185 17 2		

STATEMENT No. 4, showing proceeds from sales of 39 tubs of Butter per Jas. W. Robertson.

39 tubs, weighing 1,950 lbs. = \$369.52.

NOTE.—The 39 tubs were the balance of the shipment; in the expectation of obtaining a better price, they were held through February and March; the market did not improve while the butter deteriorated in quality. Some of it was ultimately sold as low as 65s. per cwt. In view of these circumstances, the Dairy Commissioner took it on his own account and made up the amount required to bring it equal to the average price of the other 360 tubs of the shipment.

\* On the whole shipment of 399 tubs of butter.

## Report of the Dairy Commissioner.

### ACCOUNT Sales of 39 Tubs Butter sold by Messrs. Hodgson Bros., Liverpool, England.

Tubs. Cwt. qr. lbs.	£ s. d.	£ s. d.
10, 4 1 26, at 75s. ....	16 16 2	
5, 2 1 5, at 70s. ....	8 0 8	
5, 2 1 3, at 68s. ....	7 14 10	
6, 2 2 15, at 65s. ....	8 11 2	
3, 1 1 8, at 90s. ....	5 18 11	
5, 2 0 21, at 65s. ....	7 2 2	
5, 2 0 20, at 65s. ....	7 1 7	
39 17 1 14		61 5 6
<i>Charges.</i>		
Carriage from Manchester .....	0 12 7	
Cartage, 4s. 11d.; portorage, 6s. 6d.; warehousing, 4s. 11d.; insurance, 1s. 6d. ....	0 17 10	
Two months' discount .....	0 10 2	
Commission and guarantee .....	3 1 3	
		5 1 10
Net proceeds .....		56 3 8
	£56 3s. 8d. = \$269 68	
Contributed by Jas. W. Robertson .....	99 84	
	\$369 52	

### SUMMARY OF BUSINESS FOR THE SEASON 1892-93 AT THE SUSSEX, N.B., WINTER DAIRY STATION.

The Station was in operation from November 7 to April 17.

Milk was furnished by 24 patrons.

The quantity of milk received at the Station was 150,513 lbs.

The quantity of butter manufactured was 6,496 + lbs.

The quantity of milk required to make a pound of butter was 23.13 lbs.

The average net price realized for butter was 23.62 + cents per lb.

The net value to the patrons was 85.5 cents per 100 lbs. of milk, plus the skim-milk returned.

#### PROCEEDS FROM SALES OF BUTTER.

	lbs.	\$ cts.
Sold to sundry persons per J. W. Hart .....	6,391	1,509 74
do patrons .....	105	24 40
From buttermilk .....		9 59
	6,496	\$ 1,543 73
Charge for manufacturing butter 6,496 lbs. @ 3½ c. per lb		\$ 227 36
Divided among patrons, butter .....		24 40
Cash .....		1,287 01
Small balances (added to amount retained for manufacturing charge) .....		4 96
		\$ 1,543 73

## DAIRYING, STOCK ACCOUNT.

	No. of Boxes.	No. of Pounds.	Price.  \$ cts.
Purchases of cheese, 1891-92--			
Perth, Ont. ....	267	16,603	1,627 60
London, Ont. ....	376	24,418	2,521 49
Dunham, Que. ....	306	20,095	2,002 23
Manitoba. ....	33	1,939	203 60
New Brunswick. ....	166	10,105	1,004 82
Nova Scotia. ....	100	6,441	624 78
Sundry places. ....	40	2,630	249 61
	1,288	82,231	8,234 13
Sales of cheese, 1891-92--			
A. Clement & Son, Glasgow. ....	1,172	73,534	7,447 91
Thos. Shaw, Montreal. ....	86	5,082	399 83
Bate & Co., Ottawa. ....	10	544	57 12
Balance on hand, June 30, 1892. ....	20	1,088	.....
Accounted for by shrinkage. ....		1,983	.....
	1,288	82,231	7,904 86
Purchase and make of cheese, 1892-93-			
Balance on hand, June 30, 1892. ....	20	1,088	.....
C. A. Matheson, Perth. ....	1,476	109,366	10,550 28
L. C. Archibald & Co. ....	3	220	19 80
W. F. Gerow. ....	3	201	18 09
Alex. W. Grant. ....	5	314	30 61
A. Macfarlane. ....	57	3,967	376 87
C. L. Tilley & Son. ....	6	367	34 86
A. A. Ayer & Co. ....	9	723	68 69
New Perth Dairy Station, shipped. ....	527	33,902	.....
do do sold locally* .....		27,136½	.....
	2,106	177,284½	11,099 20
Sales of cheese, 1892-93 -			
By A. J. Rowson, London, Eng., as per Statement No. 3 of New Perth Dairy Station, and per account sales No. 1 hereafter. ....	753	49,239	5,159 65
By A. Callender & Co., Liverpool, as per account sales Nos. 2 and 3 hereafter. ....	549	41,674	4,169 68
By A. Clement & Son, Glasgow, as per account sales No. 4 hereafter. ....	167	10,491	1,091 47
By Hodgson Bros., Liverpool, as per account sales No. 5 hereafter. ....	525	36,780	3,599 64
Thomas Shaw, Montreal. ....	28	1,938	185 73
A. F. MacLaren, Windsor, Ont. ....	2	144	14 40
A. A. Ayer & Co., Montreal. ....	6	380	29 45
By T. J. Dillon, as per Statement No. 2 of New Perth Dairy Station, P. E. I. ....		27,072½	2,726 69
New Perth Dairying Company. ....		64	6 40
To World's Fair account. ....	28	1,840	188 60
At Experimental Farm, Ottawa. ....	8	402	42 21
	2,066	170,024½	17,213 92
By A. J. Rowson, not yet paid for (from Imperial Institute). ....	5	314	.....
By A. Clement & Son (not yet paid for), as per account sales No. 6 hereafter. ....	30	2,250	.....
Given away in Great Britain to pressmen and others. ....	4	266	.....
Given away at Experimental Farm, Ottawa, on occasion of farmers' excursions. ....	1	51	.....
Accounted for by shrinkage†. ....		4,379	.....
	2,106	177,284½	.....

\* There were sold to the patrons and milk drawers at New Perth 1,980 lbs. for \$210.34, which amount was deducted from the balances due them when the final settlement was made.

† The original weight of the cheese was taken when they were from 15 to 30 days old. There was a shrinkage in weight during the time the cheese were held for examination in store and in the experimental curing room; then there was the shrinkage on the shipments to Great Britain before they were sold there.

## Report of the Dairy Commissioner.

### No. 1.—CHEESE FROM PERTH DAIRY STATION, ONT. (C. A. Matheson, Esq.)

Account Sales 250 Boxes Cheese sold for Jas. W. Robertson, Ottawa, ex ss. "Brazilian" 22nd November, 1892, by A. J. Rowson, London, Eng.

1893.		£	s.	d.	£	s.	d.	
Jan. 14.....	Ex. 30	Boxes. 247	Cwt. 151	qr. 2	lb. 0	at 56s.....		424 4 0
		3	given away.					
		250						
		Less 3 months' discount at 5 p.c.....					5 6 0	
		<i>Charges.</i>						
		Freight, dock, landing and delivery charges.....					19 11 4	
		Receiving, weighing, cooping, delivering, rent, insurance, &c.....					3 2 6	
		Commission and guarantee, 4 p.c.....					16 19 4	
							39 13 2	
		Net proceeds.....					379 4 10	

### No. 2.—CHEESE FROM PERTH DAIRY STATION, ONT. (C. A. Matheson, Esq.)

Account Sales of 528 boxes Cheese, ex ss. "Numidian," sold for account of Jas. W. Robertson, Ottawa, by Andrew Callender & Co., Liverpool.

1893.		£	s.	d.	£	s.	d.		
Jan. 4.....	By sale	Boxes. 190	Ex. 34	Cwt. 131	qr. 2	lb. 21	at 50s.....		329 4 5
	do	165	35	116	0	4	at 50s.....		290 1 9
	do	173	36	110	2	19	at 52s.....		287 14 10
		528		358	1	16			907 1 0
		Less 2 months' interest.....					7 11 2		
		<i>Charges.</i>							
		Freight on 416 cwt. 2 qr. 6 lbs. at 40.85 cents per 100 lbs.....					39 14 2		
		Master Portorage.....					1 18 3		
		Entry dock and town dues.....					1 10 0		
		Attending ship, carting, receiving, storing, opening and showing, weighing, cooping and delivering.....					7 10 6		
		Rent, 98s. 4d.; fire insurance, 40s.....					6 18 4		
		Interest on charges.....					0 12 6		
		Bank commission.....					1 0 6		
		Brokerage and guarantee, 2 p.c.....					18 2 10		
							77 7 1		
		Net proceeds due 14th January, 1893.....					822 2 9		
		Liverpool, 18th January, 1893.							

## No. 3.—CHEESE FROM LIVERPOOL EXHIBITION.

Account Sales of 21 Boxes Cheese ex ss. "Sardinian," sold for J. W. Robertson, Ottawa, by Andrew Callender & Co., Liverpool.

1892.		Boxes.	Cwt.	qr.	lbs.	£	s.	d.	£	s.	d.		
Aug. 9	By sale	3 Canadian Factory, No. 1, wg.	2	1	7 at 48s.				5	11	0		
	do	3 The Glen	1	2	18 at 48s.				3	19	9		
	do	3 Ex. 10.	1	2	22 at 48s.				4	1	5		
	do	3 Palace Rd. Cheese Factory	1	3	5 at 48s.				4	6	2		
	do	3 Empey	2	2	18 at 48s.				6	7	9		
	do	3 Empress Queen	1	3	17 at 48s.				4	11	3		
	do	3 Empress	1	2	19 at 48s.				4		2		
		21	13	2	22				32	17	6		
		Less 2 months' interest									0	5	6
		<i>Charges.</i>									32	12	0
		Freight on 16 cwt. 0 qrs. 17 lbs. at 25s. per ton					1	0	2				
		Master Portage					0	1	6				
		Entry dock and town dues					0	2	6				
		Attending shipment, carting, receiving and storing, opening and showing, warehousing, coopering, and delivering, cartage to and from show, and expenses attending same, etc.					1	10	0				
		Rent, 1s. 5d.; fire insurance, 1s					0	2	5				
		Brokerage and guarantee, 2 p. c.					0	13	2				
											3	9	9
		Net proceeds due 19th August, 1892.									29	2	3
		Liverpool, 20th August, 1892.											

## No. 4.—CHEESE FROM EXPERIMENTAL CURING-ROOM, C.E. FARM, OTTAWA.

Account Sales of 167 Boxes Cheese sold for J. W. Robertson, Ottawa, by Andrew Clement & Son., Manchester.

1893.			Cwt.	qr.	lbs.	£	s.	d.	£	s.	d.				
June 14	20 Ex. 2,	9	4	2	10 at 48s.				11	0	3				
		11	5	1	17 at 44s.				11	17	8				
	13 Ex. 71	7	1	12	at 53s.				19	9	11				
	52 L. 73,	22	12	3	9 at 55s.				35	5	8				
		30	17	2	16 at 56s.				49	8	0				
	82 Ex. 75	45	3	11	at 55s.				126	1	8				
	167	93	2	19					253	3	2				
		<i>Charges.</i>													
		2 months' discount					2	2	3						
		Commission, 3 p. c.					7	11	10						
											9	14	1		
													243	9	1

## Report of the Dairy Commissioner.

### No. 5.—CHEESE FROM PERTH DAIRY STATION, ONT. (C. A. Matheson, Esq.)

Account Sales of 526 Boxes Cheese ex ss. "Numidian," sold for account of Jas. W. Robertson, Ottawa, by Hodgson Bros., Liverpool.

1893.			£ s. d.	£ s. d.
Jan. 31	Ex. 31	155 boxes	Cwt. qr. lbs. 94 3 14 at 55s.....	260 18 2
	32	170 do	94 0 15 at 50s.....	235 6 8
	33	100 do	68 2 18 at 49s.....	168 4 5
	33	100 do	70 0 11 at 50s.....	175 4 11
		525	328 1 16	839 14 2
			1 box given away.	
		526		
		Discount		9 17 6
		<i>Charges.</i>		831 16 8
		Freight, primage, £36 9s. 1d.; dues, &c., £1 7s. 3d.	47 12 8	
		Advance in Canada	500 0 0	
		Commission and guarantee at 4 p. c.	33 11 9	
		Brokerage	2 17 10	584 2 3
		Net proceeds		247 14 5

### No. 6.—CHEESE FROM PERTH DAIRY STATION, ONT. (C. A. Matheson, Esq.) Account Sales 30 Boxes Cheese sold by A. Clement & Son.

1893.			£ s. d.	£ s. d.
Jan. 9	Ex. 34	10 boxes	Cwt. qr. lbs. 6 2 21 at 52s. 9d.....	17 12 10
	35	10 do	6 3 23 at 53s.....	18 8 8
	36	10 do	6 1 22 at 53s.....	17 1 8
				53 3 2
		<i>Charges.</i>		
		2 months' discount	0 8 11	
		Commission, 3 p. c.	1 11 10	
		Freight	0 15 3	2 16 0
		Net proceeds		50 7 2



## DAIRYING, STOCK ACCOUNT.

	No. of Tubs.	No. of Pounds.	Price. § cts.
Butter made in 1891-92—			
Mount Elgin Dairy Station.....		11,062	
Woodstock Dairy Station.....		11,635	
		22,697	
Butter sold in 1891-92—			
J. L. Grant & Co., Ingersoll.....		8,920	1,559 66
Jas. Park & Son, Toronto.....		1,176	258 98
A. Clement & Son, Glasgow.....		9,619	1,953 75
Thos. Shaw, Montreal.....		805	155 28
D. Derbyshire, Brockville.....		99	19 18
		20,619	3,946 85
Sold to patrons, Mount Elgin.....		835	
do Woodstock.....		610 <sup>15</sup>	
Sold to sundry persons, Mount Elgin.....		344	79 29
Given away at Mount Elgin.....		56 <sup>1</sup>	
do Woodstock.....		30 <sup>20</sup>	
Accounted for by shrinkage.....		202 <sup>1</sup>	
		22,697	4,026 14
Butter made and purchased in 1892-93—			
Kingslear Dairy Station, N. B.....		23,691 7	
London do Ont.....		5,563	
Mount Elgin do Ont.....		23,798	
Sussex do N. B.....		6,496 7	
Wellman's Corners do Ont.....		14,037	
Woodstock do Ont.....		15,120	
S. M. Barre for Liverpool Exhibition.....	1	50	12 50
C. C. Brown do.....	1	46	9 20
Isaac Wenger do.....	1	50	10 00
		88,852 4	31 70
Butter sold in 1892-93—			
Fitzgerald, Scandrett & Co., London, Ont.....	368	18,720	4,439 48
Hodgson Bros., Liverpool, Eng.....	84	4,144	900 36
A. J. Rowson, London, Eng.....	185	9,095	1,706 21
J. T. Warrington.....	108	5,519	911 90
A. Clement & Son, Glasgow.....	184	9,167	1,527 76
A. Callender & Co., Liverpool.....	4	194	37 48
Thos. Shaw, Montreal.....	142	7,131	1,597 85
Sold locally at the dairy stations.....		24,867 7	5,897 96
	1,075	78,837 7	17,019 00
Sold to patrons at the dairy stations and deducted from the balances due them in making the final settlement.....		9,368	
Accounted for by shrinkage.....		646 7	
Fitzgerald, Scandrett & Co., due on account.....			52 32
	1,075	88,852 4	

## Report of the Dairy Commissioner.

### PART X.—CANADIAN DAIRY PRODUCTS AT THE WORLD'S COLUMBIAN EXPOSITION.

In the summer of 1892, I was invited by Prof. Wm. Saunders, Executive Commissioner for Canada at the World's Columbian Exposition, to make such arrangements as might be necessary and advantageous to the dairymen of Canada in making a representative and creditable display of butter and cheese at Chicago in 1893.

During the winter of 1891-92 some 75 boxes of cheese of the make of 1891 were selected and purchased from Messrs. J. L. Grant & Co., of Ingersoll, Ont. At that time no announcement had been received from the chief of the Department of Agriculture of the World's Fair, showing the classification, plan for exhibiting, or method of judging which would be adopted. It was thought prudent to have those cheese of 1891 on hand, in case an opportunity should be presented through which they might be used to illustrate the keeping qualities of Canadian cheese. They were exhibited on the Dairy Pyramid in the Agricultural Building from the opening of the exhibition, and were examined there by the judges of cheese in the June competition. The following is the verdict given on them:—

“We consider the two-year-old cheese on exhibition there to be excellent in flavour, in body and texture, and have never seen cheese which tried better at the same age.

“(Sgd.) JOHN H. HODGSON,  
A. F. MACLAREN.”

Some of them were also put on exhibition in October, 1893. They were examined by the judges and by the leading experts in cheese-making who visited the World's Fair. They were rated as “almost faultlessly fine.” These cheese of 1891 were ultimately sold at 10 cents per pound; and thus very little loss was entailed by the purchase of them.

On August 18th, 1892, I issued a bulletin giving information of the plan which it was proposed to follow in securing exhibits of cheese and butter. 4,500 copies of this bulletin were distributed (in English and French), and a summary of its contents was published in many of the newspapers. It appeared to meet with the approval of the dairymen of Canada—with one or two unimportant exceptions. I attended the meetings of the Dairymen's Boards of Trade at several places and urged upon the dairymen the desirability of preparing to make exhibits. I also met the Cheese and Butter Association of Montreal, to take counsel with its members in regard to the plan to be followed.

Several gentlemen, whose official positions, personal ability and interest in the success of Canadian dairy products commended them, were invited to assist in making final selections of exhibits. D. M. Macpherson, Esq., Lancaster, Ont., President of the Dominion Dairymen's Association, gave a ready assent and rendered excellent service. The following is a copy of a letter which was sent to Wm. Eager, Esq., President of the Dairymen's Association of Eastern Ontario:—

OTTAWA, October 8, 1892.

WM. EAGER, Esq.,  
President Dairymen's Association of Eastern Ontario,  
Morrisburg, Ont.

DEAR SIR,—I am writing the Presidents of the other two Dairy Associations of Ontario, to associate with themselves some one who is active in promoting the work of the Associations and who is in cordial sympathy with the effort which I am making to secure a most creditable display of Canadian cheese and butter at the World's Columbian Exposition. If you desire to seek the advice of the Board of Directors in this matter, please do so; or you may nominate some competent expert, whom with yourself, I may consult in reference to matters that may arise from time to

time in the selection of cheese from Eastern Ontario. Since the Dairy Associations at their last conventions recommended this work to the charge of my department, I am anxious to avail myself of their further helpful advice.

The enclosed sheet contains a copy of the resolutions which have been cut from the official reports (of the Dairy Associations of the province of Ontario.)

I am, yours very truly,

JAS. W. ROBERTSON,  
*Dairy Commissioner.*

Similar letters were sent to John Geary, Esq., London, Ont., President of the Dairymen's Association of Western Ontario, and D. Derbyshire, Esq., Brockville, Ont., President of the Ontario Creameries Association. Mr. Eager nominated John T. Warrington, Jun., Esq., Belleville, Ont.; Mr. Geary nominated A. F. MacLaren, Esq., Stratford, Ont., (now of Windsor, Ont.); and Mr. Derbyshire nominated J. S. Pearce, Esq., London, Ont. Mr. H. S. Foster, Knowlton, Que., President of the District of Bedford Dairymen's Association, had been appointed by the Executive Commissioner for the province of Quebec, to assist in preparing exhibits. He and Mr. J. de L. Taché, Ex-Secretary of the Dairymen's Association of Quebec, were invited to co-operate. Subsequently all these gentlemen were also requested to give personal attendance at Chicago in October, 1893, to assist in looking after the interests of Canadian cheese and butter.

#### THE MAMMOTH CHEESE.

As a unique feature of the Canadian exhibits, I was authorized to manufacture a Mammoth Cheese, which was intended as an advertising vehicle which would carry news-paragraphs, about the Canadian dairy industry and the opportunities which this country enjoys and affords for successful dairy farming, into all lands whence we might hope to attract desirable settlers. Particulars are mentioned in the fly-leaf in a following page. Through the courtesy of Mr. Van-Horne, President of the Canadian Pacific Railway Company, a special World's Fair cheese train was arranged for, to leave Perth on Monday, 17th April. A time-table was published, showing when the train would stop at the various railway stations between Perth, Ont., and Windsor, Ont. Throngs of people crowded the stations. The surface of the steel case of the cheese had been nicely painted before it left Perth; that was almost entirely covered by the autographs of persons of all ages, who scrambled on the car to inscribe their names. By this same World's Fair cheese train, were sent 6 large cheese of 1,000 pounds each, which had been obtained from Mr. D. M. Macpherson of the Allan Grove Combination. There were also sent 176 boxes of cheese similar to those which were to be entered in the different classes for competition, together with 10 cases of cheese of Stilton shape, to be used in decorating the Dairy Pyramid. These cheese of Stilton shapes were obtained from Mr. C. W. Riley, Ingersoll, Ont., Mr. Geo. Hatley, Brantford, Ont., and Mr. H. S. Foster, Knowlton, Que.

Permission was obtained from the Chief of the Department of Agriculture to place the Mammoth Cheese in the Agricultural Building, instead of in the Dairy Building, which was in a rather out-of-the-way part of the grounds. The Mammoth Cheese was made the centre of a Dairy Pyramid on the space allotted to Canada.

It was duly installed within a few days after the opening the Exhibition on May 1st. A short delay was caused by the ponderous exhibit breaking some of the joists supporting the floor.

The official judges were invited to examine the Mammoth Cheese and those on the Dairy Pyramid, which had, already on the 14th of June, been exposed to extreme heat under the glass-roofed building wherein they were placed. The following is a copy of the testimonial which they gave:—

JACKSON PARK, CHICAGO, ILL., 14th June, 1893.

We have examined the Mammoth Canadian cheese on the Dairy Pyramid in the Agricultural Building at the World's Columbian Exposition. For a cheese of such

## Report of the Dairy Commissioner.

huge size, we pronounce the flavour "remarkably good," and the body "extraordinarily fine." We found the 1,000 pound cheese to be of fancy quality and in first rate condition.

We consider the 2-year-old cheese on exhibition there to be excellent in flavour, in body and texture, and have never seen cheese which tried better at the same age.

After examining the cheese on the dairy pyramid from the provinces of Ontario, Quebec, New Brunswick, Nova Scotia and Prince Edward Island, it is our judgment that they are a lot of superior quality, and form a display which is most creditable.

(Signed), JNO. H. HODGSON,  
A. F. MACLAREN."

The judges bored into the Mammoth Cheese to a depth of 2 feet and found it uniformly solid. As it had become a centre of attraction, a display card from the Immigration Department was attached to it. Fly-leaves to the number of some 70,000 were given away to those who stopped to make inquiries. These cards contained a cut of the Canadian dairy pyramid, and gave the following facts concerning the Mammoth Cheese and the dairy interests of Canada :—

The "Canadian Mite," was manufactured at the Dominion Experimental Dairy Station, at Perth, Lanark County, Ontario, under the supervision of Prof. James W. Robertson, Dominion Dairy Commissioner. It forms part of the pyramid of Canadian Dairy Products at the World's Columbian Exposition, at Chicago.

207,200 pounds of milk were used in making it; that quantity is equal to the milk for one day in September of ten thousand cows. Mr. J. A. Ruddick, of the Dairy Commissioner's Staff, was the cheesemaker, and he was assisted by cheesemakers from twelve adjacent factories. Their names are :

Messrs. James McCann, Riverside Factory,  
James Clark, Mississippi Factory,  
Richard Halpenny, Drummond Centre Factory,  
Wallace Symes, Balderson's Corners Factory,  
David Ennis, Falbrook Factory,  
W. Wrathall, Harper's Corners Factory,  
Max. Gibson, Bathurst Mutual Factory,  
John McMunn, Tay Banks Factory,  
John Wiltsie, S. L. U. Factory,  
James Kirkland, Lone Star Factory,  
Thomas Wright, Stanleyville Factory,  
Elijah Hughes, Clear View Factory.

The cheese weighs 22,000 lbs. net. It is incased in the mould or hoop of steel in which it was pressed, and a pressure of more than two hundred tons was applied to make it perfectly solid. It measures twenty-eight feet in circumference by six feet in height.

\* \* \* \* \*

The exports of cheese from Canada exceed in value the total exports of cheese from the United States. The soil, climate, cattle and transportation facilities in Canada are admirably adapted for the prosecution of successful dairy farming.

The Dominion Government has established experimental dairy stations in different parts of Canada, and the Provincial Governments manage travelling dairies and dairy schools for the education of those interested in that branch of farming.

There are over 1,500 co-operative cheese factories and creameries in Canada. In most of the provinces there are excellent opportunities for intelligent farmers with some means, to make dairy farming pay well.

There are great areas of unoccupied fertile land in the Canadian North-west; and in the older provinces of Ontario, Quebec, New Brunswick, Nova Scotia, Prince Edward Island, Manitoba and British Columbia, improved farms can be purchased in neighbourhoods where all the snug conveniences of life may be enjoyed.

Free farms of 160 acres can be obtained in the Canadian North-west. For information apply to the Department of the Interior, Ottawa, Canada; or to James Anderson, Suite 509, Stock Exchange Building, Chicago, Ill.

A stair-case was built at one side of the Mammoth Cheese, to permit visitors to look at it, where a small portion of the cheese was uncovered. Some mischievous lads broke through the rind of the cheese and dug into it, for the purpose of getting a taste, and left it in a rather injured condition. In consequence of this, only a small portion was thereafter to be seen through glass.

The Mammoth Cheese was examined in June, again in July, again in September, and lastly in October, when the following recommendation was issued on its behalf by the official judges:—

“WORLD'S FAIR GROUNDS, JACKSON PARK,  
“CHICAGO, 13th October, 1893.

“We, the undersigned, judges of cheese at the World's Columbian Exhibition in October, 1893, certify that we this day examined the Mammoth Cheese from Canada in the Agricultural Building by boring into it with a trier to a depth of 33 inches.

“We report that the cheese is sound from the rind to the centre, that it draws perfectly solid, and cuts close in the texture; it has a good, clean flavour, which is quite tasty. In our opinion, it has kept its flavour remarkably well. We found the colour uniform and true; the workmanship of the making is most creditable. We attach a score card, which shows 95 points out of a possible score of 100 points, and recommend that a medal and diploma be awarded to the Dairy Commissioner for Canada.

“Being informed of the conditions under which the Mammoth Cheese, now thirteen months old, was exhibited during the summer in a building with a glass roof, where the temperature often stood over 95 degrees, the excellence of its quality was a source of surprise and wonder to us all.

(Signed)

“GEO. E. PERLEE,  
“A. H. BARBER,  
“A. F. MACLAREN.”

The cheese has been shipped to Great Britain; but it had already served its end in having directed the attention of food consumers and farmers throughout most of Europe, to the possibilities which Canada enjoys and offers for the production of fine dairy products and the following of dairy-farming with success.

#### SELECTION OF EXHIBITS.

A second edition of the bulletin “Canadian Dairy Products for the World's Columbian Exposition,” was issued on the 28th April, 1893. It was similar to the bulletin issued in August, 1892, with the addition of particulars of the rules of the Exposition relating to butter.

From the cheese at Montreal and Ingersoll, 162 exhibits were selected to be forwarded to Chicago for the Exhibition in June. Of these, 135 were of the make of 1892, and 27 lots were of the make of 1893. Forty-three exhibits of butter were sent.

#### CHEESE.

Each exhibit of cheese and butter was judged according to a score of points. The score cards set forth an analysis of the excellencies of the different exhibits under the proper headings. Those used for cheese were:—

Flavour.....	45
Texture and body.....	30
Colour.....	15
Finish.....	10

It was possible for a perfect exhibit to receive 100 points.

The judges appointed by the Exposition Committee on awards, were Messrs. John H. Hodgson, of New York, and A. F. MacLaren, of Windsor, Ont. Both are



EXHIBITION OF CANADIAN DAIRY PRODUCTS—AGRICULTURAL BUILDING,  
WORLD'S FAIR, CHICAGO.



JUDGES OF CHEESE AT THE WORLD'S FAIR:

A. H. Barber (Chicago),  
John H. Hodgeson (New York),

Geo. E. PerLee (New York),  
A. F. MacLaren (Windsor, Ont.)

## Report of the Dairy Commissioner.

judges of the highest reputation on the continent. They agreed to recommend that all exhibits of cheese, which received a score of 90 points and over, should be awarded a medal and diploma.

One hundred and twenty-nine exhibits from Canada were found to be scored high enough to entitle them to awards; and 31 exhibits of Canadian cheese were scored at a higher number of points severally, than the highest award given to any exhibit from any other country in the same classes. The following are the names of the successful exhibitors, together with the points scored by each successful exhibit:

### *Ontario.*

	Points.
J. W. Blyth, West Flamboro, Ont.....	98
W. F. Gerow, Napanee, Ont.....	97
John Lain, Big Springs, Ont.....	97
J. A. Ruddick, Perth, Ont.....	97
James A. Gray, Atwood, Ont.....	96
John Dempsey, Fairview, Ont.....	96
Gideon Moore, Kenilworth, Ont.....	96
T. J. Ballantyne, Listowel, Ont.....	96
J. T. Warrington (Allan's Settlement) Belleville, Ont.....	96
McAuley & Keeley, Railton, Ont.....	96
John Morrison, Newry, Ont.....	96
J. A. James, Nilestown, Ont.....	96
Amos Pickard, Wellburn, Ont.....	95
W. S. Stocks, Markdale, Ont.....	95
Jas. E. Young, Strathroy, Ont.....	95
James A. Gray, Atwood, Ont.....	95
F. E. Kline, Lakefield, Ont.....	95
W. F. Gerow, (No. 2) Napanee, Ont.....	95
Everetts & Strong (Lone Star) Easton's Corners, Ont.....	95
Geo. McDonald, Bluevale, Ont.....	95
B. J. Connolly, Kintore, Ont.....	94
Frank Meech, North Augusta, Ont.....	94
D. M. Macpherson (Fraserfield), Lancaster, Ont.....	94
D. M. Macpherson (Apple Hill) Lancaster, Ont.....	94
E. J. Madden, Newburgh, Ont.....	94
Sarah Baskett, London, Ont.....	94
M. K. Everetts & Son (Rideau Valley) Easton's Corners, O.	94
W. F. Gerow, Napanee, Ont.....	94
B. J. Connolly, Kintore, Ont.....	94
W. Whelan, Centreville, Ont.....	94
W. F. Gerow, Napanee, Ont.....	94
J. T. Warrington, (Alexander) Belleville, Ont.....	94
W. Woods, Molesworth, Ont.....	93
J. T. Warrington, (Prince of Wales) Belleville, Ont.....	93
F. E. Kline, Lakefield, Ont.....	93
B. J. Connolly Kintore, Ont.....	93
B. J. Connolly, Kintore, Ont.....	93
D. A. Dempsey, Stratford, Ont.....	93
Everetts & Strong, Easton's Corners, Ont.....	93
D. M. Macpherson, (Bainsville) Lancaster, Ont.....	93
John Brayley, Marston, Ont.....	93
J. S. Clarke, Warwick West, Ont.....	92
John Connolly, Malcolm, Ont.....	92
Frank Millson, Pinkerton, Ont.....	92
George Cleall, Selby, Ont.....	92
R. Cornett, Dundalk, Ont.....	92
J. J. Porritt, Tweed, Ont.....	92



	Points
S. R. Payne, Warsaw, Ont .....	92
J. A. James, Nileston, Ont.....	92
R. Cuddie, Woodstock, Ont .....	92
W. Whelan, Centreville, Ont.....	92
J. T. Warrington, (Union) Belleville, Ont.....	92
W. H. Effingham, Crumlin, Ont.....	91
Sarah Baskett, London, Ont.....	91
G. E. McTaggart, Rodgerville, Ont.....	91
James McKellar, Tiverton, Ont.....	91
James McCabe, Eastwood, Ont.....	91
William Eager, Morrisburg, Ont.....	91
L. P. Hubbs, Hillier, Ont.....	91
Charles Stewart, Flesherton, Ont .....	91
B. J. Connolly, Kintore, Ont.....	91
W. Whelan, Centreville, Ont.....	91
J. Wilford, Brownsville, Ont.....	91
M. K. Everetts & Son, (Rideau Valley) Easton's Corners, O.	90
J. A. Ruddick, Perth, Ont .....	90
G. B. Brodie, Pond Mills, Ont .....	90
J. T. Warrington, Belleville, Ont.....	90
Mrs. Eliza Parsons, Guelph, Ont.....	90
B. J. Connolly.....	90
E. J. Madden, Newburgh, Ont.....	90
Unknown, Ont.....	95

*Quebec.*

A. T. Newton, Abercorn, Que.....	97
Andrew Fossy, Granboro', Que .....	96
C. A. Beattie, (No. 2), Iron Hill, Que. ....	96
Nap. Desfosses, (No. 1), Nicolet, Que.....	96
Nap. Desfosses, Nicolet, Que.....	95
C. A. Beattie, Iron Hill, Que.....	95
J. N. Duguay, La Baie du Febvre, Que.....	95
R. Wherry (Mountain Pass), Knowlton, Que.....	95
Mrs. A. Macfarlane, Sutton Junction, Que.....	95
S. Duhamel, Pigeon Hill, Que.....	95
C. D. Jewell, Sweetsburg, Que.....	95
Mrs. Nazaire Vidal, Warwick, Que.....	94
Edmund Deauplaise, St. Pie de Guire, Que.....	94
D. F. Sweet, Sweetsburg, Que.....	94
W. A. Perkins, East Dunham, Que.....	94
Ger. St. Pierre, East Arthabaska, Que.....	94
R. Wherry, Knowlton, Que.....	94
R. J. Tilson, Haseville, Que. ....	94
W. A. Wells, Sutton, Que... ..	94
W. Parent, St. Elphège, Que.....	94
H. O. Wales, Sutton Junction, Que.....	94
Mrs. A. Macfarlane, Sutton Junction, Que.....	94
Mrs. A. Newton, Abercorn, Que .....	94
R. Wherry (No. 2), Knowlton, Que .....	94
J. N. Duguay (No. 3), La Baie du Febvre, Que. ....	94
Mrs. M. J. Tracy, Mansonville, Que.....	93
R. J. Tilson, Haseville, Que.....	93
Mrs. C. D. Jewell, Sweetsburg, Que... ..	93
C. D. Jewell, Sweetsburg, Que.....	93
George Miller, West Brome, Que.....	93

## Report of the Dairy Commissioner.

	Points.
Arthur Macfarlane, Cowansville, Que.....	93
R. Morrison, Knowlton, Que.....	93
C. A. Beattie, (No. 1), Iron-Hill, Que.....	93
A. Macfarlane, Sutton Junction, Que .....	93
D. O. Bourbeau, Victoriaville, Que .....	93
Edmund Deauplaise, St. Pie de Guire, Que.....	92
W. S. Purdy, Savage's Mills, Que.....	92
D. O. Bourbeau, Victoriaville, Que. ....	92
W. A. Perkins, East Dunham, Que.....	92
Mrs. C. D. Jewell, Sweetsburg, Que.....	92
A. Crittenden, West Brome, Que.....	92
Alfred Trudel, St. Prosper, Que .....	92
T. McKee, Sutton Junction, Que.....	91
George Miller, West Brome, Que.....	91
W. Parent, St. Elphège, Que.....	91
J. N. Duguay, (No. 1.) La Baie du Febvre, Que.....	91
R. Wherry, Knowlton, Que.....	91
J. W. Benjamin, West Brome, Que.....	91
Gabriel Hamel, Cap Santé, Que. ....	91
C. A. Beattie, Abercorn, Que.....	91
J. A. Howie, (Vale Perkins), Millington, Que .....	90
J. L. & H. S. Gilbert, Dunham, Que.....	90

### *Maritime Provinces.*

Angus Cameron, Antigonish, N.S.....	96
D. McPhie, River John, N.S.....	92
T. J. Dillon, New Perth, P.E.I.....	91
T. J. Dillon, New Perth, P.E.I .....	90
Allen Kennedy, Union Centre, N.S.....	90
C. L. Tilley & Son, Waterville, N.B.....	90

### BUTTER.

It was not expected that the main exhibit of butter from Canada would be made until October. The judges of butter in the June competitions were Messrs. Manfield of Wisconsin, and John S. Pearce of London, Ont. The scoring card used was :

Flavour .....	45
Grain .....	25
Colour .....	15
Salting .....	10
Packing .....	5

---

100

The minimum standard of points, at and above which the judges decided to recommend exhibits for a medal, was fixed at 97. Notwithstanding the few lots which were sent from Canada, 13 were scored at above the minimum. Eleven of these went to the province of Quebec, mostly to the county of Brome, where they were collected by H. S. Foster, President of the District of Bedford Dairymen's Association.

The following is the record of points scored by exhibitors:

J. D. Leclair, Ste. Thérèse de Blainville, Que.....	99
do .....	99
L. R. Whitman, Knowlton, Que.....	99
H. Chamberlain, West Bolton, Que .....	99
J. D. Leclair, St. Hyacinthe, Que.....	98

	Points.
N. P. Emerson, Sutton Junction, Que .....	98
T. L. Burnett, Farnham Centre, Que.....	98
S. R. Brill, Teeswater, Ont.....	97
J. D. Leclair, Ste. Thérèse de Blainville, Que.....	97
N. P. Emerson, Sutton Junction, Que.....	97
T. L. Burnett, Farnham Centre, Que.....	97
Croll & McCulloch, Glenroy, Ont.....	97
W. P. Hillhouse, Knowlton, Que. ....	97

After the June competition, some of the cheese, which had won awards, were displayed for a time in the dairy building. No provision was made for keeping the building cool, and nearly all the cheese which had been in competition, as well as those from the dairy pyramid in the agricultural building, were put temporarily into the cold storage building on the exhibition grounds. Unfortunately, that building was shortly afterwards destroyed by fire, with a lamentable loss of life. A few boxes of cheese were rescued from the debris, but most of those we had put in, were either wholly consumed or spoiled.

#### CHANGE OF PLAN.

In my opinion it was not desirable that another exhibit of cheese or butter should be sent from Canada before October. An intimation to that effect was made public through the newspapers and in other ways. The following letter which I sent to the president of the Dairymen's Association of Western Ontario, sets forth some of the reasons why it was decided not to send cheese or butter to Chicago a second time before the cool weather of autumn:—

“OTTAWA, July 1st, 1893.

“ John Geary, Esq.,  
President Dairymen's Association of Western Ontario,  
London, Ont.

“ My Dear Sir,—This afternoon I telegraphed you as follows: ‘I offer my congratulations upon success of Canadian cheese at Chicago; letter from Wheaton received; I will be glad to accept what assistance Association can offer in collecting exhibit for September or October.’

“ Late to-night I received your telegram, which reads as follows: ‘Exhibit at Chicago considered by executive to-day; think full information should be made public at once; are June cheese to be sent to Chicago, when will it be judged? What other months are to be shown, and when? How many lots from Western Ontario? Is number limited? Following resolution carried unanimously ‘that selections of cheese for Chicago be made at factories, and it be left to the Executive of the Association to choose men in the trade to make such selection.’ Answer at once.”

Had Saturday not been a holiday and our office, to which messages are telephoned, not been closed, I might have been able to telegraph reply. Let me answer the points seriatim:—

1. *Full Information.*—If this refers to a publication of the results of the competition in June at Chicago, they cannot be published officially until I receive *official* intimation of them from the authorities of the World's Fair. I received the information informally, and it was given to the press in that way. The names of the successful exhibitors were given to the press of Toronto and Montreal yesterday, and should appear in Monday's paper.

If it refers to the next competition in which Canada will take part, information on that point was given to the public through the three morning newspapers of Toronto, and from them was copied into nearly all the papers of the Dominion. At least, I suppose so, as I have heard of it from the Maritime Provinces, Quebec and Ontario.

The reasons which caused me to advise that no Canadian cheese or butter be sent to Chicago for the July competition are briefly these:

## Report of the Dairy Commissioner.

(a) No exhibitor who takes part in the competitions will receive more than one medal, no matter how many lots of his may score high enough;

(b) Canadian cheese took such an unprecedentedly high place in the June competition, that the good name of our industry and country was not likely to gain any additional prestige from any competition so close in point of time as the following month;

(c) The cost of making a creditable and representative exhibit is considerable, and should not be incurred unless an equivalent advantage can be gained;

(d) The time to get a satisfactory number of satisfactory exhibits together was short, as notwithstanding the fact that I had flooded the cheese-makers with bulletins on the subject, the interest had waned and almost died out, until the publication of the magnificent success in June revived it with additional intensity. I thought I foresaw that result.

(e) I think Canadian cheese and butter should be sent to Chicago for the competition for which exhibits are to be received during the first ten days of October. The competitions at our own exhibitions in Canada this year are likely to be unusually keen and general; these will be held mostly in September. I do not think that it would be to the advantage of Canada to take part in both the September and October competitions at Chicago; and I prefer the latter for the reason stated, and also because of the colder weather of October for our butter and cheese.

2. *Re June Cheese.*—I recommended to the authorities in Chicago last autumn the desirability of having sub-classes or sections for Junes, Julys, Augusts, &c., in which they would be judged separately as Junes, Julys, &c. They kept to the original announcement that "all cheese will be divided into two classes, that made previous to the year 1893, and that made during the year 1893." What is wanted is the *best* cheese in 1893,—no matter in what month made. As a rule Junes are not quite so fine, and would not score as high in September or October, as Augusts or Septembers would.

3. *Number of Lots.*—The number of lots which may be sent from Western Ontario is limited only (1) to 1 *cheese* for each class in which entry is made, (2) to the number of lots which are fine enough to pass inspection as per clause 6, page 8 of the Bulletin "Canadian Dairy Products for the World's Columbian Exposition." (Copy enclosed.)

4. *Resolution Adopted.*—I will be very glad if the association will designate men in the trade to make selections at the factories and to render such other assistance as they can give. The resolution reads, "That selections of cheese for Chicago be made at the factories, and it be left to the Executive of the Association to choose men in the trade to make such selections." I welcome this offer of assistance on the part of the executive. I do not suppose that the executive intend to intimate by the words that "it be left to the executive," that they are unwilling that other cheese which may be offered for exhibition (besides those which their appointed men in the trade may select) should also be sent forward to Chicago, if counted worthy. The executive of the association has always had the right and privilege which it has now expressed a willingness to exercise, but if the resolution intimates in even the slightest degree, that the executive of the association desires to exercise exclusive control to the extent of excluding from the World's Fair any cheese from Western Ontario which may not be selected under their supervision, then to that extent it does not meet my approval.

5. The facts contained in this letter may be found in more extended form in the bulletin issued from my office 28th April last, and mailed to all the cheese-makers, whose addresses I have—about 1,300 in all."

\* \* \* \* \*

On the 24th July, 1893, a third edition of the bulletin "Canadian Dairy Products for the World's Columbian Exposition," was issued. It contained full particulars of the provisions which had been made, and a copy of it is submitted herewith :—

DEPARTMENT OF AGRICULTURE.  
CANADIAN DAIRY PRODUCTS  
FOR THE  
WORLD'S COLUMBIAN EXPOSITION.

DAIRY COMMISSIONER'S OFFICE,  
Ottawa, 24th July, 1893.

I have been directed by the Honourable the Minister of Agriculture, to make such arrangements as may be necessary to assist the dairymen of the Dominion to make another truly representative and creditable display of Butter and Cheese at the World's Columbian Exposition. Dairy products will be received at Chicago for the next exhibition in which Canada will be represented between the first and tenth of October.

The following extracts from the rules of the Department of Agriculture of the World's Columbian Exposition, set forth the particulars in reference to the classes for Butter and Cheese.

Canadians may be Exhibitors in any or all of them.

BUTTER.

EXTRACTS FROM THE RULES OF THE DEPARTMENT OF AGRICULTURE OF THE  
WORLD'S COLUMBIAN EXPOSITION.

"12. The arrangement of all dairy exhibits will be under the control of this Department.

"13. Exhibits of butter will be classified and limited, as follows:—

- Class 1. *Dairy*,—butter made by exhibitor on the farm from a mixed herd. Exhibit to consist of not more than one package, weight to be not less than 10 nor more than 20 pounds.
- Class 2. *Dairy*,—butter made by exhibitor on the farm from a herd of *one breed*. Exhibit to consist of not more than one package, weight to be not less than 10 nor more than 20 pounds.
- Class 3. *Prints and fancy packages*,—butter must be manufactured by exhibitor. Exhibit to occupy space not exceeding 18 inches square. Total weight of exhibit not to exceed 20 pounds.
- Class 4. *Creamery*,—butter made by the exhibitor from the milk of *mixed herd* from cream separated from the milk in the creamery where the butter is made. Exhibit to consist of one commercial package, to weigh not less than 55 pounds.
- Class 5. *Creamery*,—butter made by exhibitor from gathered cream. Exhibit to consist of one commercial package, to weigh not less than 55 pounds.

"19. Butter will be judged on the following points, the figures set opposite indicating the maximum per cent, the total of all such maximums being 100 :

Flavour.....	45
Grain.....	25
Colour.....	15
Salting.....	10
Packing.....	5

Total..... 100

"The general standard of colour for butter will be "*June Grass Butter*."

## Report of the Dairy Commissioner.

Canadians should make excellent exhibits in all classes, except in class 3.

In that class, *Prints and fancy packages*, we want only a few choice lots.

In order to afford intending exhibitors every reasonable facility, I am permitted to make the following announcements and to invite the hearty co-operation of butter-makers, creamery-managers, patrons and dairymen, in an effort to make such a display of CANADIAN BUTTER as will direct the attention of the world, in a favourable manner, to the admirable opportunities which Canada offers for profitable dairy farming.

(1.) Those who intend to exhibit may write to the Dairy Commissioner, Ottawa (postage free), asking for butter tubs, address labels, and entry forms.

(2.) Any butter-maker, dairyman or representative of any dairy or creamery, may send butter for exhibition, addressed to the Dairy Commissioner at Montreal or Ingersoll, Ont., to reach either place not later than 26th September.

(3.) For the *Dairy* and *Creamery* classes, tubs of a uniform size and style will be furnished at cost price to intending exhibitors.

(4.) The butter should be packed securely so as to avoid injury from heat during transit from the place of manufacture to Montreal or Ingersoll, Ont. Refrigerator cars will be used between these places and Chicago; and refrigerator space under glass has been provided at the Dairy Building on the Exhibition Grounds.

(5.) The Dominion Government will pay all freight charges, as well as the cost of caring for the butter during the exhibition and until it is disposed of afterwards.

(6.) By the authority of the Honourable the Minister of Agriculture, I am permitted to state that the Government will advance such a price as may be fixed by the Dairy Commissioner, on all the butter which is received at Montreal and Ingersoll.

(7.) Several expert judges of acknowledged reputation in Ontario and Quebec have been invited to assist the Dairy Commissioner in selecting from the lots which are received at Montreal and Ingersoll, such butter as may be counted worthy of being sent to Chicago.

(8.) After the awards have been made at Chicago, the butter which has won medals, or honourable mention, will be arranged in Provincial groups, where it will be used as may best set forth facts pertaining to the dairy and general agricultural interests of the several Provinces of Canada.

### CHEESE.

#### EXTRACT FROM THE RULES OF THE DEPARTMENT OF AGRICULTURE OF THE WORLD'S COLUMBIAN EXPOSITION.

" 14. Exhibits of cheese from the United States and Canada will be classified and limited, as follows :—

Class 1. *Cheddars*—Exhibit to consist of one cheese, diameter not less than 14 nor more than 16 inches, height not less than 9 inches, weight to be not less than 50 pounds.

Class 2. *Cheddars*—Home trade—Exhibit to consist of one cheese not less than 6 inches in height and not less than 12 nor more than 15 inches in diameter.

Class 3. *Mediums*—Exhibit to consist of one cheese not less than 6 nor more than 7½ inches in height, diameter not less than 14 nor more than 15½ inches.

Class 4. *Flats*—Exhibit to consist of one cheese, diameter not less than 13 nor more than 16 inches, weight not less than 25 nor more than 40 pounds.

Class 5. *Young Americas*—Exhibit to consist of four cheese in one package, total weight to be not less than 30 nor more than 45 pounds.

Class 6. *Domestic Swiss*—Exhibit to consist of one cheese, weight to be not less than 30 pounds.

Class 7. *Brick Cheese*—Exhibit to consist of six bricks in one package, total weight to be not less than 20 nor more than 40 pounds.

Class 8. *Dairy*—Cheese made by exhibitor on the farm from exhibitor's own herd. Exhibit to consist of one cheese, weight to be not less than 30 pounds.

Class 9. *Pineapple Cheese*—Exhibit to consist of four cheese in one package.

" 15. Cheddars and flats will each be classified in two groups, viz., white and coloured, and will be separately judged. Cheese other than that mentioned above, offered for exhibition from the United States and Canada, and all cheese offered for exhibition from points outside of the United States and Canada will be subject to such limitations and restrictions as to quality as may be decided upon by the Chief of the department at the time application for space is made.

" 16. All cheese exhibited from the United States and Canada, known commercially as "*American*" and "*Canadian*" cheese, must be manufactured of full new milk.

" 17. Cheese that has been cut, bored, or tried in any way, will not be admitted for exhibition.

" 18. All cheese will be divided into two classes, that made previous to the year 1893, and that made during the year 1893, and will be judged on the following points, the figures set opposite each indicating the maximum per cent, the total of all such maximums being 100 :—

Flavour .....	45
Texture and body.....	30
Colour.....	15
Make up.....	10
	100

Canadian manufacturers of cheese should make numerous and excellent exhibits in Classes 1, 5 and 8. Class 5 will admit cheese which are commonly known as "*Canadian Loaf*" or "*Truckle*" cheese.

Since all cheese will be divided into two main classes, "that made previous to the year 1893, and that made during the year 1893," the cheese of the make of 1892 which were reserved at Montreal and Ingersoll will be entered in the exhibition to be held in October.

In order to give every cheese-maker, who has cheese of excellent quality, an opportunity of taking part in the exhibition, I am permitted to make the following announcements, and to invite the hearty co-operation of all cheese-makers, salesmen, factory managers and patrons, towards making such a display of Canadian cheese as will call the favourable attention of the world to the admirable facilities which the Dominion offers for profitable dairy farming.

(1.) Intending exhibitors may write to the Dairy Commissioner, Central Experimental Farm, Ottawa, (postage free) asking for address labels for cheese, and entry forms.

(2.) Any cheese-maker or other representative of any factory or dairy, may send by freight cheeses for any or all of the classes, addressed to the Dairy Commissioner, at Montreal, or Ingersoll, Ont., to reach either place not later than 26th September.

(3.) Two cheeses or packages for every entry should be sent; one cheese can be bored for testing at Montreal or Ingersoll, while the other may be forwarded intact to the World's Fair. The cheese from every factory, which will merit the highest number of points when judged in October—no matter in what month they were made—are wanted. Probably those selected from the last half of August or the first ten days of September will be best.

(4.) The Dominion Government will pay all freight charges, as well as the cost of caring for the cheese during the exhibition and until they are disposed of afterwards.

(5.) By the authority of the Honourable the Minister of Agriculture, I am permitted to state that the Government will advance such a price as may be fixed by the Dairy Commissioner, on all the cheeses which are received at Montreal and Ingersoll.

## Report of the Dairy Commissioner.

(6.) Several expert judges of acknowledged reputation in Ontario and Quebec have been invited to assist the Dairy Commissioner in selecting from the lots which are received at Montreal and Ingersoll, such cheeses as may be counted worthy of being sent to Chicago.

(7.) After the awards have been made at Chicago, the cheeses which have won medals or have received honourable mention, will be arranged in provincial groups in the dairy building and on the dairy pyramid, where they will be used to advertise the dairy and general agricultural interests of the several Provinces of Canada.

### GENERAL.

The Dominion Government will bear all expenses of transporting, placing, caring for, and disposing of the butter and cheese.

The several exhibitors will be afforded every opportunity which may exist, or which may be provided, for winning medals and prestige for themselves; and they will not be asked to incur any loss, as the Government will not claim any rebate on the price which is advanced on the butter and cheese. This provides for liberal treatment of those engaged in the great dairy industry of Canada, and I invite your cordial co-operation in the effort to make the Canadian exhibit of butter and cheese the best which has ever been made.

JAS. W. ROBERTSON,  
*Dairy Commissioner.*

After conferences with the Executive Committees of the Dairymen's Associations of Western Ontario and of Eastern Ontario, these committees decided to invite expert judges, mainly from among the cheese buyers, to assist the cheese-makers to make selections at the factories, of exhibits to be sent to Ingersoll and Montreal. It was agreed that the expenses incurred by these cheese buyers should be paid by the Dominion Government. Helpful assistance was rendered by these specially nominated experts, as well as by others who had also assisted in selecting cheese at the factories in the autumn of 1892.

### OCTOBER COMPETITION.

For the Exhibition in October, 539 exhibits of cheese and 167 exhibits of butter were sent to Chicago from Montreal and Ingersoll.

The judging was conducted in the fairest manner, as the following extracts from a report of a meeting of the official representatives of dairying at the World's Fair, will show :—

“ A meeting of the official representatives of Dairying at the World's Columbian Exposition, from Iowa, Wisconsin, New York, Illinois, New Hampshire, Vermont, Nebraska, Connecticut, Minnesota and Canada was held on the Exhibition Grounds on Saturday, October 7th, 1893.

“ A deputation (consisting of Messrs. Robertson, McKinstry, Ashburn, Gabrielson, Smith, Loomis and Arms), was appointed to lay the following recommendations before the proper authorities :—

1. “ It is recommended in the judging of butter, that one person bore samples from the exhibits of butter and that a sample be given directly on a separate trier to every judge.

2. “ It is recommended that every judge record his own judgment on a separate score card without consultation, and that the final score of points on every exhibit be the average of the score of points given by the three judges ; but, in case there should be a difference of five points or more between the scoring of two of the judges in any one division of the score card, there shall be another examination made on lines similar to those of the first examination.

3. “ It is recommended that the exhibitors be allowed a clerk to keep a record of the scores for the use of the representatives of dairying from the different States, and that the same clerk be named and paid by those representatives.



4. "It is recommended that the same rules that govern the judging of butter shall govern the judging of cheese; and further, that the several exhibits of cheese be presented to the judges in a room, or in such a way that the source (as to locality and the individual exhibitor, cannot be known to the judges.

5. "It is recommended that three judges be appointed on cheese, viz.: one judge from Canada, one judge from the district of the Eastern States, and one judge from the district of the Western States.

"These recommendations, in the form of propositions, were adopted one by one, and unanimously, by the representatives of dairying at the World's Columbian Exposition from Iowa, Wisconsin, New York, Illinois, New Hampshire, Vermont, Nebraska, Connecticut, Minnesota, Indiana, and Canada.

(Signed) JAS. W. ROBERTSON,  
*Chairman.*  
A. P. MCKINSTRY,  
*Secretary."*

"Confirmed:

For Iowa, C. I. Gabrielson; for Wisconsin, D. W. Curtiss; for New York, G. L. Smith; for Illinois, Lovejoy Johnson; for New Hampshire, W. D. Baker; for Vermont, H. M. Arms; for Nebraska, D. P. Ashburn; for Minnesota, A. P. McKinstry; for Indiana, Laura D. Wooley; for Canada, Jas. W. Robertson.

These recommendations were, as far as practicable, carried out, and the judging was done in such a way as to prevent any conscious or unconscious bias on the part of those who acted.

#### CHEESE.

Messrs. Geo. E. Perlee, of New York, A. H. Barber, of Chicago, and A. F. MacLaren, of Windsor, Ont., were the judges appointed. It was decided by the judges to recommend (1), that cheese of the make of 1892, which were scored at 90 points or over, should be entitled to an award of a medal and diploma, and (2) that cheese of the make of 1893, which scored 95 points or over, should be entitled to an award of a medal and diploma.

The following is a list of the successful exhibitors, together with the number of points scored by each:—

#### CHEESE OF 1892.

##### ONTARIO.

	POINTS.		POINTS.
G. B. Brodie, Pond Mills.....	97½	D. M. Macpherson, Fraserfield.....	96
J. E. Young, Strathroy.....	97½	J. S. Clarke, Warwick West.....	96
J. W. Blyth, Lynden.....	97	J. Morrison, Newry.....	96
W. F. Gerow, Napanee.....	97	Sarah Baskett, London.....	96
G. Cleall, Selby.....	97	J. A. James, Nilestown.....	95½
G. Macdonald, Bluevale.....	97	Evertts & Strong, Easton's Corners.....	95½
R. Cornett, Dundalk.....	97	M. K. Everetts & Son, Rideau Valley.....	95½
A. Pickard, Wellburn.....	97	W. Whalen, Centreville.....	95½
W. S. Stocks, Markdale.....	97	J. J. Porritt, Tweed.....	95½
D. A. Dempsey, Stratford.....	96½	J. Beaton, Brantford.....	95½
M. K. Everetts & Son, Rideau Valley.....	96½	J. A. Ruddick, Ottawa.....	95½
J. Connolly, Malcolm.....	96½	L. P. Hubbs, Hillier.....	95½
J. A. Ruddick, Ottawa.....	96½	McAuley & Keeley, Railton.....	95½
Jas. McKellar, Warton.....	96½	W. H. Effingham, Crumlin.....	95
S. Howard, Gorrie.....	96½	G. E. McTaggart, Rodgerville.....	95
F. E. Kline, Lakefield.....	96½	D. M. Macpherson, Apple Hill.....	95
T. J. Ballantyne, Listowel.....	96½	J. McCabe, Eastwood.....	95
J. A. Gray, Atwood.....	96	D. M. Macpherson, Bainsville Factory.....	94
E. J. Madden, Newburgh.....	96	J. A. James, Nilestown.....	94
J. T. Warrington, Union.....	96	T. Meech, North Augusta.....	94
W. F. Gerow, Napanee.....	96	S. R. Payne, Warsaw.....	94
G. Eager, Chesterville.....	96	J. Raphael, Mallorytown.....	94
B. J. Connolly, Kintore.....	96	J. Wilford, Brownsville.....	94

# Report of the Dairy Commissioner.

	POINTS.		POINTS.
J. T. Warrington, Allan's Settlement.....	94	F. Wilson, Pinkerton.....	92½
J. Dempsey, Fairview.....	93½	C. Stewart, Flesherton.....	92
W. Embury, Tweed.....	93½	J. T. Warrington, Plum Grove.....	91½
J. T. Warrington, Prince of Wales.....	93½	do Alexander.....	91
do Allan's Settlement.....	93½	M. K. Everetts & Son, Old Fairfield.....	90
do Harold Factory.....	93	J. Lain, Big Spring.....	90

## QUEBEC.

J. Lemire, La Baie.....	97	Miller & Crittenden, West Brome.....	95
A. McFarlane, Sutton Junction.....	96½	D. F. Sweet, Sweetzburg.....	95
C. A. Beattie, Sutton Mountain.....	96½	J. W. Cummings, Ansen.....	95
Mrs. M. J. Tracey, Millington.....	96½	Mrs. A. MacFarlane, Sutton Junction.....	95
J. N. Duguay, Blue Star, No. 3.....	96	Wm. McFarlane, West Brome.....	94½
A. Fossy, Grandboro.....	96	M. Fleurant, St. Patrick's Hill.....	94½
J. Morneau, St. Patrick's Hill.....	96	H. O. Wales, East Dunham.....	94½
T. W. McKee, Sutton Junction.....	96	J. N. Duguay, Blue Star, No. 3.....	94
N. Desfosses, Blue Star, No. 25.....	96	J. J. Ingalls, Dunboro.....	94
L. Genest, St. Patrick's Hill.....	96	A. T. Newton, Sutton.....	94
S. Duhamel, Pigeon Hill.....	96	Wm. Parent, Blue Star, No. 20.....	94
R. Wherry, Knowlton.....	96	G. Boland, Ste. Ursule.....	94
C. A. Beattie, Iron Hill.....	96	C. D. Jewell, Sweetzburg.....	93½
Wm. Parent, Blue Star, No. 20.....	95½	W. A. Wells, Sutton.....	93½
R. Wherry, Mountain Pass.....	95½	N. Desfosses, Nicolet.....	93
Ed. Deauplaise, Blue Star, No. 21.....	95½	D. O. Bourbeau, Victoriaville.....	93
C. A. Beattie, Sutton.....	95½	G. St. Pierre, East Arthabaska.....	93
M. Robert, Milton East.....	95½	L. Genest, St. Patrick's Hill.....	92
Mrs. A. Newton, Sutton.....	95	J. N. Duguay, Blue Star, No. 1.....	92
R. J. Tilson, Haseville.....	95	Mrs. N. Vidal, Warwick.....	90
G. St. Pierre, Arthabaska.....	95	W. Perkins, East Dunham.....	90

## MARITIME PROVINCES.

T. J. Dillon, New Perth, P.E.I.....	97	T. J. Dillon, New Perth, P.E.I.....	93
I. H. Hawkinsworth, Mabou, N.S.....	97	J. A. Bartir, Avondale, N.B.....	92½
J. N. Sloat, Tracey Mills, N.B.....	96	Allan Kennedy, Union Centre, N.S.....	92
L. C. Archibald, Antigonish, N.S.....	95	C. L. Tilley & Son, Waterville, N.B.....	90
A. Cameron, Dunmore, N.S.....	94½	Sussex Dairy Co., Sussex, N.B.....	90

## CHEESE OF 1893; CHEDDAR.

### ONTARIO.

A. W. Mallory, Mallorytown.....	99½	A. McGregor, Rankin.....	99
T. J. Ballantyne, Listowel.....	99½	J. R. Wiltse, Scotch Line.....	99
D. McKellar, Lakeside.....	99½	J. W. Mitchell, Lansdowne.....	99
L. A. Zufelt, Chesterville.....	99½	J. R. Dargavel, Elgin.....	99
C. H. Woods, South Finch.....	99½	J. H. Singleton, Newboro.....	99
A. F. Gardiner, Hawkesbury.....	99½	W. Campbell, Cannamore.....	99
J. Brayley, Marston.....	99	Dargavel & Murphy, Elgin.....	99
J. McDermott, Tiverton.....	99	P. W. Strong, Brockville.....	99
A. Pickard, Wellburn.....	99	R. R. Cranston, W. Magdala.....	98½
P. H. Green, Sheffield.....	99	G. H. Barr, Culloden.....	98½
B. L. King, Railton.....	99	W. W. Harris, Rothsay.....	98½
L. Stevens, Delta.....	99	R. Chown, Ingersoll.....	98½
H. Hockey, Dereham Centre.....	99	W. Murray, Underwood.....	98½
J. H. Singleton, Singleton.....	99	J. Marten, Wellman's Corners.....	98½
W. H. Sweet, Tilsonburg.....	99	J. L. Talbot, Lucan.....	98½
A. Chalmers, Moncton.....	99	W. B. Stevens, Lambeth.....	98½
J. Geary, London.....	99	W. Trousdale, Railton.....	98½
J. A. Gray, Atwood.....	99	T. Keenan, Kingston.....	98½
A. Spence, Belleville.....	99	Elgin Model Factory, Elgin.....	98½
J. B. Muir, Avonbank.....	99	J. Whitton, Wellman's Corners.....	98½
J. S. Isard, Willisroft.....	99	W. S. Sifton, Strathroy.....	98½
J. Morrison, Newry.....	99	G. Goodhand, Milverton.....	98½
Hodgson Bros., Roblin Factory.....	99	W. Eager, South Mountain.....	98½
H. E. Brintnell, Plainfield.....	99	A. Latta, Plainfield.....	98½

	POINTS.		POINTS.
W. Fitzgerald, Dufferin.....	98½	F. C. Taylor, Fairview.....	97½
H. P. Richardson, Kerwood.....	98	T. C. Mallory, Yarmouth Centre.....	97½
C. O. Luton, Lyons.....	98	J. C. Russell, Hollbrook.....	97½
R. White, Belleville.....	98	A. Millson, Gorrie.....	97½
R. Jardine, Camlachie.....	98	M. Chalcraft, Delaware.....	97½
E. Bates, Mount Elgin.....	98	E. Smith, Thorndale.....	97½
R. J. Hampton, Osman.....	98	J. Perkins, Leesboro.....	97½
J. D. Corliss, Vittoria.....	98	J. S. Grieve, Salford.....	97½
M. Morrison, Harriston.....	98	J. McComb, Belleville.....	97½
G. Beaton, Norwich.....	98	E. Cohoe, Humberstone.....	97½
W. J. Allan, Belleville.....	98	J. B. Gardiner, Mainsville.....	97½
T. D. Barry, Putnam.....	98	A. A. Parker, Rockford.....	97
M. R. Brown, Appin.....	98	L. D. Monk, Dorchester.....	97
G. Dickey, Lambeth.....	98	W. Hales, Belleville.....	97
J. F. Williams, Ingersoll.....	98	W. J. Atkinson, Granthurst.....	97
G. B. McLeod, Thamesford.....	98	J. M. Smith, Long Lake.....	97
J. McKellar, Tiverton.....	98	E. A. Hunter, Welland Station.....	97
R. Facey, Harrietsville.....	98	C. Stewart, Flesherton.....	97
T. Myers, Forfar.....	98	G. Moore, Kenilworth.....	97
J. A. Kinsella, Lancaster.....	98	M. J. Gray, Atwood.....	97
L. Patten, Oxford Mills.....	98	W. W. Brown, Atercliffe Station.....	97
R. T. Beckett, Malakoff.....	98	D. A. Dempsey, Stratford.....	97
C. J. Gilroy, Glen Buell.....	98	W. P. Dempsey, Belleville.....	97
F. Millson, Pinkerton.....	98	J. J. Miller, North Bruce.....	97
T. Grieve, Wyandotte.....	98	F. Boyes, Nileston.....	97
Miss E. A. Hannen, London.....	98	J. Herity, Warkworth.....	97
R. Lannigan, Belleville.....	98	D. W. Garvey, Talbotville.....	97
Murdoch & Morrison, Harriston.....	98	R. Cornett, Dundalk.....	97
P. Keeleher, Belleville.....	98	W. T. Hollis, Preston Station.....	97
J. Morrison, Henfry.....	98	J. H. Wilkinson, Verschoyle.....	97
T. G. Bell, Belleville.....	98	W. Fitzgerald, Dufferin.....	97
J. McKellar, Tiverton.....	98	Henderson Bros., Athens.....	97
P. Campbell, Morewood.....	98	S. R. Payne, Warsaw.....	97
A. Campbell, No. 2, Ormond.....	98	Wm. Eager, Johnson's Factory.....	97
G. Cleall, Selby.....	98	J. L. Phillips, Brockville.....	97
J. Bissell, Brockville.....	98	W. Wartman, Cushendall.....	97
J. Hamilton, Vars.....	98	W. Cleugh, Belleville.....	97
G. G. Publow, Perth.....	98	J. W. Blyth, Varney.....	97
W. Duff, Inverary.....	98	J. Given, Belleville.....	97
J. Raphael, Mallorytown.....	98	A. M. Ketcheson, Belleville.....	97
B. Bond, York.....	97½	G. B. McLeod, Thamesford.....	97
J. Roberts, Allenford.....	97½	T. Stacey, Fullarton.....	97
E. E. Chaffee, Summerstown.....	97½	A. P. McCallum, Watford.....	97
Hodgson Bros., Victoria Factory.....	97½	L. Stevens, Delta.....	97
D. McMillan, Poole.....	97½	H. Jack, Carthage.....	97
T. Burnside, Belleville.....	97½	W. J. Dunlop, Trowbridge.....	97
J. F. Williams, Ingersoll.....	97½	J. Gay, Sine.....	97
W. G. Wright, Belleville.....	97½	J. Fowler, Mount Chesney.....	97
T. O'Flynn, Kinkora.....	97½	N. Webster, Lansdowne.....	97
W. D. Angus, Newbridge.....	97½	G. Jackman, Napanee.....	97
W. Woods, Molesworth.....	97½	Hodgson Bros., Brook Factory.....	97
J. C. Brintnell, Plainfield.....	97½	S. Halladay, Elgin.....	97
N. E. Thompson, Eldorado.....	97½	A. Shrumm, Bismarck.....	97
J. Latta, Trenton.....	97½	S. R. Lee, Hickson.....	96½
Hodgson Bros., Madoc Factory.....	97½	J. Thompson, Evelyn.....	96½
A. W. Mallory, Mallorytown.....	97½	G. V. De Long, Harron.....	96½
W. Pomeroy, Mitchell.....	97½	L. C. McInnes, Lucknow.....	96½
J. Brodie, Mapleton.....	97½	J. H. Stillman, Ingersoll.....	96½
J. Hogan, Kingston.....	97½	E. Johnson, Birr.....	96½
J. W. Copeland, Eastwood.....	97½	J. Dickenson, Springfield.....	96½
W. A. Bothwell, Woodstock.....	97½	B. Mallory, Frankford.....	96½
T. J. Humphrey, Hickson.....	97½	I. T. Saul, Birr.....	96½
J. McCann, Perth.....	97½	W. Latta, Thurlow.....	96½
J. A. McIntosh, Kohler.....	97½	J. Latta, Shannonville.....	96½
W. Morris, Avon.....	97½	D. W. Garvey, Talbotville.....	96½
S. Howard, Gorrie.....	97½	J. Dempsey, Fairview.....	96½
J. Evans, Belmont.....	97½	J. Ireland, Beachville.....	96½
J. S. Isard, Williscroft.....	97½	J. Mackenzie, Belleville.....	96½
W. Pow, Mount Elgin.....	97½	H. Clark, Smith's Falls.....	96½
W. J. Spry, Belleville.....	97½	J. S. Dougan, Bridgewater.....	96½

# Report of the Dairy Commissioner.

	POINTS.		POINTS.
J. Lappin, Lansdowne.....	96½	R. Groat, Georgetown.....	95½
E. V. Halladay, Elgin.....	96½	E. A. Sims, Devizes.....	95½
R. Cavanagh, Appleton.....	96½	B. Bachelor, Birnam.....	95½
J. H. Singleton, No. 5, Singleton.....	96½	W. S. Cook, Belleville.....	95½
W. Munroe & Son, Navan.....	96½	W. J. Magury, Warwick West.....	95½
A. E. Millson, Peebles.....	96½	A. Campbell, White Globe No. 1.....	95½
B. B. Bellamy, Jellyby.....	96	R. B. Cochrane, Elginburg.....	95½
W. Campbell, Cannamore.....	96	W. Clark, Princeton's Corners.....	95½
J. Wilford, Brownsville.....	96	O. Vandervoort, Belleville.....	95½
J. McKelvie, Belleville.....	96	Sarah Baskett, London.....	95½
P. Campbell, Morewood.....	96	A. Herity, Belleville.....	95½
D. Gillen, Belleville.....	96	T. Naylor, Campbellford.....	95½
W. H. McLean, Crinan.....	96	M. Knechtel, Tavistock.....	95½
W. Caldwell, Drumbo.....	96	G. McDonald, Bluevale.....	95½
C. G. Miners, Tilsonburg.....	96	W. J. Niblock, Kingscroft.....	95½
J. Brodie, Mapleton.....	96	B. L. King, Railton.....	95½
B. J. Connolly, Kintore.....	96	W. Lloyd, Roslyn.....	95½
W. McIlvride, Stayner.....	96	J. McDermott, Tiverton.....	95½
A. McCombs, Selkirk.....	96	W. W. Harris, Rothsay.....	95½
P. W. Strong, Soperton.....	96	O. & R. Banks, Thamesford.....	95
A. Campbell, No. 2, Ormond.....	96	Coffin Bros., Villa Nova.....	95
H. Clark, Smith's Falls.....	96	G. A. Walker, S. Cayuga.....	95
G. W. Henderson, Belleville.....	96	J. G. Patterson, Conn.....	95
Mrs. R. McCrow, Drumbo.....	96	J. Connolly, Alsfeldt.....	95
W. Johnson, Belleville.....	96	W. H. Olds, Simcoe.....	95
G. Kerr, Singleton.....	96	J. W. Blyth, Varney.....	95
J. Lowry, Frankford.....	96	S. T. Wallace, Lavender.....	95
M. McNicoll, Belleville.....	96	J. Clark, Belleville.....	95
H. Morton, Belleville.....	96	R. S. Tivy, Belleville.....	95
W. Meiklejohn, Belleville.....	96	Sarah Dougan, Belleville.....	95
G. A. Boyes, Mapleton.....	95½	S. Howard, Gorrie.....	95
P. McIntosh, Winchester Springs.....	95½		

## QUEBEC.

G. St. Pierre, Victoriaville.....	99½	J. N. Gaudreau, Magog.....	98
C. St. Laurent, St. Valère de Bulstrode.....	99½	C. Wilkins, Mansonville Station.....	98
J. H. Lefebvre, La Baie.....	99½	R. Wherry, Mountain Pass.....	98
J. D. Barrington, Ste. Martine.....	99	A. Crittenden, W. Brome.....	98
E. G. Welch, Farnham.....	99	Sarah Newton, Sutton.....	97½
T. Durman, Landerville.....	99	C. M. Harvey, Venice.....	97½
E. Normand, St. Gilbert.....	99	S. Duhamel, Pigeon Hill.....	97½
H. Lefebvre, St. Zephirin.....	99	G. McCrumm, Iron Hill.....	97½
A. Macfarlane, Cowansville.....	99	W. T. Gardiner, St. Louis Station.....	97½
N. Vidal, Warwick.....	99	E. Deauplaise, St. Pie de Guire.....	97½
R. Blunt, Foster.....	99	A. Brissette, Stanfold.....	97½
Sarah Newton, Sutton Flat.....	99	Mrs. E. G. Welch, Farnham.....	97½
Mrs. Blunt, Foster.....	99	E. Proulx, La Baie.....	97½
J. N. Duguay, Blue Star, No. 6.....	99	E. G. Welch, Yamaska.....	97½
A. Plante, St. Ours.....	99	A. S. Lloyd, Ormstown.....	97½
A. W. Woodard, Sutton Flat.....	98½	H. P. Sweet, W. Brome.....	97
C. Newton, Sutton Flat.....	98½	W. Parenteau, St. Pie de Guire.....	97
Mrs. W. McFarlane, W. Brome.....	98½	W. J. Sheldon, Brome Corners.....	97
A. Trudel, St. Prosper.....	98½	L. Gilbert, St. Ferdinand d'Halifax.....	97
H. P. Sweet, W. Brome.....	98½	W. J. Sheldon, Brome Corners.....	97
M. Toof, Sweetsburg.....	98½	Wm. Macfarlane, W. Brome.....	97
Mrs. A. McFarlane, Cowansville.....	98½	J. G. Wales, E. Dunham.....	97
J. Savard, St. Alban.....	98½	Mrs. K. L. Perkins, E. Dunham.....	97
A. T. Newton, Sutton Flat.....	98½	J. A. Macdonald, Athelstan.....	97
J. A. Plamondon, Ste. Anne de la Pérade.....	98½	C. A. Beattie, Iron Hill.....	97
A. T. Newton, Sutton Flat.....	98½	C. M. Willey, Abercorn.....	97
Mary Larose, Sutton Flat.....	98	N. Parenteau, St. Michel, Yamaska.....	97
Mrs. E. G. Welch, Farnham.....	98	Mrs. A. McFarlane, Cowansville.....	96½
T. L. Burnett, Farnham Centre.....	98	A. W. Woodard, Sutton Flat.....	96½
W. H. Walker, Huntingdon.....	98	T. H. Noyes, Sweetsburg.....	96½
J. G. Wales, E. Dunham.....	98	J. D. Leclair, St. Hyacinthe.....	96½
Nellie Ettershanks, Knowlton.....	98	Mrs. M. J. Tracey, Millington.....	96½
A. Gérin, St. Edwidge.....	98	D. Demers, St. Zephirin.....	96½

POINTS.		POINTS.	
W. Parent, St. Elphège.....	96½	E. Rivard, St. Casimir.....	96
Mrs. E. M. Carter, Cowansville.....	96½	J. B. Strong, Sutton Flat.....	96
N. E. Clément, Ste. Anne de la Pérade....	96½	S. Duhamel, Pigeon Hill.....	95½
A. Belisle, La Baie.....	96½	L. Gilbert, St. Ferdinand d'Halifax.....	95½
J. A. Macdonald, Athelstan.....	96	O. Lafond, Yamaska, East.....	95½
R. Wherry, Knowlton.....	96	E. Hamelin, Grondines.....	95½
H. W. Perkins, E. Dunham.....	96	Mrs. J. Hawke, Stanbridge East.....	95½
Addie Peacock, Sweetsburg.....	96	J. Felix, Champlain.....	95½
A. Macfarlane, Cowansville.....	96	E. A. Russell, Stanbridge East.....	95
A. C. Carter, Cowansville.....	96	A. Whitehead, Robinson Bury.....	95
D. O. Bourbeau, Victoriaville.....	96	A. Allie, St. Thomas de Pierreville.....	95
J. N. Duguay, LaBaie.....	96	E. Boivin, St. Thomas de Pierreville.....	95
O. Parent, St. Zépherin.....	96	W. H. Tillson, West Farnham.....	95
E. A. Russell, Stanbridge East.....	96	C. Newton, Sutton Flat.....	95
H. O. Wales, Sutton Junction.....	96	A. Trudel & Co., St. Ubalde.....	95
A. Crittenden, W. Brome.....	96	A. Trudel, St. Ubalde.....	95
Mrs. N. Vidal, Warwick.....	96		

**MARITIME PROVINCES AND MANITOBA.**

S. M. Barré, Ste. Anne, Man.....	99	A. Cameron, Antigonish, N.S.....	96
Wm. Topping, Elmbank, N.S.....	98½	J. Burgess, Murray Harbour N., P.E.I....	96
D. Shunk, Ste. Anne, Man.....	97½	J. R. Moore, Morell, P.E.I.....	96
C. L. Tilley & Son, Richmond Factory, N.B.	97	C. J. Brown, Cornwall, P.E.I.....	96
S. M. Barré, Ste. Agathe, Man.....	96½	J. E. Hopkins, Nappan, N.S.....	95½
J. McKenzie, Sailors' Hope, P.E.I.....	96½	G. Burgess, St. Peter's Bay, P.E.I.....	95½
E. L. Head, New Perth, P.E.I.....	96½	R. H. Hood, Mt. Stewart, P.E.I.....	95½
C. L. Tilley & Son, Woodstock, N.B.....	96	Morell Dairy Co., Morell, P.E.I.....	95

**CHEESE OF 1893; FLATS AND YOUNG AMERICAS.**

**ONTARIO.**

J. Brown, Ingersoll.....	98½	Miss E. A. Hannen, London.....	98
S. Howard, Gorrie.....	98½	S. Howard, Gorrie.....	96½
J. W. Blyth, Varney.....	98½	J. W. Blyth, Varney.....	96
S. Howard, Gorrie.....	98½		

**QUEBEC.**

W. H. Tillson, W. Farnham.....	99½	E. Russell, N. Stanbridge.....	97
W. H. Tillson, W. Farnham.....	98	S. Duhamel, Pigeon Hill.....	96½
J. G. Wales, E. Dunham.....	98		

In the October competition, 489 exhibits of cheese from Canada, were recommended by the judges for awards. The following table shows the exhibits by Provinces:

CHEESE OF 1892.		CHEESE OF 1893.			
Exhibits. For Awards.		Exhibits. For Awards.			
Ontario.....	59	58	Ontario.....	274	259
Quebec.....	45	42	Quebec.....	113	105
P. E. Island.....	2	2	P. E. Island.....	19	8
Nova Scotia.....	5	4	Nova Scotia.....	10	3
New Brunswick.....	4	4	New Brunswick.....	4	2
	115	110	Manitoba.....	4	3
				424	380

One hundred and thirty of these exhibits received severally a higher number of points than the highest award given to any exhibit of cheese from any other country in the same classes.

Less than 10 per cent of all the exhibits of cheese from Canada, were not recommended by the judges for awards. The general excellence and superiority of the

## Report of the Dairy Commissioner.

Canadian cheese was thus clearly established. The keeping quality of Canadian cheese—one of the points of the greatest commercial value—was also brought out impressively by 115 exhibits of cheese of the make of 1892. Of these no less than 110 carried off awards and were described by the judges (two United States experts and one Canadian) as the finest lot of old cheese which they ever examined.

The plan to secure a thoroughly representative exhibit of cheese from all the provinces has been amply justified by its success. The intention was to present a collection of cheese which would represent the output of the factories in every part of the Dominion where dairying upon the co-operative plan has been established. The word "Canadian," by which our cheese are known on the British markets, was the one which fittingly described the exhibit. While the several provinces received due credit for the number of awards which went to dairymen in them, the effectiveness of the result for creating a favourable impression among the farming classes of Europe and the cheese-eating public of Great Britain was edged and conserved by the success won for "Canadian," and Canada.

A considerable gain to Canada will come through the favourable impression produced abroad by this victory, and the dairy farmers in the different parts of the Dominion will be encouraged and stimulated to pay more attention to a further development of this branch of farming for which our country seems to be specially adapted. Cheese-making in Ontario has been a foremost industry for several years, but the reputation of the cheese from the province of Quebec was far behind that of its sister provinces. Now it is practically abreast of it.

When it is known that all of the exhibits from Prince Edward Island with the exception of those from two factories, were cheese of July make, which had not been kept in cold storage and afterwards came in competition in Chicago with the finest of August and September cheese, the success of the cheese from the Island Province—the Gem of the Gulf—is all the more astonishing and gratifying.

### BUTTER.

The judges of butter were Mr. J. R. Morin, of the firm of Messrs. J. R. Morin & Co., of Iowa, Minnesota and Nebraska, and Mr. E. A. Harris, of H. A. Hovey & Co., of Boston, Mass., and Mr. A. A. Ayer, Montreal, Que.

One hundred and sixty-seven packages of butter were sent and 27 lots were found to be entitled to awards. The judges recommended that all exhibits which received a score of points over the following be awarded a medal and diploma. Minimum of points to entitle to an award: 95 in class IV, 94 in class V, and 93 in classes I, II, and III. The following is the list of successful exhibits:—

### ONTARIO.

#### CLASS V.—GATHERED CREAM.

	POINTS.
A. Wenger, Ayton, Ont.....	95½
J. A. Struthers, Owen Sound, Ont.....	95
Holliday & Co., Chesley, Ont.....	94
Isaac Wenger, Ayton, Ont.....	94
Alex. E. Wark, Paisley, Ont ....	94

#### CLASS IV.—SEPARATOR CREAM.

Binion & Rutherford, Iroquois, Ont.....	95
H. J. Hayes, Glenroy, Ont.....	95

#### CLASS I.—DAIRY BUTTER MADE ON THE FARM FROM A MIXED HERD.

Mrs. Chas. Long, Blessington, Ont.....	94½
Thomas H. Mason, Straffordville, Ont.....	93

## QUEBEC.

## CLASS IV.—SEPARATOR CREAM.

	POINTS.
A. W. Kimpton, Piedmont, Que.....	96½
Alphonse Furvoy, St. Michel, Que.....	96
N. E. Bernatchez, Montmagny, Que.....	96
Z. S. Lawrence, West Shefford, Que.....	96
Frank Wilson, Montreal, Que.....	95
East View Stock Farm, Cookshire, Que.....	95
A. Chicoine, St. Marc, Que.....	95

## CLASS III.—PRINTS AND FANCY PACKAGES.

Mrs. M. N. Emerson, Sutton Junction, Que.....	94
N. P. Emerson, Sutton Junction, Que.....	94

## CLASS II.—DAIRY BUTTER MADE ON THE FARM FROM A HERD OF ONE BREED.

Walter Taylor, Cookshire, Que.....	94
------------------------------------	----

## CLASS I.—DAIRY BUTTER MADE ON THE FARM FROM A MIXED HERD.

John J. Emerson, Sutton Junction, Que.....	95
John Dougall, Cowansville, Que.....	94
G. W. L. French, Island Brook, Que.....	94
Melville Patterson, Knowlton, Que.....	93½
Henry Miller, Knowlton, Que.....	93½
Wm. Birch, Coaticook, Que.....	93½

## NEW BRUNSWICK.

## CLASS V.—GATHERED CREAM.

P. L. Richard, St. Louis, N. B.....	95
-------------------------------------	----

## MANITOBA.

## CLASS V.—GATHERED CREAM.

Dr. Barnardo, Russell, Man.....	94
---------------------------------	----

The results from the butter competition, while not so gratifying to Canada as those from the cheese, are still full of encouragement and use. The whole of the butter on exhibition was judged by three eminent experts (two from the United States and one from Canada). The body of the Canadian butter was on the whole rated very high; most of the exhibits lost several points on flavour. The circumstances of the exhibition were not favourable to Canadians, by reason of the distant points from which most of the butter had to be sent—some lots came all the way from Manitoba on the one hand and from New Brunswick on the other. The defects in the flavour were mostly attributed to the use of inferior salt, or salt which had acquired foul flavours or odours by exposure to the odours from other commodities in the holds of vessels or in warehouses. This little matter was the great matter which ruled out 50 or more of our exhibits of butter which were excellent in every other respect. In future, particular care must be given by the butter-makers to prevent the salt from being exposed in any foul atmosphere, as otherwise it is liable to acquire taints and transfer them into the butter.

## GENERAL.

The most of the credit for the success of the exhibition is due to the cheese-makers, butter-makers and dairymen who took pains to provide such excellent quality in their exhibits, and who responded so generally and carefully to the appeal

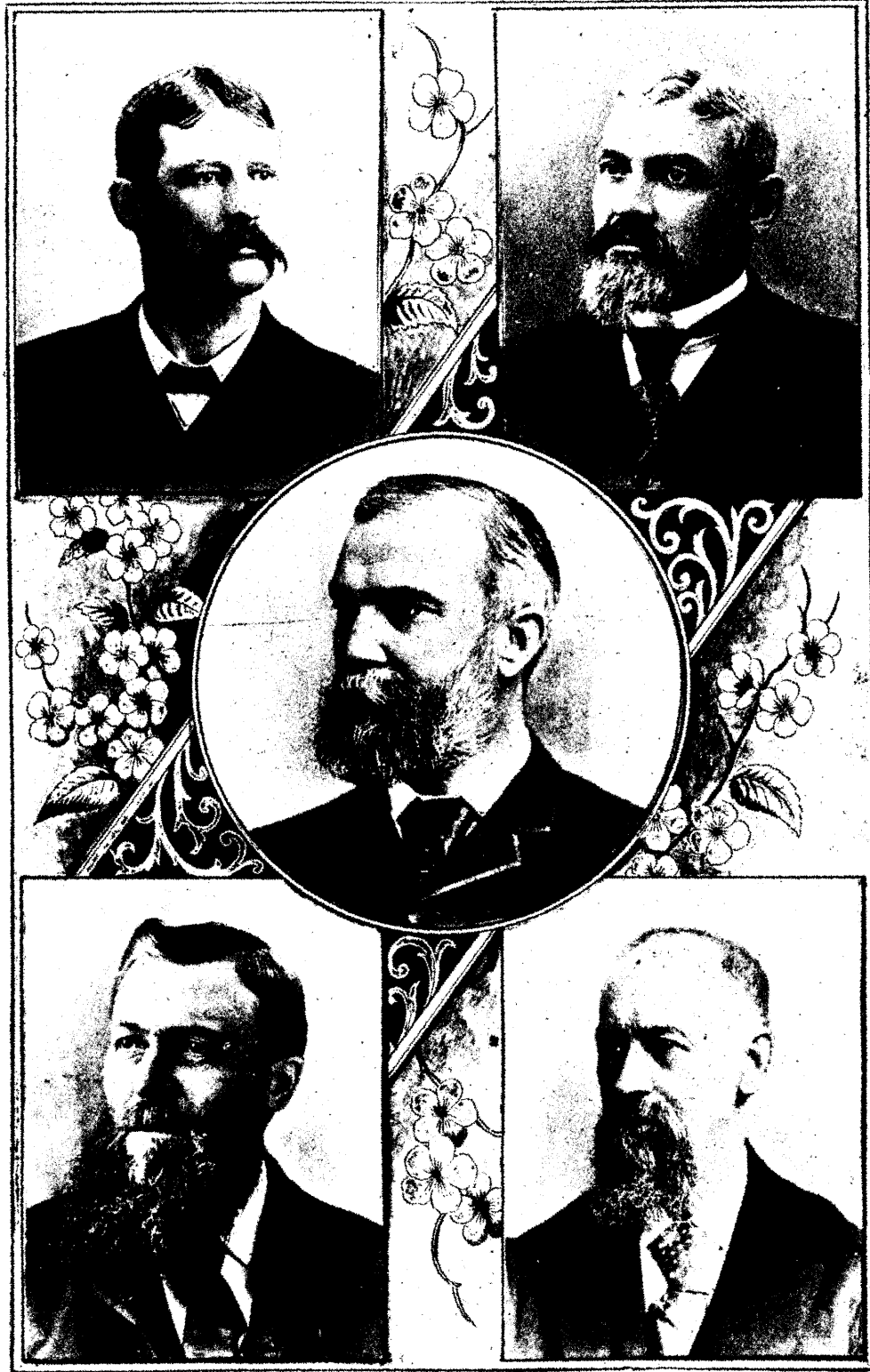

JUDGES OF BUTTER AT THE WORLD'S FAIR.

George D. Mansfield (Wisconsin),

E. A. Harris (Boston, Mass.),

A. A. Ayer (Montreal, Que.),

John S. Pearce (London, Ont.),

J. R. Morin (Iowa).



## Report of the Dairy Commissioner.

in the Bulletin. Honour and praise are also due to the leading dairymen from Canada, who assisted in the task of selecting the cheese and butter and of seeing that Canada was fittingly represented in her dairy interests at Chicago. Among these were: Messrs. D. M. Macpherson, Lancaster, Ont., president of the Dominion Dairymen's Association; Wm. Eager, Morrisburg, Ont., ex-president of the Dairymen's Association of Eastern Ontario; Wm. Bissell, Algonquin, Ont., president of the Dairymen's Association of Eastern Ontario; D. Derbyshire, Brockville, Ont., president of the Ontario Creameries' Association; Col. O. P. Patten, Brome Corners, Que., who represented H. S. Foster, on behalf of the dairy interests of the province of Quebec; John S. Pearce, London, Ont., a director in the Dairymen's Association of Western Ontario, and in the Ontario Creameries' Association. It was regretted that Mr. John Geary, London, Ont., president of the Dairymen's Association of Western Ontario, was unable to attend with the others. His colleague from the Board of the Dairymen's Association of Western Ontario, Mr. A. F. MacLaren, Windsor, Ont., was one of the judges, and in that capacity, by his expert knowledge, fairness, unflinching geniality and ability, he rendered service equally satisfactory and acceptable to the United States and Canadian dairymen. Mr. J. C. Châpais, St. Denis, Que., Assistant Dairy Commissioner, was also in attendance. Mr. J. de L. Taché, Quebec, who did much to secure exhibits of creamery butter from Quebec, was at Chicago earlier in the season. Mr. H. S. Foster, Knowlton, Que., President of the District of Bedford Dairymen's Association, who did the lion's share of the work in that province in securing exhibits, was prevented by illness from going to Chicago.

### SUMMARY.

#### *Cheese.*

	Exhibits.	Recom- mended for awards.
June competition.....	162	129
October do .....	539	490
	701	619

#### *Butter.*

June competition.....	43	13
October do .....	167	27
	210	40

The immediate effect of this sweeping achievement at Chicago will be to still further enhance the reputation of our cheese in the British markets. It will also further stimulate our dairymen to pay more attention to the home-end of the business. I estimate that the resulting improvement in the quality of cheese throughout the whole Dominion will represent an increase in intrinsic value of not less than from  $\frac{1}{4}$  to  $\frac{1}{2}$  cent per pound. As the exports of cheese from Canada are now over 130 millions of pounds annually, the monetary value directly resulting from the success at Chicago will not be less than four or five hundred thousand dollars. To this is to be added the permanent benefits of the acquisition of knowledge, improvement in practice and gain in prestige.

The lessons from the World's Columbian Exposition, when applied to our butter-making, will doubtless prove beneficial; and it is my opinion that we shall be able to carry forward our cheese business to still wider extension and higher attainment and at the same time bring up the reputation and the quality of our butter abreast of it within five years, if the individual dairymen give their hearty co-operation and follow out carefully the instructions which are given.

The results from the whole matter will be of prime and far reaching value to Canada. Everything that promotes the dairying business increases the demand for labour on the farms. That helps to retain a larger population in rural districts. It includes such a rotation of crops and system of culture as will help to increase the fertility of the soil. In the largest and best sense it furthers the material prosperity of the people, and from that arises progress in all the admirable and lovable accessories and qualities of life with contentment.

## PART XI.—REPORT OF THE ASSISTANT DAIRY COMMISSIONER.

(MR. J. C. CHAPAIS.)

SAINT DENIS (en bas), COUNTY OF KAMOURASKA, P.Q.

30th June, 1893.

Professor JAMES W. ROBERTSON,  
Dairy Commissioner,  
Ottawa.

DEAR SIR,—According to the instructions received from you in December last (1892), I have lengthened the period covered by the present report until the thirtieth of June instant. Consequently, all my work since the first January, 1892, until the thirtieth of June, 1893, is referred to in my present report.

### SUMMARY OF MY VISITS.

During this period, I have gone through four (4) provinces of the Dominion, I have visited thirty-two counties, one hundred and four localities, and I have given one hundred and twenty-two (122) lectures. I travelled over sixteen thousand three hundred and sixty-four (16,364) miles, and I spoke to seventeen thousand eight hundred (17,800) persons. Twenty-nine (29) of these lectures have been given before eleven (11) great conventions of a district or provincial character.

I give, in the following table, the indication of the work done in each province, showing the number of lectures given in the different counties and localities of these provinces :

### MANITOBA.

Counties.	Localities.	Lectures.	Counties.	Localities.	Lectures.
Lisgar.....	Pigeon Lake .....	1	Selkirk.....	Boissevain .....	1
	St. Charles .....	1		Brandon .....	1
	St. Eustache .....	1		Crystal City.....	1
	St. Frs.-Xavier.....	1		Elkhorn .....	1
Marquette.....	Minnedosa .....	1		Killarney .....	1
	Portage la Prairie .....	1		Notre Dame de Lourdes..	1
Provencher .....	La Broquerie .....	1		Oak Lake .....	1
	Letellier .....	1		Pilot Mound .....	1
	Lorette .....	1		St. Alphonse .....	1
	St. Jean-Baptiste.....	1		Somerset .....	1
	St. Malo .....	1		Souris .....	1
	St. Norbert .....	1		Virden .....	1
	St. Pierre .....	1		Wawanesa.....	1
	Ste. Agathe.....	1		Westminster .....	1
	Ste. Anne des Chénes....	1			
				Total, Manitoba.	29

# Report of the Dairy Commissioner.

## NEW BRUNSWICK.

Counties.	Localities.	Lectures.	Counties.	Localities.	Lectures.
Gloucester.....	Bathurst.....	1	Gloucester.....	Pockmouche.....	1
	Bathurst Village.....	1		Shippegan.....	1
	Caraquet.....	1		St. Isidore.....	1
	Grande Anse.....	1		Tracadie.....	1
	Paquetville.....	1			
	Petit Rocher.....	1		Total, N. Brunswick.	10

## ONTARIO.

Counties.	Localities.	Lectures.	Counties.	Localities.	Lectures.
Prescott.....	Alfred.....	2	Prescott.....	Plantagenet.....	2
			Total, Ontario.....		4

## QUEBEC.

Counties.	Localities.	Lectures.	Counties.	Localities.	Lectures.	
Arthabaska.....	Arthabaskaville.....	1	Missisquoi.....	Sweetsburg.....	1	
	Warwick.....	1				
Beauce.....	Scott.....	1	Montmagny.....	Montmagny.....	3	
	Ste. Marie.....	1				
Bellechasse.....	Armagh.....	1	Montmorency....	Chateau-Richer.....	1	
	Bulkland.....	1		L'Ange-Gardien.....	1	
	St. Damien.....	1		St. François.....	1	
	St. Lazare.....	1		St. Jean.....	1	
	St. Magloire.....	1		St. Joachim.....	1	
	St. Philémon.....	1		St. Laurent.....	1	
Bonaventure.....	Carleton.....	1		St. Pierre.....	1	
	New Carlisle.....	1		St. Tite des Caps.....	1	
	Port Daniel.....	1		Ste. Famille.....	1	
Champlain.....	Ste. Anne de la Pérade.....	1		Nicolet.....	Bécancour.....	2
Chicoutimi.....	Hébertville.....	1		Ottawa.....	East Templeton.....	1
Dorchester.....	St. Anselme.....	1			L'Ange-Gardien.....	1
	St. Hénédine.....	1		Quebec.....	City.....	6
Drummond.....	Kingsey French Village.....	1			Ste. Foye.....	1
Gaspé.....	Cap Chat.....	1	St. Hyacinthe.....	St. Hyacinthe.....	2	
	Fox River.....	1	Shefford.....	Waterloo.....	2	
	Ste. Anne des Monts.....	1	Temiscouata.....	St. Modeste.....	1	
Huntingdon.....	Hemmingford.....	1	Terrebonne.....	St. Faustin.....	1	
Kamouraska.....	St. Denis.....	1		St. Hippolyte.....	1	
	Chambord.....	3		St. Jérôme.....	1	
Lac St. Jean.....	Roberval.....	1		St. Jovite.....	1	
	St. Félicien.....	1		St. Sauveur.....	1	
	St. Jérôme.....	1		Ste. Adèle.....	1	
	St. François de Sales.....	1		Ste. Agathe.....	1	
Laval.....	L'Islet.....	1		Ste. Julie.....	1	
L'Islet.....	St. Cyrille.....	1		Ste. Marguerite.....	1	
	St. Eugène.....	1		Ste. Thérèse.....	5	
	Amqui.....	1				
	Cedar Hall.....	1		Total, Quebec.....	79	
Matane.....	St. Moise.....	1				

Before proceeding, I must add that, although I am especially charged with the French portion of the work done in your department, I have given, in order to comply with circumstances, fifteen lectures in English.

I am now going to tell you what kind of work I have done in every one of the provinces visited, following the order which they occupy in the preceding table.

#### MANITOBA.

In the month of February, 1892, after having received instructions from you, through letters of the 26th December, 1891, and of the 2nd, 19th and 28th January, 1892, I made a trip through the province of Manitoba, so as to give lectures on agriculture, regarding its relation with dairying. I left for Manitoba on the 2nd of February, and returned on the 29th of March, after having passed six weeks in visiting the localities hereafter mentioned.

I arrived in Manitoba on the 8th of February, and from the 9th till the 21st, I gave nine lectures in French in the following places: La Broquerie, Letellier, Lorette, St. Jean Baptiste, St. Malo, St. Norbert, St. Pierre, Ste. Agathe, and Ste. Anne des Chênes.

I was, during this first part of my trip, in company with the Honourable Mr. LaRivière, member of the House of Commons for the county of Provencher, who was extremely kind and obliging to me and who greatly facilitated my endeavours. Mgr. Taché, Archbishop of St. Boniface, was also considerate in allowing one of his priests, l'Abbé Cloutier, to accompany me during a few days, in order to introduce me to the parish priests of the different parishes.

From the 27th February till the 6th March, I fulfilled, in this second series of lectures, the task of replacing you in the below-mentioned localities which you were expected to visit during February, which expectation you could not fulfil on account of uncontrollable circumstances. I had, therefore, to give my lectures in English in the following localities: Boissevain, Brandon, Elkhorn, Killarney, Minnedosa, Pilot Mound, Portage la Prairie, Souris, Virden, Wawanesa, and White-water.

I at length finished my trip by another series of lectures delivered in French, from the 6th March till the 19th March in Notre-Dame de Lourde, Oak Lake, Pigeon Lake, St. Alphonse, St. Charles, St. Eustache, St. François Xavier, and Somerset.

Since, my return, I have received numerous demands for information concerning the province of Manitoba, and I have thought it expedient to take the opportunity of the present report to give in full the reasons which induce us to recommend to Manitoba farmers the adoption of a mode of mixed culture which enables them to engage in the dairy industry, and which need not withdraw their interests from the other branches of agriculture.

#### *Wheat in Manitoba.*

As a general rule, wheat is the base of culture throughout the whole province of Manitoba. Oats are somewhat grown; barley somewhat less; cattle breeding for beef is practised to some extent, but wheat is king, and a farmer who has not 50 acres sown in wheat dislikes to own the fact. In 1891, Manitoba is reported to have produced, in round numbers, 23,000,000 bushels of wheat, 15,000,000 bushels of oats, and 3,000,000 bushels of barley.

In order to understand why wheat is so extensively cultivated in Manitoba, and also why it should be less in order to make place for other things, two sides of the question must be considered.

#### *Causes which favour Wheat culture in Manitoba.*

Here are the reasons which greatly weigh in favour of wheat culture in this province:—

## Report of the Dairy Commissioner.

1st. The soil is one of the best constituted for the said culture. It contains all the elements needed by the plant to thrive and form a clear and hard grain; and these elements are present in abundance.

2nd. The climate is a most favourable one to promote early maturity, once the plant is eared.

3rd. The climate's dryness allows its being kept in open air in stacks in autumn, thus doing away with the vast building expense which the farmer would otherwise have to undertake.

4th. The great dryness of the soil and the absence of weeds in the ground, which is virgin soil, render it unnecessary for the present to follow the system of rotation of varied crops, as followed in the old provinces.

### *Reasons why less Wheat should be grown.*

Let us now see the reasons against those enumerated, the reasons upon which is based the idea that mixed culture is more favourable to the farmer of Manitoba than the almost exclusive culture of wheat in which he is now engaged.

1st. There are in Manitoba frequent hail storms in summer, to such an extent that insurance companies have been formed to insure against the damage caused by them. If all or nearly all the farmer's crop is wheat, it generally is far more exposed to suffer from hail than if it consists in greater part of roots or fodder plants, which always suffer less from hail than wheat.

2nd. In places where the soil has been cultivated for about ten years, weeds begin to make their appearance and will necessitate before long a mode of culture which will destroy them; and in the grounds so invaded by weeds, wheat culture should have to cease, in order to make a cleaning out of the weeds.

3rd. For some years back, wheat in Manitoba is subject, and that, quite often, to smut, vulgarly known in French as *blé noir*. It is true that good remedies have been prescribed for this disease, amongst them, the use of sulphate of copper or blue coppers (blue-stone.)

Although this remedy is efficient, its use becomes burdensome as it necessitates the purchase of sulphate of copper and much work for the farmer who sows several hundred bushels of wheat, and besides, if he neglects to apply the remedy, he sees his crops much diminished in value, in consequence of the smut spreading.

4th. It often happens that, on account of the great extent of ground which he has to sow, the farmer of Manitoba, for want of time in autumn, not being able to plough all the ground he intends to sow in the spring, will plough in the spring, and often sow a great quantity of wheat after due time. In autumn, an early frost may come and a good part of the crop be injured before it is ripe. Anxious to make money, the farmer sells all the harvest which is not frozen and keeps wheat which has just been nipped to use as seed. That seed, weakened by the frost, although springing up in the field, produces plants which bear in themselves a source of weakness and which are more easily attacked by the spores of the "smut."

I ascertained this fact from a farmer of Red River, who wanting sound wheat to finish his planting, took frozen wheat to complete it. The frozen wheat produced a crop of smutted wheat, whilst there was little among the sound grain. Moreover if the farmer continues to sow such grains he will obtain degenerated and weakened wheat which will be, in future, always more or less subject to "smut." From this we therefore conclude that it is best to sow only as much wheat as can be sown in the proper time.

5th. It is beyond doubt that it is difficult for a farmer who sows many acres in wheat to sow all in the ordinary sowing time. He must therefore sow after the allotted period, and this explains the surplus of frozen wheat met with in Manitoba. If instead of sowing wheat beyond measure and out of season, grain was sown that would ripen quickly, such as barley, and then also if a part of the field was sown in mixed grains to make green fodder, the smaller area of wheat harvest would be of a better quality, and the other grains and green fodder could be utilized with profit as food for dairy cows, the fattening of cattle, the raising of pigs, all things calculated

to bring in an increase of money to the farmers of Manitoba, if they could but reach the markets from which they are distant, with their products, the proceeds of their industry, for which they would get higher prices than for the frozen wheat they produce, at their loss, every year.

6th.—In a word, however great the richness of Manitoba soil, there will happen to it what has happened elsewhere to soils just as good. The long continued production of grain crop after grain crop has a deteriorating effect and there are new lands in Manitoba which require enriching, by manure or fertilizers in order to continue to produce good crops. Mixed culture combined with cattle-raising and the dairy industry would prevent this exhausting of the soil. Moreover we must not lose sight of this principle, that it is much easier to prevent the evil than to remedy it, and that it is also easier and less expensive to preserve the fertility of the soil than to restore it after it has lost its vigour. This is an experience, the learning of which has been a sad lesson to us in the old provinces of the Dominion.

#### *Advantages of Mixed Culture.*

All these reasons must be more than sufficient to make the Manitoba farmers understand the great interest they should have in the lessening of wheat production, and this should entice them to engage in mixed culture, and in dairy industry. Everything in Manitoba favours the development of this last industry:—abundance of natural fodder, cheap production of green fodders and of varied grains which serve as cattle food, facility and cheapness in raising young cattle, production of extraordinarily rich milk, a climate the most favourable for the production of first-class butter and cheese, a fact proved by the honours carried off by the dairy products at the exhibitions of Ontario and Quebec as well as that of Jamaica.

#### *Fodders in Manitoba.*

It has been suggested that one of the obstacles to the development of the dairy industry in the province of Manitoba is the great difficulty in harvesting of artificial fodders, resulting from the rigorous climate and the absence of snow to cover the fields which remain almost bare, exposed to frosts and thaws. Now in order to overthrow this objection, testing culture of different fodder plants was made at the experimental farm at Brandon, and it is proved that many fodder plants are of a possible and easy culture in Manitoba. I indicate them in the following table:—

# Report of the Dairy Commissioner.

## TEST OF FODDER PLANTS AT EXPERIMENTAL FARM, BRANDON.

English Name.	Botanic Latin Name.	Common French Name.	Botanic French Name.	Use.
Brome Grass, Canadian.	<i>Bromus Ciliatus</i>		Brome du Canada.	Pasture, native.
Brome Grass, Hungarian.	<i>Bromus inermis</i>		Brome inermis.	Meadow and pasture.
Clover, Bokhara.	<i>Métilotus albus</i>	Trèfle d'odeur	Métilot blanc.	Pasture.
Clover, Red Mammoth.	<i>Trifolium pratense</i>	Grand trèfle rouge.	Trèfle des prés, mammoth	Meadow and pasture.
Clover, White Dutch.	<i>Trifolium repens</i>	Trèfle blanc de Hollande.	Trèfle rampant.	do
Corn, Indian, Long Yellow Flint.	<i>Zea Mays</i>	Blé-d'Inde, long jaune glacé.	Mais cultivé.	Green fodder, ensilage.
Corn, Indian, Northern Dakota.	do	do	do	do
Corn, In lan, Squaw.	do	Squaw	do	do
Drop seed grass, Gemminated.	<i>Muhlenbergia glomerata</i>		Mulhenbergie agglomérée.	Meadow, native.
Fescue, Hard.	<i>Festuca durincola</i>		Fétuque durétte.	Meadow and pasture.
Fescue, Meadow.	<i>Festuca pratensis</i>		Fétuque des prés.	do
Fescue, Sheep.	<i>Festuca ovina</i>		Fétuque des brebis.	do
Lyme Grass, Wild Rye.	<i>Elymus Virginicus</i>		Elyme de Virginie.	Pasture, native.
Lyme Grass, Canadian.	<i>Elymus Canadensis</i>		Elyme du Canada.	do
Millet, Common.	<i>Panicum miliaceum</i>	Seigle sauvage.	Miller commun.	Green fodder.
Millet, German.	<i>Setaria Germanica</i>	Moha.	Sétaire d'Allemagne.	Meadow and pasture.
Millet, Hungarian.	<i>Setaria Italica</i>	Moha de Hongrie.	Sétaire d'Italie.	Green fodder.
Orchard Grass, Rough Cocksfoot.	<i>Dactylis glomerata</i>	Foin dur.	Dactyle pelotonné.	Meadow and pasture.
Vetch, Common.	<i>Vicia sativa</i>	Vesce-lentille.	Vesce cultivée.	Green fodder.

I will add to this that besides the plants indicated in the table, common pease and oats sown together give a great abundance of excellent green fodder, and this is sufficient to settle the question of production of hay and grass in Manitoba, and to prove that it cannot be a hindrance to the development of the dairy industry.

The few remarks which I have just written are the recapitulation of the lectures I gave in Manitoba, in the course of my visit, adding to it the principles of feeding and care of dairy cattle, which I alluded to in my report of last year and which consequently do not require repetition.

STATE OF THE DAIRY INDUSTRY IN MANITOBA.

I shall not enter into detailed advantages which the dairy industry offers in the different and numerous districts which I visited, these indications being contained in the reports of the visit made in Manitoba by our inspectors, Messrs. Whitley and McEwan in the season of 1891, whose reports are contained in the official report of our department for the year 1892.

I shall content myself with briefly mentioning the establishments of Messrs. Barré and Mignault, at Jolys (St. Pierre), Mr. de la Borderie in St. Malo and Mr. Pelletier in Lorette, which are kept in a praiseworthy way, both with regard to the plant, buildings and materials used, as well as the quality of products manufactured in their factories. Mr. Barré has done a great deal for the co-operative dairy industry in Manitoba, and his services were recognized last year (1891) by members of the Provincial Dairy Association of Manitoba, who, although being in great majority English, elected him president of their society. Mr. Pelletier comes from a district of the province of Quebec, St. Hyacinthe, which is known for the excellence of its dairy products, and for the prosperous aspects the co-operative dairy industry now presents. Therefore Mr. Pelletier has ideas of progress which he well knows how to put in practice. As to Mr. de la Borderie, an old country Frenchman, to him is owing the advantage of, first in the Dominion of Canada, introducing in a practical fashion the packing of butter in hermetically closed boxes for exportation to tropical countries. These three pioneers of the dairy industry in Manitoba should serve as an example to those who are willing to follow their steps; for success, the necessary consequence of their works, awaits all those who imitate them.

I shall give here certain statistics on the condition of co-operative dairy industry in Manitoba, in 1891, so as to give an idea of what has been done in that line.

Thirty factories of butter and cheese have been in operation, in Manitoba, during the year 1891, representing a capital of \$75,000. It is calculated that the cows contributing milk are worth \$125,000. Thus the co-operative dairy industry in Manitoba, in 1891, may be valued at \$200,000 without counting the value of the land or farm buildings or farm machinery.

Now, if we compare these figures with those of 1886, which are the first official figures furnished on that industry in Manitoba, we give the following result of the comparison:—

	1886.	1891.
Factories .....	5	30
Capital invested.....	\$9,000	\$75,000

Before ending this first part of my report which concerns Manitoba, I wish to tender my sincere sentiments of gratitude to Mgr. the Archbishop of St. Boniface, the Abbé Cloutier, the Honourable M. LaRivière as also the priests of the different parishes I visited, MM. Barré, Mignault, Pelletier, the editor of *Le Manitoba*, for the cordial aid which they gave me in the accomplishment of my work in visiting their province. They have proven to me that which I already partly knew, that they are wide awake to everything that might improve the condition of their fellow citizens.

NEW BRUNSWICK.

The table of my visits shows that I have given ten lectures in this province.

The first work I had to undertake in this province was to try and convince that part of the population engaged in the fisheries, and which inhabits the localities situated on the sea shore, of the poor prospects offered them by the fishery industry in which they are engaged to the extent of excluding all other industries.



## Report of the Dairy Commissioner.

This done, I set to work to teach them the principles of rural economy which could raise them from the straightened condition in which this fishing industry and the exclusion of all others places them. I pointed out to them the raising of cattle as the first step to take in that way.

This was my second visit in New Brunswick with the development of the dairy industry in view. I must say that I found the disposition of the French population that I visited quite open to my suggestions. Memramcook, one of the most central and well adapted places for carrying on a factory, saw this spring the opening of a butter factory. Dairymen's associations are organizing in St. Louis de Kent, Petit Rocher, Bathurst. Bathurst village is also one of the best adapted localities for the development of the dairy industry, and every thing indicates that next spring a butter or cheese factory will be open, thanks to the constant and energetic efforts of the parish priest who does all he can to forward the undertaking. Tracadie, another place, offers numerous advantages in the same way and things seem to be promising everywhere.

I advised in these places, to provide a way for the opening of factories by cultivating fields and pastures and to enlarge their stock by raising a number of dairy cattle before attempting to open too prematurely these factories which would not have at first the support they would require to keep them up.

The directorship of the *Courier des Provinces Maritimes*, in Bathurst, contributed to strengthen these views by publishing my lectures and furnishing me with information as to the needs of each locality.

### ONTARIO.

I visited only two localities in this province, Alfred and Plantagenet, in Prescott country.

I was invited to be present at two great conventions of farmers held under the auspices of the Central Farmers' Institute and the Farmers' Institute of that county. My audience in these two localities was French-Canadian. I was obliged in these two instances to depart from my ordinary programme and give lectures on horticulture and entomology, in order to comply with the wishes and needs of those who invited me.

### QUEBEC.

As usual, my position as French Assistant Commissioner, has given me more work in the province of Quebec than anywhere else. Twenty-six counties and sixty-three localities were visited, and I delivered seventy-nine lectures.

I was present, in this province, at thirteen district or provincial conventions, apart from my visits from place to place.

I have continued to follow last year's programme, that is advocating agriculture especially as based on the dairy industry, the opening of butter or cheese factories and the organization of factory syndicates, delivering on these subjects, lectures, the summary of which, I gave in my report of last year. Moreover, I worked, especially during the last six months, to encourage the adoption of the milk paying system according to richness as determined by means of the Babcock apparatus. My lectures on this subject are a recapitulation of what is written on the question in the report of our department for the year 1891. I also worked to have the idea of butter manufacture in winter accepted, and in this, my success was illustrated by the fact that the Department of Agriculture for the province of Quebec has offered a five cents premium for November, ten cents for December and fifteen cents for January for each hundred pounds of milk converted into factory butter. More than fifty factories have worked with this view during the autumn of 1892 and winter of 1893, and are satisfied with the results obtained.

At the great conventions which I have already mentioned in this report, I gave lectures on: "The possibilities of the dairy industry," which will find room here, since it tends to show that it is really the best source of profit to the farmer. I here give this lecture just as stenographed at the annual convention of the Dairymen's association for the province of Quebec, held at Ste. Thérèse, county of Terrebonne in December last.

## THE POSSIBILITIES OF THE DAIRY INDUSTRY.

*Mr. President and Gentlemen:—*

In my position as director of the Dairymen's Association, I have followed with much interest the course of our annual convention. I only find one fault in these conventions: I could wish that they were like the meetings of a certain club of negroes at New Orleans. A negro belonging to this club was trying to make proselytes and to recruit new members, so, among other details in the advantages offered by the club, he gave those he wished to inveigle the following one: "We have an annual meeting every quarter." (Laughter.) I feel, seeing the interest the people of Ste. Thérèse take in our deliberations, that these annual meetings might easily be made to recur trimestrially without wearying anybody.

But, since we have the pleasure of meeting each other only once every year, we ought to profit all the more by it, and endeavour to study thoroughly the grand business that forms the object of our labours.

I am about to surprise you by begging you to remount at one bound to the year 1870. That year, on a fine spring evening, the son of a farmer in that part of the province I live in, was going to bed thoroughly tired out with his day's work.

It was the beginning of May: the first duty he had had to do in the morning was to lift up from the ground three aged cows that could not get up of themselves. During the day he and his father had been at plough—the old wheeled plough—with a team of a horse and a bullock. As the plough was hard to keep in the furrow, and as the horse and the bullock did not pull together, the lad had to hold the reins; you may guess whether he was tired or not!

In the afternoon, he had amused himself with harrowing with a harrow with wooden teeth, and some of those missing. So that, the lad, when evening came, and he was just going off to sleep, passed over in his mind all the miseries he had endured in the day. Half an hour after he had fallen into a deep sleep, he had a dream; he seemed to see one of the old cows he had raised from the ground in the morning come into his room and draw near his bed. To his great surprise, the cow addressed him. As the boy had followed the commencement of a college course, he had heard people talk of that man who had made the animals of old times talk so wisely: the quaint old Lafontaine. So he fancied that this must be one of those animals that had assumed the form of his father's cow, and preserved the talent that Lafontaine had endowed it with.

The aged cow, in a tremulous voice,—and this is easy to understand, if she dated her life from the times I mentioned,—said to the lad: "My good friend, you have always been very kind to me. From your earliest infancy, instead of cheying me, or setting your dog to bite my heels, you used to come and see if, in that field crowded with thistles, I had grass enough to keep me alive. If you could steal a few armfuls of hay from the horses, that have always been better fed here than we cows, you stole enough to give me a light meal. And, this morning, instead of thrashing me to make me get up, you took me by the tail, giving me such a good spring that it put me on my legs at once. (Laughter.)

"Well, I will repay you for the kindness you have always shown me by giving you some news that will surprise you. This news was imparted to me by the good genius of cows. For you must know that cows are watched over by a tutelary genius, and this genius came to me and said: 'Now that you are at the point of death (your death is not so far off) I wish to tell you what will happen to you when you shall have passed into the body of another cow, in accordance with the laws of metempsychosis. In those days, instead of seeing cows that compel their owners to lift them up from the ground by their tails every spring, you will see cows that are the greatest pride of their masters. Instead of keeping for your use, you poor things, the vilest straw in the barn, and lodging you in the meanest sheds, people will study earnestly to find food good enough for your nourishment. And in gratitude for the kindness man will show you in those days, you will become for him the best source of profit he possesses.

## Report of the Dairy Commissioner.

“In those days, man will tax his ingenuity in committing to the soil the finest products for your food. The sparse blades of clover that are found casually in those bare pastures where you are compelled to pass your summers will be replaced by rich meadows of clover; for man will have conceived the idea of harvesting that seed and sowing it for your use. In those days, the meadows will be full of fine timothy-grass, which will be reserved for you, and the time will come when, by a process unknown now, but that will be discovered by the *savants* of that time, man will find means to preserve fodder green throughout the entire winter.”

After having thus addressed him, it seemed to the youth the cow suddenly changed her bearing and even her coat. Instead of her lean carcass, he saw a cow of finely modelled shape; her coat was shining, her skin elastic, and she had every appearance of being in perfect health. Then, he awoke from his dream. (Cheers.)

In the morning he went and found his father, and related to him this curious dream. “Can you fancy? Our old cow, that I lifted up this morning by the tail, came to me during the night and talked to me in this fashion,” and he then told his father what he had seen and heard. The next morning, when he entered the cowhouse, the poor thing lay dead!

I need not explain this little allegory to make you understand what I mean by it. The title of my address is: *The Possibilities of the Dairy Industry*. This industry is for us the regenerative source of our agriculture, so long in trouble. No one among you, gentlemen, doubts the truth of this. The great work we have accomplished during the last few years, the great progress made in the mode of feeding cattle and in the production of milk, suffice to show how long is the road we have traversed.

Still, it would not astonish me, in our days, if one of our improved cows were to present itself before us to show us prospects still more brilliant. Perchance, some cow, still in possession of the talent conferred upon her by the great fabulist, may come and tell us that we can do even better than we are doing to-day. But to succeed in this, we must bring to bear all our wits, so as to profit by the knowledge acquired during the last few years, and apply it to all the branches connected with the dairy industry.

The first thing to be done to enable us to march bravely along the road of progress—and this is true not only of farmers, but of all who want to succeed in the world,—is to do everything in a well considered manner. And the system of farming of us dairymen must always be carefully thought out.

There are in the world three kinds of ignorance, which are fatal to all who are afflicted with them, but fatal in different degrees. The first is that of knowing nothing at all. In this our age, there are happily, very few afflicted with this kind of ignorance, and did it exist in any one it could be easily cured.

The second kind is that of not knowing thoroughly what one does know. Unhappily, there are more people afflicted with this style of ignorance than with the other; and it is more difficult to cure; for, if it be pretty easy to convince of his ignorance one who knows nothing, it is, in general, very hard to make any one confess that he is only a *demi-savant*.

The third kind of ignorance is that of knowing other things than those it is our business to know, and to pass our time in running after chimeras, while we neglect those things that lie within our reach.

In the farmer-class we find these three sorts of ignorance. God gives His gifts to whom he pleases; but in our social condition, we ought to devote ourselves to make these three kinds of ignorance vanish, saying to those who know nothing: ‘Enter our society, enter our farmers’ clubs, and learn.’

We must deal more lightly with those who know something, but who only partially know it, because then as when we meet any one who thinks he knows, we must beware of hurting his susceptibility. We must instil into his mind good principles without his perceiving it, and expel the bad principles that were rampant there. As for him who knows what it is of no use to him to know, we should try to make him learn things that are really useful to him. We must teach those who are following another road than that of dairying, that the road they are following does not lead so directly as ours to the prosperity and progress of the country.

We must always act with reason, and to reason we must think, "To act without thinking is to fire without aim," as the Spanish proverb has it. Before making any move, in any kind of cultivation, we must think it out, in order to understand if the change we intend to work is one based on experience and on principle. We must see that it is in conformity with safe practice, and to do so we must resort to the springs whence knowledge is drawn, and the springs I refer to are meetings like this one and like those of the farmers' clubs. Those are associations of farmers who come together to consult, and their results finish by brightening the intellect of the least gifted of men.

I said just now that to be able to reach all the possibilities that dairying offers, we must know how to utilize all the resources we possess in the different branches of cultivation which we are obliged to pursue if we wish to arrive at perfection in the dairy industry. The commencement must be the performance of our farm work in the most perfect manner possible; our land must be cleared of the stones that encumber it; it must be drained to rid it of the surplus water, and be levelled that the implements may have free scope for working. The best implements are always the most improved, and the most improved are always the least dear, however much they may have cost: plough, cultivator, harrow, roller, etc., indeed all the tools used in good farming, must be of the best class. The man who has a good tool can do twice as much as the man who has a bad one.

These possibilities appear too in a more striking form, in the feeding of our stock. Instead of a ration in which there was very little hay and a great deal of straw, we now have every kind of other foods which have been tried, and which lead to results, I will not say double, but five times what they used to be.

At present, in this province, we have raised the old yields of 40 lbs. of butter a cow to 150 lbs. We must know how to utilize all kinds of stuff: cotton-cake, green-fodders, prepared fodders, which formerly were unknown, but which now, when once fermented or preserved in a silo, are well suited to the wants of the cow and make her give the greatest possible yields.

And this good food that we must have for our cows, we have only been able to get because we have taken the greatest care of our manure, of our dung. We now know positively that badly preserved manure, as it used formerly to be, is not worth one-half as much as well preserved manure. And we also know that by having a cheap shelter under which the dung is safe from storms, and by enriching it with phosphate or plaster, by feeding the cattle in the best possible manner in order to enrich the dung still more, by all this we shall succeed in producing crops more and more abundant, and in securing by these means the food best suited to our cows.

Thus, one ton of cotton-cake, costing \$27, gives us in dung yielded by the stock this same \$27; a marvellous thing, truly, almost incredible, did not chemistry vouch for its truth. By taking better care of the dung and manure, and by having the best that science points out to us, we can grow crops five-fold as rich as formerly; and this is again one of the possibilities we have whereby to increase the products of dairying.

Let us now attend to the stock that is the source of this industry—the cows. Formerly keeping cows was considered as a make-shift. In a family, one cow was kept on in milk from the autumn to have a supply for the baby during the winter. In winter the cows ate as little as possible; in summer, they were allowed to wander about the pastures, where the burnt-up soil showed hardly a blade of grass; and this is how our cattle became a mean and degenerate race that produced no good results.

One day, in a village, now a bathing place on the St. Lawrence, the boarders had passed the night without sleep; they had been kept awake by a street-roaming pig, one of the sort that passes the year without eating. They hunted out the owner of the pig, and asked him: "Why do you keep this pig?" His answer was, "It is always good enough to drink the dish-washings that I have to give him." They used to say, once upon a time, that a cow was always good enough to eat the little food they gave her in winter, and to give a little milk in summer.

How different are things to-day! Where there were 200 cows, averaging 40 lbs. of butter a year, there are now 600, giving each three times as much milk as they gave then.

## Report of the Dairy-Commissioner.

I do not hesitate to say that, in every part of Quebec province, with the farms we possess, we can easily double and triple the number of cows, if we only knew how to improve them by the methods I have rapidly run over.

The rearing of the milk-cow is a rather complicated affair; and it is by means of rearing and selection that we have brought out the different varieties of cows that afford us profit. It is, in fact, acknowledged now that, in two or three generations, a race of cows can be so improved by feeding that they become unrecognizable. This is the universal experience.

Our cows were formerly, in general, a mixture of Ayrshires, Herefords, Short-horns, Canadians, &c. They ate a great deal and were sometimes fat, but they never paid their way. At last, it was discovered that, by the side of these cross-breeds, there was a distinct race that had developed itself side by side with them without intermixture, weighing about 500 lbs., and able to yield ample products.

We have raised the food of this to the feeding-rations of the thoroughbreds, and what is the result? It is this: not only have the cross-breeds, Shorthorns and Ayrshires, been discarded, but even the pure-bred animals of those breeds. And we have registered in the herdbook of Canadian cattle, kept by the Dairy Association, reports that prove that some of these cows give as much as 14 lbs. of butter a week.

If, by wise persistent efforts, for some years, we have succeeded in getting such good results from this race, do you not agree with me in thinking that, in 10 years, foreigners will come to search after our Canadian cows as they now search after her sister of the Isle of Jersey? For, with proper food, she is as handsome and produces quite as much. We do not want a race of butcher's beasts for the dairy. And it would be wasting time to try to get cows that would answer both purposes. When a cow, like the Canadian, has given her owner the best returns for her food for a series of years, would it be more than fair to claim for her, when old, a better fate than the butcher's pole-axe? Let us be satisfied with making this cow yield this precious milk of hers, which is the source of the finest industry that exists in the province.

I have just mentioned the word "milk"; milk is with respect to the dairy industry its raw material, and therefore deserves our special attention. What I have to say about it, will not detain you long.

Science teaches us that milk is of all things the most sensitive to its environment. A crowd of once unknown germs, which cause the numerous injuries we so well know, but the source of which we were once ignorant of, microbes, bacteria, etc., have a great share in this. Nowadays, we cannot have a slight head-ache, without fancying it is the work of a microbe, the microbe of the influenza (*grippe*), of the typhoid fever, of the cholera-morbus; and even a common cold is laid to the charge of a microbe.

What are they, these microbes? The tiniest of beings; only visible under great powers of the microscope.

The first way to get rid of them is cleanliness; and I do not mean such cleanliness as makes us *see* no dirt, but that sort that is determined that no dirt shall exist in its domains. How often have I seen patrons bringing milk to the factory in dirty cans, in which the milk stank! Still, the milk, to look at it, was clean. In the morning, the can that held the butter-milk, was emptied, rinsed with cold water, fresh milk was put into it, and it was supposed to be "all right."

But it was no better than what was done by the two Hebrews who had just landed at Montreal from an ocean steamer. Having no work, they went to try to get some from the German consul. The consul's clerk, when they entered the office, said to them: "If you want to see the consul, the first thing you have to do is to change your shirts; he will not receive you in that state." The two tramps went out, and very shortly returned in exactly the same condition. "But I gave you notice," said the clerk, "that the consul would not receive you unless you changed your shirts." "Well," replied one, "we have changed them; I took Samuel's and Samuel took mine." (Laughter.)

These folks evidently knew nothing about what real cleanliness means; and there are some of our folks who do not seem to know much more about it than they.

If there is no dirt to be seen on their hands, or on the implement they are using, it is all right. They seem to have neither smell nor taste; in fact, they seem wanting in many senses that are the endowment of our race.

Well, gentlemen, milk is a thing that must have the greatest cleanliness observed in dealing with it; but that is not all. Sad to say, I must state that, in our province, one of the things that make the perfection of dairying difficult of attainment, our own fault, one of the worst things we have to deplore in the dairy industry is—I may mention it, for we are all *en famille*, and even if we should speak of our faults, that can offend nobody—well, it is, that we are in the habit of adulterating our milk.

There is a substance that costs but a trifle, and is very easily mixed with milk; I mean *water*. People are led to put great quantities of it into their milk.

Another thing they are inclined to despoil their milk of. Some one has said: "Milk is a thing on which many things have been written, but the best article I ever saw on milk is cream." Cream is one of the things that tempt the farmer the most severely. I, for my part, try to make my cows yield as much cream as possible; the richer in cream the milk I send to the factory is, the more satisfied am I. But there are people who when they see plenty of it, skim off some. They say: "There is no harm in it," no, it is to make butter. Evidently, this is not a respectable proceeding.

Unfortunately, in some parts of the country, dishonest patrons are so numerous, that it may be said of them what was said by the following epitaph on the tomb of a lawyer: "In memory of a lawyer and of an honest man." On seeing this epitaph, a visitor exclaimed: "What on earth did they mean by burying two men under the same epitaph?" I should not be surprised one day, if at the sight of this epitaph: "To the memory of a patron of a cheese factory, and of an honest man," passers-by were to fancy that two distinct persons were there interred. (Laughter.)

But I hope this will never happen. There are enough of the class I have just been speaking of, who, rightfully or wrongfully, have lost their reputation, without adding another class. I trust the lawyers who are present will not feel bitter against me for this remark; for I was a lawyer myself, before I was converted and became a farmer.

Butter is one of the most delicate products of the dairy: it requires the greatest care, not only to make it good, but to keep it so. Formerly, it was unfortunately not uncommon to see butter of such a quality, that when the coffee at breakfast was too weak, it had only to be put near the butter to make it stronger. Now, things have altered; we make better butter than formerly; but even now it is not perfect, and you know that perfection in everything connected with the possibilities of dairying must be sought after.

Take the example of Denmark. Formerly Denmark produced but little butter, and that very bad; and now it commands the European market. In spite of some less favourable circumstances in which we find ourselves, we can succeed just as well as Denmark; and it is to that success that we must bend our efforts.

You heard Mr. Ayer yesterday illustrate the precautions to be taken not only as to the making of good butter, but also in packing it. He told us how fanciful the dealers are; for really these are fancies. If the tub is not as clean as it might be, even if the butter in it is very clean, they make us lose a cent. But this explains itself: it is the nature of man to be fanciful. We have the beautiful, the good, and before all we search out these abstractions by the senses, by the eyes. For it is the eye that gives the first indication of what is good, or bad.

Take then to market an article that cannot be found fault with, and the only way of having such an article of butter is to make it by the best rules, by the best processes that are taught us in our meetings.

It is not my part, in speaking of the possibilities of dairying, as I am now doing, to enter into details. I simply show the points to which our attention should be directed, if we desire to attain the very highest degree of perfection in the business of which we are the promoters.

## Report of the Dairy Commissioner.

Up to the present time, butter has been only a summer product in this province; it was only by chance that any was made in winter. Now, things are changing: our attention has been drawn to the fact that we are situated in the best possible circumstances for the manufacture of winter butter for exportation; and there is now a movement going on to induce the proprietors of cheese factories to convert them into creameries in the winter months. Our government has just set a generous example, by offering 5, 10 and 15 cents per 100 pounds of milk taken to the factory during November, December and January, months in which butter is proposed to be made. Every one must be anxious to profit by this.

It may be said, this year, that here is a thing but little understood: but next year, I trust we may say that winter butter-making is spreading rapidly and is yielding good returns.

What a difference from former days! I described to you the condition of the cow of 22 years ago, and her present condition. To-day, during winter—instead of doing nothing, boarding out, with very bad board too, as it used to be—the cow, I say, gives as much profit in winter as in summer, if her master knows his business. If the factories close in November, if there is no creamery near us, we will open small dairies for ourselves, make our cows give plenty of milk, milk producing butter worth 25 cents a pound. And the places where this is being done are very numerous.

But we want more than this; we want the making of winter butter to become one of our habits as much as the making of cheese in summer. By this, by making butter in winter, and the finest possible export-cheese in summer, we shall have attained the maximum of production in the dairy industry.

I told you that to-day our cheese was about to win prizes on the neighbouring market. This happened two years ago, and Toronto was the stage on which it was given us to compete with the rest. This "French cheese," which people chose to designate by hard names, will be our glory, and the province of Quebec will benefit by it in a special manner.

To perfect ourselves up to this point of dairying, it took a great deal of study, and we, the members of the Dairy Association, had to carry on this study. We did it conscientiously; we laboured with all our strength. We had among us valuable men, men of science, who came to our yearly meetings charged with fresh discoveries, with improved methods, that promised better results every time. And the results we have reached to-day give us the finest prospects for the future.

Honour to those devoted men who have given up their time to the progress of this grand industry! I trust that those who hear me will do justice to the men who have done so much for the country. (Applause.)

We thought that one of the best means to promote the interests of our dairy industry was the spirit of association. This industry, as it exists at present in this province, cannot be carried on, on such a large scale, except by co-operation, that is, the combined action of all the farmers united in associations of cheese factories and creameries, where each takes his milk to be made up. These are public places, where people meet together to labour or to make others labour in common for the production of an article, the offspring of their own industry, in order to obtain from it the best results.

We formed syndicates of factories that the different factories might unite, form strong associations between themselves, with a special view of engaging inspectors to enable them to make real progress in their business.

We have in prospect another great association; one that will bring together all the local societies: the syndicate of farmers. It is, though still in its infancy, already sanctioned by the legislature. The society will permit all farmers, whatever be the state of their means, by subscribing \$1.00 a year, to benefit by the knowledge and experience of each other, and will specially enable them to sell, on good terms, the produce they have to dispose of, without fear of foreign competition, and above all, without fear of speculations of which they are sometimes the victims through the acts of those who come to buy their goods. In the farmers' clubs, we have centres of instruction, whither all can come to imbibe knowledge, and with the aid of all these societies, by means of co-operation, we are certain to obtain finer results than we have ever dreamt of.

And now, to look a little farther, what has this dairy industry, of which I have been speaking so much, in reserve for us? Well, here it is: we were told at first that this industry if carried out *à outrance*, as it was suggested, might overload the market. Now, we know that we only export to England 42 p.c. of the cheese and 2 p.c. of the butter she consumes: I think we need not be afraid of overloading her market. But there is another thing: if we are asked to push the dairy industry to its extreme limits, it is not only because it tends to produce plenty of milk and other dairy products, but because the practice of this business will compel us to throw aside routine, to give better food to our cattle, to improve all our products, and to devote such attention to farming in general, that I fear not to say that, in 20 years from the present time, the province of Quebec will be in a position to produce wheat as it used to produce it 40 years ago. For we shall have restored to the land all its fertility, all its powers. We shall then begin to rear beasts for the butcher, and to grow grain, if the markets for butter and cheese are overloaded. We shall have restored our farms to the condition they were in when they were first cleared.

These then are the prospects I see before me; this is what I hope for; it is this the young generation will see; and this it will owe to the reiterated efforts of the men of this generation.

But, gentlemen, we must not go to sleep over this fine prospect; he who comes to a standstill on the road of progress is, in reality, slipping backwards, and for this reason: because the man who is with him, while he himself is staying behind, continues to advance. It is a providential arrangement, that when once we have entered upon the road of progress, we cannot but pursue it.

Thus, we are obliged constantly to study new methods, and new implements, in order to keep up with the times; and it is only by means of persistent inquiry and constant work that we can make sure of realizing these fine prospects.

In conclusion, allow me to say a word to the young folk who have listened to us so attentively, and have even begun to imitate us.<sup>1</sup> You know that the farmer, if he wants to have good things in his garden, must, to start with, secure good seed.

He begins by making hot beds, where his plants are to start. He prepares the land, cuts up all the weeds which might feed at the expense of the young plants. He introduces artificial heat under his hot bed, in the ground, and then waits for the Almighty to do his share.

Later on, these plants are drawn and transplanted into cold frames, that is, into frames a little cooler than those in which they had previously been, but better suited to the plants under their then state of growth.

Lastly, when the plants have by degrees become accustomed to their final abode, they are set out in the garden, protected in every way from the attacks of insects, and before long they transform themselves into superb products.

Well, gentlemen students, you are the seed of the nation. You are here in a hot bed, so to speak, where intelligent gardeners bestow on you all the care and culture you require to become what you ought to be. Later, you will be placed in cold frames, called universities, special schools. And lastly, when you leave them, full of vigour, you will find yourselves in that fine garden, the province of Quebec, where you will produce the fine fruit that is rightly expected from you, after the care that has been lavished upon you. (Cheers.)

One thing against which I must forewarn you in the position you occupy, is this: formerly, and not very long ago, there existed a strong prejudice against learning; it was thought that a man of learning must become an advocate, a notary, a professional man of some kind.

A few years ago, an educated man, who devoted himself to farming, would have passed for the least sensible man in the world. Now, this is rather different. You have perhaps no idea,—and yet you might have gained some idea of it during the last few days,—of the enormous amount of information a farmer stands in need of.

<sup>1</sup> To understand this passage in M. Chapais's address, we must remember that the convention was being held in the great hall of the College of Ste. Thérèse, and that the pupils of the college, during play-hours, had started a convention of their own, imitated from that whose sessions they had been attending.



## Report of the Dairy Commissioner.

I will go further: I will say that a farmer needs more knowledge than any one, if he is to excel in his business. Study physical science, chemistry, all the exact sciences, and not a day will pass, in your life as a farmer, in which you will not find the benefit of them.

Who are the men who, without having the strength of many others, advance the art of cultivation? They are the learned men who, like you, have passed years on the benches of colleges, and who are now the glory and boast of the agricultural class. I reckon on you, and I place among the "possibilities of the dairy industry," the hope that there will be many among you who will devote themselves, to this grand industry the information they shall have acquired here.

\* \* \* \* \*

I have given some attention to the selection of cheese and butter for the Columbian Exhibition, and just now I hear of the success of our exhibition in that line at Chicago.

I have given in several places a lecture on the production of winter milk, of which the following is pretty much the substance as stenographed at one of the conventions mentioned above.

### PRODUCTION OF MILK DURING THE WINTER SEASON.

*Summary.*—General considerations; change of the period of the calving season; allowance of food to the cows; stabling of the cows; light; ventilation; good temperature; cleanliness; water in stable; necessary conditions for the production of good butter in winter season; conclusion.

#### *Mr. President and Gentlemen:*

Fifteen years ago the Canadian farmer caused his cows to calve on the 15th May and allowed them to dry up on the 15th November. During six months of winter he fed his cows without remuneration, and, although he gave them but poor fodder, he was at a loss during six months. That, with other reasons, brought on rapidly the ruin of the farmer.

#### *General Considerations.*

When the road to ruin is apparent the farmer, as a drowning man, calls for help and looks out for a way to save himself. Happily his cries have been heard and a helping hand has been given him and theoretical, well thinking, and devoted agriculturists came to his rescue and have been able to rescue him from the damaged vessel, the cause of the wreck, and tender him the helping hand that enabled him to save himself. Those agriculturists told the unfortunate castaway: 'It is the milk industry, too little known and badly practised, which has brought on your ruin. Well, it is that same industry, well understood, that is going to save you.' And after having made that promise they have kept it. It is to complete the almost certain salvage of the farmer that these agronomists, to-day, endeavour to convince them that the milk industry must be continued the year round, and not only during six months. To cause the cow to pay her board with her milk during the winter, as she paid it during summer, as formerly, this is the rescue—and that helping hand—the Government of the province of Quebec has generously tendered to the farmers, by offering him a bonus for the milk made into butter during the winter.

The problem to be solved to obtain perfection in the practice of the milk industry consists, therefore, in making cheese in summer, for which we have always a ready market, and to make butter in winter, another product for which we can easily find a market.

I have been intrusted to explain before the members of the great and useful congress now assembled the theory of the production of the milk and the making of butter during the winter. I shall lay before you in a few words the special principles governing that theory, which is only, as I will now explain to you, the application of the practice already followed by a number of progressive farmers in our province.

*Change in the Season of Calving.*

The first thing a producer of milk, during winter, must do, is to alter the date of the calving of the cows according to season—in the province of Quebec to-day, it is the general usage to cause the cows to calve in the spring. Therefore, to secure a good production of milk from a herd during the whole year it is necessary that the cows should calve at various times in the year—some will be made to calve in the spring, others in summer, and a certain number in the fall. It is necessary to act thus for two reasons, first, because it is the only way now to be, at certain times of the year, with cows on the eve of calving and giving no milk and next because it is well known, to-day, that to produce, during the winter, butter having that peculiar flavour, so much sought, called almond flavour, it is necessary to have the milk of new calved cows, at least for the part of it. And if it became necessary to choose between fall and spring as the calving season, when it is time to begin the production of cheese in summer and butter in winter, it would be better to prefer the fall. It is easier to keep up the supply of milk of a cow during winter by proper nourishment, when she has calved in the fall than when she has calved in the spring, and besides, although a cow has long been calved in the spring, the new grass of the month of June causes her to give a fair quantity of milk during the summer.

*Feeding of the Cows.*

The only thing the producer of milk during winter must attend to, is the proper feeding of the cows, according to a system tending to increase the secretion of the milk. Now this system is easily put in practice by means of ensilage, which gives the farmer the feed necessary for his cows during the entire winter, and nearly as good in quality as the summer grass. The chief point to be observed in the feeding of the cows giving milk, is to give them a watery food rich at the same time causing activity in the production of the milk. All sound forage is good to give to milch cows, taking as a principle that by chopping and maceration, a beginning of fermentation, it is made easily assimilable to the cow who is to digest it. The ensilage fodder offers that condition in the highest degree and that is the reason it is so much recommended for milch cows. We are now opposite two distinct systems of feeding during winter. One consists in taking the greatest profit from the alimentary substances such as hay, straw, chaff, grain, roots, at the command of the farmer nearly everywhere. The other to make a special culture to produce a special alimentation. This culture is the sowing of forage plants to use as ensilage to be used afterwards as the base of alimentation. Those plants preserved in the silo and which are called ensilage, are given to the cows mixed with other alimentary substances.

It is laid down in principle in the first system of feeding that all dry forage must be chopped and made more assimilable by damping, maceration and fermentation; when in that state, grain which must always be ground is added, and as a condiment a small quantity of salt.

In the second system the prepared forage as above stated, is replaced partly by ensilage to which is added what is left of dry chopped forage and other food mentioned above to complete the ration.

For both systems the farmer, who desires to obtain the largest possible return not only in milk, but also in manure, which is of the greatest importance to him who knows that the value of manure varies according to the quality of fodder fed to the animal that produces it, is advised to add to the alimentary substances provided by the farm, linseed or cotton cake to enrich the ration and attain the maximum production.

Trials have demonstrated that for a cow of 725 pounds, the average weight of the Canadian cow of our province, the two following rations are sufficient to enable the cow to give an average of 15 to 20 pounds of milk per day, in a stable with a temperature of 66° Fahrenheit.

## Report of the Dairy Commissioner.

### First ration of ensilage food :

Ensilage .....	13	lbs.
Chopped hay.....	10	do
Chopped straw .....	2	do
Cotton-seed meal .....	1 $\frac{3}{4}$	do
Bran.....	1 $\frac{3}{4}$	do

### Second ration, chopped and fermented forage :

Hay, chopped, and fermented for 48 hours.....	10	lbs.
Straw                   do                   do .....	10	do
Bran.....	5	do
Cotton-seed meal.....	3	do

### *Stabling of the Cows.*

The third thing that a producer of milk, during winter, must pay attention to, is to have a good building to winter his cows. To make him understand what I am going to say on the subject, I will put two axioms, the correctness of which is recognized by all theoretical agriculturists as well as by breeders: Uncleanliness breeds disease; cold stops the production of milk.

A stable must have five qualities to be considered as a model. It must be lighted, the air must be pure, temperature good, perfectly clean, and in it must be found a handy system to water the cattle with abundance of clean, pure and temperate water.

### *Light.*

One word on each of the qualities required in the stable. The sun is the generator of life. All who live or exist, man, animal, plant, need the sun and its beneficent light, to be healthy and in good condition of life. This is proved by the fact that the men or the animals who live in darkness have their blood impoverished and gradually weakened, and also by this fact that plants growing continually in the shade grow thin and weak and show accidents of growth altogether anomalous.

### *Pure Air.*

Pure air is of first necessity for everything that lives. Air in penetrating the lungs serves to purify the blood carried to all the internal economy of the animal. If pure it brings to the animal health, if vitiated it causes serious diseases and often death. It is useless to longer insist on this score. If there are unbelievers on this subject let them be imprisoned for half a day in a room where lies an animal in putrefaction. On coming out of that place they certainly will have faith.

### *Good Temperature.*

It is meant by good temperature in a stable, that which is not higher than 66° and not lower than 54° Fahrenheit. A few degrees above or below that may still be accepted but they should rather be avoided.

Good air and temperature necessary can be had in a stable by ventilation which to be perfect must be constant and well regulated. Therefore ventilators are indispensable in all well kept stables and so constructed that their draught can be increased or diminished at will.

The question of temperature is important not only on account of the health of the animal, but also for the profit of the farmer. In fact, it is well known that the more an animal is kept in the cold, the more it eats and between 32° and 66° the difference may be 30 per cent; that is a cow which would have enough of one bundle of hay in a temperature of 66° would require two in a temperature of 32°. It is also well proved that a cow which is suffering from cold soon ceases to give milk.

*Cleanliness.*

Cleanliness consists not only in appearance but in reality. The good ventilation and the normal temperature above indicated strongly aid in the maintenance of strict cleanliness in the stable and are its first elements. But there is a great deal more to do to secure it. Cleanliness must bear on a scrupulous carrying off of the excrements, both solid and liquid of the animals, which must be carried to a place where their emanations and their characteristic odour of ammonia cannot invade the stables. During the time they are in the stable between the hours of cleaning, these emanations are lessened by throwing superphosphate or plaster on the alleys to prevent the waste of ammonia. Care must be taken that insects, such as spiders, and chiefly lice, do not take possession of the stable, and to succeed in that a repeated sweeping is necessary, not only of the floors but also of the walls and ceilings and twice a year the walls should be whitewashed with a mixture of carbolic acid and whitewash. It is also necessary to empty regularly the mangers, the troughs, and clean them often. Finally the animals themselves should be curry-combed, carded and brushed often to carry off the dirt which has mixed with the hair, closing the pores of the skin, preventing the secretion and keeping the animals in a bad state of uncleanness, and also in an unhealthy condition.

*Water in the Stable.*

Finally it is important, that if we wish that a cow should give milk, we must give her, over and above what I have first mentioned, an abundance of good water. For the reasons I have given above in speaking of temperature, care must be taken not to give it too cold, for if it is too cold it forces the cow to eat much more and besides causes her to dry. The water must be of the same temperature as the stable. It is necessary that it should be pure; for dirty or unwholesome water immediately imparts a bad quality to the milk of the cow. It must not be forgotten that it is important that the cow be allowed to drink when she is thirsty, in lieu of drinking only at fixed hours for the convenience of the farmer and not that of the animal. From what I have said, it is evident that the custom followed in many places of watering the cows outside at the spring or at the river in winter is hurtful in every way. It stops the secretion of the milk in the cow that is milked during winter, causes chills and brings on miscarriage of the cows with calf, and is a source of useless expense of fodder to the farmer. The strongest reason given for this habit is that it gives the cows exercise, exercise which it is claimed is absolutely necessary to keep them in healthy condition. I will answer to this reason, by proving that it is founded on false principles. In fact it can be affirmed that the cows do not need exercise during winter to remain in good health, provided the stable is what it ought to be. Since I can remember, I know of a stable, far from being a model, where the cows have been in constant seclusion without being turned out from the 15th October to the 15th May every year, and in which, however, there never has been, for nearly three years, a single case of miscarriage, of difficult calving or of sickness, other than cases of accident, and I could mention a number of other stables where things are in the same condition.

*Necessary Conditions for Making Good Butter During the Winter.*

I have pointed out very nearly all the conditions required to make the milk industry a paying industry in winter, to wit: the means of having milk in a profitable manner. Before I come to a conclusion, I have only to say a few words on the manner of keeping the milk to secure the largest profit in winter. It is acknowledged that the butter made in winter with the milk produced in the conditions I am going to indicate, is an excellent butter for export. A trial has been made last winter in connection with our department and the results obtained are conclusive. It only remains to put them in general practice.

To produce good butter in winter, there are certain conditions to be fulfilled. Besides those I have already given above the most important is the production of

## Report of the Dairy Commissioner.

good milk; it is necessary to have at least in part, the milk of fresh calved cows, to produce a quality of butter having a perfect aroma. The second is that strict cleanliness must be attended to in the manner of keeping the milk. The cold season in the winter prevents the keeping of the milk in places which can suit well in summer but where it would freeze in winter before producing the cream. This often causes the housemaid to keep it in a room inhabited and heated, but where the air is far from being pure. It is clear that milk kept under these conditions cannot produce good butter. The safest way to obviate this inconvenience is to have for the winter a dairy the same as in summer and have winter dairies fitted up in such a way as to be able to skim the milk with the centrifugal machine before it freezes.

It is a certainty, based on experience, that butter made under these conditions will find a remunerative market for the producer.

### *Conclusion.*

In concluding this address much shorter and more condensed than it ought to be to treat properly this subject, I insist on the importance there is, for the farmer producer of milk, to do all that is possible to produce milk all the year round; I will chiefly insist on a point at present indisputable, in favour of the production of milk during winter. It is this, that the best milch cow does not, in fact give the maximum of milk which she can produce in twelve months, unless she gets all the year the maximum of food fit for the production of milk, which she can assimilate and that she is milked dry during the whole of that period. This maxim that a farmer should write in large letters on his stable door is so true, that those who are convinced of its truth have put it in practice, and I can guarantee, I being one of them, that they have ascertained that it is not unusual to meet, principally among subjects of the Jersey and the Canadian breed, its sister, cows it is impossible to drain before the period of calving. This I mention to answer one objection I have often heard against the production of milk in winter. The drift of this objection is that cows milked all winter do not give much milk the following summer. This objection is true only as to the cows who have a poor pasture in summer or who during winter have been fed on very little except straw. It is to be hoped that before long this kind of cow will have ceased to exist and that in a few years it will be found as easy to make butter in winter as to manufacture cheese in summer.

\* \* \* \*

In January last, a great convention of farmers from the province of Quebec was held in the city of Quebec, under the auspices of the Dairymen's Association. I was requested to help in the organization of this Congress and I did so in every way possible, especially in all that concerned the Dairy Industry. I also gave to this work all the time I could. Having been invited to lecture before this said convention of farmers, you have been able to judge for yourself the good results it must necessarily produce. All the important questions now under consideration were discussed at this Convention, and I am certain that the time which I gave to its organization will produce as good results as my other efforts in this province.

### *Work Concerning all the Provinces.*

Besides the special work done in every province, I had to give a great deal of time to the translation of different reports for our department, to the attention to a correspondence which becomes daily more and more extended, and to the work of forwarding information which is asked from all sides and which necessitates sometimes voluminous memoranda as well as thought and study. In fact, the amount of work that claims my time is increasing from day to day and I can say, that just now, it is impossible for me to accept all the invitations that are tendered me to lecture in different places. I had to put aside at least forty of these demands for want of time. Having no secretary, the work accumulates in my office during my frequent absences and I should require a lengthy period between each trip to attend to even the most urgent demands.

I had to give, during the last eighteen months which are the object of the present report, considerable time to my lectures, the time employed for my trips having been much greater on account of the great number of miles covered and the great number of lectures given.

A glance over the following comparative tables, indicating the work done during the first twenty-one months which were the subjects of my two first reports, and the last eighteen months which are the subject of the present one, will give an idea of what I had to do and the increase which the future promises:—

	Counties visited.	Localities visited.	Lectures given.	Number of auditors.	Miles travelled.	Average of auditors.
From April 1, 1890 } to 1st Jan., 1892. }	51	92	99	13,150	11,797	132
From 1st Jan., 1892 } to 1st June, 1893. }	32	104	124	17,800	16,364	143

I am happy to state in finishing this report that a great progress has been made everywhere as far as the dairy industry is concerned, and the proof of this progress can be found in the great development of the syndicates in the province of Quebec where there were but ten in 1891-92 against thirty in 1893; in the opening of winter butter factories of which I had not to speak in my last report, and which now number nearly fifty; and also in the payment of milk according to its value in fat, a method followed in only one factory in 1891, and now followed in about forty factories in the province of Quebec.

This progress is a great source of encouragement for those who, by their efforts, contribute to it.

I have the honour to be, sir,  
Your obedient servant,

J. C. CHAPPAIS,  
*Assistant Dairy Commissioner.*

## PART XII.—REPORTS OF SUPERINTENDENTS OF EXPERIMENTAL DAIRYING.

### (1) REPORT OF J. A. RUDDICK.

TO PROF. JAMES W. ROBERTSON,  
Dairy Commissioner,  
Ottawa.

SIR,—I have the honour to submit my report of work done as one of the superintendents of dairying on your staff for the year ending 30th June, 1893.

The work overtaken by me during this time has been so varied that I shall present the report thereon under the following heads:—

- I. Experiments in cheese-making at the Perth dairy station.
- II. Winter butter-making.
- III. Meetings.
- IV. Miscellaneous work.

#### EXPERIMENTS IN CHEESE MAKING AT THE DAIRY STATION, PERTH, ONT.

The work undertaken here was in reality a continuation of that which was commenced in 1891 and briefly reported upon in the Dairy Commissioner's Report for 1891-92. Investigations were carried out along the following lines.

- I. To determine the quantity and quality of cheese made from milk containing different percentages of fat.
- II. The effect of high vs. low cooking of the curd.
- III. The effect of setting the milk at different degrees of ripeness.

## Report of the Dairy Commissioner.

Considering that the results of the first named experiment would throw a much needed light on the question of "paying by test" at cheese factories, special attention was given to this particular experiment, by repeating it oftener than any of the others. Altogether seventy-five tests were made, and carried out as carefully as possible.

It should be remembered that we had to contend with all the difficulties usually met with by the cheese-maker in any ordinary factory, and the results given will apply in any cheese factory.

### I. To determine the quantity and quality of cheese made from milk containing different percentages of fat.

Table No. 1 gives the details of all the tests made in this experiment. The weights as given under the head of *green* cheese are those taken as the cheese came from the press, while *cured* cheese refers to the weighing made when the cheese were three weeks old. Of course cheese are not fully cured at that age, but that is about the length of time which elapses before cheese are weighed for market in the ordinary course of business during this season of the year (June, July and August): hence the reason for adopting that stage for the second weighing.

TABLE I.

Date.	Lbs. of Milk.	Specific Gravity.	Per cent of Fat.	Lbs. of Fat.	Lbs. of Green Cheese.	Lbs. of Green Cheese to 1 lb. of Fat.	Lbs. of Cured Cheese.	Lbs. of Cured Cheese to 1 lb. of Fat.	Lbs. of Milk per lb. of Cheese.	Lbs. of Cheese per 100 lbs. of Milk.
June 17.....	1377	31.9	3.09	53.70	141.25	2.63	138.00	2.56	9.97	10.02
do 17.....	1485	31.7	3.04	50.29	137.50	2.73	134.00	2.66	11.08	9.02
do 17.....	1333	31.8	3.02	42.65	122.75	2.87	119.50	2.80	11.15	8.96
do 18.....	1400	32.0	3.95	55.30	149.25	2.69	145.00	2.62	9.65	10.35
do 18.....	1400	31.8	3.06	50.40	136.00	2.69	133.50	2.64	10.48	9.53
do 18.....	1400	31.9	3.04	47.60	135.25	2.84	132.25	2.77	10.58	9.44
do 23.....	1300	32.7	3.08	49.40	132.25	2.67	129.50	2.62	10.03	9.96
do 23.....	1400	32.7	3.45	48.30	134.00	2.77	131.00	2.71	10.68	9.35
do 23.....	1400	32.5	3.04	47.60	134.00	2.81	131.25	2.75	10.66	9.37
do 25.....	1300	31.9	3.09	50.70	137.50	2.71	134.75	2.65	9.64	10.36
do 25.....	1400	31.9	3.03	46.20	136.50	2.95	133.00	2.87	10.52	9.50
do 25.....	1400	32.6	3.02	44.80	133.25	2.97	129.50	2.89	10.81	9.25
do 30.....	1300	32.1	3.09	50.70	135.75	2.67	131.75	2.59	9.85	10.13
do 30.....	1400	31.6	3.05	49.00	135.50	2.76	132.00	2.69	10.60	9.42
do 30.....	1400	31.9	3.04	47.60	135.00	2.83	131.50	2.76	10.64	9.39
July 5.....	1300	32.3	3.09	50.70	135.25	2.66	131.25	2.58	9.90	10.09
do 5.....	1400	32.0	3.08	53.20	141.50	2.65	138.00	2.59	10.14	9.85
do 5.....	1400	32.1	3.05	49.00	134.25	2.73	131.00	2.67	10.68	9.35
do 6.....	1300	33.0	3.06	46.80	131.50	2.80	127.75	2.72	10.17	9.82
do 6.....	1400	32.9	3.05	49.00	136.50	2.78	132.75	2.70	10.54	9.48
do 6.....	1400	32.8	3.04	47.60	133.00	2.79	128.50	2.69	10.89	9.17
do 8.....	1300	32.3	3.08	49.40	129.50	2.61	126.00	2.55	10.31	9.69
do 8.....	1400	32.3	3.06	50.40	135.00	2.67	131.25	2.60	10.66	9.37
do 8.....	1400	32.2	3.04	47.60	130.25	2.73	125.50	2.63	11.15	8.96
do 12.....	1300	31.5	3.06	46.80	125.75	2.69	122.25	2.61	10.63	9.40
do 12.....	1400	31.3	3.04	47.60	130.25	2.73	126.75	2.66	11.04	9.05
do 12.....	1400	31.1	3.35	46.90	128.75	2.74	125.00	2.66	11.20	8.92
do 15.....	1300	31.6	3.07	48.10	127.75	2.65	123.75	2.57	10.50	9.51
do 15.....	1400	31.6	3.05	49.00	130.00	2.65	127.00	2.59	11.02	9.07
do 15.....	1400	31.5	3.03	46.20	126.75	2.74	123.25	2.66	11.35	8.80
do 16.....	1300	31.4	3.06	46.80	121.75	2.60	118.00	2.52	11.01	9.07
do 16.....	1400	32.4	3.04	47.60	134.00	2.81	130.25	2.75	10.74	9.30
do 16.....	1400	31.5	3.02	44.80	131.50	2.93	128.25	2.86	10.90	9.16
do 19.....	1300	31.6	3.07	48.10	131.25	2.72	126.00	2.61	10.31	9.69
do 19.....	1400	31.4	3.04	47.60	134.50	2.82	131.00	2.75	10.68	9.35
do 19.....	1400	31.3	3.03	46.20	132.25	2.86	129.25	2.79	10.83	9.23
do 20.....	1300	31.5	3.75	48.75	131.75	2.70	128.00	2.62	10.15	9.84
do 20.....	1400	31.5	3.05	49.00	138.50	2.82	134.50	2.74	10.40	9.60
do 20.....	1400	31.0	3.02	44.80	132.75	2.95	128.25	2.86	10.91	9.16
do 21.....	1300	31.3	3.06	46.80	133.00	2.84	128.75	2.75	10.09	9.90
do 21.....	1400	31.2	3.05	49.00	136.25	2.78	132.00	2.69	10.60	9.42

TABLE I—Concluded.

Date.	Lbs. of Milk.	Specific Gravity.	Per cent of Fat.	Lbs. of Fat.	Lbs. of Green Cheese.	Lbs. of Green Cheese to 1 lb. of Fat.	Lbs. of Cured Cheese.	Lbs. of Cured Cheese to 1 lb. of Fat.	Lbs. of Milk per lb. of Cheese.	Lbs. of Cheese per 100 lbs. of Milk.
July 21	1400	30.8	3.02	44.80	132.00	2.94	128.00	2.85	10.93	9.14
do 22	1300	31.5	3.65	47.45	129.25	2.72	125.25	2.63	10.37	9.63
do 22	1400		3.05	49.00	133.75	2.72	130.00	2.65	10.76	9.28
do 22	1400	31.1	3.02	44.80	129.75	2.89	126.00	2.81	11.11	9.00
Aug. 2	1300	30.8	3.08	49.40	131.00	2.65	126.75	2.56	10.25	9.74
do 2	1400	30.8					132.25		10.58	
do 2	1400	30.5	3.03	46.20	135.25	2.92	130.75	2.82	10.70	9.33
do 3	1300	30.5	3.08	49.40	131.25	2.65	126.75	2.56	10.25	9.74
do 3	1400	30.9	3.04	47.60	137.50	2.88	133.50	2.80	10.48	9.53
do 3	1400	30.6	3.03	46.20	133.25	2.88	127.75	2.76	10.95	9.12
do 16	1350	31.1	4.00	54.00	131.50	2.43	127.50	2.35	10.58	9.44
do 16	1425	30.8	3.08	54.15	141.00	2.60	136.25	2.51	10.45	9.56
do 16	1450	30.5	3.07	53.65	135.25	2.52	131.00	2.41	11.06	9.03
do 18	1300	31.2	4.01	53.30	127.50	2.39	123.75	2.32	10.50	9.51
do 18	1400	30.7	3.06	50.40	132.50	2.62	128.25	2.54	10.91	9.16
do 18	1400	30.7	3.04	47.60	128.00	2.68	124.00	2.60	11.29	8.85
do 20	1300	31.4	3.09	50.70	129.00	2.54	125.75	2.48	10.33	9.67
do 20	1400	31.0	3.06	50.40	136.50	2.70	133.00	2.63	10.62	9.50
do 20	1400	31.0	3.06	50.40	134.75	2.67	131.50	2.60	10.54	9.39
do 23	1300	31.4	3.09	50.70	132.00	2.60	128.75	2.53	10.09	9.90
do 23	1350	31.1	3.07	49.95	137.75	2.75	134.50	2.69	10.03	9.96
do 23	1400	31.2	3.65	51.10	140.25	2.74	136.75	2.68	10.23	9.76
do 25	1300	30.1	3.65	47.45	123.00	2.59	120.50	2.53	10.78	9.26
do 25	1350	30.0	3.04	45.90	127.00	2.76	124.00	2.70	10.88	9.18
do 25	1400	31.1	3.02	44.80	125.00	2.79	122.25	2.70	11.45	8.73
do 27	1300	31.5	3.95	51.35	136.00	2.64	133.00	2.59	9.77	10.23
do 27	1350	31.2	3.55	47.92	132.50	2.76	129.75	2.70	10.40	9.60
do 27	1400	30.0	3.05	49.00	132.50	2.70	130.00	2.65	10.76	9.28
do 31	650	31.0	4.01	26.65	68.00	2.56	66.50	2.49	9.77	10.23
do 31	675	30.5	3.65	24.63	65.75	2.66	64.25	2.60	10.50	9.51
do 31	700	31.0	3.03	23.10	65.00	2.81	63.25	2.73	11.06	9.03
Sept. 2	700	32.3	3.09	27.30	74.75	2.73	72.50	2.65	9.65	10.35
do 2	700	32.3	3.09	27.30	74.50	2.72	72.25	2.64	9.68	10.32
do 2	700	32.0	3.06	25.20	6.08	2.69	66.25	2.62	10.56	9.46



## Report of the Dairy Commissioner.

TABLE II.—Showing the variation in yield of milk containing the same percentage of fat.

Date.	Per cent of fat.	Lbs. of green cheese per lb. of fat.	Lbs. of cured cheese per lb. of fat.	Lbs. of milk per lb. of cheese.	Lbs. of cheese per 100 lbs. of milk.	Specific gravity.
Aug. 18 .....	4·1	2·39	2·32	10·50	9·51	31·2
do 31 .....	4·1	2·55	2·49	9·77	10·23	31·0
Average .....	4·1	2·47	2·40	10·24	9·87	.....
June 18 .....	3·95	2·69	2·62	9·65	10·35	32·0
Aug. 27 .....	3·95	2·64	2·59	9·77	10·23	31·5
Average .....	3·95	2·66	2·60	9·71	10·29	.....
June 17 .....	3·9	2·63	2·56	9·97	10·02	31·9
do 25 .....	3·9	2·71	2·65	9·64	10·36	31·9
do 30 .....	3·9	2·67	2·59	9·85	10·13	32·1
July 5 .....	3·9	2·66	2·58	9·90	10·09	32·3
Aug. 20 .....	3·9	2·54	2·48	10·33	9·67	31·4
do 23 .....	3·9	2·60	2·53	10·09	9·90	31·4
Sept. 2 .....	3·9	2·73	2·61	9·65	10·35	32·3
do 2 .....	3·9	2·72	2·64	9·68	10·32	32·3
Average .....	3·9	2·65	2·58	9·88	10·10	.....
June 23 .....	3·8	2·67	2·62	10·03	9·96	32·7
July 5 .....	3·8	2·65	2·59	10·14	9·85	32·0
do 8 .....	3·8	2·61	2·55	10·31	9·69	32·3
Aug. 2 .....	3·8	2·65	2·56	10·25	9·74	30·8
do 3 .....	3·8	2·65	2·56	10·25	9·74	30·5
do 16 .....	3·8	2·60	2·51	10·45	9·56	30·8
Average .....	3·8	2·63	2·56	10·24	9·75	.....
July 15 .....	3·7	2·65	2·57	10·50	9·51	31·6
do 19 .....	3·7	2·72	2·61	10·31	9·69	31·6
Aug. 16 .....	3·7	2·52	2·41	11·06	9·03	30·5
do 23 .....	3·7	2·75	2·69	10·03	9·96	31·1
Average .....	3·7	2·66	2·57	10·47	9·54	.....
June 18 .....	3·6	2·69	2·64	10·48	9·53	31·8
July 6 .....	3·6	2·80	2·72	10·17	9·82	33·0
do 8 .....	3·6	2·67	2·60	10·66	9·37	32·3
do 12 .....	3·6	2·69	2·61	10·63	9·40	31·5
do 16 .....	3·6	2·60	2·52	11·01	9·07	31·4
do 21 .....	3·6	2·84	2·75	10·09	9·90	31·3
Aug. 18 .....	3·6	2·62	2·54	10·91	9·16	30·7
do 20 .....	3·6	2·70	2·63	10·52	9·50	31·0
do 20 .....	3·6	2·67	2·60	10·64	9·39	31·0
Sept. 2 .....	3·6	2·69	2·62	10·56	9·46	32·0
Average .....	3·6	2·69	2·61	10·56	9·46	.....
June 30 .....	3·5	2·76	2·69	10·60	9·42	31·6
July 5 .....	3·5	2·73	2·67	10·68	9·35	32·1
do 6 .....	3·5	2·78	2·70	10·54	9·48	32·9
do 15 .....	3·5	2·65	2·59	11·02	9·07	31·6
do 20 .....	3·5	2·82	2·74	10·40	9·60	31·5
do 21 .....	3·5	2·78	2·69	10·60	9·42	31·2
do 22 .....	3·5	2·72	2·65	10·76	9·28	.....
Aug. 27 .....	3·5	2·70	2·65	10·76	9·28	30·6
Average .....	3·5	2·74	2·67	10·67	9·36	.....

TABLE II.—Showing the variation in yield of milk, &c.—Continued.

Date.	Per cent of fat.	Lbs. of green cheese per lb. of fat.	Lbs. of cured cheese per lb. of fat.	Lbs. of milk per lb. of cheese.	Lbs. of cheese per 100 lbs. of milk.	Specific gravity.
June 17.....	3·4	2·73	2·66	11·08	9·02	31·7
do 18.....	3·4	2·84	2·77	10·58	9·44	31·9
do 23.....	3·4	2·81	2·75	10·66	9·37	32·5
do 30.....	3·4	2·83	2·76	10·64	9·39	31·9
July 6.....	3·4	2·79	2·69	10·89	9·17	32·8
do 8.....	3·4	2·73	2·63	11·15	8·96	32·2
do 12.....	3·4	2·73	2·66	11·04	9·05	31·3
do 16.....	3·4	2·81	2·75	10·74	9·30	32·1
do 19.....	3·4	2·82	2·75	10·68	9·35	31·4
Aug. 3.....	3·4	2·88	2·80	10·48	9·53	30·9
do 18.....	3·4	2·68	2·60	11·29	8·85	30·7
do 25.....	3·4	2·76	2·70	10·88	9·18	30·0
Average.....	3·4	2·76	2·71	10·84	9·21	.....
June 25.....	3·3	2·95	2·87	10·52	9·50	31·9
July 15.....	3·3	2·74	2·66	11·35	8·80	31·5
do 19.....	3·3	2·86	2·79	10·83	9·23	31·3
Aug. 2.....	3·3	2·92	2·81	10·70	9·33	30·5
do 3.....	3·3	2·88	2·76	10·95	9·12	30·6
do 31.....	3·3	2·81	2·73	11·06	9·03	31·0
Average.....	3·3	2·86	2·77	10·90	9·16	.....
June 17.....	3·2	2·87	2·80	11·15	8·96	31·8
do 25.....	3·2	2·97	2·89	10·81	9·25	32·6
July 16.....	3·2	2·93	2·86	10·91	9·16	31·5
do 20.....	3·2	2·95	2·86	10·91	9·16	31·0
do 21.....	3·2	2·94	2·85	10·93	9·14	30·8
do 22.....	3·2	2·89	2·81	11·11	9·00	31·1
Aug. 25.....	3·2	2·79	2·70	11·45	8·73	30·1
Average.....	3·2	2·90	2·82	11·03	9·05	.....

Taking the averages of the foregoing tests as a basis of calculation, we find as follows:—

Milk.	Will contain	Will make
5,000 lbs., testing 3·2 per cent of fat.....	160 lbs. of fat.....	452½ lbs. of cheese.
5,000 do 3·3 do.....	165 do.....	458½ do
5,000 do 3·5 do.....	175 do.....	468 do
5,000 do 3·7 do.....	185 do.....	477 do
5,000 do 3·9 do.....	195 do.....	503½ do

These investigations confirm the results of previous work along the same lines, and the conclusions are that the plan, as now advocated, of paying for milk at cheese factories according to its relative value, is fair and just. While the experiments show that the amount of cheese made from milk does not increase in exactly the same proportion as the fat, the relation is very close, and the difference is more than made up by the increased value given to the cheese by the richer milk. The richer milk was nearly always in better condition and gave less trouble from taints or "gassy" curds.

## Report of the Dairy Commissioner.

The percentage of loss of fat in the whey did not bear any relation to the percentage of fat in the whole milk. It frequently happened that there was a greater loss with the poor milk than with the richer, and in all our work we found that the condition of the milk and the manner of cutting and handling the curd had more to do with it than anything else. Cutting the curd when too soft, and rough stirring immediately after cutting, seem to be the principal causes of loss in the whey. The average loss of fat in the whey was about 0.2 per cent.

### II.—*The Effect of High vs. Low Cooking of the Curd.*

In this experiment the milk was first mixed in one large vat and then divided into three smaller ones, 1,400 pounds being put into each vat. In five trials the milk of No. 1 vat was cooked to 100°, No. 2 to 95°, and No. 3 to 90°. In four trials No. 1 vat was cooked to 98°, No. 2 to 95°, and No. 3 to 90°.

When these cheese were examined by Prof. Robertson and scored, it was found that there was very little, if any, difference in quality, but in the making of the cheese it was difficult to get the curd sufficiently firm and dry when the low temperatures were used.

The curd does not "mat" so readily at a low temperature, and is more easily stirred, but requires more stirring, taking a great deal more time.

We have found it a mistake to allow the temperature to run up higher than usual when a curd is working fast. The higher temperature causes the curd to run together so much more quickly that the work of stirring is very much increased and impeded.

### III.—*The Effect of Setting the Milk at Different Degrees of Ripeness.*

Only two trials were made in this experiment, but, along with those of last year, they appear to be so conclusive that it is quite unnecessary to carry the work any further.

This experiment was conducted in the same manner as the foregoing one; that is, the milk was first mixed in one vat and then divided. Choosing days when the weather was very cool and the milk arriving at the factory very sweet, one vat was set as early as possible, the second one about one and a half hours later, and the last one usually about three hours later, the relative degree of acidity as per rennet test being as 25 is to 15 and 10.

In every trial these three curds were ready to have the whey removed at the same time, and, working together all through, were put in press at the same time.

The whey was drawn so as to have the same amount of acid development as near as possible when the stirring was finished.

There was no appreciable difference in quality when Prof. Robertson examined these cheese, but it must be remembered that there were only 1,400 pounds of milk in each vat, consequently we were able to handle it to the best advantage.

The teaching of the experiment is that there is a mistaken idea prevalent among cheese-makers that the more milk is ripened the quicker will they get through the day's work. If the milk be set earlier and sweeter more acid may be allowed to develop in the whey, but when milk is very ripe the whey must be drawn off very early in order to check the development of acid, and, consequently, the curd has not had time to become sufficiently cooked. A tender-bodied cheese is the result. Moderation in following this practice will produce the best results.

#### WINTER DAIRYING AT WOODSTOCK, ONT.

Early in November I went to Woodstock, Ont., to reopen the winter dairy station there.

The patrons of the factory having decided in favour of the centrifugal separator plan in preference to that of cream gathering, the former plan was adopted, and a No. 1 "Alexandra" separator placed in position. These separators are said to have a capacity of 3,000 pounds of milk per hour, but we found it impossible to separate more than about 2,200 pounds per hour and do good work when we started in the fall. At this time the milk was testing about 4.2 per cent of fat (the average for

November and December) and was supplied from cows well advanced in the period of lactation, with the exception of a few fresh in milk. As the season advanced and the percentage of fat in the milk decreased, owing to a larger quantity of milk being procured from freshly calved cows, we were able to gradually increase the feed of the separator until a maximum of about 2,700 pounds per hour was reached, the speed of the bowl being maintained at 6,000 revolutions per minute, and the temperature of the milk 85°—90°. The per cent of fat in the milk for March averaged 3·63.

The patrons delivered the milk to the station three times a week all winter, with the exception of a few living at some distance who came only twice a week.

No difficulty was experienced with the milk freezing on the road even in the coldest weather; on two occasions the mercury fell to 13° below zero.

The station was visited by a large number of dairymen from different parts of the country, and 7 experienced cheese-makers spent from 1 to 5 weeks with us with a view of acquiring some knowledge of butter-making and milk-testing.

The butter-making was carried on in the room used for cheese-making in the summer time. While this may be the cheapest plan on which to commence winter butter-making at a cheese factory, I would strongly urge those about to embark in the business to provide a separate room for winter work. The average cheese-making room is larger than is necessary for butter-making, it is not usually warm enough, and however well it may be adapted for cheese-making purposes, it is not always easy to arrange the butter-making apparatus to the best advantage. If a separate room is added it need not be larger than 25 x 30 feet, providing it is placed in close proximity to the boiler and engine so that steam and power may be used in either room as desired. In this case the labour and expense of changing from cheese-making to butter-making and *vice versa* is saved, and, if we include the extra wear and tear on the apparatus on account of being knocked about so much, it amounts to considerable.

Some factories have adopted the plan of making Saturday night's milk into butter instead of cheese during the hot weather, and this cannot very well be done unless separate rooms are used.

Below is given a summary of the season's work at the station:—

Month.	Lbs. of milk.	Per cent of fat.	Lbs. of Butter.	Lbs. of milk per lb. of butter.
Nov. and Dec...	111,571	4·19	5,080	21·81
Jan.....	82,904	4·18	3,837	21·60
Feb.....	63,381	3·88	2,693	23·53
March.....	87,370	3·63	3,510	24·89
Total.	345,226		15,120	22·83

As far as I have been able to ascertain, the experiment of making butter in the winter time at Woodstock has been quite successful. The patrons appear to be well satisfied with the results, and resolved to continue and enlarge the winter end of their business. It has been proved that most of the difficulties which were said to be in the way at first are only imaginary; for example, the hauling of the milk was thought to be a serious drawback, but when two or more patrons combined together and agreed to take turns in going to the creamery, the labour and expense incurred by each individual amounted to very little.

One of the chief troubles which I have noticed is that most farmers have not got a proper place to keep the milk between trips to the factory. They must keep it in a cool place in order to prevent it from souring, and yet it must not be allowed to freeze. As a consequence, I found that the milk was often moved from one temperature to another in order to prevent either extreme being reached, and the result was considerable variation in temperature in the milk.

While the business was in its experimental stages it was not to be expected that farmers would be willing to undertake much expense in fitting up their premises to meet the requirements of the case, but as it becomes more firmly established

## Report of the Dairy Commissioner.

and partakes more of the nature of a permanent business, there is no doubt but the patrons of these creameries will be found ready to do all in their power to put the business on a good footing. I draw these conclusions from the sentiments expressed by the Woodstock patrons during my intercourse with them for the last two months.

In these districts, where cheese-making is almost universally followed by the farmers, the comparatively small amount of butter made has not been depended upon as a source of revenue to any extent, being merely a side issue in dairying, and, as a consequence, the majority of farmers are not prepared as regards equipment, proper room, etc. This being the case, making butter in any quantity becomes laborious and unsatisfactory in the highest degree.

The women of the farmers' households are delighted with the new way—that of sending the milk to the creamery.

### MEETINGS.

I attended and addressed thirty dairy meetings in different parts of the country since last report. The attendance at these meetings would total up about 6,000 people.

I generally chose for my subject the question of paying for milk at cheese factories on the relative value plan, or, as it is commonly called, "paying by test." The keenest interest was manifested in this subject by all dairymen with whom I came in contact during the past winter, and I found the data derived from the experiments in cheese-making at the Perth dairy station very useful in demonstrating the fairness of the new method as compared with the old way. The invitations which I received from factorymen to attend annual meetings of patrons, were so numerous that I was unable to attend them all owing to lack of time, but everywhere that I went—and a vote was taken by the patrons to decide the matter—with one exception, it was unanimously resolved to adopt the test system.

Never since I have been connected with the dairy business has such an interest been taken in matters relating to the work. Annual meetings of cheese factory patrons, which formerly meant only the transaction of a little business and the election of officers, have been enlivened by addresses and healthy discussions, giving evidence that dairymen are awakening to a sense of the possibilities and importance of the work in which they are engaged.

### MISCELLANEOUS WORK.

Under this head my work included the operation of a working dairy at the Sherbrooke Exhibition from the 5th to the 8th of September. Butter-making, milk-testing, &c., were carried on and explained to a large number of people daily. I also had charge of the special milking tests at this fair.

After the first of November several weeks were spent in assisting different companies to fit up their cheese factories for winter butter-making, before going to Woodstock to commence operations there.

Before leaving Perth I assisted in preparing for and making the mammoth cheese for the World's Columbian Exposition at Chicago. The curd from the Perth station was used for three days along with what was brought in from the surrounding factories. My duties also kept me for several weeks at the Dairy Commissioner's Office at Ottawa.

On 17th April, I accompanied the World's Fair cheese train carrying the mammoth cheese to Chicago. Large crowds assembled at the various stations on the way to Windsor. I remained in Chicago until the work of installing and placing in position the Canadian Dairy Pyramid was completed.

During the time which I spent at the World's Fair in connection with the Dairy Exhibit, I had the pleasure of meeting many representative dairymen and dealers in dairy produce from different parts of the world, and showing them the cheese on exhibition. All expressed surprise that so many factories from such widely separated parts of the country could produce cheese of such uniform quality.

I have the honour to be, sir,

Your obedient servant,

J. A. RUDDICK.

## (2) REPORT OF J. B. MacEWAN.

OTTAWA, April 29th, 1893.

Prof. JAS. W. ROBERTSON,  
Dominion Dairy Commissioner,  
Ottawa.

SIR,—I have the honour to submit my second annual report of work carried on under your supervision during the year 1892 and up to the present time of 1893.

During the early months of 1892, the series of milk tests were continued, the object being to show, if it were possible to increase the percentage of fat or total solids in milk from a number of cows, by increasing the amount of meal fed daily.

A full report of the work was delivered to you, and the conclusions went to indicate that by increasing the amount of meal fed per cow daily from four to twelve pounds, covering a period of about five months, there was no appreciable increase in the per cent of fat in the milk, but a slight increase in the total solids and also in the quantity of milk.

These tests together with office work occupied my time up to the 9th of May, at which time an application having been made to you by Mr. D. Derbyshire, President of the Creameries Association of Ontario, and Mr. Wm. Eager, President of the Dairymen's Association of Eastern Ontario, for a person to take up the "Dairy School" work for Eastern Ontario, I at your request and in accordance with arrangements made by you with Messrs. Derbyshire and Eager, reported at Brockville on the 9th of May, and for the next five months my time was occupied in carrying out the work as mapped and supervised by the executive of the Dairymen's Association of Eastern Ontario.

The object of the work—for which a grant had been made by the Ontario Government—was the establishment of a "Dairy School" at a central point in Eastern Ontario, where all cheese-makers, dairymen, and all persons interested could attend and receive instructions in the most approved methods of making cheese in the different months of the season, the testing of milk with the "Babcock," and lactometer, and any other desired information.

Owing to the large area to be covered extending from Lancaster on the east to Port Hope, Lindsay and Peterborough on the west, it was not deemed advisable to establish this school at any one point but to have the school go from one centre to another and thus bring it within reach of every one. It was also arranged to hold meetings of dairymen wherever desired, and we were thus enabled to give some practical talks on this most important home end of the industry, along the lines of lessening the cost of production by a better system of feeding and breeding, the care of milk by thorough aeration and the absolute necessity for cleanliness in all matters pertaining to the dairy. There is room for additional work at this end of the business. It is here that the profits or losses are determined, the solution of which lies in the hands of every dairyman by the dissemination of information which will lead to the production of the greatest amount of milk of the best quality at the least possible cost, the proper care and delivery of the same at the cheese factory or creamery and the employment of expert labour to manufacture, will ensure a quality of goods that will bring the highest prices in the British market, thereby adding greatly to the profits.

I covered the ground twice, visiting Brockville, Morrisburg, Gananoque, Kingston, Napanee, Belleville, Campbellford, Peterborough, Lindsay and Port Hope districts, visiting in all 184 factories, met with 244 cheese-makers, and held 20 meetings at which nearly 1,500 dairymen attended.

I am hopeful that the money and time spent were and will be productive of good results. I found the cheese-makers, with very few exceptions, willing and anxious to learn. Generally speaking, there is room for improvement in the quality of our cheese. We find a limited number of our makers turning out at all times an excellent article, but the great majority do not understand or study the varying conditions of the milk, and there is, therefore, a sad lack of uniformity.

## Report of the Dairy Commissioner.

There are two chief faults, which are quite common, which I would like to draw the attention of our cheese-makers to: 1st. The extreme carelessness as to condition and appearance of buildings. The more we learn about the science of cheese-making, the more imperative it appears to be that the utmost cleanliness must be observed to secure cheese with the best flavour and keeping qualities. Of course, the receiving of milk in good condition is a first essential, but we are led to believe that where everything is not kept scrupulously clean it causes the presence of an unfavourable species of bacteria, and from this cause the best results are not obtained. 2nd. The prevailing inclination to over-ripen before setting. From east to west this was almost universally met with, and many times with disastrous results as to quality and yield. I find that to ripen ordinary milk to a stage that the period from the time it is set until the whey is removed with one-eighth inch of acid is three hours, and gassy milk to a stage that will allow two hours and twenty minutes to two hours and thirty minutes, with one-quarter inch acid, will give best results. For September and October I prefer to set even a little sweeter, allowing three hours and fifteen minutes from time of setting until wheying off, with one-quarter inch acid. At this season we are rarely troubled with gas, and the milk being richer, it allows time for careful handling and slow cooking.

By following these lines I find that it allows sufficient time to handle the curd very gently when soft and to cook slowly, and therefore thoroughly. In this way white whey is avoided, which means a saving of butter-fat; the curd, when ready to salt, is firm and mellow, instead of being soft and mushy, and the cheese will have that fat, meaty body (desirable qualities in a first-class cheese), instead of a soft, tender body, indicating fast and insufficient cooking and too much moisture. I am of the opinion that it is cheese of this class that are found to be off flavour, after being held for a time, but pronounced right under the trier when shipped from the factory.

I found most culpable negligence on the part of the makers in the curing of cheese in the fall of the year. Instead of keeping the temperature of the curing-room at as nearly 65° as possible, I found a number with the temperature ranging from 45° to 50°, with not even a stove in the room. Especially was this the case early in the fall, and the cheese trying somewhat pasty or salvy.

By united efforts of all interested, such as the delivery of the milk at the cheese factories in good condition, the erection of good buildings properly equipped, the employment of competent and careful makers, and the marketing of the product in good, strong, neat boxes, we can build up an enviable reputation for uniform excellence of quality.

I returned to Ottawa on the 9th of October, and my time was fully occupied in the office until the 1st of November, when, arrangements having been made to start an "Experimental Winter Dairy Station" at Wellman's Corners, Hastings County, I received instructions from you to assume the management of it.

We had everything in readiness for butter making on the 23rd of November. The only change of importance found necessary in the cheese factory plant was the boiler, which being examined by an experienced expert, was pronounced as being too small for the amount of steam we would require to run the engine, heat the milk in the receiving vat from 30° or 40°, to 90° or 95°, and elevate the skim milk by means of a steam ejector. A larger one was put in by the company, it being 8 feet in length, 30 inches in diameter, containing 22 3-inch flues, and having a good sized dome. The boiler was well bricked in, and was found to do its work well. The using of the exhaust steam from the engine for heating the milk will be found practicable and most economical. The engine put in was a horizontal 10 horse power, and we had plenty of power and to spare for our requirements.

The company carried out their part of the agreement promptly by putting on storm doors and windows, and making the boiler room frost proof, thus making their comparatively new building very comfortable for winter butter-making.

We used one milk vat for a receiving vat, elevating it high enough, so that the milk would run into the separator direct by means of a pipe inserted in the side of the vat. We used another vat for the cream. A third vat was used for the skim

milk, it being raised enough, that by the use of a 3-inch pipe and valve, each patron, after delivering his milk, would drive on and receive his share of the skim milk. In this way there was very little trouble or delay. Each patron was allowed to measure his own share of skim milk, receiving the number of inches he was entitled to according to the quantity of milk delivered and the table as published on page 175 in your report of 1890.

It was quite remarkable that we never had any trouble by any one keeping more than his share. It was clearly intimated from the start that we would trust to their honesty, reserving the privilege of measuring the quantity taken at any time, and the penalty of wilfully doing so was that they would lose their skim milk for a week.

The buttermilk was sold to the highest bidder at 15 cents per 100 pounds, and the proceeds divided among the patrons, *pro rata*, to the amount of butter manufactured.

The creamery commenced operations on November 23rd, 1892, and continued until March 31st, 1893. Cheese-making was followed up to the 21st of November, and was resumed on April 3rd, thereby making a complete year of dairying.

Milk was delivered three times per week during November, December and March, and twice per week during January and February. Sixty-two patrons in all delivered their milk at the creamery.

The total quantity of milk received was 302,728 pounds, from which was manufactured 14,037 pounds of butter.

The following is a monthly record of the season's operations and general averages:—

Month.	Amount of Milk.	Average per cent. of fat.	Amount of butter.	Lb. of milk per lb. of butter.	Lb. of butter per lb. of fat.
	Lbs.		Lbs.		
Nov. and Dec. ....	148,929	4·13	7,047	21·13	1·14
January .....	51,812	4·38	2,562	20·22	1·13
February .....	35,582	4·00	1,651	21·55	1·15
March .....	66,405	3·70	2,777	23·91	1·13
Total .....	302,728		14,037		

Average quality of the milk ..... 4·06 per cent of fat.  
 Average lbs. of milk per lb. of butter..... 21·56 lbs.  
 Average lb. of butter per lb of fat..... 1·14  
 Average lbs. of butter per 100 lbs. of milk. 4·638

The successes attending the experiment of winter dairying in this section were beyond all expectations, when it is considered that only a few dairymen had followed the move of all-year dairying, and that within a month from the time that it was decided to run the creamery the large majority had no intentions of milking their cows throughout the winter, but to follow their usual course of making them complimentary boarders for 3 or 4 months.

Those who were prepared for liberal economical winter feeding and who were following the system of having their cows come in early or at all times, of course met with the greatest success. The large majority whose cows were all long in milk and were not provided with a supply of ensilage or even much dry-cured corn, made praiseworthy effort to keep their cows milking throughout the winter; and it was due to this hearty co-operation on the part of those patronizing the creamery that we were enabled to continue butter-making and receive as much milk as we did during the months of January and February.

The paying for the milk delivered at the creamery according to its per cent of butter-fat, as tested with the "Babcock," exercises a wonderful influence for good and gave the utmost satisfaction. At first there appeared to be some misgivings as to the accuracy and reliability of the "Babcock," owing to the great variations in



## Report of the Dairy Commissioner.

this test from day to day, and the marked difference from one test to another from milk of the same herd, did certainly appear unaccountable. Quite frequently there was a difference of 1 per cent in the milk from a herd in consecutive tests. This great variation occurred frequently during the first few weeks but subsequently, the tests ran quite regular indicating that the patrons were realizing that this variation was caused more by irregular habits in handling, stabling, milking and natural causes than any fault of the "Babcock" or in its manipulation. The lowest per cent of fat in milk received was 2.4, and the highest 6.2 per cent. The last was from cows long in lactation and giving only a small quantity of milk.

I am satisfied that it was owing to this system of payment, that the milk was delivered in such good condition. It was shown that to get best results from sampling and testing, it was needful to take reasonable care of the milk, preventing it from freezing and not allowing it to remain too long without stirring, but to keep the cream well mixed with the milk so as to ensure a fair sample for testing.

The necessity for the utmost care and cleanliness when milking in the stable, so as to prevent bad flavours, was realized, and we had very little trouble caused in this way.

The feeding of turnips to milch cows was discountenanced. The feeding of them to beefers or young stock may give good results, but they should never be fed to milch cows, for either cheese or butter-making.

The general outlook for increased winter dairying as a result of the practical demonstration at Wellman's Corners is very favourable. Even the most pessimistic have had their eyes opened.

If we had had more milk from fresh calved cows, the flavour would have been improved, but this will be overcome, largely, in the course of another year. The necessity of an abundance of cheap succulent food for winter feeding has never been so forcibly shown, and a large amount of corn will be sown and a number of silos built during the coming season.

I can safely say that the results as far as known, are entirely satisfactory to the patrons of the creamery. The almost perfect work of the separator was gratifying to those interested, and the receiving of sweet skim-milk for feeding purposes was most acceptable, especially this last winter as its feeding value was unusually high, owing to the price of pork.

Part of the butter was shipped to Liverpool, Manchester and Glasgow, but at time of writing account sales have not yet been received. The balance was sold in Toronto, Ottawa, Montreal, Belleville, Trenton and Campbellford, mostly for 24 and 25 cents per pound, f.o.b. nearest station.

The company having advised me that they wished to commence cheese-making on April 3rd, we removed the butter-making apparatus on Saturday April 1st, and Monday they resumed cheese-making, receiving 12,000 pounds of milk. I think it is safe to estimate that next winter nearly double the quantity of milk will be received. I am basing my opinion on the ground that they have had a convincing object lesson of the many benefits to be derived, and it being a surety that the station will be in operation next winter, nearly all will prepare for it.

We also ran the creamery as a Dairy School, and 23 cheese-makers attended, some wishing to learn the testing of milk with the "Babcock," and the system of book-keeping in connection with the paying for milk according to test, and others wishing to learn all they could in connection with butter-making. Some remained only a few days, while others remained nearly all winter and by applying themselves diligently are now fairly competent butter-makers.

In all the operations at the station I had the able assistance of Mr. James Whitton, of the firm of J. T. Warrington, jr., Belleville, who has a small farm at Wellman's Corners, and who is beyond a doubt one of our foremost dairy farmers and dairy experts of Ontario. By the use of corn ensilage, which cost him \$1 per ton, and liberal feeding he made the following record for a year, from April 1st, 1892, to April, 1893. He had 9 cows and the average cost of feeding for the year

was \$40 per head, and after deducting the total cost of feeding from the total proceeds from cheese, butter, sales of calves, and profits from whey and skim milk, he had \$500 clear.

After the first four or five weeks had passed and everything was in good running order at the creamery, I availed myself of requests to attend meetings called to discuss winter dairying, paying for milk according to its butter-fat for butter and cheese-making and kindred subjects. I attended in all 12 meetings at the following places:—Wellman's Corners, Campbellford, Warkworth, Newburgh, Kingston, Wooler, Selwyn and Seymour West.

As a result of the winter dairying movement in that district, it has been decided to start creameries next winter at Sterling, Campbellford and Warkworth, and as these are all central points, surrounded by cheese factories and enthusiastic dairymen they should do the most good to the greatest number of people.

I returned to Ottawa on the 4th of April, since which time I have been engaged in office work, mainly posting up the books in connection with Wellman's Corners Dairy Station and preparing the lists in connection with the distribution of the seed for the "Robertson Mixture" for ensilage.

I have the honour to be, sir, your obedient servant,

J. B. MACEWAN.

### (3) REPORT OF C. C. MACDONALD.

To Prof. JAMES W. ROBERTSON,  
Dominion Dairy Commissioner,  
Ottawa,

SIR,—I have the honour to submit to you my second annual report of work done by me for the year 1892-3.

My work consisted chiefly of travelling and giving instructions in cheese and butter-making in the province of Quebec during the summer season of 1892. However, the first four months of 1892, I spent in company with Mr. J. B. MacEwan at the Experimental Farm Dairy, Ottawa, for the purpose of carrying on a series of milk tests with the Babcock milk tester.

During the month of May, 1892, a programme for visiting cheese and butter factories in the province of Quebec was prepared, and the following circular containing particulars of it was issued:—

"OFFICE OF THE DAIRY COMMISSIONER,  
"OTTAWA, 16th May, 1892.

"DEAR SIR,—The following are the dates, as far as they have been arranged, upon which one of the superintendents of experimental dairying will visit cheese factories in Quebec.

"The object of these visits is to give instruction in the best methods of testing milk and manufacturing cheese of fancy quality over as wide an area and in as short a time as possible.

"This itinerant work has been undertaken as preliminary to the experimental investigations which will be carried on during the later parts of the manufacturing season.

"The superintendent will be furnished with a Babcock milk-tester, and other new and improved apparatus. Cheese-makers are invited to bring their thermometers and lactometers to have them verified.

"All cheese-makers from the other factories in the several districts are invited to meet the superintendent, at the place which is most convenient to them. A

## Report of the Dairy Commissioner.

meeting of the patrons and others may be called by the cheese-makers, or other representatives, at these factories, for the afternoon of the dates which are marked\*.

"At these meetings a demonstration of milk-testing will be given, and information on the best methods for the care and preparation of milk for cheese factories will be furnished.

COUNTY.	CHEESE FACTORY.	DATE.
Shefford.....	Warden.....	May 26,* 27.
	South Roxton.....	do 28.
Richmond.....	Melbourne (near Richmond).	do 31,* June 1
	Danville.....	June 3,* do 4
Stanstead.....	Barnston.....	do 7,* do 8
	Way Mills.....	do 10,* do 11
Brome.....	Brome Corners.....	do 14,* do 15
	Mansonville.....	do 17, do 18
Missisquoi.....	Farnham Centre.....	do 21,* do 22
	Stanbridge East.....	do 24,* do 25
Chateauguay.....	Riverfield.....	do 28*
Huntingdon.....	Huntingdon.....	do 29,* do 30
Montcalm.....	St-Alexis.....	July 12* and 13.
do.....	St-Jacques.....	do 14* and 15.
do.....	Rawdon.....	do 16.
Maskinongé.....	Ste-Ursule.....	do 19* and 20.
do.....	Louiseville.....	do 22* and 23.
Champlain.....	Ste-Anne de la Pérade.....	do 26* and 27.
do.....	St-Prosper.....	do 29* and 30.
Nicolet.....	Ste-Monique.....	Aug. 2* and 3.
Yamaska.....	La Baie.....	do 5* and 6.
Lotbinière.....	Lotbinière.....	do 9* and 10.
do.....	St-Flavien.....	do 12* and 13.
Montmagny.....	St-Thomas.....	do 16* and 17.
L'Islet.....	L'Islet (beurrerie).....	do 19* and 20.
do.....	do (fromagerie).....	do 23* and 24.
Kamouraska.....	Ste-Anne de la Pocatière.....	do 26* and 27.
Témiscouata.....	St-Arsène.....	do 30* and 31.
do.....	Isle Verte.....	Sept. 2* and 3.

"I have the honour to be,

"Your obedient servant,

"JAS. W. ROBERTSON,

"Dairy Commissioner."

My mode of procedure upon arriving at the different factories was the same as laid down in the foregoing circular, or as nearly so as was practicable. In a few instances no meetings were held owing to the fact that the patrons of certain cheese factories had not been called to a meeting; this was beyond my power to remedy. Also in three factories visited during the last week of August and first part of September no meetings were held, as the farmers were busy with haying and harvest and it was impossible to get them together for that purpose.

In a majority of cases I have to report "progress" in the province of Quebec. I noted with pleasure the great improvement and advancement made in a great many cheese and butter factories, especially where competent instructors have been employed.

#### TRAVELLING INSTRUCTION.

That the work of travelling instruction has proved a thorough success is proved by the fact that in the districts which I visited where instructors were employed, I found the factories clean and tidy, and a far better article being manufactured. The cheese and butter-makers, and farmers too, were more enthusiastic and were doing all in their power to turn out the best possible article; whereas in most of the districts I visited where no instructors had been over the ground, I found things dirty and untidy, and the cheese and butter-makers very shiftless and indifferent. If a good, enthusiastic and competent instructor were employed for every twenty-five or thirty factories, the money would be well expended, and I am certain that a ten-fold profit would be realized by this country. It is surprising to me that more good men have not been employed to do the work where so much of it is needed.

#### CHEESE AND BUTTER FACTORIES.

I noted with pleasure some improvements in the cheese and butter factories in the way of refitting the buildings, as well as the greater improvements in the articles manufactured. I noticed a number of whey vats had been removed from under the factory to a fair distance from the building. I also noted the cleanliness of inspected factories, this assuring me again and again that inspection had wrought many changes for the better in the dairy districts of Quebec.

#### CHEESE-MAKING.

While there have been many improvements made, many defects still remain, but these, I trust, will in a short time be removed.

#### IMPROVEMENTS.

The cheese-makers of Quebec have become alive to the fact that there is work for them to do, and they are doing it.

There seems to be a lively rivalry between the Ontario and Quebec cheese-makers, and the Quebec men have something to be proud of.

I found nearly every cheese-maker that I visited using the rennet test for determining the degree of ripeness of the milk before adding the rennet to the vats or, as it is called, setting the vats.

The result of this is that a more uniform quality of cheese is made by the adoption of this test. The manner in which the test is made was fully explained to you in my report for the year of 1891-92. It is the only test that I have found practical to teach to cheese-makers, and I have yet to find the cheese-maker who has been deceived by it.

I also found better attention paid to cheese in the curing-rooms, and the cheese in most cases had a clean, tidy appearance. The factory utensils were cleaner throughout than I saw them in previous years. A deeper interest generally seemed to be taken in the work.

#### DEFECTS IN CHEESE-MAKING.

I found a few cheese-makers still using inferior material for manufacturing, and also using thermometers that were defective, some being as much as eight degrees out of the way.

Another defect is the old time syphon in some factories for drawing the whey from the vats. The whey gates are not much dearer than the syphons, and I think

## Report of the Dairy Commissioner.

cheaper in the end, and they ensure better results in fast-working curds for this reason—the whey can be drawn faster and cleaner with the gate or faucet than with the syphon.

### BOXING CHEESE.

It is a deplorable fact that cheese-makers in the province of Quebec do not box their cheese anything like what they should do. They buy poor boxes under the supposition that they are cheaper. Now if they would insist upon having nothing but the best made and strongest boxes, and paying a fair living price to the box-maker, they would find that in many instances the cheese would sell for a better price, and thus the dearer box be proved the cheapest in the end.

The boxes should be cut down just even with the top of the cheese so that the cheese cannot shake or move while being handled.

I have seen boxes that were nearly an inch too large for the cheese. This should never be. The box should always fit perfectly both at top, bottom and side.

### BUTTER-MAKING.

One very defective point I noticed in butter-making, was that the butter was being worked too much, making it greasy and sticky. I met one butter-maker who was doing this part of the work perfectly, Mr. Préfontaine of L'Isle Verte. His method for working butter (which is the proper way) was to salt the butter when it first came from the churn, merely working it enough to distribute the salt through it. Then the butter was placed in a refrigerator for four or five hours to allow the salt to do its own work.

After four or five hours the butter was again taken to the butter worker and re-worked until the colour became uniform which took a very short time. Then the butter was packed in tubs for shipment.

In this way the grain of the butter was preserved.

### BUTTER FACTORIES BELOW QUEBEC.

I must say a few words regarding these. I visited no cheese factories below Quebec. Some factories that were making cheese last year had been converted into butter factories, and with the exception of one factory which was terrible to behold the factories were all a credit to this county, the ones most notable being Messrs. Préfontaine of L'Isle Verte, Capt. H. O. Bernois of L'Ansigle, and Mr. Hébert of St. Thomas de Montmagny.

It was truly a pleasure to visit these factories, as they were neat, clean and tidy throughout.

### MEETINGS.

I attended and addressed thirty meetings in all; about 2,000 persons attended those meetings.

I met and gave instructions to 96 cheese-makers, 21 butter-makers, and 11 syndicate inspectors.

I visited 34 cheese factories, 12 butter factories, and two combination butter and cheese factories.

I spent two days at each factory. One day was in each case set apart in my programme for a public meeting, and one day for general instructions to cheese and butter-makers.

I tested over 500 samples of milk, the butter-fat ranging from 2.60 per cent to 7.00 per cent. Where I found the low percentage of fat was at a factory that had never been visited by an inspector. Here again is an instance of the good done by travelling instructors.

## THE BABCOCK MILK-TESTER.

This method of testing is used by every inspector in the province. It is simple, easily managed, and accurate.

It beats everything for making people honest. As one prominent dairyman expressed it, "It beats the Bible for making men honest."

## GREAT EASTERN EXHIBITION.

In accordance with instructions received from you, I attended the exhibition held at Sherbrooke on the 5th, 6th and 7th of September, where I took part in the management of the working dairy.

Butter-making and milk-testing were carried on and general information imparted to all who asked for it and were interested in the dairy work.

Large crowds of people visited the dairy continuously which would seem to indicate that the working dairy was one of the most interesting departments on the grounds.

After the exhibition I visited Cookshire, to spend some time on a lecturing tour in the county of Compton.

We held two meetings per day. I addressed seven meetings and gave demonstrations of testing milk at each meeting; I also delivered lectures on butter-making. All meetings were largely attended and the people were enthusiastic over dairying prospects.

There are very few cheese or butter factories in the county of Compton as yet, and what I saw in the Megantic district is still little more than an unbroken forest, but it is a beautiful and a healthy county. In a short time no doubt with proper men to develop it, it will be a district second to none in Canada.

## ACKNOWLEDGMENTS.

I would be very ungrateful if I closed this report without thanking the local press of Quebec for the assistance given to me in the performance of my duties, by keeping my programme constantly before the public, and also for the clear and full reports of my addresses to meetings.

## THE LONDON EXPERIMENTAL DAIRY STATION.

About the middle of the month of October I received instructions to take charge of the dairy station at London. Accordingly I arrived here on October 18th, and proceeded to make investigations with a view to discover what would be required for butter-making.

Here let me say the Dairy Station was a cheese factory and was operated as such in summer by Mr. John Geary. This factory had to be converted into a butter factory. This work was simple and easily managed. The cheese vats were used, one for a milk-receiving vat and one for a skim-milk vat. An experimental cheese vat having three compartments was used for a cream vat.

The requisites (not used in a cheese factory) for changing the cheese factory into a butter factory were:—

An Alexandra power centrifugal cream separator;

One 300 gallon churn;

One power butter-worker;

Twelve feet shafting with pulleys and belting.

On the 14th of November the first milk was received for butter-making.

The station was in operation five months and a half. Two students attended the station during the winter.

All the butter was sold in London except one hundred pounds.

Twenty-two patrons in all sent milk to the station.

Fifteen was the highest number sending at any one time, and five the lowest patronage at any one time.

## Report of the Dairy Commissioner.

Months.	Total Milk delivered.	Average per cent of Fat.	Lowest Sample tested.	Highest Sample tested.	Pounds of Butter Fat contained in Milk.	Pounds of Butter made.	Pounds of Milk to make one Pound of Butter.	Pounds of Butter made from one Pound of Butter Fat.
	Lbs.							
November.....	23,276	4·20	3·2	*5·9	979 30	1,123	20·72	1·14
December.....	28,843	4·32	3·5	*6·6	1,251·60	1,462	20·00	1·15
January.....	21,520	4·39	3·4	*6·7	934·97	1,026	20·97	1·09
February.....	13,108	3·98	3·2	*5·6	525·33	580	22·70	1·10
March.....	15,320	3·68	3·0	4·2	563·91	628	24·39	1·11
April.....	20,243	3·36	3·0	4·0	681·73	764	26·49	1·12
Grand totals.....	122,370	4·03	.....	.....	4,936·84	5,563	21·99	1·126

\* In my opinion these denote skim milk to have been kept back which is all right for butter-making, but for cheese-making should not be allowed.

We had the good fortune to secure the services of Mr. Ernest Moorhouse, of Newbury, Ont., who is a thoroughly competent butter-maker.

Not a bad batch of butter was turned out any one day.

The butter when first placed upon the London market did not seem to meet with universal favour. The people seemed to have to acquire a taste for creamery butter.

Later in the winter the calls for our butter became more numerous, and during the last month of making so much favour did the butter meet with that we did not have enough to supply the trade.

We also had calls for butter from outside towns and cities, but we were unable to supply them, as the London market practically took all we made.

The make here was small, owing to the fact that the farmers were not prepared for winter dairying, and had not made provision for supplying milk during the winter months.

Although the supply was very small last winter, there is every prospect of a large make this coming winter.

I have the honour to be, sir,

Your obedient servant,

C. C. MACDONALD.

### (4) REPORT OF J. D. LECLAIR.

St. HYACINTHE, QUE., 30th June, 1893.

Prof. J. W. ROBERTSON,  
Dominion Dairy Commissioner,  
Ottawa.

SIR,—I beg to submit to you the first report of the work done at the St. Hyacinthe Dairy School from its opening on the 27th of November, 1892, to the 30th of June of the present year, 1893.

According to your instructions, I came to St. Hyacinthe before the day fixed for the opening, and we were able to receive the milk on the day named.

The farmers of the neighbouring parishes of St. Hyacinthe showed some interest in availing themselves of the advantage of a winter factory. We have been very much gratified to find that they understood what source of income the lengthening of the working season of cheese and butter factories would be for agriculture. Many a time we have heard farmers express their regret for having let their cows dry up so early, and their intention to act differently hereafter.

The increase in the milk production, brought about by the numerous and instructive lectures delivered in the whole province, and encouraged by the Premier of the Quebec Government, will be really advantageous only in the measure as the quality becomes better; we have evidence of the need of a great improvement in this respect. The object being to export winter butter, we shall not attain it until the farmer knows what he must feed to his cows, in what condition they should be, and what particular care milk requires in winter.

It is to be regretted that the railway companies have not seen fit to grant more accommodation and easier freight conditions in carrying milk; we have reason to hope that they will give greater attention to this department of their traffic and will be more conciliating.

On the 10th of January was the opening of the first series of lectures of the dairy school, the "Inspector's Course"; 40 had their names entered and 32 underwent the oral and written examinations. The other courses followed uninterruptedly for the rest of the winter and the spring, and in the order settled by the Dairymen's Association of the Province of Quebec. Two hundred and sixty-eight applications for inscription were made altogether and 214 students had their names entered: 163 for cheese-making and 51 for butter-making.

#### PROGRAMME OF THE COURSES.

8 a.m.—Call by names; practical course by the students in successive order.

Reception of the milk, its inspection and test with the usual different instruments, lactometer, lactodensimeter and Babcock process.

2 p.m.—Call by names; discussion on cheese and butter-making. Explanation of milk-testing instruments and of their use in factories. Teachings of the calculations necessary in a factory and of the mode of distribution of the proceeds according to the per cent of fat in the milk furnished by each patron.

We gave special attention to explaining the instruments for milk-testing, and the new method of distribution of proceeds in factories. We wished particularly to render the makers better able to detect the frauds committed by patrons in the milk brought and to convince them of the correctness and fairness of this new mode of distribution. We delivered lectures on the duties of the maker in his factory and in his intercourse with the patrons; is he not the channel through which the knowledge indispensable in the production of an abundance and perfect quality of milk will be directly disseminated through the country?

We had milk only three times a week and not in sufficient quantity to make both cheese and butter on the same day. It was a drawback felt all the more as, on account of the large number of students at the same time, several have had to go away without having had any practice.

The students would have been particularly glad to be able to consult a few good treatises upon the making of cheese and butter.

On leaving the school, several asked as a favour to correspond with us during the working season about certain difficulties unforeseen or not understood. We thought it our duty to grant it, and we have answered with pleasure a great number of inquiries.

I am, your obedient servant,

J. D. LECLAIR.



# Report of the Dairy Commissioner.

## (5) REPORT OF H. A. LIVINGSTON.

ST. HYACINTHE, QUE., 30th June, 1893.

Prof. JAMES W. ROBERTSON,  
Dairy Commissioner, Ottawa.

SIR,—Following your instructions, I arrived at St. Hyacinthe on the 27th March and proceeded immediately to take an active part in the work of the Dairy School. We were, as a dairy school, "an Infant industry," and laboured under the difficulties common to commencements generally. Plumbers, painters, carpenters, etc., have been occupied, off and on, to the present. Again, we had very little milk, so little that the cheese department was closed, as far as practical work was concerned, after the early part of April. However, when the largest number of makers were present, we were able to make cheese two or three times a week. Milk-testing also was thoroughly gone into; also a class for the mathematics pertaining to the dairy business was carried on; instructions were given in the paying of dividends, and special attention was given to paying for milk according to its value in butter-fat, per the Babcock test. This was very irksome, many makers being in attendance who only knew but slightly the multiplication table; and for some of them it was necessary to invent a table whereby the whole work could be done by addition.

As you know already, from the reports of Mr. Leclair, the makers attended the school in large numbers. There were, one week, forty-five cheese-makers in attendance at the school.

The makers, as a rule, professed themselves willing to learn, but I found sometimes a great many ideas which had to be combatted. For instance, a goodly few think that the effect of a soft curd, when the whey comes off, may be obviated by two grindings, the first to take place in say half an hour.

Again, on Monday or in case of acid milk, they have the habit of heating in the cooking process only to 96 or 95°. I insisted on heating in that case to 100 degrees, and have again found that preconceived ideas are hard to overthrow.

In several other ways, special as well as general, did I find could useful work be done, and as well as circumstances permitted, I did it. My habit in teaching has always been to provide reasons practical and scientific for any assertions I made.

After the spring work had commenced and the makers had nearly all left, we endeavoured to institute some comparisons with testing daily and testing once a week with the Babcock tester. I selected bi-chromate of potash as the preservative, but the test bottles need a great deal of attention when this is used, as if left quite a long time, they show cream attached along the sides, and as it (the cream) is largely impregnated with the preservative, it is hard to be thoroughly re-dissolved. I found also that this difficulty could be largely overcome by placing all the jars in water, when ready to test, and then gradually heating the water around the jars to 98 degrees. If the bottles are left for from 5 to 15 minutes in this condition, the cream will, with agitation, dissolve, and the sample may be taken. A point must, however, be noticed; the fat is inclined to float to the surface in this case and cannot be seen by the naked eye, so that the sample must be taken only after two or three severe agitations. By blowing into the jar through a pipette, an active ebullition of the liquid is caused.

Allow me to draw your attention to certain peculiarities of the cheese product of March and early part of April. The fact is interesting, in as much as it was perhaps the first "winter cheese-making" of Quebec. The cheese lacked flavour—every one of them. They did not lose flavour; they never had it. We recognized it and tried in vain to correct it—the flavour was one I had never met before, not the disagreeable flavour of "off cheese," seen in summer making, but a "musty" flavour that did not seem to increase or diminish with age. A consignment was sent to Mr. A. W. Grant and another to Messrs. A. A. Ayer and Co., Montreal, and both complained (after the hasty manner of commercial men), and I fear that perhaps

my reputation suffered. I may mention that some three weeks after, Mr. Leclair and myself made a tour of our patrons, and we found the stock in a perfectly *miserable* condition,—a condition I could not believe could exist during the last fifteen years.

I am, Sir, your obedient servant,

HENRY A. LIVINGSTON.

---

(6)—REPORT OF J. W. HART.

To Prof. JAS. W. ROBERTSON,  
Dairy Commissioner, Ottawa.

SIR,—The following report of my work in the province of New Brunswick is respectfully submitted:—

In accordance with your instructions I left Ottawa for Fredericton on the 10th of May, 1892. Arriving there I called upon the Provincial Secretary for Agriculture, Mr. J. L. Inches, who very kindly promised to do anything in his power to aid me in my work, which was to conduct the Experimental Dairy Station you had arranged for at Kingsclear.

The Kingsclear Creamery, the site of the dairy station, is beautifully situated on a hill side, commanding an extensive view of the fertile valley of the swift-flowing St. John. Above the creamery, out of the solid rock, bubbles one of those springs of purest water with which Providence has so abundantly blessed this favoured region. About, are all the prime essentials for dairying with few natural drawbacks, and the oceans of creamy milk annually transmuted through the alchemy of the churn and cheese-vat into golden butter and cheese, testify to the neatness and skill of the farmers' wives and daughters, whose fame as dairy women extends far beyond the confines of their own beautiful valley.

Finding the building unfinished on my arrival, I spent a month in canvassing routes, setting up the machinery and completing the necessary arrangements for making butter. It is fitting that I should make mention of the untiring labours of the late president of the New Brunswick Dairying Company, Mr. Charles E. Murray, who was always ready to sacrifice his own interests when any business connected with the creamery required his attention, with no other recompense than the conscientiousness of duty well performed.

On the 3rd of June, you addressed a meeting of the prospective patrons in the hall near the creamery and made the final arrangements for opening. The 13th day of June saw the first cream wagon unload at the door. The routes being long and hilly, the cream-gathering system was followed. Four routes were established, on each of which the cream was gathered three times a week. Throughout the season, the cream arrived in good order, being thickened only a few times. As fast as made, the most of the butter was placed in cold storage for fall shipment to Great Britain. The oil test churn was used for finding the butter-fat contents of each patron's cream, and the division of the butter receipts was based on its readings.

On the 5th and 6th October, I attended the Provincial Exhibition at Fredericton and was appointed one of the judges on dairy products. A large amount of fine dairy butter was on exhibition, and it was no easy task to place the premiums. A few tubs were found venerated with a layer of first-class butter. These entries were not judged by the veneering. The quality of dairy cheese exhibited was inferior, but the factory-made cheese were of first-class shipping quality.

The creamery was closed on the 31st of October to make a few alterations necessary for running the business during the winter, the patrons having decided to carry it on themselves.

Having shipped the butter in cold storage at Kingsclear, 19,955 pounds, to your order at London, I relieved, 22nd November, Mr. Hopkins, who had put the Sussex,

## Report of the Dairy Commissioner.

King's County, creamery in operation as the winter dairy station. In the vicinity of Sussex a large and profitable milk trade has been built up with the St. John market. There are several dairies where from forty to sixty cows are milked. The summer price of milk at the stations along the line of the Intercolonial Railway between Sussex and St. John has been twenty cents, and the winter price twenty-five cents per can of twenty-two and a half pounds. The trade being found profitable, at certain seasons more milk was produced than could be marketed at these figures; and although limitless possibilities were present, the supply was in excess of the demand. This state of affairs brought the dairy business to a standstill. During the winter of 1892 and 1893 the creamery at Sussex was a benefit not only to the farmers patronizing it, who realized through the creamery as much from their milk as did the milk shippers, but to the milk shippers, because the price of milk was maintained and an outlet furnished for all that might be produced. To the milk shippers along the lines of railway running into St. John, I would suggest combination, in order to carry on the business at the lowest possible expense, and the erection of a building in St. John to serve as a dairy depot. Here butter and cheese could be manufactured from all milk not required for the city trade.

The Farmers' and Dairymen's Association met at Fredericton on the 25th, 26th and 27th of June. Its meetings I attended. The following is an extract from the *Daily Gleaner*, Fredericton, of June 27th:—

### “ THE ESSENTIALS TO SUCCESS IN CO-OPERATIVE DAIRYING.

“ Co-operative dairying means the association of a number of persons together for the purpose of carrying on the business of dairying. To be effective the co-operation should be hearty and genuine. In this connection the maxim of Bastiat, the French political economist, applies with force: ‘The good of each tends to the good of all, as the good of all tends to the good of each.’

“ When the soil of our farms was rich in the accumulated products of centuries of plant growth and decay, and when the prices of crude and bulky farm products ruled high, farmers may have been justified in selling these products until a certain point in soil exhaustion had been reached. In most soils this point has been reached and passed, and the tillage of the future should be directed towards conserving and increasing the supply of available plant food in the soil.

“ The constituents of soils that are removed by cropping, and which by their removal cause a soil to become barren are nitrogen, phosphoric acid and potash. In available form these are worth 18 cents, 9 cents, and 5 cents per pound respectively. Of these soil constituents, different proportions are removed from the land by different crops. Mangolds, sugar beets and carrots remove large quantities of these substances, hence are said to be “hard on the land.” This is true if these or other bulky crops be sold off the farm, but under a proper system of cultivation where they are fed on the farm and the resulting manure is applied to the land without waste, fertility will be maintained.

“ I have said that different crops draw upon the soil, *i.e.* the fertility of the soil, in different ratios. Thus, a ton of hay worth \$8 when sold will remove \$7.63 worth of fertility from the farm; a ton of potatoes exhausts the soil to the extent of \$2.08, a ton of milk \$2.39, while a ton of cheese worth \$200 removes but \$18.52 worth of soil fertility, and a ton of butter consisting chemically of carbon, and the elements of water, will remove only the insignificant amount of 9c. worth of the commercially valuable soil constituents.

“ The fertility in the soil of a farm may be compared to money deposited in a bank; draw heavily, and the supply is exhausted. By keeping the bulky products on the farm and feeding them to stock and applying the resulting manure to the land the balance on the right side of the ledger is not diminished. These are the fundamental truths, and they underlie the science and practice of agriculture. Their recognition by the supporters of a co-operative dairy concern will be a step towards making the business a success.

"Again, to attain to a high degree of success, it is necessary that patrons of a co-operative dairy enterprise should know something of the laws of breeding and rearing dairy stock; they should breed their cows to the very best sires obtainable, as the sire is half the herd. Then they should know something of the composition of feeding stuffs and the compounding of rations so as to secure the best results in feeding. Of these subjects he should know at least enough to make him eager to learn more.

"Naturally this leads us to consider the subject of dairy literature. A dairyman cannot afford to do without a dairy paper, containing as it does the experience of the best dairymen, much of which will be helpful to him in his work of every day. A good dairy paper like "Hoard's Dairyman" is like a dairy association all the year round.

"Within the last twenty-five years machinery has come largely into use in place of human muscular energy. To a large extent horse power has supplanted hand labour, and steam power is now largely used where horse power did the work. This tendency which has been instrumental in banishing the hand loom and the scythe for the more modern woollen mill and mowing machine, is supplanting the private dairies by co-operative dairies. In these hand labour is reduced to a minimum with the result that the cost of production is lowered.

"The raw material, milk, is an essential to success. While there should be cow population, productive cow population is necessary. Farmers should test their cows and sell the unproductive cows to the butcher. No man will lay up treasure on earth with such stock. If he cares nothing about earthly treasures he might lay up treasures in a better place by the boarding of a few homeless tramps and be as well off in a worldly sense as by waiting on cows that do not pay for their keep. The Babcock tester which has been operated here to-day is a convenient and accurate means of measuring a cow's productiveness.

"A cow must be made comfortable before she will yield her owner a profit.

"Clean, pure sweet milk is necessary if first-class dairy goods are to be made.

"Many circumstances will have to be considered before deciding what form a co-operative dairy enterprise shall assume. In districts suitable for dairying where there are not cows enough to support a co-operative concern, one man having a herd of twenty cows could put in a horse power outfit. With this, in addition to his own butter, he might make butter for three or four of his neighbours. Depend upon it he will never go back to the old system.

"In regard to a site for a creamery or cheese factory it should possess accessibility, plenty of good water and ample facilities for drainage. In building have everything to minimize work.

"If a bountiful supply of succulent food is grown for winter feeding, winter dairying will prove more profitable than summer dairying; the farmer will be able to hire help by the year, and labour will be paid by the immediate products of labour.

"Cows should milk ten to eleven months in the year and the farmer and his cows will find profitable winter employment in turning crops into milk, thus conserving the valuable constituents of his farm."

After returning to Sussex, I attended two meetings near Clifton, King's County, where the erection of a creamery was being agitated.

During the winter, the "dividends" at Sussex were apportioned to the patrons according to the amounts of fat found in milk delivered by each, as discovered by the weigh-scales and the Babcock test. I tested a large number of samples for the patrons and others. To show the variations in the milk that may be met with in the cows of a single herd, I append the following, tested March 21st.

	Per cent of fat.		Per cent of fat.		Per cent of fat.
No. 1.....	3·8	No. 2.....	2·4	No. 3.....	2·7
No. 4.....	5·0	No. 5.....	3·4	No. 6.....	2·8
No. 7.....	5·0	No. 8.....	6·1	No. 9.....	4·4

## Report of the Dairy Commissioner.

Nearly all the butter made at Sussex was disposed of as fast as made. Messrs. G. S. Wetmore & Co., bought over one-half of it.

On April 15th, your lease of the creamery having expired, I handed the keys over to the Sussex Dairy Co. I remained at Sussex until the 22nd, to finish up the season's business of which the following is a summary :—

Lbs. milk received... ..	147,014
do butter made.....	6,496
do do sold.....	6,391
do do supplied to patrons.....	105
do milk per lb. of butter.....	22·63
do butter per 100 lbs. milk.....	4·41
<hr style="width: 100%;"/>	
Amount paid patrons on account of butter sold. ....	\$1,287·01
do do per pound of butter.....	20½

On April 26th, in company with Mr. W. W. Hubbard, I attended a meeting at Hoyt Station, and spoke on co-operative dairying. The creamery at Kingsclear was again rented by the Dominion Government (under the management of Mr. Hubbard, the creamery had been running all winter). The first day 125·1 inches of cream were collected and 108 one-pound prints were made.

As butter was in brisk demand, the most of the May butter was marketed in Fredericton and St. John.

Having resigned to accept another situation, I left the creamery in charge of Mr. W. W. Hubbard, May 23rd, 1893.

Wherever I went in New Brunswick, I was most hospitably received, and to my friends (who are many), I am under lasting obligations for their many kindnesses.

I have the honour to be, sir,

Your obedient servant,

J. W. HART.

Clemson College, S. C.,  
October 12th, 1893.

### (7) REPORT OF W. W. HUBBARD.

KINGSCLEAR, N.B., 5th July, 1893.

Professor J. W. ROBERTSON,  
Dairy Commissioner, Ottawa.

SIR,—I have the honour to present to you a report of the work done by me, under your direction, from the 15th of May until the 30th of June of the present year.

I arrived at the Experimental Dairy Station, Kingsclear, N.B., on the 15th of May, and reported to the Superintendent, Mr. J. W. Hart. During the rest of that week, and up to the 25th of the month my time was mainly devoted to making arrangements for the completion of the cold storage building, to getting some repairs on the engine, and to visiting farmers on the eastern side of the St. John River, who might become patrons of the Station.

On the 25th Mr. Hart handed over the books and accounts, and the management of the Station to me, and amid the very general regret of all who had had any business or social relations with him, bid us farewell and started for his new field of labour in South Carolina.

During the month of May there were 2519·8 inches of cream collected at the Station, which yielded 2138·5 pounds of butter. The average number of inches of cream per pound of butter was 1·178.

On the 3rd of June our cream-gatherers made their first trip in the parishes of Queensbury and Bright, on the eastern side of the river, and secured there twenty-two additional patrons.

On the 24th of June we were obliged to shut down the factory to allow of new tubes being put in the boiler, as the old ones were leaking so badly as to make steaming impossible.

Our cream-gatherers went out again on the 30th, and the next day we churned 521 inches of cream, yielding 482 pounds of butter.

During June the total number of patrons was fifty-seven, and the number of cows four hundred and forty-four. Some of these contributed for a few days only.

The number of inches of cream collected was 6278.4, and the amount of butter made was 5556.4 pounds. The average number of inches of cream per pound of butter was 1.129.

The butter is being mainly held in cold storage, as you have directed. I have to report, though, that the local demand promises to increase. We are able to command 22 cents per pound net, here for all we sell; most of it is put up in pound prints and shipped in refrigerator boxes to the St. John market.

This price leaves the patrons 17½ cents net at their door for enough cream to make a pound of butter, and as dairy butter is at present selling from 18 cents down in the local markets, our patrons are realizing more than the majority of farmers from their cream with no labour or expense in making or marketing the butter.

We are selling some of our buttermilk for city consumption at 2 cents per gallon at the factory, the rest of it is being fed to some pigs that we hope to turn off in the fall at a good profit for the feed consumed.

The patrons will have the benefit of all profits from the buttermilk divided among them according to the quantity of cream they send to the factory.

As my work here has only just got fairly started, I cannot as yet draw any conclusions, or make any extended report.

I have the honour to be, sir,  
Your obedient servant,

W. W. HUBBARD,  
*Supt. Experimental Dairy Station.*

---

(8) REPORT OF J. E. HOPKINS.

NAPPAN STATION, N. S., 30th June, 1893.

Prof. JAS. W. ROBERTSON,  
Dominion Dairy Commissioner,  
Ottawa.

SIR,—I respectfully submit the following report of my work in Nova Scotia during the season of 1892.

On the 30th of May I arrived in Nova Scotia to discharge the duties assigned me in connection with the Dairy work. My first object was to visit the different cheese factories, meet as many farmers as I could, and see what progress had been made in dairying, and in the quality of the product made.

I found vegetation late, but in a week pasture was good and Nova Scotia looked beautiful with its rich intervals (of which nearly every farm has some.) Its many rivers and springs afford abundant water, and its broad sloping hills crowned by evergreen fir and spruce not only give picturesque scenery, but under a better system of farming would make it rich in dairy products.

When the early settlers came into the province, farming was not the exclusive or chief employment, as the natural resources were such, that tilling the soil was a secondary consideration. They have plenty of pasture in summer, but many cows

## Report of the Dairy Commissioner.

suffer in winter from want of sufficient succulent food. In consequence many are not in a condition to give a large flow of milk as it takes nearly all the summer to recuperate from the effects of the previous winter.

There is an increasing feeling among farmers throughout the province that they must change their mode of farming so as to increase the fertility of the soil, and to produce the kind and quality of dairy products that are wanted in their own province where there is a good market.

At the Dominion Experimental Farm at Nappan, managed by Col. W. Blair, it has been demonstrated that Nova Scotia can produce in abundance all kinds of food for the production of milk for either cheese or butter. Other practical farmers whom I met in different parts of the province corroborate the same. There is no good reason why Nova Scotia should not become a large exporter of dairy products.

The first place I visited was the Truro condensed milk factory. It is situated in a fine section of the country, and the farmers are increasing their herds of cows, so much so that the Company could not take all the milk for condensing purposes. They added an Alexandra Centrifugal Separator as well as cheese-making apparatus.

I made my headquarters at Antigonish, as Antigonish County produces more cheese than any other county in Nova Scotia. Four years ago Mr. L. C. Archibald, built and equipped six factories in the county and started them on the co-operative plan. They are proving a success as he spares no pains to produce a good article. He has now eight factories under his management, with one at Mabou, C. B., and one at River John, Pictou County. At the close of the season he sold for shipment to England some fourteen hundred cheese for which he received good returns.

Since Mr. Archibald started in the business others have gone into it. Mr. Jno. A. Kirk has three factories in Cape Breton, also well managed. I regret to say Mr. Kirk met with a loss in having his Middle River factory burned about the first of June, but not discouraged, he had it rebuilt and running in a few weeks.

There are 19 cheese factories in operation in the province, four of which did not make a large quantity. The factories generally are well suited for making cheese, care having been taken in locating them so as to have water running into the buildings.

Some of the makers are very painstaking, having learned the necessity of doing their best, and by close application are making a good article. At two factories I visited I could not term it anything but spoiling good milk, they were making an article that was very inferior. As the season advanced, the quality of the cheese improved. I visited the factories two or three times and in some cases oftener. I found the makers very anxious to get all the points possible in cheese-making.

I attended 26 public meetings during the season, there being an average attendance of thirty to 100 farmers and farmers' sons. On three occasions there would be upwards of 200 present. At these meetings there was a deep interest manifested in dairy farming, and many took part in the discussions. I managed to hold a meeting in the neighbourhood of each factory, as well as in other sections. As a result I expect to see other factories established next season.

In visiting the Annapolis valley, which is termed by some "The Garden of Nova Scotia," I held three very interesting meetings. I found only two cheese factories in operation. These are all that are left of the old factories that were started about twenty years ago. The Forrest Canning and Milk Condensing Factory in the neighbourhood of Kingston gives the farmers good returns for their milk. It is of great advantage to the farmers to have such an establishment in their vicinity.

The Annapolis, which is indeed a beautiful and fertile valley, noted as it is for superior apples, if devoted to dairying, combined with fruit-growing, would become one of the finest sections in our Dominion.

I spent over a week at Nappan with Col. Blair, Superintendent of the Dominion Experimental Farm. We held several meetings with the object of starting a dairy station. This is what is needed in Nova Scotia, and Nappan seems a favourable place to have a station where those desiring to learn either cheese or butter-making would have an opportunity.

At the close of the season, I started a creamery in Lower Onslow erected by Messrs. Corbutt & Putnam. It is in a good section for a creamery, and from the expression given at a public meeting held in the neighbourhood and the interest manifested, I have no doubt but that there will be a large amount of butter made next season.

In summarizing the report of my summer's work, I would say:—There were nineteen factories in operation the past season. I made fifty-four visits to the factories, giving the makers instruction in improving the cheese and showing them how to use the Babcock milk tester.

I attended twenty-six public meetings with an attendance of thirty to one hundred. I found an improvement in the quality of the cheese as the season advanced.

There will be a larger quantity of cheese made next season in the same factories, also three or four new cheese factories as well as two or three creameries.

The farmers take an interest in the reports and bulletins which you send them.

In closing I desire to thank the many farmers and others that I met for their cordiality and kindness in aiding me in the work, and I hope that the past summer's work may be a lasting benefit to the province of Nova Scotia.

Yours most respectfully,

J. E. HOPKINS.

---

(9) REPORT OF THOMAS J. DILLON.

CHARLOTTETOWN, P. E. I., 30th June, 1893.

Prof. JAS. W. ROBERTSON,  
Dominion Dairy Commissioner,  
Ottawa.

SIR,—At your request I send you a short report of my work as Dairy Superintendent from March, 1892, to June 30th, 1893.

I had charge of the Experimental Dairy Station at Mount Elgin till the 11th of April, 1892. Owing to the reference, in your report of 1891 and 1892, to the work done at this station, I deem it unnecessary to refer to it at this time.

I attended Farmers' Institute meetings at Mount Elgin, Dickson's Corners and Sparta during the winter. At your request I went to a meeting at Avonbank about the 26th of March, to give what help I could towards getting winter butter-making started there. The patrons decided at that meeting to put a centrifugal separator and butter-making outfit in their cheese factory at once; and I am glad to be able to report they are well satisfied with having done so.

At the Dairymen's Convention in London last winter, I met Mr. J. B. Muir the cheese and butter-maker, and Mr. Mountain, the company's president, who informed me they were making 850 lbs. of butter per week which sold readily in Toronto at 25c. per lb. for prints and 24c. per lb. for tubs.

I also attended a farmers' meeting at Harrow, Essex County, where they were starting a new cheese factory. The people seemed to know very little about dairying there, but a good factory was erected and 32 tons of cheese made.

We stopped butter-making on the 11th of April, and cheese-making commenced the same day.

As soon after as the necessary arrangements could be made, I started for Prince Edward Island to undertake the work you had laid out for me there.

I arrived at New Perth, where the Experimental Dairy Station was to be established, on the 14th of May. The contract for the building had been let, but there was no material on the ground. However, the contractor pushed the work rapidly. We got the plant in and commenced cheese-making on June 20th.





SHEAF OF WINTER RYE, GROWN AT BRUDENELL, P.E.I.

## Report of the Dairy Commissioner.

The spring had been cold and backward, feed was scarce, cows poor, altogether the prospects for making much cheese were not good. Meetings were held in all the neighbouring school-houses, where I got a list of names of those who were going to patronize the factory and would need milk cans. By canvassing during the day and at the meetings at night, I got 34 names on the list. As many more gave in their names the day the contracts for drawing the milk were let. The first day the factory ran, 4,200 lbs. of milk were received, which soon increased to 7,000 and 8,000 lbs. daily. The total quantity of milk received during the season was 669,168 lbs. The quantity of cheese manufactured was 63,018 lbs.

The regular milk drawers stopped on the 15th of October, but several patrons brought their own milk twice a week till the 28th October, and had cheese made for their own use. This cheese was divided the first week in November in proportion to the quantity of milk delivered. The patrons took it home and finished curing it.

About half the cheese made was sold on the Island and the balance was shipped to England on November 4th. The average price realized was 10½ cents per lb.

The whey was fed to pigs near by. I bought 18 good ones before the factory opened, and thought perhaps they would consume all the whey. The supply of milk was such that more were needed, and I had to get them as quickly as possible as the whey was running over and would soon become a nuisance. They were scarce and hard to buy near the factory, but Mr. William Cane (who had been School Inspector), informed me they were more plentiful along the north side of the Island. He kindly consented to accompany me. We set out and succeeded in getting quite a number, but unfortunately a large percentage of them were a kind known as "clam diggers," and though able to consume a large quantity of whey and other feed, they would not get fat.

There were 99 altogether and they were disposed of as follows: 40 were butchered and sold to Geo. J. Wright, of Charlottetown, at from \$5.90 to \$6.00 per 100 lbs.; 6 were sold locally alive; 3 died, and as there was no proper place to keep the remaining 50 when the weather became cold, I sold them alive at \$5.00 each, and they were shipped to Halifax. There is no packing house on the Island, and consequently no considerable demand for live hogs, I could not get 4¼ cents per lb. live weight for them, which is clear evidence of the necessity for co-operation amongst the producers, as live hogs were selling at the time in nearly all the markets of America at 5 cents per lb.

When trying to sell them, I wrote to several firms asking their best price per lb. for 50 live hogs. Among others I received the following reply:—

"We buy thin store hogs from one to two years old for \$5.00 apiece. Never bought any by live weight. Charlottetown, Oct. 3, 1892."

I attended meetings at Vernon River Bridge, Eldon, Murray Harbour North, Murray Harbour South, Brown's Creek, Lower Montague, Narrows Creek, Dundas, Rollo Bay, Souris Head, St. Peter's Bay, Morell, Mount Stewart, Baldwin's Road, Kensington, North Tryon and Stanley Bridge. I was ably and cheerfully assisted at all these meetings by Dr. J. E. Robertson, ex-M.P., Montague Bridge, Cyrus Shaw, Esq., M. P. P., and John Hamilton, Esq., of New Perth. The two latter gentlemen are President and Secretary respectively of the New Perth Dairying Company. These meetings were called to discuss dairy matters with a view of having co-operative cheese and butter factories established.

The Cornwall factory owned and operated by a farmer's stock company, was run three months last season and turned out quite a large quantity of cheese. I visited it in August when they were getting about 6,500 lbs. of milk daily.

Considerable areas of corn were planted which did so well that it is likely to become the principal fodder crop of the province. I advocated also the sowing and feeding of peas, oats, vetches and rye. The latter, as the corn plant had been a year or two previous, was almost a stranger in this province. I got 15 bushels from John S. Pearce & Co., of London, Ont., which was sown by the patrons and did very well. The accompanying photograph of a sheaf grown by Mr. George Stewart Brudenell, was sown in an open field on the 20th of September, 1892, and pulled on June 20th, 1893, and should convince any one that it will do well here.

The whole work of our dairy attracted a great deal of attention. People came from far and near to see what was being done, and the factory has hardly been without visitors who went away feeling there should be something of the kind started in their neighborhood. The interest manifested clearly showed the wisdom of the project. The object lesson did more to advance the dairy interests of the province than any other scheme that could have been devised.

Acting on your instructions to be ready to resume butter-making at Mount Elgin, Ont., by November 15th, I wound up the business at New Perth as far as possible. The patrons had received an advance of 50 cents per 100 lbs on their milk account, and a final settlement could not be made till the cheese sent to England had been sold and the account of the sales received.

I started for Ontario on Nov. 7th, having been on the Island a little less than six months.

Arrived at Mount Elgin, I found the company had sold a certain number of cheese and wanted to run a few days to make them. I made some changes in the creamery plant and began butter-making November 24th. Nearly all the neighbouring factories continued cheese-making till the 10th and 15th of December, and two, viz.: Brownsville and Nancekivells, up to the 25th. This accounts for the small quantity of butter made in November. The number of pounds of butter made each month and the pounds of milk required to make it are as follows:—

Month.	Total lbs. Milk.	Average per cent of Fat.	Total lbs. of Butter Fat.	Highest per cent of Fat.	Lowest per cent of Fat.	No. lbs. of Milk to make one lb. of Butter.	No. lbs. Butter per 100 lbs. of Butter Fat.	Total lbs. Butter
(1892-93.)								
From 25th Nov. and December..	243,756	4.09	9,959.37	5.0	3.5	20.79	117	11,725
January .....	130,525	4.16	5,436.79	6.6	3.3	19.62	122	6,653
February. ....	43,068	3.87	1,667.24	4.6	3.2	20.79	124	2,071
March.....	79,925	3.51	2,807.89	4.1	3.0	23.86	119	3,349
Totals.....	497,274	3.99	19,871.29	6.6	3.0	20.89	119	23,798

This shows an increase of over 100 per cent or 12,736 lbs. more than was made the previous winter; and the quantity of milk required to make a pound of butter was considerably less while the quality of the butter was equally good.

As you are already aware, quite a number of cheese-makers spent some time learning butter-making the first winter; and I am pleased to be able to report that several of them obtained situations as butter-makers last winter, viz.:—E. L. Smith, at Sardis, B. C.; Thomas Willing, Oregon; Albert Raby, Gladstone, Ont.; N. W. Eveleigh, Sussex, N. B.; and Thomas Horton ran his own factory near Brockville, Ont. A greater number spent some time in the factory last winter, among them being George Barr, Culloden; J. W. Steinhoff, Sebringville, Ont.; Hugh Howie, Napance, Ont.; William Clark, Mineral Point, Wisconsin; Herman Clark, Corinth, Ont.; Lewis Phelps, Dereham Centre, Ont.; Copland and A. McCoombs, Beamsville, Ont.; and J. M. Hoover, who is now in charge of one of the best cheese factories in this province. The Messrs. McCoombs had charge of the Norwich creamery from February 1st till cheese-making was resumed, and gave general satisfaction.

Several silos were built near Mount Elgin last season. In Dereham and adjoining townships, there is a general move to provide better stables for the cows; and other preparations are being made for winter dairying.

## Report of the Dairy Commissioner.

By invitation I attended the annual meetings of eleven different cheese companies to give information regarding winter butter-making etc.; a number of conventions, and also meetings for organizing companies at Freelon and Dumfries, where new factories have since been built.

A company was formed at Culloden who bought a butter-making outfit for their cheese factory; and the Saturday night's milk is being separated and made into butter there and at Mount Elgin; thus doing away with the making of cheese Saturday nights, which was a very objectionable part of the business.

Cheese-making was resumed the first of April; and as soon afterwards as I could, I started for Prince Edward Island. I reached Charlottetown, April 20th and was busily engaged locating the new factories, seeing about supplies, etc., till your arrival about the 10th of May, when final arrangements were made, for the running of their factories with twelve different companies. Ten factories are now in operation and we expect another to commence in a day or two. A factory was built and equipped at Eldon, P.E.I., and was nearly ready for operation when, unfortunately, it was burned, before coming under our management.

I feel that I cannot conclude this report without acknowledging the many kindnesses and acts of hospitality received from the people everywhere.

To the efficient butter-maker, Mr. John R. Moore, my thanks are due for the cheerful and able assistance rendered me last winter.

I have the honour to be, sir,  
Your obedient servant,

THOMAS J. DILLON.

---

### (10).—REPORT OF ROBERT CORNETT.

DUNDALK, Ont., January, 1893.

Prof. J. W. ROBERTSON,  
Dominion Dairy Commissioner,  
Ottawa.

SIR,—At your request I submit to you the following report of the work accomplished by me under your supervision, from the 1st May to end of the year.

Acting under your instructions I visited the Experimental Farm at Ottawa, remaining there during the month of May, where I met with other members of the dairy staff, and interchanged ideas on butter and cheese-making, which proved very beneficial to me in my work during the season.

After having a travelling dairy apparatus fitted up, and a Babcock milk tester given me, for use in Manitoba and the North-west, I left on the 1st of June, and arrived in Winnipeg on the 6th.

The meetings for the month of June, a list of which was given me, were to commence on the 15th. Meantime I visited Mr. S. M. Barre's cheese factory at Ste. Agathe, on Red River, where I met Mr. John Mills in charge. I remained with him two days, giving him instructions which were thankfully received. I tested the milk, which showed from 3.3 to 4.2 per cent of butter-fat. I proceeded from there to the Otterburne and St. Peter creameries, which I found well equipped, on the centrifugal-separator plan, all the surroundings neat and clean, and an excellent quality of butter being made. Milk tested from 3 to 4.4 per cent of butter-fat.

Returning to Winnipeg on the 12th June, I proceeded to Carberry on the 14th, where a new cheese factory had been in operation for a month, established by Messrs. Irish & Perry. I found them well up in the art of cheese-making, but struggling against difficulties, having to go a distance of over twelve miles, and return, for some of the milk. They were not receiving the quantity of milk they expected. I addressed a meeting of the patrons, and tried to encourage them to co-operate with Messrs. Irish & Perry to make the factory a success. This is one of the wheat sections, where the farmers are apparently married to wheat growing, which, to my

mind, is a mistake which is being made in a great many sections of Manitoba and the North-west Territories. Milk tested here from 3 to 4.2 per cent butter-fat.

On the 15th I visited the Experimental Farm at Brandon. Mr. Bedford, who is in charge, very kindly showed me over the farm, pointing out and explaining to me the experiments which are being made in the different lines of grains, grasses, roots, and tree-planting, all of which proved to be a great help to me in my after work throughout the country.

On the 16th I visited the new cheese factory at Douglas, established by Mr. Greenwood and in charge of Mr. Edgley, a cheese-maker of wide experience from the County of Leeds, Ont. Milk showed 2.4 to 4 per cent butter-fat.

This being also a wheat section, Mr. Greenwood was having uphill work in getting the farmers to take hold of the cheese industry.

I addressed a meeting of about 40 patrons and others, pointing out to them the benefits that might be derived from giving more attention to the butter and cheese industries. A number present took an active part in the discussion which followed.

On the 17th I left Reaburn by stage for Oak Point, about fifty miles north, on the east side of Lake Manitoba. A meeting in the shape of a picnic had been called by the Farmers' Institute, and about 150 people, men, women and children had assembled. I was called upon to give a lesson in butter-making, and to address the meeting on the same subject, all of which I did apparently to the full satisfaction of all present. I also tested samples of milk, which showed from 3.2 to 5 per cent butter-fat.

This section is a ranching part, the people subsisting principally by keeping and raising cattle and horses. The land is flat, broken only by sloughs, which abound, affording plenty of pasture and hay, but none of it any good for wheat.

On the 21st I visited St. Jean, on the Red River, where I met yourself and Mr. Wm. Thompson of the *Farmers' Advocate*.

It being St. Jean Baptiste day, the attention of the people was given so much to the amusements for the day, that it was impossible for the president of the Farmers' Institute to get a meeting of the members at the hour appointed; however, a meeting was held in the evening, when short addresses were delivered by Prof. Robertson, Mr. Thompson and myself, touching on matters connected with dairying and farming generally. I regret to say that the cheese factory here had just closed down from want of patronage. The people here are mostly French-speaking, and have followed grain-growing chiefly. A great many of their farms showed evidence of over cropping by the abundance of weeds in the fields.

On the 24th, 25th and 26th, I visited Glenboro', Wawanesa and Balder, with the object of attending Farmers' Institute meetings at each place. By some mistake the meeting at Glenboro' was not advertised properly, consequently no meeting was held. At Wawanesa about fifteen were present. I gave a lesson on butter-making and a short address. Mr. R. Waugh, of the *North-west Farmer*, was also present and addressed the meeting on the subject of wheat cultivation. This being also a wheat section, very little interest was manifested on the subject of dairying.

On the 30th, I attended a meeting at Portage la Prairie, and delivered a short address on dairying, about thirty members of the Farmers' Institute being present. Messrs. Thompson and Waugh being present also delivered addresses respectively on how to make Farmers' Institutes a success, and wheat cultivation. Here I met yourself again, when it was arranged for me to visit the following places with my butter-making apparatus, to give lessons in butter-making and addresses on the same subject: Neepawa, Newdale, Binscarth, Russell, Langenburg, Saltcoats, Shoal Lake, Hamiota, Oak River, Regina, Indian Head, Wolseley, Grenfell, Broadview, White-wood, Moosomin, Souris, Melita, Deloraine, Bossevain, Killarney, Pilot Mound, Manitou and Morden.

I gave lessons at every point where there were enough people present to hold a meeting. At Saltcoats and Binscarth, on the M. & N. W. R., the meetings were fairly well attended and quite an interest shown. All the other meetings on this road were poorly attended, and at some points there could be no meeting got together. The failure was owing a great deal to the neglect on the part of persons to whom bills were sent, failing to distribute them.

## Report of the Dairy Commissioner.

The country along this road is better adapted to cattle raising and dairying than it is to wheat growing, Neepawa section being the only place where wheat is sown to any great extent. The other parts on this road are broken a great deal by sloughs and deep ravines, and less or more timbered land. In the vicinity of Salt-coats to Yorkton, a number of small lakes abound.

The meetings along the Canadian Pacific Railway were better attended, a meeting being held at every point, and from twenty to fifty people present. The best turnout was at Regina. At every meeting ladies attended and showed much interest in the lessons on butter-making.

At Indian Head I was pleased to meet Mr. McKay, in charge of the Experimental Farm.

After winding up at Moosomin, I proceeded to the Exhibition at Winnipeg, where I acted in company with Mr. J. Brown as judge of dairy products. I was pleased to note the excellent quality of the butter exhibit, both dairy and creamery. The cheese exhibit was very good, but not so near perfection as the butter exhibit. Indeed the butter exhibit could not well be beaten, being a great surprise to me in extent and quality.

There was also a good exhibit of cattle and horses. The cattle consisted of Holsteins, Ayrshires, Shorthorns, Galloways, Jerseys and Highlanders, all of which were a surprise to me, and certainly very creditable to the exhibitors and the country.

After the exhibition was over I proceeded to attend the meetings, on the line of the Brandon and Souris, and the Manitoba Southern roads. Those points being all situated in a wheat growing section, where very few cows are kept, very little interest was shown. The best meeting was held at Manitou, where the "Farmer's Club" took much interest, and turned out about 40 in number. At the other points, about 10 to 20 people attended. I spoke strongly at every point on the importance of trying to give more attention to dairy interests, and to mixed farming generally, pointing out the fact that if they had more cattle and hogs, they might utilize their frozen wheat, to make 50 to 60 cents per bushel out of it, instead of having it go to waste.

After winding up at Morden I proceeded on invitation to Regina to attend a meeting called to organize a dairy association for the North-west Territories. Lieutenant Governor Royal opened the meeting. The North-west Council being in session at the time, a number of the representative men were present. A good association was put in operation, which it is to be hoped will do good work. In the evening addresses were delivered by Senator Perley, Mr. Watson, of Moose Jaw, and myself, all on the line of dairying. Senator Perley being engaged in the manufacturing of creamery butter himself, gave the meeting a very interesting and instructive address, which should do much good.

After leaving Regina on the 19th, I came to Winnipeg, and then proceeded to visit the following cheese factories:—

Lakeview, Meadow Lea, Ste. Anne, Steinbach, Grenfell and Lorette. I spent a day at each factory, assisting in the making of the cheese, and did my best to point out to the makers where they might improve. All without exception were pleased to have me call on them.

### COWS.

There is a variety of cows, ranging from the scrub up to the pure bred. The older settlers have not given attention to improving their stock, especially in the Red River section, but the new comers throughout the country have introduced better breeds, and here and there may be found herds of pure bred animals, of the different breeds, and a number of good grade animals.

The wintering of cattle seems to be the greatest drawback to keeping them. Stabling is expensive owing to the scarcity of timber and other material for building, and as the minds of most of the settlers have been running on the line of wheat growing, little or no attention has been given to the fitting up of stabling; the

greater number having only a few poles thrown together, and covered with straw or sods. But it is certain that the people are beginning to feel that it will be necessary for the future to give more attention to the beef and dairy interests, so we may look in the near future for a better condition of things in connection with the cows.

#### PASTURE.

About one-half of the country abounds with good native grasses, especially along the river valleys, and in sloughs here and there, all over the country. Plenty of native hay can be cut for winter feed in all the low lands. On the higher wheat lands, pasture is not so good, especially during dry years. Some settlers have tried to cultivate pasture, by seeding down with timothy and other seeds, with varied success. I saw some very good pasture from timothy seeding and some good timothy meadows.

Judging from the success of experiments made on the Experimental Farms at Brandon and Indian Head, the day is not far distant when plenty of hay can be made from the native grasses. Anyway, plenty of the common cereals can be raised anywhere, and cured for winter feed. Cattle seem to thrive well on the native grasses. I saw cattle which had been turned out comparatively poor in the spring, that were fit for the butcher in July.

#### WATER.

The water in most of the rivers has a muddy appearance; this is owing to the soft nature of the soil through which the rivers flow. Most of them get very low in summer.

The water in the numerous small lakes over the country is clearer and of better quality, being fed more or less from springs.

In a great many places water can be got of excellent quality by digging from twelve to thirty feet, while in other places it cannot be got under a hundred feet or more. I met with flowing wells of 100 to 110 feet deep, producing water of the finest quality. Cattle seem to do well on the water in any part of the country; and in no place could I find any bad effects from use of the water on the butter or cheese.

#### CHEESE FACTORIES.

As I expected, I found all the factories in a more or less poorly fitted up condition. All but one were owned by private individuals.

Owing to the country being sparsely settled, it is a very difficult matter to get enough of milk to any point to run a factory successfully. The amount of milk received varied from 2,000 to 5,000 pounds per day. The quality of the milk is very good, showing from 3 to 5 per cent butter-fat. There is no doubt but what a fine article of cheese can be made in Manitoba and the North-west country; but owing to the fact that the country is sparsely settled in most places, as yet, cheese factories cannot be established without running the risk of the cost of manufacturing coming too high for a profit. I met with a few men, who were drawing the milk and making it into cheese for the farmers at 3 cents per pound, having three or four teams drawing milk, some of them a distance of twelve miles and return, at a cost of from \$2.00 to \$3.00 per day, and only receiving from 2,000 to 3,000 pounds of milk per day. These people were running in debt every day. I do not approve of private persons investing their money in cheese factories. It would be much better for the farmers in any section where they felt like engaging in the cheese industry, to form a company and manage the business themselves, as the best factories are doing in the older provinces. The home market and British Columbia take all the cheese yet made in Manitoba and the North-west. Prices range from 8½ to 10 cents. Considering the difficulties the makers had to contend with, I found the cheese mostly well made and the factories kept, in most cases, clean.

## Report of the Dairy Commissioner.

Furnishings are expensive—cheese boxes costing from 15 to 18 cents each, and extract of rennet, from \$2.50 to \$3.00 per gallon.

### CREAMERIES.

I was surprised to find the creameries so well equipped; about all I visited, excepting one, being run on the centrifugal separator plan.

All are owned by private individuals, and without exception were kept very tidy, and an excellent quality of butter was being made. Some purchase the milk in the spring at 65 cents, to 80 cents in the fall, per hundred pounds of milk delivered. Others charge 5c. per pound of butter manufactured.

The amount of milk delivered per day at the centrifugal separator factories varies from 3,000 to 6,000 pounds per day. The principal market is British Columbia, where the prices range from 18 cents to 25 cents per pound, according to the season. The best results are obtained by using the separator; a pound of butter being made from 24 pounds of milk in the spring, to 18 pounds in the fall.

There are not many places as yet, where creameries can be established on the separator plan, owing to the sparse population.

Although the cream-gathering plan has failed in a few places, yet I think it will be the most feasible system for the country for some years to come.

I think farmers should unite in every section, fairly well settled, to establish creameries on the cream-gathering plan. Ice could be put up cheaply in winter, for use in setting the milk and preserving the cream sweet for collection,—say three times a week. If this could be done at once, it would help the country more than any other line connected with farming. As soon as there is enough made to induce shippers to take hold of it, there will be an opening in the English market for all fine creamery butter made.

Owing to the want of good milk-houses and cellars, and from the fact that a great number of people are inexperienced, a large proportion of the home-made butter is inferior, causing a great loss to the producers.

It is my opinion that the manufacture of fine butter in Manitoba and the North-west will prove more remunerative to the people than the manufacture of cheese, and the sooner the people take hold of this idea, the better for them.

After getting through the work allotted to me, in Manitoba and the North-west, I returned to Ontario about 1st September and met yourself at the Exhibition in Toronto, where it was arranged for me to visit as many cheese factories as possible, in what is known as the North-west cheese section of Ontario, with the object in view of helping to secure exhibits of cheese intended for exhibition at Chicago.

I visited the following factories:—Chatsworth, Markdale, Flesherton, Badjeros, Lavender, Avening, Singhampton, Ventry, Shelburne, Laurel, Camilla, West Luther, Kenilworth, Conn, Mount Forest, Varney, Harriston, Cotswold, Alsfeldt, Malcolm, Dunkeld, Pinkerton, Fordwich, Spring Bank, Bluevale, Huron, Paramount, Lakefield, Ripley, Brussels, Ethel, Silver Corners, Newry, Elma, Molesworth, Wallace, Trowbridge, Cleland's, Moncton, Donegal, Gotham, Kastnerville, Southwick, and Dempsey's, forty-four in all.

I also addressed three annual meetings at the winding up of the season's business: Chatsworth, Markdale and Camilla. The last two named were well attended, and much interest shown.

Without exception the cheese-makers expressed their pleasure at having me call on them, and most of them expressed their determination to try to exhibit cheese at Chicago, by sending them to Ingersoll for examination.

All seemed to appreciate the efforts put forth by yourself to assist them in preparing the cheese.

I cannot close my report without expressing my heartfelt thanks to all the good people of Manitoba and the North-west Territories, with whom I came in contact. All without exception used me very kindly.



I was pleased to note the pluck displayed by many under adverse circumstances. Mostly all seemed to have unshaken faith in the country, and justly so. I am convinced there is a great future for it; as the capabilities of the country cannot be surpassed anywhere on the western side of the continent.

Very truly yours,

R. CORNETT.

# Report of the Dairy Commissioner.

## I N D E X.

	PAGE		PAGE.
Aberdeenshire agriculture.....	141	Bulletins, dairy.....	61
Acknowledgments.....	30	Milk for cheese factories.....	61
Acid measure.....	79	Notes for cheese-makers for May.....	63
Addresses and lectures.....	27	do          do          June.....	68
A few economies in farming.....	82	do          do          July.....	71
To the Central Farmers' Institute of		do          do          August..	73
Ontario.....	92	do          do          September	74
On the production of milk.....	98	do          do          October..	76
The food producing resources of		The Babcock test.....	78
Canada.....	101, 126	Business at the Experimental Dairy	
To the first congress of farmers at		Stations.....	157
Quebec.....	107	Butter at the World's Fair.....	179, 191
Food production in Canada.....	134	economical production of.....	88
Addresses in Great Britain, reports of,		exports of.....	28
published in Europe.....	120	imports of, into Great Britain.....	117
Addresses by J. C. Chapais.....	201, 209	judged by score of points.....	179
Adulteration prohibited.....	65, 137	pounds obtained by different methods	
Aeration of Milk.....	61	of creaming.....	49
Agassiz, experimental farm at.....	131	quality of, wanted in Great Britain..	117
Agreement with dairying company at		stock account.....	172
Kingsclear, N.B.....	12	to prevent specks in.....	90
with dairying companies in Prince		Butter-makers instructed at Mount Elgin	242
Edward Island.....	19	Calf-steers, feeding of.....	37
with Dairy Association of Quebec....	8	Canada and the agricultural crisis.....	121
for the drawing of milk.....	20	food producing resources of.....	101
with proprietors of cheese factories..	6	Canadian beef sold as best English.....	106, 119
Agricultural depression, remedies for....	124	brand for cheese.....	65, 70
Agricultural interests in Canada.....	143	dairy products at the World's Colum-	
Agricultural organization.....	131	bian Exposition.....	173
Agricultural revival.....	93	dairy products.....	127
Agriculturist, report as.....	28	farm products in British markets....	94
Allan, George W., record of cows.....	88	food products, wholesale.....	136
Angers, Hon. A. R., Minister of Agri-		<i>Canadian Gazette</i> , article in.....	121
culture.....	108	Canadian Government and agriculture...	127
Apparatus required for the manufacture		"Canadian," the synonym for excellence	
of butter.....	7	and honesty.....	114
Apples, Canadian in Manchester.....	135	Capabilities of Canada.....	126
Awards on cheese at World's Fair, 177, 186 to		Cattle, healthy in Canada.....	136
summary of.....	193	and hog trades.....	128
Babcock, milk tester.....	8, 62, 78	scheduling of, by Great Britain.....	95
Bacon, quality of, from feeding frozen		Cereal crops from 40 acre lot.....	53
wheat.....	45	Centrifugal cream separator, compared	
Beans and sunflowers, instead of cotton		with setting methods.....	46
seed meal.....	106	Central Farmers' Institute of Manitoba,	
Beaubien, Hon. Louis.....	108	address before.....	82
Beef, Canadian in markets of Great		Central Farmers' Institute of Ontario,	
Britain.....	118	address before.....	92
<i>Bell's Weekly Messenger</i> , article from....	143	Chapais, J. C., Assistant Dairy Com-	
Branding of cheese.....	65, 71	missioner.....	9
to prevent fraud.....	115	summary of report of.....	10
Bristol Provision Trade Association, 109, 114, 145		report of.....	194
British markets, Canadian farm pro-		addresses by.....	201, 209
ducts in.....	94	Charge for manufacturing.....	6, 19
visit to.....	111	Chart, results from different methods of	
Bulletin, Canadian dairy products at the		creaming.....	48
World's Columbian Exposition, 173, 182 to 185		Cheese-boxes, advantage of good ones...	115

	PAGE.		PAGE.
Cheese, branding of.....	65, 70	Dairying Co's. in Prince Edward Island, agreements with.....	19
care of, when being retailed.....	156	Dairy industry, Manitoba.....	200
exports of.....	29	Dairymen's Association of Eastern Ontario.....	8
imports of, into Great Britain.....	116	do do Manitoba.....	26
judging by score of points.....	176	Dairy Products' Act.....	65
qualities of.....	75	Dairy products from Canada at World's Columbian Exposition.....	173
sales of, from dairy stations.....	157, 168 to 171	Dairy School at St. Hyacinthe, Que.....	108, 231
stock account.....	168	Dairy Station and School.....	8
two-year old at the World's Fair.....	173, 175	Dairy Station, Kingsclear, N. B.....	12, 164
at World's Fair from Manitoba.....	190	do London, Ont.....	164
do do Maritime Prov.....	179, 187	do Mount Elgin, Ont.....	159, 242
do do Ontario, 177, 186 to 190.....	190	do Nappan, N.S.....	14, 238
do do P. E. Island.....	137	do New Perth, P.E.I.....	157, 240
do do Quebec, 178, 187 to 190.....	190	do Perth, Ont.....	169
from Province of Quebec, improved in quality.....	145, 147	do Sussex, N. B.....	167
from Province of Quebec, at the Industrial Exhibition.....	149	do Wellman's Corners, Ont.....	162
Cheese factories, in Manitoba and North-west Territories.....	246	do Woodstock, Ont.....	161
milk for.....	61	Dairy Stations, summary of business at.....	157
on P. E. Island.....	18	Dairy work, experimental.....	46
Cheese-makers, letter to.....	21	Deep-setting pails compared with cream separator.....	46
notes for, May.....	63	Dillon, T. J.....	8
do June.....	68	work in Prince Edward Island.....	21
do July.....	71	summary of report of.....	23
do August.....	73	report of.....	240
do September.....	74	Economy in care of cattle.....	87
do October.....	76	in farming.....	82
Cheese-making, experiments in.....	215	is not meanness.....	84
Churning of cream, experiments in.....	51	in production of butter.....	88
Clear thinking before all excellence.....	84	Eggs and poultry.....	97
Committee on Agriculture and Colonization.....	111	selection and packing of, for British market.....	119
Companies for dairying, agreement with.....	19	Ensilage and Economic Cattle Feeding Association of Central Canada.....	98, 101
Competition that kills.....	122	feeding of the Robertson mixture for.....	156
Composite tests of milk.....	80	Robertson mixture for.....	153
Conclusions from feeding steers.....	32 to 39	Englishman's thought devoted to food, &c.....	113
from feeding swine.....	40, 42	English preferences for Canadian products.....	112
Condensed milk factories.....	129	Exhibitors entitled to awards at World's Fair.....	177, 178, 186-190
Conditions for farmers changed.....	93, 121	Exhibits of cheese and butter.....	4
Congress of farmers at Quebec.....	107	for World's Fair, selection of.....	176
Co-operative cheese and butter factories.....	128	Experimental Dairy Stations.....	4
essentials to success in.....	235	business at.....	157
Copeman, J. D., chairman of Produce Exchange.....	134	Experimental dairy work.....	46
Corn ensilage for fattening steers.....	31, 34	and educational work.....	122
fodder, directions for raising.....	151	Experimental farm system.....	103
Indian, on forty acre lot.....	55	farms.....	127
Cornett, Robert.....	8, 24	Experiments in cheese-making.....	7, 214
summary of report of.....	27	churning cream.....	51, 52
report of.....	243	creaming of milk.....	46
Cost of labour, for growing cereal crops.....	56	creaming of milk from cows calved over 6½ months.....	49
for growing Indian corn.....	60	feeding steers.....	31
for growing roots.....	58	feeding swine.....	39
for growing rye for fodder.....	57	sowing grain at different dates.....	104
Cows, the feeding of.....	210	Exports of dairy products.....	28
in Manitoba.....	245	Factory managers, counsel for.....	77
Cream, experiments in churning of.....	51	Factories and their surroundings.....	63, 68
Creameries in Manitoba and North-west Territories.....	247	Fat globules in milk.....	89
Creaming of milk, experiments in.....	46, 49	percentage of in skim milk.....	48
Crops, yield of, from forty acre lot.....	53	percentage of in whole milk.....	215
Cultivation of soil.....	96	Fattening of 2-year-old steers.....	32
<i>Daily Post</i> , Liverpool, article from.....	126	of swine.....	39, 96
Dairy Association of Quebec.....	8		
Dairy building, plans for, at Nappan, N.S.....	14		
Dairy bulletins.....	61		

## Report of the Dairy Commissioner.

	PAGE.		PAGE
Farmers create wealth.....	102	Leclair, J. D., Superintendent at St. Hyacinthe, Que.....	9
Institutes, benefits of.....	92	summary of report of.....	11
produce wealth.....	83	report of.....	231
Feed for cows.....	61	Lectures and addresses.....	27, 82
Feeding of steers.....	31	Lessons, in cheese and butter-making at St. Hyacinthe, Que.....	9
3-year-old steers.....	35	from enterprise of Canada.....	145
1-year-old steers.....	36	Letter to cheese-makers.....	21
calf steers.....	37	Livingston, H. A., summary of report of.....	11
steers of different ages.....	39	report of.....	233
cows.....	210	Lord Stanley of Preston.....	4, 124
Fertility, elements of, removed in products.....	87	London, Ont., dairy station.....	6, 164
of soil, preservation of.....	84	winter dairying at.....	230
Fodder corn, directions for raising.....	151	Macdonald, C. C.....	8
Fodders in Manitoba.....	198	summary of report of.....	10
Food-producing resources of Canada.....	101, 126	report of.....	226
Food production in Canada.....	134	McEwan, J. B., summary of report of.....	8
Forty-acre lot.....	53	report of.....	222
<i>Free Press</i> , Aberdeen, article in.....	141	Mammoth cheese.....	6, 174, 176
"French cheese".....	9, 108, 145	made at Perth, Ont.....	94
Frozen wheat for fattening steers.....	34	sale of.....	112
feeding of, to swine.....	42	Manitoba, dairying in.....	10
for feeding.....	86	summary of work in the Province.....	24
Gentleness, economy of.....	89	fodders in.....	198
Grain, ground, for feeding swine.....	41	cheese from, at World's Fair.....	190
Grasses grown at Brandon, Man.....	199	and N. W. Territories.....	130
Great Britain, mission to.....	4	going into mixed farming.....	139
<i>Grocers' Gazette</i> , London, report of address in.....	134	Margarine vs. butter.....	130
Governor General, The, Lord Stanley of Preston.....	4, 120, 131	Maritime Provinces, cheese from, at World's Fair.....	179-187
Hart, J. W., summary of report of.....	13	Marketing cheese, by the Dairy Commissioner.....	20
report of.....	234	Marquis, John, President of the Liverpool Trade Association.....	126
Hay and roots for fattening steers.....	31	Meanness is not economy.....	84
Hopkins, J. E.....	14	Medals for patrons, regulations in regard to.....	23
summary of report of.....	18	Meetings and lectures.....	27
report of.....	238	of farmers, objects of.....	84
Horse beans.....	153	Milk for cheese factories.....	61
Hubbard, W. W., summary of report of.....	13	Milk, composite tests of.....	80
report of.....	237	different degrees of ripeness of.....	219
Ideals for farmers.....	82	effect of feed on quality of.....	95, 98, 100
of young country.....	136	experiments in creaming of.....	46-49
Ignorance, different sorts of.....	203	production of.....	98
Imitations should be prohibited.....	123	production of, during winter.....	209
Indian corn.....	153	should be pure.....	98
crops on 40-acre lot.....	55	Miscellaneous matters.....	145
cost of labour for growing.....	60	Mission to Great Britain.....	111
Intelligence needed in farm work.....	107	Mixed cereals on 40 acre lot.....	55
Isolation of farm life.....	122	Money not sought after by the Scotch.....	135
Judges at World's Fair.....	173-186, 191	Montmagny, Rev. (Ptr.) President Dairy Association of Quebec.....	9
Judging at World's Fair, recommendations concerning.....	185	Montreal owes importance to products of the farm.....	102
butter by score of points at World's Fair.....	179	Moose Jaw, N.W.T., dairying at.....	25, 26
cheese by score of points at World's Fair.....	176	Mount Elgin, Ont., dairy station at, 4-6, 159-242	
June competition at World's Fair.....	177	Murray, Charles, President, New Brunswick Dairying Co.....	12
Kingsclear, N.B., dairy station.....	12, 164, 234	Nappan, N.S., dairy station at.....	14, 238
Labour, cost of, for growing roots.....	58	New Brunswick, summary of work in province of.....	12
Indian corn.....	60	best known for lumber.....	129
Landlord as a leader of men.....	125	New Perth, P.E.I., dairy station at.....	18, 157
Landlord's part.....	124	Nitrogen in farm products.....	87
		<i>North British Daily Mail</i> , article from... ..	124

	PAGE.		PAGE.
North-west Territories, summary of work in.....	24	Report of J. C. Chapais, Assistant Dairy Commissioner.....	194
Nova Scotia, summary of work in.....	14	Reports of Superintendents of experimental dairying.....	214
resources of.....	129	Report of J. A. Ruddick.....	214
Notes for cheese-makers for May.....	63	J. B. McEwan.....	222
do do June.....	68	C. C. Macdonald.....	226
do do July.....	71	J. D. Leclair.....	231
do do August.....	73	H. A. Livingston.....	233
do do September.....	74	J. W. Hart.....	234
do do October.....	76	W. W. Hubbard.....	237
October competition at World's Fair.....	185	J. E. Hopkins.....	238
Ontario, cheese from, at World's Fair.....	177,	T. J. Dillon.....	240
	186-190	R. Cornett.....	243
Ontario, resources of.....	130	Revival of agriculture.....	93
Ontario, summary of work in.....	4	Robertson, J. W., Dairy Commissioner.....	19
Optimism in Canada.....	129	Robertson mixture for ensilage.....	95, 153
Packages, importance of bright neat ones.....	113	Root crops on forty-acre lot.....	53
Parker, W. T., Secretary Bristol Provision Trade Association.....	145	Rowson, A. J., at meeting of Produce Exchange.....	141
Parts of Report.....	30	Ruddick, J. A., summary of report of.....	7
Part I. of Report.....	31	report of.....	214
do II. do.....	39	Rye, for fodder.....	56
do III. do.....	46	cost of labour for growing.....	57
do IV. do.....	53	grown at Brudenell, P.E.I.....	242
do V. do.....	61	Salt for cows.....	61
do VI. do.....	82	St. Hyacinthe, Que., dairy station and school at.....	8, 231
do VII. do.....	111	Sales of cheese and butter from dairy stations.....	157, 172
do VIII. do.....	145	Score card for judging cheese.....	176
do IX. do.....	157	Scotsman, <i>The</i> , Edinburgh, article from.....	132
do X. do.....	173	Scotchman and shorter catechism.....	124
do XI. do.....	194	Shallow pans compared with centrifugal separator.....	46
do XII. do.....	214	Shopkeeper gets too large a share of the price.....	94
Perth, Ont., experiments at.....	6	Shutt, Frank T., bulletin by.....	78
dairy station.....	169	Silos.....	151
Phosphoric acid in farm products.....	87	Silo, filling of.....	152
Plans for dairy building at Nappan.....	14	putting mixture into.....	155
Planting seeds for fodder for ensilage.....	155	Skim-milk for feeding swine.....	41
Potash in farm products.....	87	percentage of fat in.....	48
Potassium bichromate for keeping milk.....	80	Specks in butter, how to prevent.....	90
Poultry and eggs.....	97	Stanley of Preston, His Excellency, Lord.....	120, 131, 129
Poultry from Canada in Liverpool.....	105	Steers, feeding of.....	31
Poultry, Canadian, demand for in Great Britain.....	120	Steers, fattening of two-year-old.....	32
Preferences for names by British buyers.....	114	feeding of one-year-old.....	36
Premium on milk for the manufacture of butter.....	10	feeding of, of different ages.....	39
Price, L. A., report of his cows.....	99	Stock account.....	168
Prince Edward Island, summary of work in.....	18	Store cattle at Aberdeen.....	119, 142
size and population of.....	128	Streaks in butter, how to prevent.....	91
Production of milk.....	98	Summary of awards at World's Fair.....	193
during winter season.....	209	Sunflowers and beans instead of cottonseed meal.....	106
Protection, a new.....	123	Sunflowers for feed.....	153
in Great Britain, discussed.....	121	Superintendents of experimental dairying, reports of.....	214
Pupils in dairy school.....	9	Sussex, N.B., Dairy Station.....	167, 236
Quebec, summary of work in.....	8	Swine, for fattening.....	39
inhabitants of, are optimists.....	129	different breeds crossed.....	41
resources of.....	129	feeding on frozen wheat.....	42
as a province full of hopeful people.....	149	conditions favourable for feeding of.....	45
cheese from, at World's Fair.....	178-187-189	fattening of.....	96
Ration, cheap for a cow.....	101	products in Great Britain.....	118
for feeding steers.....	31	feeding in Canada.....	137
Reception in Great Britain.....	120		
Remedies for agricultural depression.....	124		
Report, divisions of into parts.....	30		
Reports of speeches, length of.....	109		

## Report of the Dairy Commissioner.

	PAGE.		PAGE.
Taché, J. de L., Secretary Dairy Association, of the Province of Quebec ..	9	Wellman's Corners, dairy station .....	162
Temperature, high and low in cheese-making .....	219	winter dairying at .....	223
Thorburn, A. C., President of North-west Territories Dairy Association	24	Wheat frozen, for feeding steers .....	34
Turnips, to remove flavour of, from milk.	90	for feeding swine .....	42
Valuations for fodders in feeding experiments .....	31, 33	increase in swine .....	45
Visit to British markets .....	111	Wheat in Manitoba, discussion on growing of .....	196
Water added to cream for churning .....	52	Winter dairying stations .....	3
for cows .....	61	Winter dairying in creameries, capabilities of .....	89
Watson, William, letter to .....	25	Wolseley, North-west Territories, dairying at .....	26
Wealth from farming .....	83	World's Columbian Exposition .....	3
created by farmers .....	102	Canadian dairy products at .....	173
Webb, J. R., at meeting of Produce Exchange .....	140	World's Fair cheese train .....	174
Wellman's Corners, dairy station at .....	6, 8	Woodstock, dairy station at .....	4, 6
		Woodstock, Ont., winter dairying station.	161
		Woodstock, Ont., winter dairying at .....	219
		Yield of crops on forty-acre lot .....	40-53

APPENDIX TO THE REPORT OF THE MINISTER OF AGRICULTURE

EXPERIMENTAL FARMS

REPORTS

OF THE

DIRECTOR	-	-	-	-	-	WM. SAUNDERS.
AGRICULTURIST	-	-	-	-	-	JAS. W. ROBERTSON.
HORTICULTURIST	-	-	-	-	-	JOHN CRAIG.
CHEMIST	-	-	-	-	-	F. T. SHUTT, M.A.
ENTOMOLOGIST and BOTANIST	-	-	-	-	-	JAS. FLETCHER.
POULTRY MANAGER	-	-	-	-	-	A. G. GILBERT.
SUPT. EXPERIMENTAL FARM,		Nappan, N.S.	-	-	-	WM. M. BLAIR.
do	do	Brandon, Manitoba	-	-	-	S. A. BEDFORD.
do	do	Indian Head, N.W.T.	-	-	-	ANGUS MACKAY.
do	do	Agassiz, B.C.	-	-	-	THOS. A. SHARPE.

FOR

1893

PRINTED BY ORDER OF PARLIAMENT



OTTAWA

PRINTED BY S. E. DAWSON, PRINTER TO THE QUEEN'S MOST EXCELLENT MAJESTY.

1894

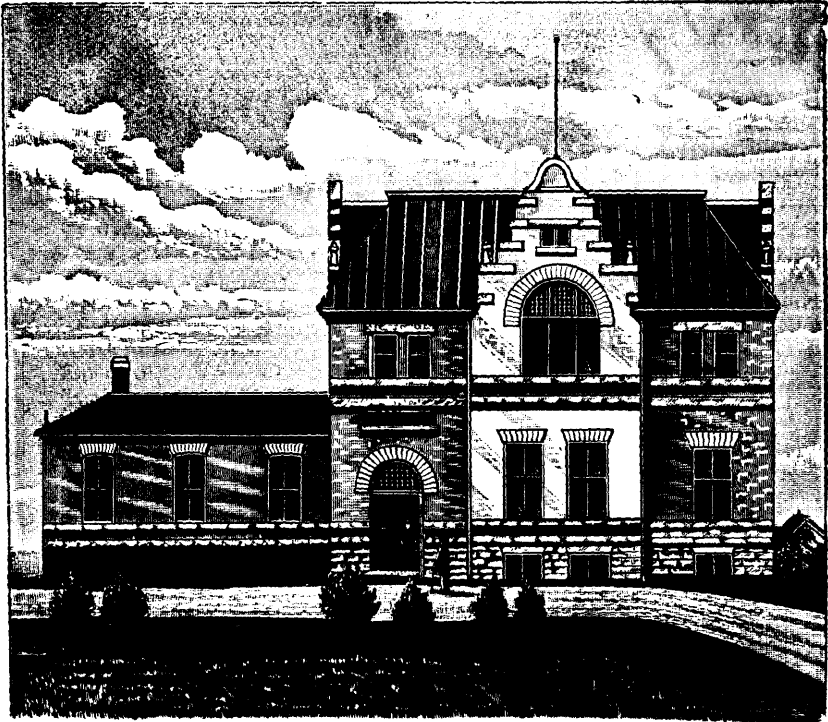

**Figure 1.—Office Building, Museum and Chemical Laboratory  
of the Central Experimental Farm.**



# Experimental Farms.

## APPENDIX

TO

# REPORT OF THE MINISTER OF AGRICULTURE

ON

## EXPERIMENTAL FARMS.

OTTAWA, 30th November, 1893.

SIR,—I have the honour to submit for your approval my seventh annual report of the work done and in progress at the several experimental farms established in different parts of the Dominion.

You will also find appended reports from the following officers of the Central Experimental Farm: From the Agriculturist, Mr. James W. Robertson; from the Horticulturist, Mr. John Craig; from the Chemist, Mr. Frank T. Shutt; and from the Entomologist and Botanist, Mr. James Fletcher. A report is also submitted from the Poultry Manager, Mr. A. G. Gilbert.

From the branch experimental farms there are reports from Mr. Wm. M. Blair, superintendent of the experimental farm for the Maritime Provinces, at Nappan, Nova Scotia; from Mr. S. A. Bedford, superintendent of the experimental farm for Manitoba, at Brandon; from Mr. Angus Mackay, superintendent of the experimental farm for the North-west Territories, at Indian Head; and from Mr. Thos. A. Sharpe, superintendent of the experimental farm for British Columbia, at Agassiz.

In these reports the results are given of much careful experimental work relating to agriculture, horticulture and arboriculture embodying the outcome of much practical work in the fields, orchards, barns, dairy and poultry buildings; also of scientific investigation of chemical problems in the laboratory and the careful study of the life history and habits of noxious insects and plants with suggestions of measures calculated to lessen the injury they cause.

The great and increasing demand among farmers for these reports is a gratifying indication of the growing desire for information among this class of the community and of the high esteem in which these records of the experimental farms are held. It is hoped that the facts brought together in the present issue will be found quite as valuable to the agricultural community as those contained in any of the preceding reports.

I have the honour to be, sir,

Your obedient servant,

WM. SAUNDERS.

The Honourable  
The Minister of Agriculture,  
Ottawa.



# Experimental Farms.

## ANNUAL REPORT

ON THE

# EXPERIMENTAL FARMS.

---

## REPORT OF THE DIRECTOR.

(*WM. SAUNDERS, F.R.S.C., F.L.S., F.C.S.*)

The season of 1893 has been very varied, both in its character and results, in different parts of the Dominion. Almost everywhere the spring season has been backward, and cold and wet weather delayed seeding. In the western and central parts of Ontario, a moist spring with an abundant hay crop was followed by a period of severe drought, which, while it did not materially affect the yield of winter wheat, had a marked influence on the different varieties of spring grain, making the average crop light. Summer dairying was also affected by the drying up of the pasture lands: later, timely rains, however, helped the root crops, which turned out fairly satisfactory. In the eastern portions of the province spring growth was also tardy and backward, but under favourable conditions as to moisture an excellent hay crop was gathered. The latter part of the summer was unusually wet, especially just preceding and during the grain harvest, and rust prevailed to such an extent that the weight and quality of spring grain was reduced far below the average, and the returns were in some respects disappointing. The wet weather, however, kept the pasture lands in good condition, and was favourable to the growth of roots for stock, and many varieties have given a generous yield. Fodder corn has also in most localities turned out fairly well.

In most parts of Quebec the season has been favourable, the yield of hay has been good and the subsequent luxuriance of pasture growth most advantageous for dairy farming, in which this province has of late made most gratifying progress. The returns of other crops have also been fairly satisfactory.

In the Maritime Provinces the early part of the season was dry and the hay crop below the average, but later on timely rains occurred in many localities, which were followed by fairly good yields in the harvest season. The later crops of roots were very fine.

In Manitoba and the eastern portions of the North-west Territories, the early part of the summer gave promise of an abundant crop which seemed almost assured, when on the 5th August, within two or three weeks from the usual time of harvest, there began a most unusual heated term. The thermometer ranged during six consecutive days in the neighbourhood of and above 90° F.; and on the 7th rose to 104°—107° F. in the shade. The high temperature on this particular day was accompanied by a parching hot wind, which blew up from the arid and desert regions south in the United States, and which almost scorched the leaves of the growing grain and brought about premature ripening with a considerable loss of bulk. This untoward circumstance reduced the promise of a generally abundant crop with a probable average of about 25 bushels per acre to one of about 14 bushels, the reduction being brought about partly by a diminished size of kernel and partly by the drying up of the later kernels which in a favourable season form towards its close in the upper part of the spikelets which compose the head of wheat. In some sections of the eastern part of Assiniboia the influence of the heated term was less felt and the yield of wheat has been excellent, many large farms having given a return of from thirty to

forty bushels per acre. In Saskatchewan and Northern Alberta the yield of all cereals has been good, the heads being plump and well filled.

In the interior climates of British Columbia, there have been few unusually heavy crops, but the yields in most instances have been fairly satisfactory, while in the coast climate the returns from the grain harvest have been below the average.

While the modifications in crops brought about by conditions of climate are beyond the control of the farmer, there are many conditions which he can influence which are most important in their bearing on plant growth and which under favourable circumstances materially affect the returns. Among these none is more important than the

#### MAINTENANCE OF THE FERTILITY OF THE SOIL,

which is the chief aim of all good farming and on which a continuance of good crops mainly depends. In the soil a large store of fertility has been laid up for man's use, which may be regarded as a savings bank reserve for the farmer, and by judicious treatment may be continually added to and improved, but by careless and injudicious management may be prodigally wasted. All soils are the result of the disintegration of rocks by the forces of nature and the intermixture therewith of organic matter, resulting from the decay of animal and vegetable remains. They vary much in fertility, partly owing to difference in composition of the rocks from which they have been formed, partly to the variable proportion of organic matter they contain, and partly to their mechanical condition and texture. These variations are commonly distinguished by special terms such as clayey, loamy, sandy or gravelly soils, indicating the materials which form the larger proportion of their bulk. The productiveness of a soil also depends partly on its power of holding water and of drawing supplies of moisture from below. Water which in the soil is usually more or less charged with carbonic acid gas is the universal solvent which nature employs to convey food to the rootlets of plants. A good loamy soil will hold much more moisture than either clay or sand and retain it longer, and among the main advantages resulting from a thorough working of the soil are the prevention of loss of water by lessening rapid and excessive evaporation during the summer, also the opening of it and making it more porous, so that its power of retaining moisture may be increased and its particles at the same time exposed to the beneficial action of air and frost. All soils contain more or less plant food in a soluble form which is immediately available for the use of growing plants—on the other hand there is always a large proportion of the elements of fertility, the immediate use of which the farmer cannot command, and which can only be made available gradually through the influences referred to.

#### CONSTITUENTS TAKEN FROM THE SOIL.

Of the mineral constituents which enter into the composition of soil, quite a number are taken up by living plants in varying proportions, but of many of the ingredients the quantities used are small and the store of such contained in the soil is usually very ample. There are, however, three ingredients which plants take in comparatively large proportions from the land, which must sooner or later in some measure be restored to it if continual good crops are to be looked for. These are nitrogen, phosphoric acid and potash. All arable land contains these important ingredients and usually in considerable proportions.

It is estimated that an acre of soil a foot deep, weighs on an average about 3,500,000 lbs., and that good ordinary loam in Europe, estimated from the results of many analyses will contain an average of not less than 3,500 lbs. per acre of nitrogen and sometimes more than that. The quantity of phosphoric acid varies in the same area from about 3,000 to 6,000 lbs., and potash from 5,000 to 8,000 lbs. From the analyses made by the Chemist of the Experimental Farms, Mr. F. T. Shutt, during the past three years, some of the samples being representative of large areas, it would appear that the soils of Canada compare favourably with those of Europe in their richness in these important constituents.

## Experimental Farms

Seventeen samples from different parts of the eastern provinces, presuming the fertile soil to have a depth of nine inches have averaged as follows: Nitrogen 6,247 lbs. per acre, phosphoric acid 3,596 lbs., and potash 6,510 lbs. Thirteen samples from different parts of the North-west plains, have also been submitted to analysis. These soils are deeper and may safely be estimated at twelve inches, and on this basis they show an average in nitrogen of 10,115 lbs. per acre, phosphoric acid 5,040 lbs., and potash 10,500 lbs.

When any of these important constituents are present in the soil in unusually large proportion, plants will sometimes, under such circumstances, take up such material in larger quantity than where the same crop is grown on poorer land. The proportions, however, which are taken from the soil are on the whole fairly uniform and for some of the more important crops may be approximately stated as below. As far as the material has been available, the figures in the following estimates have been compiled from the analyses made by the chemist of the experimental farms, supplemented by information from the "Compilation of Analyses of American Feeding Stuffs," issued by the United States Department of Agriculture, 1892. The proportions of phosphoric acid and potash have been calculated from analyses conducted by Dr. Goessmann, published in the 10th annual report of the State Agricultural Experimental Station, Amherst, Mass., 1892, and from Wolf's tables as given in "How Crops Grow," by Johnson.

1	Nitrogen, in lbs.	Phosphoric Acid, in lbs.	Potash, in lbs.
A wheat crop of 25 bushels per acre, with 2,200 lbs. of straw, takes—			
For the grain weighing 1,500 lbs. ....	28·50	12·68	8·54
"    straw    "    2,200    "    .....	12·03	4·96	10·57
Total.....	40·53	17·64	19·11
A barley crop of 35 bushels per acre, with 2,000 lbs. of straw, takes—			
For the grain weighing 1,680 lbs. ....	33·26	13·28	8·86
"    straw    "    2,000    "    .....	12·22	3·86	19·39
Total.....	45·48	17·14	28·25
A crop of oats of 50 bushels to the acre, with 2,200 lbs. of straw, takes—			
For the grain weighing 1,700 lbs. ....	32·13	10·48	8·05
"    straw    "    2,200    "    .....	13·90	4·74	24·83
Total.....	46·03	15·22	32·88
A crop of Indian corn grown for fodder purposes, to the period when the ears are in the late milk or glazing stage, takes from the soil for each ton.....	5·80	2·96	6·54
In the following estimates of the fertilizers extracted from the soil by root crops, the roots alone are considered, it being understood that the tops are cut off and left on the ground to be ploughed under and the fertilizing constituents they contain returned to the soil:—			
A crop of turnips takes from the soil for each ton of roots grown...	3·30	1·86	5·50
"    mangels    "    "    "    "    ..	3·03	1·84	7·66
"    carrots    "    "    "    "    ..	2·35	2·22	6·53
"    sugar beets    "    "    "    "    ..	4·79	1·92	9·06

It is a very important question, but one concerning which on account of its complex character, no very exact information can be given as to what effect the various natural and artificial fertilizers have on particular crops, and which are the most economical to use, to replace the important constituents taken from the soil by constant cropping. The results obtained from any method of treatment will, as a matter of course, depend largely on the proportion of these respective ingredients existing naturally in the soil; much also depends on the character of the season, whether it be favourable or unfavourable for the crop. Some conclusions however more or less general in their character, may be drawn from careful experiments on any soil, and with the object of gaining information on this important topic, a series of experiments was planned and begun on the Central Experimental Farm six years ago, which may be outlined as follows:—

#### TESTS OF THE ACTION OF FERTILIZERS ON SOME CROPS.

A piece of sandy loam, more or less mixed with clay, which was originally covered with heavy timber, chiefly white pine was chosen for these tests. The timber was cut many years ago, and among the stumps still remaining when the land was purchased, there had sprung up a thick second growth of trees, chiefly poplar, birch and maple, few of which exceeded six inches in diameter at the base. Early in 1887 this land was cleared by rooting up the young trees and stumps and burning them in piles on the ground from which they were taken, the ashes being afterwards distributed over the soil as evenly as possible, and the land ploughed and thoroughly harrowed. Later in the season it was again ploughed and harrowed, and most of it got into fair condition for cropping.

The plots laid out for the experimental work with fertilizers were one-tenth of an acre each, 21 of which were devoted to experiments with wheat, 21 to barley, 21 to oats, 21 to Indian corn or maize, and 21 to experiments with turnips and mangels. Owing to the difficulty and unavoidable delay attending the draining of some wet places, it was not practicable to undertake work on all the plots the first season. The tests were begun in 1888 with 20 plots of wheat and 16 of Indian corn, and in 1889 all the series were completed excepting six plots of roots, Nos. 16 to 21 inclusive, which were available for the work in 1890. The season of 1889 was wet when several of the plots were found to be insufficiently drained and the crops suffered in consequence. This will be mentioned when the results for that season on these particular plots are given. In the tables the result of the crop of each year is shown, also the average for the whole period during which the experiments have been continued.

In 1890 it was found that all the grain plots had become so weedy that the growth of the crops was much interfered with, and with the view of cleaning the land one-half of each of the wheat and oat plots was sown with carrots in 1891, and one-half of each of the barley plots with sugar beets. In 1892 the other half of each plot in each of these series was sown with carrots. In 1893 it was thought desirable to continue this cleaning process, and carrots were again sown on the half of the wheat and oat plots occupied with this crop in 1891, and also on the half of the barley plots cropped with sugar beets that year. It is expected that at the end of another season, the whole of these plots will be sufficiently free from weeds to warrant their being sown entirely with grain again. In the meantime some information has been gained by these tests as to the effect of the different fertilizers on carrots and sugar beets, which will be given in this connection.

#### WHEAT PLOTS.

The seed sown on each of these plots from the beginning has been in the proportion of  $1\frac{1}{2}$  bushels per acre, and each year they have all been sown on the same day. The variety chosen at the outset for sowing was the White Russian, and this was continued during 1889, 1890 and 1891. In 1892 Campbell's White Chaff was

## Experimental Farms.

substituted and this variety was also sown in 1893. The following are the records of the dates of sowing, coming up and ripening of the wheat each year:—1888, sown May 23rd, appeared above ground May 28th, ripe August 24th. 1889, sown May 17th, came up May 22nd, ripe August 30th. 1890, sown April 28th, came up May 13th, ripe August 12th. 1891, sown May 9th, came up May 18th, ripe August 24th. 1892, sown May 6th, came up May 15th, ripe August 14th. 1893, sown May 27th, came up June 2nd, ripe August 23rd. It will thus be seen that the White Russian wheat required from the date of sowing to maturity a period of 93 days in 1888; 105, in 1889; 106, in 1890; and 107, in 1891, or an average for the four years of nearly 103 days. The Campbell's White Chaff matured in 100 days from the date of sowing in 1892 and in 88 days in 1893, an average for the two years of 94 days.

### TREATMENT OF SOIL.

The usual treatment of the soil on all the grain plots has been to gang plough soon after harvest and after the shed grain and weeds have well started to plough again about 7 inches deep. In spring the plots have been disc-harrowed twice before applying the fertilizers and again harrowed with the toothed or smoothing harrow before sowing. On those plots where barnyard manure has been used, the manure has been lightly ploughed under as soon as possible after it has been spread on the land and harrowed with the smoothing harrow before sowing. Wherever barnyard manure is spoken of it is understood to be a mixture of horse and cow manure in about equal proportions.

### REMARKS.

The season of 1891 was quite favourable for wheat growing whereas 1890 and 1893 were specially unfavourable which will in a measure account for the great variation in the crops of these years notwithstanding the quantities of fertilizers applied to the land in the intervals. This also serves to show that the character of the season has a more immediate effect on the crop of the year than any application of fertilizers no matter how complete or liberal that may be. We may however rest assured that the useful elements of fertility stored in the soil will not be lost, but that they will materially aid in every favourable season by increasing the crop returns.

### BARLEY PLOTS.

The quantity of seed sown per acre on the barley plots was 2 bushels in the years 1889, 1890 and 1891 and  $1\frac{1}{2}$  bushels in 1892 and 1893. Two-rowed barley has been used for seed throughout the whole period. The variety chosen for the first three years was the Saale barley, which is highly esteemed by the brewers of Great Britain, followed by the Goldthorpe in 1892 and the Duckbill in 1893. In 1889 the seed was sown May 17th, came up May 22nd and the grain was ripe August 20th. 1890, sown April 28th, came up May 13th, was ripe August 11th. 1891, sown May 9th, came up May 16th, was ripe August 17th. 1892, sown May 6th, came up May 15th, was ripe August 18th. 1893 was sown May 27th, came up June 2nd and was harvested August 20th. The average time required from the date of sowing to maturity during the three years in which the Saale barley was used as seed was  $99\frac{2}{3}$  days, the Goldthorpe matured in 1892 in 104 days from date of sowing and the Duckbill in 1893 in 85 days.

EXPERIMENTS with Fertilizers on Plots of Wheat 1<sup>10</sup> acre each.

No. of Plot.	Manure applied each Year.	1st Season, 1888.		2nd Season, 1889.		3rd Season, 1890.		4th Season, 1891.		5th Season, 1892.		6th Season, 1893.		AVERAGE FOR THE WHOLE PERIOD.	
		VARIETY. WHITE RUSSIAN.		VARIETY. WHITE RUSSIAN.		VARIETY. WHITE RUSSIAN.		VARIETY. WHITE RUSSIAN.		VARIETY. CAMPBELL'S WHITE CHAFF.		VARIETY. CAMPBELL'S WHITE CHAFF.		VARIETY. CAMPBELL'S WHITE CHAFF.	
		Yield of Grain.	Yield of Straw.	Yield of Grain.	Yield of Straw.	Yield of Grain.	Yield of Straw.	Yield of Grain.	Yield of Straw.	Yield of Grain.	Yield of Straw.	Yield of Grain.	Yield of Straw.	Yield of Grain.	Yield of Straw.
		Per acre	Per acre	Per acre	Per acre	Per acre	Per acre	Per acre	Per acre	Per acre	Per acre	Per acre	Per acre	Per acre	Per acre
		Lbs.	Lbs.	Lbs.	Lbs.	Lbs.	Lbs.	Lbs.	Lbs.	Lbs.	Lbs.	Lbs.	Lbs.	Lbs.	Lbs.
		Bush.	Bush.	Bush.	Bush.	Bush.	Bush.	Bush.	Bush.	Bush.	Bush.	Bush.	Bush.	Bush.	Bush.
1	Barn-yard manure (mixed horse and cow manure) well rotted, 12 tons per acre in 1888; 15 tons per acre each year since.....	12 30	Not taken.	16 ..	4220	12 30	2660	22 40	2690	20 40	3260	12 30	3070	16 8½	3180
2	Barn-yard manure (mixed horse and cow manure) fresh, 12 tons per acre in 1888; 15 tons per acre each year since.....	16 40	do	16 30	4290	10 30	2220	24 20	2860	18 20	2860	14 ..	2790	16 43½	3004
3	Unmanured.....	12 30	do	10	3480	4 40	590	16 20	2140	6 40	1460	7 ..	1420	9 31½	1818
4	Mineral phosphate, untreated, finely ground, 500 lbs. per acre.....	13 10	do	10 20	3460	4 15	645	18 20	1260	6 ..	1360	7 20	1600	9 54½	1665
5	Mineral phosphate, untreated, finely ground, 500 lbs.; nitrate of soda, 200 lbs. per acre.....	14 10	do	12 10	4270	6 50	1425	18 20	3420	9 ..	2820	9 10	2310	11 36½	2749
6	Barn-yard manure, partly rotted and actively fermenting; 6 tons per acre; mineral phosphate, untreated, finely ground, 500 lbs. per acre, composted together, intimately mixed, and allowed to heat for several days before using.....	14 20	do	16 50	4520	7 35	1300	22 20	2490	15 20	2880	8 40	2120	14 10½	2662
7	Mineral phosphate, untreated, finely ground, 500 lbs.; nitrate of soda, 200 lbs.; wood ashes, unleached, 1,000 lbs. per acre.....	13 30	do	8 5	2895	5 30	1200	17 40	2880	7 40	1960	5 ..	2520	9 34½	2281
8	Mineral phosphate, untreated, finely ground, 500 lbs.; wood ashes, unleached, 1,500 lbs. per acre.....	11 40	do	6 50	1460	4 45	695	21 00	2460	6 40	1760	4 50	1320	9 17½	1530
9	Mineral superphosphate, No. 1, 500 lbs. per acre.....	13 10	do	10 ..	1930	4 35	665	21 10	2670	7 40	1840	7 20	1180	10 39½	1637
10	Mineral superphosphate, No. 1, 350 lbs.; nitrate of soda, 200 lbs. per acre.....	12 40	do	10 15	3165	6 25	1225	24 20	4600	10 40	2520	8 20	2240	12 6½	2750



## Experimental Farms.

11	Mineral superphosphate, No. 1, 350 lbs.; nitrate of soda, 200 lbs.; wood ashes, unbleached, 1,500 lbs. per acre.	12 40	do	7 30	2130	6 50	1060	23 20	3010	10	2340	9 20	2410	11 368	2190
12	Unmanured.....	14 50	do	3 10	1370	6 20	965	16 50	2270	8	1500	5	1980	9 5	1477
13	Bone finely ground, 500 lbs.; wood ashes, unbleached, 1,500 lbs. per acre.	14	do	3 20	1080	6 45	970	20	2360	8 45	1495	4	2020	9 288	1585
14	Nitrate of soda, 200 lbs. per acre.	16	do	3 50	1320	8 5	1025	24 20	3170	10 20	1800	7 20	1900	11 394	1843
15	Muriate of potash, 150 lbs. per acre.	16 40	do	7 15	2745	9 30	1275	21	3230	9 20	1860	9 20	1700	12 104	2162
16	Sulphate of ammonia 300 lbs. per acre.	15 10	do	7 40	1720	8 20	1030	26	3020	10 20	1620	9 40	1630	12 514	1804
17	Sulphate of iron, 60 lbs. per acre.	14	do	7 55	2065	7 45	1135	20 40	3320	7 40	2100	6 50	3280	10 484	2380
18	Common salt (sodium chloride) 300 lbs. per acre.	13 30	do	10 15	2165	6 30	685	21 20	3960	10 20	1580	6 20	1960	11 224	1990
19	Land plaster or gypsum (calcium sulphate) 300 lbs. per acre.	11 50	do	10	1680	5 40	630	15	2410	10 40	1540	8 30	1670	10 164	1586
20	Unmanured in 1889, mineral superphosphate, No. 2, 500 lbs. per acre each year since.	13 40	do	10 15	3375	4 35	485	20 40	2650	10 40	1360	8	1400	11 184	1854
21	No crop taken in 1888.			11 10	2510	5 30	675	20	2650	10 40	1480	8 20	1360	11 8	1735

EXPERIMENTS with Fertilizers on Plots of Barley,  $\frac{1}{10}$ th acre each.

No. of Plot	Manure applied each Year.	1st SEASON, 1889. VARIETY SOWN— SAALE, TWO-ROWED.		2nd SEASON, 1890. VARIETY SOWN— SAALE, TWO-ROWED.		3rd SEASON, 1891. VARIETY SOWN— SAALE, TWO-ROWED.		4th SEASON, 1892. VARIETY SOWN, GOLDSBOROPE, TWO- ROWED.		5th SEASON, 1893. VARIETY SOWN, DUCKBILL, TWO-ROWED.		AVERAGE FOR THE WHOLE PERIOD.	
		Yield of Grain.	Yield of Straw.	Yield of Grain.	Yield of Straw.	Yield of Grain.	Yield of Straw.	Yield of Grain.	Yield of Straw.	Yield of Grain.	Yield of Straw.	Per acre Grain.	Per acre Straw.
		Per acre	Per acre	Per acre	Per acre	Per acre	Per acre	Per acre	Per acre	Per acre	Per acre	Bush. lbs.	Lbs.
		Bush. lbs.	Lbs.	Bush. lbs.	Lbs.	Bush. lbs.	Lbs.	Bush. lbs.	Lbs.	Bush. lbs.	Lbs.	Bush. lbs.	Lbs.
1	Barn-yard manure well rotted, 15 tons per acre.	26	2	17	11	37	24	35	10	28	16	28	47
2	Barn-yard manure, fresh, 15 tons per acre.	22	4	24	4	40	3800	32	24	35	40	29	38
3	Unmanured.	18	16	10	35	22	44	10	20	7	24	13	47
4	Mineral phosphate, untreated, finely ground, 500 lbs. per acre.	17	19	11	10	28	26	8	16	10	10	15	6
5	Mineral phosphate, untreated, finely ground, 500 lbs.; nitrate of soda, 200 lbs. per acre.	19	33	12	16	35	10	10	20	18	16	19	9
6	Barn-yard manure partly rotted, and actively fermenting, 6 tons per acre; mineral phosphate, untreated, finely ground, 500 lbs. per acre, composted together, intimately mixed and allowed to heat for several days before using.	23	16	19	38	42	4	27	44	13	36	25	18
7	Mineral phosphate, untreated, finely ground, 500 lbs.; nitrate of soda, 200 lbs.; wood ashes, unleached, 1,000 lbs. per acre.	18	36	13	39	33	16	15	40	24	38	21	14
8	Mineral phosphate, untreated, finely ground, 500 lbs.; wood ashes unleached, 1,500 lbs. per acre.	15	40	10	15	31	12	12	44	17	4	17	23
9	Mineral superphosphate No. 1, 500 lbs. per acre.	24	28	14	8	30	40	19	28	15	40	21	15
10	Mineral superphosphate No. 1, 350 lbs.; nitrate of soda, 200 lbs. per acre.	20	40	15	5	33	36	21	32	25	10	23	15
11	Mineral superphosphate No. 1, 350 lbs.; nitrate of soda, 200 lbs.; wood ashes, unleached, 1,500 lbs. per acre.	20	20	16	7	33	16	13	36	25	40	21	43
12	Unmanured.	15	25	11	12	21	42	12	44	6	42	13	33
13	Bone, finely ground, 500 lbs. per acre.	14	38	9	28	23	56	12	24	17	44	15	34
14	Bone, finely ground, 500 lbs.; wood ashes, unleached, 1,500 lbs. per acre.	18	36	13	11	28	46	20	2460	19	28	20	5

## Experimental Farms.

15	Nitrate of soda, 200 lbs. per acre.....	18	26	2210	18	26	2140	33	36	3760	15	2720	25	2940	22	8	2754
16	Muriate of potash, 150 lbs. per acre.....	19	3	1955	19	23	1925	32	34	2810	12	2340	23	1590	21	28	2124
17	Sulphate of ammonia, 300 lbs. per acre.....	18	26	1410	15	25	1975	28	36	3510	13	2320	18	2540	18	47	2351
18	Sulphate of iron, 60 lbs. per acre.....	23	36	2060	13	1	865	32	44	3440	12	2140	16	2030	19	43	2107
19	Common salt (sodium chloride) 300 lbs. per acre.....	25	00	800	22	4	1955	41	12	3140	22	2380	25	2350	27	10	2125
20	Land plaster or gypsum (calcium sulphate), 300 lbs. per acre.....	25	35	1765	19	8	1690	34	8	2050	18	2060	17	1390	22	43	1971
21	Mineral superphosphate No. 2, 500 lbs. per acre.....	21	42	1050	14	28	735	36	42	3980	18	040	17	1760	21	44	1913

EXPERIMENTS with Fertilizers on Plots of Oats,  $\frac{1}{10}$ th acre each.

No. of Plot.	Manure applied each Year.	1ST SEASON, 1889. VARIETY SOWN, EARLY ENGLISH.		2ND SEASON, 1890. VARIETY SOWN, PRIZE CLUSTER.		3RD SEASON, 1891. VARIETY SOWN, PRIZE CLUSTER.		4TH SEASON, 1892. VARIETY SOWN, PRIZE CLUSTER.		5TH SEASON, 1893. VARIETY SOWN, PRIZE CLUSTER.		AVERAGE FOR THE WHOLE PERIOD.		
		Yield of Grain.	Yield of Straw.	Yield of Grain.	Yield of Straw.	Yield of Grain.	Yield of Straw.	Yield of Grain.	Yield of Straw.	Yield of Grain.	Yield of Straw.	Yield of Grain.	Yield of Straw.	Per acre Lbs.
		Per acre Bush. lbs.	Per acre Lbs.	Per acre Bush. lbs.	Per acre Lbs.	Per acre Bush. lbs.	Per acre Lbs.	Per acre Bush. lbs.	Per acre Lbs.	Per acre Bush. lbs.	Per acre Lbs.	Per acre Lbs.	Per acre Lbs.	Per acre Lbs.
1	Barn-yard manure, well rotted, 15 tons per acre.	16	1800	40	2615	41	2630	48	3520	18	3410	33	2795	
2	Barn-yard manure, fresh, 15 tons per acre	14	2000	45	2860	40	2910	47	2920	32	3200	36	2778	
3	Unmanured	15	1885	31	1260	39	1120	31	1460	15	1760	26	1497	
4	Mineral phosphate, untreated, finely ground, 500 lbs. per acre.	15	2070	35	30	27	2300	36	16	18	1680	26	1880	
5	Mineral phosphate, untreated, finely ground; 500 lbs. nitrate of soda, 200 lbs. per acre.	13	1840	40	20	58	2870	55	10	28	3660	39	2629	
6	Barn-yard manure, partly rotted and actively fermenting, 6 tons per acre; mineral phosphate, untreated, finely ground, 500 lbs. per acre, composted together, intimately mixed and allowed to heat for several days before using.	19	2350	41	6	46	16	38	6	21	26	33	18	
7	Mineral phosphate, untreated, finely ground, 500 lbs.; nitrate of soda, 200 lbs.; wood ashes, unleached, 1,000 lbs. per acre.	12	1985	36	16	50		47	2	18	28	32	31	
8	Mineral phosphate, untreated, finely ground, 500 lbs.; wood ashes, unleached, 1,500 lbs. per acre.	14	2565	41	6	55	30	35	10	17	22	32	33	
9	Mineral superphosphate, No. 1, 500 lbs. nitrate of soda, 200 lbs. per acre.	13	2525	32	32	41	6	29	14	18	8	27	5	
10	Mineral superphosphate, No. 1, 350 lbs.; nitrate of soda, 200 lbs.; wood ashes, unleached, 1,500 lbs. per acre.	13	2150	37	32	55	10	43	18	13	28	32	26	
11	Mineral superphosphate, No. 1, 350 lbs.; nitrate of soda, 200 lbs.; wood ashes, unleached, 1,500 lbs. per acre.	12	2060	32	32	42	12	37	22	23	18	29	30	
12	Unmanured	12	2770	26	16	33	18	26	16	15	30	23	2888	
13	Bone, finely ground, 500 lbs. per acre.	11	2000	27	32	37	22	33	18	18	28	25	1756	
14	Bone, finely ground, 500 lbs.; wood ashes, unleached, 1,500 lbs. per acre.	15	1785	31	6	38	8	30		17	2	26	17	
15	Nitrate of soda, 200 lbs. per acre.	15	1785	31	21	44		60	20	19	14	34	5	

## Experimental Farms.

16	Muriate of potash, 150 lbs. per acre. . . . .	11	16	3010	35	20	1950	37	22	2710	41	6	2060	4	4	2270	30	..	2400
17	Sulphate of ammonia, 300 lbs. per acre. . . . .	11	26	2700	34	27	2017	41	6	3050	48	8	4420	24	24	4000	32	5	3237
18	Sulphate of iron, 60 lbs. per acre. . . . .	16	6	2450	32	32	1260	37	22	2750	44	4	2440	18	18	2220	29	30	2224
19	Common salt (sodium chloride) 300 lbs. per acre. . . . .	15	10	2180	34	4	2620	30	20	2100	32	32	2340	24	4	2090	27	14	2146
20	Land plaster or gypsum (calcium sulphate), 300 lbs. per acre. . . . .	16	26	2930	31	6	1030	31	26	2250	37	22	2200	21	16	3190	27	26	2322
21	Mineral superphosphate No. 2, 500 lbs. per acre. . . . .	15	..	2250	23	23	1055	32	2	2480	42	12	2020	17	2	1980	26	1	1965

## REMARKS.

It will be observed that the yields of barley throughout the five years during which these tests have been continued are much more even in character than those of the wheat or oats. This is no doubt due partly to the fact that the land devoted to these plots is more uniform throughout than that set apart for the wheat and oats, and partly for the reason that the roots of the barley plant being comparatively near the surface are more immediately influenced by the application of fertilizers. The plant also seems to be more robust. As in the case of the wheat, it will be seen that the season of 1891 was favourable for this crop.

## OAT PLOTS.

The quantity of seed sown per acre on the oat plots was 2 bushels in 1889 and 1890, and  $1\frac{1}{2}$  in 1891, 1892 and 1893. The variety chosen for sowing in 1889 was the Early English, but as that seemed to be very subject to rust, the Prize Cluster was substituted in 1890 and has been continued each year since. In 1889 the seed was sown 18th May, came up 25th May and was ripe 16th August. 1890, sown 26th April, came up 14th May, ripe 8th August. 1891, sown 9th May, came up 16th May, ripe 16th August. 1892, sown 6th May, came up 15th May, ripe 16th August. 1893, sown 27th May, came up 2nd June, and was ripe 15th August. The Early English oats required 90 days in 1889 from the date of sowing to that of ripening, while the experience of the four subsequent years gives 96 days as the average time required to bring the Prize Cluster to maturity.

## REMARKS.

The yield of oats by the different plots for the five years during which these tests have been continued, will be found very variable. A comparison of the figures shows that the year 1891 was the most favourable one in the series when all the plots averaged over 41 bushels per acre. The seasons of 1890 and 1892 were also favourable: in the latter, the plots averaged about 40 bushels, and in the former nearly 35 bushels. In 1889 and 1893 the crops were much lighter.

## CORN PLOTS.

In conducting the experiments with the plots of Indian corn the object has been to obtain the largest weight of well matured green fodder for the silo, and to have that fodder so far advanced that when the corn is cut the ears shall be in the "late milk" or "glazed" condition. It was decided to test two varieties each year, growing  $\frac{1}{5}$  of an acre of each. At first a 'dent' corn, the Mammoth Southern Sweet was grown, with one of the flint sorts known as the Canada Yellow, and the cultivation of these two was continued during 1888, 1889 and 1890. In 1891 another 'dent' corn, the Red Cob Ensilage, was substituted for the Mammoth Southern Sweet, while the Rural Thoroughbred White Flint, one of the larger and stronger growing of the flint varieties replaced the Canada Yellow. Since neither of the dent sorts named attained to a sufficient degree of maturity to make good ensilage, another change was made in 1892, and two flint varieties grown, the Thoroughbred White Flint, and an earlier sort known as Pearce's Prolific. The stronger grower of the two sorts selected each year has been designated No. 1, and the less vigorous sort No. 2. The dent varieties all rank as No. 1, and in 1891 the Thoroughbred White Flint is classed as No. 2, but in the two following years this useful sort being a more vigorous grower than Pearce's Prolific, has found a place in the No. 1 series. For the first four years the No. 1 series was planted in drills 3 feet apart, using about 24 pounds of seed to the acre, and thinning the plants when up to 6 or 8 inches apart, and the No. 2 in hills 3 feet apart each way, 4 to 5 kernels in a hill. During the past two years both sorts have been grown in hills.

## Experimental Farms.

In 1888 they were planted June 7th, came up June 13th, and harvested September 12th. 1889, planted May 23rd, came up June 4th, harvested September 12th. 1890, planted May 21st, came up May 31st, harvested September 8th. 1891, planted May 21st, came up May 31st, harvested September 22nd. 1892, planted May 23rd, came up June 3rd, harvested September 17th. 1893, planted June 9th, came up June 19th, harvested October 3rd.

### REMARKS.

The yields of corn for the several years are quite variable, the better crops having been realized in 1889-1890 and 1891. In 1889 the entire series of plots under No. 1 averaged 18 tons, 1895 lbs, and those under No. 2, 10 tons, 1503 lbs; in 1890 No. 1 plots 15 tons, 728 lbs; No. 2, 10 tons, 1528 lbs., and in 1891 the No. 1 plots gave an average return of 16 tons, 1265 lbs., and the No. 2 plots 11 tons, 816 lbs. An anomalous result appears in the yield of plot 1 as compared with plot 2 for 1891. The yield of plot 1 on which well rotted manure is used was for that year at the rate of 15 tons 1,440 lbs. per acre, whereas the yield from plot 2 where the same weight of fresh manure is used was 33 tons and 20 lbs. The advantage if any in using fresh manure would be quite insufficient to account for this difference. On several occasions individual plots have been injured and the yield much lessened by the young plants being eaten off by cutworms, and as this plot is the outer one in the series, it would be specially liable to such depredations; although it has escaped record, it is quite probable that the short crop in this instance has resulted mainly from that cause. The yield from plot 4 to which 500 lbs per acre of finely ground untreated, mineral phosphate have been applied each year has in most instances been less than the crop from No. 3, the adjoining unmanured plot: this has resulted from a part of plot 4 lying comparatively low, and as a consequence the corn suffers in wet seasons. Plots 18, 19 and 20 have given comparatively poor returns for several years past. On these the soil is heavier and colder than on the other plots and not so suitable for corn, particularly in wet seasons.

### PLOTS OF MANGELS AND TURNIPS.

In conducting these experiments the roots only have been taken from the land, the tops have always been cut off and left on the ground to be ploughed under so that the fertilizing constituents they have taken from the soil might be returned to it, one-half of each  $\frac{1}{10}$  acre plot in the series has been devoted to mangels and the other half to turnips. The varieties in each case have been changed from time to time and sometimes several varieties have been used on the same plot. In 1889 the variety of mangel chosen was the Mammoth Long Red, while on the half of the plot devoted to turnips two varieties were used mentioned in the table as Nos. 1 and 2, 28 rows being sown with Carter's Prize Winner and 2 rows with Carter's Queen of Swedes. In 1890 three varieties of mangels were sown, 14 rows with Mammoth Long Red, 5 with Mammoth Long Yellow, and 5 rows with Golden intermediate. These are designated in the table as Nos. 1, 2 and 3. Carter's Elephant Swede was selected that year for the turnip plot. In 1891 three varieties of mangels were used and six of turnips. The mangels consisted of 13 rows of Mammoth Long Red, 3 of Yellow Fleshed Tankard and 6 rows of Golden Tankard. The turnips were 6 rows of Lord Derby Swede, 4 New Giant King, 3 Imperial Swede, 6 Champion Swede, 4 Purple Top Swede, and 4 rows of East Lothian Swede. In the table the mangels are referred to as Nos. 1, 2 and 3, and the turnips as Nos. 1, 2, 3, 4, 5 and 6. In 1892 and 1893, the Mammoth Long Red was used alone in the division for mangels while the variety of turnip chosen for 1892 was the Improved Purple Top Swede, and in 1893 the Prize Purple Top Swede. The season of 1889 gave the largest returns both for mangels and turnips: the crops in 1890 and 1892 were also fair; while those of 1891 and 1893 were very poor. In the first year of the course the mangel division of plots 11 and 13 suffered from imperfect drainage and during

EXPERIMENTS with Fertilizers, on plots of Indian Corn, 1/10th acre each, cut green for Ensilage.

No. of Plot.	1ST SEASON, 1888.		2ND SEASON, 1889.		3RD SEASON, 1890.		4TH SEASON, 1891.		5TH SEASON, 1892.		6TH SEASON, 1893.		AVERAGE FOR THE WHOLE PERIOD.		
	Per acre	Per acre	Per acre	Per acre	Per acre	Per acre	Per acre	Per acre	Per acre	Per acre	Per acre	Per acre	Per acre	Per acre	
	Plot No. 1— Mam. Southern Sweet, weight of green fodder.	Plot No. 2— Canada Yellow, weight of green fodder.	Plot No. 1— Mam. Southern Sweet, weight of green fodder.	Plot No. 2— Canada Yellow, weight of green fodder.	Plot No. 1— Red Cob Ensil- age, weight of green fodder.	Plot No. 2— White Flint, w. of green fodder.	Plot No. 1— Thoroughbred White Flint, w. of green fodder.	Plot No. 2— Pearce's Proli- fic, weight of green fodder.	Plot No. 1— Thoroughbred White Flint, w. of green fodder.	Plot No. 2— Pearce's Proli- fic, weight of green fodder.	Plot No. 1— Thoroughbred White Flint, w. of green fodder.	Plot No. 2— Pearce's Proli- fic, weight of green fodder.	No. 1—Weight of green fodder.	No. 2—Weight of green fodder.	
	Lbs.	Tons.	Lbs.	Tons.	Lbs.	Tons.	Lbs.	Tons.	Lbs.	Tons.	Lbs.	Tons.	Lbs.	Tons.	
1	500	13 500	19 1200	9 1320	20 1900	15 1600	13 700	15 1440	13 700	15 760	13 700	15 1460	7 1460	16 34	12 380
2	13 1420	14 960	22 400	11 1520	22 445	14 1220	33 20	14 680	15 820	9 140	12 1320	6 1380	19 1737	11 1647	7 741
3	10 1100	11 120	10 1660	6 1120	15 320	10 1370	13 300	8 360	10 420	4 1040	6 1320	3 440	11 187	7 741	
4	12 1360	9 1720	14 1200	6 1780	12 170	6 1100	9 1280	6 1120	5 1740	4 320	3 660	2 1580	9 1398	6 270	
5	13 360	13 420	17 600	9 40	12 120	12 760	19 1460	9 900	12 880	5 680	6 880	5 940	13 1050	9 290	
6	14 500	14 1800	23 1200	11 1880	19 240	14 120	24 1820	17 820	15 1620	8 140	12 300	8 1160	18 613	12 987	
7	14 200	14 640	21 1200	11 1280	15 1280	11 1060	23 120	11 1620	15 980	8 540	11 20	8 800	16 1633	10 1990	
8	13 1540	14 1040	18 1300	10 460	15 1330	8 170	14 780	10 40	9 1720	7 400	8 1300	5 1280	13 828	9 565	
9	14 1000	14 480	19 500	11 340	11 1840	10 1400	13 980	9 1300	10 360	6 660	6 1600	5 1800	12 1380	9 133	

Manure applied each year.

- 1 Barn-yard manure, well rotted, 12 tons per acre.
- 2 Barn-yard manure, fresh, 12 tons per acre.
- 3 Unmanured.
- 4 Mineral phosphate untreated, finely ground, 500 lbs. per acre in 1888—800 lbs. per acre each year since.
- 5 Mineral phosphate, untreated, finely ground, 500 lbs. per acre in 1888—800 lbs. per acre, each year since.
- 6 Barn-yard manure, partly rotted and actively fermenting, 6 tons per acre; mineral phosphate, untreated, finely ground, 500 lbs. per acre, composted together, intimately mixed and allowed to heat for several days before using.
- 7 Mineral phosphate, untreated, finely ground, 500 lbs.; nitrate of soda, 200 lbs.; wood ashes, unteached, 1,000 lbs. per acre.
- 8 Mineral phosphate, untreated, finely ground, 500 lbs.; wood ashes, unteached, 1,500 lbs. per acre.
- 9 Mineral superphosphate No. 1, 500 lbs. per acre.



## Experimental Farms.

10	Mineral superphosphate No. 1, 350 lbs.; nitrate of soda, 200 lbs. per acre.	13	50	13	940	20	1800	12	800	18	1780	11	940	15	620	15	1460	13	560	7	1500	12	900	7	100	15	1285	11	623										
11	Mineral superphosphate No. 1, 350 lbs.; nitrate of soda, 200 lbs.; wood ashes, unleached, 1,500 lbs. per acre.	15	1180	16	680	22	1400	11	1420	20	1710	15	250	18	1920	16	1270	14	20	9	1400	12	860	9	400	17	848	13	228										
12	Ummannured .....	13	1340	17	40	18	650	14	180	15	1620	10	340	12	1980	10	1860	8	1840	6	1340	7	1840	4	168	12	1878	10	1240										
13	Bone, finely ground, 500 lbs. per acre.	13	.....	17	1220	19	800	10	60	13	480	10	580	15	1340	7	1920	9	660	7	360	8	260	5	1180	13	257	9	1553										
14	Bone, finely ground, 500 lbs.; wood ashes, unleached, 1,500 lbs. per acre.	14	1080	15	380	18	1100	10	340	14	1820	9	40	16	1480	10	1480	8	1240	6	1480	8	60	5	600	13	1130	9	1053										
15	Nitrate of soda, 200 lbs. per acre.	13	480	15	1620	21	1000	11	1800	15	1120	13	210	17	1540	13	820	12	1120	7	1500	10	660	5	1860	15	320	11	635										
16	Sulphate of ammonia, 300 lbs. per acre.	14	320	15	380	20	800	13	20	15	830	12	1000	19	660	13	480	11	1460	6	1500	10	200	6	420	15	428	11	300										
17	Mineral superphosphate No. 1, 600 lbs.; No crop. No crop. Nitrate of ammonia, 150 lbs. per acre. Sulphate of ammonia, 150 lbs. per acre. Muriate of potash, 300 lbs. per acre. Double sulphate of potash and magnesia, 300 lbs. per acre in 1889 and 90; muriate of potash, 200 lbs., substituted each year since; dried blood, 300 lbs.; mineral superphosphate No. 1, 500 lbs. per acre. Wood ashes, unleached, 1,900 lbs. per acre.	16	600	9	860	16	600	11	840	17	860	13	1820	10	820	16	200	9	1660	12	720	6	660	12	980	7	320	6	1760	8	480	10	1960	5	1760	14	568	9	1552
18	Muriate of potash, 300 lbs. per acre.	16	200	9	1660	12	720	6	660	12	980	7	320	6	1760	5	80	5	760	4	360	10	1284	6	1016														
19	Double sulphate of potash and magnesia, 300 lbs. per acre in 1889 and 90; muriate of potash, 200 lbs., substituted each year since; dried blood, 300 lbs.; mineral superphosphate No. 1, 500 lbs. per acre.	17	1800	10	1340	13	1240	9	1160	11	320	9	1740	9	1840	7	1660	10	120	5	760	12	1064	8	1332														
20	Wood ashes, unleached, 1,900 lbs. per acre.	16	400	10	100	14	80	5	340	11	1560	9	1020	6	1400	6	1120	5	1760	5	460	10	1840	7	608														
21	Bone, finely ground, 500 lbs.; sulphate of ammonia, 200 lbs.; muriate of potash, 200 lbs. per acre.	20	00	13	1240	16	1650	7	1925	12	1140	9	1480	9	650	7	520	8	1200	5	1700	13	928	8	1773														

EXPERIMENTS WITH FERTILIZERS ON ROOTS; PLOTS OF MANGELS AND TURNIPS, 1/5 ACRE EACH.

No. of Plot.	1ST SEASON, 1889.		2ND SEASON, 1890.		3RD SEASON, 1891.		4TH SEASON, 1892.		5TH SEASON, 1893.		AVERAGE FOR THE WHOLE PERIOD.											
	West 1/2 Plot.	East 1/2 Plot.	West 1/2 Plot.	East 1/2 Plot.	West 1/2 Plot.	East 1/2 Plot.	West 1/2 Plot.	East 1/2 Plot.	West 1/2 Plot.	East 1/2 Plot.	Per acre.	Per acre.										
	Mangels, Mammoth Long Red roots.	Turnips, 2 varieties, Nos. 1 and 2—weight of roots.	Mangels, 3 varieties, Nos. 1, 2, 3—weight of roots.	Turnips, 6 varieties, Nos. 1, 2, 3, 4, 5, 6—weight of roots.	Mangels, Mammoth Long Red—weight of roots.	Turnips, Improved Purple Top Sweede—weight of roots.	Mangels, Mammoth Long Red—weight of roots.	Turnips, Improved Purple Top Sweede—weight of roots.	Mangels, Mammoth Long Red—weight of roots.	Turnips, Prize Purple Top Sweede—weight of roots.	Per acre.	Per acre.	Turnips—weight of roots.	Mangels—weight of roots.	Per acre.	Per acre.	Turnips—weight of roots.	Mangels—weight of roots.	Per acre.	Per acre.		
	Tons.	Tons.	Tons.	Tons.	Tons.	Tons.	Tons.	Tons.	Tons.	Tons.	Lbs.	Lbs.	Tons.	Tons.	Lbs.	Lbs.	Tons.	Tons.	Lbs.	Lbs.		
	19 340	16 1200	22 320	11 460	22 1220	9 1180	22 1900	9 1060	20 280	8 220	20 280	8 220	21 808	21 808	20 280	8 220	11 24	11 24	20 280	8 220	21 808	21 808
	17 1760	18 400	22 1740	12 580	21 1480	9 1100	21 200	13 1080	20 360	9 180	20 360	9 180	20 1608	20 1608	20 360	9 180	12 1068	12 1068	20 1608	9 180	20 1608	20 1608
	14 840	15 1000	11 780	5 160	6 1410	6 240	9 1020	6 580	7 360	2 1065	7 360	2 1065	9 1682	9 1682	7 360	2 1065	7 269	7 269	9 1682	2 1065	9 1682	9 1682
	13	13 1600	10 760	6 1600	5 1690	5 560	8 720	9 520	7 220	2 1520	7 220	2 1520	8 1878	8 1878	7 220	2 1520	7 1160	7 1160	8 1878	2 1520	8 1878	8 1878
	16 1560	13 1300	14 1650	5 920	10 1370	4 1350	12 1440	9 1760	11 460	1 1760	11 460	1 1760	13 498	13 498	11 460	1 1760	7 218	7 218	13 498	1 1760	13 498	13 498
	17 700	11 1800	19 1800	9 1580	19 1020	11 400	16 620	12 580	13 380	7 1720	13 380	7 1720	17 504	17 504	13 380	7 1720	10 1216	10 1216	17 504	7 1720	17 504	17 504
	16 1500	12 900	12 360	10 1820	7 1210	3 580	8 1620	10 540	7 245	2 245	7 245	2 245	10 987	10 987	7 245	2 245	7 1617	7 1617	10 987	2 245	10 987	10 987

Manure applied each Year.

- 1 Barn-yard manure, well rotted, 20 tons per acre
- 2 Barn-yard manure, fresh, 20 tons per ac.
- 3 Unmanured
- 4 Mineral phosphate, untreated, finely ground, 1,000 lbs. per acre
- 5 Mineral phosphate, untreated, finely ground, 1,000 lbs.; nitrate of soda, 250 lbs.; wood ashes, unleached, 1,000 lbs. per acre
- 6 Barn-yard manure partly rotted and actively fermenting, 12 tons per acre; mineral phosphate, untreated, finely ground, 1,000 lbs. composted together, intimately mixed and allowed to heat for several days before using
- 7 Mineral phosphate, untreated, finely ground, 1,000 lbs.; sulphate of potash, 200 lbs. in 1889 and 1890, substituted by muriate of potash, 250 lbs. in 1891 and subsequent years; nitrate of soda, 200 lbs. per acre.

# Experimental Farms.

8	Mineral superphosphate, No. 1, 500 lbs.; sulphate of potash, 200 lbs. in 1889 and 1890, substituted by muriate of potash, 250 lbs. in 1891 and subsequent years; nitrate of soda, 200 lbs. per acre	17 1300	15 1120	12 840	6 120	4 1360	17 60	10 1800	12 980	7 1150	14 450	10 1230
9	Mineral superphosphate, No. 1, 500 lbs. per acre	13 1600	13 600	9 780	8 1470	5 440	11 740	8 1460	5 1650	3 850	9 1648	7 1950
10	Nitrate of soda, 300 lbs. per acre	14 400	15 1100	13 1940	10 1880	3 860	17 1340	9 1120	13 165	1 1190	13 1945	7 1742
11	Sulphate of ammonia, 300 lbs. per acre	4 600	15 900	12 1440	6 490	4 420	13 1060	9 1980	11 400	2 860	9 1200	8 1500
12	Unmanured	10 1900	14 1200	8 1000	4 570	2 60	9 880	7 1340	3 1970	1 510	7 864	7 462
13	Bone, finely ground, 500 lbs.; wood ashes, unleached, 1,000 lbs. per acre	9 1800	12 1600	10 1540	6 840	2 890	12 120	6 1920	11 1640	2 580	10 388	7 702
14	Wood ashes, unleached, 2,000 lbs. per acre	13 200	13 800	13 740	10 1760	1 1700	13 60	9 660	9 1520	2 1790	11 1824	7 1842
15	Common salt (sodium chloride), 400 lbs. per acre	13 400	14	12 960	12 480	3 680	11 220	7 1640	7 770	1 1950	11 836	7 1750
16	Mineral superphosphate, No. 1, 500 lbs.; nitrate of soda, 200 lbs. per acre	No crop in 1889.	16 1400	20 320	12 830	6 1860	14 1000	8 840	12 680	3 1140	13 1977	9 1540
17	Mineral superphosphate, No. 1, 500 lbs.; wood ashes, unleached, 1,500 lbs. per acre	"	"	17 260	18 680	6 540	12 500	7 1440	11 750	2 680	12 910	8 1335
18	Mineral superphosphate No. 1, 500 lbs.; muriate of potash, 200 lbs. per acre	"	"	17 700	18 1360	7 500	12 800	9 1140	10 1960	4 990	13 162	9 1997
19	Double sulphate of potash and magnesia, 300 lbs. per acre in 1889 and 1890; muriate of potash, 200 lbs., substituted each year since; dried blood, 250 lbs.; mineral superphosphate, No. 1, 500 lbs. per acre	"	"	18 1220	17 1960	5 640	13 1600	9 600	13 1210	5 230	14 870	9 857
20	Wood ashes, unleached, 1,500 lbs.; common salt (sodium chloride), 300 lbs. per acre	"	"	17 40	18 880	6 1210	15 1500	9 420	12 580	4 70	15 117	9 1115
21	Mineral superphosphate, No. 2, 500 lbs. per acre	"	"	20 1680	17 1180	5 1600	14 1720	9 800	14 370	5 1890	16 910	9 1367

the past three years the crop of turnips has been much diminished by the attack of a species of rot which has affected the roots when partly grown and resulted in rapid decay. This disease has been common on many farms in the Ottawa district, and no remedy has yet been discovered for it. It was hoped that change of seed might affect the crop favourably, but this seems to have no appreciable effect. During the past wet season the yield has been greatly reduced from this cause. From 4 to 6 lbs. of mangel seed and 6 lbs. of turnip seed is the quantity which has been used per acre each year, and both have been sown in rows  $2\frac{1}{2}$  feet apart. The treatment of the land has been as follows: Ploughed in the autumn after the crop is gathered, disc-harrowed once in the spring, harrowed with smoothing harrow once, then ridged and sown. The land used for the turnips, which are usually sown later than the mangels, is allowed to stand after disc-harrowing, then cultivated once and ridged immediately before sowing. In 1889 the mangels were sown May 23rd, came up June 2nd and were pulled October 13th. The turnips were sown May 23rd, came up May 30th, were pulled October 14th. In 1890 mangels were sown May 21st, came up May 30th and were pulled October 15th. The dates of the sowing and coming up of the turnips for this year have been lost, but they were pulled October 16th. In 1891 mangels were sown May 16th, came up May 27th, pulled October 16th. Turnips were sown June 6th, came up June 11th, were pulled October 19th. In 1892, mangels were sown May 14th, came up May 24th and were pulled October 19th. Turnips were sown June 11th, came up June 16th, were pulled October 29th. In 1893, mangels were sown May 31st, came up June 7th, were pulled October 21st. Turnips were sown June 15th, came up June 20th and were pulled October 21st.

#### PLOTS OF CARROTS AND SUGAR-BEETS.

The plots of carrots and sugar-beets, consisting of  $\frac{1}{10}$  acre each, were sown on alternate halves of the wheat, barley and oat plots for the purpose of cleaning the land from weeds. They were begun in 1891 and have been continued to the present. The plots after wheat and oats have been sown with a field carrot known as the Improved Short White. The plots after barley were sown in 1891 with 11 varieties of sugar-beet as stated in the table. The varieties were Dippe's Klein Wanzleben 4 rows, Bulteau Desprez 4 rows, Vaurica Yellow Giant 2 rows, Vilmorin's No. 1, 4 rows, Large Sugar 4 rows, Klein Wanzleben 4 rows, Vilmorin's Improved White 2 rows, Green Necked Brabant 2 rows, Vilmorin's No. 2, 4 rows and 8 rows each of seed sent for test by Mr. A. Musy, of the Farnham Beet Sugar Factory designated I. B. and C. H. In 1892 the plots after barley were sown with the Guerande or ox-heart carrot and in 1893 with the Mammoth White Intermediate, a field carrot recently introduced. In 1891 the sugar-beets were sown 11th May, came up 26th May and were pulled 18th October. The carrots grown after wheat and oats, were sown 11th May came up 26th May and were pulled 29th October. In 1892 the carrots grown after barley were sown 11th May came up 26th May and were pulled 29th October; those after wheat were sown 6th May came up 20th May were pulled 31st October, and those after oats sown 6th May came up 20th May and were pulled 3rd November. In 1893 the carrots grown after barley were sown 30th May came up 7th June and were pulled 23rd October; those after wheat and oats were sown 30th May came up 6th June and were pulled 23rd and 24th October.

These plots have given fairly uniform returns varying but slightly from what might have been expected from the fertilizers used. The sugar-beets on several of the plots in 1891 were partly destroyed by cut-worms which will account for unexpected variations in yields that year. The carrots after oats also suffered similar injury that season. On plots 18, 19, 20 and 21 after oats, the soil is heavier than on the other plots and less suitable for carrots which will in part account for the relatively smaller yield on these plots as compared with those after wheat.

# Experimental Farms.

## EXPERIMENTS with Fertilizers on Half-Plots of Carrots and Sugar Beets, $\frac{1}{2}$ acre, after Wheat, Barley and Oats.

No. of Plot.	1ST SEASON, 1891.						2ND SEASON, 1892.						3RD SEASON, 1893.						AVERAGE YIELD OF CARROTS.			
	East $\frac{1}{2}$ Plot.		West $\frac{1}{2}$ Plot.		East $\frac{1}{2}$ Plot.		West $\frac{1}{2}$ Plot.		East $\frac{1}{2}$ Plot.		West $\frac{1}{2}$ Plot.		East $\frac{1}{2}$ Plot.		West $\frac{1}{2}$ Plot.		Improved Short White for three years.		After wheat—yield of roots.			
	Per acre	Tons	Per acre	Lbs.	Per acre	Tons	Per acre	Lbs.	Per acre	Tons	Per acre	Lbs.	Per acre	Tons	Per acre	Lbs.	Per acre	Tons	Per acre	Tons		
1	Carrots, Improved Short White, after wheat—yield of roots.	27	600	18	1390	23	1600	20	940	16	1800	20	940	19	80	15	850	22	1207	19	1797	
2	Barn-yard manure, well rotted, 15 tons per acre.	29	600	17	1120	26	1300	21	900	16	1660	19	640	20	550	20	90	16	1230	24	17	20
3	Barn-yard manure, fresh, 15 tons per acre.	22	600	8	870	15	500	14	1280	12	1080	12	180	15	40	14	1940	10	280	17	440	12
4	Unmanured.	21	1600	7	130	16	900	14	1400	12	1820	12	1060	14	1570	12	630	9	1850	17	190	12
5	Mineral phosphate, untreated, finely ground, 500 lbs. per acre.	25	1020	13	1540	20	1400	16	1240	14	1880	15	1240	17	10	15	1500	12	1870	19	1423	16
6	Mineral phosphate, untreated, finely ground, 500 lbs.; nitrate of soda, 200 lbs. per acre.	31	600	16	1840	28	800	18	1400	16	1980	18	1940	18	1720	21	1050	13	120	22	1907	20
7	Barn-yard manure, partly rotted and actively fermenting, 6 tons per acre; mineral phosphate, untreated, intimately mixed and allowed to heat for several days before using.	18	1000	11	1190	24	200	17	440	15	1060	18	200	14	1830	15	1900	15	660	16	1757	19
8	Mineral phosphate, untreated, finely ground, 500 lbs.; wood ashes, unleached, 1,000 lbs. per acre.	11	800	9	350	19	400	15	1440	14	40	16	1900	12	1680	12	820	12	820	13	640	16
9	Mineral phosphate, untreated, finely ground, 500 lbs.; nitrate of soda, 200 lbs. per acre.	10	600	11	900	17	1500	15	1640	15	1780	15	80	11	390	16	270	9	740	12	877	14
10	Mineral superphosphate, No. 1, 350 lbs.; nitrate of soda, 200 lbs. per acre.	21	800	13	1440	15	460	18	440	13	1740	14	580	13	390	18	330	12	280	14	543	13
11	Mineral superphosphate, No. 1, 350 lbs.; nitrate of soda, 200 lbs.; wood ashes, unleached, 1,500 lbs. per acre.	25	1800	13	120	6	1940	19	1300	17	1320	12	1880	15	330	17	170	12	1150	20	477	10
12	Unmanured.	23	600	8	510	6	1900	14	1600	11	400	10	1200	14	1870	13	960	7	550	17	1357	8
13	Bone, finely ground, 500 lbs. per acre.	21	1000	8	400	6	700	16	1820	10	1950	11	340	16	1490	14	1910	8	1490	18	440	8
14	Bone, finely ground, 500 lbs.; wood ashes, unleached, 1,500 lbs. per acre.	24	800	10	1630	13	...	20	1980	14	500	15	...	19	1330	17	1310	16	950	21	1370	13
15	Nitrate of soda, 200 lbs. per acre.	22	400	8	535	19	1800	20	620	13	1850	20	20	18	1990	17	1500	15	1260	19	1823	17
16	Muriate of potash, 150 lbs. per acre.	16	700	11	40	12	800	14	800	14	800	20	1280	18	1430	16	750	13	760	14	1783	15
17	Sulphate of ammonia, 300 lbs. per acre.	19	1000	10	1750	15	260	13	1900	9	1740	13	1720	14	740	16	250	11	380	15	1884	13
18	Sulphate of iron, 60 lbs. per acre.	20	1600	12	1850	17	260	15	1740	13	1440	18	620	14	820	15	1560	15	280	17	70	17
19	Common salt (sodium chloride), 300 lbs. per acre.	20	1200	11	285	18	460	18	1160	12	1680	19	1600	14	720	18	1790	13	870	17	1700	17
20	Land plaster or gypsum (calcium sulphate), 300 lbs. per acre.	21	200	10	1895	17	800	14	1240	13	720	18	1260	12	1580	17	210	11	1930	15	940	16
21	Mineral superphosphate, No. 2, 500 lbs. per acre.																					

Manure applied each Year.

## GENERAL CONSIDERATIONS.

While a period of six years in the testing of the effects of manures on crops is altogether too short to permit of drawing positive conclusions on any point, yet when a considerable degree of uniformity is found in the results throughout the series they may justify an experimenter in calling special attention to them.

The results obtained from plots 1 and 2 throughout the whole series in uniformly large average returns serves to confirm the correctness of the view generally held as to the beneficial action of barn-yard manure. It is, however, worthy of note in this connection, that in its application to wheat, barley and oats, manure used fresh from the barn has produced a higher average of grain than an equal weight of manure which has been well rotted. In the barley plots the fresh manure also gives a heavier weight of straw, while in the oat and wheat plots the advantage, as far as the crop of straw is concerned, is slightly in favour of the rotted manure. On the corn plots the fresh manure has given much the heavier crops on the No. 1 series, while the rotted manure has a slight advantage in No. 2. In the case of the roots the advantage is on the side of the rotted manure with the mangels, with the sugar beets grown in 1891, and with the carrots after barley in 1892; but the fresh manure gives the larger returns with the turnips, also with all the crops of carrots after wheat and oats and with the carrots after barley in 1893. These facts when carefully compared indicate a considerable advantage thus far in the use of fresh manure over that of rotted weight for weight, which is a most important point in the economy of manures, since, during the process of rotting, manure loses about 40 per cent of its weight, and to this loss must be added the cost of twice handling, and usually that of turning once or twice during the process of fermentation. The explanation of this rather unlooked for result, probably lies in the fact that the liquid portions of the manure, the richest in nitrogen, have much of their most valuable constituent volatilized and lost during the process of rotting.

The unmanured plots, Nos. 3 and 12, show fairly uniform results throughout, the slight differences being easily explained by variation in soil.

The crops given by plot 4 in all the series seem to show that mineral phosphate untreated no matter how finely ground has little or no effect as a fertilizer, and that the effects observable where nitrate of soda and wood ashes are used in conjunction with the untreated mineral phosphate are probably due entirely to the action of these added fertilizers. There is however no doubt that the mineral phosphate when treated with sulphuric acid and rendered soluble by being changed to the superphosphate is a most valuable addition to the fertilizing constituents of the soil.

It would appear that, when the finely ground mineral phosphate is intimately mixed with barn-yard manure in an active state of fermentation and composted for several days, better results are obtained than would be expected from the proportion of manure used and it is probable that under these circumstances some portion of the mineral phosphate is rendered soluble by the action of the ferments in the decaying manure.

The addition of highly nitrogenous fertilizers, such as nitrate of soda and sulphate of ammonia, while usually producing a fair increase in the weight of grain, has a more marked effect on the weight of straw, which is increased very considerably.

It is somewhat singular that the inferior quality of superphosphate of lime known as No. 2 has given in nearly all the tests better average results than have been obtained from the use of the more costly No. 1 quality: no explanation can yet be offered for this unlooked for result.

The experiments with the use of common salt alone, and land plaster or gypsum alone, have resulted in better average yields than was expected. These results are most probably due in large measure to the influence which both these substances exert in liberating potash in the soil, by reducing insoluble potash compounds to soluble forms and also of influencing the texture of the soil so as to enable it to retain more moisture. The use of salt alone seems to be specially beneficial to the barley crop. The tests made with sulphate of iron on grain crops have also given better results on the average than was looked for.

## Experimental Farms

Some of the less favourable results obtained from the use of artificial fertilizers which from the nature of their constituents are known as complete fertilizers are unexpected and disappointing and cannot at present be explained. In all probability the experience of a few more years will throw further light on the subject.

### DISTRIBUTION OF SEED GRAIN.

This useful department of the work of the experimental farms has demanded increased attention during the past year in consequence of the very large number of applications which have been received from all parts of the Dominion. This gratifying appreciation of the value of this distribution of useful varieties of seed grain, while manifest in most of the provinces has been most marked in the province of Quebec. 11,113 samples of 3 lbs. each were sent to this province, an increase of 2,596 over last year, and there still remained at the close of the distribution two or three thousand applications which had been received late and which could not be supplied, as the available stock of good grain was exhausted. To nearly all the provinces of the Dominion the number of samples sent from Ottawa in 1893 was in excess of any previous year. There was a slight falling off in the number sent to the North-west Territories, also to British Columbia. This apparent deficiency has been partly if not wholly made up by the larger quantity of samples sent to farmers direct from the experimental farms in the North-west Territories and British Columbia. At all the branch farms a distribution of such samples now takes place annually to the great satisfaction of the farmers in the provinces and territories where these institutions are located. It is highly desirable that all applications for samples of seed grain should be made as early in the year as practicable, if delayed there is much greater difficulty in meeting the wishes of applicants. The distribution consists mainly of samples of the principal cereals and not more than two are sent to any one applicant. No seeds of field roots, garden vegetables or flowers are supplied.

The samples sent out during the early months of 1893 were distributed as follows:—

#### *Prince Edward Island.*

Oats.....	150
Barley.....	133
Wheat...	131
Pease.....	21
Indian corn.....	67
Potatoes.....	17
	519
	519

Number of applicants supplied 281.

#### *Nova Scotia.*

Oats.....	486
Barley.....	460
Wheat.....	254
Pease.....	65
Indian corn.....	278
Potatoes.....	81
	1,624
	1,624

Number of applicants supplied 860.

*New Brunswick.*

Oats.....	476
Barley.....	425
Wheat.....	351
Pease.....	154
Indian corn.....	353
Potatoes.....	55
	<hr/>
	1,814
	<hr/> <hr/>

Number of applicants supplied 1,024.

*Ontario.*

Oats.....	1,516
Wheat.....	956
Barley.....	940
Pease.....	476
Potatoes.....	289
Indian corn.....	283
	<hr/>
	4,460
	<hr/> <hr/>

Number of applicants supplied 2,261.

*Quebec.*

Barley.....	3,338
Oats.....	2,809
Wheat.....	2,663
Pease.....	620
Indian corn.....	1,385
Potatoes.....	298
	<hr/>
	11,113
	<hr/> <hr/>

Number of applicants supplied 6,416.

*Manitoba.*

Oats.....	267
Wheat.....	183
Barley.....	179
Pease.....	84
Indian corn.....	176
Potatoes.....	19
	<hr/>
	908
	<hr/> <hr/>

Number of applicants supplied 507.



## Experimental Farms.

### *North-west Territories.*

Oats.....	256
Barley.....	167
Wheat.....	148
Pease.....	69
Indian corn.....	75
Potatoes.....	26
	741
	741

Number of applicants supplied 382.

### *British Columbia.*

Oats.....	71
Wheat.....	58
Barley.....	44
Pease.....	20
Indian corn.....	5
	198
	198

Number of applicants supplied 100.

The following list shows the number of three-pound packages of the different varieties which have been distributed:—

### *Oats.*

Banner.....	2,471
Prize Cluster.....	1,454
White Wonder.....	787
Holstein Prolific.....	702
Improved Ligowo.....	345
Abundance.....	161
Rosedale.....	111
	6,031
	6,031

### *Barley—Two-rowed.*

Duck-bill.....	1,594
Kinver Chevalier.....	1,142
Danish Chevalier.....	733
Prize Prolific.....	672
Goldthorpe.....	547
Canadian Thorpe.....	249
	4,937
	4,937

### *Barley—Six-rowed.*

Baxter's Six-rowed.....	505
Rennie's Improved.....	199
Oderbruch.....	45
	749
	749

*Wheat.*

Campbell's White Chaff.....	1,813
Ladoga.....	1,005
Red Fife.....	695
White Fife.....	361
White Connell.....	311
Rio Grande.....	292
Campbell's Triumph.....	149
Red Fern.....	118
	<hr/>
	4,744

*Pease.*

Mummy.....	1,509
	<hr/>

*Indian Corn.*

Rural Thoroughbred White Flint.....	773
Pearce's Prolific.....	722
Longfellow.....	716
North Dakota.....	411
	<hr/>
	2,622

*Potatoes.*

Thorburn.....	257
Lee's Favourite.....	241
Early Ohio.....	171
Wonder of the World.....	74
Beauty of Hebron.....	42
	<hr/>
	785
	<hr/>
Total number of samples distributed.....	21,377
	<hr/>
Number of applicants supplied..	11,831
	<hr/>

Since it has been found necessary to close the operations to be reported on for this year earlier than in the past, so that the annual report might be prepared and distributed in good season, the usual summary of the reports received from those to whom the samples were sent is necessarily omitted.

## TESTING THE VITALITY OF GRAIN AND OTHER SEEDS.

During the past season the vitality of 1,957 samples of seed grain and agricultural seeds has been tested at the Central Experimental Farm and reported on. These have been received from almost every part of the Dominion and the results have conveyed to the farmers, who have sent them for test, much useful infor-

## Experimental Farms.

mation. As will be seen in the appended table the 613 samples of wheat tested have varied much, from those perfect in germinating proportion to such as had entirely lost the power of germinating. The 383 samples of barley have varied in vitality from 100 to 22 per cent, and the 744 samples of oats tested from 100 to as low as 4 per cent. The average vitality of all the samples is a little below the average of last year.

The season of 1893 has in many sections been unfavourable for the perfect development of grain, and in some districts very wet weather occurred preceding and during harvest time, causing discolouration of the grain and in some instances mouldiness and sprouting in the field. It is important that farmers residing in districts where the conditions have been unfavourable should forward for test such samples concerning which any doubts as to vitality and usefulness for seed may exist. Samples sent for testing should not weigh less than one ounce, they can be sent to the Central Experimental Farm, at Ottawa, free through the mail, and in order that the returns may all be made before the time of seeding arrives they should be forwarded as early as practicable.

### RESULTS of Tests for 1892-93.

Kind of Seeds.	Number of Tests.	Highest Per-centage.	Lowest Per-centage.	Per-centage of Strong Growth.	Per-centage of Weak Growth.	Average Vitality.
Wheat	613	100·0	0·0	70·6	11·2	81·8
Barley	383	100·0	22·0	61·8	23·1	84·9
Oats	744	100·0	4·0	82·6	10·4	93·0
Rye	8	95·0	79·0			88·6
Pease	35	100·0	12·0			65·7
Corn	22	100·0	6·0			70·9
Clover	6	81·0	10·0			61·3
Grass	5	91·0	23·0			54·2
Beans	5	96·0	64·0			78·4
Sunflowers	9	96·0	78·0			85·8
Turnips	14	96·0	35·0			73·0
Mangels	5	84·0	14·0			32·4
Beets	6	46·0	28·0			37·0
Carrots	11	52·0	8·0			31·3
Cabbage	13	94·0	21·0			76·2
Cauliflower	3	82·0	61·0			69·0
Onions	7	88·0	15·0			53·5
Tomatoes	11	76·0	9·0			49·1
Radish	9	80·0	8·0			43·5
Parsnips	4	56·0	0·0			22·5
Celery	6	65·0	25·0			42·6
Pepper	3	53·0	1·0			23·6
Lettuce	2	89·0	82·0			85·5
Spinach	2	38·0	28·0			33·0
Cucumber	6	56·0	0·0			30·0
Musk melon	2	32·0	28·0			30·0
Water melon	2	36·0	10·0			23·0
Flax	2	90·0	59·0			74·5
Thyme	2	15·0	0·0			7·5
Sweet marjoram	2	12·0	12·0			12·0
Sage	2	47·0	0·0			23·5
Summer savory	2	33·0	0·0			16·5
Tobacco	1					66·0
Pumpkins	1					4·0
Leek	1					6·0
Endive	1					54·0
Tares	1					97·0
Asparagus	2					0·0
Tree seeds	4					0·0
Total number of samples tested, highest and lowest percentage and average vitality	1,957	100·0	0·0			83·8

## EXPERIMENTS WITH FALL WHEAT.

During the past season twelve varieties of fall wheat have been tested varying in size from about  $\frac{1}{7}$ th to  $\frac{1}{4}$  acre. The land on which they were sown was a sandy loam of medium quality. It received a fair coat of barn-yard manure in the spring of 1892, was lightly ploughed to cover the manure and sown with oats. After the oats were harvested the land was immediately gang ploughed to start shed grain and weed seeds and ploughed again and harrowed in September before the wheats were sown. The plots were all sown on September 9th, and the results are given in the appended table.

Name of variety,	Length of straw.	Character of straw.	Length of head.	Kind of head.	Date of ripening.	Yield per acre.	Weight per bushel.	Proportion rusted.
	Inches.		Inches.			Bush. lbs.		
Manchester.....	40 to 45	Stiff.....	2½ to 3½	Beardless	July 24...	24 03	57¾	Considerably.
Early Red Clawson	35 to 40	do.....	3 to 3½	do ..	do 24...	20 38	58½	do
Martin's Amber...	40 to 43	do.....	2½ to 3½	do ..	do 24...	18 37	58½	Badly.
Jones' Winter Fife.	46 to 48	do.....	3 to 3½	do ..	do 24...	18 36	54	do
Robert's (Carman's No. 3)	40 to 42	do.....	3 to 3½	Bearded..	do 22...	18 33	55½	do
Willit's (Carman's No. 2)	42 to 45	do.....	3 to 3½	Beardless.	do 24...	17 42	53½	do
Democrat.....	46 to 48	Fair.....	3 to 3½	Bearded..	do 24...	17 23	56½	do
Johnson (Carman's No. 55).....	40 to 42	do.....	3 to 3½	do ..	do 24...	16 50	53	do
Stewart (Carman's No. 51).....	45 to 48	Stiff.....	3 to 3½	do ..	do 24...	16 50	54	do
Tasmania.....	40 to 42	Fair.....	3 to 3½	do ..	do 22...	15 26	58	Very badly
Golden Cross.....	40 to 42	do.....	3 to 3½	do ..	do 22...	14 34	58¾	do
Welds No. 4.....	40 to 45	do.....	3½ to 4	do ..	do 24...	12 42	56½	do

EXPERIMENTS WITH SPRING WHEAT  $\frac{1}{20}$ TH ACRE PLOTS.

There were tested during 1893, thirty-two varieties of spring wheat. These were sown on clay loam, the previous crop was hay. The land was ploughed in the summer of 1892, shortly after the removal of the hay crop, ploughed a second time late in the autumn and gang ploughed and harrowed in the spring before sowing. It was intended to sow all the plots the same day, but owing to unfavourable weather this was found to be impracticable, a part were sown on May 26th and part on the 27th. The particulars of growth will be found in the appended table, and it will be observed that the yield of most sorts was unusually light, a result brought about mainly by rust, from which all varieties suffered. Rust first appeared on the leaves of the spring wheat during the second week in July, and gradually spread to the stems, and by the end of the month it showed itself in a very marked degree, the earlier ripening varieties being most affected. About the middle of August the earlier sorts were cut, but in every instance the yield was poor and the grain was small and did not reach its usual condition of maturity. The harvest weather was also bad and rain fell on an average every second day during August and the first week of September, the total rainfall during this period being over nine inches. Under such conditions it was impossible to save the crop satisfactorily, and after it was cut it was several weeks before it could be dried and housed. In the meantime it was found necessary to untie and spread the sheaves and tie again several times, and with so much handling much of the grain was unavoidably shed; on this account the comparison of varieties as to yield and quality is not of much value this year.

# Experimental Farms.

## TEST OF VARIETIES OF WHEAT SOWN MAY 26TH AND 27TH.

Name of variety.	Length of Straw.	Character of Straw.	Length of Head.	Kind of Head.	Date of Ripening.	Number of days Maturing.	Yield per Acre.	Weight per Bushel.	Proportion Rusted.
	Inches.		Inches.				Bus. lbs.		
Herison's Bearded.	36 to 42	Stiff	1½ to 2	Bearded	Aug. 23	89	25 00	56	Considerably.
Preston.	42 to 46	do	2½ to 3½	do	do 22	88	20 20	57	do
Dions (resembles Red Fern).	46 to 48	Fair	3 to 4	do	do 30	95	18 00	58½	Slightly.
Pringle's Champlain.	42 to 51	do	3 to 4	do	do 26	91	17 40	54½	Badly.
Wellman's Fife.	36 to 52	Stiff	2½ to 3½	Beardless.	do 28	93	16 02	55½	Considerably.
Crown	42 to 48	do	2½ to 3½	Bearded	do 23	88	16 00	55½	do
Red Fife.	40 to 48	do	2½ to 3	Beardless.	do 28	94	14 20	55	do
Beaudry.	36 to 42	Fair	2½ to 3	Bearded	do 23	88	14 20	58	do
Stanley	43 to 48	Stiff	2½ to 3½	Beardless.	do 22	88	13 50	56½	do
Red Fern.	47 to 52	Fair	3 to 4	Bearded	do 30	95	13 40	55½	do
Alpha	42 to 48	Stiff	2½ to 3½	Beardless.	do 23	89	13 20	57	do
White Russian	42 to 49	Fair	2½ to 3½	do	do 23	88	13 00	53	do
White Fife.	36 to 44	Stiff	2½ to 3½	do	do 28	93	12 30	55	do
Ottawa.	36 to 44	Fair	2½ to 3½	Bearded	do 15	80	11 40	50½	Badly.
Abundance	41 to 46	do	2½ to 3½	do	do 17	82	10 40	53	do
Rio Grande.	46 to 53	Stiff	3 to 4	do	do 31	96	10 20	53½	do
Black Sea.	36 to 45	Fair	2½ to 3½	do	do 15	80	10 20	51	do
Albert.	36 to 48	do	2½ to 3½	do	do 15	81	10 00	50	do
Ladoga.	36 to 45	do	2½ to 3½	do	do 16	81	9 40	50	do
Hungarian Mountain.	36 to 42	Stiff	2½ to 3½	Beardless.	do 28	94	9 40	51½	do
Huestons	38 to 48	Fair	3 to 4	do	do 25	91	9 30	47½	do
Great Western.	40 to 52	Stiff	3 to 4	Bearded	do 31	96	9 10	50	do
Prince	36 to 45	Fair	2½ to 3½	do	do 15	80	8 50	51	do
Carleton	36 to 45	do	2½ to 3½	do	do 15	80	8 40	52½	do
Beta.	40 to 45	do	2½ to 3½	do	do 19	84	8 20	52	do
Manitou (not distinguishable from Red Fife).	42 to 48	Stiff	3 to 4	Beardless.	do 28	93	7 40	49½	do
White Chaff	36 to 45	Fair	2½ to 3	do	do 20	85	7 00	48	do
Colorado.	36 to 47	Weak	2½ to 3½	Bearded.	do 19	85	6 20	57	Very badly.
Azima, Russian.	33 to 48	do	3 to 4½	do	Sept. 1	98	5 30	52½	Badly.
White Connell.	40 to 48	Fair	2½ to 3	Beardless.	Aug. 27	93	5 27	44	do

### FIELD CROPS OF SPRING WHEAT.

**Rio Grande.**—Soil part sandy loam and part clay loam. The previous crop was barley on the sandy loam, and corn on the clay. The land was ploughed in the autumn of 1892, disc harrowed and harrowed with the smoothing harrow in spring of 1893 before sowing; 3½ acres sown May 15th, 1½ bushels per acre, ripe August 27th; time to mature, 104 days; yield per acre, 20 bushels, 50 lbs., weight per bushel, 55½ lbs.; length of head, 3½ to 4 inches; bearded, length of straw, 48 to 50 inches, all standing well and rusted, but not so badly as other varieties.

**Wellman's Fife**—Soil, sandy loam; previous crop, oats; ploughed in autumn of 1892, gang ploughed in spring of 1893, and harrowed with smoothing harrow before sowing, 1 acre, sown May 13th, 1½ bushels per acre, ripe August 22nd, time to mature, 101 days, yield per acre, 13 bushels, 37 lbs., weight per bushel, 53½ lbs.; length of head, 3 to 3½ inches, beardless, length of straw, 36 to 42 inches, straw stiff, all standing well, but considerably rusted.

**Campbell's White Chaff.**—On clay soil, the previous crop was corn. The land was ploughed in the autumn of 1892, had a light coating of manure, 10 to 12 tons per acre in the spring of 1893, then ploughed lightly and harrowed with smoothing harrow before sowing, 2½ acres, sown May 22nd, 1½ bushels per acre, ripe August 22nd, time to mature, 92 days, yield per acre, 10 bushels, 3 lbs., weight per bushel, 54 lbs. Length of head, 2½ to 3 inches, beardless, length of straw, 34 to 40 inches, considerably broken down and very badly rusted.

EXPERIMENTS WITH BARLEY.

Twelve varieties of 2-rowed barley, and 12 varieties of 6-rowed were tested for comparative earliness and yield during the past season on plots of  $\frac{1}{20}$  acre each. It was intended to sow these all on the same day, but heavy rains prevented this and the sowing of some of the plots was unavoidably delayed for two days. These plots were adjoining those of the spring wheat on similar clay loam, and the land received the same treatment.

The barley was not nearly so much affected by rust as the wheat was, but it was apparent on the leaves about the same time. It appeared on the stems of the 6-rowed sorts about the last of July, and on the 2-rowed a week later, the 6-rowed varieties were not much injured, but the 2-rowed sorts suffered considerably.

TWO-ROWED BARLEY—TEST OF VARIETIES.

Name of variety.	Length of Straw.	Character of Straw.	Length of Head.	Date of Sowing.	Date of Ripening.	Number of days Maturing.	Yield per Acre.		Weight per Bushel.	Proportion Rusted.
	Inches.		Inches.				Bus. lbs.	Lbs.		
Thanet.....	36 to 39	Weak	3 $\frac{1}{2}$ to 4 $\frac{1}{2}$	May 29	Aug. 20	83	40	40	43 $\frac{3}{4}$	Slightly.
Swedish female, with Baxter's six-rowed male, plant 3.....	24 to 36	Fair..	2 $\frac{1}{2}$ to 3 $\frac{1}{2}$	do 29	do 13	76	30	10	49 $\frac{3}{4}$	do
Improved Chevalier.....	33 to 39	Weak	2 $\frac{3}{4}$ to 3 $\frac{1}{2}$	do 29	do 19	82	30	10	45 $\frac{3}{4}$	Considerably.
French Chevalier.....	32 to 39	do	3 $\frac{1}{2}$ to 5	do 29	do 23	86	27	14	44	Slightly.
Kinver Chevalier.....	36 to 39	do	4 to 5	do 29	do 22	85	20	20	43	do
Newton.....	32 to 41	Stiff..	2 $\frac{3}{4}$ to 3 $\frac{1}{2}$	do 27	do 25	90	19	11	43 $\frac{1}{4}$	Considerably.
Danish Chevalier.....	30 to 37	Weak	3 $\frac{1}{2}$ to 5	do 29	do 26	89	18	36	44 $\frac{3}{4}$	do
Duck-bill.....	30 to 36	Stiff..	2 $\frac{1}{2}$ to 3	do 27	do 21	86	18	16	44	Slightly.
New Golden Grains.....	36 to 39	Weak	4	do 29	do 22	85	17	44	41 $\frac{1}{2}$	do
Canadian Thorpe.....	30 to 33	Stiff..	2 $\frac{3}{4}$ to 3 $\frac{1}{4}$	do 27	do 23	88	15	40	44	Considerably.
Prize Prolific.....	24 to 38	Weak	2 $\frac{3}{4}$ to 3 $\frac{1}{4}$	do 29	do 26	89	15	40	43 $\frac{3}{4}$	do
Goldthorpe.....	32 to 36	Fair..	2 $\frac{3}{4}$ to 3 $\frac{1}{4}$	do 27	Sept. 9	104	12	34	44	do

SIX-ROWED BARLEY.—TEST OF VARIETIES.

Name of variety.	Length of Straw.	Character of Straw.	Length of Head.	Date of Sowing.	Date of Ripening.	Number of days Maturing.	Yield per Acre.		Weight per Bushel.	Proportion Rusted.
	Inches.		Inches.				Bus. lbs.	Lbs.		
Mensury.....	31 to 44	Fair..	2 $\frac{3}{4}$ to 3 $\frac{3}{4}$	May 29	Aug. 10	73	47	24	46 $\frac{1}{2}$	Slightly.
Swedish female, with Baxter's six-rowed male, garden type.....	30 to 34	Stiff..	2 to 3	do 27	do 11	76	44	28	47 $\frac{3}{4}$	do
Common six-rowed.....	33 to 42	Fair..	2 $\frac{1}{2}$ to 3	do 27	do 6	71	41	32	48 $\frac{3}{4}$	do
Odessa.....	28 to 33	do	2 $\frac{1}{2}$ to 3	do 29	do 11	74	38	26	46	do
Summit.....	30 to 36	do	2 $\frac{1}{2}$ to 3 $\frac{1}{4}$	do 27	do 11	76	35	18	48 $\frac{3}{4}$	do
Rennie's Improved.....	33 to 41	Stiff..	2 to 3	do 29	do 8	71	34	8	48 $\frac{3}{4}$	do
Baxter's female, with another barley male, name lost.....	34 to 40	Fair..	2 to 2 $\frac{3}{4}$	do 27	do 8	73	33	16	48	do
Baxter's.....	33 to 38	do	2 to 2 $\frac{3}{4}$	do 27	do 9	74	29	8	48 $\frac{1}{2}$	do
Surprise.....	31 to 36	Stiff..	2 to 3	do 27	do 12	77	28	14	47	do
Oderbruch.....	30 to 39	do	2 $\frac{1}{2}$ to 3	do 29	do 9	72	25	40	48 $\frac{1}{2}$	do
Guaymalaye Hulless.....	24 to 36	Weak	3 to 3 $\frac{1}{4}$	do 29	do 1 $\frac{1}{2}$	82	16	12	49 $\frac{1}{2}$	do
Petschora.....	30 to 36	Fair..	2 $\frac{3}{4}$ to 3 $\frac{1}{2}$	do 29	do 8	71	15	40	43 $\frac{1}{2}$	do

## Experimental Farms.

### FIELD CROPS OF BARLEY.

*Duck-bill, Two-rowed.*—On sandy loam; previous crop was vegetables; ploughed in spring of 1893, and harrowed with smoothing harrow before sowing,  $2\frac{1}{2}$  acres; sown May 12th,  $1\frac{3}{4}$  bushels per acre; ripe, August 7th; time to mature, 87 days; yield per acre, 22 bushels, 15 lbs.; weight per bushel,  $42\frac{1}{2}$  lbs.; length of head,  $3\frac{1}{2}$  to  $3\frac{3}{4}$  inches; length of straw, 39 to 43 inches, all standing well but considerably rusted; no smut.

*Oderbruch, Six-rowed.*—On light sandy loam; previous crop was corn; land ploughed in autumn of 1892; gang-ploughed in spring of 1893, and harrowed before sowing; 2 acres; sown May 31st;  $1\frac{3}{4}$  bushels per acre; ripe, August 10th; time to mature, 71 days; yield per acre, 22 bushels 19 lbs.; weight per bushel,  $46\frac{1}{2}$  lbs.; length of head,  $2\frac{1}{2}$  to 3 inches; length of straw, 28 to 30 inches; all standing well, but rusted considerably; a very few heads of smut.

*Baxter's Six-rowed.*—On light sandy loam; previous crop was corn; ploughed in autumn of 1892; gang ploughed in spring of 1893, and harrowed before sowing; 1 acre; sown, May 31st;  $1\frac{3}{4}$  bushels per acre; ripe, August 10th; time to mature, 71 days; yield per acre, 14 bushels, 33 lbs.; weight per bushel, 48 lbs.; length of head, 2 to  $2\frac{1}{2}$  inches; length of straw, 30 to 32 inches; all standing well; a considerable quantity of smut, and more or less rust.

*Rennie's Improved Six-rowed.*—This was grown alongside of Baxter's six-rowed, on similar soil; the preparation of the land was the same;  $2\frac{1}{2}$  acres; sown, May 31st;  $1\frac{3}{4}$  bushels per acre; ripe, August 11th; time to mature, 72 days; yield per acre, 19 bushels, 33 lbs.; weight per bushel,  $47\frac{1}{2}$  lbs.; length of head,  $2\frac{1}{2}$  to 3 inches; length of straw, 32 to 36 inches; all standing well; very little smut, but somewhat rusted.

### EXPERIMENTS WITH OATS.

The rust which struck the wheat and barley about the middle of July affected the oats to a much greater extent, spreading over leaves, stems and panicles, and exhausting the plants to such a degree that early in August, in most cases, all growth appeared to have ceased, and the grain dried up prematurely; comparatively few of the kernels filled, and the crop for the greater part was very light both in yield and weight of grain. To publish particulars of such results would only tend to mislead, as no satisfactory evidence could be gained of relative earliness or yield under such conditions. In many instances those oats grown on the heaviest and best soils, which under ordinary conditions would have given good returns, gave the poorest results. The best yield was from a field of a variety known as Abundance, which gave 36 bushels 11 lbs. per acre, weighing  $33\frac{1}{2}$  lbs. per bushel, while the same variety grown on a heavier and better soil was so eaten up with rust that it gave only 11 bushels 11 lbs. per acre, weighing 20 lbs. per bushel.

### SPRAYING FOR RUST.

About the time when the rust began to appear one-half of a large number of experimental plots of oats and wheat were carefully sprayed from top to bottom with the usual solution of copper carbonate, and on some of the plots the spraying was tried a second time but there was no perceptible difference between the sprayed and unsprayed portions, the remedy seemed to have no influence in staying the progress of the rust.

## EXPERIMENTS WITH PEASE.

Twelve varieties of pease were sown on plots of  $\frac{1}{10}$ th of an acre each as a test of relative earliness and productiveness. All were sown on 29th May, and in the following table will be found the particulars of the results obtained. The soil was clay loam, adjoining the  $\frac{1}{10}$ th acre plots of barley, and had similar preparation.

TEST OF VARIETIES OF PEASE.

Name of variety.	Date of Ripening.	No. of days Maturing.	Yield per Acre.		Weight per Bushel.
			Bush.	Lbs.	Lbs.
Canadian Beauty .....	Sept. 1 .....	95	34	40	61 $\frac{3}{4}$
Prussian Blue .....	Aug. 30 .....	93	33	30	62 $\frac{3}{4}$
Prince Albert .....	Sept. 2 .....	96	29	..	62 $\frac{1}{4}$
Pride .....	Aug. 21 .....	84	27	50	62
Large White Marrowfat.....	do 30 .....	93	26	20	61 $\frac{1}{4}$
Centennial .....	do 25 .....	88	25	10	61 $\frac{1}{4}$
Black-eyed Marrowfat.....	do 30 .....	93	24	..	60 $\frac{3}{4}$
Crown .....	do 28 .....	91	23	20	62 $\frac{1}{4}$
Multiplier .....	do 30 .....	93	22	50	62 $\frac{1}{4}$
New Potter .....	do 30 .....	93	22	50	61
Mummy .....	do 23 .....	86	22	40	62
Golden Vine .....	do 28 .....	91	18	20	61 $\frac{1}{4}$

## OTHER PLOTS OF PEASE.

*Canadian Beauty*.—Sown on light sandy loam, previous crop was oats; ploughed in autumn of 1892, gang-ploughed and harrowed in spring of 1893,  $\frac{1}{8}$  acre. Sown May 27th, 2 $\frac{1}{2}$  bushels per acre, ripe August 25th, time to mature, 90 days, yield per acre, 35 bushels, weight per bushel, 61 $\frac{1}{2}$  lbs.

*New Potter*.—Adjoining Canadian Beauty on similar soil with same treatment  $\frac{1}{8}$  acre, sown May 27th, 2 $\frac{1}{2}$  bushels per acre, ripe August 25th, time to mature 90 days, yield per acre, 30 bushels 49 lbs., weight per bushel, 62 $\frac{3}{4}$  lbs.

*Centennial*.—On light sandy loam, ploughed in autumn of 1892, on which was spread a light coating of manure, about ten tons per acre, in spring of 1893, which was turned under with gang plough and harrowed before sowing;  $\frac{1}{2}$  acre. Sown May 27th, 2 $\frac{1}{2}$  bushels per acre, ripe August 25th, time to mature, 90 days, yield per acre, 30 bushels 15 lbs., weight per bushel, 61 $\frac{1}{4}$  lbs.

*Golden Vine*.—Sown on land adjoining Centennial, of same character and received same treatment,  $\frac{1}{2}$  acre. Sown May 27th, 2 $\frac{1}{2}$  bushels per acre, ripe August 25th, time to mature, 90 days, weight per bushel, 62 lbs.

## FALL RYE.

Variety *Reading Giant* sown on light sandy soil, previous crop was partly oats and partly wheat. Land ploughed, then harrowed three times, no manure was used. Sown Sept. 8th, 1892, 1 $\frac{1}{2}$  bushels per acre, ripe July 27th, 1893, yield per acre, 25 bushels 8 lbs., weight per bushel, 54 lbs.; length of head, 3 to 3 $\frac{1}{2}$  inches, average length of straw, 58 inches, badly lodged, no rust or smut.

## EXPERIMENTS WITH TURNIPS.

Eighteen varieties were tested in 1893 in experimental plots in two sets sown eight days apart. In sowing the first set only fourteen varieties of seed were used and they were sown 1st June in rows 2 $\frac{1}{2}$  feet apart, the second series with eighteen



## Experimental Farms.

varieties was sown 9th June also 2½ feet apart. Both were pulled on the 25th October. The yield per acre has been calculated from the quantity obtained from 2 rows, 33 feet long and 2½ feet apart.

The land used for these experiments was a heavy sandy loam of good quality which was manured in the fall of 1891, about 18 tons being applied to the acre and an oat crop was grown on it in 1892. It was ploughed from 7 to 8 inches deep in the autumn of 1892, and gang-ploughed in the spring of 1893 and harrowed three times and rolled before sowing. The seed was sown on the flat which we find to be less economical than in ridges, the crop requiring more labour in thinning and hoeing than when sown in ridges.

The rot which has prevailed in the turnips here for the past two years and was referred to in the annual report for 1892 injured the crop again this year, but in a less degree than formerly, the injury however has been sufficient to lessen the yield very much.

### EXPERIMENTS WITH TURNIPS—FIRST SERIES—SOWN JUNE 1ST.

Name of variety.	Yield per Acre.		Yield per Acre.	
	Tons.	Lbs.	Bush.	Lbs.
Marquis of Lorne.....	16	1,132	552	12
Prize Purple Top.....	13	1,456	457	36
Carter's Prize Winner.....	13	400	440	00
Bangholm Improved.....	12	156	402	36
Jumbo or Monarch (Steele).....	11	1,628	393	48
Mixed, from Agassiz, B.C.....	10	1,648	360	48
Mammoth Purple Top.....	10	1,120	352	00
Carter's Elephant Swede.....	10	592	343	12
Bronze Purple Top.....	9	1,800	330	00
Sutton's Champion.....	8	1,424	290	24
Skirving's Purple Top.....	8	1,160	286	00
Selected East Lothian.....	8	764	279	24
Jumbo or Monarch (Vilmorin).....	8	764	279	24
Clyde Improved.....	6	1,992	233	12

### EXPERIMENTS WITH TURNIPS—SECOND SERIES—SOWN JUNE 9TH.

Name of variety.	Yield per Acre.		Yield per Acre.	
	Tons.	Lbs.	Bush.	Lbs.
Carter's Elephant Swede.....	14	908	481	48
Selected East Lothian.....	13	796	446	36
Purple Top, seed grown at Agassiz, B.C.....	12	552	409	12
Clyde Improved.....	11	572	376	12
Bronze Purple Top.....	11	440	374	00
Simmer's Giant Swede.....	11	440	374	00
Skirving's Purple Top.....	11	176	369	36
Jumbo or Monarch (Vilmorin).....	10	856	347	36
Marquis of Lorne.....	10	64	334	24
Prize Purple Top.....	9	1,800	330	00
Simmer's Champion Purple Top.....	9	744	312	24
Carter's Prize Winner.....	8	1,688	294	48
Elephant Swede (Agassiz).....	7	1,972	266	12
Sutton's Champion.....	7	784	246	24
Mixed, from Agassiz.....	7	652	244	12
Bangholm Improved.....	7	124	235	24
Mammoth Purple Top.....	6	672	211	12
Jumbo or Monarch (Steele).....	4	844	147	24

## EXPERIMENTS WITH MANGELS.

Ten varieties of mangels were sown on land adjoining the turnips; the treatment and preparation of the soil will be found under that heading. The seed was sown in rows  $2\frac{1}{2}$  feet apart, and the plants afterwards thinned out to 8 to 12 inches apart. Two sets of these plots were sown, the first on 1st June, the second on 9th June; both were pulled 25th October. The yield per acre has been calculated from the result obtained from two rows each 33 feet long and  $2\frac{1}{2}$  feet apart.

## EXPERIMENTS WITH MANGELS—FIRST SERIES—SOWN 1ST JUNE.

Name of variety.	Yield per Acre.		Yield per Acre.	
	Tons.	Lbs.	Bush.	Lbs.
Champion Yellow Globe.....	21	504	708	24
Mammoth Long Red.....	20	656	677	36
Giant Yellow Intermediate.....	19	16	633	36
Canadian Giant.....	17	1,904	598	24
Gate Post.....	17	1,640	594	00
Red Globe.....	17	584	576	24
Warden Orange Globe.....	14	1,964	499	24
Golden Tankard.....	13	1,720	462	00
Red Fleshed Tankard.....	13	1,720	462	00
Erfurt Model.....	12	1,872	431	12

## EXPERIMENTS WITH MANGELS—SECOND SERIES—SOWN 9TH JUNE.

Name of variety.	Yield per Acre.		Yield per Acre.	
	Tons.	Lbs.	Bush.	Lbs.
Giant Yellow Intermediate.....	21	1,560	726	00
Red Globe.....	21	768	712	48
Mammoth Long Red.....	18	300	605	00
Champion Yellow Globe.....	17	452	574	12
Golden Tankard.....	16	1,264	554	24
Gate Post.....	14	512	475	12
Canadian Giant.....	12	816	413	36
Warden Orange Globe.....	12	156	402	36
Red Fleshed Tankard.....	10	1,912	365	12
Erfurt Model.....	8	764	279	24

## EXPERIMENTS WITH CARROTS.

Eleven varieties of carrots were sown on land adjoining the mangels, and similar in character; the treatment and preparation of the soil was the same as that for turnips, and the particulars will be found under that heading. The seed was sown on the flat, in rows 18 inches apart. There were two sets of plots; the first sowing was on 1st June, the second on 9th June, and they were both pulled 25th and 26th October. The yield per acre has been calculated from the produce of two rows 33 feet long and 18 inches apart.

## Experimental Farms.

### FIRST SERIES, sown 1st June.

Name of variety.	Yield per Acre.		Yield per Acre.	
	Tons.	Lbs.	Bush.	Lbs.
Mammoth White Intermediate .....	28	320	938	40
Giant Short White .....	27	1,440	924	00
Improved Short White .....	25	1,920	865	20
White Belgian .....	24	840	814	00
Large Short White Vosges .....	23	640	770	20
Chantenay Half Long Scarlet .....	22	660	744	20
Early Gem .....	18	300	605	00
Half Long Coreless .....	17	1,640	594	00
Half Long Red Danvers .....	16	1,880	564	40
Carter's Orange Giant .....	15	1,240	520	40
Long Scarlet Altringham .....	12	860	414	20

### SECOND SERIES, SOWN 9TH JUNE.

Name of variety.	Yield per Acre.		Yield per Acre.	
	Tons.	Lbs.	Bush.	Lbs.
Mammoth White Intermediate .....	30	1,600	1,026	40
Improved Short White .....	28	1,200	953	20
Giant Short White .....	25	160	836	00
White Belgian .....	20	1,140	685	40
Large Short White Vosges .....	19	940	649	00
Half Long Red Danvers .....	19	720	645	20
Carter's Orange Giant .....	19	60	634	20
Chantenay Half Long Scarlet .....	17	1,200	586	40
Early Gem .....	17	540	575	40
Half Long Coreless .....	13	1,940	465	40
Long Scarlet Altringham .....	11	1,760	396	00

### EXPERIMENTS WITH SUGAR-BEETS.

Four varieties of sugar-beets were sown during 1893 on land adjoining that on which the mangels were sown. The treatment of the soil and its preparation will be found under the heading of turnips. There were two series of plots: one was sown on 1st June, the second on 9th June, and both were pulled 25th October. The seed was sown on the flat, in rows 18 inches apart and the yield per acre has been calculated from the weight of roots obtained from two rows each 33 feet long and 18 inches apart.

#### EXPERIMENTS WITH SUGAR BEETS.—FIRST SERIES, SOWN 1ST JUNE.

Name of variety.	Yield per Acre.		Yield per Acre.	
	Tons.	Lbs.	Bush.	Lbs.
White Green Top Brabant Improved .....	20	700	678	20
French .....	17	100	568	20
Klein Wanzleben .....	15	360	506	00
White Improved .....	15	140	502	20

## EXPERIMENTS WITH SUGAR BEETS.—SECOND SERIES, SOWN 9TH JUNE.

Name of variety.	Yield per Acre.		Yield per Acre.	
	Tons.	Lbs.	Bush.	Lbs.
French.....	19	1,600	660	00
White Green Top Brabant Improved.....	18	740	612	20
Klein Wanzleben.....	17	1,860	597	40
White Improved.....	17	100	568	20

## THE BEET-SUGAR INDUSTRY.

Much interest has attached for many years past to the cultivation of sugar beets, on account of the high percentage of sugar with which they can now be grown, also for the reason that so large a proportion, considerably more than one half, of the world's supply of sugar is now made from the sugar-beet. For several years past experiments have been carried on at the experimental farms and elsewhere with the best seed obtainable from many sources. The results of these tests indicate (as shown in the analyses published by the Chemist of the Farms in previous reports) that the sugar-beet grown in most parts of Canada when raised from the best seed will on the average contain as large a percentage of sugar as similar beets grown in any other part of the world.

During the latter part of 1891 the Dominion Government caused an inquiry to be made in regard to this industry and I was requested to undertake the work. On the 28th of October of that year I visited the beet-sugar factory at Farnham, Quebec, the only factory then in operation in Canada. I then proceeded to Philadelphia where I obtained from a son of Mr. Claus Spreckles information regarding the recent progress of the beet-sugar industry in California. Washington was next visited and much additional information obtained from Dr. H. W. Wiley, Chemist of the Department of Agriculture, whose general investigations into this subject have given him a world wide reputation. I also visited the beet-sugar factories in operation at Grand Island and Norfolk in Nebraska, where all the information desired was given me by the proprietors, Messrs. Oxnard Bros. On my return a report was prepared on this subject which was submitted to the Honourable Minister of Finance on the 1st of February, 1892 and subsequently distributed in the House of Commons. In this report the rise and progress of this industry in Europe, the United States and Canada were sketched; the various systems of bounty (without which it does not appear that this industry could be sustained) were explained and statistics given as to the relative cost of production of cane and beet-sugar. In summing up the evidence presented, the following remarks were made:—"It is probable that the strongest objection to the encouragement of this industry on the only basis on which it is claimed it could be established, will be found in the fact that it would require when fully developed an annual subsidy of about \$4,000,000 for the raising of which as long as we have free sugar, other industries must be taxed. This subsidy might in the course of time be lessened, but in view of all the facts presented, of the greater richness of the sugar cane when grown in the tropics and the probabilities of further improvements in the quality of the cane and in the process of manufacture it is not likely that the bounty could ever be much reduced without crippling the industry."

In the second part of this report the improvement of the sugar-beet is treated of, the most improved methods of cultivation explained and other related subjects discussed. This report was favourably received by the larger part of the press of Canada and many copies have been solicited by parties interested in this subject in the United States including Senators and Members of Congress.\*

\* Copies of this report may be had on application.

# Experimental Farms.

## EXPERIMENTS WITH POTATOES.

Sixty-one varieties of potatoes have been tested side by side on sandy loam of medium quality. The land received a coating of manure of about 18 tons per acre in the autumn of 1892, which was at once ploughed under. In the spring of 1893, the land was gang-ploughed and harrowed twice.

In planting, the seed end of the potatoe was cut off and rejected and the tubers then cut into pieces with two or three strong eyes, planted one foot apart in the rows, with the rows  $2\frac{1}{2}$  feet apart, the seed was then covered with a hoe. The potatoes were planted from May 27th to 30th, came up June 12th to 15th, and were harvested on the 19th September.

TEST of Varieties of Potatoes.

Name of variety.	Size of Plot.	Total Yield per acre of Sound and Rotten.	Yield per acre of Sound.	Yield per acre of Marketable.	Yield per acre of Unmar- ketable.	Yield per acre of Rotten.
		Feet.	Bush. Lbs.	Bush. Lbs.	Bush. Lbs.	Bush. Lbs.
Burnaby Seedling.....	66 x 2 $\frac{1}{2}$	347 36	96 48	90 12	6 36	250 48
Geo. McKenzie, from.....	66 x 2 $\frac{1}{2}$	341 00	121 00	116 36	4 24	220 00
Seattle.....	132 x 2 $\frac{1}{2}$	322 18	113 18	111 06	2 12	209 00
White Beauty.....	132 x 2 $\frac{1}{2}$	321 12	107 48	100 06	7 42	213 24
Crown Jewel.....	132 x 2 $\frac{1}{2}$	315 42	90 12	82 30	7 42	225 30
Holborn Abundance.....	132 x 2 $\frac{1}{2}$	315 42	237 36	221 06	16 30	78 06
London.....	132 x 2 $\frac{1}{2}$	315 42	146 18	136 24	9 54	169 24
Sharpe's Seedling.....	132 x 2 $\frac{1}{2}$	309 06	165 00	156 12	8 48	144 06
Dakota Red.....	132 x 2 $\frac{1}{2}$	297 00	209 00	194 42	14 18	88 00
Lee's Favourite.....	132 x 2 $\frac{1}{2}$	292 36	161 42	147 24	14 18	130 54
Daisy.....	132 x 2 $\frac{1}{2}$	288 12	118 48	104 30	14 18	169 24
Pearce's Extra Early.....	132 x 2 $\frac{1}{2}$	281 36	96 48	83 36	13 12	184 48
Northern Spy.....	132 x 2 $\frac{1}{2}$	278 18	151 48	140 48	11 00	126 30
Clark's No. 1.....	132 x 2 $\frac{1}{2}$	278 18	148 30	139 42	8 48	129 48
Early Ohio.....	132 x 2 $\frac{1}{2}$	276 06	103 24	93 30	9 54	172 42
Thorburn.....	132 x 2 $\frac{1}{2}$	264 00	103 24	96 48	6 36	160 36
Everett.....	132 x 2 $\frac{1}{2}$	261 48	125 24	118 48	6 36	136 24
Early Thorburn.....	132 x 2 $\frac{1}{2}$	261 48	125 24	118 48	6 36	136 24
do Sunrise.....	132 x 2 $\frac{1}{2}$	257 24	93 30	91 18	2 12	163 54
do Puritan.....	132 x 2 $\frac{1}{2}$	255 12	124 18	106 42	17 36	130 54
Harbinger.....	132 x 2 $\frac{1}{2}$	253 00	112 12	103 24	8 48	140 48
I. X. L.....	66 x 2 $\frac{1}{2}$	253 00	57 12	53 54	3 18	195 48
T. K. Fullerton, from.....	132 x 2 $\frac{1}{2}$	253 00	73 42	.....	.....	179 18
Vick's Extra Early.....	132 x 2 $\frac{1}{2}$	253 00	58 18	51 42	6 36	194 42
Rural Blush.....	132 x 2 $\frac{1}{2}$	251 54	206 48	174 54	31 54	45 06
State of Maine.....	132 x 2 $\frac{1}{2}$	250 48	61 36	56 06	5 30	189 12
Empire State.....	132 x 2 $\frac{1}{2}$	248 36	71 30	67 06	4 24	177 06
Lizzie's Pride.....	66 x 2 $\frac{1}{2}$	246 24	165 00	158 24	6 36	81 24
Polaris.....	132 x 2 $\frac{1}{2}$	240 54	96 48	86 54	9 54	144 06
Lee's Favourite, Mrs. Foster	132 x 2 $\frac{1}{2}$	240 54	83 36	.....	.....	157 18
Hale's Champion.....	132 x 2 $\frac{1}{2}$	234 18	.....	.....	.....	.....
Chicago Market.....	132 x 2 $\frac{1}{2}$	232 06	89 06	82 30	6 36	143 00
Early Rose, C. E. F.....	132 x 2 $\frac{1}{2}$	226 36	107 48	100 06	7 42	118 48
Beauty of Hebron.....	132 x 2 $\frac{1}{2}$	221 06	144 06	128 42	15 24	77 00
Early Rose, Brandon.....	132 x 2 $\frac{1}{2}$	216 42	77 00	69 18	7 42	139 42
Green Mountain.....	132 x 2 $\frac{1}{2}$	214 30	40 42	38 30	2 12	173 48
Burpee's Extra Early.....	132 x 2 $\frac{1}{2}$	213 24	70 24	64 54	5 30	143 00
Vamier.....	132 x 2 $\frac{1}{2}$	212 18	176 00	155 06	20 54	36 18
Irish Champion.....	132 x 2 $\frac{1}{2}$	207 00	104 30	75 54	28 36	103 24
Hopeful.....	132 x 2 $\frac{1}{2}$	201 00	50 36	46 12	4 24	150 42
Blue Cup.....	66 x 2 $\frac{1}{2}$	195 48	83 36	77 00	6 36	112 12
Seedling No. 214.....	132 x 2 $\frac{1}{2}$	178 12	82 30	78 06	4 24	95 42
do No. 115.....	132 x 2 $\frac{1}{2}$	172 42	9 54	9 21	0 33	162 48
do No. 230.....	132 x 2 $\frac{1}{2}$	171 36	27 30	20 54	6 36	144 06
Algoma No. 1.....	132 x 2 $\frac{1}{2}$	169 24	36 18	35 45	0 33	133 06
Early Gem.....	132 x 2 $\frac{1}{2}$	163 54	55 00	40 42	14 18	108 54

TEST of varieties of Potatoes—*Concluded.*

Name of variety.	Size of Plot.	Total Yield per acre of Sound and Rotten.		Yield per acre of Sound.	Yield per acre of Marketable.	Yield per acre of Unmarketable.	Yield per acre of Rotten.				
		Bush.	Lbs.	Bush. Lbs.	Bush. Lbs.	Bush. Lbs.	Bush. Lbs.				
Seedling No. 25.....	132 x 2 $\frac{1}{2}$	161	42	84	42	67	06	17	36	77	00
Vanguard.....	132 x 2 $\frac{1}{2}$	160	36	27	30	26	57	0	33	133	06
Pearce's Prize Winner.....	132 x 2 $\frac{1}{2}$	147	24	40	42	36	18	4	24	106	42
Delaware.....	132 x 2 $\frac{1}{2}$	143	00	15	24	14	18	1	06	127	36
Bras d'Or Seedling.....	132 x 2 $\frac{1}{2}$	137	30	39	36	33	00	6	36	97	54
Manitoba Kidney White.....	132 x 2 $\frac{1}{2}$	109	27	0	33					108	54
Seedling No. 33.....	132 x 2 $\frac{1}{2}$	102	18	7	42	6	36	1	06	94	36
do No. 54.....	132 x 2 $\frac{1}{2}$	90	12	8	48	7	42	1	06	81	24
do No. 77.....	132 x 2 $\frac{1}{2}$	80	18	8	48	6	36	2	12	71	30
Red River Valley.....	132 x 2 $\frac{1}{2}$	72	36							72	36
Seedling No. 188.....	132 x 2 $\frac{1}{2}$	56	39	3	51	3	18	0	33	52	48
Brant.....	66 x 2 $\frac{1}{2}$	52	48	2	12					50	36
Seedling V.....	66 x 2 $\frac{1}{2}$	48	24	24	12	17	36	6	36	24	12
do No. 140.....	132 x 2 $\frac{1}{2}$	30	48	2	12	1	39	0	33	28	36
do X.....	66 x 2 $\frac{1}{2}$	22	00	6	36	4	24	2	12	15	24

## THE HAY CROP.

The crop of hay at the Central Experimental Farm has been remarkably good during the past season. About 104 tons have been harvested of extra good quality, the yield running from 2 to 2 $\frac{1}{2}$  tons per acre. This important fodder crop has also given very satisfactory returns over the larger part of the provinces of Ontario and Quebec.

In view of the very short supply of hay in Great Britain and some of the countries on the continent of Europe, and the consequent high prices prevailing, it was deemed desirable that the attention of Canadian farmers should be promptly called to the importance of making the best of the advantage which this shortage offered, and by taking extra care in the curing of their hay to have it of that quality which would command a ready sale at the highest price.

On the 30th of June, 1893, copies of the following letter were sent to the press which was generally and widely published and commented on:

## HAY FOR THE ENGLISH MARKET.

To the Editor of ———.

SIR,—Hay is the most important and valuable of all Canadian crops, and this year the yield promises to be most abundant. The scarcity in Europe has led to increased demand in Canada, and if the incoming crop be of good quality and well cured it will no doubt command high prices. Hay containing a considerable proportion of clover is preferred in Great Britain, and this is more difficult to cure properly than hay composed chiefly of timothy. Permit me to draw the attention of farmers generally, through your columns, to the method of curing hay practised at the Central Experimental Farm, where under the good management of the farm foreman it has given excellent results. It is also, I find, the practice of many of the best Canadian farmers. When the first flower-heads of the clover have about half withered cut the hay in the morning, after the dew is off, and begin at 1 p.m. to shake it up with forks or tedder, and cock up early enough in the afternoon to permit of the work being completed before the dew falls in the evening. The cocks are allowed to stand undisturbed the next day, but during the following morning

## Experimental Farms

the hay is spread again to finish the drying, and drawn to the barn or stack before evening. If favoured with fine weather, the hay so cured will be of excellent colour, quality and fragrance, and will command the highest price. If the weather is unfavourable or showery, keep the hay in cocks until it becomes fine again. Many farmers adopt the plan of allowing the newly cut hay to dry at once, as it falls from the mower, without putting it in cocks. Hay so cured is usually more or less bleached and does not retain the fine colour and aroma which distinguishes hay of first quality, and does not command so ready a sale or so high a price.

WM. SAUNDERS,

*Director Experimental Farms.*

Ottawa, June 30th, 1893.

The attention of English dealers in hay was also called to the large surplus which Canada would have to offer, and letters of inquiry from prominent firms in Great Britain and France, were published in the press, as received. The attention of the Eastern Boards of Trade was also called to this matter, and many letters written to the larger dealers in Canada giving them information. A considerable foreign demand for Canadian hay was thus created, and large shipments have been made.

### SMUT IN WHEAT.

For several years past much depreciation has occurred in the value of wheat in Manitoba and the North-west Territories from the presence of bunt or stinking smut. This parasitic fungus has infested the grain in large percentage, and owing to the unpleasant odour of the spores which attach themselves to the grain during the process of threshing, much wheat which would otherwise have commanded a good price has been reduced in value and sometimes rendered unsalable.

In *Bulletin 3* of the Experimental Farm series, published in March, 1888, prepared by Mr. James Fletcher, Entomologist and Botanist to the Experimental Farms, this subject was brought prominently before the farmers of Canada, the life history of this and another species of smut which injures cereals, described, and remedies recommended for preventing the injury they cause.

Since that time systematic experiments have been carried on at the Experimental Farms at Brandon, Man., and Indian Head, N.W.T., which have demonstrated that blue-stone, or copper sulphate (a remedy long used in England for this purpose), is a most economical and reliable means of preventing this evil. The results of these experiments have been fully presented in the annual reports of the experimental farms, but in order to bring the matter more immediately and prominently under the notice of the farmers in the Canadian North-west, who are the chief sufferers from this trouble, a circular was prepared embodying in a condensed form the results of the experience gained, with directions for the use of the remedy, and 25,000 of these were printed and distributed among the western farmers a few weeks before the period of sowing. The following is a copy of the circular:—

TO THE FARMERS OF MANITOBA AND THE NORTH-WEST TERRITORIES.

#### SMUT IN WHEAT.

The heavy losses which have of late years fallen on many farmers in Manitoba and the North-west Territories from depreciation in the value of their wheat from the presence of smut, should be a warning to every settler to adopt the preventive measures which have been thoroughly tested and shown to be efficient on the Dominion Experimental Farms at Brandon, Man., and Indian Head, N.W.T.

The "bunt" or "stinking" smut is the result of a fungous growth which is propagated by very minute spores, visible only with a magnifying glass of high power. These spores are scattered over the wheat by the breaking of the "smut balls" during the process of threshing, and they give to the grain a characteristic and offensive odour. If smutty wheat be sown untreated these spores will vegetate

and develop minute thread-like growths, which find their way through the tissues of the young wheat plant, and multiply in the sap. Later in the season a proportion of the kernels in the head will be found to have their normal contents entirely consumed, to have become unnaturally swollen and the interior filled with a black mass of smut spores. These altered and swollen kernels are commonly known as "smut balls." Full particulars of the life history of this species of smut will be found in bulletin No. 3 of the Experimental Farm series, prepared by Mr. Jas. Fletcher, Entomologist and Botanist.

#### REMEDY.

Dissolve one pound of bluestone (copper sulphate) in a pailful and a half of water (about three gallons) and sprinkle the solution on ten bushels of seed wheat, previously spread in a tight wagon box, or on a clear floor space in barn or house, keeping the grain constantly stirred while the solution is being applied, and mixing the whole thoroughly so that every kernel of the wheat may be wetted. In a very few hours the seed will be in good condition to sow with the drill. A good plan is to apply the treatment in the evening and sow the grain the following morning. If the water be used warm and the lumps of bluestone be broken, the solution may be made in a few minutes. As the solution of bluestone lessens in some degree the germinating power of wheat, and more so when it remains long in contact with it, the safe plan is to treat the seed but a short time before sowing.

In the tests which have been carried on with this remedy for the past three years at the Experimental Farms at Brandon and Indian Head, the worst smutted samples procurable have been selected for sowing, and the results have shown, by comparing the crop from the treated with that from the untreated grain, that this remedy is thoroughly efficient. It is also easy of application, and its cost is trifling; usually about one cent per bushel of seed.

It has been often observed that a smutty crop will sometimes result when good clean seed has been sown. This is believed to arise from smut spores in the soil coming in contact with the grain when germinating. As millions of these spores are spread in all directions by wind during the period of threshing and carried long distances, there are doubtless large numbers of them in the soil in all the wheat growing districts of the country. Hence it is much safer to treat all seed before sowing, whether it is perceptibly smutty or not, as the coating of bluestone on the treated grain will protect the seed from attack by spores in the soil.

Having thoroughly satisfied ourselves of the efficacy and reliability of this remedy, and of the importance of its general use, we would strongly recommend that all seed during the coming season be treated in accordance with the directions here given, believing that every settler who acts on this advice will realize an increased crop, which will bring a higher price, and he will also assist in raising the standard of quality of the wheat grown in Manitoba and the North-west Territories to one of uniform excellence.

WM. SAUNDERS,

*Director Experimental Farms, Ottawa.*

S. A. BEDFORD,

*Supt. Experimental Farm, Brandon, Man.*

ANGUS MACKAY,

*Supt. Experimental Farm, Indian Head, N.W.T.*

The Winnipeg Board of Trade also issued a circular on this subject, and the press generally commented on the necessity of farmers everywhere using this remedy, so that this evil might be lessened, and if possible, stamped out. The results have been most gratifying; many tons of bluestone were bought and used in the manner directed, and the crop of this year is said to be almost entirely free from smut. As a precautionary measure this method of treating the wheat should be continued for several years.



## Experimental Farms.

### WORLD'S COLUMBIAN EXPOSITION.

On the 11th of January, 1892, I was appointed by Order in Council, Executive Commissioner for Canada in connection with the World's Columbian Exposition, a position which was held until the 21st of November in that year. Over ten months of incessant and heavy labour in the endeavour to discharge this duty, in addition to the work devolving on me as Director of the Experimental Farms, brought about a condition of ill-health and exhaustion which made my resignation a necessity. In the meantime, however, all the preliminary work had been completed. After a number of visits to Chicago, sufficient space was secured in excellent locations in all the buildings, a most important measure towards success, and as a result of much effort, an admirable site was obtained for a Canadian building, to serve as an office building for the Commissioners and a meeting place for visiting Canadians.

The grand dairy exhibit was arranged and provided for. The Governments of all the provinces were interviewed and negotiations conducted, the departments of work which each were to undertake agreed on, and the hearty co-operation of nearly all the provinces secured. With the able assistance of Mr. J. S. Larke (who was subsequently appointed my successor), Mr. Lucien Huot of Montreal, Mr. W. D. Dimmock of Truro, N.S., and Mr. E. A. Charters, of Sussex, N.B., the greater part of the exhibits had been secured, the particulars of which are given in my report of the progress of the work published a few weeks after my resignation.\* The way was thus prepared for the brilliant success which has crowned the efforts of our people.

To make the agricultural exhibits from the Experimental Farms as complete as possible, special sowings were made in the spring of 1892, of a very large number of different sorts of grain and seeds, and a lively interest awakened in this undertaking among all the officers connected with these institutions. In this way the finest collection of Canadian agricultural products ever seen was made available, and subsequently clothed the grand trophy which attracted so much attention in the Agricultural court.

Before the time arrived for beginning the work of placing the exhibits, my health was so far restored as to enable me to render further aid in the carrying out of this great undertaking, and at the special request of the Minister of Agriculture, and of my successor in the office of Executive Commissioner, I consented to undertake the designing and arranging of all the exterior decorations of the agricultural court, also the construction of the great central trophy, and to render what help I could by assisting in the arrangement of the products in portions of the interior of the court.

After consultation with Mr. D. Ewart, of the Chief Architect's office, Department of Public Works, he prepared a plan of the woodwork on which the decorations were to be placed which served the purpose admirably, he also supervised its construction. As soon as the preparations for the work were sufficiently advanced, I secured the able assistance of Mr. W. H. Hay, the accountant at the Central Experimental Farm, and Mr. J. Fixter, the Farm foreman, both of whom brought to bear on this undertaking much practical experience, gained at previous provincial and other exhibitions. We were also assisted by Mr. S. A. Bedford, Superintendent of the Experimental Farm at Brandon, and Mr. A. Mackay, the Superintendent of the Experimental Farm at Indian Head. With these competent assistants the work made rapid progress, and in two or three weeks it was so well advanced that all returned to their other duties, excepting Mr. Hay, who remained to complete the work which had been planned, which he did with good judgment and taste and much credit to himself.

The exterior decorations of the court were very much admired, the interior work was equally good, and the Canadian exhibit as a whole was generally conceded to be the finest agricultural display in the building. It was arranged in provincial groups, in which all the provinces, excepting Manitoba and New Brunswick

---

\* Copies of this Report may still be had on application.

were represented. The exhibit of Ontario (which included an excellent selection of samples from the Agricultural College at Guelph), was especially fine; Quebec came next in importance, followed by the North-west Territories, British Columbia, Nova Scotia and Prince Edward Island, all the displays being excellent both in the quality and variety of the articles shown.

The large central trophy was covered entirely with the products of the several Experimental Farms, from which sources were also obtained the materials for the exterior decoration of the court. Since Manitoba was not represented as a province, the front of the trophy was covered with the products of the Branch Farm for Manitoba; the samples from the Central Farm were placed on the side contiguous to the exhibits of Ontario and Quebec; the other sides of the exterior and interior of the trophy being devoted to a display of the productions of the branch farms for the North-west Territories, British Columbia and the Maritime Provinces. The samples of grain and agricultural seeds were relieved by the introduction of a very complete collection of native and cultivated grasses arranged by Mr. James Fletcher, Botanist and Entomologist of the Farms, also by a large number of photographs of different portions of the Experimental Farms, including harvest scenes, cattle, &c., the whole making a grand display, illustrating the manifold character of the work in progress in connection with the Dominion system of Experimental Farms.

Adjacent to the trophy, there was displayed in a prominent position, a collection of Canadian insects, prepared and arranged by Mr. James Fletcher, who devoted much labour to this work. In addition to many beautiful examples of insects of brilliant colour and attractive form, this collection included many species which injure agricultural and horticultural products.

The dairy exhibits which brought into such prominence the high quality of Canadian cheese and butter, were to a large extent the result of the untiring efforts of the Dairy Commissioner, Mr. J. W. Robertson, who, assisted by competent experts from the Dairy Associations and members of his own staff, and aided by practical dairymen all over the Dominion, achieved a success for Canada of which the people everywhere have reason to feel proud.

During my stay in Chicago, I was also able to render assistance to the Dominion Superintendent in charge of the Canadian horticultural products, Mr. L. Woolverton, in planning the arrangements for the display of fruits and vegetables, to which the Experimental Farms were large contributors. Mr. John Craig, horticulturist at the Central Farm, devoted himself assiduously to the collecting and preparing of fruits for this purpose during the summer of 1892, and there was put up in preserving fluids under his supervision an excellent collection representing the progress which has been made in that division of the work which he superintends. The collection embraced an extensive and varied assortment of small fruits, also a number of varieties of cherries, plums and some apples, all grown at the Central Experimental Farm. Subsequently during the period of the exhibition Mr. Craig rendered further assistance by sending forward supplies of fresh vegetables and fruits, among the latter a display of grapes, consisting of 122 different varieties, all ripened in the open air at Ottawa. These attracted much attention, and excited the surprise of visiting fruit growers who reside further south, who did not anticipate that so many sorts of grapes could be ripened so well in the open air so far north as Ottawa.

The branch Experimental Farms also did excellent service, and in addition to their large contributions to the grain exhibits they provided material for the horticultural display. Mr. Wm. M. Blair, the Superintendent of the Experimental Farm for the Maritime Provinces, forwarded from Nappan, Nova Scotia, a large quantity of very excellent roots and other vegetables, partly the growth of the Experimental Farm, and partly contributed by the farmers of Nova Scotia and New Brunswick. Mr. Blair also sent samples of the small fruits grown on the Nappan Experimental Farm. Mr. S. A. Bedford contributed from the Brandon, Manitoba Experimental Farm, a quantity of preserved vegetables, also a number of varieties of small fruits both cultivated and wild. An excellent assortment of a similar character was sent by Mr. A. Mackay from the Experimental Farm at Indian Head, N. W. T., and both these western farms sent frequent contributions of fresh vegetables during the summer season. Mr. Thos. A. Sharpe, Superintendent of the Experimental Farm at

## Experimental Farms.

Agassiz, British Columbia, provided a fine assortment of preserved fruits, all grown at the Experimental Farm, and these were followed by consignments of fresh fruit from time to time including gigantic plums, fine cherries, apples and other products.

The following list of awards affords further evidence of the high quality of the products supplied by the Experimental Farms. In Agriculture further awards are expected.

**Agriculture.** Central Experimental Farm, Ottawa, cereals and grasses. Experimental Farm, Indian Head, cereals and grasses.

**Horticulture.** Central Experimental Farm, Ottawa, collection of vegetables and collection of grapes, crop of 1893. Experimental Farm, Nappan, N. S., collection of vegetables; Experimental Farm, Brandon Man., vegetables preserved in solutions and collection of fresh vegetables, Experimental Farm, Indian Head, N. W. T., collection of vegetables. Experimental Farm, Agassiz, British Columbia, apples, crop of 1893.

The intimate knowledge of insects and their habits possessed by Mr. James Fletcher, Entomologist and Botanist of the Experimental Farms, enabled him while in Chicago, during the month of October, to render timely aid to the Executive Commissioner by examining and reporting on some injurious insects found feeding on the various grains and seeds exhibited, and which at that time were the cause of some anxiety. Mr. Fletcher was able to show that these invaders were old enemies which Canada had no reason to fear and thus the alarm which had been felt under the impression that they were new foes to agriculture was speedily allayed.

An opportunity was also afforded Mr. F. T. Shutt, Chemist to the Experimental Farms, who has had much experience in the analysis of cereals to use the information he has acquired in this branch of his work to the advantage of the Dominion. He was chosen on this occasion as an expert juror in the Agricultural department and devoted many weeks to the analysis of the finer samples of cereals shown, not only in the Canadian exhibits, but also in all parts of the Agricultural building. The results of these analyses have assisted in demonstrating the high quality of Canadian cereals and especially of the wheat grown in the Canadian North-west.

Early in the history of the exposition, elaborate plans were laid to secure the presence and services of competent men in every department of knowledge from all parts of the world to deliver addresses before conventions specially called in the interest of various branches of science, art, industry, education, etc. In the early part of the year a series of addresses was delivered under the auspices of the exposition authorities, having special reference to the timber productions of the several countries which exhibited in the building devoted to Forestry. An invitation was sent me by the chief of that department to deliver one of these addresses on 20th June, when I presented a paper on the subject of tree growth and forest distribution in Canada, in which I called attention to the timber resources of the several provinces and territories in the Dominion. Later in the season, I was invited to deliver addresses at several of the special conventions or congresses. Owing to absence on the Pacific coast, I was unable to respond to the invitation to be present at the congress of horticulture, but I returned in time to address the congresses relating to agriculture, to agricultural colleges and experiment stations and to forestry. On the occasion of these gatherings I was enabled to disseminate much information regarding the agricultural and other natural resources of Canada. At the agricultural congress, I addressed the assembly on the agricultural resources of the Dominion, when reference was made to the high character and quality of Canadian agricultural products as demonstrated by the exhibits which Canada had made. Statistics of the United States and Canada were quoted, showing that the average crops realized by the Canadian farmer were higher than those obtained by farmers in the United States, and special reference was made to the large area of fertile country in the North-west available for settlement, with which my frequent visits had made me personally familiar.

At the congress of agricultural colleges and experiment stations I had the pleasure of meeting representatives from Russia, Germany and Japan, as well as a large number from the United States, and addressed the assembly on the good work being accomplished in the several provinces of Canada by agricultural colleges, dairy schools, farmers' institutes and agricultural circles, and gave some particulars re-

garding the methods by which the Government of Canada was endeavouring to benefit the Canadian farmer through the agency of the experimental farms.

At the Forestry Congress the topic assigned for my address was "Forest Conditions of the Plains and Prairies of Canada." In introducing the subject reference was made to the vast timber resources of the older provinces and to the measures which have been taken to preserve the forests from fire and to make the best use of this great source of national wealth. The great plains from Winnipeg to the Rocky Mountains were described, the distribution of forest growth in the various sections referred to and the efforts made during the past few years through the experimental farms to improve these conditions. Attention was also called to the vast country lying north of present settlement and to the information thus far gained as to the forest resources of that great area.

### THE COMING ANTWERP EXHIBITION.

A short time prior to the close of the World's Columbian Exposition it was decided by the Dominion Government that Canada should take part in the Antwerp Exhibition, and I was requested to assist in selecting from the exhibits in Chicago such examples of agricultural products and of fruits as would be suitable for the purpose and best serve to show the character of the Canadian climate and the productiveness of the soil, also such products of the forests as could be secured. In company with the Deputy Minister of Agriculture, Mr. John Lowe, I visited the several Canadian courts and assisted in securing much useful material. On my return to Ottawa I was requested to continue to render all the assistance in my power to the furtherance of this enterprise and sent my assistant, Mr. W. T. Macoun to Chicago who made a careful selection of the best of the agricultural products shown there. A collection of about 1,500 bunches and sheaves of grain in the straw and 720 of the finest samples of cleaned grain were selected by Mr. Macoun who has had much experience in such work. There were also secured from the Manitoba Exhibits for this purpose about 120 bunches of grain in the straw and 80 samples of cleaned grain. These cereals were packed in suitable cases and are now in Ottawa awaiting shipment to Antwerp.

Under the supervision of the Dominion Superintendent of Horticulture, Mr. L. Woolverton, a large number of samples of fruit, including contributions from all the provinces exhibiting, were carefully packed and forwarded. These arrived in Ottawa in fairly good condition and are now being examined, the best specimens are being selected, the bottles filled with fresh fluids such as will withstand frost, and the collection will be repacked in time to be forwarded with the other exhibits from Canada.

### ORNAMENTAL TREES AND SHRUBS.

The ornamental planting on the Central Experimental Farm extending from the main entrance gate to the barn and around the buildings and dwellings consists of thirty-five clumps, some of them closely planted, others open and scattered to suit the several situations. These clumps contain at present 1,789 trees and shrubs, comprising a most instructive, interesting and valuable collection. In their arrangement the individual specimens have been selected and grouped with the view of producing the best effects by combinations of spring and autumnal colours, by placing those together which harmonize in form and habit, or which make pleasing contrasts in these particulars. Due regard has been had to the intermingling of a sufficient number of evergreens with the deciduous trees to lend a charm to the grounds during those periods in the year when the deciduous trees are leafless. Proper attention has also been given to the judicious placing of the several groups in accordance with the principles practised by the best landscape gardeners. There are in these groups 225 named species and varieties and a few other varieties as yet undetermined. The following are all represented, some by one or two specimens only, of others the number is much larger; those marked hardy have stood the climate

## Experimental Farms.

of Ottawa uninjured, those marked half hardy have commonly had their wood partly killed, while those marked tender are usually killed back to the snow line. Some of these trees and shrubs have been planted for 5 or 6 years, while others have only been under test for two or three seasons. Nearly all have made satisfactory growth, and these plantations are already attracting much attention from visitors.

### *List of ornamental trees and shrubs in groups and clumps on the Central Experimental Farm.*

- Abies balsamea.—Balsam fir; hardy.
- do concolor.—One-coloured fir; hardy.
- do Fraseri.—Fraser's fir; hardy.
- do pectinata.—Comb-like fir; tender.
- Acer dasycarpum.—Silver-leaved maple; hardy.
- do do Wierii.—Wier's cut-leaved maple; hardy.
- do Ginnala.—Ginnalian maple; hardy.
- do glabrum.—Smooth maple; hardy.
- do Pennsylvanicum.—Pennsylvanian or striped maple; hardy.
- do platanoides.—Plane-like or Norway maple; hardy.
- do do Schwedleri.—Schwedler's maple; half hardy.
- do pseudoplatanus.—Sycamore maple; half hardy.
- do do albo-marginata.—Variegated sycamore maple; tender.
- do rubrum.—Red maple; hardy.
- do saccharinum.—Sugar maple; hardy.
- Æsculus hippocastanum.—Common horse-chestnut; hardy.
- Alnus glutinosa.—Sticky alder; hardy.
- do do laciniata.—Imperial cut-leaved alder; hardy.
- Amelanchier Canadensis.—June berry; hardy.
- do do nana.—Dwarf June berry; hardy.
- do vulgaris.—Common June berry; hardy.
- Amorpha fruticosa.—False indigo; hardy.
- Ampelopsis quinquefolia.—Virginian creeper; hardy.
- do tricuspidata (Veitchii).—Three-pointed ampelopsis or Boston ivy; tender.
- Amygdalus nana.—Double flowering almond; half hardy.
- Artemisia Abrotanum.—Southernwood; hardy.
- Berberis Thunbergii.—Thunberg's barberry; hardy.
- do vulgaris.—Common barberry; hardy.
- do do purpurea.—Purple barberry; hardy.
- do Aquifolium.—American holly; half hardy.
- Betula alba.—European white birch; hardy.
- do do fastigiata.—Pyramidal birch; hardy.
- do do laciniata.—Cut-leaved birch; hardy.
- do do pendula Youngii.—Young's weeping birch; hardy.
- do lutea.—Yellow birch; hardy.
- do occidentalis.—Western birch; hardy.
- Caragana arborescens.—Siberian pea-tree; hardy.
- do do pendula.—Weeping caragana; hardy.
- Carya alba.—Shell bark hickory; hardy.
- Catalpa Kæmpferi.—Japan catalpa; half hardy.
- do speciosa.—Hardy western catalpa; half hardy.
- do do variegata.—Variegated western catalpa; tender.
- Castanea vulgaris Americana.—American chestnut; half hardy.
- Ceanothus Americanus.—New Jersey tea; hardy.
- Celtis australis.—European nettle-tree; hardy.
- do occidentalis.—American nettle-tree; hardy.
- Cephalanthus occidentalis.—Buttonwood; hardy.
- Cerasus Padus.—Bird cherry; hardy.

- Cerasus serotina*.—Wild black cherry; hardy.  
*Cercidiphyllum Japonicum*.—Katsura-tree; hardy.  
*Chionanthus virginicus*.—Fringe-tree; tender.  
*Cladrastis tinctoria*.—Yellow wood; hardy.  
*Clematis recta*.—Erect clematis; hardy.  
do *Virginiana*.—Virginian clematis; hardy.  
*Cornus mas*.—European dogwood; hardy.  
do do *elegantissima*.—Elegant dogwood; hardy.  
do do *variegata*.—Variegated dogwood; hardy.  
do *sanguinea*.—Blood-coloured dogwood; hardy.  
*Cotoneaster vulgaris*.—Common cotoneaster; hardy.  
*Corylus Avellana*.—Filbert; half hardy.  
do do *laciniata*.—Cut-leaved filbert; half hardy.  
*Cratægus oxyacantha*.—English hawthorn; tender.  
do do fl. pl.—Double flowering English hawthorn; tender.  
*Deutzia crenata*.—Crenate deutzia; tender.  
do do fl. pl.—Double crenate deutzia; tender.  
do *gracilis*.—Slender deutzia; half hardy.  
*Diervilla (Weigelia) grandiflora alba*.—Large flowered white weigelia; half hardy.  
do do do *variegata*.—Variegated weigelia; half hardy.  
do do *lonerii*.—Dark red weigelia; half hardy.  
do do *rosea*.—Rosy weigelia; half hardy.  
do do *alba*.—White weigelia; half hardy.  
*Dimorphanthus Mandschuricus*.—Manchurian dimorphanthus; half hardy.  
*Elaëagnus argentea*.—Silvery eleagnus; hardy.  
do *hortensis angustifolia*.—Narrow-leaved eleagnus; half hardy.  
do *angustifolia* Russian olive; hardy.  
*Exochorda grandiflora*.—Large flowered exochorda; tender.  
*Fagus ferruginea*.—American beech; hardy.  
do *sylvaticus purpurea*.—Purple beech; half hardy.  
*Forsythia suspensa*.—Drooping forsythia; half hardy.  
do *viridissima*.—Green forsythia; half hardy.  
*Fraxinus ornus*.—Manna ash; hardy.  
do *viridis*.—Green ash; hardy.  
*Gleditschia triacanthos*.—Honey locust; half hardy.  
*Gymnocladus Canadensis*.—Kentucky coffee-tree; hardy.  
*Hippophae rhamnoides*.—Sea buckthorn; hardy.  
*Hydrangea paniculata grandiflora*.—Large flowered hydrangea; hardy.  
*Juniperus communis*.—Common juniper; hardy.  
do do *Canadensis*.—Canadian juniper; hardy.  
do do *fastigiata*.—Swedish juniper; hardy.  
do *Sabina*.—Common savin; hardy.  
do *Virginiana*.—Red cedar; half hardy; sometimes hardy.  
*Juglans cinerea*.—Butternut; hardy.  
do *nigra*.—Black walnut; hardy.  
do *Sieboldiana*.—Japan walnut; hardy.  
*Larix Americana*.—American larch; hardy.  
do *Europæa*.—European larch; hardy.  
*Ligustrum vulgare variegatum*.—Variegated privet; tender.  
*Lindera Benzoin*.—Spice bush; half hardy.  
*Lonicera flava*.—Yellow honeysuckle; hardy.  
do *Periclymenum*.—English honeysuckle; half hardy.  
do *sempervirens*.—Scarlet trumpet honeysuckle; half hardy.  
do *Tatarica*.—White-flowered bush honeysuckle; hardy.  
do do Red do do do  
*Magnolia acuminata*.—Cucumber tree; half hardy.  
*Negundo aceroides*.—Box elder; hardy.  
*Pæonia moutan*.—Moutan or tree peony; hardy.  
*Pavia flava*.—Sweet buckeye; hardy.

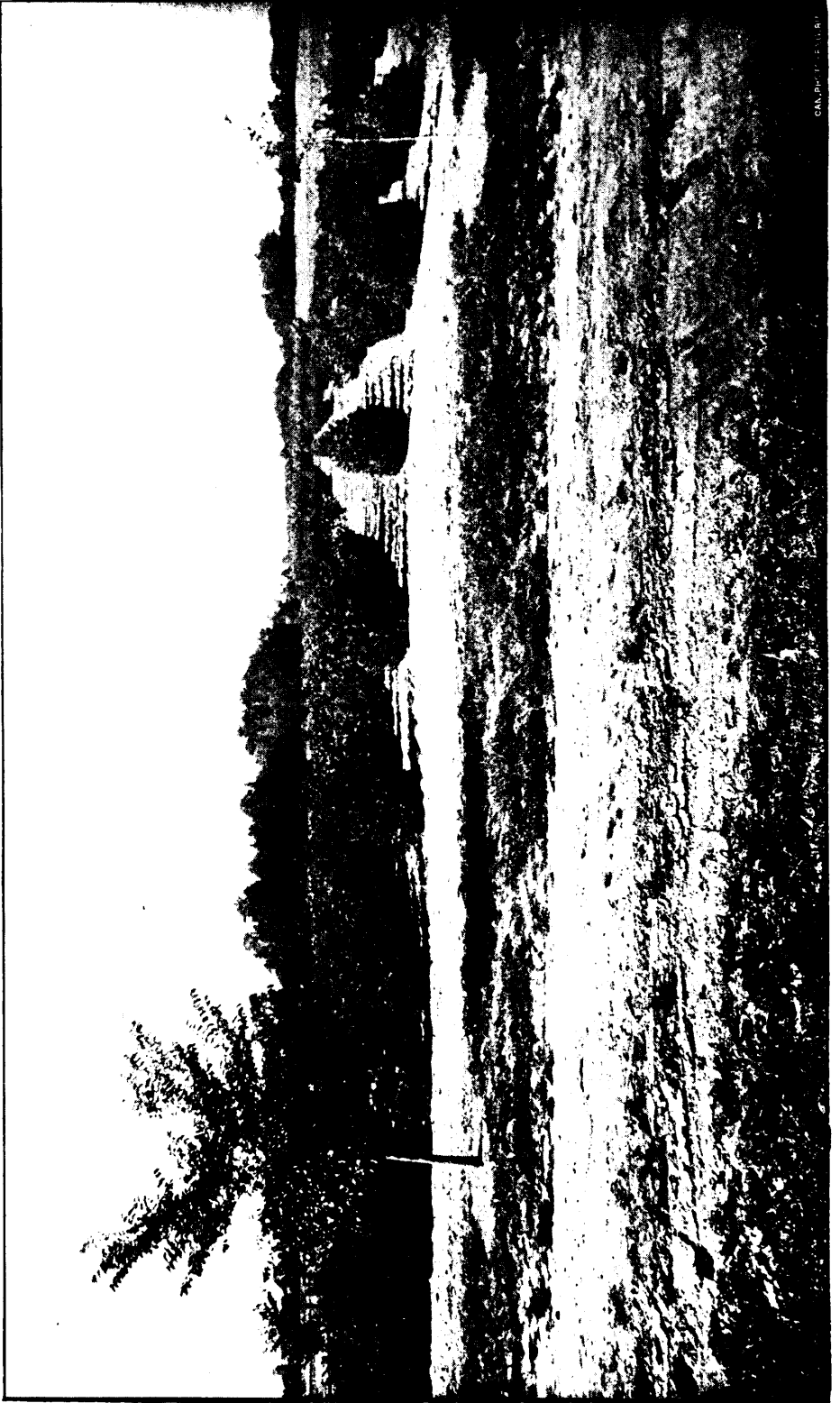

CAN. PR. 11-2-10-11

VIEW OF FOREST PLANTATION - CENTRAL EXPERIMENTAL FARM, OTTAWA.

## Experimental Farms.

- Phellodendron Amurense*.—Chinese cork-tree; half hardy.  
*Philadelphus coronarius*.—Mock orange or syringa; hardy.  
   do *cordifolia*.—Heart-leaved syringa; hardy.  
   do *deutziflora*.—Deutzia flowered syringa; hardy.  
   do *Gordonianus*.—Gordon's syringa; hardy.  
   do *grandiflora*.—Large flowered syringa; hardy.  
   do *nana*.—Dwarf syringa; hardy.  
*Picea alba*.—White spruce; hardy.  
   do *Alcoquiana*.—Alcock's spruce; hardy.  
   do *excelsa*.—Norway spruce; hardy.  
   do *pygmaea*.—Dwarf Norway spruce; half hardy.  
   do *Engelmanni*.—Engelmann's spruce; hardy.  
   do *nigra*.—Black spruce; hardy.  
   do *pungens*.—Rocky Mountain blue spruce; hardy  
*Pinus Austriaca*.—Austrian pine; hardy.  
   do *Cembra*.—Swiss stone pine; hardy.  
   do *contorta Murrayana*.—Murray's pine; hardy.  
   do *Mughus*.—Mountain pine; hardy.  
   do *nana*.—Dwarf mountain pine; hardy.  
   do *ponderosa*.—Heavy wooded or bull pine; hardy.  
   do *Strobus*.—White or Weymouth pine; hardy.  
   do *resinosa*.—Red pine; hardy.  
   do *sylvestris*.—Scotch pine; hardy.  
   do *Rigaensis*.—Riga pine; hardy.  
*Platanus occidentalis*.—Buttonwood; hardy.  
*Populus alba Bolleana*.—Bolle's poplar; hardy.  
   do *certinensis*.—Asiatic poplar; hardy.  
   do *grandidentata pendula*.—Large-toothed weeping poplar; hardy.  
   do *nigra pyramidalis*.—Lombardy poplar; hardy.  
   do *Nolesti*.—Riga poplar; hardy.  
*Pseudotsuga Douglasii*.—Douglas spruce; half hardy.  
*Ptelea trifoliata*.—Hop-tree or wafer ash; hardy.  
*Prunus Pissardii*.—Purple plum; half hardy.  
*Pyrus Americana*.—American mountain ash; hardy.  
   do *Aucuparia*.—European mountain ash; hardy.  
   do *quercifolia*.—Oak-leaved mountain ash; hardy.  
   do *furcata*.—Hardy.  
   do *Aria*.—White beam-tree; hardy.  
   do *baccata auruntiaea*.—Siberian pyrus; hardy.  
*Quercus Robur*.—English oak; hardy.  
   do *rubra*.—Red oak; hardy.  
*Retinospora ericoides*.—Heath-like retinospora; half hardy.  
   do *filifera*.—Thread-like retinospora; hardy.  
   do *obtusa*.—Obtuse-leaved retinospora; half hardy.  
   do *plumosa*.—Plumose retinospora; half hardy.  
   do *aurea*.—Golden plumose retinospora; half hardy.  
   do *argentea*.—Silver plumose retinospora; half hardy.  
   do *squarrosa*.—Squarrose-leaved retinospora; tender.  
*Rhamnus catharticus*.—Cathartic buckthorn; hardy.  
   do *frangula*.—Breaking buckthorn; hardy.  
*Rhodotypus kerrioides*.—White kerria; hardy.  
*Rhus aromatica*.—Fragrant sumach; hardy.  
   do *cotinus*.—Venetian sumach or mist shrub; hardy.  
   do *glabra laciniata*.—Fern-leaved sumach; hardy.  
*Ribes alpinum*.—Mountain currant; hardy.  
   do *sanguineum*.—Red flowering currant; tender.  
*Robinia pseudacacia*.—Common locust; hardy.  
*Rosa rubiginosa*.—Sweet briar; hardy.  
   do *rubrifolia*.—Red-leaved rose; hardy.



- Rosa rugosa*.—Japan rose; hardy.  
*Rubus Nutkanus*.—White flowered scented raspberry; hardy.  
*Salisburia adiantifolia*.—Maidenhair-tree; hardy.  
*Salix Babylonica annularis*.—Ringed willow; tender.  
   do *capræa pendula*.—Kilmarnock weeping willow; hardy.  
   do *laurifolia*.—Laurel-leaved willow; hardy.  
   do *purpurea pendula*.—American weeping willow; half hardy.  
   do *rosmarinifolia*.—Rosemary-leaved willow; hardy.  
*Sambucus nigra argentea*.—Silver-leaved elder; half hardy.  
   do   do *aurea*.—Golden-leaved elder; hardy.  
   do   do *laciniata*.—Cut-leaved elder; half hardy.  
*Sassafras officinale*.—Sassafras-tree; hardy.  
*Shepherdia argentea*.—Buffalo berry; hardy.  
*Spiræa Californica*.—Californian spirea; hardy.  
   do *Japonica alba (callosa alba)*.—White Japan spirea; hardy.  
   do   do *rubra (callosa rubra)*.—Red Japan spirea; hardy.  
   do   do *Fortunei*.—Fortune's spirea; hardy.  
   do *media rotundifolia*.—Round-leaved spirea; hardy.  
   do *opulifolia*.—Guelder-rose leaved spirea; hardy.  
   do   do *aurea*.—Golden-leaved spirea; hardy.  
   do *prunifolia*.—Plum-leaved spirea double; tender.  
   do *salicifolia*.—Willow-leaved spirea; hardy.  
   do *Van Houttei*.—Van Houtte's spirea; hardy.  
*Symphoricarpus racemosus*.—Snow berry; hardy.  
*Syringa Chinensis rothamagensis*.—Chinese lilac; half hardy.  
   do *Japonica*.—Japan lilac; hardy.  
   do *Josikæa*.—Josika's lilac; hardy.  
   do *vulgaris alba*.—White lilac; hardy.  
   do   do *Chas. X.*.—Charles X. lilac; hardy.  
   do   do *purpurea*.—Purple lilac; hardy.  
*Tamarix Amurensis*.—Russian tamarisk; hardy.  
*Thuja Lobbiai atrovirens*.—Dark green arbor-vitæ; half hardy.  
   do *occidentalis*.—Common arbor-vitæ; hardy.  
   do   do *argentea*.—Silver-tipped arbor-vitæ; hardy.  
   do   do *aurea*.—Golden arbor-vitæ; hardy.  
   do   do *Douglas No. 2*.—Douglas' No. 2 arbor-vitæ; hardy.  
   do   do *Elwangeriana*.—Elwanger's arbor-vitæ; hardy.  
   do   do *globosa*.—Globose arbor-vitæ; hardy.  
   do   do *pyramidalis*.—Pyramidal arbor-vitæ; hardy.  
   do   do *Hoveyi*.—Hovey's arbor-vitæ; hardy.  
   do   do *Tom Thumb*.—Tom Thumb arbor-vitæ; hardy.  
   do   do *vervæneana*.—Vervæne's arbor-vitæ; half hardy.  
   do *Sibirica*.—Siberian arbor-vitæ; hardy.  
   do *Tatarica (Wareana)*.—Tartarian arbor-vitæ; hardy.  
*Thuyopsis borealis*.—Northern thuyopsis; half hardy.  
*Tilia argentea*.—Silver-leaved linden; tender.  
   do *cordata*.—Small-leaved linden; hardy.  
   do *heterophylla*.—American basswood; hardy.  
   do *platyphyllos*.—Broad-leaved linden; hardy.  
   do *vulgaris*.—European linden; hardy.  
*Tsuga Canadensis*.—Hemlock spruce; hardy.  
*Ulmus Americana*.—White elm; hardy.  
   do *campestris*.—English elm; half hardy.  
   do *fulva pendula*.—Weeping slippery elm; hardy.  
   do *montana fastigiata*.—Pyramidal Scotch elm; hardy.  
   do *racemosa*.—Rock elm; hardy.  
*Viburnum Lantana*.—Pliant viburnum; hardy.  
   do *opulus*.—High bush cranberry; hardy.  
   do *pauciflorum*.—few flowered viburnum; hardy.

## Experimental Farms.

This list contains but a small proportion of the ornamental trees and shrubs under test at the Central Farm. The larger number are arranged in botanical groups in the arboratum, where under the charge of the Botanist of the Experimental Farms, Mr. James Fletcher, over 600 species and varieties have been accumulated. As soon as sufficient information has been gained as to the hardiness of these in the Ottawa climate it is proposed to publish a full list of the entire collection.

### PLANTATIONS OF FOREST TREES.

There were several objects in view in planting the belts of forest trees which line the west and north sides of the farm. One was to test by actual experiment with a number of different species the comparative results in growth and development to be had by planting at different distances apart. Five feet by five, five feet by ten and ten feet by ten were the distances chosen for these tests. Another question on which information was desired was the relative growth to which trees would attain when planted in blocks of single species as compared with those planted in mixed clumps where they are associated with a number of other sorts. Further information was sought as to how far the crops on the farm located near these tree belts will be influenced by the shelter they would afford as growth progressed. In the planting, the grouping was also designed with the object of producing pleasing effects on the landscape by the intermingling and blending of varieties. The main purpose however was to get all the useful data possible with regard to the more important timber trees of economic value so that object lessons in tree growth might be available to any who in future might desire to study this subject or to engage in the enterprise of timber growing.

The work of planting was begun in 1888 and a space laid out on the west boundary 165 feet wide extending the whole width of the farm. This gave room for a line of basswood or linden trees five feet inside the boundary fence and 40 feet apart. Fifteen feet were left for a roadway east of which there were ten rows of trees five feet apart each way followed by another ten rows ten feet apart each way. This area was planned to be filled with blocks of trees of various forms, each group to consist of a single species. Along the north boundary a space was provided 65 feet in width which was to be filled as follows. A row of mixed forest trees 40 feet apart placed five feet inside the boundary fence succeeded by ten rows of mixed trees of 10 to 15 varieties, some of which were to be planted five feet by ten and others five feet by five.

The first planting in 1888 was done under the supervision of Mr. W. W. Hilborn, at that time horticulturist of the Central farm, 1,321 trees were set out that year in the mixed belt and several blocks or clumps of single species in the wider belt, numbering about 1,500 trees in all. The accompanying plate is from a photograph recently taken of a part of the trees then planted, a portion of the 5 x 5 planting is seen to the left and part of the 10 x 10 to the right. In the spring of 1889 the work of planting in blocks of single species was resumed under the charge of Mr. Thos. A. Sharpe, now superintendent of the branch experimental farm at Agassiz, B.C., and about 1,350 were added to the number. In the autumn of the same year with the assistance of the farm foreman, Mr. John Fixter, about 4,000 more were planted in blocks of single species and 560 trees added to the belt of mixed sorts. In 1890-91 and 92 the planting was continued under the supervision of Mr. John Craig, horticulturist of the Central farm and during this period the plantation was much enlarged and the wide belt on the west side completed. Mr. Craig also took charge during these years of the necessary weeding and cultivating. During the past season this work has been continued by Mr. W. T. Macoun, foreman of forestry, and under his care the tree belt on the north boundary has been much extended, and it is hoped that in another year this will be completed. In the following report submitted by Mr. Macoun, much useful information will be found.

## REPORT OF THE FOREMAN OF FORESTRY.

Owing to the very wet season, the work of this department was greatly increased this year, and it was only by much labour with the horse cultivator and hand-hoe, that the weeds could be kept in check. Not only was frequent cultivation necessary for this reason, but the soil became compact again so soon, on account of very frequent rain, that it was extremely difficult to keep it in that porous condition which is essential to best results in tree growth.

Most of the trees and shrubs bordering the avenues in the forest plantations, and on the ornamental grounds, have made rapid growth this year and are fast becoming prominent features of the farm.

Insect enemies have been very numerous, and great vigilance was required to keep them in check. By occasional spraying with a mixture of Paris green and water and much picking off by hand, they were prevented from doing any great injury. A blight on the elms caused the limbs on a considerable number of them to die, and in some cases the whole tree was destroyed by it.

Nearly nineteen acres are now planted with the trees which form the forest belts along the northern and western boundaries of the farm. The belt on the western boundary is completed and contains 9,686 trees now living. The belt along the northern boundary, which is not yet completed, contains 5,840 trees living. Thus there is now a total of 15,526 trees living in both plantations.

## FOREST BELT ALONG WESTERN BOUNDARY.

In this belt the trees are grouped in clumps of one species each and for comparison are planted 5 feet apart and 10 feet apart each way to show results of planting at different distances. Where trees have been planted for several years the benefit of close planting is easily discernible, the trees making better growth with a less proportion of broken tops and limbs, and the weeds being prevented from growing by the dense shade long before weeds cease to thrive among the trees planted 10 feet apart.

As large additions have been made to this belt since 1889, when the last list was published, a complete record is now given in the following table. Several clumps composed of species which have not succeeded well have been partly or wholly replaced by others:—

DECIDUOUS TREES.	When planted.	Total number planted.	Number living.	Number dead.
<i>Acer saccharinum</i> —Sugar maple	1889	240	234	6
do do do	1890	60	60	
do <i>platanoides</i> —Norway maple	1889	110	110	
do <i>dasycarpum</i> —Silver leaved maple	1889	120	120	
do <i>rubrum</i> —Red maple	1889	170	170	
<i>Alnus glutinosa</i> —Sticky alder	1889	90	90	
<i>Æsculus hippocastanum</i> —Horse-chestnut	1889	90	86	4
<i>Betula alba</i> —European white birch	1889	90	90	
do <i>lutea</i> —Yellow birch	1889	150	148	2
do <i>papyracea</i> —Canoe birch	1889	120	118	2
<i>Carya alba</i> —Shell-bark hickory	1888	8	8	
<i>Catalpa speciosa</i> —Hardy Western catalpa	1889	158	154	4
do <i>Kämpferi</i> —Japan catalpa	1889	30	30	
do <i>hybrida</i> —Tea's catalpa	1889	30	30	
<i>Carpinus betulus</i> —European hornbeam	1890	148	146	2
<i>Cerasus serotina</i> —Wild black cherry	8891	231	224	7
<i>Fraxinus Americana</i> —White ash	1889	476	473	3
do do	1890	120	120	
do <i>excelsior</i> —European ash	1889	40	40	
do <i>pubescens</i> —Red ash	1889	120	120	
do <i>viridis</i> —Green ash	1889	120	120	
do <i>sambucifolia</i> —Black ash	1889	120	120	

## Experimental Farms.

DECIDUOUS TREES.	When planted.	Total number planted.	Number living.	Number dead.
Fagus ferruginea—American beech	1889	42	39	3
Gymnocladus Canadensis—Kentucky coffee-tree	1890	120	112	8
Gleditschia triacanthos—Honey locust	1890	92	86	6
Larix Europea—European larch	1888	275	265	10
do do	1890	30	20	10
Juglans nigra—Black walnut	1888	630	624	6
do do	1889	193	193	
Juglans cinerea—Butternut	1888	290	288	2
do do	1889	240	237	3
Morus hybrida—Russian mulberry	1889	90	90	
Negundo aceroides—Box elder	1889	261	261	
Pyrus Americana—American mountain ash	1889	50	50	
do Aucuparia—European mountain ash	1889	110	106	4
Platanus occidentalis—Button-wood	1889	120	119	1
do —(Nebraska seed) Button-wood	1890	150	134	16
Populus alba Bolleana—Bolle's poplar	1890	150	150	
do Nolesti—Riga poplar	1892	92	92	
do Petrovsky Petrovsk poplar	1890	50	49	1
do certimensis—Asiatic poplar	1890	40	40	
Quercus alba—White oak	1889	41	41	
do macrocarpa—Burr oak	1893	96	89	7
do rubra, Red oak	1888	21	19	2
do do do	1890	40	36	4
do Robur—English oak	1890	50	50	
Robinia pseudacacia—Common locust	1889	213	209	4
Salix laurifolia—Laurel-leaved willow	1890	140	138	2
do acutifolia—Sharp-leaved willow	1890	148	146	2
do Voronesh—Voronesh willow	1890	60	60	
Tilia vulgaris—European linden	1890	125	122	3
Ulmus Americana—White elm	1889	197	197	
do do —(Manitoba seed) White elm	1889	38	38	
do do do do	1890	94	94	
do fulva—Red elm	1889	120	120	
do racemosa—Rock elm	1889	220	213	7
do montana—Scotch or Wych elm	1890	97	92	5
do species undetermined, a small-leaved sort	1890	48	41	7
EVERGREENS.				
Tsuga Canadensis—Hemlock spruce	1889	30	13	17
do do	1890	62	61	1
Abies balsamea—Balsam fir	1890	63	63	
Picea alba—White spruce	1889	180	180	
do excelsa—Norway spruce	1889	301	301	
do do do	1893	45	39	6
Pinus Sylvestris—Scotch pine	1888	424	423	1
do do Rigaensis—Riga pine	1889	30	30	
do do do do	1893	108	102	6
do Austriaca—Austrian pine	1889	214	214	
do strobis—White pine	1889	301	301	
do do do	1890	250	247	3
Thuja occidentalis—Arbor-vitæ	1889	198	198	

### TREE PLANTING, 1893.

The spring of 1893, though unfavourable for most field work, was particularly suitable for the planting of trees. Copious rain fell during nearly the whole of May, giving the trees, when planted, good conditions for establishing themselves.

### FILLING VACANCIES IN FOREST BELT.

Every spring it is found that a greater or less number of the trees in the forest belts have succumbed either to the severity of the winter, alternate freezing and thawing in fall and spring, or from the effects of water standing on or near the surface of the soil. Last spring 450 trees were needed to fill up the gaps caused in this way during the previous two years.

## REPLACING AVENUE TREES AND ADDITION TO AVENUES.

Owing to various causes a certain proportion of the avenue trees also die each year, and this year the following numbers were required to replace those which had died. In some cases, as on the northern boundary, where the row of trees is composed of mixed species, the same kind was not always replanted.

## SPECIES.

Acer saccharinum—Sugar maple.....	24
Acer rubrum—Red maple .....	21
Fraxinus Americana—White ash.....	10
Fraxinus viridis—Green ash.....	9
Fraxinus sambucifolia—Black ash .....	10
Tilia vulgaris—European linden.....	8

Last spring another avenue was formed extending from near the farm foreman's house to the northern boundary, by the planting of 46 Norway maple trees. These have all done well, except one, which died. This avenue promises to add much to the appearance of that part of the farm.

## ADDITIONS TO MIXED FOREST BELT.

During the spring of 1893 there were 3,511 trees added to the mixed forest belt on the north boundary of the farm. Of these, only 163 have died, and those living seem well fitted, from their appearance at present, to survive the approaching winter.

The following is a list of the species planted, with total number of each, and the numbers which have lived and died:—

LIST OF SPECIES.	No. planted.	No. living.	No. dead.
<i>Deciduous Trees.</i>			
Acer saccharinum—Sugar maple.....	164	159	5
do rubrum—Red maple.....	198	193	5
do platanoides—Norway maple.....	124	124	.....
do Pseudoplatanus—Sycamore maple.....	70	64	6
do Tartaricum—Tartarian maple.....	32	32	.....
do campestre—English maple.....	31	31	.....
Æsculus hippocastanum—Horse-chestnut.....	60	60	.....
Betula alba—European white birch.....	191	191	.....
Celtis australis—European nettle-tree.....	23	19	4
Catalpa hybrida—Tea's catalpa.....	66	66	.....
Diospyros Virgintana—Persimmon.....	5	5	.....
Fraxinus Americana—White ash.....	173	172	1
do viridis—Green ash.....	72	72	.....
do sambucifolia—Black ash.....	61	61	.....
Juglans nigra—Black walnut.....	165	165	.....
Negundo aceroides—Box elder.....	298	297	1
Pyrus Americana—American mountain ash.....	25	24	1
do Aucuparia—European mountain ash.....	2	1	1
Populus alba Bolleana—Bolle's poplar.....	2	2	.....
do certinensis—Asiatic poplar.....	129	129	.....
Platanus occidentalis—Button-wood.....	2	2	.....
Quercus alba—White oak.....	4	4	.....
do macrocarpa—Burr oak.....	155	155	.....
do rubra—Red oak.....	66	64	2
Rhamnus frangula—Breaking buckthorn.....	51	51	.....
Tilia vulgaris—European linden.....	47	47	.....
Ulmus Americana—White elm.....	199	197	2
do racemosa—Rock elm.....	69	62	7
do montana—Scotch elm.....	76	67	9

## Experimental Farms

LIST OF SPECIES.	No planted.	No. living.	No. dead.
<i>Evergreen Trees.</i>			
Picea alba—White spruce.....	198	197	1
do excelsa—Norway spruce.....	290	257	33
Pinus strobus—White pine.....	129	102	27
do sylvestris Rigaensis—Riga pine.....	228	187	41
do Austriaca—Austrian pine.....	9	7	2
do Mughus nana—Dwarf mountain pine.....	78	66	12
Thuja occidentalis—Arbor-vitæ.....	19	16	3

### EVERGREEN CLUMP.

In the year 1888 a large number of young trees was procured and planted in nursery rows to remain until they should be required for the tree belts and clumps, or for other ornamental purposes on the farm.

As several hundreds of Norway spruce, Scotch and Austrian pine had, before they were needed, grown too large for successful transplanting, it was decided to leave a clump of these, as a permanent plantation, on a rising piece of land, in a prominent place near the northern boundary of the farm.

The trees, having been planted close together, had made quite a thicket, and this year it was considered necessary to cut out a large number of them to admit light and air, and give those remaining a better opportunity to develop. The trees when thinned averaged 2½ feet apart in the rows, with the rows 3 feet apart. It is proposed to thin them still further as occasion requires.

The following table shows the average height of the trees, the average circumference, 1 foot from the ground, and the number of trees left of each species after thinning. For the double purpose of increasing the size of the clump and adding to its appearance, the rows of trees were extended to the cross road near by. The additions made this year will be found in the table.

NAMES OF SPECIES.	Average height.	Average circum- ference 1 foot from ground.	Number planted, 1888.	Number planted, 1889.
Picea excelsa—Norway spruce.....	7 feet	5 in.	273	168
Pinus sylvestris—Scotch pine.....	9½ "	5½ "	636	52
Pinus Austriaca—Austrian pine.....	7 "	5¾ "	621	106
Total number of trees, 1856.....			1,530	326

### PLANTING IN POULTRY YARDS.

Although the season was far advanced, and the trees and shrubs nearly in full leaf, during the first week of June, 53 trees and shrubs were planted in the poultry yards, and notwithstanding the advanced state in which they were when planted, not one has died.

#### SUMMARY OF TREES AND SHRUBS PLANTED, 1893.

Trees replanted in forest belt.....	450
do do along avenues.....	82
Addition to avenues.....	46
do to mixed forest belt.....	3,511
do to evergreen clump.....	326
Trees and shrubs in poultry yards.....	53

W. M. T. MACOUN.

## VISITS TO THE BRANCH EXPERIMENTAL FARMS.

During 1893 it was found necessary to visit the branch farms in the west twice, the first time in May and again in August. On the first journey I left Ottawa on the 28th of April, and arrived in Chicago a day prior to the opening of the World's Columbian Exposition when an opportunity was afforded of witnessing the completion of the work in connection with the Canadian agricultural and horticultural exhibits which had been planned earlier in the season. The day following the opening ceremonies I proceeded westward.

As one of the main objects in undertaking this early journey was to reach the branch farm at Agassiz, British Columbia, in time for spring planting, only one day was spent at each of the branch farms at Brandon, Man., and Indian Head, N.W.T. on the way out, giving time only to arrange those details of farm work which were most pressing. Agassiz was reached on the 11th of May, where seven days were spent in planning and arranging the work of the year, a large share of attention being given to the planting of trees and shrubs about the Superintendent's house. These have been so grouped as to produce good effects by agreeable combinations of form and colour, and a sufficient area has been provided adjacent to the dwelling to serve the purpose of an arboretum. Over 500 specimens were planted during the period of my visit, the placing of these produced quite a transformation in the appearance of the grounds and prepared the way for giving due prominence to an exceedingly interesting feature of the work in progress there. The orchards were inspected and extensions to these planned, a nut orchard was also planted. The forest tree planting on the mountain sides in rear of the valley land was well advanced before my arrival and by the time the planting season closed over 5,000 hard-wood trees had been set out and arrangements made for the planting of a similar number each year for several years to come. The large young orchard of cherry and plum trees set out three years ago was in full bloom at the time of my visit, and presented a very handsome appearance.

I found as a result of the unusually severe winter that all the peach, apricot and nectarine trees, and most of the other sorts of comparatively tender trees and shrubs, were more or less injured and some of them killed outright. Much of the evergreen foliage of the gigantic native firs looked scorched and brown showing that even the old and long established native trees had been unable to endure without injury this unusually severe visitation, the thermometer having fallen on one occasion for a few hours as much as 12 degrees below zero. The apple, plum and cherry trees did not appear to be injured at all, and the young apple trees later on, bore a very fair crop of fruit, but from the fact of the cherry blossoms not setting and a number of the plums setting very imperfectly, it seems that the very cold weather of the winter had affected even these hardier sorts of trees. The wood of many of the young pear trees was also more or less discoloured within, showing injury which may in some instances be permanent. The spring growth however was pushing rapidly on, and Nature was doing her best to repair the damage which had been done.

The farm buildings were examined and everything found in good order, the animals of all sorts were healthy, the spring work was well advanced, most of the grain sown and much of it up and everything betokened good management and care.

A good supply of water for this farm being very much needed a sum was placed in the estimates for 1893-94 for this purpose, and during my stay I visited the source of the springs on the hillside from which it is proposed that the water should be obtained. I found the supply abundant and the quality to all appearance excellent. Subsequently a sample of this water was forwarded to Ottawa, to be analysed by the chemist of the farms who confirmed in the report of his analysis the good opinion which had been formed regarding it. I submit herewith the report of the chemist.

## Experimental Farms.

### WATER FROM EXPERIMENTAL FARM, AGASSIZ, B. C.

A careful and thorough chemical examination of this water affords the following data in parts per million:—

#### ANALYSIS.

Free ammonia .....	·032
Albuminoid ammonia .....	·024
Nitrogen in nitrates and nitrites.....	·046
Chlorine.....	2·5
Oxygen absorbed in 15 min. at 80° F.....	·296
do 4 hours do .....	·594
Total solids, at 105° C .....	83·6
do after ignition.....	60·4
Phosphates.....	none.

From the above figures, I judge this to be a first class water, free from all contamination—animal and vegetable—and of excellent quality.

FRANK T. SHUTT, M.A.,  
*Chemist, Dom. Exp. Farms.*

As soon as the arrangements were completed at Agassiz, B.C., I left for Indian Head, N.W.T., where two or three days were spent in carefully inspecting the condition of the branch farm located there, inquiring into the progress made and in discussing and planning work for the future. The forest plantations had wintered well, and the benefits arising from the planting of hedges and shelter belts to break the force of the winds, which sometimes injure the crops have been so thoroughly demonstrated, that plans were prepared for bordering nearly all the roads on the farm with such windbreaks and for planting them elsewhere on the grounds where needed. Arrangements were also made for extending the area planted with ornamental and timber trees and shrubs, the collection of which now includes about ninety species and varieties which have proven hardy there. The Austrian Brome grass (*Bromus inermis*) which has been under test at the Indian Head farm for several years, has been grown with so much success, that it was decided to sow a considerable number of acres of this grass for more extended trial for hay and pasture, and a sufficient quantity of seed was procured for this purpose. The cattle and horses had come through the winter in excellent condition, the farm crops were nearly all up and looked well and the land was very clean, giving evidence of great care in its cultivation.

On the 22nd May I arrived at the branch farm at Brandon, where several days were spent in inspecting the work in hand and planning for future progress. A day or two was devoted to the laying out and planting of the grounds around the residence of the superintendent. Quite a large number of trees and shrubs were planted, consisting altogether of varieties which have been thoroughly tested, and proven hardy in that climate. A sufficient area of land has been laid out in this connection to furnish space for all the additional varieties of hardy sorts obtainable. The trees and shrubs which have been thoroughly tested for hardiness at Brandon, include about 100 species and varieties and form a most instructive and attractive group. It is expected that this number will be considerably increased during the coming season.

As the native plum had succeeded well at the experimental farm at Brandon, it was thought desirable to increase the size of the plantation. For this purpose I visited the Brandon Hills in company with the superintendent, where the trees are found growing wild, and we succeeded in obtaining quite a number of young specimens, some of which were planted at Brandon and some sent to the branch farm at Indian Head to be tested there. (When these trees were seen during my later visit to the western farms in the autumn, they were nearly all doing well). Several additional hedges and windbreaks were also planted during this visit, to afford shelter



and form dividing lines between the plantations of small and larger fruits, ornamental trees, shrubs and flowers. All the divisions of work on this farm were making good progress, the farm crops all looked well, the land was in good order and the horses and cattle healthy and in fine condition.

A very large number of the farmers of Manitoba visit this farm from year to year, seeking information on all points relating to agriculture and horticulture, and many voluntary testimonies are received from time to time in regard to the usefulness, not only of this institution, but also of all the branch farms and of the efficient manner in which the work is everywhere conducted. I returned to Ottawa on the 28th of May.

#### SECOND VISIT TO THE WEST.

A second journey to the Pacific Coast was made in August. On the way west I visited Madison, Wisconsin, and attended the meeting of the "Society for the Promotion of Scientific Agriculture" held in connection with that of the "American Association for the Advancement of Science." At this meeting I had the opportunity of explaining the nature of some of the work in progress for the promotion of agriculture at the Experimental Farms, and during the sessions I was honoured by being elected president of the society. I also attended some of the more important sessions of the American Association for the Advancement of Science held at the same place. Journeying westward a day was spent at the North Dakota Experiment Station at Fargo, N. D., where through the kindness of Prof. W. Hays who had charge of the experimental work in agriculture, I was shown through the buildings and over the grounds. As this institution has not been long established there has not been much time yet for tree planting and the grounds in this respect, looked very bare. There was, however, some very interesting work in progress, especially with wheat, with the view of producing new varieties by selection and also to some extent by cross fertilization. Useful experiments were also in hand in regard to a proper rotation of crops for that country.

#### EXPERIMENTAL FARM, BRANDON.

Two days were spent at the branch farm at Brandon, where the crops were found to be well advanced and many of the early varieties of cereals were cut. The grain which promised an abundant yield early in the season was found to be shrunken and light, owing to the rapid and premature ripening which took place there during the unusual heated term from the 5th to the 12th of August. All sorts of grain had suffered from this cause, but the injury was most apparent in the different sorts of wheat and barley. The quality of the oats was much better and the yield also of most varieties was good. The root crops owing to hot weather and light rains had not made satisfactory progress, but all sorts of small fruits were yielding well. The growth of the avenues, forest tree plantations and ornamental trees and shrubs had been good, and the general appearance and condition of the farm was both attractive and creditable.

#### EXPERIMENTAL FARM, INDIAN HEAD.

The Indian Head farm was next visited, and similar examinations made. Most of the crops looked remarkably well and did not appear to have suffered much injury from the hot days in August, and the farm was in excellent order. Roots, however, were backward and did not promise well. Austrian Brome grass had given an excellent yield of hay, more than three tons per acre, and the crop of all the small fruits was good. The growth of the trees, shrubs and hedges had not been so luxuriant as on the branch farm at Brandon, owing to less favourable climatic conditions but they had made satisfactory progress and have already become a pleasing feature on this prairie farm.

## Experimental Farms.

### VISIT TO THE EDMONTON DISTRICT.

At Calgary the branch line of railway to Edmonton was taken which runs through a district I had not visited before. The country for the first fifty miles has much the same appearance as about Calgary, the grass is short and trees and shrubs are almost or entirely wanting, excepting along the margins of streams or watercourses where the moisture is sufficient to sustain them. North of this changes begin to occur, the grasses gradually increase in length and in luxuriance, clumps of shrubs and dwarfed specimens of trees are occasionally seen, and after a time these are succeeded by patches of woodland of stronger growth with stretches of open prairie adorned with clumps and occasional larger areas of timbered land. Streams and rivers also are oftener seen and by the time that half the distance between Calgary and Edmonton has been covered, the country is found to be well wooded and watered, grasses and pea-vines are luxuriant and abundant and the soil is a dark rich fertile loam. The woods afford shelter and the luxuriant herbage furnishes unlimited quantities of food for stock, making this part of the territories specially suitable for mixed farming. During the five days spent at Edmonton many of the farming settlements in the neighbourhood were visited which involved about 130 miles of driving. All through this district the grain crops looked remarkably well. The harvest was in progress during the time of my visit, and the heads of grain were plump and well-filled. For about sixty miles north of Edmonton until the height of land is crossed, the agricultural capabilities of the country appear to be much the same as those about Edmonton, but in the next forty miles which drain into the Athabasca River, the soil is said to be less fertile although this district is believed to include much excellent land. This belt of fertile country 200 miles or more in width, is said to extend westward from Edmonton more than 200 miles towards the Yellowhead Pass in the Rocky Mountains and eastward, varying in width, for several hundred miles to the shores of Lake Manitoba. At many points in this immense fertile area settlement is progressing satisfactorily, but the capacities of the district are such that millions will eventually find comfortable homes and abundant sustenance there.

### EXPERIMENTAL FARM, AGASSIZ.

Returning to the main line of railway and proceeding westward a journey of about 35 hours across the mountains brought me to Agassiz, where several days were spent in examining the results of the season's growth, not only on the experimental farm, but also on the lands of the neighbouring farmers. At the time of my arrival, a drought had prevailed in this part of the country for five or six weeks and crops of all sorts were suffering for want of rain. Most of the grain was short in straw, but with heads moderately well filled, the yield however was turning out considerably under the average. The root crops were then very backward, but subsequent rains improved these considerably. In the orchards many of the young plum trees were laden with fair crops of fruit of excellent quality, a collection of which was made and forwarded to the World's Fair in Chicago, but the results with most other fruits were disappointing and the apple crop was unusually light. On the experimental farm at Agassiz, there are now more than 1,100 varieties of fruits under test, about 800 of which are large fruits and most of the trees are doing well. Some of the orchards have been planted on the valley land, others on the fertile benches at different heights on the face of the mountains varying from 100 to 800 feet. The orchards located at the highest of these points thus far been found to have the healthiest trees and are the first to leaf out in the spring. A comparison of these with the trees planted in the valley land for a series of years will be most useful and instructive.

## INQUIRIES INTO HOP GROWING AND IRRIGATION.

The subject of hop growing is now attracting much attention in some parts of British Columbia, especially in the neighbourhood of the experimental farm, where there are several large hop yards, which have given excellent crops during the past season. In order to gain all the information possible for the benefit of the growers there, it was arranged that the superintendent of the farm at Agassiz should join me in visiting the hop yards which had been established in the Fraser River Valley and also some of the more important hop districts in the State of Washington, both in the coast and dry climates of that state, so that opportunity might be afforded of comparing the hops grown there with those produced in the corresponding climates in British Columbia. After visiting the noted hop districts about Puyallup and the White River Valley a trip was made to Yakima in the dry interior of the state, where nothing can be grown without irrigation. A careful comparison seemed to leave no doubt that hops can be produced in British Columbia as good in every respect as those grown in Washington.

Returning eastward a day was spent at Spence's Bridge where some magnificent apples grown by means of irrigation were obtained and forwarded to the Canadian horticultural department at the World's Fair. One of these grown by Mr. A. Clemis was an extraordinary specimen of the variety known as Red Beitegheimer, of beautiful form and colour, which measured  $15\frac{1}{2}$  inches in circumference and weighed 26 ounces.

At Calgary a visit was made to the farm of Mr. Hull, a few miles from the town, where excellent crops of oats, wheat and barley had been grown during the past season by means of irrigation. Extensive works have been begun in that neighbourhood which when completed will result in the irrigation of thousands of acres of land by utilizing portions of the water in the Bow and Elbow Rivers. With a sufficient supply of moisture in the soil there is no doubt that abundant crops of grain and fodder can be grown on the fertile lands of that district. Returning homewards Ottawa was reached on the 26th of September after an absence of more than six weeks.

## EXPERIMENTAL FARM, NAPPAN.

Later in the autumn the branch farm at Nappan, Nova Scotia, was visited the results of the year ascertained and arrangements made for future experimental work. This farm has been greatly improved during the past five years by a gradual extension of under-draining. A few acres have been drained each year, until now 78 acres have been so treated with manifestly beneficial results in quantity and quality of crops. Land so drained may be seeded much earlier in the spring, and the soil being kept more open and porous admits of a much better tilth, while the conditions for healthy plant growth are greatly improved. Many promising varieties of grain, roots and potatoes, have been tested, the results of early and late sowing compared, the influence of fertilizers on different crops noted and many other useful lines of experimental work conducted. The fruit plantations contain many varieties both of large and small fruits, most of which have made satisfactory progress and some of the young trees have borne fruit. The number of ornamental trees, shrubs and plants under test has been increased and useful information gained in this branch of the work. The cattle kept at this farm are almost wholly composed of dairy breeds, and the recent establishment of a cheese and butter factory, at Nappan, under charge of the Dominion Dairy Commissioner, has awakened a general interest in dairying in that part of the country and brought the experimental work carried on at the farm on dairy stock prominently into notice. Since the erection of the piggery several useful breeds of swine have been introduced which are having a good influence in improving the character of the hogs bred in this district. All the animals appeared to be healthy and the general condition of the farm was good, giving evidence everywhere of careful management.

# Experimental Farms.

## BEE KEEPING.

For the past two years experiments have been conducted with bees at the branch farm in Brandon, Manitoba, and recently the initial steps in the direction of investigations on this important subject have been taken at the central farm and a supply of suitable material obtained. The supervision of this work will be undertaken by the entomologist of the experimental farms, Mr. James Fletcher, who will, it is expected be able to give particulars of the progress made in this department in the next annual report.

### SUMMARY OF CROPS AT THE CENTRAL EXPERIMENTAL FARM.

The following are the results of the harvest of 1893:—

	Bushels.
Wheat .....	206
Barley.....	251
Oats .....	736
Pease .....	191
Rye.....	370
Mixed grain for feed.....	212
<b>Total No. of bushels.....</b>	<b>1,966</b>

	Tons.	Lbs.
Indian corn for ensilage.....	440	.....
Sunflower heads for ensilage.....	25	1,651
Horse beans .....	15	273
Carrots .....	131	1,332
Mangels .....	56	1,388
Turnips.....	11	1,174
Potatoes.....	34	.....
Hay.....	104	.....
<b>Total No. of tons.....</b>	<b>828</b>	<b>1,818</b>

## CORRESPONDENCE.

The following is a summary of the letters received and despatched at the Central Experimental Farm for the first eleven months of 1893, ending November 30th, also of the bulletins and reports distributed by mail during the same period:—

	Letters Received.	Letters Sent.
Director, (including in "letters received" reports on seed grain and in "letters sent" circulars of instruction and acknowledgment of reports received relating to distribution of seed grain).....	13,733	18,213
Agriculturist.....	4,663	
Horticulturist (including in "letters sent" circulars regarding diseases of fruits, and varieties of fruits suitable for Quebec) .....	1,863	3,756
Chemist.....	850	2,180
Entomologist and Botanist.....	1,735	746
Poultry manager.....	727	1,261
	<b>23,571</b>	<b>26,926</b>

Number of Reports and Bulletins mailed..... 227,899

## METEOROLOGICAL OBSERVATIONS.

TABLE of Meteorological Observations taken at the Central Experimental Farm Ottawa, 1893; maximum, minimum, and mean temperature for each month, with date of occurrence; also rainfall and snowfall:

	Maximum.	Date.	Minimum.	Date.	Mean.	Rainfall. Inches.	Snowfall. Inches.
January .....	40° 2	29th	-26° 2	4th	3° 6	.....	30 00
February .....	38° 8	10th	-23° 1	5th	9° 8	0 07	29 00
March .....	45° 0	9th	-5° 2	6th	23° 2	1 04	2 50
April .....	65° 2	13th	9° 0	2nd	36° 5	2 47	5 00
May .....	87° 5	12th	33° 8	26th	53° 3	4 69	
June .....	91° 5	20th	49° 5	7th	68° 3	4 36	
July .....	88° 3	1st	49° 0	9th	66° 1	5 01	
August .....	94° 8	10th	45° 5	30th	66° 8	8 68	
September .....	76° 3	13th and 15th	34° 9	26th	53° 6	3 22	
October .....	72° 9	13th	21° 5	31st	48° 6	1 18	
November .....	54° 2	2nd	7° 5	25th	32° 6	1 07	6 00
						31 79	72 50

Rain or snow fell on 158 days during the 11 months.

Heaviest rainfall in 24 hours 1 97 in., on September 29th.

Heaviest snowfall in 24 hours 8 00 in., on January 2nd.

During May rain fell on 17 days.

October shows the lowest number of days on which rain fell during the summer months, viz., 9.

WILLIAM T. ELLIS,

*In charge of Observations.*

## ACKNOWLEDGMENTS.

In closing this section of the report, I desire to express my obligations to all the officers composing the working staff of the several experimental farms for their ready and hearty co-operation in all departments of the work which have been planned and for the successful carrying out of the measures devised, also to the workmen for the interest they have taken in doing their part well. The success of the work has exceeded all anticipations and has gained multitudes of friends and advocates for the farms among the agriculturists and horticulturists of Canada and the most favourable comments from those best able to judge of the value of the work in other countries. The results reflect credit on all. A personal acknowledgment is specially due to those members of the Central Experimental Farm staff, who have so ably assisted me in those sections of the work of which from the beginning I have assumed the personal charge. I allude to portions of the agricultural work (by special arrangement with the agriculturist) to the forest plantations and the planting of ornamental groups of trees and shrubs, the care of the seed testing and propagating houses, and the distribution of seed grain for test. To the farm foreman, Mr. John Fixter; to the foreman in forestry, Mr. W. T. Macoun; who has also acted as my assistant in the experimental field work, to Mr. W. T. Ellis, who has had the charge of the testing and propagating houses, and to Mr. J. Kirkpatrick, who has carried on the work connected with the seed distribution, my grateful acknowledgments are due for the care and vigilance which they have shown in the management of these several divisions of the work and in collecting and preserving the data on which much of the information in this part of the report is based.

WM. SAUNDERS,

*Director Dominion Experimental Farms.*

## Experimental Farms.

# REPORT OF THE AGRICULTURIST.

(JAS. W. ROBERTSON.)

To WM. SAUNDERS, Esq.,  
Director, Dominion Experimental Farms,  
Ottawa.

SIR,—I have the honour to present reports on, (1) experiments in the fattening of cattle, (2) experiments in the feeding of swine, and (3) the Robertson mixture for ensilage.

The brevity of this report is due to two causes.

(1) The discovery that the disease of tuberculosis was widespread in our herd of cattle, led to the stoppage, for a time, of experiments in the feeding of milking cows, also to a postponement of the investigations in the Experimental Dairy. The presence of the disease of tuberculosis in a few of the cattle, had been suspected for some time; but until recently the disease was not known to be of an actively contagious nature. After it had been established that, by means of tests made by the injection of a small quantity of Koch's lymph or tuberculin, the presence of the disease in even its incipient stages could be detected, several of the animals were tested. By the steps which were taken to stamp out the disease from the herd, it became impracticable to continue the feeding of a number of cows on the crops of the 40-acre lot, which were reported on last year. A complete record of the crops of the 40-acre lot for 1893 has been taken; and it is intended that the feeding of as many cattle as can be kept on the product of it, will be resumed in 1894. For the reason mentioned, I do not consider the information available in regard to it, for the season of 1893, to be of sufficient importance to be published in its incomplete state.

(2) As in former years my duties and opportunities as Dairy Commissioner have absorbed the greater part of my time. Executive work which has arisen from the establishment and management of the Branch Experimental Dairy Stations—(there have been 19 different dairy stations under my control during the year)—has absorbed a large share of my time; the management of the exhibition of Canadian dairy products at the World's Fair claimed no few hours and days; meetings of farmers, correspondence, &c., &c., had to go sparingly served by what could be taken of it; and the planning and supervising of investigations into the feeding and management of cattle and swine and the other branches of work undertaken by me, at the Central Experimental Farm, in my capacity as Agriculturist, occupied the remainder of it. The supervision of the grain and root crops was taken by yourself, as heretofore.

For the faithful and painstaking discharge of their duties, I desire to mention with special commendation, Mr. John Fixter, farm foreman, and Mr. Robert R. Elliott, herdsman.

I have the honour to be, sir,

Your obedient servant,

JAS. W. ROBERTSON,

*Agriculturist.*

## PART I.—THE FATTENING OF CATTLE.

Experimental tests in the fattening of steers were commenced at the Central Experimental Farm in December, 1890. The main object of the experiments was to obtain information on the comparative cost of fattening steers:—

(1.) Upon a ration of which the bulky-fodder portion was mainly **corn ensilage, hay and roots**;

(2.) Upon a ration of which the bulky-fodder portion was mainly **hay and roots**; and

(3.) Upon a ration of which the bulky-fodder portion was mainly **corn ensilage**.

For the purpose of arranging such data as would be obtained from the tests, in a manner which would be clear to the farmers and useful to them in making a comparison between the cost of feeding steers on the three different classes of rations, a cash value was estimated for the component fodders in each. The prices at which the several fodders were valued for the purposes of these comparisons, are higher than the cost of production to the ordinary farmers, and may be higher or lower than the prices which could be realized from their sale as fodders.

The values at which the calculations for the different years were made, are as follows:—

TABLE I.

	1890-91.	1891-92.	1892-93.
	\$ cts.	\$ cts.	\$ cts.
Corn ensilage..... Per ton.	1 40	2 00	2 00
Hay .....	8 00	8 00	8 00
Roots (turnips, mangels and carrots).....	4 00	4 00	4 00
Straw.....	4 00	4 00	4 00
Oil-cake and cotton-seed meal.....	30 00	30 00	.....
Mixed grain (pease and barley).....	20 00	20 00	20 00
Frosted wheat.....	.....	12 00	12 00

The following table shows the rations which were fed in 1891-92. In 1890-91, instead of 2 lbs. of oil-cake in each ration, there were 1 lb. each of oil-cake and cotton-seed meal. Otherwise the rations were the same for the two years.

TABLE II.

Ration No. 1.	Lbs.	Ration No. 2.	Lbs.	Ration No. 3.	Lbs.
Corn ensilage.....	20			Corn ensilage .....	50
Hay (cut) .....	10	Hay (cut).....	20		
Roots .....	20	Roots.....	40		
Straw (cut).....	5	Straw (cut).....	5	Straw (cut).....	5
Oil-cake .....	2	Oil-cake .....	2	Oil-cake .....	2
Pease (ground).....	2	Pease (ground).....	2	Pease (ground).....	2
Barley (ground).....	2	Barley (ground).....	2	Barley (ground).....	2
	61		71		61

Feeding tests were continued during 1892-93 to obtain further data for a comparison of the economy of using the bulky-fodder portions of rations, No. 2 (**hay, roots and straw**), and No. 3 (**corn ensilage and straw**). Instead of equal

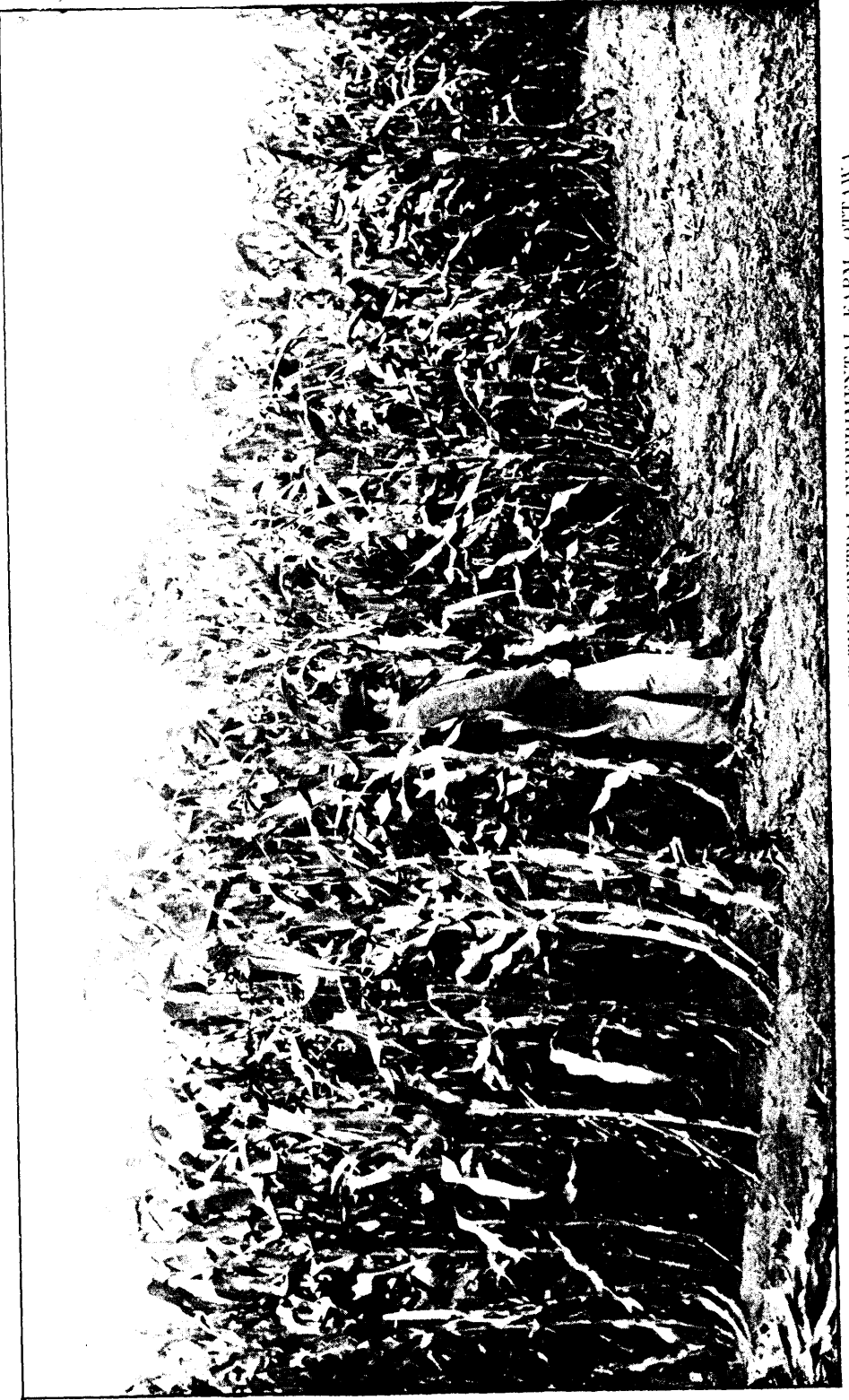

INDIAN CORN FOR FODDER AND ENSILAGE, GROWN AT THE CENTRAL EXPERIMENTAL FARM - OTTAWA.



## Experimental Farms.

quantities of meal being added to the different rations, an equal quantity of meal per head per day, was fed to the animals which were classed for comparison in the two groups.

Four steers (two of them 2-year-olds and two of them 1-year-olds) were arranged into Group I. and were fed on ration No. 2, as under; and four steers of similar age, quality and breeding, were put into Group II. and fed on ration No. 3, as under.

TABLE III.

Ration No. 2.	Lbs.	Ration No. 3.	Lbs.
Hay (cut).....	20	Corn ensilage.....	50
Roots (turnips).....	40	Straw (cut).....	5
Straw (cut).....	5		
	65		55

The animals were allowed as much of the mixture as they would eat. The meal, which was fed in addition, was a mixture of equal parts by weight of ground barley, pease and frosted wheat. The two-year-old steers in both groups were given 5 lbs. per head per day of the meal; and the one-year-old steers in both groups were given 4 lbs. per head per day of the meal. Occasionally, when the animals "were off their feed," the meal was reduced for a few days.

The two-year-old steers in both groups were fed for comparison in a test in 1891-92; and the following table of the rate of gain during the feeding period of 18 weeks at that time, shows that the animals were nearly evenly classed. In that test they were all fed on ration No. 3 (corn ensilage, straw and meal):—

TABLE IV.

	Increase in Weight.	Feed consumed per head per day.	Cost per head per day.
	Lbs.	Lbs.	Cents.
Group I., steer No. 177.....	163	45.25	9.64
do do 178.....	173		
Group II. do 175.....	129	43.94	9.36
do do 176.....	172		

During the preparatory period, for the feeding test of 1892-93, from Oct. 6 to Nov. 22, these four steers were fed on the ordinary maintenance ration. The following table shows the gain in weight during that period.

TABLE V.

	Weight, Oct. 6.	Weight, Nov. 22.	Gain.
	Lbs.	Lbs.	Lbs.
Group I., steer No. 177.....	1,105	1,105	.....
do do 178.....	1,125	1,235	110
Group II. do 175.....	1,050	1,140	90
do do 176.....	1,050	1,180	130

The following table shows (1) the increase in weight of each steer during the first 11 weeks (from Nov. 22 to Feb. 7), (2) the quantity of the ration consumed per head per day, (3) the quantity of the meal mixture consumed per head per day, and (4) the average cost per head per day for feed consumed:—

TABLE VI.

Rations.	Increase in Weight.	Bulky-fodder per head, per day.	Meal per head, per day.	Cost per head, per day.
	Lbs.	Lbs.	Lbs.	Cents.
Hay, roots and straw, steer No. 177.....	127	38·29	5·01	14·35
do do 178.....	59	37·75	5·01	14·20
Corn ensilage and straw, steer No. 175.....	107	53·54	5·01	10·17
do do 176.....	130	55·94	5·01	10·42

The steers on the hay, roots and straw ration were not showing a good appetite, and for the remainder of the feeding period (from February 7 to May 9) ration No. 2 was made up to contain 80 lbs. of roots instead of 40 lbs.

The two rations were then as follows:—

TABLE VII.

Ration No. 2.	Lbs.	Ration No. 3.	Lbs.
Hay (cut).....	20	Corn ensilage.....	50
Roots (turnips and carrots).....	80	Straw (cut).....	5
Straw (cut).....	5		
	105		55

The following table shows (1) the increase in weight of each steer during the 13 weeks (from February 7 to May 9), (2) the quantity of the ration consumed per head per day, (3) the quantity of the meal mixture consumed per head per day, and (4) the average cost per head per day for feed consumed.

TABLE VIII.

Rations.	Increase in Weight.	Bulky-fodder per head, per day.	Meal per head, per day.	Cost per head, per day.
	Lbs.	Lbs.	Lbs.	Cents.
Hay, roots and straw, steer No. 177.....	89	48·00	4·87	15·64
do do 178.....	116	48·53	4·86	15·75
Corn ensilage and straw do 175.....	92	48·40	4·82	9·45
do do 176.....	100	52·41	4·90	9·95

## Experimental Farms.

The following table shows (1) the increase in weight of each steer for the whole feeding period of 24 weeks, (2) the increase in weight per head per day, (3) the cost per head per day, and (4) the cost per 100 lbs. of increase in weight for feed consumed.

TABLE IX.

Rations.	Meal per head per day.	Increase in Weight.	Increase per head per day.	Cost per head per day.	Cost per 100 lbs. of increase.
	Lbs.	Lbs.	Lbs.	Cents.	\$
Hay, roots and straw, steer No. 177.....	4.94	216	1.28	15.05	11.70
do do 178.....	4.93	175	1.04	15.04	14.40
Corn ensilage and straw do 175.....	4.91	199	1.18	9.79	8.26
do do 176.....	4.95	230	1.36	10.18	7.43

*Conclusions.* From these tests it appears that:—

(1.) During the feeding period of 24 weeks, the steers which were fed upon ration No. 3 (**corn ensilage, straw and meal**) **GAINED** in weight on the average 19 lbs. per head **MORE**, and **COST** 5.06 cents per head **LESS**, per day for feed consumed, than the steers which were fed upon ration No. 2 (**hay, roots, straw and meal**);

(2.) The cost for feed consumed per 100 lbs. of increase in live weight, was 66.34 per cent greater on ration No. 2 (**hay, roots, straw and meal**) than it was on ration No. 3 (**corn ensilage, straw and meal**).

The following is a summary of the results from the feeding tests for three years with two-year old steers.

*Conclusions.* From the tests in 1890-91 it appears that:—

(1.) During the feeding period of 20 weeks, the steers which were fed upon ration No. 3 (**corn ensilage, straw and meal**), **GAINED** in weight, on the average, 33 lbs. per head **MORE**, and **COST** 7.33 cents per head **LESS**, per day for feed consumed, than the steers which were fed upon ration No. 2 (**hay, roots, straw and meal**);

(2.) During the feeding period of 20 weeks, the steers which were fed upon ration No. 3 (**corn ensilage, straw and meal**), **GAINED** in weight, on the average, 61½ lbs. per head **MORE**, and **COST** 3.68 cents per head **LESS**, per day for feed consumed, than the steers which were fed upon ration No. 1 (**hay, roots, corn ensilage, straw and meal**);

(3.) When the experiment was ended, the steers which were fed upon ration No. 2 (**corn ensilage, straw and meal**) were in the most attractive condition of the three lots for handling and selling.

*Conclusions.* From the tests in 1891-92 it appears that:—

(1.) During the feeding period of 18 weeks, the steers which were fed upon ration No. 3 (**corn ensilage, straw and meal**), **GAINED** in weight on the average 55½ lbs. per head **MORE**, and **COST** 3.75 cents per head **LESS**, per day for feed consumed, than the steers which were fed upon ration No. 2 (**hay, roots, straw and meal**);

(2.) During the feeding period of 18 weeks, the steers which were fed upon ration No. 3 (**corn ensilage, straw and meal**), **GAINED** in weight on the average 36 lbs. per head **MORE**, and **COST** 3.81 cents per head **LESS**, per day for feed consumed, than the steers which were fed upon ration No. 1 (**hay, roots, corn ensilage, straw and meal**);

(3.) The cost for feed consumed per 100 lbs. of increase in live weight, was 62.95 per cent greater on ration No. 2 (**hay, roots, straw and meal**), and 48.32 per cent greater on ration No. 1 (**hay, roots, corn ensilage, straw and meal**) than it was on ration No. 3 (**corn ensilage, straw and meal**).

*Conclusions.* From these tests for three years it appears that:—

(1.) On the average, the steers which were fed on ration No. 3 (corn ensilage, straw and meal) GAINED in weight on the average 35·8 lbs. per head MORE, and cost 5·38 cents LESS per head per day for feed consumed, than the steers which were fed upon ration No. 2 (hay, roots, straw and meal).

(2.) On the average of two years, the cost for feed consumed per 100 lbs. of increase in live weight, was 64·64 per cent greater on ration No. 2 (hay, roots, straw and meal) than it was on ration No. 3 (corn ensilage, straw and meal).

Feeding tests on the same two rations were carried on during the same time with four one-year old steers. These four steers, like the four two-year old steers, had been on a feeding experiment during the winter of 1891-92. The following tables show the rates of gain, etc., during that test.

TABLE X.

Breed.	Weight Dec. 1.	Weight April 5.	Increase.
	Lbs.	Lbs.	Lbs.
Shorthorn No. 174.....	595	850	255
Quebec " 173.....	480	644	164
Shorthorn " 172.....	600	812	212
Quebec " 171.....	430	605	175

TABLE XI.

Rations.	Breed.	Increase in weight per day.	Feed consumed per day.	Cost per head per day.	Cost per 100 lbs. of increase in weight.
		lbs.	lbs.	cents.	\$
Hay, roots, straw and meal.....	Shorthorn No. 174.	2·02	35·85	12·11	5·99
do .....	Quebec " 173.	1·30	25·65	8·67	6·66
Corn ensilage, straw and meal ...	Shorthorn " 172.	1·68	39·00	8·31	4·94
do .....	Quebec " 171.	1·38	31·50	6·71	4·83

*Conclusions.* From these tests with calf steers it appears that:—

(1.) During the feeding period of 18 weeks, the steers which were fed upon ration No. 3 (corn ensilage, straw and meal) GAINED in weight on the average 16 lbs. per head LESS and cost 2·87 cents per head LESS per day for feed consumed, than the steers which were fed upon ration No. 2 (hay, roots, straw and meal);

(2.) The cost of feed consumed per 100 lbs. of increase in live weight, was 27·6 per cent greater, on ration No. 2 (hay, roots, straw and meal), than it was on ration No. 3 (corn ensilage, straw and meal).

(3.) The cost of feed consumed per 100 lbs. of increase in weight was lowest in the case of a calf steer of "French Canadian" or "Quebec Jersey" breed, fed upon ration No. 3 (corn ensilage, straw and meal).

In the test of 1892-93, the two steers which had been on ration No. 2 (hay, roots, straw and meal) in 1891-92, were again put on that ration; and the other two steers were put as in the former test, on ration No. 3 (corn ensilage, straw and meal).

They were allowed as much of the bulky-fodder part of the rations as they would eat; and each steer was given 4 lbs. of the mixed meal (barley, pease and frosted wheat) per day.

## Experimental Farms.

Ration No. 2 was altered for them also after February 7th by the addition of 40 lbs. of roots as in table VII.

The following tables show (1) the increase in weight of each steer for the whole feeding period of 24 weeks, (2) the increase in weight per head per day, (3) the quantity of the ration consumed per head per day, (4) the quantity of the meal mixture consumed per head per day, (5) the cost per head per day, and (6) the cost per 100 lbs. of increase in weight, for feed consumed.

TABLE XII.

Rations.	Breed.	Weight	Weight	Increase	Increase
		Nov. 22.	May 9.	in weight.	per head per day.
		lbs.	lbs.	lbs.	lbs.
Hay, roots and straw.....	Shorthorn No. 174.	1,060	1,221	161	.95
do .....	Quebec " 173.	830	955	125	.74
Corn ensilage and straw.....	Shorthorn " 172.	1,015	1,225	210	1.25
do .....	Quebec " 171.	795	986	191	1.13

TABLE XIII.

Rations.	Breed.	Bulky-	Meal per	Cost per	Cost per
		fodder per head per day.	head per day.	head per day.	100 lbs. of increase.
		lbs.	lbs.	cents.	\$
Hay, roots and straw.....	Shorthorn No. 174.	42.30	3.95	13.89	14.50
do .....	Quebec " 173.	30.74	3.79	10.91	14.66
Corn ensilage and straw.....	Shorthorn " 172.	48.19	3.95	8.67	6.94
do .....	Quebec " 171.	40.80	3.95	7.87	6.92

*Conclusions.* From these tests, it appears that:—

(1.) During the feeding period of 24 weeks, the steers which were fed upon ration No. 3 (corn ensilage, straw and meal) GAINED in weight on the average 57.5 lbs. per head MORE and cost 4.13 cents per head LESS, per day for feed consumed, than the steers which were fed upon ration No. 2 (hay, roots, straw and meal).

(2.) The cost of feed consumed per 100 lbs. of increase in live weight, was 110.39 per cent greater on ration No. 2 (hay, roots, straw and meal) than it was on ration No. 3 (corn ensilage, straw and meal);

(3.) The cost of feed consumed per 100 lbs. of increase in weight was lowest in the case of a Shorthorn steer; but taking the tests for the two years (1891-92 and 1892-93), the cost of feed consumed per 100 lbs. of increase in weight, was slightly lowest in the case of a steer of the "French Canadian" or "Quebec" breed, fed upon corn ensilage, straw and meal.

### THE FEEDING OF HEIFERS.

Two grade Shorthorn heifers were also fed on ration No. 2 (hay, roots and straw) and one grade Shorthorn and one Holstein heifer, of about similar age and quality, were fed on ration No. 3 (corn ensilage and straw). A grade Holstein steer was also fed with these two heifers on ration No. 3.

They were allowed as much of the bulky-fodder part of the ration as they would eat; and each animal was given 4 or 5 lbs. of the mixed meal (barley, pease and frosted wheat) per day. Ration No. 2. was altered for them also after February 7th by the addition of 40 lbs. of roots, as in Table VII.

The following tables show (1) the increase in weight of each animal for the whole feeding period of 24 weeks, (2) the increase in weight per head per day, (3) the quantity of the ration consumed per head per day, (4) the quantity of the meal mixture consumed per head per day, (5) the cost per head per day, and (6) the cost per 100 lbs. of increase in weight, for feed consumed.

TABLE XIV.

Ration.	Name of steer.	Weight,	Weight	Increase	Increase per
		Nov. 22.	May 9.	in weight.	head per day.
		Lbs.	Lbs.	Lbs.	Lbs.
Hay, roots and straw .....	Ida.	850	1,021	171	1·01
do do .....	Rose.	1,065	1,280	215	1·28
Corn ensilage and straw .....	Queen.	900	1,183	283	1·68
do do .....	Ethel.	1,065	1,272	207	1·23
do do .....	Baron.	885	1,163	278	1·65

TABLE XV.

Ration.	Name of steer.	Bulky fodder per head per day.	Meal per head per day.	Cost per head per day.	Cost per 100 lbs. of increase.
		Lbs.	Lbs.	cents.	\$
Hay, roots and straw .....	Ida.	40·16	3·92	13·32	13·09
do do .....	Rose.	43·34	4·94	15·01	11·73
Corn ensilage and straw .....	Queen.	52·22	3·94	9·11	5·41
do do .....	Ethel.	53·20	4·88	10·03	8·14
do do .....	Baron.	52·98	3·95	9·20	5·56

**Conclusions.** From these tests it appears that:—

(1.) During the feeding period of 24 weeks, the animals which were fed upon ration No. 3 (corn ensilage, straw and meal) GAINED in weight on the average 63 lbs. per head MORE and COST 4·72 cents per head LESS, per day, for feed consumed, than the animals which were fed upon ration No. 2 (hay, roots, straw and meal);

(2.) The cost for feed consumed per 100 lbs. of increase in live weight, was 94·82 per cent greater on ration No. 2 (hay, roots, straw and meal) than it was on ration No. 3 (corn ensilage, straw and meal).

The following tables show the average of the results from the six animals fed upon ration No. 2 (hay, roots, straw and meal) and from the seven animals fed upon ration No. 3 (corn ensilage, straw and meal) for the whole feeding period of 24 weeks:—

TABLE XVI.

Ration.	—	Weight,	Weight,	Increase in	Increase per
		Nov. 22.	May 9.	weight.	head per day.
		Lbs.	Lbs.	Lbs.	Lbs.
Hay, roots and straw ...	Average of six animals .....	1,024	1,201	177	1·05
Corn ensilage and straw ..	Average of seven animals .....	997	1,225	228	1·35

## Experimental Farms.

TABLE XVII.

Ration.		Bulky-fodder per head per day.	Meal per head per day.	Cost per head per day.	Cost per 100 lbs. of increase.
		Lbs.	Lbs.	cents.	\$
Hay, roots and straw....	Average of six ani- mals.....	44.00	4.41	13.87	13.35
Corn ensilage and straw.	Average of seven animals.....	50.31	4.36	9.26	6.95

*Conclusions.* From these tests it appears that:—

(1.) During the feeding period of 24 weeks, the animals which were fed upon ration No. 3 (corn ensilage, straw and meal) GAINED in weight on the average 51 lbs. per head MORE, and COST 4.61 cents per head LESS per day for feed consumed, than the animals which were fed upon ration No. 2 (hay, roots, straw and meal);

(2.) The cost for feed consumed per 100 lbs. of increase in live weight, was 92.08 per cent greater on ration No. 2 (hay, roots, straw and meal), than it was on ration No. 3 (corn ensilage, straw and meal);

(3.) The cost of feed consumed per 100 lbs. of increase in weight was *lowest* in the case of a grade Shorthorn heifer (viz., \$5.44 per 100 lbs. of increase in weight), fed upon ration No. 3 (corn ensilage, straw and meal).

### PART II.—THE FEEDING OF SWINE.

The experiments in the feeding of swine during 1893 were mainly directed towards gaining information on the quantities of grain consumed per pound of increase in live weight by swine of different breeds or breeding. Incidentally, tests with the use of frosted wheat as the whole or part of the ration were continued.

#### *First Series.*

A series of experiments was commenced with four pens of swine of different breeding, by feeding them on frozen or frosted wheat, ground and soaked in cold water for an average of 18 hours. The swine in every pen were weighed once a week.

TABLE I.

Pen No. 1 contained 3 swine, crossbred by *Berkshire* sire and *Poland-China* dam

	Oct. 3.	Oct. 31.	Nov. 28.	Dec. 26.	Totals.
	Lbs.	Lbs.	Lbs.	Lbs.	Lbs.
Live weight.....	329	469	589	630	.....
Increase in weight.....		140	120	41	301
Feed consumed.....		585½	565½	364	1,515
do per lb. of increase in live weight.....		4.17	4.71	8.87	5.03

TABLE II.

Pen No. 2 contained 4 swine, grades by *Improved Large Yorkshire* sire and *Berkshire Grade* dam.

	Oct. 3.	Oct. 31.	Nov. 28.	Dec. 26.	Totals.
	Lbs.	Lbs.	Lbs.	Lbs.	Lbs.
Live weight.....	376	499	642	746	.....
Increase in weight.....		123	143	104	370
Feed consumed.....		624	631	608	1,863
do per lb. of increase in live weight.....		5·07	4·41	5·84	5·03

TABLE III.

Pen No. 3 contained 2 swine, crossbred by *Improved Large Yorkshire* sire and *Berkshire* dam.

	Oct. 3.	Oct. 31.	Nov. 28.	Dec. 26.	Totals.
	Lbs.	Lbs.	Lbs.	Lbs.	Lbs.
Live weight.....	256	331	398	426	.....
Increase in weight.....		75	67	28	170
Feed consumed.....		371½	342	232	945½
do per lb. of increase in live weight.....		4·93	5·10	8·28	5·56

TABLE IV.

Pen No. 4 contained 3 swine, purebred *Improved Large Yorkshires*.

	Oct. 3.	Oct. 31.	Nov. 28.	Dec. 26.	Totals.
	Lbs.	Lbs.	Lbs.	Lbs.	Lbs.
Live weight.....	275	338	405	314*	.....
Increase in weight.....		63	67	42	172
Feed consumed.....		370	364	276	1,010
do per lb. of increase in live weight.....		5·87	5·43	6·57	5·87

\* 2 swine only.

**Conclusions.** From these tests with 12 swine, which were continued 12 weeks, it appears that:—

(1.) On the average 5·26 lbs. of frosted wheat were consumed per pound of increase in the live weight.

#### Second Series.

A series of experiments was commenced with five pens of swine of different breeds or breeding, by feeding them all on the same ration,—a mixture of equal parts by weight of barley and frosted wheat, both ground and soaked in cold water for an average of 30 hours. After the first week a quantity of pulped carrots, equal to one-fifth of the weight of grain consumed, was given.



## Experimental Farms.

### TABLE V.

PEN No. 1 contained 4 swine, purebred *Improved Large Yorkshires*.

	Feb. 7.	Mch. 7.	Apl. 4.	May 2.	Totals.
	Lbs.	Lbs.	Lbs.	Lbs.	Lbs.
Live weight .....	756	793	825	944	.....
Increase in weight .....		37	32	119	188
Feed consumed.....		322	325	450	1,097
		45	65	90	200
do per lb. of increase in live weight.....		9.91	12.18	4.53	5.83
					1.06

### TABLE VI.

PEN No. 2 contained 4 swine, purebred *Tamworths*.

	Feb. 7.	Mch. 7.	Apl. 4.	May 2.	Totals.
	Lbs.	Lbs.	Lbs.	Lbs.	Lbs.
Live weight.....	457	524	593	691	.....
Increase in weight.....		67	69	98	234
Feed consumed.....		394	315	400	1,109
		58	63	80	201
do per lb. of increase in live weight.....		6.74	5.47	4.89	4.74
					.86

### TABLE VII.

PEN No. 3 contained 3 swine, purebred *Berkshires*.

	Feb. 7.	Mch. 7.	April 4.	May 2.	Totals.
	Lbs.	Lbs.	Lbs.	Lbs.	Lbs.
Live weight.....	351	420	469	558	.....
Increase in weight.....		69	49	89	207
Feed consumed.....		299	245	320	864
		45	49	64	158
do per lb. of increase in live weight.....		4.98	6.00	4.31	4.17
					.76

### TABLE VIII.

PEN No. 4 contained 4 swine, crossbred by *Improved Large Yorkshire* sire and *Poland China* dam.

	Feb. 14.	Mch 14.	Apl. 11.	May 9.	Totals.
	Lbs.	Lbs.	Lbs.	Lbs.	Lbs.
Live weight.....	479	571	654	757	.....
Increase in weight.....		92	83	103	278
Feed consumed.....		450	335	445	1,230
		90	67	89	246
do per lb. of increase in live weight.....		5.86	4.84	5.18	4.42
					.89

TABLE IX.

PEN No. 5 contained 6 swine, crossbred by *Improved Large Yorkshire* sire and *Essex* dam.

	Feb. 14.	Mch. 14.	Apl. 11.	May 9.	Totals.
	Lbs.	Lbs.	Lbs.	Lbs.	Lbs.
Live weight.....	420	505	633	809	..... 389
Increase in weight.....		85	128	176	..... 389
Feed consumed { grain.....		475	395	600	1,470
do { carrots.....		95	79	120	294
do per lb. of { grain.....		6·70	3·70	4·09	3·77
increase in live weight { carrots.....					·76

*Conclusions.* From these tests with 21 swine, which were continued for 12 weeks, it appears that:—

(1.) On the average, 4·45 lbs. of barley and frosted wheat, both ground and soaked, plus ·85 lbs. of pulped carrots, were consumed per pound of increase in the live weight.

### Third Series.

A series of experiments was commenced with eight pens of swine of different breeds or breeding by feeding them all on the same ration—a mixture of equal parts (by measure) of ground barley, rye, frosted wheat and bran. All the grain was ground and soaked in cold water for an average of 8 hours from August 23 to November 8 and for an average of 18 hours thereafter.

TABLE X.

PEN No. 1 contained 5 swine, crossbred by *Berkshire* sire and *Poland China* dam.

	Aug. 23.	Sep. 20.	Oct. 18.	Nov. 15.	Dec. 6.	Totals.
	Lbs.	Lbs.	Lbs.	Lbs.	Lbs.	Lbs.
Live weight.....	418	534	643	742	807	..... 389
Increase in weight.....		116	109	99	65	..... 389
Feed consumed.....		446	460	396	297	1,599
do per lb. of increase in live weight.....		3·84	4·22	4·00	4·57	4·11

TABLE XI.

PEN No. 2 contained 2 swine, crossbred by *Berkshire* sire and *Tamworth* dam.

	Aug. 23.	Sep. 20.	Oct. 18.	Nov. 15.	Dec. 6.	Totals.
	Lbs.	Lbs.	Lbs.	Lbs.	Lbs.	Lbs.
Live weight.....	188	224	276	320	346	..... 158
Increase in weight.....		36	52	44	26	..... 158
Feed consumed.....		171	163	171	133	638
do per lb. of increase in live weight.....		4·75	3·13	3·88	5·11	4·03

## Experimental Farms.

**TABLE XII.**

PEN No. 3 contained 5 swine, crossbred by *Berkshire* sire and *Improved Large Yorkshire* dam.

—	Aug. 23.	Sep. 20.	Oct. 18.	Nov. 15.	Dec. 6.	Totals.
	Lbs.	Lbs.	Lbs.	Lbs.	Lbs.	Lbs.
Live weight.....	248	319	394	482	544	.....
Increase in weight.....		71	75	88	62	296
Feed consumed.....		252	280	304	266	1,102
do per lb. of increase in live weight.....		3.54	3.73	3.45	4.29	3.72

**TABLE XIII.**

PEN No. 4 contained 5 swine, crossbred by *Improved Large Yorkshire* sire and *Berkshire* dam.

—	Aug. 23.	Sept. 20.	Oct. 18.	Nov. 15.	Dec. 6.	Totals.
	Lbs.	Lbs.	Lbs.	Lbs.	Lbs.	Lbs.
Live weight.....	210	281	345	394	430	.....
Increase in weight.....		71	64	49	36	220
Feed consumed.....		210	206	200	181	797
do per lb. of increase in live weight.....		2.95	3.21	4.08	5.02	3.62

**TABLE XIV.**

PEN No. 5 contained 5 swine, crossbred by *Essex* sire and *Improved Large Yorkshire* dam.

—	Aug. 23.	Sept. 20.	Oct. 18.	Nov. 15.	Dec. 6.	Totals.
	Lbs.	Lbs.	Lbs.	Lbs.	Lbs.	Lbs.
Live weight.....	205	256	310	373	417	.....
Increase in weight.....		51	54	63	44	212
Feed consumed.....		221	235	245	205	906
do per lb. of increase in live weight.....		4.33	4.35	3.88	4.63	4.27

**TABLE XV.**

PEN No. 6 contained 5 swine, crossbred by *Essex* sire and *Improved Large Yorkshire* dam.

—	Aug. 23.	Sep. 20.	Oct. 18.	Nov. 15.	Dec. 6.	Totals.
	Lbs.	Lbs.	Lbs.	Lbs.	Lbs.	Lbs.
Live weight.....	225	295	363	431	490	.....
Increase in weight.....		70	68	68	59	265
Feed consumed.....		256	256	258	220	990
do per lb. of increase in live weight.....		3.65	3.76	3.79	3.70	3.73

TABLE XVI.

PEN No. 7 contained 4 swine, grades by *Tamworth* sire and *Berkshire Grade* dam.

	Sep. 6.	Oct. 4.	Nov. 1.	Nov. 29.	Totals.
	Lbs.	Lbs.	Lbs.	Lbs.	Lbs.
Live weight.....	210	270	352	452	.....
Increase in weight.....		60	82	100	242
Feed consumed.....		209	230	346	785
do per lb of increase in live weight.....		3.48	2.80	3.46	3.24

TABLE XVII.

PEN No. 8 contained 5 swine purebred, *Improved Large Yorkshires*.

	Sep. 6.	Oct. 4.	Nov. 1.	Nov. 29.	Totals.
	Lbs.	Lbs.	Lbs.	Lbs.	Lbs.
Live weight.....	241	293	348	411	.....
Increase in weight.....		52	55	63	170
Feed consumed.....		241	181	242	664
do per lb. of increase in live weight.....		4.63	3.29	3.84	3.90

*Conclusions.* From these tests with 36 swine, which were continued 15 weeks and 12 weeks, it appears that:—

(1.) On the average, 3.83 lbs. of a mixture of barley, rye, frosted wheat (all ground), and bran were consumed per pound of increase in the live weight.

The tests are being continued with the swine in these pens.

### PART III.—THE ROBERTSON MIXTURE FOR ENSILAGE.

For a few years I have been seeking to find and put into the silo with Indian corn, some other fodder plant or plants, which would furnish the quantity of albuminoids necessary to make a well-balanced ration in a form which would cost much less than ripened cereals or concentrated by-products, such as oil-meal, cotton-seed meal or bran. Clovers and pease were tried with indifferent success, and the climbing or pole beans have been grown with cornstalks for trellis without appreciable advantage. It is desirable that ensilage should contain, besides the albuminoids and carbo-hydrates such as may be found in Indian corn and horse beans, a larger quantity of fat than these plants contain. In a country with such a climate as prevails in Canada during the winter, it seems advisable to provide a winter ration for cattle containing a fairly large proportion of fat, as a bland, heat-producing part of a ration in a cheap and palatable form. I venture to believe that we have now secured that in the heads of sunflowers.

The horse bean or small field bean (*Faba vulgaris*, variety *equina*) seems to meet the case, so far as the albuminoids are concerned. This plant grows with a stiff, erect stem of a quadrangular shape. It attains in Canada a height of from 3 feet to 6 feet. It bears pods from within 6 or 8 inches from the base of the stalk to near its top. The beans when ripened are of a grayish-brown colour, and of oblong round shape, about  $\frac{1}{2}$ -inch in long diameter and from  $\frac{3}{8}$  to a  $\frac{1}{2}$ -inch in short diameters. Plants have carried ripened beans in the lower pods, while the topmost ones on the same stalks were hardly out of bloom.

## Experimental Farms.

The sunflower (*Helianthus annuus*) grows luxuriantly over the whole of the temperate zone on this continent, and the seeds contain a large percentage of fat. The variety known as *Mammoth Russian* has been grown in rows 3 feet apart, and it appears to do best when the plants are from 12 to 18 inches apart in the rows. The following table shows the constituents of the horse beans and sunflower heads, as analysed by Mr. Frank T. Shutt, Chemist, Dominion Experimental Farms:—

ANALYSES IN 1892.

—	Water.	Album- inoids.	Fat.	Carbo- hy- drates.	Fibre.	Ash.	Dry matter.
	p. c.	p. c.	p. c.	p. c.	p. c.	p. c.	p. c.
Horse beans .....	89·24	2·75	73	2·26	3·71	1·09	10·76
do .....	86·15	2·69	66	4·17	4·98	1·35	13·85
Sunflower heads with seeds .....	75·62	2·35	4·86	7·88	7·94	1·35	24·38
	Lbs. per ton.	Lbs. per ton.	Lbs. per ton.	Lbs. per ton.	Lbs. per ton.	Lbs. per ton.	Lbs. per ton.
Horse beans .....	1784·8	55·0	14·6	45·2	74·2	21·8	215·2
do .....	1723·0	53·8	13·2	83·4	99·6	27·0	277·0
Sunflower heads with seeds .....	1512·4	47·0	97·2	157·6	158·8	27·0	487·6

A brief test of the feeding of a group of cows, for 70 days during the early part of the year, was made on a ration composed of:—

	Pounds.
Corn ensilage.....	40
Roots .....	50
Straw.....	8
Mixed meal .....	4

A similar group of cows was fed on the following ration, wherein the ensilage contained Indian corn at the rate of 12 parts to 1 part of sunflower heads:—

	Pounds.
Corn ensilage and sunflower heads.....	40
Roots .....	50
Straw.....	8
Meal.....	2

No appreciable difference in the quantity or quality of the milk, as to its percentage of solids from the different groups of cows, could be traced or attributed to the different rations upon which they were fed. After both groups of cows had been fed for two weeks on the different mixtures, tests were made to discover if any difference appeared in the quality of the milk from the different groups, in regard to the readiness with which the cream could be separated by the setting method, or in the quality of the butter which was obtained from it.

The following table shows the average of the tests of nine days' milk from the two groups of cows. The test was commenced on 20th February. The milk from both groups was treated exactly alike. The setting was in deep pails in ice water for 22 hours.

	With corn ensilage.	With corn ensilage and sunflower heads.
Lbs. of milk.....	122	121
Per cent of butter-fat.....	3·79	3·54
Lbs. of butter-fat.....	4·62	4·28
Lbs. of skim-milk.....	97	96
Per cent of butter-fat in skim-milk.....	·50	·35
Lbs. of butter-fat in skim-milk.....	·49	·34
Lbs. of cream.....	25	25
Per cent of butter-fat in cream.....	16·52	15·76
Lbs. of butter-fat in cream.....	4·13	3·94
Lbs. of butter-milk.....	21·50	22·50
Per cent of butter-fat in butter-milk.....	·40	·30
Lbs. of butter-fat in butter-milk.....	·09	·07
Lbs. of marketable butter.....	5·00	4·75
Lbs. of milk per lb. of butter.....	24·40	25·47
Lbs. of butter per 100 lbs. of milk.....	4·10	3·93
Per cent of butter-fat unrecovered.....	12·34	9·58
Lbs. of butter per lb. of butter-fat in milk.....	1·08	1·11

Butter from both groups was examined on 15th March, when it was found that the butter from the sunflower lot, was of richer flavour and a little higher colour than the other.

In order to obtain reliable information upon the methods of growing these three plants, Indian corn, horse beans and sunflowers, in the most advantageous manner in different parts of the Dominion, arrangements were made for distributing a small quantity of seeds, at cost price, to a number of farmers in different localities. Our experience in 1892 had pointed in the direction of planting the horse beans and corn mixed in the same rows, and the following circular of directions was sent to the farmers to whom seed was supplied:—

#### CENTRAL EXPERIMENTAL FARM,

OTTAWA, 20th April, 1893.

#### CIRCULAR OF DIRECTIONS FOR THE ROBERTSON MIXTURE FOR ENSILAGE.

##### *Soil.*

If a field with a drained, warm, loamy soil be convenient to the silo, and can be used, it should be selected in preference to a heavy clay or wet soil. In all cases, the land should receive a liberal dressing of manure, be ploughed in the spring, and be harrowed to a state of fine tilth before the seeds are planted.

##### *Time to Plant.*

The time at which Indian corn for fodder may be planted with the best results, is the best time at which to plant or sow these seeds also. In most districts that period is during the last ten days of May, or late enough in the season to escape frosts at night, and early enough to give the plants the advantage of as long a season for growing as is practicable. The horse beans and sunflowers are less liable to injury from frost than Indian corn.

## Experimental Farms.

### *How to Plant.*

The Indian corn and horse beans (which have been mixed) are to be planted in rows 3 feet apart, with from 2 to 4 grains per lineal foot in every row. A horse-power corn-planter or seed drill may be used for that purpose. Or they may be planted in hills 3 feet apart both ways, with from 6 to 10 grains in every hill. A horse-power or hand corn-planter may be used. If none of these implements and no other suitable planter be available, furrows 3 inches deep may be ploughed 3 feet apart. The seeds may be put in them and covered, after which the field should be rolled.

The sunflower seeds are to be planted by themselves, in rows 3 feet apart with not more than 3 or 4 seeds per foot in the row. They may be planted with a small hand planter, or by a method similar to the one which is used with the Indian corn and horse beans.

### *Depth of Planting.*

All the seeds should be planted to a depth of from 2 to 3 inches.

### *Cultivation.*

Only in cases where a crust forms on the land, before or immediately after the plants come up, a light harrowing will prove helpful to the crop. The cultivation between the rows, when the plants are small, should be close to them; when the plants have grown to a height of 2 feet, it should be more distant and shallow, in order not to injure the side roots.

### *Cutting in the Field.*

The crop is to be cut when the Indian corn reaches the "glazing" stage of growth, that is when the ears are just past the best condition for table use.

The corn and beans may be cut by hand or by any of the devices in use for cutting fodder corn in the field.

The heads only of the sunflowers are to be used. They may be cut by a common reaping hook or other knife. They may be put directly into a wagon or cart, or into a basket or into heaps, from which they may be loaded afterwards.

### *Putting into the Silo.*

When the Indian corn has reached the "glazing" stage of growth, the crop is to be put into the silo without wilting or drying; but if and when it has not reached the "glazing" stage before frost comes, it is to be cut and left to wilt or dry in the field for about one day.

The corn and beans (from two acres) are to be cut in lengths of from  $\frac{1}{2}$ -inch to 1-inch and put into the silo; and the heads only (from half an acre) of sunflowers are to be cut with them. They may be fed through the cutting-box on and with the corn and beans.

A fairly even distribution of the mixture should be made in the silo, while it is being filled. If the leaves and lighter parts are permitted to flutter into one place, and the stalks, ears and heavier portions are allowed to settle by themselves, the ensilage will not keep well.

The mixture is to be tramped thoroughly around the sides and in the corners of the silo.

A thin layer of uncut cornstalks should be put between the "ROBERTSON MIXTURE" and the other contents (if any) of the silo, in order to mark the exact place in the ensilage.

After the silo is filled, the surface should be levelled and thoroughly tramped; and after the lapse of not more than one day, it should be covered to a depth of 6 inches with cut straw or cheap fodder. If this be tramped occasionally, and a foot of cut straw be put on top of that a few days later, probably no waste ensilage will be found on the opening of the silo for feeding.

#### *Feeding the Ensilage.*

The "ROBERTSON MIXTURE" is to be fed with 4 lbs. less meal or grain per 50 lbs. of ensilage, than has been required with ordinary Indian corn ensilage, to make an economical ration for feeding milking cows and fattening cattle.

#### *Silo.*

Ensilage has come to mean any kind of fodder which is cured and preserved in a succulent state for the feeding of domestic animals. The silo has no power to add any nutrient to the fodder which is put into it for preservation. Its contents may become more digestible and palatable by the changes which proceed slowly under the action of ferments, or they may become less pleasant and wholesome, if fermentation goes too far.

Fodder which is deficient in nutrients before it is put into a silo, will experience no regeneration there. Degeneration into offensive material is the only and constant tendency.

To prevent deterioration and decay is the function of the silo; and to that end it should be constructed to exclude the atmosphere. To do so requires the use of building material of adequate strength. The fastening of the parts, at the foundation and at the corners of the silo, should be secure. I have found one ply of sound, 1-inch lumber, tongued and grooved, and nailed horizontally on the inside of studs 2 inches by 10 inches or 2 inches by 12 inches, to be sufficient.

A clay or earthen floor is most economical and is as good as any that can be put in.

#### *Report on results.*

Please keep a record of:—

- (1) How the soil was prepared;
- (2) How the seeds were planted;
- (3) The date of planting;
- (4) The date of cutting;
- (5) The stage of growth attained by the different plants of the mixture;
- (6) The yield per acre of Indian corn and horse beans;
- (7) The yield per acre of sunflower heads;
- (8) Any unusual condition of weather such as heavy storm, frost, etc.;
- (9) Any other occurrence or condition which may affect the crop.

A form upon which to report, will be sent to you in due season. Please fill it up carefully and return it here.

Letters on official business can be sent free of postage.

WM. SAUNDERS,

*Director.*

JAS. W. ROBERTSON,

*Agriculturist.*

On the Experimental Farm here, the mixture was planted in accordance with these directions, and tests were also made by the planting of the corn and horse beans in alternate rows, and by the growing of the horse beans in rows, by themselves. The following shows the results obtained from the different methods of planting:—

A plot of nearly 3 acres was planted on June 3rd with *Thoroughbred White Flint* corn and horse beans of the *Granton* variety. The soil on one quarter of the plot was light sandy loam and on the remaining three quarters was heavy sandy loam. A dressing of cattle-stable manure was applied at the rate of 10 or 12 tons per acre,



## Experimental Farms.

and was ploughed in. 18½ lbs. of corn and 30 lbs. of horse beans were mixed, and put on per acre in rows three feet apart. The crop came up irregularly, and on June 10th it was harrowed with light harrows. The cultivation was similar to that for an ordinary Indian corn crop.

On October 2nd the corn plants had reached the late milk stage; and the bean stalks were fairly well podded although the crop of them was thin. Three representative rows of 100 feet each were cut, and the corn and bean plants were weighed separately. The beans weighed 9·31 per cent of the whole crop. When the crop was cut for the silo on 12th October, it was found that the yield was 40 tons 1,434 lbs. from 2·827 acres. That was at the rate of 14 tons 806 lbs. per acre; or 12 tons 144 lbs. of Indian corn and 1 ton 662 lbs. of horse beans.

A plot of 5 acres was planted on 1st June with *Longfellow* corn and horse beans of the *Granton* variety. The soil of the plot was clay loam and sandy loam. No manure was applied. 18½ lbs. of corn and 30 lbs. of horse beans were mixed, and put on per acre in rows three feet apart. The crop came up on 9th and 10th June and was harrowed on 9th June with light harrows.

On 2nd October the corn plants had reached the glazing or almost ripe stage; and the beans were nearly all ripe. Three representative rows of 100 feet each were cut and the corn and bean plants were weighed separately. The beans weighed 6·3 per cent of the whole crop. When the crop was cut on 10th October, it was found that the yield was 67 tons 1,905 lbs. from 5 acres. That was at the rate of 13 tons 1,181 lbs. per acre; or 12 tons 1,469 lbs. of Indian corn and 1,712 lbs. of horse beans.

A plot of 4 acres was planted on 6th July, with *Compton's Early* corn and horse beans of the *Granton* variety. The soil was a light sandy loam. A light dressing of cattle-stable manure—about 8 tons per acre—had been applied in the fall. The plot was then sown on 3rd September with fall rye of the *Reading Giant* variety. The rye was cut on 19th June, a light dressing of manure was ploughed in, and corn and beans were planted on 26th June. The crows pulled up most of the corn and the plot was replanted on 6th July, at the rate of 18½ lbs. of corn and 30 lbs. of horse beans, per acre, mixed in the same rows, which were three feet apart.

On 2nd October, the corn plants had reached the early milk stage; and the beans were mostly in flower with a few pods at the lower ends. Three representative rows of 100 feet each were cut and the corn and bean plants were weighed separately. The beans weighed 19·78 per cent of the whole crop. When the crop was cut on 14th to 16th October, it was found that the yield was 39 tons 1,335 lbs. from 4 acres. That was at the rate of 9 tons 1,834 lbs. per acre; or 7 tons 1,912 lbs. of Indian corn and 1 ton 1,922 lbs. of horse beans.

In plots where the horse beans were grown in alternate rows with Indian corn, the beans were a comparative failure. That appeared to be attributable mainly to the unfavourable weather which prevailed.

A plot of 2 acres was planted on 1st June, with several varieties of horse beans, in rows three feet apart. The soil was a clay loam which had been cropped with barley in 1892. No manure was applied. The beans were planted with a force feed seed drill, with only two spouts running, and at the rate of two-thirds of a bushel per acre. They were planted 1st June, and came up 11th June. They were cut 16th October, and left to wilt in the field for two days before they were weighed and put into the silo. The lower pods on the stalks were filled and ripened, and the upper pods were green, with the beans not quite firm.

The following are the yields per acre of the different varieties, weighed after being wilted for two days:

		<i>Horse Beans.</i>	
<i>Granton</i> variety	.....	9 tons	1,717 lbs. per acre.
<i>Tick</i>	do .....	9 do	1,252 do
<i>Carse</i>	do .....	7 do	1,631 do
<i>Kilbride</i>	do .....	7 do	1,057 do
<i>Mazagan</i>	do .....	7 do	979 do

---

Average..... 8 tons 927 lbs. per acre.

The cost of labour for growing 2 acres of horse beans was as follows :—

Rent of land, @ \$3 per acre.....	\$ 6 00
Ploughing, @ \$2 per acre.....	4 00
Harrowing 3 times, rolling once.....	1 60
Seed, 1½ bushels.....	2 00
Sowing, 3 hours of team.....	0 75
Cultivating, single horse, 2 days @ \$1.50.....	3 00
Hoeing, 10 days.....	12 50
Cutting with scythe, 2 days.....	2 50
Loading, 3 days.....	3 75
Drawing to silo, 1½ days of team.....	3 00
Proportion of time of farm foreman.....	4 00
<b>Total.....</b>	<b>\$ 43 10</b>

These figures do not include any allowance for the use of farm machinery, nor do they include any amount as an equivalent for the exhaustion of soil. The cost for labour was \$21.55 per acre. The average yield of the horse beans was 8 tons 927 lbs. per acre, which gives an average cost of \$2.55 per ton for labour of growing, including cost of seed and rent of land.

The season in point of weather was a most unusual one over the western part of the province of Quebec and over nearly the whole of the province of Ontario. While many sections were parched with drought from June until August, the rains on the Experimental Farm here were frequent and unusually heavy. Two very severe storms swept over the farm, breaking down the cornstalks and levelling to the ground four-fifths of the sunflower stalks on the different areas on which they were planted. For that reason, the results in our trial of sunflowers during the past season cannot be taken as what might be expected in the average of years. The sunflowers in 1892 were such an average crop, as might be obtained where it was not injured by any unusual occurrence. The yield in 1892 was 7½ tons of sunflower heads per acre.

As yet, reports have been received from only some 60 farmers, who gave the mixture a trial during the last summer. On account of the unusual weather, the bean crop appears to have been a total or almost total failure in most places in the province of Ontario. In the Maritime Provinces, where the rainfall and temperature were nearer the normal, the reports are favourable and indicate what might be expected in other parts of Canada, when regard is had to the time of planting which is most suitable for the different localities. I quote the following from reports received from some farmers in the provinces of New Brunswick and Quebec :—

In all these cases, the mixture was planted according to the directions in the circular which accompanied the seeds, with the corn and beans mixed in the same rows, and the sunflowers grown in rows by themselves.

From Mr. Z. R. Estey, Lower French Village, York Co., N.B.

“Q. Beans: Were the pods formed, filled or ripened?—A. Mostly filled and ripened, and shelling considerably.

Average height of plants? Four feet.

Yield per acre? Eleven tons of corn with four tons of beans.

Yield per acre of sunflower heads? Five or six tons.

General Remarks:—The beans I am convinced should be planted later than the *Longfellow* corn.”

From Mr. Abram Alward, Butternut Ridge, Westmoreland Co., N. B.

“Q. Beans: Were the pods formed, filled or ripened?—A. Some stalks contained a large number of pods, some ripened at bottom, other stalks contained no pods, blossoms seemed to be blighted.

Average height of plants? Three feet six inches.

Yield per acre? Of sunflower heads, about 200 bushels; of corn and beans, about eight tons, green weight, of which there were five tons of corn and three tons of beans.

## Experimental Farms.

General Remarks: I am fully convinced that by planting the horse beans *early* with the corn, one can increase the yield per acre from 3 to 4 tons without injury to the corn in any way, and the beans seem to grow better and fill fully as well among the corn, as they do planted separate."

From Mr. E. C. Cole, Moncton, Westmoreland Co., N. B.

"Q. Beans: Were the pods formed, filled or ripened?—A. Pods formed very well along whole length of stalk, ripened near butt, and fairly well filled half way up.

Average height of plants? Three feet.

Yield per acre? Of sunflower heads, seven tons; of corn and beans, about twelve tons; of which three-fourths for corn and one-fourth for beans."

From Mr. Joseph R. Taylor, Taylor Village, Westmoreland Co., N. B.

"Q. Beans: Were the pods formed, filled or ripened?—A. About one-half of the beans were ripe, the rest well filled.

Average height of plants? Five feet six inches; some of the stalks measured as high as seven feet.

Yield per acre?—Of corn and beans, 16 tons 130 lbs.; of which, estimate about two-thirds for corn and about one-third for beans."

In this case the sunflowers were almost a total failure on account of the storm.

From Mr. Percy G. Mills, Rockville, King's Co., N. B.

"Q. Beans: Were the pods formed, filled or ripened?—A. The lower ones were ripened.

Average height of plants? Three feet.

Yield per acre?—Of sunflower heads, four tons; of corn and beans, fifteen tons; of which, estimate, ten tons for corn and five tons for beans."

From Mr. F. G. Goodenough, Robinson, Compton Co., Que.

"Q. Beans: Were the pods formed, filled or ripened?—A. Some were ripe. Average height of plants? About three feet.

Yield per acre:—Of sunflower heads?—four or five tons. Of corn and beans? About twelve tons; of which, estimate eight tons for corn, and four tons for beans.

General Remarks:—I think the beans are a fine thing. I will plant them with all my corn next year, if I can get them."

From Mr. Fred. Burns, Island Brook P. O., Compton Co., Que.

"Q. Beans: Were the pods formed, filled or ripened?—A. Well filled and some of them ripe.

Average height of plants? Four feet.

Yield per acre:—Of sunflower heads?—seven tons. Of corn and beans?—twenty-two tons; of which, estimate sixteen tons for corn, and six tons for beans."

From Mr. Cecil A. Barton, Frelighsburgh, Missisquoi Co., Que.

"Q. Beans: Were the pods formed, filled or ripened?—A. Ripened.

Average height of plants? Four feet.

Yield per acre:—Of sunflower heads?—About six tons. Of corn and beans?—About twelve tons; of which, estimate eleven tons for corn, and one for beans.

General remarks:—I found some beans six feet high, and containing 40 pods. The beans were ripe, and a good many of the stalks of them dry when harvested. For that reason, they did not weigh as they would have done had they been cut earlier. I had one sunflower head, 13 inches in diameter, which contained one quart of seed when shelled. I prefer one large head of sunflower to many little ones, as the seeds in the small ones are seldom well filled, and they are very much harder to harvest."

Very much valuable information on several aspects of the growing and cultivating of corn, horse beans and sunflowers, has been gained from the full reports which were sent in by the different farmers who gave the mixture a trial. From that source and the results of our own experience, I offer the following recommendations for the growing of this mixture for the coming year:—

The horse beans and sunflowers can be obtained from almost any of the dealers in seeds. It is not considered necessary or desirable that seeds should be furnished by the Experimental Farm, after information is available on the desirable methods of cultivation, and when they can be obtained from the seed merchants.

*Soil.*—If a field with a drained, warm, loamy soil be convenient to the silo, and can be used, it should be selected in preference to a heavy clay or wet soil for Indian corn. The horse beans do well in clay soils. In all cases the land will be the better for receiving a liberal dressing of manure. It should be ploughed in the spring, and be harrowed to a state of fine tilth before the seeds are planted.

*Time to plant.*—The time at which **Indian corn for fodder** may be planted with the best results, in most districts, is during the last ten days of May, or late enough in the season to escape frosts at night, and early enough to give the plants the advantage of as long a season for growing as is practicable. The horse beans and sunflowers are less liable to injury from frost than Indian corn.

Throughout the province of Ontario and the western portion of the province of Quebec, the **horse beans** may be planted with advantage from two to three weeks later than the Indian corn.

The **sunflowers** should be planted as early in the spring as is practicable,—otherwise the heads may not ripen in time to be put into the silo.

*Proportion.*—The mixture should contain about 10 tons of Indian corn fodder, to about  $2\frac{1}{2}$  or 3 tons of horse beans and about 1 or  $1\frac{1}{2}$  tons of sunflower heads. To obtain it in these proportions, it should be grown at the rate of **one quarter of an acre** of sunflowers, and **half an acre** of horse beans, to **every acre** of Indian corn.

*How to plant.*—Throughout the Maritime Provinces and in the eastern part of the province of Quebec, the Indian corn and horse beans may be mixed together and planted in rows 3 feet apart, with from 2 to 4 grains per lineal foot in every row. Elsewhere a larger crop of bean plants, not too ripe and dry for the silo, may be ensured by planting them separate from the Indian corn.

The **Indian corn** may be planted in rows 3 feet apart, with from 2 to 3 grains per lineal foot in every row. A horse power corn planter or seed-drill may be used for that purpose. Or it may be planted in hills 3 feet apart both ways, with from 4 to 6 grains in every hill. A horse power or hand corn-planter may be used. If neither of these implements and no other suitable planter be available, furrows 3 inches deep may be ploughed 3 feet apart. The seeds may be put in them and covered, after which the field should be rolled.

The **horse beans** may be planted in rows 3 feet apart, with from 3 to 6 grains per lineal foot in every row. The same machinery or method may be used as for the sowing or planting of the Indian corn.

The **sunflower seeds** are to be planted by themselves, in rows 3 feet apart. Not more than one plant per lineal foot in the rows should be left to grow. If they come up thicker, they should be thinned out to one plant for every 12 or 18 inches in the rows.

## Experimental Farms.

### REPORT OF THE HORTICULTURIST.

(JOHN CRAIG.)

---

To WM. SAUNDERS, Esq.,  
Director Dominion Experimental Farms,  
Ottawa.

SIR,—I have the honour to submit a report of some of the work carried on in the Horticultural Department of the Experimental Farm for the year 1893.

The fruit year as a whole was characterized by a very light crop in the fruit-growing sections of the provinces of Quebec and Ontario. The excessive drought and unusual amount of summer heat prevailing in Ontario between June first and September first, hastened the period of maturity of autumn and winter fruits, and this, together with the presence of apple insects in unusual numbers, caused the fruit to drop from the trees at an earlier period than usual.

The price of autumn and early winter apples in Britain did not rise in proportion to the shortage of the American crop, owing to the excessively large yield of apples in Great Britain which, coming on the London market in competition with the earlier shipments of Canadian apples, had the effect of keeping the price quite low.

At this date the English product, according to reports received, is exhausted, and it would appear that an excellent market for Canadian apples will be available during the remainder of the season.

In Nova Scotia a moderate crop of Gravensteins and Kings, and other standard apples, was harvested and excellent prices obtained.

Increased interest is noticed in the work of spraying for the prevention of fungous diseases and noxious insects. While in every instance spraying for the prevention of fungous diseases, has not rewarded the efforts of the experimenters with complete success, yet there has generally been some particular cause why better results were not obtained, and indeed it is not always wise to quote individual experiments which may have been influenced by local circumstances that do not generally prevail, and so are not applicable to ordinary conditions.

A great variety of spraying pumps are now manufactured and offered for sale in the Dominion. The principal drawback in connection with these implements is that many of them are manufactured with the idea of giving a cheap article to the public. The parts are not sufficiently well constructed to bear the strain of continued use during the spraying season, and consequently break down. This frequent stopping for repairs is one of the most annoying incidents connected with the operation of spraying, and often has the affect of discouraging the fruit-grower to such an extent as to prevent his carrying on the work effectually.

In the report of Mr. Tweddle, which is referred to in the text, special mention is made of this defect in connection with the machine he used.

#### LARGE FRUITS ON THE FARM.

The standard orchard has, on the whole, made satisfactory progress during the year. Very few varieties which went into winter in good condition were found to be injured in the spring, although the season was very severe.

None of the Russian apples suffered injury from the winter, but, as noted in the article on "Blight," large numbers have been severely attacked by this disease.

This is also true of a few varieties of American origin, notably "Wealthy" and "Wagener."

A considerable number of varieties of Russian apples blossomed, and bore fruit this season, but it was impossible to secure the specimens at maturity owing to the large number of visitors and the numerous small boys frequenting the orchard on Saturday and Sunday of each week. The orchard has since been inclosed by a barbed wire fence which will, it is hoped, obviate this difficulty another year.

The crop of cherries was light this year. A few trees blossomed but did not set fruit.

Nearly all the varieties of American plums blossomed and fruited abundantly, but none of the foreign sorts bore any fruit. Special mention should be made of "De Soto," "Weaver," and "Wyant." The two former having fruited very heavily for three years in succession. "Weaver" was so heavily laden that it was found necessary to remove at least one-half of the fruit, in order to prevent the branches from being broken by the weight of the crop.

#### VEGETABLES AND TOBACCO.

Experiments other than those contained in the report have been carried on with vegetables, including fertilizer tests, methods of cultivation, and trial of new varieties. As is well known the results of fertilizer tests, are only reliable after being carried on for a series of years, and for this reason no report is made for the present.

At the request of the Honourable the Minister of Agriculture, some experiments in the cultivation of tobacco were begun at the farm and the results will be found in the body of the report. Arrangements have been made with a tobacco manufacturer in Montreal, whereby samples of the different varieties tested at the farm, will be made up in the form of the article for which they seem best fitted, and a report will be afterwards made upon their relative excellence.

#### WORLD'S FAIR.

It was my privilege, by permission of the Honourable the Minister of Agriculture, to visit the World's Columbian Exposition at Chicago. There, in October, I had the opportunity of seeing the display of samples of the standard fruits of America, and as much time as possible was given to studying the same varieties of fruit grown under different climatic conditions, as well as other interesting questions. New fruits and new horticultural implements were also investigated with much advantage.

The display from Canada, especially from the province of Ontario, was excellent, both from an educational and from an advertising and commercial standpoint.

A great deal of credit is due to the Dominion and Provincial superintendents for the effective manner in which the horticultural resources of the Dominion were brought before the public. In this connection it may be stated that displays of fresh vegetables from the Central Experimental Farm were sent forward at intervals during the summer season. This exhibit was supplemented in the autumn by a consignment of 133 varieties of grapes which arrived in Chicago in very good condition and made an instructive and interesting exhibit, showing as it did the possibilities of this northern latitude in maturing fruit which requires as much summer heat as does the grape. This collection received a diploma from the committee on awards.

Prior to this collections of the fruit of 1892, including grapes, currants, raspberries and goose-berries were put up with preservative liquids in glass jars. These were forwarded in April, 1893, and materially assisted in keeping up the attractions of the exhibit, before the fresh fruits appeared.

#### MEETINGS ATTENDED.

I attended officially during the year the annual meetings of the Ontario and of the Nova Scotia Fruit Growers' Associations, also the autumn exhibitions at Montreal and Sherbrooke, P.Q.

## Experimental Farms.

### ACKNOWLEDGMENTS.

I beg gratefully to acknowledge the following donations :—

Mr. John Pitcairn, Point Fortune, Que.—Scions of Pitcairn apples.

J. M. Waters, Esq., Fernhill, Ont.—Seedling raspberry and rose plants.

W. M. Jones, Esq., Gartmore, Man.—Cuttings of native currant and gooseberry.

Mrs. S. Foster, Knowlton, Que.—Two trees each of Hardy and Davis's seedling apples.

Charles E. Brown, Esq., Yarmouth, N.S.—Apple scions.

Mr. R. W. Starr, Wolfville, N.S.—Apple and pear scions.

Mr. T. H. Race, Mitchell, Ont.—Scions of Oliver seedling.

Mr. A. Reeve, Highland Creek, Ont.—Gooseberry plants.

Mr. W. C. Reid, Belleville, Ont.—Apple and pear trees.

Mr. L. S. Gamache, Cap St. Ignace, Que.—Two trees of Montmagny beauty plum.

Mr. Lachlan Gibb, Montreal, Que.—Roots of Helianthus.

Mr. Auguste Dupuis, Village des Aulnaies, Que.—Horse chestnut seedlings, seed of *Larix Siberica*.

Mr. R. B. Whyte, Ottawa, Ont.—Seedling raspberries.

Mr. Robert Snelling, New Edinburgh, Ottawa.—One Snelling plum tree.

W. M. Pattison, Esq., Clarenceville, Que.—Grape cuttings.

Mr. W. H. Murphy, Ottawa.—Scions of Calumet apple.

I am much indebted to a number of Canadian enthusiasts in horticulture for information of various kinds, embodied in my report and to Mr. Wm. Taylor, foreman in the Horticultural Department, for the zeal and faithfulness with which he carried out the experiments committed to his care.

I have the honour to be, Sir,  
Your obedient servant,

JOHN CRAIG,  
*Horticulturist.*

December 15th, 1893.

## PEAR AND APPLE BLIGHT.

The disease variously known as "Apple blight," "Pear blight," "Twig blight" and "Fire blight" has wrought a serious amount of injury to trees in the Ottawa Valley during the past season.

The presence of this disease has been noticed in America for 100 years past; one of the first observers being W. Denning, of Massachusetts, who published an article on the "Decay of apple trees" which appeared in the Transactions of the Society for the Promotion of Agriculture, for 1794. In this article he describes the disease as attacking pears and quinces, and thinks that it was caused by a borer in the trunks of the trees. Later we find mention of it in the writings of that pioneer in fruit culture, Wm. Cox, in his work entitled, "The Cultivation of Fruit Trees," written in 1817. Here it is called "Fire Blight," and is minutely described. He says: "I have in twenty years lost upwards of fifty trees in the fulness of vigour; sometimes in the most open and airy situations, and in every kind of soil."

In horticultural writings numerous references can be found with regard to this disease, without absolutely divining or assigning the cause of it up to 1868, when Dr. Hull, of Illinois, first attributed the disease to fungi.

In 1877 the presence of bacteria in affected limbs was discovered by Prof. T. J. Burrill, and in 1880 Prof. Burrill published the first authoritative account of the bacterial origin of this disease, and cited in proof of his observations a large number of experiments in transmitting the disease in various ways from one tree to another by inoculation. A pertinent question at this time was whether bacteria themselves caused the death of the affected portion, or whether these followed as a natural consequence in the track of the life destroyer.

The experiments of Prof. Burrill went largely to show that the bacteria themselves were the actual cause of death, and this point was satisfactorily demonstrated by Prof. Arthur, then of the New York Experiment Station, in 1886, who proved by careful experiments that the disease could only be transmitted by using the juices of branches which contained the characteristic bacteria. In support of this position Prof. Arthur makes the following statements:—

A. "Bacteria are found in great abundance in actively blighting tissues, so as to be demonstrable to the naked eye, and occur in less abundance in proportion as the disease is less active."

B. "The disease may be introduced into healthy tissues by inoculation with germs from diseased tissues."

C. "It is communicated with equal certainty when the germs are separated from all accompanying juices of the diseased tissue, by a series of fractional cultures."

D. "*Per contra*, it is not communicated by the juices of the disease after the germs are removed by filtration."

E. "Germs connected with the disease constitute a single species, which is essential to successful inoculation."

F. "*Per contra*, the numerous species of earth, air, and water are found to a noticeable extent in connection with the disease, and cannot be made to originate it by inoculation or otherwise."

Prof. Arthur further states as the result of his investigations that "A constant ratio is found between the percentage of water in the branches of the several kinds of pomaceous fruits, corresponding to some extent with their liability to blight. The popular opinion that the more rapid growth of the shoots, the more succulent their tissues, and therefore the more liable to blight, is thus confirmed by trial."

The bacteria may keep alive in branches cut from the tree, and remaining in water or moist ground till the following season, and they may also be cultivated in solutions of garden soil, indicating the desirability of promptly destroying all blighted limbs.

With a view of obtaining information with regard to the spread and extent of this disease in the Dominion, a circular was sent to the leading fruit growers in the various provinces. The information obtained from these replies is contained in the tables annexed.



## Experimental Farms.

The following tabular statements were arranged with a view of showing the distribution of the disease principally in the provinces of Ontario and Quebec, and to bring out the opinions of practical growers with regard to those methods of cultivation which seem to favour its appearance. It is plainly indicated that without a systematic and very lengthy course of experiments, it is impossible to arrive at satisfactory conclusions regarding any line of remedial treatment; varying conditions of soil and environment lead to results at one point, which are contradicted by the experience of a grower in another section. It is interesting to note that of the replies from Ontario, while 44 per cent had observed no difference in the relative prevalence of "blight" on cultivated ground, and in orchards in sod, 38 per cent were in favour of growing in sod and 17 per cent in favour of giving high cultivation.

There seems to be no doubt that any system of cultivation conducive to rapid succulent growth which is not well ripened in the autumn, furnishes a favourable condition for the development and spread of the disease. Prof. Arthur has clearly demonstrated the truth of this statement.

In Quebec blight appeared during the year, in several of the fruit growing sections, notably in the Counties of Shefford, Argenteuil and Rouville. The soil in the portions most affected, is of a loamy or gravelly nature and frequently strongly impregnated with limestone. As pears are not grown to any extent outside of the Island of Montreal, the disease has principally been restricted to apples. Russian pears at Abbotsford 10 years planted, were very much injured this season. These have been grown in sod since planting.

TABLE I.—PEAR AND APPLE  
TABULATED Information gathered from

County.	Observer.	Appearance Previous to 1893.	Character of Injury.	Injury During 1893.
Brant .....	J. R. Howell .....	1888 .....	Severe .....	None .....
do .....	David Greig .....	1887 .....		do .....
Essex .....	N. J. Clinton .....	1875-76-88 .....	Severe on pear trees .....	do .....
do .....	W. W. Hilborn .....	None .....		do .....
Frontenac .....	D. Nicol .....	1889 .....	On apples .....	
Grey .....	R. Trotter .....		Slight on apples and pears .....	do .....
Huron .....	Alex. McD. Allen .....	For many years more or less .....	Not destructive on apples and pears .....	Slight .....
Halton .....	Geo. E. Fisher .....	Occasionally .....	On pears ; branches killed .....	Severe on apple .....
Hastings .....	W. H. Dempsey .....	For several years in June .....	On pears .....	None .....
do .....	W. C. Reid .....			
Lanark .....	W. B. Munro .....	1892 .....	Apples slightly .....	Slight .....
do .....	John Hart .....	1878 .....	Apples severely .....	Considerable .....
Lambton .....	T. C. Wheatly .....	Quite frequently .....	Severe on crabs .....	None .....
Leeds .....	W. G. Kerr .....	1892 .....	Many apple trees killed .....	Considerable .....
Norfolk .....	J. McMichael .....	During the past 20 years .....	Twigs of apples ; branches of pears .....	Very slight in June .....
Oxford .....	S. Hunter .....	For 25 years past .....	Pears .....	Very slight .....
Perth .....	T. H. Race .....	1892 .....	On young shoots of apple and pear .....	Considerable on apple .....
do .....	J. D. Stewart .....		do .....	Slight .....
Prince Edward .....	J. Wellington Boulter .....	1888-89 .....	Slight injury on twigs .....	do .....
Renfrew .....	W. R. White .....	1892 .....		Slight on apples .....
do .....	A. A. Wright .....	For several years past .....	Severe on apples .....	Very severe .....
Simcoe .....	G. C. Caston .....	Slightly .....		None .....
do .....	J. P. Cockburn .....	None .....		do .....
Toronto .....	Stone & Wellington .....	Slight .....	On pears .....	
do .....	D. W. Beadle .....			
Victoria .....	Thos. Beall .....	Slight in past years .....	On pears .....	Slight .....
Wentworth .....	E. D. Smith .....	25 years ago .....		None .....
Welland .....	E. Morden .....	1889 .....	On pears and apple twigs .....	
do .....	Stone & Wellington .....	25 years .....	On pears .....	Slight .....
Middlesex .....	B. Gott .....	For many years past in varying degree .....		None .....

## Experimental Farms.

### BLIGHT IN ONTARIO.

Fruit Growers throughout the Province.

Varieties of Pears affected.	Varieties of Apples affected.	Does High Cultivation Favour Blight?	Remarks.
Clapp's, Flemish Beauty.		Evidence conflicting...	Sometimes prevented by cutting off affected portion.
Clapp's, Bartlett.	Cayuga R. Streak.	Trees in sod free from blight.	Good results obtained by washing with 1 peck stone lime, 10 lbs. sulphur, 2 oz. crude carbolic acid, mixed with water and applied as a paint.
Bartlett, Flemish Beauty.		No difference noted...	Injury most common on south side of tree.
	Red Astrachan, Transcendent.		No difference noticed.
Louise Bonne, Duchess.			Ground cultivated; no difference noticed.
Clapp's, Osband's Summer, Bartlett.			Finds regular cultivation and manuring productive of good results. Occasional cultivation with heavy manuring injurious.
Vicar of Winkfield, Duchess, Bartlett.	Nearly all varieties; Cranberry Pippin & Golden Russet.	No difference noted...	Has had good results from splitting the bark, which hardens after the tree is attacked.
Clapp's.	Greening.	Rich ground developed more blight than poorer land.	Gives an instance of trees in rich ground being attacked, while those in sod escaped.
	Early varieties		Cutting off affected portions apparently checked spread of disease.
	Fameuse Alexander, Yellow Transparent.	Apparently it does...	
Bartlett, B. d'Anjou.	Siberian crabs	Alluvial soils favour blight.	Does not believe in growing pears in sod. Affected branches should be removed.
	Seedling trees.	Worst in old orchards seeded down.	Recommends cutting off diseased portions.
Clapp's, Flemish and most popular varieties.	Greening, Fall Pippin.	Worst on cultivated ground.	Recommends cutting off diseased branches and mulching trees with coal ashes; uses no barnyard manure.
Rapid-growing varieties.		Yes; trees in sod are less injured by the disease.	
	Nursery stock growing rapidly.	No difference...	Reports good results from the use of Bordeaux mixture.
Clapp's, Ananas d'été	Early varieties; Early harvest; Snow.	Less blight noticed on trees in sod.	
	On crabs and early varieties.	Has not noticed....	Believes in seeding down the pear orchard after three or four years and manuring annually.
	Yellow Transparent, Wealthy.	No difference noted...	Recommends cutting off affected branches.
Flemish Beauty.		Has made no observations.	
			Generally worst on low, damp, cultivated ground.
			See letter.
Clapp's, Flemish		Probably	Branches cut off and destroyed.
Nearly all varieties of early pears.			
Bartlett, Flemish Beauty.		No difference noticed...	Clean cultivation given and advocated.
All varieties, more or less.	Russian apples	Yes, on moist soils....	Believes in growing on dry, airy situations and fertilizing with wood ashes.
All varieties			Thinks neglected trees are most liable.

PEAR AND APPLE  
TABULATED Information gathered from

County.	Observer.	Appearance previous to 1893.	Character of Injury.	Injury during 1893.
Brome.....	Sec. Fruit Growers' Association.	None.....	.....	.....
Hochelaga.....	R. Brodie.....	For 12 or 13 years...	On apples during July...	Slight this year.....
Huntingdon.....	W. H. Robinson.....	.....	Slight.....	On apples in June...
Kamouraska.....	J. C. Chapais.....	None.....	.....	.....
Huntingdon.....	Jas. Fulton.....	Slight.....	On pears.....	.....
Lotbinière.....	H. G. Joly de Lotbinière.	None.....	.....	.....
Missisquoi.....	David Westover.....	.....	Slight twig blight.....	.....
Montreal.....	E. B. Meyer.....	1892.....	Twig blight severe in 1892	Slight.....
do.....	Wm. Evans.....	.....	.....	.....
Argenteuil.....	R. Hamilton.....	20 years or more.....	Twigs and branches on apples.	Apples much injured.
.....	.....	1893 only.....	Twigs of apples, branches of pears.	Severe on pears.....
Rouville.....	J. M. Fisk.....	1893 only.....	do do.....	do.....
Stanstead.....	J. Fraser.....	For several years.....	Twigs of apples.....	Slight.....
Shefford.....	Wm. Gill.....	.....	.....	Very severe on apples.

## Experimental Farms.

### BLIGHT IN QUEBEC.

Fruit Growers throughout the Province.

Varieties of Pears affected.	Varieties of Apples affected.	Does High Cultivation favour Blight?	Remarks.
			Blight not noticed.
	Alexander, Bethel	Has made no observation	Top-dresses with manure and wood ashes.
	Crab apples.	This point not noticed	
			Blight unknown in Kamouraska.
			Believes firmly in the value of cultivation and regular manuring.
			Blight unknown in this county.
	Early varieties	This point not noticed	
Flemish Beauty	Waxen crab, Transcendent, Ben Davis, Alexander.		Ground highly cultivated.
	Transcendent, Alexander, Fameuse and Russians, Switzer.	Evidence not conclusive.	Dry, airy positions seem to be less affected than moist, sheltered ones.
Russian varieties	Alexander, St. Lawrence, Arabka.	Much worse on rich cultivated ground.	Orchards with western aspects are affected more than those with southern aspects.
	Duchess and peach	More blight on uncultivated ground.	
	All varieties		

The following sketch of the history of the disease in Ontario, by Dr. Beadle, will be read with much interest:—

“In the early days of fruit-growing in the Niagara District, we had no pear-tree blight, nor apple-tree blight. \* \* \* \* \* With the advent of what people termed grafted fruit, came after a few years ‘blight’ on the pear tree, and not until several years after it had become a serious plague of the pear, did it affect the apple tree, to any appreciable extent. The first pear trees that bore fruit in my father’s garden were of the Summer Bonchretien variety. These did not blight for some time after they began to bear, and I am unable to give you the exact date of its first appearance, but by the year 1840 it had begun to appear in those, and other pear trees in the garden. In 1847, A. J. Downing complained that the ‘blight’ of the pear was a serious drawback to the extensive cultivation of the tree. In 1845 it was severe in the west, that is as far west as Indiana, and apparently was but little known in that region before that summer. About 1827 to 30 it was said to have been very destructive to pear trees at Schenectady, N. Y., but no mention was made of any injury to apple trees from this cause; it then disappeared for some twenty years. There was a similar apparent periodicity in the Niagara district. My father having learned that some had applied blacksmith’s cinders with beneficial results, tried them upon his pear trees, digging them into the ground over the roots as far as they probably extended. After this some ten years elapsed without any blight in his trees, but it broke out again, and I think there has never been as long a period of exemption since.

“I have no data that enable me to say when it appeared in the apple trees. Its first serious work on apple trees was upon the crab-apple trees, such as Red and Yellow Siberian, Montreal Beauty, &c., not unfrequently killing the whole tree. Its effects on other apple trees are confined for the most part, if not wholly, to the young shoots of the summer’s growth. I cannot now recall one instance of even a whole branch having been killed by it, and am confident that I have never known an apple tree, other than the crabs, to be ruined by the ‘blight.’ As to the time when the blight appears, there is no time after the beginning of June when it has not appeared, but usually its presence is more abundantly manifested from the middle of July to the end of August.

“With regard to varieties of pears, the Duchess d’Angouleme, Rutter and Seckel are the least subject to the ‘blight’ of the varieties with which I am acquainted. Of the rest, in some seasons one would seem to be the most subject to the ‘blight,’ in the next year some other variety would take the lead.

“Fifth inquiry, trees in sod *versus* trees in cultivated ground. No opportunity has been presented to me of making such a comparison. In 1885 I copied into the Can. Horticulturist, vol. viii., an editorial from the Philadelphia *Record* giving an account of two orchards adjoining each other, and in soil and varieties alike, situate at Newfield, New Jersey, the one cultivated to garden crops and liberally manured, the other kept in grass, ploughed occasionally and re-seeded. The first was at that time nearly destroyed by blight, the second as sound as when first set out, though the trees were only about half the size of the cultivated, had never borne as well, nor equalled them in appearance. Query:—Are the bacteria the cause, or is the diseased tree or branch favourable to the multiplication?

“Very truly yours,

“D. W. BEADLE,

“Toronto.”

## Experimental Farms.

### BLIGHT AT THE EXPERIMENTAL FARM.

The experimental pear and apple orchard are on sandy loam underlaid with a stiff gravelly subsoil much too near the surface for the ideal orchard soil.

The ground has been cultivated annually, since planting the trees five years ago, and has been manured on alternate years since that time. Blight appeared about the middle of June, 1892, in the pear orchard; although every blighted branch (or in bad cases the whole tree) was removed without delay, it continued to spread during the entire growing period and late into autumn.

None of the Russian varieties escaped injury, some twenty-five being killed to the ground. During the third week of June the disease appeared simultaneously in a block of Wealthy trees planted at some distance, and in the Russian apple orchard, which is contiguous. The injury in both cases amounted to the loss of branches, in some cases a few, in others sufficient to injure the symmetry of the tree.

In 1893 it appeared earlier than in the preceding season and simultaneously on Wealthy, the Russian apples, and pears. The injury was much more severe. One tree of Wealthy was killed, and many specimens of Russian varieties cut down to mere stumps. The injury to the Russian pears was of the same character as the year previous and quite as severe. "Flemish Beauty" and "Beurre d'Anjou" in the same orchard suffered only to a slight extent.

As soon as a branch was removed the remaining stump was painted with linseed oil. Although in every case the cutting was made 15 to 18 inches below any discoloured bark, yet in fully 50 per cent of the cases the disease appeared subsequently at a lower point in the affected branch. This feature in the course of the malady was specially noticeable in the case of the pears, as the blighting of both Russian apples and pears was so general. A report on the relative immunity of the different varieties is withheld till the experience of another season is added.

This brief review of the subject has been undertaken with the object of bringing together as much experience as it was possible to collect from the practical grower, and if feasible to make such deductions as would lead to useful practices in controlling the disease.

While the majority of the replies point to the fact that trees grown in sod have been injured less on the whole than others which were cultivated, it is not proper to conclude that this therefore is the most approved method of growing apples or pears. The nature and character of the soil should, in all cases be duly studied and a treatment given calculated to produce a fair amount of well ripened wood each year. On moist rich alluvial soil it is quite probable that clean cultivation in the long run, will not give as good results as growing the trees in sod, which should receive annually a dressing with a fertilizer in which potash and phosphoric acid form the greater proportion. On the other hand it is idle to suppose that apple or pear trees can be successfully grown on light soils without systematic cultivation and annual enrichment of the soil. Situations having subsoils which are cold and wet should be avoided. Where such conditions prevail, tile-training will mitigate to some extent the injurious effect of such unfavourable conditions.

### NEW FRUITS.

#### GRAPES.

The following new varieties fruited this season:—

**ALEXANDER'S WINTER.**—Received spring of 1891 from S. D. Alexander, Bellefontaine, Ohio. Vine a fair grower, with foliage characteristic of the *Labrusca* type.

Bunch loose, straggling, berry large, round and very slightly oval; very dark amber in colour; skin thick; fairly tender; very little juice; pulp, meaty acid. Seeds large; quality only fair. Ripens with Salem. Not likely to be valuable here.

**BRILLIANT.**—Mr. T. V. Munson, Denison, Texas, produced this variety by pollinating Lindley with Delaware in 1883. The vine is moderately vigorous. Bunch long, shouldered, berry medium size, almost round, colour deep garnet; skin thin, juicy; pulp tender; seeds large, usually two to three; quality good. Berries do not drop easily. The first fruit of this variety did not ripen this season, although claimed to be as early as Delaware by the introducer.

**CHASE BROS.**—A single vine of a variety received from Chase Bros. & Co., Rochester, N. Y., in 1887, and entered in the vineyard records under the above name has fruited for the past three seasons. The introducers write that "the variety originated with Mr. Jacob Moore, formerly of Brighton, N. Y." They further say "that the fruit is most excellent in quality, but it proved to be a very shy bearer here so much so that we did not feel justified in putting it on the market."

As fruited here the bunch is of medium size shouldered, fairly compact; berry medium size, round; colour rich bright wine, skin fairly thin, juicy, very sweet; pulp tender, melting, seeds medium size, usually two, quality good, ripens with Delaware. Berries drop somewhat after picking. While recommending this variety to growers I would have them bear in mind the experience of the New York introducers.

**ECLIPSE.**—Originated by John Burr, of Leavenworth, Kansas, and introduced by Stayman & Black, nurserymen of the same place.

Vine a weak grower; bunch medium to small, shouldered; berry large, round, vivid green in colour; skin fairly thick, small amount of juice; pulp tender, brisk acid, fair quality. Berries hold on well. Ripens a week later than Concord. Too late for this locality.

**FARBELL.**—Origin the same as the last.

Vine a moderate grower. Bunch large, tapering, shouldered; berry medium to small, round, yellowish white; skin thin, pulp rather tough; juice vinous sweet. Seeds small, numerous. Too late for this locality taking this season as a criterion.

**HERMANN JAEGER.**—Originator, T. V. Munson, Denison, Texas. Produced by pollinating *Vitus Linccumii*, the Post Oak grape of Texas—with Herbemont—an old Texas variety.

This did not fruit in sufficient quantity to give a correct impression of the size and form of the bunch which is said to be large and shouldered. Berry was small, round, black with purplish bloom; firmly attached to peduncle; juice and pulp sprightly acid. Seeds small. Not ripe when picked October 10th. Later than Concord. Not promising for this vicinity.

**IDEAL.**—A seedling produced by John Burr, and introduced by Stayman & Black, of Leavenworth, Kansas.

Bunch medium size; berry large, round, purplish amber; skin thick; juice abundant; vinous sweet; pulp tender. Seeds large and numerous; quality fair to good, ripens with Concord.

**ONEIDA.**—Said to be a seedling of Merrimack which it does not resemble in a single characteristic. Vine a short jointed, weak grower. Bunch medium size, slightly shouldered; berry small oval, amber coloured; skin thick, tough; juice rich and sweet; pulp meaty, and acid, seeds large. This variety keeps well, which seems to be its only point of merit.

**PARAGON.**—A seedling produced by John Burr and introduced by Stayman & Black. Bunch medium size, cylindrical, compact. Berry medium size, round, black with purplish bloom. Skin thin; very juicy with a tender dissolving pulp; seeds small; quality medium. Berry does not drop readily. Ripe, 5th September. Keeps till December. Berries resemble Early Victor quite closely.

**STANDARD.**—Origin the same as the last. Bunch and berry medium size, black. Skin thin: small amount of juice; pulp tough and acid. Ripens a little in advance of Concord. Loses flavour rapidly. Not promising.

**CAMPBELL.**—Produced from seed of Triumph by T. V. Munson, Denison, Texas. The first fruiting of this variety has given a small compact bunch. Berry medium to small, round; skin thin, translucent; very juicy; pulp melting. Seeds small; quality good. Ripens with Concord.



## Experimental Farms.

**WHITE BEAUTY.**—A seedling produced by John Burr and introduced by Stayman & Black, Leavenworth, Kansas. Bunch medium size, compact, shouldered. Berry round, clear white, covered with light lilac bloom. Skin thin, very juicy; pulp moderately tender. Seeds numerous; quite foxy; medium quality. Late.

### RASPBERRIES.

#### *Black.*

**OLDER.**—This variety originated with and has been introduced by R. D. McGeehon, Atlantic City, Iowa, from whom plants were received which were set out in the spring of 1892. These bore some fruit the same season and an abundant crop this year. The plant is exceedingly vigorous and roots from the tips very readily.

Berry large, round, deep black, with very large drupes. The seeds are not prominent, and the berries are borne in good sized clusters, very juicy and of good quality. It also has the habit of fruiting heavily on the young wood. This year the first fruit ripened with Hilborn, while it continued bearing till the season of Gregg had closed. (See Figure I). So far this seems to be a profitable variety.



Fig. 1. OLDER.

A number of the newer black caps are being tested, but the above is the only one which so far stands out prominently as a variety worthy of careful trial.

## SEEDLING RASPBERRIES.

The seedling raspberries so favourably mentioned by a joint committee of the fruit-growers of Ontario and Quebec, in the annual report for 1890, have been undergoing further trial. Transplanted and subjected to ordinary field culture, some have not sustained their early reputation, while others at first not deemed very promising have done remarkably well.



Fig. 2. SARAH.

One variety not mentioned by the committee in this report for the reason that being very late, it was not at its best during the time of their visit, has since shown so many points of excellence that it has been named and is now being propagated for distribution. It may be described as follows:—

SARAH.—(Record number 4-38.) Produced in London, Ont., by Prof. Saunders, from seed of Shaffer's Colossal. Plant a moderate grower, suckering freely, and pro-

## Experimental Farms.

pagating naturally only in this way. The foliage seems to be intermediate between the European raspberry *Rubus Idaeus* and the American *Rubus Strigosus*. The canes have been affected to some extent by anthracnose, but not more than Cuthbert or Marlboro growing along side. Fruit large, round; drupes large, deep garnet, firm, very juicy, pleasantly acid and exceptionally rich. See Fig. 2. A few ripe berries were found last year, and this year, at the time of the first picking of Cuthbert, but the main crop did not ripen till the season of Cuthbert was over, the last picking taking place each year from the 8th to 12th August.

A striking characteristic of this variety is its habit of ripening the fruit in consecutive order and much regularity, beginning with the terminal clusters of each branch. Of course this is in a measure true of all red raspberries, but none that I know of carry the peculiarity to the same extent.

### SEEDLING APPLES.

A large number of samples of apples, mainly seedling varieties, have been received during the past three years. The two following seem to merit propagation and careful trial:—

**DERY.**—(*Syns. Alexis Baldwin, Dery's seedling, Pomme de Fer.*) Received from F. L. Dery, of Mont St. Hilaire, Quebec, October 7th, 1891. The original tree was examined October 23rd, 1892, and samples were again received from Mr. Dery this autumn. Mr. Dery says this tree was raised from the seed of American Baldwin, planted by his father about seventy years ago. Since fruiting age it has borne moderate annual crops. It is still fairly healthy and with good care should live for many years.

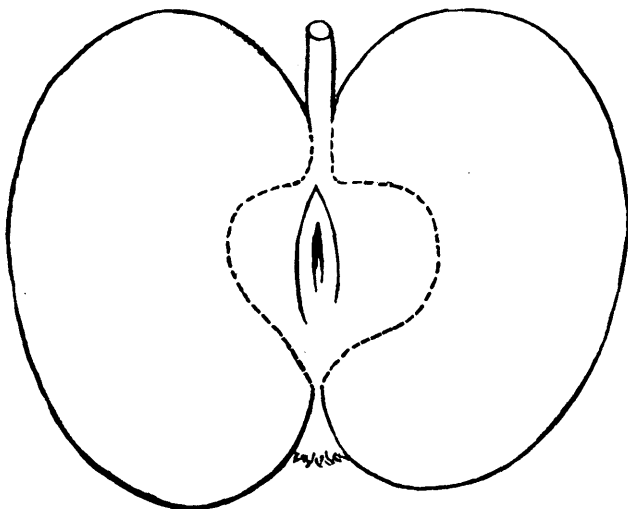

Fig. 3.—DERY.

Fruit medium to large, oblate,  $3\frac{1}{2} \times 2\frac{1}{2}$  inches, slightly ribbed. Skin green and almost entirely covered with dark red, which is specked with numerous white dots, resembling Canada Baldwin, closely in this respect. Stem short usually about half an inch. Cavity moderately shallow, regular and slightly russeted. Basin, small wrinkled. Flesh, greenish white, firm, lacking juiciness, sub-acid, quality good. See Fig. 3. The best condition is reached during March and April. The apple known and cultivated in the Eastern Townships as "Pomme de Fer" resembles the above closely and is evidently from the same stock.

CALUMET.—Received from Mr. W. H. Murphy, of Ottawa, who described the tree as growing on his farm on Calumet Island supposed to be of seedling origin, apparently about thirty years of age.

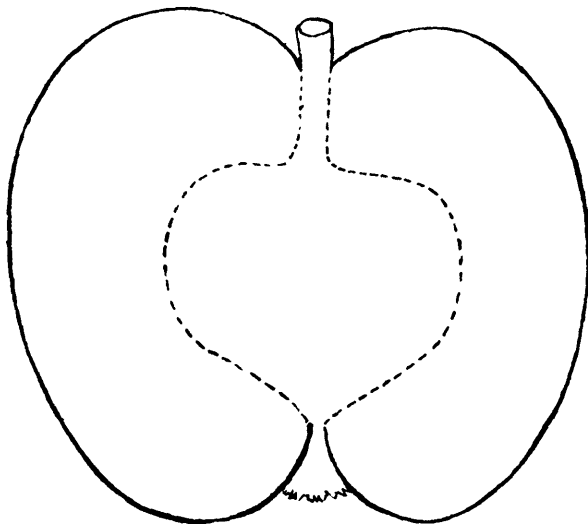

Fig. 4.—CALUMET.

Fruit medium to large, round, or approaching oblong, very regular. Skin green, when fully ripe, yellow, partly covered with streaks and splashes of light red. Stem short; cavity almost wanting: calyx open; basin small and shallow; flesh firm, white, very juicy, sub-acid, good. See Fig. 4.

Mr. Murphy says it keeps through the winter with ordinary care. Specimens kept in my office were in good eating condition on the first of last June. The skin of this variety is not of the kind that is usually affected by the "spot" disease *Fusicladium*.

#### SPRAYING EXPERIMENTS.

An extended series of spraying experiments were undertaken and carefully carried out by Mr. Joseph Tweddle, of Stoney Creek, Ont., under my direction. Mr. Tweddle has furnished a report of much interest, on the work of the season, which I wish to acknowledge very gratefully. The season in the Niagara district was an abnormal one in many respects however, and no doubt had an important effect upon the results of the experiments which in many instances were quite contrary to previous experience. Mr. Tweddle reports little protection against codling moth and "apple spot" from the use of Bordeaux mixture or ammoniacal copper carbonate, but says that some few specimens of apples could be found, showing where the disease had attacked the fruit, and apparently had been destroyed by the fungicide, leaving a russetted spot on the affected portion, the remainder of the apple being healthy. Mr. Tweddle is also of the opinion that the "codling moth" developed most and caused most destruction after the spraying season closed, although quite a percentage of the fruit was attacked before spraying was finished. One of the most important features in connection with the work is the relative efficacy of Paris green in combination with Bordeaux mixture, and when applied alone. Mr. Tweddle writing of this says: "It is apparent to me that the poisonous action of Paris green was lessened when used in combination with the Bordeaux mixture, and the effect was plainly visible in the apple and plum orchard, particularly in the plums. Where Paris green was used by itself on these, they were much more free from curculio than when it was applied with Bordeaux mixture." This raises an interesting ques-

## Experimental Farms.

tion. My report of 1891 on spraying shows the value of adding Paris green to the solutions of ammoniacal copper, but no exact figures have been gathered showing the effect of adding lime. Exact data will be obtained on this point as soon as possible. With regard to small fruits, Mr. Tweddle says "some encouraging results came from the use of Bordeaux mixture and Paris green for the destruction of the currant worm, and for the prevention of mildew on gooseberries—some of them English varieties. The first brood of the larvæ appeared in myriads on the currant bushes shortly after fruit set. A single application of the above was made soon after the worms were hatched when  $\frac{1}{8}$  inch in length, but not all were destroyed. When in two or three days, but before the worms were large enough to devour the foliage rapidly, two more applications were made on the same day, going opposite directions on the rows and completely covering the foliage. This was entirely successful in destroying the first brood, and also the second, for the lime in the Bordeaux mixture stuck the whole thing to the foliage so well that it remained all season, and if any of the second brood were hatched, they immediately received their dose and vanished." He says further: "No mildew or sunscald appeared on the English gooseberries (although none even were left unsprayed as checks on my place), yet both mildew and sunscald affected my neighbour's plantation alongside under similar conditions, where no fungicide was applied." It is hoped that the experience gained as the result of another season's work will clear up some points which at present appear contradictory and unsatisfactory.

### EFFECTS OF DILUTE SULPHURIC ACID ON FOLIAGE.

The use of sulphuric acid has been suggested by prominent horticulturists on the grounds that it contains the essential elements of a fungicide, and being prepared by simple dilution would therefore be more easily applied than the copper salts.

Some preliminary experiments were inaugurated this season in order to ascertain the maximum strength at which it could be safely applied to the foliage of various plants.

The information obtained is embodied in the following tabular statement:—

Plants Treated.	Date of Application.	STRENGTH BY WEIGHT.				Remarks.	
		$\frac{1}{4}$ per cent.	$\frac{1}{2}$ per cent.	1 per cent.	$1\frac{1}{2}$ per cent.		
Grapes.....	June 5.	Injured....	.....	.....	.....	Badly burned and shrivelled.	
Plums.....	do 5.	do .....	Badly injured.	.....	.....	Injury severe.	
Apples.....	do 5.	do .....	.....	.....	.....	Burned in spots.	
In Greenhouse.	Rose foliage, mature.	Mar. 14.	No injury ..	Injured....	Considerably injured.	Badly injured.	Injury gradually increased.
	Rose foliage, young.	do 4.	do ..	No injury ..	Slightly injured.	Considerably injured.	Half-grown leaves uninjured.
	Strawberry.....	do 4.	do ..	Slightly injured.	.....	Badly injured.	Young as well as old leaves injured.
	Geranium .....	do 4.	do ..	do ..	.....	.....	.....
	Hibiscus.....	do 4.	Slight injury.	Injured. ...	Badly injured.	Badly injured.	Scorched in spots.

The injury to the foliage in every case appeared to be due to the concentration of the sulphuric acid by the evaporation of the water used as the diluent.

The rate of evaporation would of course be largely governed by the humidity of the atmosphere and would be relatively slower under greenhouse conditions than

out of doors. This concentration of the acid into small globules over the surface of the leaf has the effect of scorching a small circular spot wherever the residue is collected. The injury was more severe and more readily detected on the foliage treated out of doors than that in the greenhouse.

Applied to roses at the rate of  $1\frac{1}{2}$  per cent by weight, while severely scorching the leaves it had no apparent effect on green and black aphid infesting the plants.

While the above experiment may be looked upon as preliminary, yet the outlook considering the dangerous character of this substance as a spraying material, is not encouraging.

#### A DISTRICT FRUIT LIST ADAPTED TO THE PROVINCE OF QUEBEC.

There is a peculiar interest and fascination connected with the testing of new varieties of fruits, which often leads orchardists into the serious mistake of planting too many kinds from a commercial standpoint. There is also a lack of knowledge in many portions of the country, new to fruit growing, with regard to the natural characteristics of the leading varieties of fruits, and their probabilities of success under given conditions. This uncertainty of course often leads to unnecessary expenditure of time and money. The following rough subdivision of the province into horticultural districts, with a list of fruits suitable for cultivation in each has been made, with the hope that it will serve as a guide to the inexperienced but intending fruit grower.

It should be remembered, however, that it will often pay better to cultivate a local variety which is well adapted to the soil and climate of the vicinity, than to import a foreign variety on the strength of a reputation built up abroad. On the other hand, certain varieties have been largely grown and exported, and are now looked upon as standards by the shipping trade; where these succeed, it is of much pecuniary advantage to the orchardist to grow them. Unfortunately there are few sections in the province of Quebec where the varieties of apples best known to the export trade can be successfully grown.

By top-grafting on hardy stocks, for which purpose Haas, and some of the hardy Russians are useful, there is no doubt that Northern Spy, Jonathan and Ontario varieties well known to the British markets, could be profitably grown in the counties of Missisquoi, Huntingdon, Beauharnois, and on the Island of Montreal. Other regions in the Valley of the St. Lawrence possess a suitable climate, but are not equally favoured in the matter of soil; the heavy clays being better adapted to raising farm crops than to the growth of fruit trees. But there is no region in this province where a large and varied collection of tree and small fruits, cannot be grown with profit and pleasure to the cultivator.

For arranging the district lists, I take occasion to acknowledge a large amount of valuable data given me by the leading fruit growers of the province.

The allotment of varieties to the different districts, was made on a two fold basis. First, to recommend only those varieties presumably well adapted and sufficiently hardy; and second, to reduce to a minimum the total number of varieties recommended in each class. Following these rules, therefore, where varieties of equal merit came into competition, the one previously inserted was again chosen; those of proved health and vigour being first selected.

It may be noticed that the same apple, Wealthy for example, appears as an autumn variety in one district, and as a winter variety in another. This is an effect produced by the amount of summer heat and the length of the growing season, characteristic of the climate in which it has been grown. In Gaspe, Duchess becomes early winter, while Wealthy sometimes ripens with difficulty, and keeps till late winter under ordinary circumstances.

The grouping of the counties was made principally on the basis of similarity of climatic conditions, and contiguity of position. The list should be looked upon as an elementary guide to amateurs and beginners in fruit growing, and it is hoped that it will form a starting point for a more complete and accurate classification which should be arranged by the Provincial Horticultural Society.

## Experimental Farms.

### ALPHABETICAL ARRANGEMENT OF COUNTIES WITH DISTRICT NUMBER.

County.	District No.	County.	District No.
Argenteuil	9	Mégantic	4
Arthabaska	4	Missisquoi	1
Bagot	2	Montcalm	8
Beauce	4	Montmagny	6
Beauharnois	1	Montmorency	12
Bellechasse	6	Montreal	10
Berthier	11	Napierville	1
Bonaventure	7	Nicolet	5
Brome	2	Ottawa	8
Chambly	2	Pontiac	8
Champlain	12	Portneuf	12
Charlevoix	12	Quebec	12
Châteauguay	1	Richelieu	5
Chicoutimi	13	Richmond	3
Compton	3	Rimouski	7
Dorchester	6	Rouville	2
Drummond	4	St. Hyacinthe	2
Gaspé	7	St. John	1
Hochelaga	10	St. Maurice	11
Huntingdon	1	Saguenay	13
Iberville	1	Shefford	2
Jacques Cartier	10	Sherbrooke	3
Joliette	11	Soulanges	10
Kamouraska	6	Stanstead	3
Laprairie	10	Temiscouata	7
L'Assomption	9	Terrebonne	9
Laval	10	Two Mountains	9
Lévis	5	Vaudreuil	10
L'Islet	6	Verchères	5
Lotbinière	5	Wolfe	4
Maskinongé	11	Yamaska	5

### DISTRICT No. 1.—HUNTINGDON, CHATEAUGUAY, BEAUHARNOIS, MISSISQUI, IBERVILLE, NAPIERVILLE.

- APPLES** ..... { Summer—Yellow Transparent, Red Astrachan, Duchess.  
 Autumn—Wealthy, Foundling, Alexander.  
 Winter—Golden Russett, Ben Davis, Scotts' Winter.
- PEARS** ..... Flemish Beauty, Beurre d'Anjou, Kurskaya.
- PLUMS** ..... { Blue—Glass Seedling, Blue Damson.  
 Red—De Soto, Wolf, Weaver.
- CHERRIES**..... Kentish, or Common Red, Early Morello, Späte Amarelle.
- GRAPES** ..... { White—Lady, Winchell, Moore's Diamond.  
 Red—Moyer, Delaware, Vergennes.  
 Black—Moore's Early, Rogers' 17, Peabody.
- RASPBERRIES**.... { White—Golden Queen.  
 Red—Heebner, Marlboro, Cuthbert.  
 Black—Hilborn, Gregg, Shaffer (purple).
- GOOSEBERRIES**.. Houghton, Downing, Pearl, Industry.
- CURRANTS** ..... { White—White Grape.  
 Red—Red Grape, Versaillaise, Moore's Ruby.  
 Black—Lee's Prolific, Prince of Wales.
- BLACKBERRIES** . Snyder, Agawam.
- STRAWBERRIES**. Bubach, Beder Wood, Warfield.

## DISTRICT No. 2.—ROUVILLE, CHAMBLY, BAGOT, SHEFFORD, BROME.

APPLES .....	{ Summer—Yellow Transparent, Duchess, Summer Arabka. Autumn—St. Lawrence, Wealthy, Fameuse, Antonovka. Winter—Golden Russet, Scott's Winter, Ben Davis, Canada Baldwin.
PEARS .....	Flemish Beauty, Kurskaya, Bessemianka.
PLUMS ... ..	{ Foreign—Lombard, Glass Seedling, Early Red. Native—De Soto, Wyant, Wolf.
CHERRIES .....	Early Richmond, Early Morello, Späte Amarelle.
GRAPES .....	{ White—Lady, Duchess, Moore's Diamond. Red—Delaware, Moyer, Lindley, Brighton. Black—Moore's Early, Worden, Peabody, Gibb.
RASPBERRIES....	{ White—Golden Queen. Red—Hansel, Heebner, Cuthbert. Black—Ohio, Gregg, Shaffer (purple).
BLACKBERRIES.	Taylor Prolific, Agawam.
GOOSEBERRIES..	Houghton, Pearl, Industry, Smith's Improved.
CURRENTS .....	{ White—White Grape. Red—Fays' Prolific, Victoria. Black—Black Champion.
STRAWBERRIES.	Bubach, Manchester, Warfield, Beder Wood.

## DISTRICT No. 3.—STANSTEAD, COMPTON, SHERBROOKE, RICHMOND.

APPLES.. .....	{ Summer—Yellow Transparent, Tetofsky, Duchess. Autumn—Peach, Gideon, St. Lawrence. Winter—Arabka, Wealthy, Ben Davis, Canada Baldwin.
PEARS .....	Bessemianka, Kurskaya.
PLUMS .....	{ Foreign—Blue Damson, Glass seedling. Native—De Soto, Wyant, Rollingston.
CHERRIES.....	Early Richmond, Large Montmorency, Early Morello.
GRAPES .....	{ White—Lady, Winchell. Red—Moyer, Delaware, Vergennes, Lindley. Black—Early Victor, Moore's Early, Worden.
RASPBERRIES ...	{ White—Golden Queen. Red—Turner, Heebner, Marlboro', Cuthbert. Black—Doolittle, Hilborn, Shaffer (purple).
BLACKBERRIES.	Snyder, Ancient Briton.
GOOSEBERRIES..	Houghton, Pearl, Red Jacket.
CURRENTS.....	{ White—White Grape. Red—Victoria, Versaillaise. Black—Black Champion.
STRAWBERRIES.	Crescent, Bubach, Windsor Chief.



## Experimental Farms.

### DISTRICT No. 4.—MEGANTIC, WOLFE, ARTHABASKA, BEAUCE, DRUMMOND.

- APPLES ..... { Summer—Tetofsky, Red Astrachan.  
                   { Autumn—Duchess, White Pigeon, Switzer.  
                   { Winter—Arabka, Scott's Winter, Hibernial.
- PEARS ..... Bessemianka, Sapieganka.
- PLUMS ..... Blue Damson, De Soto.
- CHERRIES..... Early Morello, Bessarabian, Richmond. •
- GRAPES ... .. { White—Lady.  
                   { Red—Moyer, Delaware.  
                   { Black—Hartford, Early Victor, Moore's Early.
- RASPBERRIES ... { White—Caroline.  
                   { Red—Hansel, Turner, Cuthbert.  
                   { Black—Hilborn, Mammoth Cluster.
- BLACKBERRIES. Snyder, Ancient Briton.
- GOOSEBERRIES.. Houghton, Pearl, Red Jacket.
- CURRANTS..... { White—White Dutch.  
                   { Red—Victoria, Red Dutch  
                   { Black—Lee's Prolific.
- STRAWBERRIES. Crescent, Capt. Jack, Manchester, Windsor Chief.

### DISTRICT No. 5.—VERCHÈRES, RICHELIEU, YAMASKA, NICOLET, I.O.T- BINIÈRE, LÉVIS.

- APPLES ..... { Summer—Tetofsky, Blushed Calville.  
                   { Autumn—Duchess, White Pigeon, Switzer.  
                   { Winter—Arabka, Wealthy, Hibernial, Ostrekoff.
- PEARS ..... Bessemianka, Gakovka.
- PLUMS..... Blue Damson, Rollington, De Soto.
- CHERRIES..... Kentish or Native Red, Early Morello, Bessarabian.
- GRAPES ..... { White—Lady, Martha.  
                   { Red—Moyer, Delaware.  
                   { Black—Florence, Early Victor, Moore's Early.
- RASPBERRIES ... { White—Yellow Antwerp.  
                   { Red—Heebner, Turner, Cuthbert.  
                   { Black—Mammoth Cluster, Shaffer (purple.)
- BLACKBERRIES. Snyder, Agawam.
- GOOSEBERRIES.. Pearl, Industry.
- CURRANTS..... { White—White Grape.  
                   { Red—Victoria, Red Grape.  
                   { Black—Black Champion.
- STRAWBERRIES. Crescent, Capt. Jack, Manchester.

## DISTRICT No. 6.—DORCHESTER, BELLECHASSE, MONTMAGNY, KAMOURASKA, L'ISLET.

APPLES .....	{ Summer—Yellow Transparent, Red Astrachan, Blushed Calville. Autumn—Duchess, Lubsk Reinette, White Pigeon. Winter—Wealthy, Golden Russet, Switzer, Arabka, Longfield.
PEARS .....	Flemish Beauty, Bessemianka, Gakovka.
PLUMS .....	{ Foreign—Blue Orleans (Damas), Reine Claude, Lombard. Native—Rollingston, Wolf.
CHERRIES.....	{ Montmorency Ordinaire, Kentish (Cerise de France), Bessarabian, Orel 25.
GRAPES.....	{ White—Lady; Red :—Moyer. Black—Florence, Early Victor, Moore's Early, Hartford.
RASPBERRIES ...	{ White—Framboise Blanche. Red—Antwerp, Heebner, Cuthbert. Black—Mammoth Cluster, Gregg.
BLACKBERRIES .	Snyder, Agawam.
GOOSEBERRIES..	Houghton, Pearl, Industry, "Grossellier de France."
CURRANTS.....	{ White—White Dutch. Red—Victoria, Versaillaise. Black—Black Champion.
STRAWBERRIES .	Alpine, Bubach, Warfield, Windsor Chief.

## DISTRICT No. 7.—TEMISCOUATA, RIMOUSKI, BONAVENTURE, GASPÉ.

APPLES .....	{ Summer—Tetofsky, Whitney, No. 20 (Crab.) Autumn—Duchess, White Pigeon, Charlamoff. Winter—Wealthy, Longfield, Fameuse, Antonovka.
PEARS.....	Gakovka, Bessemianka.
PLUMS.....	Blue Damson, De Soto, Blue Orleans.
CHERRIES.....	Early Morello, Bessarabian, Orel 25.
GRAPES .....	Black—Florence, Cottage, Early Victor.
RASPBERRIES....	{ White—Yellow Antwerp. Red—Heebner, Turner, Cuthbert. Black—Hilborn, Gregg.
BLACKBERRIES .	Snyder, Ancient Briton.
GOOSEBERRIES..	Houghton, Downing, Industry.
CURRANTS .....	{ White—White Grape. Red—Versaillaise, Victoria. Black—Black Champion.
STRAWBERRIES..	Alpine White, Crescent, Bubach, Captain Jack.

## Experimental Farms

### DISTRICT No. 8.—PONTIAC, OTTAWA, MONTCALM.

- APPLES ..... { Summer—Yellow Transparent, Duchess.  
                   { Autumn—Wealthy, Peach, Haas, White Pigeon.  
                   { Winter—Golden Russet, Pewaukee, La Rue, Arabka, Hibernial.
- PEARS..... Bessemianka, Flemish Beauty.
- PLUMS ..... { Foreign—Blue Orleans, Shropshire Damson, Glass Seedling.  
                   { American—De Soto, Wolf and Local Seedlings.
- CHERRIES..... Montmorency, Early Morello, Orel 25, Bessarabian.
- GRAPES . ..... { White—Lady, Winchell, Moore's Diamond.  
                   { Red—Moyer, Delaware, Mary, Vergennes.  
                   { Black—Early Victor, Moore's Early, Peabody, Roger's 17.
- RASPBERRIES... { White—Golden Queen.  
                   { Red—Hansel, Turner, Cuthbert.  
                   { Black—Hilborn, Mammoth Cluster.
- BLACKBERRIES. Snyder, Agawam.
- GOOSEBERRIES.. Houghton, Pearl, Industry.
- CURRANTS . .... { White—White Grape.  
                   { Red—Victoria, Versailles, Prince Albert.  
                   { Black—Lee's Prolific.
- STRAWBERRIES. Crescent, Sharpless, Bubach, Capt. Jack.

### DISTRICT No. 9.—ARGENTEUIL, TERREBONNE, L'ASSOMPTION, TWO MOUNTAINS.

- APPLES ..... { Summer—Yellow Transparent, Duchess.  
                   { Autumn—White Pigeon, Switzer, Gipsy Girl, Wealthy.  
                   { Winter—Golden Russet, Scotts Winter, Fameuse, La Rue, Arabka.
- PEARS ..... Bessemianka, Gakovka.
- PLUMS..... { Foreign—Shropshire Damson, Glass Seedling.  
                   { American—De Soto, Wolf, Wyant.
- CHERRIES..... Early Morello, Montmorency, Wragg, Orel 25.
- GRAPES ..... { White—Lady, Winchell, Duchess.  
                   { Red—Lindley, Vergennes, Delaware.  
                   { Black—Moore's Early, Peabody, Aminia, Gibb.
- RASPBERRIES... { White—Golden Queen.  
                   { Red—Hansel, Marlboro, Cuthbert.  
                   { Black—Ohio, Hilborn.
- BLACKBERRIES.. Agawam, Snyder.
- GOOSEBERRIES.. Houghton, Pearl, Industry.
- CURRANTS . .... { White—White Grape.  
                   { Red—Victoria, Versailles, Red Grape.  
                   { Black—Lee's Prolific.
- STRAWBERRIES. Bubach, Sharpless, Warfield.

DISTRICT No. 10.—VAUDREUIL, SOULANGES, ISLAND OF MONTREAL,  
LAVAL, JACQUES CARTIER, HOCHELAGA, LAPRAIRIE.

- APPLES ..... { Summer—Yellow transparent, Red Astrachan, Duchess.  
Autumn—St. Lawrence, Golden White, Alexander, Brockville  
Beauty.  
Winter—Wealthy, McIntosh Red, Ben Davis, Golden Russet,  
Winter, St. Lawrence.
- PEARS ..... Flemish Beauty, Beurré d'Anjou, Kurskaya.
- PLUMS ..... { Foreign—Quackenboss, Seedling Blue of Montreal.  
American—De Soto, Wolf, Wyant, Weaver.
- CHEERRIES ..... { English Red, (Ey. Richmond) Montmorency, Wragg, Griotte  
Imperiale.
- GRAPES ..... { White—Lady Winchell, Moore's Diamond.  
Red—Delaware, Lindley, Vergennes, Salem.  
Black—Moore's Early, Worden, Aminia, Peabody, Gibb.
- RASPBERRIES... { White—Golden Queen.  
Red—Hornet, Heebner, Marlboro', Cuthbert.  
Black—Hilborn, Older.
- BACKBERRIES... Agawam, Ancient Briton.
- GOOSEBERRIES.. { Foreign—Whitesmith, Industry, Rifleman.  
American—Pearl, Houghton. Smith's Improved.
- CURRANTS . ..... { White—White Grape.  
Red—Victoria, Versaillaise, Moore's Ruby.  
Black—Black Champion.
- STRAWBERRIES.. Bubach, Warfield, Beder Wood, Parker Earle, Manchester.

DISTRICT No. 11.—JOLIETTE, BERTHIER, MASKINONGÉ, ST. MAURICE,

- APPLES . ..... { Summer—Yellow Transparent, Duchess.  
Autumn—Autumn Strawberry, White Pigeon, Golden White.  
Winter—Wealthy, Golden Russet, Pewaukee, Arabka.
- PEARS..... Bessemianka, Gakovka.
- PLUMS..... { Foreign—Seedling Blue, Quackenboss, Blue Orleans.  
American—De Soto, Rollingston.
- CHEERRIES ..... Montmorency, Orel 25, Wragg, Bessarabian.
- GRAPES ..... { White—Lady, Winchell.  
Red—Moyer, Delaware.  
Black—Early Victor, Moore's Early, Worden.
- RASPBERRIES... { White—Caroline.  
Red—Hansel, Heebner, Cuthbert.  
Black—Hilborn, Ohio.
- BLACKBERRIES.. Agawam, Ancient Briton.
- GOOSEBERRIES.. { Foreign—Industry, Whitesmith.  
American—Houghton. Pearl.
- CURRANTS ..... { White—White Grape.  
Red—Victoria, Red grape.  
Black—Black Champion or Naples.
- STRAWBERRIES.. Crescent, Capt. Jack, Bubach, Parker Earle.

## Experimental Farms.

### DISTRICT No. 12.—CHAMPLAIN, PORTNEUF, QUEBEC, MONTMORENCY, CHARLEVOIX.

- APPLES ..... { Summer—Tetofsky, Red Astrachan.  
                   { Autumn—Duchess, White Pigeon, Livland Raspberry.  
                   { Winter—Golden Russet, Wealthy, Canada Baldwin, Longfield.
- PEARS ..... Bessemianka, Kurskaya.
- PLUMS .. ..... { Foreign—Blue Orleans, Damson, Quackenboss.  
                   { American—Rollingston, Wyant.
- CHERRIES..... Montmorency, Bessarabian, Orel 25, Minnesota Ostheim.
- GRAPES..... { Black—Florence, Early Victor, Hartford, Gibb.  
                   { Red—Moyer.
- RASPBERRIES... { White—Golden Queen.  
                   { Red—Hansei, Heebner, Cuthbert.  
                   { Black—Hilborn, Ohio.
- BLACKBERRIES.. Agawam, Ancient Briton.
- GOOSEBERRIES.. { Foreign—Rifleman, Industry.  
                   { American—Houghton, Pearl.
- CURRANTS ..... { White—White grape.  
                   { Red—Red grape, Victoria, Versaillaise.  
                   { Black—Black Naples.
- STRAWBERRIES. Crescent, Sharpless, Bubach, Capt. Jack.

### DISTRICT No. 13.—CHICOUTIMI, SAGUENAY.

- APPLES..... { Summer—Tetofsky, Whitney No. 20.  
                   { Autumn—Duchess, Summer Arabka, White Pigeon.  
                   { Winter—Antonovka, Ostrekoff, Longfield, Hibernial.
- PEARS..... Bessemianka, Gakovka.
- PLUMS ..... De Soto, Rollingston, Wyant.
- CHERRIES..... Vladimir, Bessarabian, Riga 18.
- GRAPES.. ..... Black—Florence, Gibb.
- RASPBERRIES... { White—Golden Queen or Caroline.  
                   { Red—Hansel, Turner, Marlboro'.  
                   { Black—Mammoth Cluster, Hilborn.
- BLACKBERRIES.. Snyder, Ancient Briton.
- GOOSEBERRIES.. American—Houghton, Pearl, Downing.
- CURRANTS... .. { White—White Dutch.  
                   { Red—Red Dutch, Victoria, Prince Albert.  
                   { Black—Black Naples.
- STRAWBERRIES. White Alpine, Manchester, Crescent, Capt. Jack.

YIELD OF VINES PLANTED 3 x 4 FEET APART AND TRAINED TO POSTS.

At the time of planting the vines which now make up the vineyard it was thought advisable to make a comparative test of the single stake method, or what is commonly known in France or Germany as the renewal system. For this purpose 325 vines were set out three by four feet apart. Twenty-five plants each of the Early Victor, Brighton, Champion, Merrimack, Wilder, Niagara and Bacchus were set out, and fifty each of Delaware, Concord and Clinton. Each vine was provided with a four and a half foot stake for the support of the three canes, which were allowed to every vine. As far as practicable these canes were renewed every year by young shoots preserved for the purpose from wood of the previous year. It was not always possible to do this but in most instances the plan was carried out. By this system the wood falls into two classes, viz. :—the fruit bearing wood produced last year, and the young canes of this year's growth, which are designed to replace the first set out and become fruit producers next year.

It will be seen by the following tabular statement of returns for the last three seasons, that the pole system is not adapted to the conditions that prevail in the greater portions of Canada, where the most complete utilization of all the available summer heat is a prime requisite to the successful cultivation of the grape.

YIELD OF VINES TRAINED TO STAKES AS AGAINST THE SAME VARIETIES ON TRELLISES.

No of Vines.	Variety.	Year.	How Trained.	Date of Colouring.	Date of Gathering	Total Yield.		Average per Vine.		Yield per Acre.		Average Yield for three years.
						Lbs.	Ozs.	Lbs.	Ozs.	Lbs.	Ozs.	
20	Bacchus.....	1891	Stakes.....	Sept. 20..	Oct. 8..	14½		11		2,495	10	3,251
	do .....	1892	do .....	do 10..	do 10..	27		1	5	4,764	6	
	do .....	1893	do .....	do 8..	do 15..	14½		0	11	2,495	10	
3	do .....	1891	Trellis.....	do 22..	do 5..	1½		0	8	272	0	6,346
	do .....	1892	do .....	do 7..	do 7..	63		21	0	11,424	0	
	do .....	1893	do .....	do 9..	do 11..	40½		13	8	7,344	0	
22	Brighton.....	1891	Stakes.....	do 11..	do 10..	52		2	6	8,621	4	4,915
	do .....	1892	do .....	do 18..	do 12..	30		1	6	4,991	4	
	do .....	1893	do .....	do 14..	do 18..	7		0	5	1,134	6	
3	do .....	1891	Trellis.....	do 12..	do 6..	25		8	5	4,522	0	3,921
	do .....	1892	do .....	do 10..	do 6..	22		7	5	3,978	0	
	do .....	1893	do .....	do 8..	do 10..	18		6	0	3,264	0	
22	Champion.....	1891	Stakes.....	do 4..	Sept. 18..	7		0	3	680	10	9,982
	do .....	1892	do .....	do 27..	do 5..	44		3	8	12,705	0	
	do .....	1893	do .....	do 26..	do 28..	100		4	9	16,561	14	
3	do .....	1891	Trellis.....	do .....	do .....	42		14	0	7,616	0	11,968
	do .....	1892	do .....	Aug. 27..	Sept. 9..	90		30	0	16,320	0	
	do .....	1893	do .....	do 20..	do 1..							
48	Clinton.....	1891	Stakes.....	Sept. 8..	Oct. 1..	25½		0	8½	1,928	7	3,289
	do .....	1892	do .....	do 13..	do 14..	73		1	8½	5,558	7	
	do .....	1893	do .....	do 12..	do 18..	32		0	10½	2,382	3	
3	do .....	1891	Trellis.....	do 8..	do 5..	33½		11	5	6,264	0	6,488
	do .....	1892	do .....	do 7..	do 10..	33		11	0	6,094	0	
	do .....	1893	do .....	do 6..	do 11..	39½		13	1	7,106	0	

## Experimental Farms.

### YIELD OF VINES TRAINED TO STAKES, &c.—*Concluded.*

No. of Vines.	Variety.	Year.	How Trained.	Date of Colouring.	Date of Gathering.	Total Yield.	Average per Vine.		Yield per Acre.		Average Yield for three years.
						Lbs.	Lbs.	Ozs.	Lbs.	Ozs.	
48	Concord	1891	Stakes	Sept. 8	Oct. 5	201	4	3	15,200	10	11,041
	do	1892	do	do 3	do 10	196	4	1	14,746	14	
	do	1893	do	do 14	do 18	42	0	14	3,176	4	
3	do	1891	Trellis	do 20	do 5	25½	8	8	4,624	0	6,494
	do	1892	do	do 7	do 6	30	10	0	5,440	0	
	do	1893	do	do 12	do 11	52	17	5	9,418	0	
45	Delaware	1891	Stakes	do 4	do 1	74	1	10	5,898	12	4,650
	do	1892	do	do 7	do 10	88	1	15	7,033	2	
	do	1893	do	do 8	do 16	13	0	4½	1,020	15	
3	do	1891	Trellis	do 5	do 1	21	7	0	3,808	0	7,684
	do	1892	do	Aug. 30	do 4	18½	6	2	3,332	0	
	do	1893	do	do 28	do 7	87¾	29	4	15,912	0	
23	Early Victor	1891	Stakes	Sept. 4	Sept. 22	32	1	6	4,991	4	3,974
	do	1892	do	Aug. 30	do 25	54	2	5	8,394	6	
	do	1893	do	do 28	do 28	30	1	4	4,537	8	
3	do	1891	Trellis	Sept. 4	do 21	5½	1	13	657	14	4,258
	do	1892	do	do 7	do 26	20¾	6	14	3,808	22	
	do	1893	do	Aug. 28	do 26	45	15	0	8,310	0	
22	Merrimack	1891	Stakes	Sept. 4	Oct. 1	75	3	6	12,251	4	8,621
	do	1892	do	do 7	do 3	63	2	14	10,436	4	
	do	1893	do	do 12	do 10	19	0	14	3,176	4	
3	do	1891	Trellis	do 4	do 1	21½	7	3	3,910	0	7,650
	do	1892	do	do 3	do 6	30	10	0	5,440	0	
	do	1893	do	Aug. 28	do 11	75	25	0	13,600	0	
20	Niagara	1891	Stakes		do 1	11½	0	9	2,041	14	4,386
	do	1892	do	Sept. 7	do 10	44	2	3	7,940	10	
	do	1893	do	do	do 15	17½	0	14	3,176	4	
3	do	1891	Trellis	Sept. 15	do 15	31½	10	8	5,712	0	8,432
	do	1892	do	do 10	do 6	36	12	0	6,528	0	
	do	1893	do	do 9	do 10	72	24	0	13,056	0	
22	Wilder	1891	Stakes	do 8	do 1	77½	3	8	12,705	0	7,373
	do	1892	do	do 8	Did not mature.						
	do	1893	do	do 14	Oct. 10	11¾	0	9	2,041	14	
3	do	1891	Trellis	do 14	do 1	16½	5	8	2,992	0	5,451
	do	1892	do	do 10	do 4	15½	5	1	2,754	0	
	do	1893	do	do 6	do 7	58½	19	8	10,608	0	

When we consider that by the single stake plan over 3,000 vines are planted on each acre, a glance at the comparative returns shows that they do not justify the greater amount of labour involved in growing them under this system.

#### EFFECT OF SUMMER PRUNING OF VINES TRAINED ON THE RENEWAL OF FRENCH SYSTEM.

The following table shows very conclusively the benefits of summer pruning when applied to the stake or renewal system. Those unpruned were allowed to grow unrestrained after being tied to the stakes in the spring. They soon formed a dense

canopy of foliage over each stake, and set little fruit which ripened very unevenly. The amount of fruit set in the case of varieties like Brighton, which are in the matter of fertilization, dependant in a measure upon pollen from other varieties, was very small, owing no doubt to the leafy covering surrounding the blossoms. It will be noticed that while the yields of both pruned and unpruned vines are in a decreasing ratio, for in 1892 and 1893 this feature is much more prominent in the case of the unpruned vines.

## YIELD of Pruned and Unpruned Grape Vines.

Number of vines.	Variety.	Trained to Stakes.	1882.		1893.		Two year average per vine.
			Yield.		Yield.		
			Lbs.	ozs.	Lbs.	ozs.	Pounds.
3	Bacchus .....	Unpruned .....	4	8	1	0	91
	“ .....	Pruned .....	3	15	2	1	1·00
3	Brighton .....	Unpruned .....	7	4	none.		1·83
	“ .....	Pruned .....	4	2	0	15	·84
2	Champion .....	Unpruned .....	3	4	7	4	2·62
3	“ .....	Pruned .....	10	8	13	11	6·04
3	Clinton .....	Unpruned .....	4	8	2	0	1·08
3	“ .....	Pruned .....	4	9	1	15	1·08
3	Concord .....	Unpruned .....	5	12	0	12	1·08
3	“ .....	Pruned .....	12	3	2	10	2·46
3	Delaware .....	Unpruned .....	5	0	0	12	·91
3	“ .....	Pruned .....	5	13	0	12	1·09
3	Early Victor .....	Unpruned .....	3	8	0	8	·81
3	“ .....	Pruned .....	6	15	3	12	1·78
3	Merrimack .....	Unpruned .....	9	4	2	0	1·87
3	“ .....	Pruned .....	8	10	2	10	1·87
3	Niagara .....	Unpruned .....	8	8	0	8	1·25
3	“ .....	Pruned .....	6	9	2	10	1·53

## EXPERIMENTS IN FALL AND SPRING TRANSPLANTING.

Opinions vary much with regard to the relative success and advantage of transplanting trees in the fall or in the spring. Some advocate fall planting, while others favour setting in spring. The effect of transplanting apple trees in the autumn in this locality has already been recorded in the report of the Horticulturist for the year 1888, p. 78.

In this connection Mr. Hilborn says: “216 apple trees were transplanted from the nursery rows in the autumn of 1887, to an orchard, with a view of testing the relative merits of fall and spring planting.”



## Experimental Farms.

“When the snow disappeared in spring it was found that nearly all these autumn planted trees were more or less injured, many of them killed to the snow line. The fact that such varieties as Duchess of Oldenburg, Tetofsky and Fameuse,—of which there are healthy bearing trees growing unharmed within a short distance of the farm—suffered equally with the tender sorts, showed clearly that these failures were due to the unfavourable season for planting, rather than the lack of hardiness of some of the sorts tested.”

In this instance it is reasonable to suppose that the injury would not have been so severe but for the unusually cold weather of the previous winter; it is right to conclude, however, that fall planting of fruit trees cannot be safely practised in this locality and in other places with similar climatic conditions.

With the object in securing data on the same subject, with regard to forest trees, the following experiment was carried out. Thirty trees each of Green Ash (*Fraxinus viridis*), Black Walnut (*Juglans nigra*), Red Oak (*Quercus rubra*) and European Mountain Ash (*Pyrus aucuparia*), were selected in the autumn of 1892. These had for three years been in nursery rows under good cultivation and were thrifty trees eight to ten feet high. Each variety was separated into three lots of ten trees each; the first assortment being planted without pruning; the second having three-quarters of the last season's growth removed, while the tops of the trees in the third lot were cut back to the main stems. They were then carefully set in rows four feet apart, and three feet apart in the row.

In the spring of 1893, on the approach of the planting season, a duplicate collection of the same varieties was made and treated in a manner similar to those which had been set out the fall previous.

The following tabular data gives the results in detail:—

SHOWING the Average growth and condition of the same Varieties of Forest Trees planted in the Fall and in the Spring.

Variety.	When Transplanted.	How Pruned.	Number Transplanted.	Number Growing.	Average Growth.	Condition.	Remarks.
Green Ash.	Fall	Not pruned	10	10	8	Healthy	
do	Spring	do	10	10	7½	do	
do	Fall	Branches cut back	10	10	10	do	Some dead points.
do	Spring	do	10	10	18	do	
do	Fall	Cut back to main stem	10	10	18	do	Some dead wood.
do	Spring	do	10	10	16	do	Not as strong as last.
Black Walnut	Fall	Not pruned	10	10	4	Injured	Killed back 6 to 12 inches.
do	Spring	do	10	10	4½	Healthy	Few dead points.
do	Fall	Branches cut back	10	10	9	Injured	Killed back 3 to 6 inches; sunscalded.
do	Spring	do	10	10	8	Fair	Some dead points.
do	Fall	Cut back to main stem	10	10	10	Injured	Badly killed back.
do	Spring	do	10	10	12	Healthy	No dead points.
Red Oak	Fall	Not pruned	10	8	5	Injured	Sunscalded.
do	Spring	do	10	10	5½	Healthy	Even growth.
do	Fall	Branches cut back	10	10	5½	Injured	Weak tufty growth.
do	Spring	do	10	9	4	Weak	do
do	Fall	Cut back to main stem	10	10	12	Injured	Dead points 3 to 6 inches.
do	Spring	do	10	10	10	Weak	(growth uneven).
European Mountain Ash	Fall	Not pruned	10	7	8	do	Killed back and sunscalded.
do	Spring	do	10	10	8	Healthy	Even growth.
do	Fall	Main branches cut back	10	10	10	Fair	Sunscalded.
do	Spring	do	10	10	10	Healthy	Even growth.
do	Fall	Cut back to main stem	10	8	15	Fair	Uneven growth.
do	Spring	do	10	10	15	Healthy	Even growth.

## Experimental Farms.

Some of the effects not clearly shown in the table were the much greater amount of dead wood, the more frequency of the sun scalds, and the unevenness of the growth of the fall planted trees, as compared to those set out in the spring.

These results are more marked in the case of the tenderer varieties and those most difficult to transplant, such as Black Walnut, Red Oak and Mountain Ash. In the case of Green Ash, which is very hardy, and one of the easiest trees to transplant, slightly greater growth was made by those transplanted in the spring; other wise there was no difference between the two sets. On the whole it is safe to conclude that in the case of trees which do not transplant easily and which are not strictly hardy, spring planting is attended with better results than autumn planting.

### PRUNING OAKS IN MID-SUMMER.

The following experiment was suggested incidentally in connection with the too severe summer pruning of a number of oaks standing in nursery rows. These had been trimmed higher than desired, and in order to learn if it was possible to form a new head the same season, they were cut back in July with the results delineated below:—

**A. THREE TREES CUT BACK TO ONE YEAR OLD WOOD.**—These made a feeble start the same year, and produced a growth of a few inches which was winter killed.

Their condition in the fall of 1893, was as follows:—

No. 1.—Dead.

No. 2.—To the ground.

No. 3.—Sprouting feebly at two feet from the ground.

**B. THREE TREES CUT BACK TO TWO YEAR OLD WOOD.**—No. 1, grew six inches the same season and eighteen inches the following summer. Fairly healthy but slightly sun scalded.

No. 2 and 3 made a slight growth the same summer, and a growth of fourteen to sixteen inches in 1893. Numerous dead points on all three.

**C. THREE TREES CUT BACK TO THREE YEAR OLD WOOD.**—Each made a growth of from six to twelve inches the same season. During 1893 a growth of fifteen to twenty inches was made of well ripened wood. All fairly vigorous and healthy. Dead points not prominent.

**D. THREE TREES CUT BACK TO FOUR YEAR OLD WOOD.**—No. 1, made a growth of ten inches which was slightly killed back the first year; 1893 a strong growth was made, but the tree was ill-shapen and spreading.

No. 2, made a weak growth which was mostly killed back the following winter.

No. 3, was killed to the ground last winter.

We can readily gather from the above that trees, however hardy and vigorous should not be heavily pruned during the season of active growth, and also that in the case of Red Oak, adventitious buds (by whose agency foliage is renewed) are most easily developed on three year old branches; so that if severe pruning is necessary during summer, it is best to cut back at once to this point.

### PROPAGATION OF ORNAMENTAL SHRUBS AND CONIFERS.

The ease with which many of our most valued ornamental shrubs may be propagated is not generally understood and appreciated. The methods employed in multiplying such fruits as grapes, currants and gooseberries, which may or should be classed among the necessities of life, are universally understood, and there is little excuse for any one—no matter how small the number of plants he starts with—if he does not increase the number sufficiently to meet the home demand.

With ornamental shrubs a more general knowledge of simple methods of propagation by the farmer, would give an increased interest and would redound to the benefit of the planter as well as the nurseryman.

The following methods have been employed here in multiplying varieties desired for lawn or decoration on this and the Branch Farms :

1. PROPAGATING FROM CUTTINGS OF THE RIPENED WOOD.—This method is attended with such slight inconvenience and difficulty as to render it practicable to every one having a small area of cultivated ground available.

In October, select a warm and well drained situation, stretch a garden line and open a trench eight or ten inches deep and the width of a spade. It will be an advantage to have one side of the trench slanting instead of perpendicular, against which to lay the cuttings. The soil at the bottom of the trench should be mellowed by digging.

Cuttings of the ripened wood of the current year's growth are then made by cutting it into nine inch lengths. These are stuck in the soil on the slanting side of the trench at regular distances of six inches apart. The earth is then filled in and carefully packed about the cuttings till level with the surface, leaving only the upper bud of each cutting in sight. They may remain in this condition till freezing weather, when the rows should be covered with a mulch of leaves or coarse manure.

The mulch should be removed the following spring and the cuttings be given good cultivation. At the end of the season a large proportion of the varieties mentioned below, will have become well rooted and have made a considerable growth; being large enough in some instances to transplant to the lawn or border.

The following classes of flowering shrubs are easily propagated in this way :—

Honeysuckle (*Lonicera*) erect and trailing.

Spiræa including bridal wreath, and nine bark.

Barberry (*Berberis*) also easily grown from seed.

Siberian Pea tree (*Caragana*) beautiful in spring.

Weigelia (*Diervilla*) Spring and summer flowering shrubs.

Japan Rose (*Rosa Rugosa*) summer blooming.

Tamarisk (*Tamarix*) Foliage beautiful.

Snowball (*Viburnum opulus*) grows most readily from layers.

Cytisus, closely allied to the laburnums.

Shrubby Five finger (*Potentilla*) summer flowering.

Sea Buck-thorn (*Hippophae rhamnoides*).

Siberian dog wood (*Cornus Siberica*) propagates best by layering.

Syringa (*Philadelphus*) the common mock orange.

Deutzia (*Deutzia*) White flowers in early spring.

Carolina Allspice (*Calycanthus Floridus*) Spring flowering.

Smoke tree (*Rhus cotinus*) Autumn flowering.

Southern wood (*Artemisia*).

This list includes a large proportion of the most desirable plants of deciduous habit suitable for lawn decoration in this vicinity

2. PROPAGATING FROM GREEN WOOD.—By this method cuttings are taken early in August from the unripened tips of the current year's growth. They should be four to six inches in length and be prepared by removing all the leaves except three or four of those last developed. They are then planted three inches deep in rows in a frame supplied with soil of equal parts of sand and loam. The frame is then covered with hot-bed sash, which is carefully shaded till the plants become rooted. The cuttings should be carefully watered and aired during this period.

On the approach of winter the rooted plants may be either taken up and stored in a cold cellar or be protected with a mulch in the frame.

Nearly all the plants mentioned in the preceding list may be propagated in this way, but it is specially useful for striking plants of the beautiful large flowered Hydrangea (*H. Paniculata grandiflora*) which can be multiplied in this manner with as much ease as the geranium.

#### PROPAGATING RETINOSPORAS AND THUJAS BY CUTTINGS.

There is no class of evergreen plants so useful for house culture in winter as potted plants, or for lawn decoration, as the various species belonging to the genus *Retinospora*, commonly called Japan Cypress, and to those may be added numerous forms of dwarf cedar (*Thuja*). It is a matter of regret that florists do not grow them more frequently as potted plants, when they may be rooted so easily.

## Experimental Farms.

The following method has been adopted here with excellent results:—

The cuttings are made in October by selecting side shoots, which are separated from the stem with the "heel" attached. A heel cutting is one provided with the thickened knot or joint found at the base of each branch. The lower branchlets are trimmed off and the cuttings inserted in boxes of sandy soil, which are kept in a cool part of the green-house, where the temperature does not exceed 50 degrees. The soil should be kept uniformly moist. In February they will have calloused, which is the preparatory stage of rooting. They should then be given more heat, when they will root freely and will be ready for setting in nursery rows or potting by the time spring opens.

During the winter of 1891 twenty varieties of *Thuja* were propagated in this way, over 40 per cent of the cuttings of each kind rooting. With *Retinosporas* the returns are much better.

### EXPERIMENTS IN PROPAGATING CHERRIES.

#### ROOT GRAFTING.

A comparative test was made in 1892 with the object of showing the relative success which might be looked for, in grafting Morello cherries upon the common commercial stocks.

The work of root grafting was performed according to the method outlined in Bulletin No. 17, reasonable precautions being taken to secure a good stand. The grafts were set in nursery rows early in May, 1892, and given clean cultivation. The results are given below:—

Variety.	Stock.	No. Grafted.	No. which grew.	Per cent
Orel-23 .....	Mazzard .....	50	13	26
Orel 23 .....	Mahaleb .....	41	None.	
Lutovka .....	Mazzard .....	50	19	38
Lutovka .....	Mahaleb .....	50	8	16
Bessarabian.....	Mazzard .....	50	14	28
Bessarabian.....	Mahaleb .....	50	None.	
Vladimir.....	American Plum .....	50	3	6
Vladimir whip graft .....	do .....	25	6	24
Spaté Amarelle .....	do .....	50	2	4
Shadow Amarelle .....	do .....	50	5	10

The above results are so poor as to render impossible the profitable propagation of cherries by these methods. It is true, however, that they may be much below the returns of professional propagators. Mazzard makes much the best showing. Success varies from year to year, according to the season, the care of the graft exercised in carrying out the details connected with the operation of grafting. Much also depends upon the condition of the soil and weather at the time of setting out the grafts. On the whole it is safer for the amateur to crown graft in the spring upon stocks planted the year previous.

The following results have been obtained in propagating cherries by crown grafting.

Variety.	Stock.	No. Grafted.	No. Grown.	Per cent
Vladimir .....	Mahaleb .....	100	92	92
Lutovka .....	do .....	100	88	88
Bessarabian .....	do .....	100	95	95
Shadow Amarelle .....	do .....	19	16	84
Gruner Glas .....	do .....	62	35	56
Orel 24 .....	do .....	68	42	61
Wragg .....	do .....	15	12	80

BIRD CHERRY STOCKS (*Prunus Pennsylvanica*.)

This native cherry has much to commend it as a propagating stock, but also possesses a few serious defects.

It is hardy and easily grown from seed. On the other hand, its growing season is so extended, and growth so rapid and succulent during that period, that it is often difficult to hit upon the most favourable time for budding. Several hundred were budded late in August of 1892, but with poor success, owing to the large amount of sap in the stocks at the time of budding, which prevented the immediate union of the buds. Growth continued till arrested by frost late in September. In order to prevent the stocks from being girdled by the fibre used in tying, it was necessary to loosen and re-tie, twice after the buds were inserted.

This year the stocks were not budded until the first week in September, and less difficulty from over-growth was experienced, and better results are looked for.

## VEGETABLES.

## EXPERIMENTS WITH CAULIFLOWERS.

A varietal test of cauliflowers was carried on this season. Twenty plants each of twenty-eight varieties were set out on 3rd June. The seed from which these were grown was sown in hot bed 4th April, and pricked into a cold frame, 28th April. The ground was prepared by deep fall ploughing and dressing with barnyard manure at the rate of 75 tons to the acre. The plants were set in rows, three by two feet apart and cultivated with a Planet jr. horse cultivator. As the heads matured they were weighed and the weights recorded with dates of cutting. The results are embodied in the subjoined table. Some of the late varieties were injured by root maggots which were not detected soon enough to be successfully treated with hellebore. The season on the whole was favourable for the development of firm crisp heads of good size.

## CAULIFLOWERS.

Variety.	Seedsman.	Per cent germinated.	Transplanted.	Date of 1st cutting.	Date of last cutting.	Percentage of Plants headed.	Total Weight.	Average Weight.
							Lbs.	Lbs. ozs.
Autumn Giant.....	Thorburn ..	61	June 3	Sept. 30..	Oct. 30..	85	56½	3 5
Early Asiatic.....	Landreth...	79	do 3	Aug. 13..	do 20..	85	63	3 11
Early Boston.....	Faxon ..	78	do 5	July 20..	Sept. 9..	60	34	2 13
Earliest Dwarf Erfurt.....	March .....	79	do 5	do 17..	do 19..	70	54½	3 14
Early Dwarf Erfurt.....	Thorburn ..	91	do 3	do 29..	do 19..	85	43½	2 9
Early Perfection.....	March .....	57	do 5	do 17..	do 6..	94	41	2 6
Early Long Island Beauty.....	do .....	93	do 5	Aug. 8..	do 6..	80	38½	2 6
Early Paris.....	Thorburn ..	79	do 3	do 5..	do 6..	65	19½	1 8
Early Snowball.....	March .....	88	do 3	July 18..	do 19..	86	44½	3 7
Early Walcheren.....	Thorburn ..	74	do 3	Sept. 19..	Oct. 20..	80	42	10
Extra Early Dwarf Erfurt.....	do ..	29	do 3	Aug. 5..	Sept. 19..	85	41	2 6
Extra Early Whitehead.....	Steele .....	.....	do 5	July 17..	Aug. 20..	70	18	1 4

# Experimental Farms.

## CAULIFLOWERS.—*Con.*

Variety.	Seedsman.	Per cent germinated.	Transplanted.	Date of 1st cutting.	Date of last cutting.	Percentage of Plants headed.	Total Weight.	Average Weight.
							Lbs.	Lbs.
Giant Purple early.....	Childs.....	94	June 3.	Sept. 6..	Oct. 28..	60	76½	5 7
Giant Purple late.....	do.....	95	do 3.	do 6..	do 20..	35	68	9 0
Giant White Pearl.....	Pearce.....	82	do 3.	July 26..	Sept. 11..	85	68	4 0
Gilt Edge Snowball.....	Thorburn ..	86	do 3.	do 29..	do 19	100	50½	2 8
Half Early Dwarf French....	do.....	92	do 3.	do 29..	do 6..	80	22½	1 6
Imperial Novelty.....	Landreth....	45	do 3.	do 17..	Oct. 20..	88.8	14½	1 12
Italian Taranto.....	Thorburn ..	58	do 3.	Oct. 2..	do 20..	35	32	4 9
Landreth's 1st.....	Landreth....	67	do 3.	July 26..	Sept. 11..	42.8	12	2 0
Large Algiers.....	Thorburn ..	72	do 3.	Sept. 6..	do 26..	70	44½	3 2
Large Early London.....	do.....	70	do 3.	Aug. 14..	Oct. 20..	95	46½	2 7
Large Early Dwarf Erfurt....	do.....	58	do 3.	July 17..	do 2..	92.3	27½	2 4
Le Normand Short Stem.....	do.....	77	do 3.	Aug. 8..	Aug. 23..	70	16	1 2
Non Pariel.....	do.....	76	do 3.	do 20..	Sept. 6..	45	7	0 12
Snowball.....	March.....	92	do 5.	do 2..	do 6..	85	41½	2 6
Stadtholder.....	Thorburn....	60	do 3.	Sept. 6..	Oct. 4..	45	34½	3 13
Veitch's Autumn Giant.....	Steele Bros..	85	do 5.	do 6..	do 20..	15	9½	3 4

**Results :**

Gilt-edge Snow-ball (Thorburn) gave the highest number of matured heads, averaging 2½ lbs. each. This was the most satisfactory early sort.

Giant White Pearl (Pearce). A medium early variety of good size, headed evenly and yielded 85 per cent of solid heads, with an average weight of 4 lbs. each.

EARLY SNOWBALL (March), This from American grown seed proved one of the best early kinds. Its maturing season covered two months, beginning July 18th, which would be an advantage to the amateur, but a drawback to the market gardener; 86 per cent matured with an average weight of 3½ pounds per head.

American grown seed gave very satisfactory returns with regard to vitality.

Among the late varieties, *Large Algiers*, *Autumn Giant* and *Giant Purple Early* were the most satisfactory.

### TREES, CUTTINGS, SEEDS, AND SCIONS DISTRIBUTED.

In order to assist the Quebec Government in furthering the very useful line of experimental work in horticulture inaugurated last year—that of establishing trial fruit stations in each county—the following varieties of apples were supplied by the Central Farm :—

Variety.	No. of Trees.	Season of Fruit.
Sweet Stripe.....	50	Fall.
Bogdanoff.....	25	Winter.
Charlamoff.....	75	Summer.

Variety.	No. of Trees.	Season of Fruit.
Cross, 15 m.....	75	Early winter.
Flat Voronesh.....	40	Fall.
Gipsy Girl.....	25	Early winter.
Arabka .....	40	Late winter.
Kara Synap .....	15	Winter.
Rosy Repka .....	100	Summer.
Simbirsk No. 4.....	25	Early winter.
Borovinka .....	100	Autumn.
Cross, Dept.....	50	Winter.
Antonovka .....	60	Early winter.
Orel, No. 5.....	100	Autumn.
Sklanka, Bog.....	75	Winter.
Voronesh Glass.....	50	Winter.
Good Peasant.....	75	Winter.
Early Sweet.....	75	Summer.
Osimoë.....	50	Winter.
Grandmother .....	25	Autumn.
Simbirsk No 1.....	100	Early winter.

Through the Ontario Fruit Growers' Association, a number of new seedling black currants have been sent out for trial to different parts of the province. In addition to these, 100 *Rosa rubrifolia* (red-leaved rose), 75 *Spiræa rotundifolia* (round-leaved spiræa), were distributed through the same medium, together with 500 plants each of Colorado blue spruce (*Picea pungens*), yellow pine (*Pinus ponderosa*), and Douglas fir (*Pseudotsuga Douglasii*).

#### CHERRY SCIENS.

In response to the offer of cherry scions for propagating purposes, of the varieties described in Bulletin No. 17, a large number of applications were received. Many of the applicants were labouring under the erroneous impression that trees instead of scions, would be sent them. One hundred and twenty-eight packages were distributed, covering every province in the Dominion, a large proportion going to the Maritime Provinces. Very satisfactory reports have been received from many who were successful in propagating them.

#### MANITOBA AND NORTH-WEST TERRITORIES.

Another distribution of seeds and cuttings of hardy forest trees was made to the Western Provinces. The details are contained in the following table:—

Packages of Plants, Cuttings, &c., Distributed.	Manitoba. — No. of Pack- ages.	North-west Territories. — No. of Pack- ages.
Forest trees .....	449	381
Cuttings.....	501	297
Cuttings and trees.....	177	27
Cherry scions.....	30	13
Fruits .....	128	52
Box elder seed.....	796	533
Ash seed.....	142	52
Asparagus seed.....	936	582



## Experimental Farms.

The following varieties of Russian apples were used in making up the packages of fruits, in addition to plants of the leading varieties of currants:—

Antonovka,	Karabovka,
Aport, 252,	Ledenetz,
Arkad, Vor.,	Orel, No. 6,
Anisovka,	Orel, 27,
Borovinka,	Rosy Voronesh,
Blushed Calville,	Repka Aport,
Cross, Vor.,	Red Streak,
Cinnamon, Vor.,	Simbirsk, No. 1,
Cinnamon Pine,	Simbirsk, No. 2,
Gipsy Girl,	Simbirsk, No. 3,
Golden Reinette,	Simbirsk, No. 5,
Knievskoe,	Vargul.
Kruder,	

### EXPERIMENTS WITH TOBACCO.

Some preliminary experiments were undertaken in the cultivation of tobacco, with a view of obtaining information with regard to the varieties best suited to the climate of Eastern Ontario and the province of Quebec; and the most approved methods of handling the young plants previous to setting out.

Seed of thirty-one varieties was sown in a mild hotbed on April 24th, 1893, in rows six inches apart. Germination took place very uniformly in ten days. On May 30th, half the number of plants of each variety were transplanted, pricking them out in a cold frame in rows eight inches apart and three inches apart in the row. On June 6th they were transplanted to the field, which was a thoroughly tilled piece of gravelly loam, that was cropped with beans the previous season, ploughed in the autumn and dressed in the spring with barn-yard manure at the rate of 50 tons per acre.

The ground was cultivated sufficiently with a Planet Jr. horse cultivator to keep down all weeds, and as long as the cultivator could pass between the rows without injuring the plants, which were set three and a half feet apart each way. This distance was found to be sufficient for the smaller and more upright varieties such as "Canadian" and "Cannelle," but did not afford enough space for large leaved vigorous kinds like "Conqueror" and "Pennsylvania Seed Leaf."

A striking difference was noted in the relative rapidity of growth of plants, which had been transplanted in hotbed, and those of the same variety set out from the original seed bed. Those transplanted in hotbed were much stockier and stronger, as might reasonably be expected, did not flag after setting in the field, and lost no time in becoming established.

As the following tabular statement shows, very few plants had to be replaced of those which were transplanted in hotbed. On the other hand, those which had not been transplanted in the hotbed were much slower in taking root and many more of these had to be replaced, as indicated in the table.

The difference in the two sets was quite plainly visible for the greater part of the summer, in fact till "topping" had taken place.

It should be stated also that in pricking out, the plants were taken in such a manner as to thin regularly those remaining, in order to allow of even development and prevent a spindling and weakly growth.

Harvesting after the "single leaf method" described in general notes which follow on the cultivation of tobacco took place Sept. 15th.

The leaves were separated into two grades, according to soundness and size, and the figures in the weight columns represent how much the leaves of each variety weighed green, immediately after picking. The second column of weights represent the amount which the same leaves weighed after drying previous to sorting and tying in "hands." The estimated returns per acre show that tobacco, as far as quantity is concerned, can be successfully grown in this and other localities having like climates.

TOBACCO.

Variety.	Seedsman.	Number set out.	Number replaced.	Size of Leaf.	WEIGHT, GREEN.		ESTIMATED WEIGHT PER ACRE.	WEIGHT, DRY.		ESTIMATED WEIGHT PER ACRE.					
					1st Grade.	2nd Grade.		1st Grade.	2nd Grade.						
											Lbs. ozs.	Lbs. ozs.	Lbs. ozs.	Lbs. ozs.	
Brazilian American, transplanted.	Thorburn.	20	0	Inches. 29×16	31	12	2	9	17	7,326	Lbs. ozs. 4	2½	1	½	1,107
do not do	do	20	4	.....	31	8	5	4	18	7,411	4	4	0	12½	1,014
Climax do	do	20	0	29×18	41	10	9	14	19	9,839	5	13	2	12½	1,636
do not do	do	20	6	.....	29	14	12	4	15	10,035	2	13	2	2½	1,210
Canadian do	Evans.	82	0	26×14	120	0	45	0	82	7,304	16	12½	6	7½	1,004
do not do	do	41	12	.....	67	0	21	0	41	7,791	8	1	3	3¾	1,000
Canelle do	Foucher	82	0	19×12	64	4	20	0	75	4,070	10	14½	2	8	648
do not do	do	41	30	.....	17	0	10	0	32	3,062	2	9¾	0	11½	367
Connecticut Seed Leaf do	Thorburn	20	1	.....	59	0	16	4	19	14,376	8	11½	0	13½	1,826
do not do	do	20	4	.....	63	0	13	12	20	13,930	6	9¾	2	0	1,582
do do	Foucher	82	3	33×15	219	0	65	0	80	8,429	27	15	10	1½	1,725
Conqueror do	Thorburn	20	1	29×17	32	4	13	12	20	8,349	5	1½	2	6¾	1,361
do not do	do	20	6	.....	24	0	6	0	20	5,445	3	8½	1	½	825
Honduras do	do	20	2	29×15	50	4	13	0	20	11,479	5	3½	1	12½	1,267
do not do	do	20	8	.....	88	10	.....	.....	18	17,872	5	12¾	.....	.....	1,169
Hector	Landreth	20	1	30×18	31	4	13	8	19	8,549	4	15¾	2	3¾	1,379
Havana Partidas, transplanted.	do	20	3	18×11	7	4	3	10	18	2,142	1	6¾	0	10½	214
Havana Vuelta Abajo.	do	20	0	16×10	12	4	3	10	20	2,904	2	2	0	11½	516
Imported Havana, transplanted	Thorburn.	20	2	21×14	24	0	3	0	20	4,900	2	2½	0	8	322



The varieties which have succeeded best both as to yield and time of ripening are *Canadian*, *Connecticut Seed Leaf*, *Pryor Yellow* and *White Burley*.

### HINTS ON TOBACCO CULTURE.

For the benefit of those who are unacquainted with the tobacco plant and its culture, the following brief outline of the course usually adopted in the management of this crop is appended.

That group of plants known to Botanists as members of the genus *Nicotiana* is a large one, and includes many useful decorative plants as well as the tobacco of commerce. The genus was named after Jean Nicot, who introduced tobacco into France in the latter half of the 16th century. *Nicotiana tabacum* and *Nicotiana Persica* with their varieties include most of the cultivated tobaccos.

The development of this industry has proceeded with great rapidity. With the French colonists of the Detroit River region and of the province of Quebec came seed of this plant to Eastern North America. In the eastern portions of this province long continued selection of home-grown seed has given rise to varieties peculiar to the region. These are usually smaller leaved hardy varieties that do not attain the height of Southern forms. The yield, however, is usually very satisfactory, and with the exercise of skill in harvesting and curing, there is no doubt that an easily marketable product of good quality can be produced.

### SOIL.

A soil which is deep, friable, rich, dry and warm, and one which may be easily traversed by the numerous tender fibrous roots of this plant, is advisable in this climate in order to hasten early maturity. A sheltered situation is also very desirable. Tobacco is peculiarly a farmer's crop inasmuch as there are few farms which do not afford an acre or half an acre of the above description.

### MANURES.

Analyses of the stems and leaves of tobacco reveal the fact that this plant draws heavily on the potash of the soil, so that in growing it a proper rotation of crops is desirable, and a careful return to the soil of those elements of fertility which have been withdrawn is of course necessary.

The following analyses are taken from the Report of the Massachusetts Experiment Station for 1892.

Substance Analysed.	Nitrogen.	Average.	Potash.	Average.	Phos. Acid.	Average.	Lime.	Magnesia.
Tobacco leaf. . . . .	2.75	2.52	7.24	6.44	.43	.51	4.17	2.17
Tobacco stems. . . . .	2.29	2.52	6.44	6.44	.60	.51	3.89	1.23

The above figures show the principal elements extracted from the soil in growing this crop, and indicate the desirability of returning them if the best results are looked for.

It should not be forgotten that the fertilizing constituents are nearly equally divided between the stalk and the leafy matter, and therefore, the utilization of the stalks for fertilizing purposes is an important feature in the economical culture of this plant. It has been estimated by Mr. Loomis of the Connecticut Experiment Station (Report for 1887, p. 84), that "the stalks contain about as much nitrogen and potash as would be furnished by an application of 70 pounds muriate of potash

## Experimental Farms.

and 300 pounds of cotton-seed meal per acre. The latter would, however, contain nearly twice as much phosphoric acid." In other words, about four tons of barn-yard manure would be needed, from which to obtain an equal amount of potash, as is contained in the stalks from an acre, but one and a half tons of barn-yard manure will furnish an equal amount of nitrogen.

It will be seen then that potash and lime are specially required, and soils in which these elements are present in large quantities produce a leaf of superior burning qualities.

### RAISING PLANTS.

Seed should be sown in a hotbed between the 10th and 20th of April; the latter date is usually the right time for this locality. In twenty days the plants should be ready to transplant to a cold frame in the manner already described. Such a course of treatment as will produce good tomato plants may be pursued with every assurance of success.

The time of setting out will depend somewhat on the locality, it must not take place till after all danger of frost is over—in this locality from May 24th to June 10th.

### TRANSPLANTING AND CULTIVATING.

The large leaved varieties should be set in rows, four feet apart and three feet apart in the row. The rows are easily lined out with a corn marker. Three feet apart each way will give sufficient space to the smaller growing sorts; such as the "Canadian" and the Turkish varieties. Although a cloudy day is preferable for transplanting, yet if plants have been handled as above described, and carefully taken up with a ball of earth attached to the roots of each, there is little need of delaying the work by waiting for clouds or rain. Like all young plants frequent cultivation is very necessary to the rapid growth of the tobacco plant, and the soil should be stirred at least once in ten days, up to the period when the plants are "topped."

### PRIMING AND TOPPING.

"Priming" is the term used to designate the removal of one or two of the lower or primary leaves, which are inferior in size and frequently become torn and injured by the cultivator.

"Topping" is the more important operation of removing the flower stalk, with one or more of the upper and smaller leaves. The energies of the plant are thus diverted from the natural channel—the production of seed—to the more perfect development of its leafy tissues. After topping, numerous suckers will appear in the axils of the leaves; those should be promptly removed.

### HARVESTING.

It is difficult to describe with sufficient accuracy for identification, the appearance of the tobacco leaf when it has arrived at the proper stage for cutting. The proper time for harvesting is more easily pointed out in practice than intelligently described. When maturity is reached the leaf loses its deep green, taking on a yellow hue, which in some varieties is mottled with deeper markings of the same colour. At this stage, if the tip of the leaf is doubled back, the mid rib will break with a clean fracture.

There are two principal methods of harvesting the crop:

1. Cutting the plant at the ground, and hanging the whole stalk while it is being dried.
2. Stripping the leaves from the plants in the field as they ripen, and stringing them on wires which are attached to laths, in such a manner as to allow each lath

with its load of leaves to be handled separately. The latter is the ideal method and one which is being introduced into many of the tobacco-growing regions of the United States with excellent results. It entails, however, a greater amount of labour than the first and older method, and at a season when the farmer is usually pressed for time. When the former method is adopted the plants are strung on laths either by piercing or splitting the stalks. After being allowed to wilt for a short time they are taken to the curing house or barn.

The best drying-houses are now supplied with a system of heating flues which hastens and facilitates the process of drying, which without these aids takes from four to six weeks according to the humidity of the atmosphere and the system of harvesting employed: the whole plant taking longer, of course, than if the "single leaf method" is adopted.

The leaves are next stripped from the plants and graded according to their quality and size, in bundles called "hands" containing a dozen leaves each.

#### FERMENTING.

In order to give the leaves a uniform colour the "hands" are arranged in a compact heap with butts outward, in which condition they remain till heating commences: when the thermometer in the centre indicates a temperature of 100 to 110 degrees the "bulk," as this heap is technically called, is opened and rearranged so that the outer tiers are brought to the centre. After the process of fermentation has been completed the "bulk" is opened, the "hands" taken out and arranged in loose tiers where they are gradually cooled.

In the case of fine cigar tobaccos the leaves are again sorted before packing in bales or hogsheads for shipment, which completes the course of treatment before marketing.

## Experimental Farms.

# REPORT OF THE CHEMIST

(FRANK T. SHUTT, M.A., F.I.C., F.C.S.)

OTTAWA, 1st December, 1893.

WM. SAUNDERS, Esq.,  
Director, Dominion Experimental Farms,  
Ottawa.

SIR,—I have the honour to submit herewith the seventh annual report of the Chemical Department of the Dominion Experimental Farms.

The work of the department is necessarily of a manifold character. That which relates to the answering of correspondents' questions, and the examining and reporting on samples of soil and agricultural products for individuals, although an extremely useful branch of the work, is not repeated here. In the following pages are recorded only the data and conclusions considered to be of general interest and value to the farming community of the Dominion. A brief outline of this matter, prepared for convenience of reference, is as follows:—

**SOILS.**—Our work on the examination of representative soils has been continued. Interesting data together with conclusions as to the relative fertility and rational treatment of the soils analysed during the past years are here given. The investigation included virgin soils from widely distant points in Canada.

An analysis of every soil received is neither possible nor desirable. A qualitative and physical examination is however made, and a report forwarded to the sender of the sample, with such suggestions as to fertilizers and modes of treatment as are deemed advisable for increased crop yields. The soils so reported on have been received from all parts of the Dominion. In this new departure, I believe, the Chemical Department has been of much benefit to our agriculturists.

**ALKALINE SOILS.**—In the chapter on alkaline soils, a distinct and progressive step towards their amelioration is recorded. The experiments of the past year have proven that by the treatment here detailed the baneful effects of magnesium sulphate (Epsom salts) in a soil, may be overcome.

The variable character of the alkali in the affected districts, does not allow us to offer any one method whereby all alkaline soils may be alike beneficially treated, unless it be that of thorough drainage. To all those in Manitoba and the North-west Territories possessing "alkali patches," the reading of the present report is commended.

**MUCKS, PEATS AND MUDS.**—The value of these naturally-occurring fertilizers is stated at some length, and the composition of many samples lately analysed given in tabular form. Suggestions for the economic use of these fertilizers are added.

**WOOD ASHES.**—Special attention is called to the value of potash in agriculture, and a plea is made for the better recognition of the value of Canadian wood ashes.

**LEGUMES.**—The results of analyses of several members of the Leguminosæ are inserted together with some remarks upon the value of these plants for fodder and as green manure.

**CABBOTS.**—An interesting investigation was made to ascertain if there were any difference in feeding value between the part of the root developed above ground and the part below the surface of the soil. Our analytical data and conclusions are here given for the benefit of our readers.

**THE BABCOCK TEST.**—Dairymen will find a record of further experiments with this useful method of ascertaining the percentage of fat in milk. These have special reference to the amount of potassium bichromate to be used in composite testing.

**WELL WATERS.**—As in former years, the analysis of farmers' well waters is a matter that has received our attention. The results of the past year are given, and attention is drawn to the danger of drinking from a contaminated supply.

**SALINE WATERS.**—Some experiments towards the improvement of certain saline waters have been made this year. The results are commended to the notice of those who unfortunately have to depend upon such unwholesome supplies.

**MISCELLANEOUS.**—Several other matters, though perhaps of less importance than the foregoing, are treated of in the following report, since they are considered of general interest to farmers.

Addresses have been delivered at several of the larger agricultural conventions in Ontario, and have received publication in their transactions.

They are as follows:—

Dairymen's Association of Eastern Ontario—Home grown Coarse Fodders.

Creameries' Association of Ontario—Paying for Milk according to Butter-fat.  
Ontario Agricultural and Experimental Union—The Chemistry of Farmyard Manure.

Convention of Executive Health Officers, Ontario—The Farm Water Supply.

Ontario Fruit Growers' Association—The Chemistry of the Copper Fungicides.

In addition to these, several Farmers' Institutes were attended and addressed.

In August, upon the nomination of Sir Henry Trueman Wood, Secretary to the Royal Commission of Great Britain, I was appointed a professional juror on cereals at the World's Columbian Exposition, Chicago.

Accordingly, with the approval of the Honourable the Minister of Agriculture and yourself, I proceeded to Chicago and there assisted in the analysis of more than 500 samples of grain including wheat, oats, barley, rye, Indian corn, buckwheat, rice and flour—among which were many samples from all parts of Canada. The awards for excellence in this department were granted from data derived from physical inspection and chemical analysis—the nutritive value as deduced from the composition of the grain, being an important factor.

In this connection, it is particularly gratifying to note that the analysis of the samples of wheat (principally Red and White Fife) sent from Manitoba and the North-west Territories, showed them to be of excellent quality and containing a very high percentage of albuminoids, thus confirming previous analyses and opinions of the wheat grown in these provinces.

The United States Department of Agriculture purpose publishing in bulletin form the analytical data of all the cereals examined.

In January last Mr. A. Lehmann, B.S.A., resigned his post of assistant chemist to accept a position on the staff of the Experiment station of Louisiana, at New Orleans. For two years and a half Mr. Lehmann had worked faithfully and well in our laboratories, and it was with much regret that I parted with an assistant who had proved himself so valuable and had taken such a deep interest in the chemical work of the Farms.

Mr. P. H. Le Rossignol, B.A.Sc. of McGill University, Montreal, was appointed to the vacant assistantship in April. Mr. Le Rossignol has shown himself a careful and skilful analyst and well qualified for the work of this department. To his ability and industry I am indebted for many of the results here recorded.

I have the honour to be, Sir,

Your obedient servant,

FRANK T. SHUTT,

*Chemist, Dominion Experimental Farms.*

Chemical Laboratories,  
Central Experimental Farm,  
Ottawa.



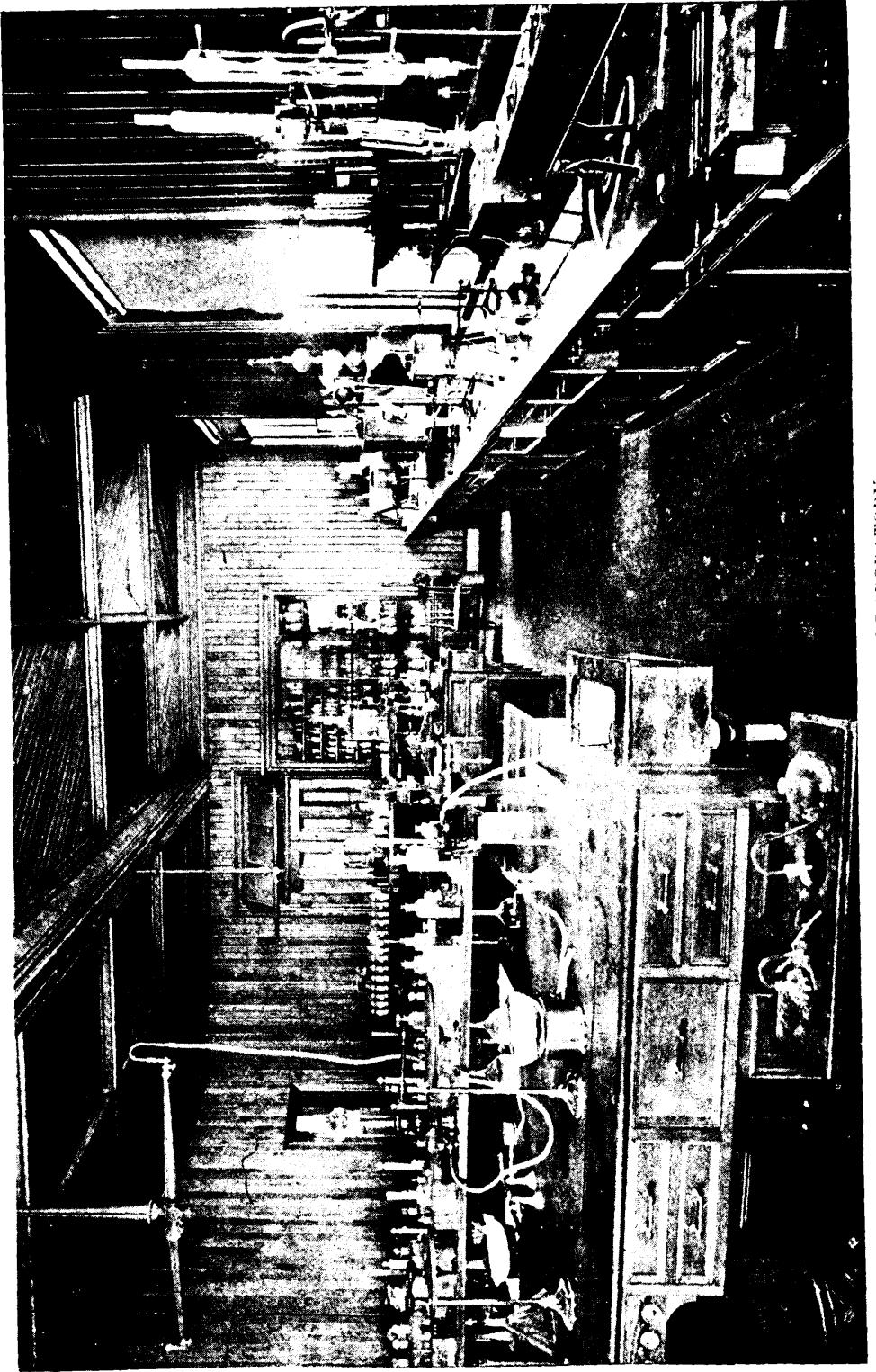

INTERIOR VIEW OF MAIN LABORATORY.

## Experimental Farms.

### SOILS.

The investigation into the composition of certain Canadian soils has been continued, and the results of the analyses of sixteen samples obtained during the past year are now given.

Since the amount of work involved in soil analysis is very considerable, the chemical examination is restricted to those samples which either represent the virgin soils covering large areas in the Dominion or, on account of supposed barrenness, present themselves as worthy of special examination.

In previous reports (1890 and 1891) the factors upon which the fertility of a soil depends have been enlarged upon, the constituents of soils enumerated, and the limits between which the elements of the plant food vary in soils given. It will only be necessary, therefore, to insert the following abstracts, which afford sufficient information to render intelligible the chemical data in the subjoined table:

**FACTORS OF A SOIL'S FERTILITY.**—"The factors upon which the fertility of the soil depend are many. The amount of plant food and its degree of solubility, the mechanical texture or tilth and the climate (temperature, amount of rainfall, &c.) are the chief of these.

"Soil, to be fertile, must contain the elements of plant food in such forms that they can be readily used for the nutrition of vegetation. At the same time its condition must not be too loose, else a firm hold will not be afforded to the roots of plants, and there will be too much drainage and evaporation; nor must it be too heavy and plastic, for then air and water could not freely permeate it nor the roots extend themselves beyond a very limited area. Generally speaking, light, loose soils are not as rich in plant food as those in which clay predominates; yet, on account of their excellent condition of tilth, they often yield, in favourable seasons, heavier crops than the latter. Stiff, heavy clays, though rich in inorganic plant food (potash and phosphoric acid) are often poor in nitrogen, while their condition is such as to prevent thorough aeration and the penetration of the roots. It is these soils especially that are benefited by drainage. By a system of drainage the water which saturates the surface soil is carried off, air allowed to permeate, the whole rendered more friable and easily worked, and much plant food is converted into assimilable forms.

"Where sand largely preponderates, the soil is not retentive of moisture and fertilizing material, especially if the subsoil be light, and though easily worked, is not so desirable in dry seasons as a heavier soil.

"A proper proportion of sand and clay, therefore, for many reasons, makes the best soil.

"With the clay and sand, varying amounts of peaty matter or humus (derived from the decomposition of vegetable matter), and of calcareous matter (principally carbonate of lime) are usually associated, and a right proportion of the two latter exerts a beneficial influence upon the tilth of a soil. From the presence of these predominating materials, soils are known respectively as clay, sandy, peaty and calcareous, according as one or the other is in excess.

"By the slow decomposition of the clay and the peaty and calcareous matter, plant nutrients are liberated in a soluble form, and therefore the function of these soil fundamentals is not only mechanical but chemical.

**THE ESSENTIAL ELEMENTS OF PLANT FOOD.**—"The most important inorganic constituents of a soil are potash and phosphoric acid. These, together with nitrogen, are known as the *essential elements* of plant food.

"*Potash*—derived principally from the decomposition of felspathic rocks, *e.g.*, granite—exists chiefly in combination with silica in a more or less soluble condition. The limits of potash in a soil lie between a mere trace and about 2 per cent. A good agricultural soil contains between .25 per cent and 1 per cent. Clay soils, usually, are the richest in potash.

"Potash, as a fertilizer, is of special value to clover, pease and other leguminous crops; potatoes, beets, cabbage, grasses and leafy plants in general, are also benefited by it. It should form a large part of manures for orchards and all fruit trees.

"*Phosphoric acid*, combined principally with lime, is found in all fertile soils. Like potash, it has been derived from the rock that originated the soil, and consequently is not constant in quantity. It never exceeds 1 per cent, even in the richest soils, and the average in good soils is about .2 per cent.

"It benefits chiefly root crops, *e.g.*, turnips and beets, and in conjunction with nitrogenous manures is very effective for the cereals, promoting an early maturity and an increased yield.

"*Lime*.—Of the inorganic elements of minor importance, lime is the principal. It affords food directly to the plant and liberates in the soil potash and nitrogen pre-existent in insoluble forms. Many consider that less than 1 per cent shows a soil to be deficient in lime, and calcareous soils are almost invariably fertile.

"No special mention need here be made of the other mineral constituents, as most soils contain sufficient for all the requirements of farm crops.

"*Nitrogen* is the element of value in the organic portion of a soil. It there exists, for the most part, in forms from which it can be but slowly absorbed by plants. By a process of fermentation, known as nitrification, it is rendered assimilable. The presence of lime (carbonate of lime) appears to assist in this useful operation, especially when the ground is sufficiently open for the air to permeate it. Moisture and warmth are also necessary to encourage the growth of the microscopic ferment which causes the formation of nitrates from nitrogenous material.

"Very rich soils contain from .5 per cent to 1 per cent of nitrogen; good, fertile soils possess on an average from .15 per cent to .25 per cent.

"Nitrogen is essentially the fertilizer for cereals, especially when associated with phosphoric acid. An excess of nitrogen, however, promotes a rank growth of straw."

#### NORTH-WEST TERRITORIES.

The samples Nos. 1, 2 and 3, were forwarded by Messrs. Osler, Hammond and Nanton, of Winnipeg, Manitoba, who furnish the following information regarding their character:

Speaking of No. 1, they say, "This soil exists in large quantities along the line of railway between Qu'Appelle River and Saskatoon, and is found as a layer between the surface and subsoil, which latter is clay. Wherever this layer is found the grass is thin and rank, and the general appearance of the soil is cold and barren." Locally, the soil is classed alkaline.

Respecting soils Nos. 2 and 3, they quote from a letter written by Mr. Dodd, their inspector, as follows: The sample No. 2 "was taken from the bench west of the arm at Chamberlain (Tp. 22, R. 26, W. 2). There were about 6 inches of surface soil, and 2½ feet of this stuff, perfectly dry. Below this 2½ foot layer was good, sweet clay, and moist. I am satisfied the whole trouble with the land is in this layer. Sample No. 3 is from corner of 2 and 3, 35, 34, Tp. 29, R. 24, W. 2. I fancy it is stronger than the other."

These soils, which from their position must be regarded as subsoils, have in many respects similar characteristics. Air dried, they are almost white, of a very fine texture, and powder easily. They are, essentially, calcareous clays. A mechanical separation of No. 1 proved it to contain but little true sand, though the treatment served to distinguish between fine clay and small agglutinated masses of clay formed by the cementing action of the carbonate of lime present. Nos. 2 and 3 possess fair proportions of sand.

Considered chemically, the following inferences may be made. In potash, while No. 1 is somewhat below the average of good soils, Nos. 2 and 3 contain amounts equal to those in soils of great fertility. The phosphoric acid in all is low, but many soils of an equally small percentage have borne abundant crops. As might be expected in a subsoil, the percentage of nitrogen is not high, though in this

Experimental Farms.

Number.	Soil.	Locality.	Water.	Organic and Volatile Matter.	Clay and Sand.	Oxide of Iron and Alumina.	Lime.	Magnesia.	Potash.	Soda.	Phosphoric Acid.	Soluble Silica.	Carbonic Acid (undetermined).	Total.	Nitrogen.	Clay.	Sand.
1	Subsoil	Between Qu'Appelle and Saskatoon, N. W. T.	3.11	6.32	54.96	9.52	14.34	.57	.10	.45	.10	.10	10.40	100.00	.128	.....	.....
2	"	Tp. 22, R. 26, W. 2.	3.12	6.23	60.44	6.69	11.90	2.74	.47	.10	.12	.10	8.09	100.00	.120	33.19	27.25
3	"	2 and 3, 34, 35, Tp. 29, R. 24, W. 2.	3.67	8.25	44.55	4.97	19.29	4.24	.44	.11	.11	.09	14.28	100.00	.092	32.83	11.72
4	"	Chilliwack, B.C.	1.74	6.66	71.52	14.32	1.49	2.61	.15	.54	.13	.19	.65	100.00	.128	69.58	1.94
5	Surface	Squamish Valley, B.C.	1.50	3.33	81.98	8.59	1.66	1.62	.38	.33	.20	.21	.20	100.00	.087	37.56	44.42
6	"	Alberni	5.31	10.22	53.46	26.45	1.08	2.78	.31	.12	.08	.72	.....	100.53	.120	53.46	.....
7	"	First Bench, Exp. Farm, Agassiz, B.C.	3.15	6.65	77.86	9.67	.84	1.19	.31	.14	.23	.07	.....	100.11	.154	28.46	49.40
8	"	Second "	2.34	4.24	79.42	10.89	.77	1.12	.34	.15	.13	.19	.41	100.00	.099	41.21	38.21
9	"	Orchard	3.42	6.69	74.97	11.08	.93	1.52	.38	.15	.18	.20	.48	100.00	.149	40.53	34.44
10	"	"	3.24	6.96	75.14	10.83	.94	1.48	.33	.17	.25	.20	.46	100.00	.148	38.79	36.35
11	"	Lot 28, Con. 1, Tp. Perry, Muskoka, Ont.	5.33	8.90	78.91	6.13	.08	.14	.04	.....	.17	.05	.25	100.00	.280	20.50	58.41
12	Subsoil	"	3.75	4.91	84.19	6.28	.13	.26	.06	.....	.17	.07	.18	100.00	.114	28.52	55.67
13	Surface	St. Clet, P. Quebec	3.25	7.51	77.65	9.32	.45	1.07	.37	.....	.32	.22	.....	100.16	.191	17.73	59.92
14	Subsoil	"	3.66	3.53	76.61	12.47	.70	1.79	.45	.....	.29	.27	.23	100.00	.047	10.54	65.07
15	Surface	St. Ignace du Nonniquue, P. Quebec	3.22	5.58	79.00	8.84	1.19	1.11	.11	.44	.18	.02	.31	100.00	.174	69.97	9.03
16	Subsoil	"	3.21	5.44	79.39	8.26	1.13	1.48	.10	.46	.18	.01	.34	100.00	.166	71.50	7.85

constituent they compare very favourably with ordinary subsoils. It is to be especially noted that they contain a high percentage of carbonate of lime.

For subsoils, therefore, they cannot be considered deficient in the essential elements of plant food.

A careful examination was then made for the presence of any deleterious alkali. The following are our results:—

	No. 1.	No. 2.	No. 3.
Total water-soluble content. ....	·307	·072	·167
which on analysis was found to contain			
Soda ( $\text{Na}_2\text{O}$ ) .. .. .	·04	—	trace
Potash ( $\text{K}_2\text{O}$ ) .. .. .	·01	trace	—
Lime ( $\text{CaO}$ ) .. .. .	trace	“	trace
Magnesia ( $\text{MgO}$ ) .. .. .	“	“	“
Sulphuric acid ( $\text{SO}_3$ ) .. .. .	·03	none	none

It is very evident from the above results that these are not alkaline soils, since the amounts of alkaline salts here found are well within the limits of those in good, arable soils. I conclude, therefore, that these soils do not contain any compound deleterious to vegetation.

It has already been mentioned that tilth or mechanical texture of soils is an important factor in soil fertility. From the nature of these samples, I am led to believe that the apparent barrenness is due to physical rather than to chemical causes. Calcareous soils, such as these, are extremely absorbent. Though they are capable of holding a considerable amount of water, they yield this water with difficulty to the roots of growing crops. It is also a characteristic of this class of soils that they generally appear dry, in spite of the fact that they may contain a very fair percentage of moisture.

These soils are from districts which enjoy a very limited rainfall; it is therefore possible that their barrenness may be in part, if not wholly, due to the absorption and retention of much of this small quantity of rain.

If the overlying surface soil is sufficiently deep and fairly rich in nitrogen, and the climatic conditions (rainfall, &c.) are favourable, there would appear to be no reason why remunerative crops could not be raised upon these soils. The alleged barrenness points to a too shallow or too poor surface soil, to an unsuitable tilth or an insufficient rainfall or other unfavourable climatic condition.

#### BRITISH COLUMBIA.

No. 4.—Soil from Chilliwack, B.C. This consisted of samples of the upper and lower layers of the surface soil and of the subsoil. It is reported by Mr. Chapman of Chilliwack, who forwarded the samples, that they are representative of an area of about 4,000 acres, all taken up with homesteads of 160 acres each. The tract lies between the mountain range and the Fraser River. Numerous streams flow from the mountain. These, on reaching the base, have no regular channels, and in consequence spread over the surface of the land, finally collecting into a sluggish stream which flows into the Fraser River. Mr. Chapman writes that a drainage scheme is now in progress to reclaim this large area of land. He reports that good yields of the cereals are obtained, though there is a tendency to lodge. Roots and vegetables also, with a few exceptions, do very well.

The specimens of the upper and lower layers of the surface soil—which varies in depth from 2 feet to 4 feet—are peaty in character, reducing easily in the air-dried condition to a deep brown powder. They were submitted to a partial analysis, with the following results:—

# Experimental Farms.

## ANALYSIS of Air-dried Surface Soil.

Constituents.	Upper layer.	Lower layer.
Moisture .....	9·37	8·61
Organic and volatile matter.....	79·14	80·57
Insoluble residue, clay and sand .....	4·54	3·66
Mineral matter soluble in acid.....	6·95	7·16
	100·00	100·00
Nitrogen, in organic matter.....	3·51	3·51

The surface soil is therefore exceedingly rich in organic matter and nitrogen. With a proper admixture of sand and clay, a soil would result, that in tilth and fertility would equal the most productive lands of the Dominion. Good drainage, a certain mixture of the subsoil and an occasional application of wood ashes and lime or marl, are all that is necessary to ensure abundant crops, providing that climatic influences are favourable.

The subsoil (No. 4) is heavy clay, possessing very little sand. Its potash and phosphoric acid are in fair amounts. For a subsoil, its nitrogen may be termed high. In lime it is somewhat deficient. A peculiarity to be noted is the large percentage of oxide of iron and alumina it contains.

No. 5 is a surface soil from the Squamish Valley in the district of New Westminster. "The valley is said to have an area of 14,000 acres. The only drainage at present is the natural one by rivers and creeks. The surface soil has an average depth of fifteen inches, the sample for analysis being representative of the first six inches. The underlying subsoil is of clay, though occasionally running into sand."

Though fairly rich in mineral constituents this soil is poor in humus and nitrogen. To improve it chemically and physically, heavy dressings of barnyard manure are necessary. An alternate method, and perhaps under the circumstances a more economical one, would be to turn under some green crop, preferably, clover or pease, which should be ploughed in while the plants are in flower. Such a treatment would not only add nitrogen in an available form, but improve the tilth and absorbent character of the soil.

No. 6 is a specimen of surface soil from Alberni, Island of Vancouver. The sample represents the soil to a depth of ten inches from an approximate area of 10,000 acres. The depth of the surface soil varies from a few inches to about four feet. The subsoil is variable, sometimes clay, sometimes sand and gravel. The soil is of a deep red colour, due to the presence of a large percentage of oxide of iron. It is essentially clay.

From the analysis I judge it to be a soil of fair quality. Of the important constituents, it is rich in potash—which might be expected from its origin—poor in phosphoric acid and of medium richness as regards nitrogen. To improve it in this latter respect, liberal application of barnyard manure or the turning under of several crops of growing clover or pease would be advantageous. Nitrate of soda or sulphate of ammonia applied in the spring would also give excellent results. Since these latter fertilizers are costly, their economic use can only be determined after several years of trial with varying quantities. It is always the safest practice, before applying more extensively these concentrated fertilizers, to ascertain on small areas the amount that gives the best results. Fish waste is also to be highly recommended as a valuable manure for these soils.

To furnish phosphoric acid, superphosphate of lime or ground bones may be used. The former gives more immediate results, while the effect of the latter is more lasting in the soil.

The addition of composted muck, if such is procurable, is to be recommended for improvement of tilth and enrichment of the soil in plant food.

Numbers 7, 8, 9 and 10 are samples of surface soil from the Experimental Farm at Agassiz. Like the other British Columbia soils examined, they may be classed as of medium quality. In tilth they are rather light, though possessing a fair amount of clay. In potash they are all slightly above the average. With the exception of No. 8 (from the second bench), they are very similar as regards nitrogen and phosphoric acid, containing what may be regarded as amounts equal to those in average fertile soils. The data prove the soil from the first bench (No. 7) to be a little richer in nitrogen than the others. Nos. 9 and 10, from the valley, are almost identical in all essential particulars. All these samples are to be considered as somewhat deficient in lime, one per cent being the lowest limit placed by many authorities for the best results.

#### PROVINCE OF ONTARIO.

Nos. 11 and 12 are surface soil and subsoil from the district of Parry Sound, and constitute members in a series of soils from Muskoka that are being examined in our laboratories.

The results of the analyses of the first five samples in the series are detailed in my report for 1891. These soils were obtained with great care by Mr. G. S. Wilgress, B.A., Barrister at Huntsville, who assures me that they are thoroughly representative of the districts from which they were obtained.

The specimens were procured from Lot 28, Concession 1, Township Perry. "The surface of the land is level or gently sloping, there being no rocky bluffs. The soil is somewhat stony and light in character, producing before cultivation much excellent hardwood, *e. g.*, maple, beech, birch and ironwood. The field from which the samples were taken was in summer fallow. It had never been manured, but had grown a splendid crop of oats the year before."

Both surface soil and subsoil are light in character, sand predominating. In this respect they are similar to the Muskoka soils already reported upon. As regards the important and valuable constituent, nitrogen, the surface soil is considerably above the average (.280 per cent), while the subsoil contains a very fair percentage. In potash, they are very low. In phosphoric acid they are close to the average found in soils of this character. In lime they are particularly deficient.

In favourable seasons, when the rainfall is ample, this soil will undoubtedly yield good crops, though somewhat too light for the best results with cereals. An admixture with clay, if such is possible, and the occasional ploughing under of a green crop, would, I consider, prove of much benefit. It is a warm soil and one that would respond readily to manures; at the same time it is one that would leach easily (more especially as the subsoil is sandy), and therefore requires frequent applications of manure rather than larger quantities at longer intervals. To supply potash and lime, wood ashes and marl are to be recommended. For fruit trees and root crops, such an application will be found of great benefit.

#### PROVINCE OF QUEBEC.

The soil and subsoil Nos. 13 and 14 are from St. Clet, Soulanges. The surface soil is a dark gray sandy loam. It is somewhat lighter in character than betokens the best tilth. It is a warm soil, permeable to water and air, and, though a *responsive* soil, is one that easily leaches. In all the essential elements of plant food this soil may be placed with those of ordinary fertility.

To increase its percentage of nitrogen and at the same time improve its tilth, the ploughing under of green crops (as before recommended) is advisable. When applying farmyard manure to soils of this character, it is usually a good practice to spread the well rotted manure immediately before the spring ploughing. A dressing of marl, plaster or lime would prove of benefit to most crops grown on this soil, as the latter is somewhat deficient in calcareous matter.

Samples Nos. 15 and 16 are from St. Ignace du Nominique, Ottawa Co., and represent the character of much of the soil and subsoil on the Lièvre River. Very

## Experimental Farms.

little difference, either chemically or physically, is to be noticed between the surface and the underlying soil. They are clay loams, of a gray colour and somewhat heavy in texture. To mellow the surface soil (No. 15) drainage is necessary; by this means the tilth would be much improved. It is a retentive and strong soil, being more especially adapted to the growth of cereals. Respecting its elements of plant food, it may be regarded as of average fertility, though in potash the percentage is low. Marl, muck and wood ashes are natural fertilizers the application of which would yield good returns. Barnyard manure, which might be ploughed under green, in addition to thorough drainage, would make this an excellent soil.

### ALKALINE SOILS.

The investigation into the character of these soils with a view to their amelioration was commenced nearly two years ago. In our report for 1891 analyses are to be found of three specimens of soils impregnated with "alkali." The data showed that sulphate of magnesium (Epsom salts), and not sulphate or carbonate of sodium (the usual forms of alkali), was in all probability the cause of the barrenness of the soil. The following suggestions were then made for the improvement of these soils:—

"As the alkali is soluble in water, a thorough drainage system should be resorted to wherever practicable. I am firmly of the belief that this would be the most efficacious method of getting rid of the poisonous material. Deep ploughing should be practised. Thorough tillage prevents surface evaporation and the accumulation of alkali near the surface. A heavy dressing of barnyard manure, animal refuse or other highly nitrogenous organic matter, is said by many to materially improve these alkali patches, inducing a vigorous growth. Again, by others gypsum is strongly recommended. Where the alkali is carbonate of soda, gypsum is beneficial in converting this caustic salt into one less deleterious to vegetation."

Since that date further analyses of alkaline soils have been made. Laboratory experiments also have been instituted which had for their object the rendering inert to vegetation the corrosive or poisonous material in the soil. The results obtained by the analyses of four samples during the past year are as follows:—

#### ANALYSIS of Water-soluble Contents of Air-dried Alkaline Soils.

Locality.	Total water-soluble contents, dried at 110° C.	Soda (Na <sub>2</sub> O).	Potash (K <sub>2</sub> O).	Lime.	Magnesia.	Sulphuric acid (SO <sub>3</sub> ).	Chlorine.	Total Nitrogen in soil.
Near Oak Point, Manitoba.....	24·010	6·29	.....	·27	2·42	10·66	2·42	·245
"                  "          .....	2·263	·512	.....	·13	·31	·56	·62	·441
Near Binscarth                  .....	5·355	1·55	·01	·38	·32	3·00	·06	·558
From a few miles north of Brandon	4·855	·38	·02	·53	·97	2·64	·27	·660

The theoretical combination of these constituents may be stated as follows:—

#### No. 1.—Near Oak Point—

	Per cent.
Magnesium sulphate (Epsom salts).....	14·88
Sodium sulphate (Glauber's salt).....	9·65
"    chloride (common salt).....	3·93
Calcium sulphate (gypsum).....	·83

#### No. 2.—Near Oak Point—

Magnesium sulphate (Epsom salts).....	1·72
"    chloride.....	·15
Sodium chloride.....	·94
Calcium carbonate (carbonate of lime).....	·23



## No. 3.—Near Binscarth—

Magnesium sulphate (Epsom salts).....	1·97
Sodium sulphate (Glauber's salt).....	3·46
“ chloride (common salt).....	·07
Potassium chloride.....	·01
Calcium sulphate (gypsum).....	·89
Calcium carbonate.....	·15

## No. 4.—From North of Brandon—

Magnesium sulphate (Epsom salts).....	5·96
Sodium sulphate (Glauber's salt).....	·355
“ chloride.....	·42
Potassium chloride.....	·03
Calcium sulphate (gypsum).....	1·07
“ carbonate.....	·325

It is to be inferred from the foregoing that not only the total amount, but also the composition of the alkali in the soils, is extremely variable. Though in all the the four specimens, magnesium sulphate is present in large amounts, and notably so in Nos. 1 and 4, sodium sulphate (also deleterious to vegetation) exists in considerable percentages in Nos. 1 and 3. The proportion of magnesium sulphate to sodium sulphate and other soluble alkali is by no means constant.

These soils were of the deep black type, so well known in Manitoba, and contained large percentages of the valuable element, nitrogen. They would undoubtedly prove exceedingly fertile if freed from alkali.

In 1892 several series of pot experiments were carried on with wheat, pease and Indian corn in soils impregnated (*a*) with magnesium sulphate, (*b*) with magnesium sulphate mixed with carbonate of lime (chalk), and (*c*) with magnesium sulphate and lime. Many of the results obtained, together with illustrations showing the growth of the plants under these circumstances, are to be found in my evidence before the “Select Standing Committee of the House of Commons on Agriculture and Colonization” for 1893. It will therefore only be necessary here to give a summary of the conclusions then reached.

In soils to which 5 per cent of magnesium sulphate (Epsom salts) had been added, the germination of the seeds was always greatly retarded. Many of the seeds sown never produced plants that appeared above the surface of the ground, while those which came up lacked robustness, made but little growth and then died. All the experiments proved that magnesium sulphate to the extent of 5 per cent in the soil is most disastrous to plant life.

In another series, sufficient carbonate of lime, in the form of powdered chalk, was mixed with the soil to theoretically convert after the lapse of time the 5 per cent of magnesium sulphate into an inert and insoluble compound. In these pots germination was also delayed, though not so long as in the former series, and a greater percentage of plants grew, though their development was not equal in vigour or luxuriance to those in the potting soil. To a certain extent carbonate of lime had counteracted the deleterious effects of the magnesium sulphate.

Further experiments were then commenced in which lime was substituted for carbonate of lime in the soil containing the 5 per cent of magnesium sulphate. The reaction of the lime in rendering the magnesium salt insoluble would be quicker, and better results were therefore expected, than in the foregoing series. This prediction proved correct. Though germination was somewhat retarded, a greater percentage of plants grew and attained a larger and healthier growth than in the soil containing the antidote, carbonate of lime. It was evident that the lime proved the more efficacious of the two.

This latter series of experiments has been repeated this year, and the results are now given in graphic form. They are in accord with those of last year and show quite distinctly that soils containing magnesium sulphate as the only form of alkali may be effectually treated by a dressing of lime. The growth of the wheat, pease and Indian corn plants under the several circumstances of the experiments is well depicted on the accompanying diagrams.

The experiments began May 28th and ended July 28th, 1893.

## Experimental Farms.

### DIAGRAM SHOWING AVERAGE GROWTH OF WHEAT PLANTS

Continuous line—Plants in potting soil.

Broken line—Plants in soil + 5 %  $\text{MgSO}_4$  + excess of  $\text{CaO}$ .

Dotted line—Plants in soil + 5 %  $\text{MgSO}_4$ .

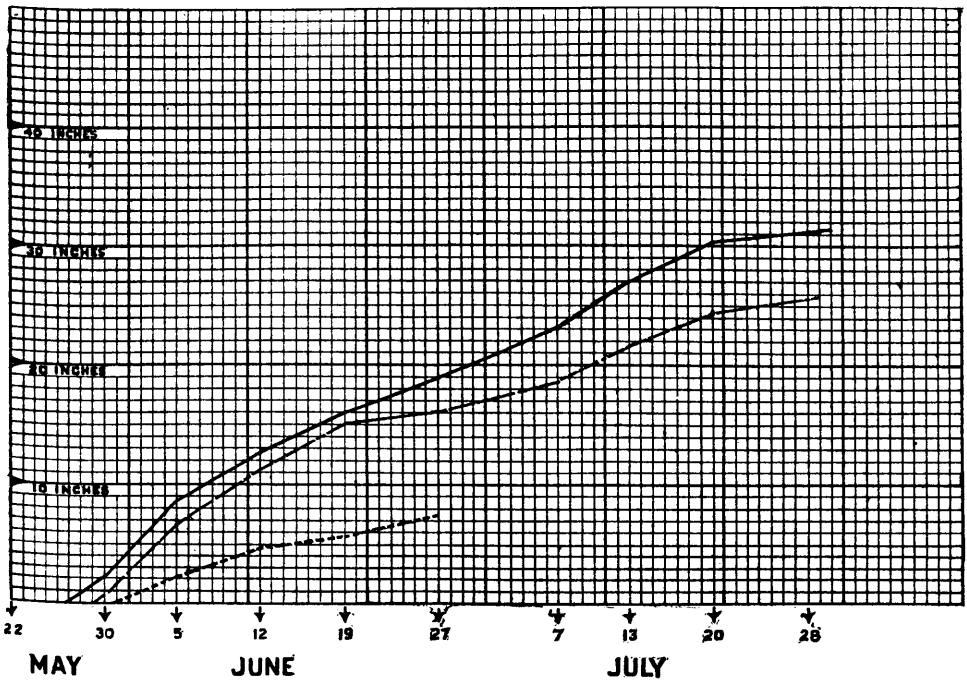

WHEAT.—Seed planted May 22nd. Experiment ended July 28th.

The average growth of the wheat plants at the close of the experiments (as denoted by the heights attained) in potting soil was 31 inches.

In the pots containing the 5 per cent of magnesium sulphate, it was  $7\frac{1}{2}$  inches on June 27th, when the plants died.

In the soil containing the lime in addition to the magnesium sulphate the growth was  $25\frac{1}{2}$  inches when the final measurements were made.

## DIAGRAM SHOWING AVERAGE GROWTH OF INDIAN CORN PLANTS.

Continuous line—Plants in potting soil.

Broken line—Plants in soil + 5 %  $MgSO_4$  + excess of  $CaO$ .

Dotted line—Plants in soil + 5 %  $MgSO_4$ .

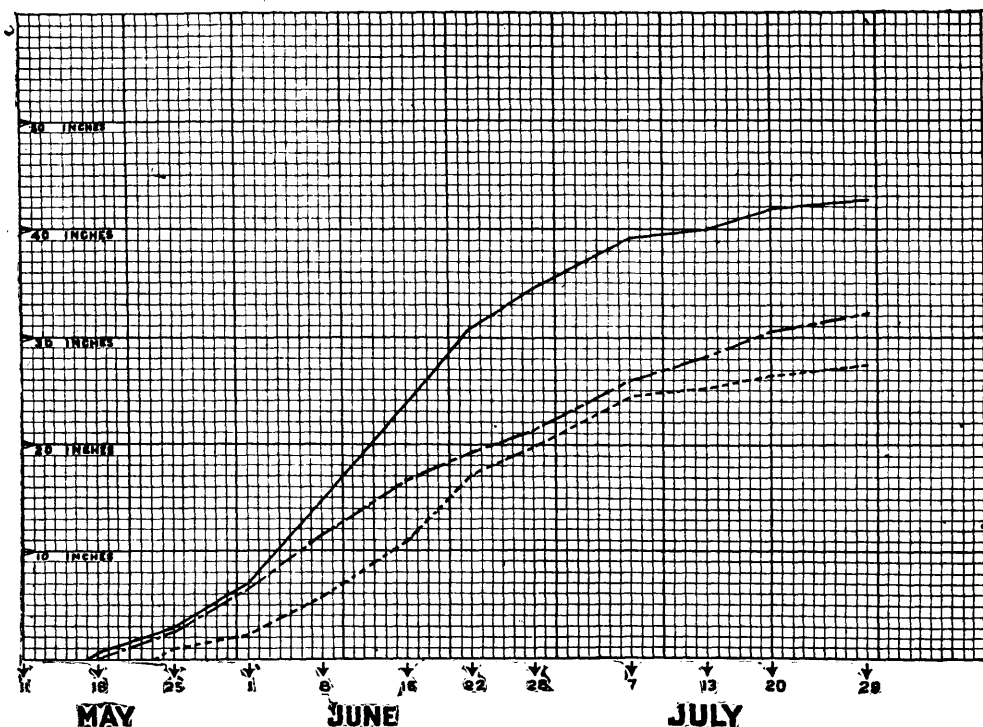

INDIAN CORN.—Seed planted May 11th. Experiment ended July 29th.

The average growth as indicated by the heights of the plants is as follows:

In good potting soil,  $42\frac{1}{2}$  inches.

In soil containing 5 per cent of magnesium sulphate,  $27\frac{1}{2}$  inches.

In the soil containing both the magnesium sulphate and lime, 32 inches.

## Experimental Farms.

DIAGRAM SHOWING AVERAGE GROWTH OF PEA PLANTS.

Continuous line—Plants in potting soil.

Broken line—Plants in soil + 5 %  $MgSO_4$  + excess of  $CaO$ .

Dotted line—Plants in soil + 5%  $MgSO_4$ .

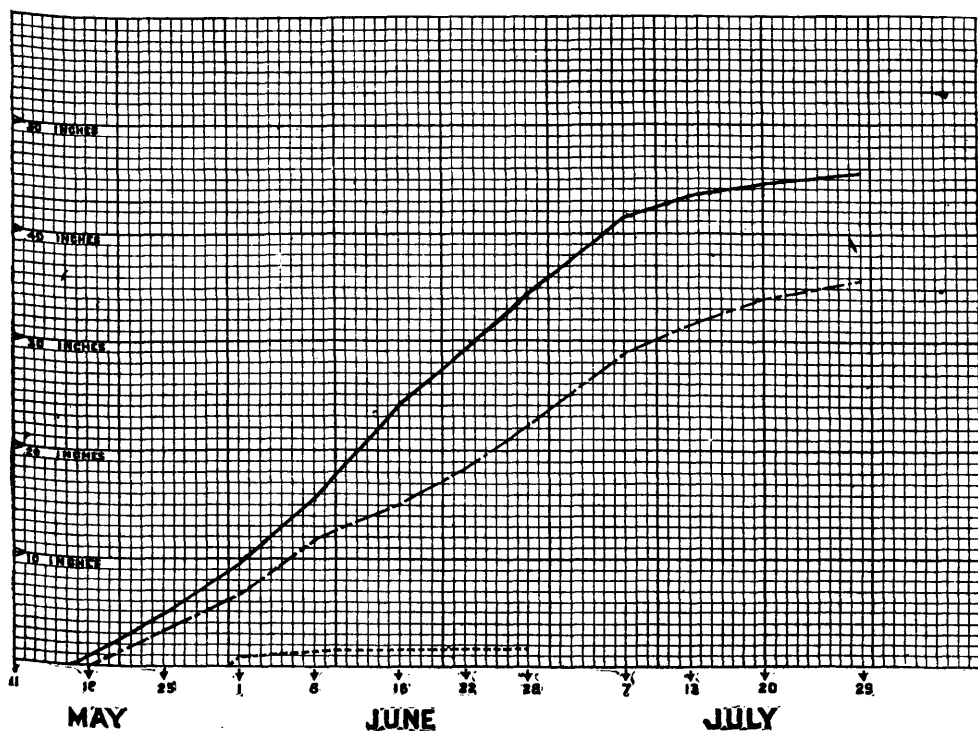

PEASE.—Seed planted May 11th. Experiment ended July 29th.

The average growth in potting soil was  $45\frac{1}{2}$  inches at the close of the experiment.

In the soil containing 5 per cent of magnesium sulphate  $1\frac{1}{2}$  inches only on May 28th, when the plant died.

In the soil containing both magnesium sulphate and lime the average height was  $35\frac{1}{2}$  inches.

The reaction between the magnesium sulphate and the lime would naturally proceed with time, and succeeding seasons would no doubt show better and better results on this treated soil. It would appear, therefore, that soils barren from the presence of this salt, may by the simple method of treatment with lime here suggested, be brought into a state of fertility.

Where a large portion of the saline matter is sodium sulphate, the treatment with lime would first result in the formation of corrosive soda and then of sodium carbonate. This would finally be converted into sodium sulphate. Although much slower in its action, carbonate of lime would here prove beneficial, since it would render the magnesium salt insoluble without reacting upon the sodium compound. An application of a mixture of gypsum and lime in such a case might also be of benefit—the former having the tendency to keep the sodium salt as sulphate—the latter converting the magnesium salt into an insoluble form. This treatment should be carried out in conjunction with drainage, which must always be resorted to wherever practicable. For soils impregnated with alkali in which sodium sulphate largely predominates, drainage, deep ploughing, thorough cultivation and high manuring are the only remedies that can now be recommended with confidence.

## MUCK, LEAF-MOULD, PEAT.

Of all the constituents of plant food taken from the soil by growing crops, there are but three that it is generally necessary to return, viz., nitrogen, phosphoric acid and potash, and repeated experiments the world over have proved that the fertility of the farm soil can only be maintained by such a return. Without it the land becomes, by successive croppings, less and less productive.

Where mixed farming is in vogue, ordinary well preserved barnyard manure is no doubt the most economical form in which to supply these elements, since by this means nearly 80 per cent of the plant food taken from the soil is replaced. From various causes, however, it often occurs that the supply is inadequate and must be supplemented from outside sources. Leaving out of consideration for the present the question of phosphoric acid and potash, we may discuss briefly the sources from which available nitrogen may be obtained, other than that already mentioned. These fall into three classes :

1. **ARTIFICIAL FERTILIZERS**, such as nitrate of soda and sulphate of ammonia. These present nitrogen to the rootlets of plants in an exceedingly soluble form. They are, moreover, concentrated fertilizers, since weight for weight they possess a much larger proportion of this element than other nitrogenous manures. Their cost, however, mitigates against their general use and necessitates, for their economical application, a considerable amount of skill and experimenting on the part of the farmer.

2. **GREEN MANURES**.—This method consists in ploughing under a growing crop, preferably of clover, pease or some other of the leguminous plants. These plants are known as nitrogen-collectors in contradistinction to others which are nitrogen-consumers. They are able to appropriate and assimilate nitrogen from the atmosphere, which when the plants are turned in is preserved in the soil for the growth of succeeding crops. For light sandy soils, poor in organic matter and nitrogen, this method of manuring can be highly recommended. It is economical, since it is both cheap and effective, improving the tilth and adding to the store of fertility.

3. **MUCK, LEAF-MOULD AND PEAT**. These consist largely of semi-decomposed vegetable matter and contain a considerable, though variable, amount of nitrogen. This nitrogen is not so readily available as in the two classes of nitrogenous manures we have just considered, but by fermentation of the material it may be converted into assimilable forms. The value of a muck or similar material depends chiefly therefore on its percentage of nitrogen. By a suitable treatment of the air-dried muck or peat, many farmers of Canada may obtain at little cost a manure not only rich in the valuable element nitrogen, but also containing notable quantities of other plant food constituents. All fertile soils possess high percentages of organic matter. This,

## Experimental Farms.

besides yielding nitrogen, liberates in the soil by its decomposition carbonic acid. This latter undoubtedly exerts a beneficial action in setting free mineral plant food. It is therefore apparent that green manuring or an application of composted muck serves many useful purposes in the soil. Besides acting chemically, such materials serve to mellow heavy soils by rendering them porous and permeable to the air, while sandy and light soils have their retentive and absorbent qualities increased. We may briefly discuss the different ways in which muck and peat may be treated before being applied to the land.

The air-dried substance is extremely absorbent and capable of soaking up and retaining large quantities of liquid manure. Its use for bedding stock and for spreading in the barnyard is therefore apparent. By a plentiful application, much valuable fertilizing material that would otherwise go to waste is saved. The stable manure not only has its good qualities preserved, but by the ensuing fermentation the nitrogen of the muck is rendered available. When it is properly preserved and fermented, there results a quick acting and forcing manure.

Without its previous use as an absorbent, the air-dried muck may be composted. Alternate layers of say 6 inches of barnyard manure and muck make an excellent compost. The whole should be kept moist, though not too wet, and the heap occasionally forked over. If sufficient manure is not obtainable, wood ashes and lime may be substituted. Such a compost would be poorer in nitrogen, but richer in potash than the one just described. To the compost heap should be added all bones, carcasses of dead animals and garbage that accrue on the farm. A compost heap not only serves to keep clean and healthy the surroundings of the farmhouse and buildings, but preserves as in a bank from which withdrawals can easily be made and in which good interest is given, much plant food that would otherwise go to waste. Every farm should have a compost heap, conveniently located. If there is not a deposit of muck in the neighbourhood which can be drawn from, the best soil obtainable should be used. Our table shows the composition of 34 different samples of muck, from all parts of Canada, examined during the past year. They vary much in quality, their value as a rule being dependent upon the amount of nitrogen contained; the condition of decay is also an important factor when considering their availability.

## ANALYSES OF MUCKS (air-dried), 1893.

Number.	Nature of Material.	Locality.	Sender.	Nitrogen.	Organic and Volatile Matter.	Sand and Clay.	Mineral Matter soluble in Acid.	Water.	Pounds of Nitrogen in one ton of the air-dried material.
1	Swampmuck.	Summerside . . . P. E. I.	W. T. Hunt. . . . .	1 280	52 58	24 05	13 68	9 69	25 6
2	"	Montague Bridge "	Geo. D. Campbell.	3 077	71 91	12 83	5 22	10 03	61 5
3	"	Baldwin's Road. "	Micipsa Moar. . . . .	2 135	72 88	6 02	10 27	10 83	42 7
4	"	" " " "	" " " "	2 135	77 48	8 52	4 95	9 05	42 7
5	"	" " " "	" " " "	2 145	60 92	24 26	7 09	7 73	42 9
6	"	Murray Harbour, South. . . . .	" " " "	" " " "	" " " "	" " " "	" " " "	" " " "	" " " "
7	"	Summerside . . . . .	A. D. McDonald. . . . .	2 355	61 33	23 25	6 39	9 03	47 1
8	"	" " " "	H. E. Wright. . . . .	1 096	33 63	44 04	15 83	6 48	21 9
9	"	" " " "	" " " "	2 143	58 88	15 43	14 26	11 43	42 8
10	"	Kildare, lot 4. " "	Thos. Cahill. . . . .	1 170	54 49	9 41	3 76	32 34	23 4
11	"	Sturgeon, King's Co. . . . .	" " " "	1 079	68 26	12 60	2 75	16 39	21 6
12	"	Braedalbane " "	John Jamieson. . . . .	559	68 33	81	1 25	29 61	11 1
13	"	Grove's Point. . . N.S.	A. Matheson. . . . .	968	32 46	48 69	10 30	8 55	19 3
14	"	" " " "	J. W. Edwards. . . . .	1 820	78 99	1 49	6 67	12 85	36 4
15	"	" " " "	" " " "	1 410	38 40	42 98	12 39	6 23	28 2
16	"	" " " "	" " " "	153	5 87	79 95	12 95	1 23	3 1
17	"	Amherst. " "	Geo. Freeman. . . . .	1 683	81 59	2 69	7 68	8 04	33 6
18	"	Little Bras d'Or, C.B. " "	Abner Rice. . . . .	692	31 26	47 90	7 46	13 38	13 8
19	"	Harrisville. . . . N.B.	Eli Harris. . . . .	1 215	65 03	1 50	14 83	18 64	24 3
20	"	St. John. " "	A. C. Fairweather. . . . .	1 680	44 17	40 13	7 24	8 46	33 6
21	"	Norton Station. " "	W. H. Baxter. . . . .	1 181	78 66	11 89	5 43	4 02	23 6
22	"	Shediac. " "	Jas. Mugridge. . . . .	2 151	69 30	10 28	10 36	10 06	43 0
23	"	Rockville. " "	Percy G. Mills. . . . .	1 808	61 62	15 71	16 18	5 99	36 1
24	"	Hampton. " "	Wm. McQuarrie. . . . .	1 570	65 97	3 67	11 46	18 90	31 4
25	"	Bishop's Crossing, Que.	O. M. Bishop. . . . .	1 745	77 04	1 93	9 47	11 56	34 9
26	"	Sutton. " "	L. E. Dyer. . . . .	1 975	59 83	10 41	9 33	20 43	39 5
27	"	Orono. " Ont.	F. L. Squair. . . . .	1 790	58 41	8 06	15 98	17 55	35 8
28	"	Newcastle. " "	W. H. Gibson. . . . .	2 000	72 93	2 29	13 47	11 31	40 0
29	"	" " " "	" " " "	1 845	62 95	6 53	22 06	8 46	36 9
30	"	Hazeldean. " "	Henry A. Allen. . . . .	1 141	26 12	48 78	11 04	14 06	22 8
31	"	Colborne. " "	J. K. Fuller. . . . .	2 261	59 61	12 13	12 99	15 72	45 2
32	"	" " " "	" " " "	2 280	64 34	6 84	12 94	15 83	45 6
33	"	Victoria. " B. C.	A. Mowat. . . . .	2 235	66 02	6 27	4 16	23 55	44 7
34	"	Chilliwack. " "	Jas. W. Chapman. . . . .	3 508	80 57	3 66	7 16	8 61	70 1
		" " " "	" " " "	3 510	79 14	4 54	6 95	9 37	70 2

The average number of pounds of nitrogen as found in the various provinces are as follows:—

	Lbs. per ton.
Prince Edward Island. . . . .	33 5
Nova Scotia. . . . .	28 0
New Brunswick. . . . .	32 0
Quebec. . . . .	37 2
Ontario. . . . .	37 7
British Columbia. . . . .	57 4
General average of all the provinces. . . . .	37 6

## "MUDS" FROM THE MARITIME PROVINCES.

The deposits formed by tides, or found in the beds of lakes and rivers are known as "muds." From their origin the latter might be designated silt. The composition of "muds" is extremely variable and dependent upon their origin. They consist largely of ground up rock matter, clay and sand, together with shells (more or

## Experimental Farms.

less broken up) and organic debris (the remains of plants and animals), in variable quantities. Frequently their chief value lies in the carbonate of lime they contain and which has been derived from shells—usually those of mussels or oysters. Some specimens possess notable percentages of nitrogen, phosphoric acid and potash. In organic matter and nitrogen, however, they never approach the richness of swamp muck.

These muds have been largely used in the Maritime Provinces as a fertilizer, and good results as a rule have followed the first applications. It has been the experience of many, however, that the beneficial effects are not lasting and that after a few years there is but little response from a repeated dressing when applied as the sole manure. This is not to be wondered at, since these muds are not complete fertilizers and cannot furnish all the plant food in the proportions required by farm crops. To a certain extent they supply the elements of fertility and also act on many soils as stimulants, but they must not be considered as concentrated manures, nor should they be used exclusively. As far as possible, they should be supplemented with more assimilable and stronger manures. Barnyard manure, superphosphate and wood ashes are probably the easiest to obtain and the cheapest for use with these muds.

The fine mechanical condition of many "muds" may have made them useful in improving the tilth of certain soils, but instances have come to my notice in which the tilth has been injured by an over application. For the improvement of such soils I would recommend the ploughing under of green crops, preferably clover or pease. This green manuring would not only mellow the soil, but would also enrich it in organic matter and nitrogen.

### ANALYSES of air-dried Muds.

Number.	Locality.	Forwarded by	Nitrogen.	Moisture.	Organic and Volatile Matter.	Insoluble residue (clay and sand.)	Residue soluble in Acid.
1	Tatamagouche, N. S.....	J. A. C. Campbell.....	·730	6·00	28·72	51·35	13·93
2	" .....	" .....	·304	2·85	11·44	68·35	17·36
3	Waterville, N. B.....	A. E. Plumer.....	·729	2·49	19·80	1·37	76·34
4	Mabou, N. S.....	H. Cameron, M. P.....	·014	·44	1·45	39·96	58·15
5	" .....	" .....	·020	·38	2·23	18·23	79·16

Nos. 1 and 3 contain very fair percentages of nitrogen. No. 2 is much of the nature of a good soil. The lake mud from Walkerville, N. B. (No. 3), consists largely of carbonate of lime, derived from shells. In all essential particulars it may be considered a marl. The samples from Mabou (Nos. 4 and 5) possess large percentages of carbonate of lime, but are poor in other constituents. They would only prove of service to soils requiring lime.

Complete analyses were made of river and mussel mud from Shediac, N. B. The data are as follows :—



## ANALYSES of "Muds."

Constituents.	River Mud.	Mussel Mud.
Moisture.....	2·23	1·72
Organic and volatile matter.....	13·18	10·52
Insoluble matter, sand and clay.....	67·68	37·51
Oxide of iron and alumina.....	12·59	9·08
Lime (CaO).....	·48	21·64
Magnesia (MgO).....	1·50	1·13
Potash (K <sub>2</sub> O).....	·23	·13
Soda (Na <sub>2</sub> O).....	1·28	1·70
Silica (SiO <sub>2</sub> ).....	·04	·07
Phosphoric acid (P <sub>2</sub> O <sub>5</sub> ).....	·14	·13
Carbonic acid, &c., undetermined.....	·65	16·37
	100·00	100·00
Nitrogen.....	·409	·294

As regards potash and phosphoric acid, neither of these specimens exceeds in richness ordinary fertile soils; in fact by reference to the table on page 131 in the present report, it will be seen that they possess amounts under, rather than above, the average found in representative virgin soils. In nitrogen, the river mud is fairly rich, the percentage equalling that found in the most fertile soils. To light, sandy soils that contain in the neighbourhood of .1 per cent nitrogen, this mud would act beneficially. The mussel mud possesses about two-thirds of the amount of nitrogen present in the river mud. The carbonate of lime, derived from the mussel shells, amounts to 38 per cent.

## WOOD-ASHES.

It may not be amiss to again call the attention of farmers to the fact that the percentage of soluble or available potash even in the most fertile soils, is extremely small, and further, that without rational treatment the successive growth of crops more or less depletes this store.

When the produce of the land is fed upon the farm, nearly 80 per cent of the plant food withdrawn from the soil by the crops is returned in the manure and thus fertility maintained. When, however, the produce is sold, and no concomitant return made, the effect of continuous croppings must be to leave the land poorer and more particularly so in its available nitrogen, phosphoric acid and potash. According to the degree to which this latter style of farming is indulged in, so must these fertilizers brought from outside sources be added to the soil.

Leaving out of consideration for the present barnyard manure and muck deposits—which do but return to the soil what has been more immediately taken from it—we may inquire from what outside, but Canadian sources, these valuable and necessary elements for plant nourishment can be obtained. Phosphoric acid for ages to come can be got from our apatite deposits, nitrogen is made available from the atmosphere through the agency of the leguminosæ (pease, clover, &c.) a comparatively rapid process, but of potash Canada has, as far as we know, no natural deposits save those which are stored in the trees of her forests.

In wood-ashes are the mineral or inorganic constituents which the trees by a slow, life-long process have taken from the soil—and chief among these is potash. As a special fertilizer for supplying potash, wood-ashes are of the greatest importance to the Canadian farmer. Nor should it be forgotten that they are also valuable for phosphoric acid, lime and other inorganic plant food, which they furnish in notable quantities.

The following analysis, made during the past year, of an excellent sample forwarded from Williamston, N. S., is now given. Analyses of fine-ashes and of the ashes of oat hulls have also been made and are here stated in tabular form, for the sake of comparison :

# Experimental Farms.

## ANALYSES OF ASHES.

Constituents.	Wood-ashes from Williamston.	Flue-ashes from Montreal.	Ashes from Oat hulls from Fergus, Ont.
Moisture.....	4.19	.19	1.06
Organic and volatile matter.....		2.22	6.14
Insoluble matter.....	4.48	65.04	84.62
Oxide of iron and alumina.....	.78	16.28	.40
Lime (CaO).....	36.40	7.51	1.02
Magnesia (MgO).....	4.40	1.76	.67
Potash (K <sub>2</sub> O).....	12.00	.19	3.59
Soda (Na <sub>2</sub> O).....	.93	.40	.57
Sulphuric acid (SO <sub>3</sub> ).....	.58	3.32	.15
Phosphoric acid (P <sub>2</sub> O <sub>5</sub> ).....	1.67	1.24	.60
Carbonic acid, &c.....	34.57	1.85	1.18
	100.00	100.00	100.00

Assigning the following values to the chief constituents: Potash, 6 cents per lb., and phosphoric acid, 5 cents per lb., the wood-ashes are worth \$16.07 per ton, the flue-ashes, \$1.24 per ton and the ashes from the oathulls, \$4.90 per ton.

**WOOD-ASHES.**—For orchards, vineyards and small fruit plantations, wood-ashes are of especial value, though at the same time they should be supplemented by a more complete manure. All leafy crops, *e. g.* cabbage, beet and potato, and leguminous plants, as the clover, pea and bean, require a liberal supply of potash and hence are much benefited by an application of wood-ashes.

They are also of much value in improving the tilth of light, sandy soils, cementing together the grains of sand and making the whole more retentive of moisture.

Wood-ashes have long been used to advantage for making a compost with muck or peat. The resulting manure is one that is exceedingly rich in available nitrogen and potash.

With these facts before us, I may be pardoned for again impressing upon our farmers and fruit growers the good returns resulting from the home use of Canadian wood-ashes, which is yet extremely limited, compared with the quantities exported. It is to be hoped that in the future their true value will be more and more recognized and appreciated throughout the Dominion.

**FLUE-ASHES.**—These were collected at the base of a flue from a furnace in which coal was burnt, and hence they may be considered as fine coal-ashes. They have an exceedingly low fertilizing value, the value of potash present being only 22 cents per ton of the ashes. Such material, however, serves a useful purpose in mellowing heavy clay soils.

**ASHES OF OAT HULLS.**—These were from a by product in the manufacture of oatmeal. As already stated, they have a considerable fertilizing value, though in this respect they are much inferior, weight for weight, to wood-ashes.

## GYPSUM.

A specimen from a mine on the Tobique River, N.S., was analysed, with the following result:—

### ANALYSIS OF GYPSUM.

Sulphate of lime (gypsum).....	68.65
Insoluble rock matter.....	15.85
Oxide of iron and alumina.....	3.91
Carbonate of lime.....	4.98
“           magnesia, &c., by difference.....	6.61
	<u>100.00</u>

Gypsum, in addition to supplying certain elements of plant food, is useful in liberating potash in the soil and absorbing or fixing ammonia.

Though not in any sense a complete fertilizer, an application on rich soils is followed by excellent results. For poor soils, its use must be supplemented by manures containing nitrogen, phosphoric acid and potash.

Gypsum has been found of special value for pease and clover. Since it sets potash free, it is also useful for turnips, Indian corn and many crops that require large quantities of this element.

Powdered gypsum when sprinkled in stable, cow-houses, &c., preserves much ammonia (valuable plant food) that would otherwise escape and be lost. Its use therefore for such a purpose is to be strongly recommended.

## LEGUMES.

Several members of the leguminosæ, to which the pea, bean and clover belong, have been analysed during the past year and their composition is now given. The plants of this order are characterized by a large percentage of albuminoids, and consequently as a rule make more valuable fodder than the grasses. It has been shown of late years by carefully conducted experiments that they procure a large proportion of their nitrogen (the essential element of the albuminoids) from the atmosphere, a property not possessed, as far as is known, by plants of other families. They have, therefore, been termed nitrogen-collectors, and must be looked upon as of special value, not only in furnishing rich and nutritious fodder, but also in keeping up the fertility of the soil. Green manuring with the legumes, *i.e.*, ploughing under a crop of clover or pease, preferably while in flower, is one of the cheapest and most effective methods of enriching and improving the soil. It increases the amount of organic matter and nitrogen, the latter becoming readily available for succeeding crops.

### ANALYSES of Legumes, 1893.

	HAY OR FRESH MATERIAL.						CALCULATED TO WATER-FREE SUBSTANCE.				
	Water.	Ash.	Protein (Albuminoids).	Fibre.	Nitrogen-free Extract (Carbohydrates).	Ether Extract (Fat).	Ash.	Protein (Albuminoids).	Fibre.	Nitrogen-free Extract (Carbohydrates).	Ether Extract (Fat).
<i>Lathyrus sylvestris</i> , Wagneri (green).	79.65	1.53	4.52	6.60	6.50	1.20	7.52	22.23	32.46	31.72	6.07
<i>Lathyrus venosus</i> (hay) . . . . .	7.11	7.37	14.06	32.47	34.10	4.89	7.93	15.13	34.95	36.72	5.27
<i>Astragalus Canadensis</i> (hay) . . . . .	9.46	6.02	10.75	33.45	38.78	1.54	6.66	11.87	36.95	42.79	1.73
<i>Melilotus alba</i> (hay) . . . . .	9.30	5.31	11.75	43.24	27.70	2.70	5.65	12.91	47.67	30.79	2.98
<i>Vicia Americana</i> (hay) . . . . .	7.01	7.99	13.87	34.33	35.58	1.22	8.59	14.92	36.90	38.28	1.31

The botanical data contained in the following notes have been kindly furnished by Mr. Jas. Fletcher, Botanist and Entomologist of the Experimental Farms.

### LATHYRUS SYLVESTRIS, Wagneri (Wagner's Wood Pea).

This is a fodder plant of recent introduction, and said to do well even on poor soils. It is a free growing, leafy pea, which in its second year of growth at the

## Experimental Farms.

Central Farm, Ottawa, produced a thick mass of leafy stems nearly four feet in height. It flowers profusely during June. It is extremely rich in albuminoids and is reported from England to be relished by the cattle, both in the green condition and as hay. For these reasons and also that it yields a very heavy crop per acre, it may become a valuable addition to our present list of fodders. Our own experience in feeding it is as yet extremely limited. It would appear that the cattle do not at first evince a fondness for it.

### LATHYRUS VENOSUS, Mühl.

A free growing, native, perennial pea, with abundance of leaves. Found on the western plains, from which the sample analysed was obtained. There appears to be no statement on record as to its value as a fodder, though judging from the analysis it is well worthy of trial.

### ASTRAGALUS CANADENSIS, L. (Canada Milk-vetch).

A stiff, free-growing, vetch-like plant, with abundant foliage and spikes of greenish yellow flowers. It occurs usually on river banks and sometimes attains a height of three feet. Flowering period, July. The sample analysed was sent by Wm. Tingey, Esq., Marieton, Assa., N.W.T., who stated that it was cut about two weeks after it had passed its prime. Probably a palatable and nutritive feed if cut while yet young, but no experience of it as a fodder is recorded, beyond that of Mr. Tingey to the effect that "cattle are particularly fond of it."

### MELILOTUS ALBA, Lam. (Bokhara Clover, White Melilot).

An introduced biennial. It is a tall, coarse plant, well known for its sweet odour. It occurs now in many waste places throughout Canada as a weed. It produces a large quantity of fodder, which when cut young is succulent and readily eaten by cattle.

### VICIA AMERICANA, Mühl.

A native, perennial vetch, with fine leaves. This sample was obtained on the western plains, where it is an important fodder. Judging from the analysis, it compares very well in feeding value with the preceding legumes.

---

## EXPERIMENTS WITH CARROTS.

It is well known that certain roots have the habit of growing out of the ground, developing to a large extent above the surface of the soil. This exposed portion is green, due to the development of chlorophyll by the action of sunlight. As this tendency is marked among certain varieties of root crops, more especially carrots, it became interesting to ascertain what difference, if any, as revealed by chemical analysis, existed between the lower, underground portion and that which was exposed.

To this end, four White Belgian carrots were selected, nearly half of each root being green, due to growth above ground. They were cut in two at the line of junction of the green and white portions. The weight of the parts were as follows:—

	Lbs.	Ozs.
Upper and green parts.....	2	10
Lower and white parts... ..	3	7
	6	17
Total weight of four roots.....	6	17

These were then submitted to analysis, with the following results:—

	Water.	Albuminoids.	Fat.	Nitrogen-free extract.	Fibre.	Ash.
Upper (green) portion .....	89·04	1·05	·41	7·54	1·11	·85
Lower (white) portion .....	90·70	·75	·21	6·65	·93	·76

The composition of the dry matter is given in the subjoined table.

	Albuminoids.	Fat.	Nitrogen-free extract.	Ash.
Upper (green) portion .....	9·60	3·72	68·81	7·70
Lower (white) do .....	7·97	2·31	71·51	8·17

These data show that in many particulars the composition of the exposed and underground parts is very similar, and that the differences, where such exist, are by no means large. The most notable of these are in the albuminoids and fat. The slightly higher percentage of the former, recorded as occurring in the exposed portion of the carrot, may probably be due to the presence of the green colouring matter (chlorophyll), which contains nitrogen as a constituent, or it may be owing to a development of soluble nitrogen compounds, whose function is to carry this important element from one part of the plant to another to be finally laid up as protein. Further experiments will be made to ascertain if this increase of nitrogen compounds is constant in the parts developed above ground, and also to find out the true character of such compounds. For the present, it will suffice to say that the apparent increased percentage does not in all probability represent any real or material increase in food value. The larger proportion of the constituent here designated as fat, found in the upper part of the root, is undoubtedly due to the presence of chlorophyll, which by the method of analysis is dissolved out and determined with the fat. This increase, therefore, has a fictitious and not a real value.

It may be concluded from the chemical data of the present experiments that no material difference in food value exists between the two portions. The questions of palatability and digestibility (since disagreeable and poisonous principles are sometimes developed in exposed roots), as well as the economic one of cost of culture and harvesting and weight of crop, are probably the most important to be considered in arriving at a conclusion as to the relative merits of those varieties of roots which grow above and below ground.

## Experimental Farms.

### THE BABCOCK TEST.

In June of this year, a bulletin (No. 13 of the Dairy series) was issued, in which I gave full instructions for working this test in the dairy, for single and composite samples—the latter by the use of potassium bichromate as a preservative. Information was also added, necessary for the calculation of the payments to patrons of creameries and cheese factories in which the percentage of fat in the milk has been adopted as a basis of remuneration.

Since that date, many questions have been received regarding the manipulation of the composite test. Chief among these have been those that referred to the maximum and minimum quantities of potassium bichromate that can be used without affecting the reading of the fat obtained. Several series of experiments were accordingly instituted to establish the limits between which this preservative can be employed with certainty, and also to ascertain the length of time a composite sample so treated may be kept without showing a diminution in its fat contents.

Composite samples were prepared in duplicate from the milk of a herd which, during the week that the samples were taken, gave the average of 3.40 per cent of butter-fat as the mean of the daily tests.

While preparing the composites (from Monday to Saturday) and until the test was concluded, the bottles were gently shaken every day to incorporate the risen cream and to prevent the latter from sticking to the sides of the bottle. The temperature of the samples throughout the test would average about 63°F.

#### EXPERIMENT A.

Date of composite samples, May 8th–15th, 1893.

Mathematical average of daily tests: 3.40 per cent fat.

Composite sample A. = 600 c.c. milk + .3 grms. potassium bichromate.

“ “ B. = 600 c.c. “ + .6 “ “

(Note. These quantities of potassium bichromate are equal to  $4\frac{1}{2}$  grains and 9 grains to the pint respectively.)

The percentage of fat was ascertained in these samples on the subjoined dates, with the following results:—

Date.	A. Fat, per cent.	B. Fat, per cent.
May 15th.....	3.4	3.4
“ 20th.....	3.4	3.4
“ 22nd.....	3.4	3.4
“ 27th.....	3.4	3.4
June 3rd.....	3.4	3.4
“ 10th.....	3.4	3.4
“ 17th.....	3.4	3.4

These tests were made with the usual quantity of acid and gave clear readings throughout.

It may fairly be concluded from these results that (1) any quantity of potassium bichromate between  $4\frac{1}{2}$  grains and 9 grains to the pint serves equally well in preserving the milk in a fluid condition without interfering with the accuracy of the Babcock test, and (2) that milk so treated, if kept carefully shaken and moderately cool, shows the same percentage of fat for at least one month.

## EXPERIMENT B.

A second series of composite tests was made during the week, May 15th to 22nd. The mathematical average of the daily tests of the samples going to make up the composites A and B was 3.05 per cent fat.

The series was carried on in duplicate:—

Composite sample A. = 600 c.c. milk + 1.2 grms. potassium bichromate.  
 " " B. = 600 c.c. " + 2.4 " " "

(This is equal to 18 grains and 36 grains to the pint, respectively.)

The fat readings are as follows:—

Date.	A. Fat, per cent.	B. Fat, per cent.
May 27th.....	3.0	2.95
June 3rd.....	3.1	3.00
" 10th.....	3.1	3.00
" 17th.....	3.0	3.00
" 24th.....	3.0	2.95
July 7th.....	3.0	2.90

After this last date the fat in both samples became slightly curdy and the percentage gradually lower. The samples were shaken daily and tests made every week until September 26th, when the respective readings were A. 2.20 per cent fat; B. 2.50 per cent fat. Both samples had curdled and were measured with difficulty.

For more than seven weeks the milk had retained its fluidity and yielded a correct percentage of fat, though the preservative had been increased to 36 grains to the pint.

## EXPERIMENT C.

A further series was then commenced in which composite sample A. had 36 grains potassium bichromate, and B. 72 grains potassium bichromate to the pint. The fat readings were made at intervals of one week from June 3rd to September 30th. The mathematical average of the percentages of fat, obtained from the daily tests of the samples making the composites, was 3.51.

The results were in accord with those obtained in Experiment B., viz., the percentage of fat *after a time* became gradually less. On September 9th, the fat in both samples read 3.1 per cent. It was further observed that, as the quantity of bichromate was increased, the volume of acid had to be slightly decreased in order to get clear readings. Towards the close of the test period, as the bichromate becomes reduced, however, the volume of acid must again be increased.

## EXPERIMENT D.

Date of composite sample, May 29th—June 3rd. Potassium bichromate to the amount of 230 grains to the pint was added. The percentage of fat, as obtained from the mathematical average of the daily tests, was 3.35.

The normal quantity of acid (17.5 c.c.) charred the fat so that it could not be read. The amount was gradually reduced till the readings became distinct, and as a result it was found that 11.5 c.c. gave clear readings and the correct percentage of fat. On June 24th the milk with this quantity of acid still showed 3.3 per cent fat. After this date the milk became lumpy and the fat adhered to the sides of the bottle, so that a representative sample could not be taken up in a pipette.

*Conclusions.*—A consideration of all these results will show that the exact amount (i.e., within certain limits) of potassium bichromate to be added is of no moment. For ordinary work from 3 to 7 grains (measured roughly on the point of a knife or in a small

## Experimental Farms.

spoon) is ample, and is to be recommended as giving excellent results. The daily shaking of the composite when adding a sample, should be done gently and thoroughly, and the bottle kept in a cool place. If the fat readings are obscure through charring due to excess of the preservative, the quantity of acid must be slightly reduced.

The basis or plan of paying in creameries and cheese factories for milk according to its percentage of fat, as made possible by the Babcock test, appears to give excellent satisfaction to all parties concerned, and it is pleasurable to note that every succeeding year marks its more extensive adoption. It puts the value of the milk upon the constituent that is of the greatest commercial value, and at the same time does away with the necessity of irritating inspection. It encourages good breeding and good feeding, and gives an impulse to intelligent and economic farming. It affords to each patron a just and equitable recompense for his merchandise and must present itself as being the best basis so far brought forward for the purchase and sale of milk.

---

## DESICCATED MILK.

A sample of this substance, which is made by the evaporation of milk, to which a certain amount of cane sugar has been added, was forwarded from Souris, Prince Edward Island, where it had been manufactured.

It is in the form of a yellowish-white powder, and it is claimed that it may be preserved in good condition and palatable for a length of time, even though exposed to the atmosphere. If it possesses this latter quality, it may for certain uses replace the ordinary condensed milk.

In view of its possible introduction into the markets as a Canadian dairy product, its analysis was deemed advisable.

### ANALYSIS.

Water .....	5.44
Fat .....	21.73
Albuminoids (casein and albumen).....	18.01
Ash.....	3.15
Milk sugar .....	25.22
Cane sugar .....	26.45
	<hr/>
	100.00
	<hr/>

---

## WELL WATERS.

It is undoubtedly owing to what has been said in previous reports that year by year there is to be noticed an increased interest taken by farmers in the condition of their water supplies. This is indeed encouraging, but from the character of the samples forwarded for analysis, it is plain that our warnings as to the danger of pollution from the barnyard, stables, &c., must be continued. It is probably true that those only who very strongly suspect contamination send samples—since farmers wishing an analysis are required to follow instructions (forwarded on application) and also to prepay express charges—yet the data here given emphasize the fact that many waters used on Canadian farms are seriously and dangerously polluted. In the majority of instances there is no necessity to have impure water, the contamination of the supply being due to the location of the well in the barnyard or stable, or in the vicinity of some such source of pollution. As a matter of course, such wells must act more or less as cess-pools.



ANALYSES OF  
Results stated in

No.	Name.	Locality.	Date.	Free Ammonia.	Albuminoid Ammonia.	Nitrogen in Nitrates and Nitrites.	Chlorine.	Total Solids at 100° C.
1	Quarantine Station.	Partridge Island, N.B.	Nov. 30.	056	130	250	36.2	104.0
2	"	"	" 30.	None.	058	1 104	19.5	112.0
3	"	"	" 30.	024	134	1 504	25.5	138.0
4	Allen Bros.	Winona, Ont.	Feb. 2.	4 270	05	None.	440.0	3536.0
5	Mummery, A. R.	Chatham, Ont.	" 3.	04	144	023	3.5	385.0
6	Radley, E. C.	"	" 3.	028	162	056	100.0	465.0
7	Kemp, D.	Weymouth, N.S.	" 3.	004	104	5 06	22.0	182.0
8	Rice, B. Spring.	Regina, Assa., N.W.T.	" 4.	21	11	.....	23.5	4240.0
9	"	"	" 4.	065	285	.....	180.0	18390.0
10	Johnson, Basil J.	St. Louis, Co. Kent, N.S.	Mar. 29.	028	066	640	125.0	324.0
11	"	"	" 29.	14	155	963	35.0	252.0
12	Carpenter, F.M., M.P.	Stony Creek, Ont.	" 29.	None.	064	2 444	430.0	1864.0
13	Petapiece, Geo. E.	Manotick, Ont.	April 5.	28 00	.....	.....	250.0	1134.0
14	"	Yarker, Ont.	May 1.	97	78	7322	28.0	308.0
15	Dunning, W. H.	Sandwich, Essex, Ont.	" 15.	97	044	180	483.0	4147.2
16	Dill, J. W.	Moosomin, N.W.T.	June 14.	78	154	None.	12.0	1867.2
17	Shearer, Jas.	Dromore, Co. Grey, Ont.	" 16.	032	022	026	5.0	226.8
18	Dunning, W. H.	Sandwich, Essex Co., Ont.	" 26.	1 01	.....	022	500.0	4146.0
	Gordon, J. G.	Moose Jaw, N.W.T.	July 10.	048	104	.....	10.0	610.0
20	Kelsey, J. F.	Agricola, Alta., N.W.T.	" 25.	2 19	455	.....	10.5	720.0
21	McDonald, Jas.	Starbuck, Man.	" 25.	1 705	070	.....	2276.0	5915.0
22	Experimental Farm.	Agassiz, B.C.	" 31.	032	024	046	2.5	83.6
23	Knight, Wm.	"	" 31.	028	074	03	1.4	140.0
24	McDonald, Hugh.	Mabou, C.E.	Aug. 11.	33	24	.....	293.0	.....
25	"	"	" 11.	10	.....	.....	275.0	.....
26	Campbell, R.	Quebec.	" 12.	036	04	349	6.0	.....
27	"	"	" 12.	Trace.	054	27	17.0	.....
28	"	"	" 12.	106	084	2 787	13.0	.....
29	"	"	" 12.	112	425	023	15.0	.....
30	"	"	" 12.	024	324	095	10.5	.....
31	"	"	" 12.	256	098	2 161	15.0	.....
32	Fathers, Joseph.	South Cayuga, Ont.	" 31.	229	314	804	46.0	2468.4
33	Tragnair, Wm.	Welwyn, Assa., N.W.T.	Sept. 26.	1 676	084	None.	23.0	1855.2
34	Tattrie, Calvin.	River John P.O., N.S.	Oct. 6.	016	042	9 24	85.0	566.0

# Experimental Farms.

## WELL WATERS—1893.

### Parts per Million.

Solids after Ignition.	Loss on Ignition.	Oxygen absorbed at 80° F.		Phosphates.	Report.
		In 15 Min.	In 4 Hours.		
80·0	24·0	·740	1·748	faint traces.	Fair; not polluted by sewage.
86·0	26·0	·268	·6768	"	Of purer quality than No. 1.
104·0	34·0	1·0032	2·1876	"	Fair, though too much vegetable matter.
3186·0	350·0	·038	·2844	traces.	Unfit for use; polluted by drainage from stable.
290·0	95·0	.....	.....	"	Fair; no indication of sewage pollution.
385·0	80·0	.....	.....	heavy traces.	Unfit for use; polluted by drainage.
132·0	50·0	·4572	1·004	traces.	Suspicious; previous contamination indicated.
3780·0	460·0	·7156	1·384	heavy traces.	Seriously polluted; unfit for use.
16752·0	1638·0	1·6432	3·1568	"	An exceedingly bad water.
276·0	48·0	·640	1·200	"	A fairly good water, though chlorine too high.
210·0	42·0	1·532	2·308	"	Not safe for drinking purposes; polluted.
1462·0	202·0	·252	·548	.....	Second class; with suspicious features.
928·0	206·0	2·584	5·076	very heavy traces.	Totally unfit for drinking purposes; very bad.
222·8	175·2	6·4952	13·3732	"	Very bad water.
3198·4	948·8	None.	18	.....	The free ammonia and chlorine indicate presence of liquid manure.
1428·0	439·2	2·0132	3·6364	traces.	Unfit for drinking purposes.
135·2	91·6	·1492	·3048	none.	Excellent; perfectly wholesome and ranking with first-class waters.
3052·0	1094·0	.....	.....	.....	Polluted as in No. 15.
440·0	170·0	.....	.....	none.	A good water; safe for drinking purposes.
566·0	154·0	.....	.....	very heavy traces.	Seriously polluted and unsafe for drinking purposes
4870·0	1045·0	.....	.....	none.	Dangerous to use; a bad water.
60·4	23·2	·296	·594	"	A first-class water of excellent quality.
87·0	53·0	.....	.....	.....	An excellent water.
.....	.....	.....	.....	.....	Not fit for drinking purposes.
.....	.....	.....	.....	.....	"
.....	.....	.....	.....	.....	A good drinking water.
.....	.....	.....	.....	.....	Probably a good and safe water.
.....	.....	.....	.....	.....	Polluted.
.....	.....	.....	.....	.....	Polluted; not fit for drinking purposes.
.....	.....	.....	.....	.....	A very fair water; safe to drink.
.....	.....	.....	.....	.....	Condemned as a drinking water.
1965·2	503·2	2·230	4·308	none.	Dangerously contaminated.
1482·0	373·2	·3764	·7532	traces.	Seriously polluted; unsafe for drinking purposes.
311·0	255·0	.....	.....	.....	Shows previous contamination.

It would unnecessarily burden these pages to give here in full the reports forwarded to the farmers who sent the samples, but sufficient is said in connection with the analytical data to point out the general character of the waters.

It would only be reiterating what has been said in previous reports were I to state here the reasons why it is of paramount importance to have pure water on the farm. It is only necessary to add that such is indispensable for the good health of man and beast, and that it is only a matter of time before the effects of an impure supply are apparent to those who choose to see them, indeed to all but the most careless. I am well assured that much sickness on the farm and poor results in the stable and dairy are to be attributed to polluted water, rather than to the causes which many now assign them.

It is remarkable that only a very small proportion of those who write for (and receive) the instructions we issue for taking the water, forward a sample. It indicates that many do not consider the knowledge of the character of their well water as worth the trouble and expense consequent upon sending the sample.

---

## MISCELLANEOUS.

### EXPERIMENTS TOWARDS THE IMPROVEMENT OF CERTAIN SALINE WATERS.

From the examination in our laboratories of several samples of saline, or, as they are usually called, alkaline waters from the North-west Territories and Manitoba, it has become apparent that many contain a large amount of Epsom salts or sulphate of magnesium. In some instances this is associated with other saline matter, as sulphate and chloride of sodium (Glauber's salt and common salt), but it often occurs that the Epsom salts is the chief, if not the only, foreign saline material. The well known purgative effect on man and animals which follows the drinking of such waters makes their improvement a subject of the greatest importance, especially to those situated in localities where ready access to a supply of pure water is not attainable.

To the end of being able to suggest a method of treatment that would result in making these waters potable, the following experiments were made:

A. To 50 c.c. of a saline water containing Epsom salts were added 100 c.c. of lime water, which precipitated the magnesia as the flocculent hydrate. After settling till the supernatant fluid was clear, the whole was filtered, and the filtrate tested for magnesia with negative results. The washings of the magnesium hydrate however showed traces, pointing to the fact that while magnesium hydrate is insoluble in dilute lime water, it is slightly soluble in pure water, probably owing to the latter containing some carbonic acid gas in solution.

B. To 100 c.c. of a 1 per cent solution of Epsom salts ( $\text{MgSO}_4, 7 \text{H}_2\text{O}$ ) 200 c.c. of lime-water were added. After standing several hours and filtering, 100 c.c. of the filtrate, after separation of the lime, were tested for magnesia. A very slight precipitation ensued. This precipitate was carefully determined and found to be equal to .00064 gram of magnesium oxide. By calculation it is ascertained, therefore, that 1.18 per cent. of the original amount of Epsom salts was still in solution, or in other words, the 1 per cent. of Epsom salts had been reduced by this treatment to .01 per cent.

These experiments being considered very fairly successful and satisfactory in showing that lime-water can precipitate the magnesia in an inert form, the next step was to ascertain if, after treatment, simple exposure of the water to air would serve to separate out the excess of lime used for precipitating the magnesia as the insoluble carbonate. For it should be noted that the water after the precipitation of the magnesia is strongly alkaline and caustic, due to the presence of the lime as already explained. The experiment now to be detailed offers a solution to this question.

C. The saline water used was taken from the same sample as that employed in experiment A. It was forwarded from near Regina, N.W.T., and contained 715 grains of Epsom salts to the gallon. To 100 c.c. of the water were added 200 c.c. of lime-water,

## Experimental Farms.

the subsequent treatment being that already described in experiments A and B. The filtrate from the magnesium hydrate was exposed in a shallow dish to the atmosphere of the laboratory for ten days. A considerable precipitation of carbonate of lime ensued, due to carbonic acid in the air, and the water was no longer found to be alkaline to test paper, proving the absence of caustic lime.

From the results of these experiments, I think we may fairly conclude (1) that by the use of lime-water the deleterious magnesium salt may be practically removed, and (2) that by the subsequent exposure of the treated water to the atmosphere, the excess of lime used in precipitating the magnesia may be precipitated as the innocuous carbonate.

No practical application of this mode of treatment on a large scale has yet been made, though its cheapness, simplicity and thoroughness warrant me in suggesting it as well worthy of trial by those compelled to use water more or less impregnated with Epsom salts. Wooden tubs or troughs could be used for the precipitation and subsequent exposure, and no expense, save the cost of the burnt lime, need be entailed. The precipitation of the magnesia and subsequently of the lime by exposure might proceed simultaneously and in the same vessel, and the clear supernatant water subsequently poured or siphoned off. If such a process were adopted, care must be taken not to have too great an excess of lime, or the total conversion into carbonate would take a very long time.

It must be remembered that the water so obtained, though free from Epsom salts and caustic lime, would not rank as first class. It would be a hard water, containing both sulphate and bicarbonate of lime, the latter, however, could be got rid of by a subsequent boiling, which would throw it down as the insoluble carbonate. If the water, however, did not originally contain much sulphate and chloride of sodium, I am of the opinion that a fairly palatable water would result, and certainly one much more wholesome than the original.

---

### SLUG-SHOT: AN INSECTICIDE.

A sample of this material was forwarded by a correspondent in Cape Breton, accompanied by a request for its analysis and a report as to its value for killing the potato beetle.

It is a pinkish red, earthy powder, not unlike burnt clay. It was carefully examined for arsenic and other poisonous compounds with negative results. Further examination proved it to contain flowers of sulphur. This constituent was determined and found to be 5.4 per cent. It is scarcely necessary to add that this material must prove valueless for preserving potato vines from the ravages of the potato beetle.

---

### THE VALUE OF DILUTE SULPHURIC ACID FOR CHECKING THE SPROUTING OF POTATOES.

From a series of experiments recorded in my last report,\* the conclusion arrived at under the conditions of the experiments was that a 2 per cent solution of sulphuric acid was valueless for checking the sprouting of potatoes. These trials were, however, made in the spring, and the treated tubers were not protected from light—conditions which it was thought were perhaps unfavourable to the best results of the treatment. In the experiment the results of which are now given, the potatoes were treated in the autumn and preserved in the dark.

On November 30th, 1892, three varieties of potatoes, Early Ohio, Beauty of Hebron and State of Maine were treated (a) for twenty minutes and (b) for one hour with a 2 per cent solution of sulphuric acid. Immediately after the expiration of these periods, the several samples were repeatedly washed with water, allowed to drain, placed in jars and stored in a dark place, the other details of the experiments being similar to those given last year. On March 13th, 1892, the potatoes were

\*Pages 141, 142, Report of Experimental Farm, 1892.

examined. The potatoes of all the samples, both treated and untreated (the latter being stored as checks) had sprouted. It was noticed that the sprouts of the treated tubers were longer than those of the untreated, showing apparently that the action of the acid treatment was to accelerate rather than retard the sprouting. These results corroborate those obtained and reported on last year. The sprouting of the untreated tubers, as well as of the treated, may probably have been assisted by the presence of air which freely surrounded the potatoes in the jars. Potatoes stored in a bin have smaller air spaces between them, and under such conditions it is found that those on the surface are the first to sprout. It is, however, quite evident from our two years' work on this subject that 2 per cent sulphuric acid has not the deterrent action in preserving potatoes that has been claimed for it.

## Experimental Farms.

# REPORT OF THE ENTOMOLOGIST AND BOTANIST

(JAMES FLETCHER, F.R.S.C., F.L.S.)

---

W. SAUNDERS, Esq.,  
Director, Dominion Experimental Farms,  
Ottawa.

SIR,—I have the honour to hand you herewith a report upon some of the more important subjects which have been brought officially under my notice during the past season.

### DIVISION OF ENTOMOLOGY.

With regard to insects injurious to the agricultural industries, the enormous increase and spread of the Cattle Horn-fly claim first mention. This fly has undoubtedly caused great loss. Where the well known remedies have been applied perseveringly, there has been decided relief to the infested cattle, and much needless loss has been averted. In most instances of failure, I have found on inquiry that the remedy had been applied once or twice only and then given up. Canadian farmers must recognize the fact that this is an exceptional visitation, and that therefore they must take exceptional measures to combat it. As to the trouble and expense of these measures, leaving aside altogether a consideration of the cruelty to the animals, that is merely a matter of dollars and cents. The question which all must ask themselves, is, Will the benefit I shall reap overbalance the cost of the applications? In reply to this I can answer emphatically that it will, many times over, and further, that the better they attend to the instructions given, so much greater will the profit be. Judging from the past history of the introduction and spread of this pest in America, I am led to hope that in districts which have been badly infested this season, the attack will be decreasingly less severe year after year in future.

Grasshoppers have been destructive in western Ontario and a few of the usual fruit pests have been locally abundant. Two of the worst of these, the Plum Curculio and the Codling Moth, have caused much injury in Ontario. Spraying the trees with Paris green for both of these pests still remains the best remedy. Where the work is done carefully and intelligently it is practically all sufficient, the occasional cases of failure which are sometimes heard of, and these are very rare, are almost invariably due to careless work. One of the most remarkable instances I have ever seen of the results of good careful work, was in the orchard of Mr. S. A. Fisher at Knowlton, Que. When I visited him in September last, I could not find in his orchard a single apple which had been injured by the Codling Moth. This was the first year he had sprayed his orchard. In previous years his crop had always been badly infested, and this year the orchards of his neighbours all around him, none of which had been sprayed, were so still. In British Columbia, where fruit-growing has become a leading industry of the country, the Apple Aphis has developed in a remarkable manner and is doing much harm. Besides information from my own correspondents I see by the extremely valuable report for 1892, published by Mr. J. R. Anderson, the Statistician of the Department of Agriculture of British Columbia, one of the best colonial reports I have ever seen, that this insect is alarmingly abundant and destructive throughout the province.

Early in October by the kind permission of the Hon. Minister of Agriculture, I had the great advantage of attending the World's Columbian Exposition at Chicago, where I not only acquired much information of value to my department by examining the many excellent collections of insects there displayed in illustration of the value of applied entomology, but was able to be of service in reporting upon certain pests of stored grain, which just at that time had been noticed to be destroying the cereals exposed as samples or used in ornamentation of the various courts in the Agricultural Building. From the fact that very few connected with the exhibits knew the life histories of the pests concerned, there was a good deal of unnecessary anxiety at the time of my visit, which I was pleased to be able in a measure to allay. The entomological division of my department was represented at Chicago by a collection of 20 cases of insects systematically arranged. In the preparation of this collection I was materially assisted by Mr. J. Alston Moffat, of London, who arranged the cases of moths, and by Mr. W. Hague Harrington, of Ottawa, who prepared two beautiful cases of Hymenoptera. I have also to gratefully acknowledge donations of insects from the Entomological Society of Ontario, the Rev. C. J. S. Bethune, of Port Hope, Messrs. H. S. Saunders and W. Rennie of London, Ont., and Prof. W. Saunders, of Ottawa. When finished, the collection presented a very creditable appearance and, when returned, will form the nucleus of a reference collection at the Central Experimental Farm. Such a collection for reference has been much needed in the past. I hope during the coming winter to much increase this collection from the large amount of material which had accumulated previous to the appointment of my assistant, Mr. Guignard, and which could not be arranged, owing to pressure of other work.

#### DIVISION OF BOTANY.

In the Division of Botany the experiments with grasses, native and foreign, have been continued and have attracted much attention from visitors to the farm. The increased importance of the dairy industry during the last decade, has naturally drawn much attention to the subject of fodder plants. The experimental grass plots covering about  $1\frac{1}{2}$  acres are situated on a piece of moderately good land, lying to the west of the main road to the office and between the road and the poultry house. The ground is varied and provides the different kinds of soil and degrees of moisture necessary for the testing of grasses of various habitats. The method which has been followed in furnishing these beds has been to obtain seed by exchange, purchase or collection in the field, and cultivate the plants until a sufficient quantity were on hand to set out a plot of one square rod to each species. There are about 130 of these plots now in use. It is considered that plots of this size are large enough to give a correct idea of the value of a grass from its habit of growth and weight of product per acre. In addition to the whole plots of 1 square rod are half plots where grasses are grown which are of known value or have been tested and which may be of interest to visiting farmers. Grasses of botanical interest only are grown in mixed beds, about 4 rows being given to each species. A bulletin (*C.E.F.*, No. 19.) having been lately issued entitled: "*Grasses, their Uses and Composition.*" treating of the work of this department in that line, it is not thought advisable to devote much space in this report to that subject. Experiments have been carried on, but are not yet completed with permanent pasture and hay and lawn mixtures. Samples of the best mixtures offered for sale by seedsmen were secured and sown, and although on the whole these mixtures were satisfactory, there were several points in which it was thought they could be improved. Some of the grasses which form a large proportion of the mixtures were not suited to our climate, and others came to maturity at seasons so different that the grasses could not all be at their best when mown for hay. Careful notes have been kept of the time of flowering of all the different varieties year by year, and these have been made use of in some trial mixtures for hay which have been sown in 6 large plots of  $\frac{1}{20}$  acre each, lying to the north of the road leading to the poultry house and beyond the row of birch trees shown to the right of the illustration. In addition to the true grasses about 15 plots have

## Experimental Farms.

been devoted to clovers and other fodder plants; these lie immediately in front of the poultry house. Early last spring a distribution of seeds of grasses for trial was made to farmers in all parts of the Dominion: over 1,000 packets were sent out to 110 different individuals. With the seeds a letter of instructions was sent and a blank form for filling in data as to time of sowing, flowering, etc. I am sorry to say that very few reports have been so far received, which is much to be regretted; for farmers all over Canada are buying large quantities of grass seed every year much of which is quite useless to them. If these reports were made, we should have exact data from all provinces which could be tabulated and would then be of great economic value.

A large addition has been made to the collection of plants in the Arboretum and Botanical Garden, details of which will be found on page 34 of this report.

There has been much correspondence concerning Weeds, particularly from the North-west and Manitoba, where farmers seem to be alive to the importance of destroying these agricultural marauders which drain the soil of its nourishment and choke out the crop. A special collection, separate from the large *hortus siccus*, is being prepared of the weeds of the farm, as well as a reference collection of the seeds of weeds for examination and comparison.

*Meetings.*—I have during the year attended nine agricultural meetings to deliver addresses upon subjects connected with my department:—

1. Dairymen's Association of Western Ontario, London, Ont.
2. Farmers' and Dairymen's Association of New Brunswick, at Fredericton, N.B.
3. Central Farmers' Institute, Toronto.
4. Meeting of fruit growers of Lincoln Farmers' Institute, St. David's, Ont.
- 5-7. District of Bedford Dairymen's Association, Cowansville, Que., followed by two meetings of horticulturists on the following days at Knowlton and Waterloo, Que.
8. County of Carleton Farmers' Institute at March Corners, Ont.
9. Township of Fitzroy Farmers' Institute at Galetta, Ont.

*Acknowledgments.*—I beg again to express my thanks to my many correspondents who have rendered me much valuable assistance in making observations and sending me prompt notice of the occurrence of injurious insects. I am more and more convinced every year of the value of being in constant correspondence with those actually engaged in the cultivation of the soil. If suggested remedies are successful, the very best must be discovered and made known as widely and as quickly as possible; if they fail, the reason of this must be found out, and if useless, farmers must be warned against them, so that neither labour, time nor money may be lost which might be better employed. I have again to acknowledge many courtesies extended and valuable reports received from colleagues, official entomologists and botanists in other countries, amongst whom I would particularly name Prof. Riley, the United States Entomologist; Miss E. A. Ormerod, of England; Dr. J. A. Lintner, of New York; Dr. J. Ritzema Bos, of Holland; Mr. F. Turner, of New South Wales, and Mr. C. French, of Victoria, Australia.

An object which has attracted much attention in my office is a wall case given by Prof. Fernald, Secretary of the Massachusetts Gypsy Moth Committee, illustrating by means of beautifully mounted specimens the life history of the Gypsy Moth (*Ocneria dispar*, L.), which has been the cause of so much loss in the New England States.

For identification of difficult species I gratefully acknowledge my indebtedness to the following specialists: For Coleoptera, Mr. Albert Fauvel, of France, Dr. John Hamilton, of Allegheny, Pa., Dr. George H. Horn, of Philadelphia, Pa., and Mr. W. H. Harrington, of Ottawa; for Lepidoptera (*Noctuidæ*) Prof. J. B. Smith, of New Brunswick, N. J.; (*Microlepidoptera*) Prof. C. H. Fernald, Amherst, Mass.; for *Coccidæ*, Prof. T. D. A. Cockerell, Las Cruces, New Mexico.

For botanical specimens: Prof. J. Macoun, Ottawa; for microscopic fungi, Mr. J. Dearness, of London, Ont., and Prof. B. D. Halsted, of New Brunswick, N. J.

To all of whom I here respectfully tender my heartiest thanks.



The following donations of plants and seeds have been received during the year:

Prof. Beal, Michigan Agricultural College: collection of grass seeds, 14 species.

F. Turner, Esq., Botanist, Department of Agriculture, New South Wales: seeds of grasses and fodder plants, 19 species.

Prof. O. Luggar, Minnesota Experiment Station: collection of grass seeds, 37 species.

Steele, Briggs, Marcon & Co., Toronto: collection of imported grass seeds, 34 species, and 13 varieties of rape.

W. R. Carles, Esq., Chinkiang, China: seeds of *Stillingia sebifera* and *Anemone sernua*; also bulbs of *Tulipa edulis*.

J. A. Balkwill, Esq., London, Ont.: roots of native plants.

I have the honour to be, sir,

Your obedient servant,

JAMES FLETCHER,

*Entomologist and Botanist.*

## DIVISION OF ENTOMOLOGY.

### CEREALS.

The grain crops of the Dominion as a whole have been less injured by insect pests during the past season than has been the case for many years. The only occurrences of unusual severity have been by Cut-worms to wheat in Manitoba, and by Locusts chiefly to oats in Ontario. Specimens of the true Army-worm (*Leucania unipuncta*, Haw.) from which the moths were subsequently raised, were sent to me from Manitoba by Mr. Richard Waugh, of Winnipeg, who writes as follows:—

“August 4.—I send you this day samples of some caterpillars which have appeared in great numbers on the end of a wheat field, just outside the city, eating both blades and ears. The field abuts on the river and the path is strewn with the worms which are in great force.”

“August 18.—The army-worm has destroyed a lot of wheat on the east side of the Red River in Northern Minnesota, and I believe our visitation is a stray lot from that section. They devoured both the leaves and the green heads, but vanished in a few days.”

The Wheat-stem Maggot (*Meromyza Americana*, Fitch) was observed to a small extent in wheat fields in the Ottawa district; but few complaints were received from other parts. The larvæ were found much more abundantly this year in the root-shoots of grasses than in the stems of wheat and barley.

### CUT-WORMS IN GRAIN CROPS.

Year after year complaints are received concerning the injuries of Cut-worms to grain crops, and during the past season, these have been very numerous in Manitoba and parts of the North-west Territories. Up to the present time no satisfactory remedy has been devised to put a stop to these depredations. A great desideratum is more knowledge as to the exact identity and life habits of the species concerned. I trust I may be able next year with the assistance of correspondents in the West, to obtain specimens and work out the life histories and food habits of some of the western Cut-worms, on which there is yet much to learn before a practical remedy can be recommended. The following letters will, I think, give an idea of the urgency

## Experimental Farms.

of this case and will indicate the present state of the entomological information in our hands:—

“ August 19.—I was told a few days ago, that a report had been sent out by you which contained a simple remedy for destroying cut-worms. If such is the case, I would like to have it sent to me. I had a 20-acre field of wheat entirely destroyed last year when the second leaf was about one inch long. Where the drill teeth ran, the ground was as fine after they had done as if it had been sifted; there was not a leaf to be found. As far as I can learn, this grub is known as the little black grub, and what would kill the cut-worm, would kill it.”—JOHN STEWART, *Regina, Assa.*

*Reply*:—“ April 26.—I fear the report that I have a simple remedy for destroying Cut-worms is rather more than I can myself admit. Cut-worms are amongst the most troublesome of our farm enemies, more particularly when, as in your case, they attack grain crops. There are upwards of 400 kinds of Cut-worms, some of which differ from the others in their habits. I shall be obliged if you will send me this spring some living specimens for examination. This can be done easily by mail and free of postage. As the Cut-worms you refer to attacked your grain crop, it is just possible that they might not injure some other plants, such as potatoes, which do not belong to the Grass family, like the small grains. Could you not put your infested field under some other crop next season, so as to try this?”

“ June 12.—The Cut-worms are not so numerous this summer, as they were last. This evening I could only obtain a few. Last 12th of June, they could have been got by the handful. I send you a box of the grubs.”—JOHN STEWART.

*Reply*:—“ June 21.—Yours of the 12th inst. and the insects referred to therein arrived safely. The Cut-worms in your grain crop are the Clay-backed Cut-worm (*Carneades insulsa*, Walk.—*Agrotis campestris*, Grt.), which in many districts of Manitoba and the Territories has done much harm during the last ten years. I find by my notes that this species is always *most numerous where weeds have been allowed possession of the ground during the previous autumn*. Were you able this season, as suggested by me, to put that part of your farm which was badly infested last year under any other crops than grain?”

“ June 19.—I am sending you by this mail in a small box some Cut-worms that are doing considerable damage to wheat and oats. A neighbour of mine has had a field of 30 acres of wheat completely cleared by them, and now they have started on my oats in an adjoining field. The land where they began was badly summer-fallowed last year and the weeds came very thickly, chiefly pig weed or lamb's quarters. They seem to have bred in this field. Can you give us any information how to get rid of them? I thought of summer-fallowing all my land on this place next year and sowing timothy. It is no use trying to grow grain where these insects are. I had a small piece of last year's fallow that the weeds had started on this spring, adjoining my neighbour, and when the grubs had cleaned his field they started on the pig weed on mine. I hauled dry straw and manure and covered them up with it and then set fire to it the next day. They got up into the straw over night and I must have burnt millions of them, for I could take them up by the shovelful. I never saw anything like it. I have put feed oats on the land, but expect they will clear the whole. I see they are on many farms here, but the owners do not seem to think much of them, I fear they will be getting worse. There is one thing certain. We shall have to adopt a different method of working our summer-fallows.”  
—WM. RICHARDSON, *Douglas, Man.*

In reply Mr. Richardson was informed that the caterpillars sent were the Clay-backed Cut-worm, and that his theory was correct that the prevalence of these insects was largely consequent upon imperfect summer-fallowing of the previous year.

“ June 27.—I inclose a few specimens of grubs which are doing considerable damage to gardens and early summer-fallowed lands. Whole fields are being destroyed by them. Can you give us any information concerning their habits of life, such as how deep the eggs are deposited and if late fall-ploughing would kill them.”  
—JOHN LAWRENCE, *Sewell, Man.*

In reply Mr. Lawrence was informed that the species was the same as referred to above, and the usual remedies were given.

Early last spring I had some correspondence with Mr. Richard Waugh upon this subject, which began by his sending me a letter from Mr. John Stewart, complaining of the injuries to his crop of 1892, in which he also mentioned that a crop of flax had been left untouched; to this I replied, March 26:—"I have read your correspondent's letter carefully and noticed that the crops attacked by the caterpillars were oats and wheat (Gramineæ), and that flax the only other crop mentioned, which belongs to a different family of plants, was uninjured. Now some of the Cut-worms which destroy grass crops, grains included, do not injure other crops, and it is just possible that the species in question may be one of these. Should this be the case, the simplest remedy which suggests itself is to put the land under some other crop than one belonging to the Grass family for two or three years. Potatoes are good for this purpose, not only because comparatively few insects injure that plant, but because potatoes are late in appearing above the ground in spring. I surmise that the insect complained of is the same Cut-worm as some years ago was sent to me by Mr. A. Burrows, and upon which I wrote an article for *The Nor' West Farmer*. It is difficult to suggest a definite remedy for any insect without seeing specimens. I hope that Mr. Stewart or any other farmers will send me specimens of insects which may trouble them."

"June 7.—Yesterday when at Carberry speaking at the Institute, considerable damage was reported to summer-fallowed wheat by caterpillars of which I send you a sample. Very weedy fields which had been allowed to grow so without disturbance, suffered most, and a cultivated strip in the same field seemed free of the insects. Barley was being sown on the top of the ruined wheat, in the hope that it would escape. I asked one man to try a half bushel of flax. Some allege that late ploughed fallow does not suffer, and it is assumed that deep ploughing and rolling later in the year would either bury them or divert them from coming there. Others allege that mellowness of the soil is as much the attraction as the green weeds. Some years ago a crop of wheat was saved by the grubs eating up the pig weed in the crop and leaving the less palatable vegetation. Such grubs have devoured the crops in clean gardens that were summer-fallowed. Will you please consider this and give us your opinion as to remedial action? Prof. Luggier killed the grasshopper-grubs in Minnesota by deep ploughing."

*Reply*:—"June 21.—The grubs sent with your letter are the Clay-backed Cut worm (*Agrotis campestris*)\* which is frequently very troublesome in Manitoba. You are correct when you say that Cut-worms are most injurious where weeds have been allowed to grow undisturbed the previous year. It is just possible but hardly likely that the barley sown where the wheat was ruined will escape. This Cut-worm, I think, comes to full growth only toward the end of June, and the barley would, of course, be up long before that. Grain crops being occasionally saved owing to the fact that the grubs attacked by preference pig weed and other plants growing among them, is merely due to the fact that some varieties of Cut-worms feed only upon certain kinds of plants; but then again on the other hand, others are virtually omnivorous, and will eat anything. There are in Canada about 300 different kinds of Cut-worms, many of which differ widely in their tastes and habits. I am afraid that the deep ploughing remedy for this pest, would not avail much. Prof. Luggier's experiments in Minnesota were with grasshoppers' eggs not with the grubs. There are some Cut-worms which pass the winter in the moth state and lay their eggs in the spring, as in the case of the Army-worm moth. It is just possible that those gardens which were infested after having been kept clean the year before, were devastated by a species having this habit. These, however, are luckily few in number, so that, on the whole, I consider one of the best remedies for Cut-worms is, keeping the land as clean as possible in the autumn."

There is perhaps no one single question concerning which so many inquiries are made by farmers and gardeners every year as the best remedy for Cut-worms.

\* = *Carnedes insulsa*, Walk.

## Experimental Farms.

In my annual report for 1888, I published a rather extensive article upon this subject, but as the edition is entirely exhausted, I reproduce here with a few slight alterations part of that article which I think will be of use at the present time.

"Cut-worms are the caterpillars of dull coloured active moths belonging to the Noctuidæ or Owlet moths, of which there are upwards of 400 on the North American lists. Fig. 1 shows the moth of the Devastating Cut-worm (*Hadena devastatrix*, Brace). Of course, the different species vary somewhat in their habits, but taken as a class they are very similar, and in the present state of our knowledge, it will be more convenient to treat them as a class, at any rate in a report like this, which is prepared particularly with the hope of helping farmers to overcome their insect foes. As Cut-worms



are the caterpillars of so many different species of moths, the inaccuracy of speaking of them as *the* Cut-worm is apparent. Moreover many other insects are sent in and reported upon as Cut-worms, which do not belong to this class at all. Of these the White Grubs, the larval state of the June Bugs (*Lachnosterna*), are most often referred to. There is some reason in this from their occasional habit of biting off plants in the manner of the true Cut-worms, which are the caterpillars of the moths referred to above; these latter may be described in a general way as smooth, almost naked, greasy-looking, caterpillars of some dull shade of colour similar to the ground in which they hide during the day. The head is smooth and shining and sometimes of a different colour from the rest of the body. On the top of the segment next to the head is a smooth chitinous plate known as the thoracic shield. There are generally three or four series of bristle-bearing tubercles along each side of the body, and when disturbed the caterpillars curl up into a ring.



Their habits are almost always nocturnal; they lie hid by day just beneath the surface of the soil and come out at night to feed. When, however, they develop in large numbers, they frequently change their habits and feed by day, owing probably to the reduced food supply consequent upon their ravages. The habits of most Cut-worms are probably as follows. The egg is laid in the spring, summer or autumn, and the insects may pass the winter, either in the perfect moth state, as a chrysalis, as a young half-grown caterpillar, or as an egg. Those which hibernate as moths lay the spring eggs and moths are produced again before winter sets in. Most of the eggs which are laid in the summer or autumn hatch soon after, and the caterpillars either become full fed the same season and pass the winter underground in the chrysalis state, or after feeding for a short time, become torpid and pass the winter as half-grown caterpillars. In this condition they may be found late in the autumn under stones, logs or heaps of dead vegetation, in the roots of grasses or in cells beneath the surface of the ground. Of some, as in the case of *Carneades ochrogaster*, Gn., the eggs are laid in the autumn, but do not hatch until the following spring. The ravages of the young caterpillars which hatch in the summer and autumn, are seldom noticed then, on account of the abundant vegetation at those seasons. In the spring, however, not only are the caterpillars much larger and capable of more mischief, but the land is cleared of all weeds and vegetation other than the crop which is to be grown, and when the Cut-worms, revived by the warmth of the sun and the opening of spring, come from their winter retreats, there is nothing for them to eat but the farmer's early crops. They are particularly troublesome in gardens cutting off young cabbages, tomatoes and other plants, as soon as pricked out. When the caterpillars are full-fed, they burrow into the ground to a depth of some inches and turn to brown chrysalides inside a smooth cell or light cocoon. (Fig. 3.) From these, after a few weeks, the perfect moths emerge. They are very active at night, and when disturbed have the same habit as their caterpillars of dropping to the ground and remaining perfectly still as if dead. From their dull colour they are then difficult to find.



Fig. 3.—Cut-worm Chrysalis in cell.



Fig. 4.—The Gothic Dart Moth.  
Wings open and closed.

When at rest (See Fig. 4.), their wings lie horizontally over their backs, and the upper ones entirely cover the lower pair. The upper wings are generally crossed with one or more waved lines and always bear two characteristic marks, one about half way down the wing, orbicular in shape, the other nearer the tip, reniform or kidney-shaped. Owing to their nocturnal habits, Cut-worms frequently do a great deal of harm to vegetation without being recognized as the cause. It is important, in the view of discovering

useful remedies, to ascertain as soon as possible the habits of all these caterpillars."

The remedies given below are from *Bulletin 11*, of the Experimental Farm series.

**Remedies.**—(i.) *Clean Culture.* As the young caterpillars of many species hatch in autumn, the removal of all vegetation from the ground as soon as possible in autumn deprives them of their food supply and also prevents the late-flying moths from laying their eggs in that locality. Fields or gardens which are allowed to become overgrown with weeds or other vegetation late in the autumn are almost sure to be troubled with Cut-worms the next spring.

(ii.) *Traps.*—Large numbers may be destroyed by placing between the rows of an infested crop, or at short distances apart on infested land, bundles of any succulent weed or other vegetation which has been previously poisoned by dipping it, after tying it in bundles, into a strong mixture of Paris green (2 oz. to a pailful of water). The Cut-worms eat the poisoned plants and bury themselves and die. In hot, dry weather these bundles should be placed out after sun-down, and a shingle may be laid on each to keep it from fading.

(iii.) *Banding and Wrapping.*—(a.) It will be found to well repay the trouble and expense, to place a band of tin around each cabbage or other plant at the time of setting out. These may very easily be made by taking pieces of tin 6 inches long and  $2\frac{1}{2}$  wide and bending them around a spade or broom handle so as to form short tubes. In placing them around a plant the two ends can be sprung apart to admit the plant, and then the tube should be pressed about half an inch into the ground. I have found this a useful means of disposing of empty tomato and other cans. To prepare these easily, they need only be thrown into a bonfire, when the tops and bottoms fall off and the side becomes unsoldered. The large piece of tin can then be cut down the centre with a pair of shears, and forms two tubes.

(b.) Wrapping a piece of paper round the stems of plants when setting them out will also save a great many and is highly recommended.

(c.) Hand-picking or digging out the Cut-worms whenever a plant is seen to be cut off, should, of course, always be practised.

**Natural Enemies.**—There are two enemies of Cut-worms which deserve especial notice, and, from the good service they do, should be known by sight to every cultivator. They are the Fiery Ground-beetle or Cut-worm Lion (*Calosoma calidum*, Fab., Fig. 5) and the Black Ground Wasp (*Ammophila luctuosa*, Smith) which closely resembles Fig. 6. Both of these are desperate enemies of Cut-worms, the former feeding on them in all of its stages, the latter digging them out and storing its nest with them as food for its young grubs.



Fig. 5.—Fiery  
Ground Beetle.



Fig. 6.—Ground Wasp.

## Experimental Farms

### THE RED-LEGGED LOCUST

(*Melanoplus femur-rubrum*, DeG.)

One of the notable attacks of the year, mention of which has been made by several correspondents in Western Ontario, has been that of "Grasshoppers" or more properly Locusts. Their injuries have been most serious in those parts of Ontario which have suffered from a lack of rain. They are also mentioned several times in British Columbian correspondence. In Ontario and Quebec the species of which I have received most specimens, was the common Red-Legged Locust.

Occurring with this, however, were many specimens of the Lesser Migratory Locust (*Melanoplus atlantis*, Riley) and the large green Two-striped Locust (*Melanoplus bivittatus*, Say).

Special complaints were made of Locust injuries to oats by many correspondents. Major Lloyd, of Oakville, Ont., and Mr. G. C. Caston, of Craighurst, Ont., speak of their damages in turnip fields, and records of their injuries to vegetation in general were frequent; the following extracts will give some idea of the losses due to these pests:—

"There is almost universal complaint of the damage to the oat crop by grasshoppers. Four-fifths of the correspondents from the Lake Erie counties refer to them. From Lambton, Simcoe, Middlesex, Northumberland and Durham, Prince Edward, Lennox and Addington, and Frontenac, come reports of great destruction to every thing growing in the fields. Correspondents report them more numerous and destructive than for many years."—*Bull. 47, Ont. Bureau of Industries, Aug., 1893.*

"Oats this season are a light crop, owing to the prevalence of rust and the prevalence of grasshoppers."—*Bull. 48, Ont. Bureau of Industries, Nov., 1893.*

"August 15.—I remember seeing in some pamphlet when at Ottawa a description of a machine used in the North-west for destroying grasshoppers; can you let me know how this is made and used. The fact is these insects are becoming a perfect pest in many parts of Ontario, and if something is not done to at least thin out their numbers, the injury to vegetation will be very serious. They have done, I am told, very great damage in the neighbourhood of Woodstock, and the country round there, and out at my place at Lake Simcoe, my neighbours, as well as myself, have suffered not a little. Last autumn I was very careful to have all the stubble and the long grass round the sides of the fields cut close, so as not to leave them any harbourage or place to deposit their eggs, but they are this year more numerous than ever. If you can suggest anything that we can do to lessen the evil, I shall be very much obliged if you would drop me a line. If they go on increasing, farming in Ontario will suffer a heavy blow."

"August 19.—The grasshoppers, now that the grain is all in, are turning their attention chiefly to the kitchen garden, where they are playing havoc with everything, and there does not seem to be any effectual method of fighting them."—*Hon. G. W. Allan, Toronto, Ont.*

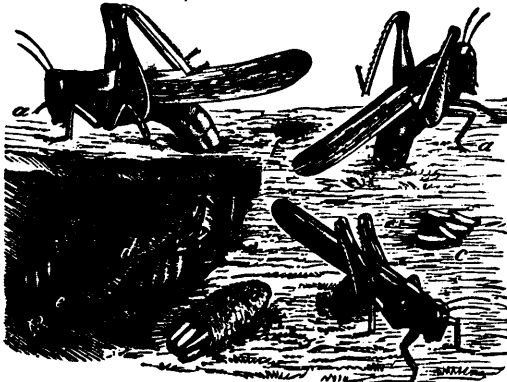

Fig. 7.—Locusts laying their eggs.

The life history of the Red-legged Locust is briefly as follows:—It is single-brooded. The eggs are laid in the autumn but hatch only the following spring. The young pass through five successive moults, attaining their full growth in July, when they have well developed wings. The females deposit their eggs in symmetrical masses called pods within burrows bored with their abdomens; each female lays 3 or 4 pods of eggs before she dies, each pod containing about 30 eggs. Prof. S. A. Forbes says:—"They select by preference for oviposition hard and dry ground, roadsides and pastures being

especially favourite localities. Meadows and pastures are commonly resorted to by the mature females, especially the latter, as the eggs seem not to be laid ordinarily on ground covered by luxuriant vegetation. I have never known them deposited in cultivated earth. The food habits of these locusts are extremely simple, and consist in eating nearly everything coming in their way."

THE LESSER MIGRATORY LOCUST is a very widely distributed species which frequently becomes injurious on account of its excessive increase. It is more nearly allied to the Rocky Mountain Locust than to the Red-legged. It is about the size of the latter, but, like the former, has longer wings and, although to a lesser degree, is migratory in its habits. This is the species to which probably most of the locust injury in Canada should be attributed, as it is a common species from British Columbia to the Maritime Provinces, and Prof. Lawrence Bruner says:—"It is the species which most frequently does the locust injury in the New England States, much of that in the Northern States, and some of that in the extreme North-west. It has also been known to become injurious in the Middle and Southern States. In its distribution this species seems to be more partial to hilly or mountainous country, and especially is this noticeable in reference to its appearance in destructive numbers. It seems also to prefer wooded or mixed country to the open prairies or plains."

The Lesser Migratory Locust is about the same size as, and closely resembles the Red-legged Locust, and, as its range is practically the same, it is impossible to separate the injuries of the two in the reports received. The two species may, however, be easily distinguished by the entomologist, from the fact that the prosternal spine of *M. atlantis* is sharply pointed, while that of *M. femur-rubrum* is spatulate or enlarged at the apex.

THE TWO-STRIPED LOCUST is the large common olive-green species with heavy body and two light stripes down the back, which is frequently found in gardens and about the edges of fields. It occurs from the Atlantic to the Pacific and from the Gulf of Mexico to the Saskatchewan. Prof. Bruner says of it:—"Its increase in destructive numbers appears to be confined chiefly to the regions lying between the Rocky Mountains and the Atlantic. This locust appears to vary considerably in size and colour. There are, however, two well defined forms, the one receiving the name *bivittatus* and the other going by that of *femoratus*, the latter occurring only northward."

The large amount of damage annually wrought by locusts is seldom appreciated. Their habits are to frequent grass lands, where a large proportion of the crop may be consumed without making much difference in the appearance of the fields. It is only after hay is cut, or in seasons of unusual drought, that locust injuries are much noticed. If, however, their numbers at all times and their voracity are considered, it will at once be seen that they must every year destroy much produce. They do not develop wings until July, and previous to that they pass most of their lives low down among the stems of grasses. Besides locusts, there are many other grass feeding insects which every year levy a heavy toll unnoticed. These may all be to a large measure controlled by the use of machines called "hopper-dozers," or "tar pans," which were invented in the west some years ago at the time of the so-called "locust invasions." Prof. Herbert Osborn, of Iowa, writing on means of destroying grasshoppers, says:—"In meadows and pastures we believe the use of the hopper-dozer the most practical plan that can be recommended. In many cases it can be used to capture these and the leaf-hoppers at the same time, especially if used when grasshoppers are still quite small and can be held by a thin layer of coal tar used on the simple flat sheet of iron. When larger they need a deeper layer of coal tar, or a pan of water with a covering of coal oil on it. A cheap and simple plan for this purpose, costing but from \$1.50 to \$2, was described many years ago by Prof. Riley. It consists of a strip of sheet iron 8 or 10 feet long, turned up 1 inch in front and 1 foot behind, with pieces soldered in at the ends (or made of wood), and hooks placed in front at the ends for the attachment of ropes. If to run on rough ground it will be better to put runners 1½ or 2 inches high underneath. Into this put a layer of coal tar half an inch deep, or water and kerosene. It can be drawn by a boy at each end, or by horse power if preferred."

## Experimental Farms.

"To treat pastures and meadows for grasshoppers and leaf-hoppers, it would seem from present experience the best plan to run over all grass lands early in May with the simple dozer described for leaf-hoppers (a piece of sheet iron 8½ feet long and 2 feet wide, was coated on the upper side with coal tar, and lying flat on the sod was dragged along by means of three cords, one fastened at each end and one in the middle). Pastures should be treated a second time about the middle of June. For meadows, the second treatment may follow hay cutting, if insects are abundant, and then if grasshoppers appear in July in numbers, resort to the deep hopper-dozer described above." (*Bull. 14, Iowa Ag. Exp. Station, p. 176.*)

Summarizing the results of his experiments with leaf-hoppers, the same writer says:—"Experiments with hopper-dozers for grass leaf-hoppers show that this method can be used very successfully in capturing the insects, that the simplest form, a flat sheet of sheet iron was most satisfactory, that one application resulted in adding 34 per cent to the crop of hay on a plot experimented on, and in one experiment leaf-hoppers were captured at the rate of 376,000 per acre."

These results are most striking, and one cannot but feel convinced that it would pay well to adopt systematically such a simple and cheap method of freeing pastures of the myriad insects which reduce the yield every year.

The use of hopper-dozers in the Western States for the destruction of locusts is recognized as one of the standard methods of fighting these injurious insects, and has been attended with marked success. The other method which is relied on is ploughing the land where the eggs have been deposited, so as either to bury them deeply, so that the young cannot emerge in spring, or so as to expose them under unnatural conditions, to the frosts of winter or their numerous predaceous enemies. In the thickly settled portions of Canada where as a rule stubble fields are regularly ploughed up before winter, we as a consequence do not suffer from locust plagues so frequently as is the case in the west.

The use of insecticides such as Paris green for locust attacks is seldom a practical remedy except on limited areas. In response to some who have applied for the receipt of the bran and arsenic remedy, I extract the following from Prof. Clarence Weed's useful little work, "*Insects and Insecticides*:"—"A mixture which has been successfully employed, consists of arsenic, sugar, bran, and water, the proportions being one part, by weight, of arsenic, one of sugar and five of bran, to which is added a certain quantity of water. The arsenic and bran are first mixed together, then the sugar is dissolved in water and added to the bran and arsenic; after which a sufficient quantity of water is added to thoroughly wet the mixture. About a teaspoonful of this mixture is thrown on the ground at the base of each tree or vine (in gardens and orchards) and left to do its work."

I found by experiment that the poison works slowly but is very effectual.



## GRANARY INSECTS.

When visiting the Chicago Exhibition, I was requested by the Executive Commissioner for Canada to examine the grain exposed in the agricultural trophy and to report to him whether it would be safe to distribute samples of it to farmers who had made application for it, and to use the straw when taken from the trophy for packing purposes. The following is a copy of my report:—

### REPORT UPON INSECT PESTS IN THE CANADIAN EXHIBIT OF GRAIN AT CHICAGO.

J. S. LARKE, Esq.,  
Executive Commissioner for Canada,  
World's Fair, Chicago.

SIR,—I have the honour to report as follows with regard to my examination of the exhibits in the Canadian Court of the Agricultural Building at the World's Fair as requested by you. I examined them carefully as well as similar exhibits situated near them in the building. I found that the greater part of the injury was due to the attacks of the Grain Moth (*Gelechia cerealella*, Oliv.). The Rice Weevil (*Calandra oryzae*, L.) and the Common Grain Weevil (*C. granaria*, L.), were also both found in smaller numbers. These were chiefly in jars of grain which had been imperfectly closed. In reply to your question whether it would be safe to use the straw of this infested grain for packing purposes and the grain for distribution, I would say that it would be safer and cheaper not to use the straw for packing, because it would be first necessary to disinfect it by inclosing it in some tight receptacle and then submitting it to the fumes of bisulphide of carbon. It would be wiser also to treat all grain required for distribution with the same chemical when, I think, there would be no danger in distributing the grain. As a matter of fact, both the Grain Moth and the Grain Weevils are now well established in all parts of the world where the climate will allow them to propagate. In Canada this is not the case and there is no doubt that our exhibit has been infested from contiguous exhibits in the Agricultural Building. Grain distributed in Canada will do no harm because the insects will not propagate here in injurious numbers, and samples sent to southern countries, even if infested, will only take insects to those countries which already exist there.

I take the liberty of forwarding you herewith a copy of my report for 1889, containing an article upon Granary Weevils. See pages 71-83. I have marked one or two passages, giving a description of the method and apparatus necessary in disinfecting grain, to which I would draw your attention. I may mention that Mr. Chittenden, a member of the entomological staff now in charge of the United States Government exhibit at Chicago, has been making a special investigation of these Granary Weevils and other pests to be found in the exhibits now at Chicago. Prof. Riley the United States Entomologist, by whose instructions this investigation is now being made, will also be in Chicago during this week, as Mr. Chittenden informs me he has been telegraphed for. As requested by you I called upon Mr. Buchanan to explain our position in this matter but was unable to see him until the day I was leaving, when I called again in company with Mr. Chittenden and told him practically what I now report officially to you.

OTTAWA, Oct. 13, 1893.

It will be observed that only three kinds of insects were mentioned in the above report. But Mr. F. H. Chittenden of the United States Division of Entomology, who was specially charged by Prof. Riley with the work of examining the food products exhibited at the Exposition, for the purpose of investigating the nature and ravages

## Experimental Farms.

of any insects which might be found, made observations upon a much larger number of species. This investigation was undertaken as a precautionary measure in case some dangerous enemy might be introduced, and Prof. Riley announces his intention of issuing a bulletin on the subject, covering at the same time other information on insects affecting stored products.

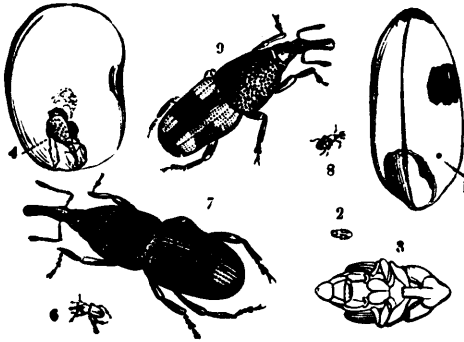

Fig. 8.—9 Rice Weevil. 7 Common Granary Weevil.

The three insects mentioned above occasionally cause slight damage to stored grain in Canada, but they cannot be considered as serious enemies. THE GRANARY WEEVILS belong to two species, the Rice Weevil, Spotted Weevil or Black Weevil of the South (*Calandra oryzae*, L.) and the Common Granary Weevil (*Calandra granaria*, L.) These are small, dark coloured, narrow beetles rather more than  $\frac{1}{2}$  of an inch in length, with their heads prolonged into a slender snout. These insects, both in the grub state and as perfect beetles, sometimes destroy considerable quantities of grain in granaries. The eggs are laid in holes which the females bore in dry grain with their slender beaks. After hatching, the young grubs feed on the contents of the kernel where the egg was laid, complete their growth and turn to beetles inside the same grain, which does not show any sign of injury until the beetle emerges, when it is found that the greater part of the inside has been consumed. The beetles themselves do even more harm than the grubs, for they also feed on the grain and live for a long time, so that in hot climates, when grain is kept in store for a length of time, the injury may be considerable; but in Canada the cold of our winters stops the development and destroys the mature beetles if exposed to it.

THE GRAIN MOTH (*Gelechia cerealella*, Oliv.). This insect is better known as the Angoumois Grain Moth but is also called in the South, the Fly Weevil. It has been treated of by various entomologists. Prof. Howard E. Weed (*Bulletin 17, Mississippi Exp. Station*) says:—"The first extensive account of the habits of this insect was given in 1736 by Réaumur, a French naturalist, who found it very destructive to barley at Lugon (France). In 1760 it was very destructive to wheat in the Province of Angoumois, and Harris states that, 'The afflicted inhabitants were thereby deprived not only of their principal staple wherewith they were wont to pay their annual rents, their taxes and their tithes, but were threatened with famine and pestilence from the want of wholesome food.' Two members of the Paris Academy of Sciences were commissioned by the French Government to visit the province of Angoumois to investigate the habits of this insect and since the publication of their report the insect has received the popular name of the 'Angoumois Grain Moth.' The first record of the appearance of this insect in America was in 1768."

The Grain Moth has never developed in Canada even to the same extent as the Granary Weevils, although occasional instances of its occurrence have been brought to my notice. In the Southern States, where it is very abundant, the moths fly from the granaries and lay their eggs upon the ripe grain in the fields; the eggs or young caterpillars are thus carried back into the granary and great loss frequently ensues. This never takes place in Canada. The small eggs are deposited in groups of from 15 to 25, generally upon the underside of the grain or in the crease of the kernel. They are white at first, turning pink before hatching. The young caterpillar is only a millimetre in length, pink, slender and covered with long hair. As a rule, only one enters a kernel, where it remains until full grown, when it is about  $\frac{3}{4}$  of an inch in length and dirty white in colour. It then changes to a brownish chrysalis, from which subsequently the small moth issues. This is rather larger than, but at first sight very much like, the Carpet Moth (*Tineola biselliella*, Hum.) The wings expand about  $\frac{1}{2}$  inch, are of a satiny cream colour and bear a few dark spots on the forewings, which are narrow, pointed and fringed. The hind wings are darker,

and have much wider fringes. Prof. Weed states that there are at least eight generations in a year in Mississippi, but that doubtless there are only two in the Northern States, as recorded by Harris.

Since the appearance in the press of notices of the infestation of the grain at Chicago, specimens of various insects injurious to stored grain, have been sent in, as well as those mentioned above, with inquiries as to the best way of treating them: (1) The Lesser Grain beetle (*Silvanus Surinamensis*, L.), a small, flat, brown, beetle with very narrow body and short legs,  $\frac{1}{2}$  of an inch in length. This insect is easily recognized by the saw-like edges and three prominent ridges of the thorax. This was sent in large numbers from a store-house in Toronto. (2) The Least Grain beetle (*Silvanus advena*, Walt.), found abundant in flour at Ottawa. (3) The Meal Snout Moth (*Asopia farinalis*, L.), from several places; and (4) *Ptinus fur*, L., a small brown beetle, somewhat oval in shape with long slender antennae, which was received from Orillia and Toronto as occurring abundantly in flour. This insect attacks numerous specimens of plants and insects in collections, and it is there probably where its ravages have attracted most notice, but the small yellowish curved larvæ about  $\frac{1}{3}$  of an inch in length, doubtless feed on many dry substances of animal or vegetable origin.

**Remedies.**—Should grain at any time be found to be infested by any of the above pests, they may all be treated in the same manner. The surest remedy is to subject the grain to the vapour of bisulphide of carbon. This chemical vaporizes when exposed to the air, and the vapour is so much heavier than air that it will run down through the mass of any grain upon the top of which it has been placed, and will destroy all contained insects. The quantity required is small, 1 lb. being enough for each ton of grain. The method of using it, is to inclose the grain in a perfectly tight bin, then pour some of the bisulphide into a shallow vessel, and place it on the top, keeping the bin tightly closed for forty-eight hours. The bisulphide does not injure the grain, but it must be used with care, on account of its extreme inflammability. The grain should then be emptied out, out of doors, and no flame, lighted cigar or pipe, must be brought near it, or an explosion will occur. In large quantities bisulphide of carbon costs only about 20 cents a pound.

With regard to the treatment of mills Prof. Weed writes as follows:—"To destroy insects infesting mills, quantities of bisulphide should be placed in open dishes or plates in various elevated parts of the mill, commencing the application in the basement and going upwards. The mill should then be closed as tightly as possible, and a watchman employed to see that no lights are brought near until the odour of the bisulphide has passed off. If a mill is thus treated on Saturday afternoon, work can be resumed as usual on Monday morning. The bisulphide should not be applied to unpainted floors or walls, as it will sink into the wood and it will take some time before the fumes will have passed away." (*Bull. 17, Mississippi Exp. Station, p. 14.*)

## ROOT CROPS.

### TURNIPS.



With the exception of Locusts in Western Ontario, the insect enemies of root crops do not appear to have been so noticeable last season as usual. The only complaints of the attacks of the TURNIP FLEA-BEETLE (*Phyllotreta vittata*, Fab.), were received from a few localities in New Brunswick, Eastern Ontario and Quebec. The single report from British Columbia was: "There are no Flea-beetles this year."

The Turnip Flea-beetle. This well known pest is shown very much enlarged at Fig. 9.

The remedy recommended, and found successful in all instances but one, was dusting land plaster or ashes and Paris green (50 lbs. to 1) over the young plants early in the morning. In the instance of failure referred to, I found that the ashes and Paris green had been mixed and carried to the field in the evening and left

## Experimental Farms.

exposed to the dew till the next morning; consequently, when applied, it did not remain on the leaves because it was not, as it should have been, perfectly dry, so as to fall upon the plants as a fine powder, when it would have remained on the seed leaves and had the desired effect.

The North-west RED TURNIP-BEETLE (*Entomoscelis adonidis*, Fab.), treated of fully last year, was much less abundant than previously, only one lot of specimens having been received, and these came without the address of the sender. Mr. J. A. Smith writes from Saskatoon: "I have seen none of the Red Turnip-beetles this season. Crop prospects good." Mr. Thomas Copland, of the same place, however, observed a few, and has been fortunate enough to discover the native food plant. He writes: "July 6.—*In re Entomoscelis*, the beetles made their first appearance here on 17th June. I send you specimens of their wild food plant, which is a common weed. I have found them feeding a little on other weeds, but the kind sent is their chief wild food. This year the beetles are attacking cabbages. I intended to sow no turnips or radishes, so as to starve them, but I have sowed some a few days ago to poison them on." The plant sent by Mr. Copland was the Small-flowered Prairie Wall-flower (*Erysimum parviflorum*, Nutt.), which, like the turnip, radish and cabbage, belongs to the Cress family.

The Turnip Aphis is mentioned in the Ontario Crop Returns for November, as having injured the turnip crop. Specimens were sent to me from Ottawa by Mr. Thomas Nicholson, which had infested his Swede turnips. This is a troublesome insect to treat, but successful experiments have been made with Kerosene emulsion in a crop where the injury was restricted to small areas. This is usually the case when the attack first begins, and the presence of the insects as a rule can be detected if looked for during the operations of thinning and cultivating the turnips.

## POTATOES.

THE COLORADO POTATO-BEETLE (*Doryphora 10-lineata*, Say) has been noticeably less prevalent this year in Eastern Ontario than usual, probably owing to the wet season. In Western Ontario, in the sections where drought was felt, it was abundant and very injurious, particularly to egg plants. In the Maritime Provinces also it was plentiful. It is only of late years that this insect has extended its ravages into Nova Scotia and Prince Edward Island, and the farmers there have not yet learnt fully the value of Paris green in destroying it. In June last the *Gold Hunter and Farmer's Journal* of Caledonia, N.S., wrote: "Kindly send formula and directions for using Paris green for exterminating potato bugs. Our people are sorely pestered with them, but are afraid to use Paris green."

*Reply*: "The proper and only practical remedy for the Colorado Potato-beetle is Paris green used in the proportion of 1 lb. to 160 gallons of water, that is, 1 oz. to 10 gallons. There is no necessity to use it stronger, and with ordinary care, there is not the slightest danger in employing this material as an insecticide. Of course, it is a poison if eaten by animals or human beings, and, therefore, must be kept in a safe place and not used carelessly." It can also be used as a dry application: 1 lb. of Paris green may be mixed with 50 lbs. of perfectly dry land plaster, air slaked lime, common flour or sifted wood ashes.

The Colorado Potato-beetle has never done much injury in Manitoba. Mr. Richard Waugh has referred to it occasionally during the last four or five years; but speaks of it as a minor pest only of uncertain occurrence. During the last season, however, it seems to have rather increased. Mr. W. G. Fonseca writes, "August 9. The Colorado bug has been invading this province by slow measures for three years past. This season has seen the invaders in increased numbers, nearly all my potatoes have disappeared. Tens of thousands have been destroyed. They are now fully winged, and there is danger of their spreading."

In addition to the ordinary Colorado Potato-beetle, the Cucumber Flea-beetle (*Epitrix cucumeris*, Harris), was the cause of considerable injury to potatoes by perforating the leaves. This occurred in many localities from Ontario to New

Brunswick. Specimens were also received of two kinds of BLISTER BEETLES, with notes of their attacks upon potatoes. *Epicauta Pennsylvanica*, DeG., was received from Mr. E. Walker, of Tuscarora, Ont., which was eating the leaves of potatoes and mangels in his neighbourhood and doing a great deal of damage on account of its abundance. The same insect was received from Mr. F. Mitchell, of Innerkip, Ont., with this statement: "I send you by mail specimens of a most destructive beetle, which has this season come upon us in myriads; they are by no means local, as they extend southward as far as Baltimore, Ont., at least; for in reports from there, I find that florists there are suffering loss to the same extent as myself. They devour the petals of almost every kind of flower. Can you inform me what they are?" The same beetle came also from Mr. A. Mackay, Indian Head, as a depredator on beans. My reply to Mr. Mitchell was:—"The insects sent with your letter are the Black Blister beetle, and I have had them sent in from several places. These beetles seldom occur in large numbers for more than one season, and I think it is unlikely that you will be troubled again next year. They are not, however, an unmixed evil, for in their grub state they live as parasites on the eggs of locusts and grasshoppers. I know of no remedy which you could apply for the protection of your asters. When they attack garden crops, as beets, mangels, potatoes, &c., dusting the plants with Paris green and plaster, 1 pound to 50, has been found successful. This, however, would not do for flowers, and the only thing which occurs to me is to sweep them off the plants by means of a hand-net mounted on a short handle."

Mr. Walker was advised to use Paris green in the same proportions, or for a liquid application to mangels, 1 pound in 100 gallons of water, in which had been previously dissolved a pound of soap. The latter must be added so as to make the solution adhere to the leaves of such plants as mangels, turnips, cabbage, etc.

The other Blister-beetle mentioned was the Gray Blister-beetle (*Macrobasis unicolor*, Kirby), of which Mr. A. Laperrière writes from Entremonts, Lake Temiscaming:—"I have just found a black beetle in great numbers in my field of potatoes, which they are devouring voraciously, leaving only the stems. I have not heard of it in other places, but here and on my son's place, it is causing much havoc, and seems to work much more quickly than the old yellow striped Potato-beetle." The habits of this beetle are very similar to the Black Blister-beetle, and like that species, it feeds upon a variety of plants. It may frequently be found in the woods feeding upon the Tall meadow rue (*Thalictrum Cornuti*, L.) and Leguminosæ.

## FODDER CROPS.

Fodder crops have been exceptionally good in Canada this year, and very few complaints have been received of either fungus or insect injuries. The new fodder plant, the English Horse bean, recommended by Prof. Robertson, the Dominion Dairy Commissioner, has been largely grown for mixing with Indian corn and the heads of sunflowers in the preparation of a complete ensilage; and the few reports of injury to fodder crops have been in connection with this plant. The small white BEAN LEAF-HOPPER (*Empoia fabæ*, Harris) has occurred in several places and done much injury by puncturing the leaves and causing them to turn black and wither. As the beans were grown this year mixed with the corn, it was difficult to treat this insect at the time it appeared, in the middle of August. The most satisfactory remedy for the leaf-hoppers is to spray the infested plants early in the season before the insects have developed wings, with Kerosene emulsion. Should this pest become numerous, it will be necessary to watch for its appearance and spray the crop, while the insects are in their larval condition when they have no wings.

BLISTER-BEETLES have also infested beans to a serious degree in some localities, as shown by the following:—

"July 1.—I am mailing you under separate cover a number of beetles (these were the Western Blister-beetle, *Cantharis Nuttalli*, Say) that have proved very destructive to our beans. The specimens were handed to me by Mr. R. Norton at Brandon.

## Experimental Farms.

Ashes appear to drive them away for a time. They eat the plants right to the ground."—S. A. BEDFORD, *Brandon, Man.*

"July 6.—*Cantharis Nuttalli* made its appearance on my beans on June 19, but we have had no such immense numbers of them as last year yet."—THOMAS COPLAND, *Saskatoon, Sask.*

"July 7.—I inclose you a few insects that are doing considerable injury in the North-west this year. They attack the Siberian pea tree (*Caragana*), beans, tares and peas, and in other places garden vegetables. I have used Paris green with good effect. Last year a few were found in our tares; so far this is the only pest that has troubled us much this year. It seems to especially appreciate Prof. Robertson's horse-beans."—ANGUS MACKAY, *Indian Head, Assa.*

The insects sent were *Cantharis Nuttalli* and the Black Blister-beetle (*Epicauta Pennsylvanica*, DeG.). It was probably the latter which was referred to as attacking garden vegetables.

"July 4.—I send you to-day some insects, and shall be very much obliged for any information you can give me about them; they have appeared on my horse-beans which I have planted with corn. They eat the leaves only, beginning on the outer edge and leaving the stalks and veins of the leaves. They have appeared on a spot three or four rods square. I do not think they breed on the plants. If these are likely to prove destructive, please tell me what I must do to destroy them. They do not eat the corn which is planted in the same hill as the beans."—PERCY G. MILLS, *Sussex, N.B.*

The insects sent by Mr. Mills were the Gray Blister-beetle (*M. unicolor*, Kirby).

The remedy recommended for blister-beetles on beans in my report last year is as follows: "In looking over all the reports received I find that they are all dated in July, so that the time of injury to this crop will seem to be limited to a few weeks, and if a sharp watch were kept for their appearance, the ravages could be controlled, either by sweeping the crops with a net mounted on a handle or by beating the beetles into a pan containing some water with a little coal-oil on the top. When the area attacked is too large for this, spraying promptly with Paris Green, 1 lb. to 100 gallons of water (or dusting with 1 lb. of Paris green to 50 of flour) would destroy them."

## VEGETABLES.

Garden vegetables in Eastern Ontario this season have not suffered very severely from insect enemies, although the abundance of some has made up for the non-appearance of others. The root maggots of the cabbage and onion were very destructive. In the case of the cabbage, experiments with Kerosene emulsion and Hellebore tea poured round the roots of infested plants were to a large measure successful. The Onion Maggot was also experimented with by sowing common salt along the rows and in the bottom of the drills: the results were conflicting, but on the whole quite encouraging, and it is proposed to continue the experiments next year.

Cabbages this year in Eastern Ontario had an almost entire exemption from the attacks of the Imported Cabbage Butterfly (*Pieris rapæ*, L.).

Beans were damaged in many places during June by Cut-worms of several kinds, *Carneades ochrogaster*, Gn., being the most generally distributed species. This caterpillar has a very wide range of destruction, specimens having been received from Cape Breton to Calgary, Alta. The protection of freshly set out herbaceous plants by wrapping a small piece of paper around the stems has been highly commended by several to whom this remedy had been suggested. Celery was received which was heavily infested late in the season by an Aphis. It was too late, the crop having been dug, to apply the usual remedies for plant lice.

Tomatoes were injured in some places by plant bugs and a report was received from Mr. W. G. Baylay of Ottawa, of the girdling of the main stem by the Buffalo Tree-hopper (*Ceresa bubalus*, Fab). The insects were, however, fewer than when he recorded the same damage in a previous year. The Tomato Stalk-borer (*Hydræcia cataphracta*, Grt.) was somewhat prevalent in the Ottawa district, the larvæ being

found in the stems of hollyhocks, sunflowers and other succulent herbaceous plants as well as of tomatoes.

Some imported fruit of early tomatoes was sent in from Mr. W. E. Saunders, of London, Ont., containing specimens of the larvæ of the Corn or Bull-worm (*Heliothis armiger*, Hbn.). These had been imported from the United States by Mr. E. West, florist of London, who stated that he had found over a dozen in each crate of tomatoes. Although *Heliothis armiger* occurs in Canada, I have never in this country seen this injury to tomatoes in the field, which is well known in the States.

The Tomato Sphinx (*Protoparce celeus*, Hbn.) was reported as rather abundant in central Ontario, but the actual damage by this large conspicuous insect was slight. A few inquiries were as usual made as to any danger from being stung by the caterpillar when hand-picking it. This, of course, as can easily be ascertained, is utterly impossible; the caterpillar is perfectly harmless.

Early planted tomatoes were somewhat injured by the Colorado Potato beetle, before the potatoes came up. This beetle also is so much attracted by the egg-plant, as to render it almost impossible to grow this vegetable in many parts of Ontario, without covering the plants.

#### ANOTHER VEGETARIAN CARRION BEETLE

(*Silpha bituberosa*, Lec.).

*Attack*.—Shining black, very active, grubs,  $\frac{3}{4}$ -inch in length, like wood lice, which devour the leaves of pumpkins, squashes and plants of the Spinach family.

A new attack of some interest recorded this year for the first time is that of the larvæ of one of the native carrion beetles upon plants of the Gourd and Goose-foot families in the North-west Territories. In Europe a very similar insect belonging to the same genus is sometimes a serious pest in mangel and beet-root fields. As these last-named plants also belong to the same large family, the *Chenopodiaceæ* or Spinach family, it is not impossible that as the North-west is settled up, this new pest may become troublesome, and it is fortunate that its habits have been found out before it does so. My esteemed correspondent, Mr. Thomas Copland, who has assisted me frequently with his careful and reliable observations, when on the look-out during the past summer for the larvæ of the Red Turnip beetle, found larvæ of the Carrion beetle mentioned. He writes from Saskatoon, N.W.T.:—

"June 5th.—I inclose you a few larvæ which I suppose may be those of *Entomoscelis adonidis*, and, as I am not acquainted with the weed on which they were feeding, I inclose some with the larvæ for them to feed upon on the way and for you to identify. These insects are very active in hunting for their food if they happen to be where weeds are few and cultivated food has not yet been supplied in the gardens and fields. It is possible I may be wrong in the identity of the larvæ."

"June 17.—I send you two more plants of the weed on which I first found the larvæ of the Carrion beetle (which I thought might be those of the Red turnip-beetle when I sent them). The plants sent were the favourite food of the larvæ: but they by no means confined themselves to these. The common lamb's quarters or pig-weed (*Chenopodium album*, L.) and several other weeds were eaten, but not quite so freely as the specimens sent. The larvæ are remarkably active and drop from the food-plants when disturbed, hiding under them or seeking crevices in the ground. I will let you know if they attack any cultivated plants. I have heard of similar, probably identical, larvæ attacking the young squash vines; but, as our vines are inclosed, I cannot say whether they are liable to attack or not."

The weeds sent were the wild North-west plant *Monolepis chenopodioides*, Moq., which also belongs, like the lamb's quarters, to the *Chenopodiaceæ*.

Referring to the above letters, Mr. Copland wrote on July 6th:—"Yours of the 28th June is to hand. I have, since receiving it, recognized and captured a specimen of the *Silpha* beetle. I have not found the larvæ on any cultivated plants, but did observe that they were rather indiscriminate feeders, and the succulent condition of the plant seemed to have everything to do with the choice, except in the case of the *Monolepis chenopodioides*, which is their favourite; they have not yet touched my beets. I will keep a look out for a second brood."

## Experimental Farms.

About the same time, I received more specimens of this insect from the same place from Mr. Geo. L. Smith :—

“ June 17.—I mail to your address to-day a packet containing a number of insects which I discovered to-day eating my squash and pumpkin vines. Some of the vines they had almost destroyed. When disturbed, they drop to the ground and hide under leaves or earth. They are the first I have seen, and they have not been working, I think, more than a couple of days. Let me know what they are and give me what information you can.”

When received these larvæ were nearly full grown, and when placed in a breeding jar, and provided with leaves of lamb's quarters and beet-root, fed freely upon them until ready to pupate. They fed at night and kept out of sight by day. The last date when they were seen feeding was 12th June, and on 24th the first fully developed beetle appeared. The pupæ were white and were found in little cells about 3 inches beneath the surface of the ground.

The larvæ are entirely black, shining, from  $\frac{1}{2}$  to  $\frac{3}{4}$  of an inch in length, rounded above, flattened beneath,  $\frac{1}{5}$  inch wide and tapering to each end. The body is divided distinctly at the segments like a woodlouse or “sowbug” (*Oniscus*).

The beetle is dull black, flattened, having a small prominence on each wing case towards the end, and with the thorax covered with fuscous hairs.

It is in habits and appearance very much like the European Beet Carrion Beetle (*Silpha opaca*, L.), which also occurs in North America, and like that species, probably has the dual habit, both in the larval and perfect states, of feeding sometimes on carrion as well as on vegetable matter. I am indebted to Dr. George H. Horn for the identification of the imago.

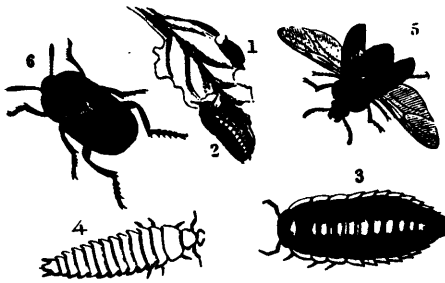

Fig. 10.—The Beet Carrion Beetle.

These two species are distinguished as follows :—

Form elongate oval (as in *trituberculata*) ..... *opaca*.

Form oval (as in *ramosa*) ..... *bituberosa*.

Of the latter Dr. Horn remarks: “It is a much broader species and in form more nearly resembles *inæqualis*.” In *opaca*, the middle costa of elytron is given as extending nearly to apical margin, while in the other species it does not attain the apical margin.

Curtis's figure of the Beet Carrion Beetle (Fig. 10) kindly lent by Messrs. Blackie & Son, of Glasgow, at Miss Ormerod's request, gives so good an idea of the different stages, that Nos. 1, 2, 4 and 5 might almost answer for those of *S. bituberosa*.

**Remedies.**—Should this insect develop into a pest of Chenopodiaceous plants such as beet-root, mangels and spinach, it will be necessary to protect the plants during the first part of June until the larvæ have attained their full growth, by dusting them with Paris green and some dusty diluent such as flour, land plaster, or ashes (1 part to 50), or in the case of spinach it may be necessary to plant a more attractive food-plant near by as a bait, to be afterwards destroyed with the infesting insects. For this purpose *Monolepis* or lamb's quarters should be tried. In the case of young pumpkins or squashes, as the season when the larvæ attain full growth is so early, these plants could be easily protected by keeping the hills covered with cheese cloth or paper after dusting the plants with the poison mixture above mentioned. It is not likely that the mature beetles will attack plants.

## FRUITS.

The crop of large fruits this year has not been remarkable for excellence. In Ontario the November bulletin says :—“The August bulletin did not speak cheerfully regarding the prospective apple crop, and reports to hand are confirmatory. The Codling moth has done much injury and so have the scab and drought, hence a



considerable quantity of the unusually light yield of apples are wormy, spotted and small." In British Columbia the orchards on the mainland have been badly infested with Apple Aphis (*Aphis mali*, Fab.) and the Oyster-shell Bark louse (*Mytilaspis pomorum*, Bouché). On Vancouver Island Mr. John Tolmie reports "The fruit crop is poor this year, mainly due to heavy showers just as the fruit was forming; small fruits have, however, done well." Mr. G. A. Knight, of Victoria, B.C., also states that the Woolly Aphis (*Schizoneura lanigera*, Hausm.) is now very abundant on Vancouver Island in apple orchards, and that the Cherry-tree Slug (*Selandria cerasi*, Peck.) Fig. 11, has been this year extraordinarily abundant. This insect



Fig. 11.—The Cherry-tree Slug.

was also complained of to a certain extent in Nova Scotia and Ontario. At Ottawa, besides cherry trees, the larvæ disfigured ornamental hawthorns and the oak-leaved mountain ash. It is easily treated with a weak application of Paris green, or may be dusted with freshly slaked lime.



Fig. 12—The Shot-borer.

THE SHOT-BORER (*Xyleborus dispar*, Fab.), I fear, is again on the increase in the Nova Scotia apple orchards. Through the kindness of Mr. W. H. Woodworth, of Berwick, N.S., and Mr. T. E. Smith, of Cornwallis, N.S., I am in possession of a large quantity of facts as to the depredations and habits of this injurious insect, and hope, at an early date, to have more definite information as to remedies than is as yet available.

Mr. T. E. Smith sent to me from North Sydney, Cape Breton, some larvæ which were abundant there upon apple trees. These, when received, had spun their cocoons; of which specimens were submitted to Prof. J. A. Lintner, and he reports: "There is hardly a doubt but that the little cocoons sent me are those of *Micropteryx pomivorella*, Pack."

THE RED-HUMPED CATERPILLAR OF THE APPLE (*Edemasia concinna*, Sm. & Abb.) was rather abundant upon young apple trees at Ottawa, and specimens were also sent by Mr. E. Hutcherson from Ladner's Landing, B.C. These are the first specimens I have seen from British Columbia.

The curious caterpillars of the Unicorn Prominent (*Cælodasys unicornis*, Sm. & Abb.) and of the Hag-moth (*Phobetron pithecium*, Sm. & Abb.) were sent as apple insects by Mr. W. J. Kerr, from Smith's Falls, Ont.

A pest which I found to be very abundant in the peach orchards round St. Catharines was the Peach Bark-beetle (*Phænotribus liminaris*, Harris). This was first brought to my notice by Mr. C. E. Fisher, of Queenston, and I have later received specimens and facts bearing on the life history both from that gentleman and Capt. James Sheppard. Some experiments which are being carried on to control this insect are not yet completed, so a report upon them is deferred for the present.

Most of the fruit insects reported this year have been enemies of the apple.

THE APPLE-TREE APHIS (*Aphis mali*, Fab.).—From British Columbian reports this insect is committing serious injury in the apple orchards. In the East it is seldom that this insect develops in sufficient numbers to be ranked as a first class pest, but this season a large number of reports have been received from British Columbia complaining that even old trees had been killed. Mr. John S. Warren, in a letter to the *Orillia Packet*, gives an account of the condition of the orchards at Okanagan Mission, B.C., in which he speaks of serious loss from the Apple Aphis. Mr. J. H. Christie also sends specimens of Aphis infested

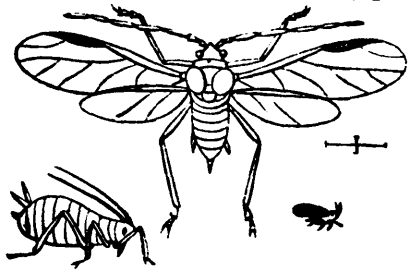

Fig. 13.—The Apple Aphis.

twigs from the same place, of which he says: "The contents of this parcel will, I think, be somewhat of a surprise to you. The twigs sent were cut from three different orchards from trees six to eight years old, and you will have a better idea of the state of affairs here when I tell you that several ten to fifteen year old trees have been destroyed during the last year by Aphis. Large

## Experimental Farms.

magnificent trees now stand blackened and disfigured monuments of the negligence of the owners. This appears to be a new pest, trees of the old-timers never having suffered before." Mr. G. M. Kinnear, of Ducks, B.C., also sent specimens of Apple Aphid with report on their serious injury to his trees.

Late in autumn the females of the Apple Aphid lay small black eggs on the twigs of the apple trees. These eggs do not hatch until the following spring. In *Insect Life* (vol. VI. p. 152), Prof. F. M. Webster, of Ohio, announces the important discovery that in the autumn this insect also migrates to fall wheat, where it propagates enormously and does much harm. Perfect females then return to the apple trees to deposit their eggs. The most satisfactory remedy I have found to be the Kerosene emulsion which should be sprayed on the trees early in spring just when the leaf-buds are bursting. As large numbers of eggs are frequently laid on the trunks of trees, these should also be well sprayed.



Fig. 14.—The Oyster-shell Bark-lice.

THE OYSTER-SHELL BARK-LOUSE (*Mytilaspis pomorum*, Bouché) is probably the worst pest of the apple tree, concerning which this year, as well as every other year, there has been much inquiry from every province of the Dominion. The life history of this insect is remarkable. About 1st of June, minute white, mite-like insects with six legs, emerge from beneath the scales on the bark, and for two or three days, during which alone of their whole lives they have the power of locomotion, run about over the twigs seeking for a suitable place to attach themselves. They then pierce the young bark with their beaks and live on the sap of the tree. They never move from that place again. Each gradually secretes a waxy mantle and by August has transformed itself into a scale covering a cluster of eggs. These remain unchanged through the winter, and the young do not hatch until the next June.

**Remedies.**—This insect, like many others, thrives most on unhealthy trees. When detected, therefore, measures should be adopted for inducing a vigorous growth as well as for the removal of the scale insects. Spraying just before the buds open with the Kerosene emulsion will destroy many of them; but the best time, which will vary slightly in different localities, is when the young lice are active, for they are then most susceptible to injury. Prof. A. J. Cook, of Michigan, says that no fruit grower or lover of shade trees can afford to be ignorant of the Carbolic acid emulsion. He writes: "I make it just as I do the kerosene emulsion, only stronger; one part of crude carbolic acid to from 5 to 7 parts of soap solution (one quart of soft soap, or 1 lb. hard soap in two gallons of water) is of the proper strength. This is the best preparation I know of to protect against the Apple-tree Bark-lice and Apple-tree Borers. It is applied to the trunk and larger limbs by means of a stiff brush or cloth about twenty days after the trees blossom." With regard to some inquiries which have naturally suggested themselves to two of my correspondents as to how insects which only have the power of locomotion for three days or so, and then only when extremely minute, can spread so rapidly from tree to tree in an orchard, I believe the generally accepted opinion is, that this is effected through the agency of other larger insects and birds, upon which they crawl when they visit the trees, and by which they are carried to other trees.

An attack upon Apple trees which I do not think has been previously recorded from Canada is of the Otiorhynchid beetle, *Anametis grisea*, Lec. This was received from Mr. R. Z. Rogers, of Grafton, Ont., together with specimens of the way in which apple trees were injured by having the bark eaten off the young twigs. Specimens of a very similar species were forwarded from Okanagan Mission, B.C., by Mr. F. J. Watson. As these beetles are wingless and have to climb up the stems of trees attacked, any mechanical means of preventing them, such as a band of cotton batting or one of the various kinds of "tree protectors" placed around the trunks at the time when the perfect beetles are about, would prevent injury by the mature insects. In *Insect Life* (vol. IV., p. 401) reference is made to considerable damage by this beetle to young peach trees in Goodison, Michigan; the beetles hid near the surface of the ground during the day time and ate the bark and buds during the night. Similar

damage to apple trees was reported from Wisconsin in 1882. The larvæ in all probability feed on the roots of the trees.

### THE MOTTLED UMBER MOTH

(*Hibernia defoliaria*, L.)

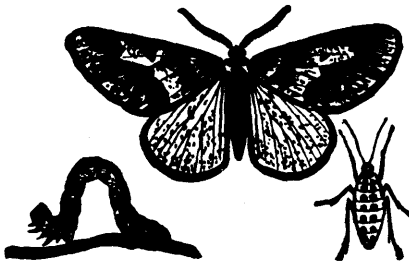

Fig. 15.—The Mottled Umber Moth.

**Attack.**—Slender loopers or “measuring worms,” found on plum and cherry trees;  $1\frac{1}{2}$  inches in length, with chestnut red heads, dark reddish brown backs, mottled with broken narrow black lines, the lowest distinct and waved; the sides bright yellow, paler beneath, including the legs. There is a dark reddish patch shaded with black, surrounding each spiracle.

Some years ago a few specimens of the Mottled Umber Moth, the well-known apple tree pest of England, were taken at Victoria, B.C., by the Rev. George W. Taylor, and since then a

few more specimens have been taken by Mr. W. H. Danby of the same place. In June last I received from the latter gentleman a consignment of caterpillars, which may be described in general as above. He wrote:—

“June 20.—I send you herewith some caterpillars which feed mostly on cherry and plum trees. This species is just now rather a prominent nuisance in orchards—what is it?” In acknowledging these specimens, it was surmised that they might be the caterpillars of the Mottled Umber Moth, and Mr. Danby was requested to be on the look out for the moths. I have since received the following notes:—

“November 10.—I think you are right as to the larvæ I sent you: for I to-day caught a fine specimen of *H. defoliaria*. This moth is very uncertain in its appearance. I have seen none since the few I mentioned to you in 1889, but I expect to get more within a week or two.”

“November 20.—I send you some very fine males of *H. defoliaria*. I took no less than 93 males, but only one female. This latter is quite the regular apterous female of the English *defoliaria*; but some of the males are very dark, and some very much suffused. I have as fine a series for my collection as it is possible to get. This moth occurs very rarely for a few years, and then like other pests is very common. All I took I got in one day, since which none have appeared.”

“December 7.—*H. defoliaria* was wonderfully plentiful this year as compared with other seasons. During June and early in July the larvæ were a pest in most plum and cherry orchards. They seemed to prefer the plum. Apple trees growing close to plum and cherry trees were not attacked; nor can I find from such inquiries as I have made, that the larvæ were seen by any one on apple trees. I will, however, make careful observations on this point next year. The moths were very abundant in the latter half of November. The sexes seemed to average 1 female to 6 males. The electric lights proved a great attraction to the males: I collected on one morning eight dozen on the walls and doorways of two hotels, which had been attracted by the lights; and more or less were to be found for several days afterwards.”

The caterpillars sent me by Mr. Danby were received at Ottawa on June 28th, and were full-grown. They pupated in a few days, most of them on the surface of the ground, but some a short distance beneath. A few specimens were parasitised by a Tachinid fly. The first moth, a male, emerged on November 27th, so that the pupal stage lasted almost five months. The pupa is smooth, dark reddish brown, nearly  $\frac{1}{2}$  of an inch in length, and has the last segment terminated with a stout spine. The male moth is of a dull ochre-brown hue, expanding  $1\frac{1}{2}$  inches, and has the upper wings dotted and crossed diagonally by two dark waved bands; the space between these is pale and bears on each wing a dark discal spot; the lower wings are paler than the upper, and like them sprinkled with brown dots and they have a dark spot near the middle. The female moth is brown with two rows of conspicuous spots down the back. The wings are almost entirely aborted.

## Experimental Farms.

I have to thank my good friend Miss Ormerod for the above excellent cut of this insect, which is the same as is used in her *Manual of Injurious Insects*, page 336.

The occurrence of this insect at Victoria is worthy of note, as in England it is one of the worst orchard pests, and will probably add one more to the already too long list of apple tree pests. Prof. J. A. Lintner, has already noted no less than 282 different species of insect enemies of the apple. Miss E. A. Ormerod says as to the food of the Mottled Umber Moth:—"The caterpillars are very abundant, and very injurious to the leafage of various kinds of fruit and forest trees, as oak, lime, &c. They have been especially noted as feeding at times on unripe cherries, gnawing away one side of the fruit." (*Manual of Injurious Insects*, p. 337.) The habits of this moth are very similar to those of our Canker-worms (*Anisopteryx*). When the moths appear in the autumn, the females crawl up the trunks of trees and lay their eggs on the branches. In this condition the insect passes the winter.

**Remedies.**—The usual remedies for the Canker-worms are applicable for this species and consist of tying sticky bandages or mechanical contrivances around the trunks of fruit trees to prevent the females from crawling up to deposit their eggs, or what will be found far more effective, spraying the trees in spring when the young caterpillars hatch, with Paris green and lime, 1 pound of each to 200 gallons of water.

An exact description of the larvæ taken from the British Columbian specimens is as follows:—

**MATURE LARVA.**—Length  $1\frac{1}{2}$  inches. Head round, bilobed at apex, chestnut red, mottled. Mouth parts darkened, dorsal region reddish brown, darkened with fine black broken lines arranged as follows: a dorsal double stripe which widens a little in the middle of each segment and is shaded with pale yellow; two narrow sub-dorsal lines, rather indistinct, and placed on a reddish field; a double lateral stripe the lower line of which is distinct and sinuous. Beneath this dorsal area the stigmatal area is bright yellow. The spiracles themselves are white, ringed with black and are in the centre of blotches of reddish brown, shaded anteriorly with black. Ventral area including thoracic feet and prolegs, pale yellow. Some specimens are much darker than others; in the darkest there is a broken supraventral stripe just beneath the substigmatal fold, sometimes running up on to it. The prolegs on 10th segment are also sometimes darkened exteriorly.

I believe the British Columbian insect to be identical with the English, as I can find no difference between either the moths or the caterpillars.

## SMALL FRUITS.

Small fruits in Ontario and Quebec have been a good crop this year, strawberries in Eastern Ontario exceptionally so, and, although various insect pests have been sent in, there are none of them which call for special mention.

**THE RASPBERRY CANE-BORER** (*Oberea bimaculata*, Oliv.) was abundant at Ottawa, as evidenced by the conspicuous injury on the young canes. The injury by this insect, however, I believe to be slight, if the grub be prevented from boring down into the canes, as can so easily be done in June by picking off the injured tips as soon as they show by fading, that an egg has been deposited. The method of nipping back the young shoots of raspberries, at this period, moreover, is in accordance with the views of some horticulturists as to the best way of cultivating the raspberry.



Fig. 16.—  
Raspberry  
Cane-borer.



Fig. 17.—The Gooseberry  
Fruit-worm, Moth and  
Cocoon.

**THE GOOSEBERRY FRUIT-WORM** (*Dakruma convolutella*, Hbn.) is reported by Mr. B. Loiselle as abundant at Ste. Philomène, Que. The only remedy which so far can be recommended for this insect, which seems to be attracting much more attention in Canada than formerly, is hand-picking the injured fruit as soon as its premature coloration shows that it is infested.

**THE CURRANT SAW-FLY** (*Nematus ribesii*, Scop.) was as usual abundant in many places, and when neglected did much harm by defoliating the bushes. Much loss

every year is due to fruit growers not recognizing the fact that if the late summer brood of this insect is allowed to destroy the leaves, because as some say, "It does not matter now, as the fruit is all picked for this year;" nevertheless, they do suffer much in the quantity and quality of the next year's crop, which is largely fed, as in all early flowering plants, from material laid up through the leaves in the previous season. The larvæ of this saw-fly are extremely easy to destroy. The first brood appears in May and for this first brood only a weak mixture of Paris green ( $\frac{1}{2}$  oz. to a pailful of water is sufficient) may be sprayed on the bushes, or a dry mixture of 1 oz. of Paris green to 6 lbs. of flour, well mixed together, may be dusted over the bushes after a shower, or when damp with dew. For the second brood of caterpillars, which appears just before the fruit ripens, Paris green must on no account be used, owing to its poisonous nature; but instead of it, white hellebore, dusted on dry, or in water, 1 oz. to a pailful of water, will be found quite effective.

Black currants were much affected by Red Spider in the districts where drought prevailed. The same pest was also very abundant on a plantation at Ottawa, where, however, it was to a large extent kept in check by numbers of one of the small Lady-bird beetles (*Scymnus punctatus*, Melsh.) (?)



Fig. 18.—Currant Span-worms and Chrysalis.

THE CURRANT SPAN-WORM (*Eufitchia ribearia*, Fitch) was also present in small numbers at Ottawa, and specimens were sent in from Mr. R. Bogue, of Moose Jaw, Assa., who writes: "July 5.—The inclosed caterpillars are doing much mischief on my currants. They first attacked wild bushes, later the cultivated ones. They have not touched the red and white currant bushes. They strip the leaves off, leaving only the fruit." Mr. W. F. Morden also writes from Morden, Man., concerning the same insect, stating that he had tried spraying the bushes with white hellebore, but that it had not worked as satisfactorily as he would have liked, and asking if there was a better remedy. This caterpillar is much more difficult to destroy than the false caterpillars of the Imported Currant Saw-fly, and it is necessary to use Paris green. As there is only one brood in the season, it is easily controlled. If it is considered inadvisable to use Paris green, the conspicuous yellow and black larvæ can be easily picked off by hand.



Fig. 19.—Moth of Currant Span-worm.

Strawberries have been little attacked, no report having been received of the work of the Strawberry-weevil (*Anthonomus signatus*, Say), this year. White Grubs (*Lachnosterna*) and true bugs have also only been reported as injurious to this crop in single instances.

Several kinds of the true bugs have been abundant in gardens, and have attracted more than usual notice. Mr. J. A. Morton, of Wingham, Ont., sent a box containing the Tarnished Plant-bug (*Lygus pratensis*, L.), and the Four-lined Leaf-bug (*Pæcilocapsus lineatus*, Fab.), which had been very destructive in his garden. He said: "They seem to be omnivorous, and attack currant and gooseberry leaves, and sage, also fennel, the leaves of *Cypripedium spectabile*, the common chickweed, this latter not so much as I would like, flowers of Gladioli very badly, when they shrivel, sweet corn kernels when young, if they can get at them." In replying, I suggested that the attack upon the last five plants named was by the TARNISHED PLANT-BUG, and upon the three first by the Four-lined Leaf-bug. The former insect (Fig. 20) passes the winter in the perfect state and attacks plants throughout the season. It is a difficult insect to combat, when, as this year, it occurs in excessive numbers. It sucks the juice from the leaves and flowers of many plants, frequently injuring the young shoots



Fig. 20.—The Tarnished Plant-bug.

## Experimental Farms.

of apple trees and annuals in gardens, its poisonous punctures causing the flowers to become distorted. Spraying the infested plants with Kerosene emulsion, or dusting them with insect powder, are the active remedies which have been attended with most success, but these cannot be claimed to be altogether satisfactory. The cleaning up of gardens and the burning of all rubbish in the autumn, which will reduce the shelters available for the perfect insects to pass the winter, are very important. Advantage may also be taken of the fact, that although during the heat of the day these bugs are extremely active, they are comparatively sluggish early in the morning, when many of them may be destroyed by beating them off the plants into an inverted umbrella or other receptacle.



Fig. 21.—The Four-lined Leaf-bug.

THE FOUR LINED LEAF-BUG (Fig. 21, natural size and enlarged,) is not injurious to as large a number of plants as the last named. It is a bright greenish yellow bug,  $\frac{3}{10}$  inch in length, with two spots on the thorax, and four black stripes down the back. The presence of this insect upon plants is easily detected by the brown spots it makes upon the leaves near the tips of the branches. This injury is most often seen upon currants, gooseberries, and mint, but also on several other plants, as weigelas, dahlias, snapdragon and sage. Mr. M. V. Slingerland has lately published a very complete account of this insect, which he has made a subject of special study. He has made the important discovery that the winter is not passed in the perfect state, but in the egg state, the eggs being imbedded in the tips of shrubs. This discovery places at any rate a partial remedy within our hands, namely, cutting off the young shoots containing the eggs and burning them. Mr. Slingerland says: "On bushes which have been infested this year the egg scars can soon be found, as the whitish tips of the eggs are quite conspicuous. After a few have been found and their characteristics noted, it will take but a few minutes to look over a bush and clip off the tips of shoots containing eggs. The eggs remain in these tips nine months, thus making it practicable to do the pruning during winter months when other work is not so pressing. The leaves will then also be off, and the egg scars can be more easily seen."

Of insects attacking the grape vine, the kinds which have been most troublesome are the Grape-vine Leaf-hopper (*Erythroneura vitis*, Harris) and the Grape-vine Flea-beetle (*Graptodera chalybea*, Illig.). Specimens of the Beautiful Wood Nymph (*Eudryas grata*, Fab.) were sent to me by a few correspondents, but more as objects of beauty than as injurious insects. On the Experimental Farm at Ottawa, Mr. Craig, the Horticulturist, records unusual injury by the Large Red-headed Flea beetle (*Systema frontalis*, Fab.). Major Roland Gregory sent me twigs of grape-vines injured by the Snowy Tree-cricket (*Ecanthus niveus*, Serv.).



Fig. 22.—The Grape-vine Leaf-hopper.

THE GRAPE-VINE LEAF-HOPPER.—This is a well known enemy of the grape vine and Virginian creeper, and is generally spoken of among fruit-growers as the "Thrip." It is about  $\frac{1}{8}$  of an inch in length, marked with red and pale yellow, as in the enlarged figure (Fig. 22). It is very active and generally occurs in large colonies, when its attacks upon the foliage are so severe that vines are frequently defoliated and the fruit is consequently destroyed. It is furnished with a sharp beak with which it sucks the juice out of the leaves, causing them first to turn white in patches and then fall from the vine. It passes the winter in the perfect state, hidden amongst fallen leaves and other rubbish. In the spring it flies to the vines and deposits its eggs, from which the injurious swarms of young leaf-hoppers hatch.

**Remedies.**—These consist of clean culture and the clearing away of all fallen leaves in autumn, so as to reduce as far as possible the opportunities of wintering near the vines. For this same reason the ground should be raked and kept smooth in autumn. The vines should be examined during the summer, and if the young insects are observed on the leaves, the vines should be sprayed with Kerosene emulsion before the insects reach their perfect development, when only they acquire wings and are able to fly.



Fig. 23.—The Grape-vine Flea-beetle.

**THE GRAPE VINE FLEA-BEETLE.**—This is a shining blue-black flea-beetle  $\frac{1}{4}$ -inch long, which sometimes appears in large numbers on grape vines when the buds are bursting, and again late in summer. The grub is of a dirty, yellowish-brown, with black shining bristle-bearing tubercles on the body. This, like the mature beetle, feeds on the foliage which it riddles with holes. Fig. 23 shows the Grape Vine Flea-beetle enlarged; the hair line at the side indicates its real length.

**Remedies.**—Dusting the vines in early spring when the beetles appear with Paris green and lime (1 lb. to 50), or spraying  $\frac{1}{2}$ -lb. Paris green to 50 gallons of water. Clean culture and the burning of all leaves and rubbish, as well as keeping the ground smooth, will prevent the mature beetles, which pass the winter in that state, from hibernating near the vines.



Fig. 24.—The Snowy Tree-cricket.

**THE SNOWY TREE-CRICKET.**—This is not so frequently injurious to the grape as to the raspberry, of which, however, Prof. Saunders (*Insects Injurious to Fruits*, p. 308) considers it the most troublesome enemy. The injury is committed by the female in the operation of depositing her eggs. These are laid in the autumn in long rows of punctures which weaken the stems so that they break easily. The young hatch out in the spring and feed upon other small insects. The injured twigs should always be cut out and destroyed. Fig. 24 shows the female of the Snowy Tree-cricket life-size.

**THE LARGE RED-HEADED FLEA-BEETLE.**—This beetle belongs to an extensive family of injurious beetles, the *Chrysomelidæ*, and is a slender beetle  $\frac{1}{2}$  of an inch in length by  $\frac{1}{8}$  in width at the widest part. The whole body is black and shining, with a dull red patch on the top of the head in front. The beetle was particularly troublesome last season and attacked a great variety of plants. Potatoes and horse-beans, many kinds of deciduous shrubs and particularly grapes were at times badly damaged. Mr. Craig found it very injurious to young grape vines at Ottawa. Its attacks were worst on those varieties which belonged to the thin-leaved grapes derived from *Vitis riparia*. The greatest damage was done to some young seedlings which were not trained on trellises and which had not been sprayed with fungicides.

**Remedy.**—Spraying infested plants with Paris green,  $\frac{1}{2}$  lb. to 50 gallons water.

## THE BLACK VINE WEEVIL

(*Otiorhynchus sulcatus*, Fab.).

**Attack.**—Snout beetles, three-tenths of an inch in length, black, spotted with white, which attack foliage of various plants. In the larval state, yellowish white grubs, with head darker, which attack the roots. It may be specially noted as bearing on the question of remedies, that the wing cases which in most beetles are separate and cover true wings, in this family are joined together, and the beetles have no wings, so that they can only reach their food plant by crawling.

Last winter I received from Mr. G. A. Knight, of Victoria, B.C., some specimens of Coleopterous larvæ. He wrote later:—

“February 25.—I received your letter some time ago, asking for some more grubs. They are now turning into beetles, so I send them on. They are from Cyclamen plants in the green-house.”

“March 31.—The weevil grubs only eat the roots of the Cyclamens and make them sickly and unsaleable. I had thrown my plants away before I received your last letter. I only grow a few Cyclamens, there being little demand for them. I raise the plants from seed every year. I think I have seen a few of these larvæ out of doors. They attack lots of other plants in the green-house beside Cyclamens.

## Experimental Farms.

Gloxinias and Adiantums they are very bad on, eating the roots of the Gloxinias and the young fronds close to the roots of the Adiantums."

The Black Vine Weevil is a rare insect in Canada. In the *Canadian Entomologist*, XXIII. (1891), page 72, Mr. W. Hague Harrington writes: "*Otiorhynchus sulcatus*, Fab., was found by me at Sydney, C.B., Nova Scotia, in August, 1884, and again in September last. It is apparently quite abundant, as at several points I found fine fresh specimens under boards, &c. Provancher states that this beetle is common in Quebec, and adds: 'We think that its larva lives in haws, as we have nearly always found it beneath hawthorns and apple trees.'" It may be noted that this last suggestion is erroneous, as the larvæ live in the soil and attack roots. In 1891 I received a specimen of this weevil from Mr. W. H. Danby, of Victoria, B.C., and later, as recorded above, specimens came from Mr. Knight of the same place. These are the only records that I know of, of the occurrence of this insect in the Dominion. In *Insect Life*, III., page 37, Mr. E. A. Schwarz says: "*Otiorhynchus sulcatus* occurs in both North America and Europe. In the latter country it has been frequently mentioned as an enemy to grape vines, strawberries and other cultivated plants. In North America, Dr. J. A. Lintner (*Second N.Y. Rep.*, 1885, p. 51) introduced it, on the testimony of Mr. S. Henshaw, as a species injurious to 'bulbs and house plants,' Mr. Henshaw's statement apparently referring to injury done in Massachusetts. Quite recently Dr. H. A. Hagen (*Psyche*, V., 1890, No. 167-68, p. 333) states that this species has injured Cyclamens in green-houses at Montvale, Mass., the flowers being destroyed, and in some instances the bulbs injured. As to the probable future course of this pest, we do not anticipate that its injury will be a very serious one, nor that it will spread very much. The species was already known from North America to coleopterists more than sixty years ago, and is confined to the extreme north-eastern portion of the country (from New York northward to Newfoundland and Nova Scotia). For this reason we are inclined to believe that it is not an imported species, but that it belongs (with the other species of *Otiorhynchus* known from North America) to the circumpolar fauna."

By a further note (*Insect Life*, IV., p. 222), it is shown that the weevil has a great partiality for ferns, and it is stated to be "still comparatively rare in this country. In Europe it has long been known as a pest attacking the grape, strawberry and raspberry, and Miss Ormerod records an instance of its having ravaged a field of mangel-wurzels in England. The beetle feeds at night and remains under shelter during the day. Its nocturnal habits render it comparatively easy to deal with. The larvæ are not so readily destroyed, but the beetles may be shaken at night from the plants infested by them or may be captured by what is known as the chip-trap process, both well known methods employed against the native Plum Curculio."

In the letter given above by Mr. Knight it is shown that this insect is capable of committing considerable injury in British Columbia, and it is probable that less careful observers have overlooked it.

## FOREST TREES.

Forest insects have not been brought before the department very much during the past season, most of the injuries reported having been to cultivated shrubs. The most serious of these is by the WESTERN TEN-LINED JUNE BUG (*Polyphylla decemlineata*, Say) upon nursery trees in Vancouver Island. Grubs were sent by Mr. G. A. Knight, of Victoria, who had found them very destructive in his nursery. He wrote: "I send you some young plants of *Cupressus Lawsoniana* to show how plants of different kinds are attacked by these pests. They are also very bad on strawberries and young cherry trees. In fact, I know nothing that they will not attack. They are also very hard on young grafts, such as Irish yews, *Cedrus Deodara* and *C. Libani*, Araucarias, etc. There appears to be no remedy for this destruction in a nursery because the plants are dead before one knows that the grubs are at work. The only way seems to dig up the plant and kill the grub."



"March 31.—I send you some more large grubs and some small ones that I found with them. A few days ago I was digging up two rows of young plum trees raised from cuttings, and found about one hundred of the large grubs and a large number also of the small ones."

In July last Mr. Knight also sent me the larvæ, chrysalides and a perfect beetle with the following note: "Last week I was forking among the roses and I found about thirty chrysalides. I forward you some of them. The grubs are playing havoc again this season."

This large handsome beetle is  $1\frac{1}{4}$  inches in length by over  $\frac{1}{2}$  inch wide. It is shaped like the ordinary June-bug, is of a tawny brown appearance with four white stripes and a short dash from the shoulders on each wing case. The colour of the wing cases is really black, but they are so covered with tawny scales as to give the beetle a brown appearance. The thorax is piceous, bears three longitudinal white stripes and is covered with tawny scales. The whole of the thorax beneath is densely covered with long silky down, which also appears above as a conspicuous tuft between the thorax and the wing cases. Abdomen beneath banded with white. A remarkable character in this genus is that in the antennæ of the males, the terminal joint is very much enlarged and curved, in this species  $\frac{3}{8}$  inch in length. It consists of seven plates closely appressed together. The larva from which this large beetle comes is a formidable enemy. When full-grown and stretched to its full length, it is  $2\frac{1}{2}$  inches in length, by  $\frac{5}{8}$  inch wide. The body is curved and white. The head pale chestnut, the mandibles black. Thoracic feet long and slender. When full grown, it forms a large cell nearly 3 inches in length by 1 inch in diameter and changes to a pupa from which the perfect beetle emerges two or three weeks later. I regret to say that for the present, I am unable to suggest any practical remedy.



Fig. 25.—Canker-worm

CANKER-WORMS, the larvæ of two Geometrid moths (*Anisopteryx vernata*, Peck, and *A. pomataria*, Harris), were very abundant in the Ottawa district last spring. Only one instance, however, came under my notice of their attacking fruit trees. They were so abundant in the woods that basswoods (*Tilia*), ashes, and maples (*Acer dasycarpum*, Ehrh.) were in some places almost defoliated. In Winnipeg they were very abundant upon the ash-leaved maples grown as shade trees. Through the commendable efforts of Mr. W. G. Fonseca, of that city, some of the residents were induced to spray their trees with Paris green, and as a consequence many trees were saved. The result of this spraying will also show itself in the future.

The NEGUNDO PLANT-LOUSE (*Chaitophorus negundinis*, Thomas).—For several years complaints have been received from Manitoba of an injurious plant-louse upon the ash-leaved maples (*Negundo*), but I always failed to obtain specimens until this year, when a letter was received through Mr. S. A. Bedford from Mr. Thomas Partington, town clerk of the town of Selkirk, Man., as follows:—

"June 9.—I inclose sprig of maple for your inspection. All the maples in the town (and we have hundreds of them planted) are covered with these lice, and we are afraid the trees will be ruined. Will you please advise me what to do. Would spraying with tobacco water do, or smoking smudges made underneath have any effect? Kindly advise us as soon as possible."

At the same time other specimens were received from the same place, from Mr. A. H. Vaughan. Both of the above were advised to use the ordinary Kerosene emulsion. Subsequently I received the following very satisfactory letter:—

"July 10.—In re insects on trees, I thank you for your letter and Bulletin 11. We tried the Kerosene emulsion and found it quite effectual. I think 9 parts of water to 1 of emulsion is a little too strong. With 20 gallons of oil and soap and 12 times as much water we have sprinkled and saved many hundreds of large trees."—THOMAS PARTINGTON, Town Clerk, Selkirk, Man.

## Experimental Farms.

# LIVE STOCK.

### THE HORN-FLY

(*Hæmatobia serrata*, Rob-Desv.).

On page 144 of my last year's report I referred to a new cattle pest which had appeared in Canada for the first time in the summer of 1892. This was the Cattle Horn-fly, *Hæmatobia serrata*, of which an enlarged representation is given here-

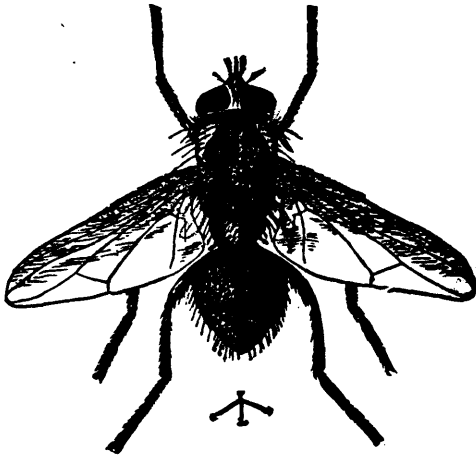

Fig. 26.—The Horn-fly. Enlarged.

with. The perfect insect is shaped much like the Common Cattle-fly or the House-fly, but is smaller and slighter, being only one-sixth of an inch in length, that is, one-third the size of those insects. The colour is dark gray with a yellowish sheen, and the body is covered with short black bristles. The head consists almost entirely of the dark-red silver-edged eyes, but bears on its lower surface the black dagger-shaped tongue which is the cause of so much torture to cattle. When not in use this organ is carried projecting in front of the head. This pest will be at once distinguished from the ordinary Cattle-fly by its smaller size, greater activity and a characteristic habit of gathering in clusters upon the horns of cattle, for which reason it is now generally known as the Horn-fly. It is also for some unaccountable reason often referred to as the "Texas fly." This is only the second year since it first appeared in Canada, but it has increased and spread so quickly, that it has produced great consternation among cattle owners. The frequent assertion that the flies or the maggots have caused the death of cattle by boring into the horns, head or body, is entirely inaccurate: the whole injury is due to the bites of the fly; however, the irritation from this cause is in many cases so great that animals fall off rapidly both in flesh and yield of milk.

The life history is briefly as follows:—The mature flies appear early in spring and lay their eggs upon the fresh droppings of cattle. These soon hatch and the maggots live in the dung while it is in a moist condition. They then turn to pupæ in or beneath the dung, and the flies again appear within two or three weeks from the time the eggs were laid. There can thus be several broods in a season.

The enormous increase and rapid spread of this insect throughout the provinces of Ontario and Quebec caused naturally enough, as stated, great consternation among stock owners and dairymen. In many districts the loss was most serious, and I have been informed by cheese-makers that during July in the several districts the amount of milk supplied by their patrons was reduced at least to half the quantity it would have been, but for these pests. A large number of letters were received asking for remedies. The following are selected to show how severe the injuries were, although from what I have been told at farmers' meetings, these do not at all indicate the real extent of the loss in many districts of both Provinces.

"July 18.—Will you kindly send me recipe for the fly pest on cattle? The milk has gone down tremendously in this section during the past week owing to the flies."—OGDEN HINCH, *Napanee, Ont.*

"July 30.—The horn-fly is playing the mischief hereabouts and we must take prompt measures to fight the pest and minimize the loss it is entailing. The falling off in milk production within a week has been about 25 per cent, in spite of the fact

that frequent rains have kept the pastures in unusually good condition for the season. The milk delivered at a local creamery has diminished in eight days or so from 21,000 to 15,000 lbs. This you will see is a serious matter."—C. H. PARMELEE, *Waterloo, Que.*

"August 10.—Please send me a horn-fly Bulletin. The flies are very bad and the cows are shrinking and other cattle losing flesh in a frightful way. I have been spraying my cows, etc., for a fortnight with Kerosene emulsion as recommended; but it seems to do but little good. Have you found anything better at Ottawa?"—SYDNEY A. FISHER, *Knowlton, Que.*

So great was the demand for information on this subject from the Province of Quebec that the French edition of Bulletin 14 on the Horn-fly was soon exhausted, and by instruction of the Honourable Minister of Agriculture, I prepared a revised edition which was printed and distributed widely. At the same time I also prepared a single-sheet illustrated circular for publication in newspapers. Copies of this circular were sent to the leading French and English newspapers, together with stereotypes of the above figure, and by that means many who would not otherwise have been reached, obtained the information required to enable them to protect their cattle. The following are the remedies which I have suggested:—

*Remedies.*—Almost any greasy substance rubbed on the animals will keep the flies away for several days. A number of experiments were tried in the field, with the result that train-oil alone, and train-oil or lard with a little sulphur, oil of tar or carbolic acid, added, will keep the flies away for from five to six days, while with a small proportion of carbolic acid it will have a healing effect upon any sores which may have formed. Axle-grease, tallow, and any such greasy substance can be used to advantage, but train-oil or fish-oil seem to be more lasting in their effects than any others experimented with.

The safest and most convenient way of using carbolic acid is in the shape of carbolized oil which can be prepared by dissolving one ounce of crystallized or liquefied carbolic acid in 1 quart of oil. Train oil, fish oil, tanner's oil, olive oil or any other fixed oil will answer; but not coal oil, as carbolic acid is not soluble in this liquid. The crude carbolic acid does not dissolve easily in fixed oils, and therefore must not be used. Instances have been reported to me of injury to animals, and the hands of operators, when the crude has been substituted for the purer form of carbolic acid.

An effective and undoubtedly the easiest remedy to apply, if a small spray pump be used, is the Kerosene emulsion; which consists of the following:—Kerosene (coal oil), 2 quarts; rain water, 1 quart; common hard soap, 2 oz. Boil the soap in the water till all is dissolved; then while boiling hot, turn it into the coal oil, and churn it constantly and forcibly with a syringe or force pump for five minutes, when it will be of a smooth creamy nature. If the emulsion be perfect, it will adhere to the surface of glass without oiliness. As it cools it thickens into a jelly-like mass. This gives the stock emulsion, which must be diluted before using with nine times its measure (that is, twenty-seven quarts) of water. It will be found to mix much more easily if done at once, before it cools. The above proportions give three quarts of the stock emulsion, which with twenty-seven quarts of water added make up thirty quarts of the mixture ready for use. This may be applied to the animals by means of a sponge, brush, rag, or, what will certainly be found most convenient where there are many animals to treat, by means of a force pump and spray nozzle. The emulsion thus made and sprayed over the cattle kills all the flies it reaches, and if repeated twice a week will almost entirely relieve cattle from annoyance. Another method of diluting the coal oil is to make the emulsion with milk instead of soap and water. Take sour milk, one part; coal oil, two parts. Mix the two thoroughly, as described above for the soap emulsion. Then dilute with water, so that one part in ten will be coal oil.

Prof. H. A. Morgan, of the Louisiana Experiment Station, has tried some experiments during the past year with various materials, the results of which he summarizes as follows:—"It was soon found that none of the solutions were of much value except Kerosene and Fish-oil emulsions, and after a third trial, all were discarded except these. At this time the Fish-oil emulsions had shown superiority

## Experimental Farms.

over the Kerosene, and further trials soon showed that animals after four or five days from time of spraying with Fish-oil emulsion were free from attack of flies, while those upon which Kerosene emulsion had been used were more or less annoyed." (*Louisiana Exp. Station Bull., 2nd series, No. 22.*) Fish-oil emulsion differs from Kerosene emulsion only in the substitution of fish-oil for coal oil or kerosene.

A good way to fight this pest will doubtless be to prevent it from breeding and increasing. As stated above, the maggots can live only in the moist droppings of cattle. Any means, therefore, which will insure the drying up of these before the maggots are full grown, will destroy them. This can be done most easily by spreading the dung out in the pastures regularly and at short intervals. Twice a week would be sufficient, and it would be equally effective in wet weather when the substance would be washed away, as in hot weather when it would be dried up.

Where the flies gather in large numbers, on the ceilings and walls of stables in cool weather, or when driven from the cattle by applications, they can be destroyed by spraying them with either Kerosene emulsion or a strong decoction of Pyrethrum Insect Powder. Dusting them with dry Pyrethrum powder by means of an "insect gun" would also be effective.

In studying the history of this insect since it first appeared in North America in 1887, I have noticed that at the places where some years ago its attacks were very severe, it is now much less troublesome. I was, therefore, led to hope that after a time, the considerable loss which Canadians are now suffering from the Horn-fly, would be much less. Correspondence with entomologists confirmed this view. In reply to letters, on this point and with regard to any new remedies which might have been discovered, addressed to the United States Entomologist, and other specialists who have studied this pest, I have received the following:—

"Yours of 25th has been received during Prof. Riley's absence. We have found nothing better than Kerosene emulsion for the protection of cattle from the Horn-fly. In answer to your second question, I may say that it has been almost the invariable rule that the second year the flies are worst, and after this bad second year the numbers are fewer. We have explained this on the ground that native parasites preying ordinarily on native dipterous larvæ in cow-dung acquire a taste for the Horn-fly larvæ after a short time."—L. O. HOWARD, *Acting Entomologist, Washington, D.C.*

"Concerning the Horn-fly, I have nothing new in the way of remedies. As I have stated on several occasions, the insect is not now troublesome in our State, and there is no necessity for applications of any kind to cattle. Our farmers found fish-oil with a little carbolic acid to be much the most satisfactory material that could be used, and I never could induce any to try the Kerosene emulsion. A *propos* of this, at the Madison meeting of the Association of Economic Entomologists, in the course of a discussion, almost all those who had been advocating the use of Kerosene emulsion on live stock, stated that they did not further recommend it, because of the difficulty of getting farmers to make it properly, and of the danger where it is not properly made."—PROF. JOHN B. SMITH, *New Jersey Agric. Coll. Exp. Station.*

Prof. W. B. Alwood, of West Virginia, has found that the stock emulsion diluted ten times and mixed with one part of water extract of tobacco waste (made by steeping 1 pound of tobacco stems in 1 gallon of hot water for an hour or more), gave almost perfect immunity for a period of three days, and that two treatments per week almost entirely relieved his cattle from annoyance. He makes the application with a knapsack pump fitted with a cyclone nozzle, and the work is done just after milking time. His method is as follows:—The animals are driven into an inclosure through a gate which will only admit one at a time. A man with a knapsack pump on his back stands at the gate and sprays one side of each animal as it passes; they are then driven out again, and the other side is treated in the same manner. The quantity of liquid thus applied is very small, but has been found sufficient.

Prof. Alwood writes recently:—"Concerning treatment of Horn-fly I am proceeding still just as given in my note at Washington meeting. (*See above*). Of

course details vary with conditions and surroundings. The Horn-fly has given no trouble to speak of, this season. It began its depredations here in 1889, was bad in 1890 and 1891, less so last year, and was scarcely noticed this year after July."

With reference to the remedies above given I must mention that I have had complaints from two or three, that the Kerosene emulsion did not protect the cattle for a sufficient time to make it worth while to apply it. I, therefore, have experimented to find something more effective. The results of these experiments were that, when the flies are at their worst, it is necessary to spray cattle with the ordinary Kerosene emulsion every two days. Tanner's oil containing some carbolized oil, or oil of tar, is more lasting in its effects, but takes longer to apply and requires much greater labour.

## DIVISION OF BOTANY.

A large number of additions have been made during the year to the collection of shrubs and trees in the Arboretum; many species of the following genera were allotted places in their own groups in the Botanical garden, viz., the Ashes (*Fraxinus*), the Lilacs (*Syringa*), the Elms (*Ulmus*), the Meadow Sweets (*Spiræa*), the Withe bushes (*Viburnum*), the Poplars and Willows (*Salicaceæ*), and in addition to these, several specimens were added to other orders of plants. Many plants were set out in the border for perennials, and the seeds of others were sown for future transplantation.

At present the collection of trees and shrubs in the Arboretum consists of 600 different species and varieties, all of which are arranged to show the individual species to the greatest advantage and grouped in families. There are in nearly all cases two specimens of each kind.

Notes have been taken as to the comparative beauty of the different varieties of flowering shrubs, their hardiness at Ottawa and the dates at which they flower. Herbarium specimens have also been taken to show to any one wishing to know the appearance of the best and hardiest shrubs and ornamental trees before purchasing. The following is a list of the orders represented in the Arboretum, with the numbers of species in each order:—

Anacardiaceæ.....	9	Magnoliaceæ.....	1
Anonaceæ.....	1	Moraceæ.....	5
Araliaceæ.....	1	Myricaceæ.....	3
Berberidaceæ.....	12	Oleaceæ.....	60
Betulaceæ.....	13	Platanaceæ.....	2
Bignoniaceæ.....	5	Rhamnaceæ.....	6
Caprifoliaceæ.....	51	Rosaceæ.....	64
Celastraceæ.....	9	Rutaceæ.....	2
Compositæ.....	1	Salicaceæ.....	56
Coniferæ.....	83	Sapindaceæ.....	34
Cornaceæ.....	18	Saxifragaceæ.....	27
Cupuliferæ.....	47	Simarubaceæ.....	1
Ebenaceæ.....	1	Solanaceæ.....	1
Elæagnaceæ.....	12	Ternstroemiaceæ.....	1
Ericaceæ.....	1	Thymelaceæ.....	1
Hamamelaceæ.....	2	Tiliaceæ.....	8
Juglandaceæ.....	9	Urticaceæ.....	27
Lauraceæ.....	2	Verbenaceæ.....	1
Leguminosæ.....	23		

## Experimental Farms.

### AWNLESS BROME, AUSTRIAN BROME

(*Bromus inermis*, Leyss).

This grass which has sprung rapidly into favour with most who have tried it, has now been under cultivation at Ottawa for 6 years. It has been reported upon favourably two or three times (*C. E. F. Annual Report*, 1890, p. 185; 1891, p. 213; *C. E. F. Bulletin* 19, p. 10.) and all reports which are now being received, particularly from the North-west Territories, are almost universally in praise of it. In order to get it known as soon as possible in those districts where such a grass was urgently needed, samples were distributed to farmers in all parts of Canada in rather larger packets than those which were included in the collections of desirable grasses sent out for testing. From such reports as are to hand, I am therefore able to speak more confidently of the value of this grass than if the opinion were formed only upon my experience with it here at Ottawa.



Fig. 27.—Awnless Brome Grass.

It is a perennial with a running rootstock. It is conspicuous for its free leafy growth and tall stems which bear an abundance of good seed. It has proved itself to be very hardy, earlier than most of the grasses in cultivation, and a heavy cropper. It flowers at Ottawa in the last week of June. On good rich moist soil it has produced over  $3\frac{1}{2}$  tons of hay to the acre, and later a heavy aftermath of succulent leafy shoots. It has great power to withstand drought, as has been observed by my western correspondents. Prof. S. M. Tracy, Director

of the Mississippi Experiment station and one of the leading specialists of economic grasses in the United States, says of it: "This is nearly related to the well-known 'rescue grass,' but is decidedly superior in its more permanent character and ability to thrive on drier and less fertile soil. It starts into growth with the autumn rains, and is fresh and green during the winter months, being uninjured by our heaviest frosts." (This is in Mississippi, but it is equally true in Canada.—*J. F.*) "It forms a compact sod so firm as to prevent the growth of other grasses and weeds, and the yield of forage is larger than from any other winter grass we have tested. It is eaten well by all kinds of stock." (*U. S. Dept. of Ag. Rep.*, 1892, p. 209.)

On the whole we consider this one of the most valuable of the introduced grasses, both from its feeding qualities as evinced by the following analysis made by Mr. Shutt, in which it is shown to be rich in albuminoids and at the same time low in fibre, and also for its free luxuriant habit of growth, its earliness, heavy aftermath and hardy nature. The seed is light and should be sown by hand when there is a slight breeze. It may be sown from 28 to 35 lbs. to the acre. The seed weighs 14 lbs. to the bushel.

Analysis of Awnless Brome.	Green Plants.	Water-free Substance.
Water .....	63·02	0·
Ash .....	3·12	8·45
Protein (albuminoids) .....	4·99	13·50
Fibre .....	11·18	30·24
Carbohydrates .....	17·27	46·65
Fat .....	0·42	1·16
	100·00	100·00

## GRASS FOR THE PROTECTION OF SHORES AND HARBOURS.

Inquiries are frequently made for the seeds of grasses to be grown as binders of shores and sand banks. During July last, information was sought on this subject by Mr. E. T. P. Shewen, resident engineer of the Department of Public Works at St. John, N.B., Mr. Shewen writes:—

“August 30.—My object in using the grass is to stop the dry drift of sand which is now filling a harbour. The beach I wish to protect at Cape Traverse is flooded in gales.”

At the time I received the above letter I had neither seed nor plants of the true Beach grass, *Ammophila arundinacea*, Host., (= *Calamagrostis arenaria*, Roth, = *Psamma arenaria*, R. & Sch.), nor could I, although it is a native of Canada, obtain any from seedsmen or others. In 1890 I received from Mr. John Mather of Ottawa, seeds of that grass and the closely similar *Elymus arenarius*, L., both imported from Scotland by him for the very purpose desired by Mr. Shewen. Of all the seed sown of both species, only two plants of *Elymus arenarius*, Sea Lyme grass, grew, and these have increased and spread enormously since they were first put out in 1891. These two grasses are extremely alike in appearance and habit of growth, in fact in everything except their inflorescence. I therefore sent Mr. Shewen in September about 100 sets of this grass and some of the seed. Some time in October I had the pleasure of showing Mr. Artemas Howatt of Tryon, Prince Edward Island, over the grass beds and was explaining the uses of the Sea Lyme grass to him, when he told me he was sure it, or a similar grass, grew on the shores of Prince Edward Island. It at once occurred to me that the grass he spoke of might be the Beach grass I had been trying to get. He kindly sent me, on his return home, a good supply of the roots and some of the seeds from which I saw it was the true Beach grass.

I at once wrote to Mr. Shewen, and he has corresponded with Mr. Howatt with a view to getting a supply of the grass roots.

These two grasses mentioned are probably the best varieties for growing for the purpose named, on the sea shore, where the disturbance is sometimes very great. Indeed this disturbance seems to be a necessary factor towards their full development. They will however flourish inland and at localities where they are in no way affected by the sea or its influences, as I have found at Ottawa. On lake and river shores the different forms of *Agropyrum repens*, L., (Quack, Couch, Scutch, etc.) may be grown, or the Holy grass (also called “Indian Hay” and “Vanilla Grass,” *Hierochloa borealis*, R. & S.). A trial might also be made with the new fodder grass, *Bromus inermis*, Leyss, (Awnless or Austrian Brome grass). When it can be obtained, however, it is probable that the true Beach grass (*Ammophila arundinacea*) is the best of all for protecting harbours, and after that the Sand Lyme Grass (*Elymus arenarius*).

The following extract from Sowerby's *English Botany*, will show the great value of this grass for the purpose recommended: “This grass is known as Mat grass or Murram. Dr. Prior says, the latter name is derived from the Gaelic *muram* or the Danish *marhalm*, sea haulm or straw. Its value as a natural sand-binder cannot be overrated; many thousand acres, on various parts of our coast, are preserved from being overwhelmed by the drifting sand by means of its agency. In the latter part of the last century a large district on the eastern side of Scotland, near the Moray Firth, was completely destroyed and rendered in a few years as desert as the Sahara by the advance of the sand from the shore, owing to the wanton destruction of the Murram that grew upon it. This grass, therefore, when found growing on sandy shores, should always be carefully preserved by proprietors of land. Acts of Parliament have been passed to protect it, which are but little attended to; and in Holland it is said that its destruction is a penal offence. The strong underground stems, which render it so valuable as a protection against the action of the wind and waves, are capable of being made into ropes; and people near the coast often plait them into mats, whence one of the common names of the grass. Professor Buckman says: ‘We have exhumed rhizomata of this grass several feet

## Experimental Farms.

in length, and as these mat and weave together, in the position indicated, they act as powerful conservators of the coast-line, and we cannot help thinking that the *Psamma* might be cultivated with advantage with the view of keeping together some of our slippery railway embankments. To this it may be objected that it is a maritime species; but inasmuch as we have grown it on the sandy clays of the Forest Marble, far remote from the seaside, we have no fear of its success on this account.' ”

The following is extracted from “*Grasses and Forage Plants*” by Charles L. Flint (Boston, 1887), and shows what an important role the plant has played in the history of a part of the American coast: “This grass is very generally diffused on sea coasts over the world and is found inland on the shores of Lake Superior. It has also been cultivated by way of experiment and with success on the sands at Lowell, Massachusetts, and still further up on the banks of the Merrimack River. Though not cultivated for agricultural purposes, it is of great value in protecting sandy beaches. It is preserved in England and Scotland by act of Parliament. It flowers in August.

“As it is of national importance in protecting our sandy coasts, some account of its culture may not be inappropriate or uninteresting. The town of Provincetown, once called Cape Cod, where the Pilgrims first landed, and its harbour, still called the Harbour of Cape Cod,—one of the best and most important in the United States, sufficient in depth for ships of the largest size, and in extent sufficient to anchor three thousand vessels at once,—owe their preservation to this grass. To an inhabitant of an inland country it is difficult to conceive the extent and the violence with which the sands at the extremity of Cape Cod are thrown up from the depths of the sea, and left on the beach in thousands of tons, by every driving storm. These sand-hills, when dried by the sun, are hurled by the winds into the harbour and upon the town. A correspondent at Provincetown says: ‘Beach grass is said to have been cultivated here as early as 1812. Before that time, when the sand drifted down upon the dwelling-houses, as it did whenever the beach was broken, to save them from burial, the only resort was to wheeling it off with barrows. Thus tons were removed every year from places that are now (owing to the cultivation of this grass) perfectly secure from the drifting of sand. Indeed, were it not for the window glass in some of the oldest houses in these localities, you would be ready to deny this statement; but the sand has been blown with such force and so long against this glass as to make it *perfectly ground*. I know of some windows through which you cannot see an object, except to remind you of that passage where men were seen ‘as trees walking.’ ”

“The mode of culture is very simple. The grass is pulled up by hand and placed in a hole about a foot deep, the sand is then pressed down upon it. These holes are dug about one foot and a half apart. The spring is the usual time of planting, though many do this work in the fall or winter. The roots of the grass, from which it soon covers the ground, are very long; I have noticed them ten feet, and I suppose upon high hills they extend down into wet sand.

“Congress appropriated, between the years 1826 and 1839, about \$28,000, which were expended in setting out Beach grass near the village of Provincetown, for the protection of the harbour. From the seed of that grass it is estimated that nearly as much ground more has become planted with it, as was covered by the national government. In 1854 five thousand dollars were wisely expended by the general government in adding to the work; and the experience of former years was of great value to the efficiency of this latter effort.”

The Beach grass and Sand Lyme grass are harsh coarse grasses with tough pale grayish leaves and spread by long underground root stocks. The leaves are tipped with a sharp hard spike which is capable of piercing the skin. The chief difference between these two grasses is a botanical one, viz., in the arrangement of the flowers; for practical purposes they are so much alike that, if the true Beach grass cannot be obtained, the Sand Lyme grass may be used, but it has not apparently power to spread quite as rapidly.



As to the fodder value of these grasses, we have made no experiments; but the following extracts bear on this point:—

"*Psamma arenaria*.—This grass seems to be indestructible by drift sand, and authorities differ as to whether it is eaten by stock; but the park ranger at Port Fairy says they eat it ravenously in winter and thrive well upon it." (*Report of Agric. Bureau of South Australia for 1892*, p. 12.)

"*Elymus arenarius*.—Sinclair calls this grass the sugar-cane of Great Britain. It contains a large quantity of saccharine matter, and it is probable that, mixed with beach grass, as it is in Holland, it would be valuable to cut up and mix with common hay for winter feed." (*C. L. Flint. Grasses and Forage Plants*, p. 120.)

### TUMBLE WEEDS.

#### TUMBLE MUSTARD (*Sisymbrium sinapistrum*, Crantz).

This new pest in the North-west Territories is still very abundant about Indian Head, notwithstanding the efforts which have been made by Mr. Mackay and others to eradicate it. Mr. Mackay writes from Indian Head under date Nov. 14:— "We were almost buried yesterday with a neighbour's tumble weed. A hurricane blew all day from the North-west, and the edge of a field adjoining the farm is now 10 feet deep with this weed. The trees are full and fences cannot be seen for bank of weeds. The result of yesterday's blow will be to give us many extra days' work next summer, for millions of seeds have been left on the farm. Looking between here and the town while the weeds were galloping along, the prairie seemed like the ocean with a big storm blowing." It is needless to say that every effort should be put forth now to eradicate this annual weed, as it is evidently one of the very worst pests which has ever been introduced into the country. The name "Tumble Mustard," proposed by Prof. W. M. Hays of the Minnesota Agricultural Experiment station, is, I think, particularly appropriate for this pest, for, as he says, "it draws attention to the important fact that the weed combines the spreading power of a 'tumbler' with the longevity of seeds of a mustard." The weed which more than any other has always been known as Tumble weed in the west is *Amarantus albus*, L.

#### THE RUSSIAN THISTLE, Russian Tumble Weed (*Salsola Kali*, L., var. *Tragus*, DC.)

This plant which has attracted so much attention in the United States, has not yet been found in Canada; but it is well to warn our farmers to take every precaution against its introduction. The United States Government has issued a timely bulletin by Mr. L. H. Dewey, Assistant Botanist of the United States Department of Agriculture, illustrated by figures of the plant in different stages, and of the seed enlarged. The *Farmer's Advocate*, of London, Ont., has wisely published a warning article to Canadian farmers, giving quotations of the above, and reproductions of the figures. The publishers have kindly lent me the figures used in that article for this notice.

These will serve to draw attention to the plant and show those who have not seen the above articles, what its appearance is. It is not a true thistle, but is a variety of the European Salt-wort, and is related to the lamb's quarters and spinach. It takes its name "thistle" from the fact that, as the seeds ripen, the stems develop at each joint instead of leaves three sharp spines. The spines are described as harder than, and as sharp as, those of the Canada thistle, so that farmers have to wrap leather round their horses' legs when cutting grain infested by it. It is an annual, and has been introduced for fifteen years. It has now spread over an area of 30,000 square miles, and is abundant and troublesome over two-thirds of that area. Mr. Dewey says in his bulletin: "In the badly infested areas more than 940,000 acres are devoted to wheat raising. The average loss on this land, which may be attributed to the Russian Thistle alone cannot be

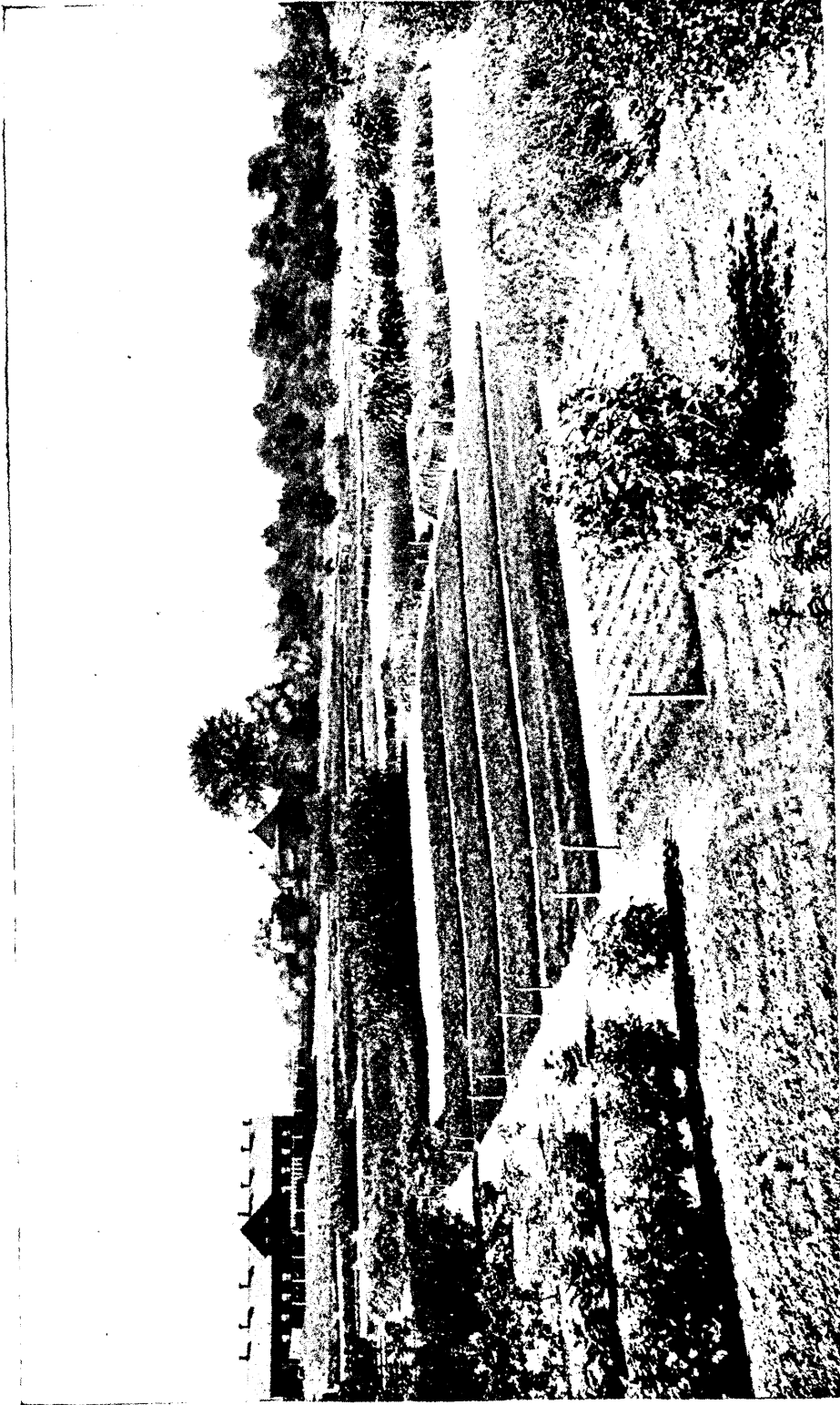

GRASS-BEDS. CENTRAL EXPERIMENTAL FARM, OTTAWA.

Experimental Farms.

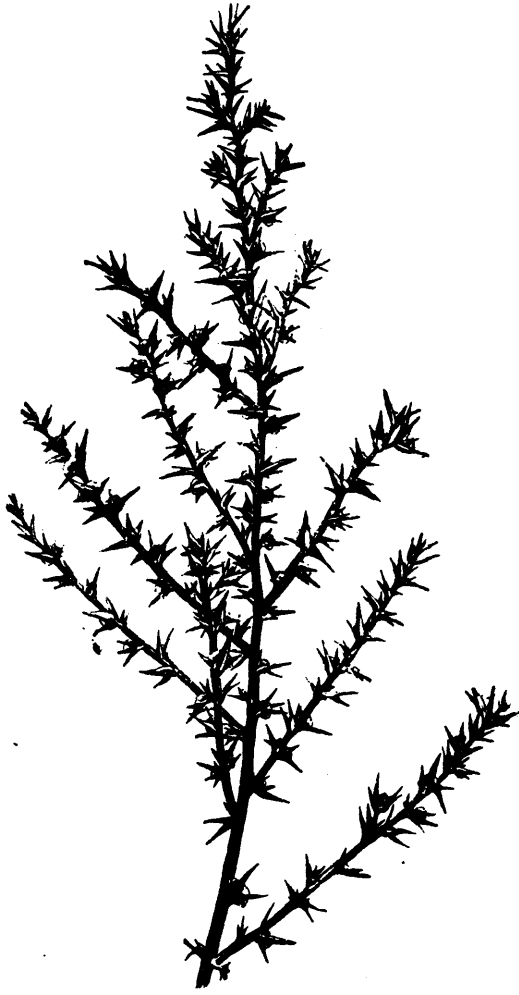

Fig. 28.



Fig. 29.

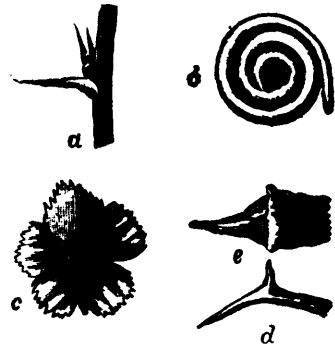

Fig. 30.

**RUSSIAN TUMBLE WEED.**

Fig. 28.—A branch of a mature plant. Fig. 29.—A young stem showing the nature of the leaves before the flowering period and a single seed enlarged. Fig. 30.—Enlarged details of the prickles, the flower and the seed from which the seed coat has been removed.

less than five bushels per acre; and 3,200,000 bushels at the minimum price of 50 cents per bushel (which is considerably less than the average price) indicates a loss to the farmers in the two Dakotas of \$1,600,000. The loss in other crops, the injuries caused by the spines, and the fires caused by the plants jumping fire-breaks, will bring the total loss to something more than \$2,000,000 for the year 1892.

"These figures may seem alarming, but they are based on conservative estimates. If they are alarming to the farmers, it is well, for it is only when alarmed that most men will take effective measures to avoid danger."

I have been on the lookout for this weed through my correspondents for the last two years, and my attention was officially directed to it during the past summer by the Immigration Branch of the Department of the Interior. I am glad to be able to report that so far it has not been detected in the Dominion.

## REPORT OF THE POULTRY MANAGER.

(A. G. GILBERT.)

To WILLIAM SAUNDERS, Esq.,  
Director Dominion Experimental Farms,  
Ottawa.

SIR,—I beg to submit the sixth annual report of the Poultry Department. During the winter of 1891–92 careful watch was taken of the laying stock in order to discover, if possible, the cause of and remedy for egg and feather eating, the two vices fowls in close confinement are most addicted to. The subject is one of the greatest importance, necessitating the closest attention in order that correct conclusions may be arrived at. If the fowls eat their eggs, it is apparent that the whole means of money making is gone from the poultryman, until the practice ceases. Observation was continued last winter and to the notes already made and published the following may be added:—

1. That the vicious practices are most indulged in during the months of February and March.
2. That, unless at once checked on first showing, they continue until the fowls are allowed outside.
3. That the non-layers do not indulge in the vices until the others commence.
4. That the inactivity of the layers, caused by overfeeding, leads to the vices.
5. That the breeds of the more nervous temperaments viz., Black Minorcas, Andalusians, Red Caps, &c. &c., are most addicted to the practices.
6. That the vices first show among the fowls in the greatest number in one pen.
7. That egg eating began where the laying nests were most exposed to view of the fowls.

### CONCLUSIONS ARRIVED AT.

It must be understood that the fowls were closely confined to their pens from the time winter prevented their running outside, until the snow disappeared in early spring. The conclusions to be arrived at from the foregoing are:

1. It is imperative that the layers be kept in constant activity.
2. That they must have plenty of room to scratch in.
3. That the pullets are better separated (when possible) from the older fowls.
4. That plenty of green stuff should be fed in the shape of clover hay, cabbage, mangels, turnips, &c.
5. That green bones, cut up and fed regularly, are the best preventives.
6. That the laying stock should have access to barn, shed or stable to scratch in, whenever circumstances permit.
7. That the nest boxes *must* be so arranged that they will be dark and not too easy to get to.
8. The more limited the quarters, the greater the necessity of exercise.
9. The more natural the conditions under which the layers are kept, during the close season, the better for them, the more profitable the result.

In the portions of the Dominion where the winters are comparatively mild the care and treatment of the stock are attended by a *minimum* amount of labour and anxiety. In such localities opportunities to let the layers out for a run frequently occur and the vices mentioned above are not experienced. On the other hand there are portions of the country where necessity compels the housing and the artificial treatment of the layers during certain months. As remarked in report of 1891, it is to persons so situated that the experiments relating to the care and management of fowls in winter quarters will be most valuable.

## Experimental Farms.

A FEW PLANS FOR THE FARMER.—HOW RANGE AND SCRATCHING ROOM MAY BE SECURED.

The farmer with one breed, or his ordinary barn yard fowls will have little difficulty or expense in arranging a house so that while it gives some warmth to the layers at night, which is very desirable, will also afford room for them to range, scratch and dust in during the day, and so prevent the vices aforementioned. It is with the object of giving some help in this direction that the following plans are submitted:

Diagram No. 1.

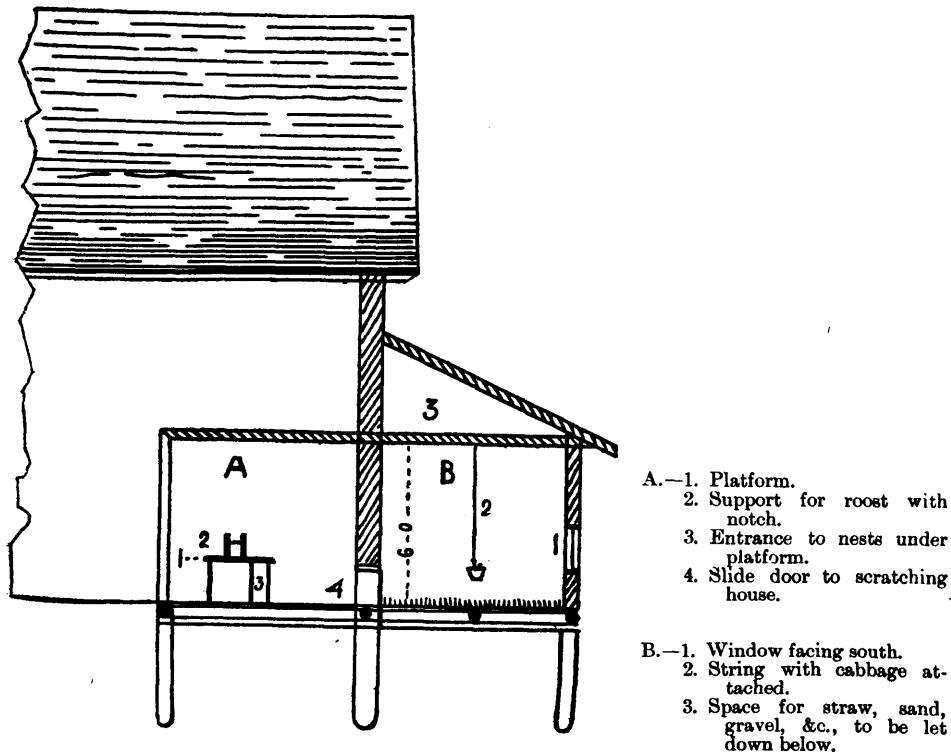

- A.—1. Platform.  
 2. Support for roost with notch.  
 3. Entrance to nests under platform.  
 4. Slide door to scratching house.
- B.—1. Window facing south.  
 2. String with cabbage attached.  
 3. Space for straw, sand, gravel, &c., to be let down below.

The above plan No. 1 represents a house and addition that can be added to the end or side of a barn facing south. A small portion "A" of the end of the barn is partitioned off for the roosting and laying room. The ceiling is made low, and under this low ceiling is the platform and roost so placed as to economise the animal heat of the fowls during the cold night, and keep them as comfortable as possible during that period. The roost should be a 2 x 4 inch scantling, broadside down, and placed 10 or 12 inches over a platform which should be two and a half feet wide and eighteen inches from the ground. Under this platform should be the nests so arranged that by boarding the front of the platform, they (the nests) will be kept dark. The partitions of the nests will support the platform. The object of keeping the nests dark is to offer no inducement to the hens to stay in, or about them after the egg is laid, and to keep the other hens from seeing the eggs. Egg eating is so prevented and prevention is a great deal easier than the cure. After keeping themselves comparatively warm by scratching busily all day in the scratching room the layers require some warmth during the night and in most poultry houses that is the very time they are coldest.

"B." This is an addition that can cheaply be made to the barn and should be to the south. A slide admits the fowls from A to B. On the floor of this scratching

house B is  $2\frac{1}{2}$  feet of dry sand, fine gravel, fine coal cinders, ashes, lime and grit in the shape of ground oyster shells, broken mortar or plaster, pieces of old crockery broken up, and any other substances calculated to make the conditions as like those of the outside run, of the open season, as possible. The floor may be of boards or earth but it must be kept perfectly dry. A narrow trough 2 or  $2\frac{1}{2}$  inches wide should be attached to the wall so as to permit of the proper feeding of soft food, if given. The object of this scratching house is to keep the layers busy all day and as much as possible out of house A, where they are only wanted to go to roost in and to lay. A fair sized window or windows should be in the south wall so as to admit as much sunlight as possible.

The houses can be made as large or as small as the number of hens require, always allowing 4 feet square for each hen, at the least, in the scratching room, and 8 to 10 inches roosting room for hens of medium and small size.

Diagram No. 2.

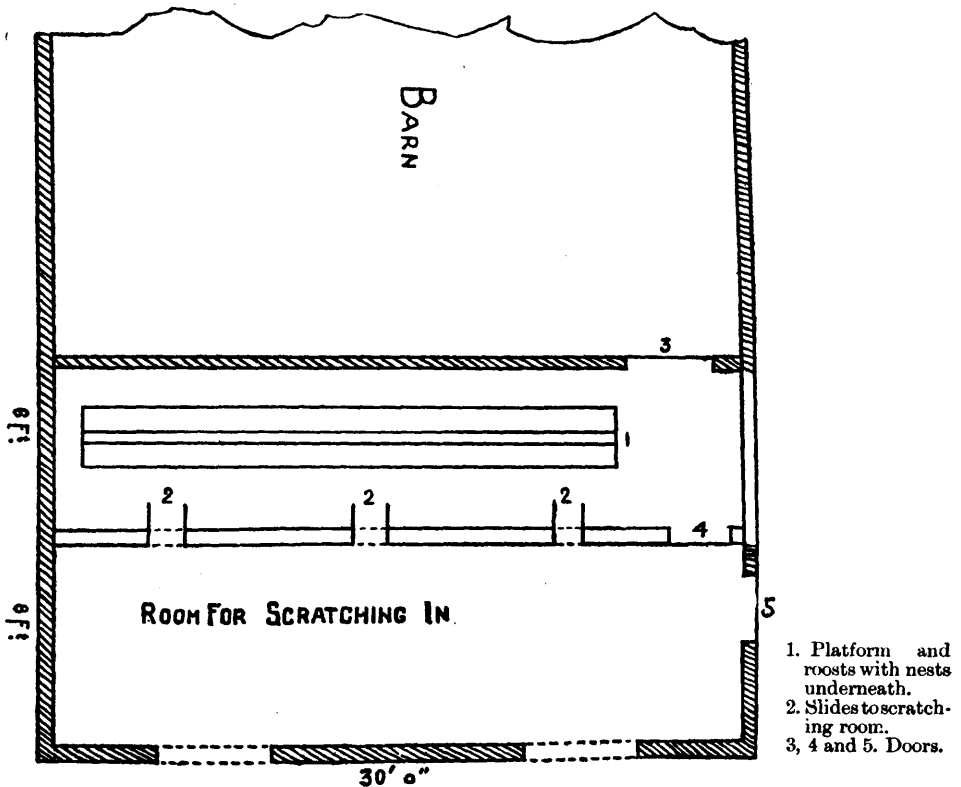

The above plan, No. 2, shows the end of the barn with the roosting and laying room and scratching room attached.

The numbers are explained as follows:—

1. Is the platform and roost with the nest boxes underneath. This platform need not run all the length of the room. Indeed, the room might be made smaller and warmer at night by making the platform into smaller lengths and running them cross-ways or from north to south.
2. Are the slides to allow access to scratching-room. In a smaller house one or two might do.
- 3 and 4. Are doors to get into the apartments.
5. Is a side door to get in and out of the room for scratching, to clean up, etc. If it can be managed without, there need be no necessity for this door, as the fewer openings the less cold the premises are likely to be.

## Experimental Farms.

*Diagram No. 3.*

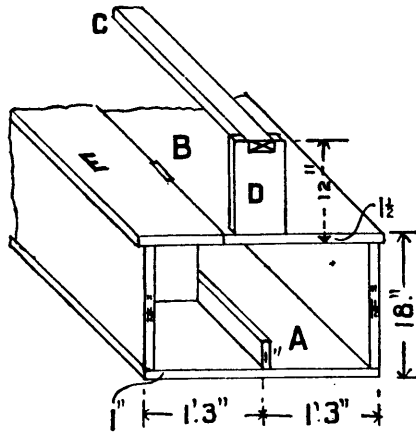

**DIAGRAM SHEWING PERCH  
AND NEST BOXES UNDER**

The<sup>d</sup> above diagram shows the darkened nests. A is the passage way to the nests under the platform B. The 2 x 4 inch scantling roost is shown by C. D shows the piece of wood with notch to support the roost. E is a portion of the platform hinged so as to lift up (as shown in diagram 4) to permit access to the nests.

*Diagram No. 4.*

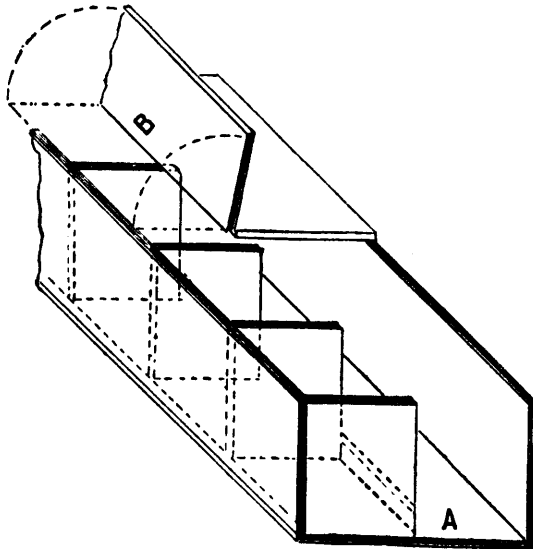

**DIAGRAM  
SHEWING NEST BOXES**

The above diagram shows the arrangement of the nests under the platform, the passage way A and the hinged board B. The hinged board lifts up so as to allow access to the nest boxes.

## THE RESULTS HOPED TO BE ATTAINED.

The results hoped for in having the houses constructed as outlined, briefly summarized are:—

1. By a southern exposure to secure as much sunlight and warmth as possible.
2. The sunlight being a great incentive to scratching, dusting in the earth, etc.
3. To prevent by constant exercise any opportunity to indulge in feather eating.
4. By having the nests dark and secluded, to prevent egg eating.
5. By the comparatively low ceiling to keep the layers as comfortable as possible during the night, by economizing the heat of their bodies.
6. By the liberal quantity of sand, fine gravel, grit, &c., &c., placed on the floor of scratching-room, or shed, to make the conditions as natural as possible and so afford every inducement to constant activity.

## THE PROPER TREATMENT OF THE LAYING STOCK IN ABOVE QUARTERS AN IMPORTANT CONDITION.

Before going on with the consideration of this subject, it must be insisted that the laying stock be under two years of age, and that they should never be allowed to exceed that age. The winter quarters may be according to the most approved designs; the treatment the very best known, and yet eggs will be few in number if the hens are over the age mentioned. It has been remarked, in previous reports, that in the case of Leghorns, Minorcas or Andalusians another year may be permitted, but except in the case of experts, it is best to be on the safe side. And in the case of selecting breeders from the best layers, it may be necessary to keep a hen two and a half or three years of age, but at present we are strictly speaking of how best to secure eggs in paying quantities. It is like going over old ground to repeat the instructions so fully given in 1889 report as to the treatment of the laying stock, but as the conditions as to housing, &c., &c., in the present case are somewhat different, it may be admissible so to do.

## THE EARLY RATION.

The first essential to success is proper feeding. If a mash is prepared for the morning ration only enough to satisfy should be fed. On page 107 of 1889 report, the following rule is laid down *re* the early morning ration: "Feed only enough soft food to *barely satisfy*, never so much as to gorge. When a hen has had so much food that she will go into a corner and mope, she has had too much and if the overfeeding is continued, will soon cease to lay." The rule is *emphasized* on the present occasion. Where opportunity permits the cutting, or breaking up (not grinding) of green bones they might be given for the morning ration and nothing else. There is really no rule as to the quantity of green bones to feed, so much depends upon the breed, but one pound to 15 or 20 hens, may be mentioned as a guide. If the hens are exercising well and laying freely, and the latter generally follows the former, a small quantity of grain may be fed at noon, but it must be so scattered in the straw, or buried in the sand, that the hens will have to search for every grain of it. A plan that has been found successful is the suspension of a cabbage by a string from the ceiling, about three feet from the ground, so that the hens will have to jump to get at it. Substituting a piece of tough meat, raw, or partially cooked, will be found to answer well. Experience has proved that green stuff in the shape of any of the dry clovers steamed and mixed in the morning mash, or exposed by itself, is much relished by fowls. When mixed in the mash it should be cut up into inch pieces. Vegetables of some kind must be kept before the layers at all times. It is astonishing the quantity of grass, fowls and chickens eat, when at large, and if we are to make the conditions of their artificial treatment as natural as possible, green food must be liberally supplied. It is not necessary to



## Experimental Farms

use every kind of vegetable in rotation, but vegetables of one kind or another, are as a rule, abundant on a farm and the inferior or unmarketable specimens may be given to the poultry. Small potatoes boiled and mixed with wheat bran to which may be added the table and kitchen waste and a couple of handfuls of coarse sand or ground mortar, the whole fed warm for the morning ration, will be found an excellent variation.

### LIGHT FEEDING OR NONE, AT NOON.

Where meat, bones, and vegetables are furnished liberally and regularly there will be no necessity for a noon ration. It must be borne in mind that the tendency is rather to overfeed than otherwise where poultry are cared for, and on the other hand where poultry are not looked after, they get neither care nor comfortable quarters, and of course there is little likelihood of results of any kind being obtained.

### THE AFTERNOON RATION.

The evening or rather early afternoon ration, for winter days are short, should be a generous one. It is well to remember that a long night fast is before the layers and it is proper to have them go to roost with a full crop. It is better to feed whole grain for this afternoon ration. Should cut, or broken up green bones, not have been fed in the morning it might be well to give a half ration of them at noon and the remaining half at the afternoon grain ration, reducing the grain in proportion to the quantity of bone fed. Neither bones, nor mash, should be fed in anything or anywhere, but in the clean narrow trough at the side of the scratching room. Mr. Alexander Stewart, the well known market gardener and farmer of Hintonburg, told me that he always found his Plymouth Rock hens to lay well in winter on oats and plenty of cabbage. His poultry house was not a particularly warm one.

### KEEP THE WATER FROM FREEZING IF POSSIBLE.

It would be a very great gain if the shed or house for scratching in, could be so constructed or situated, as to prevent the freezing of the drink water. And where the water does freeze care should be taken to have the chill taken off before it is given to the layers. It should be supplied in this luke warm condition at least three times a day. Laying hens drink a large quantity of water. But a cold house has other disadvantages such as the vegetables freezing solid; droppings freezing hard to platform and the floor becoming very cold. It has been before remarked that when the layers are kept in a very cold house, the food instead of going to make eggs is drawn upon to supply animal heat. And yet artificial heat is not desirable when it can possibly be done without. If the house could be kept at the freezing point, or three or four degrees higher, it would be found suitable. Before going further it may be as well to summarize the information so far given as to the exercising and feeding of the layers. In that shape the points may be easier to remember.

### SUMMARY OF EXERCISE AND FEEDING POINTS.

1. Do not gorge the layers by overfeeding.
2. Use every incentive to keep them from idleness.
3. Feed as much cut or broken green bones as possible.
4. Less grain is to be fed when bones and vegetables are supplied in abundance.
5. The evening ration should be a grain one and generously fed.
6. The object being to keep the crops of the layers full during the long night fast.

7. The soft food and cut bones should be fed in a clean narrow trough.
8. When necessary take the chill off the drink water and supply regularly.
9. Keep only young, active, prolific layers, and select from them to breed from.
10. Kill the non-layers for they are only eating away the profit margin.
11. Keep no male bird with the laying fowls. They do better without him.
12. Keep a sharp watch on the layers and anticipate every want.

#### THERE MUST BE NO COMPLAINT ABOUT TROUBLE.

"Oh! all this entails a great deal of trouble" may be remarked. Of course it does, but is it as much, or any more, than that experienced by the successful dairy farmer; the market gardener; the cattle breeder, or that peculiar to any other department of the farm?

"And it requires a lot of study to learn the proper management of poultry," is the next objection heard. And so it does, but when that knowledge is acquired there is no department of the farm that will pay a larger percentage of return for the time invested. The great drawback to the poultry department heretofore has been that no systematic or intelligent efforts have been made to develop its true value. Eggs have been put on the market when the warm spring weather made everybody's hens to lay and prices were, in consequence, at the very lowest. During the winter the fowls were non-productive and their keep was likely a loss to the farmer. And they were so kept because the farmer did not care to make them remunerative. Taken even at the lowest, the egg and poultry trade of Canada and the United States represent enormous figures. But the object is not to discuss the poultry interests at this time, but to glance at the inducements held out in different parts of the country to the farmer to produce eggs in winter.

#### INDUCEMENTS TO PRODUCE EGGS IN WINTER.

In rapidly scanning the Dominion the following are the phases presented by the different provinces. In the sections where the winters are comparatively mild, and the procuring of eggs a matter of little difficulty—prices are cheap. On the other hand in those portions where the winter season is more severe and the production of eggs attended with greater difficulty—prices are high. In Montreal new laid eggs command a high figure during December, January, February and the earlier portion of March. Mr. Thomas Hall, poultry breeder, and market gardener of Outremont, a suburb of Montreal, says he has no trouble in obtaining 45 cents per dozen from choice customers for *new laid* eggs during the months mentioned and in periods of scarcity as high as 60 cents is sometimes got, at retail. It is to be remembered that there is great difference in the fresh egg of the grocer which may be several months old, but good enough for cooking purposes, and the new laid egg only two or three days, or even a week old. The flavour of the first named is seriously affected, while it is perfect in the new laid article.

In Toronto, new laid eggs are quoted at 30 cents per dozen by retailers and the *Poultry Review* of the same city, says there is plenty of money in eggs at that price.

From Fort William a correspondent writes "that eggs are at a good price there at any time."

A correspondent at Ashcroft, B.C., says, "The average price of eggs in this locality, all the year round, is 25 cents per dozen."

Another correspondent from the neighbourhood of Calgary, N.W.T., wishes "he had a number of good laying fowls, for eggs here are 50 cents per dozen in winter and command a good price at any time."

From what can be learned there is a good market for new laid eggs at Halifax and St. John, during the winter months.

In our own locality the price obtainable at the grocers for new laid eggs during the cold season is from 30 to 35 cents per dozen according to the severity of the sea-

## Experimental Farms.

son: when retailed to special customers they occasionally bring as high as 50 cents per dozen.

And when and where eggs are at their very cheapest there is the British market to be taken into consideration. Speaking of that market a bulletin issued by the Finance Department in relation thereto says "Canadian poultry and eggs which arrived in excellent condition realized the very highest prices in the London market" and again that a leading Canadian dealer who had made a handsome profit out of a shipment of Canadian turkeys expressed himself confident, "that an unlimited, steady and profitable trade can be done in England with Canadian poultry and eggs." The complaints made about some of the shipments were small size of the egg and bad packing. The shipper can easily remedy the latter, but it is only the farmer, who can by breeding the right kind of fowls, put the large egg on the market.

### WHEN AND HOW HE CAN DO IT.

After the farmer has taken advantage of the high prices of the winter home market, he can on the return of the warm spring weather—if he has the proper breed of fowls—allow them free range outside. After a short season of rest they will begin to lay again and if non-sitters will continue to do so, until the moulting period begins—in the latter part of the month of September—and which will continue for the next two months. But by this time his layers will have well earned their rest. And by the end of September his early hatched pullets ought to begin to lay. Thus a large number of eggs can be had to put on the best market offering. If he has non-sitters and does not use an incubator and brooder the farmer will have to keep a certain number of one of the sitting breeds to hatch out his chickens. All depends upon intelligent management. And he will require to reserve a certain number of his two-year old hens for breeding purposes. His male bird should be a vigorous yearling cockerel. He should make it a strict rule to allow no male bird among the laying stock. The reason for so doing has been given in report for 1889, p. 107, as follows:—"Take away the male birds from the laying hens. The cock bird is a nuisance in the pen of layers. He not only monopolizes the most of the food, but teaches the hens to break eggs and so learn to eat them. Besides the stimulating diet is too fattening for him and will ruin him as a breeder." The separation of the male bird from the breeding stock during winter, is also insisted upon by a great many of the leading breeders. The experience of five years at the Experimental Farm at Ottawa, when the winter season is long, leads to the same conclusion. But the farmer with one breed and one or two cock birds need have little trouble in keeping the birds apart, if he thinks it necessary so to do in the case of his breeding stock.

### DIFFERENT BREEDS.

#### THEIR APPEARANCE AND CHARACTERISTICS—EGGS, THEIR SIZE AND COLOUR— MARKET CHICKENS.

It will be noticed that the foregoing remarks apply particularly to egg production, but should eggs and poultry be sold by weight throughout the Dominion, a probability of the near future, rapidly maturing chickens, as well as large eggs will be more profitable for the home market. The following information as to the colour and size of eggs laid by the fowls of the different breeds named, as well as to the weight put on per month by the chickens hatched and reared at the Experimental Farm may be useful. Some of the breeds are represented by cuts.

## WHITE LEGHORNS.

An active prolific layer of white eggs. Some strains lay much larger eggs than others. The hens of a good strain will lay eggs  $2\frac{1}{4}$  oz. each or 1 lb. 10 oz. to 1 lb. 11 oz. per doz. Pullets' eggs  $1\frac{9}{10}$  oz. each, or 1 lb. 8 ozs. per doz. Chickens hardy and grow quickly. Require to be kept active in close confinement and regularly supplied with lime, grit, &c. There is no standard weight for the Leghorn family.

## BLACK MINORCAS.

The females lay a large white egg, weighing as follows: Hens,  $2\frac{3}{8}$  to  $2\frac{1}{4}$  oz. each, or 1 lb. 11 oz. per doz. Pullets' eggs, 2 oz. each, or 1 lb. 7 oz. per doz. The hens lay from 130 to 150 eggs each according to room and range. The chickens are hardy and make vigorous growth. The plumage is jet black. The standard weight of the cockerels must be  $6\frac{1}{2}$  lbs.; pullet,  $5\frac{1}{2}$  lbs.; cock, 8 lbs.; hen,  $6\frac{1}{2}$  lbs. Must be kept busy in winter quarters and regularly supplied with egg shell making material.

## ANDALUSIANS.

Another member of the Spanish or Mediterranean class but of blue colour in feather. Indeed! they are sometimes called the Blue Spanish. They are prolific

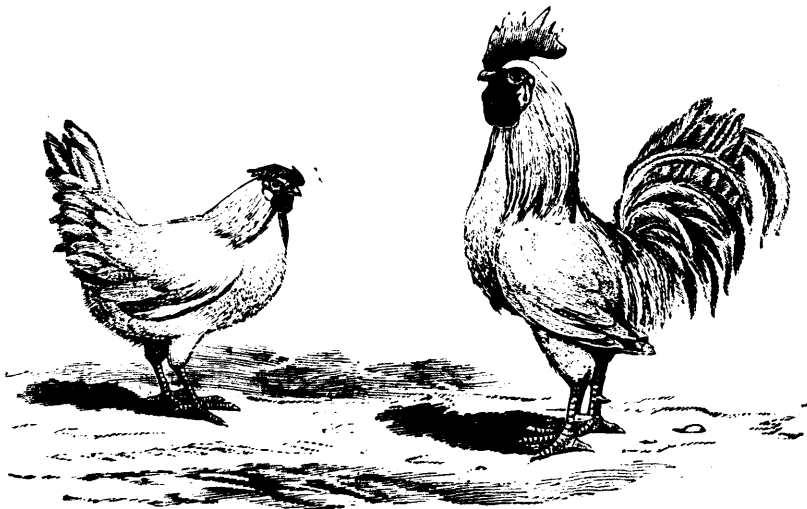

layers of large white eggs. Chickens are hardy and grow vigorously, of the same type as the Black Minorcas, and require the same conditions of treatment in winter quarters. Hens' eggs weigh  $2\frac{1}{4}$  to  $2\frac{3}{4}$  oz. each, or 1 lb. 11 oz. per doz. No weight qualification is demanded by the standard.

## RED CAPS.

A prolific layer of eggs, of medium size, but not quite so white in shell as those laid by the Leghorn family. Some strains lay larger eggs than others. Dr. Nivin, of London, Ont., claims for his Red Cap hens a yield of 150 eggs in a year. If properly cared for, they lay well in winter. Chickens are hardy and grow rapidly. They are an English breed and have gained many friends.

## Experimental Farms.

### HOUDANS.

A breed of French origin, but having the five toes of the Dorking. The plumage is mottled black and white and there is a heavy crest on the head. The females lay a large white egg. Hens' eggs  $2\frac{1}{4}$  oz. each or 1 lb. 11 oz. to 1 lb. 13 oz. per doz. The flesh is white and of very superior quality and the body of the fowl is plump and heavy. The chickens are hardy, and grow rapidly, the cockerels showing a development of 1 lb. per month. They are great foragers and require range. They do not seem to lay as many eggs during the close confinement of winter. It is the intention, another year, to give a number of pullets of the same age a trial as winter layers. The standard demands the following weights:—Cock, 7 lbs.; hen, 6 lbs.; cockerel, 6 lbs.; pullet, 5 lbs. It will be noticed that the weights are not as great as those called for in the case of the Black Minorcas.

### LAYERS OF EGGS OF DARK COLOUR.

#### LIGHT BRAHMAS.

Hens are layers of large coloured eggs, in number about 100 to 110 per year. When in winter quarters eggs are not quite so large as when hens are running at large. Hens' eggs from  $2\frac{1}{4}$  to  $2\frac{1}{2}$  oz. each; per dozen 1 lb.  $9\frac{1}{2}$  oz. to 1 lb. 13 oz. Chickens hardy and grow well at development of 14 to 16 oz. per month for cockerels.

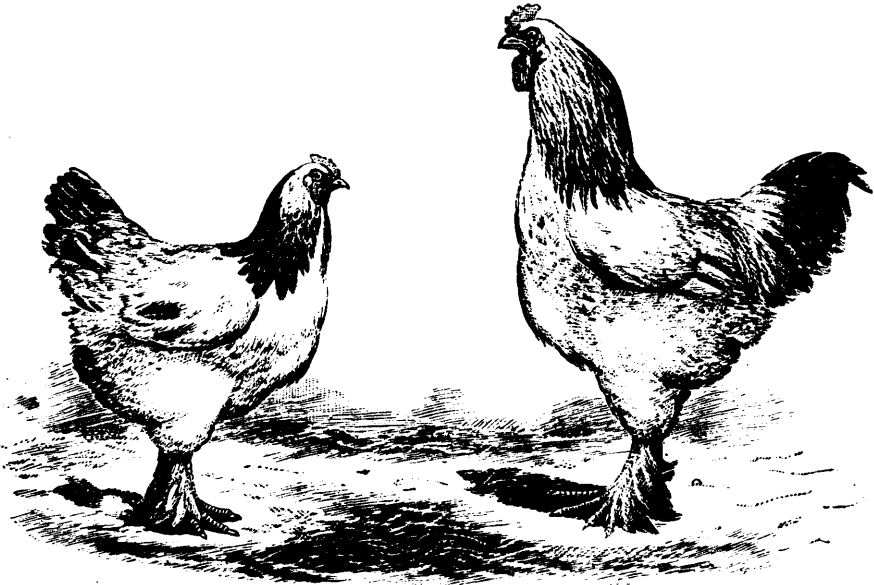

Layers require to be kept busy in winter quarters and must not be over fed or will get too fat. They are a very popular breed, being quiet and easily kept in bounds by a low fence. The weights demanded by the standard are: cocks, 12 lbs.; hens,  $9\frac{1}{2}$  lbs.; cockerel, 10 lbs.; pullets, 8 lbs. They are classed among the Asiatics.

#### BUFF COCHINS.

Of the Asiatic type. A fair layer of richly coloured eggs. Some strains lay much larger eggs than others. At the farm a hen of one strain layed eggs weighing only  $1\frac{3}{8}$  oz. each, while a hen of another strain layed eggs  $2\frac{1}{4}$  oz. each. They require to be kept active when in close quarters, as they put on fat very easily. The weights are: cock, 11 lbs.; hen,  $8\frac{1}{2}$  lbs.; cockerel, 9 lbs.; pullets, 7 lbs. The chickens are hardy

and grow well, showing about the same development as the Light Brahma cockerels. They are great favourites with many fanciers and some very fine specimens are held in Ontario.

#### LANGSHANS

Are classed as belonging to the Asiatic family. They are a very valuable breed. In England they are much prized as a market fowl on account of their white flesh.

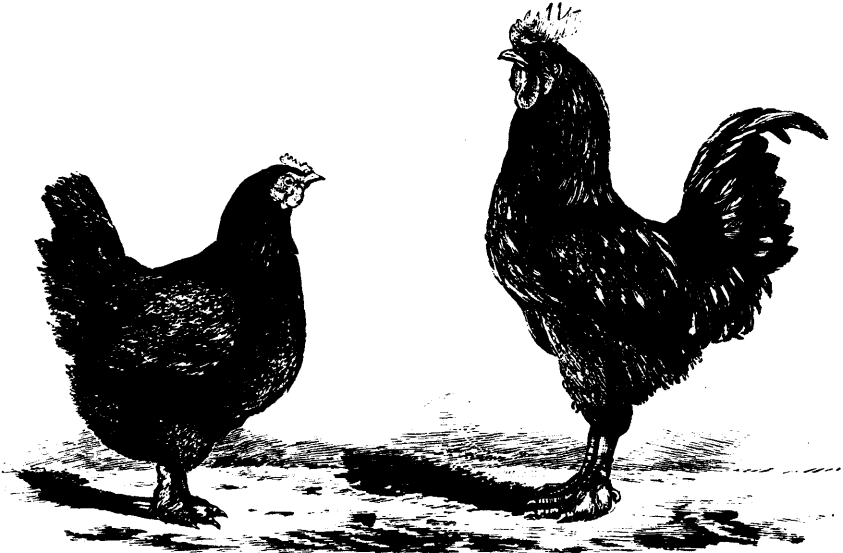

The hens lay a rich dark brown egg of fair size and in goodly number. The chickens are hardy and grow well. The standard demands the following weights: cock,  $9\frac{1}{2}$  lbs.; hen, 7 lbs.; cockerel, 8 lbs.; pullet, 6 lbs. Although these weights are necessary to permit of a successful exhibition in the show room, they are as a rule exceeded by the male birds.

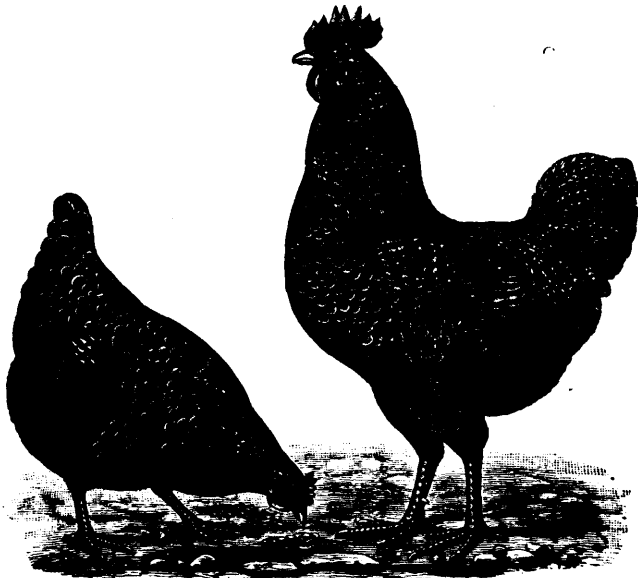

BARRED PLYMOUTH ROCKS.

## Experimental Farms.

### PLYMOUTH ROCKS.

One of the best known breeds on the continent and one of the best for the farmer, who wishes an all round fowl. The pullets and young hens are good layers and the cockerels put on more flesh per month than any breed so far tried at the Experimental Farm. The chickens are hardy and grow well, the cockerels putting on 1 lb. to 1½ lbs. of flesh per month, when properly cared for and fed. Early pullets will lay at age of five to five and a half months. The laying stock require to be kept busy, and the hens must not be overfed as they get fat very easily. The pullets will stand a little more pushing, as the pullets of all heavy breeds will. The hens make excellent mothers. There are three varieties of this popular breed, viz. : Barred, White and Buff. The latter is a new comer.

### SILVER LACED WYANDOTTES.

Another breed of American origin and a great favourite with a great many, on account of their laying and table qualities. The cockerels make good growth, showing a development equal to 14 to 16 oz. per month. They are square and compact in shape. The hens are excellent layers of eggs of fair size : some strains lay large brown eggs, and they make excellent mothers. They come close after the Plymouth Rock as a general purpose fowl. There are three other varieties, the White, Golden and Buff. The white variety is described later on. The weights called for are : cock, 8½ lbs. ; hen, 6½ lbs. ; cockerel, 7½ lbs. ; pullet, 5½ lbs.

### THE NEW VARIETIES ON TRIAL.

The White Plymouth Rocks, White Wyandottes and the Coloured Dorkings are the three new breeds on trial at the Experimental Farm. The value of the Dorkings, as table fowls, in Great Britain, is well known, and it is hoped by their numerous admirers that they will be much more extensively bred in this country than they have been. The characteristics of the three breeds are given as follows :—

#### WHITE PLYMOUTH ROCKS.

All the good points of the Barred are claimed for this variety with the additional ones of greater size and whiter appearance of flesh when dressed for market. The latter claim is advanced on the ground that the white "pin" feathers do not show so darkly as in the barred. In order to give them a fair trial, eggs from two of the best strains in the country were procured and from them 17 pullets and 8 cockerels were hatched. The chickens were strong from their hatching out and made good progress, a cockerel hatched on the 20th May last showing 6 lbs. on the 21st September. Two others weighed 4 lbs. 5 oz. and 4 lbs. 8½ oz. respectively. The pullets are large and handsome. So far they are fully equal, if not superior, to the barred in growth and robust health. Careful observation well be made of the one variety as compared with the other. The standard weights required are : cock, 9½ lbs. ; hen, 7½ lbs. ; cockerel 8 lbs. ; pullet, 6 lbs.

#### WHITE WYANDOTTES.

A very promising variety, showing so far, all the good points of the Silver Laced. They are claimed to dress better for market on account of the white pin feathers showing less. The same point it may be remembered, is claimed for the White Plymouth Rocks. From eggs of different strains procured, eleven pullets and ten cockerels were hatched. The chicks displayed hardiness and grew well. A cockerel hatched on the 30th May last, weighed on 2nd October following, 4 lbs.

Two cockerels hatched 12th June, weighed 4 lbs. 6 oz., and 3 lbs. 15½ oz. on 13th October. Other weights were 3 lbs. 14 oz., 3 lbs. 11½ oz., 3 lbs. 10 oz.

The merits of the breed as furnishing early cockerels for market will be seen. Careful note will be taken of the laying qualities of the pullets. The weights required are: cock, 8½ lbs.; hen, 6½ lbs. Cockerel, 7½ lbs.; pullets, 5½ lbs.

#### COLOURED DORKINGS.

We have no cut of this favourite English breed. There are three varieties, viz., Coloured, Silver Gray and White. Of these, the Coloured are considered the hardiest, although the breeders of the Silver Gray contend there is no difference. They are a breed that will surely come to the fore on the score of superior quality and quantity of flesh. They are only fair layers. The chickens were equal in hardiness to that of other breeds. A cockerel hatched on the 25th May showed 3 lbs. 8 oz. on the 26th October. An accident resulted in the loss of the other cockerels so that we have the record of only one. The eggs laid by three hens procured last fall were of medium size. The hens show the long compact bodies so characteristic of the breed. The weights by the standard are: cock, 9½ lbs.; hen, 7½; cockerel, 8 lbs.; pullet, 6 lbs. Since writing the above a letter was received from Mr. John Dickinson, of Barrie, Ont., in which he states "that with his sons he is breeding Coloured Dorkings with great success, and that at date of letter, 2nd Dec., he had cockerels hatched late in May last, which weighed 9½ lbs." This is certainly a strong endorsement of the worth of the breed as a market fowl.

#### EGGS LAID AND THE BREEDS WHICH LAID THEM.

The winter of 1891-92 will be remembered for its severity. In the poultry buildings of the farm the cold was felt as it was almost everywhere else. The lowest temperature was noted in No. 1, or the house wherein the layers were kept, when the temperature went down to 20° below freezing on the night of the 24th December, and it remained so for twelve or fourteen hours afterwards. Outside the thermometer registered 28° below zero, accompanied by a strong and piercing wind from the north-west. In previous reports it has been stated that where the laying stock is kept in cold houses, the food instead of going into eggs is drawn upon to furnish animal heat, and it has been urged upon the farmers to keep their fowls in as comfortable quarters as possible, in order to obtain eggs. Attention is also given to the subject in this report for it is one deserving consideration. It will be interesting then to note the eggs laid by the different breeds under the circumstances as noted. It will be seen that some of the breeds said to be the best winter layers and hardiest of fowls did not prove themselves so. The breeds which did best during the cold season were the Plymouth Rocks, Black Minorcas, Andalusians, Red Caps and White Leghorns, as follows:—

#### PLYMOUTH ROCKS.

There were eleven hens and nine pullets. Of this number seven pullets were separated and reserved for breeding stock. The remainder laid 211 eggs. During January 97, February 53 and March 59. Some of the hens were two years of age and the pullets late.

#### BLACK MINORCAS.

Of this breed there were four hens and thirteen pullets. The hens and five of the pullets were kept as breeders. The remaining eight pullets laid 213 eggs. In January 89, February 50 and March 74.



## Experimental Farms.

### ANDALUSIANS.

There were eleven hens and seven pullets of which number five of the hens were used as breeders. The remainder laid during the three first months of the year 182 eggs, viz., January 71, February 72, March 39.

### RED CAPS.

There were five hens and six pullets of this breed, three hens and two pullets being reserved as breeders. The remainder laid 165 eggs as follows: January 55, February 69, March 39.

### WHITE LEGHORNS.

Of this breed there were seventeen hens and twelve pullets. The most of the hens were old and were kept for breeding from. Seven of the pullets were put into the breeding pen in No. 2 house. The remainder laid 157 eggs, viz., January 32, February 73, March 51.

### WYANDOTTES.

Nine hens and six pullets, five pullets being reserved as breeders. The remainder laid 79 eggs, January 25, February 31, March 23.

### LIGHT BRAHMAS.

There were six hens and sixteen pullets of this breed. They were all in one pen and were rather crowded. The pullets were of late hatch. The hens did nothing, the pullets seemed at a stand-still during the cold season, and did not begin to lay until the change of season in the beginning of April. The lesson to be learned from the foregoing is that pullets of this breed must be hatched early, so as to have every opportunity to mature before the winter season begins, and they must not be crowded. This has been remarked in previous reports.

### LANGSHANS.

There were three hens and eight pullets of this breed. The pullets were late of hatch as in the case of the Brahmas and the same remarks made *re* last named, apply to the former, as their characteristics are about the same. The three hens laid 95 eggs, viz., January 10, February 25, March 27. Several of the pullets were sickly during the early part of the winter and a good deal of trouble was experienced in getting them on their feet and they were never robust. Fine specimens of this breed have been reared this season from superior stock and good results are hoped for, as the breed is a good one.

### HOUDANS.

There were eleven old hens of this breed kept for breeding stock and such being the case it would be hardly fair to expect an egg record. These hens did not begin to lay until April.

### WHITE LEGHORN-BRAHMA CROSS.

There were six pullets of this cross and one of White Leghorn-Plymouth Rock cross. They were of different ages, some being late. Three pullets laid 75 eggs during the first three months of the year, viz., 42 during January; 30 in February and 3 in March. A number of eggs were eaten during the last named month. In

April when the fowls got out, the egg eating ceased and the seven pullets laid 133 eggs during the month. In April the seven pullets laid 7 eggs *per diem* 5 times; six eggs *per diem* 10 times, five eggs 5 times and the remainder at the rate of 4, 3 and 2 per day. This is excellent laying even for that time of year.

#### MIXED OR COMMON FOWLS.

There were twenty-nine fowls of all ages and size. They were of no particular breed and were kept for sitters only. They were fairly representative of the barn yard fowl of the ordinary farm yard. These fowls were placed in two pens in a cold part of the building but no colder than the fowl house so common in the country. They were fed the same rations as the Plymouth Rocks, Minorcas and Red Caps but they laid few eggs until the month of April when they laid 312 eggs. The record is 32 eggs for January, 37 for February and 18 for March. In April eggs were down to 15 and 17 cents per dozen so that they began to lay when eggs were cheap. It may be said that the mixed fowls were no worse than the Brahma thoroughbreds. But in the case of the latter breed the explanation is given that the pullets were of too late hatch and when they did begin to lay their eggs were worth one dollar per setting to the farm as thoroughbred eggs sold for hatching from.

The total number of eggs laid during the eight months of the year was 6,228. Of this number the months show as follows: January, 434; February, 442; March, 384; April, 1,278; May, 1,563; June, 758; July, 788; August, 581. It will be seen that more than half the total number of eggs were laid—most of them by the pure bred fowls—during the months of April, May and June when they were readily purchased at one dollar per setting for hatching.

#### THE EXPERIENCE GAINED.

The experience of last and previous winters confirms what has been written in previous reports, viz.:

1. Pullets should be hatched out as early as possible.
2. The laying stock should be young and birds of the same age should be in the one pen.
3. A warm or comfortable house is more economical in the long run than a cold one.
4. What will go into eggs in the pullets will make the hens of the heavy breeds too fat to lay.
5. The laying stock require ample room. See instructions on a previous page.

#### BREEDING PENS MADE UP.

After a very cold winter the weather moderated about the beginning of March, and the breeding pens were made up as follows:—

Breed.	When mated.	No. in Pen.	Remarks.
Brahmas	March 3	1 cockerel, 9 hens	
Plymouth Rocks	do 3	1 cock, 11 hens	
Brahmas (2nd pen)	do 3	1 do 11 pullets	
White Leghorns	do 27	1 do 9 do	
do (2nd pen)	do 25	1 cockerel, 7 hens	
<i>Crosses.</i>			
Langshan-Black Minorca	do 30	1 do 5 do	
White Leghorn-Brahma	April 2	1 do 5 do	

## Experimental Farms.

As in previous years the demand for eggs for hatching was much greater than could be filled, and many disappointments were the result, but the orders were taken in rotation, and as far as possible farmers had first choice.

### EGGS SET AND CHICKENS HATCHED.

When set.	Description of Eggs.	Number of Chicks hatched.	When hatched.	Remarks.
April 8.	11 Black Minorca.....	5	April 29.	From Toronto.
do 19.	8 Red Caps, 3 crosses.....	7	May 11.	
do 21.	11 Langshans.....	7	do 13.	From F. A. Mortimer, Pottsville, U.S.
do 24.	13 Plymouth Rock.....	7	do 17.	
do 29.	13 White Plymouth Rocks.....	12	do 20.	From Allan's Corners, Q.
do 29.	13 S. L. Wyandottes.....	6	do 20.	do Todmorden, Ont.
do 29.	13 do.....	6	do 20.	do do
May 2.	8 W. P. Rocks, 5 Langshans.....	10	do 23.	do Toronto.
do 3.	13 Red Caps.....	8	do 24.	do do
do 4.	13 Coloured Dorkings.....	6	do 25.	do London, Ont.
do 9.	13 White Plymouth Rocks.....	12	do 30.	do Toronto.
do 9.	13 Langshans.....	6	do 30.	
do 11.	13 White Wyandottes.....	10	June 1.	do Kingston.
do 13.	13 Black Minorcas.....	7	do 3.	do Toronto.
do 17.	13 White Wyandottes.....	10	do 6.	do Ottawa.
do 18.	8 G. Polands, 5 P. Rocks.....	12	do 8.	
do 22.	13 White Wyandottes.....	6	do 12.	
do 27.	13 Red Caps and Plymouth Rocks.....	9	do 17.	
do 27.	9 Plymouth Rocks, 4 G. Polands.....	9	do 17.	
do 29.	13 B. Plymouth Rocks.....	7	do 19.	do Kingston.
do 30.	13 Houdans.....	12	do 20.	
do 30.	13 Langshans-B. Minorca, cross.....	12	do 30.	
do 30.	Sundry eggs.....	9	do 30.	
		195		

### SITTERS SCARCE.

The difficulty in obtaining early sitters clearly proved the necessity of the assistance of a good incubator. It is an every year experience. When sitters become numerous the season is too far advanced to permit of early chickens being hatched out so as to obtain pullets that will lay while the hens are moulting, or early hatched cockerels to make early market chickens. The probabilities are that the time is not far distant when artificial incubation will be well understood and generally practised. The first hen to become broody was a Plymouth Rock, and she was given eleven Black Minorca eggs on the 8th April. The hens were all "set" on board floors covered with two to three inches of sand and earth. Description of the nests used, and the method of setting the hens have been fully described in previous reports. Drink, food and a dust bath were in close proximity to the sitters at all times.

### PROGRESS OF THE CHICKS.

The chicks made good progress, considering that the ground has been used for the same purpose for the four previous years. It is the intention to give the newly hatched chickens entirely new ground next spring, a large space having been fenced in for that purpose. After hatching, the chicks were allowed to remain in the nest until thoroughly strong on their legs. Their first food was stale bread soaked in milk and squeezed dry, varied by stale bread crumbs. In a day or two granulated oatmeal was added, then crushed corn and after 12 or 15 days whole wheat. A splendid mash for the rapidly growing youngsters was found to be shorts, cornmeal, bran,

bone meal, and bread and table scraps from the houses of the farm, the whole being mixed up with boiling milk or water. Where milk is in abundant supply it will be found one of the best foods for the growing chicks or the laying hens. Some figures showing the weights made by chickens of certain breeds have been given in a preceding page, but the following may be stated without repetition :—

The most rapid growth was made by a White Plymouth Rock, which hatched on the 20th May, weighed on the 21st October following 6 lbs.; representing a development of 19 oz. per month. This gain may not represent that made in the first month after hatching, but it was subsequently made up.

The next best growth was made by a cross of the Langshan—Black Minorca breeds, the Langshan male being used. This cockerel was hatched on the 11th May, and weighed on the 21st October, 5 lbs. 15 oz. The Barred Plymouth Rocks came next, closely followed by the Wyandottes, both White and Silver Laced. In some cases the weights were the same.

The White and Silver Laced Wyandottes made about the same progress. Both represent a development of 1 lb. per month, taking the heaviest weights. On new ground the figure named should be fairly representative for all cockerels. With special feeding the cockerels might be pushed to a heavier weight. The same may be said of all the breeds mentioned.

The chicks were fed a little and often for the first four or five weeks, and as their size increased and their rations became more solid, they were fed four times daily. Care was taken that the evening ration of grain was a generous one, the object being to keep their crops as full as possible, and for as long as possible during the night. The necessity of pushing their chickens to early maturity has been urged on the farmers in previous reports.

#### DISEASES OF POULTRY.

Numerous inquiries were received during the year from different parts of the country as to diseases affecting poultry. Satisfactory information was given in almost every case.

On the 7th July last a letter was received from Mr. Hector Chauvin of Montebello, P.Q., stating "that a disease (similar to that of cholera) had shown itself among his chickens. Since the previous Sunday he had lost thirty and he noticed many others which were sickly looking. He feared for the remaining 260."

As the distance was not great and it was known that Mr. Chauvin had valuable chickens, a visit was paid to that gentleman's poultry yard. The disease was found to be a slight diarrhœa caused by acute indigestion, the result of a little overcrowding and too close confinement. It had already been checked by the timely and judicious remedies given by Mr. Chauvin, who is thoroughly up in poultry matters. It was advised that his chickens be allowed free run outside.

Mr. Chauvin has a large and well constructed poultry house, fitted up according to the most approved methods and furnished with all the latest machinery, conveniences, &c. It is doubtful if there is a more completely furnished poultry establishment in the Dominion. Mr. Chauvin sold all the eggs laid by his hens last winter, in Montreal, at 40 cents per dozen.

#### SUSPECTED TUBERCULOSIS.

The following may be of service to others. On the 21st November ult. Mr. M. Cowley, of Bristol Corners, P.Q., wrote under date of the day previous:

"SIR,—My hens have taken a disease this fall that proves fatal in a month or six weeks time. They first take lame in one leg, then their comb wilts away. They hobble round for a few weeks and die. I opened four of them and found that all their livers were diseased. The livers looked as if they had been covered with hay seed and some were ulcerated. It seems to be more prevalent with my Brown

## Experimental Farms.

Leghorn hens. None of the cock birds have it yet, nor have this year's chickens. The sick ones are mostly last year's birds. My hens have the same run as any farm yard fowls. The disease seems to be general round here. I would be glad if you could let me know what to do."

As the disease seemed to affect several localities Mr. Cowley's letter was forwarded to Prof. Wesley Mills, of McGill University, Montreal, and the following reply was received:—

MCGILL UNIVERSITY,  
MONTREAL, 28th November, 1893.

DEAR SIR,—I am in receipt of your letter of 23rd instant. From the account of the disease given by Mr. Cowley, I should suspect some germ disease, possibly tuberculosis. If you will forward one of the birds to my address as above, as soon after death as possible, I will ask our professor of pathology to kindly make a careful examination.

In any case I would recommend isolation of sick birds and disinfection of the houses in which the fowls have been kept, with a special care to comfort and feeding.

Faithfully yours,

WESLEY MILLS, M.D.

In accordance with the above Mr. Cowley was requested to send the fowl to the address as requested. On the 18th December, Mr. Cowley drove in from Bristol's Corners with a fowl which had died of the disease and the subject was at once forwarded to Dr. Mills. The result of the examination will be awaited with interest.

### BEGINNING OF WINTER LAYING.

After enjoying a free run outside, the fowls went into winter quarters during the third week in November. The hens were in most cases over their moult, but some were still very ragged. The White Leghorns were the first to lay followed by the Light Brahmas. Up to date none of the pullets had laid.

### THE POULTRY SHOW AT THE INDUSTRIAL.

During the Industrial Exhibition at Toronto, in September last, the meeting of the Ontario Poultry Association held on the 15th of the month named was attended and upon the invitation of the president an address was delivered on "the value of poultry as a means of revenue to the country and to the farmer." The exhibition of poultry, held in the enlarged and improved poultry building of the Exhibition Association, was the best fall show ever seen on the continent at the time of year. The management, arrangement and judging of the birds were simply magnificent.

### INCREASED INTEREST IN POULTRY.

Apart from the numerous excursion parties which visited the Experimental Farm during the early part of the season, the increase in the number of farmer visitors to the poultry department and in the interest taken in the same were most gratifying. A largely increased correspondence and demand for plans of buildings; reports containing details as to management of poultry, &c., indicate a more general appreciation of the value of the poultry department as a means of making money.

### IMPROVEMENTS.

During the past summer season a large piece of land adjoining the poultry building has been fenced in as part of the department, and will afford change of

ground for the young chicks next season. The cedar posts in front of the main poultry building and in the runs to the rear have been removed and replaced by a light iron posts and wire netting, the whole presenting a very handsome appearance. In the outside runs in rear of the buildings one and three and to the side of No. 2, grass sods have been laid for one-half the runs and the other portions have been boxed off and filled with sand in one part and gravel in the other.

#### EARTH VERSUS STRAW COVERED FLOORS.

In No. 1, on main building which contains the laying stock, the floors of the five pens in the south wing have been covered with sand to the depth of three or four inches. A quantity of fine gravel has been mixed with the sand. In the north wing the floors of the five pens are left covered with the straw and chaff heretofore used. The object is to find out the merits of the earth *versus* the straw covered floor. It is presumed the conditions will be more natural, in so far, that better opportunity will be afforded the layers to dust, scratch in, pick up grit, &c., &c., and that while egg laying will be increased, the vices of egg and feather eating will be prevented.

#### PULLETS OF DIFFERENT BREEDS ON TRIAL.

A pen of Barred and another of White Plymouth Rock pullets and a pen each of White and Silver Laced Wyandottes are side by side in the south wing of No. 1 house. Note will be taken as to any points of superiority between these different varieties. Trial is also being made of a pen of pullets of the Langshan-Black Minorca cross and other pullets of the White Leghorn-Brabma cross, all of which promise to make good winter layers.

I have the honour to be, sir,

Your obedient servant,

A. G. GILBERT,

*Manager Poultry Department.*

Central Experimental Farm,  
Ottawa, 5th December, 1893.

## Experimental Farms.

# EXPERIMENTAL FARM FOR THE MARITIME PROVINCES.

---

### REPORT OF WM. M. BLAIR, SUPERINTENDENT.

To WILLIAM SAUNDERS, Esq.,  
Director Dominion Experimental Farms,  
Ottawa.

SIR,—I have the honour to submit herewith the following report of the operations on the Experimental Farm for the Maritime Provinces at Nappan, N. S., during the year 1893.

#### WEATHER.

The winter of 1892-93 was a cold one. Water pipes that were 4 feet deep in the ground, were frozen in several places. Seeding commenced on April 29th. The spring was fine and dry, with some very warm weather in May. During June the crops suffered much with drought, which continued until July 4th. After that the vegetation was rapid and with good harvest weather the crops were gathered in good condition and were a good average yield.

#### MANURE.

Some 200 dollars worth of special fertilizers were used, in addition to the farm-yard manure. These combined are gradually bringing up the farm to a good state of fertility.

#### HAY.

The hay was a good crop both on marsh and upland—the former as well as the latter readily responding both in quantity and quality to a more perfect drainage.

About 110 tons of excellent hay was secured in fine condition. This hay, with roots and grain grown on the farm is consumed by cattle and horses.

Thirty-three loads of English hay was secured from 10 acres of upland, while from the marsh land 50 loads of English and 17 loads of broad leaf hay were harvested, there being 30 acres of the former and 16 acres of the latter. The loads averaged 2,200 pounds.

About 10 acres of upland, that was in meadow last year, and yielded 30 tons of hay, was this year devoted to pasturage.

#### WINTER WHEAT.

Eight varieties of winter wheat were sown in September, 1892, all of which were completely winter-killed, while winter rye sown at the same time on the same kind of land yielded  $14\frac{1}{2}$  bushels from  $\frac{3}{4}$  bushel seed sown.

SPRING WHEAT.

Twenty-nine varieties of spring wheat were sown, as stated below, in plots of one-twentieth of an acre each. Four and one-half pounds of seed (equal to 1½ bushels per acre) was sown on each plot, with the results given.

Name of Variety.	Sown.	Harvested.	Number of days maturing.	Yield per acre.		Lbs. per bushel.	Condition when cut.
				Bush. Lbs.			
White Fife.....	May 4.	Aug. 29.	117	18	20	55	Long, stiff, bright straw.
Great Western.....	do 4.	do 22.	110	25	20	60½	Long, weak, bright straw.
Hungarian Mountain.....	do 4.	do 23.	111	21	00	61½	Medium long, stiff, bright straw.
Defiance.....	do 3.	do 24.	113	20	00	60	Long, stiff, bright straw.
Rio Grande.....	do 3.	do 22.	111	20	50	61½	do do
White Connell.....	do 3.	do 26.	115	25	40	61½	Medium long, stiff, bright straw.
Wellman's Fife.....	do 3.	do 24.	113	15	40	57	Short, stiff, bright straw.
Red Fife.....	do 3.	do 22.	111	26	20	59¾	Medium long, medium stiff, bright straw.
Herisson Bearded.....	do 4.	do 24.	112	21	00	62	Short, stiff, bright straw.
Red Fern.....	do 3.	do 23.	112	19	45	62	Medium long, stiff, bright straw.
Ladoga.....	do 3.	do 19.	108	21	40	60	Medium long, medium stiff, bright straw.
Pringle's Champlain.....	do 3.	do 21.	110	23	20	55	Long, medium stiff, bright straw.
Campbell's White Chaff..	do 3.	do 16.	105	24	40	59	Medium long, stiff, bright straw.
White Russian.....	do 3.	do 23.	112	21	40	59½	Medium long, medium stiff, bright straw.
Colorado.....	do 3.	do 19.	108	26	40	61	Long, stiff, bright straw.
Hueston's.....	do 4.	do 24.	112	20	40	60	do do
Azima, Russian.....	do 4.	do 24.	112	10	40	59	Very short, stiff, bright straw.
Black Sea.....	do 4.	do 19.	107	20	00	60	Medium long, stiff, bright straw.
Abundance.....	do 4.	do 20.	108	22	30	60	Medium long, weak, bright; some lodged.
Beta.....	do 4.	do 19.	107	19	40	58½	Medium long, stiff, bright straw.
Alpha.....	do 4.	do 23.	111	27	00	58	Long, stiff, bright straw.
Carleton.....	do 4.	do 22.	110	24	40	59	Medium long, weak, bright straw.
Ottawa.....	do 4.	do 22.	110	22	00	57	Medium long, stiff, bright straw.
Prince.....	do 4.	do 21.	109	15	50	60¾	do do do
Advance.....	do 4.	do 21.	109	21	30	57	do do do
Stanley.....	do 4.	do 21.	109	26	40	60	Long, stiff, bright straw.
Preston.....	do 4.	do 24.	112	21	00	59½	Medium long, stiff, bright straw.
Albert.....	do 4.	do 21.	109	17	00	59	do do do
Crown.....	do 4.	do 23.	111	20	00	60	do do do



# Experimental Farms.

## BARLEY.

Eighteen varieties of barley were sown in plots of one-twentieth acre each. Four and three-quarter pounds of seed was sown on each plot, with the results as stated below.

Name of Variety.	Sown.	Harvested	Number of days maturing.	Yield per acre.		Lbs. per bushel.	Condition of Straw when cut.
				Bush.	Lbs.		
Baxter's Six-Rowed.	May 9..	Aug. 10..	93	37	4	49½	Medium long, stiff, very rusty.
Rennie's Improved..	do 9..	do 11..	94	18	46	46½	Short, soft, bright.
Odessa .....	do 9..	do 11..	94	20	00	44	Medium long, soft, bright.
Oderbruch.....	do 9..	do 10..	93	25	00	48	Medium long, stiff, bright.
Mensury .....	do 9..	do 15..	98	19	28	45	Short, stiff, bright.
Two-Rowed Naked..	do 9..	do 19..	102	15	40	59	Short, weak, bright; some lodged.
Guaymalaye .....	do 9..	do 16..	99	24	18	58	Short, soft, bright.
Thanet .....	do 9..	do 21..	104	22	4	49½	Short, stiff, bright.
New Golden Grains .	do 9..	do 21..	104	18	26	51½	Short, weak, bright; some lodged.
Duckbill .....	do 9..	do 18..	101	31	32	49½	Medium long, stiff, bright.
Prize Prolific .....	do 9..	do 19..	102	27	4	51	Very short, weak; some rust.
Golden Melon .....	do 9..	do 22..	105	32	9	50½	Short, soft, bright; some lodged.
Goldthorpe.....	do 9..	do 22..	105	26	32	49½	Short, weak, bright.
Canadian Thorpe .	do 9..	do 18..	101	20	20	49	Short, stiff, bright.
French Chevalier .	do 9..	do 19..	102	18	16	49	do do
Improved Chevalier.	do 9..	do 19..	102	26	2	49½	Short, weak, bright.
Common Six-Rowed.	do 9..	do 21..	104	40	00	47½	Medium long, soft, bright.
Newton .....	do 9..	do 21..	104	20	00	48½	Short, stiff, bright.

Two varieties of cross-bred barley received from the Central Farm, Ottawa, of one pound each, were sown with the following results:—

Name of Variety.	Sown.	Harvested.	Number of days maturing.	Lbs. per bushel.	Condition of Straw when cut.
Summit .....	May 20..	Aug. 24....	96	48½	Long, weak, bright; lodged.
Surprise.....	do 20..	do 24....	96	49	Medium long, weak, bright; some lodged.

## OATS.

Forty-three varieties of oats were also grown in plots of one-twentieth acre each; four and a quarter pounds of seed being sown in each case, equal to two and a half bushels per acre, from which the following results were obtained:—

Name.	Sown.	Harvested.	Number of days maturing.	Yield per acre.		Lbs. per bushel.	Condition of Straw when cut.
				Bush. Lbs.			
Victoria Prize.....	May 8.	Aug. 11.	95	57	2	39 $\frac{1}{2}$	Long, stiff and coarse, bright.
Rennie's Prize White.....	do 8.	do 11.	95	56	16	37	Short, stiff, bright.
Flying Scotchman.....	do 8.	do 12.	96	67	2	38	Long, weak, bright; some lodged.
Challenge (Webb's).....	do 8.	do 11.	95	44	24	39	Medium long, stiff, bright.
Early English White.....	do 8.	do 16.	100	48	18	39	do do
Poland White.....	do 8.	do 18.	102	61	26	40 $\frac{1}{2}$	Medium long, soft, bright.
Bonanza.....	do 8.	do 18.	102	72	32	42	Long, weak, bright; much lodged
Early Racehorse.....	do 8.	do 15.	99	68	8	42 $\frac{1}{2}$	Long, medium weak, bright; some lodged.
Canadian Triumph.....	do 8.	do 15.	99	64	24	41 $\frac{1}{2}$	Long, soft and weak, bright; much lodged.
Welcome.....	do 8.	do 10.	94	54	4	39	Medium long, stiff and bright.
Hazlett's Seizure.....	do 8.	do 10.	94	56	21	39 $\frac{1}{2}$	Medium long, medium soft and bright.
Prize Cluster.....	do 8.	do 11.	95	58	8	38	Medium long, weak, bright.
Early Archangel.....	do 8.	do 12.	96	47	22	39 $\frac{1}{2}$	Medium long, stiff, bright.
Rennie's New.....	do 8.	do 22.	106	66	21	35	Short, stiff and bright.
Improved Ligowo.....	do 8.	do 17.	101	67	2	36	Medium long, weak, bright; some lodged.
Banner.....	do 8.	do 17.	101	56	16	36 $\frac{1}{2}$	Medium long, stiff and bright.
Cream Egyptian.....	do 8.	do 18.	102	89	14	39	Long, soft, bright; some lodged.
Early Blossom.....	do 8.	do 16.	100	64	24	35	Long, stiff, bright.
American Beauty.....	do 8.	do 14.	98	47	22	36	Short, stiff, bright.
Early Etampes.....	do 8.	do 19.	103	64	4	35	do do
Joanette.....	do 9.	do 19.	102	51	16	35	do do
Prolific Black California.....	do 9.	do 19.	102	56	16	35	Long, weak, bright; some lodged.
Prolific Black Tartarian.....	do 9.	do 18.	101	63	18	36 $\frac{1}{2}$	Long, soft, bright.
Abundance.....	do 9.	do 17.	100	50	20	36 $\frac{1}{2}$	Medium long, stiff, bright.
Doncaster Prize.....	do 9.	do 14.	97	50	20	37	do do
Holstein Prolific.....	do 9.	do 16.	99	68	8	38	Long, soft, bright; some lodged.
Improved Black Tartarian.....	do 9.	do 18.	101	52	32	35 $\frac{1}{2}$	Long, stiff, bright.
Early Gothland.....	do 9.	do 18.	101	50	30	39 $\frac{1}{2}$	do do
Rosedale.....	do 9.	do 15.	98	55	10	40	Medium long, stiff, bright.
Black Brie.....	do 9.	do 24.	107	44	24	33	do do
Giant Cluster.....	do 9.	do 24.	107	62	22	34	Long, weak and bright; lodged.
Black Coulommiers.....	do 9.	do 25.	108	60	00	35 $\frac{1}{2}$	Medium long, stiff, bright.
Golden Beauty.....	do 9.	do 19.	102	57	2	35	Long, weak, bright; some lodged.
Oderbruch.....	do 9.	do 19.	102	58	8	39	Long, stiff, bright.
Scottish Chief.....	do 9.	do 10.	93	63	18	40	do do
Siberian.....	do 9.	do 23.	106	55	10	35 $\frac{1}{2}$	Long, medium weak, bright.
Cave.....	do 9.	do 18.	101	61	6	37	Medium long, stiff; some rust.
Abysinnia.....	do 9.	do 18.	101	56	16	39	Long, stiff, bright.
Wide Awake.....	do 9.	do 18.	101	57	22	35	Long, weak, bright; lodged.
Imported Irish.....	do 9.	do 17.	100	54	4	39	Medium long, soft, bright; some lodged.
Columbus.....	do 9.	do 18.	101	52	12	34	Short, soft, bright; some lodged.
White Wonder.....	do 9.	do 11.	94	58	28	39 $\frac{1}{2}$	Long, weak and bright; some lodged.
American Triumph.....	do 9.	do 23.	106	51	26	37 $\frac{1}{2}$	do do

# Experimental Farms.

## EARLY AND LATE SOWING.

In order to test the relative value of early and late sowing, a field was laid off in plots of one-tenth of an acre each and sown at four different times, commencing on May 10th, one week intervening between each sowing, the same kind of grain in all cases being sown. There were two plots each of wheat, barley and oats. The following table gives the results.

### WHEAT SOWN AT DIFFERENT TIMES.

Nine pounds to each plot.		Sown.	Harvested.	Bushels per plot.	Lbs. per bushel.
1.	Campbell's White Chaff.	May 10	Aug. 26	13 $\frac{3}{4}$	60 $\frac{3}{4}$
	Red Fife.	do 10	do 26	13 $\frac{1}{4}$	57
2.	Campbell's White Chaff.	do 17	do 29	2	58 $\frac{1}{2}$
	Red Fife.	do 17	do 28	13 $\frac{3}{4}$	55
3.	Campbell's White Chaff.	do 24	do 30	2	58
	Red Fife.	do 24	Sept. 2	13 $\frac{3}{4}$	52 $\frac{1}{2}$
4.	Campbell's White Chaff.	do 31	do 2		47
	Red Fife.	do 31	do 4	1 $\frac{1}{2}$	45

### BARLEY SOWN AT DIFFERENT TIMES.

Nine and a half pounds on each plot.		Sown.	Harvested.	Bushels per plot.	Lbs. per bushel.
1.	Duckbill	May 10	Aug. 21	3	52
	Baxter's Six-Rowed	do 10	do 11	3 $\frac{1}{4}$	47
2.	Duckbill	do 17	do 26	2 $\frac{3}{4}$	51
	Baxter's Six-Rowed	do 17	do 18	1 $\frac{3}{4}$	47
3.	Duckbill	do 24	do 28	3 $\frac{1}{4}$	49
	Baxter's Six-Rowed	do 24	do 22	2 $\frac{3}{4}$	46
4.	Duckbill	do 31	do 30	3 $\frac{1}{4}$	43 $\frac{3}{4}$
	Baxter's Six-Rowed	do 31	do 26	1	46

### OATS SOWN AT DIFFERENT TIMES.

Eight and a half pounds on each plot.		Sown.	Harvested.	Bushels per plot.	Lbs. per bushel.
1.	Banner	May 10	Aug. 19	5 $\frac{1}{4}$	37
	Prize Cluster	do 10	do 18	3 $\frac{3}{4}$	40
2.	Banner	do 17	do 22	5 $\frac{1}{4}$	34
	Prize Cluster	do 17	do 21	3 $\frac{1}{4}$	40
3.	Banner	do 24	do 27	5	35
	Prize Cluster	do 24	do 26	3 $\frac{1}{4}$	39
4.	Banner	do 31	do 30	3	32
	Prize Cluster	do 31	do 29	2 $\frac{1}{2}$	38 $\frac{1}{2}$

## PEASE.

Ten varieties of pease were sown in plots of one-twentieth acre each, with results as given in the following table:—

Name, and pounds of Seed sown.	Sown.	Harvested	No. of days maturing	Yield per acre.	Lbs. per bush.	Condition when cut.
				Bush. Lbs.		
Black-eyed Marrowfat— 10½ lbs., or 3¼ bush. per acre.	May 10.	Aug. 20.	102	34 00	60	Vines made a strong growth.
Mummy— 9 lbs., or 3 bush. per acre.	do 10.	do 16.	98	32 00	61	Vines very strong growth.
Crown— 7½ lbs., or 2½ bush. per acre.	do 10.	do 14.	96	35 20	59	Vines made a very strong growth.
Golden Vine— 7½ lbs., or 2½ bush. per acre.	do 10.	do 14.	96	33 20	60	Vines, strong growth and stiff.
Multiplier— 7½ lbs., or 2½ bush. per acre.	do 10.	do 18.	100	38 40	63	Medium strong growth of vines.
Centennial— 9 lbs., or 3 bush. per acre.	do 10.	do 18.	100	33 00	62	Long vines and heavy growth.
Prince Albert— 7½ lbs., or 2½ bush. per acre.	do 10.	do 19.	101	34 20	61	Small vines; medium strong.
Pride— 9 lbs., or 3 bush. per acre.	do 10.	do 11.	93	31 20	61	Vines strong; heavy growth.
Potter— 7½ lbs., or 2½ bush. per acre.	do 10.	do 17.	99	27 20	60½	Large vines; good growth.
Rennie's No. 10— 10 lbs., or 3¼ bush. per acre.	do 10.	do 17.	99	37 20	63	Vines made a strong growth.

## TURNIPS.

Eleven varieties of turnips were sown in plots, consisting of three rows, 30 inches apart and 66 feet long, of each kind, on May 22nd. Duplicate plots of the same varieties were sown on June 6th. The following table gives the results, showing that all the varieties excepting Skirving's Purple Top, gave a larger yield from the earlier sown plots:—

Name of Variety.	1st Plot Sown.	2nd Plot Sown.	1st Plot Pulled.	2nd Plot Pulled.	1st Plot, Weight.	2nd Plot, Weight.
					Lbs.	Lbs.
Selected East Lothian	May 22.	June 6.	Oct. 18.	Oct. 18.	735	435
Sutton's Champion	do 22.	do 6.	do 18.	do 18.	750	505
Mammoth Purple Top	do 22.	do 6.	do 18.	do 18.	480	355
Carter's Prize Winner	do 22.	do 6.	do 18.	do 18.	775	503
Steele's Selected Purple Top	do 22.	do 6.	do 18.	do 18.	700	645
Jumbo or Monarch	do 22.	do 6.	do 18.	do 18.	865	550
Carter's Elephant	do 22.	do 6.	do 18.	do 18.	555	410
Marquis of Lorne	do 22.	do 6.	do 18.	do 18.	745	475
Bangholm	do 22.	do 6.	do 18.	do 18.	755	515
Skirving's Purple Top	do 22.	do 6.	do 18.	do 18.	528	605
Prize Purple Top	do 22.	do 6.	do 18.	do 18.	475	350

## Experimental Farms.

### MANGELS.

Ten varieties of mangels were sown in plots of three rows, 30 inches apart and 66 feet long, of each kind. These were sown on May 22nd, and a duplicate plot of each kind was sown on 6th June, with the following results :—

Name of Variety.	1st Plot Sown.	2nd Plot Sown.	1st Plot Pulled.	2nd Plot Pulled.	1st Plot Weight.	2nd Plot Weight.
					Lbs.	Lbs.
Gate Post or Long Red.....	May 22..	June 6..	Oct. 17..	Oct. 16..	415	450
Pearce's Canadian Giant.....	do 22..	do 6..	do 17..	do 16..	260	370
Giant Yellow Intermediate.....	do 22..	do 6..	do 17..	do 16..	455	550
Champion Yellow Globe.....	do 22..	do 6..	do 17..	do 16..	430	400
Red Globe.....	do 22..	do 6..	do 17..	do 16..	325	275
Golden Tankard.....	do 22..	do 6..	do 17..	do 16..	560	370
Red Fleshed Tankard.....	do 22..	do 6..	do 17..	do 16..	275	340
Erfurt Model.....	do 22..	do 6..	do 17..	do 16..	456	360
Warden Orange Globe.....	do 22..	do 6..	do 17..	do 16..	250	205
Mammoth Long Red.....	do 22..	do 6..	do 17..	do 16..	305	475

### CARROTS.

Ten varieties of carrots were sown on 22nd May in three rows, each 66 feet long and 24 inches apart, with duplicate plots of each variety sown on June 6th. The results were as stated below :—

Name of Variety.	1st Plot Sown.	2nd Plot Sown.	1st Plot Pulled.	2nd Plot Pulled.	1st Plot Weight.	2nd Plot Weight.
					Lbs.	Lbs.
Improved Short White.....	May 22..	June 6..	Oct. 17..	Oct. 16..	400	220
Large Short Vosges.....	do 22..	do 6..	do 17..	do 16..	295	130
Mam. White Intermediate.....	do 22..	do 6..	do 17..	do 16..	525	202
Guerande or Oxheart.....	do 22..	do 6..	do 17..	do 16..	315	110
Early Gem.....	do 22..	do 6..	do 17..	do 16..	333	140
Chantenay.....	do 22..	do 6..	do 17..	do 16..	232	140
Half Long, Denver's.....	do 22..	do 6..	do 17..	do 16..	270	155
Long Red (without core).....	do 22..	do 6..	do 17..	do 16..	193	78
Carter's Orange Giant.....	do 22..	do 6..	do 17..	do 16..	280	182
White Belgian.....	do 22..	do 6..	do 17..	do 16..	245	100

### SUGAR BEETS.

Four varieties of sugar beets were sown in three rows, each 66 feet long and 30 inches between the rows, with the results as given below :—

Name of Variety.	Sown.	Pulled.	Weight.
			Lbs.
Vilmorin's Improved.....	May 22..	Oct. 19..	214
French New Rich.....	do 22..	do 19..	126
Klein Wanzleben.....	do 22..	do 19..	104
Green Top Brabant.....	do 22..	do 19..	248

MIXED GRAIN FOR FEED.

Two kinds of mixed grain were sown on one-tenth acre plots, to be cut green and cured for hay, with the following results:—

No. 1. Mixture sown May 11. Harvested August 11.

		Weight.	
		Green.	Dry.
		Lbs.	Lbs.
5 lbs. Prize Prolific Barley.....	} 1 bushel each per acre.....	1,140	553
6 do Golden Vine Pease.....			
3½ do Banner Oats.....			

No. 2. Mixture sown May 11. Harvested August 11.

		Weight.	
		Green.	Dry.
		Lbs.	Lbs.
6 lbs. Golden Vine Pease.....	} 1 bushel each per acre.....	960	430
6 do Red Fife Wheat.....			
3½ do Banner Oats.....			

CORN.

Nine varieties of corn were sown in two rows each, in hills 3 feet apart each way 66 feet long, and in rows 3 feet apart and 66 feet long, with the following results:—

Name of Variety.	Sown.	Harvested	Weight in rows, pounds.	Weight in hills, pounds.	Condition when cut.
Compton's Early.....	May 24...	Sept. 27..	500	475	Glazed.
Golden Dew Drop.....	do 24...	do 27..	400	520	Silking.
Mastodon Dent.....	do 24...	do 27..	505	420	do
Pearce's Prolific.....	do 24...	do 27..	250	305	Soft glazed.
Smut Nose Flint.....	do 24...	do 27..	450	410	Silking.
Mitchell's Extra Early.....	do 24...	do 27..	260	280	Glazed.
Angel of Midnight.....	do 24...	do 27..	550	335	Silking.
Thoroughbred White Flint.....	do 24...	do 27..	465	400	Tasselled.
North Dakota.....	do 24...	do 27..	260	475	do

THE ROBERTSON COMBINATION FOR ENSILAGE.

Two acres of corn and beans of this combination were sown on May 23rd, also one-half acre of Russian sunflowers, and were cut on Sept. 23rd and 25th.

The corn and beans weighed when wilted two days 28,060 pounds, and the sunflower heads weighed 3,635 pounds.

The land was prepared the same as for turnips, being in grain last year, ploughed in the fall, manured this spring with forty 30 bushel cart loads of manure from the barn-yard per acre well ploughed in and cultivated, 2 barrels of superphosphate per acre was sown broadcast and then harrowed in. The seed was then sown

## Experimental Farms.

with the seed drill 3 feet apart in the rows, with 2 to 4 seeds per foot. About one-half of the corn germinated, and made slow growth. The beans all grew well.

The corn was badly broken down by a storm on August 23rd, but it did not appear to damage the beans so much. The corn was in the milk stage when cut, and some of the beans on the lower part of the stalks were ripe.

It was evident that the same kind of corn grew better that was planted in plots without the beans, but we thought the beans grown alone did not appear to be so vigorous, as those grown among the corn.

### POTATOES.

Forty-nine varieties of potatoes were planted in two rows, each 66 feet long; dates of planting, May 21st to 23rd; dates of digging, Sept. 13th and 14th; results as given below; sets, 2 to 3 eyes; 1 foot apart.

Varieties.	Weight, sound in pounds.	Weight, rotten in pounds.	Colour of Tubers.	Remarks.
Everett.	184	10	Light pink.	Medium long, oval, medium late.
Daisy.	85	12	White and pink eyes.	do large, smooth, round late
Clarke's No. 1.	138½	19½	White and pink.	do long, smooth, late.
Empire State.	168	7	White.	Large, smooth, late.
Thorburn.	168	20	Light pink, white eyes.	Medium, smooth, late.
Early Sunrise.	143½	13	Pink.	Large, smooth, early.
Sharpe's Seedling.	166	14½	White.	Long, large, late.
Crown Jewel.	132	41½	Pink and white.	Oval, medium, large, early.
Holborn Abundance.	218		White.	Large, long, late.
Lee's Favourite.	143½	19	Pink and white.	Long, smooth, early.
Vanguard.	61½	33	do	Oblong, smooth, late.
Algoma No. 1.	113	32	do	Large, oval, early.
Early Ohio.	164	9	Light pink.	Long, oval, early.
Northern Spy.	169	6	Red.	Large, long, flat, late.
Dakota Red.	185	2	do	Large, round, late.
Early Rose.	140	6	Pink.	Long, oval, early.
State of Maine.	197	13½	White.	Large, long, flat, late.
Early Puritan.	155½	19	White and pink.	Long, smooth, early.
Burpee's Extra Early.	117	28½	Pink and white.	Medium long, round, early.
Chicago Market.	161	3	Pink.	Long, oval, late.
Beauty of Hebron.	122	24	White.	Oblong, smooth, early.
Rural Blush.	165		Pink.	Long, round, late.
Delaware.	172	13½	White.	Large, round, late.
London.	142	10½	Pink.	Medium large, oval, early.
Polaris.	136	18	White.	Oblong, smooth, medium early.
Bruce's White Beauty.	114½	16	do	Medium large, oval, early.
Toronto Queen.	115	4	Light pink.	Small, smooth, oblong, early.
Earliest of All.	108	27	White.	Medium large, oval, early.
American Giant.	192	9	do	Long, large, deep eye, late.
New Variety No. 1.	160	1	Pinkish white.	Long, round, deep eye, med. late.
I. X. L.	144	8	White and pink.	Medium large, long, early.
Pearce's Extra Early.	155	11	White, some pink.	do do do
Stray Beauty.	160	2½	Red.	Round, smooth, early.
Rural New Yorker No. 2.	88		White.	Smooth, round, late.
Sugar.	99	1	do	Small, round, late
Richter's Imperial.	125	42	Pink.	Long, oval, late
Rosy Morn.	126	11	Dark pink.	Medium large, round, early.
Rose's New Giant.	130	7	White.	Large, long, flat, late.
Late Goodrich.	135	10	do	Round, with deep eyes, late.
Compton's Surprise.	128		do	Large, long, smooth, late.
Richter's Schneerose.	158	6½	do	Large, rough, late.
Early White Blue.	65	3½	White and blue.	Small, round, early.
Dixon's Early.	147	12	White and pink.	Medium large, oval, early.
Richter's Elephant.	111½	8	Light pink.	Long, smooth, early.
Lizzie's Pride.	92	16	White pink.	Large, long, oval, late.
Munro County.	123	10	Light pink.	Long, rough, late.
Early Gem.	154	7½	Pink.	Long, oval, early.
Acadian.	145½		Blue.	Large, flat, late.
Muchonic.	120		White and pink.	Large, round, late.

## CUT POTATOES FOR SEED.

Six different ways of cutting potatoes for seed purposes were tried, and the following results obtained. Taking everything into consideration, the pieces with three eyes gave the best results.

Number of Eyes.	Planted.	Dug.	Weight in pounds.	Remarks.
One eye.....	May 23...	Sept. 14...	44½	Even lot; very few small.
Two eyes.....	do 23...	do 14...	44	do do
Three eyes.....	do 23...	do 14...	66	do do
Cut in half lengthwise through the seed end.....	do 23...	do 14...	68	do some small.
Cut in half crosswise, seed end whole.....	do 23...	do 14...	70	Some very large and some very small.
Whole potatoes.....	do 23...	do 14...	63	Even, some few small.....

## BORDEAUX MIXTURE FOR THE PREVENTION OF POTATO ROT.

The following table gives the results of experiments carried on with the Bordeaux mixture as a fungicide, as applied to potatoes for the prevention of rot. The first application was made on July 28th and a second one on August 12th. For this purpose a plot of thirteen different varieties, embracing both early and late kinds was selected. This plot was divided across the middle and one-half treated, the other half was left untreated.

The mixture used was ready prepared and applied according to directions given—one pound to five gallons of water: this mixture did not appear to be so strong as the Bordeaux mixture formerly used here, the formula for which is given in the report of 1892.

Both of these mixtures were applied in the same way, with a sprayer, and the mixture tried this year did not give as good results as that formerly used.

## BORDEAUX MIXTURE.

Names of Varieties.	Treated.		Not treated.	
	Sound.	Rotten.	Sound.	Rotten.
	Lbs.	Lbs.	Lbs.	Lbs.
Dixon's Early.....	89	4	86½	8
Everett.....	134	1	96½	9
Sharpe's Seedling.....	108	5	84½	9½
Burpee's Extra Early.....	97	8	68	20½
Early Ohio.....	117	2	92	7
Richters Elephant.....	61	2	59	6
Bruce's White Beauty.....	74	10	65	6
Polaris.....	84	10	81	8
Daisy.....	68	9	42½	3
New variety No. 1.....	84	0	56	1
Vanguard.....	46	11	36	22
Northern Spy.....	92	2	103	4
Holborn Abundance.....	132	0	112	0



## Experimental Farms.

### BROOM CORN.

Three varieties of broom corn were sown on May 20, and grew well and just began to tassel out when killed with frost.

Names of Varieties.	Height of growth.	Remarks.
	Feet.	
Improved Dwarf .....	3½	Season too short for it to mature, but it reached a good growth.
California Golden .....	5	
Long Brush .....	4½	

### BEANS.

Seven varieties of beans were planted in small plots, with results as given below. The Early Dun Coloured has proved to be one of the best ripening sorts, and yielding heavy, while the Seville Long Pod ripened and yielded the best of the several sorts tried.

Names of Varieties.	Planted.	Pulled.	Condition when pulled.
Early Dun Coloured .....	May 24	Sept. 27	Very early ; all ripened.
Crystal White Wax .....	do 24	do 27	Medium early ; one-half ripened.
Best of All .....	do 24	do 27	Only part ripened.
Golden Wax .....	do 24	do 27	Fairly early ; not one-half ripened.
Common Long Pod .....	do 24	Oct. 9	Three-quarters ripened.
Seville Long Pod .....	do 24	do 9	Nearly all ripened well.
Early Mazagan .....	do 24	do 9	One-half ripened.

### MILLET.

Three varieties of millet were sown, but failing to get well started before the drought, in the early part of the season, which seemed to affect it, it failed to mature. The varieties sown were Pearl, White French and American.

### HEMP.

One variety of hemp was sown on May 20th and grew remarkably well, reaching a height of 3½ feet; the seed ripened and was secured.

### FLAX.

One half bushel of Russian flax was sown on May 24th and cut on August 22nd from which 6 bushels of good seed was obtained.

### BUCKWHEAT.

Silver Hull buckwheat was the only kind grown this year, 3 acres were sown which gave a return of 104½ bushels. This has proven to be the most profitable buckwheat grown here. It was sown on May 27th and cut August 27, and filled out well.

## WINTER RYE.

One-half acre was sown in winter rye, September 9th in the fall of 1892, which grew well, yielding  $14\frac{1}{2}$  bushels from  $\frac{3}{4}$  bushel sown, weighing 55 pounds per bushel. Two and one-half bushels were sown this fall which it is proposed to experiment with as to its value as an early green feed for stock.

## CAULIFLOWER.

Fifteen varieties of cauliflowers were transplanted from the hotbed and made very good growth. Among the best varieties noticed were the Early Snowball, Extra Early Dwarf Erfurt, Thorburn's Nonpareil, and Autumn Giant. The following table gives character of the growth:—

Name of Variety.	Remarks.
Gilt Edge .....	Fair growth; very early; small heads.
Le Normand Short Stem.....	Good growth; medium early; large heads.
Thorburn's Nonpareil .....	Strong growth; medium early; large firm heads.
Early Dwarf Erfurt .....	Fair growth; early; large heads.
Early Paris.....	Fair growth; early; solid medium heads.
Large Early Dwarf Erfurt .....	Good growth; medium early; large heads.
Large Early London.....	Strong growth; medium early; fair heads.
Extra Early Dwarf Erfurt.....	Medium growth; very early; large firm heads.
Half Early Dwarf French.....	Fair growth; medium late; medium heads.
Italian Taranto.....	Strong growth; late; good solid heads.
Autumn Giant.....	Very strong growth; late; large firm heads.
Stadtholder.....	Medium growth; late; medium heads.
Early Snowball.....	Strong growth; early; large fine heads.
Large Algiers.....	Medium growth; late; fair heads.
Early Walcheren.....	Medium growth; medium early; good heads.

## GENERAL STATEMENT OF CROPS.

Fifty-six acres in hay land grew 110 tons, and in addition to the plots of grain for testing purposes which yielded 248 bushels, there were 10 acres in oats and pease which gave 453 bushels, and 3 acres in buckwheat which gave  $104\frac{1}{2}$  bushels, making in all  $805\frac{1}{2}$  bushels of grain grown this year.

The plots of roots gave 577 bushels, and in addition, there were 5 acres in turnips which yielded 4,620 bushels, making in all 5,197 bushels of roots.

Three acres were sown with corn, beans and sunflowers for ensilage; 4 acres were devoted to grain crops for feeding purposes during the summer months.

About 3 acres were in small fruits, nursery and shrubbery. The remainder of the cleared land was devoted to pasturage.

## DRAINAGE AND ITS ADVANTAGES.

Nine acres of land has been underdrained this year: this with that previously drained, makes 70 acres of the farm thoroughly underdrained. This work has cost an average of about \$50 per acre, including main drains with from 8 to 4-inch tiles; about 49 acres are laid with 3-inch tiles, the remainder with 2-inch. They are principally 30 feet apart and 3 feet deep, in some of the land that was very boggy they are 20 and 22 feet apart, while 7 acres are drained with tiles placed 24 feet apart and  $2\frac{3}{4}$  feet deep.

In some cases where the land was uneven, the drains had to be deepened in places to insure a gradual fall, this being necessary in all underdrains. To accomplish this object, it was necessary in one place to lay a main drain of 4-inch tiles

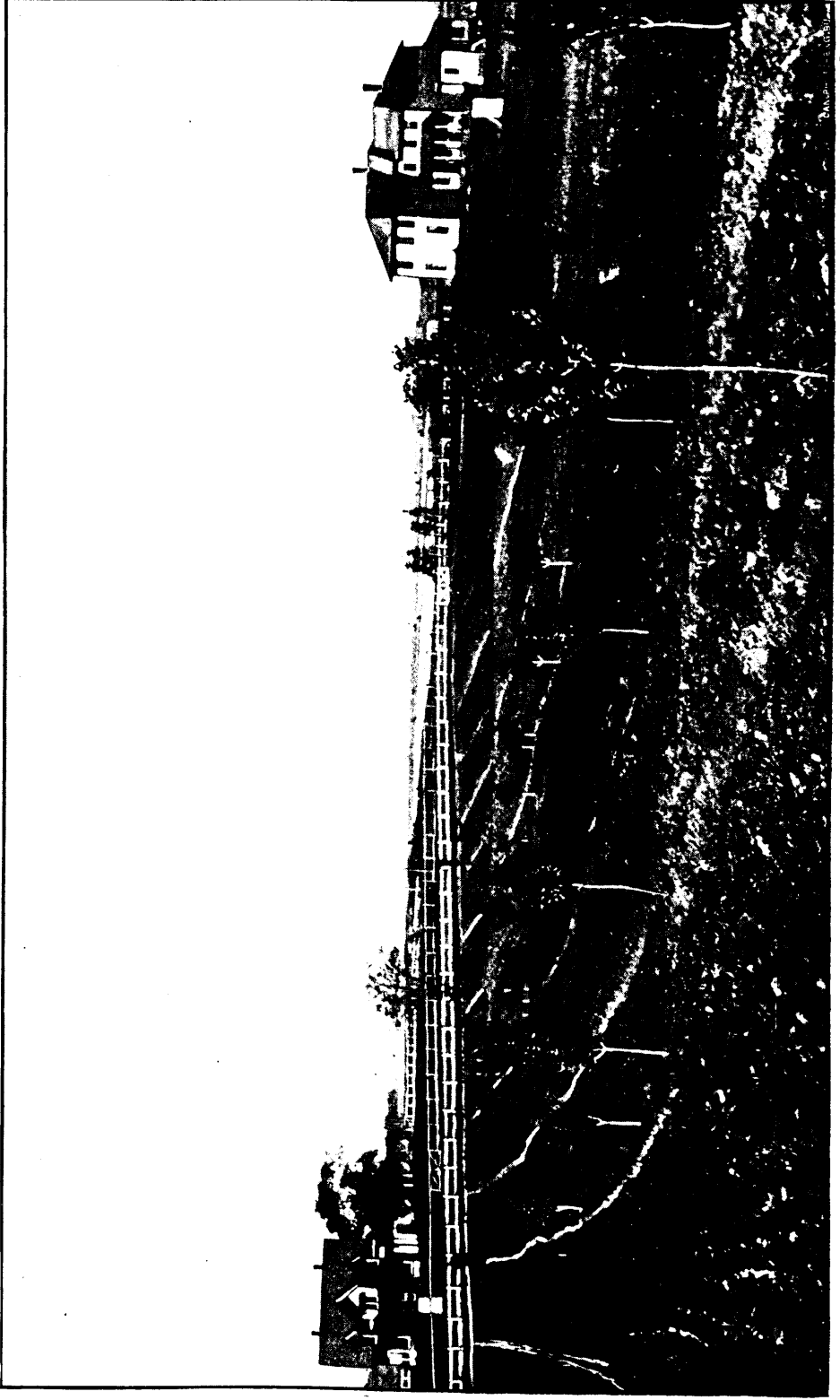

GENERAL VIEW--EXPERIMENTAL FARM, NAPPAN, N.S.

## Experimental Farms.

9 feet deep, and in another an 8-inch main drain was laid for several rods 8 feet deep, while in other places the drains are from 4 to 5 feet deep.

Tiles landed on the farm cost, including freight :

2 inch,	\$13.00	per M.
3 "	18.00	"
4 "	24.00	"
6 "	45.00	"

The advantages of draining are very many, about 10 days earlier seeding, consequently earlier ripening, when the weather is more suitable for harvesting.

The land is more easily worked and this insures better cultivation than is possible on wet land.

During heavy rains all surplus water is carried away rapidly, the land retaining a sufficient quantity for nourishment; and thus by making the water level lower, the plants are enabled to feed at a greater depth, making more plant food available, thereby providing food and nourishment for crops during severe drought.

The following statement shows cost of draining  $3\frac{6}{10}$  acres of land, fertilizers used; also yield of turnips grown on the same.

Cost of draining per acre.....	\$ 54 28
Cost of draining $3\frac{6}{10}$ acres.....	\$ 195 41
Fertilizers used—	
9030-bush. cart loads manure @ 80c.....	\$ 72 00
2,160 lbs. bone meal @ 2c. per pound.....	43 20
700 lbs. guano @ 3c. per pound .....	21 60
	136 80
Total cost.....	\$ 332 26

Yield of turnips per  $3\frac{6}{10}$  acres, 3,600 bushels; 3,600 bushels @ 10c. per bushel, \$360.00, showing a balance of \$27.79 on  $3\frac{6}{10}$  acres, or a balance of \$7.72 per acre towards cost of labour.

### GRASSES.

Of the 30 varieties of grasses tried on the farm 11 varieties appear to be suitable to the climate, and from their appearance I think some of them would be valuable if added to our pasture grasses. I have carefully saved the seed from these plots and am now trying them on a field which is being prepared for permanent pasture.

The following are the most suitable varieties: Western Rye Grass, Orchard Grass, Italian Rye Grass, Late or Fowl Meadow, Fringed Brome, Reed Canary, Western Brome, Austrian Brome Grass, Tall Fescue, Meadow Fescue and Red Top.

### STRAWBERRIES.

The following varieties of strawberries fruited this year: Crescent, Capt. Jack, New Dominion, Manchester, May King and Maggie.

The following varieties were sent here from the Central Farm in May last, and have made good growth, viz.: Sharpless, Warfield and Bubach. There was also a large variety of plants sent from the Central Farm in August last, some of which are living, but many failed to root, and from the experience gained here it appears that May is the best time to transplant strawberries, in this climate.

### RASPBERRIES.

Raspberries and blackberries always make good growth. The new wood this year overshadowed the fruit before it was ripe. In some cases the canes were seven feet high;—this rapid growth appeared to injure the fruit.

## GOOSEBERRIES AND CURRANTS.

Ten varieties of currants were received from the Central Farm last May, these have made good growth and will be further reported on another year.

Nineteen varieties of gooseberries were also received, nearly all of which are growing well.

## NUTS.

Two varieties of filbert nuts, Cosford Cob and Kentish Cob were sent from the Central Farm last season and are growing well.

## POULTRY.

There are now on the farm fifteen White Leghorn fowls and one pair of Plymouth Rocks, and it is proposed to add other breeds shortly.

## ORNAMENTAL TREES AND SHRUBBERY.

All the ornamental trees and shrubs previously planted here are growing well and others have been set out this year. The young forest trees in the nursery are growing remarkably well.

## HUNGARIAN WHEAT.

A small package of Hungarian wheat was sent from the Central Farm. It received all possible attention, but failed to head and has all the appearances of winter wheat.

## BUILDINGS.

The dairy room in one of the buildings, was fitted up in the spring with the necessary appliances to care for the milk until the dairy station was completed on the 1st of July. It is now used for cleaning cans, pails, and keeping the milk over night: we find this a very useful and convenient building.

We also found it necessary to have some of the cattle and horse stalls repaired; the floors in some cases were worn out and decayed.

## STOCK.

No cattle were bought for feeding experiments last year. A few young steers, which were raised on the farm, were sold in the spring for beef.

Of the thorough-bred cattle now on hand, there are four Shorthorn cows and one bull. A year old bull was sold last spring to the Earltown Agricultural Society.

There are also two Ayrshire cows and one heifer calf and one bull; also two Holstein cows, one heifer (yearling) and two bulls. A bull calf was sold last spring to James Frie, Shediac.

The remaining cattle, 52 in all, are grade cows, steers, and calves.

The surplus milk, after feeding the calves and supplying five families on the farm with milk has been delivered at the dairy station since July 3rd to be converted into cheese and butter.

Five horses are found necessary to carry on the work of the farm, and a pair of one-year-old colts are being raised.

A Yorkshire boar and sow were sent from the Central Farm, also a Berkshire boar. There are in addition 6 Berkshire sows, also five young grade pigs.

## Experimental Farms.

### FRUIT TREES.

An orchard was commenced three years ago, and additions have been made to it each spring since until now there are 222 apple trees, consisting of 72 varieties; 90 plum trees, 26 varieties; 90 cherry trees, 29 varieties; 62 pears, 21 varieties; 26 crab apple trees, 7 varieties; in all 481 trees, covering about 12 acres. These trees are making good healthy growth, they do not make wood fast, but with few exceptions are growing stout and strong.

Some have commenced to bear. The Longfield has borne for 2 years a small hard apple, but the wood appears weak, and the limbs having fruit on them break easily with the wind. The Wagener, Scott's Winter, Red Astrachan, Yellow Transparent, Maiden's Blush, Tetofsky and Borovinka fruited this year. A heavy storm of rain and wind on August 22nd shook the young trees very badly, blowing off much of the fruit and breaking some of the branches.

The canker worm and bark lice are the most troublesome pests so far.

### MEETINGS ATTENDED.

I attended a farmers' meeting at Belmont on January 12th; was at a meeting of the Farmers and Dairymen's Association of New Brunswick, at Fredericton, on 26th and 27th of January; at the farmers and dairymen's meeting at Truro on March 15th and 16th, also a meeting of Provincial Grange at Bass River, N.S., on June 27th.

### EXHIBITIONS ATTENDED.

I exhibited grain in straw and in glass bottles, grasses, potatoes and beans at Pictou exhibition held on 19th, 20th and 21st of September, and also at Charlotetown on the 26th, 27th, 28th and 29th of September, in all about 127 varieties of grains and grasses and 49 varieties of potatoes were shown.

I also attended the Sackville exhibition on 13th of October.

I have the honour to be, sir,

Your obedient servant,

WM. M. BLAIR,  
*Superintendent.*



GENERAL VIEW, EXPERIMENTAL FARM, BRANDON, MAN

## Experimental Farms.

# EXPERIMENTAL FARM FOR MANITOBA.

REPORT OF S. A. BEDFORD, SUPERINTENDENT.

BRANDON, MAN., 30th November, 1893.

To Wm. SAUNDERS, Esq.,  
Director, Dominion Experimental Farms,  
Ottawa.

SIR,—I have the honour to submit herewith my sixth annual report of the experiments undertaken and work accomplished on the Brandon Experimental Farm during the past eleven months.

The past spring will be long remembered as one of the most backward ever experienced in this part of the province. The first wheat sowing was done on this farm on 1st May, fully two weeks later than the average season. But spring once opened the weather was all that could be desired and growth was very rapid, and prospects for a heavy crop were excellent, until 15th July, when dry weather accompanied with extremely hot winds set in, the thermometer reaching 106·4 in the shade on 7th August, and all vegetation received a severe check.

The land on the Experimental Farm being in a good state of cultivation did not suffer as badly as the average farms in this section, still the berry of the earlier varieties of wheat grown on the farm, was greatly shrunken, and the returns especially of hay, roots and fodder plants would have been much larger, but for the drought and hot winds of July and August followed by a dry autumn.

The past season has emphasized the necessity in this portion of the province of a shorter course of rotation than is generally adopted, it is questionable whether more than two, or at the most three crops should be grown on the same land without summer fallow; properly summer-fallowed land is not only freer of weeds, but retains moisture to a much greater extent than loose land filled with unrotted stubble, a condition that obtains in most of the land here when cropped for several years in succession.

This fall in digging drains through stubble land the soil was found almost perfectly dry for 5 and 6 feet deep, while in summer fallow the soil was found quite moist for the same depth.

As a result of the high temperature and bright weather, there has been an almost total absence of injury from rust or fall frost, the first severe frost was experienced on the 16th September when the thermometer showed 8 degrees of frost, at that date even the latest sown wheat was cut and out of danger.

In addition to the repetition of some former experiments so necessary to the reaching of accurate conclusions, a quantity of entirely new work, much of it arranged so as to meet suggestions made by farmers of the province, has been undertaken this year.

### RESULTS OF TESTS WITH VARIETIES OF WHEAT.

In addition to the varieties tested on this farm for the past four years a number of new varieties, principally cross-bred wheats, have been tried here this year for the first time. These wheats were originated at the Central Experimental Farm, are nearly all early maturing varieties and were in the milk stage when the hot winds of the 7th August prevailed, and for that reason the kernel was greatly shrunken and the yield reduced; and being nearly ripe at the time of a severe wind storm which



occurred on 14th August, when much of the grain was beaten out, the yield was reduced from this cause also.

It will be noticed that nearly all these varieties are early and many of them have short bearded heads.

The Stanley and Alpha are exceptions, having fair sized bald heads and are thus far the most promising of the series.

The accompanying table gives full particulars regarding the test of varieties of wheats for this year.

As all the varieties stood up equally well, the column giving the character of straw is omitted this year.

#### TEST OF THIRTY-NINE VARIETIES OF WHEAT.

Sown in the valley, 3rd May; soil, black loam, summer fallow, sown with common drill,  $1\frac{1}{2}$  bushels per acre, bluestoned, no smut; size of plots, one-tenth acre.

Variety.	Length of straw.	Kind of head.	Length of head.	No. of days maturing.	*Rust.	Ripe.	Yield per acre.	Lbs. per bush.
	Inch.		Inch.				Bush. lbs.	Lbs.
Goose.....	47	Bearded.	3	113	None.....	Aug. 24.	36 10	62½
Herisson Bearded.....	44	do	2	107	do.....	do 18.	32 40	62
Rio Grande.....	47	do	4½	110	do.....	do 21.	31 40	61
Pringle's Champlain.....	40	do	3½	107	Little.....	do 18.	31 30	60
Gehun.....	34	Bald	2½	107	None.....	do 18.	30 30	62
Preston.....	38	Bearded.	3½	103	do.....	do 14.	30 ..	59
Red Fife.....	41	Bald	4	110	do.....	do 21.	29 20	60
Old Red River.....	44	do	4	110	do.....	do 21.	28 50	60
White Russian.....	47	do	4	110	do.....	do 21.	27 50	59
Hueston's.....	41	do	4½	110	do.....	do 21.	27 40	58
White Fife.....	39	do	4½	110	do.....	do 21.	27 40	60
Albert.....	42	Bearded.	3	103	do.....	do 14.	27 30	55
Green Mountain.....	39	Bald	3½	107	do.....	do 18.	27 10	59
Azima, Russian.....	41	Bearded.	3½	113	do.....	do 24.	27 ..	60½
White Connell.....	39	Bald	4	110	do.....	do 21.	26 50	60
Great Western.....	47	Bearded.	4	111	do.....	do 22.	25 50	60
Red Fern.....	43	do	4	103	Little.....	do 14.	25 50	59
Emporium.....	47	do	4½	107	do.....	do 18.	25 40	60
Hungarian Mountain.....	38	Bald	3	107	None.....	do 18.	25 30	58
Golden Drop.....	42	do	2½	105	do.....	do 16.	24 50	61
Stanley.....	37	do	4	103	do.....	do 14.	24 40	59
Ladoga.....	45	Bearded.	3	103	do.....	do 14.	24 ..	57
Wellman's Fife.....	44	Bald	4½	110	do.....	do 21.	23 50	58
Colorado.....	41	Bearded.	3	101	do.....	do 12.	23 20	60
Campbell's Triumph.....	41	Bald	3	101	do.....	do 12.	23 ..	57
Crown.....	42	Bearded.	3½	110	do.....	do 21.	22 10	60
Alpha.....	45	Bald.....	4	109	do.....	do 20.	22 ..	59
Stonewall.....	42	Bearded.	3	101	do.....	do 12.	22 ..	57
Prince.....	40	do	2¾	103	do.....	do 14.	21 20	56
Manifold.....	42	do	3	103	do.....	do 14.	21 ..	56
A. No. 1.....	42	do	3	105	Little.....	do 16.	20 30	57
Campbell's White Chaff.....	41	Bald.....	4	104	do.....	do 15.	19 40	57
Trial.....	42	Bearded.	3	104	None.....	do 15.	19 ..	57
Black Sea.....	42	do	3	104	do.....	do 15.	18 10	57
Abundance.....	42	do	4	107	Little.....	do 18.	17 50	56
Ottawa.....	40	do	3	104	do.....	do 15.	17 40	56
Beta.....	41	do	3	104	do.....	do 15.	16 50	56½
Carleton.....	43	do	3	104	None.....	do 15.	16 40	56
Anglo-Canadian.....	37	do	4½	123	Badly.....	Sept. 3.	7 ..	32

NOTE.—The weights per bushel given here, and also with all other grain tables in my report, are not the maximum weights that the grain could be brought to, but were taken from grain cleaned to a condition fit for milling purposes only.

## Experimental Farms.

### *Cross-bred Wheats.*

The parentage of the cross-bred varieties referred to in the table is as follows :—

(Bearded)	Carleton.. ....	Ladoga female and	White Fife male. ....	
(Bald)	Stanley.....	do	Red do	.....
(Bearded)	Preston.....	do	do do	.....
do	Prince.....	do	White do	.....
do	Abundance...	do	Red do	.....
do	Ottawa.....	do	do do	.....
do	Albert.....	do	do do	.....
(Bald)	Alpha.....	do	White do	.....
(Bearded)	Crown.. .....	do	do do	.....
do	Stonewall....	do	Red do	.....
do	Manifold....	do	White do	.....
do	A No. 1.....	do	Red do	.....
do	Trial.....	do	do do	.....
do	Beta.....	do	do do	.....

#### *Summary of tests of varieties continued over a number of years.*

The conditions surrounding even the best conducted field experiments are so variable that any one year's experience should not be considered final and only by repeated tests continued through a number of years can we hope to reach correct conclusions.

A number of the leading varieties of grain have now been tested on this farm for several years and a short summary is submitted of the results obtained.

The greater portion of these varieties have been grown during four greatly varying seasons and the average results may be considered fairly reliable.

In the accompanying table it will be noticed that Blue Stem, a variety grown quite extensively in the North-western States, has given a large average yield, but we find that it matures on an average 4 days later than Red Fife, a great objection here.

White Connell gives a slightly larger return than Red Fife, and White Fife somewhat less than Red.

The yield from Ladoga averages nearly 9 bushels per acre less than Red Fife, but Ladoga matures on an average eight days earlier.

Hungarian Mountain is a hard variety that promises well and I think deserves some attention.

Campbell's White Chaff is an early ripening variety, but soft in the berry and not nearly as productive here as the Fifes.

TABLES showing the average wheat yields for four years, with average weight per bushel, and days taken to mature.

Variety.	Years included.	Average yield per acre.	Average days maturing.	Average weight per bushel.
		Bush. lbs.		
Blue Stem.....	1890-91-92.....	34 42	134	57
Pringle's Champlain.....	1890-91-92-93.....	33 18	125	58½
White Connell.....	1890-91-92-93.....	32 8	123	59
Rio Grande.....	1890-91-93.....	32 2	129	60
Hungarian Mountain.....	1890-92-93.....	31 57	125	60
Red Fife.....	1890-91-92-93.....	31 56	130	57½
Defiance.....	1890-91-92.....	31 4	133	58
French Imperial.....	1890-91-92.....	30 32	128	62
White Fife.....	1890-91-92-93.....	30 23	128	58
Club.....	1890-92-93.....	29 19	120	61
Green Mountain.....	1890-92-93.....	28 34	121	60½
Red Fern.....	1890-91-92-93.....	28 33	125	59
White Russian.....	1892-93.....	28 10	.....	58½
Emporium.....	1892-93.....	27 40	.....	59
Colorado.....	1890-91-92-93.....	27 6	122	57
Wellman's Fife.....	1890-92-93.....	26 58	126	60
Old Red River.....	1890-92-93.....	26 6	124	60½
Gehun.....	1891-92-93.....	25 50	119	60
Campbell's White Chaff.....	1890-92-93.....	24 49	123	59½
Golden Drop.....	1890-92-93.....	23 2	123	61
Ladoga.....	1890-91-92-93.....	23 ..	122	56
Campbell's Triumph.....	1890-92-93.....	22 36	120	59
Hard Red Calcutta.....	1890-92.....	18 42	120	61

EARLY MEDIUM AND LATE SOWN WHEAT.

These experiments which proved so interesting in 1892 have been repeated this year, and the season being different, the results are not quite the same. With one exception the wheat plots yielded in the order they were sown, the first sown giving the best return and decreasing each week after. They also ripened in the exact order of sowing, again emphasizing the fact that to escape fall frosts, wheat should be sown as early as possible. Red Fife again gave the largest yield, and ripened as early as the Campbell's White Chaff, the rust on the latter variety appearing to delay its ripening, soil, black loam  $\frac{1}{10}$  acre, sown with common drill,  $1\frac{1}{2}$  bushels per acre, summer fallow.

When Sown.	Variety.	Length of Straw.	Length of Head.	Rust.	No. of days maturing.	Ripe.	Yield per Acre.	Lbs. per Bush.
		Inches.	Inches.				Bush. lbs.	Lbs.
May 2..	Red Fife.....	43	4	None.....	108	Aug. 18..	28 10	59
do 9..	do .....	43	3½	do .....	104	do 21..	33 20	60
do 16..	do .....	43	3½	do .....	100	do 24..	28 50	60
do 23..	do .....	43	3½	do .....	101	Sept. 1..	26 40	56
do 30..	do .....	34	3½	Little .....	96	do 3..	22 10	61
June 6..	do .....	35	3	do .....	98	do 12..	18 50	59
May 2..	Campbell's White Chaff..	42	3	do .....	108	Aug. 18..	23 30	60
do 9..	do .....	46	3½	do .....	104	do 21..	23 ..	57½
do 16..	do .....	38	3½	do .....	104	do 28..	17 ..	57
do 23..	do .....	36	3	do .....	101	Sept. 1..	15 ..	57
do 30..	do .....	30	3½	Badly....	96	do 3..	15 ..	57
June 6..	do .....	34	2½	Very bad.	95	do 9..	12 30	59

## Experimental Farms.

### EARLY, MEDIUM AND LATE SOWN OATS.

With oats the Banner plots yielded in the order of sowing, but the returns from the Prize Cluster were irregular; the last named variety is more readily affected by drought, the absence of rain even for a short time lessens the yield. The Banner oat has again proved the most productive, but ripened, on an average, 6 days later than the Prize Cluster, soil, black loam, sown with drill, 10 pecks per acre, plots  $\frac{1}{10}$  acre, summer fallow.

When Sown.	Variety.	Length of Straw.	Length of Head.	Rust.	No. of days maturing.	Ripe.	Yield per Acre.	Lbs. per Bush.
		Inches.	Inches.				Bush. lbs.	Lbs.
May 2..	Prize Cluster..	41	8	None.....	94	Aug. 4.	61 26	40
do 9..	do .....	40	9 $\frac{1}{2}$	do .....	90	do 7.	69 24	40
do 16..	do .....	42	9	do .....	87	do 11.	64 24	40 $\frac{1}{2}$
do 23..	do .....	44	8	Little .....	86	do 17.	48 28	34
do 30..	do .....	40	9	Badly .....	85	do 23.	52 12	40
June 6..	do .....	39	9	do .....	80	do 25.	50 30	38
May 2..	Banner .....	42	7	None.....	101	do 11.	86 16	33
do 9..	do .....	41	7	Little .....	98	do 15.	75 10	33
do 16..	do .....	40	7 $\frac{1}{2}$	do .....	94	do 18.	69 4	34
do 23..	do .....	46	8	do .....	91	do 22.	61 26	34
do 30..	do .....	46	9	do .....	91	do 29.	57 12	32
June 6..	do .....	44	7	do .....	87	Sept. 1.	52 32	32

### EARLY, MEDIUM AND LATE SOWN BARLEY.

Baxter's six-rowed with a single exception yielded in the order sown, ranging from 40 bushels for the first sown plot, to 34 bushels for the last. Two-rowed Duckbill like the Prize Cluster oat, and apparently from the same cause, gave a very irregular yield.

Sown with common drill, 2 bushels per acre, soil strong loam, summer-fallowed, size of plot, one-tenth acre.

When Sown.	Variety.	Length of Straw.	Length of Head.	Rust.	No. of days maturing.	Ripe.	Yield per Acre.	Lbs. per Bush.
		Inches.	Inches.				Bush. lbs.	Lbs.
May 2..	Baxter's Six Rowed .....	37	3	None .....	97	Aug. 7..	40 40	49
do 9..	do .....	34	2 $\frac{1}{2}$	do .....	90	do 7..	28 16	49 $\frac{1}{2}$
do 16..	do .....	37	2 $\frac{1}{2}$	do .....	88	do 12..	36 12	48
do 23..	do .....	37	2	do .....	81	do 12..	35 40	46
do 30..	do .....	34	2 $\frac{1}{2}$	do .....	77	do 15..	35 ..	45
June 6..	do .....	32	2 $\frac{1}{2}$	do .....	73	do 18..	34 18	42
May 2..	Duckbill Two Rowed .....	37	3 $\frac{1}{2}$	do .....	102	do 12..	43 46	49
do 9..	do .....	34	3 $\frac{1}{2}$	do .....	95	do 12..	42 34	47
do 16..	do .....	31	3 $\frac{1}{2}$	do .....	93	do 17..	47 24	50
do 23..	do .....	29	3	do .....	87	do 22..	45 40	48
do 30..	do .....	33	3 $\frac{1}{2}$	do .....	90	do 28..	42 4	47
June 6..	do .....	31	3	do .....	87	Sept. 1.	36 32	48

## THE CUTTING OF WHEAT AT DIFFERENT STAGES OF RIPENESS.

Two years ago a series of experiments were commenced to determine the proper stage at which wheat should be cut; at that time fall frost seriously interfered with the completeness of the experiment. The past season was a more favourable one and the result quite clear.

When the season is backward and fall frosts threaten, the temptation to harvest wheat before it is fully matured is great, but it is evident from the following table that considerable loss results both in quantity and weight of sample if the grain has not at least reached what is generally called the dough stage.

In this experiment both red and white varieties of wheat were used, and the result with each is practically the same.

The plots were one-tenth acre; soil black loam, summer-fallowed previous year, sown with common drill on 5th May,  $1\frac{1}{2}$  bushels per acre.

Variety.	Stage when cut.	No. days from sowing.	Date of cutting.	Yield per acre.	Weight per bush.
				Bush. lbs.	Lbs.
Red Fife, 1st cut. ....	Early milk stage. ....	94	August 7	16 20	45 $\frac{1}{2}$
do do 2nd do. ....	Late do. ....	97	do 10	24 10	54 $\frac{1}{2}$
do do 3rd do. ....	Dough stage. ....	101	do 14	28 20	58
do do 4th do. ....	Ripe yellow. ....	108	do 21	28 40	60
White Connell 1st cut. ....	Early milk stage. ....	94	do 7	15 40	48
do do 2nd do. ....	Late do. ....	97	do 10	20 20	53
do do 3rd do. ....	Dough stage. ....	101	do 14	28	58
do do 4th do. ....	Ripe yellow. ....	108	do 21	29	60

The accompanying view is from a photograph taken during wheat harvest at the Brandon Farm.



HARVESTING WHEAT, EXPERIMENTAL FARM, BRANDON, MAN.

## Experimental Farms.

### HOME GROWN, AGAINST CHANGED SEED.

Red Fife was procured from the North-west Territories and sown alongside of Red Fife grown on the Experimental Farm, the result is slightly in favour of the home grown seed, but the experiment will have to be repeated several times before a safe conclusion can be reached.

Sown on black loam soil 5th May with a common drill,  $1\frac{1}{2}$  bushels per acre, land summer-fallowed the previous year, size of plots one-tenth acre.

Variety.	—	Length of straw.	Length of head.	No. days maturing.	Ripe.	Yield per acre.		Weight per bush.
						Bush. lbs.	Lbs.	
Red Fife.....	Home grown ....	42 inches.	4 inches..	111	Aug. 24	29	50	57
do .....	Changed seed...	42 do	4 do ..	111	do 24	27	50	58

### CULTIVATION OF FALL PLOUGHED LAND.

With the object of retaining moisture it is generally considered advisable to harrow and roll land after ploughing in the fall. To ascertain whether this method is beneficial or not four adjoining plots were selected, one received a fall ploughing only, the others were also worked more or less with harrow and roller.

It will be seen by the accompanying table that the plot simply fall ploughed, gave the largest return, and was the freest from weeds.

The absence of weeds can be explained by the more thorough work of the harrow in spring on the rough furrows of this plot. For a comparison a summer-fallowed plot adjoining was sown the same time, this gave three bushels per acre more than the best of the fall ploughed plots, and nearly five bushels more than the average of them.

Soil black loam, summer-fallowed, sown with press drill on the 2nd May,  $1\frac{1}{2}$  bushels seed per acre, bluestoned, no smut or rust, size of plots one-tenth of an acre.

Variety.	How treated.	Weeds.	Length of Straw.	No. days maturing.	Ripe.	Yield per acre.		Weight per bushel.
			Inches.			Bush.	Lbs.	Lbs.
Red Fife...	Summer fallowed.....	None .....	43	109	Aug. 19.	26	20	59
do .....	Fall ploughed only.....	do .....	37	104	do 14..	23	20	59
do .....	Fall ploughed and harrowed twice.....	Few .....	35	104	do 14..	22	40	60
do .....	Fall ploughed and rolled twice.....	Weedy.....	38	103	do 13..	21	30	58
do .....	Fall ploughed, harrowed and rolled.....	Very weedy..	32½	103	do 13..	19	10	60

## THE USE OF BARN-YARD MANURE AS A FERTILIZER.

Last year a few tests were made with barn-yard manure as a fertilizer for wheat, to ascertain whether the effect of the manure was lasting or not; these plots were sown again this year with wheat; very little increase is shown from the manure applied in 1892, but the unrotted gives slightly the best return.

Upland prairie, light loam, sown 12th May with press drill,  $1\frac{1}{2}$  bush. per acre, one-tenth acre plots, 20 tons per acre of each kind of manure applied in spring of 1892.

Variety.		Length of straw.	No. days maturing.	Ripe.	Yield per acre.	Lbs. per bushel.
		Inches.			Bush. lbs.	
Red Fife. . . . .	Unrotted manure. . . . .	36	93	Aug. 13. . . . .	15 10	56
do . . . . .	Rotted manure. . . . .	38	93	do 13. . . . .	13 50	56
do . . . . .	No manure. . . . .	36	96	do 16. . . . .	13 30	55

Besides the plots included in the preceding table, eight additional ones on clay loam were this year treated with manure which was applied both on the surface and ploughed in. It will be seen that manure applied on the surface has generally given the best return, it no doubt acted as a mulch and retained the moisture during the drought. Fall ploughing appears to encourage weed growth, and this agrees with our experience every year. Soil clay loam, Red Fife, sown 2nd May with press drill,  $1\frac{1}{2}$  bushels per acre, plots, one-tenth acre, wheat stubble land.

When ploughed.	Kind of manure.	How manure was applied.	Weeds.	Length of straw.	No. days maturing.	Ripe.	Yield per acre.	Weight per bushel.
				Inches.			Bush. lbs.	Lbs.
Spring. . . . .	None. . . . .		No weeds. . . . .	42	104	Aug. 14. . . . .	22 40	59
Fall. . . . .	Unrotted. . . . .	On the surface. . . . .	Weedy. . . . .	35	104	do 14. . . . .	22 20	60
Spring. . . . .	do . . . . .	do . . . . .	Few weeds. . . . .	38	104	do 14. . . . .	22 10	59
do . . . . .	Rotted. . . . .	do . . . . .	do . . . . .	35	104	do 14. . . . .	21 . . . . .	60
do . . . . .	do . . . . .	Ploughed in. . . . .	do . . . . .	37	102	do 12. . . . .	19 20	60
Fall. . . . .	do . . . . .	On the surface. . . . .	Very weedy. . . . .	31	103	do 13. . . . .	19 10	60
do . . . . .	None. . . . .		do . . . . .	36	103	do 13. . . . .	17 . . . . .	59
do . . . . .	Rotted. . . . .	Ploughed in. . . . .	do . . . . .	33	103	do 13. . . . .	17 . . . . .	59

## TEST OF DRILLS.

The difference each year between the returns from drilling and broad-casting have been so great on this farm, that the importance of this question should be kept constantly before the farming public.

In addition to a report of this year's tests of drilling and broadcasting wheat, a summary of four years' tests is also given; it will be seen that the average difference in favour of drills is over 5 bush. per acre with wheat, and 11 bush. with barley. It is estimated that there are one million acres devoted to wheat in this province, and if only 25 per cent of this is sown broadcast and the results reached on this farm fairly represent the whole province it represents a loss of over one million bushels a year.

We find that in addition to the increased yield obtained by sowing with a drill, the grain also ripens more evenly and stands up better.

## Experimental Farms.

### TEST OF DRILLS FOR SOWING WHEAT.

Wheat stubble ploughed in spring, soil rich black loam, Red Fife wheat, sown 3rd May, size of plots one-fifth acre.

	Pecks per acre.	Length of Straw.	No. days maturing.	Ripe.	Yield per Acre.		Weight per Bushel.
		Inches.			Bush. lbs.	Lbs.	
Press Drill, wheel coverers, 3½ inches.....	6	41	103	Aug. 14..	29	35	60
Broad-cast Machine, and ploughed in.....	8	41	110	do 21..	27	35	60½
Press Drill, wheel coverers, 7 inches.....	6	44	104	do 15..	25	55	60
Common Drill .....	7	41	108	do 19..	23	50	60
Press Drill, chain coverers. ....	6	41	108	do 19..	18	30	60
Broadcast Machine.....	8	40	111	do 22..	17	15	60

### FOUR YEARS' TEST OF DRILLS IN SOWING WHEAT.

Kind of Drill.	Years included.	Average Yield per Acre.		Average Days Maturing.
		Bush. lbs.		
Common Drill.....	1890-91-92-93.....	30	44	128
Press do .....	1890-91-92-93.....	30	29	128
Broadcast Machine .....	1890-91-92-93.....	25	18	130

### THREE YEARS' TEST OF DRILLS IN SOWING BARLEY.

Press Drill.....	1890-91-92.....	57	45	112
Common Drill.....	1890-91-92.....	53	44	112
Broadcast Machine.....	1890-91-92.....	46	37	112

### TEST OF BLUESTONE AS A SMUT PREVENTIVE.

The use of bluestone as a smut preventive is increasing very rapidly in this province. Merchants who a few years ago were unable to sell a hundred pounds in a season, now import it by the ton, and the almost total absence of smut this year is evidence that this fungus is being rapidly brought under control.

The results of this season's experiments with bluestone were practically the same as last, the untreated giving about 30 times as many smutty heads as the treated, the treated also gave from 6 to 7½ additional bushels per acre.

Land summer-fallowed, size of plots, one-tenth of an acre, six pecks per acre, bluestone liquid sprinkled on the seed, results obtained by counting the wheat



heads on ten feet square. Common drill used, soil clay loam, sown 10th May, cut 24th August.

Variety.	How treated.	Yield per Acre.	Weight per Bush.	Smutty Heads.	Heads with no Smut.
		Bush. lbs.	Lbs.		
Very smutty Red Fife. . . . .	1 lb. bluestone to 5 bushels. . .	27 30	58	10	1,980
do . . . . .	1 do 10 do . . . . .	25 50	58	12	1,572
do . . . . .	No bluestone. . . . .	20 00	55	306	1,956

#### VARIETIES OF OATS.

Forty-five varieties of oats have been tested on the Experimental Farm this year, and although the season has been unfavourable the yield was large and the weight per bushel fair.

It is customary in this country to sow oats on land unfit for wheat, and for that reason the grain throughout the central and western portions of the province suffered very severely from the unfavourable weather during August.

On the Experimental Farm, nearly all the oats were sown on summer-fallow and the drought and hot winds have had very little effect on the yield, but the straw was shorter than usual, but stiff and free from rust.

That excellent variety the Banner oat has again made a good record for itself, yielding 91 bushels per acre. Although this variety has been introduced for a number of years, it is still one of the best oats we have, being productive, with a kernel of medium weight, white in colour, and apparently thin hulled.

The following varieties have been tested this year for the first time.

Wide Awake,—a white branching oat, productive, but rather light in weight for a white oat, this variety yielded 68 bushels per acre, the best return from the new varieties of the year.

Imported Irish,—white, with a branching head medium early, the straw of this variety was quite rank for the season, and free of rust.

Cave,—a rather short strawed white oat, with a very handsome branching head, yield 65 bushels: this variety was badly beaten out by wind, otherwise it would have made a better return.

Golden Beauty,—a late ripening white oat, with long straw and kernel: this variety is the lightest weighing oat of the season.

White Wonder,—a very early ripening variety, maturing in 93 days, and like all oats of its class, it weighs well. Oderbruch, a promising side oat, but rather light in weight. Scottish Chief and Canadian Beauty are both early, white oats with branching heads, the last named ripens with the Welcome, but does not equal that variety in productiveness. The Columbus has proved both unproductive and light in weight, and its yellow colour is against it.

# Experimental Farms.

## TEST OF FORTY-FIVE VARIETIES OF OATS.

Sown on 6th May in valley on clay loam soil, summer-fallowed, sown with common drill, 9 pecks of seed per acre, size of plots, one-tenth of an acre.

Variety.	Length of straw.	Kind of straw.	Length of head.	No. of days maturing.	Ripe.	Yield per acre.		Weight per bushel.
	Inch.		Inch.			Bush. lbs.	Lbs.	
Banner	41	Branching	9	98	Aug. 12	91	6	35
Abundance	40	do	8	98	do 12	85		35
Rosedale	43	Half sided	7	97	do 11	82	22	35½
American Beauty	42	Branching	8	100	do 14	82	2	35
Victoria Prize	40	do	7	96	do 10	79	4	42
White Russian	43	do	8	97	do 11	77	2	38
Early Gothland	42	Sided	7	96	do 10	76	16	35½
Welcome	41	Branching	7	90	do 4	76	6	41
English White	38	do	10	95	do 9	75	20	34
Challenge White	45	do	7	96	do 10	75		40
Improved Ligowo	38	do	7	96	do 10	75		38½
Archangel	46	do	9	96	do 10	75		40½
Prize Cluster	41	do	8	90	do 4	74	4	41½
Cream Egyptian	45	do	11	96	do 10	72	2	40½
Bonanza	43	do	8	90	do 4	71	26	40
Winter Gray	47	do	10	90	do 4	71	6	41
Abyssinia	45	Sided	7	100	do 14	69	14	37
Wide Awake	41	Branching	8	100	do 14	68	8	37
White Dutch	40	do	11	93	do 7	67	22	38
Imported Irish	44	do	7½	96	do 10	66	17	37
Imported Blk. Tartarian	47	Sided	8	100	do 14	66	16	35
Rennie's Prize White	46	Branching	10	94	do 8	66	16	40
Early Blossom	43	Half sided	8	103	do 17	66	6	35
Early Etampes	35	Branching	6½	100	do 14	66	6	34
Cave	39	do	8	101	do 15	65	10	36
Holstein Prolific	44	do	7	100	do 14	65	10	32
Golden Beauty	42	do	8	102	do 16	64	24	31
Joanette	31	do	6	98	do 12	64	24	34
Black Tartarian Prolific	38	Sided	7	100	do 14	64	24	33
Black Coulommiers	41	Branching	8	do	do	64	24	35
Hazlett's Seizure	46	do	13	96	do 10	63	8	39½
Flying Scotchman	37	do	7	90	do 4	62	32	35
Royal Doncaster	29	do	7	96	do 10	59	24	35
White Wonder	43	do	11	93	do 7	59	4	41
California Prolific	46	Sided	8	100	do 14	58	18	31
Poland White	37	Branching	9	96	do 10	57	22	38½
Oderbruch	40	Sided	8	100	do 14	56	6	35
Giant Cluster	35	do	8	100	do 14	54	14	28
Scottish Chief	42	Branching	8	93	do 7	54	14	40
Canadian Beauty	39	do	9	90	do 4	53	28	40½
White Hungarian	38	Sided	7½	104	do 18	53	18	33
American Triumph	47	Branching	9	102	do 16	53	8	32½
Siberian	43	Sided	8	102	do 16	51	16	36
Swedish	36	do	7	104	do 18	47	2	31
Columbus	42	Branching	7	100	do 14	31	6	34

## AVERAGE RESULTS FROM FOUR YEARS' TESTS WITH VARIETIES OF OATS.

In addition to tables giving the past season's tests with oats, the average results with several of the leading varieties for the past three or four years are given.

In this table also the Banner takes the lead for productiveness, with the high average of 82 bush., closely followed by English White and Rosedale.

Winter Gray and Prize Cluster are the two earliest varieties, but they are behind in productiveness, Winter Gray also gives the highest average weight per bushel.

It is evident from the returns, which cover several seasons of varying temperature and rainfall, that some of these varieties may be safely regarded as less desirable than others for this province.

Variety.	Years included.	Average Yield per Acre.	Average days maturing.	Average weight per bushel.
		Bush. lbs.		Lbs.
Banner .....	1890-91-92-93 .....	82 8	112	35
English White .....	1890-91-92-93 .....	78 13	109	34
Rosedale .....	1890-92-93 .....	74 5	109	37
White Russian .....	1890-91-92-93 .....	74 3	112	36
Welcome .....	1890-91-92-93 .....	73 18	106	38
Australian .....	1890-91-92 .....	72 19	121	34
Early Blossom .....	1890-91-92-93 .....	72 5	112	36
Archangel .....	1890-91-92-93 .....	71 28	107	39
Black Champion .....	1890-91-92 .....	71 14	120	35
Black Tartarian .....	1890-91-92-93 .....	70 19	114	34
Glenrothern .....	1890-91-92 .....	70 8	123	35
Holstein Prolific .....	1890-91-92-93 .....	69 16	117	34
Winter Gray .....	1890-91-92-93 .....	67 12	105	40
Prize Cluster .....	1890-91-92-93 .....	64 19	105	37
American Triumph .....	1890-91-92-93 .....	64 10	118	33
Early Race Horse .....	1890-91-92 .....	62 5	112	39
Rennie's Prize White .....	1890-92-93 .....	61 22	104	39

## VARIETIES OF BARLEY.

Although barley in common with other cereals suffered from the excessive heat and drought of August the returns from this year's crop are nevertheless good, and when taken in connection with the results of the feeding tests it will be seen, that this can be made one of the most profitable crops grown in the province.

Barley has two strong points in its favour; it is seldom injured by fall frosts, it can be sown after wheat in spring, and harvested before that staple crop is ripe, by this means profitably utilizing the spare time between wheat seeding and harvest.

We have found that crushed barley is an excellent food for horses, cattle, swine and poultry.

# Experimental Farms.

## TESTS OF VARIETIES OF BARLEY.

Sown 16th May with a common drill, 8 pecks per acre, on clay loam soil, summer-fallowed, size of plots  $\frac{1}{10}$  acre.

Variety.	Length of straw.	Kind of head.	Length of head.	Number of days maturing.	Ripe.	Yield per acre.		Lbs. per bush.
	Inch.		Inch.			Bush.	lbs.	
Odessa.....	37½	6 row	2½	85	Aug. 9..	57	4	48
Mensury.....	40	6 do	3½	86	do 10..	54	18	47
Sharpe's Improved Chevalier.....	36	2 do	3	90	do 14..	53	6	48
Kinver Chevalier.....	39	2 do	3	90	do 14..	51	2	47
Golden Grains.....	36	2 do	4½	90	do 14..	48	46	48
Duckbill.....	36	2 do	3½	86	do 10..	48	26	48
Goldthorpe.....	36	2 do	3	92	do 16..	48	16	45
French Chevalier.....	36	2 do	4	90	do 14..	47	44	48
Baxters.....	35	6 do	2	80	do 4..	46	42	47
Danish Chevalier.....	33	2 do	4	90	do 14..	45	30	45½
Oderbruch.....	36	6 do	2½	86	do 10..	45	10	48
Canadian Thorpe.....	36	2 do	2½	90	do 14..	44	38	45
Rennie's Improved.....	33	6 do	2½	80	do 4..	43	16	47
Common Six-rowed.....	32	6 do	2½	83	do 7..	43	6	49½
Prize Prolific.....	33	2 do	4½	90	do 14..	42	14	47
Thanet.....	41	2 do	5	90	do 14..	40	10	45
Petschora.....	31	6 do	3½	83	do 7..	39	28	42
Guymalaye.....	37	6 do	3	85	do 9..	31	2	55

### RESULTS OF TESTS WITH BARLEY FROM 1890 TO 1893.

In the following table will be found a summary of the results obtained with some of the principal varieties of barley, during the past four years; the Duckbill, Goldthorpe and Odessa are the three most productive varieties, these are also stiff strawed sorts, an important consideration in this country where the rich soil encourages a rank and tender growth of straw.

Variety.	Years included.	Average yield per acre.	Average days maturing.	Average weight per bushel.
		Bush. lbs.		Lbs.
Duckbill Two-rowed.....	1890, '91, '92, '93	59 28	102	50½
Goldthorpe do.....	1890, '91, '92, '93	59 21	109	49½
Odessa Six-rowed.....	1890, '91, '92, '93	59 10	97	51
Prize Prolific Two-rowed.....	1890, '91, '92, '93	55 16	105	50
Sharpe's Improved Chevalier Two-rowed.....	1892, '93	54 38	94	49½
Danish Chevalier do.....	1890, '91, '92, '93	54 11	104	50½
California Prolific do.....	1891, '92	53 46	105	50½
Kinver Chevalier do.....	1891, '92, '93	52 22	103	50
Rennie's Six-rowed.....	1890, '91, '92, '93	51 31	94	50
Beardless Two-rowed.....	1890, '91, '92	50 27	110	51
Mensury Six-rowed.....	1892, '93	47 34	89	47½
Thanet Two-rowed.....	1890, '92, '93	44 32	101	50
Baxter's Six-rowed.....	1890, '92, '93	41 7	88	49

## PEASE.

Twelve varieties of pease have been tested on the farm this year, the season was favourable, and nearly all the varieties have given a good return.

This crop if grown on clean land has always given profitable returns here, the only objection to its increased cultivation is the difficulty found in harvesting and threshing it. To ascertain whether this could be lessened a trial was made of growing it with other grain, and using a binder to cut, and a separator to thresh the combined crop. Grown with other grain, both stood up well, and were readily cut with a binder, and we found no difficulty in threshing it with a separator, but the accompanying table will show that the return of pease from this method was small.

It is said that pea harvesters are in use in eastern Canada, but they have not been introduced here.

## TEST OF VARIETIES OF PEASE.

Sown May 5th on summer fallow, with a common drill; soil-clay loam; size of plots one-tenth acre.

Variety.	Amount sown per acre.	Apparent thickness.	Length of straw.	Length of pod.	Number of days maturing.	Ripe.	Yield per acre.		Weight per bushel.
	Bush.		Inch.	Inch.			Bush. lbs.	Lbs.	
Golden Vine.....	2½	Right	41	2	101	Aug. 14..	36	20	65
Prince Albert.....	2½	Thin	50	3	108	do 21..	32	40	64½
Multiplier.....	2½	do	49	2½	114	do 27..	31	50	63
Crown.....	2½	Right	34	2	99	do 12..	31	50	64
Mummy.....	3	do	38	3	110	do 23..	30	50	64
Prussian Blue.....	2½	do	41	2¾	108	do 21..	29	50	63
Potter.....	2½	Very thin.	38	3	115	do 28..	29	00	62
Pride.....	3	Thin	38	3	96	do 9..	28	30	63
White Marrowfat.....	3½	do	35	3½	115	do 28..	27	00	64
Black Eyed Marrowfat.....	3½	do	44	3	111	do 24..	26	30	62
Canadian Beauty.....	3½	do	49	3	116	do 29..	25	50	62
Centennial.....	3	do	48	3	115	do 28..	18	40	63½

## MIXED CROPS GROWN FOR GRAIN.

Variety.	Pecks per acre sown.	Date of sowing.	How sown.	Lbs. per bushel.	Yield of mixed grain, per acre.		Proportion of pease per acre.	
					Bush. lbs.	Bush. lbs.		
Pease—Crown.....	8	May 5	Press drill.....	31	56	14	4	40
Oats—Prize Cluster.....	4	do 5	do.....					
Pease—Crown.....	8	do 5	Press drill.....	60	27	..	3	40
Wheat—Red Fern.....	4	do 5	do.....					
Pease—Crown.....	8	do 5	Press drill.....	50	49	30	3	40
Barley—Prize Prolific.....	4	do 5	do.....					
Pease—Crown.....	4	do 16	Press drill, north & south	31	64	19	2	30
Oats—Holstein Prolific.....	8	do 16	do east and west.					
Pease—Crown.....	4	do 16	Press drill, 3½ inches.....	31	61	29	1	10
Oats—Holstein Prolific.....	8	do 16	do do.....					
Pease—Golden Vine.....	4	do 16	Common drill.....	31	46	4	1	10
Oats—Banner.....	4	do 16	do.....					
Wheat—Red Fife.....	4	do 16	do.....					

## Experimental Farms.

### THICK AND THIN SOWING OF PEASE.

The quantity of seed per acre generally sown here has been regulated by eastern experience, and has always appeared too little for this province.

To test this matter, three plots of Prince Albert peas, a variety of medium size, were sown with different quantities of seed, and the results seem to show that a liberal seeding is the most profitable.

Soil, black loam, plots one-tenth acre, sown with common drill on summer-fallow.

Variety.	When sown.	Amount sown per Acre	Apparent Thickness.	Length of Straw.	Length of Pod.	No. Days maturing.	Ripe.	Yield per Acre.		Weight per Bush.
		Bush.		Inches.	Inches.			Bush. lbs.	Lbs.	
Prince Albert.....	May 5..	2	Thin ...	50	3	111	Aug. 24.	22	30	64
do .....	do 5..	3	Right ..	50	3	109	do 22.	27	30	64
do .....	do 5..	4	Thick ..	50	3	108	do 21.	26	20	64

### ROTATION OF CROPS.

At present very few farmers in this country, practice a rotation of crops, many following wheat with wheat until the land is so impoverished or made foul with weeds, that less than half a crop is obtained.

As this system, or rather want of system, will have to be changed before many years, some experiments were undertaken this year for the purpose of throwing light on the proper rotation for this country.

It will be seen that both fodder corn and millet stubble, gave better returns than summer-fallow, this, however, is the result of only one year's test.

Variety sown.	How prepared.	Character of Soil.	When sown.	Length of		When cut.	Days Maturing.	Yield per Acre.		Lbs. per Bush.
				Straw.	Head.			Bush.	lbs.	
				In.	In.					
Red Fife, Barley stubble	Spring ploughed ....	Loam . . .	May 3.	39	4	Aug. 19	108	17	05	59
do summer-fallow.	No spring preparat'n	do ....	do 3.	40	4	do 20	109	24	35	58
Red Fife, Millet stubble	Spring ploughed ....	Loam ....	May 2.	36	4	Aug. 19	109	28	20	59
do summer-fallow.	No spring preparat'n.	do ....	do 2.	43	4	do 19	109	26	20	59
Red Fife, Fodder Corn stubble .....	Spring ploughed ....	Clay loam	May 17.	38	3½	Aug. 21	97	35	30	61
do summer-fallow.	No spring preparat'n.	do ..	do 17.	41	4	do 21	97	31	30	60
Red Fife, Pea stubble...	Spring ploughed ....	Light loam	May 12.	34	3½	Aug. 13	93	14	40	54
do do .....	Unploughed .....	do ..	do 12.	32	3½	do 13	93	13	10	54
do summer-fallow.	No spring preparat'n.	do ..	do 12.	36	3½	do 15	95	15	00	55
Red Fife, Oat stubble...	Spring ploughed ....	Light loam	May 12.	34	3½	Aug. 13	93	13	20	55
do summer-fallow.	No spring preparat'n.	do ..	do 12.	36	3½	do 15	95	15	00	55

## LOSSES FROM SOWING INJURED SEED GRAIN.

Complaints are being received from all parts of the province regarding the lack of germinating power in the grain sown last spring, some farmers losing their whole crop from this cause.

The grain of this province if properly stacked and garnered will always show a high germinating power; and the losses this year can generally be traced to the use of damp wheat for seed, the grain garnered in a damp condition may be apparently sound, but experience has proved that grain ever so slightly heated, is unsafe to sow and should be tested before sowing, and if this cannot be done, it should be discarded, and only perfectly sound seed used.

Where doubts exist regarding the germination of seed grain, a sample should be forwarded by mail to the Central Experimental Farm, Ottawa, where it will be tested and the returns sent back, free of charge.

All seed grain intended for distribution from this farm is tested for germinating power before being sent out.

The following tables give the number of samples tested, and the average germinating power of each kind of grain grown on the Experimental Farm in 1892. These were tested at the Central Experimental Farm.

Wheat, 49 samples tested: average germinating power, 91 per cent; strong plants, 84 per cent; weak plants, 7 per cent.

Oats, 41 samples tested: average germinating power, 97 per cent; strong plants, 86 per cent; weak plants, 11 per cent.

Barley, 34 samples tested: average germinating power, 90 per cent; strong plants, 75 per cent; weak plants, 15 per cent.

## COUCH GRASS EXTERMINATION.

Numerous letters of inquiry are received each year regarding the best plan for destroying Couch or Quack Grass.

The above terms are applied indiscriminately here to two quite distinct grasses, both of them different from the couch grass of the east, *Agropyrum repens*. One variety, *Agropyrum glaucum* or Colorado Blue Stem, Fig. 2, has a bright bluish-green narrow blade, and ripens its seed in July, the other *Hierochloa borealis*, Holy Grass or Sweet Grass, Fig. 3, has a wide, light green blade, and ripens its seed in May; the last mentioned is the more common, and is fast getting possession of some farms, and completely chokes out any grain that may be sown with it. Both varieties are readily propagated from both seed and root stocks.



Fig. 2.—COLORADO BLUE-STEM. (*Agropyrum glaucum*, R. & S. var. *occidentale*, V. & S.) .





Fig. 3.—*Hierochloa borealis*, R. & S.

The sweet grass ripening early, generally sheds its seed before summer-fallows are ploughed and the one ploughing usually given summer-fallow here covers this seed, and spreads the root stocks over the field, the smallest piece of which will grow and become a centre of distribution another year.

Last spring four one-tenth acre plots badly infested with the sweet grass were set apart for experimental work.

All were ploughed May 28th.

Plot 1, was at once sown with three bushels of barley per acre, and the crop allowed to ripen.

Plot 2, also sown, but with oats, and the crop allowed to ripen.

Plot 3, was summer-fallowed by ploughing once and the weeds kept down with surface cultivation.

Plot 4, also summer-fallowed but ploughed twice and couch grass roots brought to the surface by harrowing.

Very little sweet grass is left in Plots 1 and 2, and none whatever can be seen in Plot 4, twice ploughed; but in Plot 3, ploughed but once, the grass appears thicker than ever.

These plots will be kept in view and their condition reported on next year.

## Experimental Farms.

### FODDER CORN.

This plant has generally given such good returns here that an increased area has been sown every year.

In addition to the fifteen varieties sown in small plots, a field of eleven acres was sown this year for ensilage purposes.

As this plant makes its principal growth late in the season, it suffered severely from the drought and hot winds of August, this reduced the yield to one-half of last year's crop, but the open fall and high temperature was favourable to early maturing and all the varieties formed ears, some of them reaching the roasting stage.

In addition to the usual plan of sowing in rows, a set of duplicate plots were planted in hills; sowing in rows is by far the most expeditious and has this year given the largest return; there was no noticeable difference in point of earliness between the two methods of sowing.

The land for this crop was prepared by ploughing in ten loads of rotted manure in spring, was then well harrowed and the corn sown with a press drill.

This land was in millet the previous year.

FODDER CORN sown on 26th May, with a press drill, in rows three feet apart, and nine inches apart in the row, cut 14th September.

Variety.	When tasseled.	In Silk.	Early Milk.	Late Milk.	Stage when cut.	Height in inches	Leafiness.	No. of Stools.	Weight green cobs per doz.		Yield per acre, green.	
									Lbs.	Tons.	Lbs.	Lbs.
Mastodon Dent .....	Aug 20	Aug 25	Sept 4	.....	Early milk	84	Little ...	2	7	13	950	
Angel of Midnight....	do 1	do 9	Aug 25	Sept 4	Roasting ears	62	Fair .....	3	7½	11	1,100	
Compton's Early .....	do 1	do 10	do 25	do 4	Late milk.	62	Good .....	3	9	11	1,100	
Golden Dew Drop....	do 4	do 20	do 27	do 5	do .....	63	do .....	4	7½	11	1,100	
Great Northern .....	do 2	do 9	do 26	do 6	Roasting ears	64	do .....	4	8½	11	1,100	
Gold Dollar .....	do 3	do 10	do 24	do 5	do .....	69	Very good	4	10	11		
North Dakota Flint ..	do 1	do 9	do 24	do 4	do .....	59	Good .....	6	8	10	1,450	
Thorobred White Flint	do 25	Sept 5	Sept 11	.....	Early milk	52	do .....	4	.....	9	1,800	
Gold Coin .....	July 28	Aug 9	Aug 23	Aug 29	Roasting ears	65	do .....	3	6½	9	700	
Early Minnesota .....	Aug 1	do 5	do 26	Sept 5	do .....	52	do .....	4	5½	9	700	
Pearce's Prolific .....	do 3	do 9	do 15	Aug 24	do .....	56	Fair .....	3	5	8	1,050	
Smut Nose Flint .....	do 4	do 15	do 25	Sept 3	Late milk.	63	Good .....	3	6½	8	1,050	
Early Champion .....	do 1	do 9	do 26	do 5	Roasting ears	39	Poor .....	5	8	6	1,200	
Mitchell's Extra Early	July 25	do 1	do 10	Aug 20	Nearlyripe	45	do .....	3	4	4	1,900	
Burpee's First of All.	do 29	do 7	do 25	do 24	Roasting ears	44	do .....	5	5½	4	800	

FODDER CORN planted on 26th May, in hills, three feet apart each way, three grains in a hill, cut 14th September.

Variety.	When tasseled.	In Silk.	Early Milk.	Late Milk.	Stage when cut.	Height in inches	Leafiness.	No. of Stools.	Weight green cobs per doz.		Yield per acre, green.	
									Lbs.	Tons.	Lbs.	Tons.
Mastodon Dent	Aug 20	Aug 25	Sept 4		Early milk	84	Little	2	7	11	1,100	
Great Northern	do 2	do 9	Aug 26	Sept 6	Roasting ears	64	Good	4	8½	10	900	
Angel of Midnight	do 1	do 9	do 25	do 4	do	62	Fair	3	7½	9	1,800	
Golden Dew Drop	do 4	do 20	do 27	do 5	Late milk.	63	Good	4	7½	9	700	
Compton's Early	do 1	do 10	do 25	do 4	do	62	do	3	9	9	1,500	
Thorobred White Flint	do 25	Sept 5	Sept 11		Early milk	52	do	4		8	1,600	
Gold Coin	July 28	Aug 9	Aug 23	Aug 29	Roasting ears	65	do	3	6½	8	1,600	
Smut Nose Flint	Aug 4	do 15	do 25	Sept 3	Late milk.	63	do	3	6½	8	500	
Pearce's Prolific	do 3	do 9	do 15	Aug 24	Roasting ears	56	Fair	3	5	7	1,400	
Gold Dollar	do 3	do 10	do 24	Sept 5	do	69	Very good	4	10	7	1,400	
North Dakota Flint	do 1	do 9	do 24	do 4	do	59	Good	6	8	7	300	
Early Minnesota	do 1	do 5	do 26	do 5	do	52	do	4	5½	7	300	
Early Champion	do 1	do 9	do 26	do 5	do	39	Poor	5	8	5	1,000	
Mitchell's Extra Early	July 25	do 1	do 10	Aug 20	Nearlyripe	45	do	3	4	4	1,900	
Burpee's First of All	do 29	do 7	do 25	do 24	Roasting ears	44	do	5	5½	3	160	

MIXED GRAIN FOR HAY.

Six plots have been sown with mixed grain for hay, the returns are very variable ranging from under 2 to nearly 4 tons per acre.

Plots 5 and 6 were sown for the purpose of testing cross-sowing pease against sowing them in every other drill.

In plot 5 the oats were sown at the rate of 8 pecks with a seven-inch drill, then the pease were sown at the rate of 4 pecks in the spaces between the oat drills, making alternate drills of oats and pease, 3½ inches apart.

In plot 6 the oats were sown in 7-inch drills, east and west, and then the pease north and south.

It will be seen that the 3½ inch drills gave much the best return.

Soil clay loam, size of plots one-tenth acre, summer-fallowed.

Variety.	Pecks per Acre Sown.	Date of Sowing.	How Sown.	When Cut	Weight per Acre Dry.
1 { Oats, Prize Cluster	4	May 5	*Press drill	Aug. 17	Tons. lbs. 1 1,850
{ Pease, Crown	8	" 5	do		
2 { Wheat, Red Fern	4	" 5	Press drill	" 21	2 350
{ Pease, Crown	8	" 5	do		
3 { Barley, Prize Prolific	4	" 5	Press drill	" 14	2 1,850
{ Pease, Crown	8	" 5	do		
4 { Wheat, Red Fife	4	" 16	Common drill	" 17	2 1,800
{ Oats, Banner	4	" 16	do		
{ Pease, Golden Vine	4	" 16	do		
5 { Oats, Holstein Prolific	8	" 16	Press drill, 3½ in	" 17	3 1,950
{ Pease, Crown	4	" 16	do		
6 { Oats, Holstein Prolific	8	" 16	Press drill, east and west	" 17	2 1,500
{ Pease, Crown	4	" 16	do north and south		

\* Injured slightly by alkaline soil.

## Experimental Farms.

### MILLETS.

The hot, dry August of this year was very much against a large yield of millet, but the land selected for this crop was clean and naturally moist and the returns were very fair for the season.

The plots were of 2 sizes,  $\frac{1}{10}$  and  $\frac{1}{20}$  acre. The  $\frac{1}{20}$  acre plots were sown in drills 12 inches apart, and cultivated between the drills with a Planet jr. drill, the  $\frac{1}{10}$  acre plots were sown in 7 in. drills and not cultivated, it will be noticed that in every case the cultivated drills gave the largest return.

One-twentieth of an acre of hemp was also sown. This reached 6 feet high and gave 1,300 pounds of the dry product per acre.

Variety.	Size of Plot.	How treated.	Yield per Acre.			
			Green.		Dry.	
			Tons.	lbs.	Tons.	lbs.
Hungarian Grass.....	$\frac{1}{20}$ acre	1-foot drills, and cultivated between.....	3	1,900	2	100
do .....	$\frac{1}{10}$ "	7-in. drills, not cultivated .....	3	1,050	2	300
Common Millet.....	$\frac{1}{20}$ "	1-foot drills, and cultivated between.....	3	200	2	100
do .....	$\frac{1}{10}$ "	7-in. drills, not cultivated .....	2	1,150	1	1,000
German Millet.....	$\frac{1}{20}$ "	1-foot drills, and cultivated between .....	3	100	1	1,800
do .....	$\frac{1}{10}$ "	7-in. drills, not cultivated.....	3	.....	1	800
American Millet.....	$\frac{1}{20}$ "	1-foot drills, and cultivated between.....	3	700	1	1,300
White French Millet.....	$\frac{1}{20}$ "	do do .....	3	.....	1	1,400
Hemp.....	$\frac{1}{20}$ "	do do .....	2	900	..	1,300

### GRASSES.

The plots of native and hardy imported grasses sown in 1890 and 1891 were again cut this year: the yield of all was somewhat smaller than usual, and the timothy sown in 1890 was scarcely worth the cutting. The native grasses sown the same year are however still giving fair yields.

A considerable area was sown to grass seed this year both with and without a grain crop; owing to the dry summer very few of the varieties, native or imported, sown in spring with a grain crop, have grown well; but six acres sown with native grasses alone, have made a good catch, and were from four to six inches high when winter set in.

The plan of sowing grass seed alone on fallowed land late in summer, is, it seems, the most certain for this country, and would be more generally adopted if it were not for the loss of a grain crop which that method entails.

The accompanying table gives the yield and other particulars of the plots of hardy grasses sown during 1890-92; the plots vary in size from one-tenth to one-half an acre each.

Variety.	Size of Plot.	When sown.	When cut.	Yield per acre, dry.	
				Tons.	lbs.
<i>Elymus Americanus</i> .....	25 x 310 links.....	Spring 1891.....	July 18.....	1	1,870
<i>Muhlenbergia glomerata</i> .....	60 x 480 do .....	do 1891.....	Sept. 1.....	1	881
<i>Agropyrum tenerum</i> .....	25 x 480 do .....	do 1892.....	July 18.....	1	400
Austrian Brome.....	25 x 480 do .....	do 1891.....	do 1.....	1	333
Sheep's Fescue.....	25 x 480 do .....	do 1890.....	do 1.....	..	1,500
Timothy.....	$\frac{1}{2}$ acre.....	do 1890.....	do 1.....	..	1,080

## SUNFLOWERS FOR SEED AND ENSILAGE.

Two acres of Russian sunflowers were sown at three different times, May 8th, 15th and 22nd, and although there were eleven degrees of frost after the plants were up, the frost had no apparent effect on them, the early sown were the finest plants all the season. The sowing was done with a common wheat drill, in rows three feet apart, the seed dropped about one foot apart, and thinned to two feet after the plants were up; soil clay loam. The field was kept clean with a Planet jr. cultivator during the growing season. The plants averaged 6 feet high when cut, the heads were cut with sickles on September 9th, and run through the cutting box with the fodder corn for ensilage, the seed being nearly ripe at that date.

After the heads were cut, the stalks were allowed to dry, then cut and piled for fuel. They burn well when dry and give out considerable heat, but last for a very short time. Where wood cannot be obtained they could be utilized for summer fuel, but would not be suitable for winter fires.

The following table gives full particulars of this crop.

Variety.	Sown.	When cut for silo.	Yield of heads per acre.	When cut for seed.	Yield of threshed seed per acre.	Weight of seed per bushel.	Yield of stalks per acre.	Max. diameter of heads.
Mammoth Russian.	May 8.	Sept. 9.	11,220 lbs.	Sept. 16.	35 bush...	37 lbs.....	4½ cords..	12 inches.

## SILOS.

The ensilage made in the fall of 1892 from well matured and wilted North Dakota Flint Corn proved to be excellent, much better than that made from un-wilted corn in 1891; only a very small quantity on top and on the west side of the silo was injured.

This year the yield of fodder corn was light and only one silo was filled, partly with corn and sunflower heads, and the balance with corn and horse beans. The silo is not yet opened for use, but judging from appearance the ensilage promises to be as good as last year.

Since the silos were built at the Experimental Farm a number of others have been built in different parts of the province, and all appear to give good satisfaction.

## FIELD ROOTS.

Owing to the light rainfall during the season of growth, all kinds of field roots throughout the central and western parts of the province gave a very unsatisfactory yield, the returns on the Experimental Farm were no exception to the rule, the yield being scarcely one-half of an average crop.

The soil selected for roots was a strong clay loam, thoroughly summer-fallowed the previous year, and all weeds were kept down between the rows by the use of the Planet jr. cultivator.

The yield per acre has been calculated from the results obtained from three rows of each variety one chain long.

## Experimental Farms

### RESULTS OF EXPERIMENTS WITH TURNIPS DURING 1893.

Land in summer-fallow the previous year, treated with ten tons rotted manure per acre, applied in the spring of 1893. Turnips were sown in flat drills  $2\frac{1}{2}$  feet apart. Two sowings were made, one on 3rd June and one on 19th June. Taken up Oct. 10th; soil, clay loam.

Variety.	YIELD FROM PLOTS SOWN 5TH JUNE.			YIELD FROM PLOTS SOWN 19TH JUNE.		
	Yield per Acre.			Yield per Acre.		
	Bush.	Tons.	lbs.	Bush.	Tons.	lbs.
Carters's Prize Winner .....	352	10	1,120	296	8	1,760
Selected Purple Top .....	312	9	720	293	8	1,580
Selected East Lothian .....	293	8	1,580	253	7	1,180
Sutton's Champion .....	293	8	1,580	281	8	860
Bangholm Improved .....	278	8	680	253	7	1,180
Skirving's Purple Top .....	275	8	500	231	6	1,860
Rennie's Prize Purple Top .....	272	8	320	246	7	760
Marquis of Lorne .....	253	7	1,180	234	7	40
Jumbo or Monarch .....	249	7	940	227	6	1,620
Carter's Elephant .....	234	7	40	202	6	120
Mammoth Purple Top .....	187	5	1,220	225	6	1,500
Monarch .....	139	4	340	92	2	1,520

### YIELD OF MANGELS AND SUGAR BEETS.

Sown in flat drills  $2\frac{1}{2}$  feet apart on clay loam soil, summer-fallowed the previous year, treated with ten tons of rotted barn yard manure applied in spring of 1893. Two sowings were made, one on 6th June and one on 20th June. The roots were pulled on 6th October.

Variety.	YIELD FROM PLOTS SOWN 6TH JUNE.			YIELD FROM PLOTS SOWN 20TH JUNE.		
	Yield per Acre.			Yield per Acre.		
	Bush.	Tons.	lbs.	Bush.	Tons.	lbs.
Mammoth Long Red .....	429	12	1,740	274	8	440
Champion Yellow Globe .....	420	12	1,200	386	11	1,160
Giant Yellow Intermediate .....	378	11	680	293	8	1,580
Gate Post .....	344	10	640	278	8	680
Golden Tankard .....	344	10	640	312	9	720
Canadian Giant .....	340	10	400	305	9	300
Warden Orange Globe .....	340	10	400	288	8	1,280
Red Globe .....	319	9	1,140	259	7	1,540
Red Fleshed Tankard .....	261	7	1,660	181	5	860
Erturf Model .....	155	4	1,300	146	4	760
Green Top Brabant (Sugar Beets) .....	385	11	1,180	264	7	1,840
Vilmorin's Improved do .....	344	10	640	246	7	760
French New Rich do .....	322	9	1,320	264	7	1,840
Klein Wanzleben do .....	316	9	960	246	7	760

## RESULTS OF EXPERIMENTS WITH FIELD CARROTS.

Land in summer-fallow the previous year, treated with ten tons per acre of rotted stable manure, applied in spring. Carrots were sown in flat drills eighteen inches apart. Two sowings were made, one on 6th June and one on 20th June. Soil clay loam.

Variety.	YIELD FROM PLOTS SOWN 6TH JUNE.			YIELD FROM PLOTS SOWN 20TH JUNE.		
	Yield per Acre.			Yield per Acre.		
	Bush.	Tons.	lbs.	Bush.	Tons.	lbs.
Large Short Vosges.....	154	4	1,240	146	4	760
Early Gem.....	147	4	820	139	4	340
Improved Short White.....	146	4	760	132	3	1,920
Chantenay.....	146	4	760	132	3	1,920
Half Long Danvers.....	146	4	760	95	2	1,700
White Intermediate.....	139	4	340	117	3	1,020
Long Red without core.....	110	3	600	95	2	1,700
White Belgian.....	110	3	600			
Carter's Orange Giant.....	102	3	120	95	2	1,700

## POTATOES.

The potato crop throughout the central and western parts of the province is lighter this year than it has been for a number of years; the dry summer and fall reducing the yield to less than one-half of an average crop. Fortunately the eastern parts of the province fared better and are in a position to supply the deficiency in the west.

The land on the Experimental Farm selected for this crop was a stiff clay soil, very retentive of moisture and for that reason suffered but slightly from the drought, but the cold, wet soil, delayed germination in spring, making the plants late to ripen and injuring the quality so badly that tests in this particular would be misleading, and are not included in the tables this year.

The accompanying tables give particulars of this crop. The returns per acre are based on the product of 2 rows, each one chain long.

## Experimental Farms.

### POTATOES.

Ploughed in, in rows three feet apart, one foot apart in the row; weeds kept down during the growing season with a one-horse cultivator. All were planted 26th May, and the last were taken up 5th October.

Variety.	Yield per Acre.	Earliness.	Size.
	Bush.		
Daisy .....	253	Late .....	Medium.
Rural Blush .....	251	do .....	do
Rose Valley .....	245	Late .....	Large.
Genesee Seedling .....	244	do .....	do
Everett .....	242	do .....	do
The Freeman .....	238	do .....	Small.
Sharpe's Seedling .....	236	Medium .....	Medium.
Dakota Red .....	229	Late .....	Large.
Polaris .....	229	do .....	do
Bruce's White Beauty .....	223	do .....	Medium.
Harbinger .....	220	do .....	Small.
Burpee's Extra Early .....	220	Early .....	
New Variety No. 1 .....	216	Late .....	Large.
Empire Bell .....	205	do .....	Medium.
Holborn Abundance .....	201	Medium .....	do
State of Maine .....	201	Late .....	do
Pearce's Prize Winner .....	201	do .....	Large.
Pearce's Extra Early .....	196	do .....	do
Cream of the Valley .....	190	do .....	do
White Unknown .....	188	do .....	do
Lizzie's Pride .....	187	do .....	Medium.
Algoma .....	187	Early .....	do
American Giant .....	187	Late .....	Small.
I. X. L. ....	183	do .....	Medium.
Toronto Queen .....	179	do .....	Large.
Northern Spy .....	174	do .....	do
Early Puritan .....	170	do .....	do
Green Mountain .....	168	do .....	Medium.
Crown Jewel .....	165	do .....	Large.
Lee's Favourite .....	165	Medium .....	Medium.
Early Rose .....	165	do .....	do
Thorburn's Late Rose .....	165	Late .....	Large.
Early Sunrise .....	161	do .....	do
Vanguard .....	157	do .....	do
Early Ohio .....	152	Very early .....	Medium.
Delaware .....	148	Late .....	do
Empire State .....	146	do .....	Large.
Beauty of Hebron .....	137	do .....	do
Steele's Earliest of All .....	135	do .....	Very large.
Rural Blush .....	128	do .....	Medium.
Thorburn's Paragon .....	110	do .....	do
Clarke's No. 1 .....	106	do .....	Large.
Chicago Market .....	100	do .....	do
Snowdrop .....	95	do .....	Small.

### SWINE FEEDING EXPERIMENTS.

Two series of experiments in swine feeding were undertaken in the winter of 1891-2, with the anticipation that supplementary tests would be made during the following summer. For this reason the results were not published in the last report. It was afterwards found impracticable to make the summer tests for want of suitable accommodations.

The building in which the swine were kept during the winter was very open and cold, the thermometer often going below zero, they were thus fed at a great disadvantage, but as the conditions were such as obtain on many farms in this country during winter, the results of these experiments may be useful as showing what can be done under very unfavourable circumstances.



## FEEDING FROZEN WHEAT TO SWINE.

Two Berkshire grade pigs were selected for this experiment, they were purchased at 5c. per pound live weight, and sold at the same rate, their combined live weight when the test began 7th December, was 180 lbs. They were fed three times a day, all the chopped No. 3 or badly frozen wheat they would eat clean, mixed with cold water at the time of feeding, the building being too cold to admit of soaking the food for any length of time before using.

The accompanying table will show that this wheat, although badly injured, and fed under unfavourable conditions realized in its value in pork 49 cts. per bushel. The market value of such wheat during the winter of 1891-92, was about 30 cts. per bushel, and it would not realize 20 cts. this winter.

	Amount of wheat consumed each month by the two swine.	Gain in pounds of pork each month.	Return per bushel of wheat fed.	Pounds of wheat consumed for one lb. of pork.	Weight of the swine at end of month.
	Lbs.	Lbs.	Cts.	Lbs. oz.	Lbs.
First month .....	330	67	60	4 14	247
Second do .....	319	45	42	7 1	292
Third do .....	294	55	56	5 5	347
Fourth do .....	313	39	37	8 0	386

*Summary.*

It took on an average 6 lbs. 1 oz. of wheat during the four months, to make one pound of pork.

Average return per bushel of wheat consumed, 49 cents.

## FEEDING BARLEY TO SWINE.

The two pigs selected for this test were also grade Berkshires, their combined weight at the commencement of the test, 28th December, was 117 lbs. These were also purchased at five cents per pound live weight, and sold at the same rate.

The barley was fed three times a day, chopped and mixed with water at the time of feeding. No more was fed than would be eaten up clean at each meal.

The following results show that the barley fed in this experiment realized in pork 50 cents per bushel, farmers at that time were selling the same grade of barley on the market at an average of 25 cents per bushel, a difference of one hundred per cent in favour of feeding it.

	Amount of barley consumed each month by the two swine.	Gain in pounds of pork each month.	Return per bushel of barley fed.	Pounds of barley consumed for one pound of pork.	Weight of swine at the end of month.
	Lbs.	Lbs.	Cts.	Lbs. oz.	Lbs.
First month .....	288	83	69	3 7	200
Second do .....	335	71	50	4 11	271
Third do .....	370	65	42	5 11	336
Fourth do .....	341	62	43	5 8	398

## Experimental Farms.

### Summary.

It took an average of 4 lbs. 11 oz. of barley during the four months to make one pound of pork.

Average return per bushel of barley fed 50 cents.

### CATTLE.

The cattle on the farm have been perfectly healthy during the year, and there have been no losses through sickness.

During the year there has been added to the herd the following calves, all bulls, viz.: two Ayrshires, two Holsteins and one each of Shorthorn and Galloway, and one Grade.

Three young bulls, one each of Holstein, Ayrshire and Galloway were sold by public auction on November 15th. The herd now consists of 7 Shorthorns, 6 Ayrshires, 7 Holsteins, 4 Galloways and 3 Grades.

A record has been kept of the yield of milk given by each cow; but as the necessary apparatus for testing the quality of the milk of the different breeds, is about to be supplied it is thought best to defer publishing the yields until the relative richness of the milk of the different breeds can be accurately determined.

### FATTENING STEERS WITH FROZEN WHEAT AND BARLEY.

Recognizing the fact that the results of several years' experiments are required in almost every line before reliable conclusions can be reached, the experiments in feeding steers with frozen wheat and barley commenced in the winter of 1892-3, were continued last winter, but with three steers in each group instead of two.

Nine very even and fairly thrifty steers, raised by farmers near here, were secured for this purpose. They were all grades, Shorthorn blood predominating and about 2½ years old, they were purchased in the fall at 2½ cents per pound live weight, and sold in the spring at 3½ cents.

The nine steers were divided into three groups of three each, and fed for five months *all they would eat clean* of the following rations:—

#### Composition of the different Rations.

##### First lot of steers—

	Lbs.
Cut wheat straw .....	20
No. 3 frozen wheat chop.....	15

##### Second lot of steers—

	Lbs.
Cut wheat straw .....	15
No. 3 frozen wheat chop.....	9
Turnips sliced.....	20

##### Third lot of steers—

	Lbs.
Cut wheat straw.....	10
Barley chop.....	10
Turnips sliced.....	20

The several ingredients were spread in layers in a heap, and after being moistened were thoroughly mixed and fed *all they would eat up clean* the following day, in three feeds.

*Feed consumed.*

The total amount and cost of feed consumed during the feeding period (151 days) was as follows:—

First lot of steers—

6,344 pounds cut straw.....  
 4,996 “ wheat chop at ½ cent per lb ..... \$24.98

Second lot of steers—

6,101 pounds cut straw .....  
 3,833 “ wheat chop at ½ cent per lb..... 19.16  
 140 bush. turnips at 5 cents per bush..... 7.00  
\$26.16

Third lot of steers—

5,140 pounds cut straw.....  
 5,478 “ barley chop at ½ cent per lb..... \$27.39  
 184 bush. turnips at 5 cents per bush..... 9.20  
\$36.59

Summary of Results.	First cost of Steers.	Cost of Feed.	Price sold for.	Profit.	Daily gain of each Steer.
	\$ cts.	\$ cts.	\$ cts.	\$ cts.	Lbs. oz.
First lot of steers—Wheat and straw.....	76 50	24 98	127 05	25 57	1 4
Second do Wheat, turnips and straw.....	77 85	26 16	128 62	24 61	1 3
Third do Barley, turnips and straw.....	72 62	36 59	130 27	21 06	1 13

Last year's return from the frozen wheat fed to group 1, was equal to 56 cents per bushel, this year it equals 60 cents.

Deducting the value of turnips, the frozen wheat fed to Group 2 realized last year 61 cents per bush., this year, 68 cents.

The wheat fed was the same both years, but the steers were much quieter last winter and for that reason better feeders.

No. 3 frozen wheat sold at an average of 30 cents per bushel in the winter of 1891-2 and about 25 cents last winter.

After deducting the value of turnips, the barley fed to group 3 realized forty-two cents per bushel.

Fortunately the crops in this province have escaped injury from frost during the past two years, but in case of injurious frost occurring at any future time it is well for the farmer to know that prime beef can be made from even badly frozen wheat, and that he is not compelled to sell it at a sacrifice as is so often done.

Barley is a grain that can be sown after wheat seeding, it is seldom if ever injured by fall frost, if sown in good season, and judging from the returns obtained under field culture on this farm, it should be a profitable crop at 42 cents per bushel.

# Experimental Farms.

## APPLE TREES.

The apple trees planted here in 1889 were divided into two lots, one lot was set out in cleared scrub land on the side hill facing the south; it is sheltered on every side by scrub 6 to 12 feet high. As the scrub on each side extends for some distance, very little snow drifted into the plots, and seldom more than six inches of snow lies on the ground each winter, this condition with the southern exposure is probably in part responsible for the heavy losses in trees each year. The other plot used as an apple orchard is in the lower part of the valley with a slightly northern exposure: this plot has simply one row of trees 7 to 15 feet high on the south, east and west sides, the north being without protection; every winter the snow drifts into this plot from 5 to 10 feet deep, completely covering the apple trees, and is not thawed out until late in the spring.

It will be seen from the following table that all the varieties of apple trees but one planted in this plot have survived the past four winters, although the growth has not been large.

The Anis apple is the most promising variety grown on the farm thus far, and it is interesting to note that Prof. Budd, of the Iowa Experimental Station, states "That this variety in Iowa is perfect in tree, and its fruit has the size, fine colour, keeping capacity and nearly the high quality of the Jonathan."

APPLE Trees planted in the valley on black loam soil, spring of 1889: plot sheltered by a row of trees on the south, east and west.

Variety.	No. of trees planted.		Season's growth.	Present condition.	Variety.	No. of trees planted.		Season's growth.	Present condition.
	1889	1893				1889	1893		
Anis red	8	8	11	Extra g'd.	Livland Raspberry	1	1	16	Poor.
Anis yellow	2	2	15	Good.	Lead	1	1	21	do
Antonovka	2	2	18	Fair.	Liebig	1	1	8	Good.
Aport	2	2	13	do	McIntosh red	1	1	18	Poor.
Alexander	2	1	18	do	Plikanoff	2	2	20	Good.
Arabka, winter	1	1	12	Good.	Pointed pipka	1	1	12	do
do summer	2	1	14	do	Peach	1	1	17	Fair.
Borovinka	1	1	16	Fair.	Repolovka	1	1	29	do
Borodovka	1	1	10	do	Red repka	1	1	9	do
Bogdanoffs Glass	1	1	11	Poor.	Simbirsk No. 2	1	1	15	do
Ben Davis	1	1	15	do	Shaker pippin	1	1	16	do
Baldwin Canada	2	1	8	Good.	Switzer	1	1	14	Good.
Christmas	1	0			Steklianka	1	1	30	do
Duchess of Oldenburg	4	4	18	Very good	Serinkia	1	1	28	Fair.
Grimes golden	1	1	13	Poor.	Scott's winter	1	1	19	Poor.
Golden russet	1	1	12	do	Tsiganka	1	1	16	Fair.
Grandmother	3	3	11	Good.	Tetofsky	1	1	14	do
Grand Duke Constantine	1	1	22	Fair.	Ukraine	2	2	22	do
Golden white	1	1	17	do	Winter St. Lawrence	3	3	27	Good.
Haas	1	1	13	do					

APPLE TREES planted on the upland with southern exposure, sheltered on all sides by scrub, soil light loam: trees planted spring of 1889.

Variety.	Number of Trees planted, 1889.	Number of Trees alive, 1893.	Season's growth.	Present Condition.
			Inch.	
Anis, red.....	2	2	25	Good.
do yellow.....	2	0		
do mottled.....	1	0		
Autumn streaked.....	1	0		
Antonovka.....	1	1	15	Fair.
Aport.....	1	0		
Arabka, summer.....	1	1	17	Fair.
do winter.....	1	0		
Borovinka.....	1	1	6	Poor.
Ben Davis.....	1	0		
Cross.....	1	1		Poor.
Christmas.....	1	0		
Duchess of Oldenburgh.....	3	3	20	Good.
Enormous.....	1	0		
Gernan Calville.....	1	1	15	Good.
Gipsy girl.....	1	1	10	Poor.
Hibernal.....	1	1	20	Fair.
Kruder.....	1	1	13	Poor.
Liebig.....	4	4	22	Good.
Longfield.....	2	0		
Pointed pipka.....	1	1	15	Fair.
Romna.....	1	0		
Red repka.....	1	0		
Repolovka.....	1	1	17	Fair.
Switzer.....	1	0		
Silken.....	1	1	12	Good.
Tsiganka.....	1	0		
Titovka.....	1	1	18	Poor.
Wealthy.....	2	2	16	Good.

APPLE TREES PLANTED IN 1890.

Soil, light loam; southern exposure; sheltered on all sides by scrub.

Variety.	No. of trees planted.		Season's growth.	Present Condition.	Variety.	No. of trees planted.		Season's growth.	Present Condition.
	1890	1893				In.	1890		
Antonovka.....	2	2	18	Good.	Pointed Pipka.....	2	2	21	Very good
Arabka summer.....	1	1	25	Very good	Peach.....	2	2	13	Fair.
Anis.....	2	1	11	Good.	Red Astrachan.....	2	2	11	do
do red.....	1	1	15	do	Steklianka.....	2	2	17	Good.
Ben Davis.....	3	3	16	Fair.	Serinkia.....	1	1	15	Poor.
Canada Baldwin.....	2	1	8	Good.	Stettin Yellow.....	1	1	4	Fair.
Duchess of Oldenburgh.....	2	2	18	do	Sandy Glass.....	1	1	23	do
Fameuse.....	3	1	17	Fair.	Sugar Sweet.....	2	1	5	Poor.
Gipsy Girl.....	3	3	13	Good.	Tashkin.....	2	2	15	Good.
Golden russet.....	2	1	17	Poor.	Tiesenhausen.....	1	1	9	do
Grimes' golden.....	1	0	.....	.....	Ukraine.....	3	2	16	do
Hibernal.....	4	1	24	do	Vargulek.....	3	1	19	Poor.
Haas.....	1	1	18	Good.	Yellow Arcadian.....	2	1	20	Fair.
Mann.....	1	1	13	Poor.	Yusoff.....	2	2	12	Good.

## Experimental Farms.

APPLE TREES planted in 1892, soil light loam, plot sheltered on all sides by scrub.

Variety.	Number of trees		Present condition.	Season's growth.	Remarks.
	planted.	Number of trees alive, Fall.			
	1892.	1893.		Inches.	
Little Hat .....	6	6	Fair .....	30	Soft growth.
Red Raspberry .....	6	5	do .....	14	do
Hare Pipka .....	6	6	Poor .....	24	Doubtful hardiness.
Peter .....	2	2	Good .....	22	Hardy growth.
Bode .....	6	6	do .....	15	do
Sugar Sweet .....	6	6	do .....	10	do
Blushed Calville .....	6	4	Fair .....	17	Winter kills.
Saccharine .....	6	3	Poor .....	20	Tender.

### CRAB APPLE TREES.

Crab apple trees suffered more injury from winter-killing during last season than they have done any winter yet. One quarter of them were completely killed, and many of the others badly injured.

Ten additional Transcendents were received last spring, and have made a good growth.

CRAB APPLE Trees planted on light loam soil, with a southern exposure; trees planted spring of 1889, plots protected on all sides by scrub.

Variety.	Number of Trees Living.		Present Condition.	Season's Growth.
	1892.	1893.		
Transcendent .....	9	7	Extra good...	34 inches ; hardy growth.
Whitney's No. 20 .....	3	2	Good .....	20 do do
Hyslop .....	7	4	do .....	19 do do
Orange .....	2	1	Fair .....	12 do kills back.
Early Strawberry .....	2	1	do .....	15 do do
Queen's Choice .....	1	1	Poor .....	25 do do

### PLUM TREES.

Since my last report, two more varieties of plums have been winter killed, and two others have been badly injured. De Soto and Nicholas are still promising.

The native Manitoba Plum is quite thrifty under cultivation, and one of the trees planted in 1892, bore a few very fair plums of a bright red colour this season. In May last 70 additional native plum trees were transplanted from the woods, and 68 of them are living at this date.

Variety.	When planted.	No. of Trees living,		Present condition.	Season's growth.
		1892.	1893.		
Bradshaw .....	1889	2	2	Fair .....	22 inches, tender growth.
De Soto .....	1892	2	2	Good .....	29 do hardy growth.
Early Red .....	1889	7	0		
Nicholas .....		3	3	Extra good..	31 do hardy growth.
Late Red .....	1889	1	1	Poor .....	15 do kills back.
Otschakoff .....	1889	2	0		
Native wild Plum .....	1890	7	7	Good .....	36 do good.

CHERRIES.

This climate appears particularly severe on all cultivated varieties of cherries, each year sees two or three varieties completely killed, 6 m. and Koslov Bush Morello are now the only ones at all promising.

A native variety, the Sand Cherry (*Prunus pumila*) is found growing wild on very sandy soil throughout the province, it is a very handsome shrub when in bloom, and the fruit is decidedly the largest native variety we have, and we have no difficulty in growing it on loamy soil. Introduced trees of this variety, as well as the native, seem quite hardy, and bear each year a heavy crop of rather indifferent fruit. Possibly this variety may be the starting point for improved varieties hardy enough for this country.

Variety.	When planted.	No. of Trees alive, 1891.	No. of Trees alive, 1893.	Present condition.	Present Height.	Season's growth.
Bessarabian	1890	2	0			
Lutovka	1890	5	3	Poor	40	8 inches, doubtful.
6 m Cherry	1890	2	2	Fair	63	14 do hardy growth.
12 m Cherry	1891	1	0			
Koslov Bush Morello	1890	4	4	Good	30	6 do hardy growth.
Vladimir	1892	6	4	Fair	51	12 do tender growth.
Lutvoka	1892	6	0			
Bessarabian	1892	6	5	Fair	40	10 do tender growth.
Sand Cherries, <i>Prunus pumila</i>	1892	5	5	Good	32	15 do hardy growth.

CURRANTS.

Currants of all kinds are quite hardy here, and were well covered with blossom last spring, but the hot winds of July and August caused the immature fruit to drop off, shrinking the fruit to one-half an average crop. Below will be found a description of the varieties that have fruited here, also the yield from ten average bushes. In addition to the lists given below, 13 seedlings were planted in 1891, and nine named varieties last spring. All of these are growing and will be reported on as soon as they fruit.

Variety.	Number of Trees living.		Color.	Size.	Flavour.	Yield of 10 average bushes.
	1892.	1893.				
Lee's Prolific	426	426	Black	Very large.	Excellent	18 lbs.
Champion	10	10	do	Large	Poor	17 do
Naples	100	100	do	Very large.	Good	10 do
Native, Large var	40	40	Brown black	Medium to large.	Strong.	
do, Small var	8	6	Jet black	Small	Bitter	
Raby Castle	202	202	Red	do	Good	13 do
Fay's Prolific	24	16	do	Large	do	14 do
Victoria	13	9	do	do	do	10 do
Cherry	140	140	do	do	do	10 do
White Grape	170	170	White	Very large.	Choice	15 do
Prince of Wales	8	8		Planted in 1892.		Very little fruit.
Prince Albert	17	17		do		do
Versaillaise	12	12		do		do
London Red	12	12		do		do

## Experimental Farms.

### GOOSEBERRIES.

The last of the Downing gooseberries were winter-killed last year, and that variety is evidently too tender for this country.

Smith's Improved and Houghton continue hardy, and the Houghton produced this year about one pound of fruit per bush.

A fine collection of nineteen new varieties were received last spring, these have all rooted and will be reported on next year.

### RASPBERRIES.

The yield of raspberries in common with all the small fruits was this year seriously diminished by the summer drought. The Turner and Philadelphia are quite hardy, and do not appear to require covering here, the other varieties need protection by bending down and covering with a little soil and manure.

Among the black caps the Hilborn has thus far been the best bearer, and is as hardy as any other of the tip varieties.

In addition to the list of varieties given below, three seedlings sent from the Central Experimental Farm in 1890 have proved hardy and fruited last season, the original plants of these were divided this year and for that reason did not fruit.

Variety.	Number of plants living.		Size.	Colour.	Flavour.	Remarks.
	1892.	1893.				
Turner.....	200	200	Medium.....	Red.....	Good.....	Hardy.
Philadelphia.....	200	200	Medium to small.	do.....	do.....	Extra hardy.
Cuthbert.....	150	150	Large.....	do.....	Excellent.....	Half hardy.
Marlboro'.....	50	50	Extra large.....	do.....	do.....	Hardy.
Reider.....	35	35	do.....	do.....	Good.....	Early and hardy.
Caroline.....	20	19	Medium.....	Yellow.....	do.....	Late and tender.
Golden Queen.....	20	18	do.....	do.....	do.....	Tender.
Hilborn (black cap).....	150	150	Extra large.....	Black.....	Excellent.....	do
Nevada blackberry.....	50	10	Large.....	do.....	Fair.....	do
Gainor blackberry.....	50	5	.....	.....	.....	do
Wachusett's Thornless blackberry.....	50	8	Large.....	Black.....	Fair.....	do



## FOREST TREE PLANTING.

This portion of the Experimental Farm work has given very satisfactory results during the past season.

The trees set out in nursery rows and shelter belts have generally made a rapid growth. The avenues have also done remarkably well. The accompanying cut (Fig. 4) is from a photograph showing a part of one of these avenues leading from the main road to the superintendent's house. Considerable additions have been made to the collection of forest trees and shrubs this year.

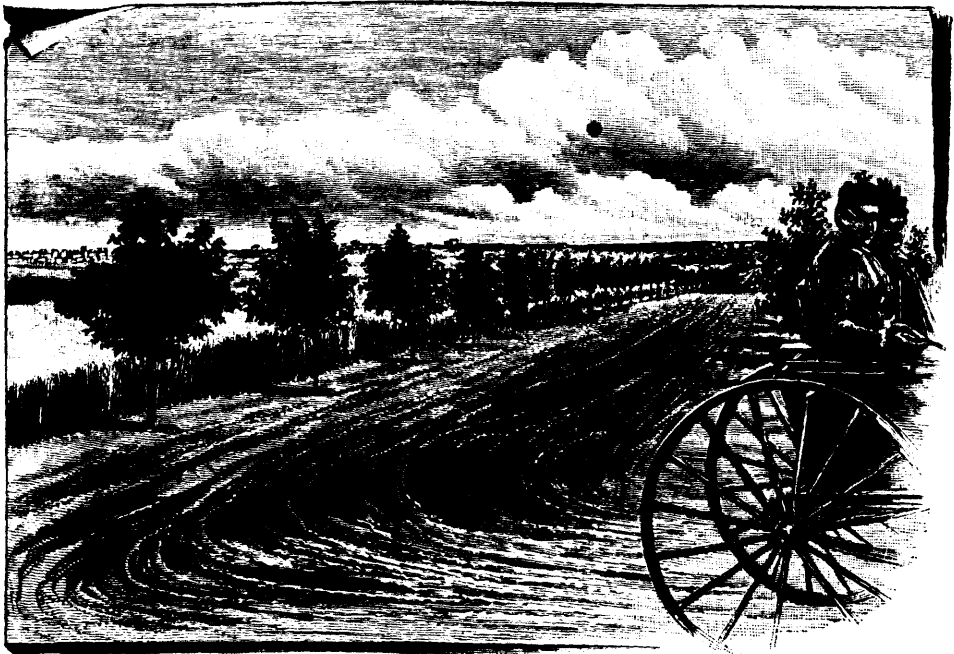

FIG. 4.—PART OF AVENUE OF MANITOBA MAPLE, EXPERIMENTAL FARM, BRANDON, MAN.

In June last I made a visit to Rat Portage, and procured from there a collection of native trees of the following varieties: White Pine (*Pinus Strobus*), Jack Pine (*Pinus Banksiana*) and Red Pine (*Pinus resinosa*) White Spruce (*Picea alba*), Black Spruce (*Picea nigra*), Balsam Spruce (*Abies balsamea*), also plants of native Sumach and Labrador Tea (*Iedum latifolium*). Although these were moved rather late in the season many of them have rooted, and will make interesting additions to the collection; there are still other varieties of trees and shrubs found in that district that have not been tested here and which it would be desirable to obtain as soon as practicable.

A number of Riga Pine, Norway Spruce and Native Oak (*Quercus macrocarpa*), the latter from seed gathered here, and a very full collection of Lilacs, Spireas with other shrubs were received from the east last spring; these have nearly all rooted and will be reported on later.

## FOREST TREES AND SHRUBS PLANTED IN SPRING OF 1892.

In the fall of 1891 a number of forest trees and shrubs were received from the Central Experimental Farm, these were heeled in over winter and planted the

## Experimental Farms.

following spring: although they were nearly covered with soil, many of the trees failed to start in the spring.

The following list includes all the varieties that rooted, with their growth and present condition.

Variety.	Number of Trees planted, 1892.	Number of Trees alive, 1893.	Season's growth.	Present Condition.
			Inches.	
Artemisia Abrotanum (Eng var)	4	4	14	Hardy growth.
do do (Russian)	25	25	49	do
Alnus glutinosa	15	15	9	do
Acer Tataricum	2	1	Small.	Tender.
do Pennsylvanicum	1	1	7	do
Butternut	10	0		
Berberis Thunbergii	20	20	4	Kills back badly.
Birch, white	20	20	13	Hardy.
do yellow	20	20	12	do
Clematis viticella	1	0		
Crataegus coccinea	1	0		
Caragana frutescens	6	4	5	Tender.
Picea excelsa	25	19	11	Half hardy.
do alba	10	4	5	do
Pyrus Americana	5	5	18	Half hardy.
Pyrus Aucuparia	25	23	17	do
Pyrus Toringo	2	2	7	Healthy.
Ptelea trifoliata	3	3		Small.
Rhamnus infectoria	2	1	6	Tender.
Ribes aureum	4	1	4	do
Spiraea opulifolia	100	100	60	Very hardy.
Syringa Josikæa	25	25	15	do
do Rothmagensis	5	5	10	Healthy.
Salix Babylonica annularis	2	1	5	Winter kills.
Sambucus aurea	5	4	30	Tender growth, very handsome.
Syringa vulgaris	25	25	14	Very hardy.
Virginian creepers, native	195	195	24	Hardy.
Viburnum Lantana	10	5	6	Half hardy.

### THE RATE OF GROWTH IN TREES ON THE EXPERIMENTAL FARM.

A number of trees were planted on the farm in 1889, from one year seedlings and rooted cuttings of the same age, these were measured this fall, and below will be found their height and also circumference one foot from the ground.

It will be seen from these measurements that forest tree protection can be quickly obtained on the rich soils of our prairies, and there is now no necessity for confining the planting to one or two varieties, as a very fair collection of useful sorts are now proven to be hardy.

Variety.	Height.	Circumference at butt.	Remarks.
Populus Bereolensis	14 feet.	13 inches.	Trimmed tree shape.
do Wobstii Riga	15 do	12 do	do
do Siberica	10 do	10 do	do
Cottonwood	12 do	10 do	do
Salix Voronesh	11 do	4 do	Bush.
do acutifolia	9 do	6 do	do
Ash-leaf Maple	12 do	10 do	do
Native White Elm	10 do	5 do	Tree shape.

Last spring the planting around the superintendent's house was commenced and the following trees and shrubs were set out, nearly all of which have been tested on the farm and found hardy.

## TREES.

Ash white, *Fraxinus Americana*.  
 Alder European, *Alnus glutinosa*.  
 Ash Mountain, *Pyrus Americana*.  
 Acer ginnala, Asiatic maple.  
 Birch, native.  
 Birch, cut leaved, weeping.  
 Beech, *Fagus ferruginea*.  
 Arbor-vitæ globe, *Thuja occidentalis globosa*.  
 Arbor-vitæ common, *Thuja occidentalis*.  
 Elm Manitoba white, *Ulmus Americana*.  
 Poplar, *Populus tremuloides*.  
 Balm Gilead, *Populus balsamifera*.  
 Russian Poplar, *Populus Petrovsky*.  
     do           do   *Siberica*.  
 Russian Poplar, *Populus Alba argentea*.  
     do           do   *bereolensis*.  
     do           do   *certinensis*.  
     do           do   *Voronesh*.  
 Pine, Jack Pine, *Pinus Banksiana*.  
     do Scotch, *Pinus sylvestris*.  
 Spruce native white, *Picea alba*.  
     do Ont.     do     do  
 Willow Voronesh, *Salix Voronesh*.  
     do Sharp leaved, *Acutifolia*.  
     do Golden leaved, *Aurea*.  
     do Laurel leaved, *Laurifolia*, French.  
     do           do     do     true.

## SHRUBS.

Southernwood, Russian, *A. abrotanum* Var. *Tobolskiana*.  
     do European, *A. abrotanum*.  
 Barberry purple, *Berberis vulgaris purpurea*.  
     do Thunbergii.  
     do common, *Berberis vulgaris*.  
 Cherry, ground or sand, *Prunus pumila*.  
 Siberian Dogwood, *Cornus Sibirica*.  
 Caragana pendula. Weeping Caragana.  
     do *arborescens*. Siberian Pea-tree.  
 Caragana mollis glabra.  
 Cytisus capitatus.  
 Currant flowering, *Ribes aureum*.  
 Elder golden, *Sambucus aurea*.  
 Honeysuckle, Tartarian.  
 Snowberry, *Symphoricarpus*.  
 Hazel nut, *Corylus Americana*.  
     do           do   *rostrata*.  
 Cornus native.  
 Cranberry, *Viburnum opulus*.  
 Sheepberry, do *lentago*.  
 Honeysuckle, native.

## Experimental Farms.

- Lilac Alba.
  - do Siberian, white.
  - do de Marley.
  - do vulgaris.
  - do Lemoinei, fl. pl.
  - do purpurea.
  - do Princess Alexandra.
  - do Josicca.
  - do Prince of Wales.
  - do Albert the Good.
  - do Alba grandiflora.
  - do Jaques Cabot.
- Olive Russian.
  - Philadelphus coronarius. Sweet Syringa.
  - do Gordonianus. Gordon's syringa.
  - do primulæflorus. Primula flowered syringa.
  - do Yokohama. Japanese syringa.
- Rose, native, Manitoba.
- Spiræa Douglasi.
  - do semperflorens.
  - do superba.
  - do opulifolia.
  - do van Houttei.
  - do Billardi.
  - do Californica.
  - do floritunda.
- Saskatoon, native, Amelanchier alnifolius.
- Viburnum Lantana.

### EXPERIMENTS WITH TREES AS WINDBREAKS.

The windbreaks surrounding the 12 plots mentioned in my last report, have continued healthy, and none of them have been injured by insect enemies.

The gaps among the cotton woods caused by cuttings not striking, have been filled with layered plants, these have all rooted and have made considerable growth.

The Russian Poplar (*Populus bereolensis*) and *Salix acutifolia* are decidedly the most promising for this purpose. Ash Leaf Maple and Elm are also thickening up well, but the Native Green Ash is growing very slowly.

These plots are in the most exposed situation on the farm, and before the windbreaks were planted, the crops sown in this field suffered severely from wind storms. This year all the plots were sown with rye or barley, and none were injured by wind, and all produced a very heavy crop.

To maintain an even growth, the tallest trees among the Willows, Maples, and Elms have been cut back. This is done quickly with a sickle, this encourages side growth, and thickens up the hedge.

In the following table particulars are given of the growth of each of the plots enclosed, the distance between the young trees in each wind break, and the growth made by each.

Variety.	Size of Plot inclosed in feet.	Distance apart of Trees.	Average Season's Growth.		Remarks.
			Inches.	Ft. In.	
Ash-leaf Maple.....	78 × 330	1 × 2	22	5 0	Healthy growth.
do .....	78 × 330	2 × 3	26	6 0	Appears the best.
do .....	78 × 330	2 × 2	29	6 0	Healthy growth.
do .....	90 × 330	3 × 3	18	4 0	Healthy.
do .....	102 × 330	2 × 2	25	5 6	do
do .....	304 × 65	4 × 4	13	4 0	do
do .....	304 × 66	1 × 2	12	3 6	do
do .....	304 × 66	2 × 2	14	3 6	Exposed to wind.
Native Green Ash.....	304 × 66	2 × 2	6	2 6	Small growth, healthy.
do .....	304 × 66	4 × 4	10	2 6	do do
Native White Elm .....	304 × 66	2 × 2	14	4 0	Very healthy.
Populus Bereolensis.....	304 × 66	4 × 4	30	8 0	Already an effective hedge.
Cottonwood .....	304 × 66	3 × 3	25	3 0	From cuttings, healthy.
Salix acutifolia.....	304 × 66	4 × 4	36	7 0	An excellent wind break.

The accompanying cut (Fig. 5) is from a photograph of one of the earliest planted hedges on the Experimental Farm.



FIG. 5.—HEDGE OF MANITOBA MAPLE, EXPERIMENTAL FARM, BRANDON, MAN.

## Experimental Farms.

### FOREST TREE AND SMALL FRUIT DISTRIBUTION.

This branch of the farm work increases each year.

Applications for fifty-nine thousand forest tree seedlings and cuttings, twelve thousand small fruit cuttings, and four hundred one pound bags of maple seed were received last winter. As the applications for forest trees exceeded our supply, ten thousand of these were sent from the Central Experimental Farm, the balance were supplied from trees grown here.

Favourable reports are being received of the trees sent out in former years, and in some instances cuttings are already being made from those sent out in 1890.

One hundred thousand cuttings are being prepared for next year's distribution.

The packages were sent by mail and each contained one hundred trees and cuttings as follows:—

Variety.	Number.	—
Ash-leaf maple . . . . .	28	Trees.
Cottonwood . . . . .	15	Cuttings.
Artemisia Abrotanum . . . . .	10	do
Native white elm . . . . .	10	Trees.
Poplar bereolensis . . . . .	4	Cuttings.
do Petrovsky . . . . .	10	do
do certinensis . . . . .	1	do
do alba argentea . . . . .	1	do
do Wobstii Riga . . . . .	1	do
Willow Voronesh . . . . .	10	do
do acutifolia . . . . .	10	do
	100	

### TABLE VARIETIES OF CORN.

The past season was favourable to the early maturing of corn, and eight of the ten varieties tested produced ears fit for the table.

All were planted in hills three feet apart each way in May and kept free from weeds during the season of growth.

Variety.	Weight of corn, per dozen, green.	When fit for table use.	Remarks.
	Lbs.		
Manitoba Squaw corn . . . . .	3	Aug. 15..	The earliest, but flavour poor.
Mitchell's Extra Early . . . . .	4	do 19..	An improved Squaw corn.
Early Minnesota . . . . .	5½	do 20..	Fair flavour.
Early Marblehead . . . . .	3½	do 23..	do
Perry's Hybrid . . . . .	5½	do 23..	do
Burlington . . . . .	4½	do 23..	Good flavour; one of the best.
Crosby's Early sugar . . . . .	4	do 24..	do , and sweet.
Burpee's First of All . . . . .	5½	do 25..	do ,
Stowell's Evergreen . . . . .	None.		
Early Champion . . . . .	do		

### LETTUCE.

Eighteen varieties of lettuce were tested on the Experimental Farm this year, seven of these were almost identical, and no doubt are the same variety under different names. All were sown in the open on 20th April.

A second sowing was made on 15th May, but the hot weather interfered with the growth of many of the varieties.

Variety.	Weight at maturity.	When started to seed.	Earliness.	Quality.	Remarks.
Silesian	26 oz.	July 30	Early.	Tender.	Wrinkled.
Denver Market	18 oz.	Aug. 1	do	do	do
Blonde Beauty	16 oz.	July 27	do	Fair.	Slightly wrinkled.
Paris Sugar	15 oz.	" 27	Late.	Tender.	Smooth.
Drumhead	12 oz.	" 15	do	Fair.	do
Nonesuch	8 oz.	Aug. 1	do	do	do and flat.
St. Louis	14 oz.	" 2	do	do	do
Hanson	17 oz.	" 1	do	do	Slightly wrinkled.
Golden Sunset	14 oz.	July 25	Medium.	do	do do
Nonpareil	22 oz.	Aug. 2	do	Very tender.	do do
Hamilton Market	16 oz.	July 25	do	do	do do
Rosedale	13 oz.	Aug. 1	do	do	do do
Trianon's White Star	12 oz.	" 1	do	do	do do
Excelsior	17 oz.	July 25	do	do	do do
Gardeners' Favourite	10 oz.	Aug. 4	do	do	do do
Boston Market	16 oz.	July 20	do	do	do do
Toronto Gem	17 oz.	Aug. 1	do	do	do do
Trianon's Cos.	20 oz.	" 1	do	do	Cos. shape.

#### CAULIFLOWERS.

Fifteen varieties of cauliflowers were tested on the farm, the season was very unfavourable for this plant and only the early varieties headed.

The following were the best this year: Thorburn's Gilt Edge, Steele's Extra Early, Extra Early Paris, and Extra Early Erfurt.

#### RHUBARB.

Mention was made in my last report of the usefulness of this plant here.

The series of experiments with seedlings commenced last year were continued this year; and the roots of twenty standard varieties were obtained from the United States and Britain, these were set out and will be reported on next year.

A few of the best plants of Victoria and Tottle's Improved Seedlings were allowed to ripen seed, each plant produced about 3 oz. of seed containing 1,800 seeds per oz.

The stalks of the plants set out last year were pulled every ten days and weighed; below will be found the returns per plant, &c., as the plants were set 4 x 4 feet the returns per acre were in some instances very large.

Variety.	Origin.	Ready for use.	Yield from each plant.		Quantity.
			Lbs.	Oz.	
Manitoba Seedling No. 1	Seedling of Victoria	May 26	21	02	Choice, tender.
do No. 2	do Myatt's Linneus	do 28	19	13	Good do
do No. 3	do Johnston St. Martin	June 1	6	00	Green, hard, poor.
do No. 4	do Stotts Mammoth	do 10	5	11	Fair quality.
Tottle's Improved	Root from J. Tottle, Stonewall	do 1	18	13	Good, tender.

#### TOMATOES.

Three varieties only of tomatoes were planted on the farm this year. All were sown in hot beds and transplanted to the open ground 1st June.

The first to ripen was Steele's Earliest of All, a large wrinkled variety; this ripened on 22nd August and yielded 23 lbs. from ten plants.

## Experimental Farms.

Atlantic Prize, nearly smooth, and large, ripened 30th August and gave a return of 20 lbs. from ten plants.

Dwarf Champion a smooth variety, medium size, ripened 1st September and gave 1 lb. per plant of choice tomatoes.

### FLOWERS.

Recognizing the fact that the surroundings of many of the farms in this province require to be made more attractive if the young people are to remain contented with a rural life, some attention has been paid each year to testing the hardier varieties of annual and perennial flowering plants.

As many of the perennial plants require very little skill or attention, a special effort has been made to collect and test the varieties likely to be hardy here.

The following have so far been found quite hardy, if protected with a few inches of litter; and have flowered freely on the dates mentioned.

### PERENNIAL FLOWERS.

Variety.	Season of Flowering.	Remarks.
Tulips, single, double and parrot.	20 May to June 15	Can remain in ground for years.
Crocus.	2 do to May 15	do do do
Scilla Siberica.	1 do to do 15	do do do
Pansies	1 do to fall frost.	do do do
Sweet William	20 June to do	Should be renewed every two years.
Pæonies herbaceous.	1 July to July 20	Can remain in ground for years.
Perennial Flax.	15 May to Aug. 1	do do do
Delphinium, Perennial.	20 July to frost.	do do do
Columbine.	1 do to Aug. 1	do do do
Bleeding Heart.	20 do to do 1	do do do
Day Lily.	1 do to do 1	do do do
Tiger Lily.	15 do to do 1	do do do
Pinks, from seed.	1 Aug. to frost	
Gladioli collection.	18 do to severe frosts.	Bulbs require to be stored in winter.
Hyacinthus candicans.	1 Sept	do do do

### ANNUALS.

Variety.	Season of Flowering.	Remarks.
Larkspur.	10 July to Aug. 1	Easy of culture and free bloomers.
Phlox Drumondii	15 do to fall frost	do do do
Escholtzia.	15 do to do	do do do
Zinnia.	20 do to do	do do do
Mignonette.	20 do to do	do do very fragrant.
Godetia.	25 do to do	do do free bloomers.
Salpiglossis	13 do to Aug. 30	do do do
Hibiscus.	1 Aug. to fall frost.	do do do
Marigold.	15 do to do	do but late to bloom.
Stocks.	1 do to do	do and fragrant.
Sweet Peas.	1 July to do	Must be sown early.
Asters.	1 do to do	do do to succeed.
Balsams.	15 Aug. to do	do do do
Verbena.	20 July to do	Easy of culture and free bloomers.
Portulacca.	1 do to do	do do do

### FARMERS' INSTITUTE MEETINGS.

During the past winter a number of additional farmers' institutes have been organized throughout the province, and invitations to address meetings have in



consequence largely increased, although more of this work was undertaken than in any previous year, I regret that other duties did not permit of my accepting all the invitations received.

Institute and other meetings were attended at the following places by invitation and the papers mentioned read by me:—

Wawanessa,	13th January,	"Experiments in feeding Steers,"	full meeting.
Winnipeg,	18th do	Dairymen's Convention, "Fodders and Grasses."	
Glenboro,	20th do	"Preventives of smut,"	small meeting.
Rapid City,	18th February,	"A Review,"	crowded house.
Douglas,	25th do	Dairy meeting, "Fodder for cows,"	full house.
Niverville,	27th do	"Summary of experiments,"	good meeting.
Morris,	28th do	do do do	large attendance.
Elkhorn,	4th March	"Cattle feeding,"	good attendance.
Virden,	11th do	"Grasses and feeding steers."	
Carberry,	12th do	"Varieties of wheats."	small attendance.
Portage la Prairie,	22nd March,	"Grasses and Fodder Plants,"	large attend- ance.
Hartney,	23rd March,	"A Review,"	good attendance.
Hartney,	11th May,	"Summer-fallow,"	full attendance.
Elkhorn,	3rd June,	do do	good attendance.
Russell,	6th do	"Grasses and Fodder plants."	
Birtle,	8th do	"Summary of experiments."	

#### TILE DRAINAGE.

Three fields on this farm, two of twenty acres, and one of two acres, have each year been more or less flooded during the spring freshets, making it difficult to utilize them for early sown crops, one field in particular remained flooded until July this year, it was found impracticable to remove the water from this field by surface drainage, and a system of tile under drainage has been commenced, 3,400 feet of this was completed during the fall, and the balance is expected to be in place in time next spring to prepare the land for barley seeding.

#### WINDMILL.

The 12-foot steel windmill mentioned in my last report, has so far given entire satisfaction, and has cost nothing for repairs since its erection.

Although located directly under a hill one hundred feet high, it pumps the water, grinds the feed, and cuts all the straw required for 35 head of cattle and ten horses.

With a moderate wind it pumps eleven barrels of water per hour, and with a stiff breeze grinds 16 bushels of oats, or 8 bushels of barley per hour.

Fodder corn for ensilage was also cut by wind power this year, one ton was cut into inch lengths in nine minutes, by a Watson Excelsior cutting box.

#### NEW BUILDINGS.

A frame implement and carriage building 28 x 72 feet has been erected this year.

Part of the ground floor will be used for storing implements and carriages, and the south end has been partitioned off as an exhibition room for produce grown on the farm.

The upper story is utilized for sorting and cleaning grain for seed and exhibition purposes. This building is close to the bank barn and will be a great convenience.

Poultry runs made of wire netting seven feet high and 60 feet long have been constructed in connection with the poultry house. Now that it is possible to keep the different breeds of poultry separate, we hope to be able to test their suitability for this country.

# Experimental Farms.

## METEOROLOGICAL.

In July 1889 this farm was supplied from the Dominion Meteorological Service with a set of instruments including four thermometers, rain gauge, wind vane, sunshine recorder, &c., since that date observations have been taken three times each day and monthly returns forwarded to the Central Office at Toronto for publication.

Below will be found the maximum and minimum thermometer readings for the past ten months, also the amount of rainfall and sunshine for the growing season.

### RAINFALL.

	Inches.
April .....	1
May .....	9
June .....	2.3
July .....	1.5
August .....	7
September .....	1.4
Total .....	<u>6.9</u>

### SUNSHINE.

	Hours.
March .....	191.0
April .....	126.5
May .....	278.6
June .....	206.6
July .....	286.5
August .....	287.4
September .....	221.0
Total .....	<u>1,597.6</u>

### TEMPERATURE.

Months.	Maximum.	Minimum.
January .....	30.5 on 8th.	— 47 on 29th.
February .....	32.6 on 20th.	— 52 on 1st.
March .....	40.4 on 31st.	— 31 on 15th.
April .....	59.6 on 30th.	— 3.6 on 1st.
May .....	88.3 on 18th.	21.3 on 25th.
June .....	95.6 on 11th.	37.5 on 9th.
July .....	96.3 on 20th.	35.6 on 9th.
August .....	106.4 on 7th.	30.6 on 28th.
September .....	93.4 on 3rd.	11.6 on 27th.
October .....	63.5 on 19th.	8.3 on 25th.

### AGRICULTURAL EXHIBITIONS.

Unfortunately a large proportion of the agricultural fairs in this province are held about the same date and only a few can be attended each year.

This year two fairs were attended on the main line of the Canadian Pacific Railway, two on the Pembina Branch, and one on the Manitoba and North-western Railway.

A full collection of grain threshed and in the straw, field roots, fruits, &c., was shown at the following places :

- Brandon, 25th and 26th July.
- Pilot Mound, 3rd and 4th October.
- Manitou, 5th and 6th do
- Neepawa, 10th and 11th do
- Carberry, 12th and 13th do

## EXHIBITS FOR THE WORLD'S COLUMBIAN EXPOSITION.

In addition to the collection of field roots, garden vegetables and preserved fruit mentioned in my last report, as having been sent to Chicago, in November, 1892. sixteen cases of grain samples, threshed and in the straw were shipped to Chicago in March last, these were shown in connection with the Dominion Exhibit in the Agricultural Hall. Two awards were received in Chicago for these exhibits.

It was intended to supplement the farm exhibit with fresh vegetables from time to time, but owing to the unfavourable season this was found impossible.

## VISITORS TO THE FARM.

It is evident by the rapidly increasing number of visitors each year, that interest in the work of the farm is not abating. This year 11,400 visited the farm, an increase of 6,000 over last year.

The Central Farmers' Institute again held their annual picnic on the farm, the Patrons of Industry also joined with them and it was estimated that over 2,000 persons attended; nearly all of whom were farmers and their families.

The farm was also visited by a large number of delegations from the United States, Britain and the continent of Europe. These parties were shown over the farm, its objects explained, and every opportunity given them to gain information as to the agricultural capabilities of this part of the province.

## CORRESPONDENCE.

During the ten months since my last report, 1,817 letters have been received and 2,332 letters despatched from this office; the correspondence includes inquiries regarding nearly every branch of agriculture and horticulture and often entails considerable labour and research.

I have the honour to remain, sir,

Your obedient servant,

S. A. BEDFORD,

*Superintendent.*

## Experimental Farms.

# EXPERIMENTAL FARM FOR THE NORTH-WEST TERRITORIES.

REPORT OF A. MACKAY, SUPERINTENDENT.

INDIAN HEAD, N. W. T., 31st October, 1893.

WM. SAUNDERS, Esq.,  
Director Dominion Experimental Farms,  
Ottawa.

SIR,—I have the honour to submit herewith my sixth annual report of work done on the North-west Experimental Farm during the year 1893.

Except roots and potatoes, crops of all kinds on the experimental farm were good the past season. A hot wind on the 6th of August made the weight of grain less than usual, but the yields in almost all cases were satisfactory.

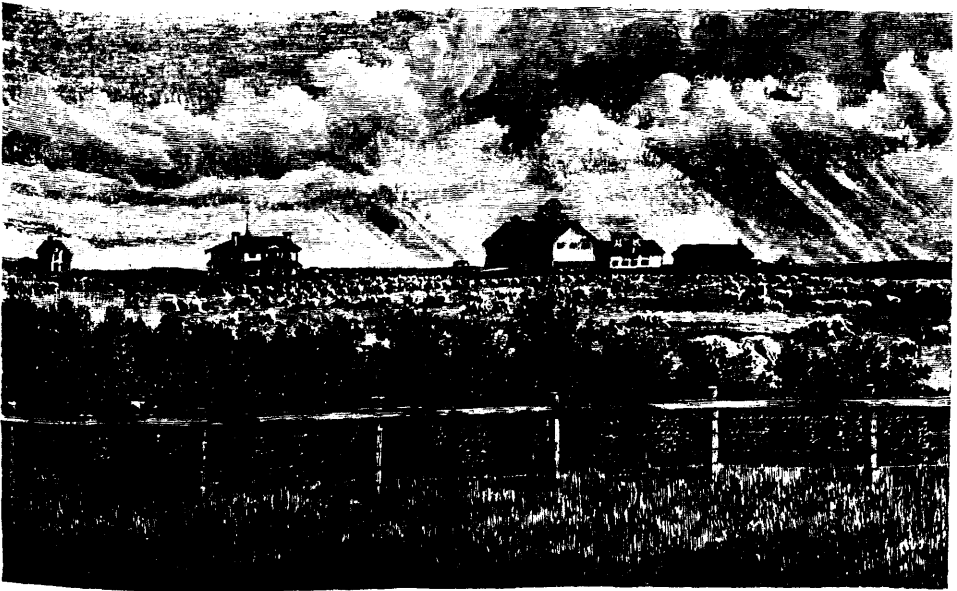

GENERAL VIEW, EXPERIMENTAL FARM, INDIAN HEAD, N. W. T., SHOWING PORTION OF FOREST SHELTER BELT. (FROM A PHOTOGRAPH).

The spring opened much later than usual, but no severe night frosts occurred afterwards and winds not being severe the grain came up evenly and made rapid advancement during the growing season.

Rain fell in abundance on the Experimental Farm and induced too much stooling on well worked land which, with warm weather caused a very rank growth of straw in several plots, but except in low places no lodging occurred.

In consequence of favourable weather, grain matured in less time than usual. The harvest commenced on August 8th when plots of oats and barley were cut and everything was in stook by the end of that month. During the whole harvest the weather continued so favourable that not over one-half day was lost in cutting and drawing in. Broken weather has taken place since harvest, but there has not been sufficient rain to do any good to the root crop, consequently the roots and potatoes on the farm were comparatively poor.

## WHEAT.

Forty-seven varieties of wheat were tested the past season. Of these, 20 were sorts tried before, 8 were new varieties obtained from commercial sources and 19 were cross-bred wheats produced at the Central Experimental Farm.

## FIELD PLOTS.

Thirty acres of clean fallowed land were sown with Red Fife for the purpose of obtaining a large quantity of clean and pure seed for distribution.

The soil of this field was unfortunately somewhat lighter than the average and the grain suffered from the extreme heat of 6th August and though sound and good for seed is not as plump as it would otherwise have been. The yield of straw and grain was large, but the sample will scarcely grade No. 1.

Six varieties, Wellman's Fife, Red Fern, White Fife, White Connell, Ladoga and Johnstone, had two acres each allowed them. These were sown on fallow but on different dates on account of wet places in the field. All suffered from the heat and in quality or quantity did not turn out as well as Red Fife although sown in the same field.

Following will be found the results in detail.

## TESTS OF WHEAT IN FIELD PLOTS.

Name of Variety.	Acres.	Sown.	Headed.	Ripe.	Matured in.	Height.	Condition.	Yield per acre.	Weight per bushel.
						Ft. in.		Bus. Lbs.	Lbs.
Red Fife . . . . .	24	Apr. 22.	July 20..	Aug. 23..	124 days.	4 7	Very heavy	35 00	61½
do 1½ bu. seed.	3	do 24.	do 20..	do 23..	122 do ..	4 7	do	35 50	62½
do 2 do . . . . .	3	do 24.	do 20..	do 23..	122 do ..	4 7	do	37 20	62
Johnston's . . . . .	2	May 1.	do 20..	do 23..	115 do ..	4 6	Medium . .	27 40	56½
Wellman's Fife. . . . .	2	do 1.	do 20..	do 22..	114 do ..	4 6	do . . . .	29 30	60
Red Fern . . . . .	2	do 1.	do 19..	do 28..	120 do ..	4 6	Straw soft.	23 40	57½
Ladoga . . . . .	2	do 1	do 17..	do 19..	111 do ..	4 7	Medium . .	25 10	58½
White Fife. . . . .	2	do 10.	do 24..	do 31..	114 do ..	4 6	do . . . .	32 16	61½
White Connell . . . . .	2	do 10.	do 24..	do 31..	114 do ..	4 6	do . . . .	30 00	61

## Experimental Farms.

### TEST OF SOWING WHEAT AT DIFFERENT DEPTHS.

Red Fife was used for this test and two inches proved to be the right depth for last season, as well as for 1892.

Name of Variety.	Depth Sown.	Sown on.	Headed.	Ripe.	Matured in.	Height.	Condition.	Yield per acre.	Weight per bush.
Red Fife.....	2 in.	May 4..	July 23..	Aug. 25..	114 days..	Ft. in. 4 8	Good.....	Bush. 41 20	Lbs. 62
do .....	2½ in.	do 4..	do 23..	do 26..	115 do..	4 8	do .....	37 10	61

### TEST OF SOWING PLOTS A WEEK APART.

Two varieties, Red Fife and Campbell's White Chaff were sown at the earliest possible date, 19th April, and seedings continued one week apart for 6 weeks, until 22nd May. The plots were one-tenth of an acre each.

In this test Campbell's White Chaff, which is a soft wheat, matured from one to two days ahead of Red Fife and all the plots came in in the order sown with seven days' difference in time of ripening between the first seeding of Red Fife and the last. The best yields were from second and third weeks' sowing. Following are dates of seeding, yield, &c.

### RESULTS OF SOWING WHEAT AT DIFFERENT DATES.

Name of Variety.	Sown.	Headed.	Ripe.	Matured in.	Height.	Condition.	Weight of Straw.	Yield per acre.		Weight per bush.
				Days.	Ft. in.		Lbs.	Bus. lbs.	Lbs.	
Red Fife.....	April 17..	July 19..	Aug. 23..	129	4 6	Stiff & good.	356	24	40	60½
do .....	do 24..	do 20..	do 25..	124	4 6	do ..	333	31	10	61½
do .....	May 1..	do 22..	do 26..	118	4 6	do ..	458	37	..	62½
do .....	do 8..	do 22..	do 26..	111	4 6	do ..	375	32	30	62
do .....	do 15..	do 23..	do 28..	106	4 6	do ..	330	30	..	61
do .....	do 22..	do 26..	do 30..	101	4 6	do ..	325	29	10	61½
Campbell's W. Chaff.	April 17..	do 18..	do 21..	127	4 10	Good.....	291	26	30	58
do ..	do 24..	do 19..	do 23..	122	4 10	do .....	369	31	40	58½
do ..	May 1..	do 21..	do 25..	117	4 10	do .....	319	30	10	61
do ..	do 8..	do 21..	do 26..	111	4 10	do .....	357	25	30	56½
do ..	do 15..	do 23..	do 27..	105	4 8	do .....	370	30	..	57
do ..	do 22..	do 25..	do 28..	99	4 8	do .....	341	29	50	57½

## TEST OF DIFFERENT VARIETIES SOWN SAME DATE, ONE-TENTH ACRE EACH.

To test the question of earliness as well as yield, 35 varieties of wheat were sown on the same day, on as uniform a piece of ground as possible. The land had been fallowed the year previous, receiving one ploughing and several surface cultivations. The soil being rather lighter than the average, all the varieties suffered a good deal from hot wind on August 6th. Twelve of the varieties were cross-bred wheats and like the older sorts were injured, which caused the grain to be small and shrunken.

In earliness, four of the cross-bred sorts, Beta, Albert, Abundance and Ottawa,—crosses between Red Fife and Ladoga—Gehun, an Indian variety, and Ladoga were first.

In yield Gehun, a wheat received several years ago from India gave the highest, closely followed by one of the cross-bred sorts and four of the older kinds. Gehun was also the best sample.

Following are the varieties tested, date sown, date of heading, &c., &c.

## TESTS OF VARIETIES OF WHEAT, ALL SOWN SAME DAY, ONE-TENTH ACRE EACH.

Name of Variety.	Sown.	Headed.	Ripe.	Matured in.		Weight of Straw.	Yield per Acre.	Weight per bush
				Days.	Ft. in.			
Red Fife	May 3.	July 21.	Aug. 25.	115	4 8	380	30 00	59 $\frac{1}{2}$
Wellman's Fife	do 3.	do 21.	do 27.	117	4 6	372	31 20	60
White Fife	do 3.	do 22.	do 27.	117	4 6	375	30 50	60
Campbell's W. Chaff	do 3.	do 22.	do 26.	116	5 0	390	28 20	60 $\frac{1}{2}$
White Connell	do 3.	do 22.	do 26.	116	4 6	348	35 20	59 $\frac{1}{2}$
Campbell's Triumph	do 3.	do 20.	do 24.	114	4 6	380	30 00	59 $\frac{1}{2}$
White Russian	do 3.	do 22.	do 22.	112	4 0	392	28 00	56 $\frac{1}{2}$
Hungarian Mountain	do 3.	do 22.	do 23.	113	4 0	399	26 50	57 $\frac{1}{2}$
Great Western	do 3.	do 20.	do 27.	117	4 6	359	35 30	61 $\frac{1}{2}$
Hueston's.	do 3.	do 22.	do 26.	116	4 6	346	35 41	61 $\frac{1}{2}$
Ladoga	do 3.	do 18.	do 18.	108	4 8	391	33 10	57
Red Fern.	do 3.	do 20.	do 23.	113	4 0	402	31 20	60
Pringle's Champlain	do 3.	do 19.	do 23.	113	4 3	394	32 40	59
Rio Grande	do 3.	do 23.	do 24.	114	4 0	426	27 20	57 $\frac{1}{2}$
Colorado	do 3.	do 18.	do 22.	112	4 8	396	32 20	60 $\frac{1}{2}$
Azima, Russian	do 3.	do 22.	do 26.	116	4 6	389	33 30	62
Black Sea	do 3.	do 20.	do 23.	113	4 6	404	31 00	57 $\frac{1}{2}$
Herison Bearded	do 3.	do 19.	do 27.	117	4 6	500	30 00	61
Prince No. 1, cross-bred	do 3.	do 19.	do 20.	110	4 6	406	27 20	56 $\frac{1}{2}$
do 2, do	do 3.	do 19.	do 20.	110	4 6	378	32 00	57 $\frac{1}{2}$
Advance do	do 3.	do 20.	do 21.	111	4 3	381	34 30	60 $\frac{1}{2}$
Carleton do	do 3.	do 21.	do 21.	111	5 0	436	27 20	56
Crown do	do 3.	do 21.	do 26.	116	5 0	392	34 40	60 $\frac{1}{2}$
Preston do	do 3.	do 19.	do 21.	111	4 6	410	30 40	58
Beta do	do 3.	do 19.	do 18.	108	4 8	448	25 20	56 $\frac{1}{2}$
Albert do	do 3.	do 20.	do 18.	108	4 8	467	22 10	56 $\frac{1}{2}$
Abundance, cross-bred	do 3.	do 19.	do 18.	108	4 0	465	22 30	56
Ottawa do	do 3.	do 18.	do 18.	108	4 6	397	33 50	57
Stanley do	do 3.	do 19.	do 21.	111	4 8	489	35 10	59 $\frac{1}{2}$
Alpha do	do 3.	do 20.	do 22.	112	4 0	404	32 40	60 $\frac{1}{2}$
Golden Drop	do 3.	do 20.	do 25.	115	4 0	403	27 00	60 $\frac{1}{2}$
Old Red River	do 3.	do 22.	do 26.	116	4 3	395	28 20	60 $\frac{1}{2}$
Red Fife (from Saskatoon)	do 3.	do 20.	do 27.	117	4 8	454	24 00	60 $\frac{1}{2}$
Gehun	do 3.	do 10.	do 18.	108	3 3	322	37 40	64 $\frac{1}{2}$
Australian	do 3.	do 20.	do 26.	116	4 8	336	35 40	59 $\frac{1}{2}$
Johnston's	do 3.	do 20.	do 26.	116	4 6	456	31 20	60

## Experimental Farms.

### TEST OF SOWING DIFFERENT QUANTITIES OF SEED PER ACRE.

In this test Red Fife was used and sown on 3rd May. The highest yield was obtained from  $1\frac{1}{4}$  bushels per acre closely followed by  $1\frac{1}{2}$  bushels seed. All the plots ripened together.

Name of Variety.	Seed per acre.	Sown.	Headed.	Ripe.	Matured in.	Height.	Yield per acre.	Weight per bush.
	Bush.				Days.	Ft. in.	Bus. lbs.	
Red Fife.....	1	May 3..	July 23..	Aug. 28..	118	4 6	38 50	62 $\frac{1}{2}$
do .....	1 $\frac{1}{4}$	do 3..	do 23..	do 27..	117	4 6	40 00	60 $\frac{1}{2}$
do .....	1 $\frac{1}{2}$	do 3..	do 23..	do 27..	117	4 6	39 40	62 $\frac{1}{2}$
do .....	1 $\frac{3}{4}$	do 3..	do 23..	do 27..	117	4 6	37 30	61 $\frac{1}{2}$

### TEST OF LAND TREATED WITH SUPERPHOSPHATE OF LIME AND FIELD LIME.

In this test three plots of  $\frac{1}{10}$ th acre each were sown with Red Fife at the rate of  $1\frac{1}{2}$  bushels per acre. On one plot 50 pounds of superphosphate of lime was sown; a second plot had 60 pounds of field lime (air slacked) sown on it, and the third plot was untreated.

The plot on which field lime was used gave at the rate of 4 bushels per acre more than either of the other two. The superphosphate of lime plot was one day earlier in ripening.

The details of the test are as follows:—

Name of Variety.	Treatment per acre.	Sown.	Headed.	Ripe.	Matured in.	Height.	Yield per acre.	Weight per bush.
					Days.	Ft. in.	Bus. lbs.	Lbs.
Red Fife....	50 lbs. Sup. ph. lime.....	May 4..	July 22..	Aug. 26..	115	4 6	36 ..	61
do .....	60 lbs. field lime.....	do 4..	do 21..	do 27..	116	4 6	40 50	62 $\frac{1}{2}$
do .....	Untreated.....	do 4..	do 21..	do 27..	116	4 6	36 20	60 $\frac{1}{2}$

### TEST OF BROADCAST, DRILL AND PRESS-DRILL SOWING.

Red Fife was used also in this test and the three plots were sown on the same date. The broad-cast plot was so much injured by winds that it was ploughed up and re-sown on 29th May.

Name of Variety.	How Sown.	Sown.	Headed.	Ripe.	Matured in.	Height.	Yield per acre.	Weight per bush.
					Days.	Ft. in.	Bus. lbs.	Lbs.
Red Fife....	*Broadcast .....	May 29..	Aug. 2..	Aug. 29..	93	4 6	25 40	60
do .....	Drill .....	do 4..	July 23..	do 28..	117	4 8	36 18	62 $\frac{1}{2}$
do .....	Press-drill.....	do 4..	do 21..	do 26..	115	5 ..	38 20	62 $\frac{1}{2}$

\*Re-sown May 29th.



**TEST OF STUBBLE FALL PLOUGHED, SPRING PLOUGHED, WITHOUT PLOUGHING AND FALLOWED LAND.**

In this test two acres of stubble land was ploughed in the fall of 1892, two acres of stubble ploughed with a gang plough at the time of seeding, two acres of stubble land sown by press drill without ploughing and not touched before or after using drill, and two acres of fallow were sown. The stubble in all cases had been fallowed in summer of 1891 and had produced a crop of Red Fife in 1892.

The fallow land gave much the better result, and the fall ploughing the result expected, and the result that has always been had in our experience, a much smaller crop no matter how well the work may be done. Spring-ploughing and the plot sown by the press-drill without ploughing, gave a fine crop of straw and a good yield of grain, but the sample was shrunken.

**TEST OF FALL AND SPRING PLOUGHING AND PRESS-DRILL ON STUBBLE COMPARED WITH SUMMER FALLOW.**

Name of Variety.	Mode of Cultivation.	Sown.	Headed.	Ripe.	Matured in.	Height.	Condition.	Yield per acre.	Weight per bush.
					Days.	Ft. in.		Bus. lbs.	Lbs.
Red Fife..	Fall ploughing; stubble..	May 2	July 15	Aug. 21	112	4 4	Light...	22 10	59
do ..	Spring do do ..	do 2	do 18	do 23	114	4 6	Medium	31 30	60
do ..	Press-drill; stubble.....	do 2	do 15	do 21	112	4 6	Medium	29 50	59½
do ..	Fallow.....	do 3	do 21	do 23	113	4 7	Good...	37 50	60

**SMUT TESTS.**

Two kinds of seed were used in these tests; one badly affected by smut and the other almost entirely free from it.

The same treatment was given in each case namely, one pound of bluestone in one and one half pails of water to 5, 7 and 10 bushels wheat; all mixed on the barnfloor and turned over several times. The heads were counted on six feet square in each plot.

**RESULTS OF SOWING SMUTTY WHEAT, TREATED AND UNTREATED.**

Name of Variety.	Treatment.	Sown.	Headed.	Ripe.	Good heads.	Smutty heads.	Yield per acre.	Weight per bush.
							Bus. lbs.	Lbs.
<i>Seed badly affected.</i>								
Red Fife.....	Untreated.....	May 4	July 23	Aug. 29	1,452	251	24 10	57½
do ..	1 lb. to 10 bush.....	do 4	do 23	do 27	1,648	8	34 20	59½
do ..	1 lb. to 7 bush.....	do 4	do 23	do 27	1,760	9	33 50	60½
do ..	1 lb. to 5 bush.....	do 4	do 23	do 27	1,590	6	31 20	61½
<i>Seed not badly affected.</i>								
Red Fife.....	Untreated.....	do 4	do 23	do 26	1,480	28	28 10	60½
do ..	1 lb. to 10 bush.....	do 4	do 23	do 26	1,536	3	28 20	60½
do ..	1 lb. to 7 bush.....	do 4	do 23	do 26	1,700	2	30 30	60
do ..	1 lb. to 5 bush.....	do 4	do 23	do 26	Record lost.		29 ..	60

## Experimental Farms.

### CROSS-BRED WHEATS.

The result of the tests of the cross-bred wheats during the past season, was not very satisfactory. All gave a large quantity of straw and there were fair yields of nearly all the sorts tried, but the grain was poor except in two cases and these were not equal to Red Fife. This was caused to a great extent, no doubt, by the hot winds of August 6th, as other varieties sown alongside the cross-bred sorts were, with few exceptions as badly hurt.

Stanley and Alpha, beardless sorts, give promise of being the most valuable of all thus far tested. These two gave 35·10 and 32·10 respectively per acre, of fairly good grain and were 4 and 5 days earlier than Red Fife sown alongside for comparison. The results of a test of 12 varieties of these cross-bred wheats sown on  $\frac{1}{10}$ th acre plots have been given and the yields of 9 varieties which were sown on acre plots will be found below. The small plots are of new sorts, tested here for the first time, and have occupied too small an area to admit of a satisfactory calculation as to yield per acre.

### TESTS OF CROSS-BRED WHEATS ON ONE ACRE PLOTS.

Name of Variety.	Cross between	Sown.	Headed.	Ripe.	Matured in.	Height.	Yield	Weight
					Days.		Ft.	per Acre.
							Bush.	Lbs.
Abundance.....	Ladoga and Red Fife.	May 2.	July 21.	Aug. 19.	110	4·7	24	56½
Carleton.....	do do	do 2.	do 19.	do 19.	110	4·7	37·15	58
Ottawa.....	do do	do 2.	do 19.	do 19.	110	4·7	20	56½
Stonewall.....	do do	do 2.	do 19.	do 18.	109	4·7	22·24	57½
Trial.....	do do	do 2.	do 19.	do 18.	109	4·7	27·15	60
Advance.....	Ladoga and White Fife	do 2.	do 19.	do 20.	111	4·7	28·9	59
Manifold.....	do do	do 2.	do 23.	do 20.	111	4·6	31·20	59½
Albert.....	Ladoga and Red Fife.	do 2.	do 18.	do 18.	109	4·7	25·27	57
A. No. 1.....	do do	do 2.	do 15.	do 15.	106	4·7	30·40	58½

### SMALL PLOTS.

New Hybrids.....	Red Fife and Club Bombay.	May 4.	July 21.	Aug. 22.	111	4·6	Plot small and no yield taken.
	Red Fife and Ladoga.	do 4.	do 22.	do 23.	112	4·6	
	Anglo-Canadian and Karachi.	do 4.	do 12.	do 24.	113	4·7	do
	Red Fife and Ladoga (Red Chaff.)	do 4.	do 21.	do 23.	112	4·7	do
	Spiti Valley and Red Fife (beardless.)	do 4.	do 10.	do 22.	111	4·7	do

### GENERAL RESULT OF WHEAT TESTS FOR 1893.

On account of there being no spring or fall frosts to injure any of the varieties of wheat tested, it may safely be said that Red Fife has given the best results in every respect.

The result of the wheat tests, on the whole, the past season, has not been altogether satisfactory. While the crop of straw in all the varieties was large, the hot winds in August injured the grain in all the late kinds considerably, and caused it to ripen prematurely, but early sorts, such as the Gehun, which were well advanced before the hot winds came suffered less. The result of the injury is not so much observed in the yield as in the weight and quality of the grain.

As to earliness, all the sorts matured in much less time than in 1892. Red Fife in 1892 took 139 days to mature; this year 115 days; Gehun, in 1892 took 121 days; this year 108 days.

#### BARLEY.

Twenty-five varieties of barley were tested the past season. Of these, 17 were old sorts and 8 new hybrids between six-rowed and two-rowed barley which have been produced at the Central Experimental Farm. Five varieties yielded over 50 bushels per acre, 8 over 40 bushels and the remainder over 30 bushels.

All kinds were very heavy in the straw but the grain was light in weight caused by the hot winds ripening it too quickly. Except two varieties and in a few others in low places no lodging took place. The straw, as will be seen, was from 3 to 4½ feet in length, and some kinds went over 400 pounds to the  $\frac{1}{10}$ th acre.

Except a few acres sown on stubble land, all the barley was put in on fallow and unless otherwise stated, 2 bushels of seed were sown per acre.

Sixteen varieties sown on the same day, under the same conditions, matured on an average in 95 days, while last year, 13 kinds under the same conditions, took an average of 120 days to ripen. The weather during the barley harvest was fine and all sorts were secured without being weather-stained.

#### FIELD LOTS.—PLOTS OF FOUR ACRES AND UPWARDS.

Five varieties were sown in fields, all of these were two-rowed, and one of them California Prolific was sown on three different dates.

All sorts were very heavy in the straw, but all, excepting Prize Prolific and Newton, stood up and were easily harvested. One field of California Prolific of 5 acres, yielded 57 bushels 44 pounds per acre, from the thresher. The grain of all the varieties is much lighter than usual.

#### RESULTS OF FIELD CROPS OF TWO-ROWED BARLEY.

Name of Variety.	Sown.	Headed.	Ripe.	Matured in.	Height.		Character of Straw.	Yield per Acre.		
					Days.	Ft. in.		Bush. lbs.	Lbs.	
California Prolific...	May 6	July 18	Aug. 12	98	4	6	Strong & fine.	45	..	49
do .....	do 8	do 17	do 11	95	4	6	Strong & fine.	57	44	49
do .....	do 9	do 20	do 14	97	4	0	Strong.	48	2	48
do fall pl'ing	do 11	do 17	do 12	93	3	9	Strong.	41	32	47
Newton.....	do 12	do 19	do 16	96	3	0	Weak.	39	17	46½
Kinver Chevalier....	do 9	do 20	do 18	101	3	0	Weak.	47	60	47
Prize Prolific.....	do 9	do 20	do 18	101	3	9	Weak.	40	..	47
Goldthorpe.....	do 11	do 21	do 17	98	3	6	Weak.	Not threshed		

#### RESULTS OF SOWING BARLEY AT DIFFERENT DATES ON ONE-TENTH ACRE PLOTS.

In this test Duckbill, a two-rowed variety, and Baxter's six-rowed were used. The first plots were sown on 24th April and the last on 29th May, with a week intervening between each set of plots.

The plots sown on 1st and 8th May gave the best returns. The three last plots in both sorts gave a smaller yield per acre and lower weights per bushel than the first three sown, caused probably by the hot wind on August 6th, catching these

## Experimental Farms.

plots while in the milk stage and hastening their ripening. All the plots were heavy in straw excepting those of the last seeding.

Name of Variety.	Sown.	Headed.	Ripe.	Matured in.	Height.		Weight of Straw.		Yield per Acre.		Weight per Bushel.
					Days.	Ft. in.	Lbs.	Bush. lbs.	Lbs.		
Duckbill.....	April 24	July 18	Aug. 12	111	4	0	222	35		48½	
do .....	May 1	do 19	do 12	104	4	0	248	43	6	50	
do .....	do 8	do 21	do 14	99	4	0	273	42	4	50	
do .....	do 15	do 21	do 15	93	4	0	263	37	44	49	
do .....	do 22	do 22	do 17	88	4	0	193	32	34	46	
do .....	do 29	do 26	do 19	83	3	10	144	26	12	44	
Baxter's 6-rowed.....	April 24	do 10	do 8	107	3	6	233	36	42	51	
do .....	May 1	do 12	do 8	100	3	6	406	42	24	50½	
do .....	do 8	do 13	do 9	94	3	6	368	40		50	
do .....	do 15	do 15	do 12	90	3	6	280	30	10	50½	
do .....	do 22	do 18	do 14	85	3	6	276	30		46½	
do .....	do 29	do 20	do 16	80	3	2	249	31	22	49	

### TEST OF VARIETIES ALL SOWN SAME DATE, ONE-TENTH ACRE PLOTS.

Sixteen varieties were sown in this test. The soil was sandy loam uniform in character and had been fallowed the preceding year. Two bushels of seed per acre was sown by drill. In earliness the six-rowed matured in from 6 to 11 days less time than the two-rowed. All sorts produced a good crop of straw, some very heavy and all stood up well.

Name of Variety.	Sown.	Headed.	Ripe.	Ma- tured in.	Height.		Weight of Straw.	Char- acter of Straw.	Yield per Acre.	Weight per Bushel.	
					Days.	Ft. in.				Lbs.	
Six-rowed sorts—											
Baxter's.....	May 10	July 12	Aug. 8	90	3	6	333	Fair	36	42	50
Common.....	do 10	do 9	do 8	90	4	0	169	Weak	36	42	51½
Rennie's Improved.....	do 10	do 12	do 12	94	4	0	298	Fair	49	18	50
Odessa.....	do 10	do 10	do 12	94	3	6	171	do	49	38	49½
Petschora.....	do 10	do 10	do 8	90	4	6	246	do	37	14	46
Guymalaye.....	do 10	do 17	do 14	96	3	6	263	do	41	2	59
Oderbruch.....	do 10	do 9	do 8	90	3	6	268	do	42	4	52½
Mensury.....	do 10	do 11	do 8	90	4	0	307	do	38	16	46
Two-rowed sorts—											
Prize Prolific.....	do 10	do 19	do 19	101	3	6	338	Weak	44	2	48
Danish Chevalier.....	do 10	do 21	do 19	101	3	6	353	Strong.	54	28	51½
Goldthorpe.....	do 10	do 17	do 18	100	3	6	258	Weak	48	46	49
Canadian Thorpe.....	do 10	do 17	do 14	96	4	3	155	Strong.	43	36	49
Improved Chevalier.....	do 10	do 17	do 18	100	3	6	438	do	42	4	51
Duckbill.....	do 10	do 17	do 16	98	4	3	233	do	50	20	50
Thanet.....	do 10	do 18	do 19	101	4	0	368	Weak	51	22	49
Kinver Chevalier.....	do 10	do 18	do 18	100	4	0	358	do	54	38	48

### TEST OF BROADCAST, PRESS DRILL AND ORDINARY DRILL.

In this test California Prolific was used. The soil, was a heavy clay loam which was fallowed the preceding year, and the seed was sown at the rate of two bushels per acre.

That put in by the Press-drill gave seven bushels more than that sown by the common drill, and 9 bushels and 28 pounds more than the plot sown

with the broadcast seeder. The straw was longer where the press-drill was used and the grain ripened 3 days in advance of either of the other two.

Name of Variety.	Sown.	Headed.	Ripe.	Ma- tured in.	Height.	Weight of Straw.	Yield per Acre.	Weight per Bushel
				Days.	Ft. in.	Lbs.	Bush. lbs.	Lbs.
California Prolific, press-drill.	May 8	July 20	Aug. 19	104	4 8	226	55 ..	49
do common drill.	do 8	do 20	do 18	101	4 6	163	48 ..	48
do broadcast seeder.	do 8	do 23	do 19	104	4 6	182	45 20	47½

#### TEST OF STUBBLE VS. FALLOW.

In this test four acres of stubble were ploughed in the fall of 1892 and four acres fallowed during the same year. Two bushels per acre of California Prolific Barley were sown by drill. The stubble land used was in rather a low place and was situated alongside of a railway embankment, both of which helped the grain when the hot winds came. The embankment especially breaking the force of the hot blasts as they passed over.

Name of Variety.	Land.	Sown.	Headed.	Ripe.	Ma- tured in.	Height.	Yield per Acre.	Weight per Bushel.
					Days.	Ft. in.	Bush. lbs.	Lbs.
California Prolific	Fallow .....	May 9.	July 20.	Aug. 14.	98	4 2	48 10	48
do	Fall ploughing of stubble .....	do 9.	do 17.	do 12.	96	4 1	41 32	47

#### TEST OF SOWING DIFFERENT QUANTITIES OF SEED PER ACRE—ONE-TENTH ACRE PLOTS

In these experiments California Prolific was again used. The soil was a heavy clay loam, which had been fallowed and was in good order. Two bushels per acre gave the best return, and the crop matured in two days less time than either 1¼ or 1½ bushels.

Name of Variety.	Quan- tity of Seed per Acre.	Sown.	Headed.	Ripe.	Ma- tured in.	Height.	Weight of Grain and Straw.	Yield per Acre.	Weight per Bnshel.
	Bush.				Days.	Ft. in.	Lbs.	Bush. lbs.	Lbs.
California Prolific.....	2	May 8	July 20.	Aug. 14.	99	4 3	308	48 14	48½
do .....	1½	do 8	do 20.	do 16.	101	4 3	316	44 28	49
do .....	1¼	do 8	do 20.	do 16.	101	4 4	229	43 44	47

## Experimental Farms.

### NEW HYBRID BARLEYS.

Two named and six unnamed hybrids were tested in the small plots. All are crosses between Swedish two-rowed female and Baxter's six-rowed male, recently produced at the Central Experimental Farm, but are of different types.

Name of Variety.	Cross between	Sown.	Headed.	Ripe.	Ma- tured.	Yield		Weight per Bushel.
						per Acre.		
					Days.	Bush. lbs.	Lbs.	
Surprise.....	Swedish and Baxter's 6-rd.	May 15.	July 15.	Aug. 14.	91	39	..	48
Summit.....	do	do 15.	do 17.	do 15.	92.	40	32	46
Type D.....	do	do 12.	do 10.	do 11.	91	Not thr		48½
do P.....	do	do 12.	do 12.	do 14.	94			
Type A.....	do	do 12.	do 9.	do 11.	91			47½
do 11.....	do	do 12.	do 10.	do 14.	94			48
do S.....	do	do 12.	do 12.	do 14.	94			49½
do C.....	do	do 12.	do 11.	do 11.	91			47

### OATS.

Forty varieties of oats were tested the past season; all being sown on fallowed land. All the varieties were very heavy in straw and gave good returns with the exception of one 5-acre block which was sown on fall ploughing, and although it gave a fair crop of straw the grain was of poor quality.

The best return was obtained from  $\frac{1}{10}$ th acre plot of American Banner, sown by press drill on 12th May, which gave 100 bushels per acre. A field of Prize Cluster, 15 acres in extent, produced 77.10 per acre and Welcome on a 5-acre plot alongside the Cluster yielded 78.18 per acre. The grain in both these cases was very good.

### FIELD PLOTS.

Field plots of 15 acres down to 2 acres were sown on different dates. All were very heavy in straw but some of the plots lodged more or less and the grain in these was light.

The heaviest crop was that of the Welcome, mentioned above which gave 78 bushels 18 lbs. per acre. The soil, which was a sandy loam was fallowed, and the land gang-ploughed twice in 1892. Two and one-half bushels of seed was sown per acre and put in by drill.

### TESTS OF FIELD PLOTS OF OATS.

Name of Variety.	Acres.	Sown.	Headed.	Ripe.	Matured in.	Height.	Yield per Acre.		Weight per Bush.
							Bush.	Lbs.	
					Days.	Ft. in.	Bush.	Lbs.	
Welcome.....	5	May 10.	July 18.	Aug. 15.	98	4 3	78	18	43
Banner.....	5	do 6.	do 20.	do 17.	104	4 6	67	00	36
Bonanza.....	2	do 6.	do 15.	do 12.	99	4 2	60	00	40
Cluster.....	15	do 8.	do 15.	do 11.	96	4 4	77	10	40
Blk. Champion.....	2	do 12.	do 19.	do 16.	97	4 0	36	14	36
White Russian.....	2	do 12.	do 18.	do 14.	95	4 2	48	10	39
Improved Ligowo.....	2	do 12.	do 16.	do 14.	95	4 0	49	10	40½
English White.....	2	do 12.	do 19.	do 16.	97	4 0	46	00	39
Winter Grey.....	2	do 12.	do 17.	do 16.	97	4 4	50	31	40

RESULTS OF SOWING OATS AT DIFFERENT DATES, ONE-TENTH ACRE PLOTS.

Two varieties, Prize Cluster and American Banner, were chosen for this test and sown on fallowed land on April 24, and on the same day each week for six weeks ending May 29th. The quantity of seed used was 2½ bushels per acre which was sown by drill.

The first three dates of seeding gave the best results. The Cluster matured on an average 10 days earlier than the Banner but the latter produced the best crop. The following are the dates of seeding, yield, etc. :—

Name of Variety.	Sown.	Headed.	Ripe.	Matured in.	Height.	Yield per Acre.	Weight per Bush.
				Days.			
Cluster.....	April 24.	July 13.	Aug. 7.	106	4 4	72 2	40½
do .....	May 1.	do 15.	do 8.	100	4 4	66 6	42
do .....	do 8.	do 16.	do 8.	93	4 4	60 30	41½
do .....	do 15.	do 21.	do 14.	92	4 5	56 10	41
do .....	do 22.	do 23.	do 19.	90	4 5	58 20	41½
do .....	do 29.	do 26.	do 22.	86	4 3	46 6	40
Banner.....	April 24.	do 17.	do 17.	116	4 6	88 28	34½
do .....	May 1.	do 18.	do 19.	111	4 6	76 20	33
do .....	do 8.	do 19.	do 21.	106	4 6	86 6	34
do .....	do 15.	do 21.	do 22.	100	4 6	87 12	34
do .....	do 22.	do 23.	do 24.	95	4 5	63 00	32½
do .....	do 29.	do 28.	do 31.	95	4 5	61 26	33½

TEST OF SOWING DIFFERENT VARIETIES ON SAME DATE, ONE-TENTH ACRE PLOTS.

Forty varieties were selected for this test. All were sown on the same day by drill at the rate of 2½ bushels per acre. The land was a uniform sandy loam which had been fallowed. The Welcome and Winter Gray were the first to ripen. These varieties matured in 92 days; while last year they took 127 and 134 days respectively to do so. Six kinds gave over 400 pounds of straw on the tenth acre plot, and one variety produced 520 pounds. The weight of the grain is lower this year than for the last two years, caused, no doubt, by the hot winds.

Name of Variety.	Sown.	Headed.	Ripe.	Matured in.	Height.	Weight of Straw.	Character of Straw.	Yield per Acre.	Weight per Bush.
				Days.		Ft. In.		Lbs.	Bush.
Cluster.....	May 9.	July 13.	Aug. 10.	94	4 6	423	Heavy.....	64 00	41
Welcome.....	do 9.	do 12.	do 8.	92	4 6	383	do .....	78 18	42
Winter Gray.....	do 9.	do 13.	do 8.	92	4 6	520	do .....	82 12	40½
Bonanza.....	do 9.	do 10.	do 7.	91	4 6	355	do .....	66 16	41½
Improved Ligowo.....	do 9.	do 10.	do 16.	100	4 3	300	Stiff.....	79 14	40½
American Beauty.....	do 9.	do 16.	do 17.	101	3 6	285	do .....	77 32	31
White Russian.....	do 9.	do 17.	do 15.	99	4 0	336	do .....	60 00	36
Abundance.....	do 9.	do 17.	do 16.	100	4 0	320	do .....	70 20	31½
Gotland.....	do 9.	do 19.	do 16.	100	4 6	422	do .....	76 00	39
English White.....	do 9.	do 19.	do 19.	103	4 6	349	do .....	70 30	33½
Royal Doncaster.....	do 9.	do 23.	do 20.	104	4 0	350	Straw very heavy.....	58 28	41
Giant Cluster.....	do 9.	do 23.	do 27.	111	4 0	345	Stiff.....	65 20	32½
Archangel.....	do 9.	do 13.	do 14.	98	5 0	365	do .....	70 20	32½
Cream Egyptian.....	do 9.	do 15.	do 10.	94	4 6	477	do .....	74 14	40
White Wonder.....	do 9.	do 15.	do 10.	94	4 6	390	do .....	55 20	40½
Columbus.....	do 9.	do 17.	do 18.	102	4 0	220	do .....	58 28	31

## Experimental Farms.

### TEST OF SOWING DIFFERENT VARIETIES OF OATS—*Con.*

Name of Variety.	Sown.	Headed.	Ripe.	Matured	Height.	Weight	Character	Yield	Weight
				in.		of			
				Days.	Ft. in.	Lbs.		Bush.	Lbs.
Challenge	May 9.	July 13.	Aug. 14.	98	4 6	226	Stiff	60 15	42
American Triumph	do 9.	do 19.	do 18.	102	4 6	340	do	58 28	31½
Siberian	do 9.	do 19.	do 24.	108	4 3	378	do	59 14	37
Abyssinia	do 9.	do 19.	do 19.	103	4 3	370	do	67 22	30
Scottish Chief	do 9.	do 16.	do 14.	98	4 3	383	do	64 24	44
Poland White	do 9.	do 17.	do 14.	98	4 0	299	do	65 02	40½
Rennie's Prize White	do 9.	do 16.	do 14.	98	4 0	149	do	73 28	42
Victoria Prize White	do 9.	do 19.	do 14.	98	4 8	259	do	66 16	41
Golden Beauty	do 9.	do 19.	do 19.	103	4 8	384	do	78 08	36
Oderbruch	do 9.	do 19.	do 20.	104	4 6	373	Weak	72 22	39
Holstein Prolific	do 9.	do 18.	do 19.	103	4 6	370	Stiff	82 12	37
Wide Awake	do 9.	do 19.	do 20.	104	5 0	361	do	76 06	38
Cave	do 9.	do 19.	do 20.	104	4 6	368	do	77 02	38
Flying Scotchman	do 9.	do 16.	do 14.	98	4 3	352	Fair	64 04	37
Early Blossom	do 9.	do 19.	do 27.	111	4 0	343	do	60 30	37½
Rosedale	do 9.	do 19.	do 18.	102	4 6	455	do	70 20	31½
Banner	do 9.	do 17.	do 15.	99	4 3	405	do	66 06	31
Imported Irish	do 9.	do 17.	do 14.	98	4 8	318	do	54 04	42
Hazlett's Seizure	do 9.	do 17.	do 14.	98	4 6	336	do	60 00.	41
Black Tartarian	do 9.	do 23.	do 27.	111	4 3	357	Heavy	56 26	37½
California Prolific Black	do 9.	do 19.	do 27.	111	3 6	367	Weak	56 26	37
Black Couloumiers	do 9.	do 19.	do 27.	111	3 8	499	do	50 10	38½
Early Etampes	do 9.	do 16.	do 20.	104	3 6	384	do	57 22	36
Joanette	do 9.	do 16.	do 20.	104	3 6	413	do	52 02	31½

### TEST OF FALL PLOUGHING, SPRING PLOUGHING, WITHOUT PLOUGHING, AND FALLOW.

This test was made to find out the yield from these four methods of growing oats. The stubble land used had a crop of Red Fife in 1892 and was fallowed in 1891. Five acres were sown in each test.

The fall ploughing was done in October 1892. The stubble was turned under 6 inches deep and one stroke of the harrow was given in the spring. It was sown by drill without harrowing after and 2½ bushels of seed used per acre.

The spring ploughing was done by gang plough, 3 inches deep at time of seeding. The seed was first sown, then ploughed in and harrowed.

In the third way, the grain was sown by drill without either ploughing or harrowing.

The fallowed land was gang-ploughed twice and harrowed twice the preceding year and was sown by drill without harrowing.

Following will be found the results of tests in detail:—

Name of Variety.	Mode of Cultivation.	Sown.	Headed.	Ripe.	Matured	Height.	Yield	Weight
					in.			
					Days.	Ft. in.	Bush.	Lbs.
Welcome	Fall ploughing	May 13	July 18	Aug. 7	87	4 0	36	38½
do	Spring ploughing	do 13	do 15	do 7	87	4 2	66	40
do	Drill, without ploughing	do 13	do 15	do 8	88	4 2	62	40½
do	Fallow	do 10	do 18	do 15	97	4 6	73	43



## TEST OF SEEDING, BROADCAST, DRILL AND PRESS-DRILL, ONE-TENTH ACRE PLOTS.

In this experiment the Banner oat was used. Two and one-half bushels per acre being sown in each case. The soil was a heavy clay loam.

The plot sown with press-drill ripened in 7 days less than that sown with the broadcast seeder and 1 day earlier than that sown with the common drill. The press-drill gave 25 bushels per acre more than the broadcast seeding and 15 bushels more than the common drill.

Name of Variety.	Mode of seeding.	Sown.	Headed.	Ripe.	Matured in.	Height.	Yield per Acre.	Weight per Bushel.
					Days.	Ft. in.	Bus. lbs.	Lbs.
Banner.....	Broadcast.....	May 12	July 23	Aug. 25	106	4 3	75 20	37
do .....	Drill.....	do 12	do 19	do 19	100	4 3	85 30	37½
do .....	Press-drill.....	do 12	do 18	do 18	99	4 6	100 ..	38

## TEST OF SOWING AT DIFFERENT DEPTHS.

The Banner was used in this test also, the condition and character of soil being the same as in the previous test.

Name of variety.	Depth of Seeding.	Sown.	Headed.	Ripe.	Matured in.	Height.	Yield per Acre.	Weight per Bushel.
					Days.	Ft. in.	Bush.	Lbs.
Banner.....	3 in. deep.....	May 12	July 21	Aug. 23	103	4 3	87 20	38
do .....	2 in. do .....	do 12	do 20	do 23	103	4 3	81 26	36

## TEST OF SOWING DIFFERENT QUANTITIES OF SEED PER ACRE.

In this test the conditions were the same except the quantity of seed sown. Two bushels per acre gave the best return.

Name of Variety.	Quantity of Seed per Acre.	Sown.	Headed.	Ripe.	Matured in.	Height.	Yield per Acre.	Weight per Bushel.
					Days.	Ft. in.	Bush.	Lbs.
Banner.....	2 bush. per acre.....	May 8	July 18	Aug. 17	102	4 3	97 32	37
do .....	2½ do .....	do 8	do 18	do 18	103	4 4	89 14	36½
do .....	2¾ do .....	do 8	do 18	do 18	103	4 3	80 00	36½

## TEST OF GROWING OATS WITH AND WITHOUT FERTILIZERS.

Three 1/10th acre plots were sown with Banner Oats. On one plot 50 lbs. superphosphate of lime was sown; on the second, 60 lbs. field lime; and the third was untreated.

## Experimental Farms.

The plot with super-phosphate of lime gave 20 bushels per acre more than either of the other two, and ripened one day earlier. In this test in 1892, the super-phosphate of lime gave much the better result, but the untreated plot that season was badly injured by winds.

Name of Variety.	Treatment.	Sown.	Headed.	Ripe.	Matured in.	Height.	Yield per acre.	Weight per bushel.
					Days.	Ft. in.	Bush.	Lbs.
Banner .....	50 lbs. Super-phosph. lime.	May 10	July 20	Aug. 21	104	4 4	85.20	36
do .....	60 " Field lime.....	do 10	do 21	do 23	106	4 4	65.20	35½
do .....	Untreated .....	do 10	do 21	do 22	105	4 4	65.20	37½

### PEASE.

Twelve varieties were sown in  $\frac{1}{10}$  acre plots and 7 of these in acre plots.

The crop of straw from all the sorts was heavy but the hot winds injured them so much that the yield was very small. Unfortunately a heavy wind storm took place immediately after the pease were pulled, which mixed the varieties so much that out of 19 plots, returns for only 6 kinds can be given, and they are not accurate for the reason that all the plots were badly threshed out by winds.

Two of the sorts that were badly mixed, Centennial and Potter, were the best of all varieties sown. The Pride also was of good quality.

### ONE ACRE PLOTS OF PEASE.

Name of Variety.	Sown.	Blossomed	Ripe.	Matured in.	Yield per acre.	Weight per bushel.	Remarks.
				Days.	Bushels.	Lbs.	
Pride .....	May 5.	July 10.	Aug. 15	103	20.00	61	
White Marrowfat .....	do 5.	do 14.	do 23	111	14.10	63	
Black Eyed Marrowfat .....	do 5.	do 17.	do 23	111	11.40	61	
Mummy .....	do 5.	do 15.	do 16	104	16.40	62	
Prince Albert .....	do 5.	do 16.	do 22	110	.....	.....	Mixed by winds.
Crown .....	do 5.	do 16.	do 16	104	.....	.....	do do
Multiplier .....	do 5.	do 18.	do 17	105	9.01	62½	

### ONE-TENTH ACRE PLOTS OF PEASE.

Name of Variety.	Sown.	Blossomed	Ripe.	Matured in.	Yield per Acre.	Condition.
				Days.	Bush. lbs.	
Mummy .....	May 10.	July 14.	Aug. 16.	99	.....	Mixed by winds.
Black Eyed Marrowfat .....	do 10.	do 16.	do 23.	106	.....	do do
Pride .....	do 10.	do 10.	do 14.	97	.....	Very fine, mix. by w.
White Marrowfat .....	do 10.	do 18.	do 23.	106	.....	Mixed by winds.
Multiplier .....	do 10.	do 18.	do 21.	104	.....	do do
Prince Albert .....	do 10.	do 19.	do 21.	104	.....	do do
Crown .....	do 10.	do 17.	do 16.	99	17.40	Small.
Potter .....	do 10.	do 16.	do 19.	102	.....	Very fine, mix. by w.
Canadian Beauty .....	do 10.	do 18.	do 22.	105	.....	Mixed by winds.
Centennial .....	do 10.	do 16.	do 17.	100	.....	Extra fine, mix. by w.
Golden Vine .....	do 10.	do 17.	do 22.	105	.....	Mixed by winds.
Prussian Blue .....	do 10.	do 19.	do 23.	106	.....	do do

FODDER-MIXTURES AND FODDER PLANTS.

As in previous years a good deal of ground was given to fodder mixtures. These were sown on stubble land and on fallow and on account of the very favourable season a heavy rank crop resulted. A portion of the crop was made into hay, a part cut green and put in silo and the remainder cut on the green side and bound into sheaves to be cut with straw-cutter and fed to horses and stock.

In previous years the bulk of these mixtures was made into hay. Last year a test was made of allowing the mixture to partially mature, then cut with a binder and after curing in stook the mixture was cut during the winter with straw-cutter and fed to stock. This method having proved very satisfactory, the bulk of the mixtures this year after filling the silo was cured in this way.

Spring rye alone made the best hay. Oats and barley made the best fodder mixture, and pease, wheat and oats gave the heaviest crop.

The following tables give the results of the tests :

FIELD PLOTS.

Names of Grain.	Sown.	Headed.	Ripe.	Weight per Acre of Cured Hay.	Cut for Silo.	Weight per Acre of Ensilage.
				Tons. lbs.		Tons. lbs.
1 Oats and Barley . . . . .	May 4.	July 18.	Aug. 14.	3 1,560	Aug. 1.	6 1,200
2 do Barley and Spring Rye. . . . .	do 4.	do 15.	do 15.	3 100	do 1.	5 1,800
3 do on Spring Rye land . . . . .	do 5.	do 20.	do 16.	2 1,100	do 1.	4 1,000
4 Spring Rye on Fallow . . . . .	April 29.	June 26.	do 1.	2 1,400	do 1.	5 100

ONE-TENTH ACRE PLOTS.

Names of Grain.	Sown.	Headed.	Cut for Hay.	Weight per Acre of Cured Hay.
				Tons. lbs.
5 { Golden Vine Pea, 6 lbs . . . . . Prize Prolific Barley, 5 lbs . . . . . Banner Oats, 3½ lbs . . . . .	May 12.	July 18.	Aug. 4.	3 500
6 { Golden Vine Pea, 6 lbs . . . . . Red Fife Wheat, 5 lbs . . . . . Banner Oats, 3½ lbs . . . . .				4
7 { Extra Early Peas, 7 lbs . . . . . White Tares, 6 lbs . . . . .				2 1,000
8 { Duckbill Barley, 6 lbs . . . . . Spring Rye, 5 lbs . . . . .	do 12.	July 1.	do 4.	3 200
9 Oats and Spring Rye . . . . .				do 1.

In addition to grain mixtures corn, horse beans and sunflowers were also sown for fodder.

The corn although promising at first gave very poor returns when cut. Nine varieties were planted. All were further advanced than in any previous year, but none produced corn fully developed.

The nine sorts were planted in hills 3 feet apart each way and the same sown by grain drill in rows 3 feet apart on fallowed land which was ploughed and harrowed before the seed was put in. All were put in the same day and the results show but little difference between the returns from the hill and drill planting.

One variety, North Dakota, was sown on potato land that had been well manured before potatoes were planted in 1893. This gave 8 tons 280 pounds per acre.

# Experimental Farms.

## RESULTS OF TESTS OF VARIETIES OF CORN.

Name of Variety.	Planted or Sown.		Tasselled.		Cut.		Weight per Acre.	
							Tons.	lbs.
Planted in Hills, 3 ft. each way—								
North Dakota.....	May	26.	Aug.	10.	Aug.	28.	4	1,900
Pearce's Prolific.....	do	26.	do	10.	do	28.	4	1,020
Mastodon Dent.....	do	26.	do	18.	do	28.	5	1,000
Rural Thoro'bred White Flint.....	do	26.	do	16.	do	28.	4	1,350
Angel of Midnight.....	do	26.	do	10.	do	28.	5	780
Compton's Early.....	do	26.	do	2.	do	28.	5	1,000
Golden Dew Drop.....	do	26.	do	6.	do	28.	5	450
Mitchell's Extra Early.....	do	26.	do	8.	do	28.	4	1,680
Smut-nose Flint.....	do	26.	do	8.	do	28.	4	1,900
Sown by Drill in rows, 3 ft. apart—								
North Dakota.....	do	26.	do	10.	do	28.	5	340
Pearce's Prolific.....	do	26.	do	10.	do	28.	4	1,900
Mastodon Dent.....	do	26.	do	18.	do	28.	4	1,580
Rural Thoro'bred White Flint.....	do	26.	do	16.	do	28.	4	1,900
Angel of Midnight.....	do	26.	do	10.	do	28.	5	1,110
Compton's Early.....	do	26.	do	2.	do	28.	5	1,000
Golden Dew Drop.....	do	26.	do	6.	do	28.	5	1,200
Mitchell's Extra Early.....	do	26.	do	8.	do	28.	4	1,080
Smut-nose Flint.....	do	26.	do	8.	do	28.	5	1,770
Planted on Potato Ground of 1892—								
North Dakota.....	do	26.	do	10.	do	28.	8	280

The horse-beans fully matured and were a fair crop. They were cut up along with the corn and put in the silo.

Between two and three acres of sunflowers were sown for the purpose of putting the heads along with the corn and beans in the silo. On account of taking longer to develop their seed, they were not far enough advanced when the corn and beans were ready and the frost killed them when only a small percentage of the heads were filled. The seed was probably put in too late, it will be sown earlier next year.

### GRASSES.

In the spring of 1892, sixteen varieties of grass were sown in plots, and mixtures of these with native grasses were sown in the field with barley.

Most of the field plots were blown out and the balance killed by dry weather after the seed came up. Out of the sixteen sorts sown only two produced a crop the past season. They were *Bromus Inermis* and *Muhlenbergia Sylvatica*. The former gave a yield of 3 tons 1,200 pounds per acre, and the latter  $\frac{3}{4}$  of a ton per acre.

As *Bromus Inermis* had stood two winters and each year given a good crop, and believing that it will be a very valuable hay for the North-west, a quantity of seed was procured and fifteen acres sown with it last spring, to which large additions will be made in the spring of 1894.

This grass has the advantage of starting to grow almost as soon as the snow is gone, and before a green blade is seen on the prairie or in any of the cultivated sorts, the *Bromus Inermis* is six inches high. In addition to this good feature, it appears to stand the winters and spring frosts to perfection; at least it has done so for the last two years, and although this may not be long enough to establish a claim to absolute hardiness for years to come, it may safely be recommended as the best and surest grass so far tested on the experimental farm. Good points also in its favour are the ease with which a good catch can be obtained, and its ability to endure our dry warm months.

## SPRING RYE.

Five acres of spring rye were sown for seed on April 29th. It came into head on June 26th, and ripened August 8th. Two acres were cut for hay on August 1st and the remaining three acres yielded  $16\frac{1}{2}$  bushels per acre.

## FLAX.

Two plots of flax were sown on May 30th, which ripened on August 31st. The straw was short and the yield of both seed and straw small.

## ROOTS.

The past season has been one of the worst since the farm was started, for field roots. All varieties tested made a good beginning, but on account of injury from a heavy wind soon after the young plants were thinned and a prolonged drought after the middle of July, the returns were small. All roots were sown on fallow land, which was ploughed and harrowed before sowing.

## TURNIPS.

Twelve varieties were tested. The first seeding was done on 25th May, and the 12 sorts were again sown on 6th June. As will be seen, the first seeding gave the best returns.

Name of Variety.	Sown.	Pulled.	Yield per Acre.	
			Rush. lbs.	
<i>First Seeding.</i>				
Carter's Elephant .....	May 25..	Oct. 9..	623	20
Prize Winner .....	do 25..	do 9..	660	..
Rennie's Purple Top .....	do 25..	do 9..	407	..
Marquis of Lorne .....	do 25..	do 9..	322	30
Jumbo .....	do 25..	do 9..	476	40
Skirving's Purple Top .....	do 25..	do 9..	236	30
Monarch .....	do 25..	do 9..	472	40
Sutton's Champion .....	do 25..	do 9..	396	..
Mammoth Purple Top .....	do 25..	do 9..	375	50
Bangholm do .....	do 25..	do 9..	403	20
Selected Purple Top .....	do 25..	do 9..	491	20
East Lothian .....	do 25..	do 9..	386	50
<i>Second Seeding.</i>				
Carter's Elephant .....	June 6..	Oct. 9..	172	30
Prize Winner .....	do 6..	do 9..	318	20
Rennie's Purple Top .....	do 6..	do 9..	227	20
Marquis of Lorne .....	do 6..	do 9..	243	50
Jumbo .....	do 6..	do 9..	330	..
Skirving's Purple Top .....	do 6..	do 9..	304	20
Monarch .....	do 6..	do 9..	282	20
Sutton's Champion .....	do 6..	do 9..	280	30
Mammoth Purple Top .....	do 6..	do 9..	221	50
Bangholm .....	do 6..	do 9..	320	50
Selected Purple Top .....	do 6..	do 9..	335	30
East Lothian .....	do 6..	do 9..	289	40

## Experimental Farms.

### MANGELS.

Ten sorts of mangels were tested. Like the turnips they were sown on different dates, May 25 and June 6. The early seeding proved to be the best. Heavy frost in the latter part of September and early in October almost spoiled the crop.

Name of Variety.	Sown.	Pulled.	Yield per Acre.	
<i>First Seeding.</i>			Bush. lbs.	
Erfurt Model .....	May 25	Oct. 9	201	40
Gate Post .....	do 25	do 9	271	20
Canadian Giant .....	do 25	do 9	265	50
Orange Giant .....	do 25	do 9	193	30
Yellow Globe .....	do 25	do 9	282	10
Golden Tankard .....	do 25	do 9	165	..
Giant Yellow (intermediate) .....	do 25	do 9	256	40
Red-fleshed Tankard .....	do 25	do 9	348	20
Red Globe .....	do 25	do 9	238	20
Mammoth Globe .....	do 25	do 9	267	40
<i>Second Seeding.</i>				
Erfurt Model .....	June 6	Oct. 9	165	..
Gate Post .....	do 6	do 9	183	20
Canadian Giant .....	do 6	do 9	183	..
Orange Giant .....	do 6	do 9	146	40
Yellow Globe .....	do 6	do 9	192	30
Golden Tankard .....	do 6	do 9	135	40
Giant Yellow (intermediate) .....	do 6	do 9	172	20
Red Fleshed Tankard .....	do 6	do 9	181	30
Red Globe .....	do 6	do 9	146	40
Mammoth Globe .....	do 6	do 9	187	..

### CARBOTS.

Nine varieties were sown on two different dates, May 25 and June 6, but no variety on either date of seeding gave a crop worth taking up.

### SUGAR BEETS.

Four varieties were tested, but late frosts injured them all. The earliest sowing gave the best results.

Name of Variety.	Sown.	Pulled.	Yield per acre.	
<i>First Seeding.</i>			Bush. lbs.	
French .....	May 25	Oct. 9	275	..
Klein Wanzleben .....	do 25	do 9	225	..
White Improved .....	do 25	do 9	192	30
Green Top Brabant .....	do 25	do 9	311	50
<i>Second Seeding.</i>				
French .....	June 6	Oct. 9	183	20
Klein Wanzleben .....	do 6	do 9	165	..
White Improved .....	do 6	do 9	132	..
Green Top Brabant .....	do 6	do 9	196	30

## POTATOES.

Thirty-four varieties were tested and like the roots were the poorest crop we have had since the farm was established. Besides being light in yield, they were small in size, scabby and only fair in quality. The potato land was fallowed in 1892, ploughed before planting and well harrowed. The potatoes were dropped in rows 3 feet apart and 13 inches in the rows, harrowed after they came up and were run through with a scuffer each week. When tops got large enough they were hilled up with a plough.

*Planted 26th May ; taken up 5th Oct.*

Name of Variety.	Yield per Acre.		Name of Variety.	Yield per Acre.	
	Bush.	lbs.		Bush.	lbs.
Crown Jewel .....	133	30	Early Sunrise .....	183	20
Empire State.....	91	40	Holborn Abundance.....	165	..
Thorburn .....	67	50	Northern Spy.....	150	20
Sharpe's Seedling.....	128	20	Dakota Red.....	155	50
Algoma No. 1.....	100	50	State of Maine.....	73	20
Early Ohio.....	91	40	Burpee's Extra Early.....	132	20
Early Rose.....	152	10	Polaris.....	152	10
Early Puritan.....	128	20	Green Mountain.....	124	20
Chicago Market.....	141	20	White Beauty.....	141	20
Beauty of Hebron.....	163	10	New Variety.....	146	40
Rural Blush.....	128	20	Pearce's Extra Early.....	143	..
Delaware.....	183	20	Toronto Queen.....	139	20
Lee's Favourite.....	124	40	Earliest of All.....	73	20
Vanguard.....	137	30	American Giant.....	135	40
Clarke's No. 1.....	165	..	Munroe Co.....	205	..
Everett.....	183	20	Early Gem.....	139	20
Daisy.....	157	40	Sunlit Star.....	128	20

## VEGETABLE GARDEN.

As in preceding years, tests were made with several sorts of many kinds of vegetables to find out the earliest and best for the North-west.

No special effort was made to produce large specimens or heavy crops, earliness and suitability being the main object. On account of protection afforded by the wind breaks, now established on the farm, the crop on the whole was the best and most satisfactory of any yet grown. This was especially the case with the onion crop.

## ARTICHOKES

Did not do well. The tops grew to a good size but were hurt by frost in September and the bulbs were small.

Sown, 4th May ; up, 22nd May.

## ASPARAGUS.

The first cutting was had on May 27. It did well and gave a large crop all through the season.

## Experimental Farms.

### BEANS.

Nine varieties were planted. The two best were Dwarf German White Wax and Wardell's Kidney. These with Yellow Six-weeks and White Kidney were the only ones that matured.

Name of Variety.	Sown.	Up.	Fit for use.	Remarks.
Lazy Wives .....	May 17...	May 31...	July —...	No good. Did not pod.
Mammoth Red German Wax .....	do 17...	do 31...	do 28...	Good.
Crystal White Wax .....	do 17...	do 31...	do 28...	Very good.
Dwarf German White Wax .....	do 17...	do 31...	do 28...	do
Wardell's Kidney .....	do 17...	do 31...	do 28...	Fair.
Dwarf Triumph .....	do 17...	do 31...	do 28...	Small.
Mohawk .....	do 17...	do 31...	do 7...	Good.
Yellow Six-Weeks .....	do 17...	do 31...	do 7...	do Ripened.
White Kidney .....	do 17...	do 31...	do 7...	do do

### BEETS.

Seven sorts were sown. All did well, but Edmonds Early and Black Knight were the best for the table.

The seven kinds were also transplanted. When so treated they grew larger than those left in the beds where sown, but were not fit for table use.

Name of Variety.	Sown.	Up.	Fit for use.	Lifted.	Bushels per acre.	Remarks.
Early Blood Turnip .....	May 15.	June 3.	Aug. 15.	Sept. 22.	701	Good shape ; light colour.
Edmund's Early .....	do 15.	do 3.	do 15.	do 22.	484	Extra good.
Rennie's Intermediate .....	do 15.	do 3.	do 15.	do 22.	666	Good shape.
Eclipse .....	do 15.	do 3.	do 15.	do 22.	726	Very good.
Arlington .....	do 15.	do 3.	do 15.	do 22.	556	do
Long Dark Red .....	do 15.	do 3.	do 15.	do 22.	635	do
Black Knight .....	do 15.	do 3.	do 15.	do 22.	302	Small ; good colour.

### CAULIFLOWERS.

Twenty-two varieties were tested and a great difference in value was noted. Giant White Pearl and Thorburn's Large Early Dwarf Erfurt, Early Snowball and Gilt Edged Snowball being the best. Some others were as early but the flowers were small and open. Short Stemmed La Normande made large flowers but the colour was bad. All the late varieties gave good promise, but were destroyed by frost in September when beginning to make head.



## CAULIFLOWERS.

Name of Variety.	Sown in Hot-bed	Up.	Trans-planted in Hot-bed.	Trans-planted in open Ground.	Fit for use.	Remarks.
Large Late Mammoth.....	April 11	April 15	April 25..	May 29..	July 7	Small.
Veitch's Autumn Giant.....	do 11	do 16	do 25..	do 29..	Aug. 20	Hurt by frost.
Early Snowball.....	do 11	do 16	do 21..	do 29..	July 14	Very good.
Gilt Edge Snowball.....	do 11	do 16	do 21..	do 29..	do 14	do
Ex. Ey. Dwarf Erfurt.....	do 11	do 16	do 21..	do 29..	do 15	Small.
Nonpareil.....	do 11	do 16	do 21..	do 29..	.....	No good.
Early Paris.....	do 11	do 16	do 21..	do 29..	.....	do
Early Walcheren.....	do 11	do 16	do 21..	do 29..	.....	do
Extra Dwarf Erfurt.....	do 11	do 16	do 21..	do 29..	July 14	Very good.
Large Ey. Dwarf Erfurt.....	do 11	do 16	do 21..	do 29..	do 14	The best.
Half Ey. Dwarf French.....	do 11	do 16	do 21..	do 29..	do 7	Very poor.
Large Algiers.....	do 11	do 16	do 21..	do 29..	Aug. 10	Hurt by frost.
Italian Taranto.....	do 11	do 16	do 21..	do 29..	do 12	Poor.
Large Early London.....	do 11	do 16	do 21..	do 29..	.....	No good.
Stadtholder.....	do 11	do 16	.....	.....	.....	Very poor and not put out.
Autumn Giant.....	do 11	do 16	April 25..	April 29..	Aug. 20	Hurt by frost.
Short Stemmed La Normand.....	do 11	do 16	do 25..	do 29..	do 8	Fair.
Gilt Edge.....	do 11	do 16	do 25..	do 29..	July 7	Very fine.
Imp. Earliest Dwarf Erfurt.....	do 11	do 16	do 25..	do 29..	do 7	Small.
Early German Erfurt.....	do 11	do 16	do 21..	do 29..	do 7	do
Giant White Pearl.....	do 11	do 16	do 25..	do 29..	do 7	Very fine.
Ex. Ey. White Heads.....	do 11	do 16	do 25..	do 29..	do 11	do

## CABBAGE.

Twelve varieties were planted and all did well.

The Jersey Wakefield, Express and Henley's Champion were the earliest but were small. Burpee's All Head was the best cabbage this season. Early Summer, Surehead and Vandergraw being next.

Name of Variety.	Sown in Hotbed.	Up.	Trans-planted in Hotbed.	Trans-planted in Open Ground.	Fit for Use.	Taken up.
Burpee's All Head.....	April 10..	April 14..	April 26..	May 29..	July 28..	Sept. 16..
New World Beater.....	do 10..	do 14..	do 26..	do 27..	Aug. 27..	do 16..
Henderson's Early Summer.....	do 10..	do 14..	do 26..	do 27..	July 28..	do 16..
Bridgeport Drumhead.....	do 10..	do 14..	do 26..	do 27..	do 27..	do 16..
Imp. Jersey Wakefield.....	do 10..	do 14..	do 26..	do 29..	do 14..	do 16..
Imp. Am. Dun. Savoy.....	do 10..	do 14..	do 26..	do 29..	Aug. 27..	do 16..
Mam. Red Rock.....	do 10..	do 14..	do 26..	do 29..	do 27..	do 16..
Henley's Champion.....	do 19..	do 23..	May 5..	do 29..	July 14..	do 16..
Express.....	do 19..	do 23..	do 5..	do 29..	do 14..	do 16..
Vandergraw.....	do 19..	do 23..	do 5..	do 29..	Aug. 27..	do 16..
Filderkraut.....	do 19..	do 23..	do 5..	do 29..	do 27..	do 16..
Surehead.....	do 10..	do 14..	April 26..	do 27..	do 27..	do 16..

## CUCUMBERS.

Four varieties of cucumbers were sown in pots in a hotbed on April 16th, and transplanted into frames in the garden on May 26th.

They gave a large crop. New Siberian is small but much the most prolific. Giant Pera is a good bearer and very large and well shaped. White Pearl is a poor producer but the pure white cucumber is very handsome and fine flavoured.

Those sown in the garden without any protection immediately about them did not produce as abundantly and were not so early.

## Experimental Farms.

### SOWN IN POTS IN HOT-BED.

Name of Variety.	Sown in Hot-Bed.	Up.	Trans- planted in open.	Fit for use.	Ripe.
Giant Pera.....	Apr. 16..	Apr. 22..	May 26..	June 22..	.....
New Siberian.....	do 16..	do 22..	do 26..	do 20..	Aug. 11..
Burpee's White Pearl.....	do 16..	do 22..	do 26..	do 22..	.....
White Spine.....	do 16..	do 22..	do 26..	do 26..	.....

### CUCUMBERS SOWN IN OPEN GROUND.

Name of Variety.	Sown.	Up.	Fit for use.
New Paris Pickling.....	Apr. 26..	May 31..	Aug. 29..
Giant Pera.....	do 26..	do 31..	do 29..
New Siberian.....	do 26..	do 31..	do 29..

### CELERY.

Eight varieties were tested. None of the sorts did as well as last year. Giant White, London Red, and White Plume were the best.

Name of Variety.	Sown in Hot-bed.	Up.	Trans- planted in Hot-bed.	Trans- planted in open.	Fit for use.	Lifted.
White Pascal.....	Apr. 11..	May 1..	May 20..	July 4..	Aug. 16..	Sept. 20..
Giant Pascal.....	do 11..	do 1..	do 20..	do 4..	do 16..	do 20..
Giant White.....	do 11..	do 1..	do 20..	do 4..	do 14..	do 20..
Paris Golden Yellow.....	do 11..	do 1..	do 20..	do 5..	do 16..	do 20..
New Rose.....	do 11..	do 1..	do 20..	do 5..	do 16..	do 20..
London Red.....	do 11..	do 1..	do 20..	do 6..	do 14..	do 20..
White Plume.....	do 11..	do 1..	do 20..	do 6..	do 14..	do 20..
Giant Golden Heart.....	do 11..	do 1..	do 20..	do 6..	do 16..	do 20..

### CITRONS.

Citrons were sown in hot-bed and transplanted in frames in the garden and in open ground. Those in frames produced much the larger specimens, two citrons weighing fifteen pounds each.

The seed was obtained from W. F. Johnston, of the variety known as Colorado Preserving. They were sown April 17th, transplanted from hot-bed May 26th, and ripe August 20th.

## TABLE CARROTS.

Five sorts were tested, Peer of All and Scarlet Nantes being the best.

Name of Variety.	Sown.	Up.	Fit for use.	Lifted.	Remarks.
Henderson's Intermediate.....	May 2..	May 20..	July 28..	Oct. 14..	Very fine.
Half-long Scarlet Carentau .....	do 2..	do 20..	do 28..	do 14..	Rough.
Peer of all .....	do 2..	do 20..	do 28..	do 14..	Very good.
New Long Red Meux.....	do 2..	do 20..	do 28..	do 14..	Stump rooted.
Scarlet Nantes.....	do 2..	do 20..	do 28..	do 14..	Very good.

## KALE.

One variety, Plumage, was sown in hot-bed on April 19th, transplanted in hot-bed on April 26th, transplanted to open ground on May 29th, and taken up on September 16th.

## KOHL-RABI.

Two sorts were tested. Both were a fair crop.  
Purple Goliath, White Vienna, they were sown May 30th, came up June 5th, and were fit for use October 1st.

## CORN.

Native corn known also as squaw corn, planted on May 25th, was fit for use on August 29th, and ripe on September 1st.

## MUSHROOMS.

A mushroom bed was made in the potato cellar, and the spawn put in on April 8th. The first mushrooms came up on June 22nd, and the bed continued bearing all summer.

## LETTUCE.

Four varieties were tested in a hot-bed, and three of these sown in open ground.

Sown in Hot-bed.	Sown.	Trans- planted in Hot-bed.	Fit for use.	Remarks.
New Buttercup.....	Apr. 17..	May 26..	July 20..	Good.
Denver Market.....	do 17..	do 26..	do 26..	Good.
Golden Queen.....	do 17..	do 26..	do 18..	Good.
Large Yellow Market.....	do 17..	do 26..	do 30..	Good.
Sown in open.	Sown.	Up.	Fit for use.	Remarks.
Denver Market.....	May 2..	May 8..	Aug. 15..	Good.
Large Yellow Market .....	do 2..	do 8..	do 15..	Good.
New Buttercup .....	do 2..	do 8..	do 15..	Good.

## Experimental Farms.

### MUSK MELONS.

Three varieties of Musk Melons were tried. Sown in pots in a hot-bed and transplanted into frames in the garden. Emerald Gem and Banquet produced a fair crop. Pineapple did not come up. The two former were sown April 17th, came up April 24th, were transplanted May 26th; the Emerald Gem was ripe August 3rd, and the Banquet September 4th.

### WATER MELONS.

Two varieties of Water Melons were sown in pots in a hot-bed, and transplanted into frames in garden. The Early Ripe produced a good crop of fair sized melons. The Early Canada was not so large, but produced more fruit. They were both sown April 17th, came up April 24th, were transplanted May 26th, and the Early Ripe was ripe September 2nd, the Early Canada September 4th.

### ONIONS.

Eight varieties were sown in a hot-bed and transplanted into the garden, and eight sorts were sown in beds in the garden. All those transplanted did extra well. Three of the varieties sown in the open ground also did well. The best onions though not the largest were Mammoth Red Victoria, Prize taker, Giant Rocca and Red Globe Danvers. In the following table will be found full particulars of the results of this test.

Onions sown in hot-bed.	Sown.	Up.	Trans- planted.	Fit for use.	Ripe.	Bushels per acre.
Mammoth White Victoria.....	Apr. 10..	Apr. 16..	May 5..	July.....	Sept. 15..	388
Mammoth Red Victoria.....	do 10..	do 16..	do 5..	do .....	Oct. 12..	677
Mammoth Pearl.....	do 10..	do 16..	do 5..	do .....	do 12..	435
Giant Prize Taker.....	do 10..	do 16..	do 5..	do .....	Sept. 15..	580
Giant Rocca.....	do 10..	do 16..	do 5..	do .....	Oct. 12..	629
Red Globe Danvers.....	do 10..	do 15..	do 5..	do .....	do 12..	580
Yellow Globe Danvers.....	do 10..	do 15..	do 5..	do .....	Sept. 15..	389
Red Wethersfield.....	do 10..	do 17..	do 5..	do .....	do 15..	411

Onions sown in open ground.	Sown.	Up.	Ripe.	Bushels per acre.	Remarks.
Red Globe Danvers.....	Apr. 19..	May 23..	Sept. 15..	365	No good.
Yellow Danvers.....	do 19..	do 23..	do 15..	435	
Extra Early Red.....	do 19..	do 23..	do 15..	504	
White Barletta.....	do 19..	do 23..	Aug. 30..	242	
Scotch Leek.....	do 10..	do 23..	.....	.....	
Salzers Earliest.....	May 27..	June 28..	Sept. 15..	290	
New Queen.....	Apr. 19..	May 23..	Aug. 30..	290	
Silver Skin.....	do 19..	do 23..	do 30..	145	

### PARSNIPS.

Three varieties were sown, the Intermediate, Student and Maltese. All produced a good crop, there being no perceptible difference in the three. They were sown May 1st, came up June 1st, and were gathered October 12th. The roots in each case were good and smooth.

## PEPPERS.

Four sorts were tested, the Large Red Squash, Cardinal, Long Red and Monstrous Mammoth, but none matured.

## PEASE.

Nine sorts were sown. Among the small varieties McLean's Little Gem, and American Wonder were best. Among the large sorts Champion of England and Yorkshire Hero were first.

Name of Variety.	Sown.	Up.	Pulled.	Remarks.
McLean's Little Gem.....	May 3..	May 18..	July 15..	Very good.
New Queen.....	do 3..	do 18..	do 28..	Large pods. Not well filled.
Early Star.....	do 3..	do 18..	do 28..	Good.
Heroine.....	do 3..	do 18..	do 28..	Not well filled.
Stratagem.....	do 3..	do 18..	do 28..	Good.
Pride of the Market.....	do 3..	do 18..	do 28..	Fair.
American Wonder.....	do 3..	do 18..	do 15..	Very good.
Champion of England.....	do 3..	do 18..	do 28..	Very good.
Yorkshire Hero.....	do 3..	do 18..	do 28..	Fair.

## RADISH.

Five sorts were tested, sown in a hot-bed, and four were sown in the garden. The two best in the hot-bed were Earliest White Forcing, and Earliest Carmine, olive shaped. The best in the garden were Rosy Gem and New Pearl Forcing.

Four kinds of Winter Radish were tested. One Long Red Chinese went to seed but the others did well.

Sown in hot-bed.	Sown.	Up.	Fit for use.	Remarks.
Carmine Olive Shaped.....	April 10..	April 13..	May 1..	Good.
New Pearl Forcing.....	do 10..	do 13..	.....	No good.
Olive Gem.....	do 10..	do 14..	May 10..	Did not do well.
Earliest White Forcing.....	do 17..	do 22..	do 18..	Very good.
Earliest Carmine, Olive Shaped.....	do 17..	do 22..	do 20..	Very good.
Sown in open ground.	Sown.	Up.	Fit for use.	Remarks.
Rosy Gem.....	May 10..	May 17..	June 20..	Extra fine.
Long Salmon.....	do 10..	.....	.....	Did not come up.
White Forcing.....	do 10..	May 17..	June 20..	Small.
New Pearl Forcing.....	June 10..	June 17..	July 20..	Extra fine.
Winter Radish.	Sown.	Up.	Fit for use.	Remarks.
Long Black Spanish.....	May 30..	June 5..	Aug. 29..	Large fine root.
Long White Spanish.....	do 30..	do 5..	do 29..	Very large.
Long White Chinese.....	do 30..	do 5..	do 29..	Fair size, straight.
Long Red Chinese.....	do 30..	do 5..	.....	All went to seed.

## Experimental Farms.

### RHUBARB.

Four varieties have been tested, Victoria, Linnæus, Carleton Club and Stotts' Mammoth.

Victoria and Linnæus have given the best results, and were fit for use May 31st. Although not as large as either Carleton Club or Stotts' Mammoth, they are of finer flavour. Carleton Club and Stotts' Mammoth are exceedingly large varieties; one stalk of the former measuring over 9 inches in circumference. Stotts' Mammoth apparently not so suitable to the climate, is gradually dying out.

### SALSIFY.

White Salsify—Sown May 2nd; up May 18; fit for use October 12th; very rooty. A poor crop.

### SPINACH.

Bloomsdale Savoy Leaved—Sown May 2nd; up May 14th. Frozen.

### SAGE.

Sown May 2nd; up May 20th. A good crop.

### SUMMER SAVORY.

Sown May 2nd; up May 20th. A good crop,

### PARSLEY.

Moss Curled—Sown May 2nd; up June 2nd. Very good crop.

### TOMATOES.

Eight sorts were tried. Earliest of All and Extra Early Atlantic were the best for colour, shape and quality of fruit.

Name of Variety.	Sown.	Up.	Trans- planted in hot-bed.	In fruit.	Ripe.	Remarks.
Strawberry. Sown in ground.....	Apr. 10.					No good.
Extra Early Atlantic.....	do 10.	Apr. 15.	May 15.	June 26.	Aug. 9.	None ripened.
Ponderosa.....	do 10.	do 16.	do 15.	do 26.		
Early Ruby.....	do 10.	do 17.	do 15.	do 26.	do 12.	
Extra Early Chemin.....	do 10.	do 17.	do 15.	do 28.	do 20.	
Dwarf Champion.....	do 10.	do 17.	do 15.	do 30.	do 20.	
Yellow Plum.....	do 10.	do 17.	do 15.	do 26.	do 7.	
Earliest of All.....	do 10.	do 15.	do 15.	do 22.	do 4.	

### TURNIPS.

Four sorts of table turnips were sown, Early Snowball proving the best.

Name of Variety.	Sown.	Up.	Fit for use.	Remarks.
Red-top Strap-leaf.....	May 30.	June 5.	Aug. 9.	No use for garden.
Early Snowball.....	do 30.	do 5.	do 9.	Very fine.
Orange July.....	do 30.	do 5.	do 9.	Good.
Breadstone.....	do 30.	do 5.	do 9.	Should be "Greystone."

## FLOWER GARDEN.

The flower garden suffered considerably from the dry weather, and especially from the hot winds in August. Although many of the flowers were good, some, such as the Pansies, were poor. Sweet Williams, Asters, Stocks, Drummond Phlox and Verbenas were extra fine.

Following are the names of the sorts grown, with remarks on each variety:—

*Pansies*.—Sowed twelve varieties of German Pansies, and one box seed from Ottawa. Did only fairly well.

*Verbenas*.—Sown in hot-bed April 12th. Planted in garden June 22nd. Did fairly well.

*Pyrethrum*.—Sown in hot-bed April 15th. Planted for borders June 15th. Did well; makes good border.

*Scabiosa*.—New Leviathan: Sown in hot-bed April 15th. Planted in garden June 14th. Bloomed July 20th. Very fine.

*Scarlet Flax*.—Sown April 15th. Planted in garden June 14th. Bloomed July 10th, till frozen.

*Xeranthemum*.—(Everlasting.) Sown April 15th. Planted in garden June 22nd. Bloomed August 1st. Good.

*Abronia Umbellata*.—Sown April 15th. Transplanted June 15th. Did not do well.

*Petunia*.—Sown April 15th. Transplanted June 22nd. Did well. Flowered throughout the season.

*Sweet Peas*.—Sown in garden on May 22nd. Did well.

*Canna*.—German seed. Sown April 15th. Only two plants came up.

*Canna tubers from Ottawa*.—Potted in hot-bed on April 27th. Planted June 8th. Flowered well.

*Gladioli*.—Potted in hot-bed April 27th. Planted June 8th. Flowered well till killed by frost in September.

*Phlox Drummondii*.—Sown in hot-bed April 15th. Fireball, Grandiflora, eight colours, and Nana Compacta, eight colours. Planted in garden June 8th. In bloom July 1st. Continued blooming throughout season. One of the best flowers for this country.

*Stocks*.—Dwarf German, ten weeks, eighteen colours. Dwarf German, eighteen colours. Large Flowering, eighteen colours. Sown in hot-bed April 16th. Planted June 8. Flowered July 1st. Mass of bloom all season. Large flowering made most show. One of the hardiest and best flowers for this climate.

*Dianthus*.—*Dianthus Imperialis* and *Dianthus Heddewigii*. Sown April 15th. Planted June 9th. In bloom July 10th. Flowered freely all summer. Stands winter well.

*Aster*.—Victoria, eight colours. Dwarf Bouquet, eight colours, and Truffauts Aster. Sown April 15th. Planted June 8th. In flower August 20th. Made good show till killed by frost.

*Godetia*.—Eight varieties. Sown in hot-bed April 15th. Planted June 8th. Did not do as well as those sown in garden on May 23rd.

*Mallow*.—Makes good border. Flowers freely.

*Zinnia Elegans*.—Sown in hot-bed May 18th. Planted June 17th. Made a good show until frozen.

*Mignonette*.—Matchett, Aurea, Victoria, Pyramidalis and Common. Sown in garden May 23rd. Bloomed in July, and continued throughout the season.

*Nasturtiums*.—Dwarf and tall varieties did fairly well, but are rather tender for the North-west.

*Flowering Flax*.—Did well for large borders. Flowers freely and stands winter well.

*Eschscholtzia*.—Twelve colours. Sown in garden on May 23rd. Made a great show.

*Poppy*.—Three varieties. Sown May 22nd. Did fairly well.

## Experimental Farms

*Convolvulus Minor*.—Sown May 22nd. Made a very showy bed. Bloomed all season.

*Portulacca*.—Sown May 22nd. Good show till first frost.

*Carnation*.—Sown in hot bed and transplanted. Flowered well and plants are in good shape for winter.

### PERENNIALS.

*Sweet William*.—Stood winter well and made good show.

*Larkspur*.—Did well. Flowered all season.

*Columbine*.—Made good show and is quite hardy.

*Tulips*.—Did well. In bloom early in June.

*Peony*.—Hardy. Had some fine flowers this season.

*Roses*.—Only one plant (M. P. Wilder) lived through the winter, but it had some fine roses on during summer.

*English Hollyhock*.—Sowed seed in hot bed and transplanted into sheltered places. Plants in good shape for next season.

*Hyacinthus Candicans*.—Planted two bulbs in garden which made flower spikes three feet high.

*Yellow Flax*.—Stood winter well and made good show this season.

*Lupins*.—Sowed in hot bed and transplanted in garden. Plants look strong and healthy.

*Lilium Thunbergianum*.—Stood winter well and had some very fine flowers on this season.

### FRUIT TREES.

*Apple Trees*.—Seven varieties of apple trees were planted in spring of 1892. Last spring every tree was dead. The varieties were Hare Pipka, Blushed Calville, Bodi, Red Raspberry, Little Hat, Sugar Sweet, and Saccharine, and as they were planted in a sheltered spot, hopes were entertained that better success might follow with them than with preceding trials, but the result was even worse, as not a live root was left.

The lonely Red Siberian Crab that has weathered four winters, and last year had a few blossoms on, succumbed this spring, and is now numbered with many others of its kind gone before.

Three varieties of Russian Dwarf apple trees, planted in 1889, made a good growth the past season. In previous years these trees were cut back repeatedly, but escaped last winter and are promising.

Last spring 27 varieties of apple trees were planted, consisting of 188 trees. Part of these were set out in a grove of young Manitoba maple trees or box elder, where ample shelter will be afforded them. Every tree is living at this date.

Several trees also of Transcendant crab were planted last spring.

*Plums*.—Four sorts were planted, consisting of Orleans Blue, Montmorency, Imperial Blue and 100 seedlings of the wild plum. All are alive and have made good growth.

In 1890 one variety of plum was received from Prof. Budd, Iowa. This variety Early Red has been cut back each winter excepting the past one, when the three trees have made a good growth and look promising.

*Cherries*.—In the spring of 1889, three trees of Blackhill Cherry were received from Prof. Budd, of Ames, Iowa. These have repeatedly been cut back until the past season, when, I have pleasure in reporting they bore fruit. This variety is I believe a native of the Western States but produces a large fruit; much larger than our native cherry, and the flavour being fairly good, it will be an acquisition to our list.

In spring of 1892, three varieties Lutovka, Vladimir and Bessarabian were planted. All were dead this spring.

Three varieties, Old French and Montmorency Cherries and a dwarf variety "Prunus Pumila" were planted the past spring.



## SMALL FRUIT.

*Currants.*—All varieties of currants gave a most abundant crop the past season. All sorts were large and fine, but *Fay's Prolific* a red variety was ahead of all others in size. No protection was given the bushes. Last spring the following eleven varieties were added to the collection: *Versaillaise*, *New Red Dutch*, *Odgen's Black*, *Baldwin's Black*, *Prince of Wales*, *Knight's Early Red*, *La Fertile*, *La Conde*, *La Hative*, *White Transparent* and *London Red*.

The following is result of last season's crop of currants:—

## BLACK CURRANTS.

*Black Naples.*—Ripened from 27th July to 10th August. Crop and currants large, but fruit did not ripen evenly.

*Lee's Prolific.*—Ripe 27th July. The fruit was of large size and the crop very heavy. Ripened evenly.

The following seedling black currants produced at the Central Experimental Farm have also been tested:

*No.  $\frac{1}{8}$ 1.*—Fairly early. Fruit medium in size and quantity.

*Climax.*—Ripened evenly on July 27th. Heavy crop of large fruit.

*Charmer.*—Poor crop of small fruit.

*No.  $\frac{2}{8}$ 1.*—Ripened July 27th. Heavy crop of large fruit.

*No.  $\frac{1}{2}$ 2.*—Poor crop. Medium sized fruit.

*No.  $\frac{1}{8}$ 3.*—Ripened unevenly. Medium crop of small fruit.

*Beauty.*—Ripened unevenly. Heavy crop of large fruit.

*No.  $\frac{1}{5}$ 5.*—Poor crop of poor fruit.

*Dominion.*—Ripened evenly. Well laden bushes of fine fruit. The best of all these new varieties with us.

*Native Black.*—Very large crop. Fruit small.

## RED CURRANTS.

*Fay's Prolific.*—Ripened 5th August. Very large crop of extra sized fruit.

*Red Grape.*—Ripened evenly on 1st August. Heavy crop of medium sized fruit.

*Red Dutch.*—Ripened very evenly 1st August. Heavy crop of fine fruit. Bunches large.

*Raby Castle.*—Ripened evenly 5th August. Large crop of medium fruit.

## WHITE CURRANTS.

*White Grape.*—Ripened 29th July. Bushes loaded down with large bunches of fine fruit.

*White Dutch.*—Ripe August 1st. A very heavy crop of large fine fruit.

## RASPBERRIES.

All varieties of raspberries came through the winter in splendid condition. The crop of fruit was very large, but dry weather injured all but the earliest, and the hot wind which did so much injury all over the country, dried up all the late fruit.

All the canes were laid down before frost came and covered first with two inches of earth, and then with well rotted manure. The covering was left on until May 9th, and then dug in among the canes.

It is very important that the covering should be left on as late as possible, so as to retard the canes in commencing to bud till all danger of frost is past.

## Experimental Farms.

The following are the varieties at present under test here:—

*Turner*.—Large red. Ripe 29th July. A good crop. Stood the dry weather better than any other sort.

*Philadelphia*.—Large dark red fruit. Ripe 29th July. In the first part of the season the berries ripened well, but dry weather affected the fruit greatly later in the season.

*Dr. Reeder*.—Ripe 29th July. Heavy crop of fine fruit. Large red berry.

*Cuthbert*.—Large red berries. Ripe on 5th August. A good crop of well-flavoured fruit.

*Caroline*.—Fine large orange coloured berries. Heavy crop.

*Golden Queen*.—Ripe 27th July. Fruit was extra fine, but crop small.

*Wild*.—Fruit and crop large, but fruit of poor flavour.

### STRAWBERRIES.

The old plots of Capt. Jack and New Dominion gave a large and fine crop of fruit, as did also the new plot of these sorts set out in spring of 1892. All the plants were covered with coarse manure during the winter.

### GOOSEBERRIES.

These came through the winter fairly well, but some of the young wood was winter killed.

*Smith's Improved*.—Ripe August 20th. Produced a good crop of fine large berries.

*Downing*.—Ripe August 25th. Small crop of good sized berries.

### HUCKLEBERRIES.

Ten bushes of huckleberries were planted last spring.

Six varieties of raspberries, 11 of currants, 21 of gooseberries, and 5 of strawberries were received and planted last spring, and will be reported on next year.

### FOREST TREES.

The past season has been without exception the best for trees since the farm started.

Those that came through the winter of 1891–2 made a good growth, and ripened their wood so thoroughly that no variety was in the least injured last winter, severe though it was. Attention was drawn to this in my last report, and the trees proved to be in even better condition than was expected at that time.

The growth the past summer has been very great, Manitoba maple, willow, etc., growing from three to four feet, and apparently the wood has ripened as well as it did last year. The early part of the season was wet, causing rapid growth, and the latter part being dry, the ripening process was helped to a great extent.

Last spring 9,000 trees were transplanted into groves, shelter belts, wind-breaks and along avenues—drawn from young plantations on the farm, and 8,525 trees received from the Central Experimental Farm, were planted principally in sheltered plots. These consisted of 500 elm, 3,000 oak, 3,000 maple, 1,000 Riga pine, 1,000 spruce and 25 Russian olive. A large number of the oak, Riga pine and spruce died after the dry weather set in.

By actual count there are at present living on the farm, not counting those received this spring from the Central Farm, the following number of trees:—In shelter belts, 46,675; in plantations, 15,800; in avenues, 1,960. These are principally maple grown from seed, and transplanted. In addition there are in lawns, gardens and other places, 270 Riga pine, 389 Norway spruce, 21 cedar, 128 mountain ash, 58

birch, 734 poplar, 650 willow, 25 Russian olive, 50 Russian poplar, 302 cottonwood, 3,500 Nebraska elm, 800 ash, 25 Buffalo berry, 306 elm, and 397 Artemisia. Besides these there are 5,000 three year old maples, 22,000 two year old, and from 10,000 to 15,000 seedlings ready to transplant; a grand total of from 110,000 to 115,000 trees, which as before stated, does not include the 8,525 trees received from Ottawa.

#### SHRUBS.

Of all the shrubs set out *Caragana* continues to give the best satisfaction for lawns, etc. The bushes planted in 1890 produced a considerable quantity of seed the past season.

Fig. 2 is from a photograph of one of these shrubs growing on the lawn near the superintendent's house.



FIG. 2. *CARAGANA ARBORESCENS*, SIBERIAN PEA TREE.  
FROM PHOTOGRAPH OF A SPECIMEN AT EXPERIMENTAL FARM, INDIAN HEAD.

*Artemisia Abrotanum* (Russian) planted for a wind-break, is by far the most valuable shrub planted for that purpose on the Experimental Farm. It is easily propagated, a quick grower, and making a thick mat, is equally as good for a wind-break as for a snow collector, both of which are invaluable on our open prairies.

Thousands of cuttings were sent out to settlers last spring, and thousands are available for the same purpose the coming season.



GROUP OF CATTLE. EXPERIMENTAL FARM, INDIAN HEAD, N.W.T.

## Experimental Farms.

Acer Ginnala planted in 1889, though cut back in 1892, grew wonderfully the past season.

Spirea opulifolia, planted in 1889, was for two seasons cut back, but is now apparently hardy. In 1892 and the past season it flowered abundantly and is making a good low hedge.

Last spring the following shrubs were planted:—Nine varieties Lilac; six of Spirea, and five of Syringa. These will be reported on next year.

### WIND-BREAKS.

The wind-breaks on the farm are already of great service, and during the past season saved the fruit and vegetable gardens from great injury if not from total loss.

As stated in my report of 1891, wind-breaks consisting of Manitoba Maple, Elm, Willow, Poplar and Artemisia Abrotanum (Russian) were planted around gardens and other plots in that year. The Elm trees have been kept back by rabbits eating the young growth, but all the other sorts grew and thickened up greatly the past season. So far as experience has shown the Artemisia hedge is first, Willow second, Maple third and Poplar fourth in usefulness. Some of the wind-breaks consist of three rows, others of two rows and some only of one row of trees. The trees are planted two and three feet apart in the rows.

Those already set out demonstrate that one row of Artemisia or Willow, with plants two feet apart in rows is ample, and one row of Maple or Poplar is also sufficient if the trees are cut back several times each season for a few years, so as to thicken up at the bottom.

I desire to call the attention of those in the North-west who may wish to have a small and pretty hedge on their lawn or elsewhere, to the fact that the Native Wolf Willow and Native Snowberry, both found in abundance on the prairie, are excellent for that purpose. Either grown from seed or transplanted, they are cheaply and easily obtained and in two or three years, with pruning can be made as nice as any eastern hedge.

Two hedges made from transplanted plants of these shrubs, attract the attention of visitors to the farm, and besides being ornamental are useful as a windbreak around the flower beds and other plots.

### CATTLE.

Stock of all kinds on the farm is at present in good health and condition. Since my last report three pure bred Shorthorns, one Polled Angus and six grades have been added to the herd. One Shorthorn cow "Wildflower" died in the summer of inflammation of the lungs.

Fig. 3 shows a group of the cattle in the pasture. From a photograph.

Two experiments were made last winter to determine the relative values of such fodders as can be grown in the North-west. The first test was between ensilage made from oats and barley sown together and the same mixture cured as hay. The second test was between a cereal crop in the form of dry fodder and the best native hay. The cereal crop consisted of oats, barley and rye cut by the binder while in a green state and before being fed cut by the straw cutter.

The tests were started rather late on account of not having the animals for the experiments, and the ensilage gave out when the tests had been under way three months, including the preparatory feeding. The records are therefore for only two months.

Besides the two tests as to the value of the feed, three grade steers and three grade heifers were fed for five months on the same rations to find out the gain of the animals of the different breeds. In addition to the five months of winter feeding the gain of the same six beasts is given for six months while on pasture.

Records have also been kept as to the increase in weight of eight pure bred heifers for twelve months, six months of which they were stall fed and the other six months in pasture, particulars of this test are also given.

TEST OF FEEDING DRY COWS ON A MIXED CEREAL CROP MADE INTO ENSILAGE  
AGAINST THE SAME MIXTURE CURED AS HAY.

This test was made to find the relative value of the two kinds of feed, both of which can readily be obtained in the North-west. The mixed feed in each case was oats and barley sown together and cut green, one portion made into ensilage and the other into hay.

HAY.

The test was made also to find out whether or not it pays to feed animals during the winter months, so as to obtain not only an increase in weight, but a higher price on account of better quality of beef.

The four cows used in this test were the ordinary grades of the country, of the Durham breed, and in all respects were as nearly equal as it was possible to get them. Before the test was begun, a uniform preliminary feeding of one month was given all the animals.

Ration No. 1—

	Lbs.
Ensilage .....	35
Meal.....	5
Daily .....	<u>40</u>

Ration No. 2—

	Lbs.
Hay .....	15
Meal .....	5
Turnips .....	15
Daily .....	<u>40</u>

Cows fed on Ration No. 1—

	Lbs.
Weight of two cows, March 20 .....	2,620
Weight of two cows, May 20.....	2,804
Gain .....	<u>184</u>

Cows fed on Ration No. 2—

	Lbs.
Weight of two cows, March 20.....	2,346
Weight of two cows, May 20.....	2,507
Gain.....	<u>161</u>

Cost of feed consumed in two months—

Ration No. 1—

2,100 lbs. ensilage, at \$2 per ton.....	\$ 2 10
300 lbs. meal, at 60 cents per cwt.....	1 80
	<u>\$3 90</u>

Ration No. 2—

900 lbs. hay, at \$4 per ton.....	\$ 1 80
300 lbs. meal, at 60 cents per cwt.....	1 80
20 bushels turnips, at 10 cents.....	2 00
	<u>\$ 5 60</u>
Cost in favour of ensilage.....	<u>\$ 1 70</u>

## Experimental Farms.

Value of Cattle at commencement and at close of feeding—

Lot No. 1.—Fed on ensilage and meal—

Weight at start of preliminary feeding, 2,450 lbs. at 2 $\frac{3}{4}$ c...	\$ 67 38
Weight at close of test, 2,804 lbs. at 3 $\frac{1}{4}$ c.....	105 15
Gain.....	\$ 37 77
Less food consumed in preliminary feed, \$2; test, \$3.90...	5 90
Net gain.....	\$ 31 87

Lot No. 2.—Fed on hay, meal and turnips.

Weight at start of preliminary feeding, 2,272 lbs., value 2 $\frac{1}{2}$ c. \$	62 48
Weight at close of test, 2,507 lbs., 3 $\frac{1}{2}$ c. ....	94 00
Gain.....	\$ 31 52
Less food consumed in prelim. feed, \$2, in test, \$5.60 .....	7 60
Net gain.....	\$ 23 92

This test seems to show, 1st, That cattle gain more on ensilage and meal, than on hay, meal and roots. 2nd. That the cost of ensilage and meal is less than that of hay, meal and roots, and 3rd. That a substantial gain is made in feeding cattle, not only in increase of weight, but in the higher price obtained for the better quality of beef.

### TEST OF CEREAL CROP IN FORM OF DRY FODDER VS NATIVE HAY.

Two 2-year old heifers in each lot. Uniform preliminary feeding one month, and test, 8 weeks.

Ration No. 1—

Dry fodder.....	Lbs. 18
Turnips.....	20
Meal.....	3
Daily.....	41

Ration No. 2—

Native hay.....	Lbs. 18
Turnips.....	20
Meal.....	3
Daily.....	41

Weekly gain of heifers fed on Ration No. 1—

Weight of heifer No. 1—958, 970, 985, 997, 1,005, 1,017, 1,028, 1,042, 1,061 .....	Lbs. Total gain 103
Weight of heifer No. 2—1,203, 1,211, 1,223, 1,234, 1,245, 1,252, 1,276, 1,285, 1,300 .....	Total gain 97
Total gain Ration No. 1.....	200

Weekly gain of heifers fed on Ration No. 2—

	Lbs.
Weight of heifer No. 1—1,130, 1,142, 1,150, 1,159, 1,168, 1,175, 1,183, 1,199, 1,215.....	Total gain 85
Weight of heifer No. 2—1,000, 1,009, 1,028, 1,037, 1046, 1,062½, 1,073, 1,081, 1,095.....	Total gain 95
Total gain Ration No. 2 .....	<u>180</u>

The above test serves to show that a mixed crop made into hay gives as good results when fed to stock as the best native hay.

GAIN OF 3 GRADE STEERS AND 3 GRADE HEIFERS; FED 5 MONTHS IN STABLE AND 6 MONTHS OF PASTURE.

The sires were pure bred, and the dams grade Durhams.

WINTER RATIONS.

December 13th to January 13th—

	Lbs.
Cut feed.....	10
Turnips .....	4
Meal.....	2
Oil cake.....	1
Daily.....	<u>17</u>

January 13th to April 1st—

	Lbs.
Cut feed .....	11
Turnips .....	10
Meal.....	2½
Daily.....	<u>23½</u>

April 1st to May 13th—

	Lbs.
Ensilage .....	10
Cut straw .....	7½
Turnips.....	8
Meal .....	3½
Daily .....	<u>29</u>

WEIGHT EACH MONTH WHILE STALL FED.

Breed.	Dec. 13.	Jan. 13.	Feb. 13.	Mar. 13.	Apr. 13.	May 13.	Total gain.
	Lbs.	Lbs.	Lbs.	Lbs.	Lbs.	Lbs.	Lbs.
Durham Steer.....	850	892	925	953	975	1,026	176
Holstein Steer.....	666	693	729	740	775	825	159½
Polled Angus Steer.....	776	792	807	845	875	907	131½
Durham Heifer.....	525	555	625	646	671	700	175
Holstein Heifer.....	673	700	725	750	775	815	142
Polled Angus Heifer.....	554	563	588	632	656	700	146



## Experimental Farms.

### GAIN ON PASTURE—WITH TOTAL GAIN.

Breed.	May 13.	Nov. 13.	Gain on Pasture.	Gain in Stable.	Total gain 11 mos.
	Lbs.	Lbs.	Lbs.	Lbs.	Lbs.
Durham Steer .....	1,026	1,240	214	176	390
Holstein Steer .....	825	1,055	230	159	389
Polled Angus Steer.....	907	1,077	170	131	301
Durham Heifer.....	700	917	217	175	387
Holstein Heifer.....	815	963	148	142	290
Polled Angus Heifer..	700	870	170	146	316

Showing that the Durham grades gained more than either of the other two breeds, both in stall feeding and on pasture.

### GAIN IN WEIGHT OF PURE-BRED HEIFERS.

The gain in weight of eight pure bred heifers for twelve months is given below. From November 12th to May 12th, they were fed a daily ration of 9½ pounds cut fodder (grain hay), 2½ pounds meal, 3 pounds turnips and as much wheat straw or chaff as they would eat. From May 12th to November 12th, they were on pasture alone, except the twelve days in November, when they were stabled at night.

Breed.	Born.	Weight Nov. 13.	Weight May 13.	Weight Nov. 13.	Gain in Stable.	Gain on Pasture.	Total.
		Lbs.	Lbs.	Lbs.	Lbs.	Lbs.	Lbs.
<i>Durhams.</i>							
Prairie Wild Flower....	May 18, 1891.	840	1,061	1,213	221	152	373
Prairie Rosebud.....	Mar. 26, 1892.	530	705	940	175	235	410
<i>Polled Angus.</i>							
Lady Eaton .....	Oct. 5, 1890.	1,010	1,147	1,285	137	138	275
Maid of Skene .....	Aug. 4, 1891.	675	785	950	110	165	275
Stella of Assiniboia.....	Oct. 10, 1891.	878	1,111	1,250	233	139	372
Pride of Assiniboia .....	Dec. 6, 1891.	730	930	1,070	200	140	340
<i>Holsteins.</i>							
Abi of Assiniboia.....	Feb. 10, 1891.	700	870	1,047	170	177	347
Queen of Assiniboia.....	Sep. 22, 1892.	290	670	890	380	220	580

### PIGS.

The increase of pigs during the summer has, on the whole, been satisfactory, but the Yorkshire White litters have done very poorly. They do not appear to thrive as well as those of the Berkshire breed.

Having no suitable building in which to feed young animals, no tests were undertaken the past year, but on completion of the piggery, now in course of erection, feeding experiments will be carried on.

## POULTRY.

Very great success cannot be reported in the poultry department for the past year. Although better than that of 1892, it was far from being satisfactory.

The Plymouth Rocks brought up the largest flock of young birds; White Leg-horns second.

The Andalusians laid the finest eggs, but the Plymouth Rocks were first in number.

Thirteen settings were sent out to settlers in April and May last.

A better roof has been placed on the poultry building, and an addition made to its size, and the yards also have been enlarged. Though not very extensive, the building is now warm and comfortable.

## STALLION.

The Clyde stallion Barlocco, sent by the Haras National Company from Montreal, reached the farm on 28th April last, and remained for three months, serving 52 mares during that time.

Barlocco captured the ninth prize for Clydesdales at the World's Columbian Exposition.

## PREPARING LAND FOR CROP.

Three methods were followed in preparing land in the season of 1892 for the crop of the past year. 1st. To plough deep with a single plough soon after seeding and cultivate the surface afterwards with a spring-toothed harrow. 2nd. To gang plough 3 inches deep first, then cultivate the surface to keep down weeds, and after harvest plough deep. 3rd. To gang plough first and last 3 inches deep with surface cultivation between the ploughings.

Wheat, barley and oats were all sown on the three differently prepared soils, and at no time could any difference be observed in the crops. The early part of the growing season being so favourable, the crop of straw was equally heavy on all, and the hot winds did no more damage on the shallow prepared ground than on the deep.

It must, however, be understood that prior to 1892 the land had all been fallowed from 6 to 8 inches deep, and with a season like the past good crops could reasonably be expected on all the fallows.

The past season the land for next year's crop has been prepared in the same three ways, and should the growing season be different, as no doubt it will, a different result will in all probability follow.

## MANURING.

The manure from stock during the winter of 1891 and the summer of 1892 was first drawn into one large pile, where it thoroughly rotted. It was then, after the other work on the farm was stopped by frost, drawn out and put on stubble land intended for fallow the past season. The same course will be adopted with manure made last winter and this summer.

## DISTRIBUTION OF GRAIN, FOREST TREES, FRUIT BUSHES, TREE SEEDS AND POTATOES.

A distribution of grain, trees, fruit bushes, tree seeds and potatoes was made during March, April and May last.

Four hundred and thirty-one bags of grain, consisting of samples of wheat, barley, oats, pease, flax and spring rye were sent out by mail.

Two thousand five hundred trees; principally Manitoba Maple, or Box Elder, were distributed by mail. Elm, Ash, Poplar, Willow, Cottonwood, Caragana and Lilac were sent out in small lots.

## Experimental Farms.

A large number of cuttings of the *Artemisia Abrotanum* (Russian) were mailed to different parts of the Territories.

Tree seeds were forwarded to 200 applicants.

197 dozen Raspberry plants, 119 dozen Currants, 15 dozen Strawberry plants, 11 dozen Gooseberry and 17 dozen *Asparagus* roots were distributed to settlers.

Two hundred and fifteen sample bags of Potatoes were also sent to applicants.

### ENSILAGE.

The capacity of the silo having been found insufficient in 1892, an additional silo was built in time for the grain and corn crop this year.

The ensilage came out of the silo, last winter, in good condition, and proved very useful during the winter and early spring months when other succulent food was becoming scarce.

Although last winter was extremely cold no harm was done the ensilage by frost. At no time was there more than a thin crust over the top.

During the past season nearly twice the quantity of ensilage has been put in the silos as there was saved in 1892. At present the corn is being used and is found to be much better than last year, on account, no doubt, of its being further advanced when cut.

### IMPROVEMENTS.

*Silo.*—During the past summer, as stated elsewhere, a silo was built 11 x 12 x 23 feet. Instead of sheeting inside and out with boards and paper before lining it up with siding, only one thickness of flooring was put in on the inside of the silo. So far as the ensilage is concerned this has proved sufficient.

*Piggery.*—A piggery 24 x 40 feet, one story high, was also built. The walls of this building are concrete, 1 part lime to 9 parts sand and small stones. The walls are 12 inches thick.

*Henhouse.*—A small addition was made to the hennery, as well as completing the building, which was not done last summer.

*Reservoirs.*—A large reservoir has been made in the pasture field this fall, as well as additions to the other reservoirs on the farm.

### WORLD'S COLUMBIAN EXPOSITION.

As intimated in my last report, the different agricultural societies, towns and individuals, through direction of the North-west Government, sent during the early part of winter exhibits of roots, grain in straw, threshed grain, grasses, etc., to the Experimental Farm, to be cleaned and sorted, and then forwarded to Chicago for the World's Fair.

This work entailed, in connection with the Experimental Farm exhibit, which was prepared at the same time, a large amount of labour. The grain in straw was all carefully sorted, the threshed grain nearly all hand picked, and the grasses sorted and named. Exhibits continued coming in until early in March, when the entire lot was shipped to Chicago.

As soon as vegetables were ready to send this fall, collections were forwarded at different dates, until the season was over.

In the latter part of March I went to Chicago, under your instructions, and remained there several weeks, returning in time for the spring work. While in Chicago I was able to render assistance in installing the exhibits from the different Experimental Farms, and render aid otherwise in the preparation and placing of some of the exhibits from the North-west.

The Experimental Farm at Indian Head received awards for collection of cereals and grasses and collection of vegetables.

## LOCAL EXHIBITIONS.

During the past fall a large collection of cereals, roots, grasses and other products of the farm was prepared for exhibition purposes. Only two points, Indian Head and Edmonton, could be reached, and on account of the high rate of express only a small portion of the exhibit could be sent to Edmonton. While in the Edmonton district I was able to attend a fair at St. Albert, but the exhibit of the products of the Experimental Farm did not reach Edmonton in time to permit of their being shown at St. Albert.

## VISITORS TO THE EXPERIMENTAL FARM.

The number of visitors to the farm greatly increased during the past season. The change from a night to a day train service, by which visitors from a distance could come and go on the same day, was a very great convenience.

Besides having all the delegates from Great Britain and the United States pay the farm a visit, an excursion party from Moose Jaw and intermediate stations favoured the farm with its presence.

## METEOROLOGICAL.

Temperature, maximum and minimum for 11 months ; rainfall for the growing season ; sunshine for the growing season.

## TEMPERATURE.

Months,	Maximum,	Minimum.
January.....	26° on 20th.....	-46° on 31st.
February.....	32° on 18th.....	-52° on 1st.
March.....	38° on 31st.....	-25° on 15th.
April.....	55° on 30th.....	1° on 5th.
May.....	81° on 18th.....	22° on 24th.
June.....	92° on 13th.....	35° on 5th.
July.....	92° on 19th.....	36° on 9th.
August.....	103° on 6th.....	30° on 28th.
September.....	93° on 7th.....	15° on 27th.
October.....	67° on 19th.....	4° on 28th.
November to 15th.....	57° on 6th.....	3° on 2nd.

## RAINFALL.

	Inches.
May.....	3.17
June.....	4.60
July.....	2.12
August.....	.12
September.....	.10
Total.....	<u>10.11</u>

## Experimental Farms

### SUNSHINE.

	Hours.
March.....	130.3
April.....	126.3
May.....	289.8
June.....	250.8
July.....	283.5
August.....	273.7
September.....	138.8
Total .....	<u>1493.2</u>

I have the honour to remain, sir,

Your obedient servant,

ANGUS MACKAY,

*Superintendent.*

# EXPERIMENTAL FARM FOR BRITISH COLUMBIA

REPORT OF THOMAS A. SHARPE, SUPERINTENDENT.

AGASSIZ, B.C., 31st October, 1893.

To WM. SAUNDERS, Esq.,  
Director Dominion Experimental Farms,  
Ottawa.

SIR,—I have the honour to submit herewith my report for 1893, being the fifth annual report of the work done on the Experimental Farm at Agassiz. The winter of 1892 and 1893, was the severest known in 30 years, in the western part of British Columbia.



GENERAL VIEW, EXPERIMENTAL FARM, AGASSIZ, B.C.

The first sharp frost was on November 24th, when the temperature was 19 above zero, followed by two nights of 16 above, after which we had warmer weather with showers and light frosts, until December 21st, when we had a sudden drop to 12 above zero followed by 8 above on the night of the 22nd, and very high winds from the north. This was followed by milder weather, and warm showers, several days early in January showing a temperature ranging from 33 to 43, and the lowest recorded for January up to the 24th was 27 above zero. The 25th showed 15 above

## Experimental Farms.

with a strong north wind, which continued blowing for several days, and on January 30th the temperature recorded here was 13 below zero, the lowest point reached. The weather began to grow milder early in February, but continued cold through that month and March, followed by a cold wet spring, delaying seeding, and early sown grain did not germinate for a considerable time.

The first grain was sown on April 10th, which was nearly one month later than last year, and vegetation was fully a month behind the average time. As the growth progressed, the damage done to fruit trees by the frost, and the long continued cold drying winds became more apparent.

The cold wet character of the spring continued up to the last of June, when it became warmer, and in July a drought of nearly six weeks set in, and as a consequence, late sown grain, of which there was a good deal, did not ripen early enough to escape the rains which set in early in September.

The hay crop is fair, but grain, roots and fruits are not nearly up to the average in quality or quantity.

This has been the most unfavourable year for farming operations, since the Experimental Farm was started.

### HOPS.

Hops, which I mentioned in my last report as being tried in several localities, have given good returns, and are commanding very fair prices. Preparations are being made in many places to plant yards on quite an extensive scale, as well as to add to those already planted. Reports as far as received are to the effect that the hop louse has given very little trouble this year, and in the few cases where they did appear, they received prompt attention.

### FRUIT.

Fruit, I am glad to report is receiving more attention each year. More trees have been planted this year in this province than in any previous year, and more interest is being taken in studying the best methods of cultivation, &c., as well as the best means of fighting the various fruit pests.

The severe weather injured the fall wheat crops on the Experimental Farm, but some varieties suffered much less than others, although all were treated exactly alike, as to time of sowing, soil, exposure, etc.

About ten acres of new land has been ploughed this season and probably nearly as much more will be broken up before the season is over. About twenty acres of land has been cleared of brush and timber, and this, when all is burned off, will be sown to grass seed and added to the pasture available for stock.

### FALL WHEAT.

During the high winds in January, the earth was blown off the roots of the wheat plants, and a very large percentage of the crop perished, while those that lived did not start to grow until very late in the spring. Consequently the varieties were all late in ripening as shown by the accompanying table. There was no smut on the wheat this year.

## FALL WHEAT.

Name of Variety.	Character of Head.	Sown.	Up.	Headed.	Ripe.	Length of Head.	Length of Straw.	No. of days to ripen.	Yield per acre.	Remarks.
Plot No. 1. Canadian velvet chaff	Bald white chaff.	Oct. 19.	Nov. 7.	June 23.	Aug. 18.	3 to 5	4 to 4½	302	20 9 Bush	Straw stiff and bright; heads very close and compact. Grain bright, plump and fairly hard. Heads average size, long and well filled out to tip. Very thin on the ground, owing to causes referred to, which affected all alike.
Plot No. 2. Carter's K.	do	do	do	July 7.	do	3	4	307	17 38	Straw stiff and bright. Heads medium length, but very well filled out; very plump and bright. This is the best of Carter's fall wheats; stooled well and stood up well.
Plot No. 3. Carter's J.	do	do	do	do	do	2	4	307	16 6	Heads short and pointed; stooled fairly.
Plot No. 4. Carter's H.	do	do	do	do	do	2	4	305	9 15	A poor wheat, it kills very badly and does not stool well.
Plot No. 5. Carter's G.	do	do	do	do	do	2½	3	308	8 50	Heads square and well filled out with plump bright grain; did not stool well, badly winter killed.
Plot No. 6. Carter's F.	do	do	do	do	do	3	4	301	10 55	Heads very open and pointed; did not winter kill as badly as some others, but does not stool well.
Plot No. 7. Carter's E.	do	do	do	do	do	3½	4	307	14 17	Heads long and well filled out; very small, white and plump, stands up well and stools fairly.
Plot No. 8. Carter's D.	Slightly bearded white chaff.	do	do	do	do	3	4	307	13 52	Stands up well; heads long and well filled out; stooled fairly well.
Plot No. 9. Carter's C.	Bald red chaff	do	do	do	do	3	4	308	19 19	Heads well filled out with plump grain; stands up well; stools well; straw bright and stiff.
Plot No. 10. Carter's B.	Bald white chaff.	do	do	do	do	2	4½	306	18 29	Straw bright and stiff. Heads well filled out; grain plump; stooled fairly well.
Plot No. 11. Carter's A.	Bald red chaff	do	do	do	do	3½	4	307	15 58	Straw stiff, standing up well; heads well filled out to tip.



## Experimental Farms.

Plot No. 12. Democrat.....	Bearded white chaff.	do	19..	do	9..	June 20..	do	18..	3	4	4	302	17 38	Heads fair in length, but very open; not filled out well; did not stool; straw soft.
Plot No. 13. Tasmania.....	Bearded red chaff.	do	19..	do	7..	do	6..	16..	2½	3	4	300	16 48	Heads very open, and not very well filled out; did not stool; stands up well.
Plot No. 14. Martin's Amber.....	Slightly bearded white chaff.	do	19..	do	8..	do	29..	22..	2	3	3½	306	11 20	Did not stool well. Heads not well filled out to tip.
Plot No. 15. Early Red Clawson..	Bald red chaff...	do	19..	do	7..	do	13..	15..	3	3½	4	299	12 36	Stands up well; heads well filled out to tip; did not stool well.
Plot No. 16. Fill Measure.....	Bald white chaff.	do	19..	do	8..	July 3.	do	21..	2½	3	3½	305	5 53	Heads well filled to tip; very plump, and straw stiff and bright, but was nearly all winter killed.
Plot No. 17. Volunteer.....	Bearded red chaff	do	19..	do	7..	June 24..	do	17..	2½	3½	3½	301	16 23	Heads compact and well filled out to tip; straw bright and stands up well.
Plot No. 18. Manchester.....	Slightly bearded red chaff.	do	19..	do	7..	do	17..	19..	3	4	3½	300	24 22	Heads quite open, and not very well filled out; stands up well and very well stoolled.
Plot No. 19. Royal Prize Red.....	Bald red chaff...	do	19..	do	7..	July 10..	do	24..	3½	4	3½	308	15 57	Heads well filled out, but did not stool; straw bright and stiff.
Plot No. 20. Square Head.....	Bald white chaff.	do	19..	do	7..	do	5..	19..	2½	3	3	303	19 50	Only a very small quantity of this variety was available for seed. The head is short, square and generally well filled; straw strong; stands up well.
White Queen.....	do	do	19..	do	7..	do	7..	20..	2½	3	3½	304	19 50	Only a few heads of this variety were saved last year, and a very small plot sown this year, with the result shown. Too tender for this climate, as it killed badly every year. Heads long and fairly well filled out; grain plump; stands up well.
Plot No. 21. Golden Cross.....	Bearded red chaff	do	19..	do	8..	June 17..	do	16..	3	4	3½	300	23 31	Long heads well filled to tip; stands up well.

SPRING WHEAT.

Thirty varieties of spring wheat were tested in plots of  $\frac{1}{8}$  of an acre. The land for these plots had been very rough. Several large fir stumps had been grubbed out, and in consequence a good deal of levelling had to be done which caused a very uneven growth, and very materially reduced the yield in almost every plot.

Name of Variety.	Sown.	Up.	Headed.	Ripe.	Height.	No. of days to maturity.	Yield per Plot.	Yield per Acre.	Remarks.
					ft.		lbs.	bush. lbs.	
Plot No. 1—Azima	May 5	May 13	July 20	Aug. 28	2 to 2½	115	17½	5 45	Bearded; did not stool well.
do 2—Abundance	do 5	do 13	do 15	do 26	2	113	31½	10 35	Bearded; did not stool well; heads very short.
do 3—Alpha	do 5	do 13	do 14	do 30	2½ to 3	117	35	11 40	Bald; heads fair length and well filled.
do 4—Albert	do 5	do 13	do 12	do 26	2½ to 3	113	40	13 20	Bearded; did not stool well; heads short but well filled.
do 5—Advance	do 5	do 13	do 16	do 28	2½ to 3	115	58	19 20	Bearded; did not stool well; heads 2 to 3 inches long; well filled.
do 6—Beta	do 5	do 13	do 12	do 28	2½ to 3	115	51½	17 15	Bearded; heads short, but well filled out.
do 7—Black Sea	do 5	do 13	do 11	do 16	3 to 3½	103	53½	17 55	Bearded; stooled fairly well.
do 8—Carleton	do 5	do 13	do 16	do 26	2½ to 3	113	50	16 40	Bearded; heads 2½ to 3 inches long and well filled.
do 9—Crown	do 5	do 13	do 13	do 28	3 to 3½	115	55½	18 25	Bearded; heads 3 inches long; very even and well filled.
do 10—Colorado	do 5	do 13	do 15	Sept. 2	3 to 3½	120	63½	21 5	Bald; heads 3 inches long; fairly well filled.
do 11—Gehun	do 5	do 13	do 13	Aug. 3	2 to 2½	117	37½	12 35	Bald; heads short, but well filled; did not stool well.
do 12—Great Western	do 5	do 13	do 16	Sept. 2	3 to 3½	120	65½	21 45	Bearded; heads 3 to 3½ inches long; straw soft and easily broken down.
do 13—Hungarian Mt.	do 5	do 13	do 16	Aug. 30	2½ to 3	117	51	17 25	Bald; heads short and well filled.
do 14—Ottawa	do 5	do 13	do 15	do 28	3 to 3½	115	40½	13 25	Bearded; heads 2 to 3 inches long, and well filled.
do 15—Huston's	do 5	do 13	do 17	Sept. 1	3 to 3½	119	52½	17 35	Bald; heads long and plump; did not stool well; very thin crop.
do 16—Ladoga	do 5	do 13	do 12	Aug. 26	2½ to 3	113	43½	14 30	Bearded; heads medium in length; well filled.
do 17—Pringle's Champlain	do 5	do 13	do 14	Sept. 2	2½ to 3	120	39½	13 15	Bearded; heads short; well filled.
do 18—Prince	do 5	do 13	do 15	Aug. 27	2 to 2½	114	51½	17 25	Bearded; heads short.
do 19—Preston	do 5	do 13	do 13	do 30	2½	117	70½	23 25	Bearded; heads short but well filled; grain plump.
do 20—Red Fife	do 5	do 13	do 17	Sept. 2	2½ to 3	120	45½	15 15	Bald; heads short but well filled.
do 21—Rio Grande	do 5	do 13	do 16	do 2	3 to 3½	120	55½	18 35	Bearded; heads 3 to 3½ inches long; straw weak and lodged.
do 22—Red Fern	do 5	do 13	do 15	Aug. 30	2 to 2½	117	44	14 40	Bearded; heads short; not well filled.
do 23—Stanley	do 5	do 13	do 12	do 31	3	118	57½	19 15	Bald; heads long and well filled.
do 24—Campbell's Triumph	do 5	do 13	do 13	do 26	3 to 3½	113	49	16 20	Bald; heads fair length and well filled.

# Experimental Farms.

do	25—White Fife.....	do	5..	do	13..	do	15..	Sept.	1..	3 to 3½	119	50	16	40	Bald; heads fair length and well filled.
do	26—Weilman's Fife.....	do	5..	do	13..	do	16..	do	2..	3 to 3½	120	47½	15	55	Bald; heads 3 to 3½ inches long; well filled.
do	27—Campbell's White Chaff.....	do	5..	do	13..	do	11..	Aug.	26..	2½ to 3	113	39½	13	10	Bald; heads short.
do	28—White Russian.....	do	5..	do	13..	do	14..	Sept.	2..	2½ to 3	120	43½	14	30	Bald; heads short.
do	29—White Connell.....	do	5..	do	13..	do	14..	do	2..	2½ to 3	120	45½	15	5	Bald; heads 2 to 2½ inches long.
do	30—Carter's L., or Anglo Canadian.....	do	5..	do	13..	do	19..	do	2..	3 to 3½	120	40½	13	35	Bearded; heads 2 to 2½ inches long; not well filled.

BARLEY.

Twenty varieties of barley were tested in plots of  $\frac{1}{16}$  of an acre each. The soil and treatment were the same in each case. Below are given the yields as well as other particulars of growth, ripening, etc.

Name of Variety.	Sown.	Up.	Headed.	Ripe.	Height.	No. of days to maturity.	Yield per Plot.	Yield per Acre.	Remarks.
Plot No. 1—Duckbill.	May 8	May 16	July 15	Aug. 25	2½ to 3	109	58	24	Stands up well; no smut; did not stool well.
do 2—Danish Chevalier.	do 8	do 16	do 16	do 25	3	109	74	30	Heads long; stooled fairly well.
do 3—French Chevalier.	do 8	do 16	do 17	do 24	2½ to 3	108	61½	25	Heads only medium; did not stool well.
do 4—Golden Grains.	do 8	do 16	do 17	do 25	3½	109	82½	34	Heads long; straw long and soft; easily lodged.
do 5—Goldthorpe.	do 8	do 16	do 20	do 29	3½	113	74½	30	Heads medium; straw stiff and bright.
do 6—Kinver Chevalier.	do 8	do 16	do 17	do 24	2½ to 3	108	59½	22	Heads medium long; straw stiff and bright.
do 7—Canadian Thorpe.	do 8	do 16	do 17	do 25	2½ to 3	109	59½	24	Heads long and plump; straw stiff.
do 8—Thanet.	do 8	do 16	do 18	do 25	2 to 2½	109	49½	20	Heads long; did not stool well.
do 9—Newton.	do 8	do 16	do 20	do 28	2½	106	40	16	Heads medium; did not stool well.
do 10—Improved Chevalier.	do 8	do 16	do 20	do 28	2½	112	49½	20	Did not stool well.
do 11—Prize Prolific.	do 8	do 16	do 20	do 28	2 to 2½	112	40½	16	Heads medium; did not stool well.
do 12—Golden Melon.	do 8	do 16	do 23	do 29	2½ to 3	113	69½	28	Heads medium length; straw weak and soft.
do 13—Baxter's Six-rowed.	do 8	do 16	June 30	do 18	3	102	61	25	Heads medium; did not stool well.
do 14—Common Six-rowed.	do 8	do 16	July 3	do 25	2½ to 3	109	86	35	Heads long and well filled; did not stool well.
do 15—Menstury.	do 8	do 16	June 28	do 16	3	100	60½	25	Heads medium; did not stool well.
do 16—Oderbruch.	do 8	do 16	July 9	do 18	2½ to 3	102	67½	28	Heads short; did not stool well.
do 17—Odessa.	do 8	do 16	do 1	do 17	2½ to 3	101	54½	22	Heads medium; very thin stand.
do 18—Petchora.	do 8	do 16	do 6	do 18	2½ to 3	102	57	23	Heads short; very thin stand.
do 19—Rennie's Improved.	do 8	do 16	do 6	do 16	3 to 3½	100	57½	23	Heads medium; stooled fairly well.
do 20—Six-rowed wh't-barley	do 8	do 16	do 12	do 19	2½ to 3	103	46½	20	Heads medium; did not stool well.

# Experimental Farms.

## OATS.

Forty-one varieties of oats were tested in plots of  $\frac{1}{16}$  of an acre each. They were all sown on the same day, treated in every way alike, the soil was of the same character throughout and fairly uniform. The yield is not very large in any case, but I have no doubt that it would have been much larger could the seed have been sown several weeks earlier.

Name of Variety.	Sown.	Up.	Headed.	Ripe.	Height.	No. of days to maturity.	Yield per Plot.	Yield per Acre.	Remarks.
					Ft.		Lbs.	Bush.	
Plot No. 1—American Beauty	May 17	May 21	July 27	Aug. 31	2½ to 3	106	79	46	16
do 2—Canadian Triumph	do 17	do 21	do 21	do 23	3 to 3½	98	52	30	20
do 3—Banner	do 17	do 21	do 26	do 30	2 to 2½	105	68	40	00
do 4—Black Brie	do 17	do 21	do 30	Sept. 2	2½ to 3½	108	68	40	00
do 5—Black Coulommiers	do 17	do 22	do 29	do 3	2 to 3	109	60	32	12
do 6—Prolific Black Tartarian	do 17	do 21	do 29	do 2	3	108	85	50	00
do 7—Bonanza	do 17	do 21	do 22	Aug. 28	3 to 3½	103	71	41	08
do 8—Prolific Black California	do 17	do 21	do 30	Sept. 1	2½ to 3	107	67	39	14
do 9—Early Archangel	do 17	do 21	do 24	Aug. 30	2½ to 3	105	68	40	00
do 10—Cream Egyptian	do 17	do 21	do 28	do 31	3 to 3½	106	75	44	00
do 11—Challenge	do 17	do 21	do 21	do 28	3 to 3½	106	63	37	02
do 12—Early Blossom	do 17	do 21	do 31	do 31	2½ to 3½	106	87	51	06
do 13—Early Escapes	do 17	do 21	do 24	do 16	2½ to 3	91	69	40	20
do 14—Early Gothland	do 17	do 21	do 28	do 31	3 to 3½	106	77	45	10
do 15—Flying Scotchman	do 17	do 21	do 26	do 30	2 to 2½	105	55	32	12
do 16—Golden Side	do 17	do 21	do 30	do 31	2 to 2½	106	60	35	10
do 17—Giant Cluster	do 17	do 21	do 31	Sept. 4	3 to 3½	110	93	54	24
do 18—Golden Beauty	do 17	do 21	do 26	Aug. 28	3 to 3½	103	98	57	22
do 19—Hazlett's Seizure	do 17	do 21	do 21	do 26	3½ to 4	98	88½	52	02
do 20—Holstein Prolific	do 17	do 21	do 27	Sept. 1	2½ to 3	107	84	49	20
do 21—Abundance	do 17	do 21	do 27	Aug. 30	2½ to 3	105	68	40	00
do 22—Improved Ligoowo	do 17	do 21	do 26	do 29	2½ to 3	104	63	37	02
do 23—Joanette	do 17	do 21	do 27	Sept. 2	2 to 2½	108	60	32	12
do 24—Oderbruch	do 17	do 21	do 30	do 6	3½ to 4	112	95	55	30
do 25—Poland White	do 17	do 21	do 18	Aug. 26	3½ to 4	101	99	58	08
do 26—Prize Cluster	do 17	do 21	do 21	do 25	3 to 4	100	80	42	02

OATS—Concluded.

Name of Variety.	Sown.	Up.	Headed.	Ripe.	Height.	No. of days to maturity.	Yield per Plot.	Yield per Acre.	Remarks.
do 27—Rosedale .....	May 17..	May 21..	July 28..	Aug. 31..	ft. 2½ to 3	106	lbs. 88	bush. lbs. 51 26	Straw bright and stiff; heads medium; grain plump.
do 28—Scottish Chief .....	do 17..	do 21..	do 19..	do 24..	2½ to 3	99	56	32	A very uneven stand; heads short and light.
do 29—Siberian .....	do 17..	do 21..	Aug. 1..	Sept. 4..	3 to 3½	110	78	45	Heads fair length; grain plump.
do 30—Victoria Prize White .....	do 17..	do 21..	July 28..	Aug. 26..	3½ to 4	101	74	43	do medium; straw stiff and bright.
do 31—Welcome .....	do 17..	do 21..	do 27..	Sept. 1..	3 to 3½	107	81	47	Straw soft and lodged.
do 32—White Russian .....	do 17..	do 21..	do 27..	Aug. 31..	3	106	74	43	Grain plump, but a thin stand.
do 33—Cave .....	do 17..	do 21..	do 30..	do 30..	2 to 2½	105	72	42	Did not stool well; heads short.
do 34—Abyssinia .....	do 17..	do 21..	do 29..	do 31..	2½ to 3	106	68	40	A light crop; heads short and poor.
do 35—Royal Doncaster .....	do 17..	do 21..	do 31..	Sept. 2..	3 to 3½	108	74	43	Grain plump; straw stiff; did not stool well.
do 36—Winter Grey .....	do 17..	do 21..	do 26..	Aug. 23..	3 to 4	98	68	40	Stands up well, but a very thin stand.
do 37—Imported Irish .....	do 17..	do 21..	do 27..	do 30..	2½ to 3	105	66	38	Did not germinate well; crop patchy.
do 38—Columbus .....	do 17..	do 21..	do 26..	do 29..	2½ to 3	97	49	28	Very thin stand.
do 39—White Wonder .....	do 17..	do 21..	do 27..	do 22..	2½ to 3	97	49	28	Thin stand; did not stool well; grain plump; straw stiff and bright.
do 40—Rennie's Prize White .....	do 17..	do 21..	do 27..	do 23..	3 to 3½	98	62	37	Did not stool well; heads short.
do 41—American Triumph .....	do 17..	do 21..	Aug. 2..	Sept. 2..	2½ to 3	108	51	30	Straw soft and lodged; heads poor.

## Experimental Farms.

### CROSS-BRED WHEATS.

Name of Variety.	Amount of Seed.	When Sown.	Up.	Headed.	Ripe.	Length of Head.	Length of Straw.	No. of days to mature.	Yield per Plot.	Remarks.
<i>Plot No. 1.</i>	Oz.					Ins.	Feet.		Lbs.	
Red Fife female with Club Bombay male, plant No. 1...	1	May 2.	May 10.	July 11.	Aug. 25.	3½ to 4	4 to 4½	115	7½	Slightly bearded; red chaff; straw soft and inclined to lodge; heads long but rather open; stooled well; grain medium long but not plump; bright amber and medium hard.
Red Fife female with Club Bombay male, plant No. 2...	1	do 2.	do 10.	do 12.	do 27.	4 to 4½	4½ to 5	117	6	Bald; heads long, tapering and loose; stooled very well; straw soft; grain plump, dark and hard.
Red Fife female with Ladoga male, plant No. 1	1	do 2.	do 10.	do 9.	do 29.	4½	3½ to 4	119	7½	Slightly bearded; heads close and well filled out; straw rather weak and inclined to lodge; stooled well; grain rather soft and dull coloured but plump.
Red Fife female with Ladoga male, plant No. 2.	1	do 2.	do 10.	do 12.	do 25.	4½ to 5	3 to 4	115	5	Bald; heads compact, well filled and grain plump; straw stiff and stands up well; amber, plump and hard.
Red Fife female with Ladoga male, plant No. 3.	1	do 2.	do 10.	do 9.	do 24.	4 to 4½	3 to 3½	114	4½	Bald; stooled well and stands up well; heads close and well filled out.
Anglo Canadian female with Indian Karachi male.	1	do 2.	do 10.	do 3.	do 23.	2½ to 4	1 to 3	113	3½	Bearded; very uneven in growth of head and straw; heads fairly close and compact; straw soft and lodged; grain pale amber, plump and quite hard.
Bed No. 7—Hungarian.	1	do 2.	do 10.	.....	.....	.....	.....	.....	.....	This is evidently a fall wheat, as it has not yet headed out.
Bed No. 8—Spti Valley female with Red Fife male.	1 lb.	do 4.	do 13.	July 15.	Aug. 27.	2½ to 3½	3½ to 4	115	.....	This plot stooled well but sported a great deal, giving bearded and bald white chaff, and the same varieties of red chaff; some ripened much earlier than others. Not threshed; will hand pick this plot to separate different varieties of grain and make clean samples for next year.

## HYBRID BARLEYS (sown at the rate of 1½ bushels per acre).

The land for these tests had been in roots in 1892, and for that crop had received a light dressing with fish guano from the canneries, both of which, no doubt, contributed to the excellent showing made.

Name of Variety.	Amount Sown.	Date of Sowing.	Date of coming up.	Headed	Ripe.	Length of Head.	Length of Straw.	Number of Days to Ripen.	Yield per Plot.	Yield per Acre.	Remarks.
No. 1.—Surprise, six-rowed, Swedish (two-rowed) female, with Baxter's six-rowed male.	Lbs. 1	April 25	May 8	June 30	Aug. 19	3	Feet. 2½ to 3	116	Lbs. 28	Bu. Lbs. 42 00	Stands up well; no smut.
No. 2.—Summit, six-rowed, Swedish (two-rowed) female, with Baxter's six-rowed male.	1	do 25	do 3	July 4	do 20	3 to 5	3	117	68	102 00	Stands up well; stooled very well; heads long and well filled out to tip; no smut.
No. 3.—Type A, six-rowed, Swedish (two-rowed) female, with Baxter's six-rowed male.	1	May 4	do 13	do 3	do 17	3½	2½ to 3	105	44	66 00	Stands up well; heads long and well filled; no smut.
No. 4.—Type B, six-rowed, Swedish (two-rowed) female, with Baxter's six-rowed male.	1	do 4	do 11	do 8	do 17	3 to 4	3	105	55	82 24	Stooled well; stands up well; heads long and filled out to tip; no smut.
No. 5.—Royal, six-rowed, Swedish (two-rowed) female, with Baxter's six-rowed male.	1	do 4	do 12	do 5	do 16	3 to 4½	3 to 3½	104	74	111 00	An extra fine plot; straw bright and stiff; heads long and very well filled; stooled very well; no smut.
No. 6.—Type P, six-rowed, Swedish (two-rowed) female, with Baxter's six-rowed male.	1	do 5	do 12	do 10	do 21	3 to 4	2½ to 3	109	60	90 00	Stands up well; stooled well; heads well filled out to tip; no smut.
No. 7.—Type S, two-rowed, Swedish (two-rowed) female, with Baxter's six-rowed male.	1	do 5	do 12	do 13	do 22	4½ to 5½	3 to 3½	110	39	58 24	Stooled well and heads fair length, but straw soft and crinkled down.
No. 8.—Trooper, six-rowed, Swedish (two-rowed) female, with Baxter's six-rowed male.	½	do 15	do 24	do 18	do 22	2 to 3	2 to 2½	100	22	66 00	Stooled well and heads long; straw stiff.



## Experimental Farms.

### TESTS OF SPRING WHEAT, BARLEY AND OATS SOWN AT DIFFERENT DATES.

These plots were one-tenth of an acre each, and were sown in six successive sowings, one week apart. These plots were all treated alike, and the soil was of the same quality and character, but when each plot was sown the remaining unsown plots were carefully harrowed to kill weeds. This, I think, in part accounts for the heavier yields of the late plots, they also had more favourable growing weather. The earlier sown plots had very cold wet weather which delayed germination and weakened the plants.

SPRING WHEAT—RED FIFE—(Sown at the rate of  $1\frac{1}{2}$  bushels per acre).

Date of Sowing.	Date of coming up.	Heading out.	Harvested	Length of Head.	Length of Straw.	No. of days to ripen.	Weight of Grain.	Bushels per Acre.	Remarks.
				inches.	feet.		lbs.	bush. lbs.	
Plot No. 1. April 19.....	April 27...	July 4	Aug. 28..	3 to 3 $\frac{1}{2}$	3	131	160 $\frac{1}{2}$	26 42	Stands up well; heads well filled out to tip; no smut.
Plot No. 2. April 26.....	May 8...	do 11..	do 30..	2 $\frac{1}{4}$ to 3	3 $\frac{1}{2}$	126	160	26 40	Heads not so long as No. 1, but well filled out; stands up well; no smut.
Plot No. 3. May 3.....	do 12..	do 15..	Sept. 2..	2 to 3	3	121	154	25 40	Straw long and bright; heads medium length and well filled; no smut.
Plot No. 4. May 10.....	do 18..	do 20..	do 4..	2 $\frac{1}{2}$	2 $\frac{1}{4}$ to 3	116	149	24 50	Stands up well; did not stool well; no smut.
Plot No. 5. May 17.....	do 23..	do 24..	do 7..	3	2 $\frac{1}{4}$	112	81 $\frac{1}{2}$	15 15	Straw and heads short; did not stool well.
Plot No. 6. May 24.....	June 1..	do 29..	do 12..	2 $\frac{1}{2}$	2 $\frac{1}{2}$	110	127 $\frac{1}{2}$	21 15	Straw short; did not stool well; heads fairly well filled.

CAMPBELL'S WHITE CHAFF—(Sown at the rate of  $1\frac{1}{2}$  bushels per acre).

Plot No. 1. April 19.....	April 26...	July 1	Aug. 22..	3 $\frac{1}{2}$ to 4	3 to 3 $\frac{1}{2}$	125	102	17 00	Straw long and stiff; heads long and well filled to tip; a little loose smut.
Plot No. 2. April 26.....	May 7...	do 7	do 24..	3 $\frac{1}{2}$	3 to 3 $\frac{1}{2}$	122	132	22 00	Straw bright and stiff; heads long and well filled.
Plot No. 3. May 3.....	do 10..	do 14..	do 28..	3 to 3 $\frac{1}{2}$	3 $\frac{1}{2}$	118	93 $\frac{1}{2}$	15 35	Straw long, bright and stiff; heads well filled out to tip; a little loose smut.

CAMPBELL'S WHITE CHAFF—(Sown at the rate of 1½ bushels per acre.)—Concluded.

Date of Sowing.	Date of coming up	Heading out.	Harvested	Length of Head.	Length of Straw.	No. of days to ripen.	Weight of Grain.	Bushels per Acre.	Remarks.
Plot No. 4. May 10 .....	do 18..	do 17..	do 30..	inches. 2 to 2½	feet. 2½ to 3	112	lbs. 105	bush. lbs. 17 30	Straw stands up well; did not stool well; a little smut.
Plot No. 5. May 17 .....	do 24..	do 23..	Sept. 2	3	2½ to 3	108	56	9 20	Did not stool well; a little loose smut; did not germinate well; heads very short and not filled out.
Plot No. 6. May 24 .....	do 31..	do 30..	do 4..	3	2½ to 3	103	95½	15 52½	Did not stool well; heads short.

BARLEY—BAXTER'S SIX ROWED—(Sown at the rate of 2 bushels per acre.)

Plot No. 1. April 19 .....	April 24..	June 29..	Aug. 17..		2 to 2½	121	100	20 40	Straw and heads short; did not stool well.
Plot No. 2. April 26 .....	May 8..	July 4..	do 19..		2½	116	84	17 24	A poor stand; did not stool well; heads very short.
Plot No. 3. May 3 .....	do 10..	do 9..	do 22..		2	112	78	16 12	A very poor crop; short straw, and did not stool well.
Plot No. 4. May 10 .....	do 18..	do 13..	do 24..		2 to 2½	107	82	17 04	Straw and heads short; did not stool well.
Plot No. 5. May 17 .....	do 24..	do 17..	do 25..		2½ to 3	101	90	18 36	Stood up well, but did not stool well; heads short.
Plot No. 6. May 24 .....	do 31..	do 19..	do 26..		2½	95	88	18 16	Heads short; a poor stand.

DUCKBILL—TWO ROWED—(Sown at the rate of 2 bushels per acre.)

Plot No. 1. April 19 .....	April 26..	July 2..	Aug. 21..		2½ to 3	125	91	18 46	Only five plots were sown in this instance. None of them stooled, and all were a poor stand.
Plot No. 2. April 26 .....	May 9..	do 11..	do 23..		3 to 3½	120	83	17 14	

# Experimental Farms.

Plot No. 3. May 3.....	do 12..	do 14..	do 26..	.....	3 to 3½	115	83	17	14
Plot No. 4. May 10.....	do 17..	do 19..	do 28..	.....	3 to 3½	110	69	14	8
Plot No. 5. May 17.....	do 24..	do 24..	Sept. 3..	.....	2½ to 3	109	102	21	12

Only five plots were sown in this instance. None of them stooled, and all were a poor stand.

## OATS—AMERICAN BANNER—(Sown at the rate of 2½ bushels per acre).

Plot No. 1. April 19.....	April 25..	July 12..	Aug. 19..	.....	3½ to 4	122	162	47	22	Straw long and stiff; heads long and well filled with plump grain; did not stool well.
Plot No. 2. April 26.....	May 7....	do 15..	do 24..	.....	3½ to 4	120	167	49	4	Straw long, bright and stiff; standing up well; grain plump.
Plot No. 3. May 3.....	do 10..	do 19..	do 28..	.....	3½ to 4	117	175	51	16	Long full heads; plump grain; straw stiff.
Plot No. 4. May 10.....	do 18..	do 23..	do 30..	.....	3½ to 4	112	197	57	32	Good full heads; straw stiff; stooled a little.
Plot No. 5. May 17.....	do 24..	do 27..	Sept. 2..	.....	5½ to 4	108	224	64	24	Straw bright and stiff; heads good; stooled fairly well.
Plot No. 6. May 24.....	June 1..	do 31..	do 4....	.....	3½ to 4	103	231	67	32	Good well filled heads; straw bright and stiff; stooled fairly well.

## PRIZE CLUSTER—(Sown at the rate of 2½ bushels per acre).

Plot No. 1. April 19.....	April 26..	July 9...	Aug. 19..	.....	3½ to 4	122	123	36	6	Stands up well; did not stool well; a thin stand; heads fair.
Plot No. 2. April 26.....	May 7....	do 13..	do 23..	.....	3½ to 4	119	164	48	8	Stands up and stooled fairly well.
Plot No. 3. May 3.....	do 10..	do 18..	do 24..	.....	3½ to 4	113	144	42	12	Did not stool very well; heads short.
Plot No. 4. May 10.....	do 18..	do 20..	do 26..	.....	3½ to 4	108	144	42	12	Straw bright and clear; did not stool well.
Plot No. 5. May 17.....	do 26..	do 24..	do 29..	.....	3½ to 4	104	146	42	32	Stands up well; heads short.
No. 6.—May 24.	do 31..	do 30..	Sept. 1..	.....	3½ to 4	100	179	52	22	Stooled fairly well; heads short.

## FIELD PEASE.

Twelve varieties of field pease were sown, at the rate of from  $2\frac{1}{2}$  bushels per acre for small pease, to  $3\frac{1}{2}$  bushels per acre for the larger varieties.

Name of Variety.	Seed per acre.	Sown.	Ripe.	Length of straw.	Length of pod.	Yield per plot.	Yield per acre.
	Bushels.			Feet.	Inches.	Lbs.	Bush. lbs.
Multiplier .....	$2\frac{1}{2}$	May 15..	Sept. 5..	3	2	128 $\frac{1}{2}$	21 25
Mummy .....	3	do 15..	do 2..	$3\frac{1}{2}$ to 4	2 to $2\frac{1}{2}$	126 $\frac{1}{2}$	21 5
New Potter.....	$2\frac{1}{2}$	do 15..	Aug. 30..	$3\frac{1}{2}$	$2\frac{1}{2}$ to 3	119 $\frac{1}{2}$	19 55
Crown.....	$2\frac{1}{2}$	do 15..	do 29..	$2\frac{1}{2}$	2	70 $\frac{1}{4}$	11 42 $\frac{1}{2}$
Centennial.....	3	do 15..	do 30..	$4\frac{1}{2}$	$2\frac{1}{4}$	102	17
Prussian Blue.....	$2\frac{1}{2}$	do 15..	do 31..	4	2	120 $\frac{1}{2}$	20 05
Pride.....	3	do 15..	Sept. 1..	$2\frac{1}{2}$	$2\frac{1}{2}$	117	19 30
Prince Albert.....	$2\frac{1}{2}$	do 15..	do 3..	3	2	94	15 40
Golden Vine.....	$2\frac{1}{2}$	do 15..	do 4..	$3\frac{1}{2}$	$1\frac{1}{2}$	94 $\frac{1}{2}$	15 45
Rennie's No. 10 .....	$3\frac{1}{2}$	do 15..	do 1..	$3\frac{1}{2}$	2	122 $\frac{1}{2}$	20 25
Black-eyed Marrowfat.....	$3\frac{1}{2}$	do 15..	Aug. 28..	$3\frac{1}{2}$	2	101 $\frac{1}{2}$	16 55
White Marrowfat.....	$3\frac{1}{2}$	do 15..	do 29..	$3\frac{1}{2}$	$1\frac{1}{2}$	80 $\frac{1}{2}$	15 05

## CORN.

Eleven varieties of corn were planted in rows three feet apart, and the stalks thinned out to four to six inches in the row.

The same varieties were planted in hills three feet apart each way, leaving two to four stalks in the hill.

The drills are the least trouble to plant, and there does not appear to be any advantage to compensate for the extra trouble of planting in hills.

The season has been a very poor one for corn, the wet weather in the spring rotted some of the seed, and retarded the growth of that which did germinate.

# Experimental Farms.

## CORN.

Name of Variety.	Planted.	Up.	Tasselled.	Early Milk.	Late Milk.	Height.	Cut.	Weight per acre.	Remarks.
Rural Thoroughbred, in rows	30	June 8	Aug. 30			Feet.		Tons. Lbs.	
do in hills	do 30	do 8	do 30			6 to 8	Oct. 16	20 808	Just showing silk, October, 16th.
North Dakota, in rows	do 30	do 9	do 24	Oct. 8		do	do 16	19 963	
do in hills	do 30	do 9	do 24	do 8		5 to 6	do 16	13 1,000	
Great Northern, in rows	do 30	do 16	do 24	Sept. 16		do	do 16	13 700	
do in hills	do 30	do 16	do 24	do 16	Oct. 10	5 to 7	do 16	15 485	Ears large and well filled out; stalks leafy.
Gold Coin, in rows	do 30	do 8	do 23	do 20	do 16	5 to 6	do 16	15 670	Ears 4 to 5 inches long and well filled out; stalks very leafy.
do in hills	do 30	do 8	do 23	do 20	do 16	do	do 16	14 900	
Angel of Midnight, in rows	do 30	do 12	do 20	do 12	do 5	6 to 7½	do 16	16-1,196	Ears long and well filled.
do in hills	do 30	do 10	do 23			6 to 8	do 16	16 307	
Compton's Early, in rows	do 30	do 10	do 23			do	do 16	20 65	Cobs formed but not in early milk when cut.
do in hills	do 30	do 10	do 23			do	do 16	17 1,930	
Mitchell's Extra Early, in rows	do 30	do 10	do 6	do 4	do 1	4 to 5	do 16	8 1,420	Corn glazed when cut; ears 4 to 5½ in. long, and well filled out.
do in hills	do 30	do 10	do 6	do 4	do 1	do	do 16	8 960	
Pearce's Prolific, in rows	do 30	do 13	do 24	do 25	do 12	5½ to 7	do 16	17 840	Ears long and well filled; stalks leafy.
do in hills	do 30	do 12	do 26			6 to 7½	do 16	16 1,768	
Smut Nose Flint, in rows	do 30	do 12	do 26	Oct. 4	do 6 to 7	do	do 16	22 1,163	Ears long and fine, but late.
do in hills	do 30	do 12	do 26	do 4		do	do 16	22 73	
Golden Dew Drop, in rows	do 30	do 15	do 28	do 1		6 to 8	do 16	23 1,938	Ears long; stalk stout and leafy.
do in hills	do 30	do 15	do 28	do 1		do	do 16	20 1,760	
Mastodon Dent, in rows	do 30	do 15	Sept. 4			7 to 10	do 16	37 75	Stalk very large and leafy, but cob only formed; no corn.
do in hills	do 30	do 15	do 4			do	do 16	36 850	

## BROOM CORN.

Three varieties of broom corn were planted on May 24th, and came up June 5th, but as they did not mature sufficiently to be of use as broom corn, only about two per cent being headed out October 16th, the crop was cut and put into the silo. The varieties planted were Early Bush Evergreen, Improved Dwarf and California Golden Long Brush.

## TESTS OF MIXTURES OF GRAIN CUT GREEN, AND CURED FOR FEED—ONE-TENTH ACRE PLOTS.

Mixture No. 1.—Contained pease, barley and oats in the following proportions, 6 pounds of pease, 5 pounds of Prize Prolific barley and  $3\frac{1}{2}$  pounds of oats, or at the rate of 1 bushel of each per acre. This was cut when the pease were nearly fit for table. The yield per acre green was 5 tons, 1,793 pounds, and when dried 2 tons 1,903 pounds.

Mixture No. 2.—Six pounds of Golden Vine Pease, 6 pounds of Red Fife Wheat,  $3\frac{1}{2}$  pounds of Banner Oats. This was cut when the wheat had formed, and was in early milk stage, and gave at the rate of 6 tons 73 pounds, green; and when dried 2 tons 1,407 pounds, losing rather more than No. 1, perhaps on account of being cut a little greener.

The stock ate both mixtures greedily and wasted none.

## LATHYRUS SYLVESTRIS WAGNERI.

This has again been allowed to ripen its seed for distribution. I distributed all that was produced last season, but have not yet had any reports.

Neither our cattle nor horses care for it when green. They were led to the plot during June and July, but in no case would they eat it, but preferred the green grasses growing alongside.

In this climate where the clovers, timothy, rye grass and other valuable grasses, grow and produce excellent crops, it does not appear to be worth cultivating.

It may however prove valuable in the interior, where there is a scarcity of rain. As it is said to withstand drought, and if fed a little at a time, cattle might grow to like it.

# Experimental Farms.

## TURNIPS.

Eleven varieties of turnips were sown alongside, and under precisely similar conditions as to land and treatment.

The sowings were made, as in the case of the mangels, two weeks apart, and the result shows in favour of early sowing.

Name of Variety.	Date of Sowing.	Up.	Yield		
			per Plot.	per Acre.	
			Lbs.	Bush.	Lbs.
Rennie's Prize Purple Top, 1st sowing	May 13.	May 21..	420	616	
do do 2nd do	do 26.	June 1..	197	288	56
Sutton's Champion, 1st sowing	do 13.	May 26..	325	478	30
do do 2nd do	do 26.	June 1..	272	398	56
Mammoth Purple Top, 1st sowing	do 13.	May 22..	267	391	36
do do 2nd do	do 26.	June 3..	237	347	36
Carter's Prize Winner, 1st do	do 13.	May 20..	308	485	4
do do 2nd do	do 26.	June 1..	227	389	56
Selected Purple Top, 1st sowing	do 13.	May 21..	339	497	72
do do 2nd do	do 27.	June 2..	252	369	36
Jumbo, 1st sowing	do 13.	May 21..	291	426	48
do do 2nd do	do 27.	June 1..	202	296	16
Carter's Elephant, 1st sowing	do 13.	May 21..	390	572	10
do do 2nd do	do 26.	June 1..	252	374	
Bangholm Improved, 1st sowing	do 13.	May 21..	400	586	40
do do 2nd do	do 27.	June 1..	251	368	8
Selected East Lothian, 1st sowing	do 13.	May 21..	305	447	20
do do 2nd do	do 27.	do 31..	188	275	44
Skirving's Purple Top, 1st sowing	do 13.	do 29..	340	498	40
do do 2nd do	do 27.	June 12..	242	354	56
Monarch 1st sowing	do 24.	May 31..	320	469	20
do do 2nd do	June 7..	June 12..	212	310	56

Three additional plots of turnips were sown on June 14th.

Two new varieties were sent by Mr. Simmers, seedsman, Toronto, and for comparison Rennie's Prize Purple Top was sown alongside. As the quantity of seed of the new varieties was limited, it was all sown on the same day. All of these varieties would have given a heavier crop if sown a month earlier.

Name of Variety.	Date of Sowing.	Date of coming up.	Yield per Plot.		Yield per Acre.	Remarks.
			Lbs.	Bush. Lbs.		
Simmers' Champion.....	June 14..	June 18..	308	451	44	Round, smooth roots; small tap root; top small and close to the bulb; very fine even crop.
Simmers' Giant . . . . .	do 14..	do 18..	336	492	48	Long, well formed, smooth bulb; top strong and healthy.
Rennie's Prize Purple Top	do 14..	do 18..	422	618	56	Bulb smooth, well shaped and even.

ROOT CROPS.

Two sowings each of mangels, turnips and carrots were made.

MANGELS.

Ten varieties of mangels were sown. Two sowings were made two weeks apart. The season has been a very poor one for mangels, the spring growth was very slow, and when the drouth set in they almost stopped growing.

It will be seen that the late sown seed produced a much lighter crop than the earlier sown, with two exceptions, viz., Erfurt Model and Canadian Giant:—

Name of Variety.	Date of Sowing.	Date of coming up.	Yield per Plot.	Yield per Acre.	
			Lbs.	Bush.	Lbs.
Erfurt Model, 1st sowing	May 12.	May 22..	164	240	32
do 2nd do	do 26.	June 4..	183	268	24
Mammoth Long Red or Gate Post, 1st sowing	do 12.	May 21..	206	302	12
do do 2nd do	do 26.	June 4..	112	164	16
Canadian Giant, 1st sowing	do 12.	May 22..	158	231	44
do 2nd do	do 26.	June 3..	176	258	08
Giant Yellow Intermediate, 1st sowing	do 12.	May 23..	188	275	44
do do 2nd do	do 26.	June 2..	130	190	40
Champion Yellow Globe, 1st sowing	do 12.	May 23..	126	184	48
do do 2nd do	do 26.	June 5..	102	149	36
Red Globe, 1st sowing	do 12.	May 22..	88	129	04
do 2nd do	do 26.	June 5..	80	117	20
Golden Tankard, 1st sowing	do 12.	May 21..	74	108	31
do 2nd do	do 26.	June 4..	60	88	00
Red Fleshed Tankard, 1st sowing	do 12.	May 22..	90	132	00
do do 2nd do	do 26.	June 3..	78	110	44
Warden Orange Globe, 1st sowing	do 12.	May 22..	120	176	00
do do 2nd do	do 26.	June 4..	80	117	20
Mammoth Long Red, 1st sowing	do 12.	May 21..	110	161	20
do do 2nd do	do 26.	June 3..	94	121	18



## Experimental Farms.

### CABBOTS.

Nine varieties of carrots were sown on land that had been in pease the year previous, and in fodder corn in 1891, and had never had any manure. This, with the unfavourable year and late sowing, accounts for the light yield.

Name of Variety.	Date of Sowing.	Up.	Pulled.	Yield per Plot.		Yield per Acre.	
				Lbs.	Tons. Lbs.	Lbs.	Tons. Lbs.
Improved Short White, 1st sowing	May 15	May 25	Oct. 31	171	12	1,080	
do do 2nd sowing	do 22	June 7	do 31	80	5	1,733	
Early Gem, 1st sowing	do 15	May 26	do 31	101	7	813	
do do 2nd sowing	do 29	June 8	do 31	74	5	852	
Mammoth White Intermediate, 1st sowing	do 15	May 25	do 31	130	9	1,067	
do do 2nd sowing	do 29	June 8	do 31	132	9	1,353	
Carter's Orange Giant, 1st sowing	do 15	May 25	do 31	120	8	1,600	
do do 2nd sowing	do 29	June 7	do 31	103	7	1,105	
Chantenay $\frac{1}{2}$ long Scarlet, 1st sowing	do 15	May 24	do 31	114	8	720	
do do 2nd sowing	do 29	June 7	do 31	82	6	27	
White Belgian, 1st sowing	do 24	do 2	do 31	124	9	186	
do do 2nd sowing	June 7	do 13	do 31	102	7	960	
White Vosges, 1st sowing	May 24	do 1	do 31	134	9	1,653	
do do 2nd sowing	June 7	do 13	do 31	88	6	907	
Long Red Coreless, 1st sowing	May 24	do 2	do 31	106	7	1,573	
do do 2nd sowing	June 7	do 13	do 31	78	5	1,388	
Danvers Orange, 1st sowing	May 24	do 2	do 31	140	10	533	
do do 2nd sowing	June 7	do 13	do 31	90	6	1,200	

### SUGAR BEETS.

Four varieties of sugar beets were sown. Two sowings of each variety were made in rows 30 inches apart and the plants thinned to about 6 inches in the rows. Three rows 66 feet long were weighed and the yield per acre computed.

The following is the yield per plot and per acre:—

Name of Variety.	Date of Sowing.	Up.	Pulled.	Yield per Plot.		Yield per Acre.	
				Lbs.	Tons. Lbs.	Lbs.	Tons. Lbs.
Klein Wanzleben, 1st sowing	May 24	June 3	Nov. 1	102	4	976	
do do 2nd sowing	June 7	do 16	do 1	72	3	336	
White Improved (Vilmorin's), 1st sowing	May 24	do 3	do 1	124	5	912	
do do 2nd sowing	June 7	do 17	do 1	102	4	976	
Greentop Brabant, 1st sowing	May 24	do 3	do 1	98	4	624	
do do 2nd sowing	June 7	do 16	do 1	74	3	522	
French (very rich), 1st sowing	May 24	do 4	do 1	98	4	624	
do do 2nd sowing	June 7	do 15	do 1	64	2	1,642	

POTATOES.

Thirty-one varieties of potatoes were planted this year, some of them have been tested before, but many of them for the first time. Owing to cold wet weather in spring, and a period of very hot dry weather when it did clear up, the potato crop is rather light in this locality.

Name of Variety.	Planted.	Date of coming up.	Growth.	Matured.	Size.	Weight.	Yield per acre.	Market-able.	Rotten.
						Lbs.	Bush.	per cent.	Lbs.
Everet.	May 16.	June 8.	Slender.	Early.	Medium.	2 rows, 66 ft.	216	80	7
Daisy.	do 16.	do 6.	do	do	Small.	60	120	75	10
Early Sunrise.	do 16.	do 6.	do	do	Medium.	100	200	60	60
Sharpe's Seedling.	do 16.	do 7.	Medium.	do	do	80	166	70	80
Crown Jewel.	do 16.	do 6.	Slender.	do	do	145	290	80	80
Holborn Abundance.	do 16.	do 8.	Strong.	Late.	Large.	1 row, 66 ft.	168	80	80
Northern Spy.	do 16.	do 7.	Medium.	Early.	Medium.	2 rows, 42 ft.	248	70	13
Dakota Red.	do 16.	do 9.	do	Late.	do	124	212	60	4
State of Maine.	do 16.	do 6.	Slender.	do	do	106	172	60	3½
Burpee's Extra Early.	do 16.	do 7.	Medium.	Early.	do	90	180	50	60
Polaris.	do 16.	do 7.	Slender.	do	Small.	96	192	60	60
Bruce W. Beauty.	do 16.	do 9.	Medium.	do	Medium.	1 row, 66 ft.	240	70	1½
Pearce's Prize Winner.	do 16.	do 8.	do	do	do	1 row, 33 ft.	192	75	1
Toronto Queen.	do 16.	do 9.	Slender.	do	do	1 row, 24 ft.	168	75	75
Earliest of all.	do 16.	do 6.	do	do	do	24	192	80	80
American Giant.	do 16.	do 8.	Medium.	Late.	do	1 row, 66 ft.	216	90	90
New Variety No. 1.	do 16.	do 9.	Strong.	do	do	54	216	90	90
I. X. L.	do 16.	do 9.	Medium.	do	do	54	286	80	80
Chicago Market.	do 16.	do 11.	do	do	do	74	304	75	2
Green Mountain.	do 16.	do 8.	Slender.	do	do	1 row, 33 ft.	200	70	70
Rural Blush.	do 16.	do 12.	do	do	Small.	25	232	80	80
Early Rose.	do 16.	do 6.	Medium.	Early.	Medium.	1 row, 66 ft.	280	80	3
Clarke's No. 1.	do 16.	do 9.	do	Late.	do	140	200	75	3
Vanguard.	do 16.	do 11.	Slender.	Early.	do	100	200	75	3

# Experimental Farms

	May 16.	June 9.	Strong.	Late.	Large	1 row, 66 ft.	376	80	6½
Empire State.....	do	do	Slender	Early	Small	1 row, 66 ft.	104	60	.....
Algona No. 1 .....	do	18.	Medium	do	do	2 rows, 52	108	75	2
Delaware .....	do	20.	do	Late	do	40	80	60	.....
Lee's Favorite .....	do	19.	do	Early	do	54	108	75	2½
Early Puritan.....	do	20.	do	do	do	1 row, 66 ft.	140	70	.....
Munro County.....	do	21.	Slender	do	do	35	136	75	.....
Lizzie's Pride .....	do	20.	Medium	do	Medium	34			

## TEST WITH BORDEAUX MIXTURE

Only one plot of potatoes was tested with Bordeaux mixture this year. The Dakota Red, which was planted in a dry loam, being used for this test and although there was no rot in either plot, the results show an advantage, more than sufficient to cover the cost of spraying, especially where potatoes are planted in low ground.

The potatoes were sprayed on July 20th, August 10th and 24th, and September 8th. This was oftener than necessary, but there was a considerable quantity of blight on the unsprayed alongside, and the last two sprayings were given to protect from that danger.

The tops of the sprayed remained healthy and vigorous until ripe, there being no blight on the foliage.

	Date of Planting.	Up.	Size.	Yield per plot.	Yield per acre.	Market-able.	Rotten.
				Lbs.	Bushels.	Per cent.	
Potatoes not sprayed.	May 24..	June 18..	Medium.....	124	248	75	
Potatoes sprayed. ....	do 24..	do 18..	Above medium..	135	270	85	

## HYBRIDS PRODUCED AT AGASSIZ, 1892.

The crosses made last summer by Mr. A. P. Saunders, B.A., and myself, were sown last spring, from which we have quite a number of new varieties of wheat, barley and pease, some of which it is hoped may be useful additions to the lists of these grains.

A number of crosses were made this summer, a few of which have been successful.

Twenty-four varieties of seedling potatoes have been selected from a lot produced from seed, in the summer of 1891. These will be planted another year, and any of sufficient merit will be distributed for testing on other farms.

## CAULIFLOWERS.

Fifteen varieties of cauliflowers, were sown in a hot-bed in spring, and transplanted as soon as the plants were large enough.

The varieties were:—Walcheren, Le Normand Short Stem, Autumn Giant, Italian Taranto, Large Algiers, Half Early Dwarf French, Early Dwarf Erfurt, Large Early London, Stadtholder, Early Paris, Thorburn's Nonpareil, Extra Large Erfurt, Gilt Edged Snowball, Early Snowball, Large Early Dwarf Erfurt.

Early Snowball was fit for use August 2nd, which was the earliest, followed by Large Early Dwarf Erfurt, August 10th, and Thorburn's Nonpareil, August 17th; Lenormand's Short Stem, September 1st. Autumn Giant is the latest and one of the best, being large, crisp and fine, and keeps for a longer time than any of the others.

## MILLETS.

Three varieties of millet were sown, Pearl Millet, White French Millet and American Millet. Neither Pearl nor White French Millet were worth anything, only growing from two to five inches high and not heading out. The American grew from nine to fifteen inches, but did not head out nor did it stool. It yielded less than one ton per acre.

## Experimental Farms.

### HEMP.

A small plot of hemp was sown, but it did not do very well, it grew fifteen to twenty-four inches high and very slender.

### JUTE.

A plot of this plant was sown, but it only grew from six to ten inches high, and an early frost in October killed it.

### PEANUTS.

A small quantity of peanuts were planted in warm sandy loam on the bench. Above ground the growth has only been from six to ten inches, and below, the nuts did not develop larger than small pease.

### SUNFLOWERS.

Five pounds of Giant Russian Sunflower seed was sown in May. It was sown at the rate of nearly ten pounds per acre with a Planet Jr. seed drill in rows three feet apart, and thinned when about a foot high to about twelve inches in the row.

On October 16th and 17th the heads were taken off, to mix with the corn in the silo. The weight of heads produced was 9,690 pounds, or at the rate of over eight tons per acre.

### APPLES.

The severe winter no doubt shortened the apple crop, but otherwise there was no damage done to the trees on the Experimental Farm.

Although some of the varieties were brought from as far south as Texas, they have made a strong growth, and appear to be equal to any demands made on them by the climate here.

Quite a number of the trees planted in the spring of 1890 fruited this year, and we were able to contribute some fine apples, as well as plums, to the Experimental Farm Exhibit at Chicago, and also to make a small exhibit of fruit at some of the British Columbia Exhibitions.

The following varieties fruited this year:—

Red Astrachan, Fameuse, Wealthy, Alexander, Ben Davis, Baldwin, Yellow Transparent, Tetofsky, Maiden's Blush, Duchess of Oldenburg, American Golden Russet, Gravenstein, Spitzenburg.

These fruited freely, and are too well known in British Columbia, to need any comment on them.

*Ribston Pippin*.—This has proved with us to be a very desirable apple. It fruits young, fruit above medium size, and is free from spot or scab, and is of first quality, keeps well up to the middle of March.

*Hurlbut*.—Is an apple not very well known in British Columbia. Fruited first time with us this year, fruit above medium size and rather handsome, yellow with red stripes, and although not yet fit for use, promises to be a very desirable early winter apple, either for dessert or cooking.

*Colvert*.—Above medium, very irregular in shape, not of very high quality.

*Red Bietigheimer*.—A very large handsome fruit, liable to spot.

*Warner's King*.—Very large, green with a blush on the sunny side; may be valuable for cooking.

*McMahan's White*.—Large and very handsome, a free producer, and a strong vigorous grower; may be desirable as a cooking apple.

*St. Lawrence*.—Productive and handsome, a medium sized winter apple.

*Red Canada*.—Small medium; productive, a winter apple.

*Hastings*.—A medium sized winter apple.

*Fanny*.—Of medium size and productive.

*Keswick Codlin*.—Large and a free producer, handsome, and a desirable fall cooking apple.

*Walbridge*.—Medium size. Tree vigorous, but not very productive when young. The Walbridge trees were three years old when planted (the only trees of that age put out) and only produced about five apples each this year.

*Seek-no-Further*.—A large fine cooking apple, moderately productive, quality good. Season September to November.

*Longfield*.—A very handsome medium sized apple. Bears young, and apt to be very small unless severely thinned; a juicy pleasant late fall and early winter dessert apple.

*Bombshell*.—Above medium in size, very irregular in shape, a fall apple, not valuable.

*Cooper's Market*.—Above medium in size, a winter apple.

*Grimes Golden*.—Medium. Very clean and free from blemishes. Tree vigorous and productive, at this date very hard, a winter apple.

*Fall Jenning*.—Of large size and inclined to spot. Tree vigorous and fairly productive, a fall apple.

*Haas*.—Fruit above medium size, tree vigorous and productive; a fall apple.

*Jonathan*.—Small. Tree a slow grower, and not very productive.

*Salome*.—Medium size. Tree vigorous, very few apples this year.

*Waxen*.—Medium to large, tree vigorous, a very few apples.

*Wellington*.—Large tree, vigorous, only a few apples.

*Sweet Bough*.—A large handsome apple, useful for dessert.

*Golden Sweet*.—Medium large, desirable for early autumn; dessert.

*Talman Sweet*.—Medium in size. Tree a moderate grower. productive.

Quite an additional number of varieties produced two or three apples, these will be referred to later when the crop is larger.

A large number of varieties have been planted this year, some of which have been obtained from England and others from different American nurseries.

From England.

Ashmead's Kernel Improved, Bismarck, Claygate Pearmain, Cockle Pippin, Cox's Orange Pippin, Devonshire Quarrenden, Dutch Mignonne, Golden Harvey, Golden Nonpareil, Juneating Red, King of the Pippins, Mannington's Pearmain, Margil, Peasgood's Nonesuch, Rosamary Russet, Tyler's Kernel, Washington, Wyken Pippin, Yellow Ingestre.

From other sources:

Golden, Stone Niemetz, No. 331, Early Bogdanoff, Renaud's Seedling, Arabka Winter; Walworth Pippin, Simbirsk No. 11, Stone Antonovka, Crimean Bogdanoff, Bogdanoff, Royal Table, Blushed Calville, Golden Reinette, Early Strawberry, Early Pennock, Golden Sweet, Summer Pippin, Summer Redstreak, Sops of Wine, Sweet June, Trenton Early, Cole's Quince, Dyer, Fall Wine, Fall Winesap, Fall Orange, Fulton, Flora Belle, Porter, Ramsdell's Sweet, Switzer, Shockley, Arkansas Beauty, American Beauty, Bauman's German, Borsdorf, Black Twig, Big Romanite, Cart-house, Clayton, Day, Fink, Iowa Blush, Ishams Sweet, Ingram, June Market, Lansingburgh, Milan, Minkler, Missouri Superior, Perry Russet, Plum's Cider, Price's Sweet, Pumpkin Sweet, Roman Stem, Rubicon, Red Winter Pearmain, Shannon Pippin, Sweet Spitzenburg, Shackelford, Smoke House, Utter's Large Red, Vandevere Pippin, White Winter Pearmain, Wythe, Waxy Juicy, Western Beauty, Yellow Newtown Pippin, Rebel, Frazer River Beauty, British Columbia, Clayton, Garfield Sugar, Lindsay, Cross, Grandmother, Volga Anis, Streaked Sweet, No. 379, Champagne, Romna, Striped Anis, Hebron, Klinett, Which with those previously planted, makes 289 varieties of apples.

## Experimental Farms.

### PEARS.

This has been a decidedly poor year for pears in this valley. Very few trees bore any fruit this year, but we have no losses to report, and the severe winter did not affect the growth which has been strong and vigorous.

Large additions have been made to the pear orchard, trees having been received from England and from different nurseries in America, Amongst others from England this year are two William's Bon Chrétien, or Bartlett. It will be interesting to note what difference, if any, climate has made in this popular variety. The trees previously planted, having been obtained from trees many years in America.

#### *New varieties planted in 1893 imported from England.*

Aston Town,	Bergamotte d'Esperin.	Gansel's Bergamot,
Huyshe's Bergamot,	Beurre Baltet Père,	Beurre Brown,
Beurre d'Amanlis,	Beurre d'Aremberg,	Beurre de Capiaumont,
Beurre Rance,	Bon Chrétien,	Catillac,
Chaumontel,	Citron des Carmes,	Colmar d'Eté,
Compte de Lamy,	Conseiller de la Cour,	Dr. Jules Guyot,
Doyenne d'Alencon,	Doyenne du Comice,	Durondeau,
Fondante d'Automne,	Fertility,	Forelle,
General Todleben,	Glou Morceau,	Gratiolle of Jersey,
Hacon's Incomparable,	Hessle,	Jargonelle,
Madam Treyve,	Magnate,	Marie Benoist,
Marie Louise d'Uccle,	Knight's Monarch,	Nouvelle Fulvie,
Nouveau Poiteau,	Princess (Rivers),	St. Swithin's,
Thompson's,	Triomphe de Vienne,	Uvedale's St. Germain.
Van Mons,		

From American nurseries we have received :—

P. Barry,	B. S. Fox,	Lucy Duke,
Wilder Early,	Directeur Alphande,	Col. Wilder,
Giffard,	Vermont Beauty,	Smith's Hybrid,

Japan Golden Russet, and Seneca.

All of these, notwithstanding the long time some of them were in transit, are alive and have made substantial growth. There are now 112 varieties of standard pears in the orchard.

#### *Dwarf Pears.*

The dwarf pear does not seem to endure severe cold so well as standards of the same varieties. Several of the dwarf trees in the orchard died after leafing out this spring, and last year's growth was seriously injured in every case.

### PLUMS.

The collection of plums has also been increased by importation from England, and from several other sources, including the Central Experimental Farm

The names of those received this year are as follows :—

From England—

Angelina Burdett,	Belgian Purple,	Belle de Louvain,
Belle de Septembre,	Bittern,	Cox's Emperor,
Curlew,	Diamond,	Early Favourite,
Early Prolific,	Early Transparent Gage,	Gisborne's,
Goliath,	Grand Duke,	Heron,
Huling's Superb,	Ickworth's Imperatrice,	July Green Gage,
Kirke's,	New Late Transparent,	Magnum bonum Red,
Magnum bonum White,	Mallard,	Mitchelson's,
Monarch,	Orleans Old,	Orleans New,
Oullins Golden Gage,	Pershere,	Roine Claude Rouge,
Stint,	Sultan,	The Czar,
Transparent Gage,	Cluster Damson,	Frogmore Prolific Damson,
King of the Damsons,	Prune Damson,	River's Early Damson.

From other sources :—

Decaisne,	Glass Seedling,	Forest Rose,
White Nicholas,	Milton,	De Soto,
Wolf,	Early Red,	Rockford.
Yellow Voronesh,	Wyant,	

From Messrs. McGill and McDonald, Tenant Prune.

The plum orchard now contains 124 varieties.

#### PLUMS.

Quite a number of the plum trees planted three years ago, fruited this year and some varieties were heavily laden, viz. : Moore's Arctic, Lombard, Pond's Seedling, Gueii, Munroe, Duane's Purple, Smith's Orleans, Victoria, Prune d'Agen, and Hudson River Purple Egg.

Name of variety.	Ripe.	Remarks.
Saunders .....	Aug. 20..	Fruit medium size ; long, yellow, and of good quality.
Moore's Arctic.....	Sept. 4..	Fruit above medium in size ; dark purple ; good flavour ; tree a very free producer.
Gueii .....	do 23..	Fruited first time this year ; averaging 55 lbs per tree ; fruit bluish purple of fair quality.
Victoria.....	do 20..	Fruit very large ; light red ; very handsome and of fair quality. Averaged about 45 lbs. per tree.
Prune d'Agen. ....	do 21..	Fruit medium. A free producer ; averaging 40 lbs. per tree.
Pond's Seedling .....	do 28..	Fruit large and handsome ; egg shaped light red ; flesh rather coarse ; a free producer ; 50 lbs. per tree.
Lombard.....	do 21..	Fruit medium in size ; round ; pleasant flavour ; productive ; over 100 lbs. per tree.
Smith's Orleans.....	do 23..	Above medium in size ; reddish purple ; fine flavour ; productive.
Duane's Purple.....	do 25..	Above medium in size ; reddish purple. Good quality. Average over 45 lbs. per tree.
Hudson River Purple Egg.....	do 23..	Fruit medium in size. Good quality. Average over 45 lbs. per tree.



## Experimental Farms.

THE following trees produced a few plums each.

Varieties.	Ripe.	Remarks.
Peters' Yellow Gage .....	Sept. 20 .....	Medium to large.
Yellow Egg .....	do 22 .....	Very large.
Sugar Plum .....	do 16 .....	Medium.
Damson .....	Oct. 3 .....	Small.
Reine Claude .....	Sept. 24 .....	Medium.
Fellenberg .....	do 18 .....	do
Peach Plum .....	Aug. 20 .....	Very large.
Coe's Golden Drop .....	do 26 .....	Large.
Bleeker's Gage .....	do 20 .....	Medium.
Red Egg .....	do 20 .....	Large.
Washington .....	do 19 .....	Above medium.
German Prune .....	do 26 .....	Medium.
Bradshaw .....	Sept. 14 .....	Large.
Imperial Gage .....	do 13 .....	Above medium.
Italian Prune .....	do 24 .....	Medium.
Columbia .....	do 20 .....	Very large.
Jefferson .....	do 12 .....	Medium.
General Hand .....	do 27 .....	Medium to large.
Niagara .....	do 14 .....	Large.
Moyer .....	do 16 .....	Medium.
Large Golden Prolific .....	do 21 .....	Above medium.
Shippers' Pride .....	do 24 .....	do

### CHERRIES.

The cherries blossomed very freely last spring, but only a few set fruit, and almost all of the fruit fell off when about a quarter grown.

Fig. 1 is from a photograph of a cherry tree at the Experimental Farm, Agassiz, second year from planting, showing the character of the growth.

The extreme cold of last winter, followed by the cold wet weather which continued all through the blossoming season, proved unfavourable for this fruit.

The cherry trees have, however, shown no lack of wood growth, and judging from the fruit buds, there is promise of an abundant crop of this, as of all other fruits next season.

The following additional varieties have been planted this year :— .

Arch Duke,	Downton,	Early Lyons,
Early Rivers,	Nouvelle Royal,	Royal Duke,
White Heart,	Shadow Amarelle,	Orel No. 24,
Rose,	Koslov Morello,	Heart Shaped Weichsel,
Gruner Glass,	Glaskirsch Doppelte,	Orel 19,
Strauss Weichsel,	Koeper,	King's Morollo.
Orel No. 20,		

There are now 67 varieties of cherry trees in the orchard.

### NECTARINES.

Nectarines suffered severely from the cold of last winter. On nearly every tree the previous year's growth was killed and had to be removed, and in young trees that is nearly all the growth there is the first spring. Most of the trees have, however, made a fairly strong growth this year.

The new varieties planted this spring are :—

Albert Victor, Humboldt, Hunt's Tawny, and Pine Apple; there are now in all 16 varieties in the orchard.

## PEACHES.

Like the Nectarines and Apricots, the peaches suffered very severely from the cold winter. Almost every tree lost the growth of 1892, and several trees of the previous spring's planting died. This did not, in many cases, appear to be due to tenderness of the variety, as in several varieties one tree died and the other lived (in most instances there are only two trees of a variety) and made in some cases a very vigorous growth.

Fig. 2 represents a peach tree, second year from planting, from a photograph.



FIG. 1. CHERRY TREE, SECOND YEAR FROM PLANTING, EXPERIMENTAL FARM, AGASSIZ, FROM A PHOTOGRAPH.

Where the trees were severely pruned back early in spring, they appear to have recovered sooner, and have made better growth than when the pruning was light.

The curl leaf in the peach and nectarine trees was worse this year than it has ever been before, the Malta being the only variety on the level land that was entirely healthy.

The varieties received in spring from England and planted on the level land were just as badly affected as the others. Among those affected, those that suffered least, were: Crawford's Early, Redcheek Melocoton, and Lemon. The first and second bench orchards suffered alike with those on the level ground, but the orchard highest up at an elevation of about 800 feet had no curl in any case, and the trees appear to have suffered less from the cold than those lower down.

The varieties of peaches in this orchard are:

Early Crawford, Hilborn, Mountain Rose, Crane's Early Yellow, Lewis Seedling; of Nectarines the Boston is the only sort planted there.

## Experimental Farms.

These varieties were procured from the same source as those in the orchards on the lower levels, were planted about the same time, and the conditions as to soil, aspect and protection, are very much the same, the only difference being in elevation.

The additions in 1893 to the collection are the following:—  
Barrington, Crimson Galande, Condor, Dr. Hogg, Grosse Mignonne, Noblesse, Sea Eagle, Stirling Castle, Sulhampstead, Violette Hative, Walburton Admirable.  
These were from England; and Longhurst and Fitzgerald, Canadian; making now 139 varieties in all.



FIG. 2. PEACH TREE. SECOND YEAR FROM PLANTING, EXPERIMENTAL FARM, AGASSIZ, B.C.. FROM A PHOTOGRAPH.

### APRICOTS.

The Apricots suffered severely from the cold winter. A few feeble blossoms appeared, but no fruit set, and some of the trees have made very feeble growth. Three have died, quite a number have lost several large limbs, but I hope these may recover.

Only two new varieties have been planted this year: Harris and Misch Musch.

### FIGS.

All but two fig bushes died from the effects of the cold weather, the survivors are: One Brown Turkey and one Early Violet which were only killed to the ground and have sent up strong shoots. The others have since been replaced with the following varieties:—

Roi du Noir, Brown Ischia, Madeleine, Pregussata, Brown Turkey, Col de Signora Bianca, White Genoa, Castle Kennedy, Black Ischia.

There are now 10 varieties of figs in the plantation, all looking well.

#### BENCH PLANTING.

The Apple, Pear, Plum, and Cherry Trees, in all of the bench orchards have made a vigorous growth this year, and the peaches as mentioned elsewhere have been entirely free from curl leaf on the highest bench.

There has been planted on the benches a large number of nut bearing trees of different varieties. Black Walnut, Butternut, Hickory nut, Chestnut, and between three and four thousand timber trees, such as different varieties of Ash, Elm, Oak, Maple, White Pine, Black Cherry, Locust, Beech and Birch. These are doing well and making satisfactory growth although there was no preparation of the ground, or care of the trees after planting, the only expense being in planting carefully, and then letting the trees take their chances. In all about 4,000 forest trees have been planted on the bench.

#### GRAPES.

No new additions have been made to the collection of grapes, and only three varieties have had any fruit this season, in no case were the bunches or berries perfect, and none of them ripened. The cold wet weather delayed growth so much and there was not heat enough to ripen the fruit, the collection consists of 90 varieties embracing most of the desirable sorts.

#### NUTS AND MULBERRIES.

An orchard has been planted containing a few trees each of English, American and Japanese Walnuts; Spanish, American and Japanese Chestnuts; Hickory, Chinquapin and Pecan nuts; Downing's everbearing New American, Black and White English Mulberries. These were put out last spring and have made good growth.

Also an orchard of hard and soft shell and Lanquedoc Almonds, and Cosfords, Pearson's Dwarf Red, White and Cut leaved filberts. These have all made satisfactory progress, and the Cosford filbert although transplanted from the nursery row very late, has borne very fine nuts this season.

The almond appears to be hardier than the peach, as the last year's growth of the trees was not seriously injured, and they do not appear to have any leaf disease.

There are now twenty varieties of nuts in the collection.

#### GOOSEBERRIES.

A large number of gooseberries were received from England last spring, and a few from nurseries in America.

The Downing and Golden Prolific gave a small crop this year. They were sprayed with the Bordeaux mixture which appeared to check the mildew very considerably, but it was not received in time to spray early in spring, and perhaps on that account the benefit was not so great as it would otherwise have been.

The varieties received this year are as follows:—

From England:—Speedwell, Leader, King of Trumps, High Sheriff, Bobby, Blackley Hero, Beauty, Leveller, White Champagne, Red Warrington, Red Champagne, Queen Victoria, Pitmaston Green Gage, Lancashire Lad, Improved Early Hedgehog, Green Overall, Governess, Early Sulphur, Dublin, Bonny Lass, Companion, Eva.

From other sources—Red Jacket, Mountain, Columbus and Oregon Seedling. Which makes in all 38 varieties now in the collection.

## Experimental Farms

### CURRENTS, RED AND WHITE.

Owing to the severe cold weather last winter and spring the old currant bushes did not fruit freely this year: their growth during summer has been healthy, and all are promising well for 1894.

The following is a list of the new varieties which have been added this year:—

La Conde, Raby Castle, Knight's Early, White Gondoin, La Hative, Prince Albert, White Transparent, La Fertile, New Red Dutch, London Red. Making 21 varieties in all.

### BLACK CURRENTS.

The black currants were a very poor crop, the berries were small and lacking in flavour, and some of them dried up before ripening. The bushes have made a vigorous growth.

The following new varieties have been added to the collection:—Prince of Wales, Russian Black Currant, Baldwin's and Crandall. Making in all 39 varieties.

### RASPBERRIES.

Besides those mentioned in my report of 1892, only five new varieties have fruited this year. Of the red berries, the Cuthbert and Saunders' Seedling, Sarah proved the best, and Golden Queen the best of the yellow ones. Several of the newer black caps fruited sparingly, viz.

*Cromwell*.—Beginning to ripen July 12th. Fruit medium size, only fair in quality, canes vigorous and prolific.

*Progress*.—Canes vigorous, not very prolific, berry good size, firm and of fair quality. Ripening July 10th.

*Thompson*.—Fruit small and poor, may be better next year, canes only medium growers. Ripening July 13th.

*Palmer*.—Vigorous grower, and prolific; berries large, sweet, and of good flavour. Ripening July 8th.

Eight varieties of Raspberries were received from England, and a large number from different nurseries in America, including twelve of the new seedlings from the Central Experimental Farm, giving sixty-three varieties of Red, Yellow and Black Raspberries on trial at present.

The following is a list of those received since 1891:—

Early Ohio, Carman, Nemaha, Champlain, Crimson Beauty, Baumforth's Seedling, Belle de Fonteney, Lord Beaconsfield, Northumberland Fill Basket, White Antwerp, Carters Prolific, Superlative, Fastolf, Muriel, Trusty, Mary, Empire, Duncan, Sir John, Carleton, Lady Anno, Sharpe, Craig, Garnet, Gladstone, Muskingum, Hilborn, Rancocas, Reider, Tyler and Muskegon.

### BLACKBERRIES.

Four varieties of Blackberries fruited this year. Agawam, Taylor and Snyder, which were reported as bearing last year and the Kittatinny, which fruited for the first time this year. Each of these varieties produced berries of good size and quality.

The growth this year has been vigorous, and all on hand are likely to fruit next year.

There are now in the collection 26 varieties, of which the following is a list:—

Agawam,	Dallas,	Crystal White,
Dorchester,	Early Harvest,	Child's Everbearing,
Early Cluster,	Gainor,	Early King,
Erie,	Lawton,	Kittatinny,
Minnewaska,	Nevada,	Lovett's Best,
Snyder,	Taylor's Prolific,	Stone's Hardy,
Wilson Junior,	Wilson's Early,	Tecumseh.
Wachusett Thornless,	Thompson's Early,	Western Triumph,
Bruntun,		Evergreen Blackberry.

#### LUCRETIA DEWBERRIES.

Last year's report of these berries must be repeated this year.  
Fruit irregular in size, berries imperfect, and flavour poor.

#### STRAWBERRIES.

The weather of last winter and spring was very injurious to the strawberry and the crop was light and poor.

None of the later additions to the collection, bore fruit this season.

Another year's experience with the varieties that fruited last year confirms the opinion then formed, that of the number tested, Bubach, Wonderful, Sharpless, Jessie, and, if heavily manured, the Wilson, are the most profitable for market, and for home use, Maggie, Cumberland Triumph and Gandy. These are all very desirable berries.

The following varieties from the Central Experimental Farm, England, and other sources have been added this year :

From the Central Experimental Farm :—

Miller's Seedling, 02,	Westlawn,	Beder Wood,
Staymans No. 1,	Auburn,	Van Deman,
Princess,	Beverly,	Westbrook,
Middlefield,	Martha,	Crawford,
Cameronian,	Gillespie,	Miller's Seedling, H.H.
Ruby,	Yale.	Haverland,
Mrs. Cleveland,	Pearl,	Shirts,
Eureka,	King of the North,	Mammoth,
John Little,	Parker Earle,	Hautbois,
Windsor Chief,	Daisy,	Moore's Prolific,
Sunrise,	Surprise,	Turner's Beauty,
Governor Hoard,	Hoffman's Seedling.	Advance,
Ottawa,	Garibaldi,	Derby,
Castle,	Flora,	Edith,
Ruth,	Countess,	Stanstead,
Early Canada,	Paul,	Bartons,
Nicanor,	Cohansick,	Boynton,
Lady Rusk,		

From England :—

Alexander II.,	Alpha,	Bonny Lass,
British Queen,	Dr. Hogg,	Eclipse,
Empress Eugenie,	John Ruskin,	Laxton Jubilee,
Amateur,	Laxford Hall Seedling,	Sir Joseph Paxton.

From J. T. Lovett, Iowa Beauty, Chairs.

Making 54 varieties, in addition to those already reported on.

# Experimental Farms.

## FLOWERS AND SHRUBS.

Nearly all of the roses were killed to the ground last winter, but a large number came up from the roots. And in addition, a large collection was received from England in the spring, and they have with very few exceptions, made a fair growth. Such shrubs as the ivy, holly, laurels, ceanothus and wistarias were killed to the ground. Many of these have sent up strong shoots, and will soon recuperate.

Many of the bulbs, such as hyacinths, crocuses, snowdrops, squills and tulips planted last fall were injured, and although many of them bloomed, the flowers were feeble and inferior to those of the previous season.

A fine assortment of gladiolus and dahlia bulbs were received in spring. These made a splendid show in their season. A fine selection of annual flower seeds forwarded from the Central Farm was received and sown, and produced a splendid display of flowers all summer.

## HEDGES.

The osage orange hedge planted in the spring of 1892 stood the winter very well, and made a fine growth this summer.

About 600 yards of native cedar have been set out along the road fence, and although the summer has been very unfavourable for transplanted trees and shrubs less than a dozen trees will replant all that are dead.

Thirty-one hedges, of ornamental shrubs, each 66 feet long, were set out last spring and all excepting the Siberian pea have grown with scarcely a gap.

The shelter belt mentioned in my last report has done very well and will soon occupy all the ground. Only about a half dozen trees were required to fill vacancies last spring. A row of maple trees has been planted on both sides of the road which leads from the Harrison Hot Springs road to the buildings, all of which have done well.

A large number of shrubs of various kinds were planted about the grounds, near the buildings and are doing well, and in another year will be an attractive feature of the farm.

## LIVE STOCK.

All the live stock continue healthy, and I have to report a good demand for young bulls old enough for service. Since my last report two Shorthorn bulls and one Ayrshire bull have been sold at fair prices.

There have been many inquiries after young pigs, which I hope to be able to supply next season.

The Dorset horned sheep mentioned in my last report, have not yet been very prolific, one lamb is all the produce as yet from the two ewes.

The poultry have suffered from hawks and weasels. These dangers will be lessened when the new poultry house, now in course of construction, is completed.

## STALLION.

The Haras National Co. sent out a very good Clyde stallion, and many people expressed a desire to patronize him, but in some instances contracts had been made with owners of other stallions before this one arrived, which necessarily limited the service.

## FENCING.

About half a mile of fence has been built, during the last year; and more will be put up as opportunity offers.

## EXHIBITIONS.

Quite an assortment of fresh fruit was sent to the Chicago Exhibition for which the Agassiz Experimental Farm received a special award. Exhibits of fruit, and of grain in the straw and cleaned were also made at local exhibitions.

Several exhibitions in various parts of the province were attended, and a marked improvement in many departments noticed, over exhibitions of the past two or three years. Although the fruit exhibit was small, the quality even this year was excellent, and in the interior where irrigation is carried on, the roots were magnificent.

## WEATHER.

Months.	Date of Lowest Temperature.	Date of Highest Temperature.	Number of days on which it rained.	Total Rainfall.	Number of Days when Sunshine was Recorded.	Total amount of Sunshine.	Number of Snow Storms.	Amount of Snow which fell.
1893.	°	°		Inches.		Hrs. Min.		Inches.
January .....	31st 13	53	11	4 $\frac{84}{100}$	19	67 03	2	1
February .....	2nd 12	20th 52	10	3 $\frac{91}{100}$	14	49 27	9	34
March .....	20th 29	5th 63	14	6 $\frac{74}{100}$	21	87 06	2	1
April .....	18th 32	26th 72	23	5 $\frac{80}{100}$	14	42 33	4	22
May .....	24th 39	27th 80	23	6 $\frac{97}{100}$	21	105 30		
June .....	3rd 39	5th 90	15	5 $\frac{44}{100}$	26	137 42		
July .....	24th 41	30th 91	8	1 $\frac{90}{100}$	29	195 12		
August .....	25th 41	31st 97	6	1 $\frac{88}{100}$	29	244 14		
September .....	23th 37	1st 87	14	4 $\frac{88}{100}$	20	107 21		
October .....	23rd 29	28th 67	17	6 $\frac{34}{100}$	20	63 00		
November 1st to 15th .....	1st 29	13th 55	11	7 $\frac{11}{100}$	7	27 18	1	2½

## DISTRIBUTION OF GRAIN.

A considerable quantity of grain was distributed last spring, but owing to the lateness of the harvest very few have their threshing done, and in consequence I have only received reports from a few farmers.

## VISITORS.

I am pleased to report that the interest taken in the farm is increasing, as evidenced by the greater number of visitors and increase of correspondence.

I have the honour to be, sir

Your obedient servant,

THOS. A. SHARPE,

*Superintendent.*



## Experimental Farms.

STATEMENT of Expenditure on the Dominion Experimental Farms, for the Year ending  
30th June, 1893.

### CENTRAL EXPERIMENTAL FARM.

EXPENDITURES, 1st July, 1892, to 30th June, 1893.

	\$ cts.
Live stock .....	299 00
Feed for stock, including experimental feeding of steers and swine; also veterinary services.....	681 57
Seed grain, trees, shrubs, &c.....	1,301 97
Implements, tools, hardware and supplies.....	883 43
Draining and drain tiles .....	184 91
Manure and fertilizers, including wages of teamsters drawing manure from city during winter.....	1,840 80
Travelling expenses.....	585 91
Exhibition expenses.....	88 75
Blacksmithing, repairs to wagons, vehicles, &c.; also harness supplies and repairs.....	466 01
Books, periodicals and newspapers.....	212 23
Telegrams and telephones.....	185 35
Wages, farm work, including experimental work with grain and other farm crops; also salaries of farm foreman and director's assistant in experimental work.....	6,123 27
do horticultural department, including salary of horticulturist.....	1,905 66
do poultry department, including salary of poultry manager.....	2,788 47
Care of forest plantations, grounds and shrubbery.....	1,348 35
Dairy department.....	614 34
Extension of water pipes to buildings.....	728 35
Contingencies, including building sidewalks, \$77.17.....	281 13
	459 15
	20,978 65

### EXPERIMENTAL FARM, MARITIME PROVINCES.

EXPENDITURES, 1st July, 1892, to 30th June, 1893.

	\$ cts.
Feed for stock and veterinary services.....	44 97
Seed grain, trees, shrubs, &c.....	132 28
Implements, tools, hardware and supplies.....	201 42
Draining and drain tiles .....	660 63
Manure and fertilizers.....	387 70
Travelling expenses.....	48 02
Exhibition expenses.....	36 06
Blacksmithing and repairs .....	61 24
Salaries.....	1,400 00
Wages, farm work, including experimental work with farm crops, fruit trees, vines, &c.....	1,381 48
do care of stock.....	692 11
do office help.....	100 00
Contingencies.....	79 69
	5,225 60

## EXPERIMENTAL FARM, MANITOBA.

EXPENDITURES, 1st July, 1892, to 30th June, 1893.

	\$ cts.
Feed for stock and veterinary services .....	64 43
Seed grain, trees, shrubs, &c. ....	441 74
Implements, tools, hardware and supplies. ....	1,096 43
Draining and drain tiles. ....	118 12
Manure and fertilizers. ....	153 93
Travelling expenses. ....	135 65
Exhibition expenses. ....	93 25
Blacksmithing and repairs .....	291 17
Telegrams and telephones .....	57 42
Distribution of seed grain .....	90 56
do forest trees .....	265 28
Salaries .....	1,400 00
Wages, farm work, including experimental work with farm crops, fruit trees, vines, &c .....	3,063 03
do care of stock .....	804 12
do forestry, tree planting .....	337 50
do office help and mail messenger. ....	230 77
Contingencies, including material and labour in construction of poultry building, \$462.31. ....	681 87
	9,325 27

## EXPERIMENTAL FARM, NORTH-WEST TERRITORIES.

EXPENDITURES, 1st July, 1892, to 30th June, 1893.

	\$ cts.
Live stock. ....	389 20
Feed for stock and veterinary services .....	297 70
Seed grain, trees, shrubs, &c. ....	462 05
Implements, tools, hardware and supplies. ....	691 85
Manures and fertilizers. ....	149 50
Travelling expenses. ....	50 60
Exhibition expenses. ....	113 82
Blacksmithing and repairs .....	244 67
Distribution of seed grain and forest trees. ....	71 45
Salaries .....	1,400 00
Wages, farm work, including experimental work with farm crops, fruit trees, vines, &c .....	3,083 23
do care of stock .....	1,019 50
do forestry, tree planting .....	136 50
do office help. ....	110 00
Contingencies, including internal fences, \$121.49. ....	384 53
	8,604 60

## Experimental Farms.

### EXPERIMENTAL FARM, BRITISH COLUMBIA.

EXPENDITURES, 1st July, 1892, to 30th June, 1893.

	\$ cts.
Live stock.....	2,112 00
Feed for stock and veterinary services.....	854 66
Seed grain, trees, shrubs, &c.....	810 01
Implements, tools, hardware and supplies.....	944 92
Manure and fertilizers.....	119 71
Travelling expenses.....	121 32
Blacksmithing and repairs.....	21 50
Salaries.....	1,400 00
Wages, farm work, including experimental work with farm crops, fruit trees, vines, &c.....	2,844 25
do care of stock.....	147 30
do forestry, tree planting.....	131 35
do clearing land, stumping, &c.....	392 64
do office help.....	120 00
Contingencies.....	127 66
	10,147 32

### SUMMARY.

TOTAL Expenditure for Experimental Farms, 1892-93.

	\$ cts.
Central Experimental Farm, Ottawa.....	20,978 65
Experimental Farm for Maritime Provinces, Nappan, N.S.....	5,225 60
do Manitoba, Brandon.....	9,325 27
do North-west Territories, Indian Head.....	8,604 60
do British Columbia, Agassiz.....	10,147 32
<i>General Expenses.</i>	
Printing and stationery.....	2,914 24
Seed grain distribution.....	3,283 44
Forest tree distribution.....	832 02
Salaries.....	4,000 00
Chemical department, including salaries of chemist and assistant chemist.....	2,622 56
Entomological and botanical department, including salaries of entomologist and botanist and assistant.....	2,455 52
Office help, distribution of reports and bulletins, including salaries of accountant, director's secretary and French correspondents.....	3,927 55
Testing the vitality of agricultural seeds, &c.....	683 23
	75,000 00

WM. SAUNDERS,  
*Director Experimental Farms.*

# Experimental Farms.

## INDEX.

	PAGE.		PAGE.
Agriculturist, report of the	63	Director, report of the	4
Acknowledgments	63	Acknowledgments	62
Cattle, tables of rations for	64, 71	Analysis of water, Exp. Farm, Agassiz	57
Cattle, fattening of	64, 71	Antwerp Exhibition	46
summary of results	67, 71	Barley, experiments with	32
Corn, beans and sunflower seeds, mixture of	76	six-rowed	32, 33
Forty-acre lot	63	Baxter's	32, 33
Heifers, feeding of	69, 70	Common six-rowed	32
Horse beans, growth of	81	Garden Type	32
Robertson mixture for ensilage	76	Guaymalaye	32
results of feeding to cows	77, 78	Mensury	32
reports on growth of	80, 84	Oderbruch	32, 33
cost of growing	82	Odessa six-rowed	32
directions for planting	84	Petschora	32
Silo	80	Rennie's Improved	32, 33
Steers, comparisons in feeding of different		Summit	32
ages	65, 68	Surprise	32
feeding of one year old	65, 68	two-rowed	32
two years old	65	Canadian Thorpe	32
Swine, experiments in feeding of	71, 76	Danish Chevalier	32
in feeding different crosses of	71, 76	Duck-bill	32, 33
in feeding of frozen wheat to	71, 72	French Chevalier	32
in feeding frozen wheat and barley		Golden Grains	32
in equal parts	72, 74	Goldthorpe	32
in feeding of frozen wheat, barley,		Improved Chevalier	32
rye and bran	74, 76	Kinver Chevalier	32
Bedford, S. A., report on Experimental Farm	229	Newton	32
at Brandon, Man.		Prize Prolific	32
Blair, W. M., report on Experimental Farm	213	Swedish female with Baxter's six-	
at Nappan, N.S.		rowed male plant 3	32
Chemist, report of	127	Thanet	32
Acknowledgments	128	Bee keeping	61
Analyses of <i>Astragalus Canadensis</i>	147	Beet Sugar Industry	38
carrots	127	Branch Experimental Farms, visits to	56, 60
gypsum	145	Carrots, experiments with	36, 37
<i>Lathyrus sylvestris</i>	146	yield of varieties of	37
venosus	147	Correspondence	61
legumes	127, 146	Crops, character of in the several Provinces	4
<i>Melilotus alba</i>	147	action of fertilizers on	9
milk desiccated	151	summary of, on Experimental Farm	61
<i>Vicia Americana</i>	147	Edmonton District, visit to	59
wood ashes	127, 144	Ellis, Wm., report of	62
Babcock test	128	Experiments with fertilizers on barley	9, 12
experiments in connection with	149	carrots and sugar beets	22, 23
Experiments with carrots	147	Indian corn	16, 18
Meetings attended	128	mangels and turnips	17, 20
Mucks, peats and muds	127, 140	oats	14, 16
analyses of	142, 144	wheat	8, 10
Potatoes, experiments to prevent sprout-		Financial statement	349, 351
ing of	155	Forest belts	52, 54
Saline waters	128	Grain tests, results of	25
experiments with	154	Hay crop	40
Slug shot, an insecticide	155	for the English Market	40, 41
Soils, analyses of	127	Hop growing, inquiries into	60
from British Columbia	132	Irrigation, inquiries into	60
North-west Territories	130	Letter of transmittal	3
Ontario	134	Macoun, Wm. T., report of	52, 55
Quebec	134	Mangels, experiments with	36
general remarks on	129	yield of varieties of	36
alkaline, analyses of	135	Meteorological observations	62
experiments with	136	Oats, experiments with	33
treatment of	127, 135	Office Building and Museum	2
Well waters, analyses of	128, 152	Pease, experiments with	34
general remarks on	151	Black-eyed Marrowfat	34
Worlds Columbian Exposition	128	Canadian Beauty	34
Craig, John, Horticulturist, report of	85	Centennial	34

	PAGE.		PAGE.
Director, report of the-- <i>Continued.</i>		Entomologist and Botanist-- <i>Continued.</i>	
Pease, experiments with-- <i>Continued.</i>		<i>Anisopteryx pomataria</i> . . . . .	184
Crown . . . . .	34	<i>vernata</i> . . . . .	184
Golden Vine . . . . .	34	<i>Aphis mali</i> . . . . .	157, 176
Multiplier . . . . .	34	Apple aphid . . . . .	157, 176
Mummy . . . . .	34	red-humped caterpillar of . . . . .	176
New Potter . . . . .	34	Arboretum . . . . .	159
Pride . . . . .	34	additions to . . . . .	188
Prince Albert . . . . .	34	genera represented in . . . . .	188
Prussian Blue . . . . .	34	Austrian brome grass . . . . .	189
White Marrowfat . . . . .	34	Bean leaf hopper . . . . .	172
Potatoes, experiments with . . . . .	39, 40	Black vine beetle . . . . .	182
List of varieties, with yield . . . . .	39, 40	Blister beetle, black . . . . .	172
Rye, fall . . . . .	34	gray . . . . .	172
Seed grain, distribution of . . . . .	25	western . . . . .	172
Seed testing . . . . .	28, 29	Boll worm . . . . .	174
Smut in wheat . . . . .	41	<i>Bromus inermis</i> . . . . .	189
remedies for . . . . .	42	Buffalo tree hopper . . . . .	173
Soil, maintenance of fertility of . . . . .	6	Cabbage butterfly, imported . . . . .	173
constituents taken from by crops . . . . .	6	<i>Calandra granaria</i> . . . . .	168, 169
elements of fertility in . . . . .	6	<i>oryze</i> . . . . .	168, 169
Trees and shrubs, list of ornamental . . . . .	47, 51	Canker worms . . . . .	184
forest, plantations of . . . . .	51	<i>Cantharis Nuttalli</i> . . . . .	172, 173
summary of, planted . . . . .	55	<i>Carneades insulsa</i> . . . . .	161
World's Columbian Exposition . . . . .	43	<i>ochrogaster</i> . . . . .	163
exhibits of Exp. Farms at . . . . .	44, 45	Carrion beetle, a vegetarian . . . . .	174
Sugar Beets, experiments with . . . . .	37, 38	Cattle Horn fly . . . . .	157, 185
yield of varieties of . . . . .	37, 38	Cereals, insect enemies of . . . . .	160
Turnips, experiments with . . . . .	34, 35	<i>Cercia bubalis</i> . . . . .	173
yield of varieties of . . . . .	35	<i>Charitophorus neyundinis</i> . . . . .	184
Wheat, Fall, experiments with . . . . .	30	Codling Moth . . . . .	157
Democrat . . . . .	30	Colorado potato beetle . . . . .	171
Early Red Clawson . . . . .	30	Cucumber flea beetle . . . . .	171
Johnson (Carman's No. 53) . . . . .	30	Currant saw-fly . . . . .	179
Jones' Winter Fife . . . . .	30	spanworm . . . . .	180
Manchester . . . . .	30	Cutworm, clay-backed . . . . .	163
Martin's Amber . . . . .	30	devastating . . . . .	163
Roberts (Carman's No. 3) . . . . .	30	Cutworms, in grain crops . . . . .	160
Stewart (Carman's No. 51) . . . . .	30	natural enemies of . . . . .	164
Tasmania . . . . .	30	remedies for . . . . .	164
Weld's No. 4 . . . . .	30	<i>Dakrura convolutella</i> . . . . .	179
Willits (Carman's No. 2) . . . . .	30	<i>Doryphora 10-lineata</i> . . . . .	171
Wheat, Spring, experiments with . . . . .	30	<i>Empoa fabae</i> . . . . .	172
Advance . . . . .	31	<i>Entomoscelis adonidis</i> . . . . .	171
Albert . . . . .	31	<i>Epicauta pennsylvanica</i> . . . . .	172
Alpha . . . . .	31	<i>Epitrix cucumeris</i> . . . . .	171
Azima, Russian . . . . .	31	<i>Eufitchia ribearia</i> . . . . .	180
Beaudry . . . . .	31	Experimental grass plots . . . . .	158
Beta . . . . .	31	Forest trees, insect enemies of . . . . .	183
Black Sea . . . . .	31	Four-lined leaf bug . . . . .	181
Carleton . . . . .	31	Fruits, insect enemies of . . . . .	175
Connell White . . . . .	31	<i>Gelechia ceratella</i> . . . . .	168, 169
Colorado . . . . .	31	Gooseberry fruit worm . . . . .	179
Crown . . . . .	31	Grain moth . . . . .	168, 169
Dion's . . . . .	31	weevil . . . . .	168, 169
Fife, Red . . . . .	31	Granary insects . . . . .	168
Fife, White . . . . .	31	Grape vine leaf hopper . . . . .	181
Fife, Wellman's . . . . .	31	flea beetle . . . . .	182
Great Western . . . . .	31	Grasses for protection of shores and har-	
Herisson Bearded . . . . .	31	bours . . . . .	190
Hungarian Mountain . . . . .	31	Grass seeds, distribution of . . . . .	159
Hueston's . . . . .	31	Grasshoppers . . . . .	157
Ladoga . . . . .	31	<i>Hadena devastatrix</i> . . . . .	163
Manitou . . . . .	31	<i>Heliothis armiger</i> . . . . .	174
Ottawa . . . . .	31	<i>Hibernia defoliaria</i> . . . . .	178
Preston . . . . .	31	<i>Hamatobia serrata</i> . . . . .	157, 185
Prince . . . . .	31	<i>Hydracia cataphracta</i> . . . . .	173
Pringle's Champlain . . . . .	31	Large red-headed flea beetle . . . . .	182
Red Fern . . . . .	31	Locust, red-legged . . . . .	165
Rio Grande . . . . .	31	lesser migratory . . . . .	166
Stanley . . . . .	31	two-striped . . . . .	166
White Chaff (Campbell's) . . . . .	31	<i>Lygus pratensis</i> . . . . .	180
White Russian . . . . .	31	<i>Macrobasis unicolor</i> . . . . .	172, 173
Entomologist and Botanist, report of the . . . . .	157	<i>Melanoplus atlantis</i> . . . . .	165
Acknowledgments . . . . .	158, 160	<i>bivittatus</i> . . . . .	165
<i>Agrotis campestris</i> . . . . .	161, 162	<i>fenur-rubrum</i> . . . . .	165
<i>Anametis grisea</i> . . . . .	177	Meetings attended . . . . .	159

# Experimental Farms.

	PAGE.
<i>Entomologist and Botanist—Continued.</i>	
Mottled Umber moth.....	178
<i>Mytilaspis pomorum</i> .....	176, 177
Negundo plant louse.....	184
<i>Oberia bimaculata</i> .....	179
<i>Edemasia concinna</i> .....	176
<i>Otiorynchus sulcatus</i> .....	182
Oyster-shell bark louse.....	176, 177
Peach-bark beetle.....	176
<i>Pieris rapae</i> .....	173
<i>Phylotribus liminaris</i> .....	176
<i>Phyllotreta vittata</i> .....	170
Plum curculio.....	157
<i>Polyphylla decemlineata</i> .....	183
<i>Protoparce celeus</i> .....	174
Raspberry cane borer.....	179
Red turnip beetle.....	171
Russian thistle.....	192
<i>Salsola Kali</i> , var. <i>Tragus</i> .....	192
<i>Schizoneura lanigera</i> .....	176
<i>Selandria cerasi</i> .....	176
Shot borer.....	176
<i>Silpha bituberosa</i> .....	174
<i>Sisymbrium sinapistrum</i> .....	192
Snowy-tree cricket.....	182
Spraying for injurious insects.....	157
Tarnished plant bug.....	180
Tomato sphinx.....	174
stalk borer.....	173
Tumble mustard.....	192
Tumbling weeds.....	192
Turnip flea beetle.....	170
Turnips, insect enemies of.....	170
Vegetables, insect enemies of.....	173
Weeds, insect enemies of.....	159
Weeds, collection of seeds of.....	183
Western ten-lined June bug.....	163
White grubs.....	176
Woolly aphid.....	158
World's Columbian Exposition.....	158
insect exhibit.....	168
report on insect pests in Canadian exhibit.....	176
<i>Xyleborus dispar</i> .....	176
<i>Experimental Farm, Agassiz, report of the</i>	
Superintendent.....	314
Apples, report on.....	337
Apricots, report on.....	343
Barley, experiments with.....	320
Barley, hybrid, varieties of.....	324
Bench orchards, report on.....	344
Blackberries, report on.....	345
Broom corn.....	330
Carrots, experiments with.....	333
Cauliflowers, experiments with.....	336
Cherries, report on.....	341
Currants, report on.....	345
Corn, experiments with.....	328, 329
Crops, remarks on.....	315
Cross-fertilizing and hybridizing.....	336
Dewberry Lucretia, report on.....	346
Exhibitions.....	348
Fencing.....	347
Figs, report on.....	343
Flowers and shrubs.....	348
Fodder plants, experiments with.....	331
Fruit.....	315
Fruit trees on bench land.....	344
Gooseberries, report on.....	344
Grain, distribution of.....	348
results of early and late sowing of.....	325
Grape vines, report on.....	344
Hedges.....	347
Hemp, experiments with.....	337
Hops.....	315
Hybrid cereals produced at Agassiz.....	336
Jute, experiments with.....	337
<i>Lathyrus sylvestris Wagneri</i> .....	330

	PAGE.
<i>Experimental Farm, Agassiz—Continued.</i>	
Live stock.....	347
Mangels, experiments with.....	332
Meetings attended.....	348
Millet, experiments with.....	336
Mixed grain for feed.....	330
Nectarines, report on.....	341
Nut-bearing trees, report on.....	344
Oats, experiments with.....	321
Peaches, report on.....	342
Peanuts.....	337
Pears, report on.....	339
Pease, field varieties, experiments with.....	328
Plums, report on.....	339
Potatoes, experiments with.....	334
Potato rot, experiments to prevent.....	336
Poultry, report on.....	347
Raspberries, report on.....	345
Shelter belt.....	347
Stallion, report on.....	347
Strawberries, report on.....	346
Sugar beets, experiments with.....	333
Sunflowers, experiments with.....	337
Turnips, experiments with.....	331
Weather.....	314, 348
Wheat, spring, experiments with.....	318
winter, experiments with.....	315, 317
Wheats, cross-bred tests of.....	323
Visitors to farm.....	348
<i>Experimental Farm, Brandon, report of the</i>	
Superintendent.....	229
Agricultural exhibitions.....	244, 271
<i>Agropyrum glaucum</i> .....	244
<i>repens</i> .....	244
Apple trees, report on.....	257
Avenues.....	262
Barley, experiments with.....	231
average of tests of.....	241
Buildings, new.....	270
Carrots, experiments with.....	252
Cattle, report on.....	255
Cauliflowers, experiments with.....	268
Cherry trees, report on.....	260
Colorado blue stem.....	244
Corn, for table use.....	267
Correspondence.....	272
Couch grass, extermination.....	244
Crab-apple trees, report on.....	259
Crops, remarks on.....	229
mixed, sown for grain.....	242
Cross-bred wheats.....	231
Currants, report on.....	260
Drills, test of.....	237
Fall ploughed land, cultivation of.....	235
Farmers Institutes, meetings attended.....	269
Feeding Steers on frozen wheat and barley.....	255
Feeding swine on frozen wheat.....	254
Flowers, experiments with.....	269
Fodder corn, experiments with.....	247
Forest trees and shrubs, report on.....	262
Gooseberries, report on.....	261
Grain, early medium and late sowing of.....	232
mixed for hay and green fodder.....	248
Grasses, experiments with.....	249
Hedges for windbreaks.....	266
<i>Hierochlea borealis</i> .....	244, 246
Holy grass.....	244, 246
Lettuce, experiments with.....	267
Losses from sowing injured seed grain.....	244
Mangels, experiments with.....	251
Manure, barn yard, use of in growing wheat.....	236
Millet, experiments with.....	249
Mixed grain for hay or green fodder.....	248
average of four years tests of.....	240
Oats, experiments with.....	238
Pease, field, experiments with.....	242, 243

	PAGE.		PAGE.
Experimental Farm, Brandon— <i>Continued.</i>		Experimental Farm, Indian Head— <i>Continued.</i>	
Plum trees, report on . . . . .	259	Parsley, experiments with . . . . .	300
Potatoes, experiments with . . . . .	253	Parsnips, experiments with . . . . .	298
Raspberries, report on . . . . .	261	Pease, test of . . . . .	287, 298
Rhubarb . . . . .	268	Peppers . . . . .	298
Rotation of crops . . . . .	243	Potatoes, experiments with . . . . .	292
Silos . . . . .	250	distribution of . . . . .	310
Smut in wheat, remedies for . . . . .	237	Poultry, report on . . . . .	310
Steers, feeding of, on frozen wheat and barley . . . . .	255	Preparing land for crop . . . . .	310
Sugar beets, experiments with . . . . .	251	Radish, experiments with . . . . .	298
Sunflowers, experiments with . . . . .	250	Raspberries, report on . . . . .	302
Swine, feeding experiments with . . . . .	253	Rhubarb, experiments with . . . . .	299
Tile drainage . . . . .	270	Rye, experiments with . . . . .	290
Tomatoes, experiments with . . . . .	268	Sage, experiments with . . . . .	299
Tree distribution . . . . .	267	Salsify . . . . .	299
Turnips, experiments with . . . . .	251	Seed grain, distribution of . . . . .	310
Visitors to farm . . . . .	272	Shrubs, report on . . . . .	304
Weather . . . . .	229, 271	Smut in wheat, remedies for . . . . .	278
Wheat, spring, experiments with . . . . .	229	Spinach . . . . .	299
average yield of . . . . .	232	Stallion, report on . . . . .	310
cutting at different stages of ripe- ness . . . . .	234	Summer savory . . . . .	305
home grown against changed seed . . . . .	235	Stock . . . . .	303
with drills . . . . .	237	Strawberries, report on . . . . .	291
Windbreaks, experiments with . . . . .	265	Sugar beets, experiments with . . . . .	309
Windmill . . . . .	270	Swine, report on . . . . .	299
World's Columbian Exposition, samples of report of the Superintendent . . . . .	272	Tomatoes, experiments with . . . . .	290, 299
Experimental Farm, Indian Head, N.W.T., report of the Superintendent . . . . .	273	Turnips, experiments with . . . . .	312
Apple trees, report on . . . . .	301	Visitors to Farm . . . . .	297
Artichokes . . . . .	293	Water melons . . . . .	273
Asparagus . . . . .	292	Weather . . . . .	274, 276
Barley, experiments with . . . . .	280	Wheat, spring, experiments with . . . . .	274, 276
sown at different dates . . . . .	280	Wheat, spring, test of different dates of sowing . . . . .	275
Beans, report on . . . . .	293	Wheat, spring, test of sowing different quantities of seed . . . . .	277
Beets, report on . . . . .	293	Wheat, spring, test of drills with broadcast sowing . . . . .	279
Cabbage, experiments with . . . . .	294	Wheat, spring, general results of tests . . . . .	278
Carrots, experiments with . . . . .	291, 296	Wheat, spring, test of sowing on stubble and fallow land . . . . .	305
Cattle . . . . .	305	Wind-breaks . . . . .	311
rations fed to . . . . .	306	World's Columbian Exposition . . . . .	213
Cauliflower, experiments with . . . . .	293	Experimental Farm, Nappan, N.S., report of the Superintendent . . . . .	215
Celery, experiments with . . . . .	295	Barley, experiments with . . . . .	223
Citrons, experiments with . . . . .	295	Beans, experiments with . . . . .	222
Corn, report on . . . . .	289, 296	Bordeaux mixture for potato rot . . . . .	223
Crops, report on . . . . .	273	Broom corn, experiments with . . . . .	223
Cross-bred wheats . . . . .	279	Buckwheat, experiments with . . . . .	226
Cucumbers, experiments with . . . . .	294	Buildings . . . . .	219
Currants, report on . . . . .	302	Carrots, experiments with . . . . .	226
Ensilage . . . . .	311	Cattle, report on . . . . .	224
Exhibitions attended . . . . .	290	Cauliflower, experiments with . . . . .	220
Flax, report on . . . . .	300	Corn, experiments with . . . . .	224
Flowers, report on . . . . .	300	Crops, general statement of . . . . .	224
Forest trees, report on . . . . .	303	Drainage and its advantages . . . . .	217
distribution of . . . . .	310	Early, medium and late sowing . . . . .	227
Gooseberries, report on . . . . .	303	Exhibitions attended . . . . .	223
Grain, early, medium and late sowing of . . . . .	285	Flax, experiments with . . . . .	227
Grasses . . . . .	289	Fruit trees, report on . . . . .	225
Huckleberries . . . . .	303	Grasses . . . . .	226
Hybrid barleys, new . . . . .	283	Gooseberries and currants . . . . .	223
Improvements . . . . .	311	Hemp, experiments with . . . . .	213
Kale . . . . .	296	Hay . . . . .	219
Kohl-rabi . . . . .	296	Mangels, experiments with . . . . .	213
Lettuce, experiments with . . . . .	296	Manures . . . . .	227
Lime superphosphate as a fertilizer for wheat . . . . .	277	Meetings attended . . . . .	223
Lime superphosphate as a fertilizer for oats . . . . .	291	Millet, experiments with . . . . .	220
Mangels, experiments with . . . . .	310	Mixed grain, experiments with . . . . .	226
Manuring . . . . .	288	Nuts, experiments with . . . . .	216
Meteorological report . . . . .	297	Oats, experiments with . . . . .	218
Mixtures of grain for hay . . . . .	298	Pease, experiments with . . . . .	222
Mushrooms . . . . .	284	Potatoes cut for seed . . . . .	221
Musk melons . . . . .	285	Potatoes, experiments with . . . . .	222
Oats, experiments with . . . . .	285	Potato rot, experiments with remedies for . . . . .	226
sown at different dates . . . . .	298	Poultry . . . . .	225
Onions, experiments with . . . . .	298	Raspberries . . . . .	225

# Experimental Farms.

	PAGE.		PAGE.
Experimental Farm, Nappan— <i>Continued.</i>		Horticulturist, report of— <i>Continued.</i>	
Robertson mixture for ensilage.....	220	Tobacco— <i>Continued.</i>	
Strawberries.....	225	Canelle.....	122
Sugar beets, experiments with.....	219	Climax.....	122
Trees and shrubs.....	226	Connecticut seed leaf.....	122
Turnips, experiments with.....	218	Conqueror.....	122
Weather.....	213	Havana Partidas.....	122
Wheat, spring, experiments with.....	214	Vuelta Abajo.....	122
Wheat, winter, experiments with.....	213	Hestor.....	122
Winter rye, experiments with.....	224	Honduras.....	122
Fletcher, J., Entomologist and Botanist, report of.....	157	Imported Havana.....	122
Gilbert, A. G., Poultry Manager, report of..	194	Muscat de Perse.....	123
Horticulturist, report of the.....	85	Oronoka white stem.....	123
Acknowledgments.....	87	yellow stem.....	123
Apples, seedling.....	99	Pennsylvania seed leaf.....	123
Apple Calumet.....	100	Persian Muscatelle.....	123
Dery.....	99	Persian Rose.....	123
Bird cherry stocks.....	118	Pryor Blue.....	123
Cauliflowers, experiments with.....	118	Yellow.....	123
Cherries, experiments in propagating.....	117	Safrano.....	123
Cherry scions, distribution of.....	120	Sterling.....	123
Blight on pear and apple.....	88	Sumatra.....	123
history of.....	94	Tennessee Red.....	123
in Ontario.....	90	Tuckahoe.....	123
in Quebec.....	92	Virginia Oak Hill yellow.....	123
on Exp. Farm.....	95	White Burley.....	123
Dilute sulphuric acid, action of, on foliage.	101	Yellow Mammoth.....	123
Fall and spring transplanting, experi- ments in.....	112	Vines, effect of summer pruning on.....	111
Forest trees and shrubs, distribution of... Fruit crop, remarks on.....	85	Vines, relative yield of on stakes and trellis	110
Fruit lists for Quebec.....	102, 109	Vegetables.....	86
Grapes, new varieties, fruited.....	95	World's Fair.....	86
Alexander's Winter.....	95	Mackay, A., Superintendent Experimental Farm, Indian Head, N. W. T., report of...	273
Brilliant.....	96	Poultry Manager, report of the.....	194
Chase Bros.....	96	Andalusians.....	202
Eclipse.....	96	Black Minorcas.....	202
Farrell.....	96	Buff Cochins.....	203
Hermann Jaeger.....	96	Chickens, growth of.....	209
Ideal.....	96	Coloured Dorkings.....	206
Oneida.....	96	Eggs laid.....	206
Paragon.....	96	set and chickens hatched.....	209
Standard.....	96	inducements to produce in winter... Campbell.....	200
White Beauty.....	97	Egg-eating, treatment for.....	194
Large fruits on the farm.....	85	Feather-picking, treatment for..... by different breeds in confinement... Fowls, morning rations for.....	194 194 198
Meetings attended.....	86	Houdans.....	203
New fruits.....	95	Langshans.....	204
Propagation of ornamental shrubs and conifers.....	115	Laying stock, rations for.....	198
Pruning oaks in midsummer.....	115	Light Brahmas.....	203
Raspberries, report on.....	97	Plans of poultry building for farmers... Plymouth Rocks.....	195 204
Older.....	97	Poultry, diseases of.....	210
Seedling.....	98	Red Caps.....	202
Sarah.....	98	Silver-laced Wyandottes.....	205
Spraying experiments.....	100	Summary.....	194, 198, 199, 208
Spraying pumps.....	85	White Leghorn.....	202
Spraying for insect and fungus pests, good effects of.....	85	White Plymouth Rocks.....	205
Tobacco.....	86	White Wyandottes.....	205
Tobacco culture, hints on.....	124	Robertson, J. W., Agriculturist, report of.	63
Tobacco, experiments with.....	121	Saunders, Wm., Director, report of.....	5
Brazilian American.....	122	Sharpe, Thos. A., Superintendent Experimen- tal Farm, Agassiz, report of.....	314
Canadian.....	122	Shutt, F. T., Chemist, report of.....	127